

An exciting hobby.... for everyone

everyday electronics

AUG. 76
30p

**Beginners
SHORT WAVE
RECEIVER**

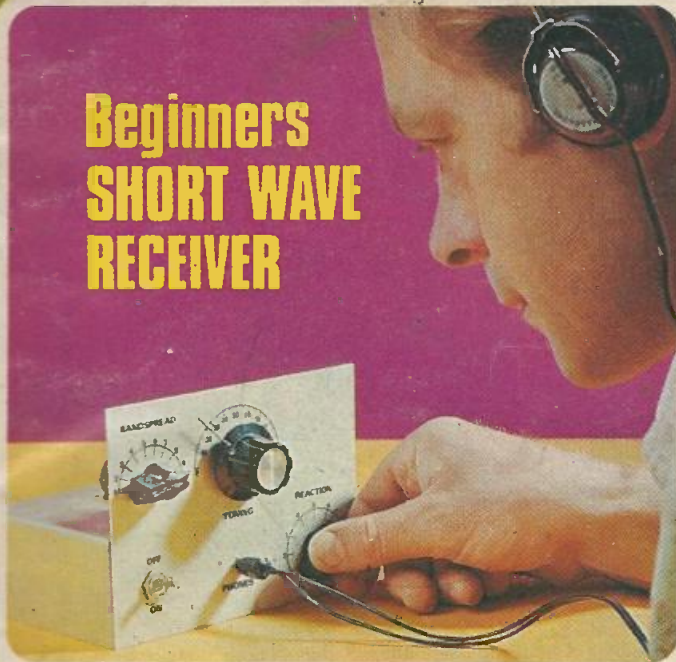

2 WATT AMPLIFIER



**Touch Sensitive
DOOR ALARM**

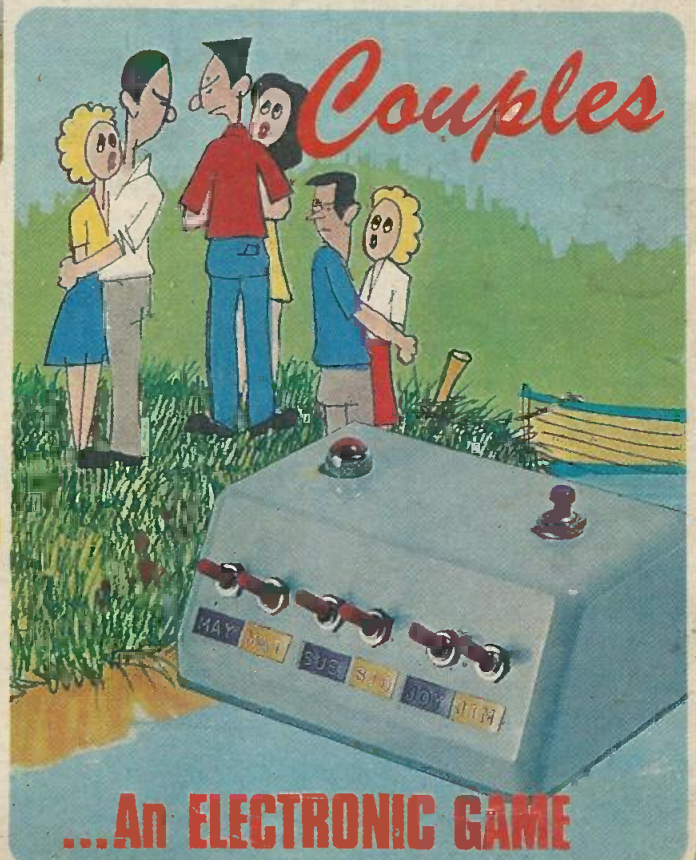

...An ELECTRONIC GAME

RADIO EXCHANGE LTD.

**ALL PRICES
INCLUDE VAT**

NEW EDU-KIT MAJOR

Completely Solderless Electronic Construction Kit. Build these projects without soldering iron or solder

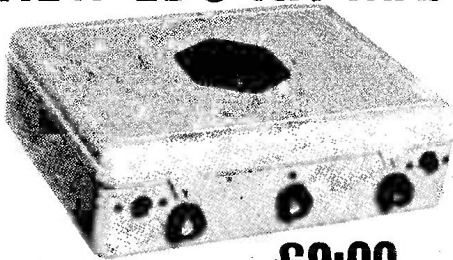

Total Building Costs

£9.00

P & P + Ins. 85p.

- ★ 4 Transistor Earpiece Radio
- ★ Signal Tracer
- ★ Signal Injector
- ★ Transistor Tester NPN-PNP
- ★ 4 Transistor Push Pull Amplifier
- ★ 5 Transistor Push Pull Amplifier
- ★ 7 Transistor Loudspeaker Radio MW/LW
- ★ 5 Transistor Short Wave Radio
- ★ Electronic Metronome
- ★ Electronic Noise Generator
- ★ Batteryless Crystal Radio
- ★ One Transistor Radio
- ★ 2 Transistor Regenerative Radio
- ★ 3 Transistor Regenerative Radio
- ★ Audible Continuity Tester
- ★ Sensitive Pre-Amplifier

Components include: 24 Resistors ★ 21 Capacitors ★ 10 Transistors
 ★ 3 1/2 in Loudspeaker ★ Earpiece ★ Mica Baseboard ★ 3 12-way connectors
 ★ 2 Volume controls ★ 2 Slider Switches ★ 1 Tuning Condenser ★ 3 Knobs
 ★ Ready Wound MW/LW/SW Coils ★ Ferrite Rod ★ 6 1/2 yards of wire
 ★ 1 Yard of sleeving, etc. Complete kit of parts including construction plans.

VHF AIR CONVERTER KIT

Build this Converter Kit and receive the Aircraft Band by placing it by the side of a radio tuned to Medium Wave or the Long Wave Band and operating as shown in the instructions supplied free with all parts. Uses a retractable chrome plated telescopic aerial, Gain Control, V.H.F. Tuning Capacitor, Transistor, etc.

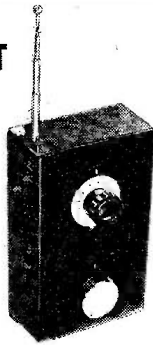

All Parts including Case and Plans.

£3.95

P & P and Ins. 45p.

NEW Everyday Series

Build this exciting new series of designs.

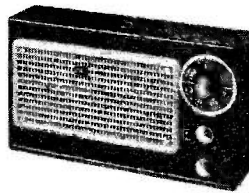

E.V. 5. 5 Transistors and 2 diodes. MW/LW. Powered by 4 1/2 volt Battery. Ferrite rod aerial, tuning condenser, volume control, and now with 3" loudspeaker. Attractive case with red speaker grille. Size 9" x 5 1/2" x 2 1/2" approx. All parts including Case and Plans.

Total Building costs **£4.30** P & P + Ins. 50p

E.V. 6. Case and looks as above. 6 Transistors and 3 diodes. Powered by 9 volt battery. Ferrite rod aerial, 3" loudspeaker, etc., MW/LW coverage. Push Pull output. All parts including case and plans.

Total Building costs **£4.95** P & P + Ins. 55p

E.V. 7. Case and looks as above, 7 Transistors and 3 diodes. Six wavebands, MW/LW, Trawler Band SW1, SW2, SW3, powered by 9 volt battery. Push Pull output. Telescopic aerial for short waves. 3" Loudspeaker. All parts including Case and Plans

Total Building costs **£6.35** P & P + Ins. 55p

TRANSONA FIVE

NOW WITH 3" LOUDSPEAKER



Wavebands, transistors and speaker as Pocket Five. Larger Case with Red Speaker Grille and Tuning Dial. Plans and Parts Price List free with parts.

Total Building costs **£4.05** P & P + Ins. 60p

POCKET FIVE

NOW WITH 3" LOUDSPEAKER
 3 Tuneable wavebands. M.W., L.W., and Trawler Band, 7 stages, 5 transistors and 2 diodes, supersensitive ferrite rod aerial, attractive black and gold case. Size 5 1/2" x 1 1/2" x 3 1/2" approx.



Total Building Costs **£3.60**

All Parts including Case and Plans. P & P + Ins. 60p.



EDU-KIT

Build Radios, Amplifiers, etc. from easy stage diagrams.

Five units including master unit to construct.

Components include: Tuning Condenser: 2 Volume Controls: 2 Slider Switches: Fine tone 3" moving coil Speaker: Terminal Strip: Ferrite Rod Aerial: Battery Clips: 4 Tag Boards: 10 Transistors: 4 Diodes: Resistors: Capacitors: Three 1/2" Knobs. Units once constructed are detachable from Master Unit, enabling them to be stored for future use. Ideal for Schools, Educational Authorities and all those interested in radio construction.

All Parts including Case and Plans **£6.30** P & P + Ins. 70p

ELECTRONIC CONSTRUCTION KITS

ECK 2 Self Contained Multi-Band V.H.F. Receiver Kit. 8 Transistors and 3 Diodes. Push/Pull output. 3" Loudspeaker, Gain Control. Superb 9 section swivel ratchet and retractable chrome plated telescopic aerial, V.H.F. Tuning Capacitor, Resistors, Capacitors, Transistors, etc. Will receive T.V. Sound, Public Service Band, Aircraft, V.H.F. Local Stations, etc. Operates from a 9 Volt PP7 Battery (not supplied with kit). Complete kit of parts including construction plans

£7.15 P & P and Ins. 70p.

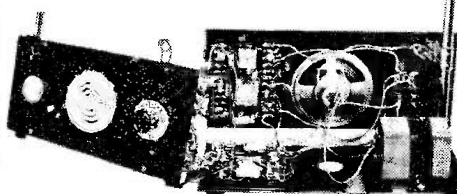

ECK 4 7 Transistors, 6 tuneable wavebands, MW, LW, Trawler Band, 3 Short Wave Bands. Receiver Kit. With 5" x 3" Loudspeaker.

Push/Pull output stage, Gain Control and Rotary Switch. 7 Transistors and 4 Diodes. 6 section chrome-plated telescopic aerial. 8" Sensitive Ready Wound Ferrite Rod Aerial. Tuning Capacitor, Resistors, Capacitors, etc. Operates from a 9 Volt PP7 Battery (not supplied with kit). Complete kit of parts including construction plans.

£6.55 P & P and Ins. 70p.



JIFFY TESTER

Easy to build and operate. Fits in the pocket. A quick checker for continuity of resistors, chokes, diodes, transistors, circuit wiring (not mains) and loudspeakers. SPECIAL APPLICATION — can also be used as a versatile signal injector. Complete with earpiece, jack plug and socket resistors, capacitors, components, etc. Complete kit of parts including construction plans.



£2.85 P & P + Ins. 30p

**TO RADIO EXCHANGE LTD.,
61A HIGH STREET, BEDFORD MK40 1SA
Tel: 0234 52367.**

ALL PRICES INCLUDE VAT Reg. No. 788372

- ★ Callers side entrance "Lavelis" Shop.
- ★ Open 10-1, 2.30-4.30. Mon-Fri. 9-12 Sat.

I enclose £.....

for

Name

Address

.....

EE/8/76

EDU-KIT JUNIOR

Completely Solderless Electronic Construction Kit. Build these projects without Soldering Iron or Solder.

- ★ Crystal Radio Medium Wave Coverage — No Battery necessary.
- ★ One Transistor Radio.
- ★ 2 Transistor Regenerative Radio.
- ★ 3 Transistor Earpiece Radio Medium Wave Coverage.
- ★ 4 Transistor Medium Wave Loudspeaker Radio.
- ★ Electronic Noise Generator
- ★ Electronic Metronome.
- ★ 4 Transistor Push/Pull Amplifier.

All parts including Loudspeaker, Earpiece, MW Ferrite Rod Aerial, Capacitors, Resistors, Transistors, etc. Complete kit of parts including construction plans.

£6.55 P & P + Ins. 60p

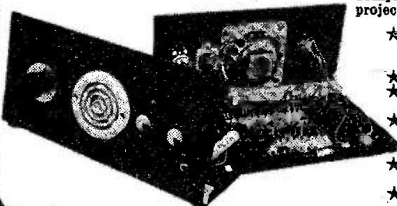



... my grandfather bought his first bits and pieces from Home Radio of Mitcham 30 years ago—and he still relies on them! So does my father. It's not surprising that I've been bitten by the same bug.

When Dad saw how keen I was on electronic gadgets he bought me a Home Radio Components catalogue. Between you and me I think he was getting fed up with me keep borrowing his! I must say it really is a smashing book. I spend hours poring over it deciding what I shall save up for next. Although I can't afford to spend much yet Home Radio treat me like a millionaire. I've been told that it's a small family business that hasn't grown too big to care for the amateur constructor.

Another thing I like about Home Radio is that if I have any queries or problems I can go right to the man at the top. On several occasions I've found him jolly helpful.

Let me tell you a bit more about this catalogue. It lists about 5,000 items and has about 2,000 pictures (so they tell me—I haven't actually counted them) and it's laid out so clearly that even I can find my way around it easily. It also tells you all about their Deposit Credit Scheme which I will be able to join as soon as I'm eighteen. I find it quite exciting to think that I shall then be able to pick up the phone on a Sunday night and read over my order to their answerphone machine, and by Monday my gear will be on its way to me. I can hardly wait!

Please write your Name and Address in block capitals

NAME

ADDRESS



POST THIS COUPON
with cheque
or p.o. for
£1.25

If you are a constructor, of any age between nine and ninety, you really must get a copy of the fabulous Home Radio Catalogue. The cost is only 90 pence, plus 35 pence for postage and packing. Why not send them a cheque or postal order for £1.25 today?

HOME RADIO (Components) LTD., Dept. EE
234-240 London Road, Mitcham, Surrey CR4 3HD

(Regn. No.
London 912966)

The price of £1.25 applies only to customers in the U.K. and to BFPO Addresses.

HOME RADIO (Components) LTD, Dept. PW, 234-240 London Road, Mitcham, CR4 3HD Phone 01-648 8422

Get a great deal from Marshall's

A. Marshall (London) Ltd Dept: EE
40/42 Cricklewood Broadway London NW23ET Tel: 01-452 0161/2 Telex: 21492
& 85 West Regent St Glasgow G2 2QD Tel: 041-332 4133
& 1 Straits Parade Fishponds Bristol BS16 2LX Tel: 0272-654201/2
& 27 Rue Danton Issy Les Moulineaux Paris 92

Catalogue price 35p
(30p to callers)

Call in and see us 9-5.30 Mon-Fri 9-5.00 Sat
Trade and export enquiries welcome

Our range covers over 7,000 items. The largest selection in Britain
Top 200 IC's TTL, CMOS & Linear

CA3020A	£1.45	CD4050	56p	NE556	£1.30	SN7448	85p	SN74157	68p
CA3028A	85p	CD4510	£1.54	NE560	£4.48	SN7450	16p	SN74160	£1.20
CA3035	£1.35	CD4511	£1.70	NE565	£1.30	SN7451	16p	SN74161	£1.20
CA3046	73p	CD4516	£1.54	SL414A	£2.35	SN7453	16p	SN74162	£1.20
CA3048	£2.15	CD4518	£1.38	SL610C	£2.35	SN7454	16p	SN74163	£1.20
CA3052	£1.62	CD4520	£1.38	SL611C	£2.35	SN7460	16p	SN74164	93p
CA3089E	£2.00	LM301AH	47p	SL612C	£2.35	SN7470	32p	SN74165	93p
CA3090Q	£4.25	LM308N	£1.17	SL620C	£3.50	SN7472	26p	SN74167	70p
CD4000	20p	LM309K	£1.80	SL621C	£3.50	SN7473	30p	SN74174	£1.06
CD4001	20p	LM3808	98p	SL623C	£5.75	SN7474	30p	SN74175	94p
CD4002	20p	LM381AN	£2.07	SL640C	£4.00	SN7475	40p	SN74176	86p
CD4006	£1.16	LM702C	75p	SN7400	16p	SN7476	36p	SN74180	£1.23
CD4007	20p	LM705	SN7401	16p	SN7480	45p	SN74181	£2.58	
CD4008	97p	TO99	40p	SN7402	16p	SN7481	£1.10	SN74190	£1.33
CD4009	57p	8DIL	40p	SN7403	16p	SN7482	67p	SN74191	£1.33
CD4010	57p	14DIL	40p	SN7404	18p	SN7483	92p	SN74192	£1.13
CD4011	20p	LM710	48p	SN7405	18p	SN7484	85p	SN74193	£1.13
CD4012	20p	LM723C	69p	SN7406	51p	SN7485	£1.25	SN74196	£1.81
CD4013	59p	LM741C	SN7407	18p	SN7486	29p	SN74197	£1.81	
CD4014	£1.01	TO5	38p	SN7408	18p	SN7490	43p	SN74198	£2.04
CD4015	£1.01	8DIL	38p	SN7409	18p	SN7491	68p	SN74199	£2.04
CD4016	56p	14DIL	40p	SN7410	16p	SN7492	43p	SN76003N	
CD4017	£1.01	LM747CN	78p	SN7412	25p	SN7493	43p	SN76013N	
CD4018	£1.01	LM747CN	78p	SN7413	40p	SN7494	74p		£1.50
CD4019	57p	8DIL	44p	SN7414	43p	SN7495	59p	SN76023N	£1.50
CD4020	£1.12	14DIL	41p	SN7417	43p	SN7496	78p	SN76033N	2.50
CD4021	£1.01	LM3900N	55p	SN7420	16p	SN74100	£1.15	SN74107	30p
CD4022	97p	LM705P	£1.99	SN7423	26p	TAA263	£1.25	TAA300	£2.67
CD4023	20p	LM7812P	£1.99	SN7425	27p	SN74118	90p	TAA350A	£2.48
CD4024	79p	LM7815P	£1.99	SN7427	27p	SN74119	£1.80	TAA350	40p
CD4025	20p	LM782P	£1.99	SN7432	27p	SN74122	45p	TAA611C	£2.25
CD4027	56p	MC1303L	£1.44	SN7430	16p	SN74121	34p	TAA622	£2.13
CD4028	91p	MC1310P	£1.91	SN7437	35p	SN74123	72p	TAA661B	£1.32
CD4029	£1.17	MC1330P	35p	SN7438	35p	SN74141	72p	TBA651	£1.80
CD4030	57p	MC1351P	87p	SN7440	16p	SN74145	74p	TBA800	89p
CD4031	£2.26	MC14553	£4.07	SN7441	76p	SN74150	77p	TBA810	89p
CD4037	97p	MC1466L	£3.95	SN7442	55p	SN74151	77p	TBA802	89p
CD4041	83p	MC1469R	£2.38	SN7443	86p	SN74153	73p	TBA920	£1.79
CD4049	56p	NE555V	50p	SN7447	81p	SN74154	£1.29		

LONDON GLASGOW PARIS AND NOW

BRISTOL

IT'S OUR SERVICE THAT MAKES US GROW

POPULAR SEMICONDUCTORS

2N696	25p	2N3906	22p	AF139	69p	BD139	42p	MPSA56	20p
2N697	16p	2N4058	20p	AF239	74p	BF115	36p	OC28	£2.00
2N699	55p	2N4062	18p	AF279	80p	BF117	70p	OC42	50p
2N706	12p	2N4921	60p	AF280	85p	BF154	25p	TIP29A	50p
2N708	21p	2N4923	70p	AL102	£1.30	BF180	36p	TIP31A	62p
2N916	43p	2N5245	29p	BC107	14p	BF181	15p	TIP32A	75p
2N918	34p	2N5294	35p	BC109	15p	BF184	35p	TIP34A	£1.20
2N1302	37p	2N5296	36p	BC147B	10p	BF194	12p	TIP35A	£2.50
2N1306	45p	2N5458	26p	BC149B	13p	BF196	13p	TIP36A	£3.55
2N1308	60p	2N5459	29p	BC157A	12p	BF197	14p	TIP41A	70p
2N1711	27p	2N6027	45p	BC158A	11p	BF198	15p	TIP42A	70p
2N2102	60p	3N128	80p	BC179	12p	BF244	35p	TIP2955	£1.00
2N2148	£1.65	3N140	£1.00	BC168B	12p	BF258	49p	TIP3055	50p
2N2218A	47p	3N141	85p	BC169B	12p	BF259	49p	TIP43	30p
2N2219A	52p	3N200	£2.60	BC182	11p	BF598	27p	ZTX300	15p
2N2220	35p	40361	45p	BC182L	14p	BFR39	24p	ZTX301	15p
2N2221	22p	40362	48p	BC183	11p	BFR79	24p	ZTX501	15p
2N2222	25p	40406	48p	BC183L	14p	BFX29	36p	ZTX502	18p
2N2369	25p	40407	30p	BC184	12p	BFX85	38p	IN914	7p
2N2646	55p	40408	50p	BC184L	14p	BFX85	41p	IN4007	7p
2N2905	37p	40409	55p	BC212	14p	BFX88	32p	IN4148	18p
2N2906	28p	40410	55p	BC212L	14p	BFY50	30p	IN5404	18p
2N2907	21p	40411	£2.30	BC213L	16p	BFY51	38p	IN5408	40p
2N2926G	13p	40594	75p	BC214L	19p	BFY52	35p	AA119	14p
2N3053	25p	40595	88p	BC237B	14p	BRY39	50p	BA102	15p
2N3054	50p	40636	£1.15	BC239C	16p	MEO412	20p	BA145	19p
2N3055	60p	40673	£1.70	BC240	17p	ME4102	10p	BA155	12p
2N3391	29p	AC126	37p	BC259B	18p	M480	£1.05	BB103B	20p
2N3393	15p	AC127	44p	BC301	45p	M481	£1.30	BB104B	34p
2N3440	57p	AC128	57p	BC307B	20p	M490	£1.05	BY126	27p
2N3442	20p	AC152	50p	BC309C	25p	M491	£1.35	BY211	70p
2N3638	16p	AC153	40p	BC327	20p	M2955	£1.00	BY212	70p
2N3702	17p	AC186	40p	BC328	19p	ME370	68p	OA47	10p
2N3706	£2.60	AC187K	25p	BC371	25p	ME71	1p	OA90	6p
2N3706	14p	AC188K	45p	BCY72	24p	ME520	6p	OA91	6p
2N3708	14p	AD161	£1.23	BD121	£2.00	ME521	75p	OA200	8p
2N3716	£2.60	AD162	£1.23	BD124	£2.00	ME2955	£1.25	BY164	57p
2N3771	£1.60	AF106	45p	BD131	51p	ME3055	75p	TIC2 diac	20p
2N3773	£2.65	AF109	45p	BD132	54p	MP813	45p	40669	£1.00
2N3789	£2.60	AF116	65p	BD136	36p	MPSA05	20p	TIC44	29p
2N3819	26p	AF116	65p	BD137	36p	MPSA06	30p	IC6D	65p
2N3904	21p	AF118	65p	BD138	39p	MPSA55	20p	ORP12	70p

PRICES CORRECT AT JULY 1976, BUT ALL EXCLUSIVE OF VAT. P. & P. 30p

A hobby that pays big salaries.

Enrol in the BNR & E School and you'll have an entertaining and fascinating hobby. Stick with it and the opportunities and the big money await you, if qualified, in every field of Electronics today. We offer the finest home study training for all subjects in radio, television, etc., especially for the CITY AND GUILDS EXAMS (Technicians' Certificates); the Grad. Brit. I.E.R. Exam; the RADIO AMATEUR'S LICENCE; P.M.G. Certificates; the R.T.E.B. Servicing Certificates; etc. Also courses in Television; Transistors; Radar; Computers; Servo-mechanisms; Mathematics and Practical Transistor Radio course with equipment. We have OVER 20 YEARS' experience in teaching radio subjects and an unbroken record of exam successes. We are the only privately run British home study College specialising in electronics subjects only. Full-est details will be gladly sent without any obligation.

BRITISH NATIONAL RADIO & ELECTRONICS SCHOOL, Dept EEC 86
P.O. Box 156, Jersey, Channel Islands.

NAME _____
ADDRESS _____
(Block caps please)

TOP QUALITY KITS



NEW! We have redesigned the EE Easybuild clock (EE Jan '76) to fit into a new attractive slim white case measuring only 4 x 15.4 x 8.5cm with a dark green front panel to make a very attractive Mantelpiece Clock with bright 0.5" Green display. The kit comes complete, except for mains cable and plug, with detailed instructions. 12 or 24 hour format. Order as 'GCK' ... £12.90 Also available ready-built: Order as 'GCK-B' ... £15.90 Kit of parts for GCK, but less case. Order as 'GMK' ... £10.95



NEW! Add CRYSTAL CONTROL and BATTERY BACK-UP to your EE Easybuild clock—OR the new GCK above. Crystal Timebase Kit (XTK) and Battery Back-up Kit (GBBK) plus one PP3 battery all fit into either clock. ● Improves accuracy to within a few seconds a month. ● Allows clock to be temporarily disconnected from the mains without losing time (display will be blank until mains power returns.) Complete kit plus full instructions. Order as 'XTK + GBBK' £6.75.

SPECIAL OFFER **SPECIAL OFFER**
GCK ONLY £9.95 if ordered with XTK & GBBK
Order as, GCK + XTK + GBBK £16.70

Built clock with Crystal, Back-up, etc.: Order as 'X-GCK-B' £20.95
IMPORTANT: All Our clocks use transformers.
After sales service available on kits.



Add VAT at 8%—25p p&p on all orders.
Goods despatched by 1st Class Post, by return.

Access & Barclaycard orders welcomed, by post or phone (phone giving your address and card no. and we'll send your order the same day.)

SINTEL 53e Aston Street, Oxford
Tel: 0865 49791.

Everyday Electronics, August 1976

FABULOUS NEW KITS

EASY TO CONSTRUCT

**DORAM
KITS
CONTAIN
EVERYTHING
DOWN TO
THE LAST
NUT!**



AM-FM-MPX Stereo TUNER

★ Output 100mV ★ Compliments audio separates

£44-95 +H

CAR PUSH-BUTTON MW/LW RADIO

★ Output 4W
★ Dual Polarity
★ Short Circuit Proof

COMPLETE WITH FITTING KIT & SPEAKER

£16-95 +H

Available NOW!

POWER SUPPLY

0-30V and 0-1A with a variable current limit

£19-95 +S

SOIL MOISTURE METER

Indicates whether water is needed for plants and lawns

£2-00 +S

TRANSISTOR TESTER

Measures hFE leakage for PNP or NPN transistor either silicon or germanium transistors - includes battery check facility

£9-95 +S

- ★ New 16-page brochure contains complete details of kit range.
- ★ Big range of kits to interest Radio, Electronic and Hi-Fi enthusiasts.
- ★ Kits sent by return-of-post.
- ★ Each kit designed by specialists - only highest quality and reliable components included.

SEND FOR YOUR NEW KIT BROCHURE TODAY
only **25p** inc. post and packing.

S - 8% V.A.T.
H - 12½% V.A.T.

DORAM

DORAM ELECTRONICS LTD
P.O. Box TR8,
Leeds LS12 2UF.

I enclose 25p please send me by return my new Doram kit brochure. Overseas orders except for N.Ireland please add 10p for post and packing surface only.

CUSTOMERS WHO ORDER THIS KIT BROCHURE TOGETHER WITH DORAM'S NEW EDITION 3 COMPONENT CATALOGUE CAN SAVE 15p ON THE INDIVIDUAL PURCHASE PRICE FOR BOTH AND OBTAIN TWO 25p VOUCHERS.

PLEASE PRINT BLOCK CAPITALS **EE8/76**

NAME _____
ADDRESS _____
POST CODE _____

An Electrocomponents Group Company

ENGINEERS FREE YOURSELF FOR A BETTER JOB WITH MORE PAY!



Do you want promotion, a better job, higher pay? "New Opportunities" shows you how to get them through a low-cost home study course. There are no books to buy and you can pay-as-you-learn.

This helpful guide to success should be read by every ambitious engineer. Send for this helpful 44 page FREE book now. No obligation and nobody will call on you. It could be the best thing you ever did.

CUT OUT THIS COUPON

CHOOSE A BRAND NEW FUTURE HERE!
Tick or state subject of interest. Post to the address below.

Electrical Engineering <input type="checkbox"/>	Colour T.V. Servicing <input type="checkbox"/>	CITY AND GUILDS Installations and Wiring <input type="checkbox"/>
Electrical Installations and Wiring <input type="checkbox"/>	C & G Radio, T.V. and Electronic Mechanics <input type="checkbox"/>	CITY AND GUILDS Electrical Technicians <input type="checkbox"/>
Electrical Draughtsmanship <input type="checkbox"/>	General Radio and TV Engineering <input type="checkbox"/>	CITY AND GUILDS Telecommunications <input type="checkbox"/>
Electrical Mathematics <input type="checkbox"/>	Radio Servicing, Maintenance and Repairs <input type="checkbox"/>	Radio Amateurs' Exam. etc. etc. <input type="checkbox"/>
Electronic Engineering <input type="checkbox"/>	Transistor Technology <input type="checkbox"/>	
Computer Prog <input type="checkbox"/>		

To: ALDERMASTON COLLEGE
DEPT. EEV 20 READING RG7 4PF

Also at our London Advisory Office, 4 Fore Street Avenue
Moorgate, London EC2Y 5EJ. Tel: 01-628 2721.

NAME (Block Capitals Please) EEV 20
ADDRESS
POSTCODE

Other subjects Age
Accredited by C.A.C.C. Member of A.B.C.C.

HOME OF BRITISH INSTITUTE OF ENGINEERING TECHNOLOGY

QUALITY STEREO SOUND.

ALMOST 1/2 PRICE OFFER! SOLENT AUDIO SYSTEM

MADE TO SELL AT DOUBLE THE PRICE IN CABINET FORM

OUR PRICE **£69.95**

£7.00 down

Solent Mark II Stereo Tuner Amplifier chassis with AM/FM radio covering long medium short and Stereo FM wavebands. Separate Base and Treble controls. 30 watts total power output (frequency response 25-20,000 Hz) AFC Switching Tape record and playback facilities. Dimensions 18 1/2" x 9" x 3 1/2". The very latest BSR automatic record deck with cue and pause control. Two matching elliptical speaker units.

Order early limited stocks available cash price £69.95. Credit Sale £7.00 deposit 9 monthly payments of £8.00 (Total Credit price £79.50). P. & P. £4.00. Send £11.00 today.

Chassis only available for cash at £49.00 + p. & p. £3.00.

Full 12 months Guarantee.
CALLERS WELCOME.

Access and Barclaycard Orders Accepted by Telephone

FREE! Stereo headphones supplied with every complete order.

LEWIS radio EE/8/76 100 CHASE SIDE SOUTHGATE LONDON N14 5PL Telephones: 01-882-1644

ELECTROTIME

SPECIALISTS IN ELECTRONIC TIMEKEEPING

ELECTRONIC DIGITAL ALARM CLOCK MODEL EC 3

- ★ LARGE 4 DIGIT DISPLAY
- ★ AM/PM INDICATOR
- ★ FLASHING SECONDS INDICATOR
- ★ 5 MINUTE REPEATING SNOOZE ALARM
- ★ 24 HOUR ALARM
- ★ BRIGHTNESS CONTROL
- ★ ATTRACTIVE WHITE CASE

COMPLETE BUILT CLOCK PRICE **£14** inc. VAT

THE "MISTRAL" I DIGITAL CLOCK

- ★ PLEASANT GREEN DISPLAY
- ★ 12/24 HOUR READOUT
- ★ FULLY ELECTRONIC
- ★ PULSATING COLON
- ★ PUSH BUTTON SETTING
- ★ BUILDING TIME 1 HOUR

COMPLETE KIT PRICE **£11.07** inc. VAT
BUILT CLOCK PRICE **£14.95**

LCD MODEL TLC4

CONTINUOUS READOUT UTILISING LIQUID CRYSTAL DISPLAY

WITH BACKLIGHT FOR NIGHT READING

FEATURES—

- ★ HOURS
- ★ MINUTES
- ★ SECONDS
- ★ DATE

RHODIUM **£39.95**
GOLD **£41.50** inc. VAT

LED MODEL TLE5

FEATURES—

- ★ HOURS
- ★ MINUTES
- ★ SECONDS
- ★ DATE
- ★ DAY OF WEEK

£29.50 inc. VAT
GOLD OR RHODIUM PLATED

We are proud to announce the opening of our new Showroom in which you will find one of the Largest Ranges of Digital Electronic Clocks and Watches available in the UK so why not call in and see us! One year's guarantee with all models Electronic accuracy to within seconds per week

ELECTROTIME, DEPT. 4/8, 11, SHEPLEY'S YARD, SHOPPING PRECINCT, TOWN CENTRE, CHESTERFIELD, DERBYSHIRE. TEL (0246) 35804

PLEASE SUPPLY
I ENCLOSE CHEQUE/POSTAL ORDER

NAME.....
ADDRESS



DRILL CONTROLLER
Electronically changes speed from approximately 10 revs. to maximum. Full power at all speeds by finger-tip control. Kit includes all parts, case, everything and full instructions. £2-95 including post and VAT. Made up model £1-00 extra.

NUMICATOR TUBES

For digital instruments, counters, timers, clocks, etc. Hi-vac XN11 Price £1-25 each, Post and VAT paid.



RADIO STETHOSCOPE

Easiest way to fault find, traces signal from aerial to speaker, when signal stops you've found the fault. Use it on Radio, TV, amplifier, anything. Complete kit comprises two special transistors and all parts including probe tube and crystal ear-piece. £2-95, twin stetho-set instead of ear-piece 88p, VAT & postage incl. in price.

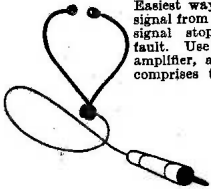

MAINS TRANSISTOR PACK

Designed to operate transistor sets and amplifiers. Adjustable output 6v, 8v, 12 volts for up to 500mA (class B working). Takes the place of any of the following batteries: PP1, PP3, PP4, PP6, PP7, PP9 and others. Kit comprises: main transformer rectifier, smoothing and load resistor condensers and instructions. Retail snip at only £1-75 including post and VAT.

MOTORISED DISCO SWITCHES

With nine 10 amp changeover switches, adjustable over 360° switches are rated at 10 amp each so a total of 2000w's can be controlled and this would provide a magnificent display. Mains operated. PRICE £2-75. DITTO BUT 12 SWITCH £3-75 POST AND VAT PAID

SOUND TO LIGHT UNIT

Another new kit this month is single Channel Sound to Light Unit, complete kit including plastic container, main components include 5 amp thyristor, plus transformer, variable pot with on/off switch and theoretical circuit diagram. PRICE £5-95 Post & VAT paid.



WINDSCREEN WIPER CONTROL

Vary speed of your wiper to suit conditions. All parts and instructions to make. £3-25 post and VAT paid.



EXTRACTOR FAN

Cleans the air at the rate of 10,000 cubic feet per hour. Suitable for kitchens, bathrooms, factories, changing rooms, etc. It's so quiet it can hardly be heard. Compact. 5 1/2" casing comprises motor, fan blades sheet steel casing, pull switch, mains connector and fixing brackets. £4-75 INCLUDING POST & VAT. Monthly list available free; send long stamped envelope.

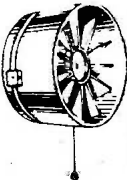

28 RPM GEARED MAINS MOTOR

This is a substantial motor (1 1/2" stack induction type) quite powerful definitely large enough to drive a rotating display or a tumbler for pollinating stone, etc. Approximate overall size 4" x 3 1/2" x 2 1/2" these are ex-unused equipment, carrying our normal ex-equipment guarantees. PRICE £2-95 POST & VAT PAID.

INTRUDER ALARMS

These kits are for the alarm described in a back issue of this magazine. PRICE £4-95. POST & VAT PAID.

FISH BITE INDICATOR

as featured in EE March. Kit of parts to make this £2-50 Post & VAT PAID. Case 70p extra.

TELESCOPIC AERIALS

for portable car radio or transmitter. Chrome plated—six sections, extending from 7 1/2 to 47in. 50p + 15p. Post & VAT.

KNUCKLED MODEL FOR F.M. 80p + 17p Post & VAT.

Pulse Transformer for Sound to Light and similar applications. Mu metal core, primary 11 ohms, tapped at 7, secondary 23 ohms. Price 75p + 6p, with circuit diagram.

Battery Operated Hooter gives a loud shrill tone from 1 1/2v. battery, metal case nickel plated, size 2" diameter by 1 1/2" deep. Price 80p + 6p. Post 10p + 7p.

MULLARD UNILEX

A mains operated 4 + 4 stereo system. Rated one of the finest performers in the stereo field this would make a wonderful gift for almost any one in easy-to-assemble modular form and complete with a pair of Goodmans speakers this should sell at about £30—but due to a special bulk buy and as an incentive for you to buy this month we offer the system complete at only £14-00 including VAT and postage.

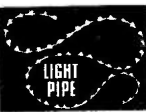

LIGHT PIPE

A mains operated travelling light array. 24ft long it uses 130 miniature bulbs which flash in sequence to make bands of light move along the tube. The tube can be draped around a particular item or set and cannot fail to attract attention—complete kit consists of—24ft of translucent tubing—740 min lamps—5yds multicore cable—motorised switch—taps for quick connections and full wiring instructions. £15 for complete kit. Post and VAT paid.

TWIN OUTPUT POWER PACKS

These have two separate B.C. smoothed outputs so can operate two battery radios or a stereo amp without cross modulation (they will of course operate one radio/tape cassette/calculator, in fact any battery appliance, and will save their oost in a few months). Specs: Full wave rectification, double insulated mains transformer—total enclosed in a hard P.V.C. case—three core mains lead terminal output—when ordering please state output voltage 4v, 6v, 7.5v, 9v, 12v or 24v. Price £3-95. Post and VAT included.



BEGINNERS SHORT WAVE RECEIVER . . .

2 Watt Amplifier . . . Touch Sensitive Alarm . . . Couples Game . . .

To receive parts for the projects featured this month, send the estimated price + 40p post. Any cash adjustment can be made later.

SHORTWAVE CRYSTAL SET

Although this uses no battery it gives really amazing results. You will receive an amazing assortment of stations over the 19, 25, 31, 29 metre bands—Kit contains chassis front panel and all the parts, £1-50—crystal ear-phone 55p including VAT and Postage.



BREAK-DOWN UNIT

Contains hundreds of useful parts some of which are as follows—66 silicon diodes equivalent OA81, 88 resistors, mostly 1/2 watt 5% covering a wide range of values 4 x .1 mfd 400v mfd condensers, 15 x .01 mfd 100v condensers, 2 HF chokes 8 x B9 valve holders, 1 x 4H choke, 1 x 115v transformer, 1 boxed unit containing 4 delay lines also tag panels, trimmer cond users, appressore, etc., on a useful chassis sized approx. 9" x 8" x 7". Only 75p (the 66 diodes would cost at least 10 times this amount). This is a snip not to be missed. Post and VAT 75p.

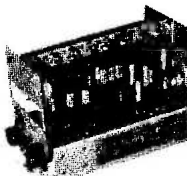

ONLY £1-50 FOR SEVEN ELECTRIC MOTORS

7 powerful batt. motors as used in racing cars and power models. Output and types vary for use in hundreds of projects—Tools, toys, models, etc. All brand new reversible and for 11-24v batts. Wiring diagrams inc. VAT, Post PAID.

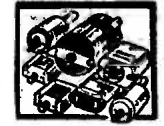

SMITHS CENTRAL HEATING CONTROLLER

Push button gives 10 variations as follows: (1) continuous hot water and continuous central heating (2) continuous hot water but central heating off at night (3) continuous hot water but central heating on only for 2 periods during the day (4) hot water and central heating both on-but day time only (5) hot water all day but central heating only for 2 periods during the day (6) hot water and central heating on for 2 periods during the day time only—then for summer time use with central heating off (7) hot water continuous (8) hot water day time only (9) hot water twice daily (10) everything off. A handsome looking unit with 24 hour movement and the switches and other parts necessary to select the desired programme of heating. Supplied complete with wiring diagram. Originally sold we believe at over £15. We offer these while stocks last at £6-95 each INCLUDING VAT and Postage.



SWITCH TRIGGER MATS

So thin is undetectable under carpet but will switch on with slightest pressure. For burglar alarms, shop doors, etc. 24in x 18in £1-95. Post & VAT 60p. 13in x 10in £1-50. Post & VAT 50p.



LIGHT OPERATED SWITCH FOR 12-24V BATTERY OPERATION

This is completely encapsulated and so make weather proof against all the elements. It can, therefore, be put to many useful applications. To name a few (1) Automatic switch for a mast head light on a boat. (2) Automatic switch on for battery operated lights or alarms in remote places. (3) Auto parking light for a vehicle, no doubt other applications would be found by our readers and we would be glad to hear about them. Encapsulate unit measures approx. 1-6" x .9" x 1-5" deep. This can be conveniently mounted through the front panel of a conduit box or similar. Price £1-95 post & VAT paid.

TERMS: Where order is under £5 please add 40p surcharge to offset packing expenses

J. BULL (ELECTRICAL) LTD.
(Dept. E.E.), 103 TAMWORTH ROAD,
CROYDON CR9 1SG.

ITS FREE!

Our monthly Advance Advertising Bargains List gives details of bargains arriving or just arrived—often bargains which sell out before our advertisement can appear—its an interesting list and its free—just send S.A.E. Below are a few of the Bargains still available from previous lists.

Motor with Gear Box by Swiss SAITA Company, makes type no. AMV5-A4SL. This is standard 220/240v. 50 HZ motor, 15 revz per minute final drive speed, the drive shaft is 4mm dia. fitted with pickup block 8mm square. Price £2-50p + 20p. Post 15p + 2p.

Motor with Gear Box made by Smiths, their type no. Q1HC. 200-250v 50 HZ operated, final drive shaft 60 rev. per minute. Drive shaft 3-5mm diameter 200mm long with flat. Price £2-00 + 20p. Post 15p + 2p. Ditto 1 rev per hour.

Motorized Time Delay. This contains 1/2 rev. per minute motor for 24v 50HZ operation, with incorporated one way INC clutch made by General Time of USA, makers ref. E16450, A2398 A4. Coupled to the motor is a dial calibrated 0-120 seconds. When coupled to the mains, the motor operates and when the pre-set switch. This obviously could be used in photography or in other application where short duration switching off or on is required. A very expensive piece of equipment, mounted on a frame approx. 2-5" x 3" x 1 1/2" deep with fixing feet. Price £3-50 + 25p. Post 30p + 3p.

Motorized Stud Switch driven by 50v SAJA geared motor at 20v's per minute. This has 24 studs and a common slip ring and will rotate continuously. Obviously has many applications. EX-equipment but covered by our normal ex-equipment guarantee. Price £1-75p + 14p. Post 20p + 4p.

Mains Instrument Transformer upright mounting, primary tapped every 10v's from 200 to 240v's, 4 secondaries—180v @ 175mA, 180v @ 125mA, 6-3v @ 1.5 amp, 6-3v @ 2-25 amp. Separate screen brought to the tag panel. Price £4-50p + 36p. Post £1-00 + 8p.

Mains Auto Transformer 100w size chassis mounted with fixing feet, tapings at the high voltage end and at the 115v end. Very well made transformer vacuum impregnated and varnished for quiet operation. Price £1-50 + 12p. Post 50p + 6p.

400w Power Transformer, chassis mounting with fixing feet. Normal 240v 50HZ primary, tapped 200v & 220v, 2 secondaries 60v's at 7 amps with 36v tapping and 6v's at 8 amps, made by Davenport, this weighs 1.6lbs and is approx. 5 1/2" x 4 1/2" x 3". Price £12-50p + £1-00. Post £1-50 + 12p.

250w Isolation Transformer for mounting under the service bench, this is in a normal frame with fixing feet. Very good quality construction with input and output terminal blocks. Price £2-75p + 36p. Post £1-00 + 8p.

EHT Transformer 3-7kv 23 mA's intermittently rated with normal 240v, 50HZ primary. This is made by Landon Kingsway Ltd., mainly for igniting oil fired boilers, their ref. no. 20/0347/02. This is totally encased with fixing feet, 3 core mains input lead and spark plug type a.h.t. output. Price £2-50p + 75p. Post £1-00 + 8p.

Car Battery Trickle Charger, normal mains input, 12v, 1 amp output, totally encased with mounting feet, 3 core mains input lead and output leads terminating with car battery size croc. clips. Price £1-95p + 25p. Post 25p + 3p.

Flexible Drive 1 1/2" long with threaded couplers at each end. Price £2 + 16p. Post 30p + 3p.

Relay 3000 Type, coil consists of 2 separate windings, 3 at 400 ohms and 1 at 570 ohms. 7 set of contacts, 3 of which are changeover, 2 others open when relay closes and the last 2 close when relay closes. Very versatile and useful relay. Price £1-00 + 8p. Post 10p + 1p.

Plug-in 11 Pin Pentax covered Relay, coil operated by 50v AC or 24v DC, 3 sets of very heavy duty contacts, gold plated at least 10 amp rating, make Omron type MK.3P5. Ex-unused equipment with base. Price £1-00 + 8p. Post 15p + 1p.

Reed Relay, Elliott ref. no. 37229/213. Uses 4 reeds, 2 of which are normally closed, the other 2 normally open. Coil detail—voltage 12dc, resistance 2-7K ohms, MA operate. 4-6. Price £1-75p + 12p. Post 15p + 1p.

Latching Relays. Two relays mounted together on a common chassis, size 3" x 1-3" x 2" approx. Two relays are made to latch mechanically so that when one is energised it will stay on although its energising current is removed until the other one is energised, each relay has two pairs of heavy duty gold plated changeover contacts. Coil volts, 45v. AC or 24v. DC. Price £2-50p + 20p. Post 15p + 20p.

Power variable Resistor, Bero, ref. L100, 100 ohms resistance max. current 1 amp. Price £1-50p each + 12p. Post 10p + 1p.

Push Button Switches. Separate on/off switches, both off with rods up, flat switch is spring return—will not stay down, second switch will lock down and can only be released by pressing first. Complete with with push knobs suitable for foot switch or similar, length approx. 6", depth below chassis approx 5". Price £1-25p + 12p.

Polarity Reversing Switch rated 5 amps 250v's mounted on brown bakelite moulded plate, size approx. 3-2" x 1" wide with 2 fixing holes. Price 75p + 6p.

In Line Switch, rated 2 amps at 250v, on/off this has a neon lamp to make it visible at night, originally intended for use on electric blankets and similar applications. Price 50p + 4p.

Surface switch. A very neat Bakelite encased switch, size approx. 1-9" long, 1-2" wide and .76" high. Rated 5 amps 250v. fixing screws hidden under cover. Price 30p + 3p.

ENGINEERS

FREE



YOURSELF FOR A BETTER JOB WITH MORE PAY!

Do you want promotion, a better job, higher pay? "New opportunities" shows you how to get them through a low-cost, Home Study Course. There are no books to buy and you can pay as you learn.

This easy to follow GUIDE TO SUCCESS should be read by every ambitious engineer. Send for this helpful 44 page free book NOW! No obligation, nobody will call on you. It could be the best thing you ever did.

CHOOSE A BRAND NEW FUTURE HERE

CUT OUT THIS COUPON

- | | | |
|---|---|--|
| <input type="checkbox"/> ELECTRICAL and ELECTRONICS | <input type="checkbox"/> AUTO and AERO Motor Mechanics | <input type="checkbox"/> MECHANICAL A.M.S.E. (Mech.) |
| <input type="checkbox"/> Practical Radio & Electronics (with KIT) | <input type="checkbox"/> C. & G. Motor V. Mechanics | <input type="checkbox"/> General Mech. Eng. |
| <input type="checkbox"/> Electronic Engineering Certificate | <input type="checkbox"/> General Auto Engineering | <input type="checkbox"/> Inst. Engineers & Technicians |
| <input type="checkbox"/> General Elect. Eng. Certificate | <input type="checkbox"/> A.M.I.M.I. | <input type="checkbox"/> Maintenance Engineering |
| <input type="checkbox"/> C. & G. Elect. Installations | <input type="checkbox"/> Air Registration Board Certs. | <input type="checkbox"/> Welding |
| <input type="checkbox"/> Elect. Install. & Work | <input type="checkbox"/> M.A.A./I.M.I. Dip. | |
| <input type="checkbox"/> C. & G. Elect. Technicians | | <input type="checkbox"/> MANAGEMENT and PRODUCTION |
| <input type="checkbox"/> RADIO and TELECOM-MUNICATIONS | <input type="checkbox"/> CONSTRUCTIONAL | <input type="checkbox"/> Computer Programming |
| <input type="checkbox"/> Colour TV Servicing | <input type="checkbox"/> Heating, Ventilating & Air Conditioning | <input type="checkbox"/> Inst. of Cost & Managements Accts. |
| <input type="checkbox"/> C. & G. Telecoms. Technician's Cert. | <input type="checkbox"/> Architectural Draughtsmanship & Design | <input type="checkbox"/> DRAUGHTSMANSHIP and DESIGN |
| <input type="checkbox"/> C. & G. Radio, TV & Electronics Mech. Cert. | <input type="checkbox"/> L.I.O.B. | <input type="checkbox"/> General Draughtsmanship |
| <input type="checkbox"/> Radio & TV Engineering Course | <input type="checkbox"/> Carpentry & Joinery | <input type="checkbox"/> A.M.I.E.D. |
| <input type="checkbox"/> Radio, Servicing & Repairs | <input type="checkbox"/> Plumbing Technology | <input type="checkbox"/> Electrical Draughtsmanship |
| <input type="checkbox"/> Radio Amateur's Exam. | <input type="checkbox"/> General Building | |
| | <input type="checkbox"/> Painting & Decorating | |



G.C.E.
—58 'O' & 'A' Level Subjects
—over 10,000 Group Passes!

Aldermaston College

Dept. TEE19 Reading RG7 4PF.
also at our London Advisory Office, 4 Fore Street Avenue, Moorgate, London EC2Y 5EJ. Tel. 01-628 2721.

NAME (Block Capitals)

ADDRESS

.....

.....

..... Postcode

Other subjects of interest..... Age.....

Accredited by C.A.C.C. Member of A.B.C.C.

HOME OF BRITISH INSTITUTE OF ENGINEERING TECHNOLOGY

BULK PURCHASE - EXCLUSIVE TO HENRY'S
ALLOWS US TO SELL AT SUCH FANTASTIC PRICES!

QUALITY ITEMS
Compare performance and specification with units costing 3 times as much!

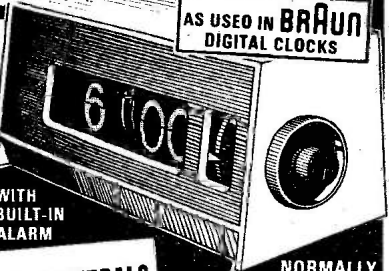

DIGITAL 24 HOUR CLOCK
WITH BUILT-IN ALARM

● **SILENT RUNNING**
● **LARGE ILLUMINATED NUMERALS**
● **AC MAINS** ● **SIZE 6 3/8 x 2 3/8 x 2 3/4**

NORMALLY £24 WITH CASE



MECHANISM ONLY
£6.00
THREE FOR £16.50

MECHANISM AND CASE
£7.99
THREE FOR £22

COMPLETE UNIT
£8.99
THREE FOR £25
POST & VAT INCLUSIVE

Send cheque/P.O./M.O. for the correct amount which includes VAT and P & P or pay by Access/Barclaycard. Send name, card number (if applicable) and address to:
HENRY'S RADIO
303 EDGWARE ROAD, LONDON W2
TRADE & EXPORT ENQUIRIES contact MIKE BAKER 01-723 1006

Henry's Radio
LONDON 404/6 Edgware Road, London W2
231 Tottenham Court Road, London W1
NOTTINGHAM 94/96 Upper Parliament Street
READING 130/131 Friar Street, Reading Berks.
HARROW 190/4 Station Road, Harrow, Middx.
CROYDON 110 North-End, Croydon, Surrey

VALVE BARGAINS

Any 5 64p, 10 £1, 50 £4-50. Your choice from the following list:
ECH84, ECC82, EF80, EF183, EF184, PC86, PC88, PCF80, PCF802, PCL82, PCL84, PCL85, PCL805, PFL200, PL38, PL504, PY81, PY800, PY88, EH90, 30PL14, 6F28.
Colour Valves 30p each PL508, PL 509, PY500/A.
Polyester Capacitors—250 v/w 25p per pack of 5—
·01µF, ·015µF, ·022µF, ·033µF, ·1µF, ·15µF, ·22µF, ·33µF, ·47µF, 1·5µF.

AERIAL BOOSTERS

We make three types of Aerial Boosters all for set top fitting, with Co-ax Plugs and Sockets.
B11—For Stereo and Standard VHF Radio.
B12—For the older VHF Television, please state BBC1 and ITV Channels.
B45—For mon. or colour this covers the complete UHF band.
All Boosters are complete with Battery and take only minutes to fit. Price **£3-60** each.
Prices include V.A.T. P. & P. under £1/15p, £1 to £3/25p above £3/35p. Overseas at cost. Money back guarantee on all orders.

ELECTRONIC MAIL ORDER
62 BRIDGE ST., RAMSBOTTOM, BURY, LANCS. Tel. Rams. 3036

Special Offers—Space needed

Capacitors C280; 0-01, 0-047—4p. 0-1, 0-22—6p. 0-47—9p. 1-0—15p. 2-2—25p. Electrolytics; 220/6-3v—6p. 2200/6-3v—17p. 0-47/2-2/4/7/220/10v—8p. 10/22/47/100/25v—6p. 220/25v—10p. 330/25v—11p. 470/1000/16v—18p. 1000/30v—11p. 15/40v—8p. Denco D.P. Coils; Range 3/4/Green—73p. Range 2/3/4/Blue—89p. Range 2/Red—89p. Range 2/500 Blue—69p. Range 2/500 Red—69p. Diodes; 4002—4p. 4004—5p. 4007—6p. 4148—3p.
I/Cs: 741—21p. 555—35p. 7400—10p. Stethoscope Earphones—85p.
Pots. Log 5K, 10K, 25K, 250K, 500K, 1M. Lin. 500K—All 15p each.
Resistors: 4 each of 25 different values—75p.
5 Pin Din Sockets—9p. Toggles Switches—55p. Slide Switches—8p. Push Switches—11p.
AC129—8p. BC107/8/9—8p. BC147/8/9—9p. BC157/8/9—9p. BF194/5/6/7—9p. BFY50/1/2—15p.
Connecting Wire—2 metres—3p. 12 metres—15p.
Goods by Return unless cheque payment.
C.W.O. VAT included. Add 20p. p/p.

CLEVELAND SUPPLIES, (EE)
P.O. BOX 20, REDCAR, CLEVELAND.
Telephone: Redcar 5355

SUMMERTIME SAIL-AWAY

SCORCHER
7490.25p each.

WITH OUR **SIZZLING PRICES!!**

PAK OFFERS

ALL U PAKS, UIC PAKS, *ULIC PAKS, AS SEEN IN OUR PREVIOUS ADVERTS AVAILABLE AT **40p** per pak

ZENER PAKS

400mW PAK No.:
1 containing 20 3v-10v
2 containing 20 11v-33v
£1.00 per pak*

RESISTOR PAKS

R1. 50 \pm w 100 ohm-820 ohm
R2. 50 \pm w 1K-8.2K
R3. 50 \pm w 10K-82K
R4. 50 \pm w 100K-1M

BUY ONE OF EACH SPECIAL PRICE £1.60 the 4*

R5. 30 \pm w 100 ohm-820 ohm
R6. 30 \pm w 1K-8.2K
R7. 30 \pm w 10K-82K
R8. 30 \pm w 100K-1M

BUY ONE OF EACH SPECIAL PRICE £1.60 the 4*

CAPACITOR PAKS

E1 18 Electrolytics 47 μ F-10 μ F
E2 18 Electrolytics 10 μ F-100 μ F
E3 18 Electrolytics 100 μ F-680 μ F

BUY ONE OF EACH SPECIAL PRICE £1.20 the 3*

MC1 24 Ceramic Caps. 22pf-82pf
MC2 24 Ceramic Caps. 100pf-390pf

MC3 24 Ceramic Caps. 470pf-3300pf
MC4 21 Ceramic Caps. 4700pf-0.047 μ F

BUY ONE OF EACH SPECIAL PRICE £1.60 the 4*

OPTOELECTRONICS

LED Displays
DL707 0.3" 70p
DL747 0.6" 1.50
DL727 0.5" 50p

Double Digit 0.0-9.9 **£1.80**
I.T.T. Nixie Tubes 5870 ST 1" Figures Lowest ever Price 5 for **£2.00**

Photo Cells ORP12/NSL4931 38p ea.
Photo Transistors OCP71 5 for **£1**

GREEN TIL211 0.125" FLV 0.2" 5 of either 75p
YELLOW 0.125" size 0.2" size 5 of either 75p

CLIPS FOR LED's 0.125" ONLY AVAILABLE AT 10 FOR 20p

IC's

NE555 Timer 38p
NE556 Dual Timer 80p
709P 8 PIN DIL 15p
741P 8 PIN DIL 18p
747 14 PIN DIL 36p
748P 8 PIN DIL 25p
 μ A711 Dual Com-parator 25p
*72301 op.amp.TO99 25p
*72770 op.amp.TO99 50p

IC SOCKETS

BPS8 9p
BPS14 10p
BPS16 11p

TRIACS

2A/400PIV 50p
6A/400PIV 55p
10A/400PIV 75p

DIACS

BR100 15p
D32 15p

THYRISTORS

TO5 15p
1A/50PIV 25p
1A/400PIV 30p
1A/600PIV 30p

TO66

5A/50PIV 25p
5A/400PIV 40p
5A/600PIV 50p

TO48

16A/50PIV 30p
16A/400PIV 60p

BRIDGE RECTIFIERS

2A/50 volt 25p
2A/100 volt 30p
2A/200 volt 35p
2A/400 volt 40p
2A/1000 volt 50p

F.E.T.'s

2N3819 12p
2N5458 (MPF104) 15p

DIY PRINTED CIRCUIT KIT

Normal Price **£7.80**

Sale Price **£5.50**

CONTAINS 6 Pieces copper laminate, box of etchant powder and measure, tweezers, marker pen, high quality pump drill, Stanley knife & blades, 6" metal rule, FULL Easy to follow instructions

TRANSISTORS

AC127	10p	*BF199	12p
AC128	10p	BF257	18p
AC141K	20p	BF258	19p
AC142K	18p	BF259	20p
OC71	9p	BFX29	18p
BC107	6p	BFX84	15p
BC108	6p	BFY50	15p
BC109	6p	BFY51	15p
*BC147	8p	BFY52	15p
*BC148	8p	2N696	10p
*BC149	9p	2N697	11p
*BC157	11p	2N698	11p
*BC158	10p	2N706	6p
*BC159	10p	2N708	8p
*BC169C	7p	2N1613	13p
*BC170	5p	2N1711	15p
*BC171	5p	2N2219A	15p
*BC172	5p	2N2369	12p
BC178	12p	2N2369A	12p
*BC182	10p	2N2905A	13p
*BC182L	10p	*2N2926g	9p
*BC183	10p	*2N2926y	8p
*BC183L	10p	*2N2926o	8p
*BC184	11p	2N3053	15p
*BC184L	11p	2N3055	36p
*BC212	10p	*2N3702	8p
*BC212L	10p	*2N3703	8p
*BC213	10p	*2N3704	9p
*BC213L	10p	*2N3705	8p
*BC214	11p	*2N3706	8p
*BC214L	11p	*2N3903	8p
BC227	12p	*2N3904	8p
BC328	12p	*2N3905	9p
BC337	11p	*2N3906	9p
BC338	11p	*2N4058	8p
BD116	50p	*2N4060	9p
BF167	10p	*2N5172	9p
BF173	10p	*ZTX300	5p
*BF194	9p	*ZTX500	8p
*BF195	9p	*ZTX107	5p
*BF196	10p	*ZTX108	5p
*BF197	10p	*ZTX109	5p
*BF198	12p		

IC INSERTION EXTRACTOR TOOL

32p!

DIODES

OA10	15p	IN4002	3p
OA47	5p	IN4003	3p
OA81	5p	IN4004	4p
OA91	5p	IN4005	4p
OA200/BAK13	5p	IN4006	3p
OA202/BAK16	5p	IN4007	6p
		3 AMP	
IN914	4p	IN5400	11p
IN4148	4p	IN5401	12p
IS44	4p	IN5402	13p
IS920	5p	IN5403	14p
IS923	5p	IN5404	13p
IS970	5p	IN5405	16p
BA100	6p	IN5406	17p
BA148	10p	IN5407	18p
IN4001	2 $\frac{1}{2}$ p	IN5408	20p

VAT CHAT

Please add 12 $\frac{1}{2}$ % to prices marked*. Remainder add 8%

UNIUNION TRANSISTORS

UT46/TIS43 18p

VOLTAGE REGS

L129/ μ A7805 85p
L130/ μ A7812 85p
L131/ μ A7815 85p

DYNAMIC CASSETTE MIKE

With 2.5mm and 3.5mm Jack Plugs **£1.50**

P&P
Postage and Packing add 25p. Overseas add, extra for airmail.

BI-PAK
P.O. BOX 6, WARE, HERTS

everyday electronics

PROJECTS...
THEORY...

A MATTER OF CONCENTRATION

Some may find it rather difficult concentrating on electronics in high summer. It's understandable, what with the fine weather and all those outdoor counter-attractions. So let us offer something small and simple that will help concentrate the mind, in one sense at any rate!

For it can really be said, without too much exaggeration, of a certain project that "it concentrates the mind wonderfully." As we recall, in Dr. Johnson's original immortal phrase the "it" alludes to the frightful and final prospect facing the doomed man awaiting execution. Leaving aside the macabre, there are other rather different and perhaps more trivial but quite pleasant matters or prospects which can be applied to this desirable end (mind concentration—of course).

One can study ponderous books on the subject, attend courses of instruction, try the ancient methods of yoga or the modern psychological approach. We have a much simpler, amusing and quite harmless remedy to offer our readers, who may at present be subjected to various distractions not uncommon in the summer months.

To be perfectly honest, what we offer is not entirely new, but it is an improvement and an extension of an old idea. More to the point, tests carried out amongst our acquaintances prove its unflinching attraction. The name of our game is *Couples*.

**Our September issue will be published on Friday, August 20
See page 417 for details.**

Though its effectiveness in concentrating the mind is certain, success in grappling with the precise problem which forms the basis of this game cannot be guaranteed. Strong minded men and women have been known to throw their hand in after a few hours baffled by the apparent intractability of the problem. Somewhat bemused, they return to the simpler matters of ordinary life that await their attention. That ought to send you scouring for your tool box and iron!

One thing remains to make clear. Our opening words may not apply universally, this we recognise. Should you therefore happen to be a fully committed all-the-year-round constructor a particular word of advice in your ear: concentrate on and complete any other project you have in mind to before starting on *Couples*. Strong willed and determined though you may be, you may still succumb like the rest to the challenge of our latest game. And we certainly don't want to be answerable for any fall in production over the next few weeks.

Fred Bennett

EDITOR F. E. Bennett • ASSISTANT EDITOR M. Kenward • TECHNICAL EDITOR B. W. Terrell B.Sc.
ART EDITOR J. D. Pountney • P. A. Loates • K. A. Woodruff
ADVERTISEMENT MANAGER D. W. B. Tilleard • P. Mew

© IPC Magazines Limited 1976. Copyright in all drawings, photographs, and articles published in EVERYDAY ELECTRONICS is fully protected, and reproduction or imitations in whole or part are expressly forbidden.

All reasonable precautions are taken by EVERYDAY ELECTRONICS to ensure that the advice and data given to readers are reliable. We cannot, however, guarantee it, and we cannot accept legal responsibility for it. Prices quoted are those current as we go to press.

Editorial Department: Everyday Electronics, Fleetway House, Farringdon Street, London EC4 4AD. Phone 01-634 4452.

Advertisement Department: Everyday Electronics Advertisements, King's Reach Tower, Stamford Street, London SE1 9LS. Phone 01-261 5148.



**EASY TO CONSTRUCT
SIMPLY EXPLAINED**

VOL. 5 NO. 8

AUGUST 1976

CONSTRUCTIONAL PROJECTS

TOUCH SENSITIVE DOOR ALARM An unusual door bell by J. H. Telford	410
COUPLES An electronic game by Alan Sproxtan	415
BEGINNERS SHORT WAVE RECEIVER An ideal first time project by R. A. Penfold	424
2 WATT AMPLIFIER For general purpose use by R. A. Penfold	433

GENERAL FEATURES

EDITORIAL	408
JACK PLUG AND FAMILY Cartoon	413
PHYSICS IS FUN A crystal set by Derrick Daines	414
TEACH-IN 76 Part 11, A.C. Theory by A. P. Stephenson	418
FOR YOUR ENTERTAINMENT Citizens band and hotel charging by Adrian Hope	423
YOUR CAREER IN ELECTRONICS The Royal Navy by Peter Verwig	424
SHOP TALK Component buying and new products by Brian Terrell	427
COUNTER INTELLIGENCE A retailer's comments by Paul Young	432
I.C.s EXPLAINED Part 4 by Brian Dance	438
PLEASE TAKE NOTE	439
PROFESSOR ERNEST EVERSURE The Extraordinary Experiments of. by Anthony J. Bassett	440
DOWN TO EARTH Impedances by George Hylton	444

BACK NUMBERS, LETTERS AND BINDERS

We are unable to supply back copies of *Everyday Electronics* or reprints of articles and cannot undertake to answer readers' letters requesting modifications, designs or information on commercial equipment or subjects not published by us. An S.A.E. should be enclosed for a personal reply. Letters concerning published articles should be addressed to: The Editor, those concerning advertisements to: The Advertisement Manager, at the addresses shown opposite.

Binders for volumes 1 to 5 (state which) are available for £2.15, including postage, from Binding Department, Carlton House, Great Queen Street, London, WC2E 9PR.

Everyday Electronics, August 1976

BUBBLE-WATCHERS
SEE PAGE 417



TOUCH SENSITIVE DOOR ALARM

By J.H.TELFORD

A door buzzer with a difference.

THE need for a door alarm on the door of my fiancée's room in her college was the cause of the design in this article. The unit is operated by placing one's finger/hand on the touchplate such that the etched name (or number) and surrounding copper are bridged; the touch plate can be used for most internal rooms and for sheltered outdoor positions.

The volume produced by the unit is enough to be audible over a radio or record player, and can be heard over a distance of two rooms. No volume control was found to be needed.

As the device was required for long periods of operation, and 10 milliamps would be consumed, it was decided to run the device from the mains.

POWER SUPPLY

The power supply used in the prototype is a conventional one as can be seen from Fig. 1. The first neon LP1 indicates that mains power is reaching the device, the second neon LP2 tells one whether the device is switched on or off. Should the fuse FS1 blow then LP2 will not light.

Switch S1 was a push-on push-off type on the prototype. The transformer used was an Eagle type with two 6 volt 280 milliamp windings—only one winding is used.

Any 1 amp 50 volt bridge rectifier will do or can if desired be replaced by four discrete diodes (type 1N4001 for example).

Mains entering the unit is first stepped down by T1 to 6 volts and then full-wave rectified by means of diode bridge D1-D4 and is then smoothed by C1 producing a d.c. level of about 9 volts available for the multivibrator/amplifier section of the unit. Resistor R1 is included in the circuit to limit the initial current drawn while the capacitor charges up.

There is a screen on the transformer which is earthed to the mains earth together with the negative supply line as a measure of safety.

AMPLIFIER/OSCILLATOR CIRCUIT

The oscillator is composed of transistors TR1 and TR2 and associated resistors and capacitors; these form a common astable multivibrator with one component missing—a high value resistor from positive rail to TR2 base. This resistance is derived from the "skin resistance" when the remote nameplate is touched.

The output from the multivibrator is fed to a two-stage amplifier with its output connected to loudspeaker LS1. Thus touching the nameplate causes a tone to be heard in the loudspeaker; the frequency of the tone (pitch) can be altered by VR1 and is dependent on the value of the skin resistance of the caller.

If it is required to operate the unit with a loudspeaker of lower impedance than about 80 ohms, then TR4 must be modified to suit. For example, use a transistor type 2N3704 when a 35 ohm speaker is employed.



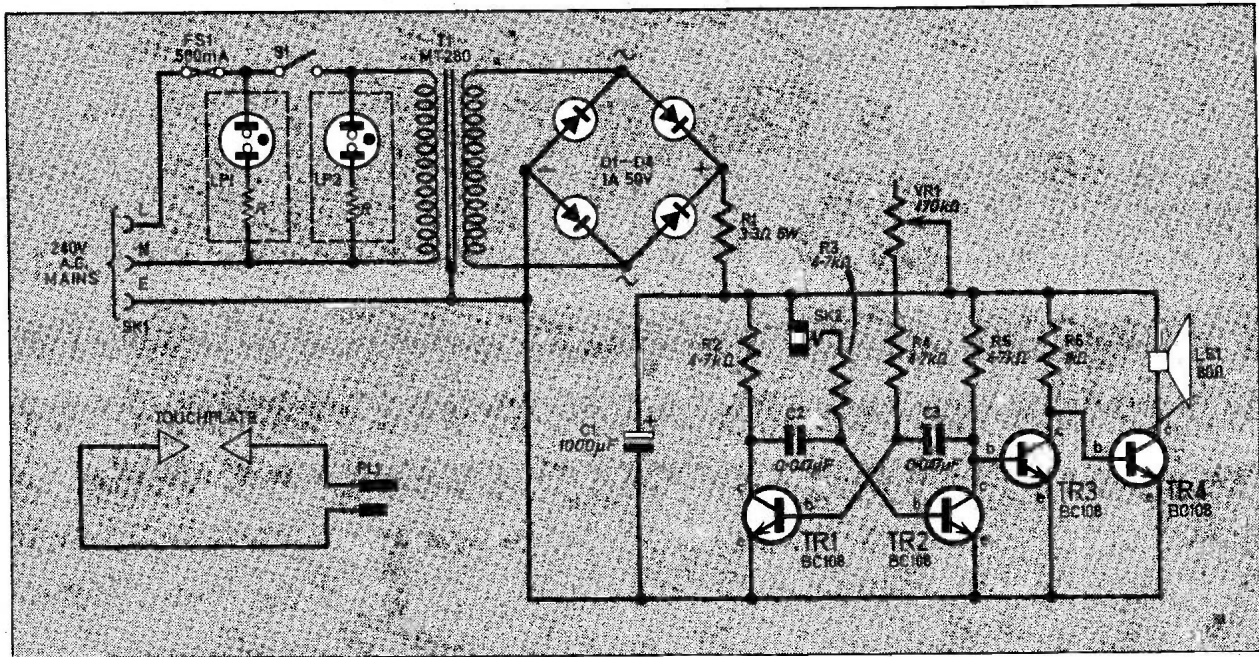

Fig. 1. Circuit diagram for the Touch Sensitive Door Alarm.

CONSTRUCTION

The prototype unit was constructed and housed in a plastic Addis food container size 240 x 125 x 80mm, but may be changed to suit individual requirements. If mounted in a metal case adequate measures should be taken to guard against possible short circuiting between component boards and case. The metal case should of course be earthed.

Most of the small components are mounted on two pieces of tagboard, 11-way for the oscillator and amplifier, and a smaller 4-way for the power supply components.

The layout of the components on the tagboards and within the prototype case and complete wiring up details are shown in Fig. 2. The layout is in no way critical and may be changed if desired.

In the prototype the speaker was glued to the base of the case which in turn forms the front panel. The remote nameplate is connected to the unit by means of a standard jack lead and is plugged in at SK2.

Begin construction by assembling and soldering the components on the tagboards and then

preparing the case to accept all the other components to be mounted on the case itself. Secure all the components in position including the boards and wire up as detailed in Fig. 2.

TOUCH PLATE

The legend on the touch plate is very much a matter of individual choice. In the example seen opposite the plate takes the form of a room/door number, but can equally be a name or symbol etched in copper as shown below. The centre portion can be solder tinned for effect as shown. One important point to make is that the legend should be one "island" enabling a bridge between the legend and the surrounding

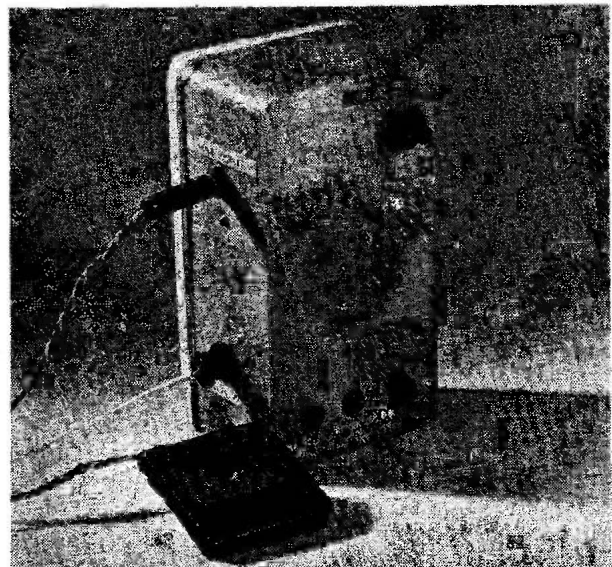

Photograph of the prototype unit.

FOR GUIDANCE ONLY

ESTIMATED COST* OF COMPONENTS
excluding V.A.T.

£4.75 plus case

*Based on prices prevailing at time of going to press

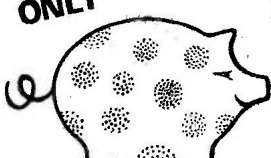

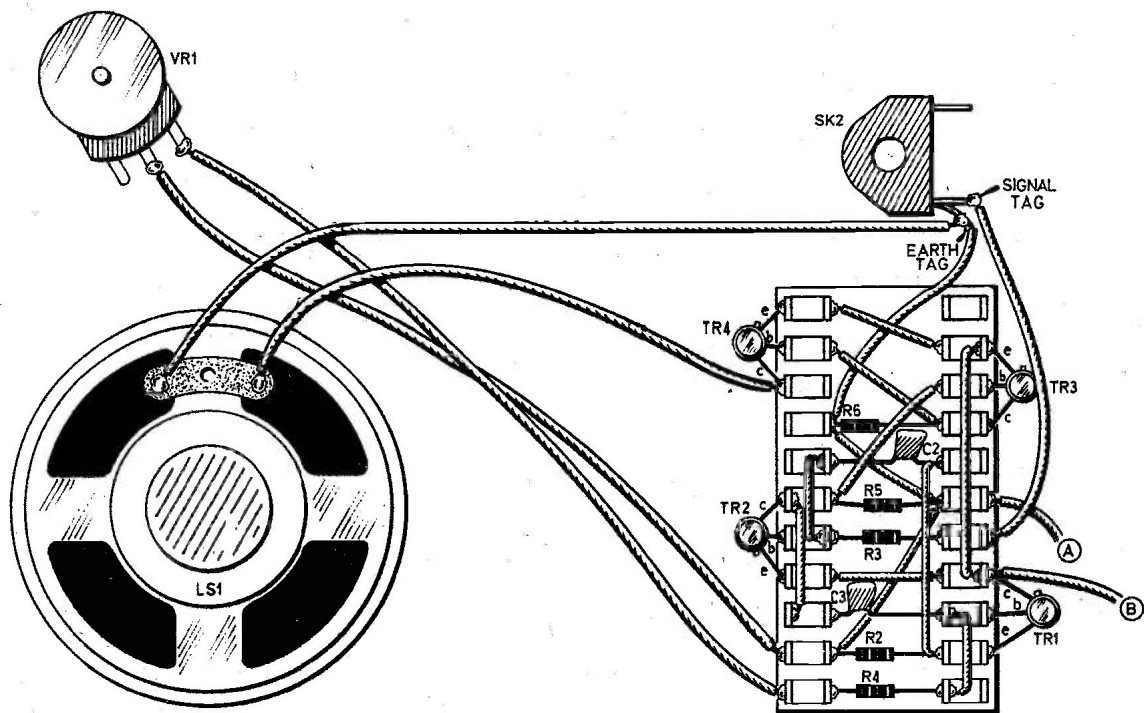

TOUCH SENSITIVE DOOR ALARM

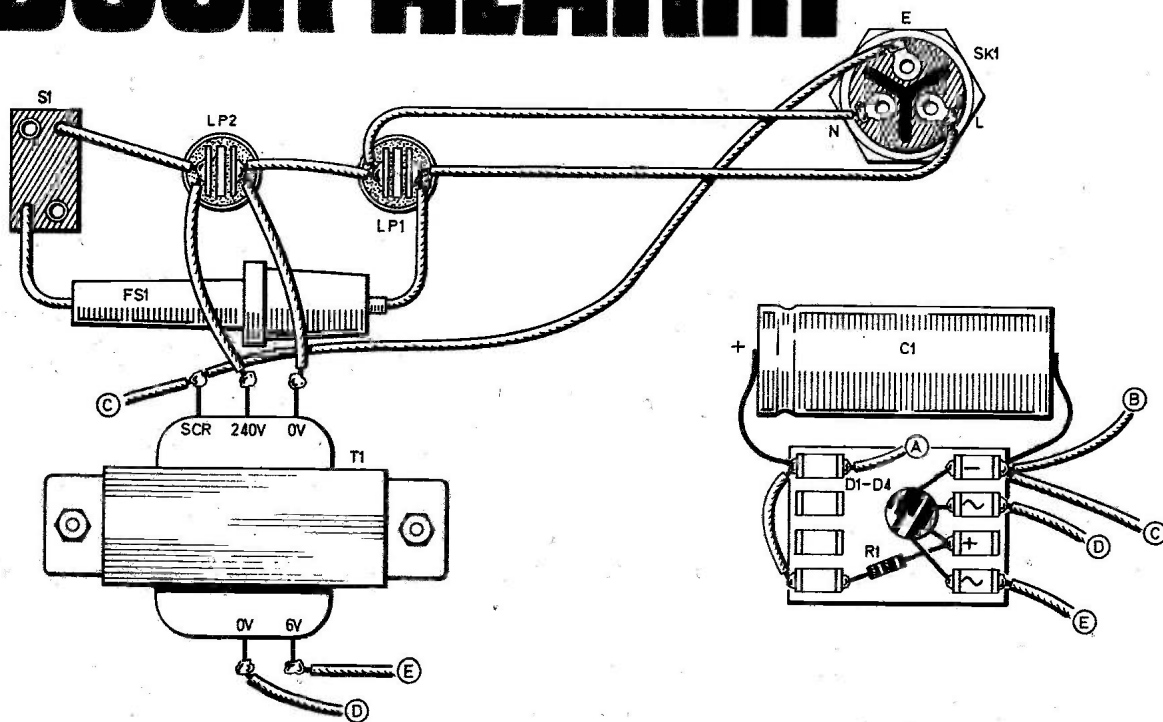

Complete wiring up details and a suggested layout for the components in the case.

Components....

Resistors

- R1 3.3Ω 6W
- R2 4.7kΩ
- R3 4.7kΩ
- R4 4.7kΩ
- R5 4.7kΩ
- R6 1kΩ
- All $\frac{1}{2}$ W carbon $\pm 10\%$

**REAL
TALK
SHOP**
SEE

Capacitors

- C1 1000μF 15V elect.
- C2 0.047μF plastic or ceramic
- C2 0.047μF plastic or ceramic

Semiconductors

- TR1 BC108 silicon npn
- TR2 BC108 silicon npn
- TR3 BC108 silicon npn
- TR4 BC108 silicon npn
- D1-D4 1 amp 50 volt bridge rectifier

Miscellaneous

- LP1, 2 mains neon (with built in R) (2 off)
 - S1 push-on push-off mains switch
 - T1 MT280 mains/6 volt 280mA secondary (Eagle)
 - LS1 miniature loudspeaker with coil impedance 80 to 100 ohms
 - FS1 500mA with in-line fuse holder to suit chassis mounting mains inlet socket (Bulgin)
 - SK2 standard jack socket
 - PL1 mains plug to suit SK1
 - PL2 standard jack plug
 - VR1 470kΩ carbon log. or lin.
- Tagboards: 11-way, 4-way; copper clad board for touch plate; case; knob; mains cable; two-core cable for connection of unit to touch plate.

"land" to be made at any point along the legend.

A wire should be connected to each, the legend and land surround and these taken via a suitable length of cable to a jack plug.

For indoor use the plate can be attached to a door or doorpost using Blu-Tak, Plasti-Tak or similar, for example, or bolts/screws as should be for outside use.

With the assistance of aluminium grille, an Isocon block (fibreglass) can be made to encase the touchplate and wiring (leaving the front exposed of course!).

TESTING AND USE

With the touchplate not plugged into the unit, temporarily connect a 330 kilohm resistor across the jack socket and plug the unit into the mains. On turning on at S1 a tone should be heard from the loudspeaker. The pitch should be variable by means of VR1. Switch off the unit at the mains and remove the 330 kilohm resistor. On switching on again, no sound should be heard from the loudspeaker.

The touchplate can now be tested by plugging in at SK2 and placing your hand across the touchplate. Sound should emanate from the speaker for as long as the hand is across the touchplate.

Operation frequency depends on hand resistance, which varies greatly. The alarm can be used in many types of environment, but outdoors in rain or other severe conditions, the alarm may double as a rain alarm if not properly sheltered.

In outdoor cases, and in the case of it facing a corridor along which a lot of people pass then screws and the Isocon casing will prove of use.

Finally, provided the instructions are adhered to, the unit will be electrically safe, and mothers need not fear for their children operating the device. □

JACK PLUG & FAMILY...

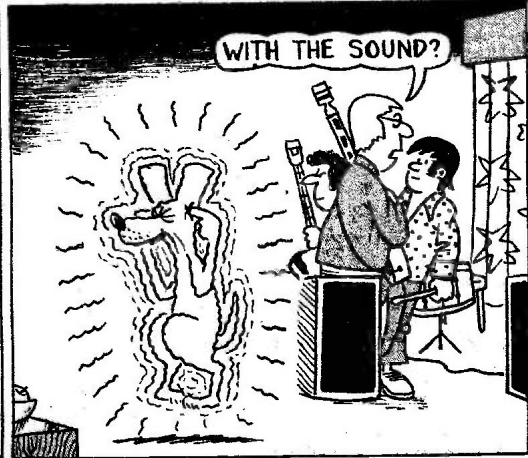
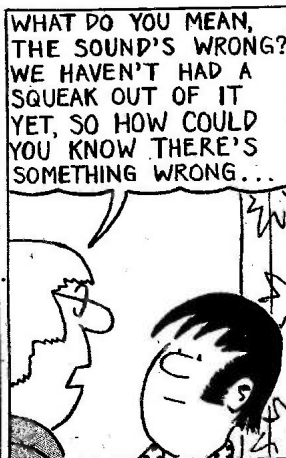
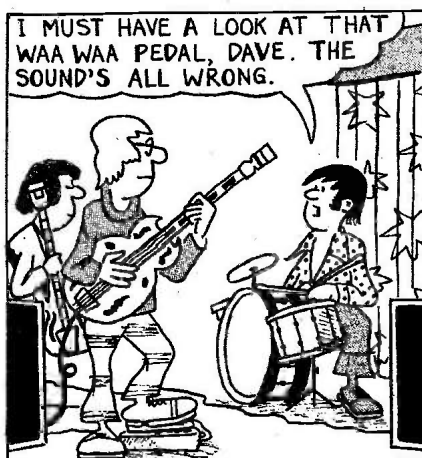

Physics is FUN!

By DERRICK DAINES

THE DIODE RECEIVER

THE diode receiver (or crystal set, as it used to be called) is more than just a museum piece. For one thing, it is easy to build and get working. For another, it will run virtually for ever at no expense and finally it forms a most valuable introduction to radio theory and can provide an interesting test-bed for experimentation.

The circuit of such a diode receiver is shown in Fig. 1. Crystal earpieces are common these days and it is unlikely that readers will have to buy one. The three capacitors and the diode should be above suspicion, so it is recommended that these be bought. Notice that one capacitor is a variable (tuning) type and ought to be fitted with a knob to prevent interaction from the hand.

Construction is not particularly critical and even the bottom of a cardboard box will suffice to hold the tuner. Connections between components should be of a fairly thin gauge plastic coated wire. Solder joints are advised, but not essential.

GOOD AERIAL AND EARTH

A good aerial and a good earth on the other hand are really essential. The aerial should be 50 to 60 feet long and rigged as high as possible. Copper wire is best, but I have had good results from control-line wire for model aeroplanes and even from a reel of garden wire. The best results that I ever got were from a disused telephone line, but not a word to Richard Marsh about that!

A very good earthing can be obtained from a jubilee clip fastened to a cold water tap.

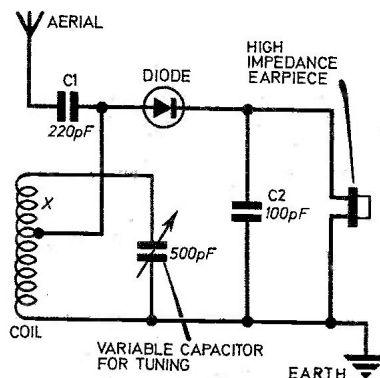

Fig. 1. Circuit of a single diode receiver.

Some readers may be a little surprised that so far I have not mentioned the coil. I have left this until now for a very real reason. The simple truth is that in these days of crammed radio waves almost *any* coil will pull in some station or other. Try it and see!

Fling a few turns of very fine copper wire round a 150mm length of ferrite rod, leaving a tapping loop out (marked X in Fig. 1) after putting on one third of the turns. Connect up—et voila!—some radio station or other! Turn the coil round and you will get a different station or group of stations. Substitute other coils—any coil you happen to have around—and the chances are that each time you will be able to pick up something. You may not understand it, it may be Swahili, or something, but you'll get it.

If you have a number of discarded diodes, try different ones. Try turning them round—experimenting in this fashion will teach you much more about radio in a few hours than watching somebody else. Go away and leave it. Come back in a week and the set

will still be working. (Look, mum, no batteries!) Finally, when you settle for one particular radio station, wind the following coil.

COIL

Obtain 100mm of 8mm ($\frac{5}{16}$ inch) diameter ferrite rod and put on a single turn of Sellotape. Now you need about 1 metre of 38 s.w.g. copper wire. Wind on 16 turns and bring out a coupling loop. Wind on a further 34 turns, making 50 in all. Each turn should be neatly laid by the side of the others in a single layer and the whole coil should take up no more than about 25mm in the centre of the rod. Secure the coil with another single layer of Sellotape. This coil will, with the capacitors specified, give you medium wave coverage. Long wave coils can be obtained from stripped-down radio sets.

The fact that the receiver works with no batteries is adequate proof that there is energy in radio waves. We receive the signals and hear them because of the energy put out by the broadcasting station and it is because we must provide a complete circuit for the energy that such a good earth and aerial is required. Later, we can do some experiments to study the nature of radio waves.

The diode is a gadget that we can also study later. Suffice to say here that it blocks current in one direction but not in the other. The radio frequencies are picked up by the aerial and amplified by the tuned circuit (the coil and variable capacitor) and detected by the diode.

The final capacitor is chosen so that it is reactive at audio frequencies but conductive at radio frequencies, thus only audio frequencies go through the earpiece.

Everyday Electronics, August 1976

MANY readers will probably be familiar with the "across the river" electronic and non-electronic versions of the puzzles involving a farmer with hen, fox and corn or rabbit and lettuce. Here is another electronic puzzle on the same theme, but slightly harder to solve, involving six people who wish to cross a river by small boat subject to certain conditions as detailed later.

CIRCUIT DIAGRAM

The circuit diagram of the Couples game is shown in Fig. 1. Basically it consists of a parallel lamp/audible alarm arrangement in series with a bank of switches. Certain combinations of the switches cause the lamp to light and the alarm to sound when S7 is made.

The wiring between the switches has been

**FOR
GUIDANCE
ONLY**

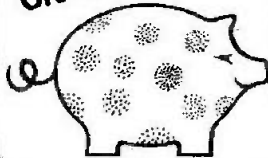

ESTIMATED COST* OF COMPONENTS

excluding V.A.T.

£3 to £7.50

**Depending on
component types**

*Based on prices prevailing at
time of going to press

Components . . .

**WAV
JOHS**
SEE

Switches

S1-S6 d.p.d.t. miniature toggle switches
(6 off)

S7 push-to-make release-to-break push
button

Miscellaneous

LP1 i.e.s. 12 volt 0.75 watt lamp

WD1 Bleep tone or similar 12 volt audible
warning device

B1 9 volts type PP4

Case type BX56 as used in prototype (Home
Radio); lampholder to suit LP1; battery con-
nectors to suit B1; insulated connecting wire.

arranged such that if the switches are made in the correct order according to the rules, the lamp will not light, nor the alarm sound when S7 is depressed.

COMPONENTS

The layout of the components within the case of the prototype is shown in Fig. 2 together with complete wiring up details. The layout is not critical and may be changed to suit in-

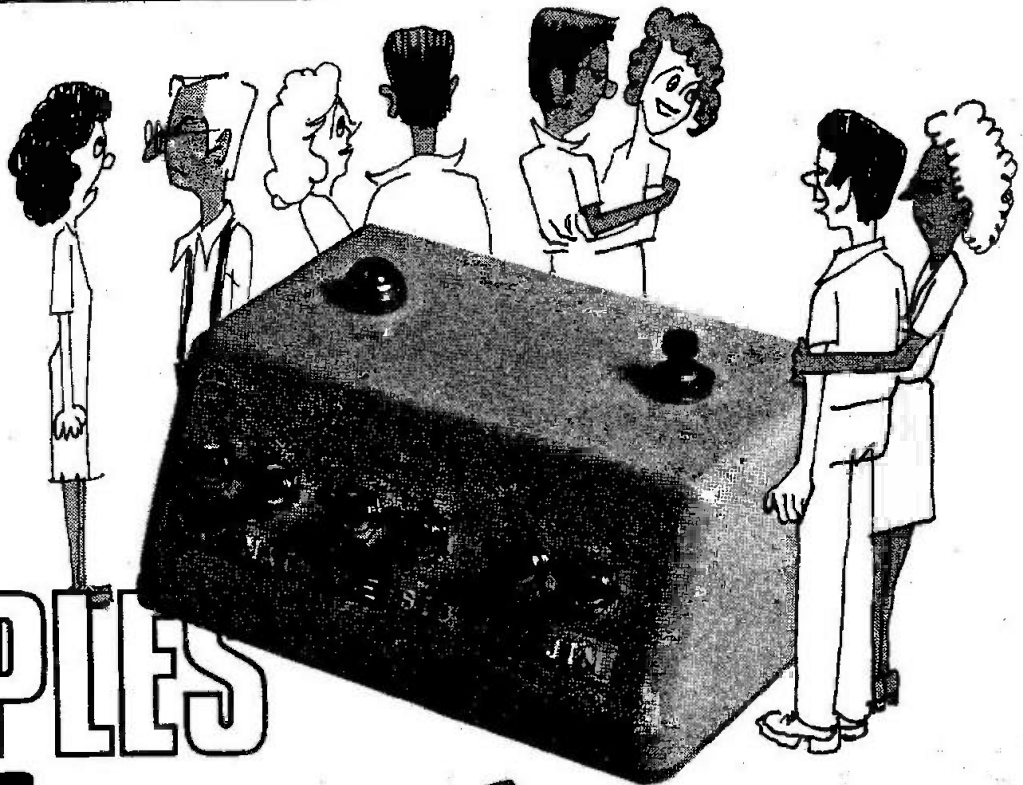

COUPLES

an Electronic Game
By ALAN SPROXTON

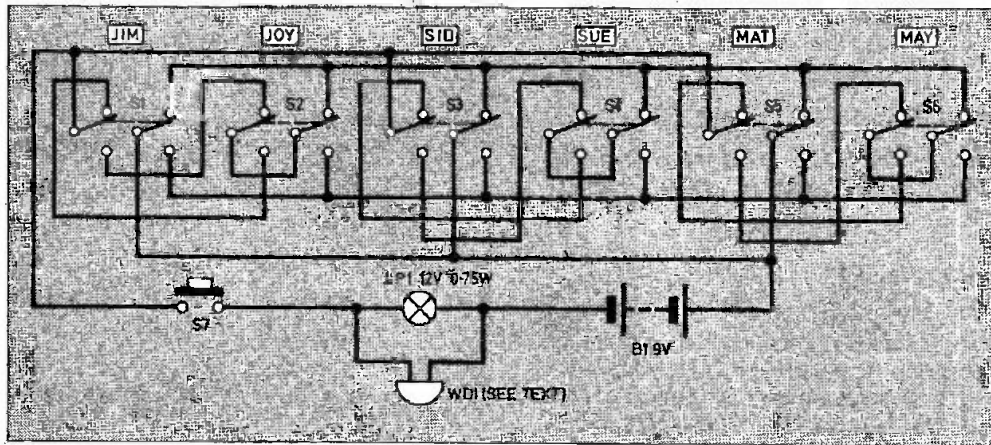

Fig. 1. The circuit diagram for the Couples game.

COUPLES

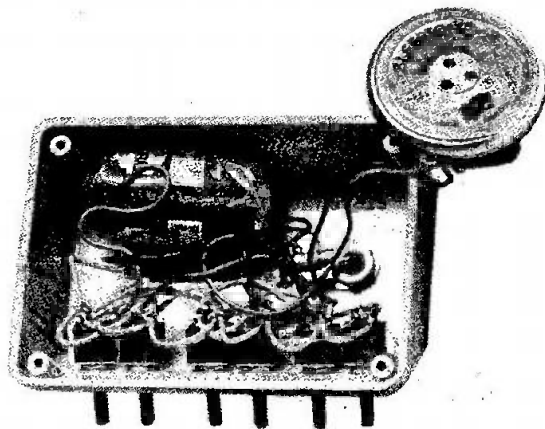
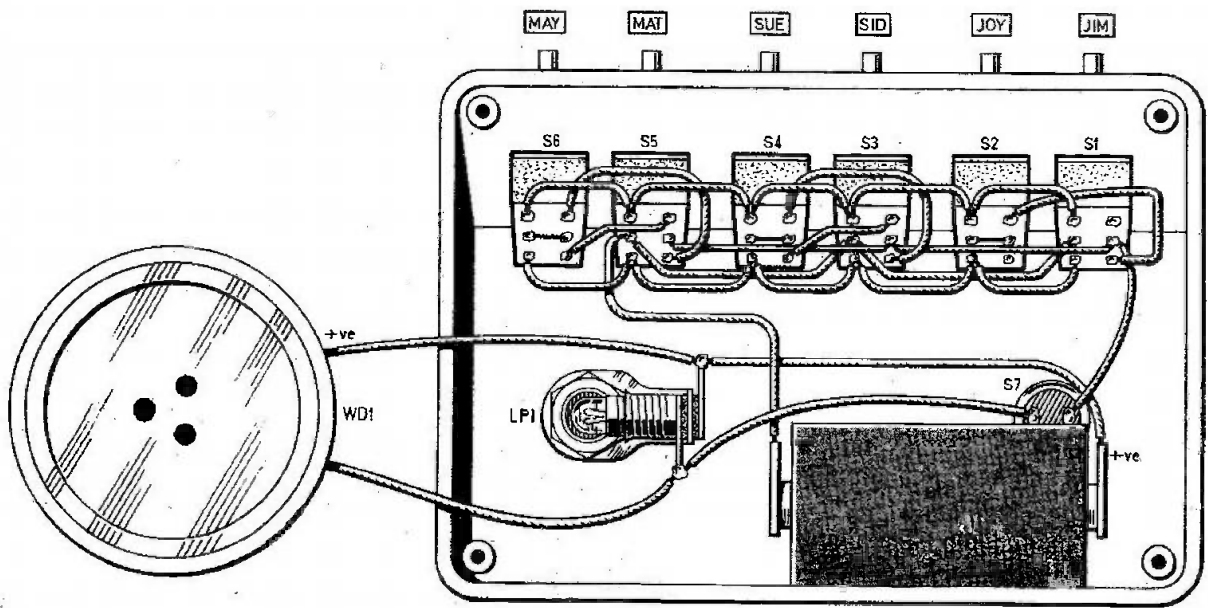

Fig. 2. Layout of the components and complete wiring-up details within the case.

Photograph of the completed prototype with base plate removed.



dividual requirements.

The miniature switches specified can prove rather expensive as is one of the other items, namely the Bleephone. Larger, more generally available switches may be used or even the cheaper double-pole double-throw slide variety. The case will have to be made larger thereby enabling the Bleephone to be replaced by one of the many slightly larger but cheaper audible alarm units.

WIRING-UP

Wiring up of the unit must be carried out using insulated wiring. First, with all the components to hand, a case should be chosen and then prepared to accept the components, not forgetting the battery, which when fitted in place are to be wired up according to Fig. 2.

It will be necessary to drill some small holes near to the position of the alarm unit to allow the sound to be clearly heard.

RULES, CONDITIONS AND MODE OF PLAY

The toggle (or slide) switches represent three adjacent married couples, see photograph. The object of the game is to get all the people across the river without making a wrong move. The game starts with all the switches in the down position (pointing towards the name tags) representing the couples on one side of the river bank. Crossing the river is accomplished by pushing the switches up. Now the boat available for crossing the river can hold no more than two persons at any one time, therefore no more than two switches can be moved at a time.

The husbands are all very jealous and will not allow their wives to be in a party with the other men unless they themselves are with them. After each move the push button S7 must be operated; a wrong move will be indicated by the lamp lighting up and the audible warning being sounded.

Before you start just try a quick test. Move Sue and Joy across the river, then press the button. No sound or light should be noticed. Put back Sue and Joy where they were. Now move Jim and Joy across and again there should be silence. Bring Jim and Joy back. Now move Sid and Jim across. This time you will get a buzz and a light. This is because Sue and Joy are left in a party which includes a man (Mat). Put back Sid and Jim.

Right off you go—you have to get all the switches from bottom to top, moving them one or two at a time without a buzz. Don't forget the boat has to be brought back by someone each time, and don't forget to check after each move by pressing the button.

It can be done, and when you have mastered it, see what is the smallest number of moves you can do it in. □

Everyday Electronics, August 1976



NEXT MONTH

Are you making the most of electronics? Look at these useful projects which will be described in next month's *Everyday Electronics*.

No other hobby can rival the range of interests and possible applications offered by electronics. And *Everyday Electronics* comes up with an exciting selection of designs every month. It doesn't do to miss even one month!

FERMENTATION INDICATOR...

An electronic bubble watcher for wine makers. Ingenious unit built into a conventional airlock. A flashing light tells all!



CLUNK-CLICK JOGGER...

This simple circuit warns the motorist to "belt-up". A wise safety precaution and it may soon be law! So be prepared with this electronic reminder.

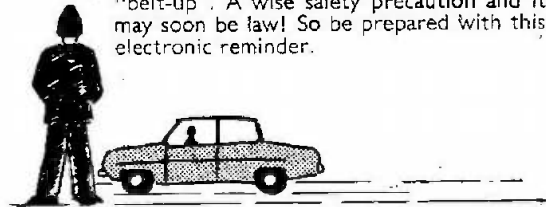

Also...

Capacitance, Inductance & Resonance Tester

and Electronic Thermometer

everyday electronics

August issue on sale Friday August 20

Don't risk missing your copy of next month's *E.E.* Place a firm order with your newsagent now!

TEACH-IN '76

By A.P. STEPHENSON

Part Eleven

INTRODUCTION

A.C. Theory is concerned with the behaviour of coils, capacitors and resistors towards voltages and currents which are varying in a sinusoidal manner. The equations which follow are true only for sinewaves.



11.1 THE SINEWAVE

The kind of voltage variation known as a **sinewave** is shown in Fig. 11.1a. There are several important features and check points which require understanding and memorising.

Peak voltage (V_p)

There are two peak voltages, one positive and one negative. The total voltage across these two peaks is called the peak-to-peak volts (V_{pp}) or by the more descriptive term "swing".

Root mean square or r.m.s. value (V_{rms})

The r.m.s. voltage is 0.707 of the peak value and is so useful in calculations that, unless otherwise stated, it is taken for granted that the term "voltage" means the r.m.s. value, i.e. there is really no need to write V_{rms} . The r.m.s. value of a sinewave is that voltage which a d.c. voltage must be in order to produce the same heating effect in a resistor.

Example

The peak value of the mains is actually 335 volts but 0.707 of this is 240 volts which is how the mains is usually described.

The Instantaneous value (v)

The instantaneous voltage is the voltage at some specified instant of time so it can only be represented by an equation involving time which is $v = V_p \sin 2\pi ft$ where t is the time elapsed since the last zero (which was reached by rising from a negative value). This last proviso is important because there are two zeros in a cycle.

The Average Value (V_{av})

Over a full cycle, the average value must be zero because the voltage is continuously changing its direction and never getting anywhere.

If we put a sinusoidal voltage across our voltmeter it would simply tremble around the zero volts mark

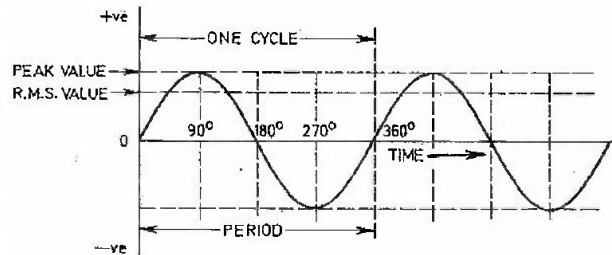

Fig. 11.1a. Important features of a sinewave.

because the inertia of the pointer would be unable to follow the changes of polarity. The average value over half a cycle is useful and mathematics tell us that $V_{av} = 2V_p/\pi = 0.64 V_p$ approximately.

The Period (T)

This is the time taken to complete one sequence of variation or "cycle".

The Frequency (f)

This is the number of cycles per second and is:

$$f = 1/T$$

The unit is the hertz (symbol, Hz, and is equal to one cycle per second).

The mains frequency is 50Hz, so its period is 1/50 second. Audio equipment has to deal with frequencies within the range 20Hz to about 20kHz, while f.m. radio is in the one hundred MHz range. Colour television is even higher frequency, but is low in comparison with radar.

The Time Axis

The horizontal time axis on the sinewave graph can be calibrated in actual time in seconds (or ms, μ s etc.). It is also convenient to divide it into degrees

in which case one cycle equals 360 degrees, half cycle equals 180 degrees and so on. The more scientific way is to divide it into radians: one radian is equal to 57 degrees of arc, and one cycle equals 2π radians.

11.2 THE REACTANCE (X)

When a sinusoidal voltage is applied to a resistor the current flowing is calculated by normal Ohm's law and the frequency is unimportant.

With coils and capacitance however, the current which flows is absolutely dependant on frequency. Another fundamental difference is the manner in which the current is opposed.

Resistors oppose current simply by a kind of molecular friction leading to heat, but coils and capacitors oppose by developing a voltage which is acting against the supply. This "back voltage" effect is called **reactance** but is measured in "ohms".

Inductive Reactance (X_L)

Inductive reactance (see Fig. 11.2 (a)) is the opposition in ohms of a perfect coil, i.e. no winding resistance. Such a coil, although not quite achievable in practice, will in future be called an **inductor** or sometimes an **inductance**. The formula for calculations is

$$X_L = 2\pi fL \text{ ohms}$$

Example

An inductance of 0.1 henry is across a 10 volt, 50Hz supply. The reactance of the inductance is $X_L = 2\pi \times 50 \times 0.1 = 10\pi = 31.4$ ohms. The current is therefore $I = V/X_L = 10/31.4$ amps = 0.32 amps.

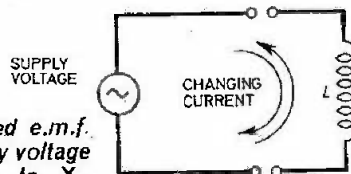

Fig. 11.2a. The induced e.m.f. just balances the supply voltage acting in opposition to X_L ohms.

Capacitive Reactance (X_C)

It is difficult to imagine how a capacitor, which is essentially two plates separated by an insulator, can pass a current. The answer is simple—it can't! At least it can't pass current straight through, but by virtue of its capacity to store electrons, a current can flow into its plates and out again see Fig. 11.2b.

Thus an a.c. voltage across a capacitance causes a continuous flow of electrons into and out of the plates

Fig. 11.2b. The current flowing is just enough to produce a voltage across C which balances the supply. The opposition is X_C ohms.

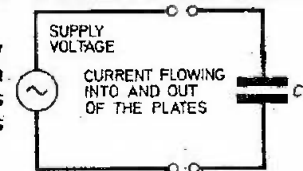

so, because we define a current as a flow of electrons or charges, there must be currents circulating. The higher the frequency the greater the circulation so it is not altogether surprising to learn that:

$$X_C = \frac{1}{2\pi fC} \text{ ohms}$$

(The higher the frequency, the less the opposition.)

It is very important to have at your fingertips how X_L and X_C behave to changes of frequency. Although the formulae themselves give this information, it is often more informatively shown in the form of a graph as in Fig. 11.2c. These two points should be noted (i) for zero frequency, X_C is infinite but X_L is zero (ii) for infinite frequency, X_C is zero but X_L is infinite.

The graphs are shown for some constant values of C and L, but it should be clear from the equations that X_L increases with the value of L but X_C decreases with the value of C.

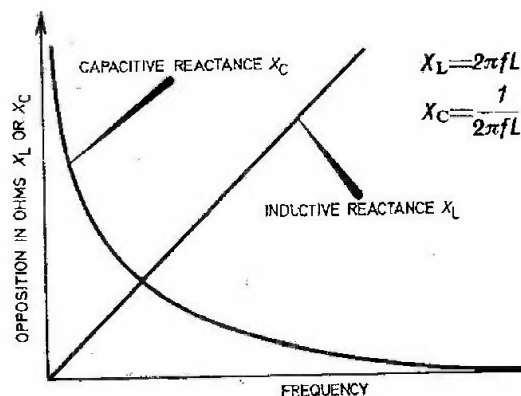

Fig. 11.2c. Graph showing how X_L increases but X_C decreases with frequency.

11.3 PHASE ANGLE (θ)

The phase angle is the fly in the ointment to students of a.c. and is responsible for the sickening number of equations which pollute the pages of text books. It is all due to the inherent laziness of current in inductive circuits (see previous graph of L/R time constants Fig. 10.3b) and the laziness of voltage in capacitive

circuits (see graph of C/R times constants in Fig. 4.6a).

The current in a pure inductance is always lagging behind its voltage by exactly 90 degrees but in a capacitive circuit it is the voltage which is lagging behind its current by 90 degrees. It is conventional however to state (and remember) these facts in a

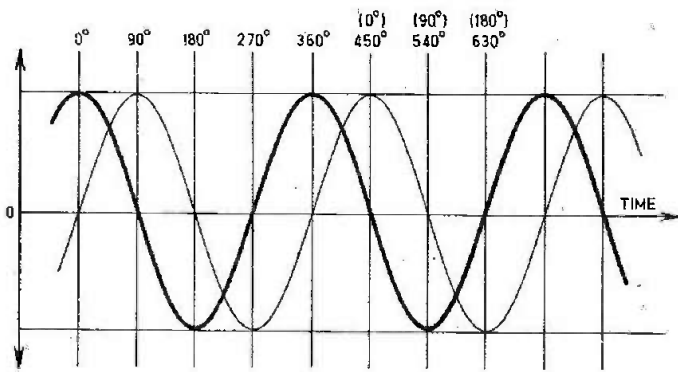

Fig. 11.3a. Phase difference between sinewaves. The "heavy" curve is "leading" the "light" one by 90 degrees, so the latter is "lagging" by 90 degrees.

slightly different way: Current Lags in inductive circuits Current Leads in capacitive circuits.

This is illustrated in Fig. 11.3a but does require a little assistance. A "leading" waveform is one which reaches its positive peak first!

It has been customary for many years to represent

these angle differences ("phase-angles") by vector diagrams, i.e. straight lines drawn at some fixed angle to each other. To distinguish between lag and lead, which after all are purely relative terms, the convention is that "all vectors are assumed to rotate anticlockwise"; Fig. 11.3b shows how vector diagrams can be used to show phase angles between voltages and currents.

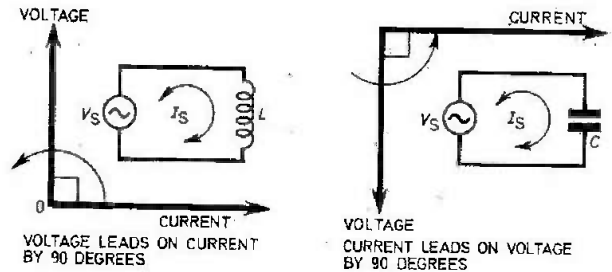

Fig. 11.3b. Phase angles in vector notation.

11.4 IMPEDANCE (Z)

It is very seldom that practical circuits will contain only a single capacitor or inductor, in most cases there will be mixtures which include resistors as well. The general term for any mixture of either X_L , X_C , or R is called **impedance** and because it represents the combined opposition, is measured in ohms. For any complex network, the current is always,

$$I_s = \frac{V_s}{Z}$$

where V_s is the supply voltage and I_s is the supply current.

The trouble is finding Z for a particular network because here we meet some weird kind of arithmetic. For example we might expect that a 3 ohms resistor and 4 ohms inductive reactance in series would have an impedance of $3 + 4 = 7$ ohms. But this would be ignoring the effects of phase angle.

The current through and the voltage across a resistor are in phase with each other but a reactance

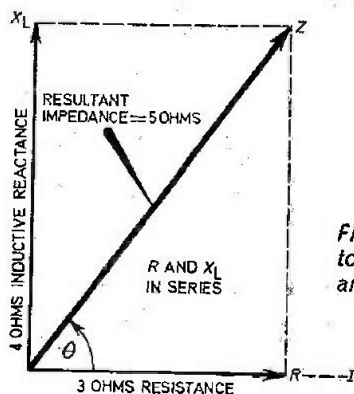

Fig. 11.4a. Using vectors to find impedance of R and X_L in series.

such as X_L has a 90 degree phase shift between its voltage and current. When we draw the vector diagram for such a combination and perform a little pythagoras we find that the resultant opposition Z is $\sqrt{(3^2 + 4^2)} = 5$ ohms instead of 7, see Fig. 11.4a.

For X_C and R in series, see Fig. 11.4b. Those of us who remember a little trigonometry will see that the angle between Z and the reference dotted line I can be found from the equation,

$$\Theta = \tan^{-1} \frac{X}{R} = \tan^{-1} \frac{4}{3} = \tan^{-1} 1.33$$

which from mathematical tables yields $\Theta = 53.13$ degrees. (Anyone who can't be bothered with trigonometry needn't worry—just draw the ohms to scale and measure the resultant Z with a ruler and the angle with a protractor).

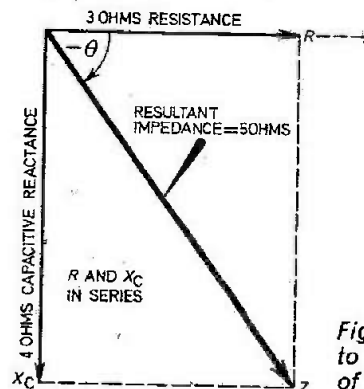

Fig. 11.4b. Using vectors to find the impedance of R and X_C in series.

From all this we can write general equations as follows:

$$R \text{ and } X_L \text{ in series } Z = \sqrt{(R^2 + X_L^2)}, \Theta = \tan^{-1} \frac{X_L}{R}$$

R and X_C in series $Z = \sqrt{R^2 + X_C^2}$, $\Theta = -\tan^{-1} \frac{X_C}{R}$

We can also draw vectors which illustrate how voltages divide and they would be exactly the same as in Fig. 11.4a and b, except the horizontals would be V_R , the verticals V_L or V_C and the resultant V_S ; Fig. 11.4c shows the voltage distribution for a 5 volt supply across a 3 ohms resistor in series with a 4 ohm inductive reactance. To justify this we note that $Z = \sqrt{3^2 + 4^2} = 5$ ohm which makes the current $I = 5 \text{ volts}/5\text{ohms} = 1$ amp. This makes $V_R = IR = 3$ volts and $V_L = IX_L = 4$ volts.

Some readers will, quite rightly, look at the voltages of Fig. 11.4c with horror. What has happened to old Khirchoff—why don't the voltages add up to 5 volts?

The answer is that Khirchoff in a.c. theory must be re-worded to "the Vector Sum of the voltages must

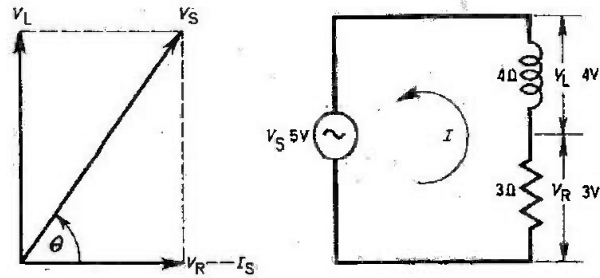

Fig. 11.4c. Voltage vectors of a series LR circuit.

equal the supply voltage". In general if A and B are at right angles, the vector sum is $\sqrt{A^2 + B^2}$ instead of $(A + B)$.

THE OPERATOR (j)

A useful little dodge to simplify the appearance of vector sums and to aid their manipulation is to introduce operator j . The symbol j before a number (or symbol) means rotate 90 degrees anticlockwise. Thus instead of drawing a vector diagram for R , X_L and Z , we can convey the same information by writing

$$\dot{Z} = R + jX_L$$

Also, by using $(-j)$ to represent 90 degrees clockwise rotation the equation for R , X_C and Z may be written as, $\dot{Z} = R - jX_C$.

(The "dot" over the \dot{Z} is a warning that the equation is in vector form). Equations written in this way are called *Rectangular Form*, i.e. in terms of the rectangular components of the resultant. The j terms are called **imaginary** to distinguish them from the non j terms which are called **real**.

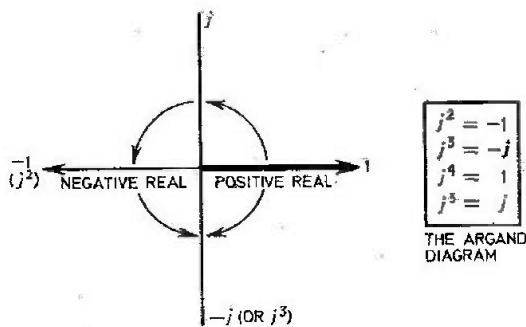

Fig. 11.5a. The so-called Argand diagram.

Resistances are always drawn horizontally and reactances vertically in vector diagrams, hence horizontals are real, verticals are imaginary. The Argand diagram of the system is shown in Fig. 11.5a, which may help to explain these absurd terms. If j means rotate 90 degrees, then $(j \times j)$ brings the vector to -1 which means $j^2 = (-1)$ or $j = \sqrt{-1}$. But mathematicians refuse to believe in the square root of a negative number so they say that j is imaginary. An unfortunate choice of terms because there would be nothing imaginary about the coffin

Everyday Electronics, August 1976

if you touched $j1000$ volts!

There is an alternative method of expressing a vector known as *Polar Form* in which the resultant is given in the form of a magnitude (called the modulus) and an angle (called by another silly name, the argument). Thus a polar form equation would look something like

$$\dot{Z} = |Z| \arg \Theta \text{ or } \dot{V} = |V| \arg \Theta$$

A numerical example may help the understanding and to distinguish the difference between polar and rectangular form.

Example

A series combination of 3 ohms resistance and 4 ohm inductive reactance would be written in rectangular form as $Z = 3 + j4$. If we now convert to polar form it becomes

$$\dot{Z} = \sqrt{(3^2 + 4^2)} \arg \tan^{-1} \frac{4}{3} = |5| \arg 53^\circ$$

It is a little more difficult to convert from polar to rectangular but study of Fig. 11.4a plus a little elementary trigonometry will show the method; If $\dot{Z} = |5| \arg 53^\circ$ then $R = 5\cos 53^\circ$ and $X_L = 5\sin 53^\circ$ which gives $\dot{Z} = 3 + j4$ back again.

Those of you who possess scientific calculators may be able to perform these conversions direct—it is becoming quite common place for these devices to include "Polar to Rectangular" (or vice versa) at the touch of a button.

More Complex Examples

Previous calculations have been simple in two respects, (a) the chosen figures 3, 4, and 5 is a natural set of numbers which ensures easy arithmetic and (b) only two components at a time were involved.

If a multitude of series components are to be handled, the rule is, "add the resistors, then add the j terms separately until the network reduces to one resistor and one reactance in the form $Z = R + jX$. To find the resultant impedance and phase angle simply convert this to Polar Form.

TEACH-IN '76 EXPERIMENTS AND EXERCISES

EXPERIMENT 11A

To demonstrate half wave rectification.

WARNING

These experiments involve connecting the bell transformer to the domestic electricity supply. So it is wise to learn an elementary rule at the outset.

This rule is just the common sense acceptance that 240 volt 50Hz mains is lethal and no experiments or voltage measurements must be carried out on the primary 240 volt side of the bell transformer. If you have no previous experience or are very young, it is wise to enlist the aid of someone experienced to connect up the primary cable and the mains plug for you.

Always switch off at the mains when making adjustments and keep the plastic cover in position on the transformer.

PROCEDURE

1. Assemble the components as shown in Fig. 11A.1 using twin mains cable from the primary to the live and neutral of the plug. Leave the switch on the Circuit Deck in the off position. The speaker and capacitor will be used later.
2. Insert the mains plug and switch on the mains. Wait a few moments, keeping an eye out for smoke or other signs of protest from the transformer.
3. Close the switch S1 and lamp LP1 should light which proves two things—the transformer is doing its job and the secondary circuit is safe because if there was a lethal voltage the lamp would have blown.

Fig. 11A.1. Wiring details and theoretical diagram for Experiment 11A.

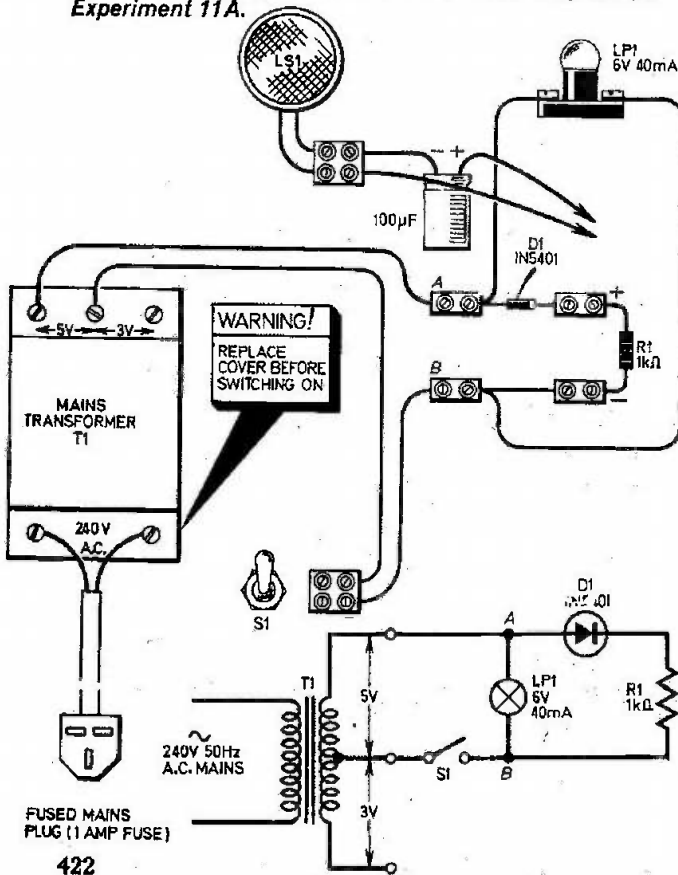

422

4. Using the meter on the 10V range, measure the voltage across AB. The meter should read zero because the 5 volts present is pure a.c. which has an average value of zero.

5. Connect the speaker with the 100µF capacitor in series across AB, and note the faint 50Hz hum. The speaker, due to its very small size, is capable of responding efficiently to such a low frequency. If you have a larger speaker you can try it out but remember the power dissipation! If your speaker has say an impedance of 8 ohms, direct connection across the 5 volts r.m.s. winding would deliver a power of $(5/8)^2 = 3.13$ watts. If your speaker is less than this power rating the speech coil may be damaged. It would be wise to connect the 50 ohm potentiometer in series to reduce the power if there is any doubt. Disconnect the speaker before continuing with the next step and unscrew the lamp.

6. Measure the voltage across the 1 kilohm load, R1. Because the diode is now in series producing half wave rectification the meter should read the average voltage which is V_p/π minus the small drop across the diode. The transformer is stated to deliver 5 volts r.m.s. which is $5 \times 1.41 = 7.07$ volts peak and therefore $7.07/\pi = 2.25$ volts average. Allowing for the diode volts drop expect something around 2 volts although reasonable deviation should not cause undue alarm (or disgust with a.c. theory) because bell transformers are not high accuracy devices—neither is the mains supply.

7. Connect a 1000µF capacitor in parallel with the load resistor R1 (remembering an electrolytic has polarity). This should bring the d.c. voltage across the load almost up to peak volts because of the reservoir action. Measure this voltage, which should be around $5 \times 1.41 = 7.07$ volts. Note the capacitor has about trebled the voltage available.

EXERCISES

11.1 An 0.1 henry coil is carrying a.c. current at a frequency of 500Hz. What is the inductive reactance?

11.2 At what frequency will a 100µF capacitor have a reactance of 10 ohms?

11.3 If the r.m.s. voltage is 20V what is the peak to peak voltage?

11.4 If a 230 volt supply is across a 1000 ohms impedance, what current will flow?

11.5 Write the impedance (in rectangular form) of the following circuits:

(a) $R=8$ ohms; $X_L=3$ ohms; $X_C=7$ ohms

(b) $R=22$ ohms; $X_C=17$ ohms; $X_L=5$ ohms.

11.6 Convert to polar form:

(a) $Z=8+j34-j28$

(b) $Z=5+j10-j5$

Answers

11.1 31.4 ohms. 11.2 159Hz. 11.3 56.4 volts.
 11.4 0.23 amps. 11.5 (a) $Z=8+j3-j7$ (b) $Z=22+j5-j17$. 11.6 (a) $Z=10$ arg 37°. (b) $Z=7.07$ arg 45°.

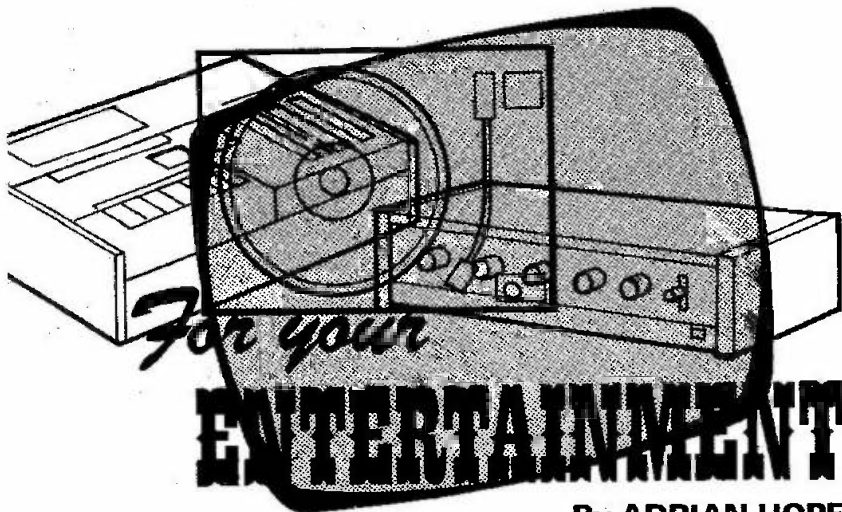

By ADRIAN HOPE

CITIZENS BAND

How long will the Home Office be able to maintain its position over refusing to allow Citizens Band Radio in the U.K.—and is its position justified or not? These are two questions which have already been touched on in this column and which we shall doubtless be returning to in the future.

To re-cap briefly, the Home Office has the power to say yes or no to CB radio in the U.K. and the Post Office is entrusted with enforcing the current nay. But although it is illegal to manufacture, import or use CB transceivers, they can quite legally be bought, sold and advertised.

The official reason for refusing to allow CB use is that although the sets are all nominally tuned only to the frequencies around 27MHz, they may generate spurious harmonics which interfere with normal reception of radio and television. But is interference really a real risk?

CB is now a way of life in the U.S.A. and several Continental countries (including Germany) and so far we have heard little about actual interference problems.

Also there has been a credibility gap in the U.K. on the whole business of interference since some very questionable arguments over "jeopardising vital services" were used to justify the legal sinking of the pirate radio ships. But if readers have any concrete evidence of CB interference problems, here or abroad, do please tell us.

REGULATIONS

A point little appreciated, but important to note, is that if anyone is contravening the laws of the airwaves it is probably the Home Office for refusing us permission to use the 27MHz bands for CB!

The Radio Regulations agreed by the International Telecommunication Union at Geneva in 1959 clearly set aside the 27MHz band for "industrial, scientific and medical" use and added the proviso that "radio communication services operating within those limits must accept any harmful interference that may be experienced from the operation of industrial, scientific and medical equipment". In other words, if you use the 27 megahertz band for voice communication you cannot complain that hospital equipment or bleep paging systems are interfering with you.

But the clear and inescapable implication is that we should be entitled to use the band for voice communication if we wish.

CREDIT CARDS

It is always interesting to see how different countries apply modern technology to everyday life. A friend staying recently at a large Paris hotel was given a perforated card and told it would answer his every need. Sure enough, it did.

In each bedroom a refrigerator contained drinks which could be released by the simple expedient of posting the card momentarily into the requisite slot. When he checked out of the hotel, he was

required to hand over the card to a girl, who posted it into another slot. Immediately an IBM golfball typewriter sprang into action and typed out and itemised (completely accurately) an account of every drink bought. All the "purchase" slots throughout the hotel were linked to a central computer.

I encountered a similar system recently in Japan. There, the hotel bedrooms were equipped with refrigerators which, at the push of a button, dispensed (very expensive) drinks. Each button was, again, directly linked with a central accounting computer.

In the lift of a Tokyo hotel one day I was worried by what appeared to be the sound of wild birds trapped in the lift shaft. Then I heard the same sound in the restaurant and again in the foyer. It turned out to be electronically produced imitations of wild birdsong. The irony is that in one of the ancient temples in Kyoto a much more pleasant sound of imitation birdsong is produced by the ages old system of mounting the floorboards on squeaky nails.

VIDEO GAMES

Video games are even more fashionable in Japan than here and on the Continent. In Osaka I noticed several amusement arcades with all manner of sophisticated extrapolations from the basic video ping-pong game with which we are all now so familiar.

One required a driver to steer the video image of a car round a tortuous track; another enabled him to shoot down UFO's; and another took the form of a rifle range, with a light sensitive rifle pointed at the screen obliterating a bright video target whenever a "hit" was scored.

The most fascinating of all gadgets was a colour video game, in which several contestants back the winner of a horse race. The console contains a range of different video cassette tapes (or more likely film cassettes scanned by a telecine system), which are selected and displayed on a large colour TV screen, completely at random. Each film is a version of a horse race, but with a different winner. To play the game the contestants place a bet to predict the winner; and there is automatic pay-up to whoever has backed the display on the screen.

Your Career in **ELECTRONICS**

By Peter Verwig

THE ROYAL NAVY

A career in electronics is an exciting prospect! Month by month our contributor Peter Verwig explains what working in electronics is all about, how to prepare yourself for a rewarding career, and the job opportunities available in the world's fastest growing industry.

IN THE April 1976 issue of **EVERYDAY ELECTRONICS** I described a career in the Merchant Navy as a ship's radio and electronics officer. A few readers, nearing or at the end of their courses, wrote that they were having great difficulty in getting an appointment and expressed the opinion that the tone of the article was far too optimistic.

Of course they were right on the first point and the reason is not hard to find. A large number of ships have been laid up during the world trade recession and, because of the shortage of jobs ashore, many sea-going officers have naturally tended to stay in their present positions who would otherwise have elected to leave the service and created more sea-going vacancies.

On the second point, that of presenting the story in a tone of optimism, it needs to be remembered that a young person start-

ing a course now would not complete training until 1978 and by that time we all hope that world trade, on which we all depend for our prosperity, will once again be at a high level of activity.

EMPLOYERS CHOICE

The present situation is that for nearly every form of occupation the balance is in favour of the employer. From a stream of applicants for every vacancy he can pick and will pick only the cream and quite wisely so. That is why I have stressed over and over again the importance of obtaining professional qualifications.

It may be true that a person without, say, ONC can do a particular job equally as well as a person with ONC or even HNC, but when applying for a job at least your prospective employer knows that you have the ability

to absorb knowledge, have been able to express yourself well and demonstrate your knowledge and skill through an examination process and, as you have the proof in the form of a certificate, he can concentrate on assessing factors like personality and enthusiasm.

Remember too, that all employers have to be much more careful these days in their selection of people. A few years ago an employer, if he took on a "bad egg" by mistake, could easily rectify matters by the simple expedient of instant dismissal. Today the employer is far more circumscribed in what he can do.

It is right that employees should enjoy protection from unfair dismissal and have other forms of protection but this has had its effect in making employers far more selective in the first instance.

This month I have chosen the Royal Navy as a career for intelligent young people who like the idea of long term security laced with an active and often adventurous life. The Royal Navy will train you in electronics, encourage your promotion up through the ranks, will look after you in sickness and health, pay you well while you are serving and give you a cash gratuity or pension, or both, when you leave depending on your length of service.

ENLISTING

But don't imagine that you can just walk into a recruiting office and sign on in one of the Royal Navy's technical branches because these are regarded as being for

Sea King, anti-submarine warfare helicopter.

Computer Assisted Action Information System (CAAIS) installed in H.M.S. Torquay.



the elite. The Royal Navy is just as careful as any civilian employer in selection of engineering recruits. In fact more so, because as well as the natural intelligence to succeed in a trade, the Royal Navy also looks for character and leadership qualities and a high standard of physical fitness.

If you are accepted, you represent a very heavy investment in training and re-training throughout your career and such investment is not made lightly. And because of its heavy investment in people, the Royal Navy tends to favour the long-service engagement.

THE ROLE OF THE NAVY

In thinking about the Royal Navy as a career you will no doubt reflect on the fact that there is great pressure from some quarters for cuts in defence expenditure and this may lead you to believe that a naval career has little long-term prospect. This is not so.

The form of the Royal Navy may change in response to new tasks and new defence technology, as it has done ever since the days of Nelson, but the need for an efficient navy is as great as ever it was. In fact new tasks are at hand in the protection of Britain's oil installations in the North Sea and possibly in the Celtic Sea if oil or natural gas is found there, and the Royal Navy's role in NATO is well established and the need for strong participation is increasing rather than diminishing.

It is true that in numbers of ships the Royal Navy of today shows a big reduction, but this is more than compensated for by increases in mobility, more effective sensors of all types, and infinitely more powerful weapons systems.

ELECTRONICS AFLOAT

Perhaps the best example of how electronics has now dominated naval operations in the past twenty years or so is that the ship, except for the smaller sizes, is no longer fought from the traditional bridge but from an operations room below, which is crammed with electronic displays and data-processing equipment. This is the nerve centre which accepts all the inputs from the ship's own radars and sonars,

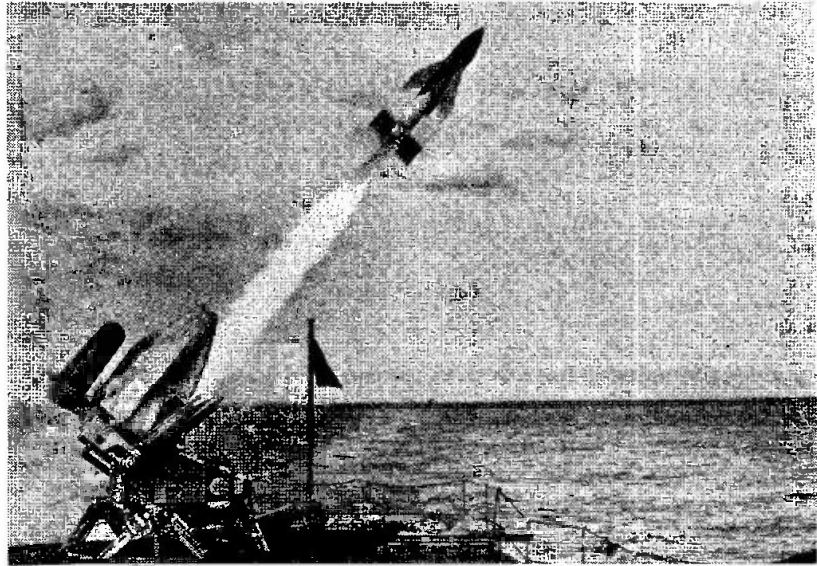

A Shorts Seacat surface-to-air missile leaving the launcher.

from other friendly naval forces and air support, where all movements of friend and foe are tracked, threats evaluated with the aid of computers, and appropriate weapon deployment decided.

A complete action can be undertaken without actually seeing an adversary with the naked eye, the whole tactical situation being displayed electronically and the weapons trained onto targets and fired automatically.

Action Data Automation (ADA) systems of this type may be of varying complexity depending upon the level of computer participation. For example, a comparatively low-cost system may employ only computer assistance rather than a fuller measure of control and the system then becomes a Computer Assisted Action Information System (CAAIS) which still retains a high level of human decision-making.

Some idea of the complexity of such equipment can be gathered from the digital display system ordered from Plessey for H.M.S. Invincible which alone represented a contract worth £1 million.

If we turn to another area, naval communications, we find equally dramatic advances. The Royal Navy was the first in the world to have a fully operational shipboard satellite communications system. This is the SCOT system, supplied by Marconi and operating through the Skynet II military communications satellite, also built by Marconi, launched in November 1974 into geostationary orbit 22,000 miles up over the Indian Ocean.

In the more traditional sphere

of radio communications, modern technology in the Royal Navy is based on the Integrated Communication System Stage 3 (ICS3), a modular system which can be built to any degree of complexity. It can not only provide all the external radio links ship-to-ship, ship-to-shore, and ship-to-air for tactical and strategic use in the low, medium and h.f. bands but also has an interface to v.h.f. and u.h.f. systems and controls distribution of messages and facilities throughout the ship.

Various users, for example, can be rapidly switched to any equipment. A feature is a telegraph message handling system with electronic storing and sorting of messages.

ICS3 has been such a marked success that a similar system is to be fitted to the next generation of warships under construction for the Royal Netherlands Navy "S" class frigates.

It would be quite easy to take up the whole of this article with brief reviews of other technical developments in surveillance, target illuminating and tracking radars, in underwater sonar equipment, and in missile guidance systems, or even in new advances in ship's navigation systems. Let it suffice that for any given volume of space, the modern warship will have a higher density of electronics than is to be found anywhere except, perhaps, in a modern military aircraft such as the MRCA Tornado.

FIGHTING FIT

What emerges from the above is that the Royal Navy needs men with exceptional skills to

keep this technical equipment (on which it is now wholly dependent) in fighting fitness.

If you believe you have good ability, your prospects can be bright as an artificer which involves a four-year apprenticeship.

The artificer in the Royal Navy is primarily a technical manager able to trace faults himself and to direct the necessary repairs. If he stays in the ranks he can rise to Fleet Chief Petty Officer drawing over £80 per week but many artificers graduate to officer rank and nearly half of all engineer officers in the Royal Navy started their careers as artificers.

QUALIFICATIONS AND REQUIREMENTS

All artificer candidates must be between 16 and 21 years old and they are selected by interview and aptitude tests at a Naval Careers Information Office of which there are some 60 throughout the British Isles.

Successful candidates (who must be medically fit) are then required to pass a written qualifying examination in three subjects, Mathematics, Science and English, unless they are exempted by having appropriate passes at "O" levels or their equivalent. Details of the exemptions and copies of previous examination papers can be obtained at R.N. Careers Offices.

If you already have four "O"

Plessey Type 195 Dunking Sonar fitted in a Sea King helicopter.

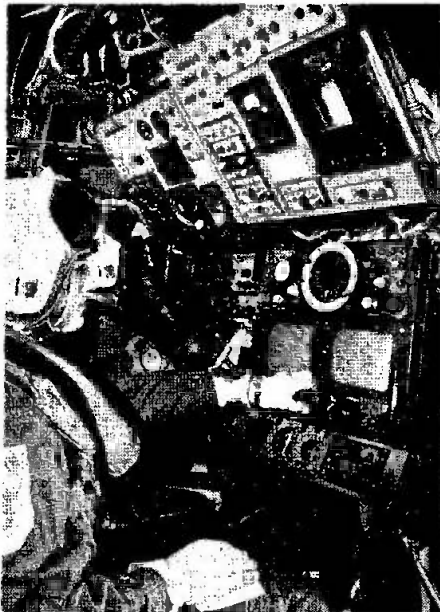

levels (including mathematics and a science subject) you might qualify for a shorter training period and, thus, faster promotion.

All artificer apprentices spend their first year at H.M.S. Fisgard at Torpoint near Plymouth which, with naval overtones, is very much like a technical college accommodating some 500 students.

From the start the apprentice artificer wears the appropriate uniform, the double-breasted jacket and peaked cap. His duty time is broadly divided into 45 per cent in the classroom, 20 per cent in workshops and the remainder on general navy training and other activities including sport. He may also spend a week at sea. There are three terms in the year with 21 days' leave at the end of each term.

After the first year, students go for advanced training to one of three establishments, H.M.S. Caledonia, H.M.S. Collingwood or H.M.S. Daedalus. The first is for marine engineering, the second and third, respectively, for advanced training in weapons and aircraft and it is in H.M.S. Collingwood or H.M.S. Daedalus that future electronics artificers are to be found.

The specialities of particular interest to readers of E.E. are Control Electrical Artificer, Radio Electrical Artificer, Radio Electrical Artificer (Air), and Electrical Artificer (Air).

ACTIVITIES

The titles conceal rather than reveal the scope of activities. The control artificer, for example, looks after the electronic computer, the navigation equipment and submarine detector equipment, while the radio artificer not only has responsibility for the general radio communications equipment but also surveillance radars and other specialised equipment including that used for signal cryptography.

One problem is getting a place in the speciality of your choice. Your aptitude will be assessed during your first year but there is also the question of immediate vacancies and the future requirements of the Service. In practice about 80 per cent of apprentices get their first choice and anyone with a real flair for electronics should manage to get into one of

the four electronics categories even if not one of their first choice.

On completion of his third year the young apprentice is promoted Artificer 3rd Class which is Leading Rating. The following year he becomes Artificer 2nd Class (Petty Officer) and after one or two years more he may expect to become Artificer 1st Class, Chief Petty Officer at the age of 23 or 24, drawing pay of some £70 per week.

MECHANICS

If you are too old for entry as an artificer apprentice or feel you are not quite up to the standard, you can join as a mechanic at any age between 16 and 33 and still get your training at H.M.S. Collingwood or H.M.S. Daedalus. If you are showing particular promise you may be selected for advanced training to artificer standard and attain P.O. or C.P.O. rank, but you can also reach these ranks as a mechanic or mechanician.

DEGREE COURSE

If you are a high-flyer in the academic sense you can read for your engineering degree with the Royal Navy and get a commission. The Royal Naval Engineering College runs degree courses or you can take a University Cadetship, and read for a degree at the university of your choice, spending up to six weeks a year in the RNEC workshops. It is also possible to enter the Royal Navy with a commission if you have already graduated.

One of the first questions potential recruits ask is "if I join am I stuck with what may become a lifetime of misery? Can I change my mind?"

The last thing the Royal Navy wants is unhappy people. Yes, you can opt out with an early discharge during your initial period of training but you may have to pay £20 for the privilege.

You may also, when signing on, opt for what is called a Notice Engagement which allows you to give 18 months' notice of intention to leave.

The Career Engagement runs for a full nine years plus 12 years on reserve with the option of signing on for longer periods. The Career Engagement carries a higher rate of pay.

Everyday Electronics, August 1976

**New products and
component buying
for constructional
projects**

SHOP TALK

By Brian Terrell

FROM time to time we feature in *Everyday Electronics*, circuit designs for musical effects units such as Fuzz, Waa-Waa, Tremolo etc. for use with electric guitar, electronic organ etc.

A problem encountered by many designers and constructors is finding a suitable case to house the completed circuitry. Ideally the case needs to be of metal for screening purposes.

Normally effects units are to be situated on the floor to be operated by foot (for speed and convenience) and so must be of robust construction and able to take a "bashing", with the top panel strong enough to hold a footswitch. Another important factor is that the case size should not be too large, but large enough to house a component board, reasonable battery size, several controls and input and output sockets—usually jacks. Finally the cost of the case must be reasonable.

With these requirements known,

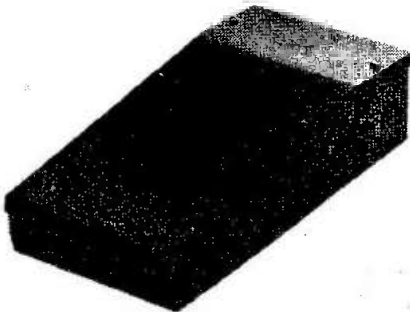

Photograph of a prototype version of the Olson type M20 case. The production models will have countersunk screws.

Everyday Electronics, August 1976

Olson Electronics have made available the case shown below in the photograph. The case has a gentle sloping front panel suitable for mounting a footswitch, made from 18 s.w.g. steel plate; the base, internal welded edges, is made from 20 s.w.g. steel plate.

The size of the case is 205 x 100mm being 50mm tall at one end and 25mm at the other. The lid is removable. The case is designated M20 and is hammer finished in a range of colours comprising orange, blue and silver-grey. The cost is £2.60 including V.A.T., post and packing and is available from Olson Electronics Ltd., 5-7 Long Street, London E2.

2W Amplifier

Although there is a high component count for the *2W Amplifier* project, no difficulties should be encountered in obtaining them. The transformer used in the prototype and shown in the wiring up diagram appears somewhat unusual on the primary side. In fact the type used had two 0-120V windings connected in series.

The "triple" input sockets used are not essential and single ones may be substituted. The case used to house the unit is a matter of individual choice but for those readers who wish to use the one in the prototype, this can be obtained from H. L. Smith, Edgware Road, London.

Couples

To enable the components to be fitted in the case chosen by the author for the *Couples Electronic Game*, the choice of components was rather limited to miniature types which tend to be expensive. If the size of the case is unimportant to the constructor, then standard, and cheaper components may be used.

The most expensive single item in the unit is the Bleepone. If one looks through the advertisements and/or in local electronic component shops, many cheaper audible alarms such as buzzers and bells will be found.

As mentioned in the article, the d.p.d.t. toggle switches may be replaced by the relatively cheap and readily available slide types. The battery voltage and its capacity will eventually be determined by the audible warning device chosen which will also affect the bulb rating.

An alternative sounder has recently been introduced by ITT and is now available through R.S.T. Valve Mail Order Co., 16a Wellfield Road, London SW16 2BS. The sounder is a

piezo ceramic type which works from 5-16V, takes only 10mA and produces a clear penetrating tone. The price including postage and V.A.T. is £1.88.

S.W. Receiver

There should be no buying problems for the *S.W. Receiver* project. Your local Radio/TV repair shop should be able to help out with the supply of the valveholder.

You will note that a different coil is required for each of the ranges discussed in the article. If you have difficulty in obtaining these coils, you can obtain them from the manufacturers, Denco (Clacton) Ltd., 357/9 Old Road, Clacton-on-Sea, Essex. The costs are £1.08 for 1 coil, £2.00 for two coils, and £2.99 for all three. These prices include V.A.T. and post/packing.

Touch Sensitive Door Alarm

The components for the *Touch Sensitive Door Alarm* should not present any purchasing headaches. Note that the 3.3 ohm resistor called for is a high wattage type. If you use a lower wattage than specified your attention will be drawn to this fact by smoke rising from the unit.

Although an Eagle type M280 transformer is specified in the component list for this project, this is by no means critical as any mains/6 volt 250 to 300mA secondary will do. In fact the M280 has an additional secondary winding redundant in this application.

Help!

It helps us to help you if you *always* mention this magazine when purchasing parts for our projects—**wherever they are coming from.**



"Try counting the sheep in your head—not on your calculator."

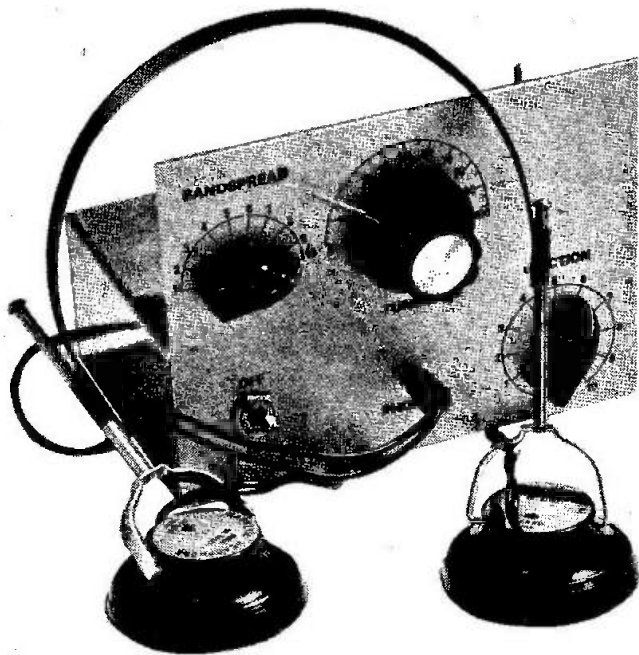

Beginners SHORT WAVE RECEIVER

Uses ready-wound plug-in coils for extensive range.

ALTHOUGH this receiver uses only a single active device (a field effect transistor), it provides reception of a large number of amateur and broadcast stations over a wide range of frequencies. Plug-in ready-made coils are used to extend the coverage. Frequency coverage is from approximately 1.67 to 31.5MHz in three ranges, the coverage of each band being approximately as follows:

Range 3 1.67 to 5.3MHz (180 to 57 metres)

Range 4 5 to 15MHz (60 to 20 metres)

Range 5 10.5 to 31.5MHz (28 to 9.5 metres)

The range numbers quoted are those used by the manufacturer of the ready made coil units.

As so few components are used in the design, it is very inexpensive and simple to construct. The current consumption from the PP3 battery is a little less than 1 milliamp, the receiver can be used extensively for many months before the battery becomes exhausted.

THE CIRCUIT

The complete circuit diagram of the receiver is shown in Fig.1.

Signals received by the aerial are coupled into the primary of L1. The tuned winding of L1 selects the signal at the desired frequency and

couples this into the gate of TR1, but it rejects other signals. Capacitor C1 provides an a.c. return to earth for one end of the tuned winding.

The potential divider formed by R1 and R2 provides a small forward bias to the gate of TR1, which is coupled to TR1 gate via the tuned winding of L1. Variable capacitor C3 is the main tuning capacitor, and C2 is the electrical band-spread capacitor.

The field effect transistor, TR1 operates as a regenerative detector, and consists basically of a grounded source r.f. amplifier having L2 as its drain load. This stage is purposely biased in such a way that it distorts the r.f. signal by amplifying one half cycle of the signal more than it amplifies the other. In this way it acts as a form of rectifier, and thus detects the r.f. signal.

The detected output appears at the junction of L2 and R3, and is coupled to the output socket via C7; C8 filters the r.f. content of the output signal leaving only the audio signal.

Decoupling for the source bias resistor of TR1, R4, is provided by C5 and C6; C6 provides decoupling at audio frequencies, and as electrolytic

By R.A. PENFOLD

capacitors are not very efficient at high radio frequencies a separate r.f. decoupling capacitor is used, and this is the function of C5.

Regeneration is applied to the circuit from the drain of TR1 via a third winding on L1. The level of regeneration is controlled by VR1, and C4 provides d.c. blocking.

Regeneration is the process of sending some in-phase r.f. signal from the output of TR1, back to the input for amplification for a second time. This will have the obvious effect of increasing the amplification of the circuit, and perhaps less obviously, it will increase the distortion level of TR1, and so increase the detection efficiency of the circuit.

If too much regeneration is applied, the circuit will oscillate continuously, and so VR1 is kept adjusted just below this point in order to provide the best sensitivity.

FOR
GUIDANCE
ONLY

ESTIMATED COST*
OF COMPONENTS

excluding V.A.T.

£8.00 including
coils but excluding
case

*Based on prices prevailing at
time of going to press

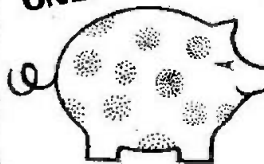

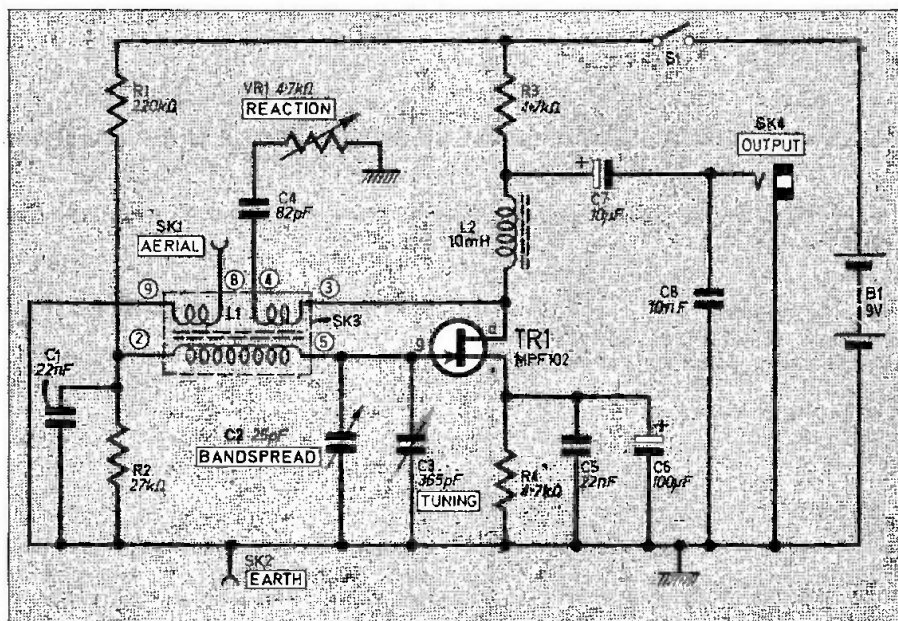

Fig. 1. Circuit diagram of the Short Wave Receiver.

METALWORK

The front panel of the receiver is home made from 18 s.w.g. aluminium, and is 150×115mm. The layout of the components on the front panel are shown in photograph below.

Construction of the front panel is quite straightforward, except for the three small mounting holes for C3. The positions of these are most easily located by making a paper or cardboard template using the front of C3 as a pattern. The three holes are all drilled for 4BA clearance, and are all countersunk. Three short 4BA countersunk screws, which, incidentally, are not supplied with C3, are used to mount the latter. Make sure that these screws do not penetrate too far so as to foul either its fixed or moving plates, and if necessary space it off the front panel slightly using some washers or 4BA nuts, so as to prevent this.

The 16 s.w.g. aluminium chassis measures 150×100×50mm (approx.), and can be purchased ready made. The front apron of the chassis is drilled to match the lower part of the front panel, and then SK3, S1, and VR1 are used to fasten the chassis and front panel together.

The rear apron of the chassis is drilled to take SK1 and SK2, and the battery mounting bracket, which is mounted by two short 6BA bolts.

A 19mm diameter hole is required for the coil-holder, and this is best cut using a 19mm chassis punch. The two smaller mounting holes for the coil-holder should be drilled for 6BA clearance using a No.3 twist drill, and their positions are located by using the coil-holder as a template.

Ensure that the pins of the coil-holder are orientated into the same position as those on

the prototype receiver, with pin 1 towards the front of the receiver, see Fig. 2. A solder tag is mounted on each of the mounting bolts of the coil-holder, on the underside of the chassis. A 3mm diameter hole is drilled near one of the tags of C3, where a lead connecting C2 and C3 to the under chassis wiring will pass through the chassis. Do not carry out any drilling while C2 and C3 are mounted on the panel, as this could easily result in them being damaged.

The general layout of the chassis can be seen clearly in the accompanying photographs, and although the exact layout is not critical, this general layout should be adhered to. Do not mount the coil-holder too far forward, or it will be difficult to wire it up.

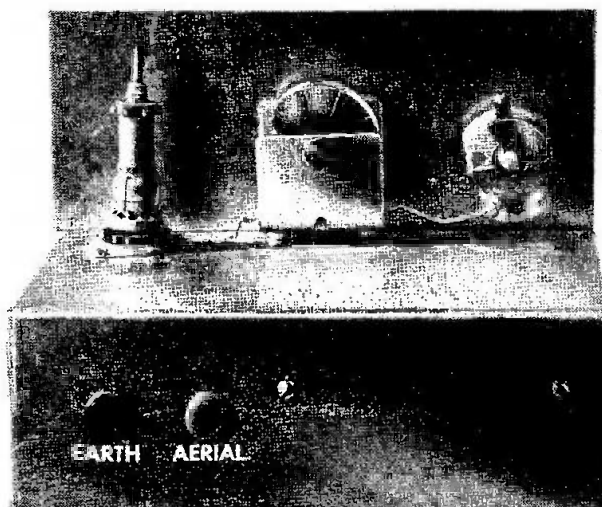

Rear-view of the prototype unit.

Components

Resistors

- R1 220k Ω
 - R2 27k Ω
 - R3 4.7k Ω
 - R4 4.7k Ω
- All $\frac{1}{4}$ W carbon $\pm 10\%$

**YIVAL
JOHS**
EES

Capacitors

- C1 22nF plastic or ceramic
- C2 25pF air spaced variable (Jackson C804)
- C3 365pF air spaced variable (Jackson type 00)
- C4 82pF polystyrene or ceramic
- C5 22nF plastic foil
- C6 100 μ F 10V elect.
- C7 10 μ F 10V elect.
- C8 10nF plastic foil

Semiconductor

- TR1 MPF102 *n*-channel field effect transistor

Miscellaneous

- VR1 4.7k Ω carbon lin.
 - S1 on/off toggle
 - L1 Denco miniature dual purpose coil
Green Ranges 3, 4 and 5 (3 off or as required)
 - L2 10mH r.f. choke (Repanco CH4)
 - SK1, 2 wander sockets 1 red, 1 black (2 off)
 - SK3 B9A unskirted valveholder
 - SK4 3.5mm jack socket
 - B1 9 volt type PP3
- Aluminium chassis size 152 x 100 x 50mm 16 s.w.g. or material to build; 18 s.w.g. aluminium for front panel and battery bracket; two pointer knobs; one large diameter knob for tuning; crystal earpiece (or headphones 4000 ohms) fitted with 3.5mm jack plug.

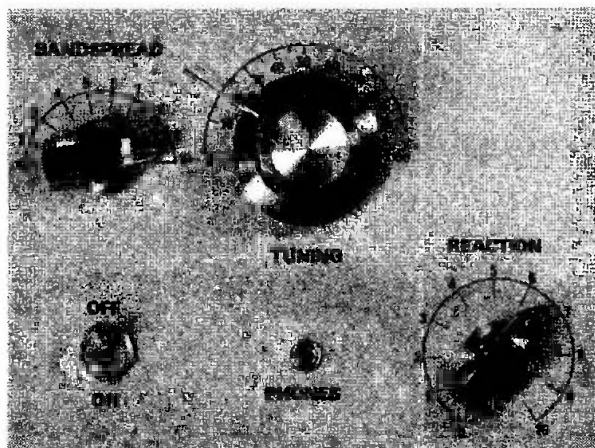

Photograph showing the front panel of the receiver.

length of insulated 7/22 or 18 s.w.g. aerial wire, set out of doors, and as high as possible. A length of 20 metres or more is preferable, although it is not an absolute necessity for the aerial to be quite this long.

A short indoor aerial will provide reception of a number of stations, but results will not be comparable to a proper outdoor aerial.

An earth connection merely consists of a metal plate, pipe, or other metal object having a fairly large surface area, buried in moist earth a couple of feet or so down. A short lead made from a fairly heavy gauge wire (aerial wire is suitable) is used to connect this to the receiver.

An earth is not really necessary for reception on Ranges 4 and 5, but is virtually essential for good reception on Range 3, as is a long aerial.

NOTES ON USE

When initially testing the receiver it is best to use Range 4. The desired range is selected by plugging the appropriate coil into the coil-holder. Plug a pair of high impedance headphones, or if preferred a crystal earpiece, into SK3, and switch the receiver on. Start with VR1 adjusted almost fully anticlockwise.

Adjusting the main tuning knob will probably provide reception of a few stations, and if VR1 is gradually advanced in a clockwise direction, the number of stations should increase. The volume from these stations will also increase. If VR1 is advanced too far the detector will break into oscillation, and there will be a tone of varying pitch as the set is tuned across a station.

For maximum sensitivity and selectivity VR1 should be adjusted just below this point. It will need readjustment virtually every time either C2 or C3 are adjusted, in order to keep the receiver properly peaked.

For the reception of c.w. (morse) and s.s.b. (single sideband) signals, VR1 should be adjusted just beyond the threshold of oscillation so that the detector is just gently oscillating. The

WIRING

A point to point wiring system is used, and is shown in Fig. 2.

Clean and tin the solder tags and leads of the components before trying to solder them. Where more than one component is connected between the same two points (as are R4, C5, and C6 for instance), they should first be connected together, and then soldered into the rest of the circuit. Make all the wiring as short and direct as possible, insulating the leads where there is any danger of a short circuit occurring.

To finish the receiver, transfers, including dials around VR1, C2, and C3 if required, can be affixed to the front panel as seen in photograph, and then the control knobs are fitted.

AERIAL AND EARTH

With any receiver of this type a good aerial is absolutely essential for good results to be obtained. A suitable aerial consists of a long

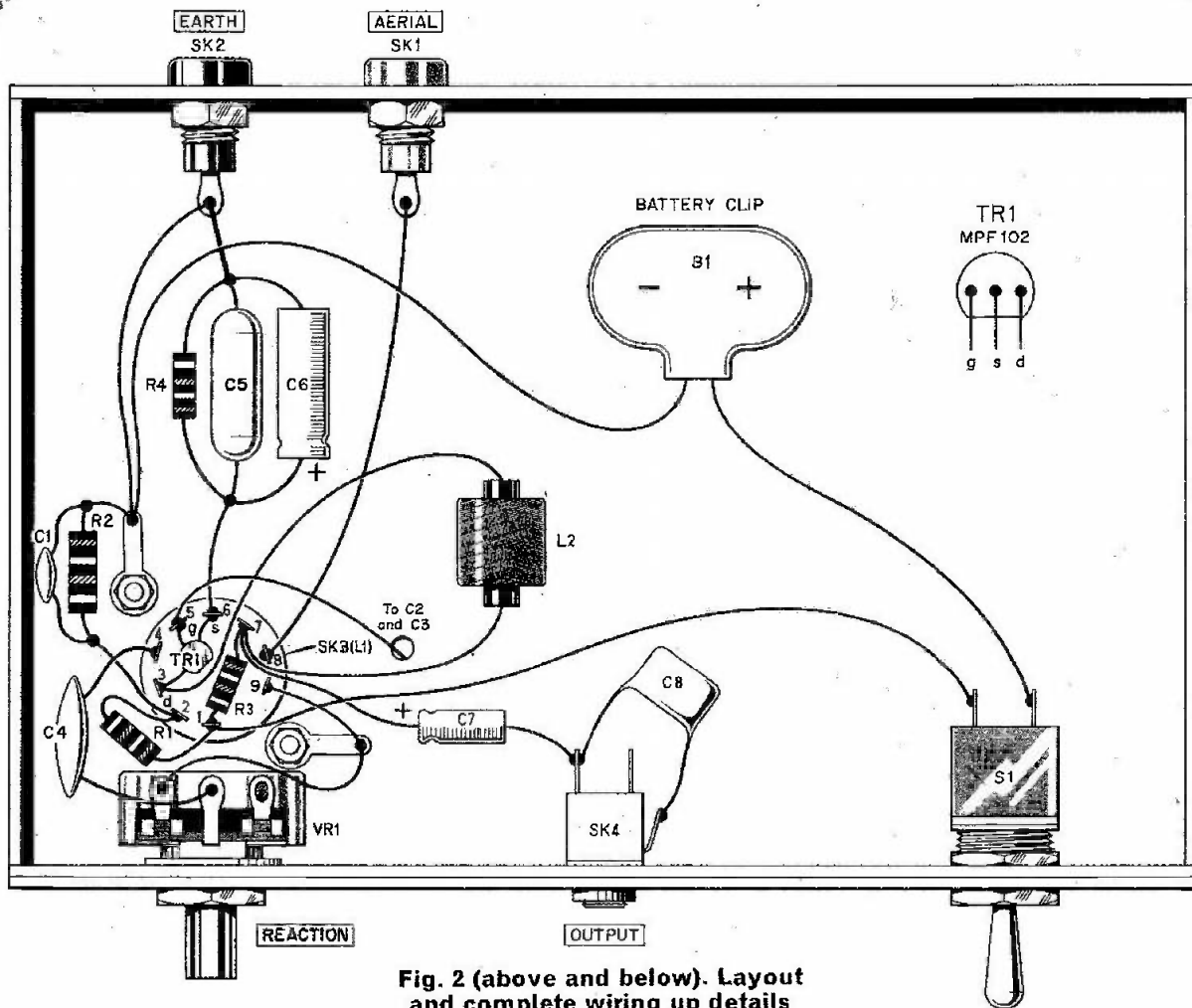
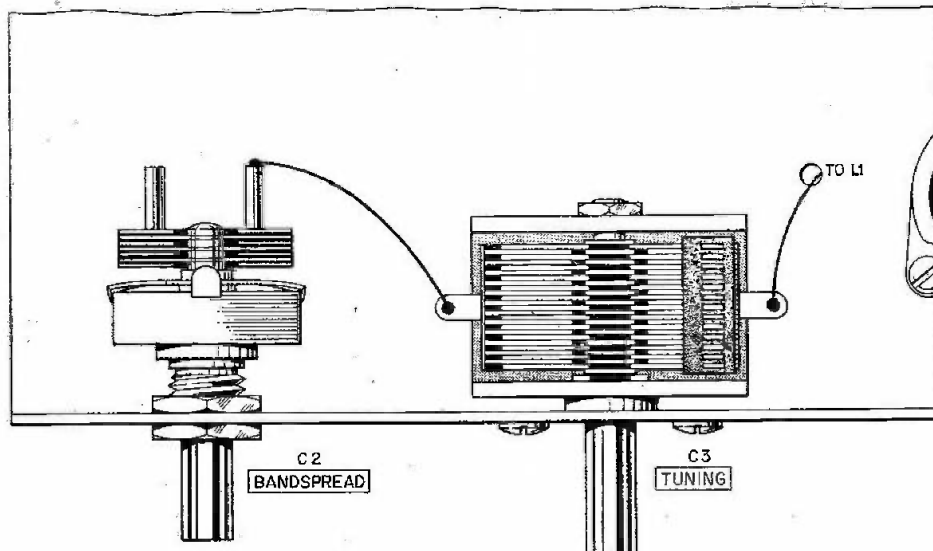

Fig. 2 (above and below). Layout and complete wiring up details of the receiver.



SHORT WAVE RECEIVER

bandspread control is then adjusted to give the required c.w. pitch, or in the case of an s.s.b. transmission, to clarify the signal.

On strong s.s.b. signals VRI can be further advanced if there is a loss of audio quality caused by the detector being swamped; c.w. and s.s.b. are the main forms of transmission used on the amateur bands.

Fine tuning is rather difficult using the main tuning control, and so C3 is set to the part of the band which is to be searched for signals, and then C2 is used to scan this area of the band. As C2 has a much lower value than C3, it only covers a small part of the range, and so tuning is much less cramped using C2.

Range 4 is likely to be the range of major interest as it contains most of the popular s.w. broadcast bands, and will usually provide reception of a number of interesting stations.

Range 5 provides reception of the h.f. s.w. bands, and the level of activity on this range will depend very much upon the prevailing atmospheric conditions at the time. Included in the coverage of this band is the 20 metre amateur band, which is the best amateur band for DX listening. Range 3 covers the trowler band, and will provide reception of numerous maritime transmissions. Probably of principal interest on this band though are the 80 and 160 metre amateur bands.

Note that the coils as supplied have their cores screwed right in. In use the core of the Range 5 coil should be adjusted so that about 4mm of the metal threaded part of the core is protruding from the top of the coil. The Range 3 and Range 4 coils are similarly adjusted, but so that about 10mm of this metal thread protrudes from the top of the coil. □



SOMETIMES wonder, if, while we have been dabbling into the realms of electronics, we may have inadvertently strayed into realms that the gods regard as their exclusive territory, and in return they are exacting a terrible revenge. I assure you it's all happening. They have placed on Earth an assorted group, of cretins, morons, and incompetents, put them in a little box at Westminster where they now control our fate.

The first step was to make them introduce a scheme of tax called V.A.T. This caused a fair number of bankruptcies, suicides, besides causing many component dealers to be incarcerated in asylums. This obviously failed to assuage the gods' anger, so they made the little men bring out a multi-rate V.A.T. and to complete the job shower us with regulation upon regulation of which I here give you a sample:

"Delete the whole of Note (4) and the operative date and substitute the following: (4) Item 1 of the items overriding the exceptions relates to item 1 of the ex-

cepted items; Items 2 and 3 of the items overriding the exceptions relate to item 2 of the exceptions and items 4 to 6 of the items overriding the exceptions relate to item 4 of the exceptions items."

Jolly stuff isn't it? You do not like it? Repeat it a second time, it might grow on you. To me it sounds like a Marx Brothers script, but more non-sensical!

Bear in mind this is one part, of one page, of one pamphlet, of which we have had so many in the last few years, that even laid flat, one upon another would now measure a foot high. The biggest joke is that this V.A.T. was supposed to simplify everything (their word not mine). Those of us who have survived have only done so by pretending it is not there. Well you know what they say, "Those whom the gods would destroy, they do first make mad."

Turning to more pleasant things which is not difficult, in my last article but one, I talked about exhibitions; now at least three of them are over. All splendid shows, but I will just briefly talk about

the last one at Birmingham International.

I mentioned that, due to British Rail, this would be as easy to visit as Olympia, and I was right. I boarded the train at Euston at 11.40 a.m., had lunch on the train, and at 1 p.m. as I was paying the bill, we were pulling into Birmingham International. I was very impressed with the sheer size of the halls, and my only criticism, is that I think a few more seats could be provided for the weary.

One aspect which depresses me, is the way the Postal Service has deteriorated lately. At the beginning of the month of May, all Sunday collections were discontinued and the last collection from my local box is now 5.15 p.m. instead of 6.45 p.m.

The amateur constructor is bound to depend on mail order services for 90 per cent of his wants, because even if he is London based, component shops are very few and far between, and the difficulty in the provinces must be even greater.

Now the most likely time he would be sending off his orders is the week-end. As it stands, unless he catches the early post Saturday morning, it will not be collected until Monday, which means that I and my colleagues will not receive it until Tuesday or Wednesday.

I think the only answer is, for other mail order firms to do as we have done. Arrange for their customers to open accounts, and then install an answerphone. We have run this system for about six years. It works extremely well, and I think the facility is much appreciated by the enthusiasts.

2 WATT AMPLIFIER

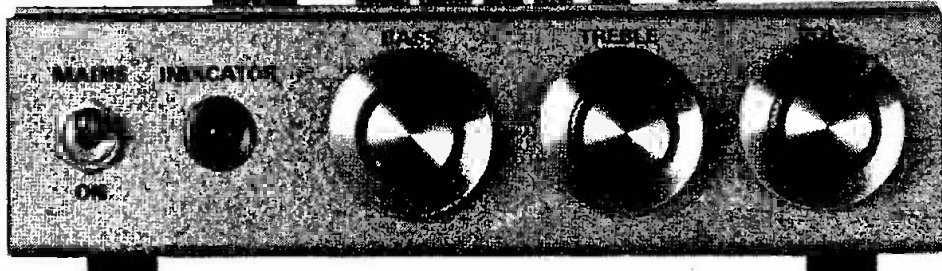

By
R.A. PENFOLD

A compact mono amplifier for a variety of needs.

AMONG the most useful and popular of electronics projects are the various types of amplifier that frequently appear in the amateur electronics journals. Although most of these are designed for some specific purpose, the amplifier described here is a general purpose unit which is equally well suited to being a workshop amplifier as it is to being used for entertainment applications.

When using an 8 ohm speaker a good quality output of up to 2 watts r.m.s. is available. The unit is mains powered but has a very low hum and noise output level.

The output power and distortion figures are not up to hi fi standards, but listening tests show that the unit provides a very acceptable volume and output quality.

A brief specification for the unit is shown in the table below.

There are three inputs to the amplifier, each providing a different input impedance and sensitivity. Together these should cater for most

signal sources, such as musical instruments, tuners, ceramic and crystal cartridges, etc.

CIRCUITRY

For the sake of simplicity the circuit has been based on an audio amplifier integrated circuit. Apart from reducing the number of components required, thus bringing the unit within the scope of the beginner, this also gives economic advantages over a discrete component equivalent. The complete circuit diagram of the amplifier is shown in Fig. 1.

The preamplifier is based on a common emitter amplifier, TR1; R6 provides a degree of negative feedback to this stage, which reduces noise and distortion and increases the basic input impedance of the stage.

Each of the three input sockets is coupled to the base of TR1 via its own series resistor, and d.c. blocking capacitor C2. The purpose of the series resistors is to increase the input impedance and reduce the sensitivity of the preamplifier to the required levels. These resistors, together with the input impedance of TR1, in fact form three simple attenuators.

There is some loss of treble response at inputs 1 and 2 due to the high values of R1 and

SPECIFICATION	
Input Sensitivity	} For an output of 2W r.m.s. into an 8 ohm load at 1kHz
Input 1 500mV into 1.25M Ω	
Input 2 200mV into 500k Ω	
Input 3 18mV into 50k Ω	
Signal to Noise	
67dB, all inputs open circuit, unweighted, maximum volume, flat response	
Frequency Response	
-0 to -3dB (with reference to 1kHz) 40Hz to 20kHz	
Total Harmonic Distortion	
0.9% for 1 watt into 8 ohms	
2.2% for 2 watts into 8 ohms	

FOR GUIDANCE ONLY

ESTIMATED COST* OF COMPONENTS
excluding V.A.T.

£8.00 plus case

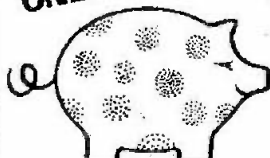

*Based on prices prevailing at time of going to press

R2 combining with the input capacity of TR1 to form a treble cut filter. The treble tone control can more than compensate for this loss, however.

The output from the collector of TR1 is coupled to the tone control networks via C3. These can provide both cut and boost of the bass and treble responses; VR1 is the treble control and VR2 controls the bass.

This is a passive tone control system and therefore has a considerable loss of signal between its input and output. However, the output stage is quite sensitive, and requires an input of only about 20mV for full output. This high gain is used to compensate for the losses in the tone control networks.

POWER AMPLIFIERS

The volume control (VR3) is fed from the output of the tone controls and in turn feeds the non-inverting input of the integrated circuit type TBA820.

Negative feedback is internally applied to the inverting input (pin 5), and an external resistor (R11) and capacitor (C8) are used to decouple some of the feedback. These set the voltage gain of the device at the required level. With R11 at the value shown, a voltage gain of about 46dB (200 times) is produced.

Capacitor C9 decouples the positive supply line to the preamplifier section of the i.c., and helps to reduce the level of mains hum at the output; C12 reduces the high frequency response of the device, which would otherwise extend well beyond the audio spectrum with the consequent risk of instability resulting.

Capacitor C10 forms the capacitive section of an R-C network connected across the output of the device. These compensate for the fact that speaker impedance rises with frequency, and they thus aid stability.

Components C11 and R12 provide what is termed "bootstrapping", between the output and driver stages. This produces a higher efficiency by providing a higher output voltage swing for a given supply voltage.

The output is coupled to the speaker via a d.c. blocking capacitor, C13; C1, R7, and C14 are supply decoupling components and these prevent instability due to positive feedback through the supply lines.

POWER SUPPLY

As the TBA820 i.c. has no form of thermal shut down protection circuitry, it must not be run from a potential greater than about 12V when using an 8 ohm speaker. It is then impossible to damage the device through overheating.

Fig. 1. The complete circuit diagram of the 2W Amplifier.

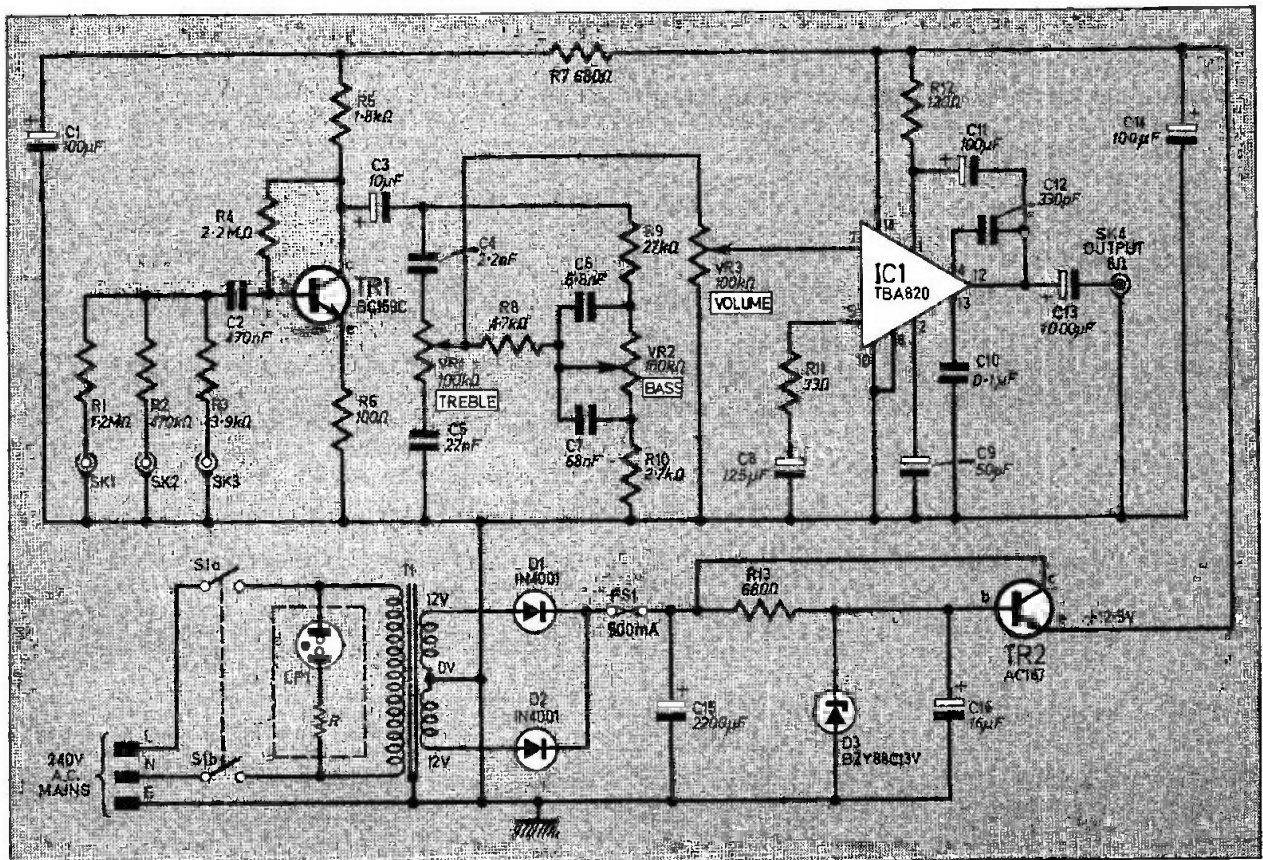

A speaker of less than 8 ohms impedance must not be used.

It is safe to use a speaker having an impedance of more than 8 ohms, but the maximum available output power will be reduced.

In order to ensure that the TBA820 is operated safely, a regulated power supply is used. This provides an output of about 12.5 volts.

A centre tapped transformer, T1 feeds a push-pull full-wave rectifier using D1 and D2; C15 provides considerable smoothing for the rough d.c. output of the rectifier network.

Components R13, D3, C16 and TR2 provide an emitter follower regulator and electronic smoothing circuit of conventional design. Only an extremely small ripple content is present on the output, at TR2 emitter, the actual figure for the prototype being 500 microvolts.

CASE

It is best to use a metal case as this will screen the wiring from possible sources of electrical interference. A ready made aluminium case is used for the prototype, and this has approximate outside dimensions of 200 x 150 x 50 mm and has a removable lid.

Any case of a similar size would be satisfactory, and it is not too difficult to construct a suitable case from aluminium oneself.

The layout of the components within the case is shown in Fig. 2. Detailed dimensions are not

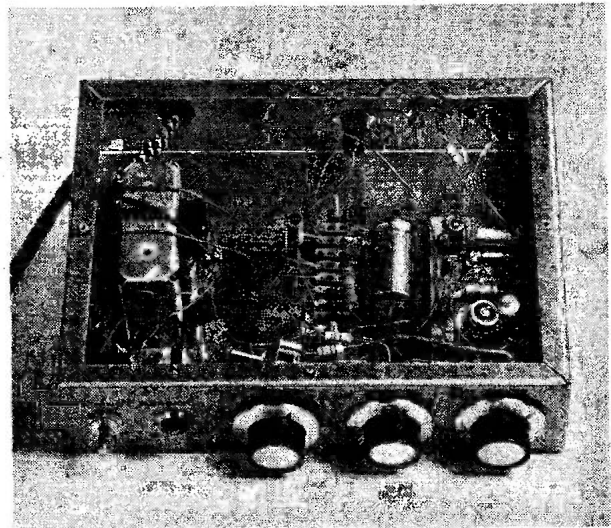

Photograph showing the prototype amplifier with lid removed.

shown for the mounting of components, as the requirements here will vary according to the particular make of component employed. In many cases the components themselves can be used as templates to help mark out the case ready for drilling. The beginner should not attempt to radically alter this general layout.

The large oval cut-out for the input sockets can be cut out using a fretsaw. With some sockets it is possible to use the more simple method of drilling three 8mm diameter holes to

Components

Resistors

R1	1.2M Ω	R8	4.7k Ω
R2	470k Ω	R9	27k Ω
R3	3.9k Ω	R10	2.7k Ω
R4	2.2M Ω	R11	33 Ω
R5	1.8k Ω	R12	120 Ω
R6	100 Ω	R13	680 Ω
R7	680 Ω		

All $\frac{1}{4}$ W carbon $\pm 10\%$

Capacitors

C1	100 μ F 10V elect.
C2	0.47 μ F type C280
C3	10 μ F 16V elect.
C4	2.2nF polystyrene
C5	22nF type C280
C6	6.8nF polystyrene
C7	68nF type C280
C8	125 μ F 10V elect.
C9	50 μ F 16V elect.
C10	0.1 μ F type C280
C11	100 μ F 10V elect.
C12	330pF ceramic
C13	1000 μ F 16V elect.
C14	100 μ F 16V elect.
C15	2200 μ F 25V elect.
C16	16 μ F 16V elect.

**RTV
TALK
SHOP**
SEE

Potentiometers

VR1	100k Ω carbon log.
VR2	100k Ω carbon log.
VR3	100k Ω carbon log.

Semiconductors

IC1	TBA820 audio frequency 2W amplifier
D1	1N4001 or similar
D2	1N4001 or similar
D3	BZY88C13V Zener diode 13V 400mW
TR1	BC169C silicon <i>npn</i>
TR2	AC187 germanium <i>npn</i>

Miscellaneous

T1	mains/12-0-12V 500mA secondary
LP1	mains panel neon with built-in resistor
S1	d.p.d.t. toggle
FS1	500mA 20mm long fuse and panel mounting holder
SK1, 2, 3	triple phono socket (1 off)
SK4	phono socket
Veroboard	0.1 inch matrix Veroboard size 17 strips by 32 holes; 9-way tagstrip; clip-on heatsink for TR2; control knobs (3 off); case size 200 x 150 x 50mm (minimum); rubber feet (4 off); mains lead

accommodate the the terminals of the sockets. Phono, DIN, and jack plugs are commonly used as terminations on speaker leads, and the output socket should be of a type which is commensurate with the plug fitted to the speaker lead.

In order to obtain a low level of mains hum it is necessary for T1 and the component panel (when completed) to be mounted at opposite ends of the case.

The transformer is mounted using a couple of short 4BA bolts, and the input sockets require a fixing of four short 6BA bolts. A solder tag is mounted on one of the mounting bolts of T1, and another is secured under one of the upper fixings of the input sockets. This last tag is used as an earthing point for the outer connectors of the input and speaker sockets. It is important to fit the mains input lead hole with a grommet.

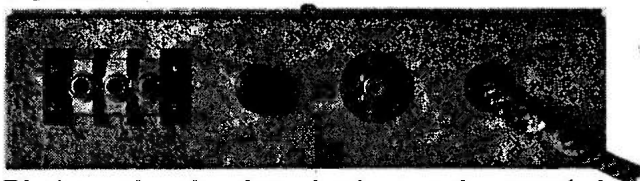

Photograph showing back panel mounted components.

COMPONENT PANEL

All the amplifier components, except the controls and R1 to R3, are mounted on a piece of 0.1 inch matrix Veroboard having 32 holes by 17 copper strips. Details of this are illustrated in Fig. 3.

First cut out a panel of the correct size and then drill the two 4BA clearance mounting holes using a No.24 twist drill. The breaks along the copper strips should be made next, and if the special tool for this purpose is not available, a small hand held twist drill can be used.

The various components are then mounted and soldered in, with the i.c. and TR1 being left until last. Veropins were used at the six points where leads connect to the panel.

The panel is mounted by use of a couple of 25mm long 4BA bolts. A couple of extra nuts are used over each bolt in order to space the panel a little way clear of the case.

Resistors R1, R2, and R3 are mounted on the appropriate tags of the triple phono socket. With the layout of Fig. 2, the lead which connects these to the component panel is very short, and need not be screened. The leads connecting the panel to SK4 and the centre tag of VR3 are also wired up at this point.

TONE CONTROLS

The tone controls are wired up using a point to point wiring system. This wiring is shown in Fig. 2 and is quite straightforward. When soldering the components into circuit it is

Everyday Electronics, August 1976

important that the leadouts are well tinned with solder. A dry joint is likely to result if the constructor ignores this advice.

Try to keep this wiring as short and neat as possible.

POWER SUPPLY WIRING

A 9-way tagstrip acts as a constructional basis for the power supply circuitry. A suitable tagstrip can be cut down from a longer one; Fig. 2 shows complete details of the power supply wiring.

Again, make sure that all leads and tags are well tinned with solder prior to making a connection. As TR2 is a germanium transistor it is easily damaged by excessive heat, and a heat-shunt should be used on each leadout as it is soldered into circuit; TR2 is fitted with a small clip-on heatsink to help with heat dissipation.

A solder-tag is used to earth one tag of the strip via one of the mounting bolts. The tagstrip is mounted in much the same way as the component panel, except using 6BA bolts. Once it has been mounted, the remaining wiring can be completed.

USING THE UNIT

It is advisable to thoroughly check the wiring of any freshly completed project before connecting the power and switching on, but in cases such as this where the mains is involved, it is especially important.

An external speaker in its own cabinet is required, and this must be capable of handling at least 2 watts r.m.s. and have an impedance of 8 ohms. A speaker having an impedance of more than 8 ohms can be used, but with a 15 ohm speaker, for instance, the maximum output power will be only a little more than one watt.

If in doubt as to which input should be used for a particular piece of equipment, results will usually be best if the least sensitive input which gives adequate volume is used. Screened leads must always be used at the inputs.

The desired input is merely selected by plugging the ancilliary equipment into the appropriate socket, with the other two sockets left unconnected. □

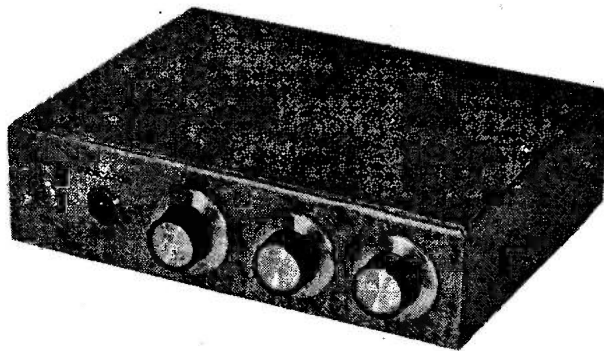

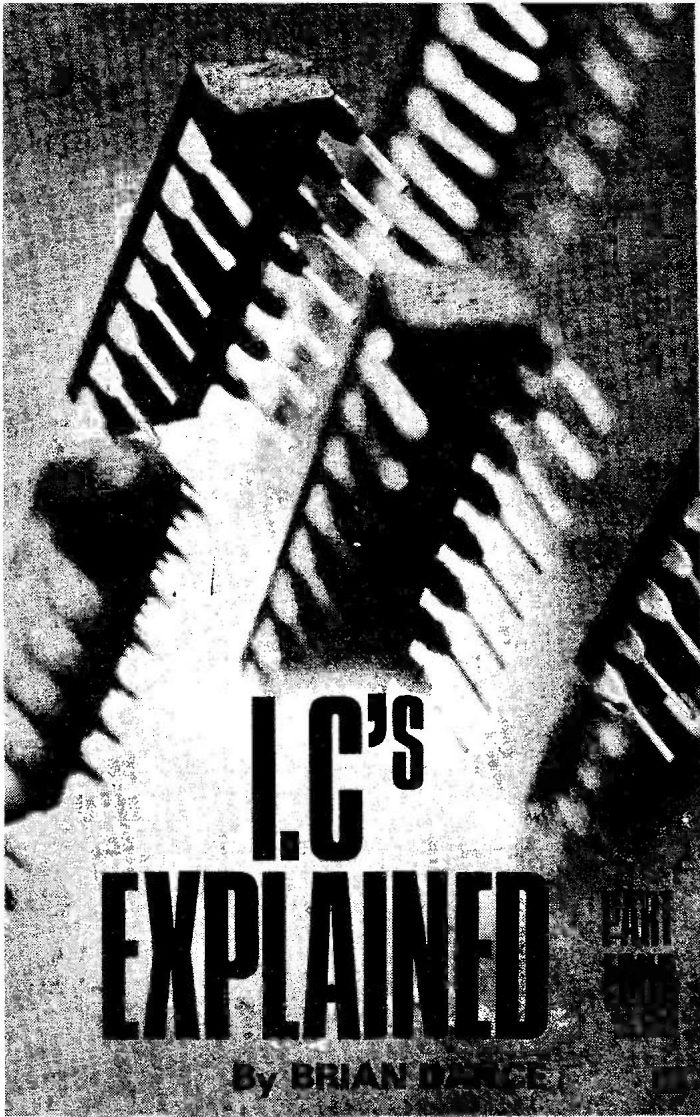

A NEW development is the recent introduction by Fairchild of their low power Schottky and micrologic family; these devices operate with about one-fifth of the current required by standard TTL devices, but can also operate at higher speeds. This family includes, for ex-

ample, the 9LS00/74LS00 low power version of the 7400 mentioned earlier, whilst the 9LS90/74LS90 is a decade counter which can be used up to about 50MHz and consumes only about 9mA.

TTL DECADE COUNTING

As a typical application of TTL devices, we will discuss a decade counting circuit. Counters are based on individual flip-flops which can, for example, be made from two NAND gates with the output of each gate connected to one of the inputs of the other gate.

A typical decade counter is shown in Fig. 4.1. The well-known 7490 TTL device performs the actual counting, whilst the TTL 7447A device changes the coding of the information so that it is suitable for driving a Hewlett-Packard 5082-7730 light-emitting-diode digital display. The latter shows the state of the count in the 7490 as an illuminated red digit.

The circuit shown in Fig. 4.1 counts up to ten and indicates one digit. If more than ten pulses are to be counted, the output from pin 11 of the 7490 counter can be fed to the output of another identical circuit which counts the number of tens. The output from the latter can be fed to further circuits until the required number of digits is obtained.

The input pulses to the circuit of Fig. 4.1 must be standard TTL pulses. The voltage in their 1 state should be between 2 and 5V, whilst their low or 0 state should be less than 0.8V.

These pulses drive the 7490 counter which contains four flip-flops and three gates. It counts in the binary coded decimal system but automatically returns to zero at the tenth pulse. The 7490 device contains a divide-by-two and a divide-by-five counter in one package.

Fig. 4. 1. Basic TTL decade counter with digital l.e.d. display.

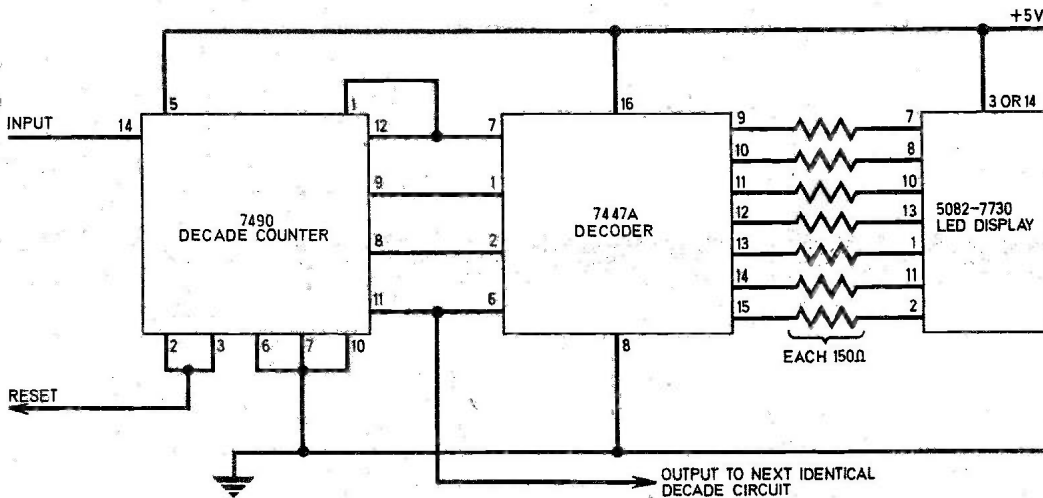

The reset line may be momentarily connected via a 1 kilohm resistor to the positive 5V line if it is required to reset the count to zero. Any number of reset lines can be "commoned" through 1 kilohm resistors so that all of the digits can be simultaneously reset to zero.

The binary coded decimal outputs from the 7490 are fed into the 7447A binary-coded-decimal to 7 bit decoder. This relatively complex device which contains a total of nearly fifty gates and inverters provides seven outputs suitable for driving the seven segments of the 5082-7730.

DISPLAY

The 5082-7730 indicator will fit into a standard dual-in-line socket. It contains the seven segments shown in Fig. 4.2. When all are passing a current, the digit 8 is shown, but if all except segment 4 are illuminated, the digit 0 is shown. Any of the ten digits can be displayed by allowing a current to flow in the appropriate segments.

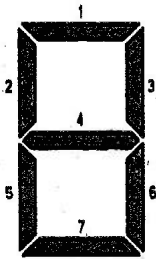

Fig. 4.2. Arrangement of a seven segment indicator.

It may be noted that whilst one could construct the Fig. 4.1 circuit using separate bistable circuits and gates, this would involve far more effort than the use of the 7490 and 7447A m.s.i. devices; in addition, the circuit would occupy far more space.

The 7490 requires a current of about 32mA (max. 53mA), whilst that required by the display depends on the digit being indicated. Maximum current is required for an 8 when all of the segments are glowing and minimum current for a 1.

VARIATIONS

If the numerical display is not required (or not required in all of the decades), the 7447A and the 5082-7730 may be omitted where they are not required.

If the 7490 is replaced by a 7493 integrated circuit, the input pulse frequency will be divided by a factor of 16 instead of 10, but the additional 6 states will not produce normal digits on the display. A 7492 device can be used to divide by 12. Division by many other factors can be obtained using these devices.

Another possible modification involves the use of gas discharge Nixie numerical indicator

tubes instead of the 5082-7730 l.e.d. display. The 7490 outputs would then be fed to a 74141 decoder instead of the 7447A; the 74141 changes the binary-coded decimal signals to decimal information and its ten outputs can control the current to the cathodes of the numerical indicator tube.

COUNTING APPLICATIONS

Counting circuits, such as the ones described, are used in a wide variety of applications including the counting of objects coming off a production line and the counting of the pulses from nuclear particle detectors. Counting circuits are also used in accurate timers where the number of pulses counted is proportional to the time interval involved.

An early use for counting circuits was for pulse dividing in electronic clocks. The 50Hz mains pulses were divided in frequency by 5 and then by 10 to produce 1Hz pulses. A seconds counter displays the number of these pulses; at the 60th pulse it is reset to zero and an output pulse is sent to the minute counter. Similarly the minutes pulses are divided by 60 to provide the hour pulses.

We shall see later that large numbers of counting circuits are no longer used as individual integrated circuits in electronic clocks. A single complex device performs all of the functions required.

Continued next month.

PLEASE TAKE NOTE

In the *Auto Cool* article (July '75 issue), the fuse rating quoted is a continuous rating. If a British type car fuse is used this would normally be quoted at its "Blow rating" and should thus be 10 amps to pass 5 amps continuously.

Most British type car fuses now show both the blow rating (at which they are quoted) and the continuous rating (which is half the blow rating). Continental car fuses are normally marked in continuous rating as are normal mains fuses.

Not only is the British car industry the odd one out it has in certain cases also developed its own symbols for various other electrical items such as capacitors and potentiometers which all helps to confuse everyone.

TEACH-IN '76

It has been brought to our attention by Mr. R. D. Bonahan of Bristol, that under the heading 10.2 Electromagnetic Induction, the equation should be modified to read: Induced volts = $-L \times$ rate of change of current.

The Extra-ordinary Experiments of Professor Ernest Eversure

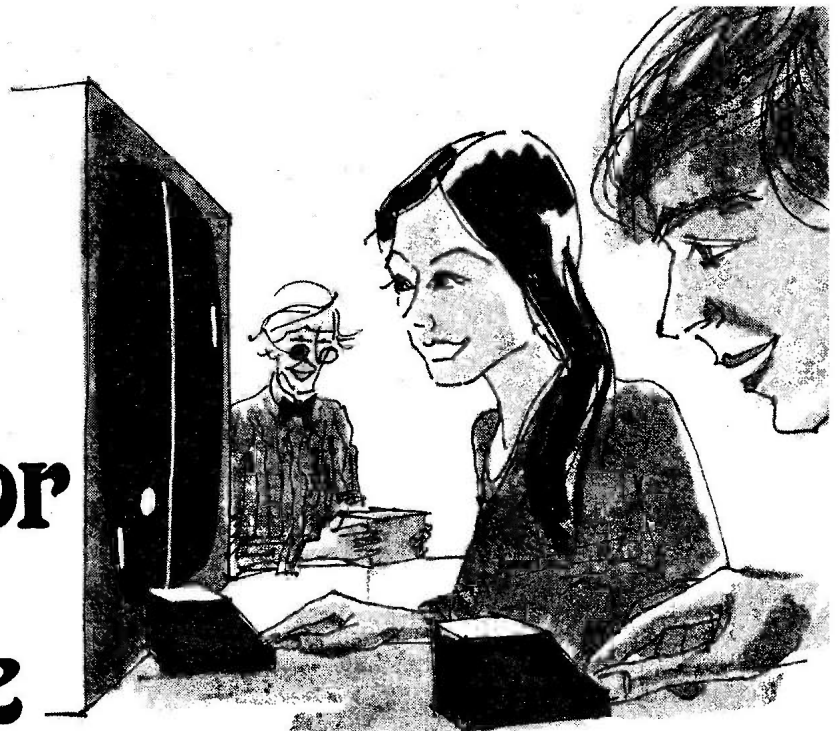

by Anthony John Bassett

AT FIRST Suzy and Bob saw what looked like a number of ordinary TV-tennis and football electronic games, but each having a number of extra control knobs or buttons.

"See what you think of this one," remarked the Prof., plugging one of the sets into the control console of a large viewscreen. "At first it seems to be very much like any other of the TV games which are available, but with an added feature of interest. I have used a couple of random noise generators similar to that which Bob has just built, to inject low frequency random noise into the ball-position circuits.

"On the screen, one moving dot is the 'ball' and two vertical lines, which can be moved by means of potentiometers controlled by the players, are the players 'bats'."

GOOGLY BALL

"Normally the ball moves in straight lines across the screen, but the random noise turns it into a 'googly ball', which moves rather less predictably, like one of those trick rubber balls which have a weight inside."

Bob and Suzy each took one of the control-units which was wired to the main cabinet of this first games unit and enabled each player to control a bat (for tennis) or a 'man' (for football).

A switch allowed them to select goalposts, tennis nets, etc., to appear on the viewscreen according to the game being played.

As Bob switched on the unit a tennis net appeared on the screen, and Suzy immediately pressed the 'serve' button on her control unit. The moving dot, which was the ball, appeared almost immediately, moving diagonally in a straight line towards Bob's side of the viewscreen.

Bob moved his bat into position to intercept the ball, but as he did so, Suzy leaned over to the master unit and pressed the 'googly ball' switch.

Now the ball no longer moved in a straight line, and Bob once again found himself facing a moving dot controlled by random low-frequency electronic 'noise' signals.

"I can see that I can leave you two with these electronic games for a while—there are quite a few different ones for you to try."

The random-noise generators, together with the googly ball switch circuit, make these TV games quite a lot more challenging and exciting, thought the Prof.

However this was only the first of the Prof's. experimental electronic games that Suzy and Bob had tried, and after a while although Bob was doing quite well Suzy was still leading—but

only just.

Whilst Bob and Suzy were playing on the electronic games machine, the Prof. had been receiving a series of visitors, who had each come along to consult him on some kind of practical problem.

CAPACITORS

The Prof's. experimental Robot had been kept busy forming and testing a number of electrolytic capacitors, including one which Suzy had brought.

The Prof., together with his latest visitor, had been observing Suzy and Bob as they played on the electronic games machines, and now as the Prof. brought the visitor across to where they were playing the latest match, at the same time he delivered the electrolytic capacitor to Suzy.

"This capacitor is all right now, Suzy," the Prof. informed her. "One section was faulty, according to the tests performed by the Robot, and it took a long time, charging it at a low current to bring it up to the correct working voltage. The other sections were not as bad, and they reached the correct voltage much more rapidly."

"How does the Robot know, Prof. how long it should take to test a capacitor which is not faulty, and how long it should



This hobby brings big rewards.

A soldering iron and a screwdriver. If you know how to use them, or at least know one end from the other, you know enough to enrol in our unique home electronics course.

This new style course will enable anyone to have a real understanding of electronics by a modern, practical and visual method. No previous knowledge is required, no maths, and an absolute minimum of theory.

You build, see and learn as, step by step, we take you through all the fundamentals of electronics and show you how easily the subject can be mastered and add a new dimension not only to your hobby but also to your earning capacity.

All the training can be carried out in the comfort of your own home and at your own pace. A tutor is available to whom you can write, at any time, for advice or help during your work. A Certificate is given at the end of every course.

1

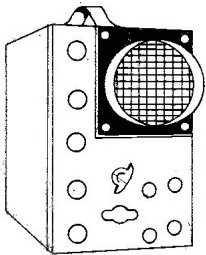

Build an oscilloscope.

As the first stage of your training, you actually build your own Cathode ray oscilloscope! This is no toy, but a test instrument that you will need not only for the course's practical experiments, but also later if you decide to develop your knowledge and enter the profession. It remains your property and represents a very large saving over buying a similar piece of essential equipment.

2

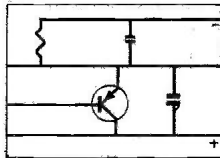

Read, draw and understand circuit diagrams.

In a short time you will be able to read and draw circuit diagrams, understand the very fundamentals of television, radio, computers and countless other electronic devices and their servicing procedures.

3

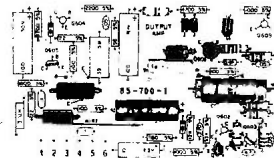

Carry out over 40 experiments on basic circuits.

We show you how to conduct experiments on a wide variety of different circuits and turn the information gained into a working knowledge of testing, servicing and maintaining all types of electronic equipment, radio, t.v. etc.

To find out more about how to learn electronics in a new, exciting and absorbing way, just clip the coupon for a free colour brochure and full details of enrolment.

PLUS FREE GIFT!

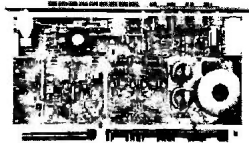

ALL STUDENTS ENROLLING IN OUR COURSES RECEIVE A FREE CIRCUIT BOARD ORIGINATING FROM A COMPUTER AND CONTAINING MANY DIFFERENT COMPONENTS THAT CAN BE USED IN EXPERIMENTS AND PROVIDE AN EXCELLENT EXAMPLE OF CURRENT ELECTRONIC PRACTICE

Brochure without obligation to:
**BRITISH NATIONAL RADIO EEL 86
 & ELECTRONICS SCHOOL, Dept
 P.O. Box 156, Jersey, Channel Islands.**

NAME _____

ADDRESS _____

(Block caps please)

TECHNICAL TRAINING IN ELECTRONICS AND TELECOMMUNICATIONS

ICS can provide the technical knowledge that is so essential to your success; knowledge that will enable you to take advantage of the many opportunities open to you. Study in your own home, in your own time and at your own pace and if you are studying for an examination ICS guarantee coaching until you are successful.

City & Guilds Certificates:
Telecommunications Technicians
Radio, TV, Electronics Technicians
Technical Communications
Radio Servicing Theory
Radio Amateurs
Electrical Installation Work
MPT Radio Communications Certificate

Diploma Courses:
Colour TV Servicing
Electronic Engineering and Maintenance
Computer Engineering and Programming
Radio, TV, Audio Engineering and Servicing
Electrical Engineering, Installation
and Contracting

POST OR PHONE TODAY FOR FREE BOOKLET.

ICS To: International Correspondence Schools

Dept 710W Intertext House, London
SW8 4UJ or telephone 622 9911

Subject of Interest.....

Name

Address

Tel:

G SPRING MADNESS MILIGAN BARGAIN SLIDE RD

Echo-chambers. Variable time delay. Variable number of repeats Uses cartridge tape (not loop) giving very long life. More versatile than other units costing several times the price! **£37-50**

F.M. Tuners. 2-transistor chassis with stereo-decoder and L.E.D. Indicator. Requires only 6 volts, 20ma. **£12-99**

Stereo Amps. 3-watt, 8ohm. With knobs and Escutcheon **£2-75**

10-watt Amps. 12 volt D.C. 3/815ohm output **£4-40**

Cartridges. Acos GP 104. Ceramic/Diamond **£1-50**

Cartridges. Acos GP 101. Crystal/Sapphire/Compatible **£0-50**

Speakers. 2 1/2" - 8-ohm **£0-35**

Speakers. Car Stereo. 8-ohm, 5-watt. In cabinets **£2-50**

Dynamic Tape Mikes with remote-control facility **£0-99**

Crystal Tape Recorder Mikes **£0-60**

Crystal Mike inserts with bracket **£0-20**

Indicators. 12-volt L.E.D. in Chrome Bezel **£0-35**

"Bargain Bags" 4lbs Caps/Resistors/Transistors/Diodes **£4-00**

ALL ABOVE ITEMS PLUS 12 1/2% VAT



Fluorescent 12-volt Camping Lights. 21" 13-watt **£4-99**
12" 8-watt **£3-99**

"Disco type 3-Channel flashing light units. Built-in mike. No connection needed to amp **£17-50**

Multimeters. A.C. 0-1000V. DC 0-1000V. 0-100 ma. 0-150kohm **£3-50**

Multimeters A.C. 0/1000 volts. 5 Ranges. **£2-50**

D.C. 0/1000 volts. 7 Ranges. **£2-50**

D.C. current 0/10 ua to 0/500ma. 4 ranges. **£2-50**

Resistance 0/130 ohms. 0/100 megohms. 8 Ranges. **£2-50**

Decibels -20 to +62 db. **£14-50**

Panel Meters. 0/30 ua. 4 1/2" x 3 1/2". Illuminating kit available. **£3-50**

Soldering irons. 15-watt. Pencil BH. **£1-40**

Servisol Switch Cleaner (with Snorkel) **£0-50**

Copper-clad Fibre Glass Board. Single-sided. Square foot **£1-00**

Double-sided **£1-25**

"Fotolak" Light sensitive spray for printed circuit making **£0-30**

Developer for same **£0-20**

Ferric Chloride for etching **£0-40**

ALL ABOVE ITEMS PLUS 8% VAT

G. F. MILWARD, 369 Alum Rock Road,
Tel. 021-327 2339 Birmingham B3 3DR.

POSTAGE: Below £10 50p
Above £10 Free

SINCLAIR IC20

IC20 10W+10W stereo IC amplifier kit with free booklet and printed circuit **£4-95**.
PZ20 Power supply kit for the above **£3-95**.
VP20 Volume, tone-control and preamp kit **£7-50**.
SP20 10W 4 ohm speaker for IC20 **£2-70**.
CS20 11 x 6 x 3in attractive case for IC20 **£2-95**.
Send sae for free leaflet.

JC12 AMPLIFIER

6W IC audio amp with free data and printed circuit **£1-95***



DELUXE KIT FOR JC12

Includes extra parts for the pcb and vol, bass and treble controls for mono version **£2-16**. Stereo model with balance control **£4-66**.

JC12 POWER KIT

Supplies 25V 1 Amp **£3-25**.

JC12 PREAMP KITS

Type 1 for magnetic pickups, mics and tuners. Mono **£1-50**. Stereo **£3-00**. Type 2 for ceramic or crystal pickups. Mono **85p**. Stereo **£1-76**.
SEND SAE FOR FREE LEAFLET ON KITS.

S-DECS AND T-DECS*

S-DeC £2-24. T-DeC £4-95.

u-DeCA £4-45. u-DeCB £7-85.

IC carriers:

16 di: plain **£1-07**.

with socket **£2-21**

10T05: plain 89p. with socket **£1-95**.

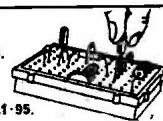

FERRANTI ZN414

IC radio chip with data **£1-34**. Printed circuit and extra parts for radio **£3-45**. Case 80p extra. Send sae for free leaflet.

SINCLAIR PROJECT 80 AUDIO MODULES

FM tuner **£13-25**. Q16 **£9-50**. PZ5 **£3-95**. PZ6 **£8-70**
PZ8 **£9-10**. Trans for PZ8 **£5-60**. Z40 **£5-75**. Stereo. **80 £11-95**. Project 80SQ **£18-95**. Quad decoder **£14-95**.

BI-PAK AUDIO MODULES

S450 Tuner **£18-95**. AL60 **£4-33**. PA100 **£13-45**. MK60 audio kit **£27-20**. Teak 60 **£9-95**. Stereo 30 **£15-95**. TC30 **£4-60**. AL250 **£16-15**. Send S.A.E. for free data.

SAXON ENTERTAINMENTS AUDIO MODULES

SA1208D **£18-95**. SA608 **£11-95**. SA308 **£9-40**. PM120/1 **£11-45**. PM1202 **£14-95**. PM601/2 **£9-95**. PM301/2 **£8-70**
Send s.a.e. for free leaflet.

SINCLAIR BLACK WATCH

Fully assembled with black strap **£20-95***.
With bracelet **£22-95***



SINCLAIR CALCULATORS*

Cambridge % **£7-35**. Scientific **£8-95**. Cambridge Scientific **£11-45**. Oxford 300 **£13-30**. Programmable and Oxfords **£3-19**; for Camb. and scientific **£3-15**.

CEM CALCULATORS*

776MD 7 digit %/memory N/A. 796MD 8 digit %/memory **£5-98**. 897D 8 digit %/4 function memory **£6-45**. SR7919D 8 digit %/memory/trig/log/pl/powers/scientific notation **£11-90**. SR1800 10 digit scientific **£20-55**. SR4148R 14 digit rechargeable scientific with charger **£21-95**. Mains adaptor for other machines **£2-95**.

CASIO CALCULATORS*

Pocket 85 8 digits %/const **£6-95**. Memory 8R 8 digit %/memory/const **£8-95**. Pocket Mini P-810 8 digits %/memory/const/minimature fits into your shirt pocket **£8-95**. FX20 8 digit %/memory/trig/log/powers/scientific notation **£16-95**. Mains adaptors for all models **£3-95**

NOVUS CALCULATORS*

750 6 digit **£5-45**. 835 8 digit %/const/sq. root/4 function memory **£7-60**. 4525 10 digit programmable scientific calculator **£45-80**. 4510 **£13-20**. 4515 **£37-65**. 4520 **£22-65**. Mains adaptor **£4-20**.

MISTRAL 1 25HR DIGITAL CLOCK KITS*

Includes pcb, power supply, case, 1/2" display, chip and all parts. Kit **£10-95**. Built **£12-50**. Also Mistral 2, deluxe assembled version with alarm and tilt sleep-over facility **£13-95**.

NATIONAL MA1001H DIGITAL CLOCK MODULE*

Complete module including 1 1/2" display and clock chip fully assembled on a 1 1/2" x 3" pcb. Just add a power supply, switches, etc. to produce a 24HR clock with alarm and auto-dim. **£8-55**.
SEND SAE FOR OUR DIGITAL CLOCK LEAFLET

PRINTED CIRCUIT KIT £3-95*

Make your own printed circuits. Contains etching dish, 100sq ins of pc board, 1lb ferric chloride, etch resist pen, small drill bit, laminate cutter.

BATTERY ELIMINATOR BARGAINS

55 WAY SUPER

New switched model, 3 to 30V in 1V steps. Fully stabilized. 1A output. Kit **£8-95**. Assembled **£11-95**. 2 Amp model. Kit **£10-95**. Built **£13-95**.

6-WAY SPECIAL

Switched output **£5-20**

of 3, 4, 5, 6, 7, 8, 12V at 500mA

6-WAY DOUBLE RADIO MODEL £6-20

Switched output

3+3/4+4 1/2+6+6+7 1/2+7 1/2+9+12+12V at 250mA. Also 15/18/24V single.

3-WAY MODEL

Switched output of 6/7 1/2/9V at 250mA with 4-way multi-jack plug and free matching socket **£2-95***.

RADIO MODELS

50mA with press-stud battery connectors. 9V **£3-25**. 6V **£3-45**. 9+9V **£4-45**. 8+6V **£4-45**. 4 1/2+4 1/2V **£4-45**. Also 9V 300mA **£3-95**.

CASSETTE MAINS UNIT

11V output with 5 pin DIN plug. 50mA **£3-45**. 300mA **£3-95**.

CAR CONVERTERS

Input 12V DC. Output 6/7 1/2/9V DC 1A regulated **£4-75**.

BATTERY ELIMINATOR KITS

Send sae for free leaflet on range.

100mA radio type with press-stud battery terminals. 4 1/2V **£1-95**. 6V **£1-95**. 9V **£1-95**.

100mA double radio type with press-stud battery terminals 4 1/2V+4 1/2V **£2-60**. 6V+6V **£2-60**. 9V+9V **£2-80**

100mA cassette type with 5 pin DIN plug. 7 1/2V **£1-95**.

Stabilized 8-way type transistor stabilized to give low hum. 3/4 1/2/7 1/2/8/12/15/18V. 100mA **£3-15**. 500mA **£4-85**.

Heavy duty 13-way types 4 1/2/8/7 1/2/11/13/14/17/21/25/28/34/42V. 1 Amp Model **£4-20**. 2 Amp model **£6-90**.

Car Converter kit Input 12V DC. Output 6/7 1/2/9V DC 1A regulated **£2-95**.

MAINS TRANSFORMERS

6-0-6V 100mA 95p. 9-0-9V 100mA 95p. 18V 1A **£1-65**.

0/12/15/20/24/30V 1A **£3-40**. 12-0-12V 100mA **£1-95**.

0/12/15/20/24/30V 2A **£5-05**. 20V 2 1/2A **£2-20**.

SWANLEY ELECTRONICS

Dept. EE, PO BOX 68,
SWANLEY, KENT.

Post 30p on orders under £2, otherwise free. Prices include VAT. Overseas customers deduct 7% on items marked*, otherwise 11%. Official orders from schools, government labs, etc, welcome.

take to form a capacitor which is faulty?" Bob wanted to know.

"The first is easy to answer, Bob. This can be found by the definition of capacitance:

One Farad is the capacitance of a capacitor which, when charged with a current of one amp for a period of one second, will undergo a change of one volt in the potential difference between its electrodes.

"So if the Robot knows the value of the capacitor in microfarads, and continually adjusts VRI and views the milliammeter to give a steady charging current as the voltage across the capacitor rises from zero towards the working voltage, he can easily calculate the time it should take, which naturally varies according to component tolerance.

"The capacitance stated on the can of an electrolytic capacitor is usually not an accurate statement of its value in microfarads, but only an approximate guide.

"This is because it is quite difficult, during manufacture, to accurately control the final capacitance of the finished product, so that each capacitor in a batch has a value slightly different from that of most of the others.

INCREASING VALUE

"Also the value of an electrolytic capacitor changes with time. Usually the capacitance in microfarads increases slightly as the capacitor grows older. This is because the dielectric slowly becomes thinner, and in effect this decreases the distance between the 'plates' of the capacitor. As it becomes thinner, this not only increases the capacitance, but it may also cause the working voltage of the capacitor to fall below the rated maximum. Then the capacitor fails, like yours did, Suzy.

"Another reason why the capacitance may rise, is that the surface of the aluminium anode may become rough and pitted with age, and this effectively increases the area of the capacitor, as a rough, pitted surface has a greater surface area than a smooth one of the same measured dimensions."

Everyday Electronics, August 1976

"What causes the dielectric to become thinner, Prof.?" Suzy enquired.

"The dielectric gradually dissolves into the electrolyte and this reduces its thickness, especially if the capacitor is left standing unused for a long time, it is wise to test and re-form any aluminium electrolytics.

"I wish that I had known that earlier," said Suzy, "This capacitor has come from our spare TV set, which has been in storage for a while. Then I got it out again because my young brother wanted to watch the other channel at just the times when my favourite science programmes came on, and when I switched it on the capacitor failed and the fuse blew. Now I should be able to get home and put it back in again before the programmes start!"

"There's no need to hurry off right now", the Prof. said, inviting her to stay a little longer. "You and Bob can both watch the science programme on the giant colour viewscreen which is attached to one of my computers. It has been fixed up to receive colour TV, and also Ceefax, the TV information service."

"Oh goody!" remarked Suzy, "that makes me look forward even more to the Science Programme.

"Can I ask you just one or two more questions about electrolytic capacitors, and what happens when you form them?" asked Suzy.

"Yes, certainly, Suzy," invited the Prof. who, although he had been answering the questions of a number of visitors who had consulted him whilst Bob and Suzy had been playing on the experimental electronic games machines, showed no signs of tiring.

"Well, Prof., if when you put an electrolytic capacitor through the forming process, it thickens the dielectric, will this not change the capacitance? And if so, could this be used to bring the capacitance to a known value by deliberately forming it to a voltage slightly different from its rated working voltage?"

"When you form a capacitor, yes it will have these effects. As the dielectric becomes thicker the capacitance will become less, as this is equivalent to increasing the distance between the plates of a capacitor. But unless you considerably exceed the rated

working voltage, the value of the capacitor should not go outside the ratings of tolerance.

"With capacitors of low working voltage, below, say, 100 volts, it is often possible to form the capacitor up to a voltage 50 per cent higher than its rated voltage, and sometimes even more, and by this means you could trim the value to the required number of microfarads. But remember that in a few weeks' time it will probably have drifted away from that value once again, so this is not a very good means of adjusting capacitance.

"I have heard about variable electrolytic capacitors where the value can be increased by dipping the anode deeper into a liquid electrolyte, and decreased by drawing it out again. But these are usually clumsy affairs, as they depend upon the force of gravity to keep the electrolyte in place, and also there is the likelihood of difficulties in keeping the electrolyte in good condition.

"Now variable capacitors of hundreds, or even thousands of microfarads are not easy to produce. But electronic circuits have been made to simulate them, and these are very useful."

"This all sounds very complicated to me!" remarked the Prof's. visitor, Dr. Angus R. Paterson, the foot specialist, who had been dancing impatiently from one foot to another whilst Bob, Suzy and the Prof. had been discussing electrolytic capacitors. Dr. Paterson had a problem with his patients which was why he was visiting the Prof., but more about that next month.

Continued next month.



"This all sounds very complicated to me!"

DOWN TO EARTH

By GEORGE HYLTON

MEASURING INPUT IMPEDANCE

MR. L. L. HAWKINS of Newport, Gwent writes about a problem which must afflict a number of readers. "I am aware", he says "that to obtain the best response from an amplifier one must match the source impedance to the amplifier impedance. My difficulty with a 10 watt valve amplifier is that I do not know its input impedance".

So the question is, how do you find out? Stripped of irrelevant details, the situation at the input of an amplifier is illustrated in Fig.1a. A source of signals (eg. a microphone or gramophone pick-up) is connected to the amplifier. The source generates a voltage V_s (Fig.1b). The signal source has its own internal impedance Z_s . This is the source impedance referred to by Mr. Hawkins. The amplifier has an input impedance, but as this impedance is nearly always a resistance (at audio frequencies) I'm showing it as R_{IN} rather than Z_{IN} .

Current I is driven by V_s through Z_s and R_{IN} . Since this current produces a voltage drop in Z_s it follows that the amplifier receives not the full V_s but only a portion of it. I've called it V_{IN} here.

If it strikes you as odd that the

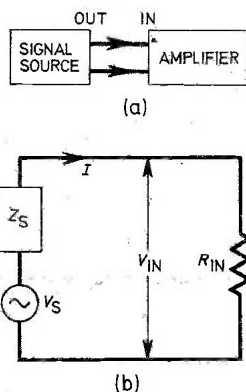

Fig. 1. Impedances and voltages associated with source and amplifier.

source should deliver less than its own voltage, reflect on the fact that if you short-circuit the source it obviously can't deliver any voltage at all!

This means, in terms of Fig.1b, that a short-circuit corresponds to R_{IN} equal to zero. The current I still flows, but there is no longer any resistance across which V_{IN} can be developed. The whole of V_s is absorbed inside the source, as a voltage drop across Z_s .

If R_{IN} is now increased from zero to higher and higher values, more and more of V_s is developed across it. In the limit, with infinite R_{IN} , the whole of V_s is delivered to the amplifier.

Infinite R_{IN} means that the source is open-circuited as opposed to short-circuited. For this reason the output of a signal source is sometimes described on makers' data sheets as "open circuit output voltage" or "output voltage into infinite load".

IN PRACTICE

In practice, of course, the load (R_{IN}) is not infinite and some of V_s is lost. To find out how much, you need to know both Z_s and R_{IN} . Common sense tells you that if Z_s equals R_{IN} , half of V_s is lost and the remaining half appears as V_{IN} . Common sense is a fine thing, and it gives the right answer if Z_s is a resistance. But if the signal source is a capacitance (eg. crystal microphone) or an inductance (eg. tape playback head) the answer is wrong.

You find, if you measure it, that when Z_s equals R_{IN} in these cases, 70 per cent of V_s gets through instead of the expected 50 per cent. This is not a serious error, but a serious consequence follows from it. If Z_s is not a resistance but an inductive or capacitive reactance then it varies with frequency. To get an even frequency response it is necessary to ensure that R_{IN} is at least equal to Z_s at all audio frequencies (I should point out, in passing, that pickups and tape

heads need an uneven frequency response, for equalisation, but that's another story.

Devices such as crystal or electret microphones, which are capacitances, do need an even response, so I'll think in terms of them from now on.)

If the source is a crystal microphone with a capacitance of 1000 picofarads and the lowest frequency of interest is 32Hz then Z_s equals 5 megohms. So you can see that getting a big enough R_{IN} may be a problem. Often, it's necessary to use a high-input-impedance buffer amplifier between the source and the amplifier itself.

METHOD OF MEASUREMENT

To get back to the question: how do you measure R_{IN} ? Great accuracy is not needed, so an ohmmeter type of measurement will do. No need for bridges. One way of doing it is to substitute an audio signal generator (test oscillator) for V_s and a variable resistor for Z_s .

Set " R_s " to zero. Apply a small V_s (not big enough to overload the amplifier) and measure V_{IN} . Increase R_s until V_{IN} falls by 50 per cent. Now R_s equals R_{IN} . (You can measure R_s on an ohmmeter, or try different known fixed resistances instead, until you find one which halves V_{IN} .)

There are snags, because V_s is in millivolts and also because the impedance of the voltmeter, which falls across R_{IN} , reduces the apparent input resistance. A high-impedance millivoltmeter is needed—and of course you haven't got one.

Never mind. Switch your ordinary multimeter to its lowest "a.c. volts" range and use it to monitor the output voltage of the amplifier. So long as you make your measurements at a fixed frequency, around 500 to 1000Hz, and keep the signals down so that they are well within the amplifier's handling capacity the measurement will be quite accurate enough. The output voltage, as before, falls by half when R_s equals R_{IN} .

In general, the amplifier input impedance is satisfactory so long as it is greater than the source impedance at all frequencies of interest. This means that at least half V_s is delivered to the amplifier input.



Stirling Sound Products

FROM BI-PRE-PAK

UNIT 1 PRE-AMP/CONTROL

SUPERB VALUE AT

£7.80

WITH ACTIVE
TONE CONTROL
CIRCUITRY

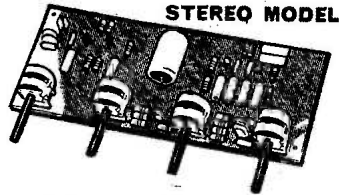

STEREO MODEL

UNIT 1, latest addition in the Stirling Sound range of realistically priced constructional modules is going to assure many more constructors of obtaining quality where price has prevented it before. UNIT 1 offers full stereo facilities, is guaranteed and easy to connect up.

- Input sensitivity—50 mV, adjustable
- Output—200 mV for 50 mV in
- Bass control—±15 dB at 30 Hz
- Treble control—±15 dB at 10 kHz
- Balance control; volume control; ½" spindles throughout
- Operating voltage—10 to 16V

MADE IN OUR OWN FACTORY IN ESSEX

MORE POWER—LESS VAT GREATER VALUE

SS.140 MK.3

**POWER
AMP:**

**Built for
hard work**

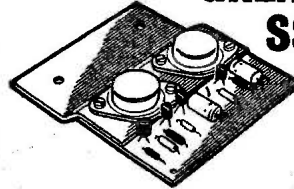

40 WATTS
R.M.S.
INTO 4Ω

£3.95

+ 8% V.A.T.

Resulting from research and development, the Mk.3 version of this most popular power amp. now includes built-in output capacitor with improved stability under severest working conditions. Greatly used for P.A., disco and similar work, SS.140 offers fantastic value for the price.

Build and save with Stirling Sound

BASIC MODULES FOR BUILDING UP TO A STEREO TUNER-AMP

★ POWER AMPS

- SS.125** De-luxe hi-fi 25W r.m.s. power amp. with a fantastic distortion rating of only 0.04% at all levels. 25W into 8 ohms using 50V supply
- SS.103** 3W r.m.s. amplifier incorporating I.C./SL60745. With current, short-circuit and thermal protection
- SL.103-3** Stereo version of above
- SS.105** 5W amplifier to run from 12V (3½" x 2" x ½")
- SS.110** Mk. 3 Similar to SS.105 but more powerful giving 10W into 4 ohms, using 24 volts
- SS.120** Mk. 3 20W module when used with 34 volts into 4 ohms

£5.00

£1.75

£3.25

£2.25

£2.75

£3.00

★ CONTROL

- SS.100** Active tone control, stereo, ± 15dB cut and boost with suitable network
- SS.101** Pre-amp for ceramic p.u., radio & tape with passive tone control details
- SS.102** Stereo pre-amp with R.I.A.A. equalisation, mag., p.u., tape and radio in.

£1.60

£1.60

£2.25

★ POWER STABILISER

- SS.300** Add this to your un stabilised supply to obtain a steady working voltage from 12 to 50V for your audio system, workbench etc. Money saving and very reliable

£3.25*

★ F.M. TUNING

- SS.201** Front end, geared drive capacitor tuning, 88-108 MHz. AFC facility
- SS.202** I.F. amp A meter and/or A.F.C. can be connected (size 3" x 2")
- SS.203** Stereo decoder
- For use with Stirling Sound modules, or with any other good mono F.M. tuning section. A L.E.D. beacon can be added to indicate when a stereo signal is tuned in (3" x 2")

£3.85

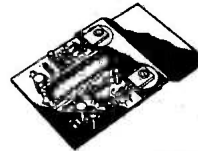

SS.125

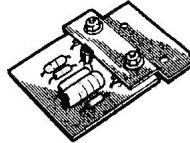

SS.100



SS.300

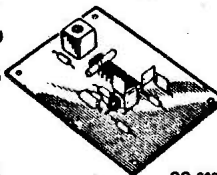

SS.202

Stirling Sound

POWER PACKS

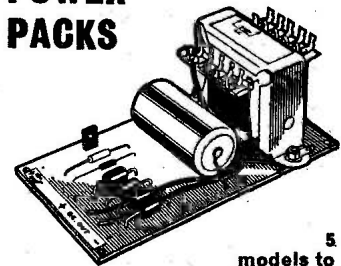

5
models to
choose from

Not only do these excellent power packs stand up unflinchingly to hard work, inclusion of a take off point at around 13-15 V adds to their usefulness and once again price value is outstanding.

Add 50p for p/p any model.

Made to serve for years

SS.312	12V/1A	£3.75*
SS.318	18V/1A	£4.15*
SS.324	24V/1A	£4.60*
SS.334	34V/2A	£5.20*
SS.345	45V/3A	£6.25*

Direct from the makers and obtainable only from Bi-Pre-Pak Ltd. Stirling Sound products are designed by professional experts and made in our own factory. They are distributed exclusively through Bi-Pre-Pak Ltd.

TERMS OF BUSINESS:

VAT at 12½% must be added to total value of order except for items marked * or (S) when VAT is to be added at 8%. No VAT on overseas orders. POST & PACKING add 30p for UK orders unless marked otherwise. Minimum mail order acceptable—£1 Overseas orders, add £1 for postage. Any difference will be credited or charged. PRICES subject to alteration without notice. AVAILABILITY All items available at time of going to press when every effort is made to ensure correctness of information.

NEW SHOWROOM

We have extended our premises and opened up a new demonstration showroom. All welcome.

Order your Stirling Sound products from

BI-PRE-PAK LTD

Co Reg No 820919

222 224 WEST ROAD, WESTCLIFF-ON-SEA, ESSEX SSO 9DF.

TELEPHONE: SOUTHEND (0702) 46344

CHEQUES/MONEY ORDERS PAYABLE TO BI-PRE-PAK LTD.

TO STIRLING SOUND (BI-PRE-PAK LTD.), 220/222 WEST ROAD, WESTCLIFF-ON-SEA, ESSEX SSO 9DF

Please send

..... for which I enclose £

Inc. V.A.T.

NAME

ADDRESS

EEC7

Everyday Electronics Classified Advertisements

BOOKS and PUBLICATIONS

Start your own business printing pound notes

Printing pound notes? Well not quite—but "start your own business rewinding electric motors" could easily be your licence to make money in 1976.

Lavishly illustrated, this unique instruction manual shows step by step how to rewind motors working part or full time, without experience. Everything you need to know easily explained, including where to obtain materials, how to get all the work you need, etc. etc.
A goldmine of information and knowledge.
Only £3.45 plus 25p P&P. From:—

Magnum Publications Dept. EES, Brinkway Trading Estate, Brinkway, Stockport SK3 8BZ

EDUCATIONAL

TAPETALK

THE CLEVER WAY TO LEARN

TWO C80 Cassettes entitled
INTRODUCING ELECTRONICS
£3.44 plus 55p VAT/P. & P.
TAPETALK, P.O. Box 99 (EE)
Milton Keynes MK3 5BR
Tel.: Milton Keynes (0908) 77710

TRAIN FOR SUCCESS

An ICS home study course will give you the qualifications to improve your career prospects in electronics.

C & G Exams

Course for Certificates in Telecoms Technicians, Electrical Installations, Radio, T.V. and Electronics Technicians & Radio Amateurs.

Practical Radio

Courses include FREE construction kits.

Colour TV Servicing

Covers principles, practice and alignment with numerous illustrations and diagrams. Other courses for Radio & Audio Servicing.

Technical Training

Courses include Electronic Technicians, Computer Technicians, Radio and Television Technicians and many more.

Write for full details TODAY.

ICS School of Electronics,
Dept. 711V, Intertext House,
London SW8 4UJ.
Telephone 01-822 9911 (all hours).

RECEIVERS and COMPONENTS

FLOATLESS SWITCH. Contains 2 CO relay, mains transformer, 24 and 8 volt, bridge rectifier, 2 transistor control circuit, neon, perapex cover. £2.25 (30p). **NEONS** 20-80p (20p). **COPPER CLAD P.C. BOARDS.** 8 1/2" x 3 1/2" 6-85p, 12 1/2" x 9" 75p, 8 1/2" x 6 1/2" 3-21.35. All C.P. **PANEL WITH 10 AMP SCR** on heat sink, 11 silicon transistors BC108, BCY22 etc, panel neon, 2 trim pots etc. 85p (25p). **C230 POLYESTER CAPS** 100-21 (20p). List 15p refund on purchase.
7lbs assorted components £2.60 C.P.

IWB RADIO

2 Barnfield Crescent, Sale, Cheshire M33 1NL
Postage in brackets Mail order only

500 COMPONENTS. Resistors, Capacitors, Diodes, Transistors, Pots, Coils, etc. Identified, formed leads, fall-out, & surplus. Good value at £1.60. All inclusive. (UK postal rates only). CWO please to L. PENSENEY, E. Bankhead Farm, South Queensferry, West Lothian.

SERVICE SHEETS

SERVICE SHEETS for Radio, TV, Tape Recorders, Stereo, etc., with free fault-finding guide, 50p and SAE. Hamilton Radio, 47 Bohemia Road, St. Leonards, Sussex.

BELL'S TELEVISION SERVICES for service sheets on Radio, TV, etc. 75p plus s.a.e. Colour TV Service Manuals on request. S.a.e with enquiries to B.T.S., 190 Kings Road, Harrogate, N. Yorkshire. Tel: 0423 55885.

FOR SALE

AKG D190C MIKES. New and boxed £24. 'E' model £26 inc. VAT and postage. J. J. FRANCIS (WOOD GREEN) LTD., Manwood House, Matching Green, Harlow, Essex. Tel: Matching 476.

46 ISSUES Everyday Electronics 1972 onwards. Any reasonable offer—12 Norton Green, Sheffield, S8 8BP. Telephone 745693.

WANTED

WANTED EVERYDAY ELECTRONICS No. 1 to July '75. A. DYSCH. 42 Wolfreton Garth, Kirkella, Hull.

WANTED BACK ISSUES dated November, December 1971, January, March, May 1972, March, April, May 1973 and March 1976. Please write to Box No. 6.

MISCELLANEOUS

PACK OF ASSORTED PIECES, single sided 1/16in copper clad laminate for P.C. Boards, approx 200 sq inches 70p plus p. & p. 30p. Cash with order to E. J. STEELE, 382 Linnet Drive, Chelmsford, Essex.

BINOCULAR MAGNIFIER



FOR PRECISION CLOSE-UP WORK—
LEAVES BOTH HANDS FREE
2 1/2 or 3x Model with
Hinged Lens Mount

£9.95

See close-up work with less eye strain & fatigue. Lightweight adjustable headband. Powerful optically ground lenses from Continental glass-works. Can be worn over normal glasses. An essential aid in industry, Home, Workshop, Collecting, Modelling, Jewellery, Watchmakers. Any fine work. **DELUXE MODELS** with superior quality lens **PLUS** hinged lens mount 3 1/2 x model 29.95 + 75p P & P 8 x model £10.95 + 75p P & P

JOHN DUDLEY & CO. LTD., Dept. EE10, 801 Cricklewood Lane, Finchley Road, London. NW2. Tel. 01-468 5917. (Callers welcome).

STYLI & CARTRIDGES. For the best at keenest prices send SAE for free illus. list to **FELSTED ELECTRONICS (EE)**, Longley Lane, Gatley, Ches. SK8 4EE.

I.C.s, TTL, C/Mos, Linear, Capacitors, Resistors (E12), SIL/Rectifiers, Diodes, LED, Thyristors, Zeners, Voltage Reg, DIL Sockets, Bridge Rectifiers, Potentiometers, Presets, Triacs, Diac, Plugs, Sockets, Cable, Vero. Carefully selected range, excellent despatch service. Same day turn round. S.a.e. list. **ORCHARD ELECTRONICS,** Flint House, High Street, Wallingford, Oxon. Tel: 0491 35529.

ENAMELLED COPPER WIRE

SWG	1lb	4oz	2oz
14-19	2.40	.80	.50
20-29	2.45	.82	.50
30-34	2.80	.85	.64
35-40	2.85	1.00	.75

Inclusive of P. & P. and VAT

S.A.E. brings Catalogue of copper and resistance wires in all coverings.

THE SCIENTIFIC WIRE COMPANY
P.O. Box 30 London E.4. 8BW.

LOWEST COST IC SOCKETS. Use Soldercon IC socket pins for 8 to 40 pin DIL's. 50p for strip of 100 pins. £1.50 for 3 strips of 100, £4 for 1000. 10p p&p for orders under £2. Add 8% VAT. Instructions supplied—send s.a.e for sample. **SINTEL**, 53a Aston Street, Oxford. Tel: 0865 43203.

LOUDSPEAKERS



Speakers, kits and cabinets for D.I.Y., Hi Fi, P.A., Disco, etc. by EMI, Fane, Goodmans, Baker, Kef, Elac, Richard Allan, Wharfedale, etc. Send stamp for free booklet "Choosing a speaker"

WILMSLOW AUDIO

Dept. EE, Swan Works, Bank Square, Wilmslow, Cheshire SK9 1HF
Tel. Wilmslow 29599

RECHARGEABLE NICAD BATTERIES

Pencell AA—84p. Sub 'C'—£1.16. 'C'—£1.92. 'D'—£2.58. PP3—£4.48. Chargers £4.48, £4.48, £4.98, £4.98, £3.98, respectively. Others. All prices include VAT, add 10% post and package. S.a.e. for price list plus 25p for information booklet. **SANDWELL PLANT LTD.,** 1 Denholm Road, Sutton Coldfield, West Midlands. 021-354 9764.

Build your own Metal Detector

Professional BFO Kit, all aluminium and plastic construction. Full kit and step by step instructions, tried and tested circuit as used by the manufacturers, G.P.O. approved, complete with Faraday screen. Send s.a.e. for details to

DETECTOR PRODUCTS,
59a, King Street,
Blackburn, Lancs.
Tel: 85561

SUPERB INSTRUMENT CASES by Bazell, manufactured from heavy duty PVC faced steel. Hundreds of people and industrial users are choosing the cases they require from our vast range, competitive prices start at a low 75p. Over 400 Models to choose from, Prompt despatch, Free literature, (stamp would be appreciated). Bazell, Department No. 24, St. Wilfreds, Foundry Lane, Halton, Lancaster LA2 6LT.

HOME SCIENTISTS
Get the key to a FANTASTIC WORLD of previously UNHEARD-OF-PROJECTS. The NEW Boffin catalogue lists LOTS of HIGHLY UNUSUAL, LOW-COST BARGAINS, READY-BUILT MODULES. Here are just a few examples, there are stacks more!

- Dazzling MINI-STROBE (pocket size) £3.50
 PEOPLE DETECTOR £4.20
 Big-Ear SOUND-CATCHER £4.20
 Mini DREAM LABORATORY £4.20
- Don't take our word for it though! GET A COPY & SEE!
 SEND ONLY 20p, and we'll RUSH YOU A COPY (YOU'LL GET THE GOODIES' JUST AS QUICKLY TOO!)
BOFFIN PROJECTS
 4 Cunliffe Road, Stoneleigh,
 Ewell, Surrey
 (Mail Order U.K. Only)

TREASURE TRACER MK III Metal Locator



- Varicap tuning
- Britain's best selling metal locator kit; 4,000 sold
- Weighs only 22oz. Fitted with Faraday shield
- Speaker and earphone operation
- Knocks down to only 17in
- Prebuilt search coil assembly
- Thoroughly professional finish
- As seen on BBC1 and BBC2 TV
- You only need soldering iron, screwdriver, pliers and snips
- Five transistor circuit
- Send stamped addressed envelope for leaflet

Complete Kit £12.50 Build & tested £17.50
 Post 85p-£1.00 VAT (8%) Post 85p-£1.90 VAT (8%)

MINKIS ELECTRONICS
 6b CLEVELAND ROAD,
 LONDON, E18 2AN (Mail order only)

4-STATION INTERCOM



£16.95 + V.A.T. £1.36

Solve your communication problems with this 4-Station Transistor Intercom system (1 master and 3 Subs), in robust plastic cabinets for desk or wall mounting. Call/talk/listen from Master to Subs and Subs to Master. Ideally suitable for Business, Surgery, Schools, Hospitals and Office. Operates on one 9V battery. On/off switch. Volume control. Complete with 3 connecting wires each 6ft. and other accessories. P. & P. 85p.

MAINS INTERCOM NEW MODEL
 No batteries—no wires. Just plug in the mains for instant two-way, loud and clear communication. On off switch and volume control. Price £29.24 per pair P. & P. 85p.

NEW! AMERICAN TYPE CRADLE TELEPHONE AMPLIFIER



ONLY £12.95 + V.A.T. £1.04

Latest transistorised Telephone Amplifier with detached plug-in speaker. Placing the receiver on to the cradle activates a switch for immediate two-way conversation without holding the handset. Many people can listen at a time. Increase efficiency in office, shop, workshop. Perfect for "conference" calls: leaves the user's hands free to make notes, consult files. No long waiting, saves time with long-distance calls. On/Off switch, volume. Direct tape recording model at £18.95 + V.A.T. £1.12 P. & P. 70p, 10-day price refund guarantee.

WEST LONDON DIRECT SUPPLIES (E.E.S.)
 189 KENSINGTON HIGH STREET, LONDON, W8

DENCO (CLACTON) LIMITED

Dept. E.E.
 357-8-9 OLD RD.,
CLACTON-ON-SEA
 ESSEX CO15 3RH



Our components are chosen by technical authors and constructors throughout the world for their performance and reliability, every coil being inspected twice plus a final test and near spot-on alignment.

General Catalogue showing full product range 32p. Overseas Customers 70p, Air-Mail Post Paid.

U.K. & OVERSEAS MANUFACTURERS/STOCKISTS ENQUIRIES WELCOME

Australian Readers Please Note—Our Complete Range of Coils are available from Hobipak, Box 224, South Carlton, 3053, Victoria, Australia and Watkin Wynne Pty. Ltd., 32, Falcon Street, CROWS NEST, 2065, AUSTRALIA. P.O. Box 392.

ELECTRONIC KIT
 BUILD, DISMANTLE AND REBUILD OVER 100 DIFFERENT PROJECTS AND DESIGN NEW CIRCUITS TOO

Radio Receivers and Transmitters, Telephone Amplifiers, Time Buzzers, Battery Checkers, Computer Circuits, Amplifiers, Directional Transmitters, Metal Detectors, Continuity Testers, Electronics Birds, Guns, Metronomes, Sirens, Roulette, Etc., Etc. **ALL IN ONE KIT**

"... educational kits of exceptional quality" (AUDIO mag.)
 "... worthwhile ... good value for money" (EVERYDAY ELECTRONICS mag.)

Educational manuals included with each kit. No previous experience required. Suitable for beginners and experts too.

- 100 project kit £19.60
- 45 project kit £15.60
- 25 project kit £12.10 (Add-on kits available too)

Prices include Manuals, Batteries, VAT and p and p

Cheque/P.O. (or 11p for illustrated literature) to DEPT. EE

Satisfaction guaranteed
ELECTRONIC-KIT LTD, 408 St. John's Street,
 London, EC1, [01-278 4579]

GF

GIRO NO. 331 7056. Access and Barclaycard accepted.
 C.W.O. only. Terms of business as in our catalogue.
 Export Order enquiries welcome (£5 min.)

Official Orders accepted from Educational & Government Departments

ALL PRICES INCLUDE VAT AS APPROPRIATE AT 8% and 12% AND P & P

SHOP HOURS—9.12.30, 1.30-5 pm 5 DAYS
 CLOSED WEDNESDAY

66 Pages—3000 Items Fully illustrated

★20p Credit Vouchers★All New Stock

- ★Satisfaction Guarantee
- ★Discounts
- ★New Price

1976 Issue



20p plus 10p postage

CTRONIC COMPONENTS Catalogue 5

GF
ORS LTD.

Resistors - Capacitors - Semiconductors - Boxes - Cases - Kits - PC materials - Tools - Test Meters - Books - Pots - Coils - Hardware - Audio Accessories - Veroboard - Transformers - Screws - Knobs - Calculators - Audio - Modules - Audio Leads - Batteries - Heatsinks - S Dec Storage Units etc. etc.

SPECIAL RESISTOR KITS (CARBON FILM 5%) (Prices include post & packing)
 10E12 1W or 1/2W KIT: 10 of each E12 value, 22 ohms—1M, a total of £70 £5.04 net
 25E12 1/4W or 1/8W KIT: 25 of each E12 value, 22 ohms—1M, a total of 1425 £11.70 net

SPECIAL CAPACITOR KITS
 C280 Kit—PC Mounting polyester 250V 5 or each value: 0-01, 0-022, 0-047, 0-1, 0-22µF, 2 of 0-47, 1µF £1.81 net

C296 Kit—Tubular polyester, 400V 5 of each value: 0-01, 0-022, 0-047, 0-1, 0-22µF, 2 of 0-47µF £2.43 net
 Ceramic Kit—square plaque 50V 5 of each value: 22, 33, 47, 100, 220, 330, 470, 1000pF, 2200, 4700pF, 0-1µF £1.71 net

250V Paper Kit—Tubular metal case 3 of each value: 0-05, 0-1, 0-25, 0-5, 1µF £1.29 net

500V Paper Kit—Tubular metal case 3 of each value: 0-025, 0-05, 0-1, 0-25, 0-5µF £1.29 net
 1000V Paper Kit—Tubular metal case 3 of each value: 0-01, 0-025, 0-05, 0-1µF £1.59 net

B. H. COMPONENT FACTORS LTD.

MULTIMETER U4323
 22 Ranges plus AF/IF Oscillator
 20,000Ω/Volt

Vdc—0-5—1000V in 7 ranges.
 Vac—2-5—1000V in 6 ranges.
 Idc—0-05—500mA in 5 ranges.
 Resistance—5Ω—1M Ω in 4 ranges.

Accuracy—5% of F.S.D.
OSCILLATOR—5 KHz and 465KHz (A. M.) at approx. 1 Volt
 Size—160 x 97 x 40mm.
 Supplied complete with carrying case, test leads and battery.
 PRICE £10.70 net

U4323

MULTIMETER U4324
 34 Ranges. High Sensitivity.
 20,000Ω/Volt.

Vdc—0-6—1200V in 9 ranges.
 Vac—3—900V in 8 ranges.
 Idc—0-06—3A in 6 ranges.

Iac—0-3—3A in 5 ranges.
 Resistance—25Ω—3M Ω in 5 ranges.
 Accuracy—dc and R—2½% of F.S.D.
 ac and db—4% of F.S.D.
 Size—167 x 98 x 63mm.
 Supplied complete with storage case, test leads, spare diode and battery.
 PRICE £12.47 net

U4324

TEACH-IN SERIES COMPONENT KIT
 KIT No. T12
 ALL COMPONENTS AS SPECIFIED BY E.E. FULLY GUARANTEED AND NEW STOCK (INCLUDES BATTERIES) £16.10 NET

WOOD KIT
 Includes all wood as specified by E.E., cut to size, ready to assemble and includes adhesive and screws. (Not drilled)
 £3.75 NET

FULL LIST AVAILABLE. S.A.E. PLEASE OR FREE WITH CATALOGUE

(E. E.) LEIGHTON ELECTRONICS CENTRE,
 59 NORTH STREET, LEIGHTON BUZZARD,
 LU7 7EG. Tel: Leighton Buzzard 2316 (Std. Code 05253).

Sparkrite mk2

Capacitive discharge
electronics ignition kit

VOTED BEST
OF 8 SYSTEMS
TESTED BY
'POPULAR
MOTORING'
MAGAZINE



- * Smoother running
- * Instant all-weather starting
- * Continual peak performance
- * Longer coil/battery/plug life
- * Improved acceleration/top speeds
- * Up to 20% better fuel consumption

Sparkrite Mk. 2 is a high performance, high quality capacitive discharge, electronic ignition system in kit form. Tried, tested, proven, reliable and complete. It can be assembled in two or three hours and fitted in 15/30 mins.

Because of the superb design of the Sparkrite circuit it completely eliminates problems of the contact breaker. There is no misfire due to contact breaker bounce which is eliminated electronically by a pulse suppression circuit which prevents the unit firing if the points bounce open at high R.P.M. Contact breaker burn is eliminated by reducing the current to about 1/50th of the norm. It will perform equally well with new, old, or even badly pitted points and is not dependent upon the dwell time of the contact breakers for recharging the system. Sparkrite incorporates a short circuit protected inverter which eliminates the problems of SCR lock on and, therefore, eliminates the possibility of blowing the transistors or the SCR. (Most capacitive discharge ignitions are not completely foolproof in this respect). All kits fit vehicles with coil/distributor ignition up to 8 cylinders.

THE KIT COMPRISES EVERYTHING NEEDED

Ready drilled pressed steel case coated in matt black epoxy resin, ready drilled base and heat-sink, top quality 5 year guaranteed transformer and components, cables, coil connectors, printed circuit board, nuts, bolts, silicon grease, full instructions to make the kit negative or positive earth, and 10 page installation instructions.

OPTIONAL EXTRAS

Electronic/conventional ignition switch. Gives instant changeover from "Sparkrite" ignition to conventional ignition for performance comparisons, static timing etc., and will also switch the ignition off completely as a security device, includes: switch connectors, mounting bracket and instructions. Cables excluded. Also available RPM limiting control for dashboard mounting (fitted in case on ready built unit).

CALLERS WELCOME. For Crypton tuning and fitting service - phone (0922) 33008.

PRICES INCLUDE VAT, POST AND PACKING.

Improve performance & economy NOW

POST TODAY!

Quick installation
No engine modification
required

Electronics Design Associates, DEPT EE8
82 Bath Street, Walsall, WS1 3DE. Phone: (0922) 33652

Name
Address

Mk. 2 DIY Ass. Kit @ £11.80	QUANTITY REQD.	I enclose cheque/PO's for £
Mk. 2 Ready Built Negative Earth @ £14.97		
Mk. 2 Ready Built Positive Earth @ £14.97		Cheque No.
Ignition Changeover switches @ £4.30		
R.P.M. Limit systems in above units @ £2.42		Send SAE if brochure only required.

CRESCENT RADIO Ltd.

164-166 HIGH ROAD LONDON N22 6EJ
(also) 13 SOUTH MALL, Edmonton, N.9
MAIL ORDER DEPT. 1 St Michaels Terrace Wood Green
London N22 4SJ Phone 888 3206 & MAIL ORDER 888-4474

POWER PACKS

PP1 Switched 3, 4j, 6, 7j, 9 and 12
volt @ 500 m/a, with on/off
switch and pilot light.
Size = 130 mm x 55 mm x 75 mm
ONLY = \$4.50

PP3 Car converter. From 12v Pos. or
Neg to 6-7j-9 volt. Easy to fit
and transistor regulated.

Plus 8% VAT £3.90 each.

CABLELESS SOLDERING IRON WAHL "ISO-TIP"

- ★ Completely Portable
 - ★ Solders up to 160 joints per charge
 - ★ Re-charges in its own stand
 - ★ Fine tip for all types of soldering
 - ★ Only 8" long and weighs just 6 ozs.
- Our Price \$9.75. Plus 8% VAT
(Spare bits are available)

ALUMINIUM BOXES

Metal Project Boxes give your work a
professional finish.

	L	W	H	Price
AB7	2 1/2	5 1/2	1 1/2	45p
AB8	4	4	1 1/2	45p
AB9	4	2 1/2	1 1/2	45p
AB10	4	5 1/2	1 1/2	55p
AB11	4	2 1/2	2	45p
AB12	3	2	1	35p
AB13	6	4	2	65p
AB14	7	5	2 1/2	75p
AB15	8	6	3	£1.02
AB16	10	7	3	£1.35
AB17	10	4 1/2	3	£1.05
AB18	12	5	3	£1.80
AB19	12	8	3	£1.50

All size are approx and in inches.
Plus 8% VAT

P.C. ETCHING KIT

This kit contains all that the constructor
will need to etch the circuits of his own
design.
Contents—Plastic etching dish. Sample
copper clad board. Laminated Cutter.
1 lb Ferric Chloride. Large Plastic
Spoon. Etch Resist Pen. Full Etching
Instructions.
Complete and Big Kit Value at \$3.75p
+ 8% VAT.

FERRIC CHLORIDE

Anhydrous ferric chloride in double
sealed one pound Poly packs.
OUR PRICE — 65p + PP + 8% per lb.

2in. PANEL METERS

Size 59mm x 46mm

0-50µA —ME6	0-100mA—ME13
0-100µA—ME7	0-500mA—ME14
0-500µA—ME8	0-1A —ME16
0-1mA —ME9	0-60V —ME15
0-5mA —ME10	0-300V a.c.—ME17
0-10mA—ME11	S meter —ME18
0-50mA—ME12	V.U. meter—ME19

Complete and Big Kit Value at \$3.75p
+ 8% VAT

MINI LOUDSPEAKERS

2 1/2" 8 ohm	80p
2 1/2" 40 ohm	60p
2 1/2" 8 ohm	60p
	+ 12 1/2%

GOODMANS CROSSOVER
3 way 8 ohm Crossover
manufactured by Goodmans.
Bargain at £1 + 12 1/2%.

U.K. CARR.
50p unless otherwise
stated

All prices are excluding VAT. Please
add to each item the VAT rate in-
dicated to all orders

ELECTROVALUE

the good components service

COMPLETE YOUR TEACH-IN WITH E.V.

To ensure success and progress, learn above all
to use components you can depend on and buy
from a firm that really knows the business
All electronic components for the E.E. Teach In
POST PAID (UK) AND INC. VAT £14.25 NETT

CATALOGUE 8 NOW ISSUE No. 2

With our first printing sold out, Cat. 8, No. 2 is now ready,
revised and brought up to date on prices, etc. 144 pages. New
items. Opto-electronics, Diagrams of Components, applications,
I.C. circuits, etc. Post free 40p, including voucher for 40p for
spending on order over £5 list value.

DISCOUNTS

On all C.W.O. mail orders, except for some items marked NETT.
5% on orders list value £10 or more 10% on orders list value
£15 or more

FREE POST & PACKING

On all C.W.O. mail orders in U.K. over £2 list value. If under,
add 15p handling charge.

PRICE STABILIZATION POLICY

Prices are held and then reviewed over minimum periods of
3 months—Next price review due July 1st.

QUALITY GUARANTEE

On everything in our Catalogue—No manufacturer's rejects,
seconds or sub-standards merchandise.

ELECTROVALUE LTD

All communications to Dept. 815, 28 ST. JUDES ROAD, ENGLEFIELD
GREEN, EGHAM, SURREY TW20 0HB. Telephone Egham 3603, Telex
284475. Shop hours 9-5.30 daily, 9-1 pm Sats.
NORTHERN BRANCH: 680 Burnage Lane, Burnage, Manchester
M19 1NA. Telephone (061) 432 4945. Shop hours Daily 9-5.30 pm; 9-1 pm Sats.

DESIGNED BY TEXAS



Texan Amplifier as featured by PRACTICAL WIRELESS
SOLE U.K. DISTRIBUTORS - HENRY'S

30,000 ALREADY SOLD

Build it yourself for only

£32 KIT PRICE INC. VAT + £1.00 p&p
Built and tested £42.00 inc. VAT + £1.00 p&p.

Build the Texan stereo amplifier, then you can be doubly proud! For a start, you'll own a superb home entertainment unit. And have had all the pleasure of doing it yourself, with the Henry's kit.

Look at the Texan specification
Incorporating fully integrated stereo preamp and power amp, with 6 IC's, 10 transistors, 6 rectifiers and zener diodes. Plus stabilised, protected circuitry, glass fibre pcb, Gardener's low-field low-line mains transformer; all facilities and controls. Slim design, chassis 14 1/2" x 6" x 2" overall, 20 watts per channel RMS, less than 0.1% distortion at 1 kHz.

- ★ Can be built Stage by stage
- ★ Ask for leaflet 5.
- ★ Everything necessary supplied.
- ★ Full after sales service and guarantees.

TEXAN FM TUNER KIT **£23.50**
inc. VAT + 50p p&p

Built and tested £28.50 inc. VAT + 50p p&p.
Build the matching Texan stereo tuner! Features advanced varicap tuning. Phase lock loop decoder. Professionally designed circuit. Everything you need is in the kit. From the glass fibre pcb to the cabinet itself. Excellent spec: 2.5 uV aerial sensitivity. 500 mV output (adjustable). Tuning range 87-102 MHz. Mains powered.

THE NATURAL FOLLOW-ON

DIGITAL 24 HOUR CLOCK
AS USED IN BRITISH DIGITAL CLOCKS
WITH BUILT-IN ALARM!
NORMALLY £24.00 WITH CASE

EXCLUSIVE HENRY'S PRICE **£6** LOTS OF 3 £16.50 INC. V.A.T. and P&P

All you have to do is make a casing and you've got a £24.00 Digital Unit.

Also from Henry's **MISTRAL DIGITAL CLOCK KIT** £11.50 inc. VAT 30p p&p

VIDEO SPORT



An up-to-the-minute game. Plugs into your own TV aerial socket. Switch on. And you're away! Choose your game - football, tennis or hole-in-the-wall. Absolutely safe. For you. Your children. And your TV. Mains powered. List Price £42.50

HENRY'S PRICE **£25.00** inc. VAT + 50p p&p
★ OVER 10,000 ALREADY SOLD
★ IDEAL GIFT

- SILENT RUNNING ● LARGE ILLUMINATE NUMERALS
- A.C. MAINS ● SIZE 6 1/2" x 2 1/2" x 2 1/2"

HENRY'S LATEST ELECTRONIC CATALOGUE **50p** + 20p carr/pack.
TRANSISTOR & VALVE DISCOUNT PRICE LIST over 2000 types SEND FOR YOUR FREE COPY

Henry's RADIO

All mail to: Henry's Radio
303 Edgware Rd. London W2

LONDON W2: 404/6 Edgware Road. Tel: 01-402 8381
LONDON W1: 231 Tottenham Ct Rd. Tel: 01-636 6681
*NOTTINGHAM: 94/96 Upper Parliament St. Tel: (0602) 40403
*READING, BERKS: 130/131 Friar Street. Tel: (0734) 583230

*CROYDON: 110 North End. Tel: 01-681 3310

NEW STORES

Please Note: MAIL ORDER CUSTOMERS AT DOWN HENRY'S WILL CREDIT ANY VAT OVERPAYMENTS



"I MADE IT MYSELF"

Imagine the thrill you'll feel! Imagine how impressed people will be when they're hearing a programme on a modern radio you made yourself.

Now! Learn the secrets of radio and electronics by building your own modern transistor radio!

Practical lessons teach you sooner than you would dream possible.

What a wonderful way to learn—and pave the way to a new, better-paid career! No dreary ploughing through page after page of dull facts and figures. With this fascinating Technatron Course, you learn by building!

You build a modern Transistor Radio . . . a Burglar Alarm. You learn Radio and Electronics by doing actual projects you enjoy—making things with your own hands that you'll be proud to own! No wonder it's so fast and easy to learn this way. Because learning becomes a hobby! And what a profitable hobby. Because opportunities in the field of Radio and Electronics are growing faster than they can find people to fill the jobs!

No soldering - yet you learn faster than you ever dreamed possible.

Yes! Faster than you can imagine, you pick up the technical know how you need. Specially prepared step-by-step lessons show you how to read circuits—assemble components—build things—experiment. You enjoy every minute of it! You get everything you need. Tools. Components. Even a versatile Multimeter that we teach you how to use. All included in the course. AT NO EXTRA CHARGE! And this is a course anyone can afford. (You can even pay for it by easy instalments).

So fast, so easy, this personalised course will teach you even if you don't know a thing today!

No matter how little you know now, no matter what your background or education, we'll teach you. Step by step, in simple easy-to-understand language, you pick up the secrets of radio and electronics. You become somebody who makes things, not just another of the millions, who don't understand. And you could pave the way to a great new career, to add to the thrill and pride you receive when you look at what you have achieved. Within weeks you could hold in your hand your own transistor radio. And after the course you can go on to acquire high-powered technical qualifications, because our famous courses go right up to City & Guilds levels.

Send now for FREE 44 pagebook - see how easy it is - read what others say!

Find out more now! This is the gateway to a thrilling new career, or a wonderful hobby you'll enjoy for years. Send the coupon now. There's no obligation.

POST TODAY FOR FREE BOOK

To: **ALDERMASTON COLLEGE**
DEPT. CEE 20 READING RG7 4PF

Also at our London Advisory Office, 4 Fore Street Avenue, Moorgate, London EC2Y 5EJ. Tel: 01-628 2721.
Yes, I'd like to know more about your course. Please send me free details—plus your big, 44 page book that tells about all your courses.

NAME

ADDRESS

POSTCODE



HOME OF BRITISH INSTITUTE OF ENGINEERING TECHNOLOGY

Make it with MAPLIN!

ELECTRONIC COMPONENTS
WIDE RANGE • HIGH QUALITY • FAST SERVICE

The 4600 SYNTHESISER

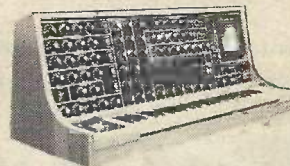

We stock all the parts for this brilliantly designed synthesiser, including all the PCB's, metalwork and a drilled and printed front panel, giving a superb professional finish. Opinions of authority agree the ETI International Synthesiser is technically superior to most of today's models. Complete construction details in our booklet now available price £1.50, or send SAE for specification.

ELECTRONIC ORGAN

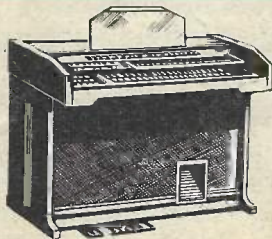

BUILD IT YOURSELF ... IN STAGES

Get started with a 49 note instrument - features tremulant and reverberation. Ideal to learn on. Leaflet MES 51. Price 15p gives full details to build this complete instrument.

Extend the range of MES 51 by adding another keyboard and several new tone colours. Leaflet MES 52. Price 15p also shows how to use 61 note keyboards.

Fully controllable attack and decay controls (normally found only on the most expensive organs), up to seven footages on each keyboard, up to 70 controls including drawbars, and a 13 note pedalboard, make up the additions described in the step-by-step 32 page instruction leaflet MES 53. Price 35p.

GRAPHIC EQUALIZER

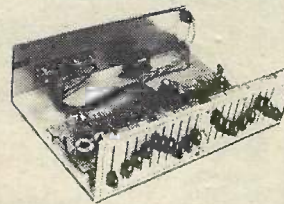

A really superior high-quality stereo graphic equalizer featuring 9 octaves per channel. We stock all the parts (except woodwork) including the metalwork drilled and printed. 15p brings you a reprint of the article.

DIGITAL CLOCK KITS

ONLY **£8.60** INC. VAT
E/P/P

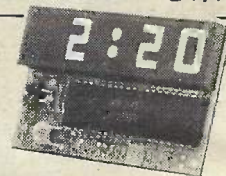

This is a fully constructed and tested electronic clock module as illustrated. Data sheet supplied. Simple to connect

to alarm and your battery/mains radio. Smart case available. Data sheet available separately. Please send SAE.

- Bright 4 Digit 0.5" Display
- Flashing Colon (1Hz)
- Switch for Display Seconds
- Alarm Set Indicator
- P.M. Indicator
- Power Failure Indicator
- Sleep Timer
- Snooze Timer
- Time can be set accurately to within one second
- Leading Zero-Blanking

SIMPLE ALARM KIT - £9.38 ALARM CLOCK KIT - £10.99
ALARM CLOCK & RADIO CONTROLLER KIT - £11.51
SMART PLASTIC CASE with fully punched chassis - £2.49
Please send SAE for our Clock data sheet.

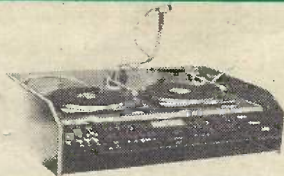

100 W PER CHANNEL STEREO DISCO

- Automatic voice operated fader
- Belt drive turntables
- Monitor facilities (Headphones and VU meters)
- Sound operated light show - plus many other advantages.

Send for our leaflet MES 41, giving full details for construction. Price 20p. Soon you'll be the Deejay everyone wants at their party!

Full construction details to be published in *Electronics Today International* on sale August.

Get our FABULOUS NEW 1977/78 CATALOGUE

PUBLICATION DATE OCT. 28, 1976 ON APPROVAL

All new . . . Completely re-written . . . Hundreds of new lines.
Lots of exciting new projects to build - PRICE 50p.
SEND NO MONEY NOW. Overseas send 8 International reply coupons.

JOIN OUR MAILING LIST NOW!
Published every two months our Newsletter gives full details of our latest guaranteed prices. Send just 30p and we'll send you the next six news letters as they are published.

- SAVE ££'s ON SPECIAL OFFERS!
- DETAILS OF NEW PROJECTS AND NEW LINES



MAPLIN ELECTRONIC SUPPLIES
All mail to: P.O. Box 3, Rayleigh, Essex SS6 8LR.
Shop: 284 London Road, Westcliff-on-Sea, Essex
(Closed on Monday). Tel: Southend (0702) 44101

Please rush me a copy of your brand new 1977/78 catalogue the instant it is published (October 28th, 1976). Only if I am completely satisfied that it is worth every penny will I send 50p within 14 days of receipt. If I am not satisfied I may return the catalogue to you within 14 days without obligation. I understand that I need not purchase anything from your catalogue should I choose to keep it.

NAME _____

ADDRESS _____

If you do not wish to cut magazine, write your request for catalogue on separate sheet
1975/76 GREEN COVER CATALOGUE STILL AVAILABLE PRICE 40p