

Parfitt

Construction and theory for everyone

# everyday electronics

JULY 75  
25p

*Drive straight in!*

**AUTOMATIC  
GARAGE DOORS**



**EXCITING AND  
USEFUL PROJECTS  
TO BUILD AT HOME-**

*We show you how*  
**... IN FULL DETAIL**

Plus REGULAR THEORY AND  
GENERAL INTEREST ARTICLES

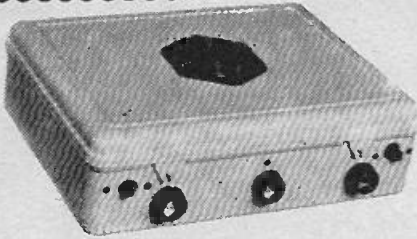
**ADD-ON AMPLIFIER**





# NEW EDU-KIT MAJOR

Completely Solderless Electronic Construction Kit  
Build these projects without soldering iron or solder



- ★ 4 Transistor Earpiece Radio.
- ★ 5 Transistor Push Pull Amplifier.
- ★ Batteryless Crystal Radio.
- ★ Signal Tracer.
- ★ 7 Transistor Loudspeaker Radio MW/LW.
- ★ One Transistor Radio.
- ★ Signal Injector
- ★ 5 Transistor Short Wave Radio.
- ★ 2 Transistor Regenerative Radio.
- ★ Transistor Tester NFN-FNP.
- ★ Electronic Metronome.
- ★ 3 Transistor Regenerative Radio.
- ★ 4 Transistor Push Pull Amplifier.
- ★ Electronic Noise Generator
- ★ Audible Continuity Tester.
- ★ Sensitive Pre-Amplifier.

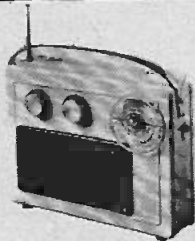
Total Building Costs

**£7-23** PP & Ins. 58p  
(Overseas Seamall P & P £3-40)  
(+25% VAT £1-80)

Components Include: 24 Resistors ● 21 Capacitors ● 10 Transistors ● 31" Loudspeaker ● Ear-piece ● Mica Baseboard ● 3 12-way connectors ● 2 Volume controls ● 2 Slider Switches ● 1 Tuning Condenser ● 3 Knobs ● Ready Wound MW/LW/SW Coils ● Ferrite Rod ● 6 1/2 yards of wire ● 1 Yard of sleeving etc. ● Parts Price List and Plans 55p free with parts.

## NEW ROAMER NINE

WITH V.H.F. INCLUDING AIRCRAFT



Nine Transistors, 9 Tunable wavebands as Roamer Ten. Built in ferrite rod aerial for MW/LW. Retractable chrome-plated telescopic aerial for VHF and SW. Push Pull output using 600mW transistors. 9 Transistors and 3 diodes, tuning condenser with V.H.F. section, separate coil for aircraft, moving coil loudspeaker, volume ON/OFF and wave-change controls. Attractive all white case with red grille and carrying strap. Size 9 1/2" x 7" x 2 1/4" approx. Parts Price List and Plans free with parts.

Total Building Costs **£6-95**  
(+25% VAT £1-75)

PP & Ins. 58p  
(Overseas Seamall P & P £3-40)

## NEW Everyday Series

Build this exciting New series of designs E.V.5. 5 Transistors and 2 diodes. MW/LW. Powered by 4 1/2 volt Battery. Ferrite rod aerial, tuning condenser, volume control, and now with 3" loudspeaker. Attractive case with red speaker grille Size 9" x 5 1/2" x 2 1/4" approx. Parts Price List and Plans free with parts.

Total Building Costs **£3-40** PP & Ins. 50p  
(Overseas Seamall P & P £2-30)  
(+ 25% VAT 85p)

E.V.6. Case and looks as above. 6 Transistors and 3 diodes. Powered by 9 volt battery. Ferrite rod aerial. 3" loudspeaker, etc. MW/LW coverage. Push Pull output. Parts Price List and Plans free with parts.

Total Building Costs **£3-98** PP & Ins. 50p  
(Overseas Seamall P & P £2-30)  
(+ 25% VAT £1-00)

E.V.7. Case and looks as above. 7 Transistors and 3 diodes. Six wavebands. MW/LW. Trawler Band. SW1. SW2. SW2, powered by 9 volt battery. Push Pull output. Telescopic aerial for short waves. 3" Loudspeaker. Parts Price List and Easy Build Plans free with parts.

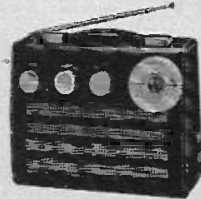
Total Building Costs **£4-48** PP & Ins. 50p  
(Overseas Seamall P & P £2-50)  
(+ 25% VAT £1-12)

## ROAMER TEN Mk 2

WITH VHF INCLUDING AIRCRAFT

Now with free earpiece and switched socket. 10 Transistors. Latest 4" 2 watt Ferrite Magnet Loudspeaker. 9" Tunable Wavebands, MW1, MW2, LW, SW1, SW2, SW3. Trawler Band, VHF and Local Stations also Aircraft Band. Built in Ferrite Rod Aerial for MW/LW. Chrome plated 6 section Telescopic Aerial, can be angled and rotated for peak short wave and VHF listening. Push Pull output using 600mW Transistors. Car Aerial and Tape Record Sockets. 10 Transistors plus 3 Diodes. Ganged Tuning Condenser with VHF section. Separate tone Controls. Attractive Case in black with silver block-in. Size 9" x 7" x 4". Easy to follow instructions and diagrams. Parts price list and plans 50p free with parts.

Total building costs **£9-50** PP & Ins. £3-50  
(+25% VAT £2-37)



## POCKET FIVE

NOW WITH 3" LOUD-SPEAKER

3 Tunable wavebands. M.W. L.W. and Trawler Band. 7 stages. 6 transistors and 3 diodes, supersensitive ferrite rod aerial, attractive black and gold case. Size 5 1/2" x 1 1/2" x 3 1/4" approx. Plans and Parts Price List free with parts.

Total Building Costs **£2-95** PP & Ins. 38p  
(+25% VAT 75p)  
(Overseas Seamall P & P £2-30)



## ROAMER EIGHT Mk I

NOW WITH VARIABLE TONE CONTROL

7 Tunable Wavebands: MW1, MW2, LW, SW1, SW2, SW3 and Trawler Band. Built in Ferrite Rod Aerial for MW and L.W. Chrome plated Telescopic aerial can be angled and rotated for peak short wave listening. Push pull output using 600mW transistors. Car aerial and Tape record sockets. Selectivity switch. 8 transistors plus 3 diodes. Latest 4" 2 watt ferrite magnet loudspeaker. Airspace ganged tuning condenser. Volume/on/off, tuning wave change and tone controls. Attractive case in rich chestnut shade with gold block-in. Size 9 x 7 x 1 1/2 in. approx. Easy to follow instructions and diagrams. Parts price list and plans free with parts.

Total building costs **£6-98** PP & Ins. £3-50  
(Overseas Seamall P & P £2-50)  
(+25% VAT £1-75)



## TRANSONA FIVE NOW WITH 3" LOUDSPEAKER

Wavebands, transistors and speaker as Pocket Five. Larger Case with Red Speaker Grille and Tuning Dial. Plans and Parts Price List free with parts.

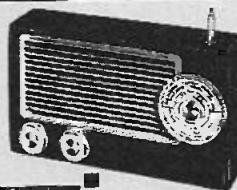
Total Building Costs **£3-20** PP & Ins. 38p  
(+25% VAT 80p.)  
(Overseas Seamall P & P £2-30)

## TRANS EIGHT

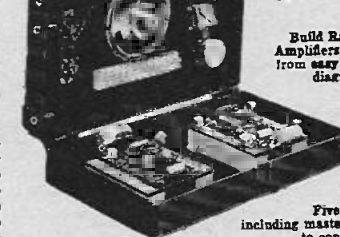
8 TRANSISTORS and 3 DIODES

6 Tunable Wavebands: MW, LW, SW1, SW2, SW3 and Trawler Band. Sensitive ferrite rod aerial for M.W. and L.W. Telescopic aerial for Short Waves. Sin. Speaker. 8 improved type transistors plus 2 diodes. Attractive case in black with red grille, dial and black knobs with polished metal inserts. Size 9 x 5 1/2 x 2 1/4 in. approx. Push pull output. Battery economiser switch for extended battery life. Ample power to drive a larger speaker. Parts price list and plans free with parts.

Total building costs **£4-78** PP & Ins. 50p  
(+20% VAT £1-20)  
(Overseas Seamall P & P £2-50)



## "EDU-KIT"



Build Radios, Amplifiers, etc., from easy stage diagrams.

Five units including master unit to construct

Components include:

Tuning Condenser: 2 Volume Controls: 2 Slider Switches: Fine Tone 3" Moving Coil Speaker: Terminal Strip: Ferrite Rod Aerial: Battery Clips: 4 Tag Boards: 10 Transistors: 4 Diodes: Resistors: Capacitors: Three 1" Knobs: Unit, once constructed are detachable from Master Unit, enabling them to be stored for future use. Ideal for Schools, Educational Authorities and all those interested in radio construction. Parts price list and plans free with parts.

Total building costs **£5-50** PP & Ins. 50p  
(Overseas Seamall P & P £3-40)  
(+ 25% VAT £1-37)

## RADIO EXCHANGE LTD

★ Callers side entrance "Lavelle" shop  
★ Open 10-1, 2.30-4.30, Mon.-Fri. 9-12 Sat.

## ROAMER SIX

CASE AND LOOKS AS TRANS-EIGHT

6 Tunable Wavebands: MW, LW, SW1, SW2, etc. Sensitive ferrite rod aerial and telescopic aerial for Short Waves. Sin. Speaker 8 stages—6 transistors and 2 diodes. Attractive black case with red grille, dial and black knobs with polished metal inserts. Total Size 9 x 5 1/2 x 2 1/4 in. approx. Plans and building parts price list free with parts.

Total building costs **£4-38** PP & Ins. 50p  
(Overseas Seamall P & P £2-50)  
(+ 25% VAT £1-10)

Please allow up to 28 days for delivery.

To RADIO EXCHANGE CO., 61a HIGH STREET, BEDFORD, MK40 1SA  
Tel. : 0234 52367. Reg. No. 788572.

I enclose £..... for  
Name.....  
Address.....  
(Dept. EE7.)



The world's  
**DEAREST**  
Catalogue?



When I told a pal of mine that the Home Radio Components catalogue costs 65 pence plus 33 pence for postage and packing, he whistled through his teeth and exclaimed "It must be the world's most expensive catalogue!"

He changed his tune though when I showed him my copy and he compared it with the lower priced catalogues he'd already bought. He even finished up by admitting "The dearest is the cheapest in the end". Well, that old saying certainly sums it up as far as catalogues are concerned.

With its 240 pages, giving over 6,000 items clearly listed and profusely illustrated, the Home Radio Components catalogue certainly stands out head and shoulders above the rest. And when you remember that the catalogue includes 14 vouchers each worth 5 pence when used as instructed, enabling you to claw back 70 pence of your 98 pence, it's just about the best investment any keen electronics constructor could make. What's more, the catalogue is backed up by a Mail Order Service that takes all the fuss and frustration out of component buying.

Why not prove it for yourself? Send off the coupon below with your cheque or postal order for 98 pence. Then you'll be able to boast to your friends that you own the world's cheapest dearest catalogue! Then, when they ask to borrow it, just let them have a tantalising glimpse—but make sure they send for their own!

**65p. plus 33p** POST AND PACKING

**POST THIS COUPON**  
with cheque or P.O. for 98p.

The price of 98p applies only to customers in the U.K and to BFPO Addresses.

Please write your Name and Address in block capitals

NAME .....

ADDRESS .....

.....

.....

HOME RADIO (Components) LTD., Dept. EE, (Regn. No. 234-240 London Road, Mitcham, Surrey CR4 3HD London 912966)



**HOME RADIO (Components) LTD. Dept. EE, 234-240 London Road, Mitcham, CR4 3HD. Phone 01-648 8422**



GIRO NO. 331 7056 ACCESS ACCEPTED  
C.V.O. only. P & P 15p on orders below £5  
Discounts: £10-10%, (except net items)  
Export Order enquiries welcome (VAT free)  
Official Orders accepted from  
Educational & Government Departments  
**ALL PRICES INCLUDE VAT**

**SPECIAL RESISTOR KITS** (Prices include post & packing)  
10E12 4W KIT: 10 of each E12 value, 22 ohms—1M, a total of 570 (CARBON FILM 5%), £3-85 net  
10E12 1W KIT: 10 of each E12 value, 22 ohms—1M, a total of 570 (CARBON FILM 5%), £3-95 net  
25E12 4W KIT: 25 of each E12 value, 22 ohms—1M, a total of 1425 (CARBON FILM 5%), £9-00 net  
25E12 1W KIT: 25 of each E12 value, 22 ohms—1M, a total of 1425 (CARBON FILM 5%), £9-00 net  
5 4W KIT: 5 of each E12 value, 10 ohms—1M, a total of 305 (METAL FILM 5%), £3-45 net  
**DUE TO CURRENT WORLD SHORTAGES, RESISTOR KITS MAY TEMPORARILY CONTAIN  
WATTAGE OR VALUE SUBSTITUTIONS.**

**MULLARD POLYESTER CAPACITORS C280 SERIES**  
250V P.C. Mounting: 0-01µF, 0-015µF, 0-022µF, 0-033µF, 0-047µF, 3p. 0-068µF, 1µF, 10p. 0-1µF, 4p. 0-15µF, 5p. 0-22µF, 6p. 0-33µF, 8p. 0-47µF, 10p. 0-68µF, 13p. 1µF, 1p. 1-5µF, 24p. 2-2µF, 2p.

**MULLARD POLYESTER CAPACITORS C296 SERIES**  
400V: 0-001µF, 0-0015µF, 0-0022µF, 0-0033µF, 0-0047µF, 3p. 0-0068µF, 0-01µF, 0-015µF, 0-022µF, 0-033µF, 3p. 0-047µF, 0-068µF, 0-1µF, 4p. 0-15µF, 7p. 0-22µF, 9p. 0-33µF, 13p. 0-47µF, 15p. 0-68µF, 1p. 1-5µF, 13p. 2-2µF, 1p.

**MINIATURE CERAMIC PLATE CAPACITORS**  
50V: (pF) 22, 27, 33, 39, 47, 56, 68, 82, 100, 120, 150, 180, 220, 270, 330, 390, 470, 560, 680, 820, 1K, 1K5, 2K2, 3K3, 4K7, 6K8, (µF) 0-01, 0-015, 0-022, 0-033, 0-047, 2p. each. 0-1, 30V, 5p.

**POLYSTYRENE CAPACITORS 160V 5%**  
(pF) 10, 15, 22, 33, 47, 68, 100, 150, 220, 330, 470, 680, 1000, 1500, 2200, 3300, 4700, 6800, 10,000, 4p.

**RESISTORS**  
CF—High Stab Carbon Film, 5% MF—High Stab Metal Film, 5%.

W. Type Range	1-99	100-499	500-999	1000+	Size mm
CF 22-1M	1	0-80	0-65	0-60	2-4 x 7-5
CF 22-2M2	1	0-80	0-65	0-60	3-9 x 10-5
CF 22-1M	1	0-80	0-65	0-60	5-3 x 16
MF 10-2M7	2	1-7	1-4	1-1	4-2 x 10-8
MF 10-2M2	2	1-6	1-3	1-1	3-7
MF 10-10M	3	1-98	1-81	1-65	6-6 x 13
MF 10-10M	4-5	3-52	3-08	2-75	8x17-5

For value mixing prices, please refer to our catalogue. (Price in pence each)  
**VALUES AVAILABLE—E12 Series only. (Net prices above 100.)**

**PRESET SKELETON POTENTIOMETERS**  
MINIATURE 0-25W Vertical or horizontal 7p each 1K, 2K2, 4K7, 10K, etc. up to 1M Ω  
SUB-MIN 0-05W Vertical, 100 Ω to 220K Ω 7p each

(E.E.) 59, NORTH STREET,  
LEIGHTON BUZZARD, BEDS.  
Tel. Leighton Buzzard 2316 (Std. Code 05253)  
CATALOGUE No. 4—20p

**B. H. COMPONENT FACTORS LTD.**

**Miniature Mullard Electrolytics**

1-0µF 63V 7p	68µF 63V 14p
1-5µF 63V 7p	100µF 10V 7p
2-2µF 63V 7p	100µF 25V 7p
3-3µF 63V 7p	100µF 63V 17p
4-7µF 63V 7p	150µF 16V 7p
6-8µF 63V 7p	150µF 63V 17p
10µF 25V 7p	220µF 6-4V 7p
10µF 63V 7p	220µF 10V 7p
15µF 16V 7p	220µF 16V 8p
15µF 63V 15p	220µF 63V 25p
16µF 40V 7p	330µF 16V 14p
22µF 25V 7p	330µF 63V 28p
22µF 63V 7p	470µF 6-4V 8p
32µF 16V 7p	470µF 40V 25p
33µF 16V 7p	680µF 16V 17p
33µF 40V 7p	680µF 40V 28p
47µF 10V 7p	1000µF 16V 25p
47µF 25V 7p	1000µF 25V 28p
47µF 63V 8p	1500µF 6-4 17p
68µF 16V 7p	1500µF 10V 28p
	2200µF 10V 28p
	3300µF 6-4 28p

**POTENTIOMETERS**  
Carbon Track 5K Ω to 2M Ω, log or lin. Single, 17p Dual Gang 43p. Log Single with switch 28p. Slider Pots. 10K, 100K, 500K, 30mm, 34p, 45mm, 47p, 60mm, 55p.

**DIODES**  
IN4001 6p  
IN4002 7p  
IN4003 9p  
IN4004 9p  
IN4005 12p  
IN4006 14p  
IN914 7p  
IN916 7p  
BA100 10p  
OA5 42p  
OA47 9p  
OA81 11p  
OA200 8p

**PLUGS**  
DIN 2 Pin 12p  
3 Pin 13p  
5 Pin 180° 16p  
Std. Jack 20p  
2.5mm Jack 13p  
Phone 7p

**SOCKETS**  
DIN 2 Pin 10p  
3 Pin 10p  
5 Pin 180° 12p  
Std. Jack 18p  
2.5mm Jack 13p  
Phone 7p

**ELECTROLYTIC CAPACITORS. Tubular & Large Cans**  
(µF/V): 1/25, 2/25, 4/25, 4.7/10, 5/25, 8/25, 10/10, 10/50, 16/25, 22/63, 25/25, 25/50, 32/25, 50/25, 100/10, 100/25, 7p, 50/50, 8p, 100/50, 200/25, 10p, 250/50, 18p, 500/10, 8p, 500/25, 17p, 500/50, 25p, 1000/10, 17p, 1000/25, 25p, 1000/50, 40p, 2000/10, 20p, 1000/100 90p, 2000/25, 30p, 2000/100, 95p, 2500/25, 38p, 2500/50, 65p, 3000/50, 80p, 5000/25, 69p, 5000/50, £1-20.

**HI-VOLT: 8/350, 23p, 16/350 35p, 32/350, 38p, 50/250, 27p, 100/100, 27p, 100/250, 40p, 32/500, 46p, 16 + 32 + 32/350, 65p.**

**METALLISED PAPER CAPACITORS**  
250V: 0-05µF, 0-1µF, 6p, 0-25, 6p, 0-5µF, 7p, 1µF, 9p, 500V: 0-025, 0-05, 6p, 0-1, 6p, 0-25, 7p, 0-5, 9p, 1000V: 0-01, 1p, 0-022, 13p, 0-047, 0-1, 19p, 0-22, 28p, 0-47, 36p.

**V.A.T. PLEASE ADD 15% TO ALL PRICES**  
OUR LATEST FULLY ILLUSTRATED CATALOGUE IS NOW AVAILABLE AND CONTAINS 3,000 STOCK LINES INCLUDING TEST METERS, CALCULATORS, TOOLS, SURPLUS EQUIPMENT, HARDWARE, ETC., ETC.  
AMATEUR RADIO EQUIPMENT IN STOCK

**5E12 1W METAL FILM. 5 each Value 10 Ω-1M. Total of 305 £3-75. NET**

**CJL PRICES INCLUDE P&P AND V.A.T.**

- AERIAL, telescopic, 15-120cm. £1.20
- AERIAL, telescopic, h and v swivel, 15-80cm. £1.78
- **BIB HI-FI ACCESSORIES**
- CASSETTE TAPE RECORDER CARE KIT £1.95
- CASSETTE SPLICING AND EDITING KIT £1.50
- HI-FI STEREO TEST CASSETTE £2.10
- TAPE EDITING KIT £1.35
- GROOV-KLEEN RECORD CLEANER £1.85
- EARPHONE, stethoscope style, 8 ohm dynamic £1.00
- HAND DRILL (Leytool), compact precision drill, 5/16" chuck, Gears totally enclosed, S/L bearings. £2.99
- **INTEGRATED CIRCUITS**
- AUDIO POWER AMPLIFIER (National) LM380 £1.00
- A.M. RADIO RECEIVER (RCA) CA3123E £1.40
- F.M. STEREO DECODER (Motorola) MC1310P £2.80
- TIMER (Signetics) NE555V £0.78
- VOLTAGE REGULATOR (Fairchild) uA7805 £1.70
- VOLTAGE REGULATOR (Signetics) NE550A £0.80
- D.I.L. SOCKETS (Pkg of 3) 8 or 14 pin £0.50
- KEYNECTOR, rapid connect to mains-single/multiple leads. Built-in plano switches neon & 13A fuse £3.20
- LOCKFLEX RULE (Rabone Chesterman), 3m/10ft precision pocket rule. Easy to read, 13mm/1/2" wide steel tape. Blade length lockable-power return. A superb rule £0.93
- MICROPHONE, lightweight dynamic, remote start stop, 200 ohms, 100-10kHz, 6mV average output £1.80
- MULTIMETER, attractive design, Vdc-10, 50, 250, 1,000. Vac-10, 50, 250, 1,000. Idc-100mA. R-150K. £4.95
- SIGNAL INJECTOR, audio through video signals, excellent for servicing amplifiers, radio & tv £3.92
- SOLDERING IRON, 25 WATT (Antex), X25, 240V, Very low leakage, 1/8" long life bit (interchangeable) £2.05
- U3/32" bit £0.47 □ 3/16" bit £0.47 □ Element £1.10
- STAND, ST3, High grade base, chrome plated spring, sponges and accommodation for spare bits £1.00
- SPEAKER, miniature, 75mm dia, 8 ohms £0.80

**CJL** CJL LTD, P.O. BOX 34, CANTERBURY, CT1 1YT

**ENGINEERS**

**FREE**

This 76 page FREE book shows how!

**YOURSELF FOR A BETTER JOB WITH MORE PAY!**

Do you want promotion, a better job, higher pay? "New Opportunities" shows you how to get them through a low-cost home study course. There are no books to buy and you can pay-as-you-learn.

This helpful guide to success should be read by every ambitious engineer. Send for this helpful 76 page FREE book now. No obligation and nobody will call on you. It could be the best thing you ever did.

**CUT OUT THIS COUPON**

**CHOOSE A BRAND NEW FUTURE HERE!**

Tick or state subject of interest. Post to the address below.

Electrical Engineering	General Radio and TV Engineering	CITY AND GUILDS Electrical Technicians
Electrical Installations and Wiring	Radio Servicing, Maintenance and Repairs	CITY AND GUILDS Telecommunications
Electrical Draughtsmanship	Transistor Technology	Radio Amateurs' Exam
Electrical Mathematics	CITY AND GUILDS Installations and Wiring	etc. etc.
Electronic Engineering		
Computer Programming		

**ALDERMASTON COLLEGE**  
Dept EEV 07 Reading RG7 4PF

NAME (Block Capitals Please) \_\_\_\_\_

ADDRESS \_\_\_\_\_ POSTCODE \_\_\_\_\_

Other subjects \_\_\_\_\_ Age \_\_\_\_\_

Accredited by C.A.C.C. Member of A.B.C.C.

**HOME OF BRITISH INSTITUTE OF ENGINEERING TECHNOLOGY**



# CHROMASONIC electronics

Dept. 1. 56, Fortis Green Road,  
Muswell Hill, London. N10 3HN.  
telephone: 01-883 3705

C - MOS

74 TTL

LINEAR I.C.'s

1-24			25-99			100up		
CD4004A	23p	19p	15p	7400	14p	12p	10p	
CD4001A	23p	19p	15p	7401	14p	12p	10p	
CD4002A	23p	19p	15p	7402	14p	12p	10p	
CD4003A	£1.59	£1.33	£1.06	7403	15p	12p	10p	
CD4007A	23p	19p	15p	7404	14p	13p	11p	
CD4008A	£1.75	£1.46	£1.17	7408	16p	13p	11p	
CD4009A	Use	CD4049		7409	16p	13p	11p	
CD4010A	Use	CD4050		7410	16p	13p	11p	
CD4011A	23p	19p	15p	7413	27p	24p	20p	
CD4012A	23p	19p	15p	7417	27p	22p	20p	
CD4013A	69p	58p	46p	7420	14p	12p	10p	
CD4014A	£1.75	£1.46	£1.17	7427	27p	22p	18p	
CD4015A	£1.75	£1.46	£1.17	7430	16p	13p	11p	
CD4016A	69p	58p	46p	7432	27p	22p	18p	
CD4017A	£1.75	£1.46	£1.17	7437	27p	22p	18p	
CD4018A	£2.51	£2.09	£1.67	7441	75p	62p	50p	
CD4019A	85p	66p	53p	7442	65p	55p	43p	
CD4020A	£1.97	£1.64	£1.31	7443	65p	55p	43p	
CD4021A	£1.75	£1.46	£1.17	7447	95p	83p	67p	
CD4022A	£1.83	£1.53	£1.22	7467A	95p	83p	67p	
CD4023A	28p	19p	15p	7448	85p	71p	57p	
CD4024A	£1.26	£1.05	84p	7470	30p	25p	20p	
CD4025A	23p	19p	15p	7472	25p	21p	17p	
CD4026A	£2.79	£2.33	£1.86	7473	30p	25p	20p	
CD4027A	£1.97	£1.64	£1.31	7475	47p	40p	31p	
CD4028A	£1.53	£1.28	£1.02	7477	47p	39p	31p	
CD4029A	£1.12	£1.76	£1.41	7476	32p	26p	21p	
CD4030A	71p	59p	47p	7482	75p	62p	50p	
CD4035A	£1.75	£1.46	£1.17	7485	£1.30	£1.09	87p	
CD4040A	£2.01	£1.68	£1.34	7486	32p	26p	21p	
CD4042A	£1.49	£1.24	99p	7489	£1.56	£2.80	£2.10	
CD4043A	69p	58p	46p	7490	47p	40p	32p	
CD4049A	69p	58p	46p	7491	65p	55p	45p	
CD4051A	£2.78	£2.32	£1.85	7492	57p	44p	36p	
CD4052A	£2.78	£2.32	£1.85	7493	49p	40p	32p	
CD4055A	£2.12	£1.76	£1.41	7495	67p	55p	45p	
CD4060A	£2.51	£2.09	£1.67	74100	£1.08	89p	72p	
CD4066A	£1.13	94p	75p	74101	35p	26p	22p	
CD4068A	28p	24p	19p	74121	34p	26p	22p	
CD4069A	28p	24p	19p	74122	47p	39p	31p	
CD4070A	28p	24p	19p	74141	78p	63p	53p	
CD4071A	28p	24p	19p	74145	68p	58p	48p	
CD4077A	71p	59p	47p	74154	£1.75	£1.48	84p	
CD4081A	28p	24p	19p	74174	£1.00	83p	67p	
CD4082A	28p	24p	19p	74180	£1.06	86p	71p	
CD4085A	£1.28	£1.06	85p	74181	£2.20	£2.50	£1.90	
CD4086A	£1.28	£1.06	85p	74192	£1.35	£1.14	90p	
CD4092A	£1.56	£1.20	£1.04	74193	£1.35	£1.14	90p	
CD4099A	£2.95	£2.46	£1.96	74196	£1.64	£1.34	99p	

555 (8 pin dip) V5p	●	7824UC (TO-220)	●	MC1303L	£1.84	SN76003N	£3.30
555 (TO-99) T 81p	●	555 (14 pin dip)	●	MC1306P	80p	SN76013N	£1.98
703 (RF/IF Amp)	●			MC1310P	£2.39	SN76023N	£1.98
				MC1312	£2.42	SN76227N (MC1327)	
				MC1314	£4.13		£1.89
				MC1315	£2.62	SN76532N	£1.85
709 (8 pin dip)	38p			MC1327	£1.12	SN76544N	£1.81
709 (TO-99)	45p			MC1330P	83p	SN76550-2 (TA.A550)	
709 (14 pin dip)	38p			MC1339P	£1.52	89p	
				MC1350	64p	SN76550-2	81p
				MC1351	89p	SN76622N (TBA120)	79p
				CA2111	£1.19		
				CA3045	£1.98		
				CA3048	88p	SN76666N (CA3065)	£1.12
				CA3053	59p		
				CA3065	£1.60	TA.A263	£1.50
				CA3075	£1.64	TA.A300	£2.16
				CA3078	£1.28	TA.A310A	£1.87
				CA3080	59p	TA.A320	£1.44
				CA3081	£1.86	TA.A330	£2.43
				CA3082	£1.88	TA.A370	£3.40
				CA3089E (TOA1200)	MC1485L	TA.A550	79p
				CA3097E	£1.67	TA.A570	£2.74
				CA3123E	£1.76	TA.A700	£5.03
				CA3401E (LM3900)	68p	TBA1205	£1.25
				CA3500E	£1.44	TBA231	£1.02
				CT7001	£5.34	TBA281 (723)	£2.59
				LM005T (TO-3)	£1.48	MFC6030A	79p
				LM36T (TO-3)	£1.46	MFC6040	99p
				LM37T (TO-3)	£1.46	MFC6070	£1.68
				LM38T (TO-3)	£1.46	MM5314	£4.80
				LM39T (TO-3)	£1.46	MM5316	£9.99
				LM301T (TO-99)	65p	MVR15V (TO-3)	£1.45
				LM301A T (TO-99)	59p	MVR15V (TO-3)	£1.45
				LM301A S (8 pin dip)	59p	NE540L	£1.25
				LM301A S (8 pin dip)	59p	NE546A	£1.16
				LM301A S (8 pin dip)	59p	NE555V	79p
				LM307 T (TO-99)	59p	NE555	£1.29
				LM307 S (8 pin dip)	59p	NE560B	£5.08
				LM308 T (TO-99)	57p	NE561B	£5.08
				LM308 S (8 pin dip)	57p	NE562B	£5.08
				LM308 S (8 pin dip)	57p	NE563	£2.96
				LM308 T (TO-99)	57p	NE565N	£2.63
				LM308 S (8 pin dip)	57p	NE567V	£1.87
				LM308 T (TO-99)	57p	NE587	£2.63
				LM308 T (TO-99)	57p	SL414A	£2.09
				LM308 S (8 pin dip)	57p	SL415A	£2.75
				LM308 T (TO-99)	57p	SL437D	£2.50
				LM308 S (8 pin dip)	57p	SL440	£2.94
				LM308 T (TO-99)	57p	SL610C	£2.03
				LM308 S (8 pin dip)	57p	SL611C	£2.03
				LM308 T (TO-99)	57p	SL612C	£2.03
				LM308 S (8 pin dip)	57p	SL613C	£2.51
				LM308 T (TO-99)	57p	SL680C	£3.06
				LM308 S (8 pin dip)	57p	SL621C	£3.06
				LM308 T (TO-99)	57p	SL622C	£2.62
				LM308 S (8 pin dip)	57p	SL623C	£2.57
				LM308 T (TO-99)	57p	SL624C	£2.84
				LM308 S (8 pin dip)	57p	SL830C	£1.87
				LM308 T (TO-99)	57p	SL840C	£3.75
				LM308 S (8 pin dip)	57p	SL841C	£3.75
				LM308 T (TO-99)	57p	SL842C	£3.75
				LM308 S (8 pin dip)	57p	SL850C	£9.85
				LM308 T (TO-99)	57p	SN75401N	86p
				LM308 S (8 pin dip)	57p	SN75482N	£1.10
				LM308 T (TO-99)	57p	SN76001N (TAA611)	£1.82
				LM308 S (8 pin dip)	57p		
				LM308 T (TO-99)	57p		

7824UC (TO-220)	£1.72	MC1303L	£1.84	SN76003N	£3.30
555 (TO-99) T 81p	●	MC1306P	80p	SN76013N	£1.98
555 (14 pin dip)	●	MC1310P	£2.39	SN76023N	£1.98
703 (RF/IF Amp)	●	MC1312	£2.42	SN76227N (MC1327)	
		MC1314	£4.13		£1.89
		MC1315	£2.62	SN76532N	£1.85
709 (8 pin dip)	38p	MC1327	£1.12	SN76544N	£1.81
709 (TO-99)	45p	MC1330P	83p	SN76550-2 (TA.A550)	
709 (14 pin dip)	38p	MC1339P	£1.52	89p	
		MC1350	64p	SN76550-2	81p
		MC1351	89p	SN76622N (TBA120)	79p
		CA2111	£1.19		
		CA3045	£1.98		
		CA3048	88p	SN76666N (CA3065)	£1.12
		CA3053	59p		
		CA3065	£1.60	TA.A263	£1.50
		CA3075	£1.64	TA.A300	£2.16
		CA3078	£1.28	TA.A310A	£1.87
		CA3080	59p	TA.A320	£1.44
		CA3081	£1.86	TA.A330	£2.43
		CA3082	£1.88	TA.A370	£3.40
		CA3089E (TOA1200)	MC1485L	TA.A550	79p
		CA3097E	£1.67	TA.A570	£2.74
		CA3123E	£1.76	TA.A700	£5.03
		CA3401E (LM3900)	68p	TBA1205	£1.25
		CA3500E	£1.44	TBA231	£1.02
		CT7001	£5.34	TBA281 (723)	£2.59
		LM005T (TO-3)	£1.48	MFC6030A	79p
		LM36T (TO-3)	£1.46	MFC6040	99p
		LM37T (TO-3)	£1.46	MFC6070	£1.68
		LM38T (TO-3)	£1.46	MM5314	£4.80
		LM39T (TO-3)	£1.46	MM5316	£9.99
		LM301T (TO-99)	65p	MVR15V (TO-3)	£1.45
		LM301A T (TO-99)	59p	MVR15V (TO-3)	£1.45
		LM301A S (8 pin dip)	59p	NE540L	£1.25
		LM301A S (8 pin dip)	59p	NE546A	£1.16
		LM301A S (8 pin dip)	59p	NE555V	79p
		LM307 T (TO-99)	59p	NE555	£1.29
		LM307 S (8 pin dip)	59p	NE560B	£5.08
		LM308 T (TO-99)	57p	NE561B	£5.08
		LM308 S (8 pin dip)	57p	NE562B	£5.08
		LM308 S (8 pin dip)	57p	NE563	£2





# -the lowest prices!

**BRAND NEW TEXAS GERM. TRANSISTORS**  
 Coded and Guaranteed  
 Pak No. QSVT  
 T1 8 2G3713 OC71  
 T2 8 D1374 OC75  
 T3 8 D1216 OC81D  
 T4 8 2G381T OC81  
 T5 8 2G382T OC82  
 T6 8 2G344A OC44  
 T7 8 2G344B OC45  
 T8 8 2G378 OC78  
 T9 8 2G399A 2N1302  
 T10 2G417 AF117  
 All 65p each pak

**MD 190 NIXIE DRIVER TRANSISTOR.**  
 Suitable replacement for BSX 21, C 407, 2N 1893 120vab.  
 1 25 100+  
 0.19 0.17 0.16

Sil. trans. suitable for FET Organ Metal TO-18 Eqt. ZX300 6p each. Any Qty.

**GP 100 TO 3 METAL CASE GERMANIUM TRANSISTOR.**  
 V<sub>be</sub> -80V. V<sub>ceo</sub> -50V. I<sub>c</sub> -10 ampe. P<sub>tot</sub> -30W. h<sub>fe</sub> -30-170.  
 Replaces the majority of Germanium power transistors in the OC, AD and NKT range.  
 1 25 100+  
 0.47 0.44 0.40

**GP 300 TO 3 METAL CASE SILICON TRANSISTOR.**  
 V<sub>be</sub> -100V. V<sub>ceo</sub> -60V. I<sub>c</sub> -15 ampe. P<sub>tot</sub> -115W. h<sub>fe</sub> -20. 100T. -1MHz. Suitable replacement for 2N 2055, BDY 11 or BDY 30.  
 1 25 100+  
 0.55 0.53 0.51

**NEW 9th EDITION**  
 over 300 pages  
**TRANSISTOR EQUIVALENTS BOOK.** A complete cross reference and equivalent book for European, American and Japanese Transistors. Exclusive to BI-PAK. £2.30 each.

**A LARGE RANGE OF TECHNICAL AND DATA BOOKS ARE NOW AVAILABLE IN STOCK. SEND FOR FREE LIST.**

**GENERAL PURPOSE NPN SILICON SWITCHING TRANS. TO-18**  
**SIL. TO 2N706/8. BSY-57/28/98A.** All suitable devices no open or short circuits. ALSO AVAILABLE in PNP Sim. to 2N2906, BCY70. When ordering please state preference NPN or PNP.  
 20 For 0.55  
 50 For 1.10  
 100 For 1.92  
 500 For 8.25  
 1000 For 14.50

**ALL G.P. DIODES 5p**  
 300mW 50 0.45  
 400V(Min.) 100 1.65  
 Sub-Min. 500 5.50  
 Fully Tested 1,000 9.90  
 Ideal for Organ Builders.

**ADI61/162**  
 M/P COMP. GERM. PNP TRANS. OUT LOWEST PRICE OF 75p PER PAIR.

**LOOK FOR OUR AUDIO & ELECTRONIC COMPONENTS ADVERTISEMENTS PRACTICAL WIRELESS EVERYDAY ELECTRONICS AND RADIO CONSTRUCTOR**

**FULL RANGE OF ZENER DIODES VOLTAGE RANGE 2-35V. 400mW (DO-7 Case) 5p ea. 14V (Top-Hat) 18p ea. 10W (SO-10 Stud) 32p ea.**

**QUALITY TESTED SEMICONDUCTORS**

Pak No.	Description	Price 5p
Q 1	20 Red spot transistor PNP	0.54
Q 2	16 White spot R.F. transistors PNP	0.54
Q 3	4 OC77 type transistors	0.54
Q 4	6 Matched transistors OC44/45/81/81D	0.54
Q 5	4 OC75 transistors	0.54
Q 6	5 OC75 transistors	0.54
Q 7	4 AC128 transistors PNP high gain	0.54
Q 8	4 AC126 transistors PNP	0.54
Q 9	7 OC81 type transistors	0.54
Q10	7 OC71 type transistors	0.54
Q11	2 AC127/128 Complementary pairs PNP/NPN	0.54
Q12	3 AF116 type transistors	0.54
Q13	3 AF117 type transistors	0.54
Q14	2 OC111 H.F. type transistors	0.54
Q15	7 2N2928 Sil. Epoxy transistors mixed colours	0.54
Q17	5 NPN 2xST141 & 3xST140	0.54
Q18	4 MADD'S 2xMAT 100 & 2xMAT 120	0.54
Q19	3 MADD'S 2xMAT 101 & 1xMAT 121	0.54
Q20	4 OC44 Germanium transistors A.F.	0.54
Q21	4 AC127 NPN Germanium transistors	0.54
Q22	20 NKT transistors A.F. R.F. coded.	0.54
Q23	10 LA202 Silicon diodes sub-min.	0.54
Q24	8 OAB1 diodes	0.54
Q25	16 IN914 Silicon diodes 75P1V 75mA	0.54
Q26	8 OA95 Germanium diodes sub-min IN69	0.54
Q27	2 10A PIV Silicon rectifiers IB426R	0.54
Q28	2 Silicon power rectifiers BYZ13	0.54
Q29	4 Silicon transistors 2x2N596, 1x 2N597, 1x 2N698	0.54
Q30	7 Silicon switch transistors 8N706 NPN	0.54
Q31	6 Silicon switch transistors 2N708, NPN	0.54
Q32	3 PNP Silicon transistors 2x2N1131, 1x2N1132	0.54
Q33	3 Silicon NPN transistors 2N1711	0.54
Q34	7 Silicon NPN transistors 2N2369, 500MHz (code P397)	0.54
Q35	3 Silicon PNP TO-5, 2x2N2904 & 1x2N2905	0.54
Q36	7 2N3646 TO-18 plastic 300MHz NPN	0.54
Q37	3 2N3053 NPN Silicon transistors	0.54
Q38	7 PNP transistors 3x 2N3703, 2x2N3702	0.54

**555 I.C. 65p each**

**MAMMOTH I.C. PACK**  
 APPROXIMATELY 200 PIECES ASSORTED MANUFACTURERS FALL-OUT INTEGRATED CIRCUITS INCLUDING LOGIC 74 SERIES LINEAR and AUDIO AMPLIFIERS  
 MANY CODED also SOME UNKNOWN TYPES - YOU TO IDENTIFY  
**PAK NO. M.I.C. 200**  
 PRICE £1.25 per PAK including p & p & V.A.T.

**INTEGRATED CIRCUIT PAKS**

Manufacturers "Fall Outs" which include Functional and Part-Functional Units. These are classed as "out-of-spec" from the maker's very rigid specifications. But are ideal for learning about I.C.'s and experimental work.

Pak No. Contents Price	Pak No. Contents Price	Pak No. Contents Price
UIC00 - 12 x 7400 0.54	UIC46 - 5 x 7446 0.54	UIC90 - 5 x 7490 0.54
UIC01 - 12 x 7401 0.54	UIC48 - 5 x 7448 0.54	UIC91 - 5 x 7491 0.54
UIC02 - 12 x 7402 0.54	UIC50 - 12 x 7450 0.54	UIC92 - 5 x 7492 0.54
UIC03 - 12 x 7403 0.54	UIC51 - 12 x 7451 0.54	UIC93 - 5 x 7493 0.54
UIC04 - 12 x 7404 0.54	UIC53 - 12 x 7453 0.54	UIC94 - 5 x 7494 0.54
UIC05 - 12 x 7405 0.54	UIC54 - 12 x 7454 0.54	UIC95 - 5 x 7495 0.54
UIC06 - 8 x 7406 0.54	UIC60 - 12 x 7460 0.54	UIC98 - 5 x 7498 0.54
UIC07 - 8 x 7407 0.54	UIC70 - 8 x 7470 0.54	UIC100 - 5 x 74100 0.54
UIC10 - 12 x 7410 0.54	UIC72 - 8 x 7472 0.54	UIC121 - 5 x 74121 0.54
UIC20 - 12 x 7420 0.54	UIC81 - 12 x 7481 0.54	UIC141 - 5 x 74141 0.54
UIC30 - 12 x 7430 0.54	UIC74 - 8 x 7474 0.54	UIC151 - 5 x 74151 0.54
UIC40 - 12 x 7440 0.54	UIC76 - 8 x 7476 0.54	UIC164 - 5 x 74164 0.54
UIC41 - 5 x 7441 0.54	UIC80 - 5 x 7480 0.54	UIC193 - 5 x 74193 0.54
UIC42 - 5 x 7442 0.54	UIC81 - 5 x 7481 0.54	UIC199 - 5 x 74199 0.54
UIC43 - 5 x 7443 0.54	UIC82 - 5 x 7482 0.54	
UIC44 - 5 x 7444 0.54	UIC83 - 5 x 7483 0.54	
UIC45 - 5 x 7445 0.54	UIC86 - 5 x 7486 0.54	

Packs cannot be split, but 25 assorted pieces (our mix) is available as PAK UICXI.

2 Amp. BRIDGE RECTS.	16899 NPN SILICON DUAL TRANSISTOR	LINEAR INTEGRATED CIRCUIT PAKS
50 v RMS 35p each	(Similar to 2N2060)	Manufacturers fall-outs
100 v RMS 40p ..	1 25 100+	ULIC700 10-209 0.54
200 v RMS 45p ..	0.28 0.28 0.23	ULIC710 7-710 0.54
400 v RMS 50p ..		ULIC741 7-741 0.54
1,000 v RMS 55p ..		ULIC747 7-747 0.54
Size 16 mm x 16 mm.		ULIC748 7-748 0.54

**KING OF THE PAKS Unequalled Value and Quality**

**SUPER PAKS NEW BI-PAK UNTESTED SEMICONDUCTORS**

Money back refund if not satisfied

Pak No.	Description	Price 5p
U 1	120 Glass Sub-Min. General Purpose Germanium Diodes	0.54
U 2	50 Mixed Germanium Transistors AF/RF	0.54
U 3	75 Germanium Gold Bonded Sub-Min like OA6, OA47	0.54
U 4	30 Germanium Transistors like OC51, AC128	0.54
U 5	60 200mA Sub-Min. Silicon Diodes	0.54
U 6	20 Sil. Planar Trans. NPN like BSY96A, 2N706	0.54
U 7	18 Sil. Rectifiers TOP-HAT 750mA VLTG. RANGE up to 1000 0.54	
U 8	50 Sil. Planar Diodes DO-7 Glass 250mA like OA200/202	0.54
U 9	20 Mixed Voltage, 1 Watt Zener Diodes	0.54
U 10	20 BA Y50 charge storage Diodes DO-7 Glass	0.54
U11	20 PNP Sil. Planar Trans. TO-5 like 2N1182, 2N2904	0.54
U13	30 PNP-NPN Sil. Transistors OC200 & 2S 104	0.54
U14	160 Mixed Silicon and Germanium Diodes	0.54
U15	20 NPN Sil. Planar Trans. TO-5 like BFY51, 2N697	0.54
U16	10 3 Amp Silicon Rectifiers Stud Type up to 1000PIV	0.54
U17	30 Germanium PNP AF Transistors TO-5 like AGY 17-22	0.54
U18	8 6 Amp Silicon Rectifiers BYZ13 Type up to 800 PIV	0.54
U19	20 Silicon NPN Transistors like BC108	0.54
U20	12 1.5 Amp Silicon Rectifiers Top Hat up to 1000 PIV	0.54
U21	30 AF, Germanium Alloy Transistors 2G300 Series & OC71	0.54
U23	25 MADD'S like MHz Series PNP Transistors	0.54
U24	20 Germanium 1 Amp Rectifiers GJM Series up to 300PIV	0.54
U25	25 300MHz NPN Silicon Transistors 2N708, BSY27	0.54
U26	30 Fast Switching Silicon Diodes like IN914 Micro-Min.	0.54
U29	10 1 Amp SCR's TO-5 can. up to 600PIV CB125-600	1.08
U32	25 Zener Diodes 400mW DO-7 case 8-33 volts mixed	0.54
U33	15 Plastic Case 1 Amp Silicon Rectifiers IN4000 Series	0.54
U34	30 Silicon PNP Alloy Trans. TO-5 BCY26 28302/4	0.54
U35	25 Silicon Planar Transistors PNP TO-18 2N2906	0.54
U36	20 Silicon Planar NPN Transistors TO-5 BFY50/51/52	0.54
U37	30 Silicon Alloy Transistors SO-2 PNP OC200, 2S232	0.54
U38	20 Fast Switching Silicon Trans. NPN 400MHz 2N3011	0.54
U39	30 R.F. Germ. PNP Transistors 2N1303/5/TO-5	0.54
U40	10 Dual Transistors 6 lead TO-5 2N2060	0.54
U43	25 Sil. Trans. Plastic TO-18 A.F. BC113/114	0.54
U44	20 Sil. Trans. Plastic TO-5 BC116/116	0.54
U45	7 3A SCR. TO66 up to 600PIV	1.08
U46	20 Unijunction transistors similar to T1843	0.54
U47	10 TO220AB plastic triacs 50V 6A	1.08
U48	9 NPN Sil. power transistors like 2N3055	1.08
U49	12 NPN Sil. plastic power trans. 60W like 2N2924/5296	1.08

Code No's. mentioned above are given as a guide to the type of device in the pak. The devices themselves are normally unmarked.

FREE	SIL RECTS. TESTED
One 55p Pak of your own choice free with orders valued £4 or over	PIV 300mA 750mA 1A 1.5A 5A 10A 30A
	50 0.05 0.06 1N4001 0.05 0.08 0.15 0.31 0.80
	100 0.05 0.07 1N4002 0.06 0.10 0.17 0.28 0.78
	200 0.06 0.10 1N4003 0.07 0.12 0.28 0.25 1.90
	400 0.08 0.15 1N4004 0.08 0.15 0.30 0.88 1.35
	600 0.09 0.17 1N4005 0.10 0.18 0.38 0.45 1.90
	800 0.12 0.19 1N4006 0.11 0.20 0.38 0.55 2.10
	1000 0.14 0.30 1N4007 0.12 0.25 0.48 0.65 3.80
	1200 — 0.35 0.30 0.58 0.75 3.00

CADMIUM CELLS	DIACS	TRIACS
ORP12 48p	FOR USE WITH TRIACS. BR100 (D32) 25p each	VBOM 9A 6A 10A TO-5 TO-66 TO-48
	10 amp POTTED BRIDGE RECTIFIER on heat sink. 100PIV. 99p each	p p p 2p
		100 33 55 83
		200 55 66 99
		400 77 83 121

Giro No. 388-7006 Please send all orders direct to warehouse and despatch department.

**BI-PAK**  
 P.O. BOX 6, WARE, HERTS  
 Postage and packing add 20p. Overseas add extra for airmail.  
 Minimum order 55p. Cash with order please.  
 Guaranteed Satisfaction or Money Back



## become a RADIO-AMATEUR!

learn how to become a radio-amateur  
in contact with the whole world. We give  
skilled preparation for the G.P.O. licence

BAPV

**free!**

Brochure, without obligation to:

**BRITISH NATIONAL RADIO & ELECTRONICS  
SCHOOL**

Dept EEB 75 P.O. Box 156, JERSEY

NAME: \_\_\_\_\_

ADDRESS: \_\_\_\_\_

BLOCK CAPS please

# ELECTROVALUE

The best of all!

## CATALOGUE 7 ISSUE 3

with 25p refund voucher

Up-dated Price & Product Information

112 pages plus cover As comprehensive and up-to-the-minute as possible. Thousands of items from vast ranges of semi-conductors including L.C.A. to components, tools, accessories, technical information and diagrams are included as well as a refund voucher worth 25p for spending on orders list value £5 or more SEND NOW FOR YOUR COPY BY RETURN post it's an investment in practical money-saving and reliability! **30p** paid

**PRICES** as shown in our latest catalogue (No. 7, Issue 3) were due for review by April 1st. In fact these have remained unchanged since January, reviewed only at 3-monthly intervals as from July 1st next. This is instead of making day-to-day price changes.

**DISCOUNTS** apply on all items except the few where prices are shown NETT. 5% on orders from £5 to £14.99; 10% on orders list value £15 or more.

**FREE POST AND PACKING** in U.K. for pre-paid mail orders over £2 (except Baxandall cabinets). If under there is an additional handling charge of 10p.

**QUALITY GUARANTEE.** All goods are sold on the understanding that they conform to maker's specification. No rejects, seconds or sub-standard merchandise.

**ELECTROVALUE LTD**

All communications to Section 215, 28, ST. JUDES RD, ENGLEFIELD GREEN, EGHAM, SURREY TW20 0HB. Telephone Egham 3603; Telex 284475. Shop hours: 9-5.30 daily, 9-1 pm Sats.

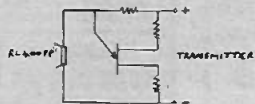
**NORTHERN BRANCH:** 680, Burnage Lane, Burnage, Manchester M19 1NA. Telephone (061) 432 4945. Shop hours: Daily 9-5.30 pm; 9-1 pm Sats.

# BRITAIN'S FASTEST SERVICE!

component specialists for the discerning amateur and professional



★ **ULTRASONICS** ★  
40Khz Transducers at low price as used  
in many magazine articles. Price includes  
suggested circuits. Type RL400 PP.  
Per Pair £4.58 VAT inclusive.



**CA3035—INTEGRATED CIRCUIT**  
3 AMPLIFIER ARRAY. 129 DB at 40Khz.  
IDEAL FOR USE IN RL400PP ULTRASONIC  
TRANSDUCER RECEIVER  
Data available 17p. PRICE £1.78 VAT inclusive.



## COS-MOS LOGIC NEW LOW PRICES

CD4000AE	27p	CD4014AE	1.83	CD4024AE	1.32	CD4042AE	1.56
CD4001AE	27p	CD4015AE	1.83	CD4025AE	27p	CD4043AE	2.29
CD4002AE	27p	CD4016AE	71p	CD4026AE	2.21	CD4044AE	2.29
CD4007AE	27p	CD4017AE	1.85	CD4027AE	1.03	CD4046AE	2.29
CD4009AE	85p	CD4018AE	2.59	CD4028AE	1.59	CD4049AE	27p
CD4010AE	77p	CD4019AE	84p	CD4029AE	2.21	CD4050AE	71p
CD4011AE	27p	CD4020AE	2.06	CD4030AE	77p	CD4051AE	2.92
CD4012AE	27p	CD4022AE	1.92	CD4035AE	1.85	CD4056AE	1.83
CD4013AE	71p	CD4023AE	27p	CD4040AE	2.11	CD4069AE	27p

ALL PRICES INCLUDE VAT

# ARROW

Specialists in  
● Educational ● Government ● Overseas  
See catalogue for further details

### IMPORTANT

OUR NEW TRADING  
POLICY MEANS THAT THE  
PRICE YOU SEE IS THE  
PRICE YOU PAY. NO VAT  
TO ADD.

### ACCURATE

RAPID  
RELIABLE  
OBLIGING  
WORLDWIDE

# ARROW

SERVICE PLUS  
QUALITY PRODUCTS BY RETURN  
COMPREHENSIVE CATALOGUE

NO HIDDEN EXTRAS!

VAT Reg. 246062672

# ARROW ELECTRONICS LTD.

DEPT. EE 10, 7 COPTFOLD ROAD  
BRENTWOOD ESSEX CM14 4BN  
Tel. 0277 219435 Telex 99443

REGISTRATION No. 1062424

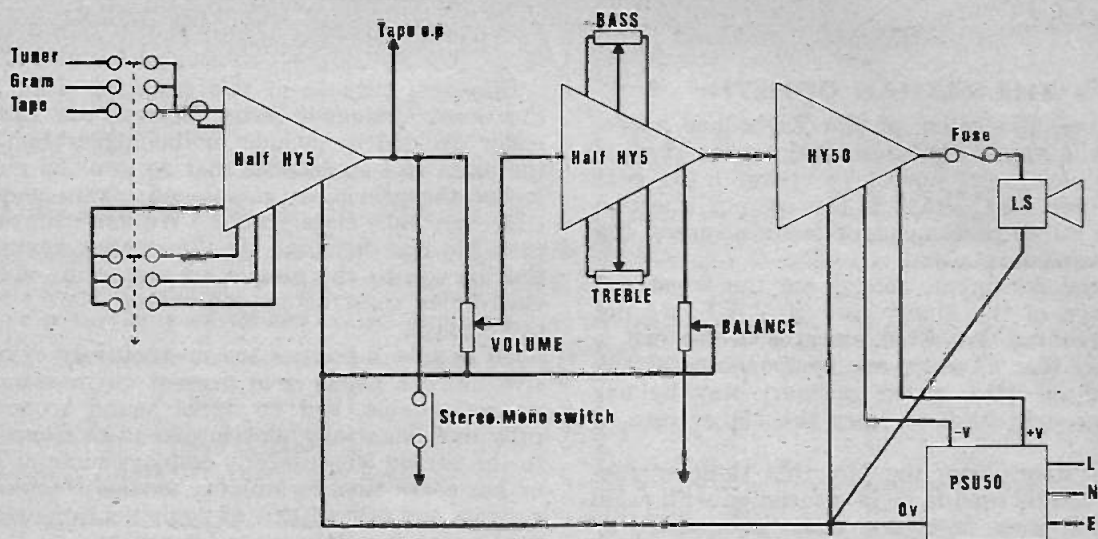
I enclose PO/Cheque for 20p  
Name \_\_\_\_\_  
Address \_\_\_\_\_  
Arrow Electronics Limited  
7, Coptfold Road  
Essex  
Brentwood,  
CM14 4BN



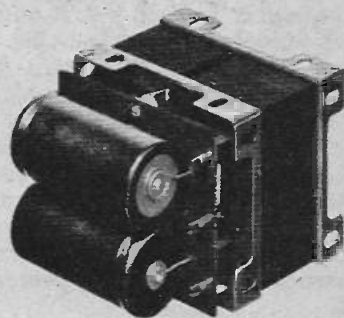
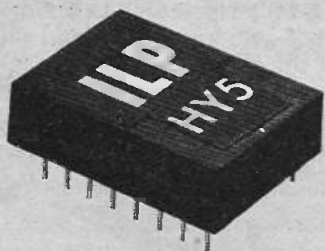


I.L.P. (Electronics) Ltd

# SHEER SIMPLICITY!



MONO ELECTRICAL CIRCUIT DIAGRAM WITH INTERCONNECTIONS FOR STEREO SHOWN  
POWER CONNECTIONS FROM PFU50 to HY5 NOT SHOWN FOR CLARITY OF DIAGRAM



The HY5 is a complete mono hybrid preamplifier, ideally suited for both mono and stereo applications. Internally the device consists of two high quality amplifiers—the first contains frequency equalisation and gain correction, while the second caters for tone control and balance.

**TECHNICAL SPECIFICATION**

Inputs: Magnetic Pick-up 3mV RIAA; Ceramic Pick-up 30mV; Microphone 10mV; Tuner 100mV; Auxiliary 3-100mV; Input Impedance 47kΩ at 1kHz. Outputs: Tape 100mV; Main output 0db (0-775V RMS). Active Tone Controls: Treble ±12db at 10kHz; Bass ±12db at 100Hz. Distortion: 0.5% at 1kHz. Signal/Noise Ratio: 68db. Overload Capability: 40db on most sensitive input. Supply Voltage: ±18-25V.

**PRICE £4.50** + 36p VAT  
P. & P. free

The HY50 is a complete solid state hybrid HI-FI amplifier incorporating its own high conductivity heatsink hermetically sealed in black epoxy resin. Only five connections are provided, input, output, power lines and earth.

**TECHNICAL SPECIFICATION**

Output Power: 25W RMS into 8Ω. Load Impedance: 4-16Ω. Input Sensitivity 0db (0-775V RMS). Input Impedance: 47kΩ. Distortion: Less than 0.1% at 25W typically 0.05%. Signal/Noise Ratio: Better than 75db. Frequency Response: 10Hz-50kHz ±3db. Supply Voltage: ±25V. Size: 105 x 50 x 25mm.

**PRICE £5.98** + 48p VAT  
P. & P. free

The PSU50 incorporates a specially designed transformer and can be used for either mono or stereo systems.

**TECHNICAL SPECIFICATIONS**

Output voltage: 50V (25-0-25V). Input Voltage: 210-240V.  
Size: L.70. D.90. H.60mm.

**PRICE £6** + 48p VAT  
P. & P. free

## TWO YEARS' GUARANTEE ON ALL OUR PRODUCTS

I.L.P. Electronics Ltd.  
Crossland House,  
Nackington, Canterbury  
Kent CT4 7AD  
Registered Office  
Tel (0227) 63218

Please supply, .....  
Total Purchase price .....  
I Enclose, Cheque  Postal Orders  Money Order   
Please debit my Access account  Barclaycard account  EE7.  
Account number .....  
Name & Address .....  
Signature .....

# everyday electronics

PROJECTS  
THEORY...

## THE VATMAN COMETH

Does the Chancellor of the Exchequer appreciate the chaos his latest Budget has created in the electronics world? To charge 8 per cent or 25 per cent?—that is the current question in the minds of component manufacturers, distributors and retailers.

Official documents setting out the scope and coverage of the higher rate of V.A.T. are not light reading. But what emerges in the end is the fact that all electronic components—at any rate those used in the ordinary way by our readers—will have to carry the higher rate of V.A.T.

This stems from the fact that these components can be used in or in association with radio and television receivers, audio equipment, or electronic musical instruments, or certain kinds of electrically operated domestic appliances.

All the goods just mentioned are now subject to the higher rate of V.A.T. and the Chancellor in his wisdom has decreed that no private individual shall avoid this extra tax through the simple expedient of building his own colour set, for example. Mr. Healey must have had horrible nightmares of tens of thousands of lads and lasses up and down the country all industriously soldering away night after night until the colour set or stereo equipment was completed on the kitchen table. We are all for home construction but, we must protest, this is ridiculous.

However, because of this frightful vision of the Great Cottage-Industry Revival, our Chancellor decided to include in the higher tax all the parts and accessories that go into the making of the previously mentioned luxury goods. (His—not our—classification.) We don't suppose that for one moment the Chancellor realised that he was by this simple act clobbering every electronics constructor, regardless. More's the pity though.

To impose a heavier tax on relatively expensive finished goods is in present circumstances understandable, and no doubt sound economically and financially. But to extend this burden to the person who usefully employs some of his or her spare time in building modest electronic gadgets and other items of equipment of varied application is pretty mean we reckon.

Looking for the silver lining, it is true to say that despite the increased cost of components it will still be financially rewarding to build one's own equipment. And soldering irons (and solder) at least remain at the old rate of 8 per cent.

See *Shop Talk* and *Counter Intelligence* for further information and comments about V.A.T. changes.

*Fred Bennett*

Our August issue will be published on Friday, July 18

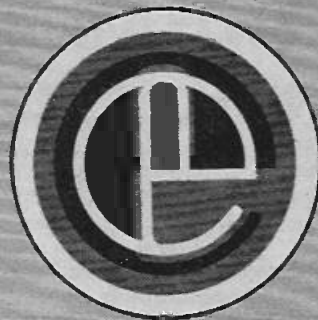
EDITOR F. E. Bennett • ASSISTANT EDITOR M. Kenward • TECHNICAL EDITOR B. W. Terrell B.Sc.  
ART EDITOR J. D. Pountney • P. A. Loates • K. A. Woodruff  
ADVERTISEMENT MANAGER D. W. B. Tilleard

© IPC Magazines Limited 1975. Copyright in all drawings, photographs, and articles published in EVERYDAY ELECTRONICS is fully protected, and reproduction or imitations in whole or part are expressly forbidden.

All reasonable precautions are taken by EVERYDAY ELECTRONICS to ensure that the advice and data given to readers are reliable. We cannot, however, guarantee it, and we cannot accept legal responsibility for it. Prices quoted are those current as we go to press. Everyday Electronics Fleetway House, Farringdon Street, London, E.C.4. Phone: Editorial 01-634-4452; Advertisements 01-634-4202.



...EASY TO CONSTRUCT  
...SIMPLY EXPLAINED



VOL. 4 NO. 7

JULY 1975

### CONSTRUCTIONAL PROJECTS

<b>AUTOMATIC GARAGE DOORS</b> Complete automated system by P. H. Alley	350
<b>ADD-ON AMPLIFIER</b> For use with tuners etc. by R. A. Penfold	358
<b>SELF POWERED RECEIVER</b> Novel simple m.w./l.w. receiver by R. N. Soar	368
<b>CELL CHARGER</b> Constant current charger by George Hylton	372

### GENERAL FEATURES

#### EDITORIAL

<b>FOR YOUR ENTERTAINMENT</b> Buying abroad by Adrian Hope	357
--	-----

#### PLEASE TAKE NOTE

<b>WORKSHOP PRACTICE</b> Part 4 Professional Finish by Mike Hughes	362
--	-----

<b>YOUR CAREER IN ELECTRONICS</b> Apprenticeship by Peter Verwig	366
--	-----

<b>SHOP TALK</b> Component buying by Mike Kenward	370
---	-----

<b>COUNTER INTELLIGENCE</b> by Paul Young	375
---	-----

<b>PROFESSOR ERNEST EVERSURE</b> The Extraordinary Experiments of. by Anthony J. Bassett	376
--	-----

<b>COMPONENT CHECKING</b> With a multimeter	379
---	-----

<b>ELECTRONICS OFFSHORE</b> by Bill Maconachie	381
--	-----

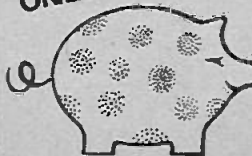
<b>PHYSICS IS FUN</b> De-magnetising by Derrick Daines	387
--	-----

<b>DOWN TO EARTH</b> Ohm's law and the golden triangle by George Hylton	388
---	-----

Publisher's Annual Subscription Rate, including postage Inland £4.00, Overseas £3.90, USA/Canada \$11. International Giro facilities Account No. 5122007. State reason for payment "message to payee". Address to Everyday Electronics, Subscription Department, Carlton House, Great Queen Street, London, WC2E 9PR. Binders for volumes 1 to 4 (state which) and indexes for volume 1 and 2 available for £1.85 and 30p respectively, including postage, from Binding Department, at the above address.

We are unable to supply back copies of Everyday Electronics or reprints of articles and cannot undertake to answer readers' letters requesting designs, modifications or information on commercial equipment or subjects not published by us. An s.a.s. should be enclosed for a personal reply. Letters concerning published articles should be addressed to: The Editor, those concerning advertisements to: The Advertisement Manager, both at the address shown opposite.

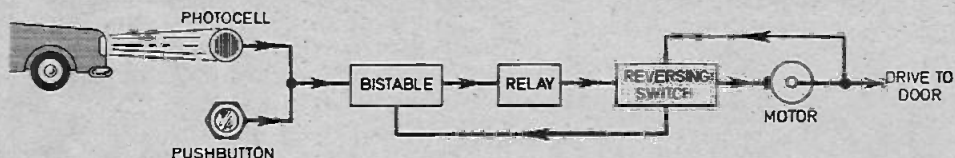
FOR  
GUIDANCE  
ONLY



### ESTIMATED COST\*

PLEASE NOTE...  
Our estimated cost no longer includes VAT due to the anomalies arising from the new rate. We will review this situation in the light of any future rulings.

## HOW IT WORKS



With the garage closed and car approaching, a flash of the headlamps is sensed by the photocell which switches the bistable. This triggers the relay thus driving the motor and lifting the door. When the door is right up the reversing switch is automatically actuated resetting the bistable and stopping the motor.

Drive in and press the button to restart the sequence, this time the door comes down because the reversing switch has been actuated. When the door is right down the switch reverts to its original position resetting the bistable and stopping the motor.

LIKE washing machines and vacuum cleaners, one has to own an Automatic Garage Door before appreciating the convenience it offers. No more is it necessary to expose ones person to the elements in order to open or close the garage door, whether going out or returning home.

A drive down any road on an estate of houses is normally convincing enough evidence that most people find opening and closing the door an inconvenience, by the number of wide open garage doors during daylight hours, their owners obviously of a mind that the inconvenience outweighs the display of their worldly junk to the world.

Many of us would like to own an Automatic Garage Door but unfortunately in this country there would be little or no change from £150 for a commercially built one, which would put such an expense low or non existent on our list of priorities. It was at this junctive over six years ago that the author decided to build a system.

### BASIC DESIGN

It was decided that the triggering device would have to be one of the following; a manual switch in the garage paralleled with one on an outside post in the driveway, breaking a light

Patent applied for in respect of this design.

# AUTOMATIC GARAGE DOORS

By R. H. ALLEY



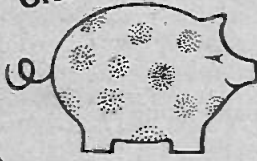


**FOR GUIDANCE ONLY**

**ESTIMATED COST\* OF COMPONENTS**  
excluding V.A.T.

**£10 electronics**  
**£32 door and motor**

\*Based on prices prevailing at time of going to press



beam, or making use of the car headlights to trigger a photocell circuit. The latter seemed a more exciting challenge bearing in mind the lights come free with the car. Also it would avoid the necessity of digging up the driveway to run wire underneath for a manual switch arrangement and breaking the beam principle had security risks, child interference problems and complexity in negating the effects of sunlight.

At the same time it was decided a special type of door was called for. With solid doors and one small side window in the garage there was little natural light and consequently it was dark and dismal. The doors would thus have to be transparent or better still, semi transparent. A glass framed door would be too heavy and fragile so it was decided to try and use translucent corrugated p.v.c. sheets, easily obtainable with about 40mm pitch corrugations, which could be flexed round a 25 cm radius bend. Also it passed over 80 per cent of the ambient light so the door would be like a big picture window.

It may be possible to motor drive some existing doors but readers will have to make their own mechanical arrangements if they wish to do this since it is not possible to design and prove systems to meet every need.

A photocell light dependent resistor would be placed on the rear wall of the garage. Shining the car's headlights through the plastic door

**Photograph showing the raised door fitted in the slide rails. Note the metal strengthening bars.**



Everyday Electronics, July 1975

onto the cell, placed at the end of a 100mm tube to screen it from much of the ambient light, would trigger the system and the door would be pulled up a slide rail and around the bend by a motor driven cord.

After driving the car into the garage a flick of the car light switch or pressing a switch inside the garage paralleled with the cell, would operate the motor in reverse direction closing the door. Now the door could not be opened from outside because the car would be screening the cell.

The security aspect was justified on the premise that although it was possible to open the door from outside when the car was not in the garage it would require an intensity of light only found in the headlights of a car, thus children could not open the doors with a domestic torch and a would-be intruder would have to bring his car into the drive rendering him vulnerable if he had to make a quick getaway. In any case why should a burglar try to get into an empty garage!

### CONSTRUCTING THE SLIDE RAILS

Construction of the door is not difficult although a number of parts are involved. First the slide rails. These are made from 183cm lengths of 50mm wide strips of aluminium, 18 s.w.g. guillotined from a 183cm by 45cm sheet by the metal sales company for a small charge, two 190cm lengths of 25mm × 15mm wood (finished to 22mm × 13mm) and two 213cm lengths of 38mm × 25mm (finished 34mm × 22mm). See Figs. 1 and 2, for as the saying goes, one picture is worth a 1,000 words.

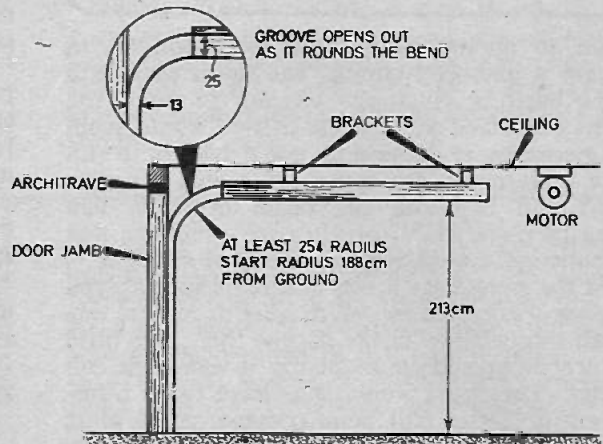
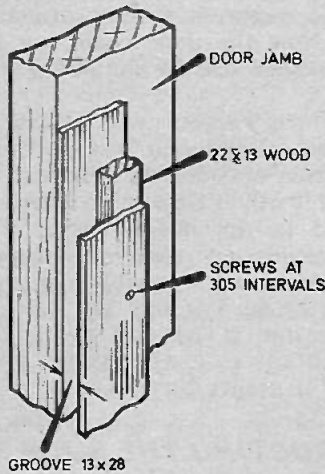
A 91cm length of aluminium strip is placed behind and in line with the inside edge of the wooden door jamb. Over this is placed the 22mm × 13mm wood and over that a 183cm length of aluminium strip. The whole then forms a groove 13mm wide and 28mm deep and is screwed to the door jamb with wood screws. After putting in the bottom screw for location purposes, place a 183cm length of aluminium strip between the wood and door jamb and butting up against the 91cm strip, then continue screwing at approximately 30cm intervals.

Now to construct the top horizontal part of the slide rail fix a 213cm length of 34mm × 22mm wood to the ceiling or rafters with either two metal or wooden brackets. The door will only weigh 7 to 12kg (15 to 20lb), depending on size, so a light fixing is sufficient. Bend the rear most vertical aluminium strip to at least a 25cm radius before screwing it at 30cm intervals to the bottom surface of the 34mm × 22mm horizontal wood support thus leaving a metal runner for the door to slide along.

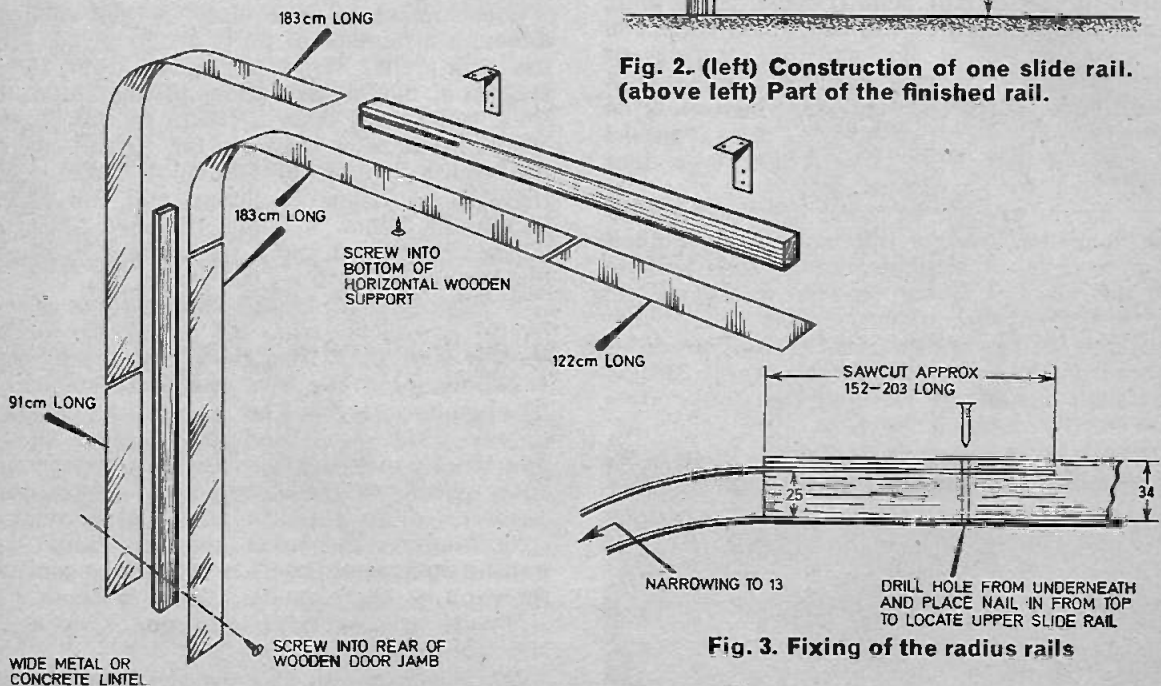
Finish this bottom runner by butting up another strip of aluminium, 122cm length, and screwing that at 30cm intervals to the bottom surface of the horizontal wood support. Note

# AUTOMATIC GARAGE DOORS

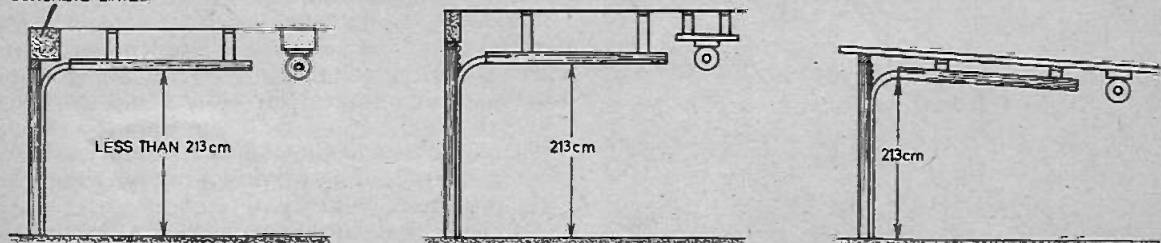
**Fig. 1. Basic rail arrangement and fixing to doorway.**



**Fig. 2. (left) Construction of one slide rail. (above left) Part of the finished rail.**



**Fig. 3. Fixing of the radius rails**



**Fig. 4. Arrangement for various garages**



that the strip of aluminium will bend easily forming a perfect radius without any kinks by virtue of its inherent springiness.

Bend over the innermost vertical aluminium strip forming a similar radius before slotting into the slit in the horizontal wood support, formed by a saw cut. Fix it in the slit by drilling through from underneath and putting a nail in from the top (see Fig. 3). You will notice that the groove progressively widens from 13mm to 25mm as it rounds the bend. This is purposely designed this way to reduce much of the friction between the door and runner as it flexes round the bend.

## VARIOUS DOOR SIZES

Note the dimensions given are for door opening 213cm wide and 198cm high. If your own opening is higher stick to these dimensions, closing the resultant gap at the top by either nailing or screwing a piece of wood or corrugated p.v.c. to the arcitrave. If this is done after installing the door a minimum gap can be achieved. Alternatively you can increase the height of the slide rail at the cost of extra material all round. The maximum width of the door will be governed by the length of p.v.c. sheets available, normally 366cm.

As you can see there will have to be a minimum header return of at least 33cm to allow for the radius and motor shaft fixing. If you haven't got this amount of header simply start the radius lower down. Alternative arrangements necessary to facilitate fitting the door to the majority of garage door openings which often differ considerably are shown in Fig. 4.

Make the brackets to suit your garage ceiling allowing the horizontal slide rail to be at least 75mm from the ceiling. The length of the sawcut

in the wooden horizontal support is determined by the length of the vertical aluminium strip left to form the top radius and the positioning of the horizontal wood support. Make the sawcut too long rather than too short otherwise it will be necessary to trim the strip with a pair of metal shears.

The important points of the design are: The slide rail and grooves should be smooth and there should be no projections whatsoever within the sliding area which would rub against the plastic door. The only possibility of any projection is if the corner(s) of any aluminium strip has bent over accidentally and to obviate this it is advisable to bend each corner over slightly the other way with a pair of pliers after construction of the slide rail (Fig. 5).

The minimum radius of the slide rail curve is 25cm but can be more. The horizontal rail should be at least 75mm from the ceiling to avoid the door rubbing on the ceiling and because of the minimum distance of the motor shaft from the ceiling. Depending on the motor used the rail may have to be more than 75mm from the ceiling.

The distance between the slide rails has to remain constant within  $\pm 5$ mm, should this vary too much there is a chance it may restrict the door in one place and allow the door to fall out of its track in another. Also the horizontal rail should be squared up with the vertical rail as viewed from the rear otherwise the door may tend to be pulled up and out of square causing side thrust, resulting in undue friction and wear. Once one of the slide rails is square the other one is automatically square if the distance between the rails is constant.

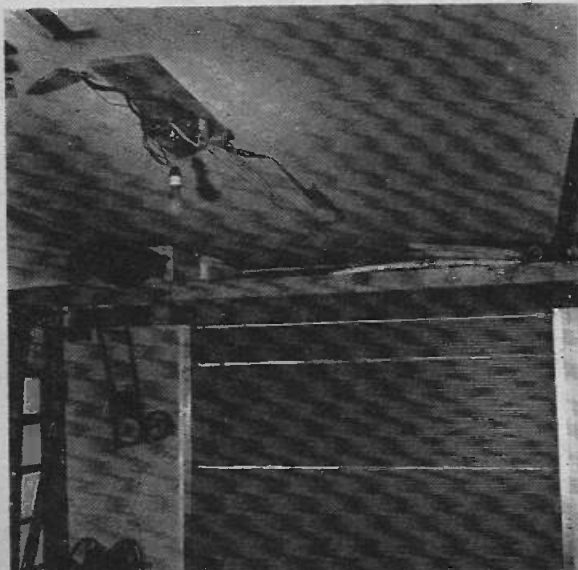
## DOOR CONSTRUCTION

Now to the construction of the door. Purchase four (you will need five for a longer door) sheets of corrugated plastic from your local hardware store or timber merchant (see Fig. 6). The sheets used for the prototype had the trade name Corolux and incidentally conformed to BS2782 as being fire retardant, but similar sheets are made under various names though it may be difficult to establish their resistant property. The suitability of such material should be checked with the local authority.

The sheets are sold in various lengths from 183cm (6ft) up to 366cm (12ft) but are all 66cm (26in) wide and have 9mm deep corrugations, not be confused with those having about 50mm deep corrugations which are far too thick and rigid to flex around a 25cm radius. Various colours are available so choose to suit your outside decor. The Corolux "natural" was used for the prototype, this has a slightly bluish tinge but allows more daylight into the garage and blends with any outside decoration.

Purchase wooden or metal stiffeners. At least 7 lengths to suit the width of the door will be

The complete door system.



## Materials

45 × 183 cm 18 s.w.g. aluminium, guillotined into 9, 50mm × 183cm strips.

22 × 13mm finished wood 190cm long (2 off).

34 × 22mm finished wood 213cm long (2 off).

7 lengths of 25mm diameter wood or metal tube the width of the door plus 50mm.

4 pieces of Corolux plastic panel with 9mm deep corrugations, 660mm wide and the width of the door plus 50mm or longer, colour as required (see text).

Aluminium or brass bar 150mm × 20mm diameter for winding shaft.

Brackets to hold top runner (4 off).

Small pulley wheel with wall mounting brackets.

5A connector blocks (2 off) and 100mm tensioning spring for cord tensioner.

Angle brackets for mounting PCC1 tube and S2.

Nylon or terylene cord, approx. 7 meters.

Rubber bungee approx. 60 cm long unstretched.

Various fixings e.g. screws, bolts, nails, etc. —see text and drawings.

required and these are used to give lateral strength to avoid buckling and are also used as an intermediary for joining the sheets together. Wooden stiffeners are cheaper than metal ones but the latter were used for the original doors and these are more suitable from an aesthetic point of view. You will need a 3mm drill and a "Pop riveter" (small brass screws if using wooden stiffeners). These riveters cost about £2 to £3, are available under a host of trade names and are an extremely useful and convenient tool for which you will no doubt find many uses long after the door is finished.

Now follow the sequence:

(1) Measure the distance between the inside of each slide rail groove which will be equivalent to the distance between the inside of the wooden door jambs plus twice the depth of the grooves. Call this measurement 'x'. Call the distance between the inside edges of the slide rail (which should be equivalent to the distance between the inside edges of the wooden door jambs) 'y'. As a check  $x - y = \text{depth of groove} \times 2$ .

Cut each strengthening tube to  $x$  minus 5mm then cut away half the section on each end of the tubes to the measurements shown in Fig. 7 and drill 3mm holes for the rivets on the opposite side to the cut away, at approximately 25cm intervals, starting 13mm in from the ends of the tube. In the centre of the top tube also drill a 5mm hole parallel with the 3mm holes.

(2) Lay the four plastic sheets on the garage floor overlapping each by one corrugation. Slide a metal tube, with the rivet holes facing upwards underneath each overlap plus one

under the top end of the door, but not the one at the bottom of the door as this will not be fitted until it has been established that a fifth sheet will not be required. Also place two tubes under the top sheet of the door, their positioning according to Fig. 6 and where extra support is required, as will be evident when the door is being raised. Place each tube in line with one edge of the sheets then drill the plastic coincident with each hole in the tube including the 5mm hole and fix the sheets to the tubes with Pop rivets except for the 5mm hole.

(3) Pencil mark each plastic sheet coincident with the other end of the tubes, place a straight edge between each one and mark each ridge. Using a small tenon saw cut the sheet along this line removing the plastic burrs with a sharp knife. Afterwards chamfer the four sharp corners of the plastic door, a 5mm radius being sufficient.

(4) The door is now ready to be slid into its slide rails from the rear for which you will need at least two people owing to the size of the door and its awkward handling feature. When it slides down the vertical groove ensure you restrain it from gathering too much speed and hitting the ground with some force. In fact it will not damage the door but the noise is deafening.

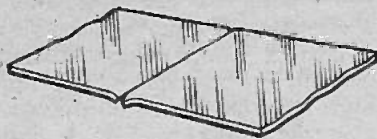
When it is lowered it is imperative that the top of the door should be horizontal i.e. round the bend of the radius so that when the cord is attached and the door pulled horizontally there should be no component of the pull tending to force the aluminium strip lower radius downwards (Fig. 8). If not too sure on this point thread a short length of nylon cord through the 5mm hole drilled in the top tube and standing on some step ladders (have someone anchoring the ladders) pull the door up with a horizontal pull, as the motor cord will do.

If you have a spring balance the initial force required should be from 13 to 18kg (30lb-40lb) depending on the size of the door, reducing as the door comes up. As the door leaves the ground it will be evident by the flexing of the plastic why the two extra strengthening tubes are used.

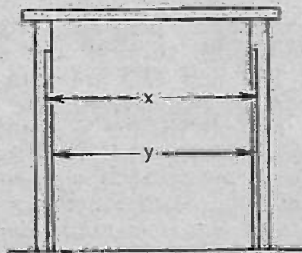
Finally grease the inside of the grooves with Moly slip, Shell Retinax "A" or similar. The door can be opened and closed normally by using the corrugations as handholds but ladies may find it a bit of a struggle without the aid of counterbalancing (more on this later), and is the reason why the door was designed with a motor drive in mind as it is more easily opened by pulling from the top as opposed to pushing from the bottom.

There will no doubt be some who would question the mechanical strength and durability; the prognosis of a corrugated plastic door sliding up and down in lightweight aluminium rails may

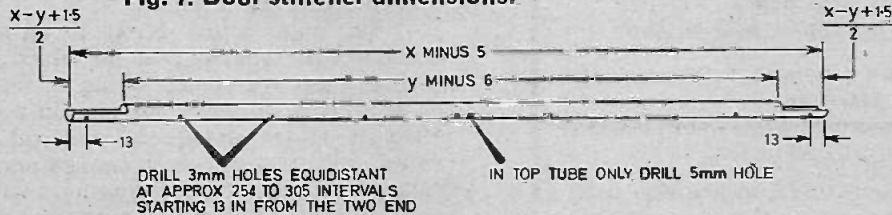




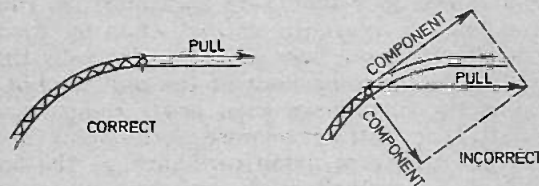
**Fig. 5. Rail corners bent out to protect door.**



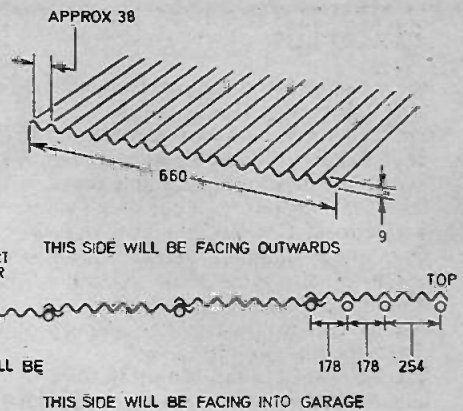
**Fig. 7. Door stiffener dimensions.**



**Fig. 8. Showing correct arrangement of cord pull**

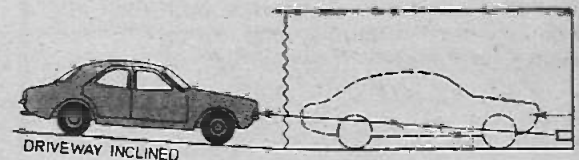


**Fig. 9. The complete circuit diagram of the Automatic Garage Doors.**



**Fig. 6. Material used for door and construction of the door**

**Fig. 10. Car's lights cannot shine on the photocell at all times unless the driveway is level.**



## Components . . . .

### Resistors

R1	2.5k $\Omega$	R5	15k $\Omega$
R2	18k $\Omega$	R6	8.2k $\Omega$
R3	470 $\Omega$	R7	15k $\Omega$
R4	220 $\Omega$	R8	10 $\Omega$ 1W

All  $\pm 10\%$   $\frac{1}{4}$ W carbon except R8

### Capacitors

C1	0.2 $\mu$ F plastic or paper
C2	100 $\mu$ F elect. 12V
C3	4.7 $\mu$ F tantalum 10V $\pm 20\%$
C4	4.7 $\mu$ F tantalum 10V $\pm 20\%$
C5	250 $\mu$ F elect. 25V
C6	Supplied with motor

### Semiconductors

TR1	2N3702 silicon pnp
TR2	2N3702 silicon pnp
D1	OA81 or similar germanium
D2	IN4001 or similar silicon
D3	IN4001 or similar silicon
PCC1	ORP12 light dependent resistor

### Switches

S1	s.p.s.t. pushbutton
S2	3 pole double throw toggle (mains 1A)
S3	s.p.s.t. cord pull (mains, 1A)

### Miscellaneous

VR1	10k $\Omega$ skeleton preset
T1	12-0-12V at 300mA mains transformer (Douglas MT 213CT or similar)
FS1	2A fuse and holder
M1	Parvalux SD8S mains motor with reduction gear and capacitor (C6)
LP1	60W 240V lamp and holder
RLA1	Omron 1051 12V, 465 $\Omega$ , relay with normally open heavy duty contacts Veroboard 22 strips by 20 holes, 0.15 inch matrix, connecting wire, tube to suit PCC1 100mm long, angle bracket for circuit board, 4BA and 6BA fixings, material for motor and circuit cover—see text.

not be good, but experience has proved otherwise. The original doors have been sliding up and down for over 5 years now many more times a day than the normal because of continuous research and modifications required of a prototype. So far there is no perceptible wear of the plastic.

## MOTOR

The speed of the motor shaft needs to be between 60-150RPM depending on the length of time you are prepared to wait for the door to open and close (approx 16 seconds at the slowest speed) and a worm and wheel gearbox should be used. The power of the motor needs to be at least  $\frac{1}{8}$  horse, and it must be reversible.

After testing many types the best has been found to be the Parvalux SD8S which incorporates its own worm and wheel gearbox. The

torque available at the output shaft is 20lb in and the speed between 68 and 104 r.p.m.

Obviously other motors which meet these requirements can be used and a secondhand one would reduce the overall cost.

## SEQUENCE

The complete electronic system is shown in Fig. 9. This circuit represents the most successful and simple of over twenty previous designs.

First a general run through the sequence observing that TR1 and TR2 are in a bistable configuration with TR1 conducting in the quiescent stage. Assume the car is in the garage and the door is down. You come in through the side entrance of the garage (single entry garages are covered later) and press S1 momentarily. This connects TR1 base to the positive line through R1 switching TR1 off and TR2 on thus energising the relay, closing the contacts RLA1 and completing the circuit to the motor which pulls up the door. When the door is fully up S2 is mechanically switched to its alternate positions which has the following effect:

S2a—grounds the base of TR2 through C4 switching TR2 off and TR1 on. This de-energises the relay breaking the circuit to the motor.

S2b—puts the motor into reverse mode.

S2c—switches on the garage light.

In the 10 to 16 seconds all this has been going on you have got into the car "clunk-clicked" yourself in and started the engine. Now the door is up you can back the car out and on leaving the garage flash the headlights. This reduces the resistance of PCC1 which increases the voltage at TR1 base, both by d.c. voltage divider action between PCC1, R1, VR1 and the relay coil and by a.c. action through C2, speed up capacitor, switching TR1 off and TR2 on. The relay energises closing RLA1 and the motor runs in the reverse direction lowering the door. When the door is fully lowered S2 is mechanically switched to its alternate position and this has the following effect:

S2a—grounds the base of TR2, this time through C3, switching TR2 off and TR1 on, de-energising the relay and breaking the circuit to the motor.

S2b—puts the motor back into the forward mode.

S2c—switches off the garage light.

The system is now ready for re-triggering on your return by flashing the car headlights through the door on to PCC1.

Why, you may ask, is S1 necessary inside the garage? If the drive up to the garage is level then the car headlamp will shine on to PCC1 up the tube when outside or inside the garage so S1 is not necessary. If the drive is not level and the tube and PCC1 are lined up with the headlight when the car is outside they will not line up when the car is inside the garage (see Fig. 10).

Continued next month.

SEE  
**SHOP  
TALK**



# for your Entertainment...

By Adrian Hope

**H**OLIDAY time is on us now, but please don't let the sun go to your head if you go abroad for a holiday. However fast electronics prices may rise in this country, they are unlikely ever to overtake those on the Continent.

Over recent years I have run numerous consumer checks on the over-the-counter cost of audio gear in Europe, and off-hand I cannot think of any one item that has been consistently cheaper there than here.

Also there is very little audio hardware available on the Continent that is unavailable here. So however exciting something may look in a foreign shop window with a foreign price tag, do be sure to translate that foreign price tag into its British currency equivalent before buying.

If you think you are likely to be tempted to buy abroad, take some current issues of a few British magazines on holiday with you. Not only will they make good beach reading, they will also jog your memory on British prices.

## FILM AND TAPE

Most people now know that still and movie film is far more expensive almost everywhere in the world than here (Kodak film costs fifty or a hundred per cent more in most holiday countries abroad), but perhaps it isn't so well known that even recording tape is also well up in price.

In France a few months ago, I noticed that you needed to pay nearly £1.50 for an ordinary BASF C-120 cassette; just over a pound for a C-90; and around 75p for a C-60. But it was possible to buy them in London at the time for around £1; 70p; and 50p. And

all these are one-off prices, i.e. the prices for cassettes bought one at a time. Most British shops offer reductions for bulk purchase, by which the cost can be brought down further, but one sees less of this on the Continent.

## DISCS

Of course one audio item always worth buying abroad is a gramophone record that is unavailable in the UK. But you must expect to pay for the privilege. Even last year the regular French price for an LP was already averaging £3 or over and it is doubtless well above that by now.

Astonishingly, 45 r.p.m. singles sell at around £1 a time. Admittedly they are packaged rather more decoratively than here, but that price still seems absurdly high by any standards. The only cheap way to buy discs is to watch out for special offers. You are unlikely to find worthwhile bargains in tourist resorts, but there are several record shops in the Saint Michel Left Bank area of Paris that constantly have sale offers, and many of the French record companies do now offer bargain packs at budget prices, for instance, double albums of good jazz.

## CHEAP EXCURSIONS

But, on the whole, it is small wonder that French audio enthusiasts have been taking cheap day excursions from Calais or Boulogne to London to buy their hi fi in the West End. Each traveller can take back £65 worth of gear into France without problems at the customs, so a Normandy couple need only make two trips (sometimes at a total travelling cost of only around £30) to

import over £250 worth of audio gear legally into France without paying a centime in duty.

But I have often wondered what happens when it goes wrong on them when they get it back to France. And it will be interesting to see whether the new British VAT luxury rates makes these shopping trips no longer worth while.

## DUTY FREE BUYING

While on the subject of VAT and buying abroad, do also be careful over the prices charged for luxury goods at duty-free shops at airports and on board ships.

Certainly, before the 25 per cent VAT rate was introduced, it was very difficult to find a consumer durable bargain at a duty-free shop. Over recent years I have checked out duty or VAT-free prices of electronic gear at both Gatwick and London Airports and have found that usually the same gear can be bought cheaper in London's West End.

The 25 per cent luxury rate may well make the duty-free prices look more attractive, but do read the Customs Concession Guide at the shop before buying duty-free. Check especially carefully on the current limit for goods that can be bought duty-free and then imported back into the UK without liability to pay VAT. If you buy more than £10 worth of luxury items duty-free on your way out of the country, you may well be forced to pay 25 per cent VAT on them when you pass through customs again on your return!

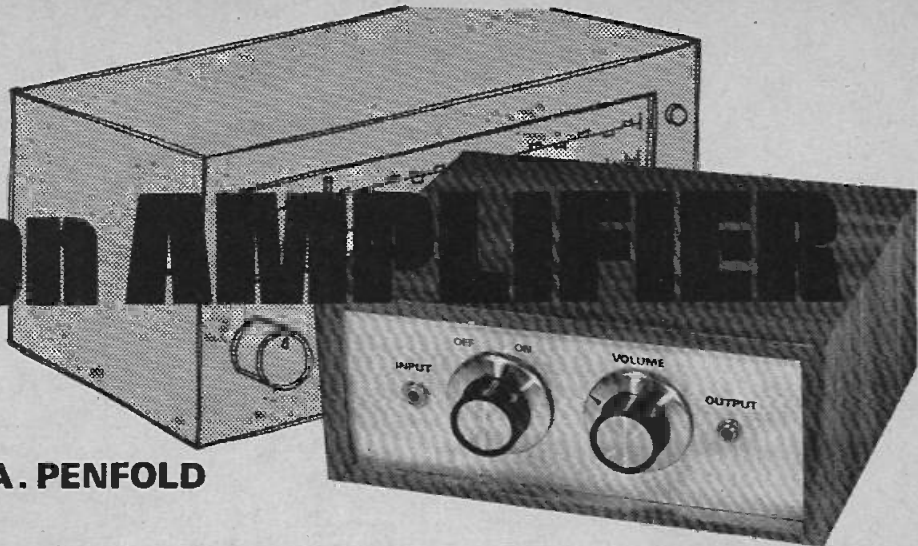
## WEEKEND IN FIJI

All this makes me feel like emigrating to Australia, because I am reliably informed that our Australian cousins can fly off to Fiji for a week-end and buy audio gear there at less than half the Australian price.

The only restrictions on what they can take back home down under are governed by *weight*. So a couple disappears off to Fiji for a couple of days holiday, buys an amplifier and then shops around for a pair of speakers to make up the maximum weight.

The simplicity of that scheme appeals to me. You put your luggage on the scales and if it is under weight you are OK—if it is overweight you pay duty on the difference.

# Add-on AMPLIFIER



By R. A. PENFOLD

## A simple battery powered 0.5 watt amplifier.

**T**his amplifier is primarily intended for use as an add-on unit for use in conjunction with the *M.W./L.W. Tuner*, May 1975. It can however be used with any similar tuner, or for a variety of other purposes, and an amplifier such as this is always useful to have in the workshop.

The maximum available power output is 500mW ( $\frac{1}{2}$  watt) into an 8 ohm speaker. As one would expect of a simple amplifier of this type having only a four transistor circuit, the output quality is something less than hi fi, but is nevertheless perfectly acceptable.

Power is obtained from an internal 9 volt battery type PP7, and for good battery economy a class B output stage is used.

### CIRCUIT OPERATION

A complete circuit diagram of the amplifier is shown in Fig. 1. A three-stage circuit is used, and there is direct coupling between stages. Transistor TR1 is a common emitter input stage, TR2 a common emitter driver stage, and TR3 and TR4 the complementary emitter follower output stage.

Although one might expect the circuit to have a very high voltage gain with its two common emitter stages, this is in fact not the case. This is due to the large amount of negative feedback used. Negative feedback merely means passing some of the output signal back to the input in such a way that the two signals oppose one another.

In this circuit the negative feedback is obtained by connecting the emitter of TR1 to the output of the circuit (TR3 and TR4 emitters) via R4. In order to understand how this feedback is applied, reference should be made to Fig. 2, which shows the basic circuit configuration used in this design.

Consider a negative pulse applied to the base of TR1. This will cause the voltage at its collector to swing more positive, which will turn TR2

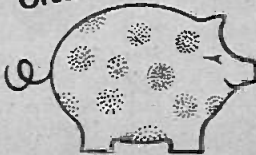
harder on, causing the voltage at its collector to swing more negative. Transistors TR3 and TR4 are emitter followers, and will provide no voltage amplification, but do provide a large amount of current amplification. The voltage at the junction of the emitters of TR3 and TR4 is therefore virtually identical to that at the collector of TR2.

Thus a negative input pulse causes the output to go more negative, and since TR1 has its emitter connected to the output via R4, this will cause its emitter to go negative also. Transistor TR1 base is held at a certain potential by a combination of the potential divider action of R2 and R3, and the level of the input signal, as its emitter is pushed more negative, its base emitter voltage is reduced, and it conducts less. This causes a reduction in its collector potential.

This is in direct opposition to the original input signal which increased TR1's collector potential. The effect of the feedback is to reduce the voltage gain of the circuit to unity. This is very useful at d.c., as to work most efficiently the amplifiers quiescent output voltage should be slightly more than half the supply potential. The potential divider network, R2-R3, provides about 5 volts at the input, and so about the same potential appears at the output.

At a.c., however, a gain of only one is of little use, and it is necessary to remove some of the

FOR  
GUIDANCE  
ONLY



ESTIMATED COST\*  
OF COMPONENTS  
excluding V.A.T.

£2.70

excluding case

\*Based on prices prevailing at  
time of going to press

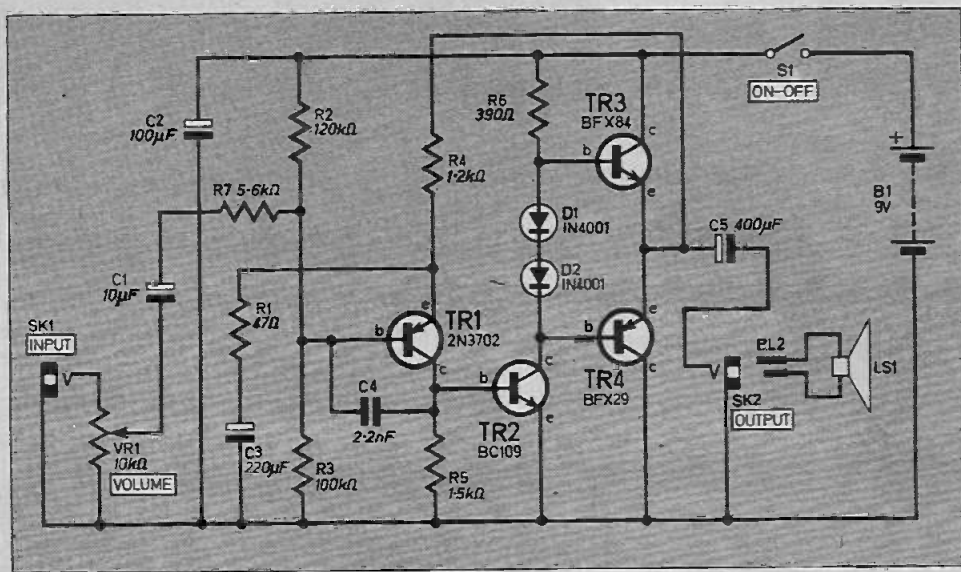


Fig. 1. The complete circuit diagram of the Add-on Amplifier.

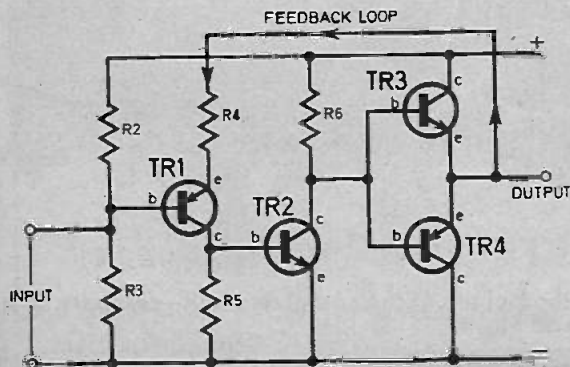
feedback, and so raise the gain of the circuit. This is the purpose of R1 and C3 (Fig. 1). It is desirable to leave as much feedback as possible as reduces the noise and distortion generated by the circuit.

### OUTPUT STAGE

If one compares Fig. 2 with the practical circuit diagram, Fig. 1, it will be seen that there are a few additional components shown in Fig. 1. The two diodes in the collector circuit of TR2, D1 and D2, are used to provide a small forward bias to the output transistors under quiescent conditions.

In a complementary output circuit of this type, the *nnp* transistor (TR3) amplifies positive output half cycles, and the *pnnp* transistor (TR4) amplifies negative ones. About 0.65 volts is needed at the base of each output transistor

Fig. 2. The basic configuration of the circuit for the Add-on Amplifier.



with respect to its emitter, before it will begin to conduct, and when it first begins to turn on, the gain of each transistor is rather low.

## Components....

### Resistors

- R1 47 $\Omega$
  - R2 120k $\Omega$
  - R3 100k $\Omega$
  - R4 1.2k $\Omega$
  - R5 1.5k $\Omega$
  - R6 390 $\Omega$
  - R7 5.6k $\Omega$
- All  $\frac{1}{4}$ W  $\pm 10\%$  carbon

### Capacitors

- C1 10 $\mu$ F elect. 12V
- C2 100 $\mu$ F elect. 12V
- C3 220 $\mu$ F elect. 12V
- C4 2.2nF plastic or paper
- C5 400 $\mu$ F elect. 12V

### Semiconductors

- TR1 2N3702 silicon *pnp*
- TR2 BC109 silicon *nnp*
- TR3 BFX84 silicon *nnp*
- TR4 BFX29 silicon *pnp*
- D1, 2 1N4001 or similar silicon

### Miscellaneous

- SK1, 2 3.5mm jack sockets and plugs to suit (2 off each)
  - VR1 10k $\Omega$  log. carbon potentiometer
  - S1 s.p.s.t. rotary or toggle switch
  - B1 9V PP7 battery and connectors
  - LS1 8 $\Omega$  loudspeaker (see text)
- Veroboard 0.1 inch matrix 20 strips by 29 holes, control knobs, 6BA fixings, connecting wire, materials for case and bracket.

SEE  
**SHOP  
TALK**



# Add-on AMPLIFIER

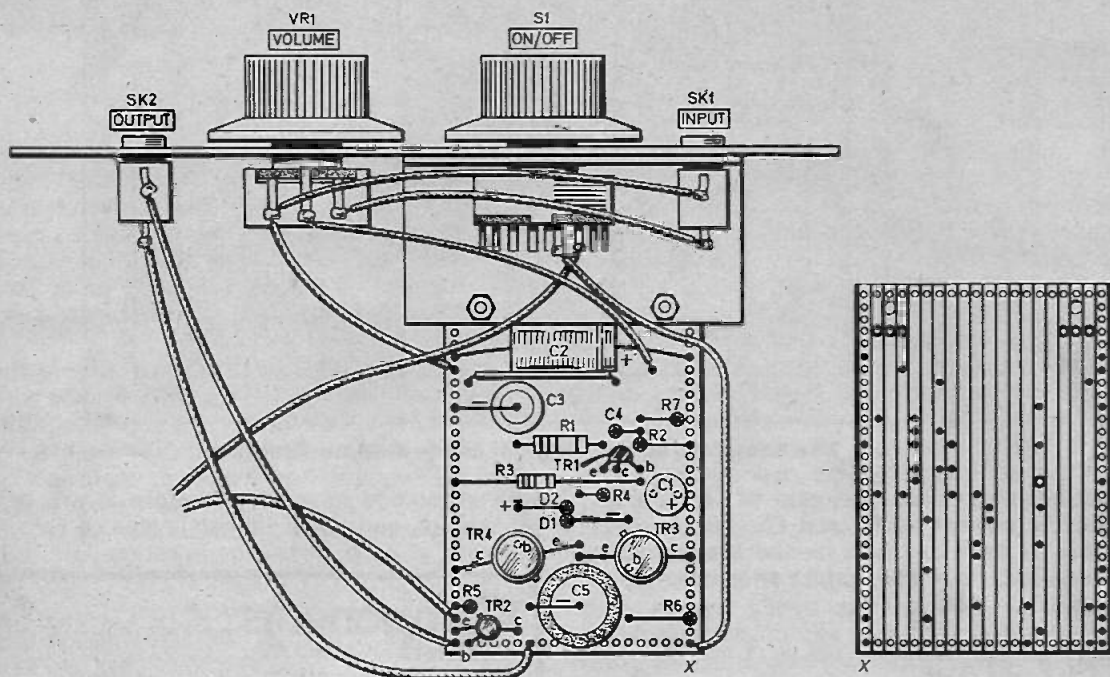


Fig. 4. Layout and wiring of the complete amplifier.

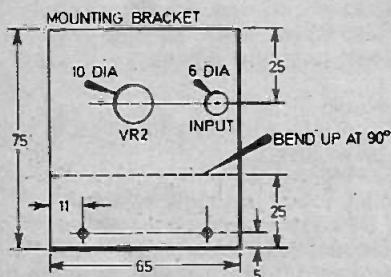
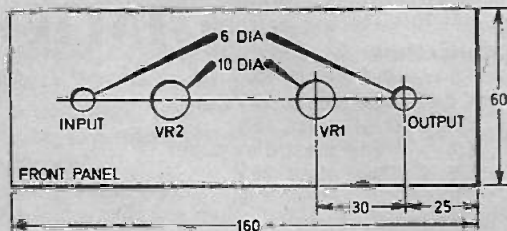
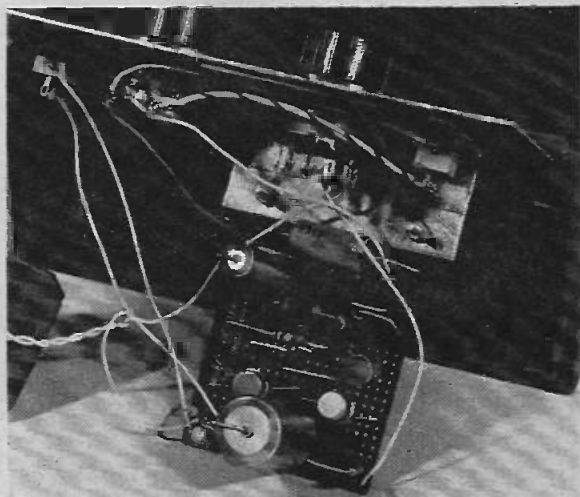
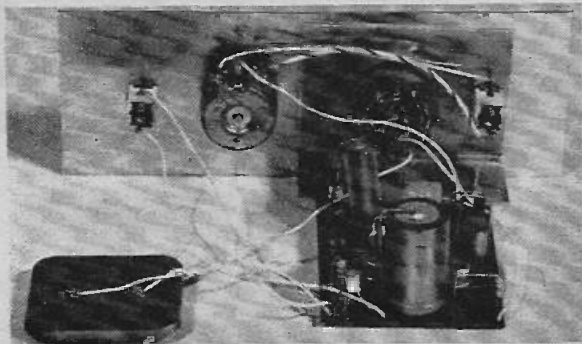


Fig. 3. Front panel and board mounting bracket details.



Photograph of the completed unit—compare this with Fig. 4.



The small forward bias provided by D1 and D2, which operate as a sort of low voltage Zener diode, bypasses this part of the output transistors characteristics, so that they operate on a more linear part. Without this bias, severe distortion would result, especially at low output levels.

The use of emitter followers at the output, and the high current gain that they afford, permits the loudspeaker to be directly driven from the output, via the d.c. blocking capacitor, C5.

The volume control is formed by VR1, and the input signal is fed via this, C1, and R7 to the input of the amplifier. Resistor R7 and C4 are required in order to reduce the high frequency response of the circuit, and so ensure good stability. Only a single supply decoupling component is required, and this is C2. The collector load resistors for TR1 and TR2 are R5 and R6.

## CASE

The case for the prototype was constructed from plywood. The front panel and mounting bracket for the component panel are made from 18 s.w.g. aluminium, and are shown in Fig. 3. Once the drilling has been completed, the fold in the bracket is made with the aid of a vice.

There is of course no need to use a particular type of case, and a commercially made case measuring about 170×135×70 mm can be used. The same general method of construction can be retained.

Components VR1, S1 and the input and output sockets are mounted on the front panel. The component panel mounting bracket is mounted by being trapped between the panel, and VR1 and the input socket.

## COMPONENT PANEL

All the small components are contained on a small 0.1 inch matrix Veroboard having 29 holes by 20 copper strips, Fig. 4 shows the layout of this board. The board is not sold in this size, and it must be cut from a larger piece using a small hacksaw. Then the two 6BA clearance mounting holes are drilled using a No. 31 twist drill. The seven breaks in the copper strips are then made using either the special tool, or a twist drill held in the hand.

All the components can then be mounted and soldered into position. The transistors and diodes are left until last, and it will be easiest to connect the insulated link wire if it is connected before C2 and C3. Be careful to ensure that the transistors, diodes, and electrolytic capacitors are all connected with the correct polarities.

The completed component panel is bolted to its mounting bracket using a couple of short 6BA bolts.

## WIRING

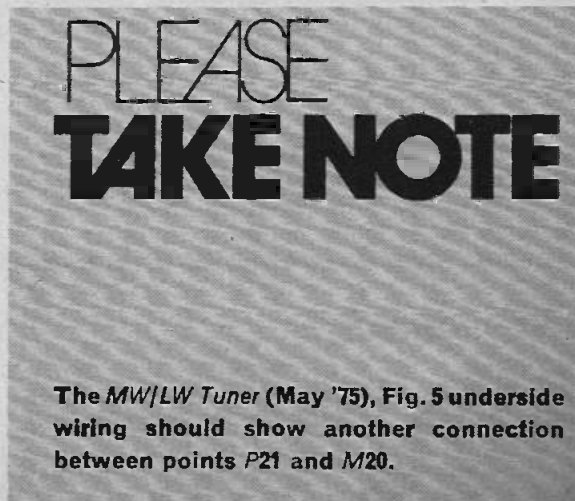
To complete the unit, the front panel controls, sockets, etc., are wired up. This wiring is shown in Fig. 4, and is largely self-explanatory. All leads must be insulated, and should be reasonably short and direct. On the prototype S1 is two contacts of a 3-way 4-pole wafer switch with adjustable end stop, but there are several alternatives available.

Finally a battery is connected, the unit is installed in its case, and control knobs are mounted on VR1 and S1. As a finishing touch legends can be applied to the front panel above the controls and sockets.

## NOTES ON USE

An external speaker is required, and this should have an impedance of 8 ohms, and be rated at 1/2 watt or more. A fairly large diameter, say 100 mm or greater, will usually give a better volume than a miniature type, as well as higher quality. The speaker should be mounted in a proper cabinet, or on a baffle board. The speaker lead should be terminated in a 3.5 mm jack plug.

For use with the tuner unit a short screened lead with a 3.5 mm jack plug at each end is required for connecting the two units. If a second lead with a 3.5 mm jackplug at one end, and a couple of crocodile clips at the other is made up, the unit can be used as a general purpose workshop amplifier. □

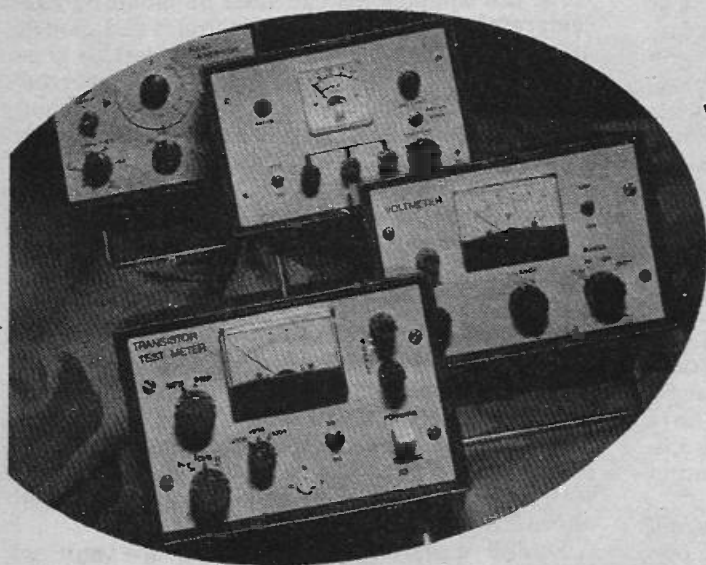


# Workshop Practice

By MIKE HUGHES M.I.E.R.E.

PART FOUR

A Professional Finish



**W**E CONTINUE this month with the professional finish giving details of front panel finishes and lettering.

## FRONT PANELS

Obviously it depends on the type of cabinet you have made for your equipment but very often you might want to produce a smart looking front panel with markings and lettering to designate controls or to give the piece of equipment some form of identity.

Irrespective of the complexity or neatness of the internal wiring of an electronic unit it is the impact the final presentation has that really gives you the satisfaction of having "made a good job of it". Quite often it may take a lot more time to finish off the front panel than it took to carry out the electronic assembly of a piece of equipment, however, this is time well spent—particularly if you are going to have to live with the results of your handywork.

Here we shall suggest some simple domestic ways of producing smart professional looking finishes. All the methods we suggest can be carried out with readily available materials but some may take a lot of elapsed time to get the best results. Still, when you are making something as a hobby one should discount time and concentrate more on the quality of the end product.

## FALSE FRONT

If you have been following this series you will recall, from Part 1, that we described a way of making a simple cabinet for an amplifier and advocated the use of a false front fascia panel to hide the necessary fixing screws, etc. This panel would be cut from a flat piece of material (whether plastic or metal) and would simply

carry any lettering that was necessary and would have holes cut in it to allow for the spindles of controls.

The descriptions that follow will all refer to flat front panels without bends but we hope you will be able to infer how these could be applied in other circumstances.

## GRAINED FINISH

The most common front panel material is, of course, aluminium so let's start by assuming that this is what we have available first of all. A well finished aluminium surface can be exceedingly attractive—this is often the accepted finish on professional equipment but in those cases the manufacturers have had the advantage of sophisticated polishing and anodising processes. You can, however, emulate these finishes very closely with the minimum amount of bother.

You must first ensure that the panel is *absolutely flat*—there should be no dents or bends at the edges, hence ideally, you should be thinking in terms of something like 16 gauge material that has been cut to size with a guillotine or a tool like the Goscut. Make sure that all the holes have been drilled and you can then work on the outside surface to produce a "grained" finish.

First of all wash the surface in detergent water to remove traces of metal cuttings and grease. Decide which way you would like the grain to run (it is usual to have it going in a horizontal direction if you want the final unit to have a slim-line appearance) and then *very gently* rub the surface of the aluminium in that direction *only* with a fine grade of household wire wool. Work in long sweeps from one end of the panel to the other.

You will see very fine scratch lines appearing on the surface. Do not be impatient and press



hard because the wool will dig into the surface and produce a rather flat and uneven dull grey effect. Provided you take your time and maintain a light pressure you can work your way over the surface and produce a very even regular grained effect. If there are any slight dents in the surface you will not get the best finish!

Make certain that you do not get finger marks on the abraded surface because the fine scratches will retain the natural skin oils and this will cause a stain to appear.

As soon as you have obtained sufficient "depth" to the graining, give the panel another thorough wash in detergent water and then in clean warm water—to remove all traces of detergent. The panel should then be carefully dried off with paper towels.

As soon as possible after the panel is really dry you should give the surface a coat of clear varnish to protect it from finger marks. The best varnish to use is clear polyurethane and is most easily applied from an aerosol spray can. By building up extra coats of varnish you can change the textured appearance of the panel from a flat matt to one having a high gloss sheen.

If you intend to carry out lettering it is probably best to stick with a matt surface and then put extra coats of varnish over the lettering to serve the dual function of protecting them and producing the gloss surface; you will find that the lettering methods we advocate will work best on slightly matt surfaces.

## LEGENDS

You can use ready made panel transfers, or rub-on lettering such as Letraset or Dry Print to produce legends for the front panel. There are a number of commercially produced transfers but the problem with these is that you often find you only want a few of the made up words that are provided and this means you can end up with the larger proportion of transfers unused while you have run out of the more frequently used words.

A lot of the commercially produced transfers rely on a water soluble gum to give adhesion between the words and the panel. While you get a reasonable degree of bonding to metallic and varnished surfaces there is a tendency for the words to flake off after a period of use. The author prefers to use rub-on lettering as it offers more flexibility in your choice of words and also in colour and type style. It may be a little more difficult to handle but the final job is usually better.

## LETTERING STYLES AND SIZES

Rub-on lettering sheets can be obtained from most office stationers and there is a vast range of different type faces. When selecting the style

### Folio Medium

ABCDEFGHIJK  
abcdefghijklmn

### Folio Light

ABCDEFGHIJK  
abcdefghijklmno

### Futura Medium

ABCDEFGHIJK  
abcdefghijklmn

### Grotesque 215

ABCDEFGHIJKL  
abcdefghijklmno

### Helvetica Medium

ABCDEFGHIJ  
abcdefghijklm

### Univers 53

ABCDEFGHIJ  
abcdefghijklm

Fig. 1. A selection of some commonly used sans serif type faces.

you have to make three decisions: the type itself is usually described by the name of the fount, i.e., "Gothic", "Univers", "Folio", "Cooper Italic", etc. These founts can be obtained as "feint", "medium" or "bold" letters. The usual choice for panel lettering is a bold, sans serif type that is very easy to read.

A sans serif type can be distinguished from ordinary serified type because the letters do not have the little curls at their ends. To produce a "name" for the equipment you might like to use a slightly more original type face such as "Cooper Italic" or "Flash". The choice is yours and there is such a wide variety of types to choose from. A sample is shown in Fig. 1.

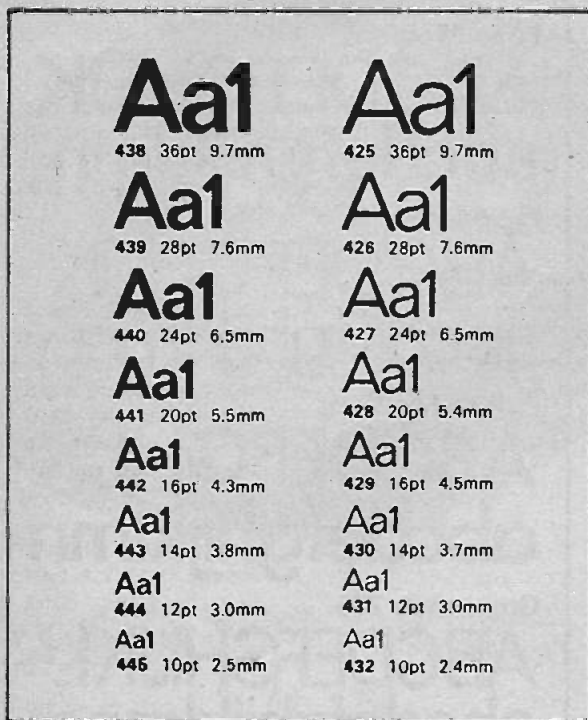


Fig. 2. A range of point sizes. Bold type is shown in left-hand column.

Each type style is available in different sizes (called point sizes) and you should select the size carefully. For labelling volume controls, etc., you will probably find that 10pt is satisfactory, but for the name of the unit you might wish to go up to 20 or 24pt, see Fig. 2 for comparison of point sizes.

If you need to put a lot of numerals on the panel you ought to look at the sheet of letters carefully to see if you are likely to get enough numbers. If not it is worth investing in a sheet of numbers only—but make sure that they are the same point size and type style as small differences become very obvious when you look at the final result!

The third decision you have to make is the colour of the lettering. Probably you will not have much choice because most shops stock only black. However, if you particularly want a specific colour it is worth enquiring if it could be obtained for you.

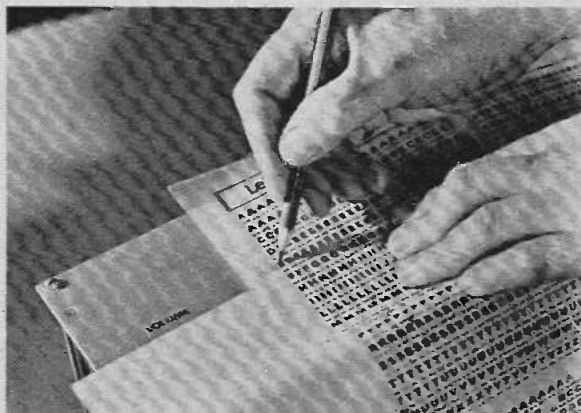
Fig. 3 (right). Using a strip of paper as a guideline and for word positioning.

## GUIDE LINES

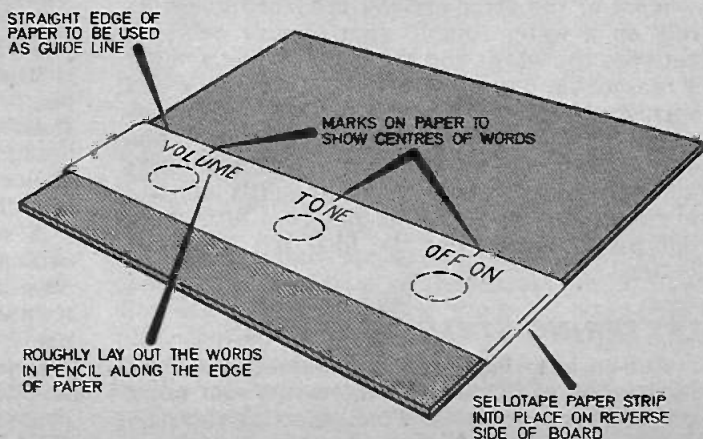
Most rub-on lettering sheets have guide lines under each letter to help you keep them running in a straight line. When it comes to applying these to the varnished front panel of brushed aluminium there is a slight problem because you cannot draw a guide line without damaging your carefully prepared surface. A simple solution is to Sellotape a straight edge of paper on to the panel to act as a guide. This can run the full length of the front panel if you need several designations at different points and require them all to fall on the same line, see Fig. 3.

## POSITIONING WORDS

Obviously it is desirable to centre each word you make up so that it falls onto the same centre as the control in question. This is easier said than done because different letters have different widths so it is not always correct to centralise the middle letter of the word. An "i" is the most narrow letter and an "m" is the widest. You just have to estimate which letter will fall on your centre line and then it is best to work



Photograph showing Letraset being applied to an aluminium front panel using a straight edge of paper as the guide line.



from the centre outwards in both directions as you spell the word.

Be very careful when you do this because it is the easiest thing in the world to make a spelling mistake when printing part of a word in reverse order of letters!

If, as I suggest, you use a piece of paper as a guide line you will probably find it a help to mark the positions of the centre of each word and write down the words along the edge of the paper as shown in Fig. 3 for guidance as you carry out the rubbing down operation.

## BURNISHING

Provided you have kept the varnished surface completely free from grease and finger marks, you should have no difficulty in getting the letters to stick when you rub them down with gentle pressure from a smooth blunt pencil point (do not use a sharp pencil because you can sometimes leave tell-tale marks on the varnished surface).

As you finish each word you should check it for accuracy and if satisfactory it should be "burnished" firmly into place. To do this place the siliconised protective sheet (from the lettering sheet) over the panel and firmly rub down the letters with quite a lot of pressure from the smooth back surface of a teaspoon.

If you find, *before burnishing*, that you have made a mistake, you can remove the lettering by pressing a small piece of Sellotape over the offending character and then peeling the Sellotape away—usually the letter will come away with the tape. This method of removing rub-on

lettering works equally well on paper and card provided you did not use excessive pressure from the pencil when rubbing them down.

When all the lettering is in place you should apply at least one more coat of varnish over the panel to hold them firmly in place. A panel made up like this will stand a lot of wear and tear and is almost as durable as one produced by the commercial anodising process.

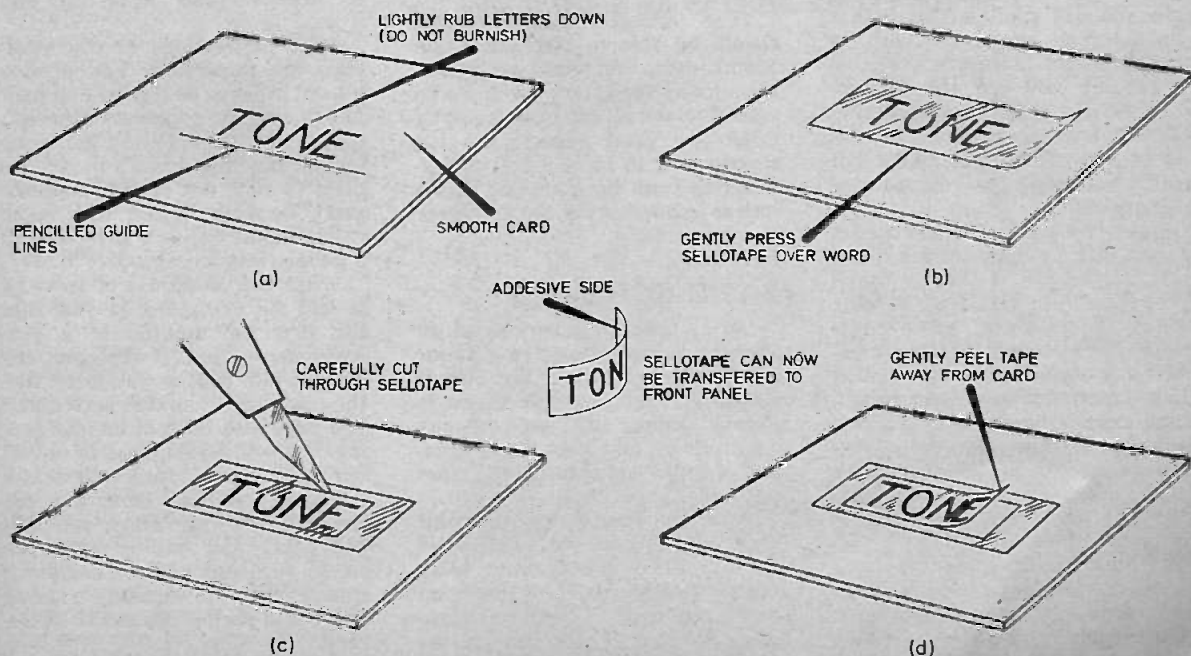
## USING CARD

For those who are not too confident about applying the lettering directly to the panel there is another method you can adopt (as outlined in Fig. 4). Obtain a piece of smooth surfaced card (such as used for plain postcards)—glossy card should not be used. Draw a pencil line as a guide for the lettering and then simply make up the words you require on the card using the lightest possible pressure when rubbing down.

Do not burnish the result but instead lightly lay a strip of transparent Sellotape over the row of letters and lightly rub down the tape. Using an artist's knife cut the Sellotape into rectangles round each word, but do not cut through the card.

With care you will find that you can prise up the tape and peel it off the card with the word firmly stuck to the sticky side of the tape. All you need do now is transfer the piece of Sellotape to your front panel, position the word accurately, and press it into place. For simple panels there would be no need to provide any extra coat of varnish as the tape gives ample protection to the lettering. (To be continued.)

Fig. 4. Outline of the card/Sellotape method for producing legends for front panel.





# Your Career in **ELECTRONICS**

By Peter Verwig

A career in electronics is an exciting prospect! Month by month our contributor Peter Verwig will explain what working in electronics is all about, how to prepare yourself for a rewarding career, and the job opportunities available in the world's fastest growing industry.

## THE APPRENTICESHIP

To become an apprentice means by definition to be young—an immediate school leaver or almost so, normally not more than 17½ years old and generally about 16.

To be an apprentice sounds in some young ears to be old-fashioned and certainly the idea of apprenticeship stretches far back in history. In 1558, during the reign of Elizabeth I, apprentices were obliged to wear blue cloaks in summer and blue gowns in winter and an apprenticeship term could be as long as seven years during which the apprentice was paid very little, if at all, and was almost a slave to his master.

Fortunately, things are very different today although the basic principle still applies. This is that you enter an agreement with an employer and in return for such services as you are able to provide during your apprenticeship you will not only get paid according to your developing skills but are also trained and encouraged in those skills.

Many top people in electronics started life as apprentices. Some have stayed on in their original companies and climbed the promotion ladder. Some, after a few years, have moved to other companies or organisations to broaden their experience as well as to win promotion. Quite a few former apprentices now run their own businesses. To be an apprentice is an honourable and commendable way to start a career and it has great advantages.

All the major companies and quite a few of the medium and smaller companies have apprenticeship schemes. Some

have their own engineering training centres where you will spend your first year. Others may attach you to a group of already qualified people where you will work under supervision while you are learning.

It's a good idea to look before you leap. If you live in South East England, for example, where 50 per cent of the whole of Britain's electronics industry is located, there may be several firms with first-class apprenticeship schemes within easy reach of your home, thus giving you a choice. But don't worry if the apprentice opening you are hoping for is a long way from home. Company welfare departments will find you good lodgings.

Your school careers master should be able to give you some sound advice and when you attend a company for interview don't be scared to ask all the questions you think you need answers to—it's clearly best to have a full understanding from the start and this is just as important for the employer as for yourself.

## BASIC SCHEME

Let us take a closer look at an apprenticeship scheme in a major electronics group and see how it all works. The example given is a blend of more than one company but may be taken as representative of today's standards and what you might expect.

From the company's viewpoint what is required is good basic material for further training so an initial requirement is that you have attained a certain educational status. If you are to go

ahead for National Certificate courses during a technician apprenticeship the company will expect you to have GCE 'O' level passes or CSE Grade 1 passes in mathematics; physics or physics with chemistry, or mechanics, or engineering science (not general science); and two other subjects such as engineering drawing, chemistry, metalwork or English language.

If you haven't got English language you will be required to take this some time during your apprenticeship. For City and Guilds courses you will need to have completed a five-year secondary school course to an acceptable standard and this should include mathematics, a science subject (e.g. physics or chemistry) and metalwork or engineering drawing.

## INTERVIEW

The interview is the key moment. You may have already been given some written tests in the selection procedure. If you think you have not done very well at these, don't despair because company training officers are very aware of problems of nervousness and will assess you on overall performance. What they really want to know is whether you have the makings of an engineer and the courage and determination to succeed if you are given your chance. They look for keenness and enthusiasm and a good brain.

First impressions at the interview are important. You need a logical mind to be a good engineer and a scruffy appearance or one that is over-trendy won't help your image, but this doesn't mean you need to turn out in old-fashioned gear. Be with it, but with some restraint, as befits a person with a serious mission ahead.

What are conditions of service? It will be explained to you that the first six months is a probationary period. If the company doesn't like you, or you don't like the company, then it is better that you part with mutual understanding. You will be required to attend regularly a prescribed course at a technical college, generally for one full day (for which you still get paid) and one evening per week. Paid day release continues throughout the official training and for a period beyond if necessary.

You will be expected to attend regularly at the company's laboratory or factory and work the normal working day. Holidays will be three weeks with pay plus the statutory public holidays. After the age of 18 you may be asked to participate in the company pension scheme. A company with more than one laboratory or manufacturing plant will have the power to direct you to any of their locations to broaden your experience if recommended by the training officer.

Your side of the bargain depends very much on yourself. An apprenticeship is an opportunity, not a drudge needing to be borne bravely. If we assume you join one of the big groups your first week will be spent on an induction course. You will be told something of the history of the company, its business, its products and its welfare and social sides. You will see something of the laboratories and factories and meet people with whom you will be working, sooner or later.

## TRAINING

The whole of the first year will be spent at the company engineering training centre in the company of your fellow first-year apprentices. Here you study engineering practice, learn the relationship between your theoretical studies and the practical aspects of research, development, design, manufacture and marketing of products and also start forming in your own mind the particular branch of the profession in which you would like to specialise later on.

The following two years, or more, are generally spent working in various departments, perhaps for up to three months in each. This achieves two things. It gives you a good working knowledge of the company as a whole and, as your experience broadens, will enable you and your training supervisor to decide where your aptitude and interests lie.

Even if you have made up your mind that you want to work, for example, in a laboratory, never despise those parts of your training in mechanical engineering or in production. You will do your final job all the better for having been exposed to the problems of other departments. No design engineer can be successful if he knows nothing of fabrication,

assembly, and testing of products. But it often happens that during your training your first ideas on a career may not be your final ones.

The comprehensive training allows you to change direction in relation to your own development and newly acquired skills. Generally, by the third year some pattern is emerging and your final year will mostly be spent on projects where your technical knowledge and skills are directed towards your chosen specialisation.

Don't forget that you can still get to chartered engineer status through an apprenticeship. If you get credit passes on your 2-year day release ONC course at technical college you have a good chance of moving on to a 3-year sandwich course at a college of technology or university. If you get ordinary passes on your ONC course, you then go ahead to your HNC. It's entirely up to you how fast you get on—or how slowly.

## SPARE TIME

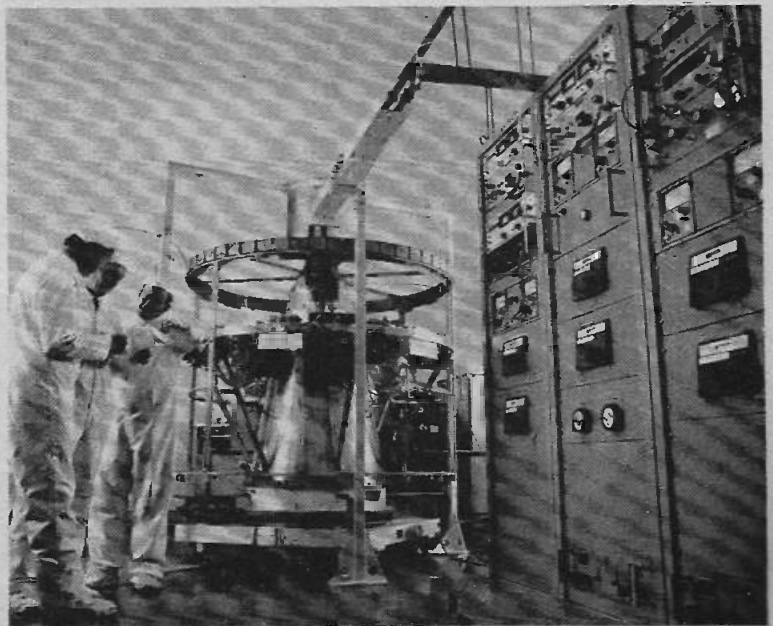
You'll be glad to know that once you are launched on your apprenticeship it's not work all

the way, or devoid of fun. There are company sports and social clubs and often an Apprentice Association affiliated to it. A young lady student apprentice at one of the major electronics groups recently won a Duke of Edinburgh's gold award. She needed a lot of spare time for that.

An apprentice group in a mechanical engineering division of the same firm had an interesting exercise designing and manufacturing a fire escape for a local hotel. They set to with enthusiasm and completed the job in five weeks.

Can an apprentice get to the top? Forty years ago a young lad of 15 joined Redifon as an engineering apprentice. Today he is Sir Raymond Brown, chairman and managing director of Muirhead Ltd. On his way up he was a co-founder of Racal Electronics Group (in 1950) and was the first Head of Defence Sales at the Ministry of Defence. He is well known on Industry committees and is President of the Electronic Engineering Association, the body which represents some 80 per cent of the capital goods sector of Britain's electronics industry.

**Skynet II defence communications satellite. Designed and built by Marconi Space and Defence Systems for the Ministry of Defence, it is seen here in final test and is now in orbit over the Indian Ocean maintaining communication over an area between Britain and the Far East.**



# SELF POWERED RECEIVER

By R.N. SOAR

**T**his simple receiver, unlike the traditional type of crystal receiver, does not use a crystal diode as the detector, but instead uses a transistor. This has an added advantage in that some gain is produced even though no battery is used.

## CIRCUIT DESCRIPTION

The complete circuit diagram for the Self Powered Receiver is shown in Fig. 2. The circuit is capable of receiving both medium wave and long wave transmissions. For medium wave a parallel resonant circuit is formed by L1 and C1 and for long wave is formed by C1 and L1 and L2 in series. Wave change is accomplished by switch S1.

The resonant circuit can be tuned by means of the variable capacitor C1. The aerial is con-

nected to the tuned circuit at the midway point of L1.

The r.f. passes from the resonant circuit to the emitter of TR1 where it is rectified by the emitter/base diode of TR1. Audio frequency, varying d.c., results at the collector which drives the headphones. Some of the resulting d.c. charges up capacitor C2 which helps to bias TR1 in a forward direction which produces a little amplification.

## COIL

The coil was home-made and wound on a 40 mm diameter cardboard tube (the middle of a toilet roll was found ideal). The medium wave winding, L1 consists of 70 turns of 26 or 28 s.w.g. enamelled copper wire wound side by side with a tapping at 35 turns.

The long wave coil, L2 consists of 200 turns of 32 or 34 s.w.g. enamelled copper wire wound in two piles of 100 turns each, see Fig. 3.

At the start and end of each winding, a dab of Bostik or nail varnish should be applied to the tube to prevent the coils unwrapping.

## SIMPLY

The block diagram of the simple receiver is shown in Fig. 1. The modulated r.f. carrier wave from the radio station transmitter is picked up by the receiver aerial and tuned circuit and then passes to the detector stage. Here the a.f. vary-

ing d.c. is extracted and is available for the headphones. Also, part of this d.c. is used to forward bias the transistor and so produce some amplification.

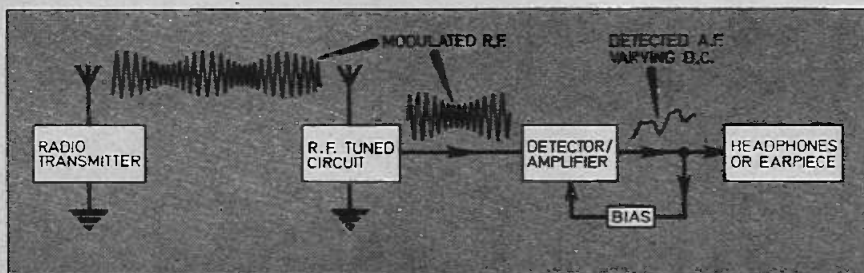


Fig. 1. Block diagram of the Self Powered Receiver.



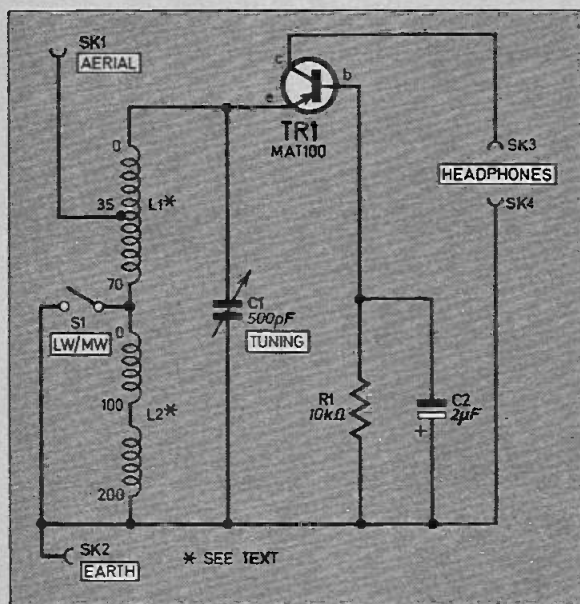


Fig. 2. The complete circuit diagram.

When winding the medium wave coil, after 35 turns a loop should be made external to the tube, and then the winding operation carried on. When completed, the centre-tapped loop should be twisted together, the enamel cleaned off the end and then tinned. All the coil ends should be bared and tinned, ready for wiring up.

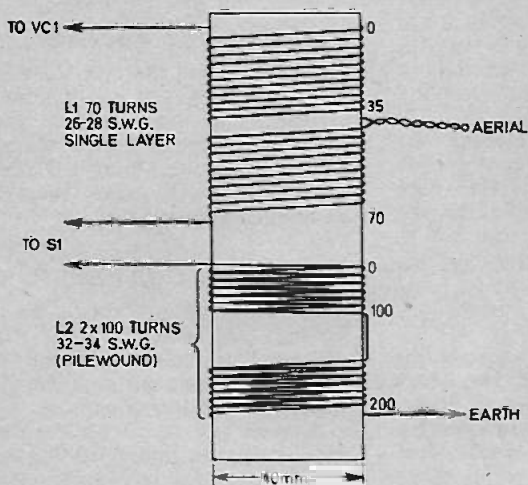


Fig. 3. Details of the tuning coil.

FOR GUIDANCE ONLY

**ESTIMATED COST\***  
OF COMPONENTS  
excluding V.A.T.

**£1.40**

\*Based on prices prevailing at time of going to press

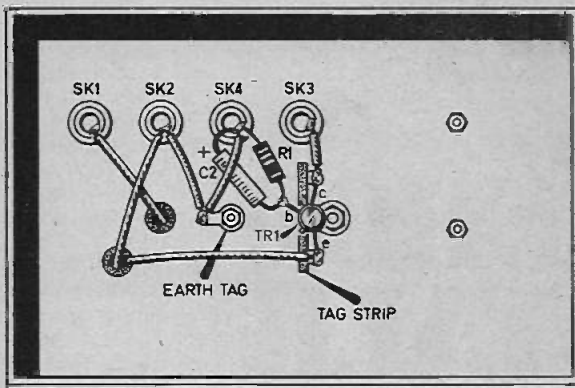
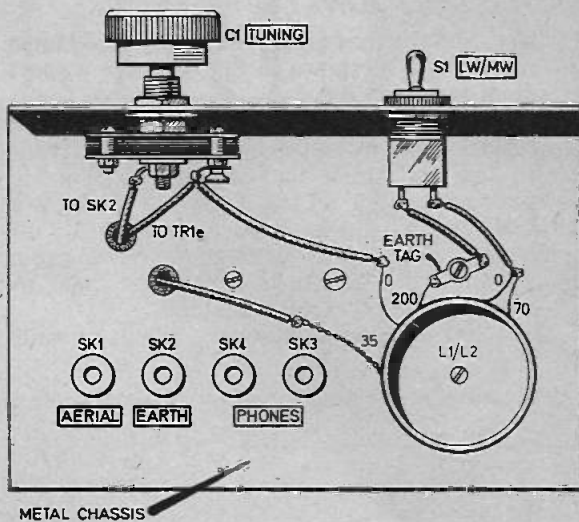


Fig. 4. The layout of the components and wiring up details.

## Components....

### Resistor

R1 10kΩ ¼W ±10% carbon

### Capacitors

C1 500pF variable  
C2 2μF elect. 16V

### Transistor

TR1 MAT100 pnp

### Miscellaneous

S1 on/off toggle  
SK1-4 single-pole sockets (4 off)  
Tagstrip, 2-way with separate mounting pillar; aluminium and batten for chassis (size to suit); knob; 26-28 s.w.g. and 32-34 s.w.g. enamelled copper wire—approximately 15 metres of each; solder tags (2 off); 6B A nuts, bolts and washers.

SEE  
**SHOP  
TALK**

## CONSTRUCTION

The prototype unit employed a very basic form of construction as shown in Fig. 4 where a short length of tagstrip was used.

The hardware consists of two pieces of sheet aluminium (size to suit) one forming the front panel and the other the base plate. Wooden battens were nailed to the baseplate to form a sort of stand. These battens should be of sufficient depth so that the components mounted on the underside of the baseplate are clear of the area on which the unit will stand.

The front panel is attached by means of nails

to the front batten so as to form an L-shaped chassis. Before assembling the chassis, make all the necessary cut-outs as indicated in Fig. 4.

## IN USE

With a good aerial and earth (mains earth must not be used), using 2000 ohms impedance headphones, good reception was obtained on the prototype for Radio 1, 2 and 4 and reasonable reception of Radio 3. When the aerial is plugged in there is a short delay before the set starts to work due to the charging up of C2. □

*New products and  
component buying  
for constructional  
projects*

# SHOP TALK

By Mike Kenward

How, precisely, the new V.A.T. rules will be interpreted is far from clear at the time of writing. But one thing is sure. Suppliers of components are in the front line and they have our sympathy. They face the wrath or indignation of their customers when they apply the higher rate of V.A.T. to all components (with perhaps those few unarguable exceptions). The suppliers are, of course, accountable to the tax authorities, so they cannot take chances. In short, when in doubt, the higher rate of 25 per cent is bound to be applied.

The individual customer has no option but to accept the increased price, though if he does feel there is a particular case for exemption from the higher rate he can take the matter up with his local V.A.T. office. This is the only advice we can offer our readers at this time. Some clarification of the situation must emerge before long, though

it is doubtful whether much or any relief will be forthcoming.

## Automatic Garage Doors

Some of the parts for the mechanics of the *Automatic Garage Doors* may be difficult to get in some areas. Wood, aluminium and small parts should not be too difficult but those readers in outlying areas will probably have to visit their nearest large town.

The motor is the main item and the most costly, this is available from three sources and the following specification should be quoted: Parvalux SD8S 230/250V 50Hz single phase motor with gears giving a speed between 68 and 104 r.p.m. (a number are available), single or double shaft including capacitor.

For general information the motor provides an output torque of 20lb/in and is available with either bronze or fibre gears—the bronze type cost £1.35 plus V.A.T. (at 8 per cent) extra, but are obviously more substantial although the fibre ones are adequate.

The motor in the above form may be available off the shelf from two suppliers but if ordering direct from Parvalux expect a delivery time of 4 to 5 weeks. Cost is £16.58 plus £1.20 for packing and carriage plus V.A.T., a total of £18.20. Or with bronze gears £19.66.

Suppliers are Parvalux Electric Motors Ltd., Wallisdown Road, Bournemouth (Tel. 0202 512575), M. R. Suppliers Ltd., 32A Coptic St., London W.C.1. (Tel. 01-636-4178), Halolux Electric Motors, Ridgeway Industrial Estate, Iver, Nr. Slough, Bucks (Tel. 0753-65433).

The motor reversing switch is rather unusual in that it is a three

pole switch. This is available from Lock Distribution, Neville Street, Middleton Road, Oldham OL9 6LF, Lancs. Order type MST 306D, 3P.D.T. lever switch and include a cheque or p.o. for £1.80 to cover the cost and postage. Both the motor and reversing switch may be available from some suppliers and readers could make quite a saving if ex-equipment parts are obtained. The specific relay can be obtained from Home Radio although it may be available elsewhere and other types can be used—see text; this also applies to the transformer.

## Self Powered Receiver

The parts for the *Self Powered Receiver* should not prove difficult although you may have to look around for the transistor, do not use a substitute. You will probably have to buy 2oz reels of enamelled copper wire.

## DEAC Cell Charger

Once again there should be no buying problems for the *Cell Charger*; all parts should be available if not from all suppliers, at least from the larger ones.

Almost any small plastic case can be used to house the finished unit or a wooden box can be made up.

## Add-on Amplifier

The *Add On Amplifier* shows a good example of an author using what he has to hand although a much cheaper alternative is available—the part in question the on/off switch. The author has used a 4 pole 3 way rotary switch as a s.p.s.t. switch. Small rotary s.p.s.t. types are available or a toggle type could be employed.

# Next Month...

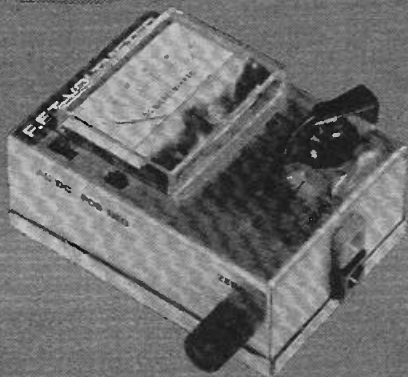
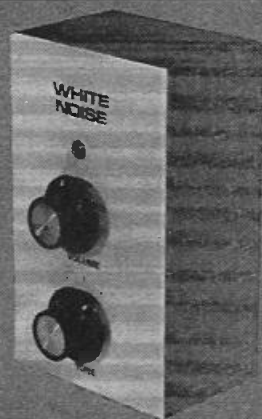


## INTRUDER ALARM

If you own or rent a colour T.V., audio or photographic equipment, or gold or silver jewellery then you are a possible target for a burglar. Even if the items are insured your home may be ransacked and your privacy invaded. The simple answer—build our Intruder alarm.

## WHITE NOISE GENERATOR

White noise is a basic sound that can be used or filtered to provide various sound effects. Full construction details of this simple unit will be shown.



## F.E.T. VOLTMETER

A voltmeter with very high input impedance is often essential for checking voltages in circuits with low operating current. This compact design provides a.c. and d.c. ranges up to 1000V at 10 megohms input impedance.

# everyday electronics

AUGUST ISSUE  
ON SALE  
JULY 18





# CELL CHARGER

By GEORGE HYLTON

**R**ECHARGEABLE cells such as DEAC cells must not be charged at too high a current. One way of making sure that excessively high currents cannot flow into the cell is to use constant-current charging.

This method forces the same current into the cell irrespective of how "flat" or "full" it is. So long as the user remembers to stop charging after the appropriate time, damage cannot occur.

## LIMITING RESISTOR

Many so-called constant-current chargers are not truly constant-current at all. They merely apply a relatively high voltage to the cell via a resistance which limits the current to a safe value. A typical circuit is shown in Fig. 1.

Here 12 volts d.c. is applied via 1 kilohm series resistor. The current cannot exceed 12 milliamps. The trouble with this sort of circuit is that the current can be a good deal less than its nominal value.

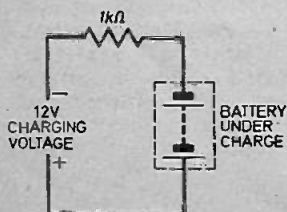


Fig. 1. Charging a battery via a current limit resistor.

If a 6 volt battery of cells is charged, the battery voltage at the start of charging is likely to be at least 5 volts. This 5 volts opposes the charging voltage, leaving a net 7 volts to drive current through the 1 kilohm resistance. So the charging current is only 7mA instead of the nominal 12mA. If the charging is regulated on a time basis, the battery is not fully charged when taken off charge.

## HIGHER VOLTAGE

One way round the problem is to use a much higher charging voltage. With 120 volts and 10 kilohms, for instance, the current would only fall to 11.5 milliamps when the battery voltage was 5 volts. A safer and more elegant solution, which produces similar results even with a low charging voltage, is the electronic constant-current circuit.

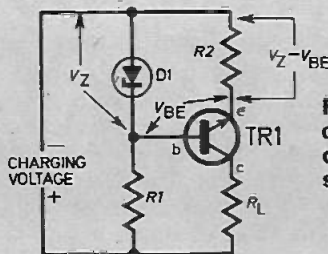
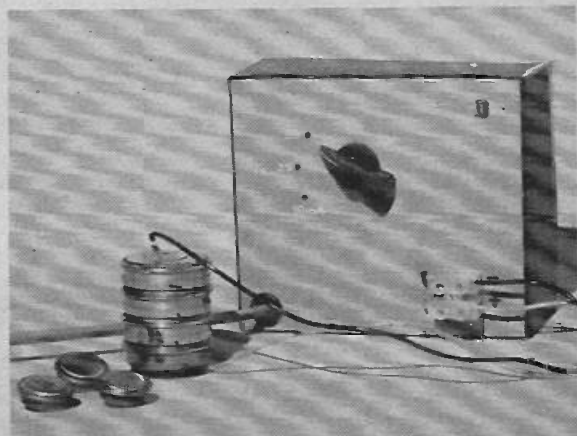


Fig. 2. Using a Zener diode to produce a constant current source.

## ZENER DIODE

A simple example which gives quite good performance is shown in Fig. 2. Here a constant voltage  $V_z$  from a Zener diode  $D1$  is applied to a transistor. Part of  $V_z$  is used up in maintaining the working base-emitter voltage  $V_{BE}$ . The rest is dropped across an emitter resistance  $R2$ . For a silicon transistor,  $V_{BE}$  is around 0.7 volts. If  $V_z$  were 2.7 volts, this would leave 2 volts across  $R2$ . The emitter current is then  $2/R2$ , and for a transistor with a high  $h_{fe}$  the collector current is nearly the same.



For example, for a charging current of 10 milliamps,  $R_2$  would need to be 200 ohms. The collector current is almost independent of the collector voltage, so long as there is enough voltage to operate the transistor (say 0.3 volts between collector and base). This means that the voltage dropped by the load  $R_L$  does not affect the collector current, for a range of  $R_L$  from zero up to the value which absorbs so much voltage that only 0.3 volts is left for the transistor. To put in some actual figures, suppose  $V_{\infty}$  is 10 volts. The Zener absorbs 2.7 volts, and a further 0.3 volts is needed to operate the transistor, making a total "waste" of 3 volts. The remaining 7 volts is available for the load. If the load is not a resistance but a string of 1.5 volt cells on charge, any number of cells up to four can be connected in series without affecting the charging current.

### LOW VOLTAGE REFERENCE

In practical circuits it is desirable to keep the "wasted" voltage small. This means using a low-voltage Zener. However, it is not absolutely necessary to use a Zener at all. Any source of stable voltage will do. The only other requirement is that this voltage reference source should pass much more current than the base current of the transistor. Taking a figure of 50 milliamps for the maximum changing current required, and an  $h_{FE}$  of 20, the base current is  $50/20 = 2.5$  milliamps. A current of 10 milliamps through the voltage reference is enough to make the circuit work reliably. (For transistors with  $h_{FE}$  more than 20, or for charging currents less than 50 milliamps, the performance of the circuit is improved.)

Now, 10 milliamps is a suitable current for a light-emitting diode, and the voltage drop across a light emitting diode (l.e.d.) is pretty constant at about 1.6 volts. So here is a suitable low-voltage reference, with the bonus point that it acts as a pilot light as well!

In round figures, the wasted voltage is 2 volts, so a charger for a single 1.5 volt cell need only have a supply voltage of above 3.5 volts. For two 1.5 volt cells in series, you need a minimum of 5 volts, for three, 6.5 volts and so on.

### CIRCUIT

The complete Cell Charger is shown in Fig. 3. By switching in different emitter resistors the charging current can be set to 10, 25 or 50 milliamps nominal. (There are slight variations due to semiconductor and resistor tolerances.)

If desired, the mains power supply section can be omitted as the circuit will work from d.c. input voltages up to 15 volts, and will charge strings of up to eight 1.5 volt cells, the maximum number depending on the input voltage, as explained above.

### RATE OF CHARGE

The charging rate for DEAC and similar cells depends on the capacity of the cells. If you do not know the correct charging current, but you do know the capacity of the cell (in milliampere-hours) you can work out the current:

$$\text{charging current} = \frac{10}{\text{cell capacity (mA H)}}$$

This gives the estimated maximum safe charging current. It is kinder to the cell to charge at

**FOR GUIDANCE ONLY**

**ESTIMATED COST\***  
OF COMPONENTS  
excluding V.A.T.

**£3.00**

\*Based on prices prevailing at time of going to press



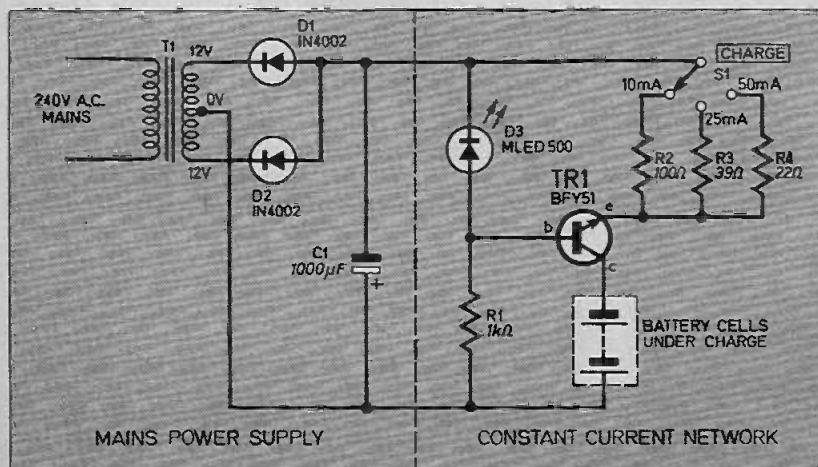


Fig. 3. The complete circuit diagram of the Cell Charger. It can be seen to consist of two parts, the mains power supply and a constant current network

## Components....

### Resistors

R1	1.2k $\Omega$
R2	100 $\Omega$
R3	39 $\Omega$
R4	22 $\Omega$
	All $\frac{1}{4}$ W carbon $\pm$ 5%

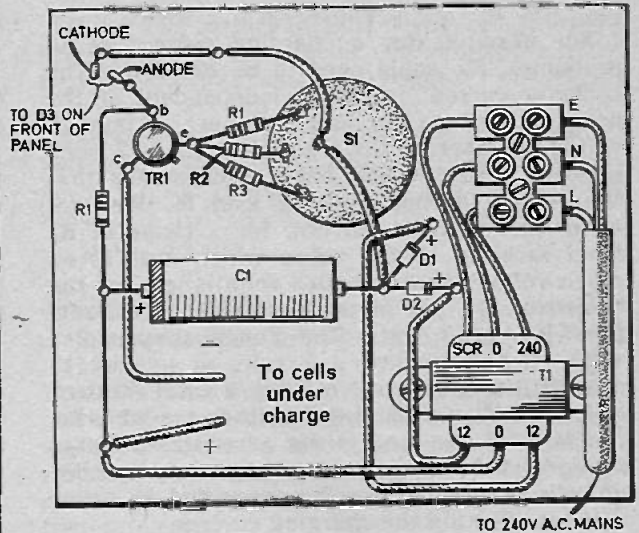
SEE  
**SHOP  
TALK**

### Semiconductors

TR1	BFY51 silicon npn
D1, D2	IN4002 (2 off)
D3	MLED500 light emitting diode

### Miscellaneous

C1	1000 $\mu$ F elect. 25V
S1	1-pole 3-way wafer switch
T1	Mains/12-0-12V 50mA secondary (Eagle MT12)
	Terminal block; 2 amp 5-way; pointer knob; pins; screws; plywood; materials for case.



TO 240V A.C. MAINS

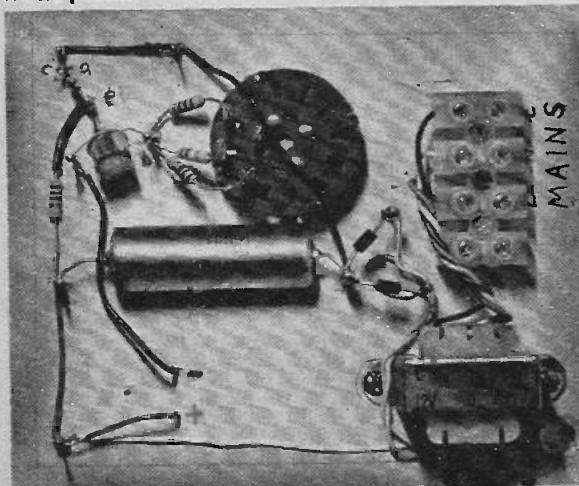
Fig. 4. The layout and wiring details of the components on the rear of the front panel.

a lesser current for a correspondingly longer time. The degree of charge can be estimated by measuring the cell voltage, which is about 1.1 volts when fully discharged rising to 1.5 volts when the cell is fully charged and still "on charge" at maximum permissible current. (For half maximum current the voltage is 1.46 volts.) An accurate meter is required: even a 1 per cent error makes the last figure in the voltage reading unreliable when you are measuring this sort of voltage to three figures.

## CHARGING TIME

The charging time is another matter entirely. For a fully discharged DEAC cell (to 1.1 volt), it is 14 hours at maximum current. If the cell is put on charge before being exhausted, less

Photograph of the completed prototype unit front panel.



charging time is needed. Note that the 14-hour charge at maximum current puts 40 per cent more electrical energy into the cell than comes out again when the cell is used. This extra 40 per cent is wasted in heating up the cell during charge. This explains why quick charging of these cells with high currents is not permitted. The cells would be damaged by excessive internal heat.

If the charging current needs to be set to a value not provided for in the circuit, work out the required value (say R) from:

$$R = \frac{1000}{\text{charging current (in milliamps)}} \text{ ohms}$$

eg for 30 milliamps charging current  
R=33 ohms.

The capacity of the cell or battery in milliamp-hours is sometimes written into the type number. For example, a cell marked XYZ 225 is likely to have a capacity of 225 milliamp-hours. The corresponding maximum charging current is then 22.5 milliamps for a standard 14-hour charge.

## LARGE METER SCALE

What can be done if you do not have an accurate voltmeter and so are unable to determine when a cell is fully charged? So long as you have a meter which gives a large pointer deflection when voltages around 1.5 volts are applied, it is possible to use the cell to calibrate the meter. This is done by charging the cell for a very long time at a very low current, say 0.5 milliamps.

The cell voltage rises slowly and then levels out at about 1.45 volts. Mark the meter scale accurately at this point and use it as an indication of "full charge" in the future. (Under maxi-



mum-current condition the cell will not be quite fully charged at this voltage, but this is preferable to overcharging.)

## CONSTRUCTION

The prototype used a convenient and very simple form of construction, all the components being mounted on the rear face of the front panel. The latter was made from a piece of 6 mm thick plywood (size 130×110 mm) to which mains connections (the transformer and terminal block) are easily secured using small wood screws.

Anchorage and connection points for the other components are afforded by the use of pins driven into the wood. These should be 12 mm brass marine pins, obtainable from most do-it-yourself shops, or new plated domestic pins

obtainable from office stationers.

Begin assembly by cutting the plywood to size and drilling the holes for S1 and the feed-through wires. Next drive in the pins as indicated in Fig. 4, position the components and wire up as shown.

The light emitting diode D1 is located on the front face of the panel and should be positioned so that the curved surface of D1 is outermost as the light comes out of this surface. The mains lead that comes out of the front panel, via a grommet, should be terminated in a fused plug.

Label the front panel as shown in the photograph and mount the panel into a suitably sized case.

Connection to the battery to be charged is made by means of the terminal block on the front panel which should be clearly marked positive and negative. □



## ...Counter Intelligence

BY PAUL YOUNG

*A retailer discusses component supply matters.*

As I am writing this article on thirtieth of April, you will not be surprised when I tell you my subject is V.A.T.! By now I am sure our Editor has already taken up cudgels on your behalf and indeed it was his suggestion that I should raise the subject in *Counter Intelligence*. I told him, there is nothing easier, the difficulty is, that if I say what I really think, the result will be quite unprintable.

The Treasury were warned by many eminent people, on no account to bring in a multi-rate of V.A.T. and this was endorsed by everyone likely to be affected. If it is a question of raising more revenue, the Chancellor only needed to increase the rate of V.A.T. to 10 per cent or even 12 per cent. As it stands, the Customs and Excise will need far more staff to deal with it, and therefore much of the extra revenue raised will be lost in additional wage bills. It makes me wonder whether Professor Northcote Parkinson was right, when he propounded his famous law.

However, to come down to cases, how will it affect you, the amateur constructor? I regret to say, almost everything will carry the higher rate of tax. The only exceptions being Test Gear, Tools and Soldering Irons. There are

some others but they are insignificant. In terms of finance it means that on every pound you spend Mr. Healey will take 16p. I am sure it is not going to stop, you continuing with what is one of the most absorbing hobbies of all time. Although it is a small consolation, certainly many other hobbies, sailing for example, have been equally hit.

The EVERYDAY ELECTRONICS team of designers have always been very price conscious, and I have no doubt that they will accept this as a challenge to produce projects that will strain your pocket even less. We, for our part will strive to supply your components at the lowest possible prices.

## THREE CHINS!

A glance through the adverts will convince you that there already exists fierce, though friendly competition between my fellow dealers, and I must admit I can not always compete. Consequently I have the occasional customer who writes to tell me that my resistors are a penny dearer than anybody else's. From your point of view this is all to the good, (the competition I

mean, not the fact that my resistors are a penny dearer).

Last Friday however we all put aside our differences and berated the V.A.T. men in their lair. All the big names in the component supply business were there, and a goodly sprinkling of smaller fry like myself.

You might argue that we were looking after a sectional interest, but I do not see it quite in that light. To me we are all part of a team, the designers, the magazines, the component suppliers, and, the most vital link in the chain, you the constructor. Your success is our success and our success is your success.

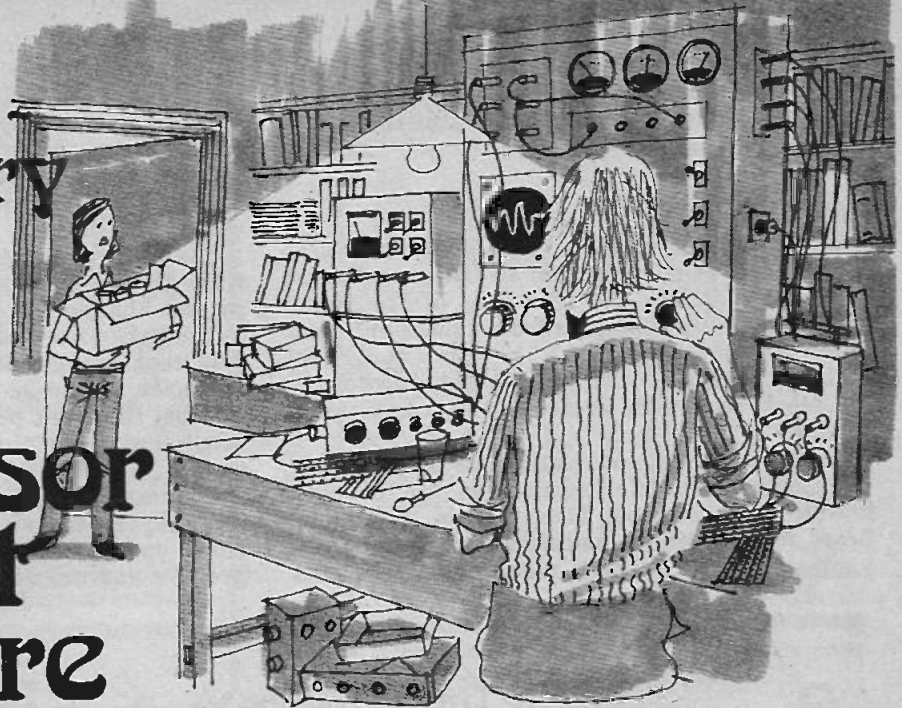
I can only suppose that this restriction is vital to the economy of the Nation, but what sticks in my throat is being told to tighten my belt, by a gentleman with three chins!



"Doris, remember me sending £10 to that firm for a calculator?"

# The Extraordinary Experiments of Professor Ernest Eversure

by Anthony John Bassett



Professor Ernest Eversure, or the Prof. as his friends call him, has been experimenting in electronics for more years than anyone can remember and we thought that you might like to hear of, and perhaps repeat, some of his extraordinary experiments. Anthony J. Bassett recounts some of these experiments every month so why not follow the Prof's work and learn along with young Bob, his friend.

BOTH Bob and the Prof. were highly pleased with the class A amplifier circuit (described in last month's issue of E.E.). Now Bob wanted to know more about transistor switching action, and a means to compare this action with the class A amplifying action.

The Prof. drew out a circuit (Fig. 1) which can be used to demonstrate both types of action.

"Try this circuit, Bob," he remarked, "You can build it quite quickly on a piece of perforated circuit board."

Bob collected together the necessary components and assembled them together as shown in Fig. 2. He then connected a 6-volt lantern-battery to the circuit and switched on. The variable wirewound resistor VR1 was set to minimum, and the first bulb, then each alternate bulb lit brightly, whilst the current flowing through the other bulbs was so low that the filaments only glowed very faintly.

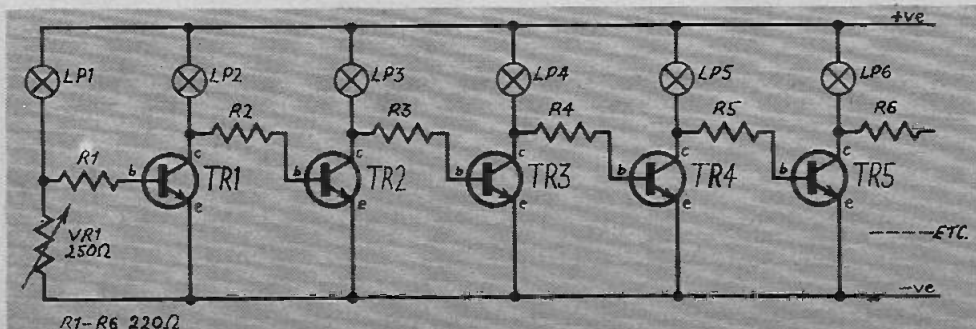
As Bob gradually adjusted the potentiometer to higher resist-

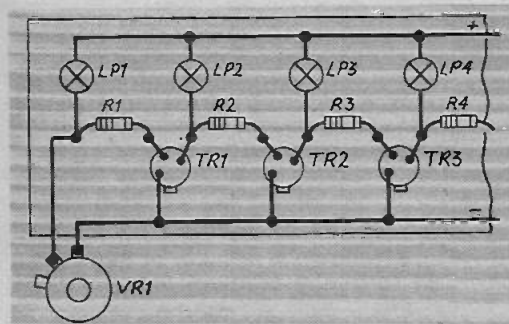
ance, the first bulb glowed progressively less brightly, whilst the next bulb began gradually to glow more and more. Then LP3 began to glow more brightly, and, at a certain point, quite suddenly the odd numbered bulbs to the right began to glow brightly whilst the even numbered bulbs became dim. Bob found that only a very small adjustment of VR1 in either direction was necessary to cause the sudden switching action which affected the higher-numbered bulbs, whilst the brilliance of the lower-numbered bulbs did not alter by anything like as much.

## CONTROL

"Could this circuit be used to control electric motors or relays, as well as lamp bulbs?" queried Bob, "If so, just one control-

Fig. 1. Circuit to demonstrate transistor amplifying and switching action





**Fig. 2. Layout and wiring of the circuit shown in Fig. 1. The transistors are mounted upside down.**

potentiometer could be used to control the speed of some motors gradually, whilst others switched on or off at predetermined points."

"I think it would be possible to build some very interesting equipment by using this type of circuit to drive motors, relays, transformers, and many other devices in addition to bulbs," replied the Prof. "But you will need to protect the transistor with a diode whenever an inductive device of this nature is connected to the collector. (See Fig. 3.)

"Also, as many of these devices are likely to pass a much higher current than the small indicator bulbs which you are using, it may be necessary to use a transistor with a much higher current and power-handling capability—just as we did with the amplifier circuit. This would also probably entail a change in the base-bias resistor in accordance with the current gain of the transistor in use.

"In the circuit you have just built as you slowly vary VR1, this gradually changes the voltage across R1 and the current through R1 into the base of TR1. The brightness of the first bulb LP1 is an indication of the voltage across the bulb, and as the bulb becomes dimmer, this indicates a greater current through R1. This causes TR1 to conduct more and more, and LP2 to become brighter.

"Due to the gain of TR1, the

change in current through LP2 occurs at a greater rate than the change through LP1. This happens around the point where TR1 is biased into the region of highest gain. Similarly the current through TR3 changes even more rapidly—and so on along the line of lamps until a point is reached where the change in conduction of each transistor is so rapid as to be, for many purposes, an instant switching action. This circuit thus contains the elements of both analogue and digital computer action in a very simple form, yet despite its simplicity it can be put to practical use for purposes of both analogue and digital control."

"I've thought of another use for the circuit," commented Bob, "We have been studying political science at school. Democratic Government, and debate are important subjects here, by a simple alteration, the circuit (Fig. 1) can be made into an interesting classroom poll indicator!

"If the lamp LP1 is replaced by a number of resistors which can be switched into circuit individually, the lamps will respond according to the number of switches which make contact, until the point is reached where transistor switching action takes place to indicate that a majority of the switches are making contact (Fig. 4). Potentiometer VR1

can then be adjusted so that switching action takes place when more than 50 per cent of the switches are closed—or VR1 can be set to give switching action on any chosen proportion of votes.

"This circuit is so simple, Prof., that it gives me a much better idea of transistor amplifying and switching action. I can see how one transistor can control the following one by either enabling current to flow through it, or by disabling the flow of this current."

The Prof. agreed about the basic simplicity of the circuit.

"I would like to point out, though, how easily we could cause this type of circuit to perform much more complicated functions simply by branching the chain of transistors in various ways. By this means, any one transistor can either control or be controlled by more than one other."

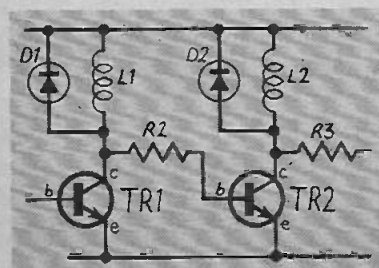
### MORE FUNCTIONS

The Prof. drew a number of diagrams to illustrate this (Figs. 5, 6, 7, 8).

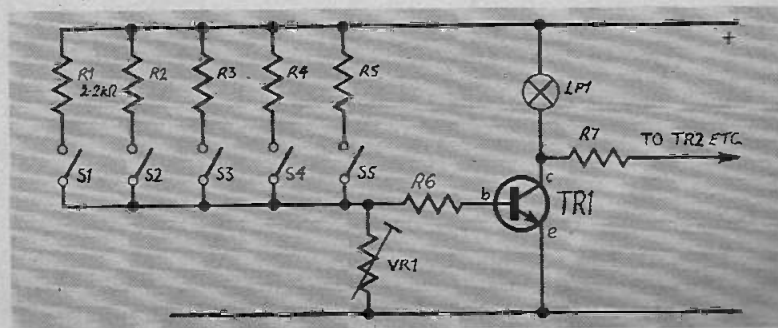
"In Fig. 5, if any one of the transistors TR1, 2, 3, etc., is switched 'on' it will disable TRN by removing its base bias, thus preventing TRN from conducting. If none of these transistors conducts, then current through TRN will be 'enabled'.

"In Fig. 6, we have a circuit resembling that of Fig. 4, but the manually operated switches have been replaced by transistors. In order to cause switching action along the chain of transistors, a proportion of the transistors TR1, 2, 3 etc. must be switched 'on', and this proportion may be determined by the ratios of the resistor values. If the resistors in series with TR1, 2, 3 etc. are not of equal value, then by this means some of the transistors can be made to

**Fig. 3. Diode protection for inductive loads.**



**Fig. 4. A poll indicator use 2.2 kilohm resistors with up to 20 switches.**





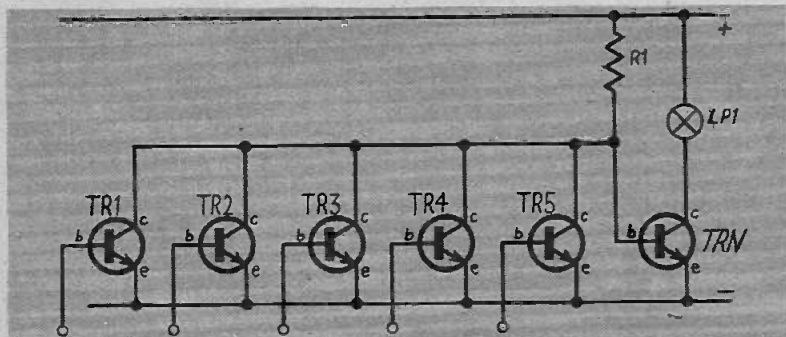


Fig. 5 (left). Any one of transistors TR1 to 5 may conduct thereby turning off TRN.

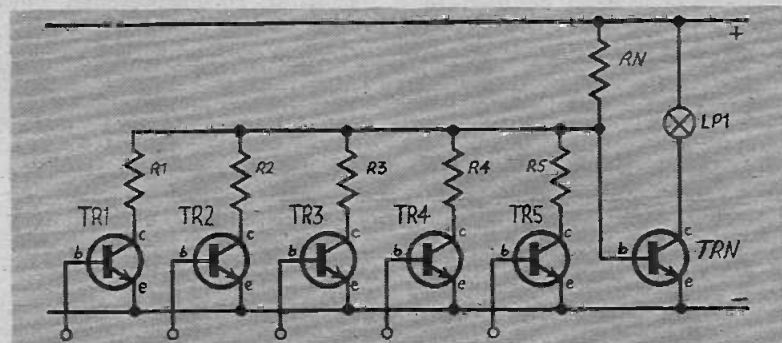
Fig. 6 (below). A number of transistors TR1 to 5 may conduct before TRN is cut off.

have a larger effect than others—a bigger say in the voting, if you like to compare it with your school political studies, Bob!”

The Prof. now came to Fig. 7.

“Here is another way in which the chain of transistors may be branched. One transistor TRN controls several transistors TR1, 2, 3, etc., or, if you like, it may merely contribute to their control as is shown here. (Fig. 8.)

“It is quite easy to apply this to your poll indicator circuit. In many practical democratic systems some party has the power of veto, and we can incorporate this into the poll indicator. Here is a circuit which will do this (Fig. 9). Transistor TR5 (Fig. 1) can be disabled either by TR4 or by TR10 which will overcome a majority vote when the ‘veto’ switch is closed. However, by adjusting



VR2, the ‘veto’ can be defeated by an even larger majority. VR2 adjusts the size of the majority which will defeat the veto, so that if the veto is not exercised a simple majority would be sufficient to pass the motion being debated, but if the veto is being exercised, the majority necessary to pass may need to be, say 80 per cent, 90 per cent or whatever

figure is selected.”

“I see,” said Bob, “VR2 controls the bias current to TR9, and in order to defeat a veto, the majority must be sufficiently high to enable TR9 to conduct, thereby disabling TR10 and defeating the veto.”

The Prof. agreed. “The poll indicator is a good illustration of an electronic circuit which can respond in a programmed way to the demands of input signals and controls which may be either analogue or digital in nature. Although you have pointed out that basically the circuit is very simple, this type of circuit may be made to perform very complicated functions by branching and extending the chain to whatever extent is required.”

“By replacing some of the lamps with other devices such as

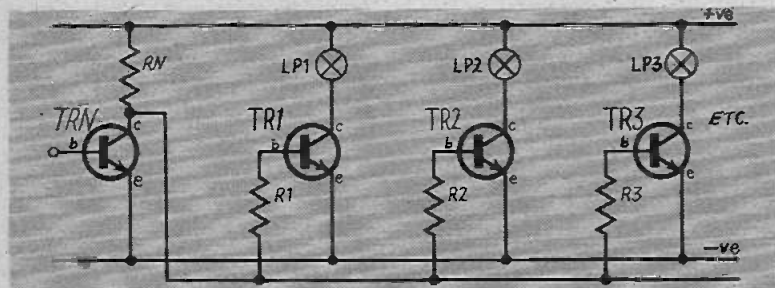
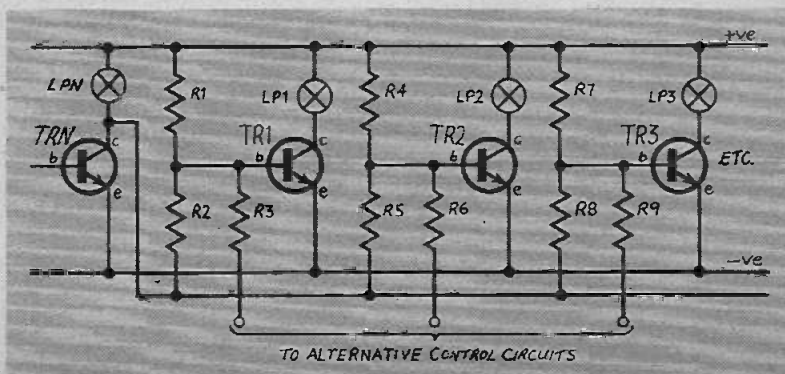


Fig. 7 (above). TRN controls several other transistors, each of which may be part of another complex.

Fig. 8 (right). TRN partially controls the other transistors.



d.c. motors, relays, transformers, oscillators and so on, and taking the precautions which you mentioned earlier," queried Bob, "could not this circuit be used in an even more practical and versatile way, for controlling battery-operated or low voltage power devices directly, and maybe for control of high-powered or mains-operated devices by way of relays?"

Once again the Prof. agreed, but he warned: "In some circumstances it may become necessary to take precautions against

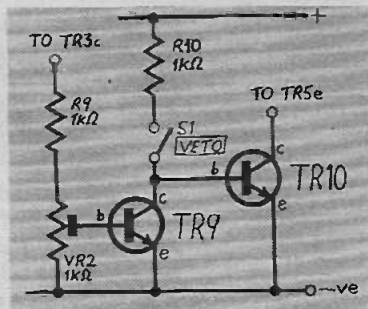
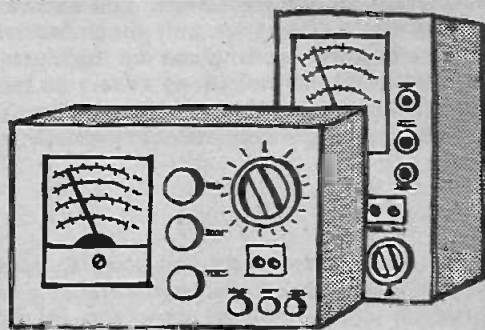


Fig. 9. A veto circuit for the poll indicator.

instability. For instance, this would apply where the circuit is built up to an extent where a lantern battery might be insufficient to power it, and an accumulator or a stabilised power-supply might be needed. It may also be necessary to decouple the most sensitive parts of the circuit using capacitors to prevent unwanted oscillation, or pickup of interfering signals. Where the transistors are switching rather than acting as class A amplifiers, these problems are less likely to occur."

# Component Checking with a MULTIMETER



THE resistance ranges of a multimeter can be used to check components other than resistors; in this article we show how you can do this.

You must remember that there is a battery inside your meter which comes into play when you switch to the resistance ranges. The polarity of this battery is such that its positive terminal is effectively applied to the black lead which comes out of the meter.

The simple rule is that "positive comes out of the black lead"!

## DIODES

To check a diode you should switch to a low resistance range, set zero and connect the black lead to the anode of the diode (i.e. the end without the identifying mark) the red lead should go the cathode (or banded) end of the diode. When connected this way round the diode should be forward biased and current should flow.

This will be indicated on the meter and you should see a resistance of a few hundred ohms. Power rectifiers will show a lower resistance than small signal diodes.

Next proceed to check the reverse characteristics of the diode by reversing the leads connected to it and switch to a higher resistance range. A good silicon diode should indicate almost infinite resistance (certainly greater than a couple of megohms) but germanium diodes might show something in the order of 1 megohm. If lower resist-

ance values are obtained the diode is suspect.

If you want to check a resistor or a diode that is in a circuit you **must** disconnect one end of the component before carrying out these tests otherwise the shunting effect of other circuit components can modify your results.

## TRANSISTORS

To carry out a rudimentary test on transistors the device **must** be taken out of the circuit. For *npn* transistors connect the **black** meter lead (that from which positive comes) to the base and the red lead firstly to the emitter and then to the collector. If the meter is set to a low resistance range you should read a low resistance (again about 100 ohms—as for the diode) for each test.

Now put the red lead on the base and switch to a medium resistance range; put the black lead on the emitter and collector and you should, for silicon transistors, see almost infinite resistance for both measurements. If you see a low resistance when connected to the emitter drop the range to a lower value as the internal battery voltage of the meter might be exceeding the reverse breakdown of the base/emitter junction.

Germanium transistors will show between 100 kilohm and 1 megohm. The preceding tests check that the base/emitter and base/collector junctions are satisfactory. Finally check for collector/emitter leakage by connecting the meter leads across the

collector and emitter while the meter is switched to a high resistance range. With either polarity of connection you should see almost infinite resistance for silicon transistors and over 100 kilohm for germanium devices.

When you have the black lead connected to the collector you can make a quick check that the device has current gain by gently resting your finger between the base and collector terminals. The small current flowing through your finger will cause base current to flow and the transistor will start to conduct between collector and emitter—shown by the needle of the meter rising to give a lower resistance value.

When carrying out the above tests make quite sure that you have the correct lead polarities and remember that all the forgoing related to tests on *npn* devices. All the polarities should be reversed when working on *pnp* transistors. You should also remember that the tests are only rough indications that the transistor is working and not too much faith should be put on the indications of reverse leakage across the junctions—power transistors might show considerable leakage and still be perfectly satisfactory.

## CAPACITORS

There are not many tests that you can apply to capacitors with a simple multimeter and it is out of the question to think you can get a value for capacitance without a considerably more complex set up—or a reactance bridge. Sometimes (admittedly rarely) low value capacitors have been known to go short circuit. This can be easily checked by using the meter as a continuity tester.

A good polycarbonate capacitor (the same goes for paper, silver mica or polystyrene) should show infinite resistance. Any hint of a reading on the meter—even when set to its highest resistance range—means that the capacitor is faulty.

With capacitors having values of  $0.1\mu\text{F}$  and greater you will see a very brief "kick" on the needle as you apply the connections. This is the initial current surge as the capacitor charges up. For  $0.1\mu\text{F}$  the surge does not last very long but is sufficient to give a glimpse of a kick if you watch the needle closely.

Higher value capacitors will show larger kicks and from about  $10\mu\text{F}$  upwards to might see the needle momentarily go right up to zero ohms and then fall back towards infinity as the charge reaches maximum and no further current flows into the device under test.

You can use this to give a rough indication of the charge holding characteristics of the capacitor. Once charged up like this you should be able to remove the test leads and reconnect after a few seconds to a minute and you should **not** see a further kick on the needle. This indicates that the previous charge has been stored without internal leakage.

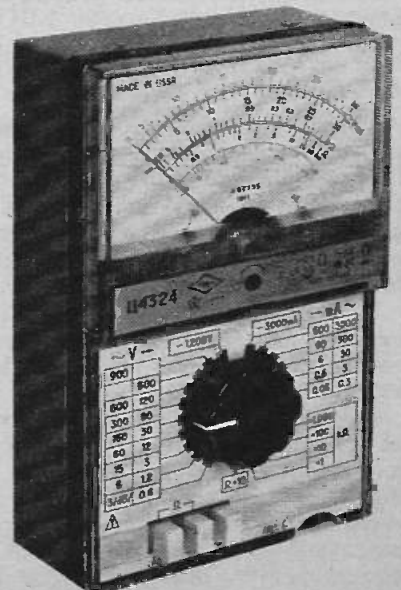
If you do this test you must, of course, not hold both wires of the capacitor while waiting between measurements because it will discharge through your body!

Polarity of leads for these measurements is unimportant except in the case of electrolytic capacitors. You must always connect the black lead to the positive terminal of these devices. High value electrolytics (greater than  $100\mu\text{F}$ ) will take several seconds to reach maximum charge but even when this is arrived at do not expect to see infinite resistance because electrolytics are always prone to a certain amount of leakage.

If, however, the resistance reading does not rise above 500 kilohm even after a minute of charging (longer for very high value devices) then the capacitor is immediately suspect and would be quite likely to go short circuit when higher voltages are applied. □



Left the TMK model TP5SN 20,000  $\Omega/\text{V}$  meter and right a Russian meter having a similar sensitivity. Both these meters are suitable for use with our projects and for the checks described above.





**I**n the ten years since *Mr. Cap*, the first drilling rig to put its feet down on the floor of the North Sea, spudded in, as the oilmen call it, in 85 feet of water off the Dogger Bank in December, 1964, a complex and highly sophisticated communications network has been evolved to meet the urgent and specialised needs of the many other rigs and platforms that have followed in *Mr. Cap's* seabed footsteps. Moreover, the offshore industry has found many other ways in which it can be served by modern electronics.



So far as their radio communications equipment is concerned offshore rigs are classified by the Post Office as ships, and when *Mr. Cap* moved into the North Sea it was fitted with a couple of ordinary radiotelephone installations operating in the medium frequency band between 1.6 and 3.8MHz to provide contact with its supply ship *East Tide* and the base station of the servicing helicopters.

In effect, the rig became just another compulsorily fitted coastal vessel, even if stationary, adding its relatively small quota of radio traffic to the babel already congesting the air in what is one of the busiest shipping areas in the world.

### **INADEQUATE**

In those early days perhaps that was thought to be enough in the way of communications facilities and no doubt there were some who thought, or even hoped, that *Mr. Cap* would soon be disappointed, pull up its feet, and go away, leaving the North Sea to normal shipping again. But this was only the beginning, as we now know.

Since then the number of rigs has grown dramatically and they have marched farther North and farther out from the shore. By the beginning of this year the number of rigs busily drilling in the British sector of the North Sea and in the Celtic Sea had mounted to 30, while a relatively easy winter has made possible the completion of the module assembly work on *Graythorp 1*, the first of four mammoth production platforms being established in the Forties Field 200 miles east of Aberdeen, and a start on the piling-in to the seabed of *Highland 1*, the second of these platforms now in position.

Still others are going into the Ekofisk complex for Phillips Petroleum and into the Frigg Field for Total Oil.

The modest facilities originally provided for *Mr. Cap* soon proved inadequate for its communication needs. Besides, Post Office coast stations working radiotelephone traffic off the East Coast were already at full stretch—this was before single sideband became mandatory for maritime working—and as other rigs stepped into the North Sea it seemed that radio chaos might soon threaten in the 1.6 to 3.8MHz band in which the calling frequency, 2182kHz, is also that used for distress.

# **ELECTRONICS OFFSHORE**

By **BILL MACONACHIE**

As the number of rigs at work became plural it was soon evident that mere access to the public correspondence radiotelephone channels via the Post Office coast stations was not only insufficient, it was unacceptable to the oilmen for privacy reasons.

## SECURITY

When you talk to these people about their communications links, person-to-person communication tends to dry up and you get the kind of look you might expect if you walked into the Pentagon and asked the time in Russian. This security-mindedness is understandable enough, for this modern-day Klondike, with its prospectors in duffel coats and anoraks, is a highly-competitive big-money business, and when a rig wants to let its shore base know how things are going it naturally doesn't want to inform its competitors as well. Even an apparently harmless request for another few hundred feet of drill casing to be sent out could tip them off that deeper drilling was worth while.

What each rig wanted, therefore, was round-the-clock use of its own exclusive channel for high-speed telegraphy and teleprinter working over and above pretty well unrestricted access to the public correspondence R/T (radio telephone) channels to link into the ordinary shore telephone system. And since the most suitable frequencies for providing such facilities lie in the band between 2 and 4MHz, already very heavily loaded by traffic with coastwise shipping and fishing vessels, the problem facing the Post Office was one of somehow fitting the substantial demands of the offshore rigs and their increasing fleets of supply ships into an already overcrowded radio traffic pattern.

As an example, Wick radio station now handles something like 25,000 public correspondence R/T calls a year. Nearly half of them are rig traffic and an oil rig call lasts on average ten minutes, about twice the duration of the normal ship call.

## SPECIAL CENTRES

Whatever we may say when a letter we are expecting is a bit late in dropping through the letterbox, this was a problem the Post Office's marine wireless telegraphy people met with commendable expertise and speed. The coast stations of Humber, near Hull; Cullercoats, not far from Newcastle; and Stonehaven on the Kincardineshire coast of Scotland were nominated as special centres for offshore communications and six months after Mr. Cap had spudded-in new transmission and reception facilities had been installed and put into operation at all three stations.

These made extra radiotelephone channels, exclusive to the offshore traffic though not to

individual rigs, available at Humber and Cullercoats, using suppressed carrier and independent sideband equipment enabling each station to conduct speech communication with several rigs simultaneously. Humber used the lower sideband and Cullercoats both the upper and lower.

The relatively broad bandwidth required for speech communication, however, rendered it impracticable to provide completely exclusive circuits for more than four rigs and for the sake of impartiality it therefore became necessary to ask all rigs to share the same radiotelephone channels for their calls into the shore telephone service through terminal equipment linked with the coast stations' radio installations.

It was, however, technically feasible for each rig to be allotted its own individual voice frequency channel with an extremely narrow bandwidth using equipment with a very high degree of frequency stability in accordance with Post Office specifications specially laid down for rig installations.

Exclusive use of a teleprinter and high speed telegraphy circuit is thus provided, the former being worked in the upper sideband and the latter in the lower or vice versa. Using i.s.b. (independent sideband) equipment, these facilities are available through Humber and Stonehaven and now the newer station established at Norwick on the island of Unst in the Shetlands, and remotely controlled from Wick which is also the control point for two v.h.f. links, one local and the other at Lerwick.

## AUTOSPEC

It was fortunate as well as fortuitous that back in 1965 the Marconi company had just developed its "Autospec" high speed automatic error correcting equipment for single path teleprinter transmission, and this device, with its capacity for handling a heavy volume of traffic with remarkably high accuracy and speed, was

The 30ft dish aerials of the tropospheric scatter link terminal at Brimmond Hill, near Aberdeen, beamed on the B.P. platforms in the Forties Field.





Marconi Marine's prefabricated oil rig radio station is built into a pressurised sealed cabin with air-conditioning, automatic gas-detection and fire-prevention systems, and explosion-proof lighting. Entry is through a gas-sensing air-lock. The cabin is placed complete aboard the rig and has only to be connected up to be in operation.

immediately specified by the Post Office for incorporation in all oil rig teleprinter installations in the British sector of the North Sea, under specification W6652.

A more up-to-date version of this equipment, "Autospec II," embodies the most modern techniques and circuitry and is now in use, and a somewhat simpler but similar system known as "Spector" has since been introduced and, though primarily designed for ship installation, has been fitted on a number of rigs with Post Office approval.

Teleprinter messages are processed on to punched tape which keys the transmitters at speeds much higher than human fingers could ever accomplish, and on most rigs it is the usual practice to have the installations fully duplicated. In this way one transmitter and its associated receiver can be working the teleprinter circuit while the other pair operate on voice frequency telegraphy. Besides serving as an insurance against communication loss in case of a breakdown, duplication allows each transmitter/receiver combination to have a "rest period" by changing over their respective duties each day. This gives each of them every second night on teleprinter traffic which is generally much lighter when offices ashore are closed or manned only by a small "watchkeeping" staff.

### **CLOSE RANGE COMMUNICATION**

Between rigs and their supply ships and helicopters close range communication over distances of 40 to 50 miles is maintained by v.h.f. using f.m. for contact with the surface craft and a.m. to keep in touch with the helicopters while they are airborne. Again, a rig will be fitted with duplicated v.h.f. installations in both modes. Medium frequency R/T is used for con-

tact with the supply ships when they are beyond v.h.f. range, working on the normal maritime channels.

Besides all this equipment for external communications, rigs need efficient and comprehensive intercom. networks to carry orders and information from point to point, the usual installation comprising a master panel and outstations, generally of the talk-back loudspeaker type, at strategic locations. Key personnel may also carry u.h.f. pocket radios of the intrinsically-safe type as they move about the rig.

Crew amenities are catered for by "piped" entertainment from broadcast receivers, tape and record players, and t.v. receivers are generally provided in messrooms and recreation rooms. The latest addition to these off-duty amenities are teleplayers which reproduce a selection of programmes from video-tape libraries which are changed every month.

### **HOMING**

Although a rig is stationary once it is on site, navigational aids such as radar, direction-finders, and radiobeacons are fitted to help in homing in their supply ships in difficult weather conditions which are far from rare in the North Sea. Radar watch is also maintained to keep a look out for passing ships which may be steering too close for safety or in contravention of the Continental Shelf (protection of installations) regulation which prohibits the approach of unauthorised craft within 500 metres of specified rigs and platforms—a regulation which may be more rigidly enforced in view of recent anxieties about sabotage or even hi-jacking of rigs.

One rig has its undersea pipeline network engraved on its radar screen so that watch can be kept for vessels trawling or anchoring over the pipes, and Shell have been experimenting with a Racon on one of their rigs as a homing aid, though the Chamber of Shipping view this with some unease, feeling that widespread use of radar responders by rigs close to one another could clutter up the screens of passing ships with too many echos.

Weather chart facsimile receivers, too, are widely used to reproduce the Met Office weather charts broadcast from Bracknell and give early warning of approaching bad weather.

### **RIG POSITIONING**

Positioning a rig over the right area of the seabed before exploratory drilling begins is an operation accomplished with the aid of electronics. Once the preliminary survey has indicated that drilling in a certain spot is likely to be worth while, the contours of the seabed and type of bottom are ascertained using echo sounders and side-scan sonar. The rig is then towed into approximately the correct location, ready for more accurate position fixing.



This can be achieved by a number of methods—Tellurometer's dynamic electronic measuring system which works in the 3GHz band to measure distances from fixed points; hyperbolic systems such as the Decca Hi-Fix; satellite navigation; or sonar systems like Marconi's "Sona-fix" or that developed by Kelvin Hughes.

In the latter system four dual-frequency sonar responders are placed on the seabed by divers. Three of these are used for the actual positioning while the fourth plays the part of a watchdog to see that none of the others moves from its position. All have the same receiving frequency and are triggered by a narrow beam on this frequency transmitted from the rig. When triggered, however, each responds on its individual transmitting frequency to avoid any possibility of triggering a response from the others.

Meantime, the rig's anchors have been laid out and by hauling in or slacking off on the anchor cables the rig is manoeuvred into its proper position by triangulation of the signals received from the responders.

Bringing a rig back to its undersea wellhead after bad weather or operational demands may have forced it to move away, demands even greater precision of manoeuvring, and Kelvin Hughes supply a special sonar system for this purpose. Again, the rig is brought into approximately the right position and its anchors are laid out.

Sonar transducers are then mounted on the end of the drill pipe which is then lowered until one of them, a side-scanning transducer, locates the abandoned wellhead on the seabed. The rig is then manoeuvred by means of its anchors until a second transducer with a specially narrow directional beam facing vertically downwards is brought into observation of the wellhead, indicating that the drill pipe is immediately above it. The drill pipe is then lowered, observed by an underwater t.v. camera, and divers make the reconnection.

## TROPOSPHERIC SCATTER

Once actual production begins, as it is hoped it will by this autumn through the BP platforms in the Forties Field, remote control and monitoring of operations sends the need for communications shooting up far beyond the capacity of normal rig installations. Marconi Communication Systems, Ltd., have been busy establishing a tropospheric scatter link to carry data and voice transmissions for telemetry and control from a station on Brimmond Hill, outside Aberdeen, to *Graythorp 1*, *Highland 1*, and the other two BP production platforms which are to join them later in the Forties Field. Operating in the extremely high 2.5GHz. band, the link provides 132 communications channels simultaneously, and the entire system is designed to operate

unattended under control by a base station at Dyce which is connected by microwave link to the Brimmond Hill terminal. Normal communications installations supplied by the Racal/Plessey consortium will be fitted on the platforms when they go into operation.

The Post Office is spending about £8 million on similar links which in the first instance will serve platforms in the Frigg and Beryl Fields, 120 miles east of the Shetlands, and the Piper Field 110 miles east of Aberdeen, through shore terminals at Scousburgh on South Shetland and at Mormond Hill near Peterhead respectively.

Although BP own and operate the shore terminal for their Forties Field as do Phillips Petroleum the terminal of their similar tropospheric scatter link to the Ekofisk complex, the Post Office will own and run the Scousburgh and Mormond Hill terminals and all future shore terminals of this kind in the U.K.

## SATELLITES

Yet further advances in rig and platform communications seem to be imminent. Two "Marisat" maritime communications satellites are to be put into geostationary orbit 23,000 miles above the Atlantic and Pacific areas.

Originally scheduled for launching "in early 1975", delays have been caused by trouble with the launcher rocket and although the first has not taken off as we go to press it is anticipated that both should be in orbit by the summer. Meanwhile, the Norwegian Telecommunications Directorate has announced that it is to set up what it believes will be the first ever satellite

The main operating console for the Redifon radio installation of the rig *Pentagone 84*. This contains a receiver used for teleprinter operation, an amplitude modulated v.h.f. transceiver, an R551C s.s.b. receiver with associated synthesiser and i.s.b. adaptors, a special control panel with testing facilities for teleprinter circuits and controls for the selection and "marrying" of various transmitters and receivers. Two line-linking units enabling radiotelephone outputs to be connected into the rig's internal telephone system, and a marine v.h.f. mounted on top of the console.



# Sinclair Scientific kit

**Britain's most original calculator – now in kit form**

The Sinclair Scientific is an amazing calculator.

It offers logs, trig, and true scientific notation over a 200-decade range – features normally found on calculators costing around £50 or more.

Yet even ready-built, it costs a mere £21.55 (including VAT)

And as a kit it costs under £15!

**Forget slide rules and four-figure tables**

On the Scientific, you can handle *directly* all three trig functions, their inverses,

$\log_{10}$ ,  $\text{antilog}_{10}$ , giving quick access to  $x^y$  (including square and other roots).

plus, of course, the four arithmetic functions and any calculation based on them.

In fact, virtually all complex scientific or mathematical calculations can be handled with ease.



**Now only  
£14.95  
(inc. VAT)**

**So is the Scientific difficult to assemble?**  
No. Powerful though it is, the Sinclair Scientific is a model of tidy engineering. All parts are supplied – all you need provide is a soldering iron and pair of cutters. Complete step-by-step instructions are provided, and our Service Department will back you throughout if you've any queries or problems.

Of course, we'll happily supply the Scientific or the Cambridge already built, if you prefer – they're still exceptional value. Use the order form.

#### Features of the Scientific

- 12 functions on a simple keyboard
- Scientific notation
- 200-decade range
- Reverse Polish logic
- 25-hour battery life
- Genuinely pocketable

#### Features of the Cambridge

- Only  $4\frac{1}{2}'' \times 2'' \times \frac{1}{16}''$ . Weight  $3\frac{1}{2}$  oz.
- Fully-floating decimal point.
- Algebraic logic.
- Constant on all four functions (+ - × ÷).
- Constant and algebraic logic combine to act as limited memory.
- Clear, bright 8-digit display.
- Operates for weeks on 4 AAA batteries.

# Sinclair Cambridge kit

At its new low price, the Sinclair Cambridge kit remains unbeatable value.

The Cambridge is now Britain's most popular pocket calculator. And it's not surprising. Check the features – then ask yourself what other calculator offers such a powerful package at such a reasonable price.

**Take advantage of this money-back no-risk offer today**

The Sinclair Cambridge and Scientific kits are fully guaranteed. Return either kit within 10 days, and we'll refund your money without question. All parts are tested and checked before despatch – and we guarantee any correctly-assembled calculator for a year. This guarantee also applies to calculators supplied in built form.

Simply fill in the preferential order form below and post it – today!

**Now only  
£9.95  
(inc. VAT)**



To: Sinclair Radionics Ltd. FREEPOST, St Ives, Huntingdon, Cambs., PE17 4BR.

Please send me

- Scientific kit – £14.95 inc. VAT  
 Scientific built – £21.55 inc. VAT  
 Cambridge kit – £9.95 inc. VAT  
 Cambridge built – £13.99 inc. VAT

\*I enclose a cheque for ..... made out to Sinclair Radionics Ltd, crossed.  
 \*Please debit my \*Access/Barclaycard account number: .....

☞ Delete as required

Signed \_\_\_\_\_

Name \_\_\_\_\_

Address \_\_\_\_\_

Please print. FREEPOST – no stamp required.

EE/7/75

Sinclair Radionics Ltd.  
 London Road, St Ives, Huntingdon, Cambs., PE17 4JH. Tel: St Ives (0480) 64646  
 Reg. no: 699483 England. VAT Reg. no: 213817028

**sinclair**

# MINI BLOWTORCH with the maxi uses

Just what the keen "Do it Yourself" enthusiast has been waiting for - a precision blow torch that puts the heat exactly where it's needed with a pencil point flame.

Invaluable for the amateur radio or electronic engineer, model maker etc. Easy to hold - easy to use - no tool kit is complete without one.

\*PIN POINT FLAME UP TO 3500°F.  
\*LIGHTWEIGHT \*EASY AND SAFE TO USE  
\*4-5 HOURS LIFE \*BUTANE GAS \*REFILLS  
READILY AVAILABLE \*ADJUSTABLE HEAT  
INTENSITY

1. SPECIAL COOLING FINS
2. BRASS NOZZLE
3. PIN POINT FLAME
4. DETACHABLE SOLDER PENCIL



## Longs

Reg England 68496.  
Longs Ltd.  
Hanworth Lane  
Trading Estate,  
Chertsey,  
Surrey KT16 9LZ  
Tel: Chertsey 61241  
Telex: 929811

Fill in this coupon now and send for your Mini Blow Torch. Money back guarantee if not satisfied. Please send me ..... Mini Blow Torch/es at £6.25 each I enclose cheque/postal order for £.....

NAME \_\_\_\_\_ POSITION \_\_\_\_\_  
COMPANY \_\_\_\_\_  
ADDRESS \_\_\_\_\_  
SIGNED \_\_\_\_\_ EE



Part of the Redifon installation for *Pentagone 84*, showing (l to r) the emergency m.f. radio-telephone, the G543 i.s.b. transmitter and the G452 transmitter for teleprinter work on s.s.b. or i.s.b. The settee beyond these transmitters contains the 24 volt emergency batteries in a sealed gas-tight compartment.

communication system for offshore oil platforms. Receiving stations, equipped with installations ordered from the Japanese firm C. Itoh and Co., Ltd., are being established at Moi in southwest Norway and on platforms operated by Phillips, Elf and Mobil in the Norwegian sector of the North Sea.

The shore station at Moi will have a capacity of 120 speech channels, 60 data channels, 360 telex channels, and an unspecified number of additional control channels, and the Norwegians aim to have the complete system in operation by November this year.

In Britain, Redifon Telecommunications Ltd., will be putting their "Seacomm" compact shipborne satellite communications terminal through its test paces as soon as the "Marisat" satellites are in orbit and hope to have it on the market this summer.

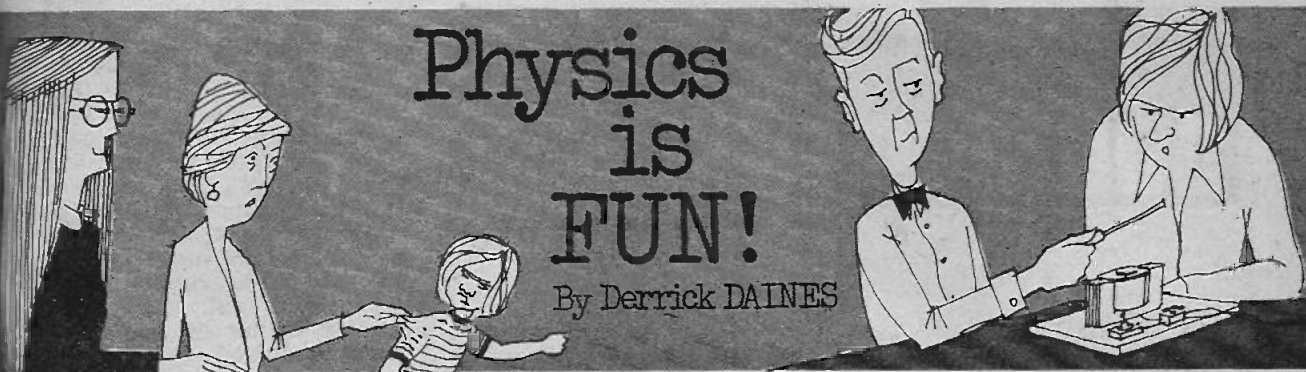
They claim that by the end of this year communication by satellite will be every bit as efficient as by tropospheric scatter while it will have the advantage that no costly shore terminals such as those on the Aberdeenshire coast and in the Shetlands will be necessary. It is an interesting claim, but one that obviously cannot be substantiated until the "Marisat" satellites are in orbit and the system has been proved, even though the Norwegians have already committed themselves to reliance on it.

Meanwhile, the race to start the oil flowing ashore goes on, and with exploration and production costs practically in orbit themselves the oilmen simply cannot afford to wait even a few months until a new system, however attractive, has been proved and put into full operation. □



# Physics is FUN!

By Derrick DAINES



## A DE-MAGNETISER

Since the series began, I have had some correspondence about the problem of de-magnetising small tools. A magnetic screwdriver can be very useful in some circumstances, but in others it is just a darned nuisance. What can one do about it?

Well, in a previous article I pointed out that one way of getting rid of magnetism is to heat the metal. Obviously, this is not good for tools since heating will remove the temper of the steel and a soft screwdriver is worse than a magnetic one.

I also illustrated a method of magnetising across the width of a tool. This is fine in theory, but not so easy in practice, as you may have found out if you tried it, so this month I thought that a de-magnetiser would make a welcome subject for discussion.

A word of warning is in order. Mains voltage is involved and so the young or inexperienced should not be allowed near. Misuse could be fatal.

The gadget is simply a heavy coil wrapped round a core, (see Fig. 1). An old mains transformer would be ideal, provided that it is of reasonable size (say 1 amp or above) and that the primary winding is sound. It is absolutely vital

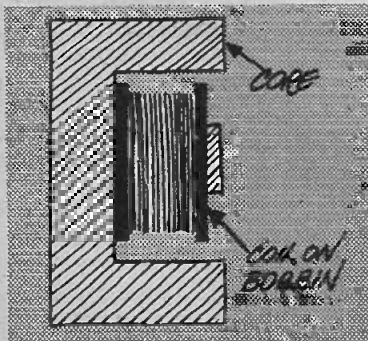


Fig. 1. Details of making your own coil, using transformer E's.

that all insulation is also above suspicion.

Most transformers are wound on "E" and "I" leaves fitted together so that they form a squared-off "8", with the coil round the centre bar. With care, the core can be dismantled a leaf at a time, discarding the "I" part and retaining the "E". Re-assemble the "E"s all the same way round, as per the illustration.

Now the secondary winding must be removed and the insulation and continuity of the primary winding carefully checked. Add a few turns of insulating tape for safety's sake.

If the reader is starting from scratch, he should wind about 600 grams of 16 gauge enamelled copper wire onto a thick card bobbin, making sure that the bobbin is a tight fit onto an "E" core. Now all that is needed is an on/off switch, a two-way 2A terminal block and you are ready to go, see Fig. 2.

The mains supply is switched on and the tool or other small object to be demagnetised is put into contact with the core. (Remember my strictures about

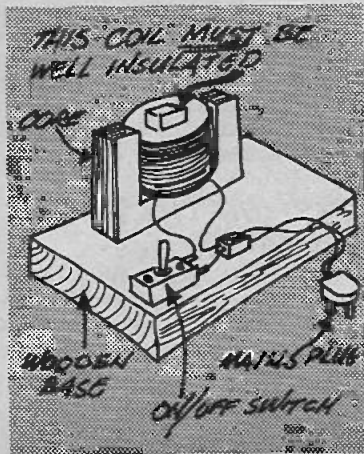


Fig. 2. The de-magnetiser built up.

adequate insulation?) Leave the unit switched on and slowly withdraw the tool until it is a foot or more away. Switch off. That is all there is to it—the tool will now be demagnetised.

How does it work? Well, the mains supply is an alternating current changing polarity 50 times every second. This induces in the core a magnetic field that is also changing polarity at the same rate. The molecules of iron are therefore jostled back and forth, constantly trying to change ends. As the tool is removed from the magnetic field, the effect is slowly reduced, leaving (as it were) the molecules glued into randomly-aligned positions.

Of course, the gadget will work with lower voltages, but the whole point is to have a powerful magnetic source.

Teachers and others who wish to make a unit for the unsupervised use of the inexperienced, may like to experiment with a step-down transformer in front of the coil to provide 100 volts and a resistor of about 10 ohms as a current limiter (see Fig. 3).

A fuse would also be advisable and a plastic box for the coil to prevent direct contact. Such a set-up would not be fatal in the event of misuse, but of course its power to demagnetise would be curtailed.

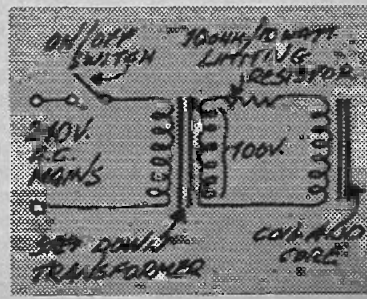


Fig. 3 Using a step-down transformer and limiting resistor.

# DOWN TO EARTH

By GEORGE HYLTON

You don't have to be a mathematical genius to understand electronics, but it helps. The problem for those of us who aren't—and I'm certainly not—is how to get by with the absolute minimum of maths.

One of our many teenage readers, Kevin Jones of Kettering, explains his problem like this: "I know a bit about components and the colour code for resistors. But what I want to know is how to work out the values of how many amperes to the watt, how many watts to the volt, how many ohms, etc?"

These are the kind of questions which face everybody at the beginning, so here goes.

## UNDERSTANDING

First, a word of encouragement. Certain pioneers in science and engineering got by without much mathematical knowledge. The classical example, I suppose, was Michael Faraday, whose inability to do maths didn't prevent him from discovering the principles of electromagnetism — discoveries which led in time to radio.

What Faraday had was a genius for *understanding*, an ability to visualise magnetic fields as invisible "lines of force", without size or weight, stretching out into space, and to see that you could, in principle, pluck them like harp strings and send vibrations running along them to infinity.

Of course, it needed the mathematical genius of Maxwell to quantify these ideas and work them up into a usable theory of fields and waves. But Faraday's imaginative understanding had to come first.

So what do you do if you have the imagination but not the maths, but want to make practical working circuits? First, get to *understand*. Then steal the maths from the mathematicians, but in a simplified and painless form, such as a graph, which does the calculations for you.

## RELATIONSHIP

The things our reader wants to work out are the relationships between voltage, current, resistance and power. As it happens, they lend themselves to a simple pictorial representation which is a great help to the beginner. But first a flashback.

Georg Simon Ohm was a German scientist anxious to make his mark on the world of learning. This was in the early days when people were still puzzling over whether the kind of electricity you got by rubbing a glass rod with cat's fur was the same as you got by immersing bits of two different metals in a salt solution, and suchlike problems.

Researchers thought of electricity as some invisible liquid, "the electric fluid", which could flow over insulating surfaces or along conductors. Ohm was interested in the conductors. If electricity was a fluid, did a conductor behave like a water pipe? If so, the fatter the conductor the more easily should the current of electric fluid flow. A short conductor should let it flow more easily than a long one. Water flows through a pipe under pressure. The greater the pressure, the faster the flow.

In an electric circuit, the pressure is the electromotive force, the voltage of the battery or generator. If the water-pipe "model" was right, then the flow of electric current should increase if you increased the voltage.

## TESTING THE THEORIES

So Georg Simon Ohm, armed with only the crudest of instruments (no multimeters in those days!) set to work to test his

theories. At first, it seemed he was wrong. The current did increase as the voltage was increased but not in proportion. Then Ohm found out that his batteries were unreliable and his theory right.

The amount of current which flowed through a piece of wire of a certain length depended exactly on the voltage. Double the voltage, double the current. But it depended on the wire, too. Halve the length, and the current doubled. Double the length and the current halved—so long as the battery voltage didn't change.

Current ( $I$ ), voltage ( $E$ ), and resistance ( $R$ ) in a complete working circuit are interdependent quantities. If you know any two you can work out the third. This means that Ohm's Law is really three laws in one:

$$I = E/R, R = E/I, E = I.R.$$

## GOLDEN TRIANGLES

It's rather tedious to memorise this lot, so electrical students use a simple aid to memory. Write the last of the three "laws" in the form of a triangle, with  $E$  at the top and  $I.R$  underneath.

This is the first of our golden triangles. If you cover up whichever quantity you want to know ( $E$ ,  $I$ , or  $R$ ), the exposed part reminds you of its relationship to the other two. So if you cover up  $E$  you are left with  $I.R.$ , showing that  $E = I \times R$ .

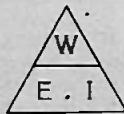
For the other two relationships, the dividing line across the triangle reminds you that they involve fractions. If you cover up  $I$  you are left with  $E/R$ , showing that  $I = E/R$ . Cover  $R$ , and you have  $E/I$ .

The golden triangle idea can be adapted to any three quantities which are related to one another in the same sort of way as  $I$ ,  $E$  and  $R$ . This brings us to the second triangle, which shows the three connections between, current, voltage, and wattage.

Using 1 and 2, you can work out all the things which Kevin wants to work out. However, for power calculations there are also short cuts, using squared voltages or currents, and these are shown in triangles 3 and 4.



①



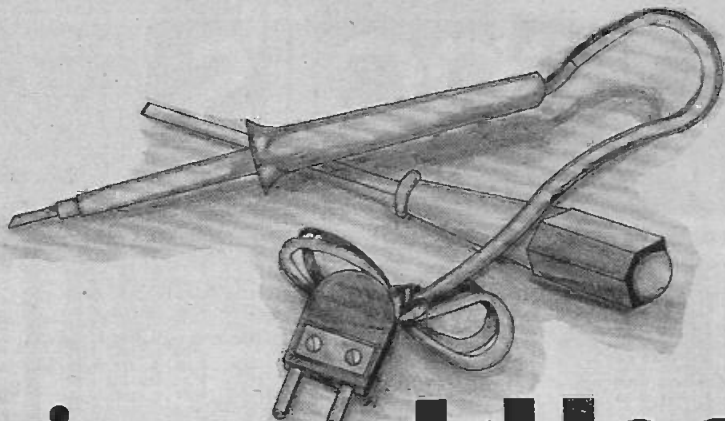
②



③



④



# This could lead to something big.

A soldering iron and a screw driver. If you know how to use them, or at least know one end from the other, you know enough to enrol in our unique home electronics course.

This new style course will enable anyone to have a real understanding of electronics by a modern, practical and visual method. No previous knowledge is required, no maths, and an absolute minimum of theory.

You build, see and learn as, step by step, we take you through all the fundamentals of electronics and show you

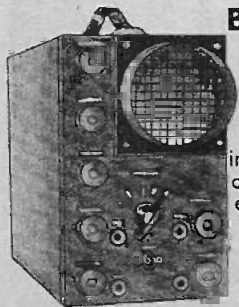
how easily the subject can be mastered and add a new dimension not only to your hobby but also to your earning capacity.

This course is accepted by and used in a large number of schools and colleges and forms an invaluable grounding for professional training in the subject. All the training is planned to be carried out in the comfort of your own home and work in your own time. You send them in when you are ready and not before. These culminate in a final test and a certificate of success.

**1**

## Build an oscilloscope.

As the first stage of your training, you actually build your own Cathode ray oscilloscope! This is no toy, but a professional test instrument that you will need not only for the course's practical experiments, but also later if you decide to develop your knowledge and enter the profession. It remains your property and represents a very large saving over buying a similar piece of essential equipment.



**2**

## Read, draw and understand circuit diagrams.

In a short time you will be able to read and draw circuit diagrams, understand the very fundamentals of television, radio, computers and countless other electronic devices and their servicing procedures.



**3**

## Carry out over 40 experiments on basic circuits.

We show you how to conduct experiments on a wide variety of different circuits and turn the information gained into a working knowledge of testing, servicing and maintaining all types of electronic equipment, radio, t.v. etc.



**PLUS**



## FREE GIFT!

ALL STUDENTS ENROLLING IN OUR COURSES RECEIVE A FREE CIRCUIT BOARD ORIGINATING FROM A COMPUTER AND CONTAINING MANY DIFFERENT COMPONENTS THAT CAN BE USED IN EXPERIMENTS AND PROVIDE AN EXCELLENT EXAMPLE OF CURRENT ELECTRONIC PRACTICE

To find out more about how to learn electronics in a new, exciting and absorbing way, just clip the coupon for a free colour brochure and full details of enrolment.

WAA

Brochure without obligation to:  
**BRITISH NATIONAL RADIO & ELECTRONICS SCHOOL, Dept EEL75**  
**P.O. Box 156, Jersey, Channel Islands.**

NAME.....

ADDRESS.....

(Block caps please)



# Marshall's

A. Marshall (London) Ltd. Dept. EE  
 42 Cricklewood Broadway London NW2 3HD Telephone 01-452 0161/2 Telex 21492  
 & 55 West Regent Street Glasgow G2 2DD Telephone 041-332 4133

Everything you need is in our  
**New 1975 Catalogue**  
 available now price 25p  
 (100 pages of prices and data)

Call in and see us 9-5.30 Mon-Fri  
 9-5.00 Sat  
 Trade and export enquiries welcome

## Top 500 Semiconductors from the largest range in the UK

2N456	0-80	2N2924	0-20	2N5195	1-46	AF117	0-35	BC214L	0-18	BF178	0-35	8D1L	0-38	OC72	0-23
2N457A	1-20	2N2926	0-20	2N5245	0-47	AF118	0-35	BC237	0-16	BF179	0-43	14D1L	0-40	OC81	0-25
2N490	3-16	2N3054	0-60	2N5294	0-48	AF124	0-30	BC238	0-15	BF180	0-38	M7110	0-47	OC83	0-24
2N491	4-38	2N3055	0-73	2N5296	0-48	AF125	0-30	BC239	0-15	BF181	0-36	LM3900	0-70	ORP12	0-33
2N492	5-00	2N3390	0-48	2N5298	0-50	AF127	0-28	BC253	0-25	BF182	0-33	LM723C	0-90	RS3	1-80
2N493	8-20	2N3391	0-25	2N5457	0-49	AF139	0-63	BC257	0-16	BF184	0-30	LM741T09	0-40	SL14A	1-80
2N696	0-42	2N3391A	0-25	2N5458	0-46	AF186	0-46	BC258	0-16	BF185	0-30	8D1L	0-40	SL610C	1-70
2N697	0-16	2N3417	0-29	2N5459	0-49	AF200	0-65	BC259	0-17	BF184	0-12	14D1L	0-38	SL612C	1-70
1N698	0-82	2N3392	0-13	2N5492	0-58	AF239	0-66	BC261	0-25	BF195	0-30	M747	1-00	SL620C	2-60
2N699	0-59	2N3393	0-15	2N5494	0-58	AF240	0-90	BC262	0-25	BF196	0-13	LM7488D1L	0-60	SL621C	2-60
2N706	0-14	2N3394	0-15	2N5496	0-61	AF279	0-70	BC263	0-25	BF197	0-15	LM7805	0-50	SL623	4-59
2N706A	0-16	2N3402	0-18	2N6027	0-45	AF280	0-79	BC300	0-38	BF198	0-18	LM7805	0-50	SL640C	3-10
2N708	0-17	2N3403	0-19	2N5777	0-45	AL102	1-00	BC301	0-34	BF200	0-40	14D1L	0-73	SL641C	3-10
2N709	0-42	2N3640	0-59	3N128	0-73	AL103	1-00	BC302	0-29	BF225	0-23	LM7805	0-50	SN76003N	2-92
2N711	0-50	2N3441	0-97	3N139	1-42	BC107	0-14	BC303	0-54	BF244	0-21	LM7812	2-50	SN76013N	1-95
2N718	0-23	2N3442	1-40	3N140	1-00	BC108	0-14	BC307	0-17	BF245	0-25	LM7824	2-50	SN76023N	1-60
2N718A	0-28	2N3414	0-10	3N141	0-81	BC109	0-14	BC308A	0-15	BF246	0-58	MC1303	1-50	SN76033N	1-60
2N720	0-57	2N3415	0-10	3N200	2-49	BC113	0-13	BC309C	0-20	BF247	0-65	MC1310	2-92		
2N914	0-99	2N3416	0-15	40361	0-40	BC115	0-17	BC327	0-27	BF254	0-19	MC1330P	0-90		
2N916	0-28	2N3417	0-21	40362	0-45	BC116	0-17	BC328	0-28	BF255	0-19				
2N918	0-32	2N3638	0-15	40363	0-88	BC116A	0-18	BC337	0-20	BF257	0-47				
2N929	0-37	2N3638A	0-15	40389	0-46	BC117	0-21	BC338	0-20	BF258	0-53				
2N930	0-22		0-15	40394	0-56	BC118	0-14	BCY30	0-80	BF259	0-53	MC1351P	0-80	ST2	2-92
2N1302	0-19	2N3639	0-27	40395	0-65	BC119	0-29	BCY31	0-85	BF259	0-24	MC1352P	0-24	TAA300	1-80
2N1303	0-19	2N3641	0-17	40406	0-44	BC121	0-35	BCY32	1-15	BF279	0-24	MC1466	3-50	TAA263	1-10
2N1304	0-26	2N3702	0-11	40407	0-45	BC125	0-16	BCY33	0-85	BF282	0-92	MC1469	2-75	TAA550	0-60
2N1305	0-24	2N3703	0-12	40408	0-50	BC126	0-23	BCY38	1-00	BF283	0-25	ME0402	0-20	TA611C	2-18
2N1306	0-31	2N3704	0-15	40409	0-52	BC132	0-30	BCY38	1-00	BF284	0-25	ME0404	0-13	TAA621	2-03
2N1307	0-30	2N3705	0-15	40410	0-52	BC134	0-13	BCY39	1-50	BF285	0-25	ME4102	0-11	TAA661B	1-32
2N1308	0-47	2N3706	0-15	40411	2-25	BC135	0-13	BCY40	0-97	BF286	0-28	ME4104	0-11	TBA41B	1-25
2N1309	0-47	2N3707	0-18	40594	0-74	BC136	0-17	BCY42	0-28	BF287	0-30	MJ480	0-95	TBA651	1-25
2N1671	1-54	2N3709	0-13	40595	0-67	BC137	0-17	BCY42	0-28	BF288	0-25	MJ490	1-05	TBA810	1-50
2N1671A	1-67	2N3709	0-13	40596	0-67	BC138	0-24	BCY58	0-30	BF289	0-25	MJ491	1-45	TBA820	1-15
		2N3710	0-15	40602	0-61	BC140	0-68	BCY59	0-32	BF290	0-28	MJ2955	1-00	TBA920	4-00
2N1671B1	85	2N3711	0-15	40603	0-58	BC141	0-68	BCY70	0-17	BF291	0-30	MJE340	0-48	TIL209	0-30
2N1711	0-45	2N3712	1-20	40604	0-56	BC142	0-23	BCY71	0-29	BF292	0-30	MJE370	0-65	TIP29A	2-70
2N1907	3-50	2N3713	1-20	40636	1-10	BC143	0-25	BD115	0-75	BF293	0-23	MJE371	0-75	TIP31A	0-58
2N2102	0-60	2N3714	0-20	40637	0-86	BC145	0-21	BD116	0-75	BF294	0-23	MJE372	0-60	TIP32A	0-62
2N2147	0-78	2N3715	1-50	40673	0-73	BC147	0-14	BD121	1-00	BF295	0-21	MJE373	0-60	TIP33A	0-74
2N2148	0-94	2N3716	1-80	AC126	0-20	BC148	0-14	BD122	0-82	BF296	0-18	MJE374	0-60	TIP35A	1-90
2N2160	0-90	2N3717	2-20	AC127	0-20	BC149	0-15	BD123	0-82	BF297	0-18	MJE375	0-60	TIP36A	2-70
2N2218A	0-22	2N3772	1-80	AC128	0-20	BC153	0-18	BD131	0-40	BF298	0-18	MJE376	0-60	TIP38A	0-58
		2N3773	2-65	AC151V	0-27	BC154	0-18	BD132	0-50	BF299	0-21	MJE521	1-70	TIP32A	0-74
2N2219	0-24	2N3774	1-15	AC152V	0-27	BC157	0-16	BD135	0-43	BF300	0-29	MJE2955	1-00	TIP33A	1-01
2N2220	0-26	2N3790	0-40	AC153	0-35	BC158	0-16	BD136	0-49	BF301	0-24	MB1055	0-75	TIP34A	1-50
2N2221	0-18	2N3791	2-35	AC153K	0-40	BC158	0-16	BD137	0-53	BF302	0-25	MB1111	0-32	TIP35A	2-90
2N2222	0-21	2N3792	0-60	AC154	0-25	BC167B	0-15	BD138	0-63	BF303	0-25	MB1112	0-40	TIP36A	2-70
2N2223	0-31	2N3794	0-10	AC176	0-30	BC168B	0-15	BD140	0-87	BF304	0-63	MB1113	0-47	TIP41A	0-79
2N2224	0-20	2N3819	0-37	AC176K	0-40	BC168C	0-15	BD140	0-87	BF305	0-18	MPF102	0-30	TIP42A	0-90
2N2225	0-20	2N3820	0-38	AC187K	0-35	BC169B	0-15	BD529	0-80	BF306	0-18	MPSA05	0-25	TIP29C	0-80
2N2226	0-25	2N3904	0-27	AC182	0-40	BC169C	0-15	BD530	0-80	BF307	0-18	MPSA06	0-31	TIP30C	0-85
2N2368	0-25	2N3906	0-27	AC191V	0-27	BC170	0-15	BF39	0-24	BF308	0-24	MPSA12	0-35	TIP31E	1-00
2N2369	0-20	2N4037	0-42	AC192	0-22	BC171	0-16	BF39	0-24	BF309	0-79	MPSA25	0-26	TIP32E	1-25
2N2369A	0-22	2N4038	0-42	AC193	0-26	BC172	0-17	BDY20	1-05	BF310	0-05	MPSA56	0-31	TIP33E	1-45
2N2369B	0-22	2N4039	0-19	AC194	0-26	BC173	0-18	BF115	0-58	BF311	0-05	MPSU05	0-58	TIP34C	1-40
2N2647	0-98	2N4050	0-15	AD142	0-57	BC178	0-28	BF117	0-58	BF312	0-33	MPSU06	0-58	TIP41C	1-45
2N2904	0-22	2N4061	0-15	AD143	0-68	BC182	0-12	BF123	0-35	BF313	0-35	MPSU56	0-63	TIP42C	1-60
2N2904A	0-24	2N4062	0-15	AD149V	1-13	BC182L	0-12	BF125	0-35	BF314	0-35	MPSU56	0-80	TIP49	0-70
2N2905	0-25	2N4126	0-21	AD150	1-13	BC183	0-12	BF152	0-23	BF315	0-42	NE555V	0-70	TIP53	0-58
2N2905A	0-26	2N4210	0-10	AD161	1-15	BC183L	0-12	BF153	0-23	BF316	0-42	NE556	1-30	TIP2955	0-93
2N2906	0-19	2N4920	0-10	AD167	1-15	BC184	0-13	BF154	0-16	BF317	0-42	NE557	4-48	TIP3055	0-50
2N2906A	0-21	2N4921	0-83	AD162	1-05	BC184L	0-13	BF159	0-27	BF318	0-42	NE558	4-48	TIP325	0-13
2N2907	0-22	2N4922	1-00	AF106	0-40	BC186	0-25	BF160	0-23	BF319	0-42	NE559A	4-48	ZTX300	0-13
2N2907A	0-24	2N4923	1-00	AF109A	0-40	BC187	0-27	BF163	0-32	BF320	0-42	NE560	4-48	ZTX301	0-13
2N2908	0-19	2N5190	0-92	AF114	0-35	BC208	0-12	BF166	0-40	BF321	0-42	OC23	1-35	ZTX302	0-13
2N2909	0-22	2N5192	1-24	AF116	0-35	BC212K	0-16	BF173	0-27	BF322	0-42	OC28	0-76	ZTX500	0-15
				AF119	0-35	BC212L	0-16	BF177	0-29	BF323	0-42	OC35	0-60	ZTX501	0-13
										BF324	0-42	OC42	0-50	ZTX502	0-18
										BF325	0-42	OC45	0-32	ZTX502	0-18
										BF326	0-42	OC71	0-17	ZTX530	0-23

**PW TELE TENNIS KIT**  
 As featured on BBC Nationwide and in the Daily Mail 2 Oct '74. Ideal game for whole family. No need to modify your TV set, just plug in to aerial socket.  
 Parts list as follows: A Resistor Pack £1-00 p & p 20p; B Potentiometer Pack £1-25 p & p 20p; C Capacitor Pack £3-10 p & p 20p; D Semiconductor Pack £14-50 p & p 20p; E IC Sockets £4-00 p & p 20p; F Transformer £1-15 p & p 25p; G PCB's £7-50 p & p 20p; H Switches £4-50 p & p 20p; I UHF Modular Kit £7-50 p & p 20p.

Special Prices—complete kit excluding case £42-00 p & p 50p. Sections A-F incl. £23-50 p & p 30p. Assembly instructions with complete kit or 75p on request.

**P.C. Marker Pan Dolo 33PC 0-87p**  
 Zeners 400MW 16p; 1W-17p  
 IC Sockets 8D1L 16p; 14D1L 17p; 16D1L 20p.  
 Resistors 1w-2p; 1w-3p; 1w-9p; 5w-10p; 10w-12p.  
**Scorpio Car Ignition Kit-£11-50**  
 + VAT  
 1IMF440V £1-10. Transformer-BST80246-£1-20; £3-00.  
**OPTO & LED'S**  
 Red, green and yellow  
 0-16 diameter, 31p  
 0-20 diameter, 33p  
 DL707 £2-35 or 4 for £8-00  
 Mintron £1-55

**Cmos Circuits—CD Range**

4000	0-36	4016	0-66	4030	0-87
4001	0-36	4017	1-72	4031	5-19
4002	0-36	4018	2-88	4032	9-31
4006	1-58	4019	0-86	4041	1-86
4007	0-36	4020	1-91	4042	1-88
4008	1-63	4021	1-72	4043	1-80
4009	1-18	4022	1-66	4044	1-80
4010	1-18	4023	0-36	4045	2-65
4011					



## "I MADE IT MYSELF"

Imagine the thrill you'll feel! Imagine how impressed people will be when they're hearing a programme on a modern radio you made yourself.

# Now! Learn the secrets of radio and electronics by building your own modern transistor radio!

Practical lessons teach you sooner than you would dream possible.

What a wonderful way to learn—and pave the way to a new, better-paid career! No dreary ploughing through page after page of dull facts and figures. With this fascinating Technatron Course, you learn by building!

You build a modern Transistor Radio... a Burglar Alarm. You learn Radio and Electronics by doing actual projects you enjoy—making things with your own hands that you'll be proud to own! No wonder it's so fast and easy to learn this way. Because learning becomes a hobby! And what a profitable hobby. Because opportunities in the field of Radio and Electronics are growing faster than they can find people to fill the jobs!

**No soldering – yet you learn faster than you ever dreamed possible.**

Yes! Faster than you can imagine, you pick up the technical know how you need. Specially prepared step-by-step lessons show you how to read circuits—assemble components—build things—experiment. You enjoy every minute of it! You get everything you need. Tools. Components. Even a versatile Multimeter that we teach you how to use. All included in the course. **AT NO EXTRA CHARGE!** And this is a course anyone can afford. (You can even pay for it by easy instalments).

**So fast, so easy, this personalised course will teach you even if you don't know a thing today!**

No matter how little you know now, no matter what your background or education, we'll teach you. Step by step, in simple easy-to-understand language, you pick up the secrets of radio and electronics.

You become a man who makes things, not just another of the millions, who don't understand. And you could pave the way to a great new career, to add to the thrill and pride you receive when you look at what you have achieved. Within weeks you could hold in your hand your own transistor radio. And after the course you can go on to acquire high-powered technical qualifications, because our famous courses go right up to City & Guilds levels.

**Send now for FREE 76 page book – see how easy it is – read what others say!**

Find out more now! This is the gateway to a thrilling new career, or a wonderful hobby you'll enjoy for years. Send the coupon now. There's no obligation.

**POST TODAY FOR FREE BOOK**

To: ALDERMASTON COLLEGE CEE 07  
DEPT. CEE 07  
READING RG7 4PF

Yes, I'd like to know more about your course. Please send me free details—plus your big, 76-page book that tells about all your courses.

NAME .....

ADDRESS .....

POSTCODE .....



**BIET**

HOME OF BRITISH INSTITUTE OF ENGINEERING TECHNOLOGY

# CRESCENT RADIO LTD.

11-15 & 17 MAYES ROAD, LONDON N22 6TL  
(also) 13 SOUTH MALL, EDMONTON, N.9

MAIL ORDER DEPT.  
11 MAYES ROAD, LONDON N22 6TL  
Phone 888 3206 & (EDM). 803 1685

## ABS PLASTIC BOXES

Handy boxes for construction projects. Moulded extrusion rails for P.C. or chassis panels. Fitted with 1mm front panels.  
1005—105mm x 73mm x 45mm—51p.  
1006—180mm x 74mm x 47mm—66p.  
1007—185mm x 124mm x 60mm—95p.  
1021—106mm x 74mm x 45mm—50p.  
(sloping front) Plus 8% VAT

## CLEAR PLASTIC PANEL METERS

Size 59mm x 46mm x 35mm these meters require a 38mm hole for mounting.

ME5 — 0 to 50 micro amp Full Scale  
ME7 — 0 to 100 micro amp .. ..  
ME8 — 0 to 500 micro amp .. ..  
ME9 — 0 to 1mA .. ..  
ME10 — 0 to 5mA .. ..  
ME11 — 0 to 10mA .. ..  
ME12 — 0 to 50mA .. ..  
ME13 — 0 to 100mA .. ..  
ME14 — 0 to 500mA .. ..  
ME15 — 0 to 1 amp .. ..  
ME16 — 0 to 50 volts .. ..  
ME17 — 0 to 300 volts A.C. Full Scale  
ME18 — "8" Meter  
ME19 — "VU" Meter

OUR PRICE £3.00  
Plus 8% VAT



## LOW VOLTAGE AMPLIFIER

5 transistor amplifier complete with volume control, is suitable for 9V d.c. and a.c. supplies. Will give about 1W at 8 ohm output. With high IMP input this amplifier will work as a record player, baby alarm, etc., amplifier. **£2.00**  
Plus 25% VAT



## LIGHT EMITTING DIODES

TL 209 (Red) with Clip 22p each  
TL 209 (Green) with Clip 38p each  
TL 209 (Yellow) with Clip 80p each  
Med 600 T092 Type .. 16p each  
Plus 8% VAT

## CLOCK CHIP

CT7001 MOS/LSI Digital Clock/Calendar Chip plus full Circuits and Information Leaflet .. .. £4.95  
Circuits and Information Sheet .. 15p  
L4704 Led Display for above £1.90  
Or 4 for £4.20  
Plus 8% VAT

## 3 KILOWATTS PSYCHEDELIC LIGHT CONTROL UNIT

Three Channel—Rear—Middle—Tribble. Each channel has its own sensitivity control. Just connect the input of this unit to the loudspeaker terminals of an amplifier, and connect three 250V up to 1000W lamps to the output terminals of the unit, and you produce a fascinating sound-light display. (All guaranteed.)  
**£18.50 plus 35p P. & P.**  
Plus 8% VAT

## POWER PACKS

PP1 Switched 3, 4, 6, 7, 9 and 12 volt @ 500 mA, with on/off switch and pilot light.  
Size—130 mm x 55 mm x 75 mm  
ONLY—£4.00  
PP2 Switched 6-7-9 volt Battery Eliminator. Approx size 2 1/2" x 3 1/2". Ideal for cassette recorders. £3.25 each.  
PP3 Car converter. From 12v Pos. or Neg to = 6-7-9 volt. Easy to fit and transistor regulated. £3.90 each.  
Plus 8% VAT

U.K. CARE. Send 35p for a 20p unless otherwise stated. **CRESCENT CATALOGUE**

## VEROBOARD

	-1	-15	Plain '16
2 1/2 x 3 1/2	25p	24p	15p
2 1/2 x 5	34p	34p	18p
3 1/2 x 3 1/2	34p	34p	..
3 1/2 x 5	39p	45p	..
17 x 2 1/2	1.05p	77p	80p
17 x 3 1/2	1.45p	1.16p	75p
17 x 5	1.85p	..	1.10p

Pin Insertion tool 85p, Spot face Cutter 45p, Pkt. 36 pins (static 1 or 15) 25p  
Plus 8% VAT

## 10 INCH DUAL CONE L/S

Manufactured by "ELAC" to a very high standard these loudspeakers are a real bargain.

Spec: Size—10" Dual Cone  
Power—10" Watts  
Frequency—40-12000Hz  
Our Price £3.75 Plus 25% VAT

## WIRE WOUND VARIABLE CONTROL

250 Ohm approx diameter—1 inch long Standard spindle only 25p each.  
Plus 25% VAT

## ALUMINIUM BOXES

Metal Project Boxes give your work a professional finish.

	L	W	H	Price
AB7	2 1/2	5 1/2	1 1/2	54p
AB8	4	4	1 1/2	69p
AB9	4	5 1/2	1 1/2	64p
AB10	4	5 1/2	1 1/2	83p
AB11	4	2 1/2	2	54p
AB12	3	2	1	45p
AB13	6	4	2	69p
AB14	7	5	2 1/2	34p
AB15	3	3	3	99p
AB16	10	7	3	£1.25
AB17	10	4 1/2	3	£1.02
AB18	12	5	3	£1.20
AB19	12	5	3	£1.50

All size are approx and in inches.  
Plus 8% VAT

## BARGAIN PROJECT BOX

A plastic box with moulded extrusion rails for PC or Chassis panels with metal front plate fitted with four screws (all supplied)

An ideal box to give a small project a professional finish.  
Size (internal) 81mm x 51mm x 38mm.  
OUR PRICE 40p Plus 8% VAT

## BARGAIN TRANSFORMERS

18 volt 500mA  
240 volt primary  
approx size—60mm x 40mm x 50mm  
fixing centres—75mm  
Our Price £1.00 Plus 8% VAT

## CABLELESS SOLDERING IRON WAHL "ISO-TIP"

★ Completely Portable  
★ Solders up to 150 joints per charge  
★ Re-charges in its own stand  
★ Fine tip for all types of soldering  
★ Only 8" long and weighs just 6 oz.  
Our Price £9.75 Plus 8% VAT  
(Spare bits are available)

## 12-0-12 VOLT 500mA 240 VOLT PRIMARY TRANSFORMER

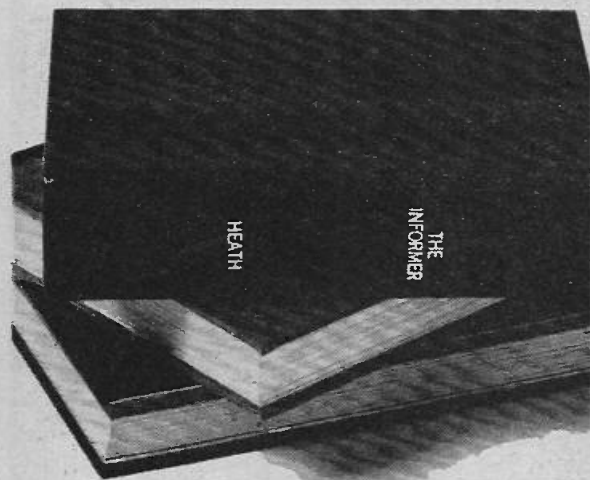
approx. size = 60mm x 40mm x 50mm. Fixing centres—75mm.  
A REAL BARGAIN AT £1.20 each.  
Plus 8% VAT

## LOW NOISE LOW PRICE CASSETTES

Good quality tape in well made screw type cassettes.  
Presented in single plastic cases.  
C60—31p  
C90—42p  
C120—53p  
10% discount on ten or more cassettes of one type Plus 8% VAT

All prices are excluding VAT. Please add to each item the VAT rate indicated to all orders

# Enough books are written about crime, this one stops it.



Outside it's a book. Inside it's an ingenious ultrasonic burglar alarm from Heathkit. The GD-39. A complete kit that can be assembled in only a few enjoyable hours, with the help of a very easy to follow instruction manual.

The GD-39 works by transmitting a silent, ultrasonic signal throughout the room. And continuously monitoring it. Any movement made by an intruder in the room will then automatically produce a change in the signal. Which triggers off a lamp and, thirty seconds later, a remote buzzer, that just you hear, or a loud bell.

Enough to scare the living daylights out of a burglar. For more details, and a bookful of other ideas, just post the coupon now for your free Heathkit catalogue.

Or, if you're in London or Gloucester, call in and see us. The London Heathkit Centre is at 233 Tottenham Court Road. The Gloucester showroom is next to our factory in Bristol Road.

Heath (Gloucester) Limited,  
Dept. EE-75, Bristol Road,  
Gloucester GL2 6EE.  
Tel: (0452) 29451.



## The GD-39 Ultrasonic Burglar Alarm

To: Heath (Gloucester) Limited, Dept. EE-75, Gloucester GL2 6EE. Please send me a free Heathkit catalogue.



Name \_\_\_\_\_

Address \_\_\_\_\_

Postcode \_\_\_\_\_

Remember easy terms are available with the Heathkit Monthly Budget Plan.

HEATH  
Schlumberger

## IMPROVE PETROL CONSUMPTION

Fit the brilliant New Scorpio Mk II "Dual Polarity" Capacitive Discharge Electronic Ignition System. Suitable for all cars with coil/distributor ignition up to eight cylinders



- \* Genuine Improvement in overall petrol consumption (independent report claims at least 8 - 10%).
- \* Much easier cold weather starting, less strain on your battery.
- \* Less use of choke - Increase engine life.
- \* Smoother running at lower revs. - makes your four cylinder car feel like a six cylinder.

TOGETHER WITH THE FOLLOWING "SCORPIO" MK II PLUS FEATURES NOT PREVIOUSLY AVAILABLE WITH OTHER MAKES:-

- \* Only one model used for both positive (+) and negative (-) earth vehicles - If you change your car, you can certainly transfer your "Scorpio". No need to specify vehicle polarity when ordering.
- \* There is a 6 volt model available.
- \* Specially suppressed against radio interference (can be troublesome with electronic ignition systems).
- \* Retains your original contact-breaker points, which last their mechanical life - no points burn.
- \* Will drive electronic tachometers.

PRICE for complete "Scorpio" Mk. II unit, fully tested and ready for immediate installation, with easy to follow instructions - £13.85 (includes V.A.T., post and packing free - UK only) PLEASE STATE WHETHER 12 VOLT OR 6 VOLT REQUIRED.

For the D.I.Y. Man, there is a complete kit of parts available with easy to follow, comprehensive instructions, PRICE only £10.85 (includes V.A.T., post and packing free - UK only). THOUSANDS ALREADY IN USE, FULLY GUARANTEED.

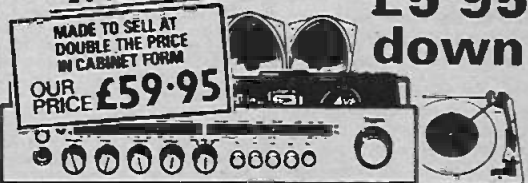
Please forward stamped addressed envelope for our FREE interesting brochure - "Electronic Ignition - How it Works," containing circuit and itemised price list.

ELECTRO SPARES, Dept. E.E., 288 Eccleall Road, Sheffield S11 8PE.  
Telephone: - Sheffield (0742) 66888.

## QUALITY STEREO SOUND.

ALMOST 1/2 PRICE OFFER! SOLENT AUDIO SYSTEM

£5.95  
down



\* Stereo Tuner Amplifier chassis with AM/FM radio covering long medium short and Stereo FM wavebands. Separate Base and Treble controls. 30 watts total power output (frequency response 25-20,000 Hz) Tape record and playback facilities. Dimensions 18" x 8 1/2" x 3 1/4". The very latest BSR automatic record deck with cue and pause control. Two matching elliptical speaker units.

Order early limited stocks available cash price £59.95. Credit Sale £5.95 deposit 9 monthly payments of £7.00 (Total Credit price £68.95). P. & P. £3.00. Send £8.95 today.

Chassis only available for cash at £42.00.

Full 12 months Guarantee.

CALLERS WELCOME.

Stereo headphones supplied with every complete order.

LEWIS radio EE/7/75 100 CHASE SIDE SOUTHGATE  
LONDON N14 5PL Telephone: 01-882-1644



# BI-PRE-PAK

Bargains in Semi-Conductors, components, modules & equipment.

## Bargains from our FREE Catalogue

20 large pages, filled with real bargains in transistors, I.C.s, components, equipment, etc. Send large S.A.E. with 6p stamp for your FREE copy of 6th Edition by return. Meanwhile, for prompt delivery order from this month's ad. NOW.

### TRANSISTOR PACKS ALL AT 50p EACH TESTED & GUARANTEED

B79	4	IN4007 Sil. Rec. diodes. 1,000PIV 1 amp. plastic	H39	6	Integrated circuits 4 gates BMC 962. 2 flip-flops BMC945
B81	10	Reed Switches, 1 long 1/2" dia. High-speed P.O. type	H41	2	BD131/BD132 Complementary Plastic Transistors
H35	100	Mixed Diodes. Germ. Gold bonded, etc. Marked and Unmarked.	H65	4	40361 Type NPN Sil. Transistors TO-5 can comp. to H66
H38	30	Short lead, NPN Silicon Planar Ex Equipment.	H66	4	40362. Type PNP Sil. Transistors TO-5 can comp. to H65

### UNMARKED & UNTESTED

B1	50	Germanium Transistors PNP, AF and RF	H6	40	250mV zener diodes. At least 20 good.
B66	150	Germanium Diodes Min. glass type	H15	30	Silicon rectifiers 750mA assorted. Top-hat type.
H68	10	Experimenter's pack of I.C.s. D.T.L. and T.T.L. (some marked)	H34	15	Power Transistors. PNP, Germ. NPN Silicon TO-3 Can
B86	100	Sil. Diodes sub. min. IN914 and IN916 types	H67	10	3819N Channel FET's plastic case type

### PLASTIC POWER TRANSISTORS

40 WATT SILICON				
Type	Polarity	Gain	VCE	Price
40N1	NPN	15	15	20p
40N2	NPN	40	40	30p
40P1	PNP	15	15	20p
40P2	PNP	40	40	30p

90 WATT SILICON				
Type	Polarity	Gain	VCE	Price
90N1	NPN	15	15	25p
90N2	NPN	40	40	35p
90P1	PNP	15	15	25p
90P2	PNP	40	40	35p

### NEW X-HATCH GENERATOR Mk. 2



Essential for Colour T.V. alignment of 4 patterns. Featuring plug in IC's and a more sensitive sync. pick-up circuit. The case is virtually unbreakable—ideal for the engineer's toolbox—only measures 3" x 5 1/2" x 3". Operates from 3 U.2 type batteries (extra).

P/P add Complete £7-93\* Ready built unit only £9-93\*

### TO CLEAR

Hundreds of various portable transistor radio chassis with FM & AM tuning. Ideal for experimenters. All electronic components in good order, but no instructions or tuning drives. A cheap way to make a portable. Each £1

### SUNDRY

Capacitor Discharge Ionition Kit £7-50 (8). 8 assorted relays £1-00 (8). Rev counter device (for cars) £1-00. U.H.F./TV Tuner Units £2-50. LM.389 Audio I.C. £1-00. Technical books of all kinds (no VAT).

### TERMS OF BUSINESS

V.A.T. Prices shown do not include V.A.T. This must be added to total value of your order including postage at 25%, except for prices marked \* or (8%) when only 8% V.A.T. is required. No V.A.T. on overseas orders.

POSTAGE Except where stated, add 20p for postage & packing in U.K. Overseas—add £1, any difference being charged or refunded.

PAYMENT Cash with order, Cheque or money order. Minimum order value £1. You can also pay by ACCESS.

IMPORTANT—Every effort is made to ensure accuracy of prices and description at time of preparing this advertisement and going to press. Prices are subject to alteration without notice.

## BI-PRE-PAK LTD

CO. REG. NO. B.10019

222 224 WEST ROAD, WESTCLIFF-ON-SEA, ESSEX SSO 9DF.

TELEPHONE: SOUTHEND (0702) 46344.

WRITE ORDER SEPARATELY AND ATTACH COUPON IF REQUIRED

challenging values!



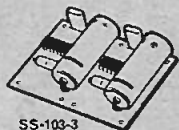
## Stirling Sound

STIRLING SOUND AUDIO MODULES come to you as basic units assembled on P.C.B.s enabling you to add required components in layouts of your own choice. Modules are tested and boxed before despatched and include well printed instructions.

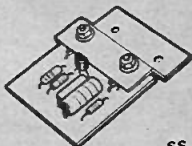
### PRE-AMP TONE CONTROLS

Pre-amplifiers; tone control

SS.100	Active tone control unit to provide bass, treble, balance and volume controls	£1-60
SS.101	Pre-amp for ceramic cartridge, tape and radio	£1-60
SS.102	Pre-amp for low output magnetic cartridge, tape and radio. With R.I.A.A. correction ±1dB at 1K	£2-25



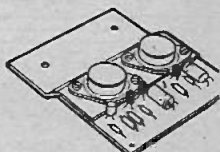
SS-103-3



SS.105

### POWER AMPLIFIERS

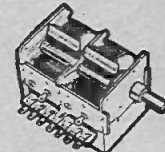
SS.103	Compact I.C. amp. with 3 watts R.M.S. output. Operating voltage 10-20v. Size 3 1/2" x 2"	£1-75
SS.103-3	Stereo version of above using one I.C. on each channel	£3-25
SS.105 MK2	New Improved all-purpose power amp which will run excellently on a 12V supply. With 5 watt output, two make a good stereo amp. Size 3 1/2" x 2"	£2-25
SS.110 MK2	Similar in size to SS.103 but with a 10 watt output. Ideal for many domestic and small-size P.A. applications. Operates from 26 to 32V.	£2-75
SS.140	Excellent designed 40 watt R.M.S. (into 4 ohms) hi-fi amplifier. S/N ratio better than 75dB. THD better than 0.2%. Power requirements—45V. d.c. With 0-15" centre edge connections. Two can be bridged to give 80 watts R.M.S. into 8 ohms	£3-60



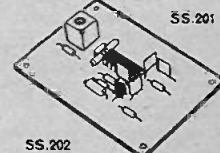
SS.140

### BUILD A STEREO FM TUNER!

SS.201	Ganged tuning condenser with accurately engineered slow-motion drive in rugged housing. Excellent sensitivity. Tunes 88-108MHz. With A.F.C. facility. Operates from 6-16V	£6-25
SS.202	I.F. stage (with I.C.) Pre-tuned. A.F.C. connection. Operates from 4.5 to 14V	£5-25
SS.203	Stereo Decoder. Designed essentially for use with SS.201 and 2, this module can also be used in most mono FM tuners. A LED may be attached. Operating voltage 9-16V. d.c.	£5-62



SS.201

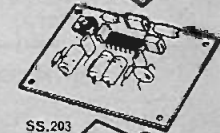


SS.202

SPECIAL £5 MONEY SAVING OFFER  
Buy all three modules for building a stereo FM Tuner (Total list £17-21) and you pay only £12-12

### POWER SUPPLY STABILIZER

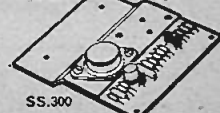
SS.300	Add this to an unregulated supply (say typically 45V output) to obtain a steady powerful working output adjustable from 12 to 60V. Essential on your audio and special systems as well as test bench. Money saving and very reliable	£3-25
--------	--	-------



SS.300

### MAINS TRANSFORMERS FOR ABOVE

Add 35p per transformer for PIP	
Type A 18V/1A (Suit SS.103)	£1-50
Type B 25V/2A (Suit SS.110)	£2-00
Type C 30V/2A (Suit SS.140)	£4-50
Bridge Rectifiers—Type A 27p. Types B & C 38p	



SS.203

Founded 1959

To BI-PRE-PAK, 224-226 WEST RD., WESTCLIFF-ON-SEA, ESSEX

Please send .....  
for which I enclose ..... Inc. V.A.T.  
Name .....  
Address .....

E.E. 7

# Everyday Electronics Classified Advertisements

RATES: 11p per word (minimum 12 words). Box No. 30p. extra. Semi-display—£7.50 per single column inch. Advertisements must be prepaid and addressed to Classified Advertisement Department, "EVERYDAY ELECTRONICS," I.P.C. Magazines Ltd., Fleetway House, Farringdon Street, London EC4A 4AD.

## EDUCATIONAL

### CITY & GUILDS EXAMS

Study for success with ICS. An ICS home study course will ensure that you pass your C. & G. exams. Special courses for: Telecons. Technicians', Electrical Installations, Radio, TV & Electronics Technicians', Radio Amateurs'. Full details from ICS School of Electronics, Dept. 335, Intertext House, London SW8 4UJ. Tel: 01-622 9911 (all hours).

### TECHNICAL TRAINING

Get the training you need to move up into a higher paid job. Take the first step now—write or phone ICS for details of ICS specialist home study courses on Radio, TV, Audio Eng. and Servicing, Electronics, Computers; also self-build radio kits. Full details from ICS School of Electronics, Dept. 336, Intertext House, London SW8 4UJ. Tel: 01-622 8911 (all hours).

### COLOUR TV SERVICING

Learn the technique of servicing Colour TV sets through new home study course approved by leading manufacturer. Covers principles, practice and alignment with numerous illustrations and diagrams. Other courses for radio and audio servicing. Full details from ICS School of Electronics, Dept. 337, Intertext House, London SW8 4UJ. Tel: 01-622 9911 (all hours).

## FOR SALE

**MICROPHONES:** AKG D202E1, £45.00; AKG D190C or 'E' £20.00; AKG D224, £60.00; Sennheiser MD211N, £45.00. All brand new and boxed. Please add 25% for VAT. All other AKG and Sennheiser mikes. SAE for quote to J. J. Francis (Wood Green), Ltd., Manwood House, Matching Green, Harlow, Essex. Tel: Matching 476.

## WANTED

**TELEPHONES WANTED,** candlestick type or older (foreign and English). 01-722 4151.

**ADVERTISER** contemplating constructing various projects, needs the help of one with some experience to get started. Essex. Box No. 9.

## RECEIVERS and COMPONENTS

**VALVES.** Radio, TV, Transmitting, Industrial, 1930 to 1975. 2,000 types stocked, many obsolete: X78-TH4-2P-N78 EBL1 EBL21-TH41-PX4, etc. List 20p. We wish to purchase new and boxed valves. Cox Radio (Sussex) Ltd., The Parade, East Wittering, Sussex. West Wittering 2025

3 ASSORTED M.C. METERS £1.30 (40p).  
LARGE COMPUTER PANELS 35-50 Transistors, Long Leads, 85p (50p). COPPER CLAD PAX PANELS 6" x 6", 6-65p, c.p. 8 1/2" x 9 1/2" c.p. 12" x 12" 84p c.p. T.V. CONVERGENCE PANELS 2x ACT28, 3 Studded Coils, 3 Slide Switches 11 w.w. Pots, 3 Carbon Presents, 2 Ferrite Chokes, etc. £1.28 c.p. VALU-PAKS P9, 100 S/mica Caps 73p. c.p. P24, 100 Polyester Caps, Mullard C280 series, £1.18, c.p. Send 12p for lists. Refund on purchase. 71bs ASSORTED COMPONENTS £2.29, c.p.

J. W. B. RADIO

2 Barnfield Crescent, Sale, Cheshire M33 1NL  
Postage in Brackets Mail Order Only

**COMPONENTS GALORE.** Pack of 600 mixed components manufacturers surplus plus once used. Pack includes Resistors, carbon and W.W., capacitors various, transistors, diodes, trimmers, potentiometers etc. Send £1+10p. and p. c.w.o. to CALEDONIAN COMPONENTS, Strathore Road, Thornton, Fife.

## MISCELLANEOUS

### GADGETS GALORE!!

★ READY BUILT + TESTED ★

Signal Injector £2.25 Signal Tracer £3.25  
Logic Probe £4.45 Noise Generator £6.95  
Metronome £3.95 Continuity Tester £3.95  
Now available from our new shop!!

Prices include U.K. Postage and Batteries  
Please call or write (SAE list) to:

G.K. SERVICES (G2)

38 High St., St. Mary Cray, Orpington  
BR5 3NJ

**CONSTRUCTION AIDS.** Screws, nuts, spacers, etc., in small quantities. Aluminium panels punched to spec. or plain sheet supplied. Fascia panels etched aluminium to individual requirements. Printed circuit board-masters, negatives and boards, one-off or small numbers. Send 6p for list. **RAMAR CONSTRUCTOR SERVICES,** 29 Shelbourne Road, Stratford-on-Avon, Warks.

### A REALLY PRACTICAL INTRODUCTION TO RADIO AND ELECTRONICS

Specially prepared for beginners, the information you need on two large (33" x 23") data sheets. Sheet one covers radio transmission, reception and components. Detailed, easy to follow instructions take the uncertainty out of your first ventures into radio construction, and help you to avoid mistakes and disappointments. A construction technique which eliminates soldering, and crystal clear, full size wiring diagrams enable you to tackle the long, medium and short wave receivers described on sheet two with confidence. All components are easy to obtain. Send 65p + 10p P and P to:—

### TEKNA DATA SHEETS,

RADIO AND ELECTRONICS,  
11 Lawn Avenue, Doncaster, South  
Yorks. DN1 2JE. Mail order UK only

**SUPERB** instrument cases by Bazelli, manufactured from heavy duty P.V.C. faced steel. Hundreds of Radio, Electronic and Hi-Fi enthusiasts are choosing the case they require from our range. Make your VAT go further with our competitive prices which begin at a low 75p. Examples: width, depth, height: 7in x 7in x 5in, £2.65; 8in x 10in x 6in, £3.60; 12in x 8in x 7in, £4.00; 12in x 12in x 7in, £4.40. Over 200 models to choose from. Prompt despatch, free literature (stamp would be appreciated). Bazelli, Department No. 24, St. Wilfrids, Foundry Lane, Halton, Lancaster LA2 6LT.

**DIGITAL CLOCK CHIP,** AY-5-1224, with data and circuit diagram, £3.66 plus VAT. "Jumbo" LED digits (16mm high), Economy type DL-747, only £2.04 each plus VAT, post free. Greenbank Electronics, 94 New Chester Road, Wirral, Merseyside L62 5AG.

### PRINTED CIRCUIT COPPER CLAD

Single Sided. Quality material. Flame retardant to N.E.M.A. Spec.

Paper Base (FR2) 1/16 x 7 x 5, 3 for £1.

Epoxy Glass (FR4) 1/16 x 7 x 5, 2 for £1.

Also panels cut to your requirements, quotation by return.

Prices include P. & P. Cash with order.

P. G. Oliver & Co.

4 Hearsall Lane,

COVENTRY CV5 6HH.

## CHEAP EAGLE

We will not be beaten on Eagle prices. Up to 40% off recommended retail. S.A.E. for general price list.

## LRS ELECTRONIC SUPPLIES

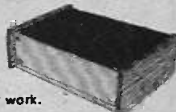
3 CLIVESWAY HINCKLEY

**LOWEST COST IC SOCKETS.** Use Soldercon IC socket pins for 8 to 40 pin DIL's. 50p for strip of 100 pins, £1.50 for 3 strips of 100, £4 for 1000. 10p p&p for orders under £2. Add 8% VAT. Instructions supplied—send for sample. **SINTEL,** 53e Aston Street, Oxford. Tel: 0865 43203.

### H.M.ELECTRONICS (E.E.)

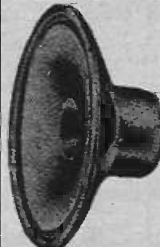
DESIGNERS OF SPECIALTY ELECTRONIC CASES

DEC CHASSIS



A beautifully designed modern cabinet to give that extra finish to your work. 5 standard sizes. Please send 15p (refundable) for folder of leaflets.

## LOUDSPEAKERS



Speakers, kits and cabinets for D.I.Y., Hi-Fi, P.A., Disco, etc. by EMI, Fane, Goodman's, Baker, Kef, Elac, Richard Allan, Wharfedale, etc. Send stamp for free booklet "Choosing a speaker"

### WILMSLOW AUDIO

Dept. EE, Swan Works, Bank Square,  
Wilmslow, Cheshire SK9 1HF  
Tel. Wilmslow 29599

### HOME SCIENTISTS

Get the key to a FANTASTIC WORLD of previously UNHEARD-OF PROJECTS. The NEW Boffin catalogue lists LOTS of HIGHLY UNUSUAL LOW-COST BARGAINS, READY-BUILT MODULES. Here are just a few examples, there are stocks more!

Dazzling MINI-STROBE (pocket size) £3-50

PEOPLE DETECTOR £4-20

Big-Ear SOUND-CATCHER £4-20

Mini-DREAM LABORATORY £4-20

Don't take our word for it though! GET A COPY & SEE!

SEND ONLY 20p, and we'll RUSH YOU A COPY (YOU'LL GET THE GOODIES' JUST AS QUICKLY TOO!)

### BOFFIN PROJECTS

4 Cunliffe Road, Stoneleigh,

Ewell, Surrey

(Mail Order U.K. Only)

**AERIAL BOOSTERS—£3-30**  
We make three types of aerial boosters B43-UHF-TV, B12-VHF-TV, B11-VHF-Radio.

**VALVES BARGAINS**  
ANY E-50p, 10-75p, 50-£3-30.  
ECC82, EF80, EF183, EF184, PCCT189, PCF80, PCF802, PCL82, PCL84, PCL85/805, PFL200, PL38, PL504, PY800, PY85.

**COLOUR TV VALVES—PL508, PL509, PY500-25p each.**  
Prices exclude VAT, P&P 10p, SAE—leaflet  
Electronic Mail Order Ltd, 42 Bridge Street, Ramsbottom, Bury, Lancs. Tel RAMS 3034



ONLY £11-00.

### MULTIMETER

Type U4324

20,000 Ω/V, Overload protected, Ranges: 0-5, 1-2, 3, 12, 50, 60, 120, 500, 1200V DC; 3, 6, 15, 50, 150, 300, 600, 900V AC; 0-0.6, 0.6, 6, 60, 600mA, 3A DC; 0-3, 3, 30, 300mA, 3A AC; 5 resistance ranges to 5M Ω, dBA, —10 to +12. Size 167 x 98 x 63mm. Supplied complete with test leads, clips spare diode and instructions.

**PC ETCHING KIT**  
Contains 1lb Ferric chloride, DALO etch-resist pan, 100 sq in copper clad board, etching dish, abrasive cleaner and instructions. £3-30

### FERRIC CHLORIDE

Anhydrous to Mill-spec In double-sealed 1lb packs. 1lb 90p; 5lb £1-80; 10lb £4-70.

### VEROBOARD

100 ad lns 0-1, 0-15 & 0-2" good-size offcuts (About 8 pieces) £1-15.

### TRANSFORMERS

Miniature type remain primary, 100mA sec. 0-0-6V 95p; 0-0-9V £1-00; 12-0-12V £1-05.

### TIB BARGAIN PARCELS

Contain hundreds of resistors, pots, capacitors, switches + PC boards with transistors and diodes, also loads of odds and ends. £3-00.

**GREENWELD ELECTRONICS [EE7]**

51 SHIRLEY PARK ROAD,

SOUTHAMPTON SO1 4FX

Tel (0703) 772501. Also at 38 Lower Addicombe Rd, Croydon & 21 Dartford Bdy SE8.

ALL PRICES INCLUDE VAT AND UK POSTAGE. SAE LIST, ENQUIRIES. CALLERS WELCOME.

# ELECTRONI-KIT

"EDUCATIONAL KITS of EXCEPTIONAL QUALITY"

(AUDIO mag).

All components are beautifully encapsulated in unbreakable transparent plastic blocks. Perfect connections are made WITHOUT SOLDERING, SCREWING OR WIRING

**INCREDIBLE VALUE.** Build, dismantle and rebuild projects any number of times and invent your own experiments.

**COMPLETELY SAFE.** Instructive and FUN—all kits operate from 9v. battery. VALUABLE MANUALS included with every kit. No previous knowledge is required, even with the largest kits.

**KIT 2A—30 projects £10-45.** Radios, amplifiers, alarms, microphones, Morse, etc.  
**KIT 3A—100 projects £20-45.** As 2A plus electronic birds, cats, sirens, organs, metronome, guns, light and sound, burglar alarms, etc.

**JADX—105 projects £25-25.** As 3A plus solar cell experiments and complete sophisticated control panel, etc.

**4ADX—150 projects £33-95.** As JADX plus Relay and Meter experiments; ion concentration—, volume—, out-pump—, field intensity—, volt—, resistance meters, ammeter, illuminometer, etc. and many, many more.

ADD-ON parts and manuals available.

The three larger kits include Electrical experiments too.

All prices include Battery, Manual, VAT & p. & p.

Cheque/P.O. (or 1lp for literature) to:

Satisfaction guaranteed

ELECTRONI-KIT LTD, 408 St. John's Street, London, EC1. (01-278 4579)

BUILD THE

## TREASURE TRACER

MK III. Metal Locator

- Variable tuning
- Britain's best selling metal locator kit
- Weighs only 20oz. Fitted with Faraday shield.
- Speaker and earphone operation
- Knocks down to only 17in.
- Prebuilt search coil assembly
- Thoroughly professional finish
- As seen on BBC1 and BBC2 TV
- You only need soldering iron, screwdriver, pliers and snips
- Five transistor circuit

Send stamped, addressed envelope for leaflet

Complete Kit £10-90 Built & tested £15-25

Post 60p—92p VAT (8%) Post 60p—£1-21 VAT (8%)

MINIKITS ELECTRONICS,

6b CLEVELAND ROAD,

LONDON, E18 2AN (Mail order only)

# SPARKITE MK 2

## CAPACITIVE DISCHARGE ELECTRONIC IGNITION KIT

"Sparkite MK 2" is a high performance, high quality, capacitive discharge, electronic ignition system. Sparkite completely eliminates problems of the contact breaker. Mishfire due to contact breaker bounce is electronically eliminated, contact breaker burn is eliminated, the condition of the contacts is not relevant to the performance of the ignition, and the system is no longer dependent on the dwell period for recharging.

Sparkite will give you 15 to 20% better fuel consumption, instant all weather starting, cleaner plugs—they last up to five times longer without attention, faster acceleration, higher top speed, longer coil and battery life, efficient fuel burning and less air pollution, smoother running, continual peak performance.

The kit comprises everything needed. Ready drilled pressed steel case coated in matt black epoxy resin, ready drilled base and heatsink, top quality 5 year guaranteed transformer and components, cables, coil connectors, printed circuit board, nuts, bolts, silicon grease, full instructions to make the kit negative or positive earth, and 10 page installation instructions.

WE SAY IT IS THE BEST SYSTEM AT ANY PRICE

Voted best of 8 Ignition systems tested by a leading Motoring Magazine

Price: D.I.Y. assembly kit £16-00 including VAT post and packing. Ready built unit £17-00 including VAT post and packing. (Both fit all vehicles with coil/distributor ignition up to 8 cylinders.) Switch for instant changeover from "Sparkite" ignition to conventional ignition £2-75 including VAT post and packing. R.P.M. limiting control £2-42 including VAT post and packing. (Fitted in cage on ready built unit, dashboard mounting on kit.) We can supply units for any petrol-engined vehicle (car, motorcycle, etc.) with coil/contact breaker ignition. Details on request.

CALL IN AND SEE US FOR A DEMONSTRATION



VOTED BEST OF 8 IGNITION SYSTEMS TESTED BY A LEADING MOTORING MAGAZINE

## ORDER NOW

To: Electronic Design Associates Dept. E.E. / 62 Bath Street, Walsall, WS1 3DE. Phone 38632.

From: Name

Address

Quantity Please Supply

Sparkite Mk. 2 D.I.Y. Assembly kits at £16-00

Sparkite Mk. 2 Ready Built Negative earth at £17-00

Sparkite Mk. 2 Ready Built Positive earth at £17-00

Ignition changeover switches at £2-75

R.P.M. Limit systems in the above units at £2-42

Fluorescent light assembly kits at £3-46

Fluorescent light built units at £4-18

Diffusers for the above at 50p

of number aluminium boxes at

of number aluminium boxes at

of number aluminium boxes at

I enclose cheque/P.O.s for £..... Cheque No.....

(Send S.A.E. if brochure only required).

# ELECTRONICS DESIGN ASSOCIATES of WALSALL

## ALUMINIUM BOXES

## FLUORESCENT LIGHT KIT

Prices include S.A.E. orders and VAT (at 8%). No should be added to the total order value for postage and packing.

No. 7	5 1/2"	by 2 1/2"	by 1 1/2"	high	87p
No. 8	4"	by 4"	by 1 1/2"	high	46p
No. 9	4"	by 4"	by 1 1/2"	high	46p
No. 10	5 1/2"	by 2 1/2"	by 1 1/2"	high	49p
No. 11	4"	by 2 1/2"	by 1 1/2"	high	50p
No. 12	3"	by 2 1/2"	by 1 1/2"	high	50p
No. 13	6"	by 4"	by 2"	high	56p
No. 14	7"	by 5"	by 2 1/2"	high	75p
No. 15	8"	by 6"	by 3"	high	83p
No. 16	10"	by 7"	by 3"	high	£1-14



You can build this reverse polarity protected 12V SW fluorescent light. Everything needed is supplied, white enamelled drilled metalwork, ready drilled heatsink, printed circuit board, high quality components and transformer, and caps, cable, the fluorescent tube, nuts, bolts, washers and simple assembly and operating instructions. When complete the light has many uses: workshop and work bench illumination, garage lighting, emergency lighting, lighting for camping, and boating, as an inspection lamp and many more.

Price: Assembly kit £3-46 inc. VAT post and packing. Ready built £4-18 inc. VAT post and packing. Diffuser 50p inc. VAT post and packing.



## MAINS TRANSFORMERS

All models 230-250 volt primaries 2 p

1V	1 amp (special)	1.75
2-4v	5 amp	85
6-3v	2 amp	1.00
6-3v	3 amp	1.50
9v	1 amp	95
9v	3.5 amp	1.85
12v	1 amp	1.00
12v	2 amp	1.50
6.5v-0-6.5v	1 amp	1.25
18v	1 amp	1.85
20v	1 amp	1.00
24v	1 amp	1.50
24v	3 amp	3.50
12-0-12v	50mA	1.20
6-0-6v	50mA	1.20
8-0-8v	1 amp	1.25
18-0-18v	2 amp	8.60
25v	1 1/2 amp	1.85
50v 2 amp & 6.3v 1 amp		5.50
60v 5 amp & 5v 1 amp		7.50
27v	8 amp	4.50
30v	37 amp	22.00
80v tapped 75v & 70v	4 amp	5.50
230v-60mA & 6.3v	1.5 amps	1.75
275-0-275v at 90mA & 6.4v	3 amps	2.25

### Transformer

6v and 12v	2 amps	1.25
6v and 12v	3 amps	2.25
6v and 12v	5 amps	3.50

FHT Transformer 5kV at 23mA (intermittent) 5.50

## NUMERICATOR TUBES

For digital instruments, counters, timers, clocks, etc. 2H-vac XNII Price 99p each, 10 for 98

## OIL PUMP

Driven by Redmond Motor of approx. 1/20th horse power, pump originally intended for oil-fired boilers etc, with normal inlet and outlet pipes and unions. £2-15 plus 30p post and insurance.

## LIGHT DIMMER KIT

For dimming up to 250v without heat sink or 750w with heat sink. This comprises quadrae variable control potentiometer, condenser, resistors, tag strip for mounting and data. Price £1.50.

## RELAY BARGAIN

Type 600 relay, 2 changeover one open and one closed contact. Twin 500 ohm coils make this suitable for closing off DC 5v, DC 12v, DC 24v or AC mains using resistor and rectifier. 39p each.

## AM/FM TUNER

Unit made by the American GEC company, 8 transistor, all-wired ready to work. Complete with tuner condenser, needs only scale and pointer. Tuning AM range 540 to 1620 KHz, FM range 88 to 108 MHz. 5 switches for on-off and AFC. Output for MXP or direct. Special mp price £8 plus 30p post. Three or more post free.

## 7 WATT STEREO AMPLIFIER

Again by the American GEC company. This has exceptionally good tone quality. Is complete with pre-amp and treble base, volume and balance controls. Also has mains smoothing circuit and rectifier so requires only mains transformer. Output for 15 ohm speakers. Inputs for tuner, pick-up, mike, etc. Special mp price £8 plus 30p post. Three or more post free.

## WINDSCREEN WIPER CONTROL

Vary speed of your wiper to suit conditions. All parts and instructions to make. £2.75.

## PORTABLE CABINET OFFER

A nicely made portable cabinet, soft padded black finish intended for portable stereo system. Dimensions as sketch. With motor board cut out for Garrard SP 25. This was obviously a very costly cabinet originally made for a deluxe record player. Offered at £1.95 plus 41 carriage free if bought with the Garrard or BBR record decks.

## CAR CASSETTE POWER SUPPLY

To give stabilized output of 6 or 9v, complete kit contains 2 transistors-zener diode-vero board panel resistors and plastic case to house it with constructional data. £2.50.

## PLAY YOUR 8-TRACK CASSETTE FROM MAINS

12v, 700mA unit all assembled and in neat plastic case with mains lead and terminals, full wave rectifier and transformer has overload protection and is double insulated. One of today's best buys £1 £2-95 + 35p VAT.

## HONEYWELL PROGRAMMER

This is a drum type timing device, the drum being calibrated to equal divisions for switch-setting purposes with trips which are infinitely adjustable for position. They are also arranged to allow 2 operations per switch per rotation. There are 15 changeover micro switches each of 10 amp type operated by the trips, thus 15 circuits may be changed per revolution. Drive motor is mains operated 5 revs per min. Some of the many uses of this timer are Machinery control. Boiler firing. Dispensing and Vending machines. Display lighting animated and signs. Signalling, etc. Price from makers probably over £20 each. Special mp price £2.60 plus 25p post and insurance. Don't miss this terrific bargain.

## SWITCH TRIGGER MATS

So thin is undetectable under carpet but will switch on with slightest pressure. For burglar alarms, shop doors, etc. 24in x 18in £1.90 13in x 0in £1.50

## HORSTMANN 24-HOUR TIME SWITCH

With 6 position programmer. When fitted to hot water systems this could programme as follows:

Programme	Hot Water	Central Heating
0	Off	Off
1	Twice Daily	Off
2	All Day	Off
3	Twice Daily	Twice Daily
4	All Day	All Day
5	Continuously	Continuously

Suitable, of course, to programme other than central heating and hot water, for instance, programme upstairs and downstairs electric heating or heating and cooling or taped music and radio. In fact, there is no limit to the versatility of this Programmer. Mains operated. Size 3in x 3in x 2in deep. Price £4.25 as illustrated but less case.

## TAPE DECK

In metal case with carrying handle, heavy fly wheel and capstan drive. Tape speed 31. Mains operated on metal platform with tape head and guide. Not new but in good order. Price £1.85 plus 50p post and insurance.

## SHORTWAVE CRYSTAL SET

Although this uses no battery it gives really amazing results. You will receive an amazing assortment of stations over the 19.25-21.39 metre bands—Kit contains chassis from panel and all the parts. £1.50—crystal earphone 50p.

## SPIT MOTOR

200-250V Induction motor, driving a Carter gearbox with a 1/4" output drive shaft running at 5 revs p.m. Intended for roasting chickens, also for driving models—windmills, coloured disc lighting effects, etc. £2.50 plus 20p post and ins.

## AUTOMATIC GARAGE DOOR SELF POWERED RECEIVER ADD-ON AMPLIFIER DEAC CHARGER

To quickly receive parts to construct these and other featured projects —send the estimated cost as shown—any price adjustments can be made later.

## 12 VOLT 1 1/2 AMP POWER PACK

This comprises double-wound 230-240V mains transformer with full wave rectifier and 2000 mF smoothing. Price £2.95 plus 30p post & packing.

## HEAVY DUTY MAINS POWER PACK

Output voltage adjustable from 15-40V in steps—maximum load 250W—that, from 8 amp at 40V to 15 amp at 15V. This really is a high power heavy duty unit with dozens of workshop uses. Output voltage adjustment is very quick—simply interchange push on leads. Silicon rectifiers and smoothing by 3,000mF. Price £2.75 plus £1.00 post.

## DISTRIBUTION PANELS

Just what you need for work bench or lab. 4 x 12 amp sockets in metal box to take standard 13 amp fused plug and on/off switch with neon warning light. Supplied complete with 6 feet of flex cable. Wired up ready to work. £2.75 plus 25p P. & P.

## RADIO STETHOSCOPE

Easiest way to fault find trace-signal from aerial to speaker, when signal stops you've found the fault. Use it on Radio, TV, amplifier, anything. Complete kit comprises two special transistors and all parts including probe tube and crystal earpiece, £2.20 twin stetho-set instead of earpiece 89p extra post and ins. 20p.

## CENTRIFUGAL BLOWER

Miniature mains driven blower centrifugal type blower unit by Woods. Powerful but specially built for quicker running—driven by cushioned induction motor with specially built low noise bearings. Overall size 4 1/2" x 4 1/2" x 4". When mounted by flange, air is blown into the equipment but to suck air out, mount it from centre using clamp. Ideal for cooling electrical equipment or fitting into a cooker hood, film drying cabinet or for removing flux smoke when soldering, etc. etc. A real bargain at £2.50p.

TERMS:—ADD 8% V.A.T. Except where noted Send postage where quoted—other items, post free if order for these items is £6.00, otherwise add 30p.

# J. BULL (ELECTRICAL) LTD.

(Dept. E.E.), 102/3 TAMWORTH RD., CROYDON CRO IXX.

## NEW ITEMS THIS MONTH

The bargains in this column are just some of the items which appeared in the April supplement of our catalogue. You can receive this catalogue and the next 13 supplements by sending £1.

High power battery motor, 12v operated, strong enough to power a motor mower, go-cart or similar. Speed easily variable. These motors can also be used as a brake for any rotating machine, simply by coupling the spindle to the machine and short-circuiting the windings by a variable resistance, price £2.50.

50v amplifier transformer made by Farneco 80 obviously very well-made, 2 amp, upright mounting with shrouds, a transformer that will enhance the performance of any amplifier. Offered at only £4.50 + 75p post—less than current cost.

3 core waterproof flux, standard pvc, circular, new colour code, 100 metre drums. £5 per drum + 75p post.

Tachometer motor/generator made by the famous Volthead Co., when driven at 1,000 revs. the voltage generated is exactly 3. At higher or lower revs. proportionately higher or lower voltages. The motor therefore is the basis of a very useful general purpose revolution counter. Price 50p.

DC high current panel meters, 2 1/2" wound wide angle 240° movement meters, with mounting pins for flush mounting fitted with external shunts, made by Crompton Parkinson or similar high quality maker for the GPO but brand new, still in their original cartons. These are a real bargain at £5.50 each. Reasonable quantities available in the following ranges: 0-10 amps 0-20 amps 0-30 amps 0-40 amps 0-50 amps.

50 amp fuses, cartridge type, mounted in plug-in fuse carrier with panel mounting fuse holder. Price 50p each. 100 amp ditto, price 85p each. Post 25p each.

100 amp 50 volt silicon rectifier on heat sink for panel mounting. £2.50.

Miniature plug-in uni-selector switches made for the GPO, unused, perfect condition. 50v coil 360° rotation 4 pole 25 va. £2.50.

Edge mounting moving coil meter, size 3" x 2" scaled DB made for the GPO, unused still in original maker's cartons. £2.50 each.

Relay "elasta" Swiss made with watchmaker's precision, 1600 ohm coil operates heavy duty gold or silver contacts, one set changeover and two other sets open or relay closing. A really high-class relay, supplied in a transparent plastic box which can be used as a dust cover. Do not miss this bargain at 55p.

2 circuit toggle switch normal panel mounting through 3/8" hole, one circuit changeover, the other circuit simply on-off, 20p each.

GPO switchboard. We have an assortment of these, the old fashioned type with the winking eyes and lever switches, all mounted in wooden box. Price depends on number of lines, for instance the 8 line 40 extension model is £25.

Highly sensitive moving coil relay, panel mounting with glass window, this measures approx 6 1/2" x 4" x 5" the actual triggering current can be varied from a fraction of a milliamper to 6 milliamper by removing the front and adjusting the setting level. Few only of these, price £2 each.

100 amp contactors, with auxiliary microswitch, coil voltage 50 volts DC. Price £3-50 each.

Ditto, mounted in a pair with optional selector bar which prevents both contactors closing together; enclosed in perspex cover. Price £7 each.

Figure of eight twin flex wire, 14 strands, suitable for lighting or loudspeaker extension etc. Price £2 for 100 metre coil + post 60p.

Miniature multi-core wire, colour coded cores, 15 core screened overall, then pvc covered. 30p per metre. £28 per 100 metre coil, post 50p.

Mains motor 1 1/2" stack induction type, 1" spindle of 1 1/2" length, special quiet bearings made by Smiths for fans and blowers etc. £1.75 each, post 25p.

18" x 8" Speakers, E.M.I. good performance unit, mid range unit, very suitable for columns etc., these are 3 ohm coil. We can offer at approx. half price—only £1.95 each plus 50p each post.

Klaxon hooper mains operated, makes loud, shrill noise, ideal as fire alarm. Well-made unit. £2.50 + 60p post.

Break-down unit, contains a whole range of most useful parts some of which are as follows—66 silicon diodes equivalent OA91. 63 resistors, mostly 1 watt 5% covering a wide range of values. 4 x 1 mfd 400v condensers. 15 x .01 mfd 100v condensers. 2 25F chokes. 2 x 29 valve holders. 1 x 4R choke. 1 x 110v transformer. 1 boxed unit containing 4 delay lines. Tag panels, trimmer condensers, suppressors, all mounted up on a useful chassis sized approx. 9" x 5" x 7". Offered at only 75p—the 86 diodes would cost at least 10 times this amount, so this is obviously a snip not to be missed. Post and packing 80p.

White ex GPO telephones, last standard desk model with internal bell and dial. £3 + 75p post. Black, ditto, £1.50 + 75p.

Black, ditto, less internal bell. £1 + 50p.

Wall mounting with switched hook but not dial or bell. £1.50 + 50p.

# FREE!

## Over 150 ways to engineer a better future

HIGHER PAY

A BETTER JOB

SECURITY

### find out how in just 2 minutes

That's how long it will take you to fill in the coupon. Mail it today and we'll send you full details and a free book. We have successfully trained thousands of men at home—equipped them for higher pay and better, more interesting jobs. We can do as much for YOU. A low-cost home study course gets results fast—makes learning easier and something to look forward to. There are no books to buy and you can pay-as-you-learn.

Why not do the thing that really interests you? Without losing a day's pay, you could quietly turn yourself into something of an expert. Complete the coupon (or write if you prefer not to cut the page). No obligation and nobody will call in on you . . . but it could be the best thing you ever did.

Others have done it, so can you

"Yesterday I received a letter from the Institution informing that my application for Associate Membership had been approved. I can honestly say that this has been the best value for money I have ever obtained, a view echoed by two colleagues who recently commenced the course". Student D.I.B., Yorks.

"Completing your course, meant going from a job I detested to a job that I love, with unlimited prospects"—Student J.A.O. Dublin.

"My training quickly changed my earning capacity and, in the next few years, my earnings increased fourfold". Student C.C.P., Bucks.

**FIND OUT FOR YOURSELF**

These letters and there are many more on file at Aldermaston College, speak of the rewards that come to the man who has given himself the specialised know-how employers seek. There's no surer way of getting ahead or of opening up new opportunities for yourself. It will cost you a stamp to find out how we can help you. Write to

**ALDERMASTON COLLEGE**

Dept. TEE 06 Reading RG7 4PF.

**HOME OF BRITISH INSTITUTE OF ENGINEERING TECHNOLOGY**

Practical Radio & Electronics Certificate course includes a learn while you build **3 transistor radio kit.**

Everything you need to know about **Radio & Electronics** maintenance and repairs for a **spare time income** and a **career** for a better future.

This FREE 76 page book can put you on the road to success through a B.I.E.T. Home Study Course. Choose your subject now!

CUT OUT THIS COUPON

Tick or state subject of interest. Post to address below.

<input type="checkbox"/> ELECTRICAL ENGINEERING City & Guilds Wiring and Installations C. G. Electrical Tech-Primary Gen. Electrical Eng.	<input type="checkbox"/> Practical Radio & Electronics (with self-build kit) Radio Amateurs' Exam	<input type="checkbox"/> Construction Surveyor's Inst. Clerk of Works Diploma <input type="checkbox"/> C. & G. Building Quantities <input type="checkbox"/> General Building <input type="checkbox"/> General Civil Eng. Heating, Ventilation & Air Conditioning <input type="checkbox"/> Carpentry & Joinery <input type="checkbox"/> Painting & Decorating <input type="checkbox"/> Plumbing
<input type="checkbox"/> AERONAUTICAL ENGINEERING Air Registration Board Certificates Gen. Aero Engineering	<input type="checkbox"/> ELECTRONIC ENGINEERING Gen. Electronic Eng. Practical Electronics (with kit)	<input type="checkbox"/> AGRICULTURAL ENGINEERING
<input type="checkbox"/> AUTO ENGINEERING City & Guilds Auto Engineering Practice Inst. Motor Industry M.A.A./I.M.I. Management Diploma Gen. Auto Engineering Auto Diesel Maintenance Motor Mechanics Service Station and Garage Management	<input type="checkbox"/> REFRIGERATOR SERVICING	<input type="checkbox"/> G.E.J. (Part 1) Inst. Cost & Management Accountants Works Management etc. etc.
<input type="checkbox"/> TELECOMMUNICATIONS City & Guilds Telecommunications	<input type="checkbox"/> MECHANICAL ENGINEERING Society of Engineers Inst. Engineers and Technicians General Mechanical Eng. Welding Maintenance Eng. General Diesel Eng.	<input type="checkbox"/> DRAUGHTSMANSHIP Institute of Engineering Draughtsmen & Designers General Draughtsmanship Architectural Draughtsmanship Technical Drawing
<input type="checkbox"/> RADIO & TV Gen. Radio and TV Eng. Radio Servicing, Maintenance and Repairs	<input type="checkbox"/> CONSTRUCTION & BUILDING Institute of Building	

**G.C.E.**  
—58 'O' & 'A'  
Level Subjects  
—over 10,000  
Group Passes!

**POST TODAY FOR A BETTER TOMORROW**

To Aldermaston College,  
Dept. TEE 07, Reading RG7 4PF.

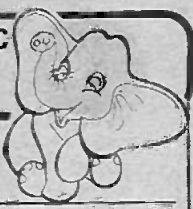
NAME.....  
Block capitals please  
ADDRESS.....  
.....  
.....  
POSTCODE.....  
OTHER SUBJECTS.....  
.....  
.....  
AGE.....

Accredited by C.A.C.C.

Member of A.B.C.C.

# Henry's Radio

LARGEST SELECTION OF ELECTRONIC COMPONENTS AND EQUIPMENT. LOW PRICES—MEAN LESS VAT.



## You can build the Texan and Stereo FM Tuner TEXAN 20 + 20 WATT IC STEREO AMPLIFIER

Features glass fibre PC board, Gardners low field transformer 0-1C's, 10-transistors plus diodes, etc. Designed by Texas Instrument engineers for Henry's and, P.W. 1972. Supplied with full chassis work, detailed construction handbook and all necessary parts. Full input and control facilities. Stabilised supply. Overall size 15 1/2" x 22" x 6 1/2" mains operated. Free teak sleeve with every kit. **£38.75 (Carriage 50p).** (also built and tested £49.87)



## HENELEC STEREO FM TUNER

Features capacity diode tuning, lead and tuning meter indicators, stabilised power supply—mains operated. High performance and sensitivity with unique station indication IC stereo decoder. Overall size in teak sleeve 8" x 22" x 6 1/2". Complete kit with teak sleeve. **£26.25 (Carriage 50p).** (also built and tested £31.20)



## JOIN THE LARGE BAND OF HAPPY CONSTRUCTORS!

### NEW SPECIAL PURCHASE MULLARD TYPE LP1179 AND LP1171 AM/FM TUNER MODULES

These two modules together form a high quality AM/FM tuner covering the long, medium and VHF broadcast bands. Requires only 16 resistors and capacitors and a switch to complete. Supplied with circuits and spec. data

**FM LP1179**  
Coverage 87-108 MHz  
Bandwidth 300 KHz  
Selectivity 36 dB  
Signal to noise at limiting threshold 40 dB  
Audio output 75 mV with built in tuning gang



**LP1171 AM**  
Bandwidth 6.5 KHz  
Sensitivity 1 pV  
Built-in AGC LP1171  
Supply 6V negative earth  
LP1179 and LP1171 £4.60 each or £8.63 pr.  
Suitable Ferrite aerial £8.83



**Mullard Modules**  
LP1157 AM/Type 2.83  
LP1185 10-7 I.F. Unit 6.81  
LP1186 10-7 F/M Tuner 7.31  
Gorler Perm. F/M Tuner 4.82

**Amplifiers with controls**  
E1210 12 volt 2 1/2 + 2 1/2 watts 8 ohms 9.24  
SAC14 Mains 7 + 7 watts 8 ohms 14.70  
SAC30 Mains 15 + 15 watts 8 ohms 18.99  
CAO38 9 volt 1 1/2 + 1 1/2 watts 8 ohms 8.35  
CA068 12 volt 5 + 3 watts 8 ohms 12.08

**FM and AM Tuners and Decoders**  
FM5231 (tu 2) 6 volt fm tuner 9.95  
TU13 12 volt version (FM use with Decoder) 9.85  
SD412 Stereo Decoder for Tu 3-12 volt 9.95  
SP528 6 volt stereo FM tuner 8.99  
A1007 9 volt MW-AM 5.58  
A1018 9 volt FM tuner In cabinet 17.44  
A1005M (S) 9-12 volt Stereo decoder FM for above 7.82  
5475 12 volt Stereo decoder general purpose kit 6.99

**Power Supplies Mains Input**  
(chassis-rest cased)  
470C 675/9V 300 MA with adaptors 4.00  
P500 9 volt 500 MA 4.00  
HC244R 3/5/7.5/9V. 400 MA stabilised 5.50  
\*P11 2v. 4 amp. 3.30  
\*P15 28V. 4 amp 3.92  
\*P1080 12V 1A 5.88  
\*P1081 45V 0.9A 9.75  
P12 4 1/2-12V. 2.1 amp 7.72  
SE1015 3/6/9/12V. 1 amp stabilised 13.50  
P1075 3/4.5/7.5/9/12V. 4 amp 5.25  
SE800A 1-18 VOLT 0-1A stabilised 18.90

### SINCLAIR MODULES & KITS

**SINCLAIR PROJECT 80**  
ST80 Stereo preamplifier 14.05  
Audio Filter Unit 8.17  
Z40 15 Watt Amplifier 8.40  
Z60 25 Watt Amplifier 8.17  
P25 Power Supplies for 1 or 2 Z40 5.73  
P26 Power Supplies (S Tab) for 1 or 2 Z40 8.18  
TRANSFORMER FOR PZ8 4.88  
FM TUNER 14.05  
STEREO DECODER 8.35  
IC20 power amp kit 9.34  
P220 power supply for 1 or 2 IC20 5.88

### PACKAGE DEALS (carr./packg 35p)

2 x Z40 ST80 PZ5 29.32  
2 x Z60 ST80 PZ8 32.60  
2 x Z60 ST80 PZ8-trans 46.42  
805 Kit 42.25

### Sinclair Special Purchases

\*Project 60 stereo preamp £7.94 (post 20p)  
\*Project 605 Kit £23.44 (post 25p)

### EMI SPEAKERS SPECIAL PURCHASE

13 In. x 8 In. chassis speakers (Carr./packing 30p ea. or 50p pr.)  
\*150 TC 10 watts 8 ohms twin cone £2.53  
450A Built In tweeter 8 ohms £4.43  
EW 15 watt 8 ohms with tweeter £8.61  
350 20 watt 8, 15 ohm with tweeter £10.06 each  
\*Polished wood cabinet £8.00 carr., etc. 35p each or 50p pair.



### UHF TV TUNERS

625 line receiver UHF translocated tuners UK operation. Brand new. (Post packing 25p. each).  
TYPE A variable tuning slow motion drive £3.50  
TYPE B 4-button push-button (adjustable) £4.60  
TYPE C variable tuning £2.90  
TYPE D 6 Button UHF/VHF £5.75

### PA-DISCOTHEQUE LIGHTING EQUIPMENT



Without doubt U.K.'s best range of modular and complete equipment. Lighting, mixing, microphones, accessories, speakers, amplifiers, lenses, etc., etc.  
FREE stock lists (Ref. No. 18) on request CALL IN AND SEE FOR YOURSELF at HENRY'S DISCO CENTRE, 362 EDGWARE ROAD. TEL. 01-402 5854

### TEST EQUIPMENT MULTIMETERS

Carr/packing £ p  
U4324 20kΩ/V with case 9.99  
U4313 20kΩ/V with steel case 14.90  
U4317 20Ω/V with case 18.36  
U4341 33kΩ/V plus transistor steel case 11.34  
U4323 20kΩ/V plus 1kHz OSC with case 8.64  
U4341 Laboratory meter £56.16  
U4312 20kΩ/V with case £11.07  
U4315 20kΩ/V with case £10.80  
U4317 20Ω/V with case £18.36  
ITI-2 20kΩ/V slim type 6.43  
THL33D (L33DX) 2kΩ/V Robot 7.50  
TPSSN 20kΩ/V (Case £2) 11.61  
TP10S 20kΩ/V 9.18  
TW20S 20kΩ/V 14.04  
TW50K 50kΩ/V 15.93  
S100TR 100kΩ/V plus transistor tester 32.40



### NEW REVOLUTIONARY SUPERTESTER 680R

£ p  
680R Multi-tester 19.98  
ITE15 AC Multivoltmeter 21.27  
440Hz-28MHz 21.54  
ITE85 28 Range valve voltmeter 24.30  
ITE200 RF Generator 20.47  
ITE22D AF Generator 20.79  
\*HM350 In circuit transistor tester 21.05  
\*C3025 Deluxe meter 7.50  
\*TT145 Compact transistor tester 15.93  
\*G3-38 R/C osc. 20Hz-200KHz (carr. £1.00) 46.00  
\*SE350A De-luxe signal tracer 13.98  
\*SE400 Mini-lab all in one tester 16.74  
Ci-5 Scope 500,000KHz (carr. £1.00) 46.00  
Radio activity counter 0-10r (carr. £1) 10.75  
Mains unit for above (carr. 50p) £4.05

### TAPE HEADS

Marriot XRPS/17 1/2 Track High 3.12  
Marriot XRPS/18 1/2 Track 3.75  
Marriot XRPS/36 1/2 Track Med. 5.78  
Marriot XRPS/63 1/2 Track High 1.89  
Marriot Erase Heads for Marriot 17/18/36 (XES11) 88p  
Marriot BXIZE 343 1/2 Track erase 81p  
R/RP1 Rec'd/Play 1/2 Track 48p  
HRP S'igla Trk Rec/Play 37p  
Boogen Type UL29 Erase 1.99  
Miltare Stereo Cassette Rec/Play 2.59

### EXCLUSIVE 5 WATT IC AMPLIFIERS

Special purchase 5 watt output 8-16 ohm load. 30 volt max. DC operation, complete with data. Price £1.70 each or 2 for £3.25.  
Printed Circuit Panels 54p.



### 8 DIGIT POCKET ELECTRONIC CALCULATORS

Sinclair Cambridge Built £11.00  
Cambridge Kit £9.95  
Cambridge Memory Built £17.50  
Scientific Built £16.00  
Scientific Kit £14.85

**FREE:—**  
SEND NOW FOR OUR FREE LIST NO. 36 FOR OUR COMPLETE RANGE OF 1,000'S OF SEMICONDUCTOR DEVICES AT NEW LOW PRICES.

### EXTRA DISCOUNTS

Semiconductors—Any one type or mixed SN74 Series IC's, 12—extra 10%; 25—extra 15%; 100—extra 20%.

### TRANSISTORS & INTEGRATED IC'S

TTL "7400 series" IC's from 18p each  
Cosmos "4000 series" IC's from 25p each  
Linear Op-Amps from 43p each  
Significa Phase Lock IC's; RCA Linear IC's; T03 Power Devices in PNP and NPN; from 13p  
BC107 and "BC range" from 13p  
Range of OC Types 20p  
Plastic Power Devices, Rectifiers, Zener, Power Regulator IC's and many others.  
Diodes up to 10 watts

### DIL SOCKETS

8 PIN 15p  
14 PIN 16p  
16 PIN 18p  
24 PIN £1.15  
28 PIN £1.25



### NOMBREX TEST EQUIPMENT Model 35 Stabilised Power Supply

A short/circuit proof power supply delivery up to 30 volts at 1 Amp. Built-in Volts and ammeters **£36.72**

### Model 40 Wide Range Audio Signal Generator

A high stability signal generator using the low distortion Wien bridge principle. **£36.72**

### Model 41 RF Signal Generator

Covering 150 KHz to 220 MHz in 8 ranges. Built in AF mod. Output up to 50mV. **£40.46**

### Model 42 Wide Range RF Signal Generator

Covering 150 KHz to 300 MHz in 8 ranges. Highest range on harmonic. **£26.46**

### Model 43 RC Bridge

Null indicating bridge for resistors and capacitors. Resistance range 10R to 10M ±2% at Centre Scale. **£25.38**

### Model 44 Inductance Bridge

Measures 1μH to 100H in 4 ranges ±5% accuracy. Q measurement from 0.1-1,000 ±10%. **£36.72**

### Model 45 Direct Reading Frequency Meter

10Hz to 100 KHz in 4 ranges. Input from 10MV to 5V **£88.88**

All models except Model 35 are internally powered from 9V battery (extra). Carriage and packing all models 37p.

### ELECTRONIC FOOTBALL & TENNIS WITH THE VIDEO SPORT ON YOUR OWN TV

Play three exciting electronic ball games ● FOOTBALL ● TENNIS ● HOLE IN THE WALL on your own TV! Just plug Video Sport into the aerial socket of your TV and away you go. Completely safe for you, your children and your TV. Mains operated.

**OUR INCREDIBLE PRICE £35.00 INC. VAT**  
DEMONSTRATIONS NOW IN ALL CENTRES

**NOW OPEN—SUPERMARKET**  
Come and browse round the new components supermarket at 404 Edgware Road. Bargains galore. Goodie Bags. Components, etc. WATCH FOR FURTHER DEVELOPMENTS!

# Henry's Radio

Electronic Centres  
404-406 Electronic Components & Equipment 01 402 8381  
309 PA-Disco-Lighting High Power Sound 01-723 6963  
303 Special offers and bargains store  
All mail to 303 Edgware Road, London W2 1BW  
Prices correct at time of preparation. Subject to change without notice. E. & O. E

Hi Fi and Electronics Centres Open 9 am - 6 pm