

# ETI

## ELECTRONICS TODAY INTERNATIONAL

TOMORROW'S TECHNOLOGY TODAY

THE  
MAGAZINE  
FOR PRACTICAL  
ELECTRONICS  
& COMPUTING



# Interactive digital TV

The information  
superhighway  
at home

The ETI 8088SBC  
interrupt driven  
multitasking  
control computer

Construct a  
multicore  
cable tester

Advanced  
electric motors

## Plus

- Build a universal tester
- Using PIC microcontrollers
- Timer to check camera shutter speed
- Analog virtual instrument interface



AUGUST 1995 £2.15



08 >



NEXUS

**"moving from schematic to layout could not be easier"**

Electronics World & Wireless World Jan 1995

**PRO+ now  
with SPICE  
file export  
& SpiceAge  
DDE link!**

Quickroute 3.0 for Windows 3.1 has been designed from the start to be as easy to use as possible, without sacrificing the power professional engineers need to get the job done. Quickroute is available with schematic capture, support for busses & power rails, 1-8 layer auto-routing, SPICE file export, and our new extended library pack.

- Quickroute 3.0 PRO+ can also connect to the Windows simulation package SpiceAge using Windows DDE. Contact POWERware for more details!

## Quickroute 3.0

**Integrated Schematic and PCB  
Design for Windows 3.1**

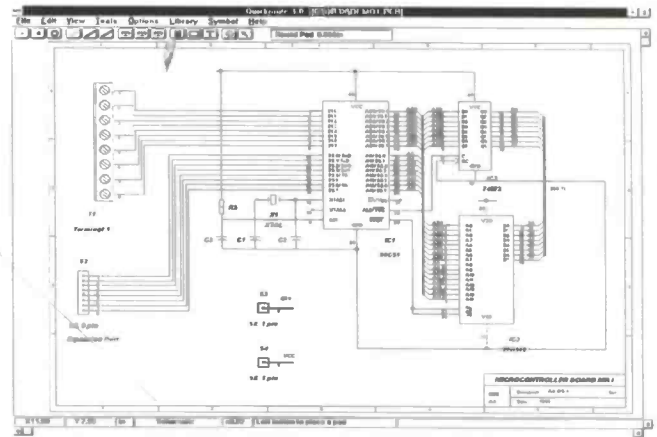
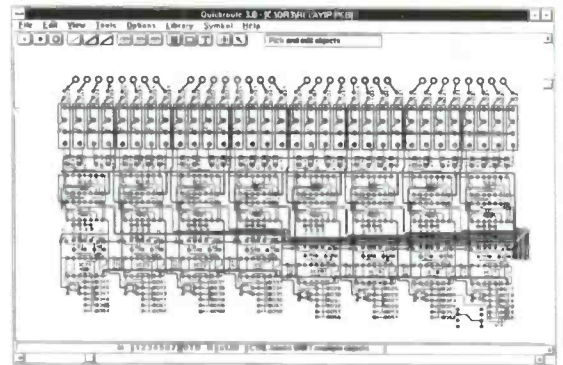

**Busses and Power rails handled easily  
using Global Nets on PRO+**

**DESIGNER £99**

\*Schematic & PCB Drawing \*1/2 layer auto-router  
\*Supports Windows printers/plotters \*Full set of  
libraries \*Clipboard support \*Designer Special (manual  
on disk) also available.

**PRO £199**

\*Schematic & PCB Design \*Schematic Capture  
\*Integrated Rats-Nest Generation \*1-8 layer Auto-router  
(faster than Designer) \*Net-List Export \*Supports  
Windows printers/plotters \*CAD-CAM outputs.

**PRO+ £299**

As the PRO but also includes \*Advanced Schematic Capture  
(Busses, Power rails, etc) \*Larger Schematic & PCB Designs  
\*Gerber file IMPORT for File Exchange \*Extended libraries  
(CMOS, SMT, etc) \*SPICE Export \*SpiceAge DDE link.

\*Prices exclude P+P and V.A.T. VISA/MasterCard  
Accepted \*Network versions available.

**POWERware, 14 Ley Lane, Marple  
Bridge, Stockport, SK6 5DD, U.K.**

**Tel/Fax 0161 449 7101**

**email [info@powrware.demon.co.uk](mailto:info@powrware.demon.co.uk)**

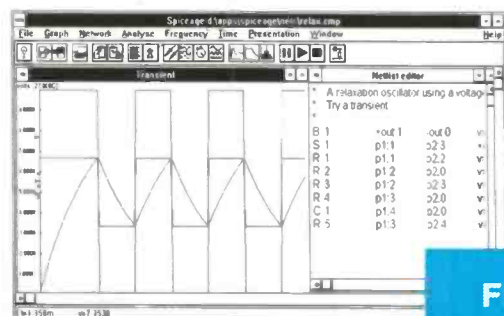

**DDE link to SpiceAge  
Simulator with PRO+**

**FREE  
Demo Pack  
Available.**

# Contents

**ETI**  
ELECTRONICS  
TODAY INTERNATIONAL  
TOMORROW'S TECHNOLOGY

THE  
MAGAZINE  
FOR PRACTICAL  
ELECTRONICS  
& COMPUTING

## Interactive digital TV

The Information superhighway at home

The ETI 8088SBC interrupt driven multitasking control computer

Construct a multicore cable tester

Advanced electric motors

**Plus**

- Build a universal tester
- Using PIC microcontrollers
- Setup to check camera shutter speed
- Analog virtual instrument interface



## Volume 24 No.8

## & Features & Projects

### Digital Interactive Television 12

Advanced technology which combines very powerful personal computers, with fibre optic networks, telephone systems, data communications systems and television looks set to bring a whole range of new multimedia services into the homes of nearly everyone within the next ten years. Nick Hampshire looks at the world leading technology being developed in this country, and where it will take us in the coming decade



### Analogue shutter timer 18

Robert Penfold shows how to build a timer for checking the accuracy of camera shutters

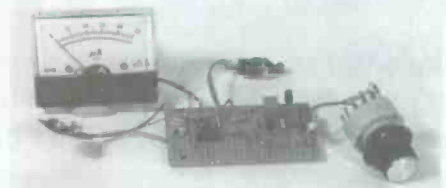

### 8088 Interrupt-based single board control computer 24

The first part of a new computer project designed by R.Grodzik based around the popular 8088 processor and specifically designed for multitasking control applications

### Designing a PIC microcontroller based project 48

In Part 2 of this short tutorial series, Bart Trepak looks at the circuit and design of a PIC based alarm clock

### DC and electronically commutated electric motors 30

Today there is a very wide range of electric motor technologies in use. Douglas Clarkson takes a look at some of them

### Serial ADC for Virtual Instrumentation 56

An add-on module for the ETI 80188 single board computer by Richard Grodzik

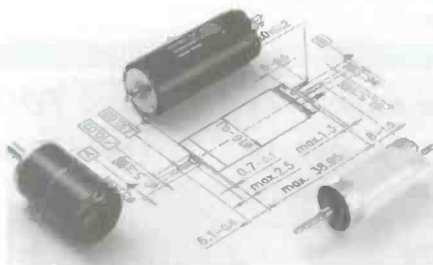

### Multi checker 40

A pocket-sized multi-purpose tester for home and car, designed by Tim Parker

### Multi-core cable tester 60

Finding faults in multicore cables can be a nightmare. Paul Stenning has developed a piece of equipment which makes the task much easier

## Regulars

- News and event diary 6
- Practically speaking 69
- PCB Foils 70
- Open Forum 74



SUBSCRIPTIONS  
& BACK ISSUES HOTLINES:  
01858 435344

ORDERS  
& ENQUIRIES:  
01858 435322  
Lines Open 9am - 6:30pm

## Subscribe & Save

Phone the hotline and take advantage of our special offer detailed on page 54

# Pico Releases PC Potential

Pico's Virtual Instrumentation enable you to use your computer as a variety of useful test and measurement instruments or as an advanced data logger.

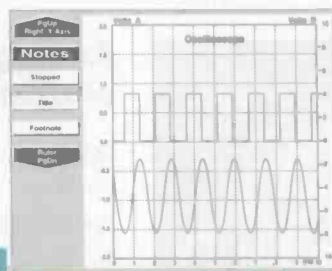

**PicoScope**  
'Virtual instrument' software.

Hardware and software are supplied together as a package - no more worries about incompatibility or complex set-up procedures. Unlike traditional 'plug in' data acquisition cards, they simply plug into the PC's parallel or serial port, making them ideal for use with portable PC's.

**Call for your Guide on 'Virtual Instrumentation'.**

**PicoLog**  
Advanced data logging software.

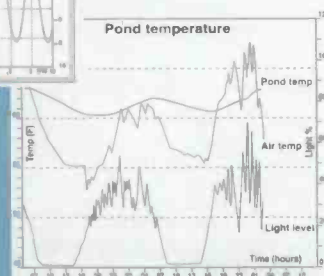

## NEW from Pico TC-08 Thermocouple to PC Converter

### 8 channel Thermocouple Interface

- Connects to your serial port - no power supply required.
- Supplied with PicoLog datalogging software for advanced temperature processing, min/max detection and alarm.
- 8 Thermocouple inputs (B,E,J,K,N,R,S and T types)
- Resolution and accuracy dependant on thermocouple type. For type K the resolution is better than 0.1°C.

**TC-08** £ 199

**TC-08** + Calibration Certificate £ 224

complete with PicoLog, software drivers and connecting cable. A range of thermocouple probes is available.



## SLA-16 & SLA-32 Logic Analysers

### Pocket sized 16/32 channel Logic Analysers

- Connects to PC serial port.
- Up to 50MHz sampling.
- Internal and external clock modes.
- 8K Trace Buffer.

**SLA-16** £ 219  
**SLA-32** £ 349  
with software, power supply and cables

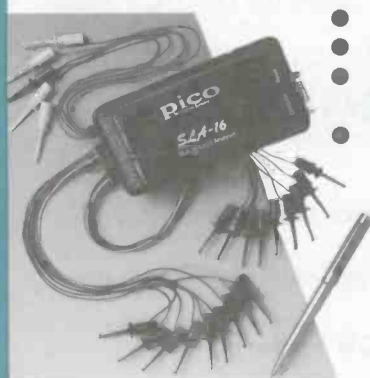

## ADC-100 Virtual Instrument

### Dual Channel 12 bit resolution

- Digital Storage Scope
- Spectrum Analyser
- Frequency Meter
- Chart Recorder
- Data Logger
- Voltmeter

The ADC-100 offers both a high sampling rate (100kHz) and a high resolution. It is ideal as a general purpose test instrument either in the lab or in the field. Flexible input ranges ( $\pm 200\text{mV}$  to  $\pm 20\text{V}$ ) allows the unit to connect directly to a wide variety of signals.

**ADC-100** with PicoScope £199  
with PicoScope & PicoLog £219

The ADC-10 gives your computer a single channel of analog input. Simply plug into the parallel port.

**ADC-10** with PicoScope £49  
PicoScope & PicoLog £59

### ADC-10 1 Channel 8 bit

- Lowest cost in the Pico range
- Up to 22kHz sampling
- 0 -5V input range



Carriage UK free, Overseas £9 Oscilloscope Probes (x1, x10) £10

**PICO TECHNOLOGY**

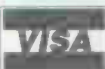

Pico Technology Ltd. Broadway House, 149-151 St Neots Rd, Hardwick, Cambridge. CB3 7QJ  
Tel: (0)1954 - 211716 Fax: (0)1954 - 211880 E-mail: 100073.2365 @compuserve.com



Phone or FAX for sales, ordering information, data sheets, technical support. All prices exclusive of VAT

**ENERGY BANK KIT** 100 6"x6" 6v 100mA panels, 100 diodes, connection details etc. £69.95 ref EF112.

**CCTV CAMERA MODULES** 46X70X29mm, 30 grams, 12v 100mA, auto electronic shutter, 3.6mm F2 lens, GCIR, 512x492 pixels, video output is 1v-p (75 ohm). Works directly into a scart or video input on a tv or video. IR sensitive. £79.95 ref EF137.

**IR LAMP KIT** Suitable for the above camera enables the camera to be used in total darkness! £5.99 ref EF138.

**PASTEL ACCOUNTS SOFTWARE**, does everything for all sizes of businesses, includes wordprocessor, report writer, windowing, networkable up to 10 stations, multiple cash books etc. 200 page comprehensive manual. 90 days free technical support (0345-326009 try before you buy) **Current retail price is £129, ours? just £29** ref EF134. **SAVE £100!!!**

**MINI MOTOR FANS 12V 1.5"** sq just £3.99 each. Ref EF199.

**CITOH PRINTERS** 80 col, 9pin matrix, serial/parallel, NLQ/draft, 3 mths warranty, good condition. £49 ref EF133.

**MICROSOFT TRACKBALL AND MOUSE** Combined unit with 4 buttons and trackball, PS2 type connector. Complete with storage bracket. Our price just £11.99 ref EF201.

**REUSEABLE HEAT PACKS**. Ideal for fishermen, outdoor enthusiasts elderly or infirm, warming food, drinks etc, defrosting pipes etc. reusable up to 10 times, lasts for up to 8 hours per go, 2,000wh energy, gets up to 90 degC. Price is £12 ref EF129. rrp £371

**1.44MB 3.5" DISC DRIVES** Returns from a top PC manufacturer so they may need attention, bargain price £8.50 ea ref EF203.

**1.2MB 6.25" DISC DRIVES** Again returns so may need attention, bargain price is £8.50 ref EF204. (1 of each 1.2+1.44 £14.99 ref EF205)

**A4 DTP MONITORS** Brand new, 300 DPI. Complete with diagram but no interface details. (so you will have to work it out!) Bargain at just £7.99 each!!!! Ref EF186

**OPD MONITORS** 9" mono monitor, fully cased complete with rasterboard, switched mode psu etc. CGA/TTL input (15way D). IEC mains. £15.99 ref DEC23. Price including kit to convert to composite monitor for CCTV use etc is £21.99 ref DEC24.

**12V 2AMP LAPTOP** psu's 110x55x40mm (includes standard IEC socket) and 2m lead with plug. 100-240v IP. £8.99 ref EF200.

**PC CONTROLLED 4 CHANNEL TIMER** Control (on/off times etc) up to 4 items (8A 240v each) with this kit. Complete with Software, relays, PCB etc. £25.99 Ref 95/26

**COMPLETE PC 300 WATT UPS SYSTEM** Top of the range UPS system providing protection for your computer system and valuable software against mains power fluctuations and cuts. New and boxed, UK made. Provides up to 5 mins running time in the event of complete power failure to allow you to run your system down correctly. **SALE PRICE just £119.00.**

**RACAL MODEM BONANZA!** 1 Racal MPS1223 1200/75 modem, telephone lead, mains lead, manual and comms software, the cheapest you want onto the net all this for just £13 ref DEC13.

**HOW LOW ARE YOUR FLOPPIES?** 3.5" (1.44) unbranded. We have sold 100,000+ so ok! Pack of 50 £24.99 ref DEC16

**6mw LASER POINTER**. Supplied in kit form, complete with power adjuster, 1-5mw, and beam divergence adjuster. Runs on 2 AAA batteries. Produces thin red beam ideal for levels, gun sights, experiments etc. Cheapest in the UK! Just £39.95 ref DEC49

**SHOP WOBLERS!** Small assemblies designed to take D size batteries and 'wobble' signs about in shops! £3.99 Ref SEP42

**RADIO PAGER** Brand new, UK made pocket pager clearance price is just £4.99 each 100x40x15mm packed with bits! Ref SEP5.

**BULL TENS UNIT** Fully built and tested TENS (Transcutaneous Electrical Nerve Stimulation) unit, complete with electrodes and full instructions. TENS is used for the relief of pain etc in up to 70% of sufferers. Drug free pain relief, safe and easy to use, can be used in conjunction with analgesics etc. £49 Ref TEN1

**COMPUTER RS232 TERMINALS. (LIBERTY)** Excellent quality modern units, (like wyse 50, 5) 2xRS232, 20 function keys, 50 thro to 38,400 baud, menu driven prnt, screen, cursor, and keyboard setup menus (18 menu's). £29 Ref NOV4.

**OMRON TEMPERATURE CONTROLLERS (E5C2)**, Brand new controllers, adjustable from 0 deg C to +100 deg C using graduated dial, 2% accuracy, thermocouple input, long life relay output, 3A 240v o/p contacts. Perfect for exactly controlling a temperature. Normal trade £50+, ours £15. Ref E5C2.

**ELECTRIC MOTOR BONANZA!** 110x60mm. Brand new precision, cap start (or spin to start), virtually silent and features a moving outer case that acts as a fly wheel. Because of their unusual design we think that 2 of these in a tube with some homemade fan blades could form the basis for a wind tunnel etc. Clearance price is just £4.99 FOR A PAIR! (note-these will have to be wired in series for 240v operation) Ref NOV1.

**MOTOR NO 2 BARGAIN 110x90mm**. Similar to the above motor but more suitable for mounting vertically (ie turntable etc). Again you will have to wire 2 in series for 240v use. Bargain price is just £4.99 FOR A PAIR! Ref NOV3.

**OMRON ELECTRONIC INTERVAL TIMERS.** \*\*\*\*\*NEW LOW PRICES TO CLEAR!!!\*\*\*\*\*

**Miniature adjustable timers, 4 pole o/o output 3A 240v,**

HY1230S, 12vDC adjustable from 0-30 secs. £4.99

HY1210M, 12vDC adjustable from 0-10 mins. £4.99

HY1260M, 12vDC adjustable from 0-60 mins. £4.99

HY2460M, 24vAC adjustable from 0-60 mins. £2.99

HY2415S, 24vAC adjustable from 0-1 secs. £2.99

HY2460S, 24vAC adjustable from 0-60 secs. £2.99

HY243H, 24vAC adjustable from 0-3 hours. £2.99

HY2401S, 240v adjustable from 0-1 secs. £4.99

HY2405S, 240v adjustable from 0-5 secs. £4.99

HY24060m, 240v adjustable from 0-60 mins. £6.99

**PC PAL VGA TO TV CONVERTER** Converts a colour TV into a basic VGA screen. Complete with built in psu, lead and s/ware. £49.95. Ideal for laptops or a cheap upgrade. We also can supply this in kit form for home assembly at £34.95 ref EF54.

**DRINKING BIRD** Remember these? hook onto wine glass (supplied) and they drink, standup, drink, standup etc! £4 each Ref EF1

**EMERGENCY LIGHTING UNIT** Complete unit with 2 double bulb floodlights, built in charger and auto switch. Fully cased. 6v 8AH

lead acid req'd. (secondhand) £4 ref MAG4P11.

**GUIDED MISSILE WIRE**, 4.200 metre reel of ultra thin 4 core insulated cable, 28lbs breaking strain, less than 1mm thick! Ideal alarms, Intercoms, fishing, dolls house's etc. £14.99 ref MAG15P5

**ASTECH SWITCHED MODE PSU** BM41012 Gives +5 @ 3.75A, +12 @ 1.5A, -12 @ 4A, 230/110, cased, BM41012 £5.99 ref AUG6P3.

**AUTO SUNCHARGER** 155x300mm solar panel with diode and 3 metre lead fitted with a cigar plug. 12v 2watt. £9.99 ea ref AUG10P3.

**FLOPPY DISCS** DSD2 Top quality 5.25" discs, these have been written to once and are unused. Pack of 20 is £4 ref AUG4P1.

**ECLATRON FLASH TUBE** As used in police car flashing lights etc, full spec supplied, 60-100 flashes a min. £9.99 ref APR10P5.

**24v AC 96WATT** Cased power supply. New. £13.99 ref APR14.

**MILITARY SPEC GEIGER COUNTERS** Unused anstraight from Her majesty's forces. £50 ref MAG 50P3.

**OUTDOOR SOLAR PATH LIGHT** Captures sunlight during the day and automatically switches on a built in lamp at dusk. Complete with sealed lead acid battery etc. £19.99 ref MAR20P1.

**ALARM VERSION** Of above unit comes with built in alarm and pin to deter intruders. Good value at just £24.99 ref MAR25P4.

**CARETAKER VOLUMETRIC Alarm**, will cover the whole of the ground floor against forced entry. Includes mains power supply and integral battery backup. Powerful internal sounder, will take external bell if req'd. Retail £150+, ours? £49.99 ref MAR50P1.

**TELEPHONE CABLE** White 6 core 100m reel complete with a pack of 100 pins. Ideal 'phone extns etc. £7.99 ref MAR8P3.

**MICRODRIVE STRIPPERS** Small cased tape drives ideal for stripping, lots of useful goodies including a smart case, and lots of components. £2 each ref JUN2P3. Box of 10 just £9.99 ref EF207.

**SOLAR POWER LAB SPECIAL** You get TWO 6"x6" 6v 130mA solar cells, 4 LED's, wire, buzzer, switch plus 1 relay or motor. Superb value kit just £5.99 REF: MAG6P8

**BUGGING TAPE RECORDER** Small voice activated recorder, uses micro cassette complete with headphones. £28.99 ref MAR29P1.

**ULTRAMINI BUG MIC** 6mmx3.5mm made by AKG, .5-12v electret condenser. Cost £12 ea. Ours? just four for £9.99 REF MAG10P2.

**RGB/CGA/EGA/TTL COLOUR MONITORS** 12" in good condition. Back anodised metal case. £79 each REF JUN79

**ANSWER PHONES** Returns with 2 faults, we give you the bits for 1 fault, you have to find the other yourself. BT Response 200's £18 ea REF MAG18P1. PSU £5 REF MAG5P12.

**SWITCHED MODE PSU** ex equip, 60w +5v @5A, -5v @ 5A, +12v @ 2A, -12v @ 5A 120/220v cased 245x88x55mm IEC input socket £6.99 REF MAG7P1

**PLUG IN PSU 9V** 200mA DC £2.99 each REF MAG3P9

**PLUG IN ACORN PSU** 19v AC 14w, £2.99 REF MAG3P10

**POWER SUPPLY** fully cased with mains and o/p leads 17v DC 900mA output. Bargain price £5.99 ref MAG6P9

**ACORN ARCHIMEDES PSU** +5v @ 4.4A, on/off sw uncased, selectable mains input, 145x100x45mm £7 REF MAG7P2

**9v DC POWER SUPPLY** Standard plug in type 150ma 9v DC with lead and DC power plug, price for two is £2.99 ref AUG3P4.

**AA NICAD PACK** encapsulated pack of 8 AA nicad batteries (tagged) ex equip, 56x32x32mm. £3 a pack. REF MAG3P11

**13.8V 1.9A** psu cased with leads. Just £9.99 REF MAG10P3

**PPC MODEM CARDS**. These are high spec plug in cards made for the Amstrad laptop computers. 2400 baud dial up unit complete with leads. Clearance price is £5 REF: MAG5P1

**INFRA RED REMOTE CONTROLLERS** Originally made for hi spec satellite equipment but perfect for all sorts of remote control projects. Our clearance price is just £2 REF: MAG2

**200 WATT INVERTER** Converts 10-15v DC into either 110v or 240v AC. Fully cased 115x36x156mm, complete with heavy duty power lead, cigar plug, AC outlet socket, Auto overload shutdown, auto short circuit shut down, auto input over voltage shutdown, auto input under voltage shut down (with audible alarm), auto temp control, unit shuts down if overheated and sounds audible alarm. Fused reversed polarity protected, output frequency within 2%, voltage within 10%. A well built unit at a keen price. Just £64.99 ref AUG6S.

**UNIVERSAL SPEED CONTROLLER KIT** Designed by us for the C5 motor but ok for any 12v motor up to 30A. Complete with PCB etc. A heat sink may be required. £17.00 REF: MAG17

**MAINS CABLE** Precut black 2 core 2 metre lengths ideal for repairs, projects etc. 50 metres for £1.99 ref AUG2P7.

**COMPUTER COMMUNICATIONS PACK** Kit contains 100m of 6 core cable, 100 cable clips, 2 line drivers with RS232 Interfaces and all connectors etc. Ideal low cost method of communicating between PC's over a long distance. Complete kit £8.99.

**ELECTRIC MOTOR KIT** Comprehensive educational kit includes all you need to build an electric motor. £9.99 ref MAR10P4.

**VIEWDATA SYSTEMS** made by Phillips, complete with internal 1200/75 modem, keyboard, psu etc RGB and composite outputs, menu driven, autodialler etc. £18 each Ref EF88.

**BOOMERANG** High tech, patented poly propylene, 34cm wing span. Get out and get some exercise for £4.99 ref EF83

**AIR RIFLES**. 22As used by the Chinese army for training purposes, so there is a lot about! £39.95 Ref EF78. 500 pellets £4.50 ref EF80.

**PLUG IN POWER SUPPLYS** Plugs into 13A socket with output lead, three types available. 9vdc 150mA £2 ref EF58, 9vdc 200mA £2.50 ref EF59, 6.5vdc 500mA £3 ref EF61.

**VIDEO SENDER UNIT**. Transmits both audio and video signals from either a video camera, video recorder, TV or Computer etc to a standard TV set in a 100' range! (tune TV to a spare channel) 12V DC \*BOME OF OUR PRODUCTS MAY BE UNUSABLE IN THE UK

op. Price is £15 REF: MAG15 12v psu is £5 extra REF: MAG5P2

**\*FM CORDLESS MICROPHONE** Small hand held unit with a 500' range £2 transmit power levels. Reqs PP3 9v battery. Tuneable to any FM receiver. Price is £15 REF: MAG15P1

**LOW COST WALKIE TALKIES** Pair of battery operated units with a range of about 200'. Ideal for garden use or as an educational toy. Price is £8 a pair. REF: MAG 8P1 2 x PP3 req'd.

**\*MINIATURE RADIO TRANSCEIVERS** A pair of walkie talkies with a range up to 2km in open country. Units measure 22x52x156mm. Including cases and earpieces 2xPP3 req'd. £30.00p REF: MAG30

**COMPOSITE VIDEO KIT**. Converts composite video into separate H sync, V sync, and video. 12v DC. £8.00 REF: MAG8P2.

**LQ3600 PRINTER ASSEMBLIES** Made by Amstrad they are entire mechanical printer assemblies including printhead, stepper motors etc etc in fact everything bar the case and electronics, a good stripper £5 REF: MAG5P3 or 2 for £8 REF: MAG8P3

**LED PACK** of 100 standard red 5m leds £5 REF MAG5P4

**UNIVERSAL PC POWER SUPPLY** complete with flyleads, switch, fan etc. 200w at £20 REF: MAG20P3 (265x155x125mm).

**GYROSCOPE** About 3" high and an excellent educational toy for all ages! Price with instruction booklet £6 REF EF15.

**FUTURE PC POWER SUPPLIES** These are 295x135x60mm, 4 drive connectors 1 mother board connector. 150watt, 12v fan, iec inlet and on/off switch. £12 Ref EF6.

**VENUS FLYTRAP KIT** Grow your own carnivorous plant with this simple kit £3 ref EF34.

**PC POWER SUPPLIES (returns)** These are 140x150x90mm, of ps are +12, -12, +5 and -5v. Built in 12v fan. These are returns so they may well need repairing! £3.50 each ref EF42.

**\*FM TRANSMITTER KIT** housed in a standard working 13A adapter! The bug runs directly off the mains so lasts forever why pay £700? or price is £15 REF: EF62 Transmits to any FM radio. (this is in kit form with full instructions.)

**\*FM BUG KIT** New design with PCB embedded coil for extra stability. Works to any FM radio. 9v battery req'd. £5 REF: MAG5P5

**\*FM BUG BUILT AND TESTED** superior design to kit. Supplied to detective agencies. 9v battery req'd. £14 REF: MAG14

**TALKING COINBOX STRIPPER** originally made to retail at £79 each, these units are designed to convert an ordinary phone into a payphone. The units have the locks missing and sometimes broken hinges. However they can be adapted for their original use or used for something else?? Price is just £3 REF: MAG3P1

**TOP QUALITY SPEAKERS** Made for Hi Fi televisions these are 10 watt 4R Jap made 4" round with large shielded magnets. Good quality. £2 each REF: MAG2P4 or 4 for £6 REF: MAG6P2

**TWEETERS** 2" diameter good quality tweeter 140R (ok with the above speaker) 2 for £2 REF: MAG2P5 or 4 for £3 REF: MAG3P4

**AT KEYBOARDS** Made by Apricot these quality keyboards need just a small mod to run on any AT, they work perfectly but you will have to put up with 1 or 2 foreign keycaps! Price £6 REF: MAG6P3

**DOS PACKS** Microsoft version 3.3 or higher complete with all manuals or price just £5 REF: MAG5P8 Worth it just for the very comprehensive manual 5.25" only.

**GAS HOBS** Brand new made by Optimus, basic three burner suitable for small flat etc bargain price just £29.95 ref EF73.

**GAT AIR PISTOL PACK** Complete with pistol, darts and pellets £12.95 Ref EF82 extra pellets (500) £4.50 ref EF80.

**DOS PACK** Microsoft version 6 with manual £9.99 3.5" ref EF209

**WINDOWS 3.1** 3.5" with manual £24.99 ref EF210.

**NOVELL NETWARE LITE** (network s/ware) £24.99 ref EF211.

**PIR DETECTOR** Made by famous UK alarm manufacturer these are hi spec, long range internal units. 12v operation. Slight marks on case and boxed (although brand new) £8 REF: MAG8P5

**MOBILE CARPHONE** £6.99 Well almost complete in car phone excluding the box of electronics normally hidden under seat. Can be made to illuminate with 12v also has built in light sensor so display only illuminates when dark. Totally convincing! REF: MAG6P6

**6"x12" AMORPHOUS SOLAR PANEL** 12v 155x310mm 130mA. Bargain price just £5.99 ea REF MAG6P12.

**FIBRE OPTIC CABLE BUMPER PACK** 10 metres for £4.99 ref MAG5P13 ideal for experimenters! 30m for £12.99 ref MAG13P1.

**HEATSINKS** (finned) TO220, designed to mount vertically on a pcb 50x40x25mm you can have a pack of 4 for £1 ref JUN1P11.

**STROBE LIGHT KIT** Adjustable from 1 Hz right up to 60Hz! (electronic assembly kit with full instructions) £16 ref EF28.

**ROCK LIGHTS** Unusual things these, two pieces of rock that glow when rubbed together! Believed to cause rain! £3 a pair Ref EF29.

**AMSTRAD GX4000** games machines, returns, untested, sold as seen. Just £2.99 ref EF186.

**NEW HIGH POWER LASERS** 15mW, Helium neon, 3 switchable wave lengths 63um, 1.15um, 3.39um (2 of them are infrared) 500:1 polarizer built in so good for holography. Supplied complete with mains power supply. 790x65mm. Use with EXTREME CAUTION AND QUALIFIED GUIDANCE.

**NEW SALE PRICE TO CLEAR JUST £249+VAT**

**WE BUY SURPLUS STOCK FOR CASH FREE CATALOGUE**

**1995 100 PAGE CATALOGUE NOW AVAILABLE, 45P STAMP OR FREE WITH ORDER.**

**PORTABLE RADIATION DETECTOR WITH NEW COMPUTER INTERFACE £59**

A Hand held personal Gamma and X Ray detector. This unit contains two Geiger Tubes, has a 4 digit LCD display with a Piezo speaker, giving an audio visual indication. The unit detects high energy electromagnetic quanta with an energy from 30K eV to over 1.2M eV and a measuring range of 5-9999 UR/h or 10-99990 Nr/h. ref NOV18

**BULL ELECTRICAL**  
250 PORTLAND ROAD, HOVE, SUSSEX.  
BN3 5QT. (ESTABLISHED 50 YEARS).  
MAIL ORDER TERMS: CASH, PO OR CHEQUE WITH ORDER PLUS £3 POST PLUS VAT.  
PLEASE ALLOW 7-10 DAYS FOR DELIVERY PHONE ORDERS WELCOME (ACCESS VISA, SWITCH, AMERICAN EXPRESS)  
TEL: 01273 203500  
FAX 01273 323077

## Rugged 486 Based CPU Card

Berkshire based Advanced Modular Computer Ltd have announced the introduction of the 7000 embedded PC, the newest addition to the company's Micro PC family of rugged industrial computers. With full 16-bit ISA compatibility and a rich feature set the 7000 CPU card can operate in a wide range of configuration and conditions. Whether installed in a passive ISA bus packplate, used in standalone mode, or side-by-side with Micro PC expansion cards, the 4.5x 4.9 inch 7000 is ideal for high-performance embedded applications. In particular the 7000 is intended for use with applications that require Window (TM) or a real-time operating system like QNX (R).

The 7000's robust 25MHz 486SLC processor features built in primary cache to maximise performance. The 16-bit data bus doubles throughput over the previous generation of 8-bit ISA bus-compatible cards.

Other key components of the 7000 include three solid state disks that look like DOS drives to the user and which together can be configured with up to 2.5 Mbytes of total storage capacity. Each disk is intended to fulfil a distinct system function. The first solid state disk contains the AT-compatible BIOS with industrial extensions, utility software and DOS 6.0 in ROM. The availability of DOS in ROM, or "instant DOS", eliminates uncertainty about how application software will run on the 7000. QNX or other real-time operating systems can be installed in place of DOS, should the user wish to do so.

The second solid state disk is intended for storage of the application program and can be configured with either 1Mbyte of EPROM or 512 Kbytes of flash memory. The flash programme is built in to a low reprogramming through a serial port. The third solid state disk is multi-functional and can be used for data conversion tables, multiple language support or other operating systems. This disk can be configured with a choice of up to 512 Kbytes of SRAM, 512 Kbytes of flash memory, or 1Mbyte of EPFCM.

The 7000 also contains 4-8 Mbytes of DRAM, a coprocessor socket that accepts an 3C387SX coprocessor, two 16C550-compatible serial ports with an RS232/422/485 interface, and LPT1 bi-directional parallel port, watchdog timer with a time-out of 1.2 seconds, an AT-style calendar clock, and keyboard and speaker ports.

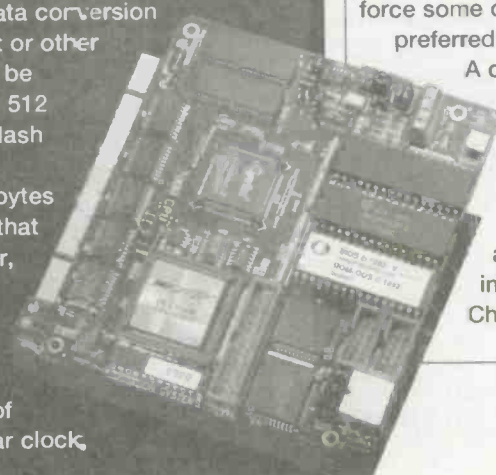

## Advanced Filter Circuit Synthesis Program

For further information  
please contact Number One  
Systems on 01480 461778.

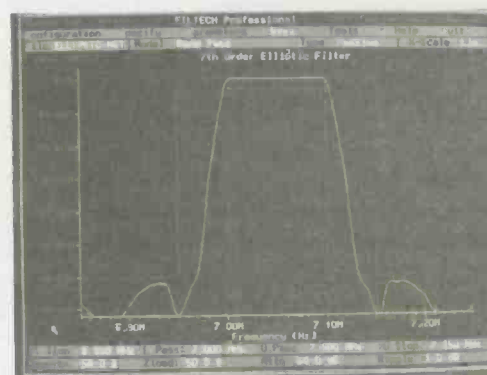

FILTECH Professional, newly released by Number One Systems, is a low cost, easy-to-use software package that can completely de-skill the process of designing both active and passive filter circuits. With FILTECH Professional, a finished filter design can be obtained simply by specifying the required frequency response and terminating impedances.

However, FILTECH Professional does not eliminate the engineer entirely. Now that the tedious and repetitive calculations are taken over by the program, the designer is free to question and experiment. It takes less than half a minute to see the effect of reducing or increasing the filter order, of changing the filter type from, say, Butterworth to Elliptic or of altering the frequency limits or attenuation level. You can even force some or all of the components to the nearest preferred value and see the effect straight away.

A circuit simulator is built right into FILTECH allowing both the filter specification and the synthesized circuit behaviour to be seen together on the same frequency plot. Available for just £245 or US\$475, FILTECH Professional designs both active and passive filters up to twelfth order and includes support for Bessel, Butterworth Chebyshev and Elliptic (Cauer) filters.

For more information  
contact AMC on  
01753 580660.

# pentium

PROCESSOR

## Cooling Fan Extends Life

Now available from Rendar is a cooling fan which can be mounted on Pentium processors to prolong their life by up to ten times.

The Pentium chip fan assists in the optimisation of PC thermal design at a price which is economical when set against the benefit of extended processor life. 'Fit and forget' is the keynote of this miniature fan, which is installed and operating within minutes and efficiently dissipates heat from the chip with high reliability. Polarity and locked-rotor protection are built in for added safety.

The fan can be used with Pentium chips mounted in either conventional or ZIF sockets. It is supplied with a jumper cable set which enables it to be powered from the computer's power source without soldering or re-making of board jumpers. It loads the 12V rail by just 1.6 watts.

For further information  
contact Rendar Limited  
on 01233 866741 S O R

Mitsubishi Electric is announcing the introduction at Embedded Systems '95 of the M3747x Group of 8bit small outline microcontrollers incorporating improved serial communications. The new devices are ideal for office automation, automotive and data logging applications where compact end product design is essential.

The microcontroller Group features USART functions enabling compact data communications. The 71 instruction set devices are specified at a minimum execution time of 0.5µs, with the fastest instructions at 8MHz. The devices operate from 2.7 to 5.5V supplies and incorporate four 8bit timers with input latch functions and PWM mode. The serial I/O has both clock synchronous and asynchronous modes.

Additional features include up to 8 channel A-D conversion with 8bit resolution and an external reference voltage. The PWM function is via an 8bit timer and key on wake-up functions and two built-in clock generating circuits are provided.

The MCU Group is designed with 32 programmable I/O ports and two input ports. A version is also available featuring 22 programmable I/Os and four input ports. Five external, six internal and one software interrupts are provided, and input/output programmable pull-up resistance is built in.

## Small Outline

### MCUs

For further  
information contact  
Mitsubishi Electric  
UK Ltd, on 01707  
276 100.

# Infinite Heatsink 100Watt Iron

Greenwood Electronic Components recently launched their new range of Superscope soldering irons. These tools are able to maintain soldering temperature against a heavy workpiece, or in sub-zero conditions, due to their unique action that enables run-up to working temperature from cold in 5 seconds. This enables the operator to have full capability when other irons have lost solder melting temperature.

This quick-heat action, with high power availability (100W), is further enhanced by manual control of temperature from 200°C to 500°C.

**Greenwood Electronic  
Components Ltd can  
be contacted on  
01734 333788.**

The standard iron is powered by a low-voltage (4V) Supply Unit. (A12V battery version is also available for Automotive or Marine use.) The unit has safety protection provided by an automatic cut-off.



## Hand held Instrument Measures Electromagnetic Disturbance

The problem of electromagnetic radiation and its disruptive effect upon electronic equipment is one that has been increasingly recognised in recent years. (So much so that the European Union has drawn up an EMC directive, coming into full effect from 1st January 1996, that will make all electrical appliances subject to various conformity standards.) A recently developed product that will enable these disruptive influences to be monitored and minimised is the Gauss Maus. This hand-held, portable instrument measures alternating and static magnetic fields and has two frequency ranges: 20Hz to 5Hz and 5kHz to 400kHz.

Electromagnetic interference can emanate from numerous sources, and all types of electronic equipment can be susceptible. For example, computers and telecommunications equipment within a building can be severely affected by other systems and products elsewhere in the building, such as lifts, escalators and air-conditioning systems. A telephone system may affect PC networks, whilst electrical cables can cause considerable disturbance in certain circumstances.

Between-floors or in-ceiling power reticulation is often not installed correctly to minimise spurious emissions and resultant fields can be as high as 500milliGauss (mG), which can grossly affect CRT monitors. The Gauss Maus is able to map these various zones of interference and allows for preventative action to be taken. Because the Gauss Maus is a hand-held instrument it affords the operator greater flexibility and allows for increased accuracy in the detection of the coverage and density of magnetic fields. The instrument is user friendly and thus easy to operate. It comprises a sensor unit, that can be held in one hand, linked by spring coil cable to a measuring unit, held in the other hand. Measurements provided are traceable to International Standards and can touch a minimum low range resolution of 0.1mG. The full range covers 0-9.9mG and 0-99mG.

Applications of the Gauss Maus will be many. Amongst those benefitting from its use will be medical establishments where magnetic fields can disrupt sensitive instrumentation, such as electron microscopes, and also where the emissions from powerful scanning equipment can be dangerous with a certain radius. Computer database centres will be able to enlist the instrument to minimise system failures and also to improve overall computer efficiency. Also, testing houses can deploy the instrument in the testing of new products, analysing their immunity to emissions from external sources and also the level of their own emissions.



**Further information  
contact Magtronics on  
0117 977 1404.**



# First 0.35 Micron Drawn Gate Array Technology

NEC Electronics has launched CMOS-9, the industry's first 0.35 micron drawn (0.27-micron effective) gate array technology. The 3.3 volt highly integrated family supports up to two million raw gates (1.2 million usable gates) arranged in a sea-of-gates architecture. CMOS-9 will provide user benefits of lower power and higher speed.

CMOS-9 utilises NEC's advanced two and three layer metal CMOS process and is ideal for applications requiring system speeds of up to 155MHz. It includes 20 base arrays, ranging from 190K to two million gates, arranged in a sea-of-gates architecture.

The CMOS-9 family provides low power dissipation (0.9µW/MHz/gate) at 3.3 volts and in this respect is 30 percent more energy efficient than a 0.5 micron technology such as NEC's CMOS-8. Furthermore, a two input NAND gate offers a speed of 119 picoseconds at 3.3 volts compared with 160 picoseconds (typical) at 5 volts.

CMOS-9 supports all standard I/O and macro functions whilst high speed I/O functions include support for the PCI bus interface at up to 66MHz. The family can also interface to existing 5 volt environments without damage by using 5 volt protected I/O. A full family of standard and slew-rate controlled LVTTTL I/O is also available.

Support for high speed interface standards, including Gunning Transistor Logic (GTL) and High Speed Transceiver Logic (HSTL), is available whilst pseudo Emitter-Couple Logic (pECL) is under development. The latter provides customers with a high speed, low noise interface to existing ECL components.

Features required to support high speed systems design include Digital Phase-Locked Loops (DPLL) to minimise chip-to-chip clock skew, and Clock Tree Synthesis to minimise on-chip clock skew. CMOS-9 also offers Random Access Memory (RAM) as a soft macro, allowing customers to optimise RAM for each application.

The CMOS-9 family is fully supported by a complete set of sophisticated design tools offered with NEC's OpenCAD (TM) Design System. The OpenCAD (TM) version 4 combines both popular third party tools with proprietary tools such as floorplanner and wire delay calculator. NEC's floorplanner guarantees more accurate simulation results by creating an estimated layout in order to minimise critical path interconnect delays.

NEC also employs a highly accurate delay calculation methodology, Table Look-up, designed specifically to respond to the challenges associated with deep sub-micron design. Table Look-up is a non-linear delay calculation developed in co-operation with Synopsys. It utilises data from NEC's proprietary delay calculator during both synthesis and simulation to ensure close correlation to final silicon.

Clock Tree Synthesis is used for clock skew management and has improved the performance of hundreds of designs since its introduction with NEC's 0.8 micron generation of ASIC products. Together with PLL, Clock Tree Synthesis manages clock skew through the insertion of a balanced buffer tree that allows devices to achieve very high performance.



0.35 MICRON

**For more information  
contact NEC  
Electronics (UK) Ltd,  
on 01908 691133.**

## Event Diary

- |                 |  |
|-----------------|--|
| 1 to 2nd July   | VHF Field Day Contest Weekend, Crystal Palace and District Radio Club, London.<br>Tel: 0181 6995732                  |
| 4 July          | Operating QRP, Sunbury and District Radio Amateurs, Wells Hall Old School, Great Cornard.<br>Tel: 01787 313212       |
| 10 July         | Summer School, Stratford upon Avon and District Radio Society, Stratford upon Avon.<br>Tel: 01789 740994.            |
| 24 July         | Construction Competition, Stratford upon Avon and District Radio Society, Stratford upon Avon.<br>Tel: 01789 740994. |
| 20 August       | Evening on Air, Crystal Palace and District Radio Club, London.<br>Tel: 0181 6995732                                 |
| 27 August       | East Coast Amateur Radio and Computer Rally, Clacton Leisure Centre.<br>Tel: 01473 272002                            |
| 2 September     | Wight Wireless Rally, Arreton Manor Wireless Museum, Newport, IOW,<br>Tel: 01983 567665                              |
| 2-3rd September | HF SSB Field Contest Weekend, Crystal Palace and District Radio Club, London.<br>Tel: 0181 6995732                   |

If you are organising an event which you would like to have included in this section please send full details to: ETI, Nexus House, Boundary Way, Hemel Hempstead, Herts HP2 7ST. Clearly mark your envelope Event Diary.

**POWER AMPLIFIER MODULES-TURNABLES-DIMMERS-LOUDSPEAKERS-19 INCH STEREO RACK AMPLIFIERS**

\* PRICES INCLUDE V.A.T. \* PROMPT DELIVERIES \* FRIENDLY SERVICE \* LARGE (A4) S.A.E. 60p STAMPED FOR CATALOGUE \*

**OMP MOS-FET POWER AMPLIFIERS HIGH POWER, TWO CHANNEL 19 INCH RACK**

**THOUSANDS PURCHASED BY PROFESSIONAL USERS**



**THE RENOWNED MXF SERIES OF POWER AMPLIFIERS**

**FOUR MODELS:- MXF200 (100W + 100W) MXF400 (200W + 200W) MXF600 (300W + 300W) MXF900 (450W + 450W)**  
**ALL POWER RATINGS R.M.S. INTO 4 OHMS, BOTH CHANNELS DRIVEN**

**FEATURES:** ★ Independent power supplies with two toroidal transformers ★ Twin L.E.D. Vu meters ★ Level controls ★ Illuminated on/off switch ★ XLR connectors ★ Standard 775mV inputs ★ Open and short circuit proof ★ Latest Mos-Fets for stress free power delivery into virtually any load ★ High slew rate ★ Very low distortion ★ Aluminium cases ★ MXF600 & MXF900 fan cooled with D.C. loudspeaker and thermal protection.

**USED THE WORLD OVER IN CLUBS, PUBS, CINEMAS, DISCOS ETC.**

**SIZES:-** MXF200 W19"xH3 1/2" (2U)xD11"  
 MXF400 W19"xH5 1/4" (3U)xD12"  
 MXF600 W19"xH5 1/4" (3U)xD13"  
 MXF900 W19"xH5 1/4" (3U)xD14 1/2"

**PRICES:-** MXF200 £175.00 MXF400 £233.85  
 MXF600 £329.00 MXF900 £449.15  
 SPECIALIST CARRIER DEL. £12.50 EACH



**OMP X03 STEREO 3-WAY ACTIVE CROSS-OVER**



**Advanced 3-Way Stereo Active Cross-Over, housed in a 19" x 1U case. Each channel has three level controls: bass, mid & top. The removable front fascia allows access to the programmable DIL switches to adjust the cross-over frequency: Bass-Mid 250/500/800Hz, Mid-Top 1.8/3/5KHz, all at 24dB per octave, Bass Invert switches on each bass channel. Nominal 775mV input/output. Fully compatible with OMP rack amplifier and modules.**

**Price £117.44 + £5.00 P&P**

**STEREO DISCO MIXER SDJ3400SE**

**★ ECHO & SOUND EFFECTS ★**

**STEREO DISCO MIXER** with 2 x 7 band L & R graphic equalisers with bar graph LED Vu meters. **MANY OUTSTANDING FEATURES:-** Including Echo with repeat & speed control, DJ Mic with talk-over switch, 6 Channels with individual faders plus cross fade, Cue Headphone Monitor, 8 Sound Effects. Useful combination of the following inputs:- 3 turntables (mag), 3 mics, 5 Line for CD, Tape, Video etc.

**Price £144.99 + £5.00 P&P**



SIZE: 482 x 240 x 120mm

**PIEZO ELECTRIC TWEETERS - MOTOROLA**

Join the Piezo revolution! The low dynamic mass (no voice coil) of a Piezo tweeter produces an improved transient response with a lower distortion level than ordinary dynamic tweeters. As a crossover is not required these units can be added to existing speaker systems of up to 100 watts (more if two are put in series. FREE EXPLANATORY LEAFLETS ARE SUPPLIED WITH EACH TWEETER.

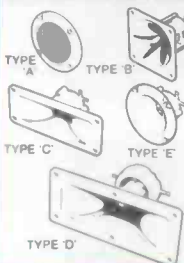

**TYPE 'A' (KSN1036A)** 3" round with protective wire mesh. Ideal for bookshelf and medium sized Hi-Fi speakers. Price £4.90 + 50p P&P.  
**TYPE 'B' (KSN1005A)** 3 1/2" super horn for general purpose speakers, disco and P.A. systems etc. Price £5.99 + 50p P&P.  
**TYPE 'C' (KSN1016A)** 2"x5" wide dispersion horn for quality Hi-Fi systems and quality discos etc. Price £6.99 + 50p P&P.  
**TYPE 'D' (KSN1025A)** 2"x6" wide dispersion horn. Upper frequency response retained extending down to mid-range (2KHz). Suitable for high quality Hi-Fi systems and quality discos. Price £9.99 + 50p P&P.  
**TYPE 'E' (KSN1038A)** 3 1/4" horn tweeter with attractive silver finish trim. Suitable for Hi-Fi monitor systems etc. Price £5.99 + 50p P&P.  
**LEVEL CONTROL** Combines, on a recessed mounting plate, level control and cabinet input jack socket. 85x85mm. Price £4.10 + 50p P&P.

**IBI FLIGHT CASED LOUDSPEAKERS**

A new range of quality loudspeakers, designed to take advantage of the latest speaker technology and enclosure designs. Both models utilize studio quality 12" cast aluminium loudspeakers with factory fitted grilles, wide dispersion constant directivity horns, extruded aluminium corner protection and steel ball corners, complemented with heavy duty black covering. The enclosures are fitted as standard with top hats for optional loudspeaker stands.

**POWER RATINGS QUOTED IN WATTS RMS FOR EACH CABINET FREQUENCY RESPONSE FULL RANGE 45Hz - 20KHz**

**ibi FC 12-100WATTS (100dB) PRICE £159.00 PER PAIR**  
**ibi FC 12-200WATTS (100dB) PRICE £175.00 PER PAIR**

SPECIALIST CARRIER DEL. £12.50 PER PAIR

**OPTIONAL STANDS PRICE PER PAIR £49.00**

Delivery £6.00 per pair



**IN-CAR STEREO BOOSTER AMPS**



**PRICES: 150W £49.99 250W £99.99 400W £109.95 P&P £2.00 EACH**

**THREE SUPERB HIGH POWER CAR STEREO BOOSTER AMPLIFIERS**

150 WATTS (75 + 75) Stereo, 150W Bridged Mono  
 250 WATTS (125 + 125) Stereo, 250W Bridged Mono  
 400 WATTS (200 + 200) Stereo, 400W Bridged Mono

**ALL POWERS INTO 4 OHMS**  
**Features:**  
 ★ Stereo, bridgable mono ★ Choice of high & low level inputs ★ L & R level controls ★ Remote on-off ★ Speaker & thermal protection.

**OMP MOS-FET POWER AMPLIFIER MODULES**

**SUPPLIED READY BUILT AND TESTED.**

These modules now enjoy a world-wide reputation for quality, reliability and performance at a realistic price. Four models are available to suit the needs of the professional and hobby market i.e. Industry, Leisure, Instrumental and Hi-Fi etc. When comparing prices, NOTE that all models include toroidal power supply, integral heat sink, glass fibre P.C.B. and drive circuits to power a compatible Vu meter. All models are open and short circuit proof.

**THOUSANDS OF MODULES PURCHASED BY PROFESSIONAL USERS**



**OMP/MF 100 Mos-Fet** Output power 110 watts R.M.S. into 4 ohms, frequency response 1Hz - 100KHz -3dB, Damping Factor > 300, Slew Rate 45V/uS, T.H.D. typical 0.002%, Input Sensitivity 500mV, S.N.R. -110 dB. Size 300 x 123 x 60mm.  
**PRICE £40.85 + £3.50 P&P**



**OMP/MF 200 Mos-Fet** Output power 200 watts R.M.S. into 4 ohms, frequency response 1Hz - 100KHz -3dB, Damping Factor > 300, Slew Rate 50V/uS, T.H.D. typical 0.001%, Input Sensitivity 500mV, S.N.R. -110 dB. Size 300 x 155 x 100mm.  
**PRICE £64.35 + £4.00 P&P**



**OMP/MF 300 Mos-Fet** Output power 300 watts R.M.S. into 4 ohms, frequency response 1Hz - 100KHz -3dB, Damping Factor > 300, Slew Rate 60V/uS, T.H.D. typical 0.001%, Input Sensitivity 500mV, S.N.R. -110 dB. Size 330 x 175 x 100mm.  
**PRICE £81.75 + £5.00 P&P**



**OMP/MF 450 Mos-Fet** Output power 450 watts R.M.S. into 4 ohms, frequency response 1Hz - 100KHz -3dB, Damping Factor > 300, Slew Rate 75V/uS, T.H.D. typical 0.001%, Input Sensitivity 500mV, S.N.R. -110 dB, Fan Cooled, D.C. Loudspeaker Protection, 2 Second Anti-Thump Delay. Size 385 x 210 x 105mm.  
**PRICE £132.85 + £5.00 P&P**



**OMP/MF 1000 Mos-Fet** Output power 1000 watts R.M.S. into 2 ohms, 725 watts R.M.S. into 4 ohms, frequency response 1Hz - 100KHz -3dB, Damping Factor > 300, Slew Rate 75V/uS, T.H.D. typical 0.002%, Input Sensitivity 500mV, S.N.R. -110 dB, Fan Cooled, D.C. Loudspeaker Protection, 2 Second Anti-Thump Delay. Size 422 x 300 x 125mm.  
**PRICE £259.00 + £12.00 P&P**

NOTE: MOS-FET MODULES ARE AVAILABLE IN TWO VERSIONS: STANDARD - INPUT SENS 500mV, BAND WIDTH 100KHz. PEG (PROFESSIONAL EQUIPMENT COMPATIBLE) - INPUT SENS 775mV, BAND WIDTH 50KHz. ORDER STANDARD OR PEG.

**LOUDSPEAKERS**

**LARGE SELECTION OF SPECIALIST LOUDSPEAKERS AVAILABLE, INCLUDING CABINET FITTINGS, SPEAKER GRILLES, CROSS-OVERS AND HIGH POWER, HIGH FREQUENCY BULLETS AND HORNS, LARGE (A4) S.A.E. (60p STAMPED) FOR COMPLETE LIST.**



McKenzie and Fane Loudspeakers are also available.

**EMINENCE:- INSTRUMENTS, P.A., DISCO, ETC**

**ALL EMINENCE UNITS 8 OHMS IMPEDANCE**

8" 100 WATT R.M.S. ME8-100 GEN. PURPOSE, LEAD GUITAR, EXCELLENT MID, DISCO. PRICE £32.71 + £2.00 P&P  
 RES. FREQ. 72Hz, FREQ. RESP. TO 4KHz, SENS 97dB.  
 10" 100 WATT R.M.S. ME10-100 GUITAR, VOCAL, KEYBOARD, DISCO, EXCELLENT MID. PRICE £33.74 + £2.50 P&P  
 RES. FREQ. 71Hz, FREQ. RESP. TO 7KHz, SENS 97dB.  
 10" 200 WATT R.M.S. ME10-200 GUITAR, KEYB'D, DISCO, VOCAL, EXCELLENT HIGH POWER MID. PRICE £43.47 + £2.50 P&P  
 RES. FREQ. 65Hz, FREQ. RESP. TO 3.5KHz, SENS 99dB.  
 12" 100 WATT R.M.S. ME12-100LE GEN. PURPOSE, LEAD GUITAR, DISCO, STAGE MONITOR. PRICE £35.84 + £3.50 P&P  
 RES. FREQ. 49Hz, FREQ. RESP. TO 6KHz, SENS 100dB.  
 12" 100 WATT R.M.S. ME12-100LT (TWIN CONE) WIDE RESPONSE, P.A., VOCAL, STAGE MONITOR. RES. FREQ. 42Hz, FREQ. RESP. TO 10KHz, SENS 98dB. PRICE £36.87 + £3.50 P&P  
 12" 200 WATT R.M.S. ME12-200 GEN. PURPOSE, GUITAR, DISCO, VOCAL, EXCELLENT MID. PRICE £46.71 + £3.50 P&P  
 RES. FREQ. 58Hz, FREQ. RESP. TO 6KHz, SENS 98dB.  
 12" 300 WATT R.M.S. ME12-300GP HIGH POWER BASS, LEAD GUITAR, KEYBOARD, DISCO ETC. PRICE £70.19 + £3.50 P&P  
 RES. FREQ. 47Hz, FREQ. RESP. TO 5KHz, SENS 103dB.  
 15" 200 WATT R.M.S. ME15-200 GEN. PURPOSE BASS, INCLUDING BASS GUITAR. PRICE £50.72 + £4.00 P&P  
 RES. FREQ. 46Hz, FREQ. RESP. TO 5KHz, SENS 99dB.  
 15" 300 WATT R.M.S. ME15-300 HIGH POWER BASS, INCLUDING BASS GUITAR. PRICE £73.34 + £4.00 P&P  
 RES. FREQ. 39Hz, FREQ. RESP. TO 3KHz, SENS 103dB.

**EARBENDERS:- HI-FI, STUDIO, IN-CAR, ETC**

**ALL EARBENDER UNITS 8 OHMS (EXCEPT EB8-50 & EB10-50 WHICH ARE DUAL IMPEDANCE TAPPED @ 4 & 8 OHM)**

**BASS, SINGLE CONE, HIGH COMPLIANCE, ROLLED SURROUND**  
 8" 50WATT EB8-50 DUAL IMPEDANCE, TAPPED 4/8 OHM BASS, HI-FI, IN-CAR. PRICE £8.90 + £2.00 P&P  
 RES. FREQ. 40Hz, FREQ. RESP. TO 7KHz, SENS 97dB.  
 10" 50WATT EB10-50 DUAL IMPEDANCE, TAPPED 4/8 OHM BASS, HI-FI, IN-CAR. PRICE £13.65 + £2.50 P&P  
 RES. FREQ. 40Hz, FREQ. RESP. TO 5KHz, SENS. 99dB.  
 10" 100WATT EB10-100 BASS, STUDIO, HI-FI. PRICE £30.39 + £3.50 P&P  
 RES. FREQ. 35Hz, FREQ. RESP. TO 3KHz, SENS 96dB.  
 12" 100WATT EB12-100 BASS, STUDIO, HI-FI, EXCELLENT DISCO. PRICE £42.12 + £3.50 P&P  
 RES. FREQ. 26Hz, FREQ. RESP. TO 3 KHz, SENS 93dB.  
**FULL RANGE TWIN CONE, HIGH COMPLIANCE, ROLLED SURROUND**  
 5 1/4" 60WATT EB5-60TC (TWIN CONE) HI-FI, MULTI-ARRAY DISCO ETC. PRICE £9.99 + £1.50 P&P  
 RES. FREQ. 63Hz, FREQ. RESP. TO 20KHz, SENS 92dB.  
 6 1/2" 60WATT EB6-60TC (TWIN CONE) HI-FI, MULTI-ARRAY DISCO ETC. PRICE £10.99 + 1.50 P&P  
 RES. FREQ. 38Hz, FREQ. RESP. TO 20KHz, SENS 94dB.  
 8" 60WATT EB8-60TC (TWIN CONE) HI-FI, MULTI-ARRAY DISCO ETC. PRICE £12.99 + £1.50 P&P  
 RES. FREQ. 40Hz, FREQ. RESP. TO 18KHz, SENS 89dB.  
 10" 60WATT EB10-60TC (TWIN CONE) HI-FI, MULTI ARRAY DISCO ETC. PRICE £16.49 + £2.00 P&P  
 RES. FREQ. 35Hz, FREQ. RESP. TO 12KHz, SENS 98dB.

**TRANSMITTER HOBBY KITS**

**PROVEN TRANSMITTER DESIGNS INCLUDING GLASS FIBRE PRINTED CIRCUIT BOARD AND HIGH QUALITY COMPONENTS COMPLETE WITH CIRCUIT AND INSTRUCTIONS**

3W TRANSMITTER 80-108MHz. VARICAP CONTROLLED PROFESSIONAL PERFORMANCE. RANGE UP TO 3 MILES, SIZE 38 x 123mm. SUPPLY 12V @ 0.5AMP. PRICE £14.85 + £1.00 P&P

FM MICRO TRANSMITTER 100-108MHz. VARICAP TUNED, COMPLETE WITH VERY SENS FET MIC, RANGE 100-300m. SIZE 56 x 46mm. SUPPLY 9V BATTERY. PRICE £8.80 + £1.00 P&P



PHOTO: 3W FM TRANSMITTER

**B.K. ELECTRONICS**

UNITS 1 & 5 COMET WAY, SOUTHEND-ON-SEA, ESSEX. SS2 6TR

Tel. 01702 - 527572 Fax: 01702-420243

POSTAL CHARGES PER ORDER £1.00 MINIMUM. OFFICIAL ORDERS FROM SCHOOLS, COLLEGES, GOVT. BODIES, PLCs ETC. PRICES INCLUSIVE OF V.A.T. SALES COUNTER. VISA AND ACCESS ACCEPTED BY POST, PHONE OR FAX.





**8 CAVANS WAY,  
BINLEY INDUSTRIAL ESTATE,  
COVENTRY CV3 2SF**  
Tel: 01203 650702  
Fax: 01203 650773  
Mobile: 0860 400683

(Premises situated close to Eastern-by-pass in Coventry with easy access to M1, M6, M40, M42, M45 and M69)

### OSCILLOSCOPES

Gould OS3000/ADVANCE 3000 - 30MHz Dual ch .....	£200
Gould 4035 - 20MHz Digital storage .....	£500
Gould 4050 - 35MHz Digital storage .....	£650
Gould 5110 - 100MHz Intelligent oscilloscope .....	£850
Gould OS4000, OS4200, OS4100, OS1000B .....	from £125
Hewlett Packard 1740A, 1741A, 17744A, 100MHz dual ch .....	from £350
Hewlett Packard 1707A, 1707B - 75MHz 2ch .....	from £275
Hewlett Packard 54201A - 300MHz Digitizing .....	£1750
Hewlett Packard 54501A - 100MHz - Digitizing 4 channel .....	£1950
Hewlett Packard 54504A - 400MHz Digitizing .....	£3500
Hitachi V422 - 40MHz Dual channel .....	£300
Hitachi V212 20MHz Dual Channel .....	£175
Nicolet 3091 - LF D.S.O .....	£1100
Phillips PM 3315 - 60MHz - D.S.O .....	£750
Phillips 3206, 3211, 3212, 3217, 3226, 3240 .....	from £125 to £350
3243, 3244, 3261, 3262 (2ch + 4ch) .....	
Phillips PM 3295A - 400MHz Dual Channel .....	£1950
Phillips PM 3296 - 350MHz Dual Channel .....	£1750
Tektronix 2213 - 60MHz Dual Channel .....	£425
Tektronix 2215 60MHz dual trace .....	£450
Tektronix 2235 Dual trace 100MHz (portable) .....	£800
Tektronix 2236 - 100 Mhz - 4 channel with Counter/Timer/D.M.M .....	£995
Tektronix 2335 Dual trace 100MHz (portable) .....	£750
Tektronix 2225 - 50MHz dual ch .....	£450
Tektronix 2465A - 350MHz , 4 channel .....	£2950
Tektronix 2465B - 400 Mhz 4 channel .....	£3950
Tektronix 464/466 - 100MHz An storage .....	from £350
Tektronix 465/465B - 100MHz dual ch .....	from £350
Tektronix 7313, 7603, 7613, 7623, 7633, 100MHz 4 ch .....	from £300
Tektronix 7704 - 250MHz 4 ch .....	from £650
Tektronix 7844 - Fitted with 7A42, 7B80, 7B85 Plug-Ins .....	£1500
Tektronix 7904 - 500MHz .....	from £850
Tektronix 468 - 100MHz Digital Storage .....	£800
Tequipment D68 - 50MHz Dual Channel .....	£200
Iwatsu TS 8123 - 100 Mhz - D. Storage .....	£850

Other scopes available too

### SPECTRUM ANALYSERS

Alltech 727 - Spec. Analyser 22.4 GHz with .....	} £2000
Alltech 70727 - Tracking Generator (10KHz - 12.4 GHz) .....	
Hewlett Packard 3580A - 5Hz-50KHz .....	£995
Hewlett Packard 3709B - Constellation Analyser with 15709A High Impedance Interface (As New) .....	£P.O.A.
Hewlett Packard 182T with 8559A (10MHz - 21GHz) .....	£3750
HP 3582A - 25KHz Analyser, dual channel .....	£2500
Hewlett Packard 35601A - Spectrum Analyser Interface .....	£1000
Hewlett Packard 8754A - Network Analyser 4 - 1300MHz .....	£3250
Marconi 2370 - 110MHz .....	£995
Marconi 2371 - 30KHz - 200MHz .....	£1250
Polrad 641-1 - 10MHz - 18GHz .....	£1500
Rohde & Schwarz - SWOB 5 Polyskop 0.1 - 1300MHz .....	£2750
Schlumberger 1250 - Frequency Response Analyser .....	£2500
Tektronix 7L12 with 7603 mainframe (1.8GHz) .....	£1500
Tektronix 7L14 with 7603 mainframe (1.8GHz) .....	£2000
Tektronix 7L18 with 7603 mainframe (18GHz) .....	£2950
Texscan AL51A (4MHz - 1GHz) .....	£995

### MISCELLANEOUS

Anritsu MG642A Pulse Pattern Generator .....	£1500
Avo VCM 163 Valve Characteristic Meter .....	£400
Ballantine 323 True RMS Voltmeter .....	£350
Data I/O Model 29B (with 12 fixtures) + Logic pack .....	£995
Datalab DL 1080 Programmable Transient Recorder .....	£350
Dyanpert TP20 Intelliplace - Tape peel Tester - immaculate condition .....	£1950
Farnell 2081 R/F Power meter .....	POA
Farnell TSV 70 MkII Power Supply (70V-5A or 35V-10A) .....	£200
Ferroglyph RTS-2 Audio Test Set with ATU 1 .....	£500
Fluke 8010A/8012A/8050A Digital multimeters - from .....	£125
Fluke 5101A AC/DC Callibrator .....	£3500
Fluke 5101B AC/DC Callibrator .....	£6500
Fluke 5220A Transconductance Amplifier (20A) .....	£3000
Fluke 720A Kelvin-Varley Voltage Divider .....	£450
Fluke 750A Reference Divider .....	£450
Gould TA 600 - Thermal Array Recorder .....	£400
Gould K100D - 100MHz Logic Analyser with Pods .....	£350
Heiden 1107 - 30V-10A Programmable Power Supply (IEEE) .....	£650
Hewlett Packard 334A - Distortion Analyser .....	£250
Hewlett Packard 3437A System voltmeter .....	£350
Hewlett Packard 3456A Digital voltmeter .....	£850
Hewlett Packard 3760/3761 Data gen + error detector .....	each £300
Hewlett Packard 3762/3763 Data gen + error detector .....	each £350
Hewlett Packard 5420A Digital Signal Analyser .....	£350
Hewlett Packard 5423A Structural Dynamics Analyser .....	£350
Hewlett Packard 54470B Digital Filter .....	£100
Hewlett Packard 54410A Analogue/Digital Converter .....	£100
Hewlett Packard 7402 Recorder with 17401A x 2 plug-ins .....	£300
Hewlett Packard 8011A Pulse gen. 0.1Hz-20MHz .....	£500
Hewlett Packard 8406A Frequency comb. generator .....	£500
Hewlett Packard 8443A Tracking gen/counter with IEEE .....	£300/400
Hewlett Packard 8620C Sweep oscillator mainframe .....	£400
Hewlett Packard 8750A Storage normaliser .....	£375

Hewlett Packard 8684A 5.4GHz to 12.5GHz Sig-Gen .....	£3000
Hewlett Packard 8640B - AM/FM Signal Gen (512MHz) .....	£850
Hewlett Packard 5340A - 18GHz Frequency Counter .....	£900
Hewlett Packard 5356A - 18GHz Frequency Converter head .....	£450
Hewlett Packard 432A - Power Meter (with 478A Sensor) .....	£275
Hewlett Packard 435A or B Power Meter (with 8481A/8484A) .....	from £750
Hewlett Packard 3438A Digital multimeter .....	£200
Hewlett Packard 6181C D.C. current source .....	£150
Hewlett Packard 59501B HP.1B isolated D/A power supply programmer .....	£150
Hewlett Packard 3711A/3712A/3791B/3793B Microwave Link Analyser .....	£3500
Hewlett Packard 5316A Universal Counter HP1B .....	£550
Hewlett Packard 5316B Universal Counter HP1B .....	£775
Hewlett Packard 5385A Frequency Counter - 1GHz - (HP1B) with OPTS 001/003/004/005 .....	£995
Hewlett Packard 3779C Primary Multiplex Analyser .....	£1000
Hewlett Packard 6623A Triple output system power supply .....	£1950
Hewlett Packard 6453A Power supply 15v-200A .....	£1100
Hewlett Packard 3764A (Opt 002) Digital Transmission Analyser .....	£2750
Hewlett Packard 3586A Selective level meter .....	£1750
Hewlett Packard 3325A - 21MHz Synthesiser/Function Gen .....	£1500
Hewlett Packard 8152A - Optical Average Power Meter .....	£1250
Hewlett Packard 8158B - Optical Attenuator (OPTS 002 + 011) .....	£1100

### HEWLETT PACKARD 6261B

**Power Supply 20v-50A £500 Discount for Quantities**

International Light - IL 1700 Research Radiometer with Erythermal Sensor Head .....	£1250
Krohn-Hite 2200 Lin/Log Sweep Generator .....	£995
Krohn-Hite 4024A Oscillator .....	£250
Krohn-Hite 6500 Phase Meter .....	£250
Lyons PG73N/PG75/PG28/PG Pulse generator .....	from £225
Marconi 2432A 500MHz digital freq. meter .....	£200
Marconi 2337A Automatic dist. meter .....	£150
Marconi 2356 20MHz level oscillator .....	£300
Marconi 2306 Programmable Interface .....	£450
Marconi 2830 Multiplex tester .....	£850
Marconi 2831 Channel access switch .....	£250
Marconi 2019 - AM/FM Signal generator - 1040 MHz .....	£1800
Multicore "Vapourrette" Bench Top Vapour Phase SMD Soldering Machine (New + Unused) .....	£650
Phillips 5390 1GHz R/F Synthesised signal gen .....	£1250
Phillips PM 5167 10MHz function gen .....	£400
Phoenix 5500A - Telecomms Analyser with various Interface Options .....	£3250
Racal Dana 9242D Programmable PSU 25V-2A .....	£300
Racal Dana 9246S Programmable PSU 25V-10A .....	£400
Racal Dana 3100 40-130MHz synthesiser .....	£750
Racal Dana 5002 Wideband eval meter .....	£650
Racal Dana 5003 Digital m/meter .....	£150
Racal Dana 9000 Microprocessing timer/count. 520MHz .....	£550
Racal Dana 9081 Synth. sig. gen. 520MHz .....	£550
Racal Dana 9084 Synth. sig. gen. 104MHz .....	£450
Racal Dana 9303 True RMS/R/Fevel meter .....	£650
Racal Dana 9341 LCR databridge .....	£250
Racal Dana 9500 Universal timer/counter 100MHz .....	£200
Racal Dana 9917 UHF frequency meter 560MHz .....	£175
Racal Dana 9302A R/F millivoltmeter (new version) .....	£375
Racal Dana 9082 Synthesised am/fm sig gen (520MHz) .....	£500
Racal 9301A - True RMS R/F Millivoltmeter .....	£300
Racal 9921 - 3GHz Frequency Counter .....	£450
Rohde & Schwarz BN36711 Digital Q meter .....	£400
Rohde & Schwarz - Scud Radio Code Test Set .....	£995
Rohde & Schwarz - LFM 2 Sweep Generator 0.02 - 60MHz .....	£1500
Rohde & Schwarz SUF 2 Noise Generator .....	£300
Rotek 3980A AC/DC Precision Calibrator with Rotek 350A High Current Adaptor .....	£POA
Schlumberger S.I. 4040 Stabilock - High accuracy 1GHz Radio Test Set .....	£5950
Schlumberger 4923 Radio Code Test Set .....	£1500
Schlumberger 2720 1250 MHz Frequency Counter .....	£500
Solarton Schlumb 1170 Freq. response analyser .....	£250
Systems Video 1258 Waveform Analyser + 1255 Vector Monitor + 1407 Differential Phase and Gain Module + 1270 Remote Control Panel .....	£2250
Systron Donner 1702 Synthesised Sig. Gen 1GHz .....	£990
Systron Donner 6054B or D 18GHz or 24GHz Freq. Counter .....	from £800
Tequipment CT71 Curve Tracer .....	£250
Tektronix TM5003 + AFG 5101 Arbitrary Function Gen. .....	£1750
Tektronix 1240 Logic Analyser .....	£750
Tektronix 1480 Waveform Monitor .....	POA
Tektronix 651 HR Monitor .....	POA
Tektronix DAS9100 - Series Logic Analyser .....	£500
Tektronix 577 - Curve Tracer with Fixtures .....	£950
Tektronix - Plug-ins - many available such as SC504, SW503, SG502, PG508, FG504, FG503, TG501, TR503 + many more .....	£POA
Time 9811 Programmable Resistance .....	£600
Time 9814 Voltage Callibrator .....	£750
Wayne Kerr B424/N LCR Component Meter Set .....	£200
W&G SPM12 Level Meter (200Hz - 6MHz) .....	£500
W&G PS12 Level Oscillator (200Hz - 6MHz) .....	£500
Weller D801/D802 Desoldering station .....	£175
Wiltron 560 Scalar Network Analyser .....	£800
Wiltron 352 Low Frequency Differential Input Phase Meter .....	£350
EIP 331 - Frequency counter 18GHz .....	£700

**MANY MORE ITEMS AVAILABLE - SEND LARGE S.A.E. FOR LIST OF EQUIPMENT ALL EQUIPMENT IS USED - WITH 30 DAYS GUARANTEE. PLEASE CHECK FOR AVAILABILITY BEFORE ORDERING - CARRIAGE & VAT TO BE ADDED TO ALL GOODS**

**A**

According to recent reports in the financial press, the cable TV and telecommunications companies, will be invest, during the next ten years, over £38 billion in construction of a sophisticated fibre optic network that will connect virtually every home in the UK. The service which will be on offer is a revolutionary fusion of telecommunications, broadcasting and computing - what is increasingly referred to as digital interactive TV.

Digital interactive TV, or iTV, can best be thought of as a service where a film or programme can be selected in much the same way as a film is selected by someone visiting a video library - what is known as a video on demand service. It will also be able to provide standard telephone communications in both voice and video form, computer data communications and new services such as home banking, tele-shopping, interactive education, specialist information services, and even multiplayer computer games.

This enormous investment forms the mass market popular end of the information superhighway. It is already seen by many as forming the basis of the next big industrial boom, one

that will change the way in which we all live, and a technology in which the UK is one of the world leaders.

In Cambridge, the world's most advanced ATM based fully digital iTV system is now up and running. This technology test system has been designed and built by a consortium of UK companies and now is connected to about 250 households, rising to over 1,000 by the end of the year, in the Cambridge area.

The consortium consists of one of the world's leading iTV companies, OnLine Media (a fully owned subsidiary of Acorn Computers), Cambridge Cable, computer giants ICL and Olivetti, plus experts in ATM switching systems, SJ Research and Advanced Telecommunications Modules Ltd. In addition, the consortium has enjoyed a lot of assistance from Cambridge University.

In addition to the Cambridge test site, there is another UK iTV test being conducted in the Ipswich and Colchester area by BT, based upon a more conventional mixture of copper cables and fibre-optic cables with ADSL technology. The BT trial system is expected to link over 2,500 households by the end of this year.



# Digital Interactive

9  
Play CD

7  
Music

3  
Documentaries

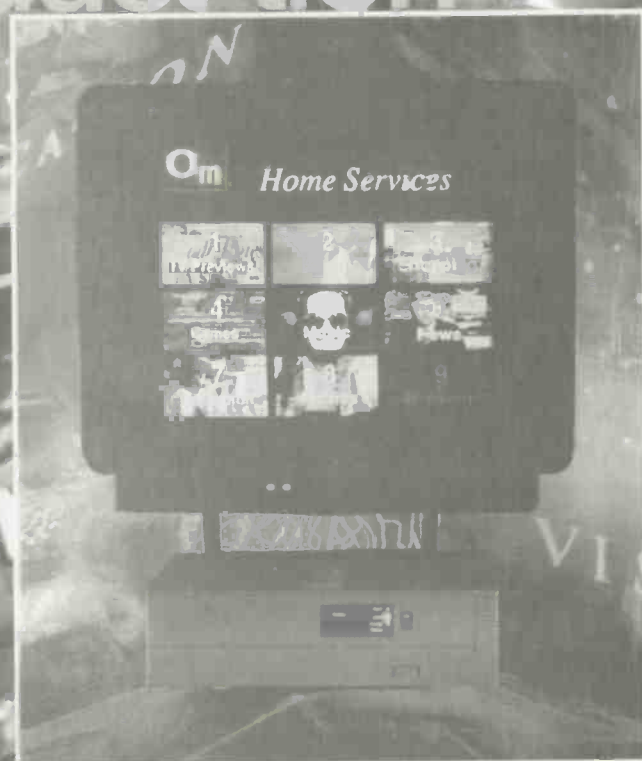

*Advanced technology which combines very powerful personal computers with fibre optic networks, telephone systems, data communications systems and television looks set to bring a whole range of new multimedia services into the homes of nearly everyone within the next ten years. Nick Hampshire looks at the world leading technology being developed in this country, and where it will lead us in the coming decade*

# Television

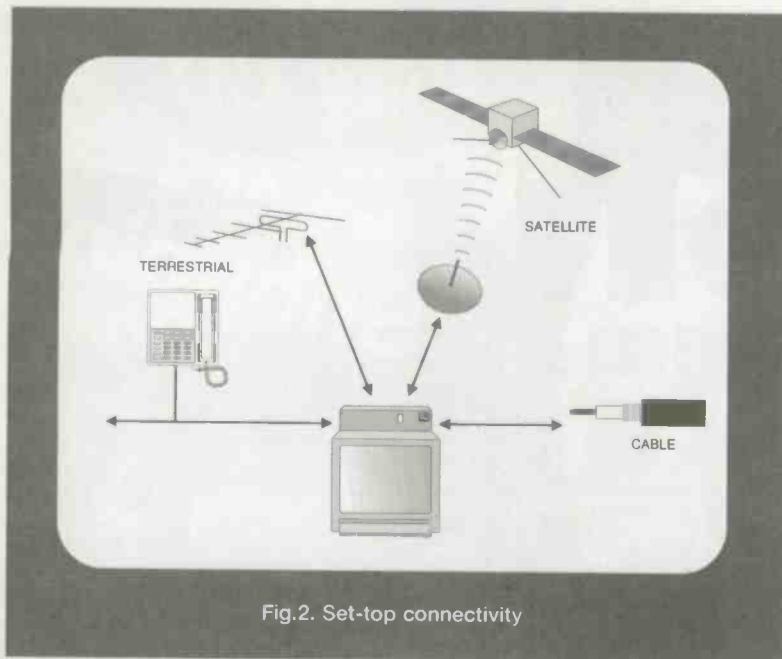

Fig.2. Set-top connectivity

sophisticated switching systems to the cable network. Switching systems which would connect the viewer to either a data storage system which stored the required film, or another user for phone/videophone/computer communications, or a specialist computer for interactive games, home banking/shopping etc.

The basis for this was laid about five years ago with the development of asynchronous time division multiplexing, or ATD, together with a form of packet switching based on ATD and known as Packet Transfer Mode. This coincided with the development of a single unified worldwide high speed network standard known as Broadband ISDN, or more commonly B-ISDN. This led in 1994 to the creation of a new switching technique which is ideally suited to interactive digital TV, this technique is based upon ATD and is known as Asynchronous Transfer Mode or ATM.

ATM is a data transmission procedure that is based upon asynchronous time division multiplexing with fixed length data packets known as cells, each packet being 53bytes long. Of these 53 bytes, five contain the header information consisting of channel and path addresses; the rest consists of the transferred data. In an

### The iTV network

The early cable TV systems were used simply as a means to distribute a large number of separate TV channels to all the subscribers. The enormous potential bandwidth of fibre optic cables meant that, with the aid of time division multiplexing, it was possible to transmit dozens of TV channels down a single fibre at the same time. No exchanges were used to select channels; this was done in the decoder box that connected the fibre optic cable to the user's TV.

This meant that, although the choice of programmes was much wider than with broadcast TV, the viewer still had to accept programme schedules with fixed programme times. Although this service was very successful, the service providers realised that there would be an even greater demand for such programmes if the user was freed from the constraints of the schedule and able to select programmes, films or other telecommunications and multimedia services according to his or her own requirements.

From this was born the concept of interactive digital TV, a concept which required the addition of

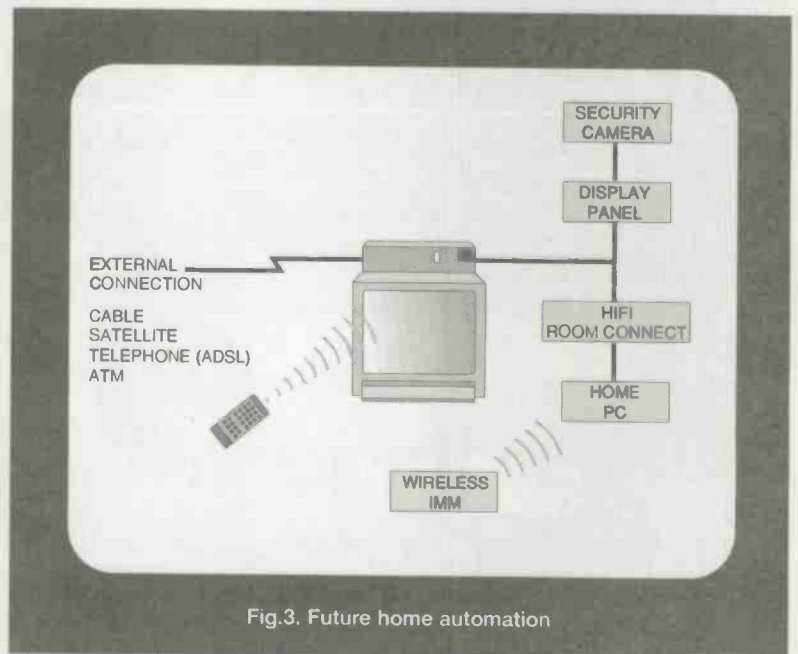

Fig.3. Future home automation

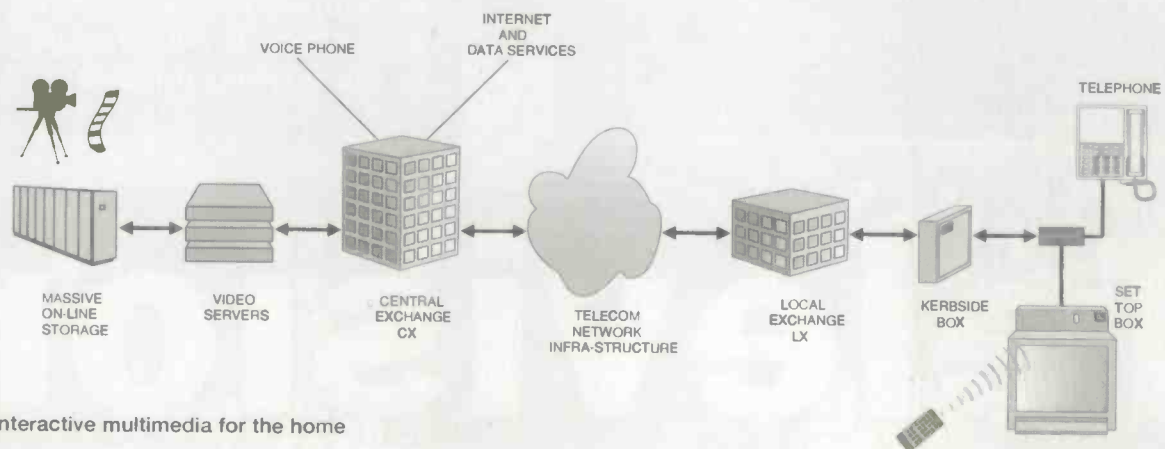

Fig.1. Interactive multimedia for the home

ATM network, every node is connected to one or more ATM switches which use the header information to route the data to the various different destinations.

ATM is rapidly becoming the preferred switching technology for iTV systems in various parts of the world. One reason for this is ATM's efficient utilisation of the total transmission bandwidth, as well as the fact that it will work at transmission rates ranging from megabits to gigabits per second.

Efficiency and high data transmission rates are very important since a conventional video with a 500 line screen requires a bandwidth of between 10 and 90Mbits per second, the variation depending upon the compression algorithm used. Indeed, data compression algorithms are a very important feature of iTV systems since they can help to reduce the enormous amount of data to a more manageable level and thus reduce the number of cables required and the amount of expensive very high speed switching electronics.

### **Image compression and decompression**

Decompression of the video data and its conversion into a form which can be input into a standard TV is the function of a special piece of iTV hardware known as the Set Top Box, or STB. This is essentially a powerful graphics computer running special decompression software, it also acts as the control terminal since it provides an interactive interface between the user and the iTV network; it can even run other software which has been downloaded over the network. Indeed, the first generation of STBs used by OnLine Media were modified Acorn Archimedes computers, and those being used in the BT trial are modified Apple Macintoshes.

Most of the current generation of STBs work with a data compression standard known as MPEG1. This standard allows a reasonable quality image, comparable to that obtained from a video, to be transmitted at a bit rate of 1.5Mb/s. This standard is already being used for some video conferencing systems, and the bit rate is comparable to that used for videophones.

When they are launched, commercial services based on fibre optic networks will probably use a higher standard, more sophisticated, compression technique known as MPEG2. This will give a very high quality image that will equal the best current broadcast TV image. The only drawback to using MPEG2 is that it will require a data transmission rate of about 10Mb/s, thereby necessitating higher bandwidth cables and faster switching and STB hardware.

### **Into the future**

Interactive digital TV is attracting enormous investment around the world. It is seen by many as the boom industry of the first part of the 21st century. And, it is an industry in which the UK has a leading position.

Much of the pioneering work on iTV is being done in the UK, and a constant stream of top executives from the world's major telecommunications and media companies are to be seen visiting companies like OnLine Media.

The iTV revolution could well provide an enormous potential boost to not only the UK electronics, media and telecommunications industry but also to the economy as a whole. iTV will also bring about enormous social and economic changes, and lead to a veritable explosion of new products, new ideas and new applications.

## **The OnLine Media Cambridge Cable system**

The Cambridge based trial is in three stages, and is currently in stage two. Stage one involved the connection of a very small number of users and was designed to allow the debugging of software and hardware associated with video servers and the OnLine Media set top boxes. This was successfully completed and stage two embarked upon last year. This second stage involved the connection of a much larger number of test users in various parts of Cambridge and connected by an ATM network supplied by Cambridge Cable to the head end central server system located in the offices of

OnLine Media.

The system has been designed to run on the type of 'hybrid-fibre-coax' now being installed generally by cable TV companies all over the UK. The connection into each home is via a symmetrical (in other words bi-directional) standard cable TV coax routed from a nearby street cabinet. Inside the home, the cable is terminated in a special box. This allows either the iTV system to be used or a standard cable TV system, and also provides a connection for telephony if it is installed. If an iTV system is used then the termination box is connected via a standard twisted pair cable to the OnLine Media STB.

The street cabinets contain an ATM switch module from SJ Research, with each interactive user being connected to a port on this switch. There are 18 such ports on each switch. This ATM switch has a bi-directional optical fibre link with the 'area' ATM switch plus a tap on the cable TV network. The system is designed so that the analog RF signal from the cable tap normally passes the switch, but when interactive services are demanded the switch will insert its digital signal on the cable.

The 'area' ATM switch to which the street cabinet ATM is connected has 8 ports (each of which represent up to 18 users) and communicates directly with the ATM switches at the head end. Currently, these ATM switches are all rated at 2Mb/s data transfer rate, but should be upgraded to 8Mb/s within a couple of months. This is a very important development since it means that they will then be able to use the higher quality MPEG2 encoding standard.

The main media server is located in OM's offices and consists of an ICL PimServer. This is a massively parallel processor and is currently fitted with 200 gigabytes of storage, sufficient to store about 350 hours of compressed film/television material. Because of the systems parallelism, a single server can easily handle simultaneous requests from hundreds of subscribers. Another advantage of the PimServer is that it is modular, which means that it can be easily expanded as demand from the network grows and the library increases. The success of the Cambridge trial is underlined by the fact that the system they have developed is now in the process of being adopted as the multimedia and iTV standard by a group of the largest UK cable TV companies as well as similar organisations in both mainland Europe and North America.

## The ARM7 the power behind the OM set top box

The heart of the OnLine Media STB is a special processor designed around the well known ARM RISC processor. This processor has been designed and made by Cambridge based Advanced RISC Machines Ltd, another subsidiary of OM's parent company Acorn Computer Group.

This specially designed processor chip is known as the ARM7500 and it integrates many of the major STB functions into a single 240-pin PGFP chip. Besides the ARM7500 an OM STB contains a few MBytes of external RAM and ROM, cable and telephone line interfaces, an ATM interface chip that has been designed around another ARM processor and, of course, an UHF tuner. Some STBs also contain a CD-ROM drive and the appropriate control circuitry.

As can be seen from the diagram in this box the ARM7500 is built around a 32-bit ARM-7 core with memory management unit and 4K four-way associative instruction and data cache. What makes this device so important for STB designers is that the internal 32-bit bus connects the CPU core with the integrated video, audio and peripheral control modules as well as memory.

The integration of all the audio and video functions on the processor chip not only means that it operates a lot faster than it otherwise would, but also that it is a lot cheaper to produce an STB since much of the circuitry is now integrated onto a single chip - factors which will probably mean that many STB manufacturers around the world will probably use the ARM7500 chip. Indeed, it could well become the standard STB processor.

On the ARM7500 chip, three data FIFOs connect the audio/video circuitry to the internal bus via a data latch. The function of these FIFOs is to isolate the real time operation of the audio and video logic from all the latencies that occur when transferring data from external memory over a bus that is shared with other devices. This prevents any display glitches which may result from processor activity.

The audio FIFO connects directly to both an on chip CD interface and an 8-bit DAC which can be used to drive an external amplifier and speaker; sound quality from this comparable to that from the average mono TV. For high quality and stereo sound, there is an option to use the serial bitstream from the FIFO to drive external DACs.

There are three 8-bit video DACs on the chip which can provide 256 colour RGB output from an on chip palette of 16million colours. Pixel depth is programmable between 1 and 32bits. There is also a 16 level greyscale that sits in parallel with the DACs, designed to directly drive a mono LCD display.

Because there is no on chip video memory, all pixel data must be stored in external memory and this is done by the on-chip DMA controller. This is a three -channel device, with each channel being hardwired to directly feed either the audio, video or cursor FIFO and thus requiring little or no CPU intervention.

In the peripheral control circuitry of the ARM7500, there are four 16-bit A/D converters, two asynchronous serial ports, 8 open collector I/O lines, plus all the control logic required to drive commercial PCMCIA support chips.

The CPU on the ARM7500 is fully static and can operate to 33MHz at which it has a processing power of 30Dhrystone MIPS. This is less powerful than some of the other processors used in STBs but these are usually general purpose devices and thus less efficient than the 7500 which has been designed specifically for this type of operation.

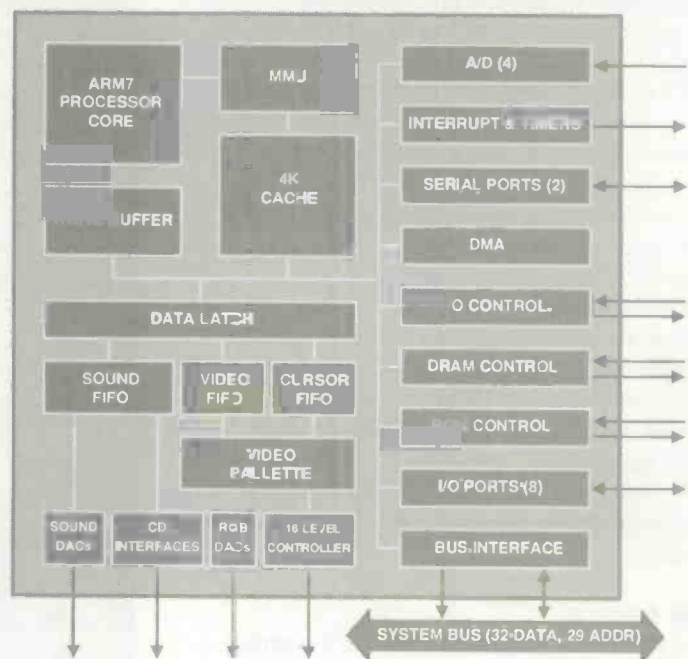

Fig.4. Block diagram of the ARM7500

## Where to see iTV technology in use

iTV technology is still in the trial stage, but if you want a taste of what the future will hold in this area then the Science Museum in Exhibition Rd, London, is currently running an exhibition entitled 'Information Superhighway'. This exhibition has working examples of OnLine Media's STB and the iTV system running sample services such as: home shopping, banking, entertainment, and education.

After September 3rd, the exhibition closes in London but will then tour the UK, starting in Manchester. For further information contact the Science Museum on 0171 938 8000.



## The BT system

The BT trial system in Colchester and Ipswich utilises existing phone networks to provide iTV. This has the potential of being a much cheaper and quicker way of delivering iTV services, but has not got the technology expansion potential of an all optical fibre ATM network based system.

The system makes use of a STB that is based on an Apple Macintosh computer - the LC475 - running Mac O/S which has been modified to support MPEG and a 2Mb/s network interface. At startup it downloads the operating system and Oracle Media Objects (OMO), the run time version of the authorware tool in which the services are created.

The network connected to the STB is a 2Mb/s stream delivered over either copper using Asymmetric Digital Subscriber Loop (ADSL), or fibre. ADSL technology delivers over an ordinary telephone loop 2Mb/s in one direction, a 9.6kb/s bidirectional control channel, and the ordinary analog telephone service.

The ADSL technology used in this trial is Discrete Multitone (DMT) which divides the spectrum into a number of bands and spreads the video transmission over them in such a way as to minimise interference and noise. The fibre optic delivery system consists of a passive optical network.

Users are directly attached to the server system without any concentration at the switching stage. The server system consists of a nCube massively parallel processor with the system running Oracle database software with the video content compressed to MPEG1 standard.

The initial results of the trial show that ADSL technology is robust with excellent resistance to noise and installation anomalies up to a range of about 6km. The trials show that MPEG1 coding and ADSL together, thereby showing that ADSL is a viable technology for the delivery of high bandwidth asymmetrical services.

This initial success has led BT to initiate the second phase market trial. This will entail up to 2,500 homes being connected by the end of this year. They will be using ADSL along with fibre in the ratio of four copper to one fibre. BT have decided to replace DMT ADSL with carrier amplitude and phase modulations, or CAP ADSL. The reason for this change is simply that CAP is available earlier and in a more integrated and therefore cost-effective form.

In the market trial, both server and STB technologies will remain the same. However, there will be an ATM based switching/concentration stage added. Users will be connected to an ATM switch with a concentration ratio of approximately two to one. This will allow twice as many users as there are server ports, with half of them being online to the server at any one time.

## The Set Top Box, or STB

OnLine Media are currently one of the world's leading suppliers of STBs their second generation STB is now available in volume production at about £300 each. The OM STB is small box that can sit on top of the TV. Input is connected to the cable network and the output to the aerial socket of the TV. It is controlled by a remote handset.

The STB box may look fairly nondescript but it contains some pretty impressive computing power. This includes a 32-bit ARM7500 processor rated at 28.7MIPS, 2Mbytes of RAM, 2Mbytes of ROM for the operating system and up to 2Mbytes of MPEG decoder RAM. This is the equivalent of a fairly powerful graphics workstation.

The ROM based operating system software is derived from Archimedes RISC OS, and is extensible via network downloading. Included is extensive support for graphics rendering, such as: outline anti-aliased fonts, Bezier curve based graphics, and bitbit operations. There is also full network support for E1, ATM, Ethernet, TCP/IP, and NFS. The ATM interface operates at 2.048Mb/sec. For multi-media operation there is a range of authoring tools including run time support for Macromedia Director, Oracle and Cybase, as well as full high level language support.

The video capabilities of the OM STB allow it to be used on either MPEG1 or MPEG2 standards. There is a capability to have computer generated graphics overlays as well as pixel by pixel video mixing. The output can be either PAL or NTSC and the resolution is programmable including 768x576 at 16bits per pixel (interlaced). The 8-bit DACs and on chip colour palette allow display of up to 16million colours, and the video data can have anything between 1 and 32bits per pixel.

The audio output is fully compliant with MPEG1, and has sample rates of 32,44.1, and 48kHz with output in either stereo, mono, joint channel or dual channel. The system is also capable of outputting computer generated CD quality (16-bits per channel) stereo sound.

The interfaces available on the system include a digital joystick socket which will accept either a twin analog, or twin switched joystick adaptor. There is also a 25pin D-type parallel port. Some versions also have a built in CD-ROM drive which can be used to play audio disks at CD quality, as well as display and manipulate PhotoCD images, and comply with full White or Green Book motion video standards.

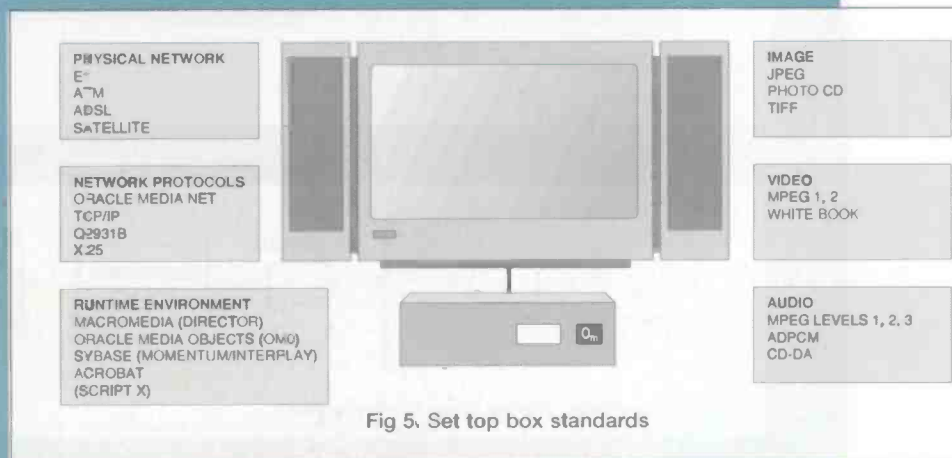

Fig 5. Set top box standards

# Analogue Shutter timer

*Robert Penfold shows how to build a timer for checking the accuracy of camera shutters*

**A** digital timer for checking camera shutters was described in E.T.I. a few years ago. A digital timer, with its multi-digit display and crystal controlled accuracy, is very desirable, but it provides what is really a significant degree of "overkill" for shutter timing. The required accuracy for camera shutters is surprisingly low, and an error of plus and minus 10% is considered to be exceptionally good. The mechanical

focal plane shutters of many up-market cameras of ten or 20 years ago rarely achieved this sort of accuracy across their full range of shutter speeds.

Since quite large timing errors are acceptable, something less than the ultimate timer is capable of testing cameras

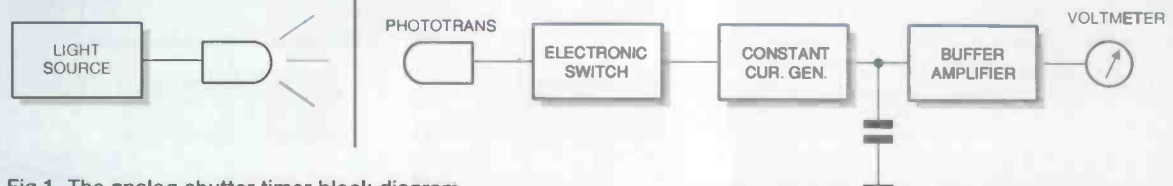
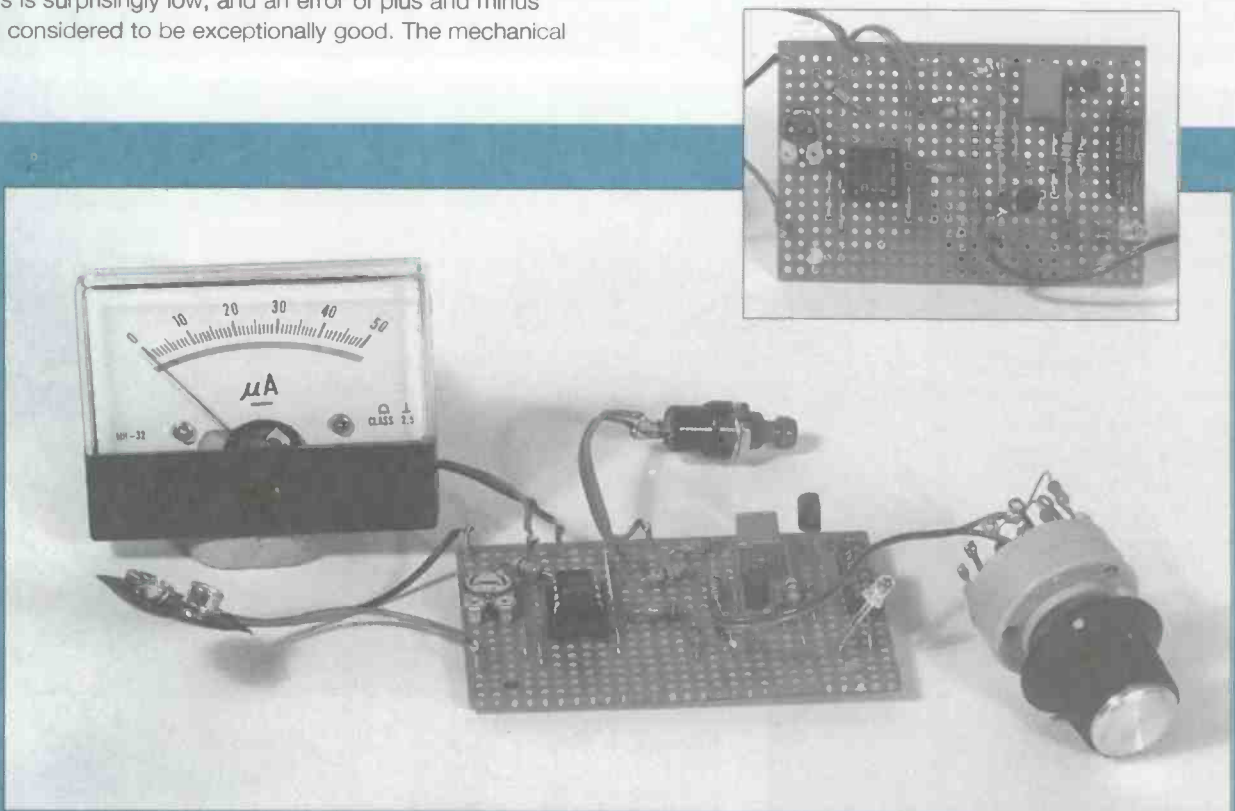

Fig.1. The analog shutter timer block diagram

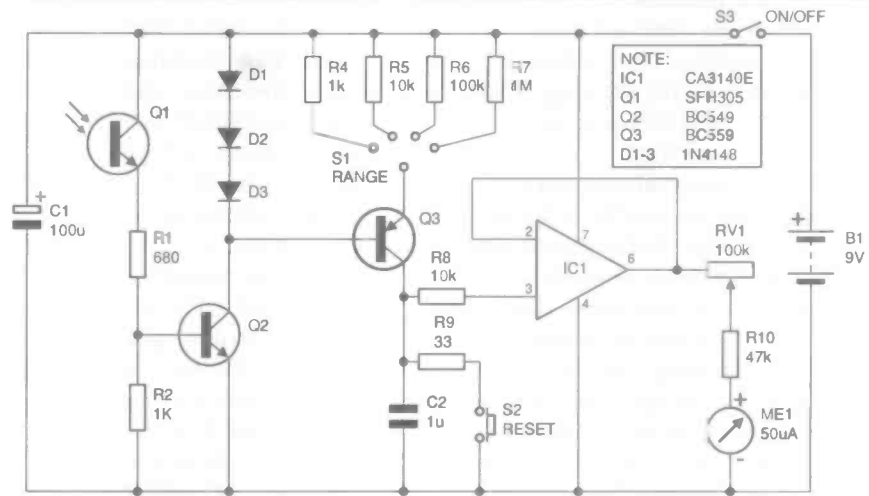

Fig.2. Circuit diagram for the analog shutter timer

Fig.3. Shutter timer component layout and wiring

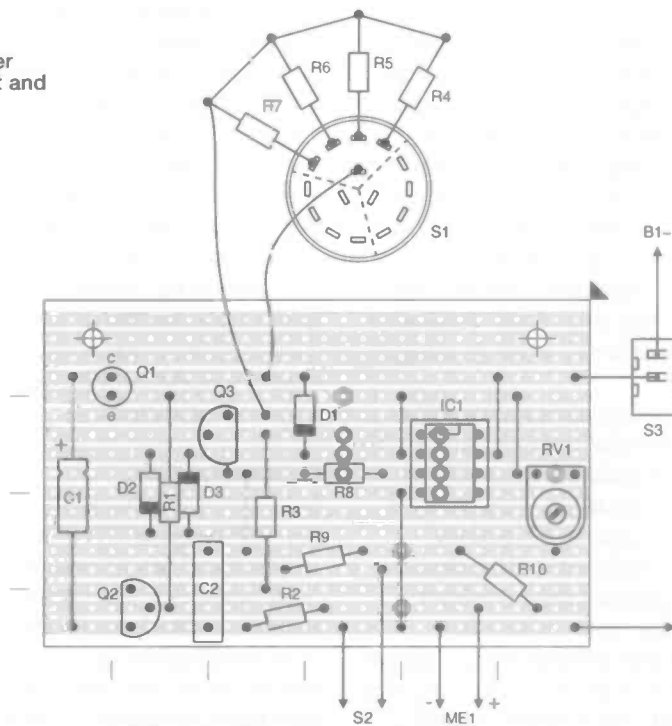
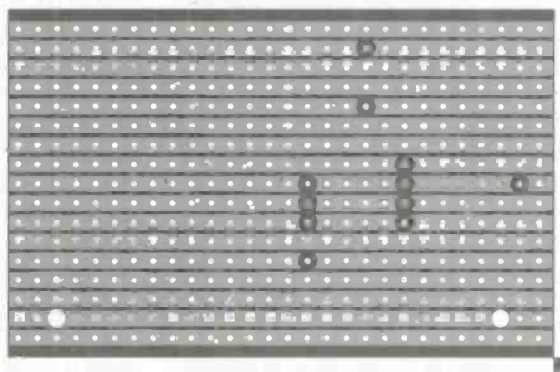

Fig.4. Underside of the stripboard panel



shutters. In fact, a simple analogue timer using an ordinary moving coil panel meter is more than adequate for this application. Provided the unit is calibrated with due care, the measured shutter times should be within a few percent of the actual times. The cost of an analogue timer is much less than that of a full-blown digital unit, but it pays to shop around for the panel meter as the cost of these seems to vary enormously from one supplier to another.

The analogue shutter timer described here has four measuring ranges, with full scale values of 5ms, 50ms, 500ms, and 5 seconds. Most cameras have shutter speeds within the range 4 seconds to 1/2000th second (0.5ms), and the unit is capable of testing any speeds within this range. A few of the more modern cameras have longer shutter speeds of up to about 30 seconds, but these are easily checked against any watch or clock that has seconds indication, and they do not require the use of a special timer. The unit is mainly intended for use with focal plane shutters, but it will work with leaf (in-lens) shutters. However, due to the way these shutters function, the accuracy will be relatively poor at the fastest shutter speeds.

## How It Works

The block diagram of Fig.1 helps to explain the basic way in which the unit functions. A light source is shone into the front of the camera, and this can be the light from a torch, an ultra-bright LED, or even just bright daylight from a window. A phototransistor is positioned behind the shutter. When the shutter is closed, the phototransistor has a very low leakage level, and it fails to switch on the next stage, which is an electronic switch. When the shutter is open, the leakage current through the phototransistor increases massively, and the electronic switch is turned on. This switch then activates a constant current generator which feeds into a charge storage capacitor.

When charged via a resistor, the voltage across a capacitor rises in a very non-linear fashion (exponentially), but with a constant charge current the voltage rises at a linear rate. In this case, the charge voltage increases at about one volt per second. The charge voltage is measured via an ordinary voltmeter circuit, but via a buffer amplifier which has an ultra high input resistance so that no significant charge current is leaked away through this circuit. The meter circuit has a sensitivity of 5 volts full scale, but with a charge rate of one volt per second this becomes a 0 to 5 second scale. When the shutter closes, the electronic switch and constant current source are switched off, and the reading on the meter is "frozen". The shutter time can be read directly from the meter's scale, and no recalibration is needed.

Over a period of time, the reading will actually change, due to various leakage currents in the circuit. The majority of the leakage is likely to be through the charge storage capacitor itself, resulting in the reading gradually reducing. However, the reading should be held accurately for at least several seconds and, in most cases, for half a minute or more. This gives the user plenty of time to read the meter before the indicated time changes significantly. The actual timer has four switched charge currents, and these provide the unit with its four measuring ranges.

## The Circuit

The full circuit diagram for the analogue shutter timer is shown in Fig.2. TR1 is the phototransistor, and it is effectively used in the emitter follower mode, but no bias is applied to its base

terminal (which is not actually connected to a leadout wire on many phototransistors).

The current flow through TR1 is only its leakage current, and under dark conditions this is the low level associated with a normal silicon transistor. This is usually a matter of a few nanoamps. Under bright conditions the leakage level is much higher, and would typically be a few milliamps. This higher leakage level is sufficient to bias TR2 into conduction, which in turn switches on TR3. The latter operates in a conventional constant current generator circuit. The four switched emitter resistors (R4 to R7) provide four output currents, and give the unit its four measuring ranges. R4 to R7 respectively provide the 5ms to 5 second ranges. In order to ensure good accuracy on all ranges it is essential that R4 to R7 are close tolerance (1%) resistors. C2 is the charge storage capacitor, and it is important for this component to have a very low leakage level. This means a good quality non-electrolytic capacitor such as a polyester or polycarbonate type. S2 is the reset switch. Operating this switch rapidly discharges C2 so that the meter is zeroed and a new reading can be taken. R9 provides current limiting which prevents contact sparking, and ensures S2 has a long operating life.

IC1 is the buffer amplifier, and this is a basic operational amplifier voltage follower circuit. The voltage across C2 is fed to the non-inverting input of IC1 via protection resistor R8. IC1 is a MOS input device which has an input resistance of over one million megohms. This ensures that it does not significantly discharge C2 even over a period of half a minute or more. The output of IC2 drives a conventional voltmeter circuit. The voltage increase across C2 will not be exactly one volt per second, and it will typically be a little higher than this. VR1 enables the sensitivity of the voltmeter to be adjusted to allow for this, so that an accurate readout is obtained. The current consumption of the circuit is only about 2 to 2.5 milliamps. A PP3 size battery is therefore more than adequate to power this project.

## Construction

Refer to Fig.3 for the stripboard layout and hard wiring, and to Fig.4 for the underside view of the stripboard panel.

The board has 27 holes by 17 copper strips. Construction of the board is largely straightforward, but the CA3140E is a MOS input device, and it consequently requires the usual anti-static handling precautions. Use a holder for this component, and do not fit it into the holder until the board and hard wiring have been completed. R4 to R7 are mounted on S1 rather than on the stripboard panel. Be careful not to overheat these resistors when soldering them in place, as this could impair their accuracy. Provided the ends of the leadout wires and the tags of S1 are generously tinned with solder first, there should be no difficulty in mounting the resistors on S1. Although TR1 is shown as being mounted on the stripboard in Fig.3, in reality it is better to mount it in a probe type case and connect it to the circuit board via a piece of thin screened cable about 0.5 metres long. The outer braiding carries the collector connection, and the inner conductor carries the emitter connection. The case from an old ball-point pen acts as a good basis for the probe.

The circuit will work using practically any silicon n.p.n. phototransistor for TR1. However, due to the way in which focal plane shutters operate, there is a definite advantage in using a small device. The problem with testing focal plane shutters is that they are never fully open at the higher speeds. In effect, a slit moves across in front of the film. The higher the

**Resistors**

(0.25 watt 5% carbon film unless noted)

- R1 680R
- R2 1k
- R3 5k6
- R4 1k 1% metal film
- R5 10k 1% metal film
- R6 100k 1% metal film
- R7 1M 1% metal film
- R8 10k
- R9 33R
- R10 47k

**Potentiometer**

- VR1 47k min hor preset

**Capacitors**

- C1 100u 10V elect
- C2 1u polyester

**Semiconductors**

- IC1 CA3140E
- TR1 SFH305 (see text)
- TR2 BC549
- TR3 BC559
- D1 to D3 1N4148 (3 off)

**Miscellaneous**

- S1 4 way 3 pole rotary  
(only one pole used)
- S2 Push-to-make,  
non-locking push-button
- S3 s.p.s.t. min toggle
- B1 9 volt (PP3 size)
- ME1 50uA moving coil panel meter
- 0.1 inch pitch stripboard having 27  
holes by 17 copper strips, control  
knob, 8-pin DIL IC holder, battery  
connector, wire, solder, etc.

shutter speed, the narrower the slit. A large phototransistor effectively widens the slit, giving measured shutter times that are longer than the actual shutter times. A phototransistor having a three millimetre LED style case is therefore better than one which has a diameter of five millimetres, or one which has a metal TO18 style case. The Maplin three millimetre diameter phototransistor (YY66W) works well, but the SFH305/2 from Electrovalue is the best choice. This is a cut down three millimetre LED which is just one millimetre wide. It should be positioned vertically behind a shutter which runs horizontally, or horizontally behind a shutter that runs vertically. The shorter lead of these LED-like phototransistors is the collector, and the other lead is the emitter (there is no base leadout wire).

Mounting the panel meter can be a bit awkward as it requires a large circular cut-out in the front panel. Most meters require a 38 millimetre diameter cutout, but it is as well to check this as there are a few exceptions. The cutout can be made using a "needle" file, "Abrafile", coping saw, etc., but it is probably best to cut just within the perimeter of the circle. A half-round file is then used to enlarge the hole to precisely the required size and shape. The meter itself can then be used as

a sort of template to locate the positions of the four 3.3 millimetre diameter holes for its built-in fixing screws.

**In Use**

A little experimentation is needed in order to get the timer to run only when the camera's shutter is open. Obviously TR1 must be shielded from any bright light sources so that the timer is not held in the "on" state while the shutter is closed. The light source in front of the camera does not need to be particularly bright, and any torch should provide more than enough light. Many other light sources are suitable, but I found a small torch to be the most convenient in use. If necessary, the sensitivity of the circuit can be increased by making R2 higher in value, or decreased by making R2 lower in value, but the specified value of 1k should give good results. The phototransistor should be positioned close to the shutter, but not so close as to risk damaging it. It is better if the measurements are made with the lens removed, but results seem to be satisfactory with fixed lens cameras if the lens is set at full aperture.

The unit can be calibrated against any camera which has a focal plane shutter that is known to provide good accuracy. It is best to calibrate the unit using a slow speed that represents a full scale reading on the timer. The obvious choice is the 1/2 second speed of the camera on the 0 to 500ms range of the timer. Simply take the measurement and then adjust VR1 for a full scale reading on ME1. An alternative method of calibrating the unit is to use the five second range, and to calibrate it against the seconds indication of a watch. With the aid of the watch hold the shutter open on "B" for five seconds, and then adjust VR1 for precisely full scale deflection on ME1. Provided this is done carefully it should provide quite good accuracy.

**EQT LTD STEVENAGE**
**Professional Sub-Contract Manufacturing & Suppliers to the Electronics Industry**

Do you have a requirement for any of the following services:

- |   |                                      |
|---|--------------------------------------|
| PCB Assembly (Conventional and Surface Mount)               | Product Design/Consultation          |
| Wave & Hand Soldering                                       | Full Procurement Service             |
| Complete Equipment Manufacture                              | PCB Test & "Burn In" Facilities      |
| Device Programming from hand written shts or PC 3 1/2" disc | Enclosure Design & Manufacture       |
| Cable Harness Assembly/loom Manufacture                     | PCB Artwork Manufacture              |
| Card Cage and Module Wiring                                 | Circuits Drawn Professionally        |
| Full Inspection   | Kit Procurement & Supply             |
|   | Component Sales                      |
|   | Refurbishment a speciality           |
|   | Top Quality Work at Reasonable Rates |

Phone Angela on (01438) 360406 or fax details of your requirements to us on (01438) 352742  
EQT LTD, Cromer House, Caxton way, STEVENAGE, HERTS, SG1 2DF

**HIGH QUALITY LOW COST  
C.C.T.V. CAMERA  
LOW LIGHT LEVEL 0.03 LUX @ F1.4.  
AUTO ELECTRONIC SHUTTER.  
COMPOSITE VIDEO OUT VIA  
BNC PLUG.  
SMALL DISCRETE SIZE.  
CAN BE USED WITH PC DIGITISER.**



This super quality CCD camera can be connected into your existing TV or video using the AV channel and can be used for discrete surveillance or observing your property externally using a suitable weatherproof housing. Can accommodate lighting levels ranging from daylight to street lighting using its built-in electronic shutter. Excellent when using with an infra red source. Built-in wide angle fixed focus lens, the camera has a resolution of 380 TVL. Can be housed inside an empty floodlight case, (extra). Camera size only 45mm x 45mm.

Special offer price of only: **£79.95 plus VAT (P&P £3.00)**

For full range of CCTV products send SAE to:  
**DIRECT CCTV LTD., DEPT ETI, UNIT 6,  
CARRICK COURT, FORREST GROVE BUSINESS  
PARK, MIDDLESBROUGH TS2 1QE**



A mini FM transmitter, very high gain preamp, supplied complete with FET electret microphone. Designed to cover 88-108 Mhz but it is easy to change it to cover 63-130Mhz. Works with a common 9v (PP3) battery. 0.2W RF. £8.22 Kit no 1001.



Electronic strob kit with an impressive 5 watt power output. Ideal for car/bike alarms etc. 6-12vdc, max current 1A, tone frequency 1.2khz. £7.05 Kit no 1003.

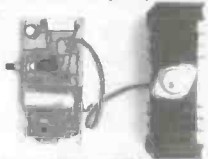

3-30v Power supply, variable, stabilized power supply for laboratory use. Shortcircuit protected, suitable for professional or amateur applications. 24v 3A transformer is also needed to complete the kit. £16.45 Kit 1007.



Powerful 1 watt FM transmitter supplied complete with piezoelectric microphone. 8-30vdc. At 25-30v you will get nearly 2 watts! £14.10 Kit no 1009.



FM/AM Scanner, well not quite you have to turn the knob yourself but you will hear things on this radio (even TV) that you would not hear on an ordinary radio! Receiver covers 50-160Mhz both AM and FM. Built in 5 watt amplifier. £17.62 Kit no 1013.



Mosquito repeller, modern way to keep nidges at bay! Runs for about a month on a 1.5v battery. £8.22 Kit no 1015.

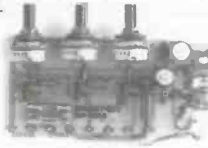

3 channel wireless sound to light system, mains operated, separate sensitivity adjustment for each channel, 1,200 watt power handling. Microphone included. £16.45 Kit no 1014.



Motorbike/cycle trembler alarm, adjustable sensitivity, preset alarm time, auto reset. Could be connected to bikes horn etc. £14.10 Kit no 1011



0-5 minute timer, adjustable from 0 to 5 mins, will switch up to 2A mains. Perfect for alarms, photographic laboratories etc. 12vdc. £8.22 Kit no 1020.



4 watt FM transmitter, small but powerful transmitter, 3 RF stages, microphone and an audio preamp include in kit. £23.50 Kit no 1028.



25 watt FM transmitter 4 RF stages, preamp required (our kit 1068 is suitable). Due to the complexity of the transmitter it is supplied in built up form only. £32.82 Kit no 1031.



Strobe light, adjustable frequency from 1- to 60 Hz (a lot faster than conventional strobes) mains operated. £18.80 Kit no 1037.



Ultrasonic radar ideal as a movement detector with a range of about 10 metres automate your cat flap! 12v operation so ideal for cars, caravans etc. £16.45 Kit 1049.



Liquid level detector useful for detecting fluid levels in tanks, fishponds, baths or as a rain or leak alarm. Will switch 2A mains. £5.87 Kit no 1081.



Combination lock 9 key, easily programmable, will switch 2A mains. Complete with keypad. 9v operation. £11.75 Kit 1114.

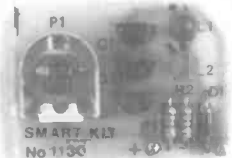

Phone bug detector, this device will warn you if somebody is eavesdropping on your phone line. £7.05 Kit no 1150.

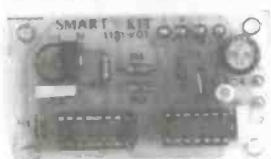

Robot voice, interesting circuit that distorts your voice! adjustable, answer the phone with a different voice! 12vdc. £10.57 Kit no 1131.



Telephone bug, small bug powered by the telephone line, starts transmitting as soon as the handset is picked up! £9.40 Kit no 1135.



Function generator, produces an analog, saw tooth and square waves adjustable from 20hz-20khz, separate level controls for each shape. Will produce all 3 together. 24vac £17.62 Kit no 1008.



3 Channel light chaser, 800 watts per channel, speed and direction controls supplied with 12 leds and mains tracks, so you can use mains light bulbs if you want. 9-15vdc £19.97 Kit no 1026.



12v fluorescent. A useful kit that will enable you to light 4' fluorescent tubes from your car battery! (you will also need a 9v 2A transformer, not supplied) £9.40 Kit no 1069.



VOX switch, sound activated switch ideal for turning tape recorders on and off when sounds are heard. Makes the tape last a lot longer! adjustable sensitivity, built in delay. £9.40 Kit 1073.



Incar sound to light. Put some atmosphere in your car with this mini 3 channel sound to light. Each channel has 6 leds. £11.75 Kit no 1086.

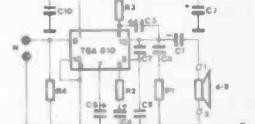

7 watt HI FI power amplifier useful, powerful, ideal for intercomms, audio systems, car use etc. 12-18vdc 500mA. £8.22 Kit No 1025.



Phone call relay, useful device that operates a relay when ever the phone rings, could be used to operate more bells or signalling lights etc. Will switch mains at 2A. £11.75 kit no 1122.



Lead acid charger, two automatic charging rates, visual indication of battery state, ideal for alarm systems, emergency lighting etc. 100mA 12vdc. £14.10 Kit no 1095.



Car alarm system, works on voltage drop and/or vibration, entry and exit delays plus adjustable alarm duration. Good for cars, caravans etc. £14.10 Kit no 1019.



Portable alarm system, based on a mercury switch. The alarm continues to sound until the unit is disabled by the owner. Buzzer included. £12.92 Kit no 1150.



Preamp mixer, 3 input mono mixer, separate bass and treble controls plus independent level controls. 18vdc, Input sens 150mv. 100mA. £17.62 Kit no 1052.

Mini metal detector, suitable for locating pipes in walls etc, range 15-20 cm, complete with case. 9v operation. £9.40 Kit no 1022.



800 watt single channel sound to light kit, mains operated, add rhythm to your party for only £9.40 Kit no 1006.



Sound effects generator, produce sounds ranging from bird chips to sirens, complete with speaker, add sound effects to your projects for just £10.57 Kit no 1045.



Guitar preamp with tone controls, small enough to fit inside any guitar, based on TL082 IC, 9-12vdc, 50mA. £9.40 Kit no 1091.



15 watt FM transmitter, 4 stage high power, preamp required. 12-18vdc. Can use either ground plane, open dipole, or Yagi. Supplied in built form only at £81.07 Kit 1021.



Telephone amplifier, Very sensitive amplifier which uses a phone pickup coil (supplied) will let you follow a conversation without holding the phone. £12.92 Kit no 1059.

**TOP 10 BEST SELLING KITS CORNER**

1. Variable speed control kit for 12v DC motors up to 30A! (you may need a heatsink for 30A) £19.97.
2. Composite video kit, converts composite signals into separate H sync, V sync and video £9.40.
3. Geiger counter kit, contains everything you need to build a working counter £22.32.
4. Solar energy kit, contains a solar panel, motor, buzzer and cable for experiments £5.87.
5. Electronic acupuncture kit, may help with migraine, poor circulation, backache etc. £8.22.
6. Electrifying apparatus kit, produces a weak adjustable high tension of 80-300v from a 9v battery, ideal for catching worms etc! £9.40.
7. A adapter bug kit, contains everything you need to build a professional bug built inside a standard 13A mains adapter! the bug is mains powered so it operates all the time the adapter is plugged in. Price is £16.45 for the complete kit including adapter. Hand tools and glue required.
8. Nicad charger kit automatic charger for cells from 1.2v to 15v, 7 settings 50600mA, transformer required 18-20v 600mA. £9.40.
- 9&10. Inverter kits, produce 240vac from a 12vdc supply, two versions are available a 15w one at £14.10, and an 80w version at £23.50.

**EXPRESS COMPONENTS**

how to order.....  
 Remember to add £1.50 p&p.  
 By phone with a credit card.  
 By post with either a cheque, postal order or credit card details.  
 By fax with credit card details.  
 EXPRESS COMPONENTS, PO BOX 517 HOVE SUSSEX BN3 5QZ. DEPT ETI  
 TEL 01273 771156  
 FAX 01273 206875  
 Overseas orders please add £3.50 post and packing.

# PCB Designer

For Windows 3.1

Runs on any PC running Windows 3.1 in standard or enhanced mode with 2MB RAM  
Will work with any Windows supported printer and monitor

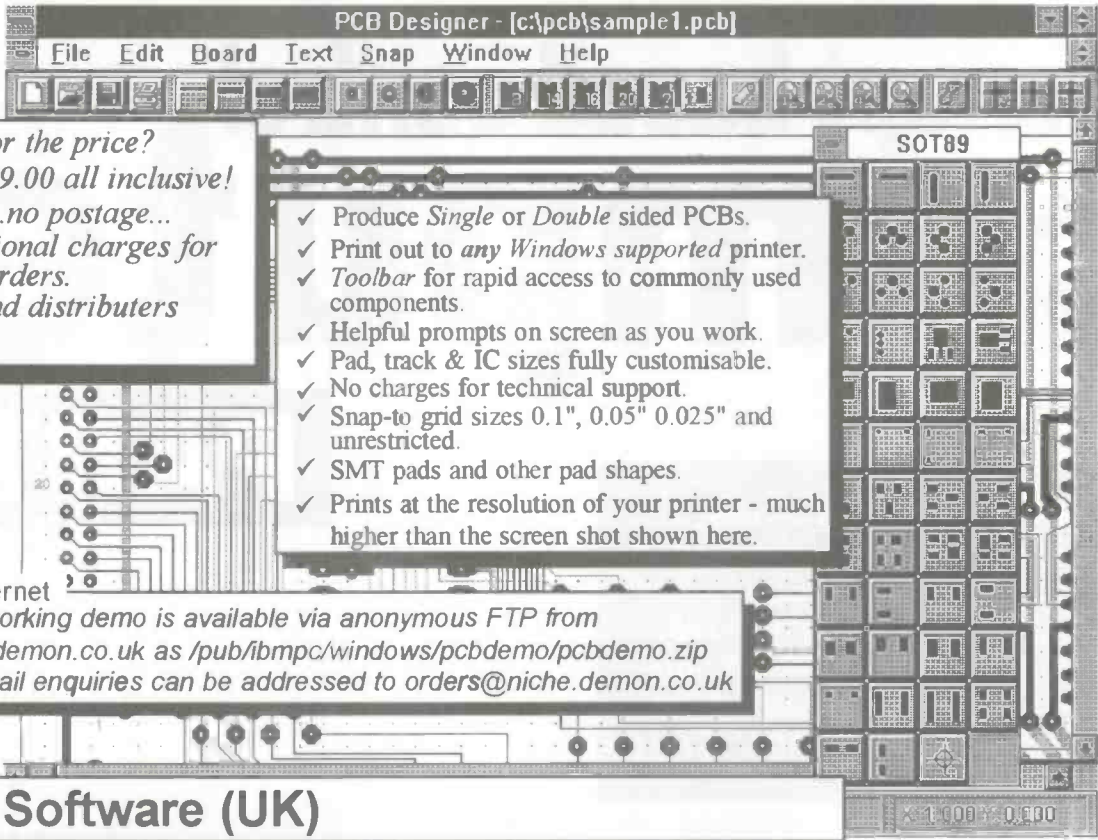

Looking for the price?  
It's just £49.00 all inclusive!  
...no VAT...no postage...  
...no additional charges for overseas orders.  
Dealers and distributors wanted.

- ✓ Produce Single or Double sided PCBs.
- ✓ Print out to any Windows supported printer.
- ✓ Toolbar for rapid access to commonly used components.
- ✓ Helpful prompts on screen as you work.
- ✓ Pad, track & IC sizes fully customisable.
- ✓ No charges for technical support.
- ✓ Snap-to grid sizes 0.1", 0.05" 0.025" and unrestricted.
- ✓ SMT pads and other pad shapes.
- ✓ Prints at the resolution of your printer - much higher than the screen shot shown here.

Internet  
A working demo is available via anonymous FTP from  
[ftp.demon.co.uk](ftp://demon.co.uk/pub/ibmpc/windows/pcbdemo/pcbdemo.zip) as /pub/ibmpc/windows/pcbdemo/pcbdemo.zip  
e-mail enquiries can be addressed to [orders@niche.demon.co.uk](mailto:orders@niche.demon.co.uk)

## Niche Software (UK)

22 Tavistock Drive, Belmont Hereford, HR2 7XN.

Phone (01432) 355 414

### WE HAVE THE WIDEST CHOICE OF USED OSCILLOSCOPES IN THE COUNTRY

#### TEKTRONIX 7000 SERIES OSCILLOSCOPES

Available from £200 - PLUG-INS SOLD SEPARATELY

TEKTRONIX 2465 4 Channel 300MHz Delay Sweep Cursors	£1750
TEKTRONIX 485 Dual Trace 350MHz Delay Sweep	£750
TEKTRONIX 475 Dual Trace 200MHz Delay Sweep	£600
TEKTRONIX 465 Dual Trace 100MHz Delay Sweep	£400
TEKTRONIX SC504 Dual Trace 80MHz in TM503	£400
TEKTRONIX 2215 Dual Trace 50MHz Delay Sweep	£400
TEKTRONIX 455 Dual Trace 50MHz Delay Sweep	£400
PHILIPS PM321T Dual Trace 50MHz Delay Sweep	£400
HITACHI V222 Dual Trace 20MHz Delay Sweep	£250
BECKMAN 9020 Dual Trace 20MHz Delay Sweep	£240
HAMEG 412 Dual Trace 20MHz Delay Sweep	£225
GOULD OS1100 Dual Trace 20MHz Delay Sweep	£200
GOULD OS110591 Dual Trace 20MHz	£200
GOULD OS300 Dual Trace 20MHz	£200
WATSU S55702 Dual Trace 20MHz	£200
HITACHI V0245 Dual Trace 100MHz Dig Storage/Cursors 40MS	£110
PHILIPS PM3305 4 Trace 35MHz Digital Storage	£650
GOULD OS4000 Dual Trace 10MHz Digital Storage	£350
TEKTRONIX 464 Dual Trace 100MHz Analogue Storage	£350
H.P. 17414 Dual Trace 100MHz Analogue Storage	£400

THIS IS JUST A SAMPLE - MANY OTHERS AVAILABLE

#### KIKUSUI 5530A DUAL TRACE 30MHz ONLY £180

EATON/ALTECH 380K11 Syn Sig Gen 1-200MHz with FM3602 AM/FM Phase Mod.	POA
H.P. 8656A Syn AM/FM Sig Gen 100KHz - 900MHz	£1900
MARCONI 2019 Syn AM/FM Sig Gen 80KHz-1040MHz	£1900
MARCONI 2018 Syn AM/FM Sig Gen 80KHz-500MHz	£1900
H.P. 8620C Sweep Osc 5-9.12 4GHz or 8-12 4GHz	£350
H.P. 8620C Sweep Oscillator Main Frame only	£300
RACAL 9081 Syn AM/FM Sig Gen 5 - 50MHz	£400
FARNELL SS0530 Syn AM/FM Sig Gen 10 - 50MHz	£400
MARCONI TF2331 Automatic Distortion Meter	£200
MARCONI TF893B Audio Power Meter Sinad.	£150
MARCONI TF2163 Attenuator DC-1GHz	£100
H.P. 8495 Attenuator DC-18GHz 0-11dB in 1dB Steps	£350
TEKTRONIX TDR1502	£1250
R & S Video Noise Meter UPSF2 with UPSF2E2	£750
R & S Mobile Tester SMSFP2 0.4 - 1000MHz	£1250

#### BRUEL & KJOER EQUIPMENT AVAILABLE PLEASE ENQUIRE

#### SPECTRUM ANALYSERS

IFR A7550 Synthesised 1 GHz	£8000
H.P. 8656A 0.01-22GHz	£4500
ANDO AC2811 with AC2811 1700MHz	£1500
POLARAD 64-1 110MHz-19GHz	£1000
H.P. 182 with 8558B 100MHz-1500MHz	from £1500
H.P. 141T with 8554A & 8552B 10MHz - 18GHz	£1700
H.P. 141T with 8554B & 8552B 100MHz - 1250MHz	£1200
H.P. 141T with 8553B & 8552A 10Hz - 110MHz	£900
H.P. 141T MAIN FRAMES ONLY, GOOD TUBES	£225
MARCONI TF2370 30Hz - 110MHz	£1000
TEKTRONIX 7L12 with Main Frame 100Hz - 1800MHz	£1200
TEKTRONIX 7L5 with Main Frame 20MHz - 5MHz	£1000

Used Equipment - Guaranteed. Manuals supplied if possible.  
This is a VERY SMALL SAMPLE OF STOCK. SAE or telephone for lists. Please check availability before ordering. CARRIAGE all units £16. VAT to be added to Total of Goods and Carriage.

**STEWART OF READING**  
110 WYKEHAM ROAD, READING, BERKS RG6 1PL  
Tel: 01734 268041 Fax: 01734 351696

MARCONI 2440 Microwave Counter 20GHz	£1250
H.P. 5341A Frequency Counter 50MHz - 1.5GHz LEB	£300
RACAL 1996 Frequency Counter 1.3GHz (Options GPB & High Stop)	£300
RACAL/DARIA 1961 Universal Counter/Timer 160MHz 9 digit	£300
MARCONI 2437 Universal Counter/Timer DC - 100MHz 8 digit	£175
RACAL 9916 Frequency Counter 10Hz - 520MHz	£175
RACAL 9906A Universal Counter/Timer 10Hz - 200MHz	£250
BLACK STAR Meteor 100 Frequency Counter 100MHz	£70
H.P. 3456A 6 1/2 digit DMM DC, True RMS AC Res HPB	£500
PHILIPS PM2534 Multi Function DMM 3 1/2 - 6 1/2 GPB/IEEE	£950
SOLARTRON 7065 6 1/2 digit Microprocessor Voltmeter	£400
ACDC/Ohms/Auto	£400
SOLARTRON 7150 6 1/2 - 3 1/2 digit DMM with IEEE	£400
SOLARTRON 7045 4 1/2 digit Multimeter Volts/KHz/Ohms	£20
THANDAR 1504 4 3/4 digit True RMS Multimeter with Adaptor	£100
GOULD J38 SineSquare Oscillator 10Hz - 100KHz	£150
FEEDBACK FG600 SineSq/Tri 0.1Hz - 100KHz	£60
JUPITOR 500 Func Gen SineSq/Tri/TTL	£70
THANDAR T4501 Func Gen 0.0005Hz - 5MHz SineSq/Tri/Ramp/Pulse etc.	£175
THANDAR T6102 Func Gen 0.2Hz - 2MHz SineSq/Tri/TTL	£70
PHILIPS PM5113 Colour TV Gen/Pal Seecam/NTSC	£850
LINDOS LA1 M82B Audio Analyser	£500
UNAOHM EP501 Audio Analyser	£350
RADFORD LD04 Low Distortion Oscillator	£300
RADFORD LDMS5 Low Distortion Measuring Set	£300
HEMO Dual Variable Filter VBF 0.1 - 100Hz	£200
RACAL Instrumentation Recorder type Store 4DN	£200
RACAL Instrumentation Recorder type Store 7DS	£500
H.P. 4261A LCR Meter with Test Fixture 16061A	£500
MARCONI TF3700 Universal Bridge Battery Operated	from £150
WAYNE KERR B424 Digital Component Meter LCR	£200
H.P. 16300 43 Channels	£750
SORENSEN DC6000-4.5B 0 - 500 Volts 0 - 4.5Amps	£700
H.P. 626B 0 - 40 Volts 0 - 20Amps	£300
FARNELL 1830100 0 - 30Volts 0 - 100Amps Metered	£200
THURLBY PL320MD 0 - 30Volts 0 - 2Amps True Digital	£225
THURLBY PL320 0 - 30Volts 0 - 2Amps Digital	£100
FARNELL L30E 0 - 30Volts 0 - 5Amps Metered	£100
FARNELL C350 0 - 350Volts 0 - 200MA Metered	£100
BRANDENBURG Model 472R 4K-3KV Metered	£200

MANY OTHER POWER SUPPLIES AVAILABLE

#### NEW EQUIPMENT

HAMEG OSCILLOSCOPE HM1005 Triple Trace 100MHz	£347
HAMEG OSCILLOSCOPE HM604 Dual Trace 50MHz Delay Sweep	£353
HAMEG OSCILLOSCOPE HM303 Dual Trace 30MHz Comp. Tester	£382
HAMEG OSCILLOSCOPE HM805-3 Dual Trace 20MHz Digital Storage	£363
All other models available - all oscilloscopes supplied with 2 probes	
BLACK STAR EQUIPMENT (PAP all units £5)	
APOLLO 10 100MHz Counter, Timer Ratio/Period/Time mt etc.	£222
APOLLO 100 100MHz (see above with more functions)	£325
METOR 100 FREQUENCY COUNTER 100MHz	£119
METOR 600 FREQUENCY COUNTER 600MHz	£145
METOR 1000 FREQUENCY COUNTER 1GHz	£189
JUPITOR 500 FUNCTION GEN 0.1Hz-500kHz SineSq/Tri	£168
ORION COLOUR BAR GENERATOR PAL/TV/Video	£285
All other Black Star equipment available	
OSCILLOSCOPE PROBES Switched X1 X10 (P&P £3)	£12

## SERVICE MANUALS & Technical Books

Available for most equipment, any make, age or model.  
Return the coupon for your FREE catalogue

MAURITRON TECHNICAL SERVICES (ETI)  
8 Cherry Tree Road, Chinnor, Oxon, OX9 4QY.  
Tel: 01844-351694. Fax: 01844 352554.

Please forward your latest catalogue for which I enclose 2 x 1st Class Stamps or £3.50 for the complete Service Manuals Index on PC Disc plus catalogue.

NAME \_\_\_\_\_  
ADDRESS \_\_\_\_\_  
POSTCODE \_\_\_\_\_

Photocopy this coupon if you do not wish to cut the magazine

## COLOUR VIDEO CAMERAS LIMITED SPECIAL OFFER

### JVC GR-S505 ONLY £99 +VAT

These are brand new camcorders but the cassette mechanism has been removed.  
Provides a PAL composite video output which can be used with a video recorder, television or monitor. Excellent image quality with 1/2" CCD and 8:1 zoom lens. Ideal for home movies, image capture, digitisation, security and many other applications. Includes 9.6V ni-cad battery and charge/power supply, uhf TV modulator and all connection leads. Camera is supplied with the casing disassembled, some soldering of connections is required to complete camera. Please telephone for further details. Insured delivery £8.



LASERTECH  
Mill Road, Great Barton, Bury St. Edmunds, Suffolk, IP31 2RU  
TELEPHONE 01284 788108 FAX 01284 788135

# 8088

# Interrupt based control computer

## PART 1

*The first part of a new computer project designed by R. Grodzik based around the popular 8088 processor and specifically designed for multitasking control applications*

**A**lthough the 80188 SBC is equipped with four interrupt lines, there may be occasions where this is insufficient or when several interrupts occur simultaneously. The 8088 SBC featured here, is based on the same architecture as the 80188 - indeed, it shares the same 8155 PIO, and is programmable in assembler. The 8088 contains an identical CPU core as does the 80188, but without the complexity of the chip select functions and internally embedded registers. It is therefore much easier to program. An external interrupt controller (8259) PIC, not to be confused with 'Arizona' microchip PIC devices, handles up to eight vectored priority interrupts for the CPU. It is designed to minimise the software and real time overhead in handling multi-level priority interrupts, permitting optimisation for a variety of system requirements.

This 8-channel interrupt controller provides the 8088 processor with the ability to perform multi-tasking control operations with ease. Any or all interrupt lines can be enabled at any time by software and, if multiple interrupts occur simultaneously, they can all be prioritised and be serviced in turn. Real-time events simply cannot be missed with this powerful system, adding a new dimension to control and data acquisition systems. This, together with 22 programmable IO lines, forms a compact control computer for which code can be developed on any PC.

The computer card built on a single-sided Eurocard sized (100mm x 160mm) PCB, requires only the addition of an 8 to 12 volt DC power supply to form a self-contained computer board. Using standard INTEL parts which are readily available from component suppliers, the approximate cost of the unit is

less than £50.

Construction is straightforward - the author's practice of locating the insulated wire links on the copper side of the board allows for a neat and tidy appearance to the finished board. A link placement diagram (mirror-view) of the PCB is provided as guidance for the constructor. With the aid of a continuity tester, always check to ensure that there is no shorting between these links and the copper conductor tracks. A standard 7805 5 volt regulator provides the power for the board. This must be heatsinked if i. c. type other than CMOS parts are used. A 2-Kbyte EPROM space is provided for program code, which was developed on a PC using the 'MASM' Assembler and sent to the board using any EPROM emulator. A programmable PIO (8155) provides the user with 22 IO lines, as well as a 14-bit timer and one page (256 bytes) of RAM for stack and interrupt vector table purposes. An onboard intelligent hex LED display serves a useful function as an indicator, being permanently connected to PORT C of the 8155 PIO. Since this display draws as much as 100 Ma of current, a blanking input control pin serves to blank the display if required.

### Development

At this point, some mention must be made of the tools required for developing any micro-processor based projects, together with a few hints and tips. Although technology has progressed somewhat, the basic principles of fault-finding and workshop practice still remain.

The 'bugbear' of any project is usually the production of a PCB. The problems start with the production of the artwork. With artwork printed in a magazine, the usual route is to get it





photocopied onto acetate sheet. But beware. Several photocopying facilities that I have approached cannot guarantee 100 % facsimile reproduction, and the image can be 'stretched' by several percent in either or both directions. This does not, however, present a problem in the majority of cases, since when the eventual PCB has been drilled and the stage of populating the components begins, IC pins can be easily re-aligned into their respective hole positions. Staying with the subject of artwork, extremely fine artwork can now be produced by the majority of bubble-jet printers, using the specially coated acetate sheets for these machines. However, these transparencies are not available at most retail outlets and have to be ordered from specialist component suppliers such as 'Farnell' or 'RS Components'. If on a tight budget, the old trick of using thin (5 gm/sq. in.) photocopy paper and making it transparent by spraying with WD40 still works: but allow it to dry completely and double the exposure time in the U. V. exposure unit. The dangers of exposure of the eyes to any U.V. source cannot be stressed too highly, so take heed.

### Making the PCB

The U. V. method of making a PCB has been long established and consists of presenting transparent artwork to a U. V. sensitised copper-clad board, exposing for 4-8 minutes, developing and finally etching, washing, drying and drilling. Always use fresh chemicals - the Ferric chloride solution has a finite usage time; once it goes a musky green colour it is time for it to be replaced. For developing, a level teaspoon of caustic soda bought at a chemist in an especially pure form is added to a pint of water. The temperature is critical (tepid/warm) - if too high, the artwork vanishes from the PCB in front of your eyes; too low and development time is prolonged. Use vinyl gloves when handling any of these corrosive chemicals - and, of course, eye protection. During the development stage, the application of a soft brush on the board's surface will hasten the process and is especially needed where an agitation tank is not available.

### Computer-aided manufacture

Now that CAD software for PCB design is readily available, professional single and double-sided boards are easily obtainable. Several years ago, the price of a one-off prototype board manufactured by a specialised board-maker was in the region of £200 - 300. Today, a Eurosize double-sided pth board can be supplied for approx £40. One such company - RAK Printed Circuit Boards (tel. 0799 26227) - provides this service. PCB software design systems such as 'Boardmaker' produce all the files necessary for C. A. M. The files are sent on a floppy or via a computer link to the manufacturer.

### The PC and associated tools.

The IBM or compatible personal computer is indispensable in a microprocessor development environment. In past years, many 'microprocessor trainers' were programmable in machine code using an on-board hexadecimal keypad. With the advent of software simulators which run on any PC, the learning curve associated with the programming of any microprocessor can be accomplished with relative ease and without the expense of purchasing a fully fledged hardware-based development system with real-time in circuit emulators etc - in some cases as much as £3,000.

For the 8088/86 series of microprocessors, the PC already has a resident software simulator present in its DOS directory

(DEBUG), details of which can be found in most 8088 books. The next stage of the learning process - actually writing and assembling software for the microprocessor requires any ASCII text editor and a cross-assembler. Assemblers such as 'TASM' and 'A86' are freely available and have been designed to run on a PC. The next stage of development consists of the target processor board running the software (object code) produced by the PC. A common method is to use an EPROM emulator (the one shown was obtained from John Morrison - tel :01532 537507). Software can be continually modified by this method until a definitive version is burned into an EPROM. A U. V. EPROM eraser is therefore also required.

### Faultfinding

An oscilloscope is not an essential part of the test tool kit required for most microprocessor-based faultfinding. A good quality logic probe with both visual and audible logic level indicators and with a pulse catching capability (available from Tandy's) will pinpoint the source of any malfunction. IC 'glomper' clips clip onto the microprocessor or logic chip being investigated and provide a means of connecting a logic analyser - which until recently was an expensive part of kit. A 'dead' microprocessor based project cannot be investigated by conventional faultfinding techniques, e.g. using the half-split method, and the only recourse of action is to painstakingly check the connectivity of every IC pin against the circuit diagram, checking for any shorts between adjacent tracks. I remember one occasion when the cause of a non-functioning 8031-based board was that a 40 pin PIO IC had been inadvertently placed in the processor socket - no amount of conventional fault-finding would have pinpointed the error!

Try this simple fault finding procedure:

- (a) Establish that the vcc supply is present and within correct voltage range.
- (b) With the logic probe, check for presence of system clock.
- (c) Write small software programs to test various parts of the system - address decoding, writing/reading RAM, accessing port lines etc, since it is still possible that a fault may exist on the board which does not prevent the execution of a program.
- (d) Ascertain if the fault lies in the hardware/software or both!
- (e) Use structured programming techniques when programming - use tried and tested compact sub-routines with one entry and exit point.
- (f) Use the logic probe to verify that software is functioning as required - e.g. a hardware breakpoint can be easily created by causing a single LED to light on one port line.
- (g) Always suspect a defective IC last. It is very rare for an integrated chip to fail other than through overvoltage.
- (h) Ensure that all 0 volt lines are connected when using ancillary equipment or interfaces. For example, if the 0 volt line of the EPROM emulator is not connected to the target uP board, the resulting symptoms defy investigation.
- (i) Remember that microprocessor development is time intensive and it is not unknown to burn the midnight oil to debug a piece of software.

### The 8088 micro-processor

The 8088 8-bit high performance micro-processor with its 16 bit internal architecture, is packaged in a 40-pin Cerdip. When used in the minimum mode configuration by tying the Min/Max pin high, the 8088 micro-processor adopts a conventional microprocessor bus system consisting of an 8-bit

data bus, a 20-bit address bus and a control bus. The addressing of external memory is done on a segmented basis: Four 16-bit segment registers, together with the 16-bit Instruction Pointer (Program counter) value produce an addressing range of 00000H to FFFFFH.

However, for ease of programming, the control card only uses a small portion of the memory map, being confined to ROM address range FF800H-FFFFFH (CODE segment at FF80H, INSTRUCTION pointer = 0000-07FFH), and RAM

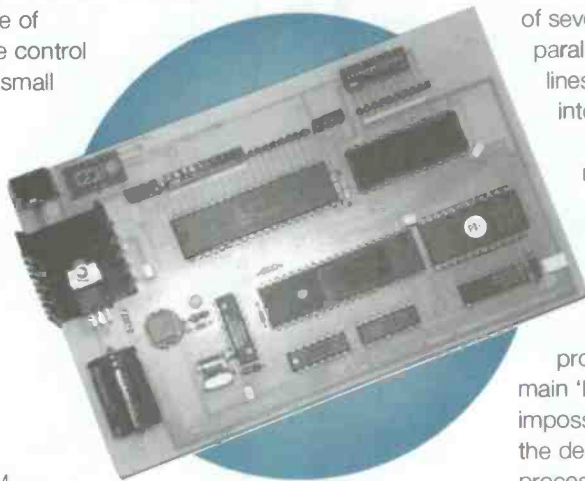

address range 00000H-000FFH - (DATA segment at 0000, INSTRUCTION pointer = 0000H-00FFH). IO addresses 0000H-0005H access the three ports (A, B, C) of the PIO as well as the inbuilt timer. Finally, the 8259 interrupt controller is located at address 6000H and 6001H. (See memory map). Since, on reset, the Code Segment register defaults to FFFFFH and the Data segment register to 0000, these registers do not require re-programming.

## Interrupts

A microprocessor conventionally executes a 'background' program in a continuous loop, and spends most of the time actually doing relatively nothing, waiting for some external impulse from the human operator or from, say, an external micro switch. This is the function of an interrupt line - to respond rapidly to this external event and then to escape from the normal background execution of a program and to run a new program specific to the event that has occurred.

For example, when a key is pressed on the keyboard, an interrupt signal is issued from the keyboard hardware and routed to the interrupt pin of the microprocessor. A software program termed the 'interrupt service routine' dedicated to the keyboard now runs. The program most likely will read which key has been pressed and return an ASCII value to a register in the microprocessor, from where it may be processed. A sub-routine will cause the letter or number associated with the key pressed to be displayed on the visual display unit (screen/monitor).

Earlier processors typically had one or two interrupt lines. The 6502, for example, had one software maskable interrupt line (IRQ) whose function as an

interrupt pin could be disabled by a simple software command, preventing the processor from responding to any interrupts. An additional line - non-maskable interrupt (NMI) - was always active and could not be inhibited by software control. As systems became more complex with the addition of several peripherals including keyboard, serial mouse port, parallel printer port, floppy disk drive etc, additional interrupt lines were required, each one dedicated to a specific interrupting peripheral.

When multiple interrupt lines are being used by a microprocessor based system, it may appear that several things are happening at the same time. This illusion is caused by the speed of the interrupt system. A click on the games joystick will actually suspend the games animation for a possible 10 microseconds while the interrupt program processes the switch interrupt and reverts back to the main 'background' graphics program - a delay which is quite impossible to perceive by human senses. While the PC sits on the desk with no keyboard or mouse input, the system processor is continuously being interrupted - albeit at a comparatively slow (millisecond) rate - by the video processor card to enable the video interrupt routine to continuously update the screen's output. An onboard hardware timer similarly emits periodic interrupt pulses to maintain the PC's internal clock.

The 8088 processor, followed by the 8086, 80286, 80386, 80486, Pentium and soon the P6, has been used in successively more powerful PCs over the years. Additional peripheral needs such as Network cards and CD ROMS has increased the requirement for more interrupt lines. If we look at the pinout of the 8088, we see that there is only one interrupt pin marked INTR. A separate interrupt controller found in all PCs - the 8259 PIC, provides a means of generating multiple interrupts. A single PIC will provide an interrupt to the 8088 with the addition of an identification data byte which is read in via the 8088's data buss identifying which interrupt pin (1 of 8) has been activated. This means that whenever a hardware interrupt occurs, the background program which the 8088 is running suspends execution, and an interrupt routine specific

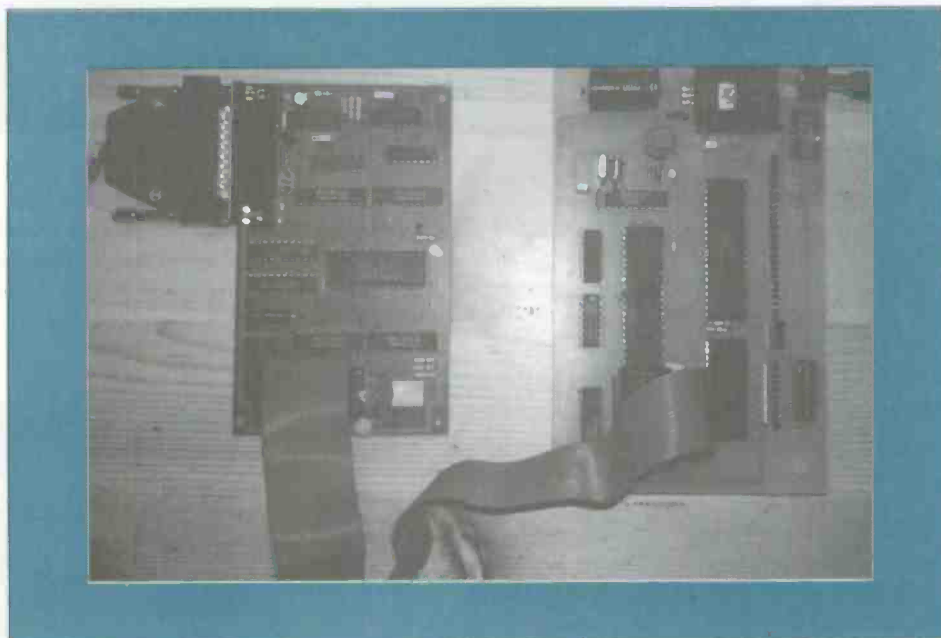

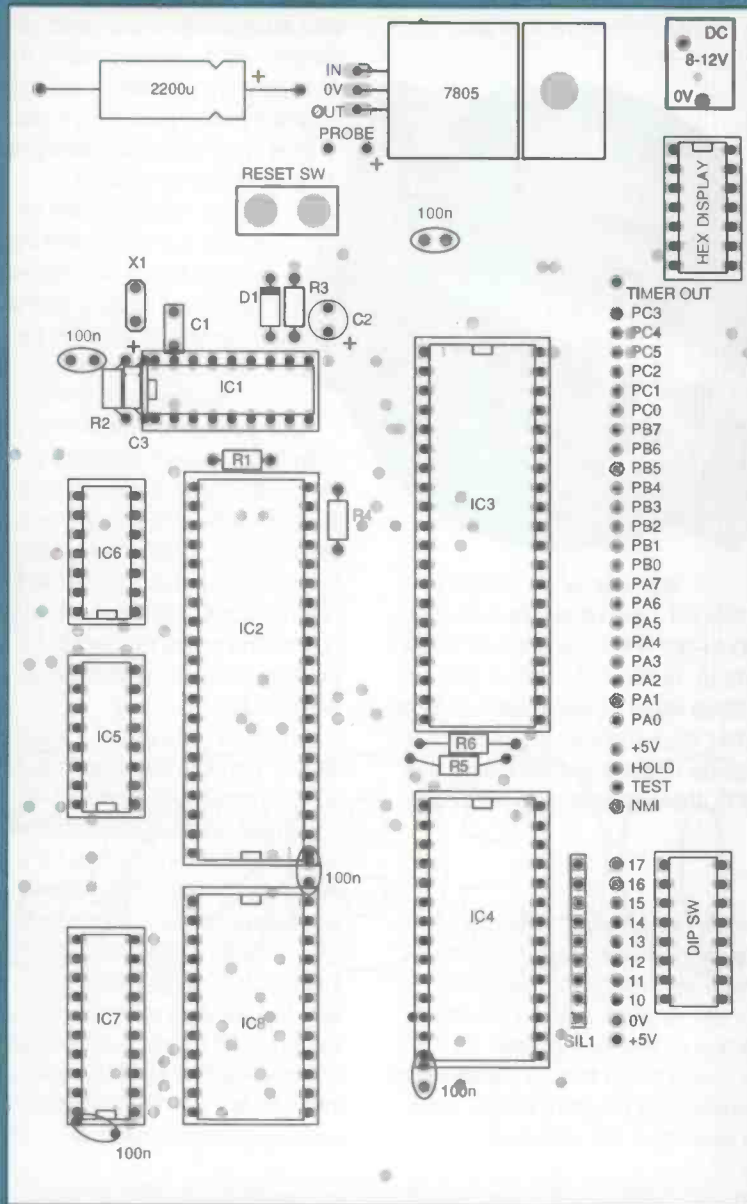

Fig.2. Component overlay for 8088 SBC

to the causing interrupt executes - on completion of which the background program recommences at the point at which it was interrupted. Eight interrupts are insufficient for present day PCs and two or more PICs are cascaded to provide a maximum of 64 interrupt lines, each line associated with a different peripheral type

At this point we shall look at the NMI interrupt source. The PC does not have this pin connected to the expansion slot, and the main use of the NMI interrupt is as a TYPE 2 software interrupt which is used to close down the system if a memory failure (parity error) or maths co-processor error - especially in floating point number calculations occurs. In control computers such as the 8088 SBC, the NMI is available as a hardware interrupt and conventionally is used to sense a power failure. In the several milliseconds of time when the voltage level starts to drop, and while the hardware is still responding due to the

voltage tolerance level, an NMI interrupt service routine can save all software variable and processor contents in non-volatile memory (i.e. battery backed RAM) - program execution time of something in the order of a few hundred microseconds.

## Next Month...

Next month we continue the project and take a look at software interrupts.

# EASY-PC, Schematic and PCB CAD

Over 19,000 Installations  
in 80 Countries World-wide!

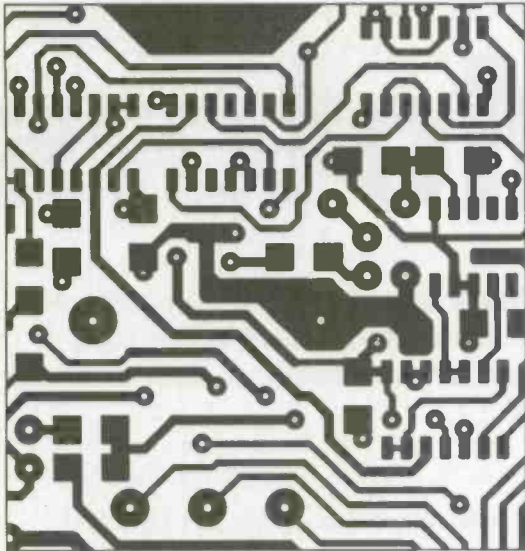

- Runs on:- PC/XT/AT/ 286/ 386/ 486 with Hercules, CGA, EGA or VGA display and many DOS emulations.
- Design:- Single sided, Double sided and Multi-layer (8) boards.
- Provides full Surface Mount support.
- Standard output includes Dot Matrix / Laser / Ink-jet Printer, Pen Plotter, Photoplotter and N.C. Drill.
- Tech Support - free.
- Superbly easy to use.

Still  
Only  
**£98.00!**

Plus P&P+VAT

BRITISH  
**DESIGN**  
AWARD  
1989

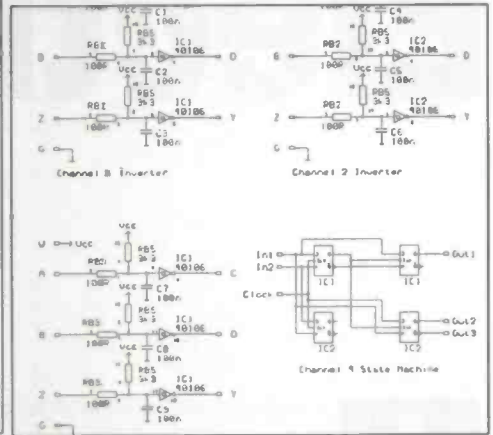

Options:-500 piece Surface Mount Symbol Library £48,  
1000 piece Symbol Library £38, Gerber Import facility £98.

## Electronic Designs Right First Time?

### Active and Passive Filter Design - FILTECH -

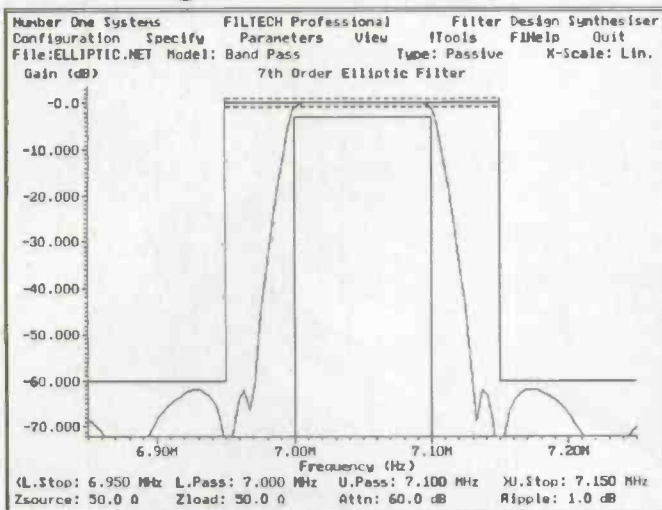

From only £145!

### Affordable Electronics CAD

FILTECH: Active and Passive Filter Design program	From \$275	£145
LAYAN: New Electro-Magnetic layout Simulator. Include board parasitics in your Analogue simulations. Links with and requires EASY-PC Professional XM and ANALYSER III Professional	\$950	£495
EASY-PC Professional: Schematic Capture and PCB CAD. Links directly to ANALYSER III, LAYAN and PULSAR.	From \$375	£195
PULSAR: Digital Circuit Simulator	From \$195	£98
ANALYSER III: Analogue Linear Circuit Simulator	From \$195	£98
STOCKIT: New comprehensive Stock control program for the small or medium sized business	\$275	£145
EASY-PC: Entry level PCB and Schematic CAD.	\$195	£98
Z-MATCH for Windows: Windows based Smith-Chart program for RF Engineers.	\$475	£245

We operate a no penalty upgrade policy.  
US\$ prices include Post and Packing  
Sterling Prices exclude P&P and VAT.

For full information, please write, phone or fax:-

## Number One Systems

UK/EEC: Ref. ETI, HARDING WAY, ST.IVES, ENGLAND, PE17 4WR.

Telephone UK: 01480 461778 (7 lines) Fax: 01480 494042

USA: Ref. ETI, 126 Smith Creek Drive, Los Gatos, CA 95030

Telephone/Fax: (415) 968-9306

International +44 1480 461778



ada4all5

# DC & Electronically Commutated Electric Motors

*Today there are a very wide range of electric motor technologies in use, Douglas Clarkson takes a look at some of them*

**I**n spite of developments in technology which have made equipment smaller, lighter and with fewer moving parts, there remains a core of applications which require compact motor control systems. While stepper motor technology is extensively used in numerous applications, increasing use is being made of DC motors especially in

portable equipment where their intermittent use provides savings in battery consumption.

Also as whole new technologies have developed, DC motors have found new areas of application. In the automotive field, for example, new applications include carburation controls and event recorders for trucks, buses and taxis. In the medical field applications are extensive and include ecg systems, infusion pumps, sterilisable handtools, renal dialysis equipment and laboratory analysis equipment. Automated ticket machines make extensive use of DC motors as do office equipment such as photocopiers and fax machines.

In the world of information technology, computer back-up systems and CD players also use DC motors. Video recorders, movie and photo cameras also use such motors extensively. The development of robotics has opened up new areas of DC

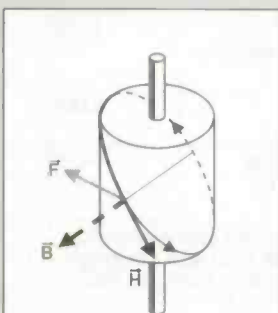

Figure 2: Relationship of magnetic field, rotor current and electromotive force (Courtesy Portescap)

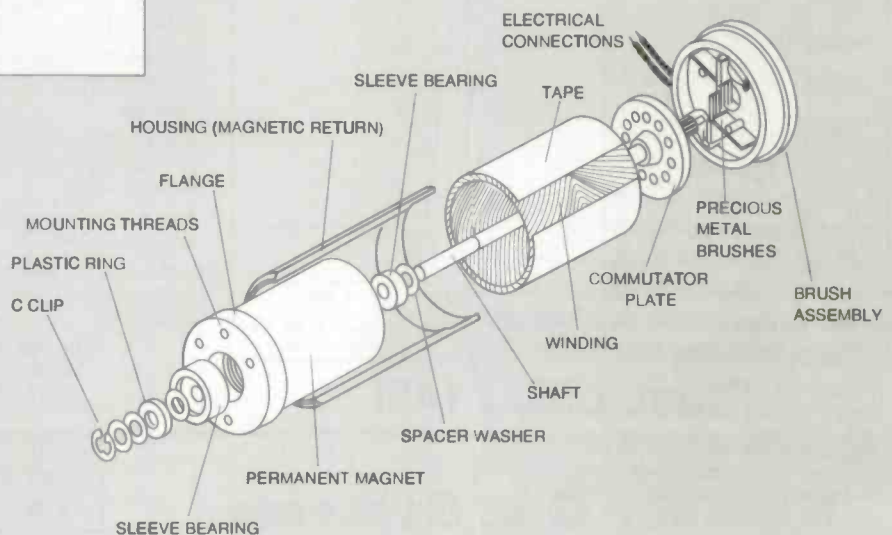
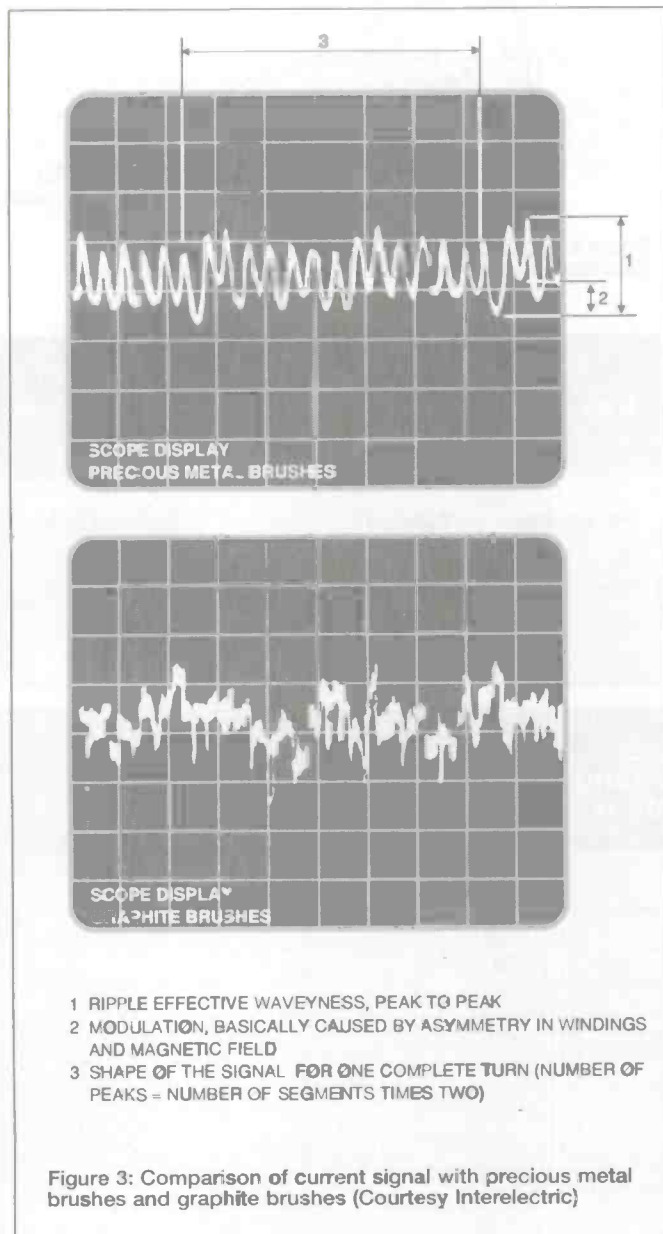
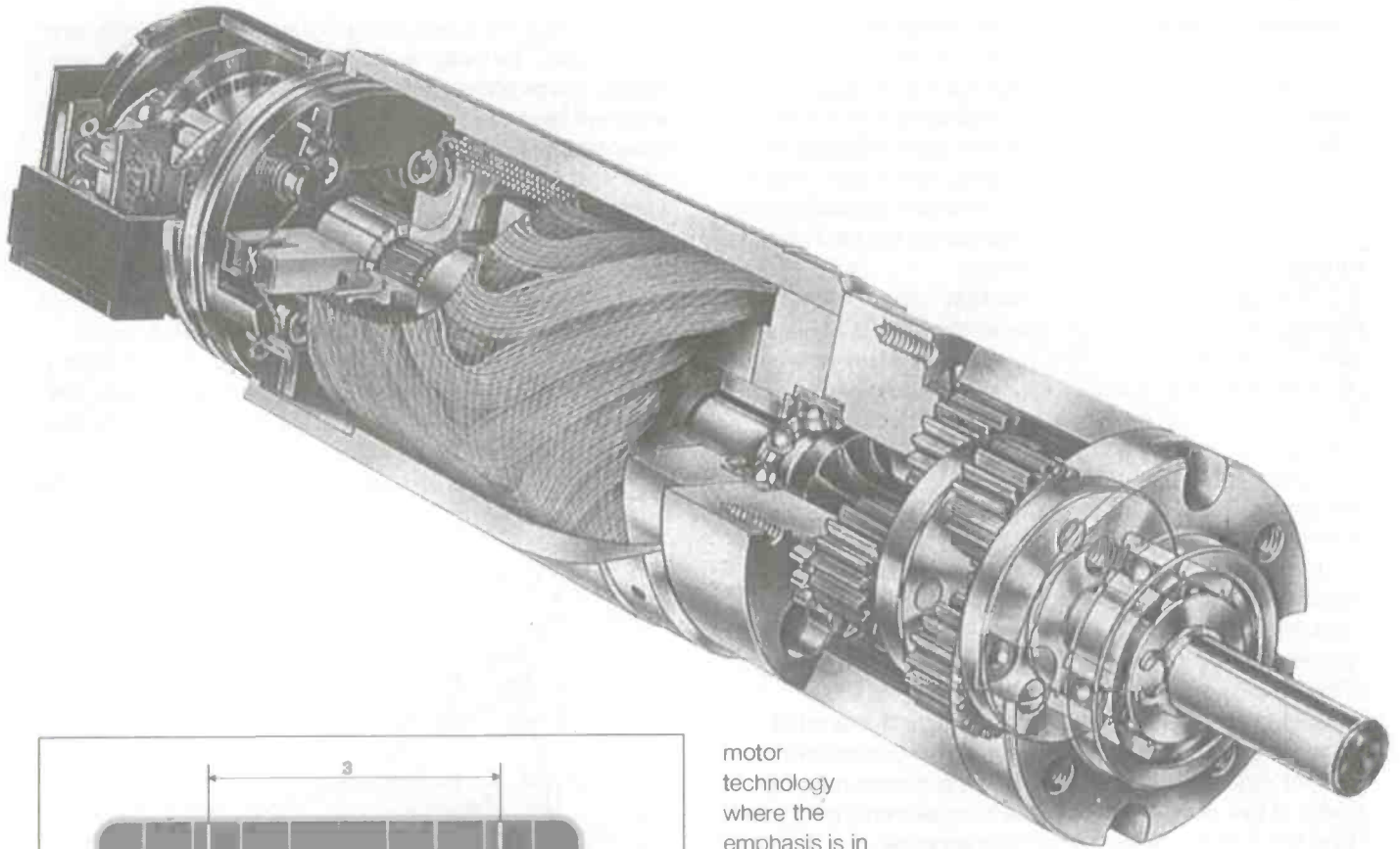

Figure 1: Basic design of DC Motor: The winding rotates in the gap between the permanent magnet and the outer case (Courtesy Interelectric AG)



motor technology where the emphasis is in precision movements and high accuracy of tracking of motion.

The DC motor is typically, however, only one component of a final mechanical drive system. There is usually the requirement to incorporate some element of gearing and, in addition, information can be required for monitoring rotational speed and absolute rotational position. In DC motor system selection, however, the key aspect will usually be the parameters of the motor/gear box system. In this context often the size of the motor system can be a critical design criteria.

In describing DC and electronically commutated (EC) electric motors, emphasis will be placed on DC motors since their use is much more extensive. Electronically commutated motors are briefly discussed in order to cover basic aspects of these more complex devices.

### Identification of Need

In determining the requirements of a DC motor system, usually the nature of the application will have defined parameters for torque, rotational speed, current and operating temperature. It is important, however, before motor and associated systems are purchased, that the basic operational requirements of the application are appreciated.

### Basic Design of DC Motor

Figure 1 indicates the basic design of the ironless rotor DC motor. The rotor winding is fabricated to be of low electrical inductance and also of low mechanical inertia. A range of wire thicknesses is typically used - varying from between 0.032 mm to 0.45 mm in the case of the Maxon range of DC motors. Windings resistances vary considerably depending on design specification. A small DC type will, however, have a typical windings resistance of around 500 ohms with an inductance of 0.1 mH.

One of the limitations of motor operation is the power

dissipation in the rotor windings. The resistance typically increases by 0.4% per degree centigrade so significant heating can reduce load current and associated motor torque. The maximum rotor temperature of Portescap motors is typically 100 C. Maxon systems tend to have a standard upper rotor temperature of 85 C and a higher specification class limit of 125 C. In assessing design criteria, however, increased motor reliability will be associated with maintaining the rotor windings at as low a temperature as possible.

The rotor is mounted over a fixed permanent magnet. Lines of magnetic field radiate out between the inner fixed magnet and the outer metal case. The current in the skew windings in the rotor flow at right angles to the magnetic field, causing a force to be exerted on the rotor to rotate it as indicated in figure 2. A commutator on the axis of the rotating spindle is supplied with current from either precious metal or carbon brushes. Commutators typically will consist of between 5 to 12 elements.

Motor life is largely determined by the resilience of the commutator surface. As each segment of the commutator is switched in and switched out, arcing can take place as the current circuit to each rotor section is established and broken. The amount of material removed from the commutator surface by this arcing is proportional to the inductance of each winding section and the square of the commutator current. One significant advantage of the ironless rotor DC motor is that the inductance of the rotor elements is reduced by a factor of around two orders of magnitude.

Materials technology, however, such as the REE system developed by Portescap, has reduced commutator wear considerably compared with previous standard technology.

The use of precious metal brushes reduces noise in the commutator current compared with graphite brushes. Figure 3 shows the greater noise signal observed with graphite brushes. Also, low contact resistances are maintained even after periods of prolonged shutdown. The reduction of noise in current supply circuitry can be important also for reduction of overall noise factors in associated electrical circuitry.

Graphite brushes and copper commutators are typically used where the most rigorous start/stop servo applications are encountered.

### DC Motor Operating Characteristics

Figure 4 indicates how operating characteristics are typically described. The list of key parameters indicated in figure 4 are described in Table 1.

The term  $n_0$  is the speed at which the motor works with zero applied load. The motor is effectively doing work against only bearing friction and air resistance. The term MH is the torque which will cause the motor to stall. The term  $I_0$  is the current drawn when no load is applied and  $I_A$  is the current at both initial start or at stall torque. As indicated in figure 4, for a specific supply voltage, the typical DC motor has a linear loading characteristic where for increasing torque the current drawn increases linearly and the motor speed decreases linearly. Figure 5 indicates how the function of the DC motor is also directly related to the supply voltage. For the series of voltages indicated, 12, 24 and 36 V, the stall torque and no load speed values are proportional to the voltage supply. The common factor, however, of the motor is the slope of the line linking no load point to stall points. This term, known as the speed torque gradient is a useful figure of merit. The lower the

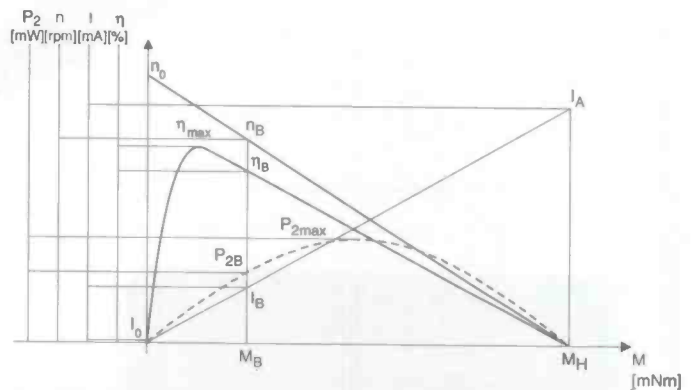

Figure 4: Typical operating characteristics of a DC motor (Courtesy Interelectric).

**Table 1**  
Key parameters referenced in DC motor specification

Parameter	Symbol	Typical Units
no	No load speed	rpm
MH	Stall Torque	mNm
Io	No Load current	ma
IA	Starting current	mA

**Table 2**  
Details of torque gradient for a range of Maxon DC motors.  
The middle pair of motor code digits is the motor diameter in mm.

Torque Gradient (rpm/mNm)	Power (W)	Motor Type	Motor Code	Nominal Voltage
25400	0.5	S-motor	23.12.910	3
2880	1.5	CLL	20.17.938	12
1190	2	A-motor	25.15.984	3
212	6	S-motor	23.22.980	18
181	4	S-motor	23.26.934	6
57.3	15	S-motor	23.32.966	12
5.35	40	F-motor	22.60.811	18
1.37	80	F-motor	22.60.881	15



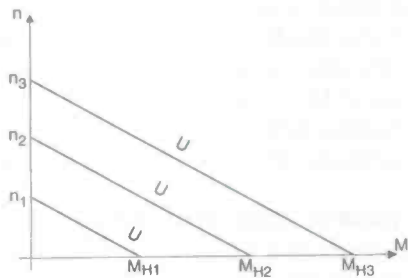

Figure 5: Variation of DC motor characteristics -function of supply voltage: slope of the line is a characteristic of a specific motor (Courtesy Interelectric)

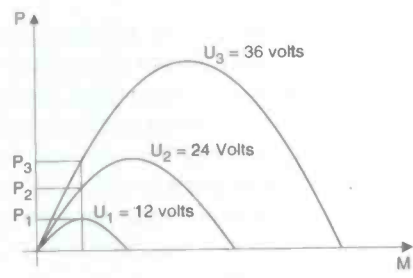

Figure 7: Variation of motor power for a set of three drive voltages (Courtesy Interelectric)

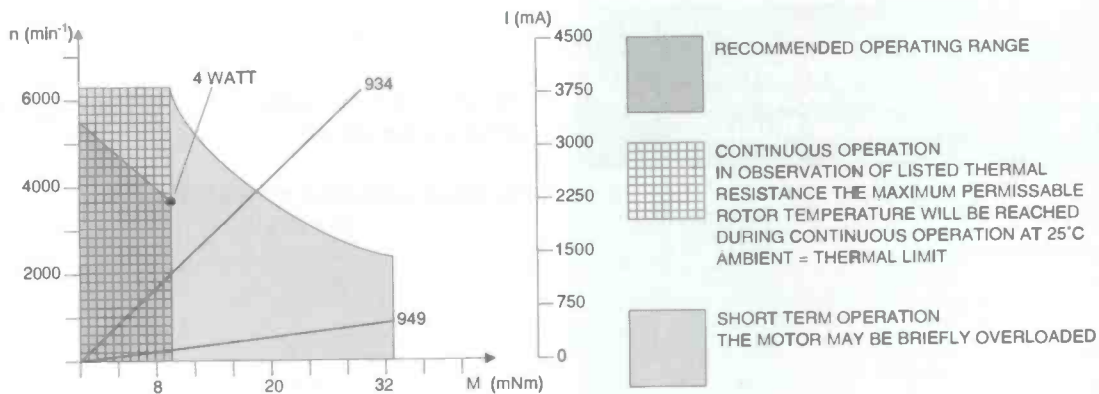

Figure 8: Operating areas of a specific DC motor. (Courtesy Interelectric)

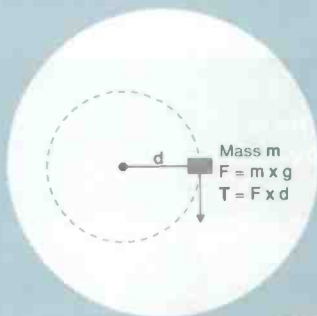

Figure 6: Principle of calculation of torque values: a mass  $m$  (kg) under gravity a distance  $d$  (metres) from the point of action gives rise to a torque  $mgd$  in units Nm.

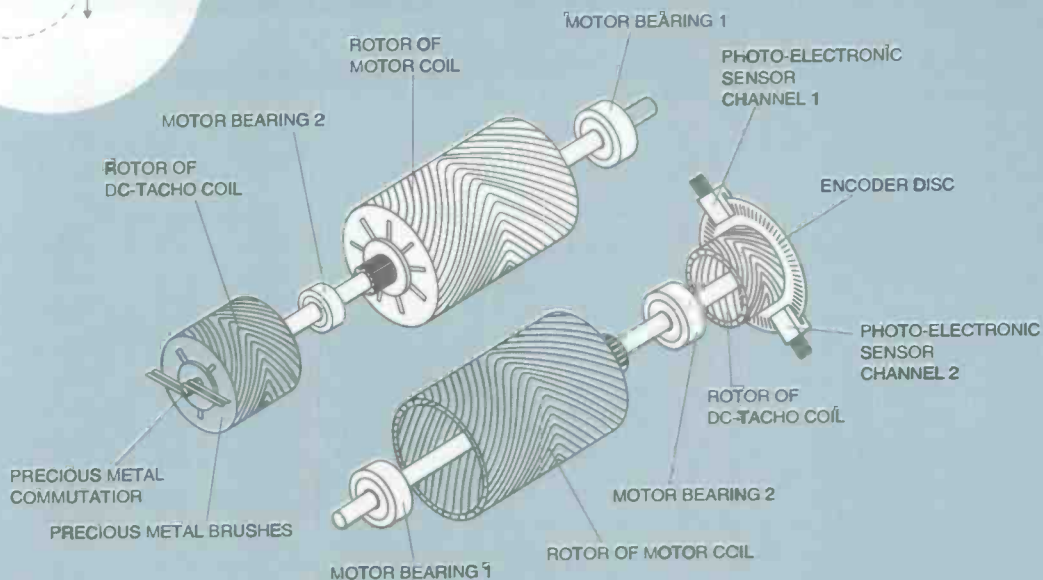

Figure 9: Combined DC tachometer/position encoder system (Courtesy Interelectric)

value the better the motor. Table 2 indicates typical values for a range of Maxon motors.

### Motor Torque

It is perhaps appropriate to clarify some definitions relating to the torque of DC motors. Figure 6 shows the application of a force  $F$  acting at a distance  $d$  from a pivot point. Table 3 indicates the values of torque as derived from the configuration outlines in figure 6. The magnitude of the torque applied is  $F$  (in Newtons) multiplied by the distance in metres. While the conventional units used should be Nm (Newton metres) it is common to use mNm (milli Newton metres) for DC motor torque values (1000 mNm = 1 Nm).

Often, however, DC motors are used with gearboxes with extensive reduction ratios. As the gear ratios are stepped down, so the torque ratios are stepped up. Consideration has to be allowed, however, for loss of mechanical efficiency in the

gear mechanisms. Thus, while the 'perfect' gear system with a 100:1 rpm reduction will result in a 100:1 increase in torque, it is typical for such a gearing to deliver only around 70% of the theoretical torque value.

While in the specification of a DC motor, a value is quoted for the stall torque, this should not be confused with the typical torque required for normal operation. The maximum operating torque is typically 40% of stall torque. Normal continuous operational torque will be somewhat less than this.

### Motor power and efficiency

In many applications a key design factor is the mechanical power which the DC motor can deliver. In one revolution of the motor the work done,  $E$ , against a torque  $T$  arising from force  $F$  acting at a distance  $R$  is:-

$$E = F \times 2 \text{ Pi} \times R \quad (1)$$

$$= 2 \times \text{Pi} \times T \quad (2)$$

$$\text{where } T = F \times R.$$

Where the rotational speed is  $n$  revs per minute, the number of revolutions per second =  $n/60$ .

The rate of doing work is therefore

$$= \frac{2 \times \text{Pi} \times T \times n}{60} \quad (3)$$

$$= \frac{\text{Pi} T n}{30} \quad (4)$$

The maximum value of effective motor power occurs at half stall torque. Thus, when either the motor is operating close to its stall torque or functioning with a light load, the motor is not

**Table 3**  
Values of torque arising from mass  $m$  suspended a distance  $d$  from a point of action as indicated in figure 6.

TDescription of Torque (mass $m$ as distance $d$ )	Torque value mNm
0.5 g at 5 cms	0.24
1 g at 5 cms	0.49
2 g at 5 cms	0.9
5 g at 5 cms	2.45
10 g at 5 cms	4.9
20 g at 5 cms	9.8
50 g at 5 cms	24.5

**Table 3a:**  
Maxon 0.5 Watt: Precious metal brushes:  
100:1 gear ratio with 75% efficiency.

motor speed rpm	motor torque mNm	motor current mA	motor Power W	motor Efficiency %	geared torque Nm	gear rpm
9480.0	0.0	10	0.00	0.0	0.000	94.8
8848.0	0.0	18	0.02	44.5	0.002	88.5
8216.0	0.1	27	0.05	56.0	0.004	82.2
7584.0	0.1	36	0.06	58.6	0.006	75.8
6952.0	0.1	45	0.08	57.6	0.008	69.5
6320.0	0.1	54	0.09	54.7	0.010	63.2
5688.0	0.2	63	0.10	50.8	0.012	56.9
5056.0	0.2	71	0.10	46.1	0.014	50.6
4424.0	0.2	80	0.10	41.1	0.016	44.2
3792.0	0.2	89	0.10	35.7	0.018	37.9
3160.0	0.3	98	0.09	30.1	0.020	31.6
2528.0	0.3	107	0.08	24.3	0.022	25.3
1896.0	0.3	116	0.06	18.3	0.024	19.0
1264.0	0.3	124	0.05	12.3	0.026	12.6
632.0	0.4	133	0.02	6.2	0.028	6.3
0.0	0.4	142	0.00	0.0	0.030	0.0

delivering significant levels of mechanical energy to the load structure. Figure 7 indicates some curves for a motor operating at three specific voltages. Since the motor power is proportional to both torque and rotational speed and these are separately proportional to voltage, the delivered power is proportional to the square of the drive voltage.

The efficiency,  $E_f$ , of the motor is given by the ratio of the available mechanical power to the electrical energy supplied:-

$$E_f = \frac{\pi T n}{30 U I}$$

where  $U$  is the voltage and  $I$  is the current drawn.

The maximum efficiency usually occurs at relatively high rotational speeds and at low torque values with values typically around 85%.

### Gear systems

The majority of applications involving DC motors will use some form of appropriate gearing. With so many more moving parts than the DC motor, the gearbox has two important parameters to maintain functional life - the maximum continuous torque and the maximum intermittent torque. These usually have a ratio of 2. While for the 'perfect' gearbox the increase in torque gain is the reciprocal of the rotational gearing factor, in practice the loss of mechanical efficiency in the gear train accounts for an

associated loss of available output torque.

Spur gears which are implemented in specific stages usually have an efficiency of 90% per stage so that a three-stage unit will have an efficiency of 73% and a five stage unit an efficiency of around 60%. A planetary gear box will tend to have similar levels of efficiency.

With age, some reduction in efficiency of gear train can be anticipated so that applications should design in adequate tolerance in operating points.

Typically in the Maxon range, small DC motors spur gearboxes develop output torques up to 0.6 Nm and with reduction ratios of 4:1 to 3000:1. Planetary gearboxes typically are used to develop higher torques up to 180 Nm with gear reduction between 4:1 and 1621:1. Maximum input rpm values are normally stated for each gearbox. This will typically be around 4000 rpm although values range between 3000 rpm to 6000 rpm.

Where a specific output torque,  $ML$  (in Newtons.metre), is required using a gear with reduction  $I$  and efficiency  $E_f$ , then the torque required from the motor,  $MM$  (milli N.m), is given by:

$$MM = \frac{ML \ 1000}{I \ E_f} \text{ mNm}$$

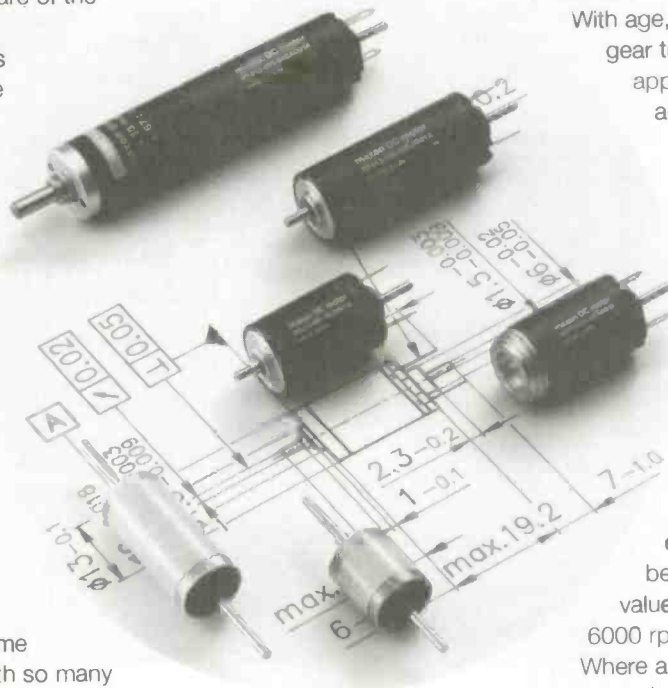
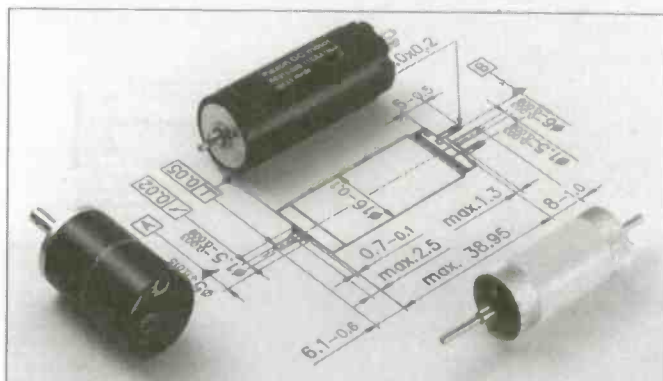

**Table 3b:**  
**axon 2 Watt : Precious metal brushes:**  
**100:1 gear ratio with 75% gear efficiency.**

motor speed	motor torque	motor current	motor Power	motor Efficiency	geared torque	gear rpm
rpm	mNm	mA	W	%	Nm	
8080.0	0.0	15	0.00	0.0	0.000	80.8
7541.3	0.5	80	0.36	76.1	0.035	75.4
7002.7	0.9	145	0.68	77.9	0.069	70.0
6464.0	1.4	209	0.94	74.5	0.104	64.6
5925.3	1.8	274	1.14	69.5	0.138	59.3
5386.7	2.3	339	1.30	63.8	0.173	53.9
4848.0	2.8	404	1.40	57.9	0.207	48.5
4309.3	3.2	469	1.46	51.7	0.242	43.1
3770.7	3.7	534	1.46	45.4	0.276	37.7
3232.0	4.1	599	1.40	39.1	0.311	32.3
2693.3	4.6	664	1.30	32.6	0.345	26.9
2154.7	5.1	728	1.14	26.2	0.380	21.5
1616.0	5.5	793	0.94	19.7	0.415	16.2
1077.3	6.0	858	0.68	13.1	0.449	10.8
538.7	6.4	923	0.36	6.6	0.484	5.4
0.0	6.9	988	0.00	0.0	0.518	0.0

**Table 3c:**  
**Maxon CLL 4 Watt: Precious metal brushes: 100:**  
**1 gear ratio with 75% gear efficiency.**

motor speed	motor torque	motor current	motor Power	motor Efficiency	geared torque	gear rpm
rpm	mNm	mA	W	%	Nm	
4090.0	0.0	12	0.00	0.0	0.000	40.9
3817.3	2.1	88	0.85	80.4	0.159	38.2
3544.7	4.3	164	1.58	80.2	0.319	35.4
3272.0	6.4	240	2.19	76.0	0.479	32.7
2999.3	8.5	316	2.67	70.5	0.638	30.0
2726.7	10.6	392	3.04	64.6	0.798	27.3
2454.0	12.8	467	3.28	58.5	0.957	24.5
2181.3	14.9	543	3.40	52.2	1.117	21.8
1908.7	17.0	619	3.40	45.8	1.276	19.1
1636.0	19.1	695	3.28	39.3	1.436	16.4
1363.3	21.3	771	3.04	32.8	1.595	13.6
1090.7	23.4	847	2.67	26.3	1.755	10.9
818.0	25.5	922	2.19	19.8	1.914	8.2
545.3	27.6	998	1.58	13.2	2.073	5.5
272.7	29.8	1074	0.85	6.6	2.233	2.7
0.0	31.9	1150	0.00	0.0	2.392	0.0



In motor design it is typical to quote motor torques in mNm and gear torques in Nm.

### Calculating motor/gear requirements

The simple BASIC programme listed in Appendix 1 provides a range of computed data based on the specification of the key DC motor parameters listed in Table 1. Where, also, a specific gearing is required, related data is also calculated.

Tables 3a, 3b and 3c indicate the typical set of data calculated using the programme of Appendix 1 for a specific motor configuration with mechanical gear ratio of 100:1 and gear efficiency of 75%.

Summary operating data is usually available for specific motors - indicating zones of continuous operation and of permitted intermittent operation. Figure 8 indicates the operational characteristics of a specific Maxon motor. Zones of recommended operation, permitted continuous operation and short term operation are specifically detailed.

### Servo sensing

In some applications there will be a requirement to control and

monitor the rotational speed of the motor and in others the requirement to rotate the motor to a given position. The aspect of determining rotation speed is relatively simple and can be undertaken by attaching a tachometer unit to the motor assembly. Usually the output of the tacho is derived from the voltage produced by relative rotation of a tacho coil and a permanent magnet. A typical specification is 0.5 V per 1000 rpm. A unit with combined tacho output and also photoelectric sensor is shown in figure 9. Servo units can also derive two independent channels A and B and a reference 'index' channel I which defines an absolute rotational position as shown in figure 10. The relative phase of A and B is an indication of rotational direction as indicated in figure 11. Digital encoders are available with up to 1000 counts per turn and with a maximum count rate of around 100 kHz.

Such encoders can usually be obtained as integral 'snap on' units to specific DC motor/gear box systems. There are applications, however, where it is required to know at all times the absolute position of the output arm. For this a servo potentiometer can be used although DC motor manufacturers and suppliers do not provide these components as integral 'snap on' accessories. Such servo potentiometers are readily obtainable but usually require bosses to be set up to match servo spindles with motor spindles. There is usually a portion over which the signal is rapidly changing as the full span voltage rolls over to the start voltage. This is typically around 2 degrees and depends on the specification of the particular servo unit. Servo pots may not be suited to systems in continuous rotation due to constant wear on potentiometer active surface.

Figure 12 indicates how a servo pot can be attached to a DC/motor system. Figure 13 shows the typical output voltage obtained with excitation voltage of 1 V as a function of angular position. Assuming the signal is read by a computer, using an A/D with 8 bit resolution, this provides a resolution of 1.41 degrees, 10 bits 0.35 degrees and 12 bits 0.09 degrees.

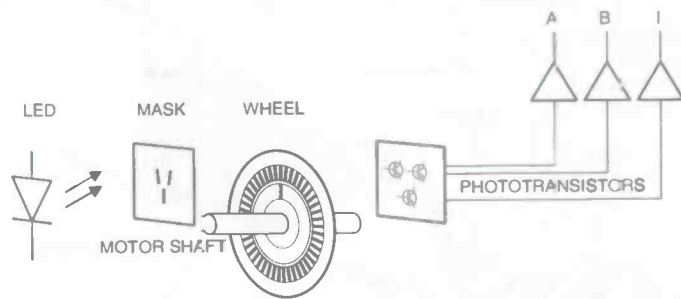

Figure 10: Details of optical position encoder. Channel A and B give change in direction and relative signals rotational direction. Channel I provides a reference positional marker (Courtesy Interelectric)

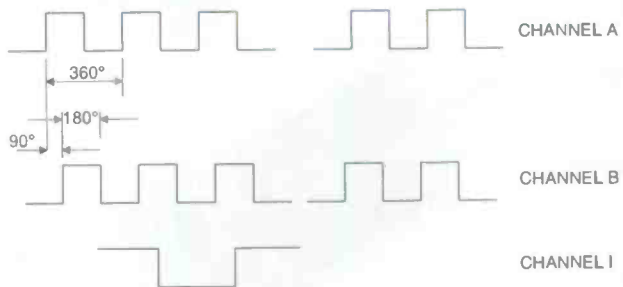

Figure 11: Signals from an optical servo system: A and B are independent positional sensors and I is a reference position marker (Courtesy Interelectric)

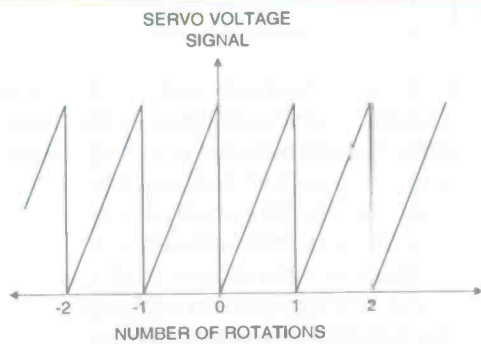

Figure 13: Output signal of servo potentiometer as a function of rotational position.

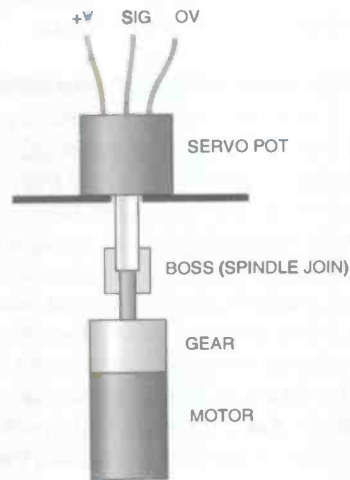

Figure 12: Mode of attachment of servo potentiometer to DC motor/gearbox combination.



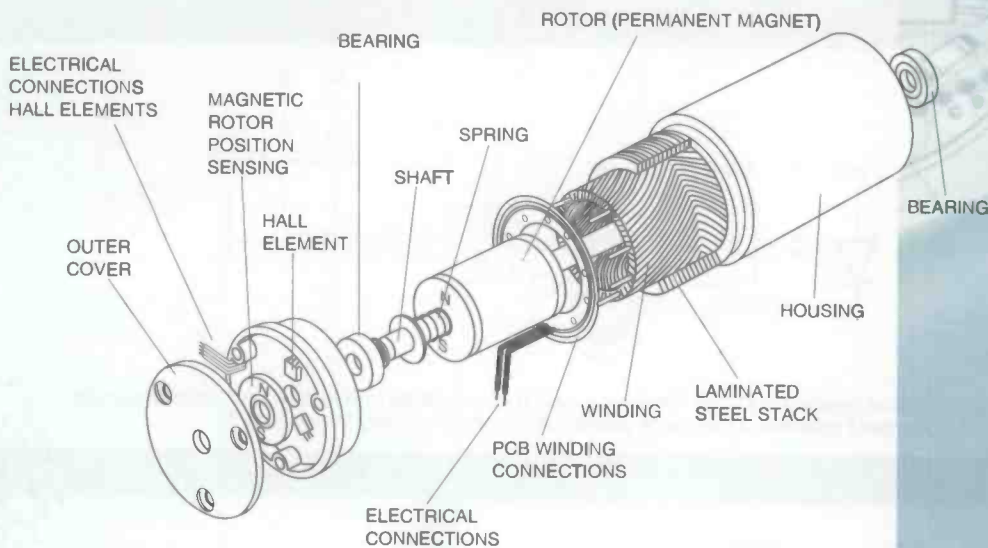

Figure 15: Schematic diagram of the control circuit necessary to drive an EC electric motor (Courtesy Interelectric)

There may in addition be other associated measurement errors such as the linearity of the potentiometer.

### Electronic commutator motors

Considerable effort has gone into developing conventional mechanical commutator technology for DC motors. Where moderate use and loading is indicated then DC motor life is usually adequate. Values of up to 20,000 hours should be achievable with appropriate correct configurations.

@B: For applications where extensive heavy duty loading is required then electronically commutated motors can find useful application. In this design of motor, the rotor is fixed and the permanent magnet in the core of the motor is instead rotated as indicated in figure 14. The control of such motors, however, is more complex and is undertaken by sensing the relative rotational position of the core and pulsing the selected rotor winding. Usually voltage pulses (positive and negative) between 12 to 50 V are used with maximum currents of around 5 A. Rotational position can usually be determined with Hall effect sensors. Such motors are usually driven by specific controller cards. The life of such motors is limited only by the resilience of the motor bearings used. The complex motor control circuitry used is shown in figure 15.

### Summary:

The general specification of electric motors has improved - providing higher torques and longer lifetimes. Part of the skill, however, in the engineer in harnessing such technology is to

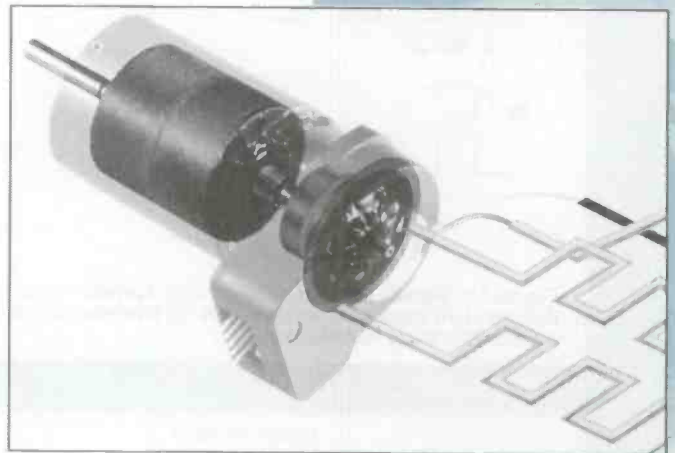

be aware of the specification and the range of products available. The simplest devices to configure are the DC types. With increased resilience of mechanical commutators DC types can cope with increased loading and wear and tear. For more exacting requirements of loading and where fine control of rotational position is required, then the electronically commutated motor may be more appropriate - although the cost of drive circuits is an additional expense. The manufacturers/agents of DC electric motors will certainly be able to provide expert advice on motor/gearbox selection in order to 'get it right first time'.

## Further information

Published by Portescap,

- 1 Physical properties of D.C. motors using an ironless rotor
- 2 Damping of D.C. motors with ironless rotors
- 3 Reliability and life of D.C. motors: the new REE System

### Appendix I

```

10 REM programme to calculate DC motor
characteristics
20 CLS : REM clear screen
30 INPUT ; "Enter Nominal Voltage ", U: PRINT
40 INPUT ; "Enter No load speed (rpm) ", no:
PRINT
50 INPUT ; "Enter Stall torque (mNm) ", MH:
PRINT
60 INPUT ; "Enter No load current (mA) ", Io:
PRINT
70 INPUT ; "Enter Starting (stall) current
(mA) ", IA: PRINT
80 INPUT ; "Enter gear ratio ( eg 25 100 etc)
", Gr: PRINT
90 INPUT ; "Enter Gear Efficiency % "; Ge:
PRINT

100 REM set up equations of current with
torque

```

```

PRINT " motor motor motor motor motor
geared gear"
110 PRINT " speed torque current Power
Efficiency torque rpm"
115 PRINT " rpm mNm mA W %Nm "
120 FOR jj = 0 TO 15: REM set loop of range
of TORQUE
130 M = MH * jj / 15: REM step through torque
values
140 I = Io + ((IA - Io) * M) / MH: REM
calculate current values
150 n = no * (1 - M / MH): REM calculate
rotational values
155 P = 3.142 * M * n / (30 * 1000): REM
calculate motor power
Ep = U * I * .001: REM motor electrical
power (Watts)
Ef = P / Ep: REM motor efficiency
Gt = (.001 * M) * (Gr * .01 * Ge): REM
output geared TORQUE
gn = n / Gr: REM output rotational speed

```

```

160 PRINT USING "#####.##"; n;
170 PRINT USING "#####.##"; M;
180 PRINT USING "#####"; I;
190 PRINT USING "#####.##"; P;
200 PRINT USING "#####.##"; Ef * 100;
205 PRINT USING "#####.##"; Gt;
206 PRINT USING "#####.##"; gn
210 NEXT jj
220 PRINT "press key to continue";
230 a$ = INKEY$: IF a$ = "" THEN 230
240 GOTO 20

```

## Points of contact

**Portescap,**  
165, rue Numa-Droz,  
CH-2301 La Chaux-de-Fonds 1,  
Switzerland.  
tel 039 25 61 11  
fax 039 25 65 90

**Portescap UK Ltd.,**  
Headlands Business Park,  
Salisbury Road,  
Ringwood,  
Hampshire, BH 24 3PB.  
tel 0425 471100  
fax 0425 477755

**Maxon Motor,**  
Interelectric AG,  
Ch-6072 Sachse/OW,  
Switzerland.  
tel +41/41-60 15 00  
fax +41/41-60 16 50

**Trident Engineering Ltd.,**  
Winnerish,  
Wokingham,  
Berks, RG11 5AS.  
tel 0734 78 64 44  
fax 0734 77 63 45  
(agents for Interelectric)

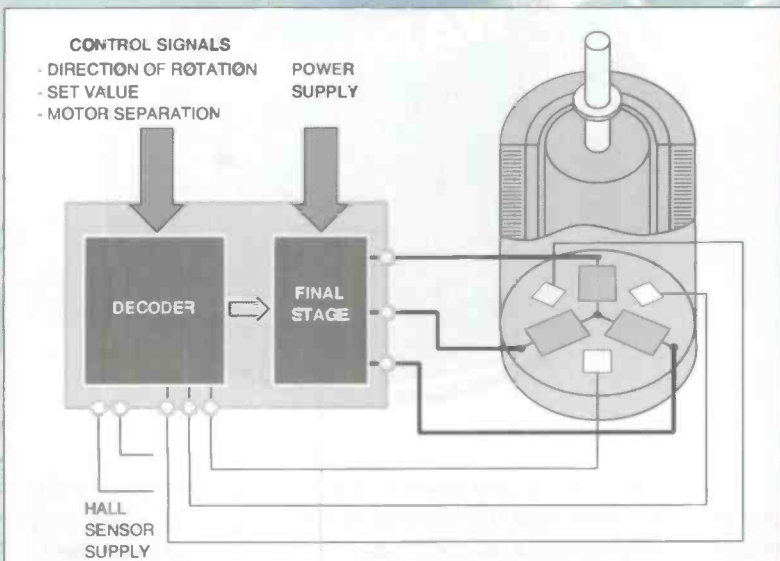
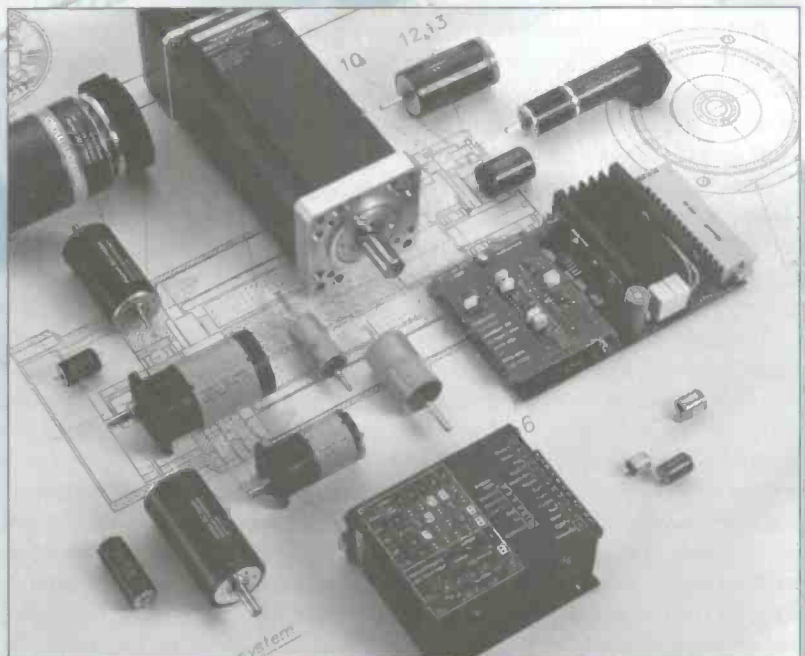

Figure 14: Design of Electronically commutated electric motor: The windings are fixed and the permanent magnet core is itself rotated (Courtesy Interelectric)



# Versatile Multi checker

**A pocket sized multi-purpose tester for hobby electronics and car, designed and developed by Tim Parker**



**W**

hen it comes to test gear, commercially available equipment is generally, by design (due to the number of built-in functions, and the high specifications to which it is manufactured) very expensive. Unfortunately, this has the effect of putting people off buying it unless they have specific requirements, and can justify the cost by the continuous use to which it would be put.

The design presented here is a simple 'no frills', low voltage Multi-Checker providing two operating functions, and utilises two LEDs to indicate the status of its two test points - whether the integral touch pads are used, or whether a pair of test leads and probes are connected for more remote testing.

Basically, it's a glorified continuity/low voltage tester. This is no belittlement whatsoever, in fact, the very opposite is generally true. The simple ideas quite often form the best designs, and usually put in more operating hours than some of the most expensive test equipment.

The Multi-Checker should fulfil the majority of basic 'good/no good' testing requirements. Experience has shown that, for a lot of the time, a complete analysis of a device's operating characteristics is not required, just a simple indication of whether or not it's working, or whether a low voltage wire/connection has a potential on it or not will do. Surprisingly, even some of the simplest of tests can be difficult to carry out using (say) a high impedance (10M $\Omega$  input) digital multimeter. For instance, try to check a low frequency pulsing voltage. The reading hardly gets a chance to stabilise before the display is updated with another one and, anyway, none of them seem to represent the voltage you expected to find at

that point - up and down all over the place aren't they? Try to test and identify the cathode of a diode using the Ohms range. What do those readings mean? For a start, they mean there isn't sufficient current coming out of the meter to get the diode conducting, and secondly that you've probably got your fingers stuck across the test probes at the same time as the diode! Oh all right, get the analogue meter out and try testing it on that instead (remember those, they're the ones with a needle pointer that passes over a calibrated scale. You can still buy them you know!)

So, you see, hi-spec and expensive doesn't necessarily mean it's the best for the job in hand. Cheap and cheerful (or nasty) can also have its good uses - and in its own right. What's more, it's also cheaper to replace if you're unfortunate enough to blow it up!

As mentioned, the Multi-Checker provides two functions (actually there are three available on the switch, but functions 1 and 2 do basically the same thing). Function 1 is a simple, low voltage indicator with an input level of up to about 20 volts. Probably the most common use for this mode will be testing for the presence or absence of voltages around a car's electrical system, or in the workshop, checking for low voltages inside domestic electrical appliances - hi-fi etc. A real benefit of the Multi-Checker is that you don't have to worry about which way round to connect the test leads, since the unit will also indicate whether the detected voltage is AC, DC or slow pulsing (on/off) DC up to about 20Hz. Furthermore, if it happens to be DC, the Multi-Checker provides the user with a polarity indication, showing which of the two test probes is connected to the positive terminal - ideal if you're looking for



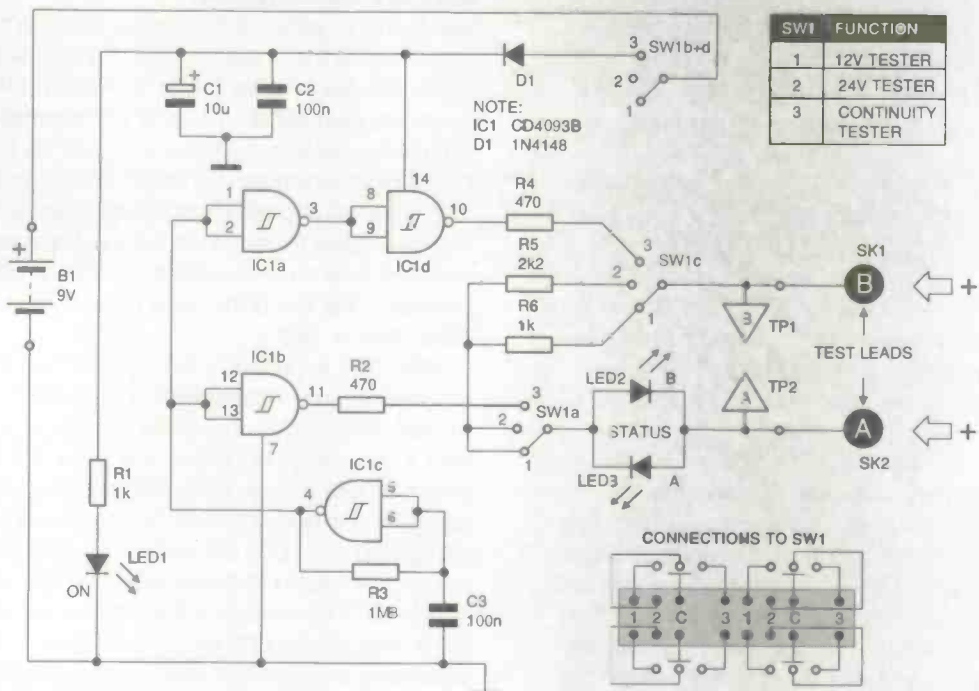

Fig.1. Multichecker circuit diagram

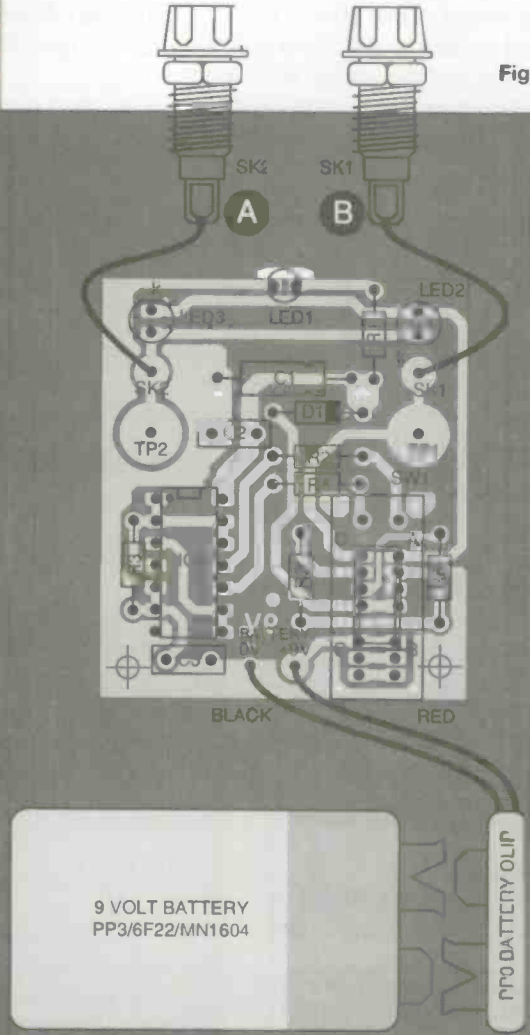

Fig.2. Component layout

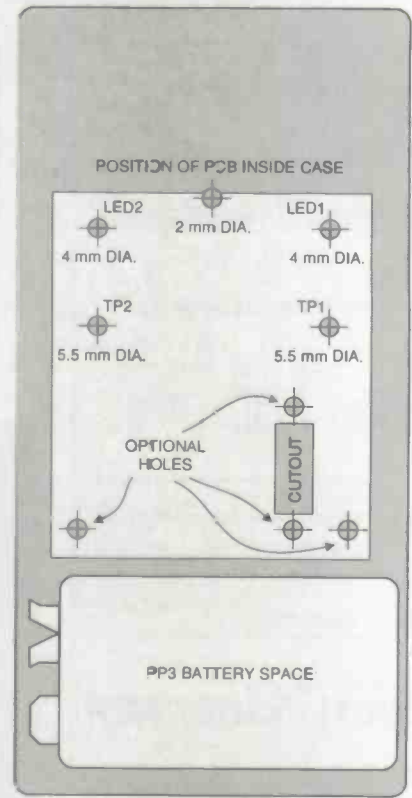

Fig.3. Drilling template

power when installing in-car accessories.

Function 2 is comparable to Function 1, except that it allows for an input of up to about 40V to be tested. This enables the unit to be used for the same purposes as those given above, but on (commercial) vehicles that are powered by 24V batteries, rather than the 12V ones found on most cars. For the electrician, it also provides simple electrical checking on 24V powered switch gear (AC or DC) used in industrial control panels.

When switched to Function 3 the Multi-Checker becomes a simple visual continuity tester, giving good or bad indication of fuses, light bulbs, switch contacts, transformer windings, speaker coils and heating elements etc - in fact anything which has a relatively low resistance. An added benefit of Function 3 is the ability to test diodes, zener diodes, LEDs and the like. By connecting them either way round, it will indicate which one of the two test points (pads or probes) is connected to the cathode of the device under test. Furthermore, if a good LED is connected, not only will the cathode be identified, but it will also illuminate, giving visual confirmation that it does actually work.

Because the prototype was used by the author for his own purposes, both the touch pads AND test lead sockets were fitted. If you intend to build this unit for someone else's use, then from a safety point of view it is best to fit only the test sockets, and provide the user with a pair of test leads and probes. This will eliminate the possibility of any (potentially deadly) hazards that may arise due to the fact that the test pads and sockets are permanently connected in parallel. Even though the Multi-Checker is not for use on mains voltages, someone is bound to poke one of the test probes into a power socket whilst holding the unit in their other hand with their thumb on the test pads - enough said. For this reason,

two possible suggestions have been given for the front panel legend, one with the test pads fitted, and one without.

### Circuit description

Due to the simplicity of the design, there isn't an awful lot to explain about the circuit diagram, the complete drawing of which appears in figure 1. Function switch SW1 is a four-pole-three-way slide switch. TP1 and TP2 are metal touch plates fitted to the outside of the case, and act as test pads for components which can be tested directly on the unit. SK1 and SK2 are 4mm sockets for attaching a pair of test leads and probes to allow more remote testing. Because none of the functions have a ground (0V) reference - and therefore are not polarised - the test points have been designated 'A' and 'B' rather than '+' and '-'.

With SW1 in position 1 or 2 (Functions 1&2), R6 or R5 respectively is connected via SW1a and SW1c in series with the test points (pads and probe sockets) and LED2 & LED3. With a low voltage DC potential applied to the test points, the polarity of that voltage will be indicated by LED2 or LED3. If test point B is connected to the positive connection then LED2 will light up and LED3 will remain off. If test point A has the positive connected to it then LED3 will light up and LED2 will remain off. If the voltage is pulsing at a frequency below about 20Hz, then either LED2 or LED3 will flash at this frequency, depending on which test point is connected to the pulsing line. At frequencies above 20Hz it will not be possible to easily detect the flashing, and the illuminated LED may give the impression that the voltage is constant.

A low voltage AC input applied to the test points results in both LED2 and LED3 lighting up, but on opposite half cycles

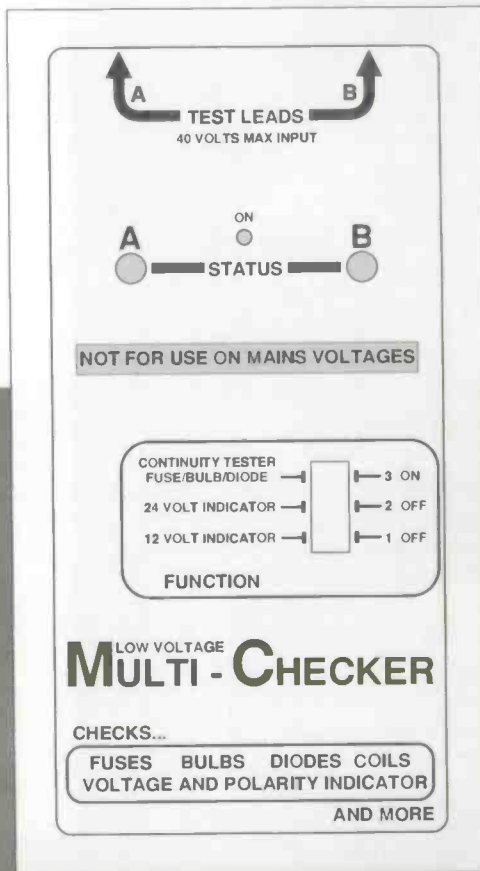
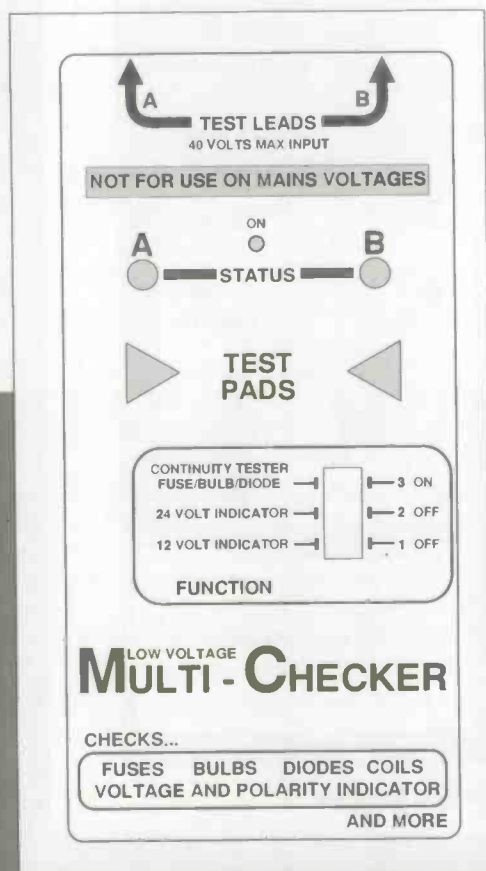

Fig.4a.  
Suggestion for the front panel legend  
Fig.4b.  
Suggestion for the front panel legend without test pads



an alternating flash of the LEDs at about 3Hz, indicating continuity. Depending on the resistance of the device under test, varying degrees of brightness will be visible from the LEDs. For instance, a direct short circuit such as a good fuse will produce a brighter flashing than (say) the primary winding of a mains transformer, due to the resistance of the winding; although in this example the effect might only be very slight.

## Construction

The component layout diagram is shown in figure 2. For reasons that should become apparent, DO NOT solder the LEDs in place until much later. Begin by soldering in the six resistors and D1, followed by IC1 and the three capacitors. Take care with the polarity of C1, D1 and IC1; remember that IC1 is a static sensitive device, so take the necessary handling precautions. The LEDs are still not fitted at this point.

On the prototype, the switch, LEDs and touch pads were brought out through the bottom of the case, with the lid forming the back of the case. This allows the use of a full-size front panel legend (assuming, of course, that one is fitted), and still have access to the lid screws in order to remove it and change the battery.

The template of figure 3 will ease the process of ensuring the various holes needed are lined up relative to the component positions on the PCB. Align it centrally on the (outside) bottom of the case. Using a sharp pointed implement, mark through the centres of the five holes (LEDs and test pads) and the corners of the switch tang aperture. These marks can then be used for drilling and cutting. The four optional hole positions (two for the switch and the two at the bottom of the PCB) can be ignored, these are provided for reference and as alternative mounting points.

The two status LEDs (2 & 3) will be better protected and have a more pleasing appearance if only their rounded tops protrude through the case, with none of the body showing. For this reason, drill undersized holes for them, and taper the inside of them to give a tight fit, allowing about 1mm of the LEDs showing externally. The power on LED (LED1) is a 3mm type and has a shorter body, so the hole for this one can be full-size. Drill two further holes in the end of the case - in line with the two status LEDs - to accept 4mm sockets.

The PCB is held in place by the touch pads only (or with countersunk screws if the touch pads aren't used). This makes possible the easy removal of the board for repair; should it get damaged in use. Each touch pad has a threaded stud, with a raised shoulder where it is welded to the back of the pad. In order for the pads to fit flush to the case, the mounting holes will require countersinking on the outside to accept the top of the stud. Alternatively, the holes can be drilled large enough to accommodate the size of the stud shoulders. If you don't intend fitting the touch pads use the first method, as the holes can be used with countersunk screws to mount the PCB in the same way.

If you are using the touch pads and intend to cover the case with a front panel legend, then the legend should be fitted now (the touch pads fit over the top of it), carefully cut out the LED holes and switch tang aperture in the legend using a very sharp hobby knife or scalpel. Otherwise secure two countersunk screws in the positions where the pads would have been; these will still be used to support the PCB and can be hidden underneath the legend.

Secure the touch pads (or screws) to the case using nuts and shakeproof washers. In the case of touch pads, avoid over-tightening the nuts, otherwise there's a risk of forcing the

stud away from the pad, and there is no way to fix it back on - you'll have to use another pad. Once they're secured, fit another nut to each stud; these will act as the PCB supports (see figure 5).

Insert the three LEDs (noting their orientation) but don't solder them in place just yet. The PCB can now be offered up to the touch pad studs (or mounting screws - whichever you've fitted), and with a little luck should line up and fit snugly over them, whilst at the same time allowing the switch to operate freely without being a tight fit in the aperture. Adjust the height of the nuts so as to support the PCB at such a height that the body of the switch is flush and parallel to the case. Secure the PCB to the studs with a shakeproof washer and nut.

Now the LEDs can be soldered in place. Turn the case face downwards and allow the LEDs to take their positions in the holes provided for them. Apply slight downward pressure to each LED whilst soldering to ensure a comfortable fit against the insides of their holes.

Figure 5 details how the PCB is held in place. Note that certain components have been omitted from the drawing for clarity. Although you won't actually be able to see this view of the completed unit, it should at least look something like it. Fit two 4mm sockets to the end of the case. Cut off the excess length of leads on a PP3 battery clip and solder the clip to the battery supply pads on the board. Use the two off-cuts to connect between the 4mm test probe sockets and their associated pads on the copper track side of the PCB. On the prototype, red and black sockets were fitted, simply because most pairs of test leads come in these colours and so would match each other, thereby eliminating any confusion for the (shall we say - novice) user as to which plug to put into which socket. Even though operationally it makes no difference whatsoever, someone is bound to ask.

## USING THE MULTI-CHECKER

### Voltage indicator

Use of the voltage indicator Functions 1 and 2 have been given earlier, the only point in mind is to select the correct voltage range. Just as a matter of interest, either of these two functions will act as an OFF position for the internal battery.

### Continuity tester

Operation of the continuity tester Function 3 has been given earlier. Basically, if continuity exists between the test points then both LEDs will flash alternately. However, a few helpful pointers on the testing of diodes might be of benefit to the novice, and these are given here.

When testing diodes (including zener diodes), these may be connected either way round on the test points. The following information refers to standard diodes - see below for testing zener diodes. With a good diode across the test points, current would only be allowed to flow in one direction, so only one of the status LEDs will flash. Which one flashes depends on which way round the diode is connected. If the cathode is connected to test point A, then only status LED A will flash. If the diode under test has its cathode connected to test point B then only status LED B would flash. This not only gives a good or bad indication of the diodes' operation, but also identifies its cathode lead.

Zener diodes can be tested using the Multi-Checker, but bear in mind the following. When a zener diode is reverse

## Kit of parts

A complete kit of parts including the case, touch pads, PCB, and a pair of test leads & probes (excluding front panel legend & battery) is available from the author by mail order only at the following address:

112 Shobnall Road  
Burton on Trent  
Staffordshire  
DE14 2BB  
(01283) 542 229

The price for the complete kit of parts is £14.99 inc.

The PCB is also available separately at £3.75 inc.

Please add postage & packing (per order):

£2.00 for the UK

£3.00 elsewhere

biased, that is, positive to cathode - negative to anode, any voltage above the clamping voltage of the zener diode will be allowed to pass through it from cathode to anode. To an unsuspecting eye this means that very low voltage ones - say 1V2 to 3V9 - will produce what looks like a faulty diode (short circuit), since both status LEDs will flash due to sufficient voltage passing back through the zener diode. One of them, however, will be dimmer than the other, but the degree of difference may not be detectable by the human eye. If it is detectable, then the brighter one is the cathode and the dimmer one the anode.

At the other end of the scale there are zener diodes with a clamping voltage slightly below, and anything above the Multi-Checkers' own battery voltage. These will give results identical to those found when testing standard diodes, since there won't be enough battery voltage to break down the junction inside the zener. To make matters worse, these results are totally dependent on the condition of the battery. If it's getting low on voltage then even the lower voltage zener diodes will give these results. So be aware of these facts if you suspect that you might be testing a zener diode.

LEDs can be tested in exactly the same way as standard diodes, with the benefit that if the LED under test is in good order it will flash at the same rate as the status LED on the Multi-Checker which is indicating its cathode terminal. Bi-colour (red/green) LEDs will result in all three LEDs flashing (the one under test and both of the status indicators on the Multi-Checker), assuming of course that the bi-colour LED is a good one. Although these types of LEDs do have designated anode and cathode leads, they are not strictly polarised, since they emit red light when connected one way round, and green light when connected the other. However, in the majority of cases, the designated cathode lead can be identified by the status LED that flashes when the bi-colour one emits red light, which is generally how manufacturers specify them.

After using the continuity function, return the switch to another position (Function 1 or 2) so as to turn off the battery power.

Finally, a word of caution. The Multi-Checker makes an ideal piece of tackle to have around the home, in the workshop or the tool box, and when used for its intended purposes should provide many years of trouble-free use, as long as it is not abused. When checking for voltages, make sure that you have previously selected Function 1 or 2; there is a strong possibility of permanent damage to IC1 if Function 3 is selected with too much voltage applied to the inputs. If you KNOW you're checking for low voltages, but not sure of the potential, begin with the switch in position 2 and, if the status LEDs seem a bit on the dim side, change to position 1.

Please make Cheques/Postal Orders payable to 'DTE MICRO SYSTEMS'. If ordering from overseas, payment must be in Pounds Sterling (£) and cheques must be drawn on a British bank.

Goods will normally be dispatched within five working days from receipt of order (subject to availability), but please allow up to 28 days for delivery.

## Mega Download Internet

Bulletin Board

0891 516 126

No Subscriptions

Full Download Access  
on your First Call

All Speeds to 28,800

Zmodem, Ymodem,  
Xmodem, Kermit,  
Sealink & others

New Files Daily

0891 516 126

Over 13,000 files  
for immediate  
download

Thousands  
of GIF files

Your own Internet  
email address for  
contact with the  
rest of the world

Science &  
Technical  
Programs

Super, Full Colour  
ANSI Graphics

Mega Download  
0891 516 126

Megadownload, POBox 3463, London SE19 1DB  
Calls charged per minute  
39p cheap rate, 49p all other times

High quality stepping motor kits (all including stepping motors) Comstep independent control of 2 stepping motors by PC (Via the parallel port) with 2 motors and software.

Kit ..... £67.00 ready built ..... £99.00  
 Software support and 4 digital inputs kit ..... £27.00  
 power interface 4A kit ..... £36.00  
 power interface 8A kit ..... £46.00  
 Stepper kit 4 (manual control) includes 200 step stepping motor and control circuit ..... £23.00  
 We are now stocking a range of stepping motors and kits to drive them please ask for the stepping motor data sheet for full information.  
 Inverter toroidal transformers 225VA 10.5-0-10.5 primary 0-260-285 secondary ..... £29.95  
 LEDs 3mm or 5mm red or green ..... 7p each  
 yellow ..... 11p each  
 cable ties ..... 1p each £5.95 per 1000  
 £49.50 per 10,000  
 High quality photo resist copper clad epoxy glass boards

Dimensions	single sided	double sided
3x4 inches	£1.09	£1.23
4x8 inches	£2.75	£2.99
6x12 inches	£6.20	£6.20
12x12 inches	£12.25	-

Rechargeable Batteries  
 AA (HP7) ..... £0.99  
 AA 700mAh ..... £1.75  
 C 2AH with solder tags ..... £3.60  
 D 4AH with solder tags ..... £4.95  
 1/2AA with solder tags ..... £1.55  
 AAA (HP16) 180mAh ..... £1.75  
 AA 500mAh with solder tags ..... £1.55  
 C (HP11) 1.8AH ..... £2.20  
 D (HP2) 1.2AH ..... £2.60  
 PP3 8.4V 110mAh ..... £4.95  
 Sub C with solder tags ..... £2.50  
 1/3 AA with tags (philips CTV) ..... £1.95  
 Standard charger charges 4 AA cells in 5 hours or 4Cs or Ds in 12-14 hours + 1xPP3 (1, 2, 3 or 4 cells may be charged at a time) ..... £5.95  
 High power charger as above but charges the Cs and Ds in 5 hours AAs Cs and Ds must be charged in 2s or 4s ..... £10.95  
 Nickel Metal Hydride AA cells high capacity with no memory if charged at 100mA and discharged at 250mA or less 1100mAh capacity (lower capacity for special discharge rates) ..... £3.75  
 High offers please check for availability  
 stick of 4 42 x 16mm nicad batteries 171mmx16mm dia with red & black leads 4.8v ..... £5.95  
 Computer grade capacitors with screw terminals 58000uf 60v ..... £4.95  
 115v ac 80v dc motor 4mm x 22mm shaft 50mm dia x 60 long body (excluding the shaft) it has replaceable thermal fuse and brushes ..... £4.95 each £3.95 100+  
 7 segment common anode led display 12mm ..... £0.45  
 LM337K TO3 case variable regulator ..... £1.95  
 £1.44 100+  
 GaAs FET low leakage current S8873 £12.95 each  
 £9.95 10+ £7.95 100+  
 BS250 P channel mosfet £0.45, BC559 transistor £3.95 per 100  
 74LS05 hex inverter £10.00 per 100, used 8748 Microcontroller £3.50  
 SL952 UHF Limiting amplifier LC 16 surface mounting package with data sheet ..... £1.95  
 AM2750Z 1.25 each 90p 100+, CD4007UB 10p 100+, 6p 100+

Sinclair light gun terminated with a jack plug and PP3 clip gives a signal when pointed at 50hz flickering light with output wave form chart ..... £3.95  
 DC-DC converter Reliability model V12P5 12v in 5v 200ma out 300v input to output isolation with data £4.95 each or pack of 10 £39.50  
 Hour counter used 7 digit 240v ac 50Hz ..... £1.45  
 QWERTY keyboard 58 key good quality switches new ..... £6.00  
 Airpax A82903-C large stepping motor 14v 7.5' step 270h/m 68mm dia body 6.3mm shaft £8.95 or £200.00 for a box of 30  
 Polyester capacitors box type 22.5mm lead pitch 0.9uf 250vdc 18p each 14p 100+ 9p 1000+ 1uf 250vdc 30p each, 20p 100+, 10p 1000+ 3.3uf 100vdc 30p each, 20p 100+, 15p 1000+ 1uf 50v bipolar electrolytic axial leads 15p each, 7.5p 1000+  
 0.22uf 250v polyester axial leads 15p each, 7.5p 1000+ Polypropylene 1uf 400vdc (Wima MKP10) 27.5mm pitch  
 32x29x17mm case 75p each 60p 100+  
 Philips 123 series solid aluminium axial leads 33uf 10v & 2.2uf 40p each, 25p 100+  
 Philips 108 series long life 22uf 63v axial 30p each 15p 1000+  
 Multilayer AVX ceramic capacitors all 5mm pitch 100v 100pf, 150pf, 220pf, 10,000pf (10n) 10p each, 5p 100+, 3.5p 1000+  
 500pf compression trimmer ..... 60p  
 40 uf 370vac motor start capacitor (dielectric type containing no pcb's) £5.95 or £49.50 for 10  
 Solid carbon resistors very low inductance ideal for RF circuits  
 27p/m 2W, 60h/m 2W 25p each 15p each 100+ we have a range of 0.25w 0.5w 1w and 2w solid carbon resistors please send SAE for list  
 P.C. 400W PSU (Intel part 201035-001) with standard motherboard and 5 disk drive connectors, fan and mains inlet/outlet connectors on back and switch on the side (top for tower case) dms  
 212x49x149mm excluding switch £26.50 each  
 £138.00 for 6  
 MX180 Digital multimeter 17 ranges 1000vdc 750vac 2Mohm 200mA transistor Hfe 9v and 1/5v battery test £12.95  
 AMD 27256-3 Eproms £2.00 each, £1.25 100+  
 DIP switch 3POD 12 pin (ERG SDC-3-023) 60p each 40p 100+  
 Disk drive boxes for 5.25 disk drive with room for a power supply light grey plastic 67x268x247mm £7.95 or £49.50 for 10  
 Hand held ultrasonic remote control ..... £3.95  
 CV2486 gas relay 30 x 10mm dia with 3 wire terminals will also work as a neon light 20p each or £7.50 per 100  
 All products advertised at new and unused unless otherwise stated. Wide range of CMOS TTL 74HC 74F Linear Transistors kits rechargeable batteries capacitors tools etc. always in stock.  
 Please add £1.95 towards P&P  
 vat included in all prices

**JPG ELECTRONICS**  
 ETI 276-278 Chatsworth Road,  
 Chesterfield S40 2BH  
 Access Visa Orders (01246) 211202  
 Callers Welcome

**BASIC Stamp** -Stamp sized Computer runs BASIC

The Basic Stamp by PARALLAX measures only 40x60mm yet is a true micro-computer that runs BASIC programmes written on your PC. Its size, ease of use and extensive I/O features make it an ideal tool for both educational and industrial applications as well as for the serious hobbyist.

Writing programmes for the Stamp is easy. A 3-pin cable connects the Stamp to your PC printer port. One piece of software is used to enter, debug and download your programme. Features include 8 I/O lines, non-volatile memory, serial comms, pulse measurement and PWM; all achieved with a minimum of external components.

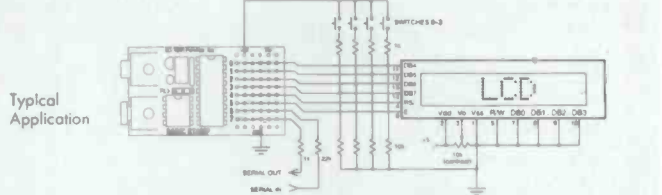

The BASIC Stamp Development Kit at £99 includes; 1 BASIC Stamp, instruction manual, PC cable, software and extensive application notes. Further Stamps are available from £29.

**Muscle Wires** -wires that contract when heated!

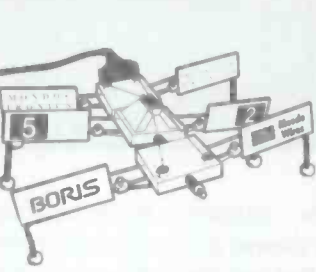

Fascinating, highly processed Shape Memory Alloy wires that actually contract when electrically heated producing a useful amount of force.  
**Low cost linear actuators at last!**  
 Their light-weight makes them excellent for use in models, robots and many other types of project. Low voltage and power allows simple control by computer or electronics (eg The BASIC Stamp).  
 Detailed Data and Project Book (128 pages) plus Muscle Wire kit suitable for 13 projects including BORIS the walking, six-legged robot; only £44.95.

All prices excl VAT and £3 postage per order. For further details of the Stamp, Muscle Wires and other products please call for our NEW colour catalogue.

**MILFORD INSTRUMENTS**  
 24hr Answerphone - 01977 683665, Fax 01977 681465  
 Milford House, 120 High Street, South Milford LEEDS LS25 5AQ

**SEETRAX CAE RANGER PCB DESIGN**

WITH COOPER & CHYAN AUTOROUTER

**RANGER3 - DOS £2500**  
**- Windows\NT £2900**

Hierarchical or flat schematic linked to artwork.  
 Unlimited design size, 1 micron resolution  
 Any shaped pad, definable outline library  
 Pin, gate & outline swapping - auto back annotation  
 Split power planes, switchable on - line DRC

**COOPER & CHYAN SPECCTRA**  
 autorouter (SP2)

Inputs: OrCAD, Cadstar,  
 PCAD, AutoCAD DXF

Outputs: Postscript, Windows bit map

R2 & R3 Outputs: 8/9 & 24 pin printers, HP  
 Desk & Laser Jet, Cannon Bubble Jet,  
 HP-GL, Gerber,  
 NC Drill, AutoCAD DXF

**TRADE IN YOUR EXISTING PACKAGE TODAY**

Seetrax CAE, Hinton Daubnay House, Broadway Lane, Lovedean, Hants, PO8 0SG  
 Call 01705 591037 or Fax 01705 599036 + VAT & P.P

**RANGER2 £150**

Upto 8 pages of schematic linked to artwork  
 Gate & pin swapping - automatic back annotation  
 Copper flood fill, Power planes, Track necking,  
 Curved tracks, Clearance checking,  
 Simultaneous multi-layer auto-router

**RANGER2 UTILITIES £250**

COOPER & CHYAN SPECCTRA auto-router (SPI)  
 Gerber-in Viewer, AutoCAD DXF in & out

**UPGRADE YOUR PCB PACKAGE TO RANGER2 £60**

All Trademarks Acknowledged

## CADPAK for Windows

CADPAK is especially suited to educational, hobby and small scale schematic and PCB design. CADPAK includes both schematic drawing and 32-bit PCB drafting tools but as an entry level product, there is no netlist link between them.

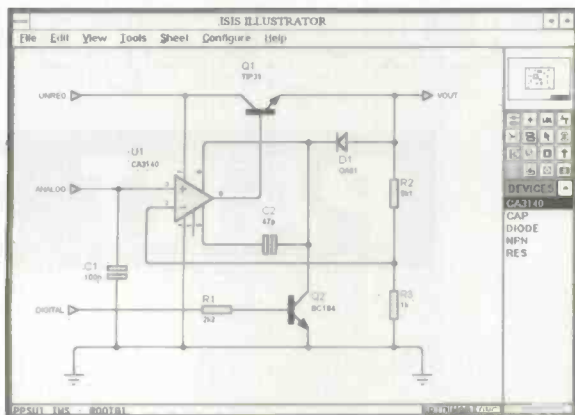

The schematic drawing module of CADPAK, ISIS ILLUSTRATOR, enables you to create circuit diagrams like the ones in the magazines.

- Runs under Windows 3.1 making full use of Windows features such as on-line help.
- Full control of appearance including line widths, fill styles, fonts, colours.
- Automatic wire routing & dot placement.
- Fully automatic annotator.
- Complete with device and comprehensive package libraries for both through hole and SMT parts.
- Advanced route editing allows deletion or modification of any section of track.
- Gerber, Excellon and DXF outputs as well as output via Windows drivers. Also includes Gerber viewer.
- Exports diagrams to other applications via the clipboard.
- CADPAK is also available for DOS.

**CADPAK FOR WINDOWS ..... £ 149**  
**CADPAK FOR DOS ..... £ 79**

## PROPAK for Windows

PROPAK has all of the features in CADPAK plus netlist based integration, automatic power plane generation and a powerful auto-router. PROPAK includes enough schematic capture and PCB design functionality for all but the most demanding applications.



PROPAK's schematic drawing editor ISIS ILLUSTRATOR+ includes even more features than ISIS ILLUSTRATOR. PROPAK's 32-bit PCB design tool, ARES for Windows, is our most powerful and easy to use yet.

- Multi-sheet and hierarchical designs.
- Netlist link between modules guarantees consistency between schematic and PCB.
- Netlists are also compatible with SPICE-AGE and most other electronics CAD packages.
- Generates a full bill of materials.
- ASCII data import facility.
- Electrical rules and connectivity checkers.
- Ratsnest display with automatic update during placement and routing.
- Multi-strategy autorouter gives high completion rates.
- Power plane generator creates ground planes with ease.
- PROPAK is also available for DOS.

**PROPAK FOR WINDOWS ..... £ 495**  
**PROPAK FOR DOS ..... £ 395**

**Call or fax us today for a demo pack. Please state whether you would like a DOS or Windows pack.**

Prices exclude postage (£5 for UK) and VAT. ISIS ILLUSTRATOR and ARES for Windows are also available separately. All manufacturers trademarks acknowledged.

# labcenter

**E l e c t r o n i c s**

53-55 Main St. Grassington, N. Yorks. BD23 5AA

Tel: 01756 753440 Fax: 01756 752857

# Designing a Pic Micro controller based project

## PART 2

**In Part 2 of this short tutorial series Bart Trepak gets stuck into the design of his PIC-based digital alarm clock**

**L**ast month, we looked at the internal architecture of the PIC16C54 series micro-controller with a view to constructing a digital clock to help even the most reluctant riser to get out of bed in the morning.

Although it's not necessary to consider the instruction set (figure 3) at this stage, it's included for the sake of completeness. The PIC series micro-controllers are so-called RISC processors (Reduced Instruction Set Computer).

Compared to other micro-processors with which some

readers may be familiar, this is certainly no exaggeration as there are only 33 instructions. This, together with the absence of some of the fancy addressing modes found in other processors, means that there aren't so many instructions to remember.

The instruction set is simply a list of the operations which a computer can perform on data presented to it. A glance through the list reveals such instructions as MOVF f,d and BSF f,b and even ANDLWk. These mnemonics are used as a sort of shorthand to help the programmer remember what each

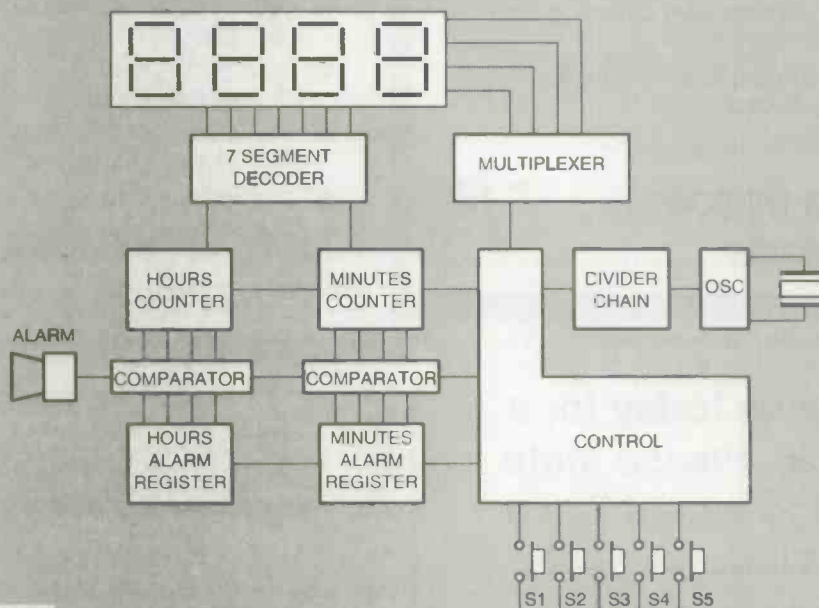

Fig.4. Alarm clock block diagram



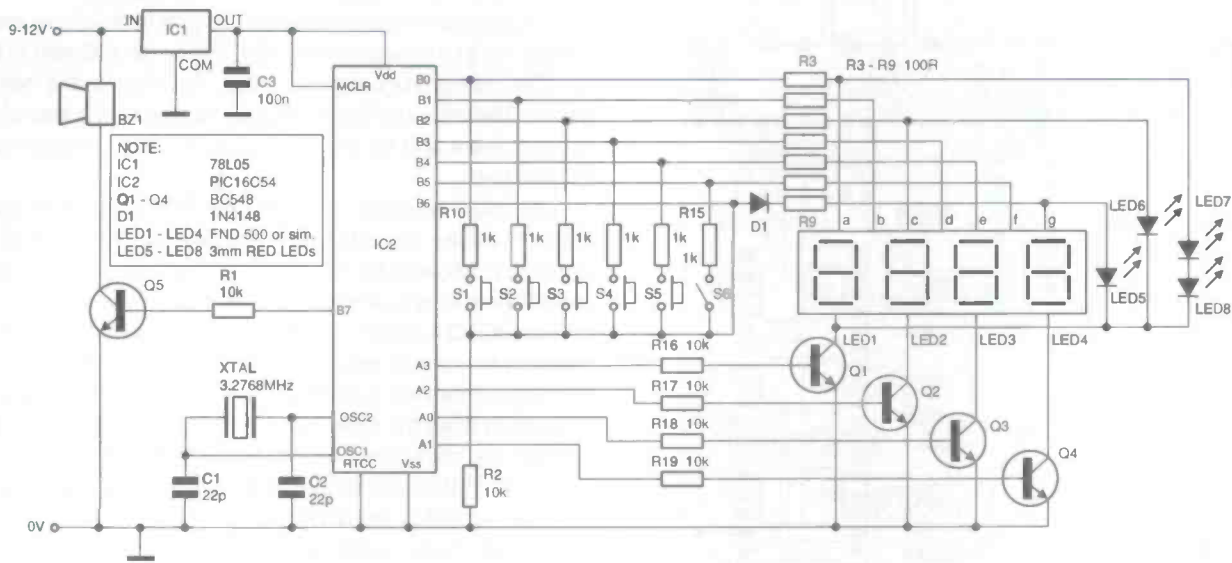

Fig.5. Alarm clock circuit diagram

instruction does without having to write each one out in full.

Budding estate agents should feel at home with this kind of thing with advertisements such as "Des Res, Nr Shps, Schls, 4 Bdrms, sep WC & Bthrm, Gdns etc." often being seen in local newspapers. The results or function of some instructions, such as NOP or CLRW are pretty obvious once it is realised that they stand for No OPERATION and CLear W (clear the W or working register or set it to zero), while others may need some explaining. This will be dealt with later on, as and when an instruction is needed in writing the programme.

### Lower case letters

A word of explanation at this stage however, regarding the lower case letters associated with some of the instructions would be useful. Taking the instruction "MOVF" as an example, which means "move the contents of file register" or more simply "MOVE File", this obviously needs to specify to the computer which file is being referred to and where the data contained in that file is to be moved to (ie. the destination).

This information is specified in the f and d parts of the instruction. The destination can either be the file itself in which case the d will be a "1" or the W register in which case d will be a "0". The "f" is the address of the file from which the data is to be moved and since there are 32 file registers in the PIC16C54 numbered from 00h to 1Fh (see figure 2) "f" can have any value in this range.

If the programme therefore required that the contents of the register 0A (i.e. the number that happened to be stored there) be moved to the Wregister, the instruction would read "MOVF 0A,0. It may seem rather pointless to write

"MOVF 0A,1" as this would simply take the data from register 0A and move it back to 0A, but in other instructions such as INCf for example (which adds 1 or increments to the data in the register) this would make more sense.

In this case the original data in the 0A register would be overwritten so that if it originally contained 02h, it would now contain 03h while if the W register had been specified as the destination, the 0A file would still contain 02h and only the W register would have 03h in it after the instruction had been executed.

The MOVF 0A,1 instruction is not as pointless as it may at first seem however, because the last column of figure 3 shows the bits in the STATUS register which are affected by executing the various instructions. For this particular one (MOVF), it can be seen that the Z (or zero) bit could change.

Thus if register 0A contained all zero's when the MOVF instruction was executed, the Z-bit in the STATUS register would be set to a one by the MOVF 0A,1 instruction and this could be tested to cause the programme to take the appropriate action if this were required in the application, while leaving the contents of the 0A register unaffected.

This test on the zero bit could be carried out by the BTFSS f,b instruction which means "test one bit in the file register and skip (the next instruction) if it is set". The file register concerned is again specified in the "f" part of the instruction while the bit to be tested in that register is specified in the "b".

Note that the bits in a register are numbered from 0 to 7 and not 1 to 8 so that the maximum value for "b" will be 7. Thus to test the zero bit in the STATUS register (which is bit 2), the instruction would read BTFSS 03,2 (03 being the address of the STATUS register as shown in figure 2).

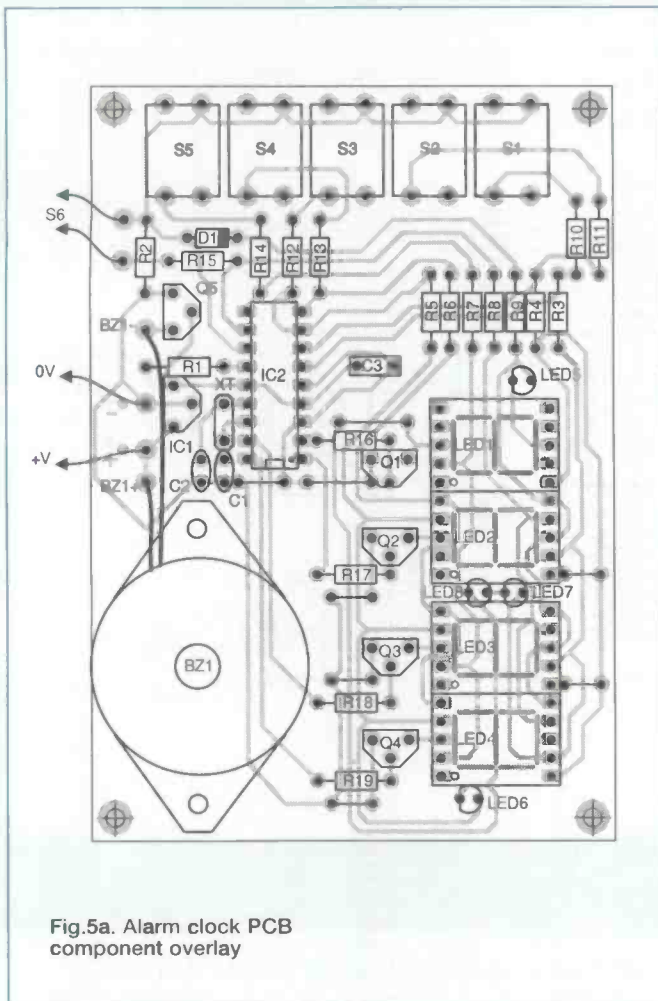

Fig.5a. Alarm clock PCB component overlay

Similarly, the BTFSCL instruction could be used which would skip if register 0A had contained any value other than zero.

Then there are the literal instructions such as "MOVLW k". This simply means "move the value k into the W register" where k is a number which can be specified in decimal, binary or hex. Thus, if for some reason the programme required that the W register contained the decimal value 24 at some point, this could be done by executing the instruction MOVLW .24 or MOVLW '00011000' or MOVLW 18h (in this article, a decimal value is written with a dot preceding it to avoid confusion with a hex number and this is not a decimal point).

Binary values are written as shown while Hex numbers will normally have a suffix "h". Since the register is 8-bits wide, "k" will be an 8-bit binary number so that if the value is specified in decimal, the maximum value will be 255 or 0FF in hex. Once in the W register, this number could be transferred to one of the file registers using the "MOVWF f" instruction if required.

This is the standard way of loading a register with a specific value; there is no single instruction available to do this. A look down the list of figure. 3 will show that the available instructions allow the data in any register to be moved, incremented, decremented, rotated left or right and acted upon by the logical operators AND, OR and EXOR (exclusive - or) as well as instructions for testing and setting or clearing individual bits.

Arithmetic operations which allow the W register to be added to or subtracted from the other registers are also included as are control instructions such as OPTION and TRIS f which are used for setting up the option register and the

input/output ports the "f" specifying which port. Last, but by no means least are the unconditional branch instructions which cause the programme to jump to another location and continue execution from there.

Normally, the programme counter (file 02) is auto incremented after each instruction so that instructions are carried out in the sequence in which they were stored in the EPROM during programming. Often, the programme needs to take a different route depending on the result of a test or some external event and for this, the value of the PC register must be changed.

This could be done by loading the PC register with the new number just like any other register using the "MOWLW k" instruction followed by "MOVWF 02" but there are also two special instructions available for this - GOTO and CALL.

The GOTO k instruction simply loads a new value k into the programme counter register so that the next instruction to be executed is fetched from this new location, while the CALL k instruction does the same but adds one to the programme counter and saves this value in the STACK register.

The RETLW k instruction returns the programme counter to the value stored in the STACK and automatically puts the value k (which can again be specified in decimal, hex or binary) into the W register. The CALL and RETLW instructions are very useful therefore in calling subroutines or often used blocks of programme code and then allowing the programme to return to its original point at the end of the subroutine.

The important thing to remember here is that the GOTO instruction allows direct loading of all 9 bits of the address into the programme counter thus allowing the programme to jump to any location in the programme memory (in the PIC16C54/55 at any rate) while the CALL instruction clears the 9th most significant bit to zero so that all jumps are made to the lower half of the programme memory.

All subroutines which are "called" must therefore be placed in the lower half of the EPROM programme memory. Since the STACK register is 9 bits wide however, the full return address will be loaded when the RETLW instruction is executed thus allowing subroutines to be called from and return to any location in the programme memory.

## PARTS LIST

● R1, R2	10k resistor
● R3 - R9	100R resistor
● R10 - R15	1k resistor
● R16 - R19	10k resistor
● C1, C2	22pF Ceramic
● C3	100nF
● IC1	78L05 5V Regulator
● IC2	PIC16C54 Micro-controller
● D1	1N4148 Si Diode
● TR1 - TR4	BC548 NPN Transistors
● TR5	2N3904 NPN Transistor
● LED1 - LED4	FND500 or similar LED Display
● LED5 - LED8	3mm Red LED
● XTAL	3.2768MHz Crystal
● BZ1	Push to Make Switches
● S6	Pressure Mat
●	18-pin DIL Socket, 2-way Connector 12Volt dc/100mA Power Supply

## Back to the clock

Armed with all this information, it is now possible to begin to design a circuit for the clock and figure 4 shows a block diagram of what will be required. How much or how little of this is incorporated in the micro-controller depends on how many I/O lines are available and how much programme memory as well as the time that will be needed to execute the programme.

Determining the last two is mainly a matter of experience but it is usually possible use a version of the PIC with a larger memory or a higher speed if things get tough although in this project, this will not be necessary.

There are not an unlimited number of input/output lines available on the PIC micro-controller and as can be seen from the block diagram, the clock will require a display, switches for setting the time and the alarm as well as a buzzer and an input for the pressure mat.

Since a four-digit display is required to show the time, this will have to be multiplexed, otherwise 28 lines would be required for the display alone! This means four lines will be required to drive the digits and if the 7 segment decoding is done by the micro, another seven lines will be used up for driving the segments - a total of 11 lines.

Alternatively, an external BCD to 7-segment decoder chip could be used which would use 4 lines for the BCD data and 4 for the digit lines and would only require 8 output lines. By specifying that the clock will have a 12-hour display, the first digit will only ever need to drive two segments to form the digit "1", assuming that the leading zero is also suppressed when displaying times such as 06:35 or 08:47.

The other segments of this digit can therefore be left unconnected so they will not light and the lines used instead to drive indicator LEDs such as the colon, AM/PM and alarm on annunciators. To make things simple, two switches (Hours set and Minutes set) will be used to set the four digits with another to select between the time and alarm display.

Even this number could be reduced by making each switch multifunction as is done in some digital watches where the time, date, alarm time, meeting reminder and auntie Mavis's birthday re all programmed in using the same switch but as we are not short of space we will settle on three. The third switch will select between normal running, set alarm time and set time sequentially so that times cannot be changed accidentally without first entering the correct mode.

Another two switches will be required to select the snooze function and the alarm on/off which together with the pressure mat (which is also a switch) will make a total of six. Since I/O ports can be programmed to be inputs as well as outputs, one of the seven segment lines could function as an input when it is not required to drive the LED display.

The other lines can then be programmed to the switch lines high so that if a switch is pressed, the input (or sense) line will also go high. Because the lines will be alternating between driving displays and switches, it is important to ensure that pressing a switch will not cause spurious segments to light and this is the reason for the 1k resistor placed in series with each switch, which has a high enough value not to light an LED.

If these were omitted, segment lines would be shorted out when a switch was pressed which could light up or switch off unintended segments and even cause damage to the chip. The 10k resistor pulls the sense line to 0 Volts when no switch is pressed and its value is high enough to give a recognisable logic 1 voltage when a switch is pressed even with a 1k

resistor in series with it.

Since during this operation some of the LEDs in the display will be reversed biased by up to 5 Volts, there may be sufficient leakage current to upset this circuit and so the diode has been inserted in the sense line so that only current flowing via the switches will be detected. In this way six switches have been connected to the circuit without using any more I/O lines and the last I/O line can therefore be used to drive the alarm buzzer.

This is an important exercise in designing micro-controller projects because I/O lines are often limited and unless savings are made, a project could require more chips such as display drivers, latches or keyboard decoders, making it far more expensive than it needs to be.

## Circuit diagram

The circuit diagram shown in figure 5 can now be drawn. Since the LED digits can draw an appreciable current which the micro-controller may not be able to supply, transistor digit drivers have been added as shown.

If small displays are used, these could be driven directly and it would only need a minor change to the programme to invert the signals from the digit drive lines. Only segments b and c are connected on the tens of hours digit so that only the digit "1" can be displayed.

Some of the other segment drives are connected to the colon, PM indicator and Alarm indicator which are formed from 0.1 inch red LEDs. The segments are driven directly by the PIC via 330 ohm current limiting resistors. The alarm is driven from output B7 and although the PIC can drive a piezo buzzer directly from one of its output pins, a transistor has been included to enable something a little louder to be connected if required.

A standard oscillator circuit consisting of a 3.2768MHz crystal and two 22pF capacitors is used and the power for the circuit is derived from the mains via any low voltage adapter consisting of a transformer, rectifier and smoothing capacitor (not shown) which is reduced to 5V dc by the regulator

## Construction

With so few parts required, it would be quite feasible to construct this circuit on strip board but a single sided printed circuit layout (figure 5A and 5B) is given as this will provide a much neater assembly. A great advantage of using a micro-controller in a design now becomes apparent.

Since all the I/O lines are identical, any line can be connected to any of the functions so that the digit drivers, for example, need not be connected to port A and the switches/LED segments to port B but could be mixed in any combination to make the printed circuit board layout easier. This would of course make the software more complicated because it would then be necessary to regard each I/O bit separately and mistakes would be more likely.

Software mistakes are easily corrected, however, and do not involve etching a new printed circuit board - just reprogramming a chip. To make the programme more easily understood, this has not been done in this instance and the connections will be those defined in the circuit diagram with port A driving the digits and port B the segments.

Note that the segment lines have been assigned so that the connections to the LEDs do not contain too many links and thus appear to be in a random order. Table 1 shows the port - segment assignment and table 2 the segments which need to

be energised (binary) to produce the numbers 0-9 together with their hex equivalents.

This printed circuit layout could easily be used in another project which requires an LED display, 5-way keyboard and a buzzer (or even a relay) simply by changing the programme stored in the PIC. A digital timer for photography or for boiling eggs springs instantly to mind and no doubt there are many others. It is therefore a good idea to fit a good quality socket to the board to enable the PIC to be inserted into the circuit many times without damage especially if you intend to experiment with other applications.

The switches have been mounted on the printed circuit board, but there is no reason why they should not be panel mounted types if you have these available. A two-way terminal block is also provided for the pressure mat and the buzzer is wired directly to the board to the points shown on figure 5a, but these arrangements may also be varied depending on requirements and the components available.

There are also eight wire links in this layout and these can be made from discarded resistor leads.

## Programming

Now that the functions of all the pins have been "defined", we can begin to write a programme to make all the lines go high and low at the correct times to drive the display, keyboard, buzzer and do all the other things required of the clock. At first sight, this can appear to be quite daunting with so many things seemingly going on at once.

Programming however, is really nothing more than writing down the specification or series of steps which must be carried out to achieve the required objective. This is in fact very similar to designing with hardware and if this design were being done in the 1960s when integrated circuits had just become available, the process would have been very similar except that instead of writing down steps, the chips required to perform the functions would have been identified.

The designer would soon have realised that what was required for a digital clock was a timebase (an oscillator) followed by a series of dividers (counters) to obtain say one pulse per second or minute. Further counters would be required to count the seconds or minutes. Some of these would need to count to 60 while others needed only to count to 12. Therefore extra gates would be required to modify each counter to make it divide by the right amount.

The last two counters which would count the hours and minutes would then need a code converter to decode the binary or, probably more conveniently, the binary coded decimal or BCD counts to drive the Neon display tubes (well they didn't have LEDs then did they?).

Going back further still to the 1950s when even ICs were not available, each counter, gate, decoder etc. would have to have been designed around individual valves and resistors (or the new-fangled transistors if you could afford them) and when these designs were ready, the designer of the complete clock would (provided he had not given up by then) simply select the required circuits and interconnect them.

In a similar way, the programme for the clock can be developed in software. The problem is broken up into smaller and smaller units such as generating the time base, counting, decoding the counts etc. and each problem is in its turn broken down until we reach the "transistor and resistor" stage (or in this case the instruction set) and solved in turn.

When this has been done, all the solutions to these small units can be assembled into a complete solution to the whole

problem - which then turns out not to have been such a problem after all. Unlike the hardware solution where the project has to be shelved because you don't happen to have a BCD counter or decoder, and your supplier will have them in six weeks time, here you have all the hardware available on the chip and you have only to tell it what to do.

There is no better or worse solution and any programme that works (i.e. does what it is intended to do) is correct. Unless the highest possible execution speed is vital, how the problem is solved is not too important as long as it works and fits into the available memory.

Some solutions may be more elegant than others and require fewer steps to achieve a given result, but there is little point in spending hours and using clever programming techniques to try to cut the length of a programme from say 180 to 150 bytes when you have to buy a micro-controller with 512 bytes of programme memory anyway.

What is important is that a logical approach is adopted and for this it is probably best to define the problem (or each problem) formally so that you get it clear in your mind what is to be done.

## Flowchart tips

One way of writing the specification would be as a series of sentences as above to define how the final device (clock) should work, but it would not be easy to refer to each sentence and the interrelationship between them would be difficult to see.

A flowchart is therefore most commonly used. This is simply a pictorial representation of the way a programme works. It can be followed much more easily in this form and any logical mistakes in the programme (hopefully) spotted more easily. The flowchart can then be made more and more detailed until the whole programme is charted and the design finished.

The natural inclination is to rush ahead and try to flowchart the whole programme, code it and programme a chip to see it work. Later, as more experience is gained, it may be tempting to skip the flowchart stage and go straight into coding the programme, but this is seldom a sensible route.

Even the simplest programmes often fail to work first time and while finding a fault in a ten-line programme is not too difficult, finding a fault in a 200-line programme is not so easy unless you have access to specialised equipment costing thousands of pounds. Even then it is likely to take some time. It is therefore best to design small parts of the programme which can be thoroughly tested before proceeding with the next part.

In this way, if the programme fails to work when the latest part is added, the fault can be easily located. Apart from this, a good flowchart will also save time if the programme needs to be modified at some future date, because it gives a good overview of what the programme is trying to achieve and how. A programme listing can never do this no matter how good the comments and other documentation.

Another point which is very important is to choose which of the parts of the programme to start with carefully. This may not often be the most logical sequence at first sight, but it will pay dividends in saved time.

Checking that a counter is working properly, for example, is difficult unless the contents of the counter can be displayed on an LED display. This can be easily done if a display routine has already been developed and so it would therefore make sense to perfect this routine before tackling the counting stages.

Some parts of the programme may be concerned with

## PIC16C5X INSTRUCTION SET

### BYTE ORIENTATED FILE REGISTER OPERATIONS

Mnemonic Operand	Name	Status Affected	
NOP	-	No Operation	None
MOVWF	f	Move W to f	None
CLRW	-	Clear W	Z
CLRF	f	Clear f	Z
SUBWF	f, d	Subtract W' from f	C, DC, Z
DECF	f, d	Decrement f	Z
IORWF	f, d	Inclusive OR W and f	Z
ANDWF	f, d	AND W and f	Z
XORWF	f, d	Exclusive OR W and f	Z
ADDWF	f, d	Add W and f	C, DC, Z
MOVF	f, d	Move f	Z
COMF	f, d	Complement f	Z
INCF	f, d	Increment f	Z
DECFSZ	f, d	Decrement f, Skip if Zero	None
RRF	f, d	Rotate right f	C
RLF	f, d	Rotate left f	C
SWAPF	f, d	Slap halves f	None
INCFSZ	, d	Incrementf, Skip if zero	None

### BIT-ORIENTED FILE REGISTER OPERATIONS

BCF	f, b	Bit Clear f	None
BSF	f, b	Bit Set f	None
BTFSC	f, b	Bit Test f, Skip If Clear	None
BTFSS	f, b	Bit Test f, Skip of Set	None

### LITERAL AND CONTROL OPERATIONS

OPTION	-	Load OPTION register	None
SLEEP	-	Go into standby mode	TO, PD
CLRWDT	-	Clear Watchdog timer	TO, PD
TRIS	f	Tristate port f	None
RETLW	k	Return, place Literal in W	None
CALL	k	Call subroutine	None
GOTO	k	Go To address (k is 9 bit)	None
MOVLW	k	Move Literal to W	None
IORLW	k	Incl. OR Literal and W	Z
ANDLW	k	AND Literal and W	Z
XORLW	k	Excl. OR Literal and W	Z

## Notes

- 1) f is a file register address 00 to IF (hex)
- 2) d is the destination of the result of operation.  
1= file register  
0= W register
- 3) b is bit number 0-7 and k is an 8-bit binary number

internal operations only and in the clock for example, there will be many operations such as counting milliseconds and comparing registers going on all the time, but the outputs of the chip will not change at all.

If such a part of the programme were coded and programmed into a chip and the circuit powered up, there would be no way of knowing if the programme was working properly or not as all the operations are internal. To help check this kind of programme therefore, a dummy piece of code to say light an LED connected to an output port when the programme reached a certain point would be useful.

With a timing routine generating a timebase of say 10mS, it would be best to switch such an output on and off alternately

each time the routine had counted up to 10mS. This would result in a wave form at the output pin which could be displayed on an oscilloscope and checked to see that the frequency was 50Hz. This confirm that the routine was working correctly.

If possible try to make each part of the programme self-contained by writing it as a subroutine. In this way, each one can be tested by using the CALL instruction and the final main programme will then consist of a string of CALL instructions calling the timing, counting, key reading, LED display and other subroutines in turn as required.

These will then be available for use in other projects and could simply be copied into new programmes when an LED display or some other function is required. This will also tend to standardise printed circuit board layouts because the same segments and digits will be connected to the same pins resulting in a minimum of work to get a new project up and running.

## Next Month...

We will look at designing a flowchart and writing programmes for some of the functions required in the clock, as well as programming the PIC micro controller.

# revised edition TRANSMITTERS

**AT LAST.** A comprehensive, easy to follow guide to building short range transmitters and surveillance devices. Packed with useful information and circuits.

★ Only £3.95 inc p&p.

(Some of the circuits included cannot be used legally in the UK)

## RADIO KITS

All kits come with pre-drilled PCBs and high spec. components.

**MICRO FM TRANSMITTER (a).** 1km range, 80-100MHz preset Inc. mic., very small (2x3cm) £6.95

**MICRO FM TRANSMITTER (b).** Variable mic. sens., tunable 90-110MHz. 1km range £7.95

**FM TRACKER.** Transmits an audio tone for direction finding, tracking etc. 80-110MHz £8.50

**ULTRA MINIATURE FM TRANSMITTER.** Runs off watch battery (Inc), only 1x2cm, 200mtrs range. 80-100MHz £8.95

**FM RECEIVER (a).** Tiny high quality FM radio. Will drive headphones direct (not inc) £10.90

**FM RECEIVER (b).** As (a) but with 3 watt audio output and tuning LED £13.50

**CRYSTAL RADIO.** includes tuner, earphone, ferrite aerial, etc. £7.50

**AM RADIO.** Single chip radio for headphones (not inc.) £8.90

## AUDIO KITS

**AUDIO POWER AMPS** 15 WATT General purpose upgrade £8.95

40 WATT High quality, HD 0.003%, switch on mute ideal for compact disc £15.50

150 WATT Rugged and powerful MOSFET design. PA/sound systems £22.95

## PREAMPS ETC

**GENERAL PURPOSE PREAMP.** Variable gain 9-25V 40mV max in £4.00

**ULTRA LOW NOISE.** For high quality mixers, mics etc 9-25V £4.50

**ACTIVE TONE.** 12dB c/b bass and treble with variable gain £8.95

**7 BAND EQ.** 150Hz-18kHz for EQ units and tone control, includes on-board preamp and pots. Variable gain £12.95

**NOISE GATE.** Dynamic noise reduction system. Variable Input and cut off level. Will accept instruments, tape decks etc £15.95

**MUSIC KITS.** Full range of on-board units for guitars and other instruments. Tone boosters, active circuits, delay lines, transducers. Send for list.

Prices include P&P. **Mail Order Only.** Make cheques and postal orders payable to:

JCG JTG

PO Box HP79, Woodhouse Street, Leeds LS6 3XN



# SAVE £££'S

## GET A HEAD START WITH OUR SUPER SUMMER SALE!

## 14 issues for the price of 12!

Gain maximum benefit from your magazine with a subscription. Not only will you be able to enjoy the luxury of having your favourite magazine delivered to your door, if you subscribe now you will receive two magazines extra FREE!

Take advantage of this special give away now!

Either send off the coupon or order now on: 01858 435344  
(lines open: 9.00am - 6.30pm.) (Enquiries: 01858 435322).

Yes, I would like to subscribe to ETI magazine for 1 year.  
Please commence my subscription from the .....issue.  
Please quote subscription number if renewing/extending

Special Subscription Rates 1 Year (14 issues for the price of 12!!!)  
U.K. Europe & Eire Sterling O/Seas U.S. \$ O/Seas  
£25.80 £34.70 £36.20 \$54.00

I enclose my cheque/M.O. for £.....  
made payable to Nexus or debit my Access/Visa:

Signature.....

Expiry.....

Name(Mr/Mrs/Miss).....

Address.....

PostCode.....

Please post this coupon with your payment to: Nexus Subscription Department,  
Tower House, Sovereign Park, Lathkill Street, Market Harborough, Leicestershire. LE16 9EF.  
Please tick this box if you do not wish to receive information from any other companies which may be of interest to you.  This offer must close on: 1/9/95 (ET09)



# Serial ADC for Virtual Instrumentation

## PART 2

*In part 2 of this add-on project for the ETI 80188 single board computer, Richard Grodzik looks at the virtual instrumentation software for graphically representing a meter on a PC screen*

**L**ast month we looked at the design and construction of a plug-in ADC module for the 80188 SBC. This little unit can be used as the basis of a virtual instrumentation system. It is a means of graphically representing a measuring instrument such as a multimeter on a PC's screen. In this case, a visual image of an analogue meter and pointer is presented to the viewer, as well as a precise digital indication. This combination of analogue and

digital readouts is a real-time mimic of actual hardware meters which, of course, do not exist, except on the PC's screen. Moreover, this is all achieved in software, so that the possibilities of facia appearance, size, colour, legend, scales as well as ergonomic considerations are infinitely variable, requiring only modifications in software. The need for stand-alone instruments is negated, since they can all be represented in pictorial 'mimic' form on the PC's screen.

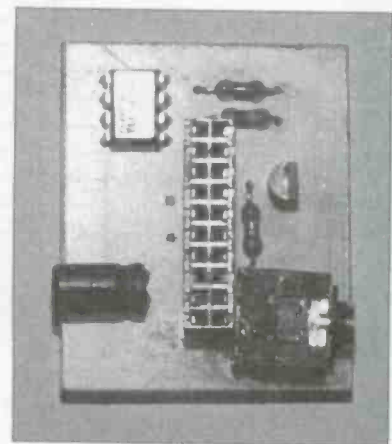
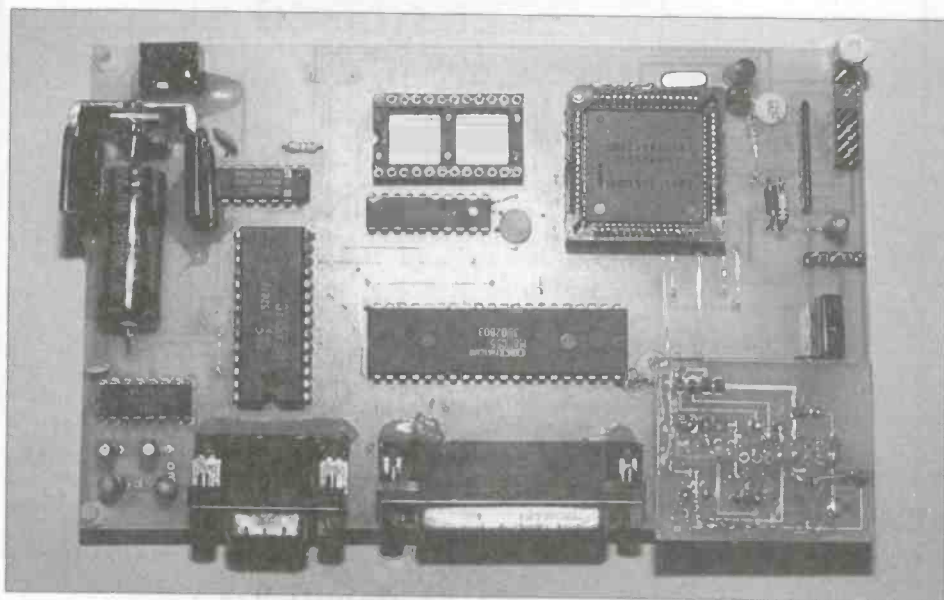



## Rotating Vectors.

Program ADC\_3.EXE contains the necessary procedures to translate the incoming raw adc hex data into a rotating needle pointer thus indicating on the screen the relative value of d.c. volts on a meter scale. How is this done?

If we consider a total rotational angle of 180 degrees i.e. pi radians, to represent adc data in the range 00 to FFH, each bit will represent 180/255 (.7058) degrees of rotation. Thus, an input d.c voltage of 2.5 volts to the ADC represented as 80H (128 decimal) will cause the meter pointer to rotate  $128 \times 0.7058 = 90.3$  degrees. i.e. half full scale deflection.

Two simple trigonometrical functions - cosine and sine - are used to calculate the x and y co-ordinates of the meter pointer, one end of which, of course, remains at a fixed point. As shown in the table, if we take the cosine and sine values of the required angle of rotation (TH), with the cosine value representing the x co-ordinate of a vector and the sine value representing the y co-ordinate of the vector, we see that as the angle increases, a rotating vector is drawn which is directly analogous to the needle movement of a meter - the angle of rotation of the vector being directly proportional to the value

of ADC data.

Note that the program, written in Turbo Pascal, however, requires that all angle calculations are expressed in radians i.e. 180 degrees of rotation = pi (3.14159) radians. For an ADC value (HEX) of 20H (32 decimal) the angle (TH) expressed in radians is calculated by:

$$TH = FSD/255 \times HEX$$

where FSD = pi (3.14159)

and HEX = 32 decimal

$$TH = 0.394 \text{ radians producing a COS value of } 0.923 \text{ and a SINE value of } 0.382$$

This is represented by a vector whose relative coordinates are +0.92 (x axis), +0.38 (y axis). See diagram.

The above calculation can be verified by selecting 'RAD' on a scientific calculator and entering the values.

Since a clockwise rotation of the needle pointer is required, program line

$$TH = FSD-TH$$

reverses the rotation, producing a conventional pointer movement- left to right.

The virtual instrumentation Program was written in Turbo

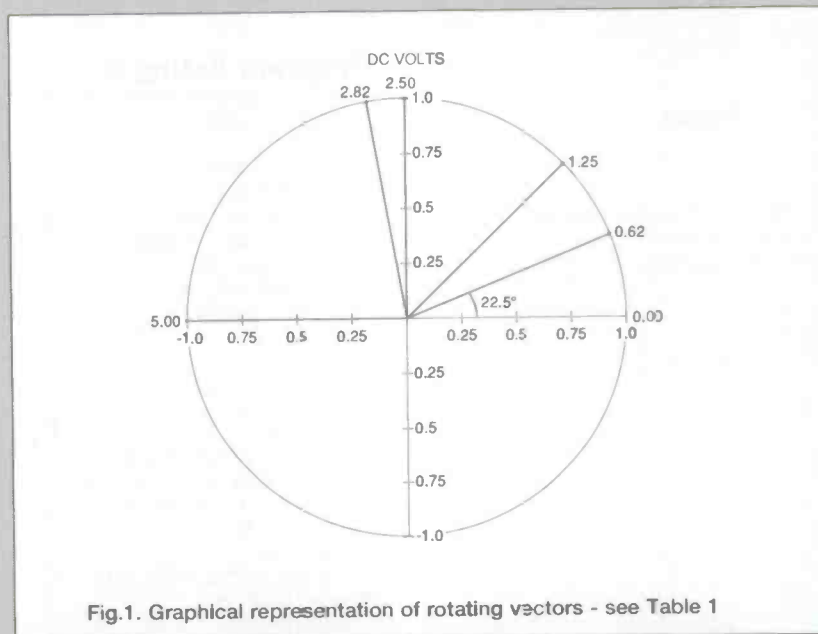

Fig.1. Graphical representation of rotating vectors - see Table 1

**Table 1**  
**Rotating vectors**

ADC Value	DC Volts	Degrees of Rotation	TH Radians	COS TH(X)	SIN TH(Y)
20H	0.62	22.5	0.394	0.923	0.383
40H	1.25	45	0.788	0.704	0.708
80H	2.50	90	1.576	-0.006	0.999
90H	2.82	101	1.774	-0.201	0.979
ffH	5.00	180	3.141	-1	0

Pascal version 4 and includes two external object files - RS.OBJ and COM.OBJ which are included in the compiled program ADC\_3.EXE. Program COM.ASM configures the COM1 serial port for the correct protocol i.e. 9600 baud, 8 data bits, 1 stop bit, no parity. Program RS.ASM polls the serial port for the ADC data, importing the value into variable HEX and also allows escape to DOS if the ENTER key is pressed - the program is aborted. After assembling the object code, ensure that these two files are available to the PASCAL compiler by selecting the appropriate OBJ code directory in the PASCAL Directory environment.

### Program Listing 1

```
PROGRAM ADC_3(INPUT, OUTPUT);
{$f+}
{$L COM}      (*External Object File*)
{$L RS}       (*External Object File*)
{$I-}
USES GRAPH, DOS, CRT, DRIVERS, FONTS;
TYPE
DIGITS=0..255;
const
detect=0;
VAR
I: INTEGER;
W: CHAR;
VL, VZ: INTEGER;
X: INTEGER;
Y: INTEGER;
REALDATA: REAL;
HEX: DIGITS;
(*INITIALISE VGA GRAPHICS MODE*)
PROCEDURE LOADDRIVER;
VAR
GRAPHDRIVER, GRAPHMODE: INTEGER;
BEGIN
GRAPHDRIVER:=9;
GRAPHMODE:=2;
IF REGISTERBGIDRIVER(@EGAVGAdriverproc)<0
THEN WRITE('NOT EGAVGA GRAPHICS');
INITGRAPH(GRAPHDRIVER, GRAPHMODE, '');
END;
(*EXTERNAL .OBJ FILES*)
PROCEDURE COM;EXTERNAL;
PROCEDURE RS(VAR HEX);EXTERNAL;
PROCEDURE DIAL;
VAR
FSD: REAL;
PZ: REAL;
TH: REAL;
K: INTEGER;
N: INTEGER;
X, Y: REAL;
X1, Y1: INTEGER;
Z: REAL;
XX, YY: INTEGER;
ORG, ORGY: INTEGER;
S: STRING[20];
XL, YL: INTEGER;
BEGIN
ORG:=300;
ORGY:=210;
Z:=0;
MOVETO(ORG, ORGY);
OUTTEXT('O');
MOVETO(ORG, ORGY);
FSD:=3.142; (*PI RADIANS OF ROTATION*)
HIGHVIDEO;
N:=HEX;
BEGIN
FLOODFILL(0, 0, GREEN);
RS(HEX); (*GET RAW ADC DATA*)
REALDATA:=HEX;
(*CALCULATE DEGREES OF ROTATION - TH*)
TH:=-FSD/255*HEX; (*RADIANS OF ROTATION*)
TH:=FSD-TH; (*REVERSE ROTATION*)
SETVIEWPORT(225, 130, 375, 240, TRUE);
CLEARVIEWPORT; (*ERASE AND REDRAW METER
```

```
MOVEMENT*)
SETVIEWPORT(0, 0, 0, 0, FALSE);
STR(REALDATA/51:0:2, S); (*SCALING VALUE*)
(*I.E. 255/51 = 5 VOLTS*)
OUTTEXTXY(ORG-20, ORGY+20, S);(*PRINT VOLTS
VALUE*)
OUTTEXTXY(ORG-12, ORGY+40, 'Volts');
RECTANGLE(ORG-25, ORGY+15, ORG+30, ORGY+30);
XL:=ORG-25;
REPEAT
PUTPIXEL(XL, ORGY+31, DARKGRAY);
XL:=XL+1;
UNTIL XL=331;
MOVETO(ORG+3, ORGY);
X:=ORG+75*COS(TH); (*X CO-ORDINATE OF POINTER*)
Y:=ORGY+70*SIN(TH); (*Y CO-ORDINATE OF POINTER*)
X1:=ROUND(X);
Y1:=ROUND(Y);
SETCOLOR(GREEN);
LINETO(X1, Y1); (*DRAW NEEDLE POINTER*)
CIRCLE(300, 210, 75);
DELAY(20); (*SPEED OF NEEDLE MOVEMENT*)
END;
END;
BEGIN
LOADDRIVER;
COM;
SETBKCOLOR(LIGHTGRAY);
REPEAT
DIAL;
UNTIL KEYPRESSED;
CLOSEGRAPH;
TEXTMODE(80);
END.
```

### Program listing 2

```
CODE SEGMENT BYTE PUBLIC
ASSUME CS:CODE
PUBLIC RS
RS PROC FAR
PUSH BP
MOV BP, SP
poll:MOV DX, 03FDH ;COM1, 002FDH=-COM2
IN AL, DX
TEST AL, 1
Jnz getdata
mov ah, 1 ;check if enter key
pressed
int 16h
jnz finish ;key pressed, exit
jmp poll ;key not pressed,
poll serial channel
getdata:LDS SI, [BP+6]
MOV AL, BYTE PTR [SI]
SUB DX, +5
IN AL, DX ;FETCH DATA
MOV BYTE PTR [SI], AL
finish:POP BP
RET 4
RS ENDP
CODE ENDS
END
```

### Program Listing 3

```
CODE SEGMENT BYTE PUBLIC
ASSUME CS:CODE
PUBLIC COM
COM PROC FAR
PUSH BP
MOV BP, SP
MOV AL, 0E3H ;9600 baud
MOV AH, 0
MOV DX, 0 ;com2=1
;com1=0
INT 014H
POP BP
RET 2
COM ENDP
CODE ENDS
END
```

**Is your PCB design package not quite as "professional" as you thought? Substantial trade-in discounts still available.**

## Board Capture

*Schematic Capture Design Tool*

- Direct netlist link to BoardMaker2
- Forward annotation with part values
- Full undo/redo facility (50 operations)
- Single-sheet, multi-paged and hierarchical designs
- Smooth scrolling
- Intelligent wires (automatic junctions)
- Dynamic connectivity information
- Automatic on-line annotation
- Integrated on-the-fly library editor
- Context sensitive editing
- Extensive component-based power control
- Back annotation from BoardMaker2

**£395**

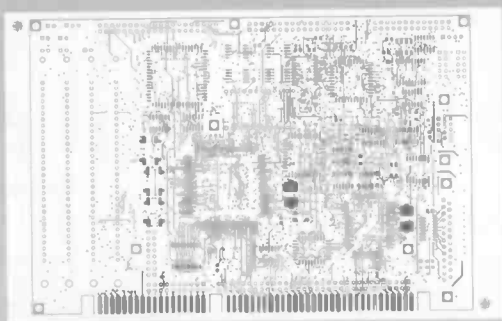
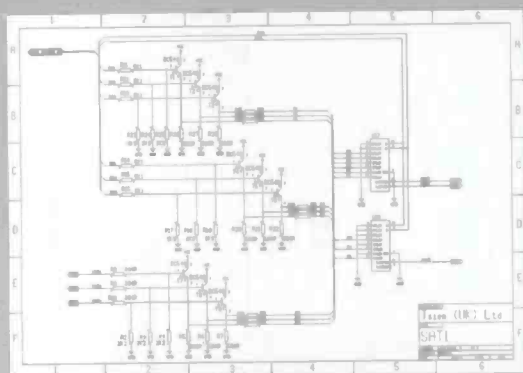

## Board Maker

*BoardMaker1 - Entry level*

- PCB and schematic drafting
- Easy and intuitive to use
- Surface mount and metric support
- 90, 45 and curved track corners
- Ground plane fill
- Copper highlight and clearance checking

**£95**

*BoardMaker2 - Advanced level*

- All the features of BoardMaker1
- Full netlist support- BoardCapture, OrCad, Schema, Tango, CadStar
- Full Design Rule Checking both mechanical and electrical
- Top down modification from the schematic
- Component renumber with back annotation
- Report generator- Database ASCII, BOM
- Thermal power plane support with full DRC

**£395**

## Board Router

*Gridless re-entrant autorouter*

- Simultaneous multi-layer routing
- SMD and analogue support
- Full interrupt, resume, pan and zoom while routing

**£200**

*Output drivers - Included as standard*

- Printers - 9 & 24 pin Dot matrix, HPLaserjet and PostScript
- Penplotters - HP, Graphtec & Houston
- Photoplotters - All Gerber 3X00 and 4X00
- Excellon NC Drill and Annotated drill drawings (BM2)

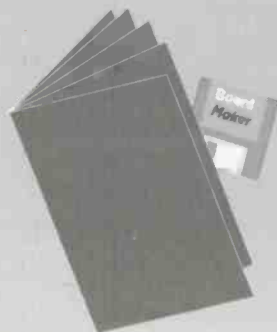

For further information contact

Tsien (UK) Limited

Aylesby House

Wenny Road, Chatteris

Cambridge, PE16 6UT

Tel 01354 695959

Fax 01354 695957

E-mail [Sales@tsien.demon.co.uk](mailto:Sales@tsien.demon.co.uk)

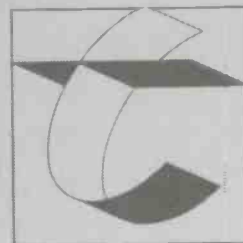

**tsien**

# Multi core Cable tracing system

**I**magine being faced with a dozen or more cable ends, all the same colour and bearing no identification. The other ends emerge in another part of the building, and you have no way of knowing which is which. You could use a continuity tester and a long length of wire to extend one of the probe leads. But if you had 50 wires, and a five minute walk from one end to the other, it would take you a good working day just to trace them all through!

The Multi-core Cable Tracing System presented here is designed to make this sort of job less of a nightmare! The Sender unit is connected to up to 64 wires at one end, and then the Readout unit is used to indicate which is which from the other end. The Readout is simply connected to any two wires at the other end, and the display indicates which wire number the positive lead is connected to. Unlike some commercial systems, this system does not require a separate known common connection between the two units.

The two units are both battery powered, allowing them to be used in situations where mains power is not readily available. A red LED on each unit indicates that the battery is OK. If the LED does not light or is very faint, the battery should be replaced.

PP3 batteries were used in the prototype but, for more regular use, larger capacity 9V batteries would be a better choice, for example six AA cells in a suitable holder. Low cost 9V plug-in mains adaptors could also be used. The two-digit, seven segment LED display on the readout unit is blanked whenever it is not connected to a cable, to conserve battery life.

This system must never be used on live cables. Ensure both ends of the cables to be traced are disconnected before using this system. If in any doubt, check with a test meter. Connection to live cables will cause damage to this system, and could be dangerous.

## Circuit design decisions

With any cable tracing system, a different signal must be sent down each wire. The signal is then identified at the other end. Several systems were considered before deciding on the simple solution used here.

An analogue system using differing voltage levels was ruled out, primarily because it would not work with my plan of having no specific ground wire between the two halves of the system. Noise pickup and voltage drops in long cables could

*Finding faults in multicore cables can be a nightmare. Paul Stenning has developed a piece of equipment which makes the task much easier*

NOTE:	
IC1	4093
IC2, 3	4024
IC4	74HC688
IC5 - IC13	74HC138
IC14	78L05
D1	RED LED

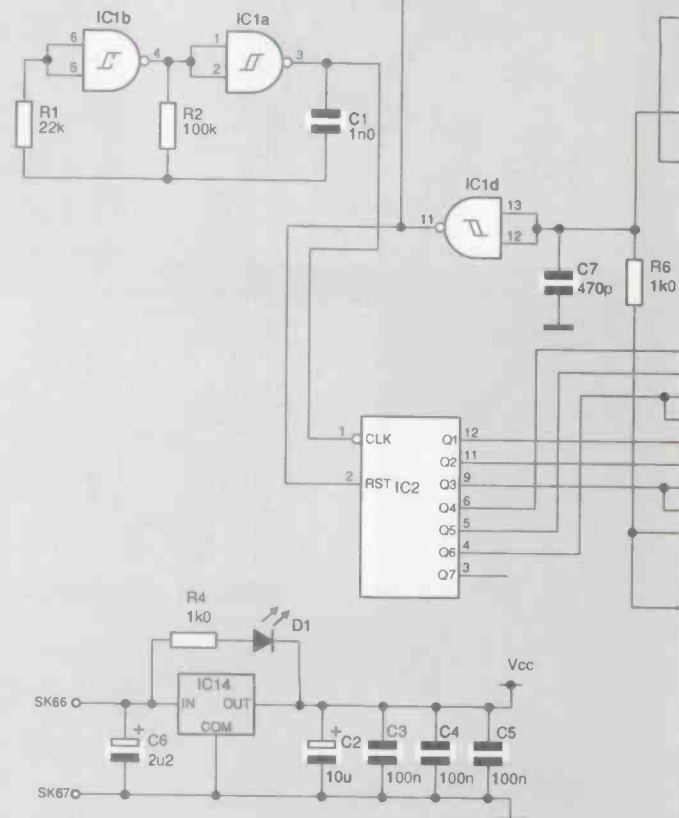



The display on the readout indicates the number of the wire that the "Reading" probe is connected to. The "Non-Reading" probe may be connected to any other wire. Please remember that the power rails in the Sender and Readout units are not linked together, so some sort of reference is needed.

The "Non-Reading" probe is internally connected to the readout positive rail. The level on the "Reading" probe therefore goes low for a period, depending on which wire it is connected to. Then the wire that the "Non-Reading" probe is connected to goes low; this effectively results in the "Reading" probe going 5V higher than a logic high level. This does not reach the logic devices due to a resistor-diode circuit, and is ignored.

### Circuit operation-sender unit

We will start with the Sender unit. The complete circuit is shown in figure 1. IC1a and IC1b (4093) form an oscillator running at about 5KHz. This drives a 4024 counter (IC2). The outputs of IC2 and another counter (IC3) are compared by a logic comparator (IC4), the output of which goes low when the two inputs are equal. This resets IC2 and increments IC3.

Assume the decimal value of the outputs of IC3 is at ten. Also assume IC2 has just been reset, so the value of it's outputs is zero. These two output values are not equal, so the output on pin 19 of IC4 is high. Once IC2 has received ten clock pulses from the oscillator, its output will be equal to that of IC3, and the output of IC4 will go low. This will increment IC3 so its output value is eleven, and also reset IC2 so its output value is again zero. As soon as this occurs, the counter outputs are no longer equal so the output of IC4 will go high again. The sequence now repeats, but this time eleven clock pulses are needed before the two counter outputs are equal.

The outputs of IC3 are decoded into 64 individual outputs by IC5 through IC13. The 74HC138 is a three to eight line decoder, with active-low outputs. IC5 decodes into banks of eight, which are then individually decoded by IC6 to IC13.

Therefore, each of these decoded lines will go low in turn, for a period determined by the number of clock cycles needed for the two counter outputs to become equal. Referring to the previous

examples, the "10" output (SK11) will be low for ten clock cycles, and the "11" (SK12) output will be low for eleven clock cycles. The output number is the SK terminal number less one.

Output "0" from SK1 will be low for a very short duration, set by the values of C7 and R6. This may not work properly in practice, so it may be better to just use outputs "1" to "63". The delay components were found to be necessary to ensure IC2 resets correctly and IC3 increments correctly.

If less than the full 64 outputs are required, you can omit some of the higher numbered 74HC138 devices. In this case, connect a wire from the pin 4 position of the first omitted device to SK66. This will cause the counter system to be reset when the missing device is reached, speeding up the process by not generating unwanted outputs.

I originally planned to run the circuit from a 6V battery with a diode to drop 0.7V. However, the frequency of the oscillator was found to vary with supply voltage, so the output pulse durations would vary as the battery ran down.

Instead I have used a 78L05 regulator, run from a 9V

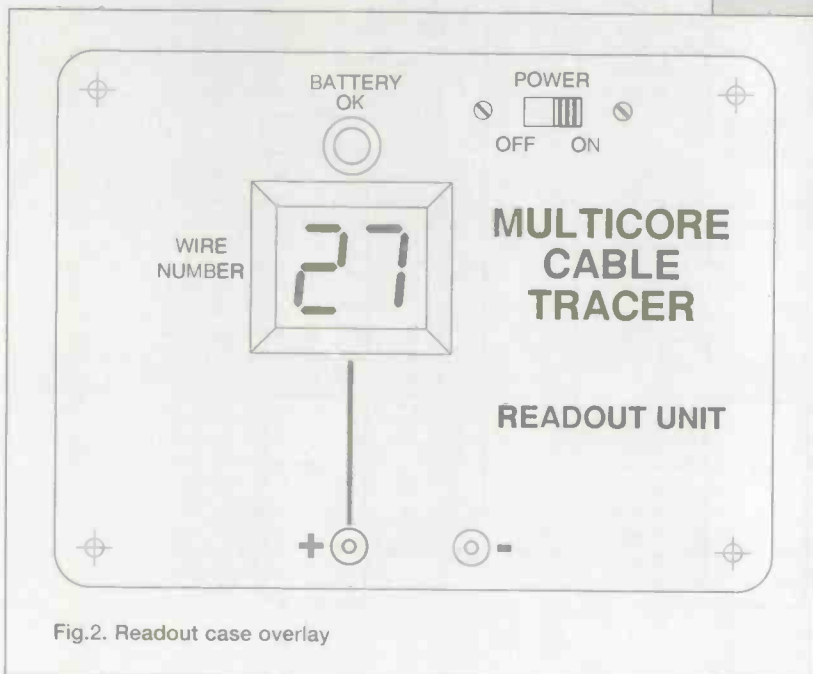
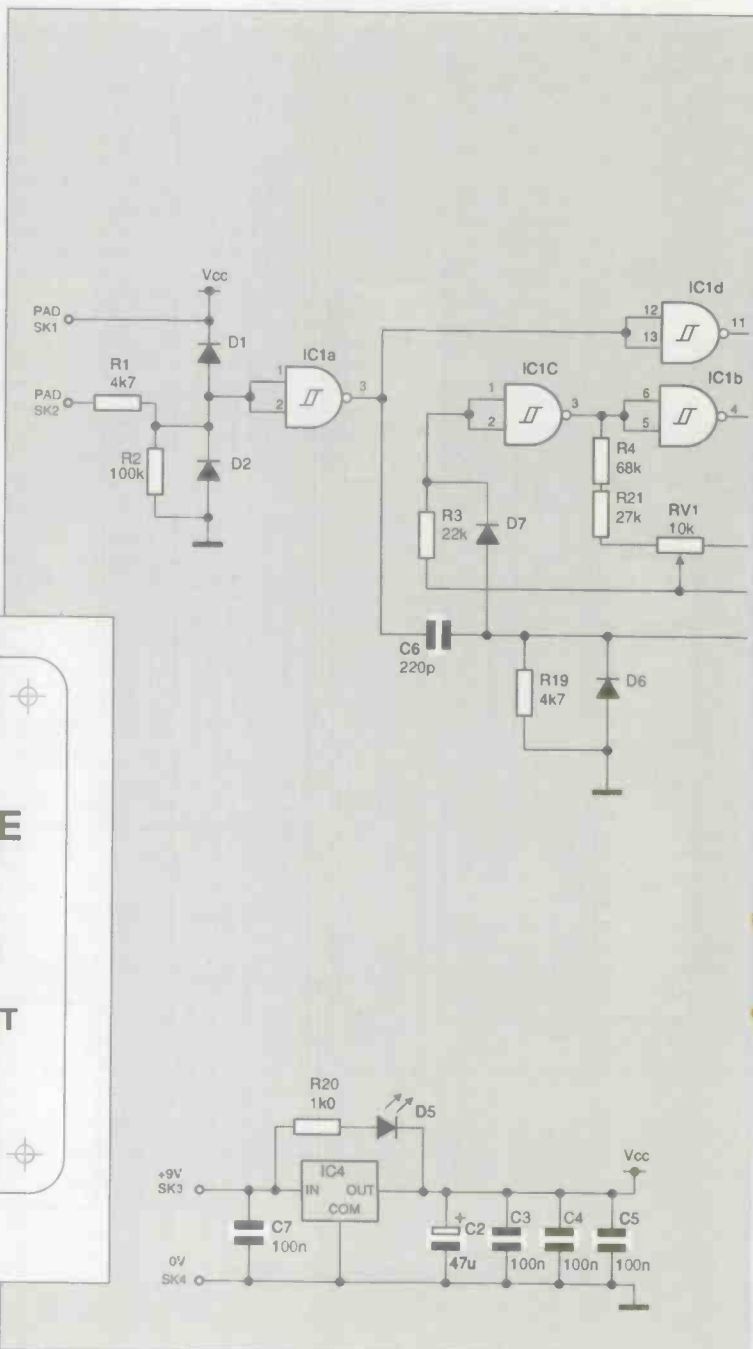

Fig.2. Readout case overlay

battery. The LED (D1) across the regulator lights when the voltage across it exceeds about 2.5V, indicating that the battery is OK. The LED series resistor (R4) has a high value to ensure insufficient current flows through it to disturb the action of the regulator. If you are using a higher voltage battery or a mains power supply unit, you may need to increase R4 further, or omit D1 and R4 completely.

### Circuit operation - readout unit

Note that the component reference numbers start at 1 on both the Sender and Readout. Try not to get confused! See Fig 3.

IC1b and IC1c form an oscillator, the same as the one in the sender unit. One resistor value is variable over a range of +/- 10%, so that the unit may be calibrated. The output is connected to the Clock input of IC2

The frequency of this type of oscillator varies with different makes of 4093 IC. To avoid any problems use the same make of 4093 IC in the Sender and Readout units. This can usually be assured by purchasing them from the same place at the same time.

IC2 and IC3 are decimal counters with decoded 7 segment outputs. These outputs are connected to the displays via emitter follower circuits. The carry output (CO) of IC2 is connected to the clock input of IC3, so IC3 is incremented when IC2 steps from nine to zero. IC3 thus drives the tens display while IC2 counts the units.

The test probes are connected to SK1 ("Non-Reading") and SK2 ("Reading"). The "Reading" input is protected by R1, D1 and D2, as described earlier. R2 holds the input low when it is not connected, blanking the display to conserve battery power. IC1a inverts the signal. When the unit is connected to the Sender, the output of IC1a is normally low, and goes high on the Sender output pulse.

When the input is high (IC1a output low), the clock inhibit inputs (pin 2) of IC2 and IC3 are held high (via IC1d), so that the counters do not respond to the clock input. The display enable inputs (pin 3) are also held high, so the displays are illuminated.

When the input goes low, the reset inputs (pin 15) of IC2 and IC3 are pulsed momentarily high, resetting the counters. This

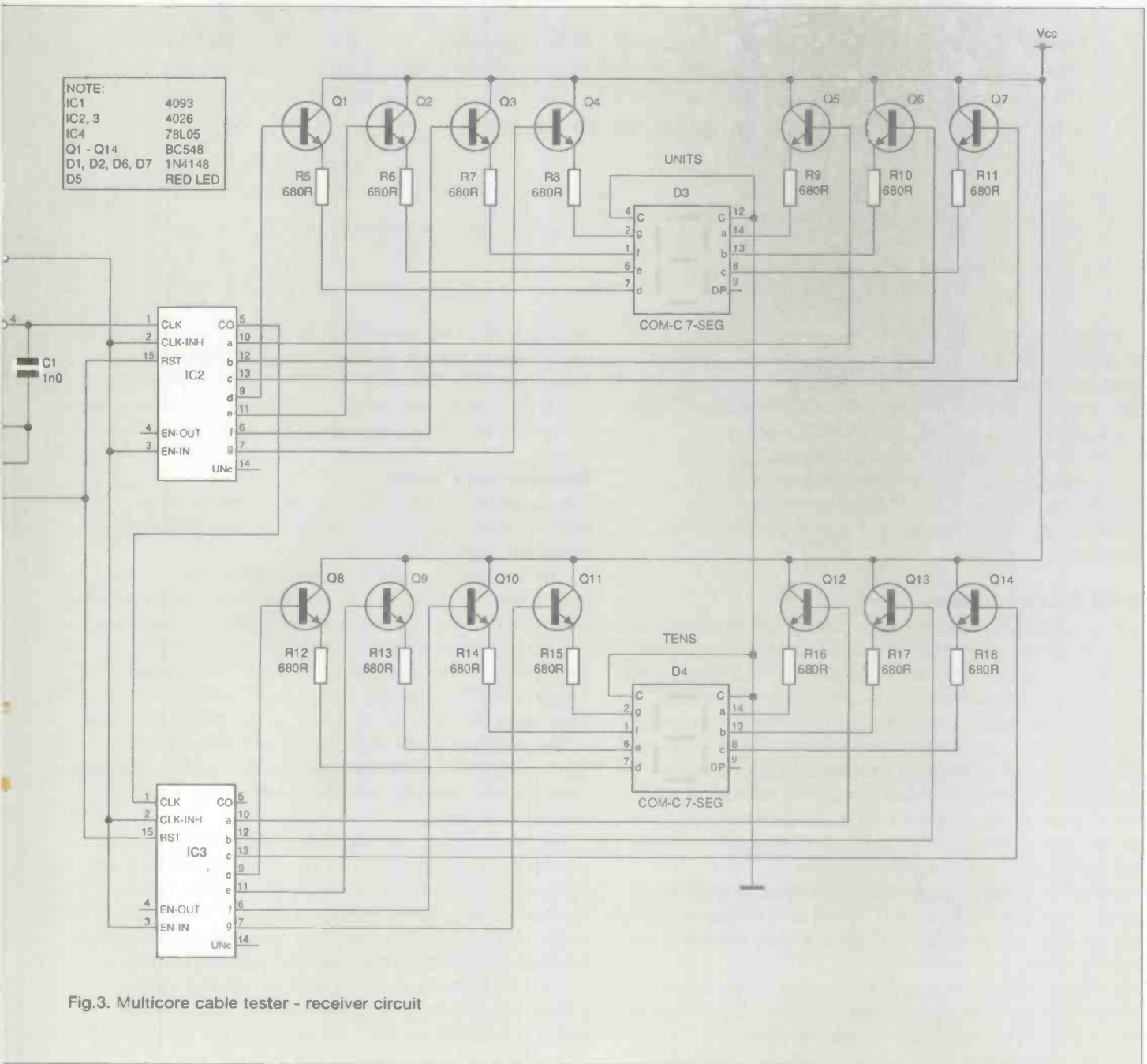

Fig.3. Multicore cable tester - receiver circuit

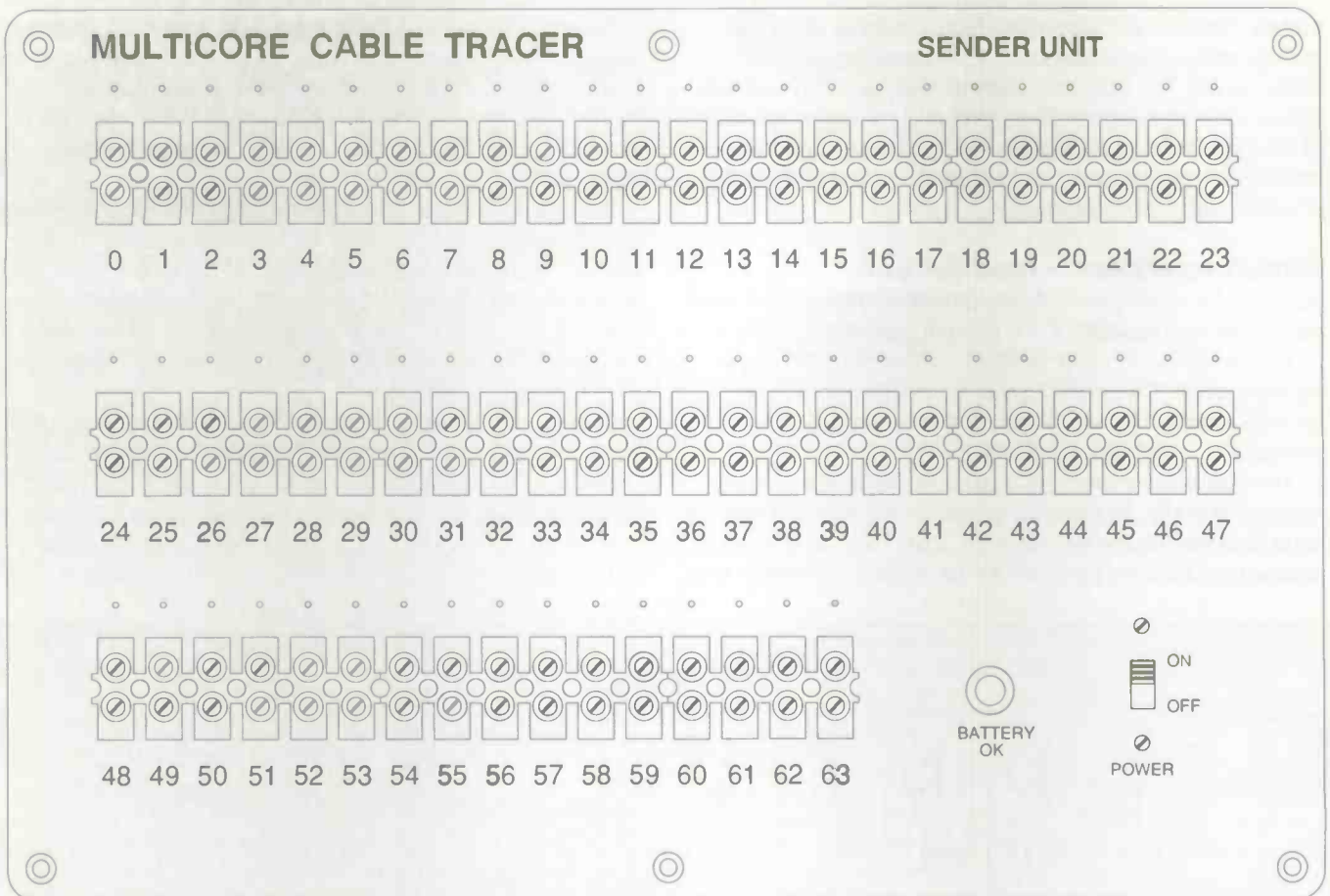

Fig.4. Sender case overlay

brief reset pulse is also coupled to the oscillator via D7, to bring the oscillator into line with the Sender unit. The clock inhibit input goes low, allowing the counters to count the clock pulses and the display enable inputs also go low, blanking the displays. This blanking period is brief, and hardly visible in practice.

When the input goes high again, the displays show the number the counters reached. This number depends on the length of time the input was low, and is therefore the wire number.

The power supply arrangement is identical to that in the Sender unit.

### PCB Construction

Because both PCBs use the same component references, the parts list has been divided into two distinct sections. To save confusion, it may be easier to completely build one PCB at a time. The PCB construction is very straightforward, and requires little comment from me. Note that some wire links pass under components, so these should be fitted first. Use terminal pins or single-in-line header strip for the off-board components - particularly on the Sender PCB - these will make wiring up much easier. Drill a hole in the Readout PCB below VR1 to allow it to be adjusted once it is fitted into the case.

Do not fit the LEDs yet. In the Sender unit (fig 5) the LED is mounted on the case, so terminal pins should be fitted in the PCB. In the Readout (fig 6) the LED has to fit through a hole in the case so it would be better to solder it once everything has been lined up.

On the prototype, the ICs and LED displays were soldered directly into the PCB. You may find it useful to use sockets for the displays to space them away from the PCB.

You may also wish to fit the ICs in sockets, particularly IC6

through IC13 on the Sender unit, since these are most likely to be damaged if the unit is inadvertently connected to low voltage live wires. The same applies to IC1 on the Readout unit. If the units are accidentally connected to live mains voltage wiring, they will almost certainly be damaged beyond repair.

### Sender unit case

The sender unit fits neatly in a low-cost plastic box, type MB6, which is readily available. Everything is constructed on the lid, simplifying construction.

The lid overlay is shown in figure 4. This diagram could be photocopied and used as a drilling template. An additional copy can be fixed to the lid before finally mounting the components.

Low-cost 5A terminal block was used for the cable connections on the prototype. Wires from one side pass through small (1.5mm) holes in the box, to reach the PCB. Push these wires through from the outside, to avoid lifting the overlay.

You could use barrier strip connectors (the type with one screw terminal and a rear solder tag) but this is more expensive. Greenweld are selling ten way-strips of this in their bargain list, at the time of writing.

It is obviously not necessary to use every fixing hole in the terminal block connectors, four screws per 12-way length are sufficient. M3 screws and nuts are ideal. The PCB mounts on the two end fixing screws of the middle row of terminal block. If you fit 12mm spacers in place of the nuts on these two screws, the PCB can be fixed to them with two short M3 screws.

The LED is fitted in a normal LED clip, which requires a 6.5mm hole. A rectangular cutout is needed for the power switch (a small slide switch). However, if you are using figure 5 as an overlay you could just drill a large round hole and let the



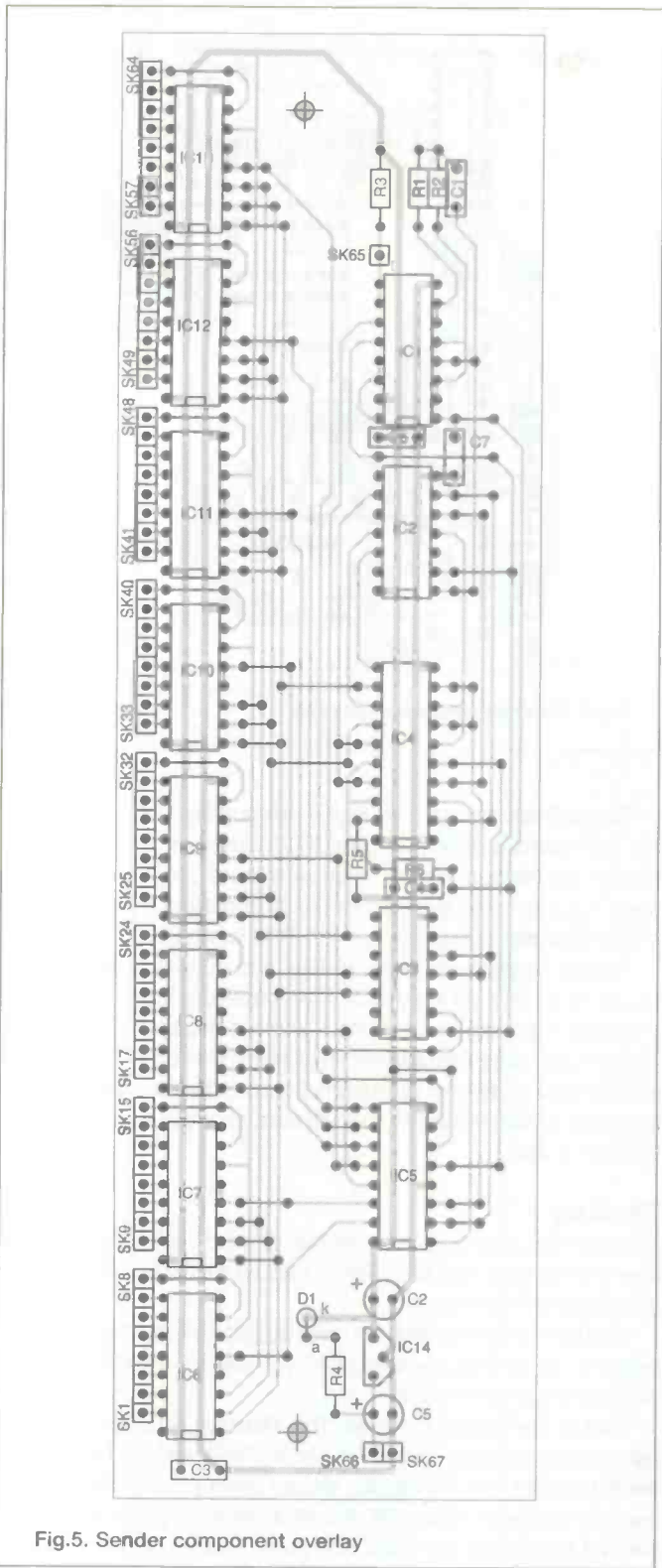

Fig. 5. Sender component overlay

overlay hide it! The slide switches are not normally supplied with M2 fixing screws, so you will need to order these separately.

The interwiring is very straightforward. Firstly, each terminal on the outside of the case is connected to the appropriately marked point on the PCB. Take care to get these correct, although any errors will show up during testing.

The LED should then be connected to the appropriate points on the PCB. If you are in any doubt about the LED pinouts, hold it up to the light so you can see its innards. The anode lead connects to the smaller internal piece to one side, and the cathode to the larger piece with a cupped shape in the top middle. This is easy to remember if you think of Cup

for Cathode and Arm for Anode (same initial letters). This simple method of lead identification holds true for all conventional single colour visible LEDs and most IR LEDs. However, it should not be relied on for some of the more fancy LEDs such as the multi-colour, flashing and low current types.

The LED anode connects to the pin closest to the edge of the PCB. Finally, connect the battery lead and the switch to the PCB. The battery negative (black) lead goes to SK66, and the battery positive (red) lead goes to the centre pin of the switch. Connect a piece of wire between SK67 on the PCB and the uppermost switch terminal.

On the prototype the PP3 battery was retained with a self-adhesive 'C' shaped cable clip. A double-sided sticky pad may be a more readily available solution. If you are using a larger capacity battery such as 6 AA cells in a suitable holder, you will need to devise some method of securing this. Check that your proposed battery holder will fit the case before ordering it—you may need to use two or more smaller battery holders wired in series.

### Readout Unit Case

The prototype readout unit was constructed in a type MB2 case. However this was rather too tight for comfort, and the corners of the PCB had to be filed down. An MB3 type is

PARTS LIST

### Sender Unit

**Resistors (all 5% 0.25W or better)**

- R1 22K
- R2 100K
- R3,R5 4K7
- R4,R6 1K0

**Capacitors**

- C1 1n0
- C2 10u 25V Radial Elect
- C3,C4,C5 100n
- C6 2u2 35V Radial Elect
- C7 470p

**Semiconductors**

● IC1	4093	Quad NAND Gate
● IC2,IC3	4024	7 Stage Binary Counter
● IC4	74HC688	8 Bit Logic Comparitor
● IC5,IC6,IC7,IC8,IC9, ● IC10,IC11, ● IC12,IC13	74HC138	3 to 8 Line Decoder
● IC14	78L05	5V 100mA Regulator

**Voltage**

- D1 RED LE

**Miscellaneous**

- Case type MB6
- PCB code ???
- Terminal block (€ off)
- SPDT slide switch LED clip
- PP3 battery
- PP3 battery clip
- wire.

slightly bigger and would be a better choice. If you want to use a higher capacity battery you may need something larger still.

The front panel overlay of the prototype is shown in figure 2. This may be of limited use if you are not using an MB2 case, but it does give some idea of the layout.

You will need to make a rectangular hole for the LED displays to show through. As mentioned previously, by using an overlay you can hide any irregularities in your cutting. A piece of red filter material fitted behind the cutout will dramatically improve the contrast of the display.

The PCB is spaced away from the box lid with 12mm long spacers. On the prototype, a piece of plastic sheet (available from model shops) was fitted behind the PCB, to prevent the battery causing short circuits. This adequately retained the battery in the MB2 case, but if you are using an MB3 case you may need to add some foam to stop it rattling.

# PARTS LIST

## Readout Unit

### Resistors (all 5% 0.25W or better)

- R1,R19 4K7
- R2 100K
- R3 22K
- R4 68K
- R5,R6,R7,R8,R9,R10,R11,R12,
- R13,R14,R15,R16,R17,R18 680R
- R20 1K0
- R21 27K
- VR1 10K Horizontal preset

### Capacitors

- C1 1n0
- C2 47u 16V Radial Elect
- C3,C4,C5,C7 100n
- C6 220p

### Semiconductors

- IC1 4093 Quad NAND Gate
- IC2,IC3 4026 Decimal counter (7 seg output)
- IC4 78L05 5V 100mA Voltage regulators
- TR1,TR2,TR3,TR4,TR5,TR6,TR7,
- TR8,TR9,TR10,TR11,TR12,
- TR13,TR14 BC548 NPN Transistor
- D1,D2,D6,D7 1N4148 Diode
- D3,D4 0.3" Com Cathode Red 7 Seg
- LED Display
- D5 RED LED

### Miscellaneous

- Case type MB2
- Red and black croc-clips
- PDT slide switch
- Red LED filter material
- LED clip
- PP3 battery
- PP3 battery clip
- wire

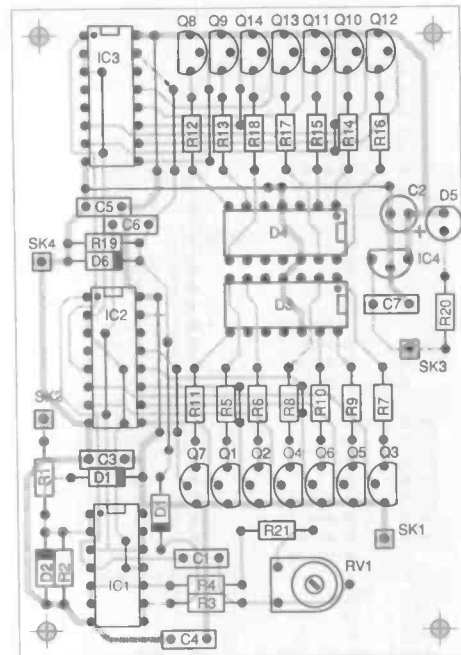

Fig.6. Readout component overlay

Before finally fixing the PCB, the wiring should be completed. The LED solders directly into the PCB; however, you will need to form the leads to allow it to show through the hole in the case. You may need to sleeve the leads to prevent them shorting. The LED anode connection on the PCB is closest to R20.

Battery negative connects to SK4 and battery positive connects to SK3 via the switch. The positive (+) test-lead (the "Reading" lead) connects to SK2, and the negative (-) to SK1. These leads pass through the small holes shown in the case and the free ends may be fitted with crocodile clips or similar. Knot the cables inside the case to save straining the PCB if they are pulled.

## Testing

If you constructed the units carefully and luck is on your side, they should work first time. All you would then have to do is calibrate the Readout unit.

Initially it is best to test the units by connecting the directly together. Once this is working OK, you can try them with a length of multi-core cable.

Switch the Readout unit on. The 'Battery OK' LED should light, and the display should be blank. Touch the two test leads together and the display should light up, and show a number between 00 and 99. It is most likely to show 00 due to contact bounce as you touch the probes together. If you can get it to show a number other than 00 (by touching the probes together abruptly), you can be confident that it is working OK.

Now switch the Sender unit on. It should not do anything exciting but the LED should light!

Connect the positive readout probe to terminal 63 on the Sender, and connect the negative to any other terminal. The display should show a steady number, although it may alternate between two adjacent numbers. You should just be able to see the display flicker about twice a second.

Adjust VR1 in the Sender until the display indicates 63. Find the points where the reading alternates between 62 and 63, and between 63 and 64. Set the preset mid-way between these two points.

If the preset does not have enough range, you may need to adjust the value of R4 or R21. If the two 1n0 timing capacitors and the two 4093 ICs are from the same batches (bought from the same place at the same time), you should have no problems.

Now try connecting the positive probe to each of the other terminals in turn. You should get the appropriate number displayed. You may get one number as the probe is connected, followed by another which remains constant. In this case just ignore the first number.

As mentioned previously, the zero output may not work correctly due to the pulse being so short. If this is the case, you would be best just to ignore it.

If you are building more than one pair of units, please note that they are calibrated in pairs. Clearly mark the units so that the right units are always used together.

### Longer Cables

If you have a long piece of multi-core cable to hand, try the units on it. It is not possible to give a maximum permissible cable length since this depends mainly on the capacitance, which in turn depends on the cable construction. In the case of individual wires, it depends on how they are installed, for example whether they are in metal conduit and how closely they are packed.

If you have problems with long lengths of cable affecting the readings, there are a couple of things you can try. Firstly you could try using 74AC138 devices for the output drive, as described earlier. Secondly, you can try decreasing the clock speed. Simply increase the values of both C1 capacitors. Remember to re-adjust VR1 after changing any values.

The problem is caused by the edges not rising and falling quickly. If the total rise and fall time exceeds about half a clock period, there is a possibility of inaccuracy. By slowing the clock, we effectively widen the acceptance range.

The drawback with this is that the time taken to get a valid reading will increase although, even if it takes several seconds, it is still much quicker than messing around with a multimeter. If the capacitors are increased to 10n, the time to get a valid reading will be no more than five seconds, which seems reasonable and should allow vast lengths of cable to be identified with no problems. This is probably the largest practical capacitor value.

If you will only be testing a limited number of wires, you can reduce this time delay by removing one or more of the output ICs and connecting the pin 2 position of the first empty IC space to SK65 (see circuit description earlier). The time saving obtained can be quite significant since the higher numbers take more time than the lower numbers.

## OMNI ELECTRONICS

174 Dalkeith Road, Edinburgh EH16 5DX • 0131 667 2611

- The supplier to use if you're looking for -
- ★ A WIDE RANGE OF COMPONENTS AIMED AT THE HOBBYIST ★
  - ★ COMPETITIVE VAT INCLUSIVE PRICES ★
  - ★ MAIL ORDER - generally by RETURN OF POST ★
  - ★ FRIENDLY SERVICE ★
  - ★ 1995/96 CATALOGUE NOW AVAILABLE Price £2.00 ★



Open: Monday-Thursday 9.15-6.00  
Friday 9.15-5.00 Saturday 9.30-5.00



## NEXUS BOOKS PUBLISHING FOR THE SPECIALIST

### THE FULL RANGE OF NEXUS BOOKS

are available from all  
book and hobby  
shops or contact  
Nexus Books  
direct for a  
Complete List.

### COMPLETE LIST,

Nexus Books,  
Nexus House,  
Boundary Way, Hemel Hempstead,  
Herts. HP2 7ST

OR PHONE

**01442 66551** Ext. 366

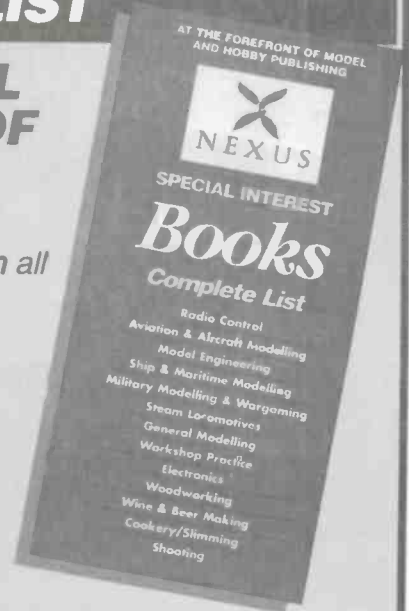

## TRANSISTORS + ICS + SEMICONDUCTORS

£30 WORTH OF VOUCHERS in the new  
**cricklewood electronics**  
Very Interesting Catalogue

- ✦ RESISTORS + CAPACITORS + INDUCTORS
- ✦ SURVEILLANCE + SECRECY + SECURITY
- ✦ PLUGS + SOCKETS + LEADS + CONNECTORS
- ✦ TV & VIDEO SPARES (INC. VIDEO HEADS)
- ✦ HIFI + DISCO + HIFI GADGETS + SPEAKERS
- ✦ AUDIOPHILE COMPONENTS (inc capacitors)
- ✦ IN CAR AUDIO + SPEAKERS (inc bass tubes)
- ✦ COMPUTER ACCESSORIES + BOARDS
- ✦ TOOLS + TEST EQUIPMENT + BENCHMARK

& much much more (over 10,000 lines).  
send today for the very interesting catalogue.  
Pay by PO, cheque, credit card or tape coins to paper.

Please send me.....copies of the 1995 Cricklewood Catalogue.  
I enclose £2.50 per copy (UK & Europe) £5 overseas.

Name.....  
Address.....

Please charge my credit card. No.....  
Expiry Date.....Tel. No:.....ETI

Cricklewood Electronics Ltd, 40-42 Cricklewood Broadway,  
London NW2 3ET. Tel: 0181-450 0995 Fax: 0181-208 1441

# DEVELOPMENT AND PRODUCTION SOLUTIONS

- Gang Programmers
- Development Programmers
- Universal Cross Assembler
- Package Converters
- Development Tools
- Emulator Pods + Adapters

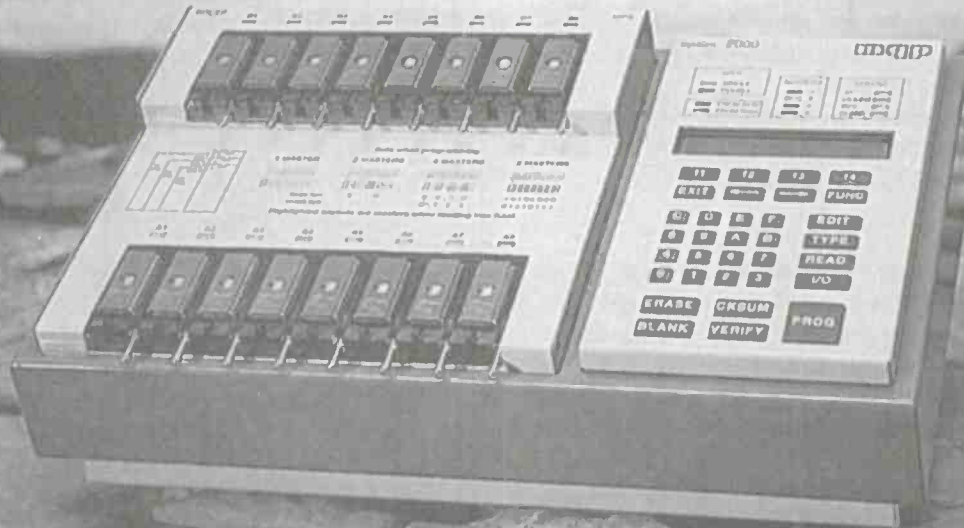

**mqp**

**ELECTRONICS Ltd**

Park Road Centre, Malmesbury, Wiltshire SN16 0BX UK  
Tel: 01753 666 8251 Fax: 01753 666 825141  
e/mail 100447.1124@compuserve.com

IRELAND 1-2800395  
GERMANY 089/4602071  
NORWAY 0702-17890  
ITALY 02 92-10 35 54  
FRANCE 1 69 30 13 79  
SWEDEN 08 590 32185  
Also from ELECTROSPEED UK



## ★★ FOR SALE ★★

DEFENCE & AEROSPACE INDUSTRY  
ELECTRONIC EQUIPMENT & COMPONENTS ALL HIGH QUALITY SURPLUS  
MANY SPECIALS. WE STOCK 1000 +  
ITEMS & IF WE DON'T STOCK IT WE MAY  
BE ABLE TO GET IT FOR YOU  
PLEASE WRITE OR PHONE FOR LISTS  
OR REQUIREMENTS

**MAYFLOWER ELECTRONICS**  
48 BRENDON ROAD,  
WATCHET, SOMERSET, TA23 0HT  
TEL (01984) 631825 FAX 634245



## FIELD ELECTRIC LTD

TEL: 01438 353781 FAX: 01438 359397  
MOBILE: 0836 640328/0806 213370  
UNIT 2, WILLOWS LINK, STEVENAGE, HERTS SG2 8AB



SONY 9" COLOUR MONITOR SUPER FINE PITCH CASED WITH DATA FOR RGB MODEL KTM 1000UB £45  
SLO-SYN HS25 STEPPER MOTOR NEW + BOXED 40 OZ IN TORQUE £8.95 C/P 4.50  
INTEL FLASH MEMORY CARDS 1Mb TO 4Mb FROM £60 C/P 6  
40AMP SWITCH MODE PSU NEW + BOXED £19 C/P 3  
COUTANT DC/DC CONVERTERS NEW 48V IN 5V OUT @ 5A £6 C/P 3  
12 VDC fans 90mm x 25mm £4 C/P 1.50  
NI-CAD BATT: OWERTY K/BOARD £17 C/P 5.00  
NEC CMV 123NE 12" COLOUR MONITOR WILL WORK ON PC SVGA/AMIGA/ATARI/BBC. SUPPLIED WITH PC VGA LEAD. CASED 240 VAC £85.00 c/p 12.00  
12VDC CENTRIFUGAL BLOWER NEW £6 C/P 2  
240V TO 110V 80 WATT AUTO TOROIDAL TRANSFORMER £7 C/P 3  
TEKTRONIX 453 OSCILLOSCOPE 50 MHz DUAL BEAM £175

REDMOND 12VDC 3000 RPM 80 WATT MOTOR NEW £6 C/P 3  
RS 207-065 AUTO TRANSFORMER 1000 WATT £40 C/P 10  
BERCO STAT 20HM 5A POT £2.50  
MICROVETEC (CUB) COLOUR MONITORS T.T.L. 6 PIN DIN INPUT £29 C/P 10.00  
MICROSOFT MS-DOS 6 UPGRADE IN SEALED PACKS ON 3.5" DISKS. UPGRADE FROM 2.11 OR LATER £15.50 C/P 4.00  
NEC 256 30 PIN SIPP MEMORY NEW £5 FOR 256K C/P 90P 12" MONO VGA CHASSIS (PAPER WHITE) ENCLOSED 240 VAC £35 C/P 12.00  
YUASA NP 10-6.6v 10ah SEALED LEAD ACID BATTERY NEW £7.95 C/P 3-50  
PC PSU ENCLOSED. NEW +5@20A +12@8A -5@ 3A 200 WATT £15.95 C/P 5  
102 KEY AT IBM COMPATIBLE KEYBOARD TERMINATOR TO 6 PIN DIN MINI PLUG £8 C/P 3.50  
ALL ITEMS UNDER £5 MIN ORDER £10.  
C/P £2.75

PLEASE ADD 17.5% VAT TO ORDER. RING FOR C/P PRICES NOT SHOWN.  
OFFICIAL ORDERS AND OVERSEAS ENQUIRIES WELCOME.

## Create your own **Mobile Robot v2**

CONTROLLED BY COMPUTERS VIA PRINTER PORT  
EXPENDABLE TO RADIO CONTROLS

**33.00**  
pounds

+£2 P&P

A complete Kit  
including hard/software for you to build  
A Catalogue  
Full of PC interfacing ideas and plans

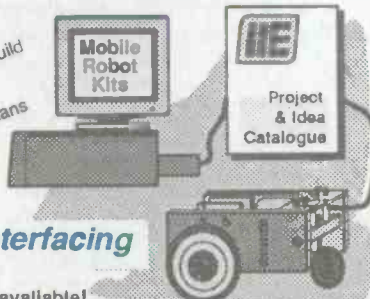

**Innovative Interfacing Enterprise**

Other PC Interfacing kits are available!  
Centronic and RS232 Explorer kits, Centronic and RS232 24-line programmable I/O cards  
Data logging systems, triple stepper motor boards, Radio controllers, see our catalogue!

Add £2 P&P in UK (£3.5 abroad) and make cheque payable to 'Innovative Interfacing Enterprise'  
58 Lamport Court, Lamport Close, Manchester M1 7EG, U.K. Tel/Fax: +44-(0)161-272-8279

Semiconductors, connectors, capacitors,  
fans, resistors, relays, manuals,  
data books and much more...

— All available at very low VAT inclusive prices —

Large SAE for current list

# BHA Trading

15 OAKWELL CLOSE, STEVENAGE,  
HERTS SG2 8UG

TEL: 01438 816474  
FAX: 01438 812569

# Practically SPEAKING

BY TERRY BALBIRNIE

**T**he hobbyist is burdened with requests to repair all types of electrical and electronic equipment. This is the best piece of advice - if you have any doubt about your ability to repair a mains-operated device safely - don't try it!

If you do decide to tackle the job, first listen to the reported nature of the fault. This often gives a clue to the problem. The simplest faults to find are those where the equipment fails to work at all. These are usually due to a detached or broken wire, a blown fuse or a burnt-out switch. Such faults are easily found using a multimeter.

## Don't re-fuse

Blown fuses are one of the commonest causes of failure. In the UK, suspect the one inside the mains plug. Fuses can also be found elsewhere - sometimes in panel fuse holders mounted on the rear of a piece of equipment. Fuses are checked by removing and testing them using a low resistance range on the multimeter. A good fuse will show a resistance of virtually zero. If a fuse has failed, always replace it with an identical one - never uprate it or change its value or type (anti-surge for quick-blow, etc).

Never assume that the blown fuse is the primary fault. It is quite possible that it is the symptom of some other fault. Try one new fuse. If it blows either straight away or over a test period, the fault must be investigated further.

## Under strain

Examine the entire length of the mains lead including the plug. Damage to flex is very common - particularly where it bends at a grommet or strain relief bush. The wire on a domestic iron is particularly vulnerable to damage, especially where the fabric covering rubs against the ironing board in the course of use. Never tape over such damage or, for that matter, cover over splits and cracks in plugs to effect a temporary repair. The whole run of wire must be replaced.

If it is suspected that one of the inner conductors in a length of wire has failed, unplug the unit from the mains and dismantle it sufficiently to expose the ends of the wires. Check that virtually zero resistance exists between the corresponding pin on the mains plug and the other end. If the fault is intermittent, bend the wire as the test is made since the break is often revealed only when the wire is under strain.

If wire needs to be replaced, never use a different type (in terms of current rating, number of conductors, type of insulation,

etc.) and never use a piece of screw terminal block to repair a damaged section.

It is increasingly common to find thermal fuses in pieces of domestic equipment which are designed to become hot in operation. Unlike conventional fuses, these blow when the equipment overheats. The main-line current flows through the device so that any abnormal rise in temperature results in the current being cut off. Thermal fuses are instrumental in preventing fires. Unfortunately, they sometimes fail for no obvious reason and the only cure is to replace them with one of the correct case style and of the same temperature characteristic. They are available in ratings from about 90 to 240 degrees Celsius. One practical point - never solder direct to the wire ends of a thermal fuse. Sufficient heat will conduct into the device to blow it. Screw connectors must be used. A thermal fuse is checked in the same way as an ordinary one using a multimeter.

Certain items of equipment are fitted with a bi-metallic thermal cut-out. This contains a strip which, on overheating, bends and breaks a pair of contacts. This cuts off the supply. However, unlike the thermal fuse, the contacts re-make when the appliance cools. After a long period of use, the strip sometimes becomes permanently bent. This can result in the contacts breaking with only a small rise in temperature or even failing to make contact at all. The only cure is replacement. On no account by-pass any type of thermal fuse or cut-out to get the equipment working - even temporarily.



## Next Month...

we shall continue by looking at some further details regarding the repair of mains-operated electronic equipment.

# ETI

ELECTRONICS  
TODAY INTERNATIONAL

# FOILS FOR THIS ISSUE

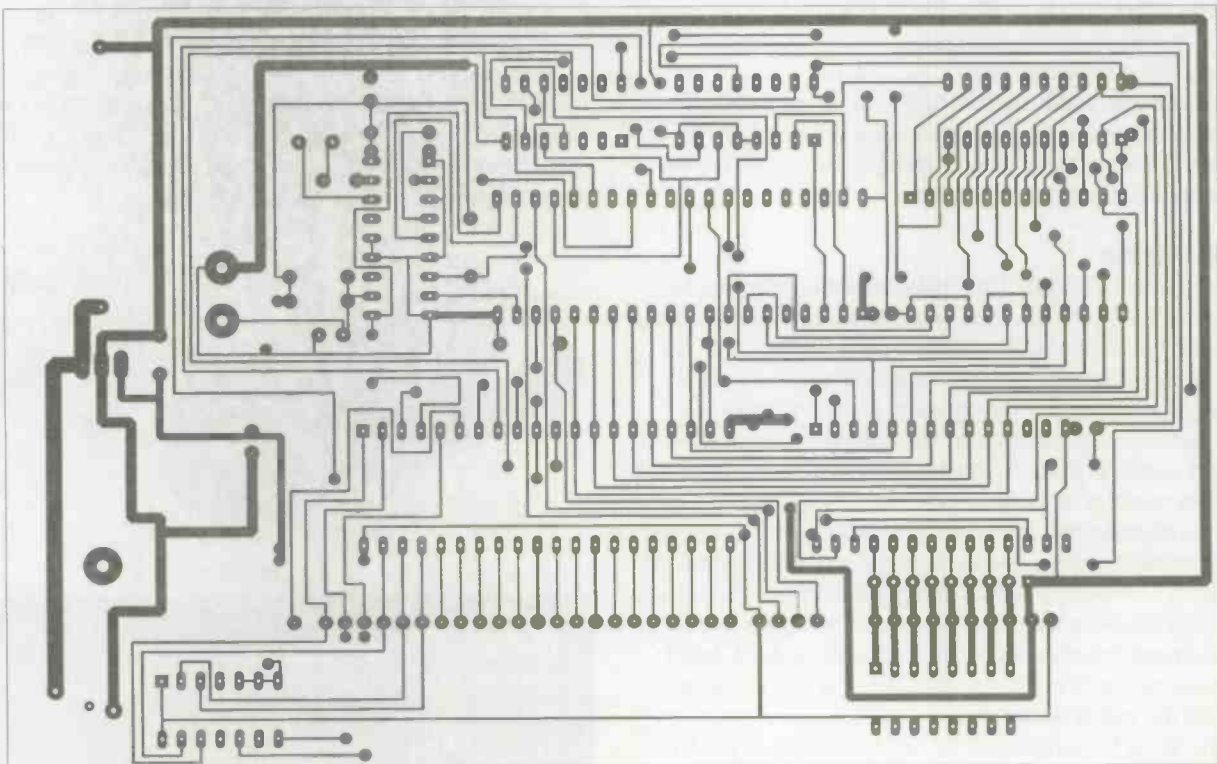
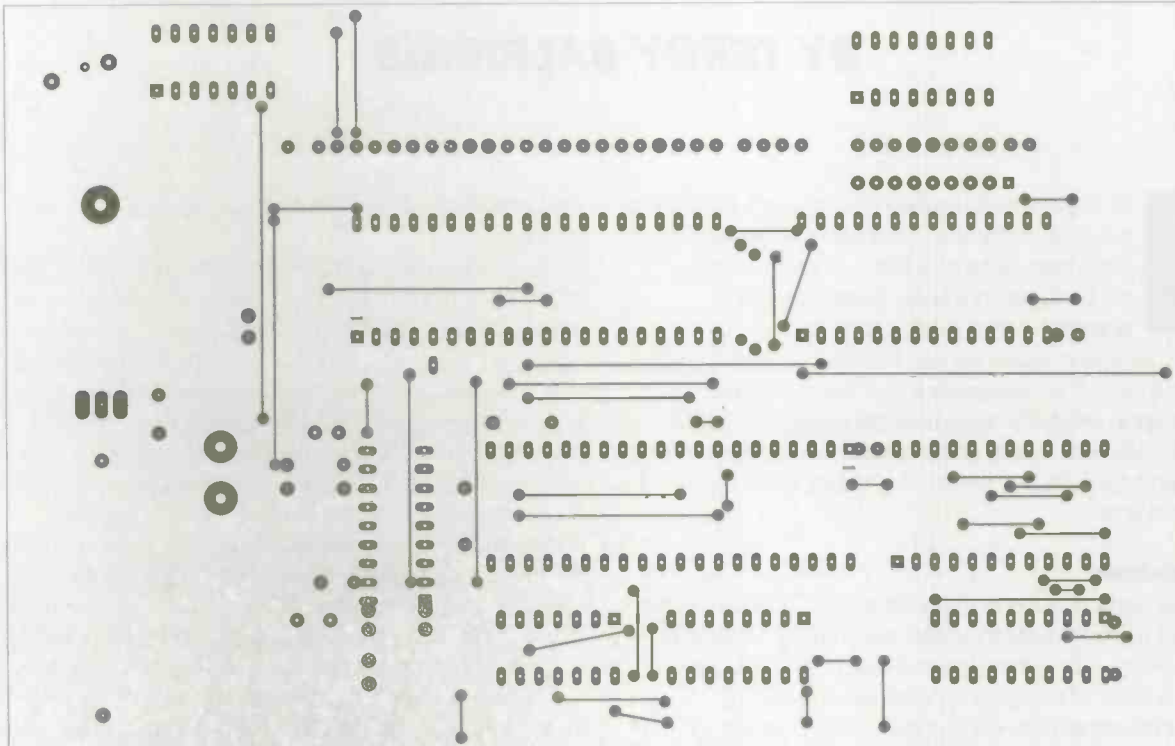

8088 Interrupt based control computer

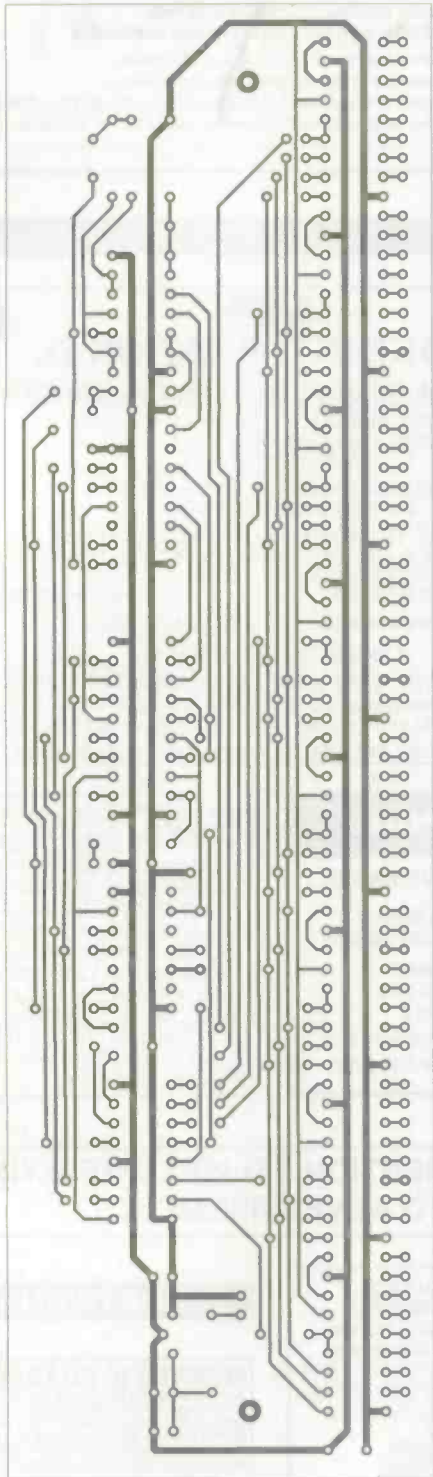

**Multicore cable tester**

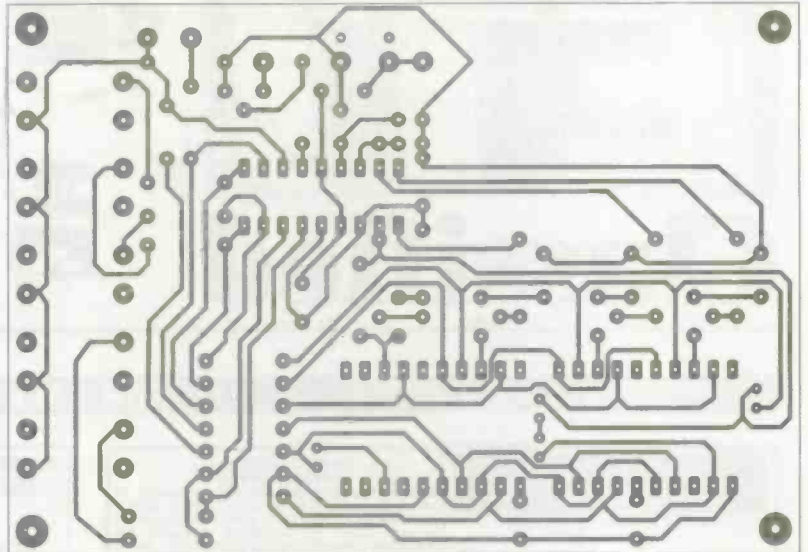

**Pic Micro controller**

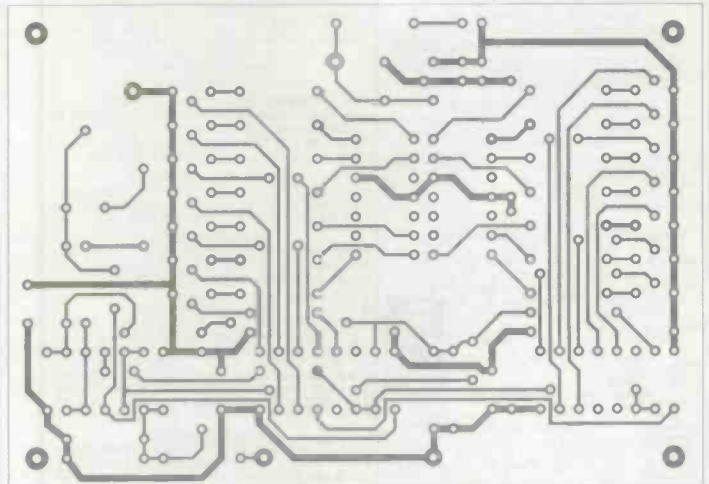

**Multicore cable tester**

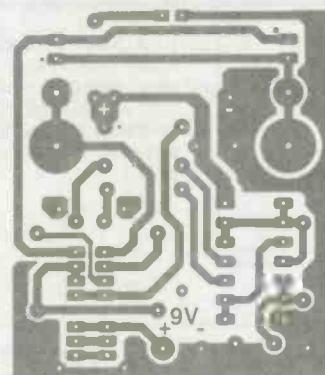

**Multi checker**

# Classified



**James Gale**  
**01442 66551**

Send your requirements to:  
ETI Classified Department, Nexus, Nexus House,  
Boundary Way, Hemel Hempstead, HP2 7ST  
Lineage: 70p per word (+ VAT) (minimum 15 words)  
Semi display: (minimum 2.5cms)  
£9.50 + VAT per single column centimetre



Ring for information on series bookings/discounts.  
All advertisements in this section must be pre-paid.  
Advertisements are accepted subject to the terms and conditions  
printed on the advertisement rate card (available on request).

## FOR SALE

### VARIABLE VOLTAGE TRANSFORMERS

INPUT 220/240V AC 50/60  
OUTPUT 0-260V

	Price	P&P
0.5KVA 2.5 amp max	£31.90	£5.00
	(£44.53 inc VAT)	
1KVA 5 amp max	£41.15	£7.00
	(£56.58 inc VAT)	
2KVA 10 amp max	£59.40	£8.50
	(£79.78 inc VAT)	
3KVA 15 amp max	£78.65	£8.50
	(£102.40 inc VAT)	
5KVA 25 amp max	£139.15	

(Plus Carnage)  
Buy direct from the Importers. Keenest prices in the country  
**COMPREHENSIVE RANGE OF TRANSFORMERS-LT-ISOLATION & AUTO**  
(110-240V Auto transfer either cased with American socket and mains lead of open frame type. Available for immediate delivery.

### WIDE RANGE OF XENON FLASH TUBES

Write/Phone your enquires

#### ULTRA VIOLET BLACK LIGHT FLUORESCENT TUBES

4ft 40 watt	£14.00 (callers only)	(£16.45 inc VAT)
2ft 20 watt	£9.00 (callers only)	(£10.58 inc VAT)
12in 8 watt	£4.80 + 75p p&p	(£6.52 inc VAT)
9in 8 watt	£3.96 + 50p p&p	(£5.24 inc VAT)
6in 4 watt	£3.96 + 50p p&p	(£5.24 inc VAT)

#### 230V AC BALLAST KIT

For either 6in, 9in or 12in tubes £8.05 + £1.40 p&p (£9.75 inc VAT)  
The above Tubes are suitable for Forged Bank Note detection, security marking etc.  
Other Wave Lengths of UV. TUBE available please telephone your enquires.

#### 400 WATT UV LAMP

Only £38.00 + £4.00 p&p (£49.35 inc VAT)  
160 WATT SELF BALLASTED BLACK LIGHT MERCURY BULB  
Available with UC or ES fitting. Price inc VAT & p&p and VAT £25.55



#### 12V D.C. BILGE PUMPS

500 GPH 15ft head 3 amp £19.98  
1750 GPH 15ft head 9 amp £34.55  
Also now available 24V D.C. 1750 GPH 15ft head 5 amp £35.55. All designed to be used submerged. PRICES INCLUDE P&P & VAT

#### SUPER HY-LIGHT STROBE KIT

Designed for Disco, Theatrical uses etc.  
Approx 16 joules. Adjustable speed £50.00 + £3.00 p&p (62.28 inc VAT)  
Case and reflector £24.00 + £3.00 p&p (£31.73 inc VAT)  
SAE for further details including Hy-Light and Industrial Strobe Kits.

### SERVICE TRADING CO

57 BRIDGMAN ROAD, CHISWICK, LONDON W4 5BB  
FAX 0181-995 0549 0181-995 1560  
ACCOUNT CUSTOMERS MIN. ORDER £10



Showroom open Monday/Friday



Ample Parking Space

### "BOFFINS SPECIAL" - UNIQUE OFFER

Surplus Precision Medical Unit, Internally in excellent condition. Designed primarily to eject a precise controllable amount of fluid from a medical syringe (batter not supplied). Contains the following removable components: Dual Micro Processor Boards and EPROMS Escap Precision 12V DC Motor with 300:1 Gear Box and optical encoder coupled to a precision threaded drive mechanism. Mains supply with 6 x 1.5V Ni-Cad A.A. cells back-up. L.C.D. Digital read-out 17mm high with legends. Audible warning.  
These are sold for the dismantling of the exceptional quality components, regret no Circuits available.  
Ridiculously low price: £20.00 + £4.00 p&p (£28.20 incl VAT)

#### 5KVA ISOLATION TRANSFORMER

As New Ex-equipment fully shrouded Line Noise Suppression, Ultra Isolation Transformer with terminal covers and Knock-out cable entries. Primary 120/240V Secondary 120/240V 50/60 Hz. .005 pF Capacitance. Size L.37 x W.19 x H.16cm Weight 42 Kilos  
PRICE £120.00 +VAT  
ox-warehouse. Carriage on request.

#### 240V AC CENTRIFUGAL BLOWER

New Manuf. Surplus Skeleton Blower suitable for mounting inside an enclosure to cool equipment. Overall size 130x110x85mm. Outlet 80x35mm. Impeller 60mm dia x 60mm long. £14.10 incl.P&P & VAT

#### SEWING MACHINE MOTOR

Brand new 220/240V AC/DC SEW-TRIC 2 lead Brush Motor. Size L. 100mm x H. 70mm x W.55mm. Spindle. 1/4in. dia x 1in. long. £14.10 incl. P&P & VAT

#### GEARED MOTORS

71 RPM 20lb inch torque reversible 115V AC Input including capacitor and transformer for 240V AC operation. Price inc VAT & p&p £27.73

#### SOLID STATE EHT UNIT

Input 230/240V AC, Output approx 15KV. Producing 10mm spark. Built-in 10 sec timer. Easily modified for 20sec, 30 sec to continuous. Designed for boiler ignition. Dozens of uses in the field of physics and electronics, eg supplying neon or argon tubes etc. Price less case £8.50 + £2.40 p&p (£12.81 inc VAT) NMS

#### EPROM ERASURE KIT

Build your own EPROM ERASURE for a fraction of the price of a made-up unit kit of parts less case includes 12in 8 watt 2537 Angstrom Tube Ballast unit, pair of bi-pin leads, neon indicator, on/off switch, safety microswitch and circuit £15.00 + £2.00 p&p (£19.98 inc VAT)

#### WASHING MACHINE WATER PUMP

Brand new 240V AC. fan cooled. Can be used for a variety of purposes. Inlet 1 1/2in. outlet 1 in. dia. Price includes p&p & VAT. £11.20 each or 2 for £20.50 inclusive

#### MICROSWITCH

Pye 15 amp changeover lever microswitch, type S171. Brand new price 5 for £7.05 inc VAT & p&p



## COOKE INTERNATIONAL

### SUPPLIER OF QUALITY USED TEST INSTRUMENTS.

ANALYSERS, BRIDGES, CALIBRATORS, VOLTMETERS, GENERATORS, OSCILLOSCOPES, POWER METERS. ETC  
ALWAYS AVAILABLE

ORIGINAL SERVICE MANUALS FOR SALE  
COPY SERVICE ALSO AVAILABLE

EXPORT, TRADE AND U.K. ENQUIRIES WELCOME  
SEND LARGE S.A.E. FOR LISTS OF EQUIPMENT AND MANUALS (50p)  
ALL PRICES EXCLUDE VAT AND CARRIAGE  
DISCOUNT FOR BULK ORDERS SHIPPING ARRANGED

OPEN MONDAY TO FRIDAY 9AM - 5PM

**COOKE INTERNATIONAL**  
**ELECTRONIC TEST & MEASURING INSTRUMENTS**  
Unit Four, Fordingbridge Site, Main Road, Barnham, Bognor Regis,  
West Sussex, PO22 0EB Tel (+44) 01243 545111/2 Fax (+44) 01243 542457  
WANTED TEST EQUIPMENT & MANUALS TO PURCHASE

## LIVERPOOL

### PROGRESSIVE RADIO

87/93 Dale Street  
Tel: 051 236 0982 051 236 0154

47 Whitechapel  
Tel: 051 236 5489  
Liverpool 2

'THE ELECTRONICS SPECIALISTS'  
Open: Tues-Sat 9.30-5.30

**KINDLY MENTION ETI WHEN REPLYING TO ADVERTISEMENTS**

## LEN COOKE ENTERPRISES

*For the best value in Used Electronic Test Instruments*  
We buy, sell and service oscilloscopes, signal generators, frequency counters, spectrum Analysers, Power meters, logic testers, etc.  
Spare parts available for most Tetraxonic scopes.  
Tel: 081-813-9946  
Fax: 081-574-2339  
Mobile: 0374 759984  
Mail order address: Unit 5, Southall Enterprise Centre, Bridge Road, Southall, Middx. UB2 4AJ  
We engineer what we buy, we support what we sell.

## SOFTWARE

### SCIENTIFIC SHAREWARE

Discover the true wealth of PD & shareware for the PC. Since 1982 PDSI have supplied the best and latest programs covering all interests Business, Leisure, Engineering, CAD, DTP, Maths, Stats, Chemistry, Education, Electronics, Ham Radio, Esoteric, Medical, Reconstructing, Programming & Languages, Tools, Utilities, WP, Editors, Comics, Special applications, Esoteric, Novelty, Astronomy & hundreds more.  
All software can be provided on floppy disc or CD ROM.  
Whatever your interest we probably have it. Send today for our PC Shareware reference guide. It runs to more than 250,000 words and is probably the most comprehensive catalogue currently available. Send £2.50 (voucher provided refundable on first order) or phone/fax using Access/Visa/MC to:  
PDSI, Wincoburn House, Beacon Rd, Crowborough, East Sussex, TN6 1UL. Tel 01892 663288 Fax 01892 667473

### ASTRA Desk Top Accounting

Overture - Invoicing, Sales, Purchases, Nominal, VAT, etc  
Premier - plus Stock, Jobs, EPIS, Barcodes, Serial No. etc  
Professional - plus Multi-Currency/Debits/Credits, etc

S&S Systems Ltd. Bretton Court, Manor Road, Wales  
Sheffield, S31 8PD, UK. (Software distributors and Apple dealers)  
Tel: (01909) 773899 • Fax: (01909) 773645 • Int Code: (+44) 1909

TURN YOUR SURPLUS TRANSISTORS, ICs ETC INTO CASH immediate settlement.  
We also welcome the opportunity to quote for complete factory clearance

### COLES-HARDING & CO

Unit 58, Queens Road, Walsbech, Cambs PE13 7PQ  
BUYERS OF SURPLUS INVENTORY  
ESTABLISHED OVER 20 YEARS  
Tel: 01945 584188 Fax: 01945 475216

READERS PLEASE NOTE that some telephone dialling codes may recently have changed. If you experience any difficulty in contacting advertisers, ring our advertising department on 01442 66551.

**THIS SPACE COULD BE WORKING FOR YOU!  
FOR DETAILS OF ADVERTISING RATES CALL  
JAMES ON 01442 66551 OR FAX YOUR  
ADVERTISEMENT ON 01442 66998**



## COMPONENTS

EPROMS PLDs + MICRO CONTROLLERS copied or programmed. We supply devices/convert discrete logic to PLDs. PLDs for ETI PC Post Card supplied at £10/P.C.B. £12. PO Box 1561, Bath 0225 444467.

## BOOKS & PUBLICATIONS

### THE BUG CONSTRUCTOR'S MANUAL

All you will ever need to know about Bugs. Over 40 Bug circuits for every application Telephone, High Power, Crystal Controlled and UHF bugs and many pages of useful information. Many previously unavailable circuits. This is the very latest book, and the "ONLY" book of its kind in the UK. A valuable asset for the hobbyist and professional. Introductory offer price only £9.95 inc. P&P. For immediate despatch, send cheque or P.O.'s payable to:

**GAINSFORD ELECTRONICS**  
71 Gainsford Road, Southampton SO19 7AW.

**FAX YOUR ADVERT ON 01442 66998**

## PLANS

**ELECTRONIC PLANS**, laser designs, solar and wind generators, high voltage teslas, surveillance devices, pyrotechnics and computer graphics tablet. 150 projects. For catalogue, SAE to Plancentre Publications, Unit 7, Old Wharf Industrial Estate, Dymock Road, Ledbury, Herefordshire, HR8 2HS.

## PRINTED CIRCUIT BOARDS

PCB's, PROTOTYPES AND PRODUCTION, Artwork copied or raised from your draft designs or schematics. Quoteline 01232 473533 or write to P Agar, 36 Woodcot Avenue, Belfast, BT5 5JA

## COURSES

Start training now with the specialists for the following courses. Send for our brochure — without obligation or Telephone us on 01626 779398 ETI 7/95

Name \_\_\_\_\_  Telecomms  
Tech C&G 2710  
\_\_\_\_\_  Radio Amateur  
Licence C&G  
\_\_\_\_\_  Micro-processor  
\_\_\_\_\_  Introduction to  
Television

Radio & Telecommunications Correspondence School  
12 Moor View Drive, Teignmouth, Devon TQ14 9UN

**READERS PLEASE NOTE** that some telephone dialling codes may recently have changed. If you experience any difficulty in contacting advertisers, ring our advertising department on 01442 66551

TO ADVERTISE FILL IN THE COUPON BELOW. IF YOU DO NOT WISH TO CUT YOUR MAGAZINE PLEASE SEND A PHOTOCOPY



ELECTRONICS TODAY INTERNATIONAL, CLASSIFIED ADVERTISEMENT DEPARTMENT, NEXUS HOUSE, BOUNDARY WAY, HEMEL HEMPSTEAD HP2 7ST

Rates: Lineage 70p per word + VAT minimum 15 words.

Semi-display £9.50 per single column cm plus VAT. No reimbursements for cancellations.

All ads must be pre-paid.

Name .....

Address .....

Daytime Tel. No: .....

Signature ..... Date .....

PLEASE DEBIT MY ACCESS/BARCLAYCARD No.

Expiry Date .....

**FOR SALE      COMPONENTS      PLANS      OTHER – PLEASE STATE**

FOR SALE	COMPONENTS	PLANS	OTHER – PLEASE STATE

# Open Forum

**T**he UK is the world's fourth largest exporter of manufactured goods, the biggest exporter being the US, followed by Germany, with Japan in third place. Indeed, if you look at export figures on a per capita of population basis then the UK is second only to Germany - and then only just. These statistics belie the impression so often given that manufacturing in the UK is dead. Rather, it shows that we are still one of the most important industrial countries in the world.

In inflation adjusted terms, exports have risen 27% during the last three years whilst domestic sales for UK industry have increased by just 6% with the biggest contribution to this rise coming from engineering and, in particular, electrical engineering and electronics. In fact, for the first time exports from the UK engineering industry exceeded, at £71 billion, the UK market for such goods which stood at just £64 billion.

In electronics the export success of the UK is quite staggering. Last year we exported more televisions, personal computers and advanced electronic components such as processor and memory chips, than either Germany, France or Italy. Over half of these exports went to Europe, and the vast majority were not only made in the UK, but designed in the UK.

If we add to these figures the sales of defence electronics, where the UK is one of the world's biggest producers, then we can see that the UK electronics industry is not only alive but thriving. The electronics and computer sector is expanding at an annual rate of about 7%, over twice as fast as the UK economy as a whole and is increasingly gaining world leadership in key sectors.

Expansion in sales, exports and innovation are most rapid in small new companies producing high technology products. These are the companies which are investing heavily in the latest equipment, and modern management techniques which allow the company to both develop new technology and rapidly respond to new developments.

Over the last 20 years, the number of such firms has doubled, it is these firms which have now reversed the enormous decline in manufacturing employment that has taken place over this period. It is businesses like these

which are behind the development of a new culture in manufacturing and engineering.

The Confederation of British Industry has challenged British industry to improve on current export figures by seizing a further one percent of the world market by the year 2000, thus returning the country to the position it held in 1980. This would mean increasing exports by about £90 billion per annum and the number of exporting companies from 100,000, to 130,000 - a difficult task but, given the current rate of increase in exports, not impossible.

Of course, at the moment exporters are benefiting from the low pound as well as pushing the technological and production quality of UK manufactured goods. But in the future, if we are to maintain this trend, companies will need to invest a lot more in research and development as well as the very latest production equipment and techniques.

To aid this, the government are seeking to make business competitiveness the driving force behind the way it funds scientific research, and with government R&D expenditure currently running at about £8 billion per annum, this move could have a major impact. Rather than spreading this money thinly over all areas of research the government, in a recent White Paper, have identified eleven priority areas where R&D expenditure could make a major difference.

These high priority areas include many of interest to the electronics and computer industry, such as: communicating with machines, software engineering for complex tasks, optical technology using light pulses, management and business processing engineering, sensors for measurement and analysis of data, security and privacy technology, remote working and multimedia.

These moves by industry to increase manufacturing, and in particular high technology exports, mean that we have the potential to rebuild the UK's manufacturing sector to compete on a world-beating level.

At ETI we will be doing everything we can to support this trend, to encourage the start-up of new companies, the development of new ideas, and the use of technology and human ingenuity to create a better world for all.



## EDITORIAL

Editor **Nick Hampshire**  
Sub Editor **Eamonn Percival**  
Editorial Assistant **Wendy Butler**

## CREATIVE

Designer **Nadia Ahdout**  
Technical Illustration **John Puczynski**  
Photography **Manny Cefai**

## ADVERTISEMENT SALES

Display Sales  
**James Gale**  
Advertisement Copy Control  
**Marie Quilter**

## MANAGEMENT

Managing Director  
**Terry Pattison**  
Circulation & Promotions Manager  
**Debra Stupple**  
Production Manager  
**Tony Dowdeswell**  
Group Editor  
**Stuart Cooke**  
Group Advertisement Manager  
**Claire Jenkinson**



ETI is normally published on the first Friday in the month preceding the cover date. The contents of this publication including all articles, plans, drawings and programs and all copyright and all other intellectual property rights therein belong to Nexus Special Interests. All rights conferred by the Law of Copyright and other intellectual property rights and by virtue of international copyright conventions are specifically reserved to Nexus Special Interests and reproduction requires the prior written consent of the company c1990 Nexus Special Interests. All reasonable care is taken in the preparation of the magazine contents, but the publishers cannot be held legally responsible for errors. Where mistakes do occur, a correction will normally be published as soon as possible afterwards. All prices and data contained in advertisements are accepted by us in good faith as correct at the time of going to press. Neither the advertisers nor the publishers can be held responsible, however, for any variations affecting price or availability which may occur after the publication has closed for press.

Subscription rates-UK £25.80 Europe £34.70 Sterling Overseas £36.20 US Dollars Overseas \$54.00

Published by Nexus Special Interests, Nexus House, Boundary Way, Hemel Hempstead HP2 7ST. Telephone (01442) 66551. UK newstrade distribution by SM Distribution Ltd, 6 Leigham Court Road, London SW16 2PG. Telephone 0181-667 8111. Overseas and non-newstrade sales by Magazine Sales Department, Argus House, Boundary Way, Hemel Hempstead, HP2 7ST. Telephone (01442) 66551. Subscriptions by Nexus Subscription Services, ETI, Queensway House, 2 Queensway, Redhill, Surrey RH1 1QS. Telephone (01737) 768611. US subscriptions by Wise Owl Worldwide Publications, 4314 West 238th Street, Torrance, CA90505 USA. For Visa/Mastercard orders in USA - Telephone (310) 375 6258 Fax (310) 375 0548. Pacific Time: 9am-9pm Weekdays. 10am-6pm Weekends. Typesetting and origination by Ebony, Liskeard, Cornwall. Printed by Wiltshire Ltd, Bristol.



Nexus House, Boundary Way,  
Hemel Hempstead HP2 7ST  
Telephone (01442) 66551  
Fax (01442) 66998

## Next Month...

In the September 1995 issue of Electronics Today International we will be featuring an interesting range of new projects. Dr Pei An shows how to build a computerised radio digital transmission system that will link up to 255 computers and could form the heart of some interesting wireless networking projects. From Robert Penfold there is a fibre-optic MIDI link project, and from Bob Noyes a message board display system.

Richard Grodzik will continue his project on the construction of an 8088 interrupt based control computer, whilst Bart Trepak is continuing his series on a practical approach to designing with the PIC microcontroller and his quest for the perfect alarm clock. Roland Oliver will show how he used the Parallax Stamp computer as the heart of a serial relay controller.

The two feature articles in next month's ETI are a detailed look by Dave Clarkeson at the Ariane 5 rocket due to be tested this autumn and which will give the European Space Agency the lift capability for manned space flight. Nick Hampshire will also be taking a look at some world leading technology which is revolutionising the familiar London black cab.

# MIXED-MODE SIMULATION. THE POWER OF VERSION 4.

New  
Version 4

## Analog, Digital & Mixed Circuits

Electronics Workbench<sup>®</sup> Version 4 is a fully integrated schematic capture, simulator and graphical waveform generator. It is simple to mix analog and digital parts in any combination.

## Design and Verify Circuits... Fast!

Electronics Workbench's simple, direct interface helps you build circuits in a fraction of the time. Try 'what if' scenarios and fine tune your designs painlessly.

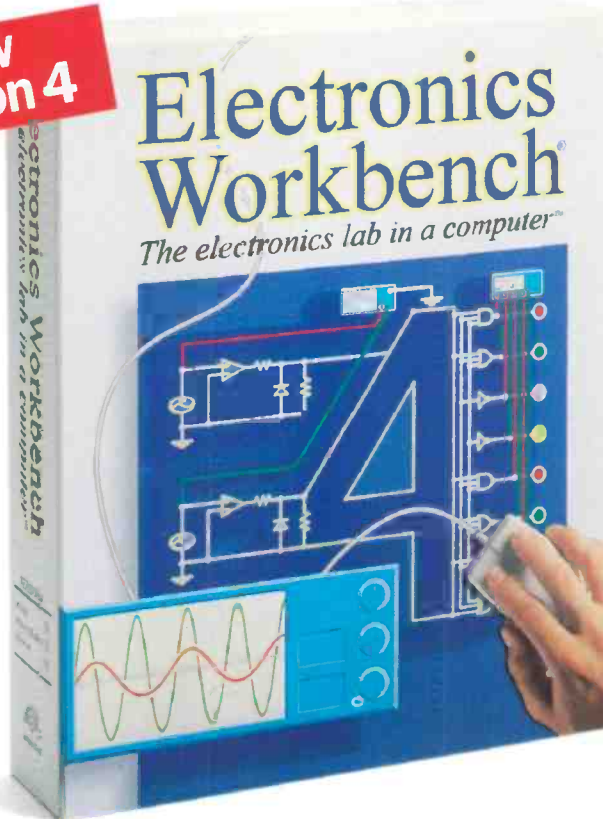

## More Power

Simulate bigger and more complex circuits. Faster. On average, Electronics Workbench Version 4 is more than 5 times faster than Version 3.

## More Parts

Multiple parts bins contain over twice the components of Version 3.

## More Models

Over 350 real world analog and digital models are included free with Electronics Workbench. And, if you need more, an additional 2,000 models are available.

## Incredibly Powerful. Incredibly Affordable.

If you need mixed-mode power at a price you can afford, take a look at this simulator and graphical waveform generator that mixes analog and digital with ease.

With over 20,000 users world-wide, Electronics Workbench has already been tried, tested and accepted as an invaluable tool to design and verify analog and digital circuits. With Version 4 true mixed-mode simulation is now a reality with incredible simplicity.

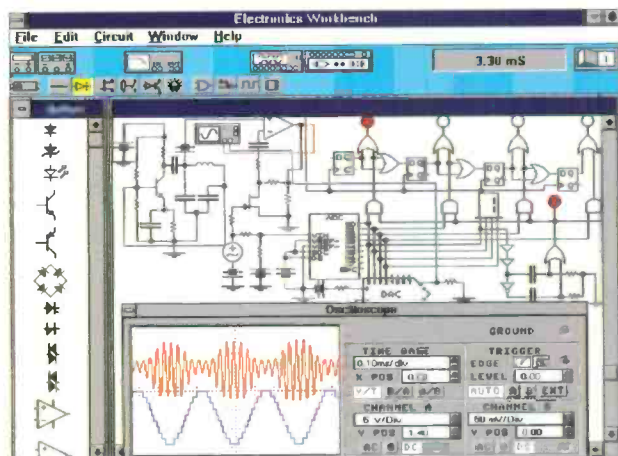

True mixed-mode simulation: Simultaneous AM transmission, digitization and pulse-code modulation of a signal.

## Electronics Workbench<sup>™</sup>

The electronics lab in a computer<sup>™</sup>

Order Now! Just £199\*

# 44-(0)1203-233-216

## RM Robnson Marshall (Europe) Plc

Nadella Building, Progress Close,  
Leofric Business Park,  
Coventry, Warwickshire CV3 2TF  
Fax: 44 (0)1203 233-210  
E-mail: [rme@cityscape.co.uk](mailto:rme@cityscape.co.uk)

Shipping charges UK £5.99. All prices are plus VAT.  
All trade marks are the property of their respective owners.  
Electronics Workbench is a trademark of Interactive Image  
Technologies Ltd., Toronto, Canada.  
\* 30 Day money-back guarantee.



Australia: 2-519-3933 • Brazil: 11-453-5588 • Cyprus: 2-62-1068 • Denmark: 33-25-0017 • Finland: 0-297-5033 • France: 14-908-9000 • Germany: 711-62-7740 • Greece: 1-524-9981  
Hungary: 1-215-0082 • India: 11-5441343 • Israel: 3-647-5613 • Italy: 11-437-5549 • Japan: 3-3382-3136 • Malaysia: 603-7778945 • Mexico: 5-396-3075 • Netherlands: 18-031-7666  
New Zealand: 9-267-1756 • Norway: 22-16-70-45 • Portugal: 1-814-6609 • Singapore: 462-0006 • Slovenia: 61-317-830 • South Africa: 331-68309 • South Korea: 2-2-222-3431  
Spain: 1-553-3234 • Sri Lanka: 1-86-5970 • Sweden: 8-740-5500 • Thailand: 66-2-398-6952 • United Kingdom: 203-23-3216



**NEW**

**FULL COLOUR GUIDE TO ELECTRONIC PRODUCTS**

Sept 1994–Aug 1995

# Maplin

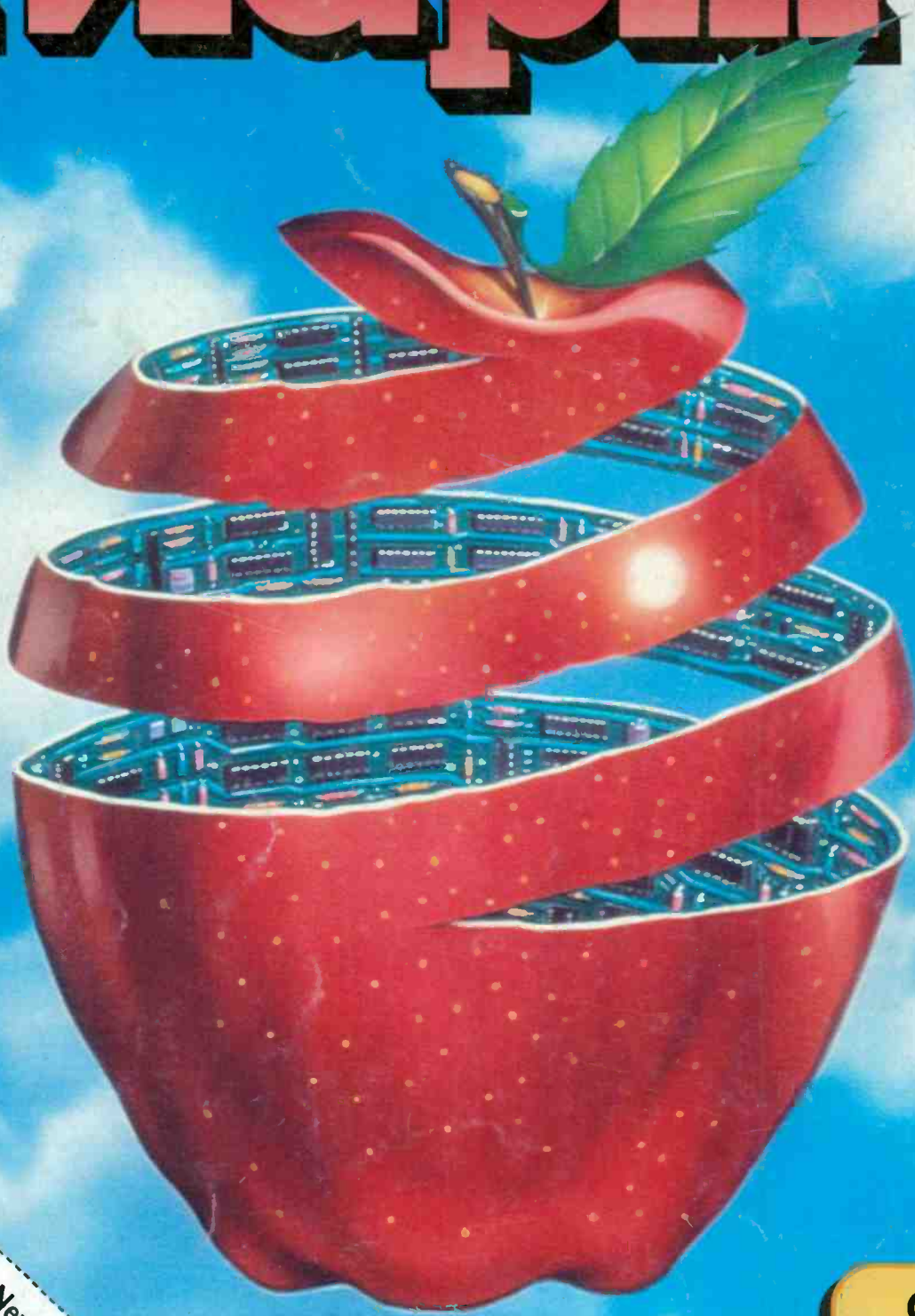

BS 5750  
Part 2 1987

Level B:  
Quality Assurance  
RS12750

**Order your copy of the New MAPLIN Catalogue on sale NOW!**  
Pick up a copy from any branch of WHSMITH, branches of John Menzies in Scotland ONLY, Eason & Son in N. Ireland ONLY, and Maplin stores nationwide for just £3.45 inc. p&p. If you live outside the U.K. send £7.30 or 18 IRCs to receive your copy for just £3.95 inc. p&p. If you live outside the U.K. send £7.30 or 18 IRCs for Airmail, in Europe (including Republic of Ireland): £6.50 or 16 IRCs for surface mail outside Europe; or £12.30 or 30 IRCs for Airmail outside Europe. I enclose £3.95/£7.30/£6.50/£12.30 (delete as applicable).

Name .....  
Address .....  
Post Code .....

Send to Maplin Electronics,  
P.O. Box 3, Royleigh,  
Essex, England  
SS6 8LR  
0795

Over 800 colour packed pages  
with hundreds of Brand New  
Products at Super Low Prices.

**CUT OF  
THIS WORLD  
ONLY  
£3.45**

Available from all branches of WHSMITH, John Menzies in Scotland ONLY, Eason & Son in N. Ireland ONLY, and Maplin stores nationwide. The Maplin Electronics 1995 Catalogue – **OUT OF THIS WORLD!**