



ELECTRONICS
TODAY INTERNATIONAL

*TOMORROW'S
TECHNOLOGY TODAY*

**WIN
SOME GREAT ETI
COMPETITION PRIZES!**

GOODBYE MONEY HELLO SMARTCARD

**HOW ELECTRONICS
WILL REPLACE THE
CASH IN YOUR
POCKET**

**KILLJOY
stop your kids
playing endless
computer games**

**HOW TO MAKE
AN RS232
Breakout box**

**NEW
SERIES**

**BEGINNERS
SECTION
Build a handy
logic probe**

**BUILD A MIDI
BASS PEDAL
UNIT**

**Protect your
valuables with
a versatile
loop alarm**

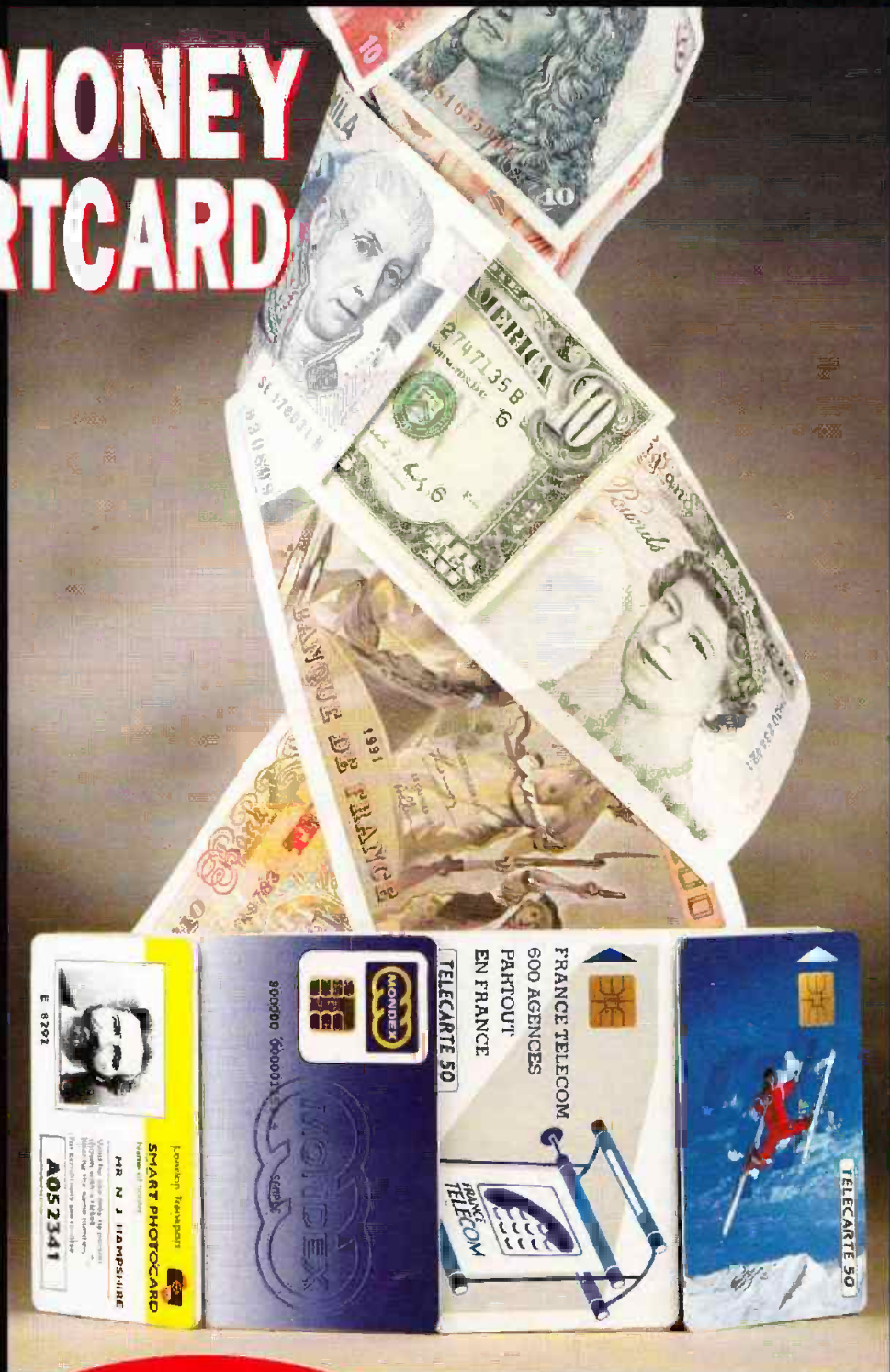

**P.C. CLINIC
EXAMINES THE
MOTHERBOARD**

July 1994 £2.15

9 770142 722054 07 > **asp**
PUBLICATIONS

At last, a fully functional upgradeable PCB CAD system to suit any budget. Substantial trade-in discounts are available against other "professional" PCB design packages ...

... call now for details.

Board Capture

Schematic Capture Design Tool

£395

- Direct netlist link to BoardMaker2
- Forward annotation with part values
- Full undo/redo facility (50 operations)
- Single-sheet, multi-paged and hierarchical designs
- Smooth scrolling
- Intelligent wires (automatic junctions)
- Dynamic connectivity information
- Automatic on-line annotation
- Integrated on-the-fly library editor
- Context sensitive editing
- Extensive component-based power control
- Back annotation from BoardMaker2

Board Maker

BoardMaker1 - Entry level

£95

- PCB and schematic drafting
- Easy and intuitive to use
- Surface mount and metric support
- 90, 45 and curved track corners
- Ground plane fill
- Copper highlight and clearance checking

BoardMaker2 - Advanced level

£295

- All the features of BoardMaker1 +
- Full netlist support - BoardCapture, OrCad, Schema, Tango, CadStar and others
- Full Design Rule Checking both mechanical and electrical
- Top down modification from the schematic
- Component renumber with back annotation
- Report generator - Database ASCII, BOM
- Thermal power plane support with full DRC

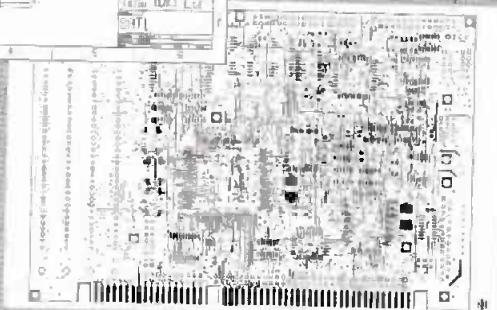
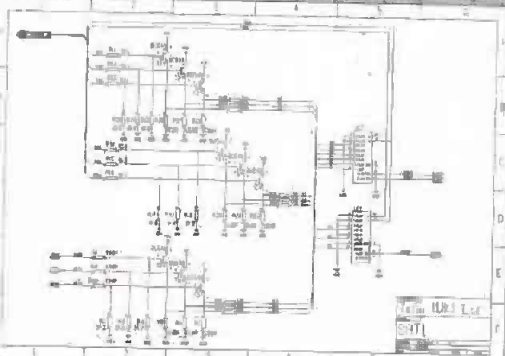

NEW

Board Router

Gridless re-entrant autorouter

- Simultaneous multi-layer routing
- SMD and analogue support
- Full interrupt, resume, pan and zoom while routing

£200

Output drivers - Included as standard

- Printers - 9 & 24 pin Dot matrix, HPLaserjet and PostScript
- Penplotters - HP, Graphtec & Houston
- Photoplotters - All Gerber 3X00 and 4X00
- Excellon NC Drill and Annotated drill drawings (BM2)

Call, write or fax for more information
or a full evaluation kit

Tsien (UK) Limited

Aylesby House

Wenny Road, Chatteris

Cambridge

PE16 6UT

Tel (0354) 695959

Fax (0354) 695957

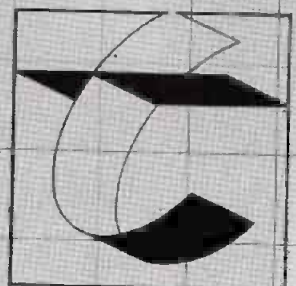

tsien



Contents



Volume 23 No.7

& Features Projects

Goodbye Money Hello Smartcard 12

We take a look at the latest developments in smartcard technology, what is inside the new generation of cards and how they are being used to replace the cash in your pocket.

An RS232 Break Out Box 18

Solve all those tricky problems associated with serial communications between computers and peripherals using this handy little device

The Experimenter's Computer 24

Adding a keypad and display. We conclude our series on the experimenters FORTH computer as developer Jim Spence shows how to add a versatile keypad to the basic system.

Killjoy 29

Bob Noyes shows how to build a timer system which will stop your children ruining their eyes by playing computer games for hours on end.

PC Clinic 35

Part 2 of our new regular series which show readers how to repair, maintain, upgrade and build circuits for personal computers.

In this issue, we look at the motherboard and the power supply.



Loop Alarm 45

This type of anti theft alarm is frequently encountered in shops, but can be just as useful in your home or on your caravan or boat. Terry Balbyrnie shows how to build this type of alarm.

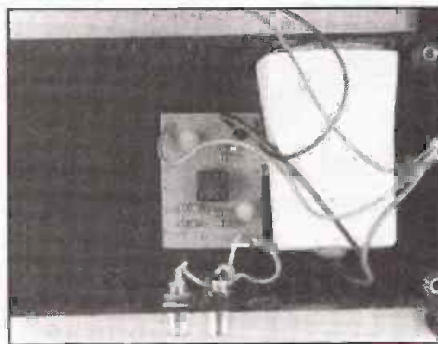

Basic Circuits 50

We begin a new series of simple circuits that can be built by anyone with a rudimentary knowledge of electronics and basic assembly skills. In this issue we show how to build a useful logic probe that can be used to test the behaviour of other circuits



SUBSCRIPTION & BACK ISSUES HOTLINE 0737 768611

Subscribe & Save
Phone the hotline and take advantage of our special offer detailed on page 61

Sending Your Data By Laser Beam 56

Ken Gill concludes his project to send data between two sites using an infra-red light beam.

An Introduction to MIDI 62

In Part 2 of this series Robert Penfold gives readers an introduction to MIDI, the now universally accepted standard for communications between electronic musical instruments.

Regulars

News and event diary 6

Talkback 54

Your letters, and ideas, plus club news.

Practically speaking 68

A new series in which Terry Balbyrnie divulges some practical hints and tips for the electronics enthusiast.

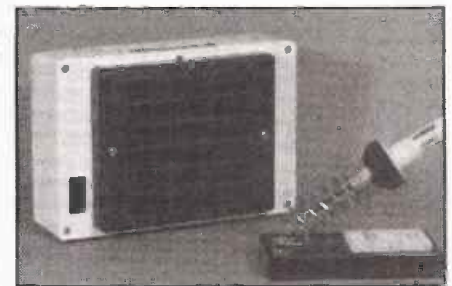

PCB foils 70

Open Forum 74

Competition 44

In this issue of ETI we have another great competition for readers to enter. Win a Fox alarm system to protect your home or business.

Low cost data acquisition for IBM PCs & compatibles

A unique range of easy to use data acquisition products designed for use with IBM compatible computers. Combined with the software they allow your PC to be used as a host of useful test and measurement instruments, or as an advanced data logger.

Installed in seconds they simply plug into the parallel port (except the ADC-16 which connects to the serial port). They are self-contained, require no power supply and take up no expansion slots.

Each device comes with a comprehensive manual. C, Pascal and Basic drivers are included for users who wish to write their own software. Software supplied on 3.5" disk.

PicoScope

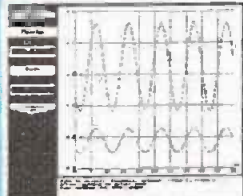

Scope, voltmeter, spectrum analyser

"Virtual instrument" software package. Storage oscilloscope with trigger, timebase, rulers and offset functions. Realtime spectrum analysis with min/max frequency and signal averaging. Multiple meters on screen (digital and bargraph).

Printer and file handling support

PicoLog

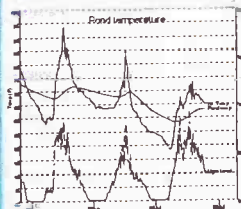

Advanced data logging software package

Collect, store, display and print data from 1 sample per ms to 1 per day. Record average, min/max values or scaled values (linear, equation, table look up). Report types: monitor (with min/max alarms), y-t graphs, x-y graphs, tabulation.

NEW ADC 100 Virtual Instrument Dual Channel 12-bit resolution

The ADC 100 offers both a high sampling rate (100kHz) and a high resolution. It is ideal as a general purpose test instrument either in the lab or in the field. Flexible input ranges ($\pm 200\text{mV}$ to $\pm 20\text{V}$) allows the unit to connect directly to low output sensors such as microphones or to high level signals ($\pm 200\text{V}$ with a x10 scope probe).



NEW from PICO

- Digital Storage Scope
- Spectrum Analyser
- Voltmeter
- Frequency Meter
- Chart Recorder
- Data Logger

ADC 100 with PicoScope £199
PicoScope & PicoLog £209

ADC 10

1 Channel 8-bit

- Lowest cost
- Up to 22kHz sampling
- 0-5V input range

The ADC 10 gives your computer a single channel of analogue input. Simply plug into the parallel port and your ready to go.

ADC 10 with PicoScope £49
PicoScope and PicoLog £59

ADC 11

11 Channel 10-bit

- Digital output
- Up to 18kHz sampling
- 0-2.5V input range

The ADC 11 provides 11 channels of analogue input in a case slightly larger than a matchbox. It is ideal for portable data logging using a "notebook" computer.

ADC 11 with PicoScope £85
PicoScope and PicoLog £95

ADC 12

1 Channel 12-bit

- High resolution
- Up to 17kHz sampling
- 0-5V input range

The ADC 12 is similar to the ADC 10 but offers an improved 12-bit (1 part in 4096) resolution compared to the ADC 10's 8-bit (1 part in 256).

ADC 12 with PicoScope £85
PicoScope and PicoLog £95

ADC 16

8 Channel 16-bit + sign

- Highest resolution
- 220Hz sampling
- 2Hz sampling - 16-bit

The ADC 16 has the highest resolution of the range, it is capable of detecting signal changes as small as $40\mu\text{V}$. Pairs of input channels can be used differentially to reject noise. Connects to serial port.

ADC 16 with PicoLog £109

PicoLog for ADC 10/11/12 £25. Oscilloscope Probes (x1, x10) £10. Carriage UK free. Overseas £8



Pico Technology Ltd., Broadway House, 149-151 St Neots Road, Hardwick, Cambridge. CB3 7QJ.

TEL: 0954-211716 FAX: 0954-211880



Phone or FAX for sales, ordering information, data sheets, technical support. All prices exclusive of VAT.

PICO TECHNOLOGY

EASY-PC, Schematic and PCB CAD

Over 18,000 Installations
in 80 Countries World-wide!

Still
Only
£98.00!

Plus P&P+VAT

BRITISH
DESIGN
AWARD
1989

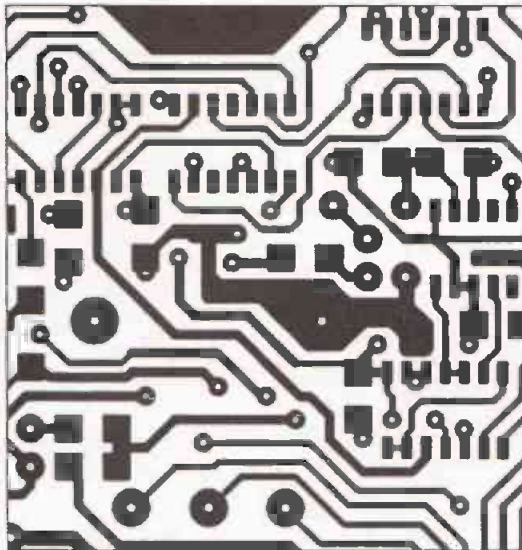

- Runs on:- PC/XT/AT/286/386/486 with Hercules, CGA, EGA or VGA display and many DOS emulations.
- Design:- Single sided, Double sided and Multi-layer (8) boards.
- Provides full Surface Mount support.
- Standard output includes Dot Matrix / Laser / Ink-jet Printer, Pen Plotter, Photo-plotter and N.C. Drill.
- Tech Support - free.
- Superbly easy to use.

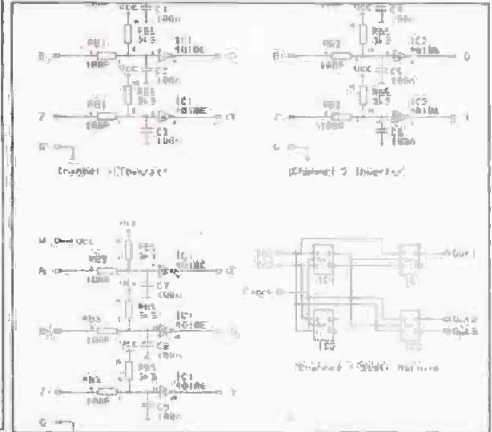

Options:-500 piece Surface Mount Symbol Library £48,
1000 piece Symbol Library £38, Gerber Import facility £98.

Electronic Designs Right First Time?

Integrated Electronics CAD

Affordable Electronics CAD



Schematic Capture



Analogue
& Digital
Simulation



And PCB Design

Prices from UK£195 / US\$375

EASY-PC: Entry level PCB and Schematic CAD.	\$195.00	£98.00
EASY-PC Professional: Schematic Capture and PCB CAD. Links directly to ANALYSER III and PULSAR.	\$375.00	£195.00
PULSAR: Digital Circuit Simulator ~ 1500 gate capacity.	\$195.00	£98.00
PULSAR Professional: Digital Circuit Simulator ~ 50,000 gate capacity.	\$375.00	£195.00
ANALYSER III: Linear Analogue Circuit Simulator ~ 130 node capability.	\$195.00	£98.00
ANALYSER III Professional: Linear Analogue Circuit Simulator ~ 750 node capability.	\$375.00	£195.00
Z-MATCH for Windows: NEW Windows based Smith-Chart program for RF Engineers.	\$475.00	£245.00
FILTECH: Active and Passive Filter Design program.	\$275.00	£145.00

We operate a no penalty upgrade policy. You can upgrade at any time to the professional version of a program just for the difference in price.

US\$ prices include Post and Packing

UK£ prices exclude P&P and VAT

For full information, please write, phone or fax:-

Number One Systems

UK/EEC: Ref. ETI, HARDING WAY, ST.IVES, CAMBS., ENGLAND, PE17 4WR.

Telephone UK: 0480 461778 (7 lines) Fax: 0480 494042 International +44 480 461778

USA: Ref. ETI, 1795 Granger Avenue, Los Altos, CA 94024

Telephone/Fax: (415) 968 9306

- TECHNICAL SUPPORT FREE FOR LIFE
- PROGRAMS NOT COPY PROTECTED.
- SPECIAL PRICES FOR EDUCATION.

ACCESS, MASTERCARD, VISA Welcome.



**ELECTRONICS
TODAY INTERNATIONAL**

News...

Save money with *ETI* and Number One Systems Price Breakers Card

On the front cover of this issue you should find a special discount card which can be used to obtain a 15% discount on Number One Systems' own range of popular, affordable and yet sophisticated computer aided electronic design and simulation software.

This card is valid only when purchasing full copies of Number One Systems OWN software products (for Educational Licences, the discount is valid for the first copy only - subsequent copies will be charged at Number One Systems standard Educational multi-user Licence rates).

This card has no cash value and cannot be used in conjunction with any other promotion. To use the discount card, send it together with your order to Number One Systems before 15/7/94, the closing date for this offer.

For more details of the company's product range, see Number One Systems advert on page 5 of this issue, or contact Number One Systems on 0480 461778.

New voice recognition and synthesis module

Colorado based Dovatron International has launched a miniature voice recognition and synthesis module which has been specifically designed for developers who require off the shelf PC compatible computing solutions in space and/or power constrained applications. Using the latest in surface mount technology and often populating both sides of the printed circuit board, Dovatron has miniaturised the products whilst retaining full PC functionality, particularly important if it is used with the miniature PC/AT products also produced by Dovatron.

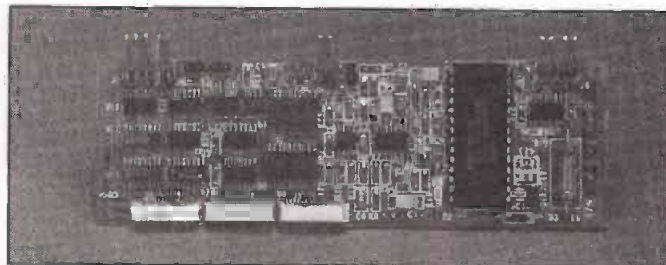

The voice recognition and synthesis module was developed by Voice Connexion of Irvine CA and offers voice input and output by providing 500 word recognition per 64K of RAM, with better than 98% accuracy and unlimited text to speech synthesis. This system provides a natural means of operator/computer communications, reduces software training time by learning functions, not keystrokes. It also allows data entry without keying in data and permits real time editing of entries. It provides an efficient hands free method of computer input and control.

For further information, contact Dovatron International of Longmont Colorado USA on 0101 303 772 5933.

Solar power in a rainy climate

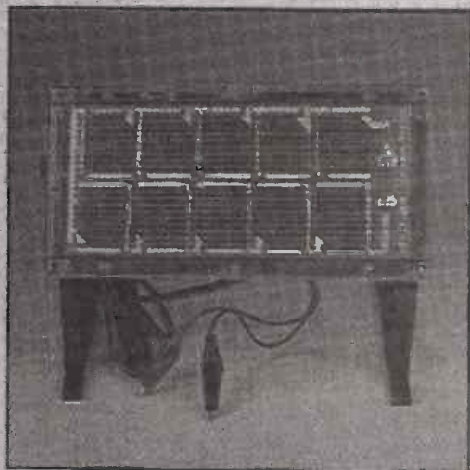

A new range of waterproof and corrosion resistant solar panels for outdoor use has been launched by Maplin Electronics. The panels are weatherproof and resistant to wind, rain, humidity, snow, ice, sand, salt air and deterioration by ultra-violet light. As such they are ideal for use in a wide range of recreational activities, including boats, cars, tents and motor homes, and are capable of powering portable TVs, radios, tape players, etc.

The panels come in four sizes, ranging from a 3V 120mA panel at £9.95, to a 12V, 120mA panel at £34.94. They are intended to be used as battery chargers and lead acid battery trickle chargers. A reverse blocking diode is built-in to prevent battery discharge and protect the panel cells. A tilt stand, made up from supplied parts, can be assembled and mounted on a vertical or horizontal surface, or be free standing, to catch the sun. Each panel is provided with red and black leads terminated in either insulated crocodile clips or car battery style clamps.

For further information contact Maplin Electronics of Rayleigh, Essex, on 0702 554161.

Remote data acquisition and control modules

IMS has announced a new range of intelligent sensor to computer interfaces, ideal for remote data acquisition and control. Supervised by a host computer over an RS232/485 network, the modules, with their own built in micro-processors, are able to monitor and control processes autonomously.

The ADAM range includes 14 analogue input types (including mV, mA,



Volts, Thermocouple), analogue output, digital I/O, relay switching and RS-485 repeater, as well as an RS232/RS485 isolated converter module. These modules communicate with the host

computer via a two wire RS485 multi-drop network using an ASCII command/response protocol. Up to 256 modules may be networked together by using repeater modules, each supporting 16 modules up to 4,000ft apart.

All ADAM modules are fully configurable by software, are contained in hardened plastic shells and are easily assembled into systems. They are designed to accommodate unregulated power supplies of between +10 and +30V DC.

For further details contact Integrated Measurement Systems Ltd., on 0703 771143

Postcard sized low cost multi-tasking

The application potential of Cambridge based MicroRobotics' award winning multi-tasking embedded controller, the Scorpion K4, is widened considerably with the release of a new plug on I/O application module which provides a comprehensive range of analogue and digital I/O facilities, enough to provide a ready to use hardware environment for many typical machine control and automation projects. With the aid of the K4's built-in language, control systems can be developed quickly and easily.

The new I/O facilities on offer include two uncommitted relay outputs capable of switching 3A/240V, four digital 2A/240V outputs and four universal digital inputs. Analogue I/O comprises four 8-bit inputs and one 8-bit output with selectable voltage ranges. Also included are two channels of serial I/O, one of which can optionally be configured for RS485/422 levels, plus two general purpose expansion interfaces, a dedicated I2C serial port, and an 8 bit bus, suitable for LCD panel, keypad, etc.

This versatile controller board measures just 4.5 x 7in and is based on the Hitachi 63C03 processor, with on board EPROM holding the programming language. In one off quantity it costs £250. For further details contact MicroRobotics on 0223 323100.

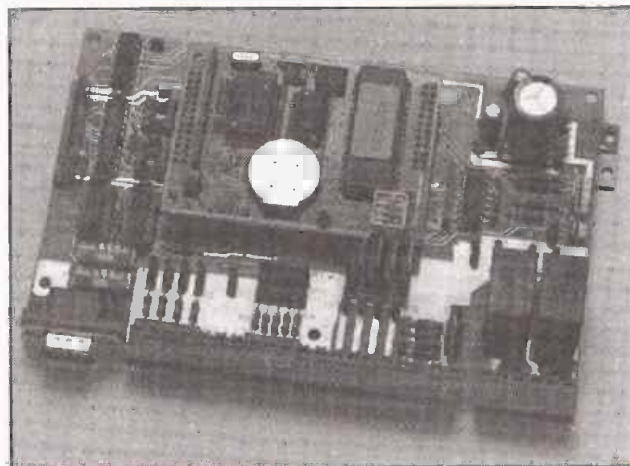

76 piece tool set

A new high quality 76 piece socket and wrench tool set is available from Maplin Electronics. It contains a comprehensive range of tools, making it ideal for the DIY motorist and for general maintenance and servicing of any mechanical equipment, whether in the field or in the workshop. This is the ideal kit for keeping in the car, since it is supplied in an extremely tough moulded plastic carrying case.

The tools are all manufactured in high quality chrome vanadium steel and bright chrome plating, the set contains eight combination spanners, five screwdrivers, one pair of universal pliers, one pair self-locking pliers, one crimping tool and a box of terminals, one hammer, six hexagonal keys in a holder, one thickness gauge, one low voltage tester and one battery terminal brush.

The set also includes a 1/2in. square drive socket set that contains 13 sockets, a ratchet handle, a sliding T-bar, two extension bars, a universal joint and a spark plug socket.

The complete kit in its case costs £38.95. For further information contact Maplin Electronics of Rayleigh Essex, on 0702 554161.

14 Bit modular data acquisition card

From Southampton based Integrated Measurement Systems Ltd. comes a new multi-function data acquisition card, the PCL814B. This card has been designed specifically for users who require a combination of high speed, high accuracy and high resolution in a PC environment.

The 814B's core high performance A/D module offers 16 channels of differential analogue signal measurement at 14-Bit resolution and 100kHz sampling rate. The card's specially designed analogue circuitry offers breakthrough noise rejection capabilities. Its modular design makes it easy to tailor to specific applications. In addition to its on-board 16 bit digital I/O, the card has two 64 pin piggy-back connectors which allow any combination of I/O modules to be added. These include a two channel 16 bit or 12 bit D/A module, a five channel 16 bit up/down counter timer module, or a 24 bit Intel 8255 digital I/O module.

For further details, contact Integrated Measurement Systems Ltd on 0703 771143

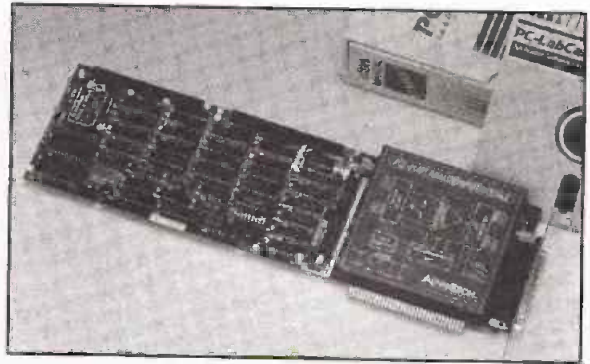

Top range scope at an economy price

Maplin Electronics has just added a new 20MHz 2 channel Digital Storage Oscilloscope to its range of test equipment. This scope, the OS3020, is a dual trace unit with digital storage capability for 'freezing' and continuously displaying fast,



complex or non repeatable frequencies. This is a useful function for digitising and observing high speed repetitive signals. In this method, one data item is sampled for every high speed sweep and the sampling point is shifted to the right with every sweep. Sampling is performed 1024 times, so that high frequencies can be digitised, even up to 20MHz.

The main features include a maximum two channel simultaneous sampling rate of 20ms/s, digitised 20MHz repetitive signal in equivalent modes, one-touch switching between real and storage modes, two save memories and pre-triggering, enabling observation of the waveform portions before the trigger point. There is direct copy of screen display using HPGL commands with RS232C interface, while roll mode provides continuous observation of slow waveforms. Averaging functions provide summation averaging of up to 256 times and the magnification function simplifies detailed waveform observation.

The OS3020 costs £749.95. For further information contact Maplin Electronics of Rayleigh, Essex, on 0702 554161.

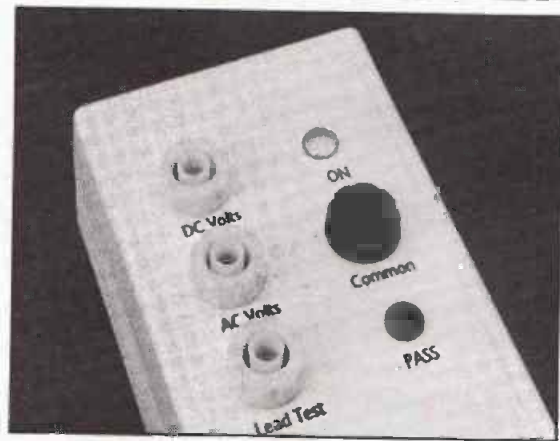

Multimeter check

A new proving unit for checking the basic functions of both analogue and digital multimeters is now available from Manchester based Alpha Electronics. The battery powered hand held unit will verify the basic AC and DC voltage operation of any meter as well as providing a means of checking the continuity of test leads and integral fuses. The unit generates an output voltage of either 205 or 220V from both the AC and DC test sockets. The test voltage is indicated by an amber light while a green light shows the lead test to have been good or bad.

This useful low cost tool is priced at £49 and further details are available from Alpha Electronics Plc, on 0942 873434.

... ..Event diary... ..

- 6 June D-Day Commemoration Display with working transmitters and receivers from the war. Wireless Museum, Puckpool Park, Seaview, near Ryde, Isle of Wight. Tel: 0983 567665.
- 7 June Using Integrated Circuits. Sudbury and District Radio Amateurs. Tel: 0787 313212.
- 8 June Junk Sale. Lincoln short Wave Radio Club, Lincoln. Tel: 0427 788356.
- 14-16 June Multimedia 1994. Earls Court, London. Tel: 071 742 2828.
- 15 June Walking Treasure Hunt. Lincoln Short Wave Radio Club, Lincoln. Tel: 0427 788356.
- 18 June Electromagnetic Compatibility. Crystal Palace and District Radio Club, All Saints Parish Church Rooms, Beulah Hill. Tel: 081 699 5732.
- 19 June Special Event Station at Great Cornard Middle School, Sudbury and District Radio Amateurs. Tel: 0787 313212.
- 27-29 June 5th Satellite Systems for Mobile Communications and Navigation Conference. IEEE London. Tel: 071 240 1871
- 20 June Electrotech, NEC Birmingham. Tel: 0483 222888.
- 25 June Special Event Station in Halstead, Sudbury and District Radio Amateurs. Tel: 0787 313212
- 13 Nov. Midland Amateur Radio Society rally at Stockland Green Leisure Centre, Slade Road, Erdington, Birmingham. Doors open at 10am, admission £1. For further details ring 021 422 9787 or 021 443 1189 (evenings only).

Windows based real time data analysis

The new SciTech Hydra-Digis system is a Windows 3 based multi-processor, data acquisition and control system. It takes the user from graphical system description, through data capture, real time analysis and display to generating complete results documentation. Thus, the system could carry out a complex 024 point FFT to floating point precision at a 5kHz real time rate (gap-free). This compares favourably with dedicated FFT analysers which typically provide a real time rate of only 2kHz.

The base hardware configuration consists of one Hydra PC card providing 16 analogue inputs, two analogue outputs, 16 digital inputs, 16 digital outputs, a trigger unit and a T805 25MHz Transputer. This configuration is controlled by Hydra-Digis software with post capture analysis and documentation by DIA-PC, the whole system running on a 486/ Pentium PC with Windows 3x.



The measurement and analysis process is designed graphically using a mouse to connect function blocks (icons), selected from a library. The library includes standard functions such as data capture, real time engineering unit conversions, PID control, time and frequency analysis functions, plus display options. Users can add their own functions written in C code.

The Hydra-Digis software generates the transputer object code automatically from the block diagram without compilation and downloads to the Hydra board, thereby freeing the PC for user interface functions. It is unnecessary for the user to write any code or have any knowledge of transputers.

For further information on this very sophisticated real time data acquisition and analysis, contact SciTech of Reading on 0734 758857.



Precision crimping tool

Crimping is a widely used method of connecting wires and cables to a whole range of different connectors, but the wide number of different types of crimp can cause a problem. To overcome this problem, Ideal Industries has introduced a new range of crimping tools.

The company has six ratchet crimp tools with a total of 45 interchangeable standard dies. The tools can be used with insulated terminal, non-insulated terminal, BNC/TNC coax, F-type connector and telephone plug applications. The tool's ratchet crimp action ensures a precise crimp time after time, to meet or exceed industry specifications. Interchangeable die sets are made from high grade carbon steel and have marked nests for easy and accurate selection. They can be changed quickly with any screwdriver.

For further details contact Ideal Industries (UK) Ltd., of Warrington, on 0925 444446

Young Electronic Designer Awards 1994.



At the end of March, an award ceremony was held at the Science Museum in London to select from about fifty finalists three Young Electronic Designers of the Year, one from the under 15 age group, one from those between 15 and 17 and one from the group aged 18 to 25. Entrants for the award, which is sponsored by Texas Instruments and Mercury Communications, came from schools and colleges all over the country and the finalists had already gone through a rigorous selection process.

Entrants were judged on the quality and originality of a project submitted by them, and on how well it had been conceived and designed. Also under consideration was the research which had been conducted into the end user's requirements, the objects' ease of use, and the thought which had been given to manufacturing it easily and cheaply, as well as the flexibility of the design with respect to future enhancements.

The overall quality of the entries of all the finalists was outstanding (the editor of ETI would have given them all a prize). Over the next few months in ETI we will be introducing a few of the finalists, as well as the prize winners and describing their designs. We hope that this will encourage other young readers to follow their example and perhaps become a finalist or award winner in next year's Awards.

We will start by looking at a couple of the youngest entrants, Alys Paterson and Rebecca Salmen, from the King Edward VII School in Sheffield. In their own words, the following is a description of their project.

"We wanted a project that would be quite different to those which we had already done in our design technology lessons. We wanted to solve a real life need in a real life way and design something which would change the lives of those for whom we were designing, just like a professional designer. One of our ideas was to help other people less fortunate than ourselves and so we talked to parents and visited two schools for handicapped children in Sheffield.

Something which attracted our attention at Tapeton Mount School, Sheffield, was the way in which the children played board games, in particular snakes and ladders. As we watched the children play, the dice kept falling off the table and getting lost on the carpet. Obviously, this presented the handicapped children with a difficult problem and significantly interrupted their game!

On returning to school we brainstormed the problem and came up with many interesting ideas from which two solutions were adopted - a large illuminated dice and an illuminated spinning dice. We built a simple prototype of the spinning dice and returned to Tapton school many times over the following months to test and refine our design.

The design is quite simple, therefore robust and easy and cheap to make. It consists of reed switches mounted on a plastic platform and a rotating wooden arm that could easily be spun by a handicapped child, and which has a magnet attached to one end. As the arm is spun the magnet opens and closes the reed switches which in turn activates a display of high intensity LEDs. These LEDs were organised in six columns with between one and six LEDs in each column. When the arm comes to rest one of the six columns of LEDs remains lit and the number of LEDs corresponds to the number of dots on the dice.

We have built designed and manufactured both the electronics, the plastic case and the rotating arm. We are now further testing the design prior to supplying Tapton Mount school with their own number spinner."

Next month we will look at a physiotherapy aid designed and developed by 19 year old Samantha Haines, winner of the Mercury 'Planet' Award for the most socially or environmentally aware project.

SEALED LEAD ACID Battery, 6v 80/100 AH made for BT, ex equipment but ok £45 each ref APR47. Ideal electric vehicle etc. **ASTEC SWITCHED MODE PSU** Gives +5 @ 3.75A, +12 @ 1.5A, -12 @ 4A. 230/110, cased, BM41012. £9.99 ref APR10P3.

TORRODIAL TX 30-0-30 480VA, Perfect for Mosfet amplifiers etc. 120mm dia 55mm thick. £18.99 ref APR19.

MOD WIRE Perfect for repairing PCB's, wire wrap etc. Thin insulated wire on 500m reels. Our price just £9.99 ref APR10P8.

12v MOVING LIGHT Controller. Made by Hella, 6 channels rated at 90watts each. Speed control, cased. £34.99 ref APR35.

ELACTRON FLASH TUBES As used in police car flashing lights etc, full spec supplied, 60-100 flashes a min. £9.99 ref APR10P5.

24v 96WATT Cased power supply. New £13.99 ref APR14.

STETHOSCOPE Fully functioning stethoscope, ideal for listening to hearts, pipes, motors etc. £6 ref MAR6P6.

OUTDOOR SOLAR PATH LIGHT Captures sunlight during the day and automatically switches on a built in lamp at dusk. Complete with sealed lead acid battery etc. £19.99 ref MAR20P1.

ALARM VERSION Of above unit comes with built in alarm and piri to deter intruders. £24.99 ref MAR25P4.

CLOCKMAKER KIT Hours of fun making your own clock, complete instructions and everything you need. £7.99 ref MAR8P2.

CARETAKER VOLUMETRIC Alarm, will cover the whole of the ground floor against forced entry. Includes mains power supply and integral battery backup. Powerful internal sander, will take external bell if req'd. Retail £150+, ours? £49.99 ref MAR50P1.

TELEPHONE CABLE White 6 core 100m reel complete with a pack of 100 clips. Ideal 'phone extns etc. £7.99 ref MAR8P3.

VIEWDATA RETURNS £6 made by Tandata, includes 1200.75 mode, kb/d, RGB and comp op, printer port. No PSU. £6 MAG6P7.

IBM PC CASE AND PSU Ideal base for building your own PC. Ex equipment but OK. £14.00 each REF: MAG14P2.

SOLAR POWER LAB SPECIAL You get TWO 6"x6" 6v 130mA solar cells, 4 LED's, wire, buzzer, switch plus 1 relay or motor. Superb value kit just £5.99 REF: MAG6P8.

SOLID STATE RELAYS Will switch 25A mains. Input 3.5-26V DC 57x43x21mm with terminal screws £3.99 REF: MAG4P10.

300DPI A4 DTP MONITOR Brand new, TTL/ECL inputs, 15" landscape, 1200x1664 pixel complete with circuit diag to help you interface with your projects. JUST £24.99. REF: MAG25P1.

ULTRAMINI BUG MIC 6mmx3.5mm made by AKG, 5-12v electret condenser. Cost £12 ea, Our? four for £9.99 REF: MAG10P2.

RGB/CGA/EGA/TTL COLOUR MONITORS 12" in good condition. Back anodised metal case. £99 each REF: MAG99P1.

GX4000 GAMES MACHINES returns so ok for spares or repair £9 each (no games). REF: MAG9P1.

C64 COMPUTERS Returns, so ok for spares etc £9 ref MAG9P2.

FUSELAGE LIGHTS 3 foot by 4" panel 1/8" thick with 3 panels that glow green when a voltage is applied. Good for night lights, front panels, signs, disco etc. 50-100v per strip. £25 ref MAG25P2.

ANSWER PHONES Returns with 2 faults, we give you the bits for 1 fault, you have to find the other yourself. BT Response 200's £18 ea REF: MAG18P1. PSU £5 ref MAG5P12.

SWITCHED MODE PSU ex equip, 60w +5v @5A, -5v @.5A, +12v @2A, -12v @.5A 120/220v cased 245x88x55mm ICinput socket £6.99 REF: MAG7P1.

PLUG IN PSU 9V 200mA DC £2.99 each REF: MAG3P9.

PLUG IN ACORN PSU 19v AC 14w £2.99 REF: MAG3P10.

POWER SUPPLY fully cased with mains and op leads 17v DC 900mA output. Bargain price £5.99 ref MAG6P9.

ACORN ARCHIMEDES PSU +5v @ 4.4A, on/off sw uncased, selectable mains input, 145x100x45mm £7 REF: MAG7P2.

GEGER COUNTER KIT Low cost professional twin tube, complete with PCB and components £29 REF: MAG29P1.

SINCLAIR C5 13" wheels complete with tube, tyre and cyde style bearing £6 ea REF: MAG6P10.

AA NICAD PACK encapsulated pack of 8 AA nicad batteries (tagged) ex equip, 55x32x32mm. £3 a pack. REF: MAG3P11.

13.8V 1.9A psu cased with leads. Just £9.99 REF: MAG10P3.

360K 6.25 brand new half height floppy drives IBM compatible industry standard. Just £6.99 REF: MAG7P3.

PPCMODEM CARDS These are high spec plug in cards made for the Amstrad laptop computers, 2400 baud dial up unit complete with leads. Clearance price is £5 REF: MAG5P1.

INFRA RED REMOTE CONTROLLERS Originally made for hi spec satellite equipment but perfect for all sorts of remote control projects. Our clearance price is just £2 REF: MAG2.

TOWERS INTERNATIONAL TRANSISTOR GUIDE. A very useful book for finding equivalent transistors, leadouts, specs etc. £20 REF: MAG20P1.

SINCLAIR C6 MOTORS We have a few left without gearboxes. These are 12v DC 3,300 rpm 6"x4", 1/4" OP shaft. £25 REF: MAG25.

UNIVERSAL SPEED CONTROLLER KIT Designed by us for the above motor but ok for any 12v motor up to 30A. Complete with PCB etc. A heat sink may be required. £17.00 REF: MAG17.

VIDEO SENDER UNIT. Transmits both audio and video signals from either a video camera, video recorder, TV or Computer etc to a standard TV set in a 100' range! (tune TV to a spare channel) 12v DC op. Price is £15 REF: MAG15. 12v psu is £5 extra REF: MAG5P2.

***FM CORDLESS MICROPHONE** Small hand held unit with a 500' range! 2 transmit power levels. Reqs PP3 9v battery. Tuneable to any FM receiver. Price is £15 REF: MAG15P1.

LOW COST WALKIE TALKIES Pair of battery operated units with a range of about 200'. Ideal for garden use or as an educational toy. Price is £8 a pair. REF: MAG 8P1. 2x PP3 req'd.

***MINIATURE RADIO TRANSCIVERS** A pair of walkie talkies with a range of up to 2 kilometres in open country. Units measure 22x52x155mm. Complete with cases and earpieces. 2x PP3 req'd. £30.00 pair REF: MAG30.

COMPOSITE VIDEO KIT. Converts composite video into separate H sync, V sync, and video. 12v DC. £8.00 REF: MAG8P2.

LQ3600 PRINTER ASSEMBLIES Made by Amstrad they are entire mechanical printer assemblies including printhead, stepper motors etc etc in fact everything but the case and electronics, a good stripper! £5 REF: MAG5P3 or 2 for £8 REF: MAG8P3.

NEW BULL ELECTRICAL STORE WOLVERHAMPTON BRANCH

**NOW OPEN AT 55A WORCESTER
ST TEL 0902 22039**

100MHZ OSCILLOSCOPES now in stock, 12x10cm screen, delayed sweep, 1Mohm/25pfinputs, modes-ch1, ch2, add, chop, alt, dual. 460 x 305 x 200mm, 17kgs, £267+Vat includes insurance and carriage.

INFRARED LASER NIGHT SCOPES Second generation image intensifier complete with hand grip attachment with built in laser lamp for zero light conditions. Supplied with Pentax 42mm camera mount, 1.6kg, uses 1xPP3, 3xAA's (all supplied) £245+Vat

NEW HIGH POWER LASERS 15mW, Helium neon, 3 switchable wave lengths .63um, 1.15um, 3.39um (2 of them are infrared) 500:1 polarizer built in so good for holography. Supplied complete with mains power supply. 790x65mm. Use with EXTREME CAUTION AND UNDER QUALIFIED GUIDANCE. £349+Vat.

'PC PAL' VGA TO TV CONVERTER Just plug in and it converts your colour television into a basic VGA screen, perfect for laptops, saves lugging monitors about or just as a cheap upgrade. Intro price £49.99 +Vat.

AMSTRAD 1512DD

1512 BASE UNIT AND KEYBOARD AND TWO 5.25" 360K DRIVES. ALL YOU NEED IS A MONITOR AND POWER SUPPLY. WAS £59.00
NOW ONLY **£39.00**
REF: MAG39

3FT X 1FT 10WATT SOLAR PANELS
14.5v/700mA
NOW AVAILABLE BY MAIL ORDER
£33.95

(PLUS £2.00 SPECIAL PACKAGING CHARGE)

TOP QUALITY AMORPHOUS SILICON CELLS HAVE ALMOST A TIMELESS LIFESPAN WITH AN INFINITE NUMBER OF POSSIBLE APPLICATIONS, SOME OF WHICH MAY BE CAR BATTERY CHARGING, FOR USE ON BOATS OR CARAVANS, OR ANYWHERE A PORTABLE 12V SUPPLY IS REQUIRED. REF: MAG34

*****WE BUY SURPLUS STOCK*****

TURN YOUR SURPLUS STOCK INTO CASH
IMMEDIATE SETTLEMENT. WE WILL ALSO QUOTE FOR COMPLETE FACTORY CLEARANCE.

1994 CATALOGUE.

PLEASE SEND 45P, A4 SIZED SAE FOR YOUR FREE COPY
MINIMUM GOODS ORDER £100. TRACE ORDERS FROM GOVERNMENT, SCHOOLS, UNIVERSITIES & LOCAL AUTHORITIES WELCOME. ALL GOODS SUPPLIED SUBJECT TO OUR CONDITIONS OF SALE AND UNLESS OTHERWISE STATED GUARANTEED FOR 30 DAYS. RIGHTS RESERVED TO CHANGE PRICES & SPECIFICATIONS WITHOUT PRIOR NOTICE. ORDERS SUBJECT TO STOCK. QUOTATIONS WILL ONLY BE GIVEN FOR QUANTITIES EXCEEDING THOSE STATED.

*SOME OF OUR PRODUCTS MAY BE UNLICENSEABLE IN THE UK

BULL ELECTRICAL

250 PORTLAND ROAD HOVE SUSSEX
BN3 5QT

MAIL ORDER TERMS: CASH PO OR CHEQUE
WITH ORDER PLUS £3.00 POST PLUS VAT.

PLEASE ALLOW 7 - 10 DAYS FOR DELIVERY

TELEPHONE ORDERS WELCOME

TEL: 0273 203500

FAX: 0273 323077

SPEAKER WIRE Brown 2 core 100 foot hank £2 REF: MAG14P2.
LED PACK of 100 standard red 5m leds £5 REF: MAG5P4.
UNIVERSAL PC POWER SUPPLY complete with flyback switch, fan etc. Two types available 150w at £15 REF: MAG15P5 (23x23x23mm) and 200w at £20 REF: MAG20P3 (23x23x23mm).
*FM TRANSMITTER housed in a standard working 13A adapter! the bug runs directly off the mains so lasts forever! why pay £700? or price is £26 REF: MAG26 Transmits to any FM radio.
*FM BUG KIT New design with PCB embedded coil for extra stability Works to any FM radio. 9v battery req'd. £5 REF: MAG5P5.
*FM BUG BUILT AND TESTED superior design to kill. Supplied to detective agencies. 9v battery req'd. £14 REF: MAG14.

TALKING COINBOX STRIPPER originally made to retail at £79 each, these units are designed to convert an ordinary phone into a payphone. The units have the locks missing and sometimes broken hinges. However they can be adapted for their original use or used for something else?? Price is just £3 REF: MAG3P1.

100 WATT MOSFET PAIR Same specs as 2SK343 and 2SJ413 (8A, 140v, 100w) 1 N channel, 1 P channel, £3 a pair REF: MAG3P2.

TOP QUALITY SPEAKERS Made by Apicot these Hi Fi televisions these are 10 watt 4R Jap made 4" round with large shielded magnets. Good quality. £2 each REF: MAG2P4 or 4 for £6 REF: MAG6P2.

TWEETERS 2" diameter good quality tweeter 140R (ok with the above speaker) 2 for £2 REF: MAG2P5 or 4 for £3 REF: MAG3P4.

AT KEYBOARDS Made by Apicot these quality keyboards need just a small mod to run on any AT, they work perfectly but you will have to put up with 1 or 2 foreign keycaps! Price £6 REF: MAG6P3.

PC CASES Again mixed types so you take a chance next one off the pile £12 REF: MAG12 or two the same for £20 REF: MAG20P4.

COMMODORE MICRODRIVE SYSTEM mini storage device for C64's 4 times faster than disc drives, 10 times faster than tapes. Complete unit just £12 REF: MAG12P1.

SCHOOL STRIPPERS We have quite a few of the above units which are 'returns' as they are quite comprehensive units they could be used for other projects etc. Let us know how many you need at just 50p a unit (minimum 10).

HEADPHONES Ex Virgin Atlantic 8 pairs for £2 REF: MAG2P8.

PROXIMITY SENSORS These are small PCB's with what look like a source and sensor LED on one end and lots of components on the rest of the PCB. Complete with flyleads. Pack of 5 £3 REF: MAG: 3P5 or 20 for £8 REF: MAG8P4.

SNOOPERS EAR? Original made to dip over the earpiece of telephone to amplify the sound-it also works quite well on the cable running along the wall! Price is £5 REF: MAG5P7.

DOS PACKS Microsoft version 3.3 or higher complete with all manuals or price just £5 REF: MAG5P8. Worth it just for the very comprehensive manual 5.25" only.

DOS PACK Microsoft version 5.0 original software but no manuals hence only £3 REF: MAG3P6 5.25" only.

CTM64 COLOUR MONITOR Made to work with the CPC464 home computer. Standard RGB input so will work with other machines. Refurbished £59.00 REF: MAG59.

PIR DETECTOR Made by famous UK alarm manufacturer these are hi spec, long range internal units. 12v operation. Slight marks on case and unboxed (although brand new) £8 REF: MAG8P5.

WINDUP SOLAR POWERED RADIO AM/FM radio complete with hand charger and solar panel £14 REF: MAG14P1.

COMMODORE 64 TAPE DRIVES Customer returns at £4 REF: MAG4P9. Fully tested units are £12 REF: MAG12P5.

MAINS CABLES These are 2 core standard black 2 metre mains cables fitted with a 13A plug on one end, cable the other. Ideal for projects, low cost manufacturing etc. Pack of 10 for £3 REF: MAG3P8. Pack of 100 £20 REF: MAG20P5.

MICROWAVE TIMER Electronic timer with relay output suitable to make enlarger timer etc £4 REF: MAG4P4.

MOBILE CAR PHONE £5.99 Well almost complete in car phone excluding the box of electronics normally hidden under seat. Can be made to illuminate with 12v also has built in light sensor so display only illuminates when dark. Totally convincing! REF: MAG6P6.

ALARM BEACONS Xenon strobe made to mount on an external bell box but could be used for caravans etc. 12v operation. Just connect up and it flashes regularly! £5 REF: MAG5P11.

FIRE ALARM CONTROL PANEL High quality metal cased alarm panel 350x165x80mm. With key. Comes with electronics but no information. sale price 7.99 REF: MAG8P6.

REMOTE CONTROL PCB These are receiver boards for garage door opening systems. Another use? £4 ea REF: MAG4P5.

6"X12" AMORPHOUS SOLAR PANEL 12v 155x310mm 130mA. Bargain price just £5.99 ea REF: MAG6P12.

FIBRE OPTIC CABLE BUMPER PACK 10 metres for £4.99 ref MAG5P13 ideal for experimenters! 30m for £12.99 ref MAG13P1.

LOPTX Line output transformers believed to be for hi res colour monitors but useful for getting high voltages from low ones! £2 each REF: MAG2P12 bumper pack of 10 for £12 REF: MAG12P3.

**BOTH SHOPS OPEN 9-5.30
SIX DAYS A WEEK**

PORTABLE RADIATION DETECTOR

£49.99

A Hand held personal Gamma and X Ray detector. This unit contains two Geiger Tubes, has a 4 digit LCD display with a Piezo speaker, giving an audio visual indication. The unit detects high energy electromagnetic quanta with an energy from 30K eV to over 1.2M eV and a measuring range of 5-9999 UR/h or 10-99990 Nr/h. Supplied complete with handbook.

REF: MAG50

POWER AMPLIFIER MODULES-TURNABLES-DIMMERS-LOUDSPEAKERS-19 INCH STEREO RACK AMPLIFIERS

PRICES INCLUDE V.A.T. & PROMPT DELIVERY FRIENDLY SERVICE • LARGE (A4) S.A.E. 60p STAMPED FOR CATALOGUE

OMP MOS-FET POWER AMPLIFIERS
HIGH POWER, TWO CHANNEL 19 INCH RACK

THOUSANDS PURCHASED BY PROFESSIONAL USERS



THE RENOWNED MXF SERIES OF POWER AMPLIFIERS
FOUR MODELS:- MXF200 (100W + 100W) MXF400 (200W + 200W)
MXF600 (300W + 300W) MXF900 (450W + 450W)

ALL POWER RATINGS R.M.S. INTO 4 OHMS, BOTH CHANNELS DRIVEN

FEATURES: ★ Independent power supplies with two toroidal transformers ★ Twin L.E.D. Vu meters ★ Level controls ★ Illuminated on/off switch ★ XLR connectors ★ Standard 775mV inputs ★ Open and short circuit proof ★ Latest Mos-Fets for stress free power delivery into virtually any load ★ High slew rate ★ Very low distortion ★ Aluminium cases ★ MXF600 & MXF900 fan cooled with D.C. loudspeaker and thermal protection.

USED THE WORLD OVER IN CLUBS, PUBS, CINEMAS, DISCOS ETC.

SIZES:- MXF200 W19" x H3 1/2" (2U) x D11"
MXF400 W19" x H5 1/4" (3U) x D12"
MXF600 W19" x H5 1/4" (3U) x D13"
MXF900 W19" x H5 1/4" (3U) x D14 1/2"

PRICES:- MXF200 £175.00 MXF400 £233.85
MXF600 £329.00 MXF900 £449.15
SPECIALIST CARRIER DEL. £12.50 EACH

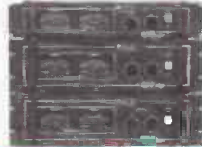

OMP X03 STEREO 3-WAY ACTIVE CROSS-OVER



Advanced 3-Way Stereo Active Cross-Over, housed in a 19" x 1U case. Each channel has three level controls: bass, mid & top. The removable front fascia allows access to the programmable DIL switches to adjust the cross-over frequency: Bass-Mid 250/500/800Hz, Mid-Top 1 8/3/5KHz, all at 24dB per octave. Bass invert switches on each bass channel. Nominal 775mV input/output. Fully compatible with OMP rack amplifier and modules.

Price £117.44 + £5.00 P&P

STEREO DISCO MIXER SDJ3400SE

★ ECHO & SOUND EFFECTS ★

STEREO DISCO MIXER with 2 x 7 band L & R graphic equalisers with bar graph LED Vu meters. MANY OUTSTANDING **FEATURES:-** including Echo with repeat & speed control, DJ Mic with talk-over switch, 6 Channels with individual faders plus cross fade, Cue Headphone Monitor, 8 Sound Effects. Useful combination of the following inputs:- 3 turntables (mag), 3 mics, 5 Line for CD, Tape, Video etc.



Price £144.99 + £5.00 P&P

SIZE: 482 x 240 x 120mm

PIEZO ELECTRIC TWEETERS - MOTOROLA

Join the Piezo revolution! The low dynamic mass (no voice coil) of a Piezo tweeter produces an improved transient response with a lower distortion level than ordinary dynamic tweeters. As a crossover is not required these units can be added to existing speaker systems of up to 100 watts (more if two are put in series). **FREE EXPLANATORY LEAFLETS ARE SUPPLIED WITH EACH TWEETER.**

TYPE 'A' (KSN1036A) 3" round with protective wire mesh. Ideal for bookshelf and medium sized Hi-Fi speakers. Price £4.90 + 50p P&P.
TYPE 'B' (KSN1005A) 3 1/2" super horn for general purpose speakers, disco and P.A. systems etc. Price £5.99 + 50p P&P.
TYPE 'C' (KSN1016A) 2" x 5" wide dispersion horn for quality Hi-Fi systems and quality discos etc. Price £6.99 + 50p P&P.
TYPE 'D' (KSN1025A) 2" x 6" wide dispersion horn. Upper frequency response retained extending down to mid-range (2KHz). Suitable for high quality Hi-Fi systems and quality discos. Price £9.99 + 50p P&P.
TYPE 'E' (KSN1038A) 3 1/2" horn tweeter with attractive silver finish trim. Suitable for Hi-Fi monitor systems etc. Price £5.99 + 50p P&P.
LEVEL CONTROL Combines, on a recessed mounting plate, level control and cabinet input jack socket. 85x85mm. Price £4.10 + 50p P&P.

TYPE A

TYPE B

TYPE C

TYPE D

TYPE E

IBI FLIGHT CASED LOUDSPEAKERS

A new range of quality loudspeakers, designed to take advantage of the latest speaker technology and enclosure designs. Both models utilize studio quality 12" cast aluminium loudspeakers with factory fitted grilles, wide dispersion constant directivity horns, extruded aluminium corner protection and steel ball corners, complimented with heavy duty black covering. The enclosures are fitted as standard with top hats for optional loudspeaker stands.



POWER RATINGS QUOTED IN WATTS RMS FOR EACH CABINET
FREQUENCY RESPONSE FULL RANGE 45Hz - 20KHz

IBI FC 12-100WATTS (100dB) PRICE £159.00 PER PAIR

IBI FC 12-200WATTS (100dB) PRICE £175.00 PER PAIR

SPECIALIST CARRIER DEL. £12.50 PER PAIR

OPTIONAL STANDS PRICE PER PAIR £49.00
Delivery £6.00 per pair

IN-CAR STEREO BOOSTER AMPS



PRICES: 150W £49.99 250W £99.99
400W £109.95 P&P £2.00 EACH

THREE SUPERB HIGH POWER CAR STEREO BOOSTER AMPLIFIERS
150 WATTS (75 + 75) Stereo, 150W Bridged Mono
250 WATTS (125 + 125) Stereo, 250W Bridged Mono
400 WATTS (200 + 200) Stereo, 400W Bridged Mono
ALL POWERS INTO 4 OHMS

Features: ★ Stereo, bridgable mono ★ Choice of high & low level inputs ★ L & R level controls ★ Remote on-off ★ Speaker & thermal protection.

OMP MOS-FET POWER AMPLIFIER MODULES

SUPPLIED READY BUILT AND TESTED.

These modules now enjoy a world-wide reputation for quality, reliability and performance at a realistic price. Four models are available to suit the needs of the professional and hobby market: i.e. industry, leisure, instrumental and Hi-Fi etc. When comparing prices, NOTE that all models include toroidal power supply, integral heat sink, glass fibre P.C.B. and drive circuits to power a compatible Vu meter. All models are open and short circuit proof.

THOUSANDS OF MODULES PURCHASED BY PROFESSIONAL USERS



OMP/MF 100 Mos-Fet Output power 110 watts
R.M.S. into 4 ohms, frequency response 1Hz - 100KHz -3dB, Damping Factor > 300, Slew Rate 45V/uS, T.H.D. typical 0.002%, Input Sensitivity 500mV, S.N.R. -110 dB. Size 300 x 123 x 60mm.
PRICE £40.85 + £3.50 P&P



OMP/MF 200 Mos-Fet Output power 200 watts
R.M.S. into 4 ohms, frequency response 1Hz - 100KHz -3dB, Damping Factor > 300, Slew Rate 50V/uS, T.H.D. typical 0.001%, Input Sensitivity 500mV, S.N.R. -110 dB. Size 300 x 155 x 100mm.
PRICE £64.35 + £4.00 P&P



OMP/MF 300 Mos-Fet Output power 300 watts
R.M.S. into 4 ohms, frequency response 1Hz - 100KHz -3dB, Damping Factor > 300, Slew Rate 75V/uS, T.H.D. typical 0.001%, Input Sensitivity 500mV, S.N.R. -110 dB. Size 330 x 175 x 100mm.
PRICE £81.75 + £5.00 P&P



OMP/MF 450 Mos-Fet Output power 450 watts
R.M.S. into 4 ohms, frequency response 1Hz - 100KHz -3dB, Damping Factor > 300, Slew Rate 75V/uS, T.H.D. typical 0.001%, Input Sensitivity 500mV, S.N.R. -110 dB, Fan Cooled, D.C. Loudspeaker Protection, 2 Second Anti-Thump Delay. Size 385 x 210 x 105mm.
PRICE £132.85 + £5.00 P&P



OMP/MF 1000 Mos-Fet Output power 1000 watts
R.M.S. into 2 ohms, 725 watts R.M.S. into 4 ohms, frequency response 1Hz - 100KHz -3dB, Damping Factor > 300, Slew Rate 75V/uS, T.H.D. typical 0.002%, Input Sensitivity 500mV, S.N.R. -110 dB, Fan Cooled, D.C. Loudspeaker Protection, 2 Second Anti-Thump Delay. Size 422 x 300 x 125mm.
PRICE £259.00 + £12.00 P&P

NOTE: MOS-FET MODULES ARE AVAILABLE IN TWO VERSIONS: STANDARD - INPUT SENS 500mV, BAND WIDTH 100KHz. PEC (PROFESSIONAL EQUIPMENT COMPATIBLE) - INPUT SENS 775mV, BAND WIDTH 50KHz. ORDER STANDARD OR PEC.

LOUDSPEAKERS

LARGE SELECTION OF SPECIALIST LOUDSPEAKERS AVAILABLE, INCLUDING CABINET FITTINGS, SPEAKER GRILLES, CROSS-OVERS AND HIGH POWER, HIGH FREQUENCY BULLETS AND HORNS, LARGE (A4) S.A.E. (60p STAMPED) FOR COMPLETE LIST.



McKenzie and Fane Loudspeakers are also available.

EMINENCE- INSTRUMENTS, P.A., DISCO, ETC

ALL EMINENCE UNITS 8 OHMS IMPEDANCE
8" 100 WATT R.M.S. ME8-100 GEN. PURPOSE, LEAD GUITAR, EXCELLENT MID, DISCO. RES. FREQ. 72Hz, FREQ. RESP. TO 4KHz, SENS 97dB. PRICE £32.71 + £2.00 P&P
10" 100 WATT R.M.S. ME10-100 GUITAR, VOCAL, KEYBOARD, DISCO, EXCELLENT MID. RES. FREQ. 71Hz, FREQ. RESP. TO 7KHz, SENS 97dB. PRICE £33.74 + £2.50 P&P
10" 200 WATT R.M.S. ME10-200 GUITAR, KEYB'D, DISCO, VOCAL, EXCELLENT HIGH POWER MID. RES. FREQ. 65Hz, FREQ. RESP. TO 3.5KHz, SENS 99dB. PRICE £43.47 + £2.50 P&P
12" 100 WATT R.M.S. ME12-100LE GEN. PURPOSE, LEAD GUITAR, DISCO, STAGE MONITOR. RES. FREQ. 49Hz, FREQ. RESP. TO 6KHz, SENS 100dB. PRICE £35.64 + £3.50 P&P
12" 100 WATT R.M.S. ME12-100LT (TWIN CONE) WIDE RESPONSE, P.A., VOCAL, STAGE MONITOR. RES. FREQ. 42Hz, FREQ. RESP. TO 10KHz, SENS 98dB. PRICE £36.67 + £3.50 P&P
12" 200 WATT R.M.S. ME12-200 GEN. PURPOSE, GUITAR, DISCO, VOCAL, EXCELLENT MID. RES. FREQ. 58Hz, FREQ. RESP. TO 6KHz, SENS 98dB. PRICE £46.71 + £3.50 P&P
12" 300 WATT R.M.S. ME12-300GP HIGH POWER BASS, LEAD GUITAR, KEYBOARD, DISCO ETC. RES. FREQ. 47Hz, FREQ. RESP. TO 5KHz, SENS 103dB. PRICE £70.19 + £3.50 P&P
15" 200 WATT R.M.S. ME15-200 GEN. PURPOSE BASS, INCLUDING BASS GUITAR. RES. FREQ. 46Hz, FREQ. RESP. TO 5KHz, SENS 99dB. PRICE £50.72 + £4.00 P&P
15" 300 WATT R.M.S. ME15-300 HIGH POWER BASS, INCLUDING BASS GUITAR. RES. FREQ. 39Hz, FREQ. RESP. TO 3KHz, SENS 103dB. PRICE £73.34 + £4.00 P&P

EARBENDERS:- HI-FI, STUDIO, IN-CAR, ETC

ALL EARBENDER UNITS 8 OHMS (Except EB8-50 & EB10-50 which are dual impedance tapped @ 4 & 8 ohm)
BASS, SINGLE COIL, HIGH COMPLIANCE, ROLLED SURROUND
8" 50WATT EB8-50 DUAL IMPEDANCE, TAPPED 4/8 OHM BASS, HI-FI, IN-CAR. RES. FREQ. 40Hz, FREQ. RESP. TO 7KHz SENS 97dB. PRICE £8.90 + £2.00 P&P
10" 50WATT EB10-50 DUAL IMPEDANCE, TAPPED 4/8 OHM BASS, HI-FI, IN-CAR. RES. FREQ. 40Hz, FREQ. RESP. TO 5KHz, SENS. 99dB. PRICE £13.65 + £2.50 P&P
10" 100WATT EB10-100 BASS, HI-FI, STUDIO. RES. FREQ. 35Hz, FREQ. RESP. TO 3KHz, SENS 96dB. PRICE £30.39 + £3.50 P&P
12" 100WATT EB12-100 BASS, STUDIO, HI-FI, EXCELLENT DISCO. RES. FREQ. 26Hz, FREQ. RESP. TO 3 KHz, SENS 93dB. PRICE £42.12 + £3.50 P&P
FULL RANGE TWIN COIL, HIGH COMPLIANCE, ROLLED SURROUND
5 1/2" 60WATT EB5-60TC (TWIN CONE) HI-FI, MULTI-ARRAY DISCO ETC. RES. FREQ. 63Hz, FREQ. RESP. TO 20KHz, SENS 92dB. PRICE £9.99 + £1.50 P&P
6 1/2" 60WATT EB6-60TC (TWIN CONE) HI-FI, MULTI-ARRAY DISCO ETC. RES. FREQ. 38Hz, FREQ. RESP. TO 20KHz, SENS 94dB. PRICE £10.99 + 1.50 P&P
8" 60WATT EB8-60TC (TWIN CONE) HI-FI, MULTI-ARRAY DISCO ETC. RES. FREQ. 40Hz, FREQ. RESP. TO 18KHz, SENS 89dB. PRICE £12.99 + £1.50 P&P
10" 60WATT EB10-60TC (TWIN CONE) HI-FI, MULTI ARRAY DISCO ETC. RES. FREQ. 35Hz, FREQ. RESP. TO 12KHz, SENS 96dB. PRICE £16.49 + £2.00 P&P

TRANSMITTER HOBBY KITS

PROVEN TRANSMITTER DESIGNS INCLUDING GLASS FIBRE PRINTED CIRCUIT BOARD AND HIGH QUALITY COMPONENTS COMPLETE WITH CIRCUIT AND INSTRUCTIONS

3W TRANSMITTER 80-108MHz, VARICAP CONTROLLED PROFESSIONAL PERFORMANCE, RANGE UP TO 3 MILES, SIZE 38 x 123mm, SUPPLY 12V @ 0.5AMP. PRICE £14.85 + £1.00 P&P

FM MICRO TRANSMITTER 100-108MHz, VARICAP TUNED, COMPLETE WITH VERY SENS FET MIC. RANGE 100-300m, SIZE 56 x 46mm, SUPPLY 9V BATTERY. PRICE £8.80 + £1.00 P&P



PHOTO: 3W FM TRANSMITTER

B.K. ELECTRONICS

UNITS 1 & 5 COMET WAY, SOUTHBEND-ON-SEA, ESSEX. SS2 6TR. Tel.: 0702 - 527572 Fax.: 0702 - 420243

POSTAL CHARGES PER ORDER £1.00 MINIMUM. OFFICIAL ORDERS FROM SCHOOLS, COLLEGES, GOVT. BODIES, P.L.C.s ETC PRICES INCLUSIVE OF V.A.T. SALES COUNTER, VISA AND ACCESS ACCEPTED BY POST, PHONE OR FAX.

Goodbye Money - Hello Smartcard

Developments in electronics look set to obsolesce the cash in your pocket and replace it with a microprocessor chip housed in a credit card sized piece of plastic. What we are witnessing is the beginning of the smartcard revolution.

If you look up 'smartcard' in a dictionary, the odds are that, unless the dictionary is very recent and very comprehensive, you will not find it there, but by the end of this decade not only will everyone be talking about smartcards, everyone will be using them. So what is a smartcard?

The concept of the smartcard was first proposed in the mid 1970s. It was a simple idea, but one that was at that time a little ahead of the technology needed to implement it. The idea was to house a small integrated circuit capable of storing data inside a conventional plastic credit card. Data which would normally be stored on the magnetic stripe on the back of the card, the data on the smartcard being accessible via a number of electrical contacts on the back of the card.

The rationale behind this idea was that data stored in a memory chip would be more secure and less easily forged than that stored on a magnetic stripe, because the data could be encrypted in a way that would be extremely difficult for anyone to decode, and because the cards would require very high technology manufacturing equipment to produce.

The early manufacturers of smartcards saw them as being primarily used in applications such as access control and security. Rather limited and specialised applications. Theorists and commentators, on the other hand saw, them being potentially used as a sophisticated means of paying for goods and services, a view which was shared by some large companies around the world, in particular French Telecom. At that time, the late 1970s, they were looking for a technology to create the now ubiquitous phone card. A technology which would enable them to eliminate many of the problems associated with coin boxes, such as unreliability, the tendency to be vandalised and the need to be regularly emptied.

French Telecom was faced with two practical alternatives, the smartcard, or the much simpler holographic card that would later be adopted by British Telecom. The French took a bold forward looking move and decided to use the smartcard and the first real commercial application for smartcards was thus born.

The Decade of the Telephone Smartcard

Throughout the 1980s, the telephone smartcard was the main

commercial use for the smartcard concept. All over France, telephone boxes were installed to take smartcards and today they comprise the majority of phone boxes. Similar developments have taken place in half a dozen other countries to which the French sold telecommunications equipment. Every year, millions of telephone smartcards are produced and sold.

As one would expect from a pioneering product, the French Telecom phone card is a very simple form of smartcard. To look at, it is the same size and thickness as an ordinary credit card, but on one side in the top left corner is a 1cm square patch of gold plated contacts, eight in all. These are used to connect the reader in the phone box to the chip on the card.

If we slice open one of these cards we will find that in the middle of the patch of contacts is a small silicon chip, about 1mm square. This chip is, in fact, just a very basic fuse link type read only memory. The reader will read the memory and determine how many charge units are left on the card and then blow a fuse link each time a charge unit is used.

To this extent the French card behaves, as far as the user is concerned, exactly like the holographic cards used by BT. However, the BT card can only be used as a phone card, but the France Telecom card can, by altering the electronics, be made to store a lot more information and be used for other applications.

Thus, when a BT card is used, it is simply thrown away (or one ends up with an annoying collection of cards with just one unit on them). The smart phone card, on the other hand, could be made rechargeable. Furthermore, by

having a network of smartcard readers attached to the phone network, they were ready to take advantage of more sophisticated developments and applications for smartcards.

The Next Step

What the smartcard concept was waiting for was the development of low cost, very low power consumption, highly integrated silicon chips. With the availability of such chips it would be possible to store more than just simple data on the card, it would be possible to store intelligence. This meant placing a microprocessor chip on the actual card, a move that was essential if smartcards were to store more than a simple remaining charge value.

A microprocessor was needed to provide the security that was essential to protect any form of rechargeable card from fraudulent use. A simple electrically programmable and erasable memory on the chip would be far too easy for crooks to reprogram, and thereby

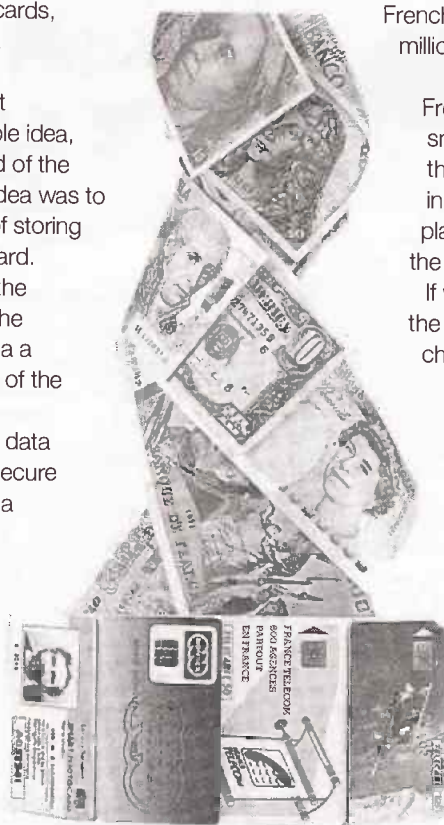

The London Transport Smartcard

In and around the London borough of Harrow, over 10,000 people are now carrying and using a bright yellow smartcard with a computer generated



image of themselves. They are all part of London Transport's first commercial trial of a smartcard ticketing system, so advanced that it is the first in the world and is attracting attention from transport system operators from as far away as Japan.

The Stored Value Ticketing project, or SVT, was born as the result of a feasibility study carried out in May 1992, which demonstrated that contactless smartcards could be used in all bus travel pass applications to give improved ticketing flexibility, better business information, faster boarding speeds and better revenue control. A later study carried out in conjunction with London Underground and British Rail has shown that the system can be extended to cover all forms of public transport.

The smartcard chosen by LT is manufactured by the British electronics and engineering giant GEC. It is a contactless card which incorporates a memory/processor chip and a loop aerial that is used to both collect power for use by the card and transfer data between the card and the card reader. The memory on the card includes an area which can be read or written to, allowing the validity of the pass to be quickly and accurately checked. The

memory can also hold stored values to pay for journeys in the same way as a phone card.

The passenger's card forms part of a complex network of computers and card terminals and this network is shown in Figure 1. In the trial system, which started on 3rd February 1994, over 200 buses on 19 different routes run by five different operators based at Harrow bus station, have been fitted with on-bus contactless smartcard readers. Local London Transport PASS newsagents, and in the near future underground stations, have also been fitted with electronic point of sale, or EPOS, terminals which can be used to reencode smart travel cards, with the



On each bus, the smartcard reader will automatically detect whether a particular card is valid and give the appropriate audio and visual acknowledgement or warning. The reader is linked to the standard Wayfarer ETM (Electronic Ticketing Machine) which stores data from the card reader for later retrieval at

the depot. This data is stored on a PC at the depot which is linked via a network to a main controlling system. The EPOS card readers in the PASS agents is also linked directly to the main controlling computer, as is the imaging and issue station terminal in Harrow bus station.

When the system is extended to London Underground, the card readers will be incorporated into the standard ticket barriers with direct linkage to London Underground's computer system.

As can be seen, all the systems are

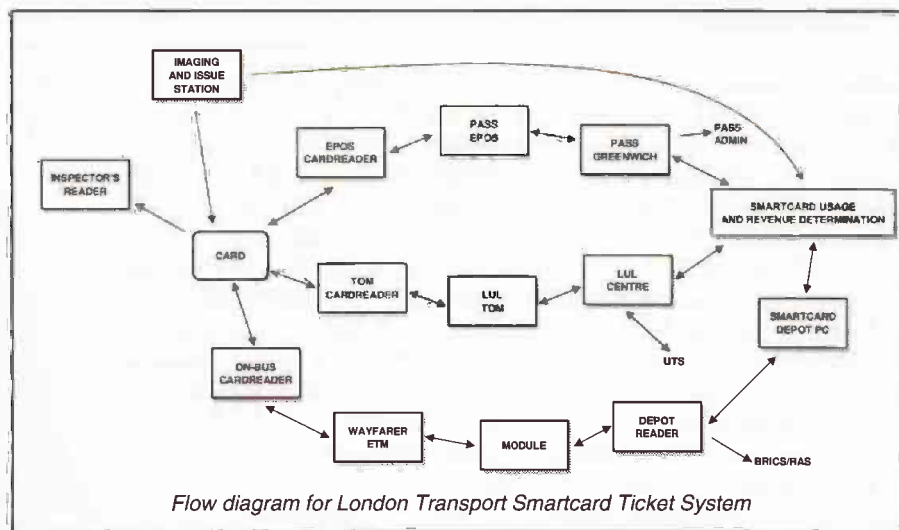

details of any new period, permit, or travel card (plus in a few months, the stored value Farecard). In addition, an office in Harrow bus station has been set up to issue new cards, each one bearing a computer generated portrait of the card holder.

linked, in most cases directly via a network, to the central controlling computer. This will enable traffic usage and revenue generation to be very closely monitored. The result should be a more profitable system and a better service for the passenger.

essentially 'print money'. It is necessary for the data to be stored in encrypted form, for access to be password protected and indeed for a host of special hardware and software security systems to be built into each card.

The Smartcard Today

The smartcards being developed today have in-built processors,

memory and even ultra thin batteries. They no longer need to rely on direct contact with the reader as some now incorporate ultra-miniature radio receivers and transmitters which permit the cards to be used in close proximity to a reader but without actually touching it. Coupled with the availability of the electronics systems is the development of manufacturing techniques, such as surface mount devices, which make it possible to automatically construct

The National Westminster Mondex Cashcard

Most people, I suspect, like having some cash in their pocket and a few notes in their purse or wallet. You need it for all the little expenses in life, buying a newspaper or a bus ticket, paying the window cleaner, or a taxi driver, giving your children pocket money. All instances where a cheque or credit card is useless and cash is still king. However, much as we may find cash useful, it is probably true to say that most big businesses, including most banks, do not like cash. They do not like having to count notes and coins, they do not like the security problems associated with cash and nor do they like the fact that physical cash does not generate any interest (it is estimated to cost £2 billion in lost interest in the UK alone).

This dislike of cash has prompted banks and big businesses to look for ways to eliminate any need for it and in this quest they have turned to smartcard technology to create what they like to call the 'electronic purse'.

Although some trials of electronic purse systems have been held in Denmark and Portugal, the leading contender in the world today is a system called Mondex, that has been developed in the UK by a partnership of the National Westminster and Midland Banks. The system is said to be at least 18 months ahead of any other comparable project and goes on large scale commercial trials in the Swindon area early next year, with 1,000 retailers and over 40,000 users. So what exactly is the Mondex system?

Mondex uses an intelligent smartcard to provide a secure and simple way of

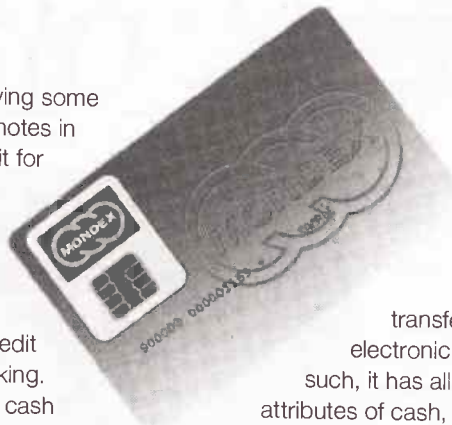

holding and transferring electronic cash. As such, it has all the attributes of cash, in particular its anonymity and the ability for one individual to transfer money to another without having to go via a third party. But unlike physical money, it can be sent down a phone line and is virtually theft free, thereby making it easy for the individual to withdraw cash as it is needed and allowing shopkeepers to easily and safely bank their takings.

The fact that Mondex uses electronic cash rather than physical cash means that it is the ideal payment mechanism for the suppliers and consumers of the new electronic information and entertainment services being supplied directly into peoples homes, over the new optical fibre based phone lines network. This means that in the new age of the 'digital highway', individuals and businesses will have a means of both sending and receiving cash down a phone line, a considerable advance on the credit and charge card which can only transfer cash in one direction and then only via a third party.

The main difference between Mondex and other cards is the fact that it is unaccounted, in other words there is no need to link each

transaction back to a specific bank account where checks are made to see if funds are available. Like physical cash, the money is either in the Mondex 'electronic purse' or it is not, therefore there is no need for the retailer to make authorisation checks or request signatures and thus no delay in receiving value. With Mondex, all that matters is that there is sufficient value stored in the card being presented to pay for the transaction, a factor which Mondex's designers have taken advantage of since this is a multicurrency system. It will be capable of handling over 100 different currencies, of which five can be held on the card at any one time. A degree of flexibility which has generated considerable interest in the EEC, in applications such as a payment device for Europe's motorway tolls (the French are already testing a contactless smartcard system attached to the vehicle for paying motorway tolls and in the UK a similar system is proposed for both motorway tolls and charging motorists to enter big cities such as London).

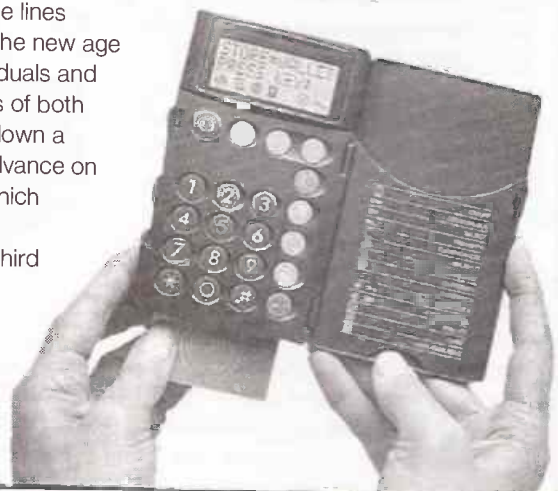

such cards in vast numbers and at very low cost.

In addition to the development of advanced cards, we have also seen the development of a wide range of smartcard readers. These range from remote wireless systems, to portable pocket sized terminals and terminals which can be built into any domestic phone.

The fact that the technology to create and manufacture sophisticated smartcards and reader systems has become available over the last couple of years has led to a renewed interest in smartcard technology and a new range of commercial applications. It is a resurgence which has seen British companies

moving to the fore and taking a world leading position.

New applications include the world's first smartcard ticketing system launched by London Transport earlier this year and now undergoing a two year public trial in the North London area. The system has potentially enormous advantages for both the traveller and for London Transport. It will eventually enable the traveller to buy tickets in advance, at a discount rate, from any station or news agent (they are all equipped with special terminals to place the appropriate data on the customer's smartcard) and use them to travel on any transport system with discounted units in much the same way as a phone card.

To get value into their cards a Mondex user will be able to charge up their cards using a range of different methods. They will be able to withdraw money from their bank accounts using special automated telling machines (ATMs) at their bank, or they can use a new generation of public phone which has been developed by British Telecom.

In the UK, this could increase the number of cash withdrawal points from the high street 15,000 ATMs to some 75,000 public phone boxes, plus semi-public phones in restaurants, bars, shops, etc. The fact that any ordinary phone, even a cell phone, will eventually be capable of being fitted with a Mondex reader that will turn it into an ATM, will eliminate all the security problems associated with handling large amounts of cash.

Another way for Mondex users to charge up their cards will be to transfer it from one individual to another. To do this a phone or an ATM is not needed, since the Mondex card

comes with a special wallet into which their Mondex card fits. This wallet is more than just a holder for the card, it has a keypad and a display, looking a little like a pocket calculator. The display will show you how much money is in the card and will also give you full information about the last ten transactions for which the card was used.

To give money to another Mondex user, simply enter your four digit PIN number into the wallet keypad and use the appropriate keys to withdraw the required amount. This is held temporarily in the wallet processor's memory and can be transferred to another Mondex card simply by

inserting that card into the wallet and performing a transfer. Besides being of use to the individual, the wallet offers what is in effect a basic terminal for small businesses and the self employed (I do have reservations about the time taken to transfer money using the wallet, if you buy a paper from a street corner news vendor, you simply give him the appropriate coins and take the paper, using a wallet will slow down the number of papers he can sell in a given time - Ed).

Thus the key elements in the Mondex system are the actual Mondex

will be used to hold and transfer cash, an enormous amount of work has gone into the card's security. The security system is in fact encoded into the chip on the card which means that the card can be used to transfer cash over standard unsecured networks, such as public phones and mobile phone networks.

The Mondex security system is extremely sophisticated and virtually impossible to crack. Every time a Mondex card is used, it generates a unique digital signature which can be recognised by other Mondex devices and it is this signature which ensures that the cards involved are genuine Mondex cards and that they are dealing with untampered Mondex signals.

The trick to the security programming used on the card is that whereas the 'key' to verifying the signature is open, the key to creating the signature remains secret and has been designed to be too complex for organised crime to crack on an economic basis. In addition the key will be frequently changed thus

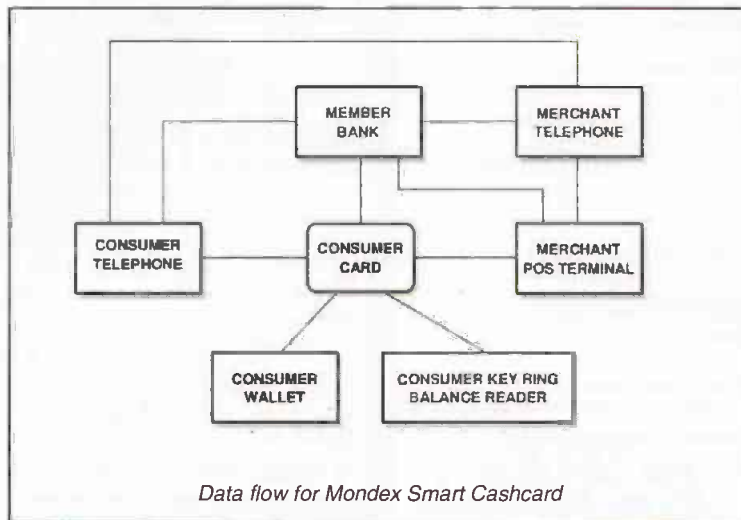

smartcard itself, the electronic wallet, the Mondex compatible phone and the Mondex compatible retailers till. All these components have now been developed and tested ready for next year's large scale launch in Swindon.

The actual Mondex cards are the same size and thickness as a conventional credit card, with a block of eight goldplated contacts in the upper left corner of the card. They decided on a card with contacts because it gives the user a better feel of control, in other words you have to have physical access to the card to do anything with it.

The cards and the wallets contain an 8 bit microprocessor chip and associated memory. Because the card

leaving fraudsters and hackers with a fast moving target that will make their work redundant, allowing Mondex to stay ahead of increasingly sophisticated criminals.

The cards are being made by Dai Nippon Printing Co. Ltd., and contain a chip manufactured by Hitachi, which is based upon its H8-310 microcontrollers. A similar chip is used in the wallet systems which are being manufactured by Panasonic and Texas Instruments. Special bank ATMs are being produced by AT&T Global Information Solutions and the phone terminals by BT, retailer terminals are coming from De La Rue Fortronic.

It will also enable the operator to be more flexible in his pricing structure, encouraging people to use buses and trains at the slackest time, or within more tightly specified areas. It will enable the operators to monitor with great precision the patterns of transport usage so that they can be more accurately tailored to users needs and to enhance the profitability of the operator. They will also allow different routes to be operated by different companies, with payment being electronically transferred from the main ticket vendor to the individual operators.

British companies are also leading the way in an even more

important application for smartcard technology, one which prompted the main title of this article. This is the Mondex Global Electronic Cash project, which has been masterminded by the National Westminster and Midland Banks, together with a range of UK, Japanese and US electronics companies and British Telecom. It will be going into public service in the UK in 1995 and will be the world's first electronic cash payment that is intended to replace physical cash. The developers hope it will become a world standard.

Mondex is an extremely complex project and represents perhaps the ultimate in electronic financial systems. It will allow

Inside a Smartcard

Many smartcard manufacturers are naturally reluctant to give any real details about what is inside their cards and how they work. One company that will give information is Mitsubishi, with its contactless IC card.

The Mitsubishi smartcard is an advanced contactless card which can be read or written to from as far away as 80cm, thus being primarily intended for use in security, access control systems, cashless vending, product tagging in automated manufacturing and warehouse systems and in ticketing/toll systems. As can be seen from Figure 1, it is the same size as a conventional credit card and about twice as thick.

The smartcard electronics are sandwiched between two layers of plastic and a block diagram of these contents can be seen in

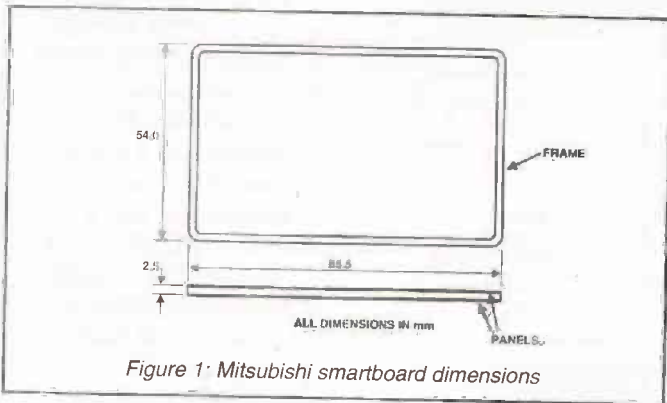

Figure 1: Mitsubishi smartboard dimensions

Figure 2. Note that the card electronics include an 8 bit microprocessor, RAM and ROM memory, a clock oscillator, I/O circuitry and a modulation/demodulation circuit with associated transmitter/receiver aerial, plus an ultra thin battery that will provide enough power for the card to be used more than 200,000 times. This is a very impressive amount of electronics packed into a very small area, most of it integrated onto a single chip which is mounted on an ultra thin circuit board with the aerial loop etched onto it.

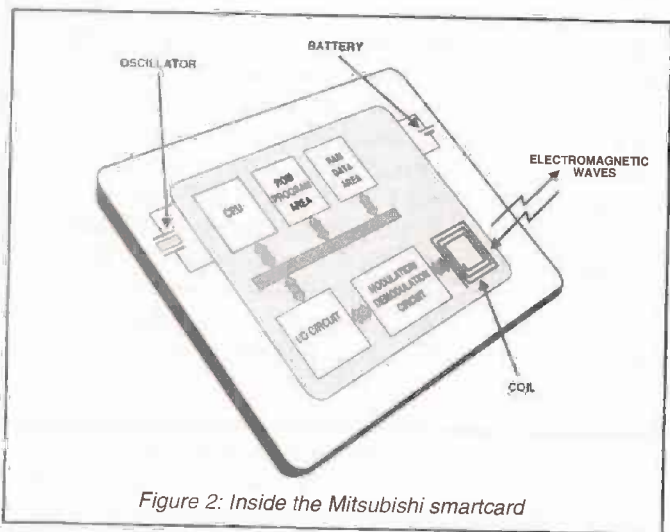

Figure 2: Inside the Mitsubishi smartcard

This card has been designed to operate as part of a system comprising a read/write device, attached to a computer network for data I/O read and write operations, as shown in Figure 3. In operation, the card is presented near to the reader/writer head, which automatically transmits data at up to 25.6Kbps, sufficient to allow a typical operation to take place in less than 0.2 seconds.

The data is transferred between the card and the terminal

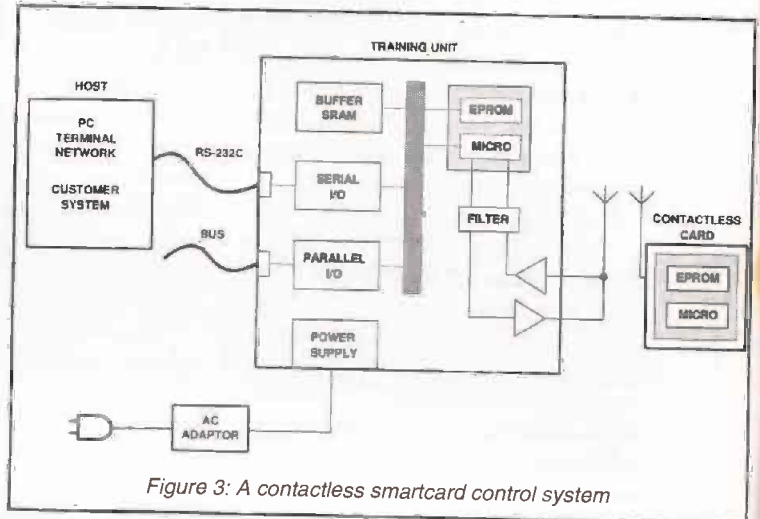

Figure 3: A contactless smartcard control system

using a strict communications protocol, which is shown in Figure 4. The data is transferred using a radion link that is based on

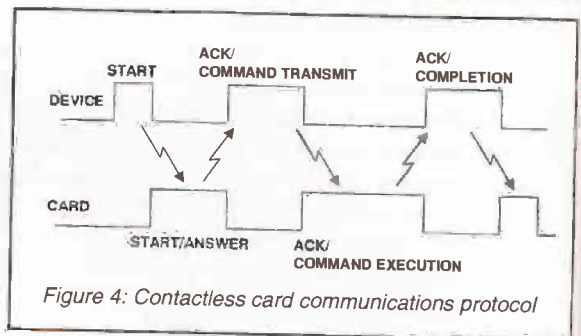

Figure 4: Contactless card communications protocol

Amplitude Shift Key, or ASK, modulation, as shown in Figure 5. The frequency can be customised for different applications and the actual data is transferred in packets, using the command and response format shown in Figure 6.

For readers who are interested in developing their own applications based upon smartcards, Mitsubishi can provide a contactless card development kit. This costs £799 and consists of three contactless cards, a card transceiver which can be connected directly to a PC and appropriate PC software and documentation. For more details contact Mitsubishi Electric UK Ltd., of Hatfield, on 0707 278652.

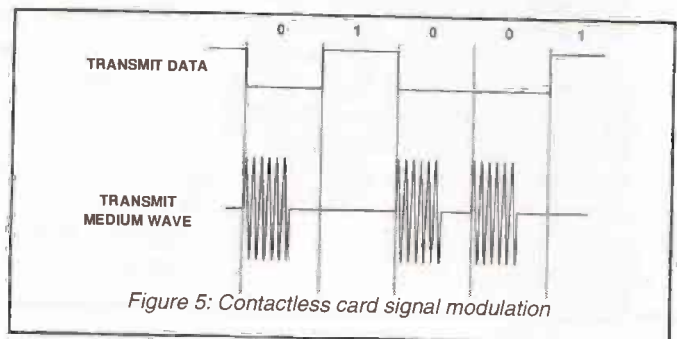

Figure 5: Contactless card signal modulation

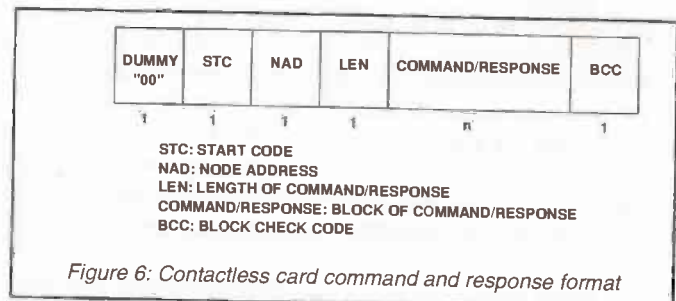

Figure 6: Contactless card command and response format

EXPRESS COMPONENTS

MAINS IONIZER KIT. Very useful kit that increases the flow of negative ions, helps clear cigarette smoke, dust, pollen etc. Helps reduce stress and respiratory problems. £15, kit, £20 built.

COMBINATION LOCK Electronic 9 key combination lock suitable for alarms, cars, houses etc, easily programmable. Includes mains 2A relay o/p 9v operation. £10 kit, £14 built.

VARIABLE POWER SUPPLY. Stabilized, short circuit protected. Gives 3-30v DC at 2.5A, ideal for workshop or laboratory. £14 kit, £18 built. 24VAC required.

LEADACID CHARGER. Two automatic charging rates (fast and slow), visual indication of battery state. Ideal for alarm systems, emergency lighting, battery projects etc. £12 kit, £16 built.

PHONE LINE RECORDER. Device that connects to the 'phone line and activates a cassette recorder when the handset is lifted. Ideal for recording 'phone conversations etc! £8 kit, £12 built.

ROBOT VOICE. Turns your voice into a robot voice! answer the phone with a different voice! £9 kit, £13 built.

PHONE BUG DETECTOR This device will warn you if somebody is eavesdropping on your 'phone line. £6 kit £9 built.

PHONE BUG. Small bug powered by the telephone line. Only transmits when the phone is used. Popular surveillance product £8 kit, £12 built.

STROBE LIGHT. Bright strobe light with an adjustable frequency of 1-60hz. (a lot faster than conventional strobes!) £16 kit, £20 built.

4W FM TRANSMITTER 3 RF stages, audio preamp. 12-18vDC. Medium powered bug £20 kit, £28 built.

3 CHANNEL LIGHT CHASER 3x 800w output, speed and direction controls, can be used with 12 led's (supplied) or TRIACS for mains lights (also supplied). 9-15v DC. £17 kit, £23 built.

25W FM TRANSMITTER. 4 stage, a preamp will be required. (Our preamp below is suitable) £79 built (no kits).

SOUND EFFECTS GENERATOR. Produces any thing from bird chips to sirens! add sounds to all sorts of things. £9 kit £13 built.

FM/AM SCANNER Well not quite, you have to turn the knob yourself but you will hear things on this radio (even TV) that you would not hear on an ordinary radio! A receiver that covers 50-160MHz both AM and FM Built in 5w amplifier. £15 kit, £20 built.

CAR ALARM SYSTEM. Works on vibration and/or voltage drop from door etc being opened. Entry and exit delays plus adjustable alarm duration. Low cost protection! £12 kit, £16 built.

15W FM TRANSMITTER. 4 stage, high power bug. You will need a preamp for this (see our preamp below which is ok) £69 built. (no kits).

1W FM TRANSMITTER. 2 stage including preamp and mic. Good general purpose bug. 8-30VDC. £12 kit, £16 built.

50 I/C's for £1.50
Nice mix of chips at a bargain price!

CERAMIC CAPACITOR PACK
Good mixed pack of 100 capacitors for just £1.00

ELECTROLYTIC PACK 1
100 small mixed electrolytic capacitors just £1.00

ELECTROLYTIC PACK 2
50 larger electrolytic mixed capacitors

RESISTOR PACK NO 1
250 low wattage resistors, ideal for most projects etc. Just £1.00

RESISTOR PACK NO 2
Hi wattage pack, good selection of mixed wattages and values 50 in all, bargain price just £1.00

PRESET PACK
Nice selection of 25 mixed preset pots for just another £1!

RELAY PACK NO 1
6 mixed relays for £1, that's just 17p each.

CONNECTOR PACK
10 different connectors, again for £1

FUSE PACK NO 1
40 mixed 20mm fuses, ideal for repairs etc, or just to stock up the spares box! Just £1.00

FUSE PACK NO 2
30 mixed 1.25" fuses again ideal for spares etc. Just £1.00

WIRE PACK
25 Metres of insulated wire for just £1.00, good for projects etc.

SLEEVING PACK
100 assorted pieces of sleeving for connectors etc. Yours for just £1.00

DIODE PACK
100 assorted diodes for just £1.00

LED PACK
20 light emitting diodes for £1.00

TRANSISTOR PACK
50 mixed transistors, another bargain at £1.00

BUZZER PACK
10 things that make a noise for just £1.00!

POT PACK
10 pots for £1, (5 different types) a snip at £1.00

DISPLAYS
10 seven segment displays for £1.00

ORDER 10 PACKS OR MORE AND CHOOSE ONE FREE PACK!!

FREE COMPONENT CATALOGUE WITH EVERY ORDER!!!

99p Post

BULK PACKS

PREAMP MIXER. 3 channel input, independent level and tone controls. Ideal for use with the hi power FM transmitters. £15 kit, £19 built.

TREMBLER ALARM. Designed for bikes etc, adjustable sensitivity, preset alarm time, auto reset. Could be adapted for all sorts of "borrowable" things £12 kit, £16 built.

ULTRASONIC RADAR A project that can be used as a movement detector in an enclosed space. Range about 10 metres, 12vDC. Good basis for car, shed, caravan alarm etc £14 kit, £19 built.

PHONE CALL RELAY Very useful kit that incorporates a relay that operates when the phone rings. Can be used to operate more bells, signalling lights etc. Good for noisy environments or if you have your headphones on! £10 kit, £14 built.

PORTABLE ALARM SYSTEM. Small 9v alarm system based on a mercury switch. The alarm continues to sound until disabled by the owner. Buzzer included £11 kit £15 built.

800W MUSIC TO LIGHT EFFECT. Add rhythm to your music with this simplesound to light kit. £8 kit, £12 built.

MOSQUITO REPELLER. Modern way to keep the midges away! Runs for

about a month on one 1.5v battery. Frequency is set to drive away mosquitos etc. £7 kit, £11 built.

3 CHANNEL SOUND TO LIGHT. Can be used anywhere as no connection is made to hi fi. Separate sensitivity controls for each channel, 1,200w power handling. Microphone included. £14 kit, £19 built.

MINI METAL DETECTOR. Detects pipes, wires etc up to 20cm deep. Useful before you drill those holes! £8 kit, £12 built.

0-5 MINUTE TIMER. Simple time switch adjustable from 0-5 mins, will switch 2A mains load, 12v op. Ideal for laboratory, photographic projects etc. £7 kit, £11 built.

7 WATT HI FI AMPLIFIER. Useful, powerful amplifier 20hz-15hz, 12-18vdc. Good for intercoms, audio systems, car etc £7 kit £11 built.

IN CAR SOUND TO LIGHT. Put some atmosphere in your car with this kit. Each channel has 6 led's that create a beautiful lighting effect! £10 kit, £14 built.

VOX SWITCH. This is a sound activated switch, ideal for use on transmitters, CB's, tape recorders etc. Adjustable sensitivity, built in delay. Mic input £7 kit, £11 built.

KITS 'N MODULES

LIQUID LEVEL DETECTOR. Useful item, can be used to detect fluid levels in watertanks, baths, ponds, fish tanks etc. Could also be used as rain alarm with an easily constructed sensor. £5 kit, £9 built.

FM TRANSMITTER. Mini FM transmitter 2 transistor, comes with FET miniature mic and is tuneable from 63 to 130MHz. £7 kit, £11 built.

FUNCTION GENERATOR. Generates sinusoidal, saw tooth and square waveforms from 20hz up to 20khz. Separate level controls for each waveform. 24vac. £15 kit, £20 built.

5 WATT SIREN. Powerful siren kit with an impressive 5 watts output. Ideal for alarms etc. £6 kit £10 built.

TELEPHONE AMPLIFIER. Very sensitive amplifier which using a 'phone pickup coil (supplied) will let you fol-

low a telephone conversation without holding the handset to your ear! £11 kit £15 built.

SWITCH PACK
10 switches for just £1.00

12v FLOURESCENT. A useful kit that will enable you to light large flourescent tubes from your car battery etc. 9v mains transformer required. £8 kit, £12 built.

KNOB PACK
10 knobs for just £1.00

REMEMBER! YOUR FREE COPY OF OUR CUT PRICE COMPONENTS CATALOGUE SENT WITH EVERY ORDER!!!

How to place your order.....
By phone.....0273 771156
By FAX.....0273 206875
By Post...PO box 517 Hove Sussex BN3 5QZ
Payment by ACCESS, VISA, CHEQUE OR POSTAL ORDER.
Cheques and postal orders should be payable to Express Components.
ALL PRICES ARE SUBJECT TO 99p POST AND VAT. Some of our products may be unlicensable for use in the UK (particularly the FM transmitters)

Breakout Box

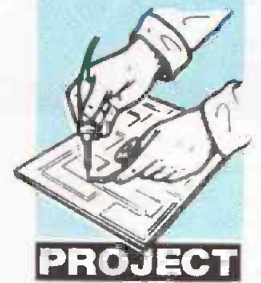

Computer owners will find this design from Robert Penfold an indispensable tool when trying to solve those all too common compatibility problems associated with serial data communications

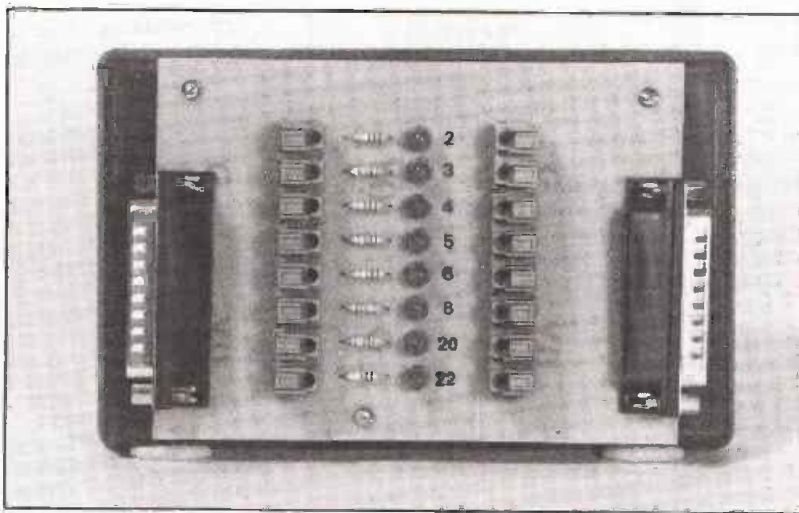

used, or by way of jumper leads which permit practically any desired method of connection to be achieved. The unit featured here uses the jumper lead method and the use of spring-loaded terminal blocks enables it to be quickly and easily reconfigured. It incorporates a number of LED indicators which show the logic levels present on the main input/output lines. These are particularly useful when trying to establish which lines are inputs and which are outputs, as well as when trying to set up the correct handshaking protocol.

RS232C Basics

The standard connector for RS232C ports is the 25 way D type, but many serial computer ports use a different connector and a somewhat cut-down version of the RS232C interface. This

is of largely academic importance, since the serial cables for these computers have a standard 25 way D connector at the end which connects to the peripheral. As we shall see, in a computing context the missing lines are of no importance. Figure 1 shows the connections for a standard 25 way serial port and for the typical cut-down computer version used on the IBM PC AT and compatibles.

Some of the pins on the standard 25 pin serial port are unused. Others are secondary lines which act as back-ups to the main lines, or have functions that are only appropriate to synchronous serial communications. In a computer context,

The world of computing is well known for its so-called standards that in reality are 'near misses'. Some computer ports conform properly to the electrical standards, but use some non-standard form of connector. Others use the right type of connector, but not necessarily with the right set of pin functions. Some do not seem to fully conform to any known standard, but are usable if you persist long enough with the interconnections, trying all the possible permutations!

Parallel printer ports have not been without their idiosyncrasies over the years, but RS232C (V24) serial ports are probably the more contentious of these two popular forms of computer interface. In theory, it should be quite simple to interconnect two devices via an RS232C style serial interface, but 'real world' ports can be quite troublesome. Matters are complicated by the fact that this type of port exists in two different forms and variations in the handshake lines further confuse the situation.

An RS232C breakout box is a device which makes it relatively quick and easy to find the right set of interconnections. It consists basically of two connectors, one of which connects to the computer while the other is coupled to the peripheral device (printer, modem, etc.). The two connectors are wired together via switches which permit various connection methods to be

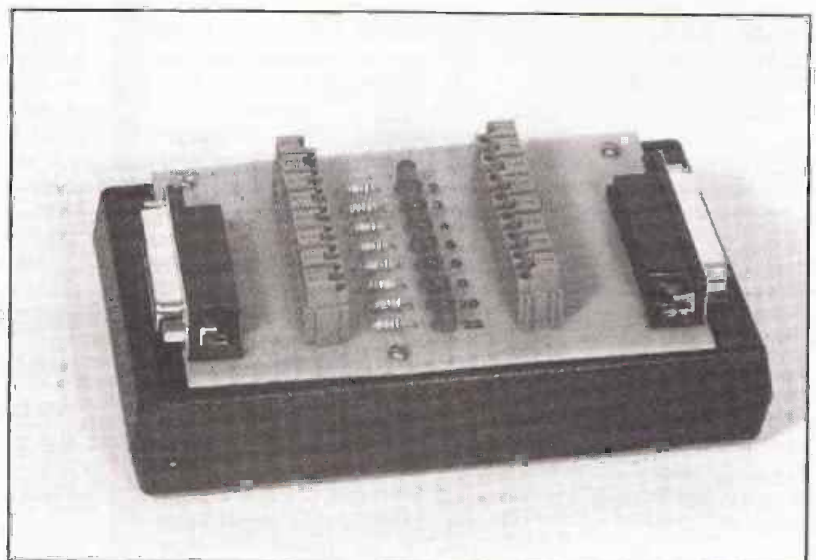

RS232C ports are only used for asynchronous communications where the data is transmitted at one of several standard baud rates. The synchronisation signals are sent on the same lines as the data, with no clock or other synchronisation signals being sent on separate lines. It is for this reason that cut down ports such as the PC AT type are perfectly acceptable. The missing sixteen pins serve no useful purpose in a computer interfacing context. In most cases some of the nine pins that are present are left unused.

For a basic two-way serial link, only three lines are required. One of these is simply the connection between the signal grounds of the two units, while the other two interconnections cross-couple the transmit and receive pins of the two units.

These are pins 2 and 3 respectively. Of course, one of these cross-couplings is omitted if communications in only one direction is required. A serial link can therefore be as basic as a simple two-wire link, but in practice it is often necessary to implement something more than a simple two or three wire link. The main problem with a basic serial link of this type is that it does not permit hardware handshaking. In some cases the receiving device will be able to keep up with a steady flow of data, but many peripherals can not do so. For example, printers and plotters are relatively slow devices, which may not be able to cope with more than a few bytes per second. Handshaking enables the receiving device to control the flow of data so that it does not become overloaded.

Handshaking can be achieved purely in software. The peripheral device sends a special code to the main unit to halt the flow of data, and another code to start the flow once again. These codes are sent down the same wires that are used to carry data and this is known as software handshaking, or 'XON - XOFF' handshaking.

Although described as software handshaking, there is actually a hardware element in this system as it requires three connecting wires, even if communication is only in one direction. This is a point which should be borne in mind when wiring up a system that uses XON - XOFF handshaking. Hardware handshaking requires an extra line to carry the on/off signal. For two way communications, two handshake lines are required, with separate lines being used to control the flow of data in each direction. Hardware handshaking works on the basis of the receiving device producing a positive voltage to permit the data to flow, or a negative voltage to halt it.

This method is clearly incompatible with software handshaking, so it is not acceptable to have one unit set for software handshaking and the other set to use the hardware variety. There are several handshake inputs and outputs on an RS232C serial port and it is largely this factor which complicates the interconnection of two serial ports. If there is

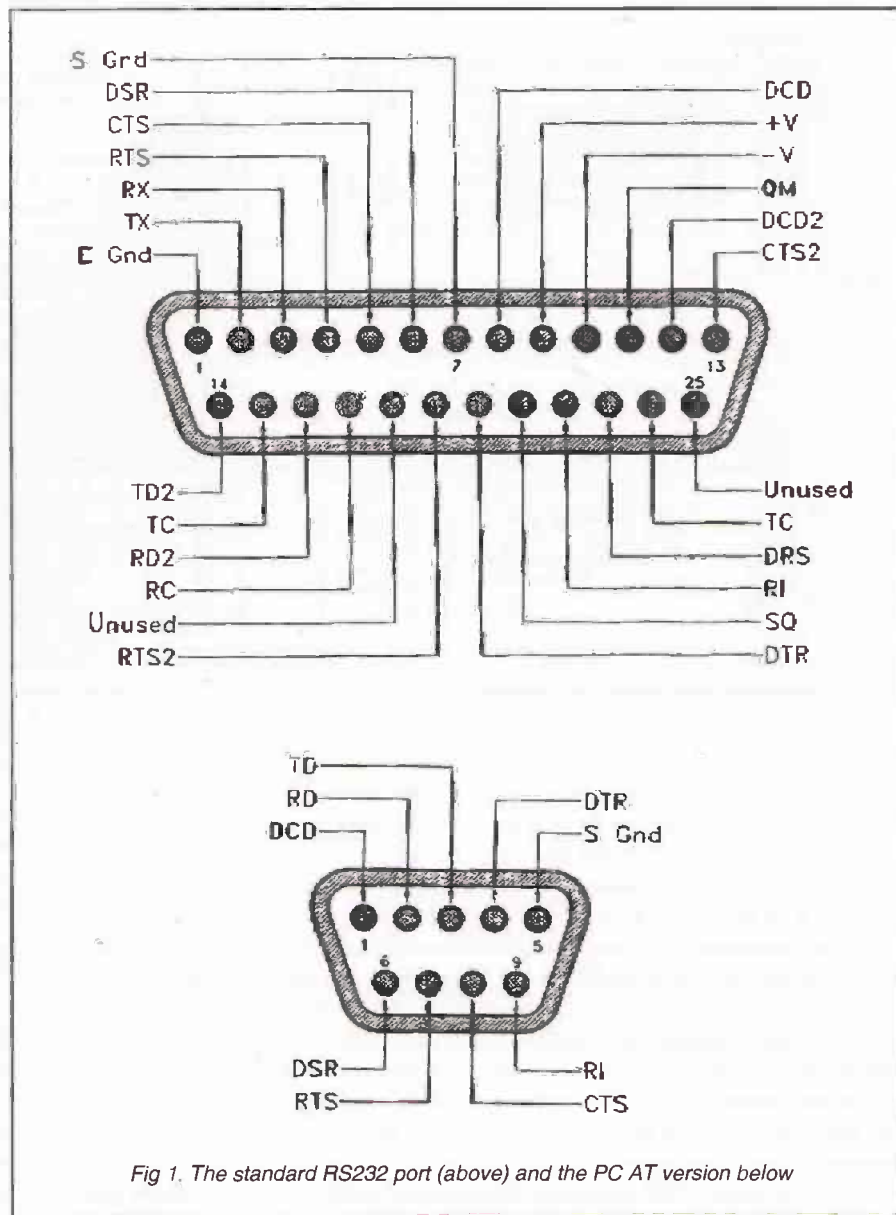

Fig 1. The standard RS232 port (above) and the PC AT version below

such a thing as the standard method of RS232C handshaking, the way in which it is meant to function is far from clear.

The handshaking can be controlled by the RTS (request to send) and CTS (clear to send) lines. The RTS pin is an output on the receiving device and it is set high by the receiving device when it is ready to receive data. It is set low in order to halt the flow of data. RTS is coupled to the CTS input on the sending device, which should obviously send data only when CTS is taken high. In practice, CTS is simply set high all the time on many devices, particularly printers and in most cases it seems to be DSR (data set ready) and DTR (data terminal ready) that actually control the flow of data.

DTR is an output on receiving devices and it is set high when the device is ready to receive data. DTR is connected to DSR on the sending device and the latter will only send data when DSR is taken high. The RI (ring indicator) and DCD (data carrier detect) are used with modems. They respectively indicate that the modem has detected a ringing signal and that it has detected a carrier signal. They are not normally used in general serial interfacing, although DCD does sometimes seem to be used as a sort of off-line/on-line indicator.

Two Of A Kind

There are two basic categories of RS232C equipment. These are data terminal equipment (DTE) and data circuit-terminating

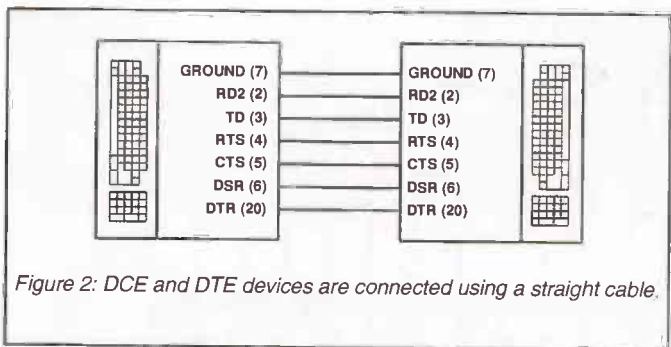

Figure 2: DCE and DTE devices are connected using a straight cable.

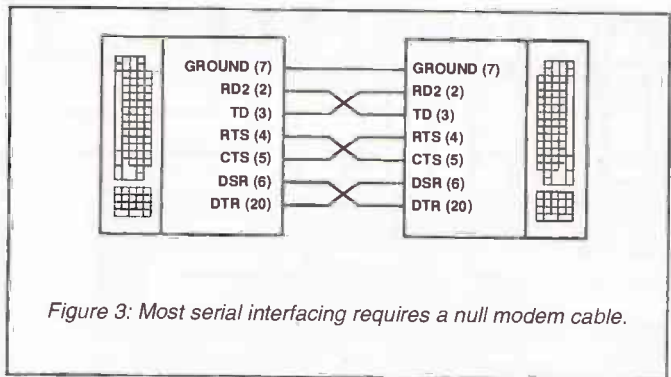

Figure 3: Most serial interfacing requires a null modem cable.

equipment (DCE). The latter is also known as data communications equipment. In general, DTE units are computers or some other major item of equipment at the heart of the system. DCE units are peripheral devices, such as printers, or plotters.

It is usually possible to tell which category a particular device falls into by looking at the 25 way D connector. If it is a plug, the unit is probably a DTE device - if it has a socket it is probably a DCE device. This is not a completely reliable method though, and many printers have a 25 way D socket but are actually examples DTE equipment. The difference between these two types of equipment is simply that DTE devices transmit data on pin 2 (TX), and receives it on pin 3 (RX). In other words, DTE equipment has a normal serial interface. DCE devices transmit data on pin 3 and receive it on pin 2. They have handshake lines which operate in the same topsy-turvy fashion, with inputs that are actually outputs, and vice-versa. The point of all this is that it enables a 'straight' lead to be used to connect a DTE unit to a DCE device. In other words, each pin on one connector is coupled to exactly the same pin on the other connector. Figure 2 shows this method of connection.

This is the method of connection normally used with modems, but this seems to be its only common computing application. Of course, this 'straight' method of connection is of no use when trying to interface one DTE unit to another. It would result in inputs being connected to inputs and outputs being coupled to outputs. RS232C outputs have current limiting, so this should not result in any damage to the equipment, but it will certainly not result in a data exchange either. When connecting one DTE unit to another DTE device (or when interfacing two DCE units) a so-called 'null-modem' cable is required. This has the data and handshake lines cross-coupled, as shown in Figure 3. It is a cable of this type that is normally required when connecting two computers together, or when connecting a computer to a printer or plotter.

The Circuit

The circuit diagram for the RS232C breakout box appears in Figure 4. SK1 and SK4 are the 25 way D connectors at the

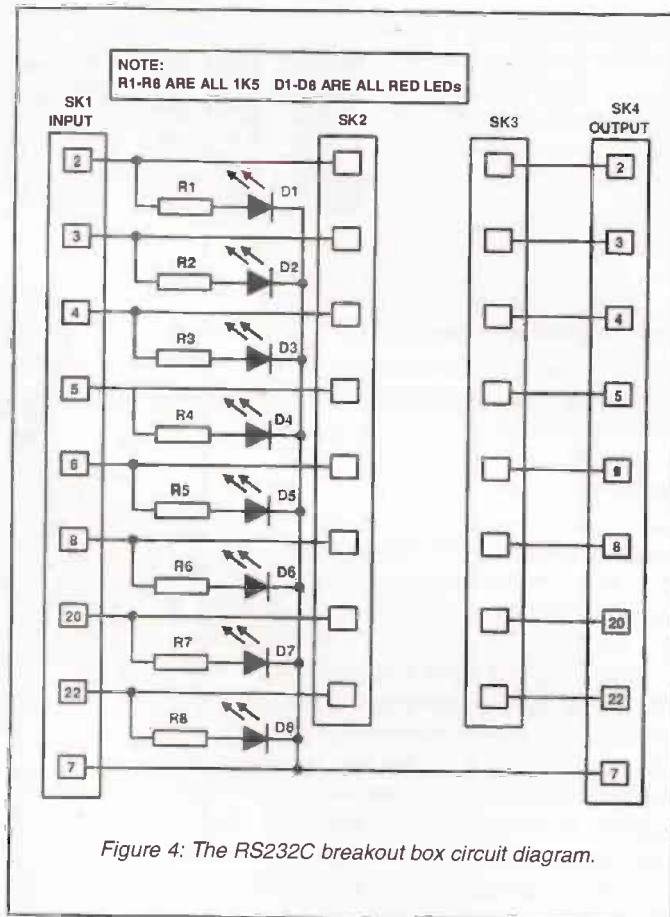

Figure 4: The RS232C breakout box circuit diagram.

notional input and output of the unit. In practice it is probably best to connect SK1 to the computer and SK4 to the peripheral device, but the unit can be used either way round. SK3 and SK4 are the spring-loaded terminal blocks rather than true sockets. These connect to the eight lines of the serial ports that are most likely to be implemented. The signal ground pins (the two pin 7s) are permanently wired together as these must always be interconnected, regardless of what other interconnections are used.

Eight LEDs on the input side of the unit indicate the state of each input/output line of SK1. Of course, once the interconnections are in place, these LEDs also indicate the states of the relevant pins of SK4. RS232C ports do not operate at normal 5V logic levels, but instead use voltages of approximately plus and minus 12V. The 1k5 current limiting resistors therefore set the LED current at about 6ma or so. This is high enough to give good LED brightness, but low enough to ensure that the LEDs do not excessively load the port outputs.

When connected with the polarity shown in Figure 4, a LED will switch on when the line driving it goes to +12V (the active state). When the line goes negative the LED will probably avalanche like a Zener diode, but the current limiting resistor will prevent it from being damaged. The resultant reverse current flow will not cause the LED to light up. If you would prefer the LEDs to switch on when the lines driving them are negative, simply connect them with the opposite polarity. Construction Units of this type can be hard wired, but construction is easier and more straightforward if the unit is based on a printed circuit board. Figure 5 shows the component overlay for this design. Note that SK1 and SK4 must be 25 way D plugs and not sockets. Sockets will fit onto the board properly, but the pin numbering for a socket is a 'mirror-image' of that for a plug. This would result in the terminal blocks to a large extent connecting to the wrong pins or the input and output connectors.

Two eight way terminal blocks are required. The correct spring-loaded terminal blocks are only sold as 2 way and 3 way blocks. The cheapest way to make up each eight way block is to use two 3 way blocks and one 2 way type, but four 2 way blocks will work just as well. The blocks interlock and it is easier if they are fitted together first, then fitted onto the board. The board does not provide a connection between pin 1 on SK1 and pin 1 on SK4 (the frame grounds or chassis connections). This connection can be hard wired if desired, but it is not really of any great consequence. It is probably not worthwhile fitting the unit into a case, but it is a good idea to mount it on a plastic box or a baseboard of some kind. Apart from giving a neater appearance, this will add strength to the unit and prevent the connections on the underside of the board from scratching practically any surface on which the unit is placed.

The terminals in the blocks and LEDs are arranged in the logical order. Working from top to bottom, they connect to pins 2, 3, 4, 5, 6, 8, 20, and 22. It is not essential to mark pin numbers onto the board, but mistakes are less likely to occur if the terminals and (or) LEDs are clearly labelled.

In Use

The best wire for making the connections between the terminal blocks is a fairly stout single core insulated type. If multi-strand wire is used, solder the ends of the leads so that the strands of wire are held together. The leads only need to be about 100 mm long and should have about 10mm of insulation removed from each end. Using the breakout box is likely to be easier if leads of several different colours are used. Different coloured leads should reduce the risk of wiring errors and make it easier to spot any that should occur.

It is quite easy to make the connections to the terminal blocks, but unless you have small fingers it will be easier to operate the spring-loaded levers using a small screwdriver. Make sure that the ends of the leads are fully pushed down into the holes in the blocks so that reliable connections are made. With the breakout box connected to the computer and the peripheral, it is quite likely that all the LEDs will remain switched off (i.e. all the outputs connecting to SK1 will be in an inactive state). It seems to be quite normal for serial ports to be totally inactive until some data is sent to them.

If the system is set to use software handshaking, it should only be necessary to get pins 2 and 3 coupled correctly. There may be some initial activity on some of the handshake lines, but the receiving device should simply ignore the handshake lines and respond to the XON and XOFF codes. In some cases, no handshaking will be used at all, but this is usually only possible when the software takes control of the computer's serial port. Software which provides high speed computer to computer links is often of this type. However, normal serial

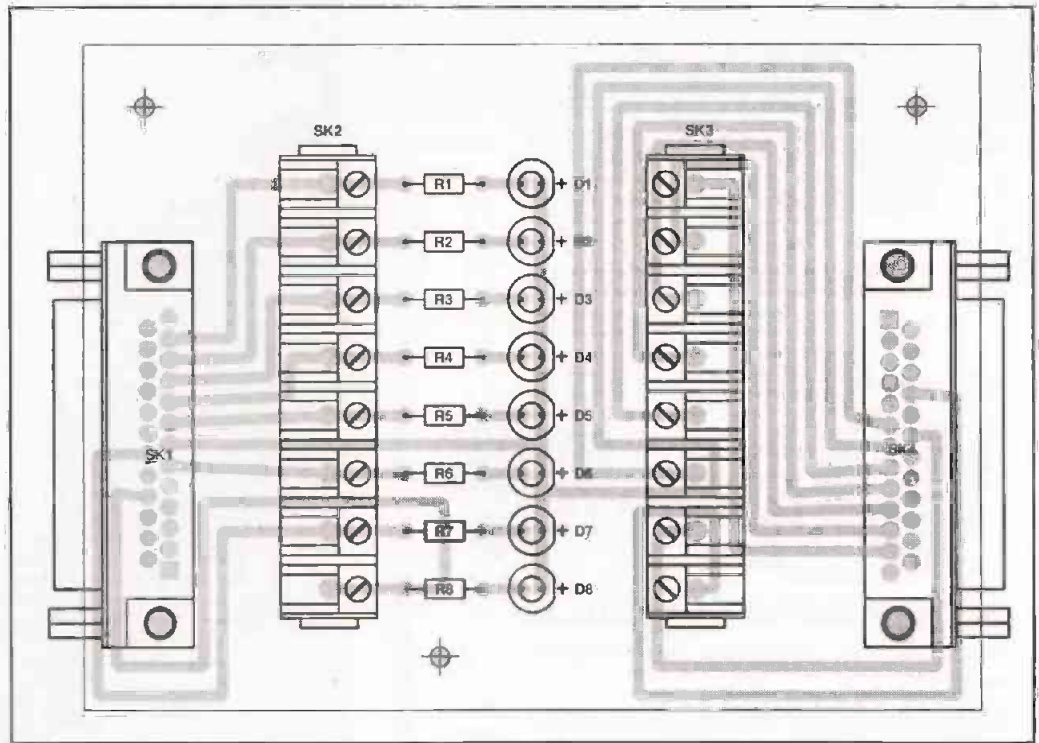

Figure 5: The component layout for the RS232C breakout box.

communications under the control of the operating system usually requires some form of handshaking, even if the peripheral device will never actually provide a hold-off. This can be problematic if the peripheral device does not provide handshake outputs.

A solution which is normally effective is to use the computer's own handshake outputs to switch on its handshake inputs. In other words, link pins 3 and 4, and pins 6 and 20 of SK1. When hardware handshaking is to be utilised, and the peripheral device does have handshake outputs, it is a matter of first trying the standard methods of interconnection that were discussed previously. If these do not work it is possible that one of the handshake lines on a peripheral device is not implemented, or is failing to go to the active state for some reason. In either case a lack of response from the appropriate LED should indicate that one of the handshake lines is not present and correct. Satisfactory operation is usually obtained if both pin 4 (RTS) and pin 20 (DTR) are driven from the single handshake output of the peripheral that is responding properly.

If you are unsure if a port is a DTE or a DCE type, couple it to SK1 using an ordinary null-modem cable. It is possible that none of the LEDs will switch on initially, but some should light up if data is sent to the port. If the LEDs for pins 5 and 6 switch on, the port is a DTE type. If the LEDs for pins 4 and (or) pin 20 switch on, the port is a DCE type.

PARTS LIST

R1 to R8	1k5	0.25 watt 5% carbon film (8 off)
D1 to D8		5mm red LEDs (8 off)
SK1, SK4		25 way D plugs, right angle printed circuit mounting type (2 off)
SK3, SK4		Printed circuit mounting spring-loaded terminal blocks, 3 way (4 off) and 2 way (2 off)
		Printed circuit board, box or baseboard, solder.
		The terminal blocks are Maplin order codes



UK Distributor for the complete ILP Audio Range

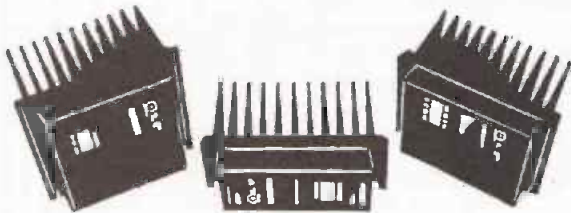

BIPOLAR AMPLIFIER MODULES

Encapsulated amplifiers with integral heatsink.

HY30P	15W Bipolar amp	£9.95
HY60	30W Bipolar amp	£12.62
HY6060	30W Stereo Bipolar amp	£26.46
HY124	60W Bipolar amp (4 ohm)	£20.69
HY128	60W Bipolar amp (8 ohm)	£20.69
HY244	120W Bipolar amp (4 ohm)	£27.38
HY248	120W Bipolar amp (8 ohm)	£27.38
HY364	180W Bipolar amp (4 ohm)	£42.86
HY368	180W Bipolar amp (8 ohm)	£42.86

MOSFET AMPLIFIER MODULES

Encapsulated amplifiers with integral heatsink.

SMOS60	30W Mosfet amp	£23.15
SMOS6060	30W Stereo Mosfet amp	£39.95
SMOS128	60W Mosfet amp	£30.95
SMOS248	120W Mosfet amp	£42.50

CLASS A AMPLIFIER MODULE

Encapsulated Class A amplifier with integral heatsink

HCA40	20W Class A amp	£36.60
-------	-----------------	--------

POWER SUPPLIES

Full range of transformers and DC boards available for the above amplifiers.

100 VOLT LINE TRANSFORMERS

Full range of speech and music types for amplifiers from 30 watt to 180 watt

PREAMPLIFIER MODULE

General purpose preamplifier for a wide range of applications.

Prices include VAT and carriage



Quantity prices available on request

Write, phone or fax for free Data Pack

Jaytee Electronic Services

Unit 171/172, John Wilson Business Park,
Whitstable, Kent CT5 3RB. U.K.
Tel: (0227) 265333 Fax: (0227) 265331

The Complete Range for PC Based Engineering & Scientific Applications

MEASUREMENT DATA ACQUISITION & CONTROL BOARDS

AR-B3001	16 Channel, 12Bit A/D Card	£66
AR-B3201	8 Channel, 12Bit A/D + 3 Channel D/A Card	£96
AR-B3204	16 Channel, 12Bit, Data Acquisition & Control Card, Progr Gain	£235
PCL-7118	8 Channel, 12Bit, Data Acquisition & Control Card, Progr Gain	£198
PCL-812-PC	16 Channel, 12Bit, Data Acquisition & Control Card, Progr Gain	£286
PCL-813	32 Channel, 12Bit, Data Acquisition Card	£325
PCL-818H	High Performance 16 Channel, 12Bit Data Acq & Control Card	£442
PCL-814	Modular Multifunction 16 Chan, 14Bit, Data Acq & Control Card	£637
PCL-816	Modular Multifunction 16 Chan, 16Bit, Data Acq & Control Card	£904
PCL-860	4 1/2 Digit Voltmeter (DGV/AD/DCR) Card	£369
AR-B2001	16 Channel Opto-Isolated Digital I/P Card	£52
AR-B2102	16 Channel Relay Switch Card	£74
AR-B2201	64 Channel Digital I/O Card	£41
AR-B9221	3 Port (24 Bit) Digital I/O, 3 Chan Counter/Timer, Prototype Card	£41
AR-B9111	16 Channel SS-T Switching Card (For AR-B9221)	£242
PCL-727	32 Digital I/P + 32 Digital O/P, 8 Channel Timer/Counter	£126
PCL-722	144 Bits (4*36) of Buffered Digital I/O	£247
PCL-724	24 Bit Digital I/O Card	£77
PCL-725	8 Channel Relay + 8 Channel Isolated Digital I/P	£166
PCL-726	6 Channel 12 Bit D/A Output Card (16 Digital I/P + 16 O/P)	£317
PCL-838	Stepper Motor Control (3 Mtrs), 16 Digital I/P + 16 O/P	£316
PCL-750	Prototype Development Card	£66
PCL-755A	Slot Extension Card (AT)	£44
PCL-756	PC-Bus 8 Bit Switch/Extension Card	£125
PCX-794	PC BUS Expansion System (Master-Slave Cards, 1m Cable)	£211
PCL-930	10 Channels of 16Bit Timer (AMD9513)	£204

SIGNAL CONDITIONING/CONTROL BOARDS (For use with PCL cards)

PCLD-762	Opto Isolated Digital I/P (16 Channel)	£132
PCLD-765	16 Channel Relay O/P Board	£163
PCLD-767	8 Channel Sample & Hold Card	£361
PCLD-788	Relay Scanner/Multiplexer Board	£196
PCLD-779	8 Channel Isolated Relay Mux and Amplifier Board	£264
PCLD-789	Amplifier & Multiplexer Board	£243

COMMUNICATIONS & INTERFACE BOARDS (RS232/422/423/485/IEEE-488)

I-104	4 Port Serial RS232 PC Card	£59
PCL-743	Dual Port RS422/485 PC Interface Card	£82
PCL-844	Intelligent 8 Port RS232 PC Card with on-board CPU	£380
AR-B9011	Dual Port RS422/485 PC Interface Card	£68
PC-232-485	RS232-RS485/422 Converter Adaptor, Self Powered	£62
PCL-848A	IEEE-488 Interface Board	£220

ADAM REMOTE/DISTRIBUTED MODULAR DATA ACQUISITION MODULES

ADAM-4001	Analogue Input Module (mV, V, mA, Thermocouple)	£163
ADAM-4021	Analogue Output Module (V or mA)	£163
ADAM-4050	Digital Input/Output Module	£119
ADAM-4060	Relay Output Module	£119
ADAM-4920	Isolated RS-232/RS-485 Converter Module	£89

19" RACK MOUNTING MULTI-SLOT INDUSTRIAL PC CHASSIS

AR-IPC14A	Industrial 19" Rack Mount Chassis, 14 Slot, 200W PSU	£439
AR-IPCMB	Industrial 19" Rack Mount Chassis, M/Board lifting, 200W PSU	£398
IPC-610A	Industrial 19" Rack Mount Chassis, 14 Slots, 250W PSU	£717
IPC-610MB	Industrial 19" Rack Mount Chassis, M/Board lifting, 250W PSU	£644
IPC-6520	19" Rack Mount Monitor Kit for 14" Monitor	£362
IPC-6305	19" Rack Mount Keyboard & Drawer, Telescopic Slide	£278

PC-BUS CARD CHASSIS FOR EMBEDDED APPLICATIONS

IPC-6706	PC-Bus Card Cage Enclosure Chassis (6 Slot Passive Backplane)	£176
IPC-6806	6 Slot Active IPC Chassis, 150W PSU, FD + HD Disk Mountings	£210
AR-IPC6MP	6 Slot Active IPC Chassis, 200W PSU, FD + HD Disk Mountings	£260
MBPC-640	Micro-Box Industrial PC Chassis (3 Slot Backplane)	£136
PCXU-205	PC BUS Expansion Unit (6 Slot Backplane & Power Supply)	£176
IPC-6010	8 Slot Backplane Card Cage (6*16 + 2*8 Bit), card clamp, speaker	£192
AR-CC6LP	6 Slot (16 Bit) Backplane Card Cage, Full Length, 150W PSU	£227
AR-CC11LP	11 Slot (16 Bit) Backplane Card Cage, Full Length, 160W PSU	£246

SOLID STATE FLASH/SRAM/ROM DISK CARDS

AR-B7008	512K ROM or 256K SRAM Disk Card	£63
AR-B7010	512K ROM Disk Card	£45
AR-B7040	4MB Flash/SRAM/ROM Disk Card	£96
PCD-890	12MB Flash/SRAM/ROM Disk Card, Dual Floppy Emulator	£199
PCD-892B	6MB Flash/ROM Disk Card	£117

Plus MUCH more...

Please CALL for your FREE copy of our latest Catalogue

OEM, Dealer & Educational Enquiries Welcome

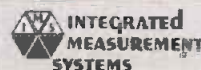

Integrated Measurement Systems Ltd,
305-308 Solent Business Centre, Millbrook Rd West
Southampton SO1 0HW, HAMPSHIRE
Tel: (0703) 771143 Fax: (0703) 704301

Designers & Suppliers of Measurement, Test & Control Systems & Software.



ESR ELECTRONIC COMPONENTS

Station Road, Cullercoats,

Tyne & Wear NE30 4PQ

Tel. 091 251 4363

Fax. 091 252 2296

74LS Series		4000 Series		TRANSISTORS		LINEAR ICs		SOLDERING IRONS		RF CONNECTORS			
74LS00	£0.22	4000	£0.17	2N1613	£0.31	BC186	£0.33	8D534	£0.47	CA311E	£0.28	BNC Solder Plug 50R	£0.93
74LS01	£0.14	4001	£0.21	2N1711	£0.26	BC204C	£0.72	8D535	£0.48	CA32A	£0.35	BNC Solder Plug 75R	£0.96
74LS02	£0.14	4002	£0.17	2N1893	£0.29	BC206B	£0.72	8D536	£0.85	CA358	£0.22	BNC Crimp Plug 50R	£0.68
74LS03	£0.14	4006	£0.40	2N218A	£0.28	BC207C	£0.72	8D649	£0.52	CA741 CE	£0.25	BNC Crimp Plug 75R	£0.68
74LS04	£0.14	4007	£0.28	2N219A	£0.29	BC208	£0.72	8D648	£0.52	CA747CE	£0.39	BNC Solder Plug	£1.08
74LS05	£0.14	4008	£0.31	2N222A	£0.18	BC209A	£0.72	8D650	£0.52	CA3046	£0.37	BNC Chassis Skt	£0.80
74LS06	£0.14	4009	£0.19	2N226A	£0.80	BC212	£0.08	8D707	£0.42	CA3086	£0.72	PL259 5 2mm	£0.68
74LS07	£0.14	4010	£0.23	2N2904A	£0.26	BC212L	£0.08	8D807	£0.80	CA3130	£0.42	PL259 11mm	£0.62
74LS10	£0.14	4011	£0.28	2N2905A	£0.23	BC212LB	£0.08	8D832	£1.78	CA3130E	£0.98	RND UHF socket	£0.68
74LS107	£0.23	4012	£0.16	2N2907	£0.20	BC213	£0.08	8D833C	£0.48	CA3140	£0.56	F Plug RG6	£0.27
74LS109	£0.21	4013	£0.21	2N2926	£0.16	BC213L	£0.08	8D834C	£0.50	CA3140E	£0.42	F Plug RG6	£1.50
74LS11	£0.17	4014	£0.30	2N3053	£0.27	BC214	£0.08	8D853C	£0.47	ICL7621	£1.70	N Socket RG8	£1.40
74LS112	£0.21	4015	£0.31	2N3054	£0.90	BC214L	£0.08	8D854C	£0.50	ICM7558	£0.42	BNC Crimp Pliers	£17.44
74LS113	£0.21	4016	£0.18	2N3055	£0.62	BC237B	£0.09	8F180	£0.31	LM301A	£0.25		
74LS114	£0.21	4017	£0.27	2N3440	£0.50	BC239C	£0.09	8F182	£0.31	LM348N	£0.31		
74LS12	£0.14	4018	£0.27	2N3702	£0.08	BC239C	£0.10	8F185	£0.31	LM351N	£0.36		
74LS122	£0.31	4019	£0.19	2N3703	£0.10	BC251	£0.13	8F189	£0.31	LM353	£0.41		
74LS123	£0.31	4020	£0.31	2N3704	£0.10	BC252	£0.13	8F195	£0.19	LM359N	£0.27		
74LS125	£0.21	4021	£0.31	2N3705	£0.10	BC251B	£0.24	8F244	£0.35	LM377	£0.27		
74LS126	£0.21	4022	£0.32	2N3706	£0.10	BC262B	£0.24	8F257	£0.33	LM380N	£1.12		
74LS13	£0.14	4023	£0.16	2N3771	£1.44	BC267B	£0.30	8F259	£0.33	LM381	£2.70		
74LS132	£0.21	4024	£0.21	2N3772	£1.51	BC307	£0.10	8F337	£0.36	LM386	£0.48		
74LS133	£0.18	4025	£0.18	2N3773	£1.79	BC308	£0.10	8F356	£0.39	LM387	£1.60		
74LS136	£0.16	4026	£0.18	2N3819	£0.40	BC327	£0.10	8F423	£0.13	LM392N	£0.79		
74LS138	£0.24	4027	£0.18	2N3820	£0.66	BC328	£0.10	8F451	£0.19	LM393N	£0.28		
74LS139	£0.25	4028	£0.22	2N3904	£0.10	BC337	£0.10	8F459	£0.29	LM748CN	£0.31		
74LS14	£0.14	4029	£0.36	2N3905	£0.10	BC338	£0.10	8F489	£0.36	LM1458	£0.25		
74LS145	£0.56	4030	£0.37	2N3906	£0.10	BC444	£0.40	8F492	£0.29	LM3900	£0.72		
74LS147	£1.26	4031	£0.70	2N4036	£0.31	BC441	£0.10	8F484	£0.31	LM3914	£2.70		
74LS148	£0.70	4032	£1.24	2N5296	£0.57	BC461	£0.10	8F485	£0.32	LM3915	£2.70		
74LS15	£0.14	4033	£1.20	2N5321	£0.57	BC483	£0.29	8F486	£0.29	LM3916	£1.60		
74LS151	£0.25	4034	£0.31	2N6107	£0.80	BC478	£0.32	8F487	£0.26	MC4558	£0.36		
74LS153	£0.25	4035	£0.29	AC125	£0.30	BC479	£0.32	8F488	£0.26	NE555N	£0.36		
74LS154	£0.70	4036	£0.31	AC127	£0.30	BC480	£0.24	8F489	£0.24	NE567N	£0.47		
74LS155	£0.25	4037	£0.22	AC128	£0.28	BC481	£0.22	8F490	£0.24	NE568N	£0.80		
74LS156	£0.36	4038	£0.28	AC189	£0.37	BC527	£0.20	8F491	£0.20	NE569N	£0.80		
74LS157	£0.25	4039	£0.31	ACV17	£0.84	BC528	£0.20	8F492	£0.20	NE573A	£0.66		
74LS158	£0.25	4040	£0.25	AD149	£1.67	BC537	£0.20	8F493	£0.20	TA820M	£0.39		
74LS180	£0.32	4048	£0.35	AD161	£0.92	BC546C	£0.08	8F494	£0.20	TA2002	£1.04		
74LS181	£0.32	4049	£0.20	AD162	£0.92	BC547C	£0.08	8F495	£0.20	TA2030	£1.35		
74LS182	£0.32	4050	£0.20	BC107	£0.14	BC548C	£0.08	8F496	£0.20	TA2062	£0.42		
74LS183	£0.32	4051	£0.36	BC107B	£0.15	BC549C	£0.10	8F497	£0.20	TL062	£0.42		
74LS184	£0.26	4052	£0.36	BC108	£0.13	BC550C	£0.10	8F498	£0.20	TL064	£0.46		
74LS185	£0.48	4053	£0.25	BC108A	£0.14	BC556A	£0.08	8F499	£0.20	TL071CP	£0.32		
74LS170	£0.30	4054	£0.56	BC109	£0.17	BC557C	£0.08	8F500	£0.20	TL072CP	£0.48		
74LS173	£0.24	4055	£0.34	BC109C	£0.17	BC558C	£0.08	8F501	£0.20	TL074CN	£0.48		
74LS174	£0.24	4056	£0.48	BC114	£0.41	BC559C	£0.08	8F502	£0.20	TL091	£0.33		
74LS175	£0.24	4057	£0.29	BC115	£0.41	BC560B	£0.09	8F503	£0.20	TL082CP	£0.34		
74LS190	£0.25	4058	£0.17	BC116	£0.41	BC5637	£0.21	8F504	£0.20	TL084	£0.63		
74LS191	£0.25	4059	£0.17	BC117	£0.41	BC5638	£0.21	8F505	£0.20	TL084CN	£0.48		
74LS192	£0.43	4060	£0.16	BC118	£0.41	BC5639	£0.21	8F506	£0.20	TL093	£0.64		
74LS193	£0.24	4061	£0.16	BC119	£0.41	BC5640	£0.21	8F507	£0.20	ULN2003	£0.52		
74LS196	£0.24	4070	£0.17	BC134	£0.36	BC5641	£0.21	8F508	£0.20	ULN2004	£0.48		
74LS198	£0.24	4071	£0.30	BC135	£0.36	BC5642	£0.21	8F509	£0.20	ULN2412	£1.16		
74LS199	£0.24	4072	£0.30	BC141	£0.27	BC5643	£0.21	8F510	£0.20	ULN2422	£2.61		
74LS20	£0.16	4073	£0.17	BC142	£0.31	BC5644	£0.21	8F511	£0.20	ULN2427E	£8.82		
74LS21	£0.14	4074	£0.17	BC143	£0.34	BC5645	£0.21	8F512	£0.20	ULN2428E	£6.12		
74LS22	£0.14	4075	£0.30	BC149	£0.21	BC5646	£0.21	8F513	£0.20	ULN2435E	£5.31		
74LS221	£0.40	4077	£0.17	BC154	£0.36	BC5647	£0.21	8F514	£0.20	ULN248E	£7.92		
74LS240	£0.32	4081	£0.14	BC157	£0.12	BD140	£0.24	8F515	£0.20				
74LS241	£0.32	4082	£0.21	BC159	£0.12	BD150C	£0.82	8F516	£0.20				
74LS242	£0.32	4085	£0.28	BC160	£0.28	BD166	£0.35	8F517	£0.20				
74LS243	£0.32	4089	£0.56	BC170B	£0.16	BD187	£0.39	8F518	£0.20				
74LS244	£0.32	4092	£0.18	BC171	£0.11	BD201	£0.40	8F519	£0.20				
74LS245	£0.36	4093	£0.18	BC171B	£0.16	BD202	£0.40	8F520	£0.20				
74LS247	£0.32	4094	£0.31	BC172	£0.13	BD203	£0.40	8F521	£0.20				
74LS251	£0.24	4095	£0.56	BC173	£0.13	BD204	£0.40	8F522	£0.20				
74LS252	£0.24	4097	£1.20	BC174	£0.18	BD222	£0.40	8F523	£0.20				
74LS258	£0.24	4099	£0.38	BC178	£0.18	BD225	£0.42	8F524	£0.20				
74LS26	£0.14	4502	£0.38	BC179	£0.17	BD232	£0.38	8F525	£0.20				
74LS266	£0.14	4503	£0.38	BC182	£0.08	BD237	£0.32	8F526	£0.20				
74LS27	£0.14	4508	£0.90	BC182L	£0.08	BD238	£0.32	8F527	£0.20				
74LS279	£0.25	4510	£0.26	BC182LB	£0.08	BD240B	£0.37	8F528	£0.20				
74LS30	£0.14	4511	£0.32	BC183	£0.08	BD243B	£0.50	8F529	£0.20				
74LS32	£0.14	4514	£0.77	BC183LB	£0.08	BD244A	£0.53	8F530	£0.20				
74LS365	£0.21	4515	£0.98	BC184	£0.08	BD248	£1.06	8F531	£0.20				
74LS367	£0.21	4516	£0.31	BC184A	£0.08	BD441	£0.41	8F532	£0.20				
74LS368	£0.21	4517	£0.31	BC184B	£0.08	BD442	£0.41	8F533	£0.20				
74LS37	£0.14	4518	£0.27										
74LS373	£0.32	4520	£0.28										
74LS374	£0.32	4527	£0.40										
74LS375	£0.34	4526	£0.40										
74LS377	£0.32	4528	£0.40										
74LS378	£0.62	4529	£0.44										
74LS38	£0.14	4530	£0.32										
74LS390	£0.25	4532	£0.32										
74LS393	£0.24	4534	£2.48										
74LS395	£0.26	4535	£1.00										
74LS396	£0.26	4538	£0.30										



The *Experimenter's* Computer - Keypad and Display

This month we come to the final part of Jim Spence's project to build a versatile Experimenter's Computer programmable in FORTH, with a look at the Key Pad.



Last month we looked at the circuitry for the experimenter's computer keypad and display, plus the Forth routines needed to generate a display. We now turn our attention to the keypad.

If we look at the circuit in Figure 1 (repeated from last month) we can see that the remaining two output lines of port 0 are used to drive the two line to four line decoder. A binary combination of the two lines will bring pins 4 to 7 low, as shown in the truth table. The output lines of IC1 are connected to the rows of the keypad.

The keypad columns are connected to the lower nibble of input port 4 and are held high by four pull up resistors. Taking column 1 row 1 as an example, if no key is pressed then D3 will remain high. If the top left hand corner key is pressed, then D3 will only go low if the input to decoder IC is 11 (binary) because the top row is connected to pin 7 of IC1. In this way all 16 switches can be uniquely detected.

Truth table for IC1

Inputs		Outputs			
2	3	4	5	6	7
0	0	0	1	1	1
1	0	1	0	1	1
0	1	1	1	0	1
1	1	1	1	1	0



The Key Pad Driver Software

The software listing for the keypad is given in box 3 It begins with the word DIPP, which is the equivalent of DIP used in the display except that this time it outputs to bits D6 and D7, leaving bits D0 to D5 alone.

PAD@, pronounced pad fetch, leaves either a 0 on the stack if no key is pressed, else it leaves a number on the stack equivalent to the key pressed. However it will only return a key value from a valid or active row. In order to use this function properly, the row must first be set and this is the job of PAD-SCAN. Before leaving PAD@, it is worth noting the delay which has been introduced if a key is detected. All software routines which read switches directly should include a de-bounce. When you place your finger on the switch, it takes about 50ms for the switch to settle down. PAD@ re-reads the switch after this delay to make sure it is valid.

The (PAD?) pad query is the most basic useful keypad word. For simple applications no other words are needed. It

will either return a 0 if no key is pressed or it will return a key code, more commonly known as a scan code, because the whole of the keypad has been scanned to see if a key was pressed.

PAD-LOOKUP translates the key scan codes into more meaningful numbers and the technique for doing this is worth explaining.

A table is created called PAD-TABLE. The word CREATE expects some text to follow it, in this case PAD-TABLE and this is now a new FORTH word. After this, bytes are compiled into the table using the word C, (pronounced see tick). When the word, PAD-TABLE, is later executed, the address of the table is left on the stack. The word PAD-LOOKUP uses this address to look along the table for the key scan code. When found, it

returns with the offset in bytes along the table. So, for example, if the scan code 4D was given to PAD-LOOKUP, it will return 3 (4 bytes along including 0) which is much easier to remember than 4D. In the code given, the table has been arranged in a more or less standard calculator layout with 0 being the bottom left. Telephone users may feel free to alter this to the other way

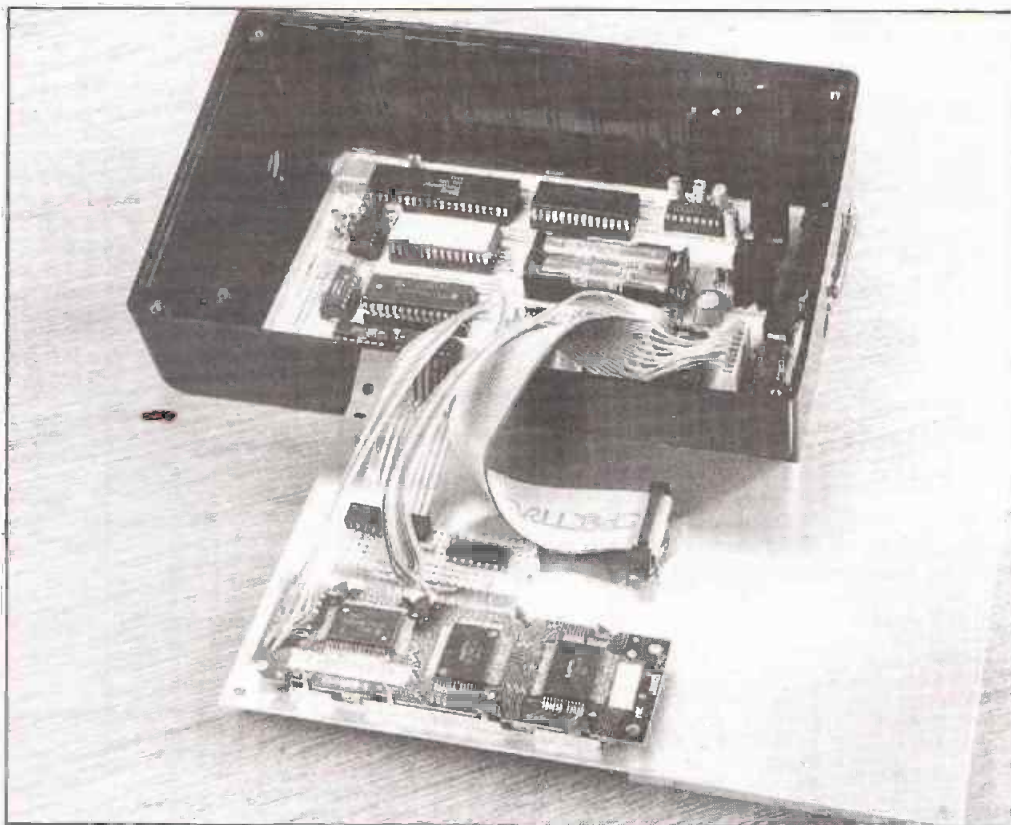

round.

The 'High' level words are KPAD and KPAD?. The former waits for a keypress and the latter doesn't. KPAD? is useful for aborting continuous loops.

The following code is the FORTH routine necessary to implement the Keypad on the Experimenter's Computer.

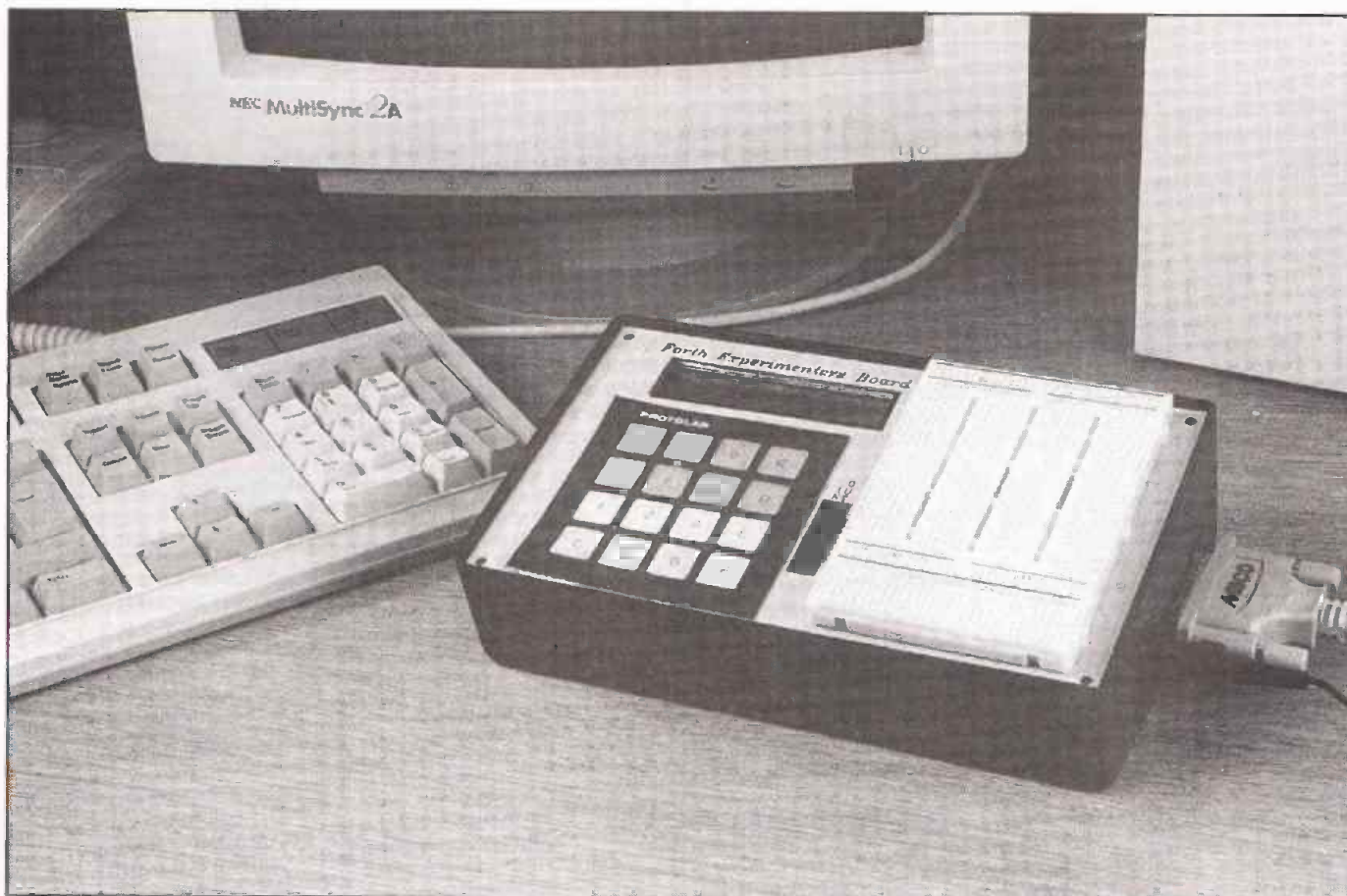

```

@L:\ Key pad driver
hex

\ Sends byte b to port specified by dport but only to
\ bits 6 & 7, leaves 0 to 5 alone
: dipp      ( b -- ) \ Display+pad o/p port
  c0 and    \ mask bits 0 - 5
  pvalue c@ \ get copy of actual port contents
  3f and    \ mask bits 0 - 5
  or        \ combine
  dup
  dport p!  \ o/p to port
  pvalue c! \ store in variable
;

\ Primary read of key pad port, simply fetches data byte b
: (pad@) ( -- b )
  4 p@      \ get port contents
  0f and    \ mask other bits
;

\ Returns a value, b if there is a key pressed on the keypad
\ at the scan position otherwise it returns zero
: pad@ ( -- b )
  (pad@)    \ read keypad
  0f =      \ 0f returned when nothing pressed
  if
    0        \ leave 0
  else
    32 0 do del1 loop \ 50ms debounce delay
    (pad@)    \ get key value
    dup       \ check once more for valid
  endif
;

keypress
  0f =
  if
    drop 0    \ drop other f and leave 0
  endif
  \ else leave key value
endif
;

\ Scans the keypad at ROW and returns VALUE. A zero value
\ indicates that no key is pressed on that row
: pad-scan ( row -- value )
  dipp
  pad@      \ get value
;

\ Scans the keypad and returns a value. If a key is pressed
\ the value is the scan code for that key. Returns 0 if no key
\ pressed
: (pad?) ( -- value )
  0          \ assume no key pressed < X see
below >
  f0 0      \ scan rows from 0 to c0
  do
    i        \ put index on stack
    pad-scan \ scan at bottom row
    ?dup    \ duplicate return value if not 0
    if
      i or \ get index and combine it with ret value
      swap drop \ drop starting value < X >
      leave    \ leave loop
    endif
    40        \ increment i (index value) by 40
  +loop      \ gives i of 0 40 80 and c0
;

\ This look up table converts the scan codes to key numbers
create pad-table
  07 c, 47 c, 4b c, 4d c, 87 c, 8b c, 8d c,
  c7 c, cb c, cd c, 0b c, 0d c, ce c, 8e c,
  4e c, 0e c,

\ Given a key SCAN-CODE it will look up the pad-table and
\ return a number corresponding to that position in the table
\ If no scan code can be found it returns the SCAN-CODE
: pad-lookup ( scan-code -- key-number )
  10 0      \ search table 16 bytes long
  do
    dup     \ value we are searching for
    pad-table i + \ offset into

```

```

table
  c@        \ get value
  =         \ see if same as value
  if
  drop      \ duplicated value
  i         \ leave index
  leave     \ the loop
endif

loop
;

\ Test to see if any key pressed, returns the scan code b if
\ a key is pressed else it returns 0
: kpad? ( -- b )
  (pad?)    \ get keypad data
;

\ Waits here until a key is pressed and returns the key
\ number
: kpad ( -- key-number )
  begin
  (pad?)    \ wait until key press
  ?dup      \ duplicate if > 0
  until
  pad-lookup \ look up translated value
;

\ ----- Test Keypad and Display Together -----
variable kk1
variable kk2

decimal
\ Dokey1 & 2 update the variable kk1 and kk2 respectively,
\ each time
\ they are called the variable is either incremented or
\ decremented
\ depending on the flag. -1 or true vale increments
: dokey1 ( flag -- )
  if
    kk1 @ 1 + dup kk1 !
  else
    kk1 @ -1 + dup kk1 !
  endif
  line1
  14 gxy di.
;

: dokey2 ( flag -- )
  if
    kk2 @ 1 + dup kk2 !
  else
    kk2 @ -1 + dup kk2 !
  endif
  line2
  14 gxy di.
;

\ Test displays two variable to the display which can be
\ either incremented or
\ decremented by pressing the appropriate keys. This would
\ be useful for making
\ a pulser with adjustable mark space ratio.
: test
  init      \ initialise display
  d" Key1 value =" \ print to display
  line2     \ set display to line 2
  d" Key2 value =" \ print to display
  begin    \ start continuous loop
    kpad?  \ see if any key pressed
    if     \ yes
      kpad \ get value of key
      case \ process key
        1 of 0 dokey1 endof
        2 of 0 dokey2 endof
        4 of 1 dokey1 endof
        5 of 1 dokey2 endof
        ine2 d" ABORTED " abort
      endcase
    endif
  again
;

```

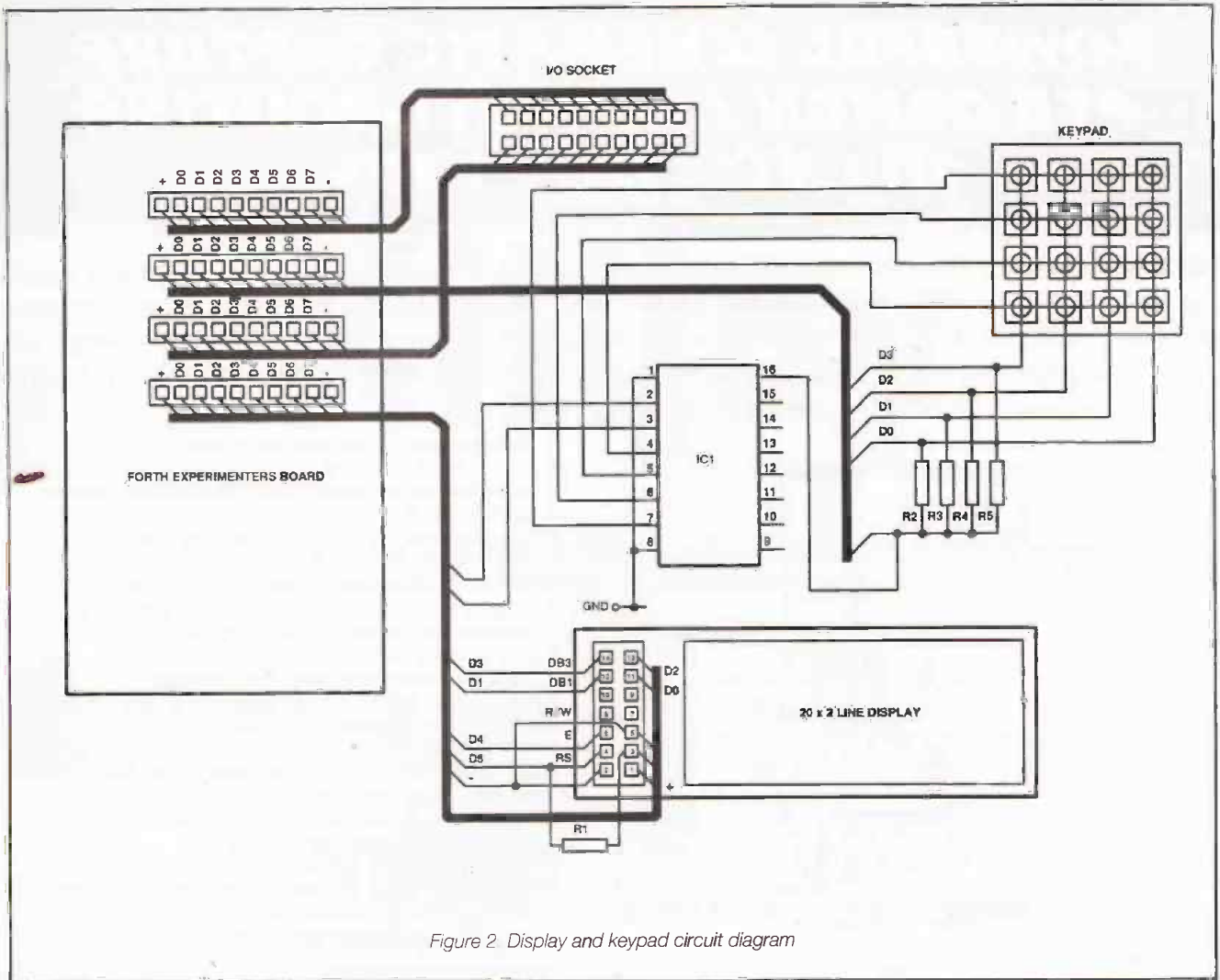
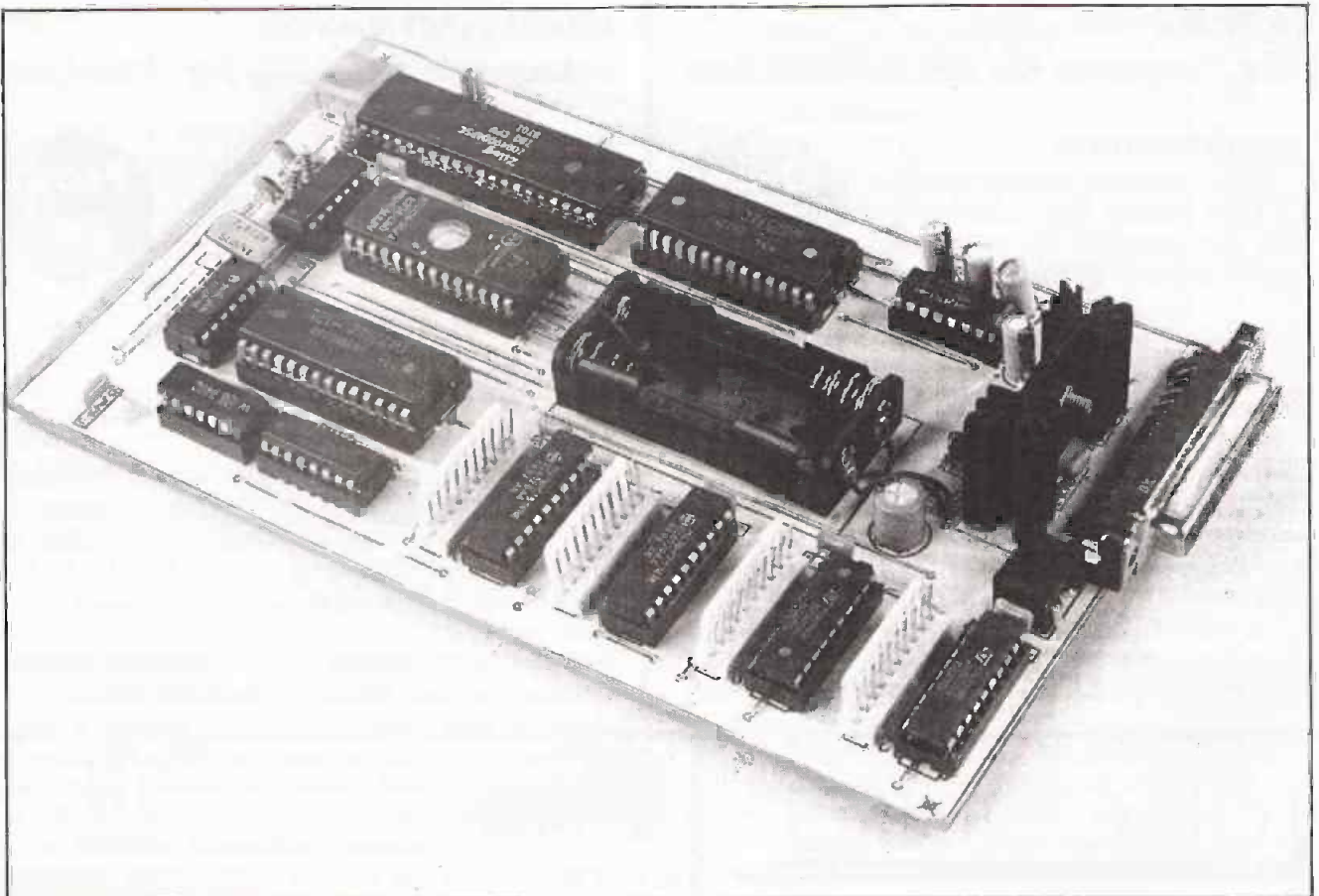
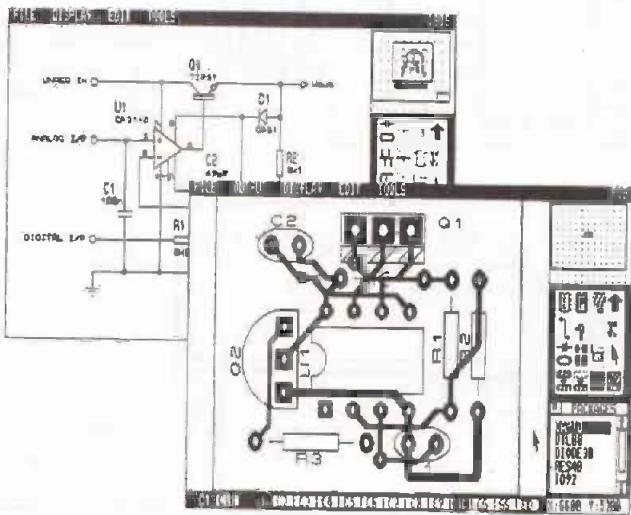

Figure 2. Display and keypad circuit diagram



POWERFUL SCHEMATIC CAPTURE, PCB DESIGN AND AUTOROUTING ALL FOR JUST £395...

PROPAK AR for DOS provides all the features you need to create complex PCB designs quickly and easily. Draw the circuit diagram using the powerful facilities of ISIS DESIGNER+ and then netlist into ARES AUTOROUTE for placement, autorouting and tidy up. Advanced real time design rule checks guarantee that the final PCB will correspond exactly with the schematic thus saving you from costly layout errors and time consuming debugging.



- Attractive, easy to use graphical interface.
- Object oriented schematic editor with automatic wire routing, dot placement and mouse driven place/edit/move/delete.
- Netlist generation for most popular CAD software.
- Bill of Materials and Electrical Rules Check reports.
- Two schemes for hierarchical design.
- Automatic component annotation and packaging.
- Comprehensive device libraries and package libraries including both through hole and SMT parts.
- User definable snap grids (imperial and metric) and Real Time Snap to deal with tricky SMT spacings.
- Manual route editing features include Auto Track Necking, Topological editing and Curved tracks.
- Autorouting for single, double and multi-layer boards.
- Non autorouting PROPAK is available for just £250 if you do not need or want the router.
- Full connectivity and design rule checking.
- Power plane generator with thermal relief necking.
- Graphics support to 800x600 Super VGA.
- Output to dot matrix and laser printers, HP and Houston plotters, Postscript devices, Gerber and Excellon NC machines plus DXF and other DTP file formats.

CADPAK

Two Programs for the Price of One

ISIS SUPERSKETCH

A superb schematic drawing program for DOS offering Wire Autorouting, Auto Dot Placement, full component libraries, export to DTP and much more.

**Only
£79**

Exceptionally easy and quick to use. For example, you can place a wire with just two mouse clicks - the wire autorouter does the rest.

PCB II

High performance yet easy to use manual PCB layout package. Many advanced features including curved tracks, auto track necking, DXF export, Gerber and NC file generation, Gerber viewing and more.

Alan Chadwick writing in ETI (January 94) concluded...
"At £79 I thought this was an excellent buy."

ISIS ILLUSTRATOR

Schematic Drawing for Windows

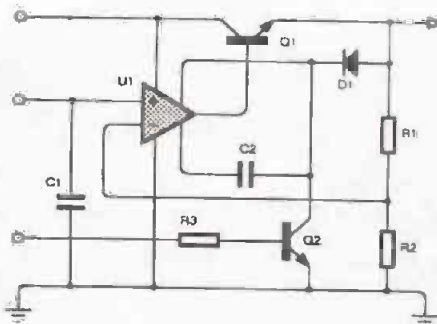

**From
£99**

Running under Windows 3.1, ISIS ILLUSTRATOR lets you create presentation quality schematic drawings like you see in the magazines. Furthermore, when the drawing is done, transferring it to another document is just a matter of pasting it through the Clipboard.

Now used by a number of prominent technical authors to illustrate their latest books and magazine articles.

Labcenter
Electronics



Call us today on 0756 753440 or fax 0756 752857 for a demo pack - state DOS or Windows. Multi-copy and educational discounts available.

WE HAVE MOVED - NOTE NEW ADDRESS

Prices exclude p&p (£5 for U.K.) and VAT. All manufacturers' trademarks acknowledged.

53-55 Main St, Grassington, North Yorks. BD23 5AA.

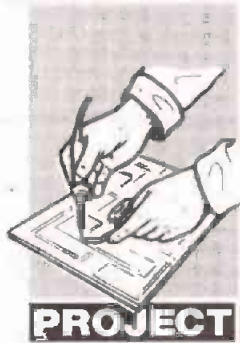

Killjoy

Bob Noyes made himself seriously unpopular with his two sons with this computer game limiter project.



A great debate has been going on in medical circles and in the media recently as to the possible risk of computer games, notably Sega and Nintendo. It has been suggested that they can cause some people to have epileptic fits. At the time of writing this project, no concrete proof has been produced to support these concerns but the general consensus seems to be that shorter rather than protracted periods of time in front of computer games may alleviate the risks.

This is fine in theory but how do you prise children, mesmerised by Sonic the Hedgehog or Mario the Plumber, away from the TV set? "Just one more minute, Dad, this is the farthest I've ever got on this game before and if I turn it off I'll have to start all over again" - or words to that effect. Imminent

starvation, when the rumbling of stomachs can be heard above the noise of the games, seems to be the only thing that gets bums off chairs and away from the TV screen.

Having two boys, each with a computer system in their room, it's hard to keep track of which one is on and for how long. The lads are aware of the possible health risk, but because they've suffered no ill effects so far they give the matter little or no thought and play on the games, regardless of the time. A device was needed to remind them how long they had been at their

games, say an hour, and if they didn't respond then it could be used to either shut down the computer or sound a buzzer or siren to indicate 'Time Gentlemen Please'.

The advantage of Killjoy over an ordinary timer is that it gives 15 minutes visual warning before switching off the game or sounding the siren - essential, as strategies in the game may change when the player/s know time is tight.

Like most switches or systems, Killjoy can be got around, but most children (or adults) who are worried about continuous sessions on computer games are quite happy to have an

'enforced' break. Because no time limits have been forthcoming from the Department of Health, I have chosen three - 1, 1.5 and 2 hours, each limit having a flashing light which comes on 15 minutes before the time limit is up. If at any stage

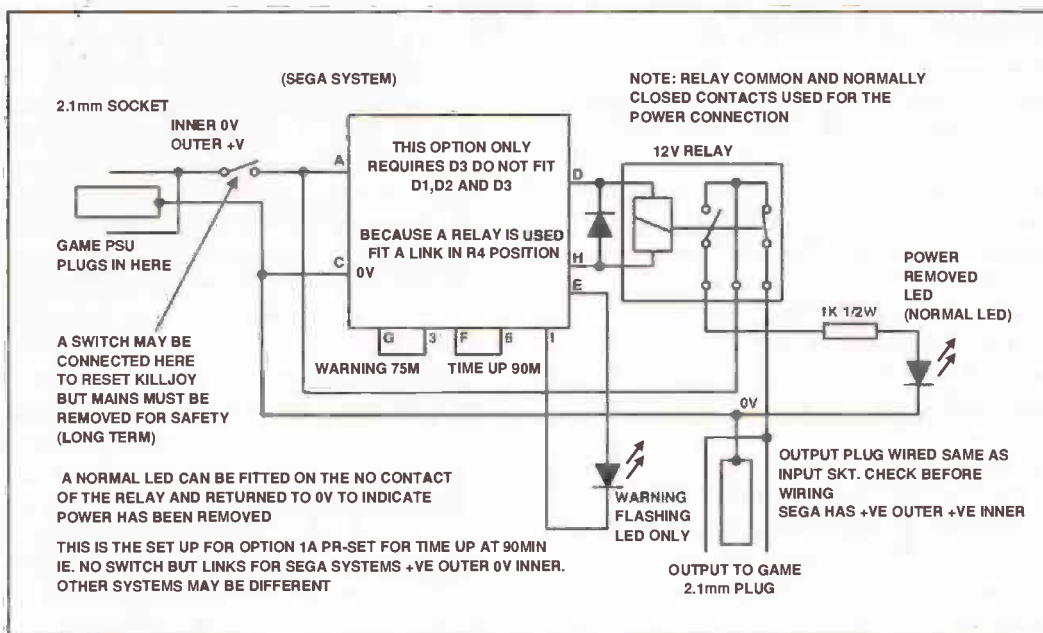

someone in authority gets off the fence and specifies a maximum time limit outside of the three I've set, simply adjusting the oscillator frequency can easily double or half these time frames (see setting up details).

When designing long period timers, one chip - ZN1034E - always comes to mind. Although a useful chip that can be made to time from seconds to days, it only provides one output. Killjoy requires an output to give a warning 15 minutes before power is removed, so another chip is needed.

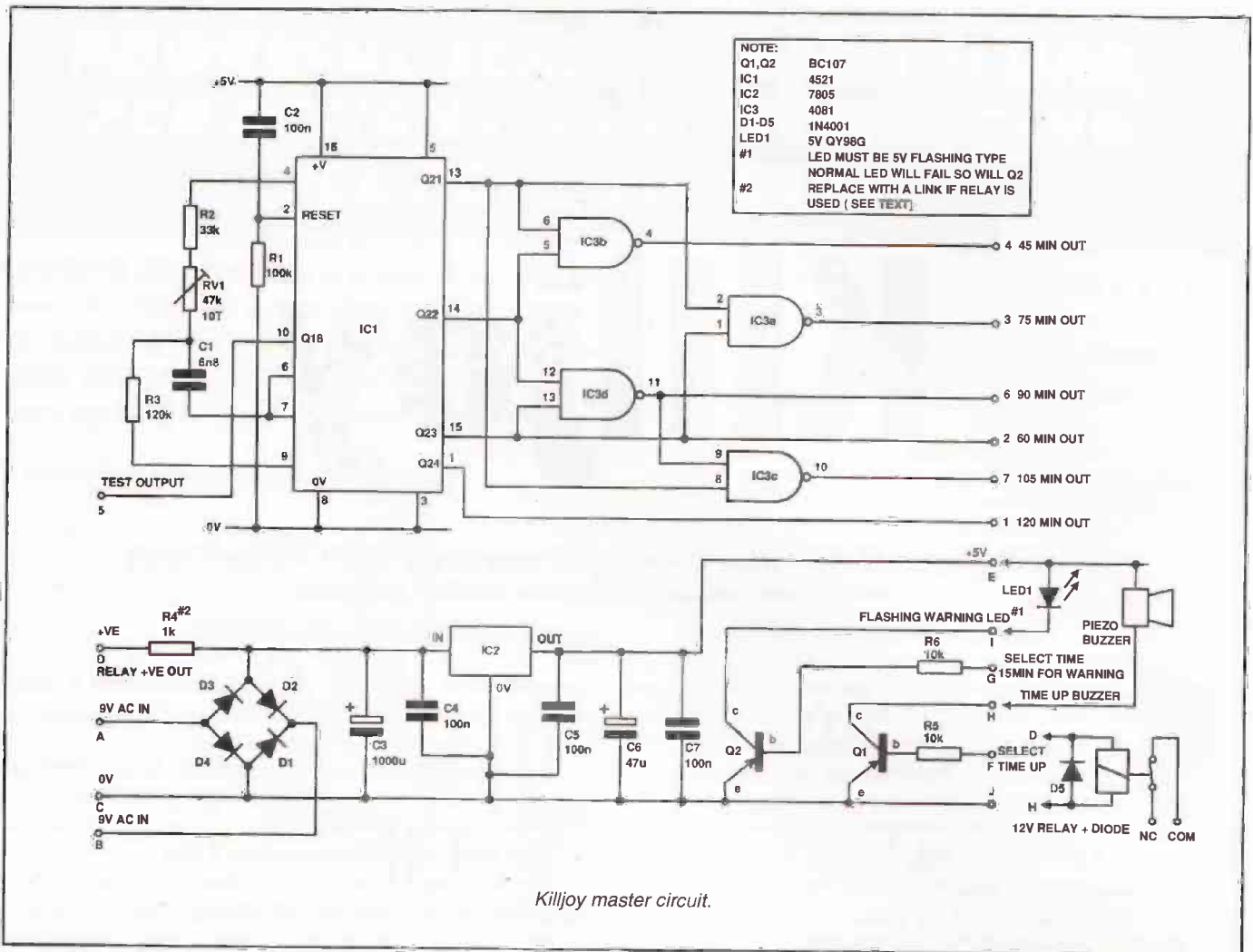

Killjoy master circuit.

After consulting data sheets, I found it - the 4521, normally associated with crystal oscillators and long division chains resulting in a time base for very accurate equipment such as clocks or frequency meters. As well as supporting a crystal oscillator, it can be made to oscillate using only C and R components. This means that much slower frequencies can be used, well outside the standard crystal ranges. Although not quite as accurate as a crystal, in this application ultra exact timing is not required, so the use of capacitor/resistor timing presents no problem.

The heart of the circuit is a 4521 CMOS oscillator and divider chain, giving Q18 to Q24 outputs or, putting it another way, it will divide by two, 18 to 24 times, giving an output for each one. Lower order divisions are not brought out in order to keep the pin out down to 16 pins.

The oscillator built around the 4521 has been arranged in such a fashion that the Q24 output will remain low for 2 hours after switch on, and then go high. It follows that if Q24 takes 120 minutes to go high, Q23 will take 60 minutes, Q22 30 minutes, Q21 15 minutes and so on. Using simple AND gates, the following times can be achieved: Q22 AND Q21 = 45 minutes, Q21 AND Q23 = 75 minutes, Q22 AND Q23 = 90 minutes, ninety minutes output from previous gate AND Q21 = 105 minutes. These combined with Q23 - 60 minutes, Q24 - 120 minutes, give all the required outputs for 1, 1.5, 2 hours as well as a 15 minute warning for each of these, 45, 75 and 105 minutes. These are taken to a switch, a 2 pole 3-way, in such a way that the switch is the selected switch off time or time up. The switch sections are wired as shown on the diagram.

The poles of switches A and B are taken to two transistors

via resistors - these transistors provide the two outputs. The warning output is an active low and goes to the -ve side of a flashing LED (this attracts more attention than a normal LED), the +ve of which goes to a +5V and is wired off the board on the front panel, so as to be seen clearly when playing the game. The time up output, also an active low, can either be taken to a relay to switch the power 'mains' or low voltage to the offending computer game. Alternatively, it can be connected to a piezo siren/buzzer, loud enough to draw attention to the time up, but not so sneaky as to remove the power on the final few seconds at a crucial level of Sonic 2 or such like.

The power supply for the CMOS ICs has been set at 5V (although these will work anywhere within the CMOS range 3-18V). This will enable the power to be drawn from the DC output of the mains power supply for the game, normally around 10V DC. As this circuit draws next to no current, there is no problem taking power from the games supply. Alternatively, a small 6Va (or larger) transformer, either 4.5V - 0 - 4.5V or 9V - 0 - 9V, can be used. If the former is used, all 4 diodes D1-D4 are required. If the latter is used, then D1 and D4 should be omitted (refer to the diagram for exact wiring).

The 7805 regulator has a small heat sink, which is merely a precaution as the CMOS ICs draw next to no current and the flashing LED only a few milliamps. Because of the low power consumption, technically the 78L05 (rated 100Ma) could be used, but the cost saving is so small that the larger 7805 (rated 1A) has been chosen.

Options

As already mentioned there are several Killjoy options

**SWITCH SELECTOR CONNECTIONS
GIVING ALL THREE OPTIONS**

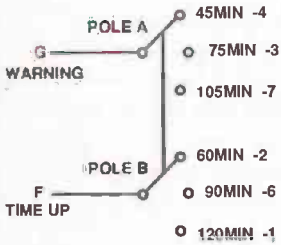

SWITCH: A 2 POLE 6 WAY ROTARY
OR 3 POLE 4 WAY ROTARY
OR 4 POLE 3 WAY ROTARY

**TABLE OF LINKS IF SWITCH NOT
FITTED**

	1 HOUR	1.5 HOUR	2 HOUR
WARNING G	45M 4	75M 3	105M 7
WARNING F	60M 2	90M 6	120M 1

EG. FOR 1 HOUR
LINK G TO 4 45MIN THEN WARNING
LINK F TO 2 60MIN TIME UP

Option 1a

The time up switches the supply to the game, either mains or the DC supply via a relay. When a relay is used, fit link in place of R4.

Option 1b

The time up can be connected to a piezo buzzer/siren to indicate time up. This allows a crafty extra couple of lives to a player if a game is going well, bearing in mind no specific times have been suggested.

Option 2a

The power supply can be taken from the power pack that's supplied with the game. Care must be taken to connect the supply the correct way round - measure first with a meter.

Option 2b

A transformer can be used, either 4.5V-0-4.5V or 9V-0-9V.

The same PCB is used for all options, although the diodes D1-D4 are used in different combinations (refer to the diagrams).

Setting Up

The 4521 division chain is the heart of the system. The output Q24 is required to remain low for 120 minutes (to provide the 2 hour output), pin 1 of the PCB. This is only half the time when considering the frequency at Q24. The frequency is the low plus the high time, therefore Q24 has a repetition rate of 4 hours.

When this is divided back to the basic time/frequency it comes out to 0.0008583 seconds or 1165.09Hz. R1, R3, RV1 and C1 are chosen to provide this frequency, ideally with the setting of RV1 in the middle allowing adjustment in either direction for adjustment to 1165.09Hz. Here, the 10-turn preset comes into its own.

If a frequency meter is available, set a frequency of 1165.09Hz at pin 4 by adjusting RV1. For those without a meter, the Q18 has been brought out to pin 5 of the PCB as a monitor pin only - it is not used in the time functions. This can be monitored using a volt meter in respect to 0V, to give a high out 5V after 112.5 seconds or 1 minute 52.5 seconds after switch on.

To set up without a frequency meter, switch power on and set a volt meter on pin 5 of the PCB, at a range to monitor 5V. This pin should go high after 1 minute 52.5 seconds. Adjust the RV into roughly the middle position. Short pin 2 to pin 16 of the IC using a small length of wire. This resets the counter chain and stops the oscillator. Release this short and note the time as accurately as possible. The time taken for pin 5 of the PCB, Q18 to go high should be noted and RV1 adjusted to make it go high after 1 minute 52.5 seconds. This should be done as accurately as possible, because any error in the procedure will result in an even larger error in the high time outputs, i.e. Q24 will have an error 64 times greater than that of Q18. Once Q18 has gone high, the preset should be adjusted to correct any error. This can only be done by trial and error. When adjusted, pin 2 of the IC should be shorted to +5V pin 16 of the IC to reset the counter chain, the procedure being repeated until pin 5 of the PCB goes high 1 minute 52.5 seconds after switch on, or the short on pin 2 of the IC to +5V removed. In practice this takes

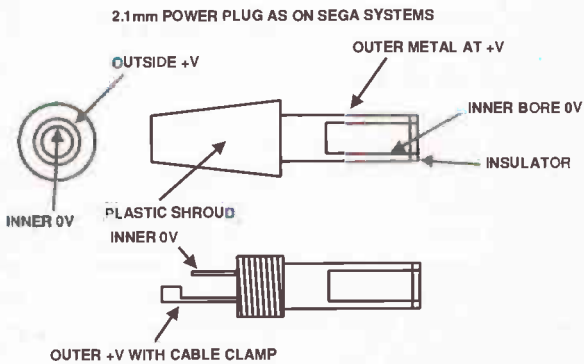

C6 MAY BE AXIAL
OR RADIAL

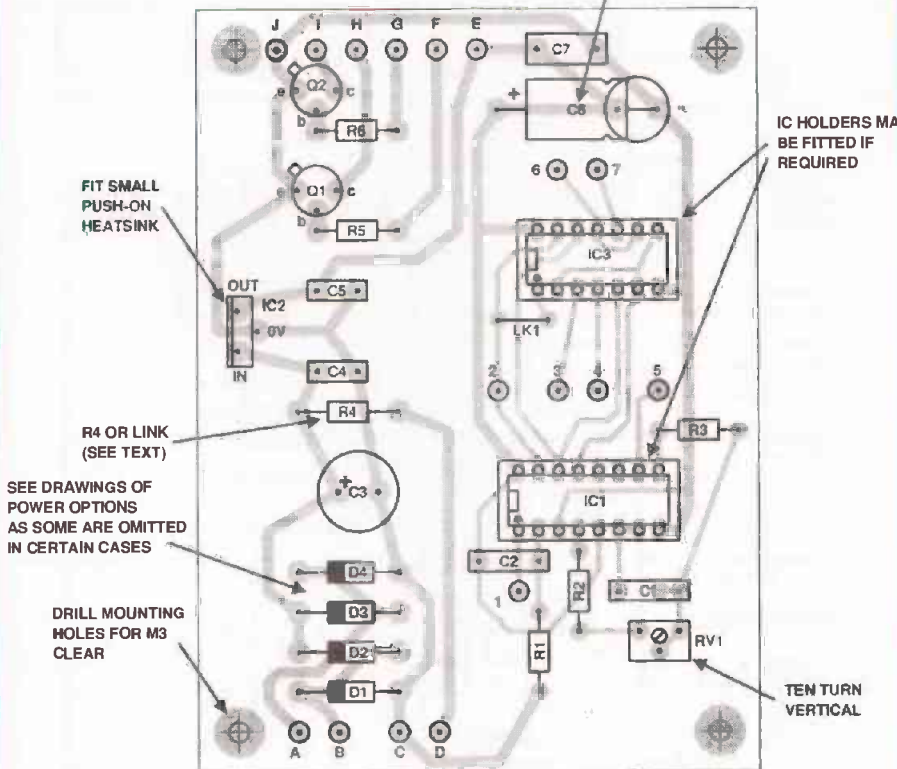

Component overlay for Killjoy PCB.

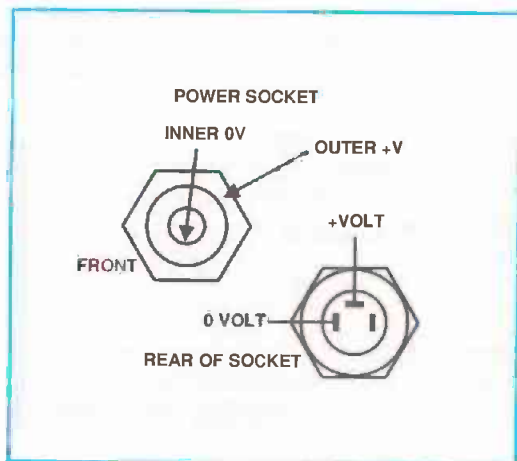

several attempts, but you get there in the end. Once the setting is right, pin 2 of 4521 should be shorted to +5V and this time Q24 monitored. This will take

If at some stage the Department of Health specifies a maximum recommended time for playing computer games outside of the three I've selected, the oscillator - set to run here at 1165.09Kz - can be speeded up to reduce the time intervals, or slowed down to increase them. This will also increase or decrease the 15 minute warning time, but the circuit will still function in the same manner. There specified times be much shorter or longer such that there is not enough adjustment on RV1, then C1 can be changed. Reducing the value of C1 to 5.6nf would increase the speed of the oscillator and hence reduce the time intervals, whereas increasing C1 to 8.2nf would reduce the speed of the oscillator and increase them.

Boxing and Construction

Firstly, the options required should be sorted out, i.e. is Killjoy going to be powered by its own mains supply (Option 2b) or be powered by the game's supply (Option 2a - easier and safer if you are not too sure).

Secondly, is Killjoy going to cut the supply to the game (Option 1a) or sound a siren/buzzer (Option 1b).

If Option 2b is chosen, then a slightly larger box should be used and the transformer, PCB and possibly the relay all mounted on a metal plate which should be earthed for safety. The box recommended is Vero Part No. 202-21039N, known at Maplin as LQ 09K, 180 x 120 x 90mm. This gives enough room for all the wiring. Because mains is involved, every wire should be checked and double checked before power is applied. If you are in any doubt at all, ask someone more competent to do it for you. If the mains plug supply is brought in from the games' own (altogether a safer option for newcomers to electronics), then a smaller box can be used such as an ABS M1005, known at Maplin as LH 63T, 161 x

around 2 hours so don't hold your breath. RV1 can be given a final little tweak (if required) to set it to go high after exactly 2 hours. You can get an indication at 1 hour by monitoring pin 2 of the PCB - if more or less than a few seconds out, RV1 should be adjusted and the procedure cancelled at this stage and started again, i.e. shorting pin 2 of the IC to +5V. Any error at one hour, Q23, will be doubled at 2 hours, Q24.

The time selector switch can be mounted on the front of the box or the time can be selected and mounted inside the box to prevent longer times being selected. Alternatively, the switch can be removed and a time chosen and wired directly. The mains or power is turned on causing the switch on capacitor C2 and R1 to instantly provide a switch on positive reset pulse to the 4521, making the counter start from zero. After being divided the correct number of times, the selected output switches the warning LED on. This flashes for 15 minutes before the final time is up and this can be used to either remove power or activate a piezo siren to indicate that time's up.

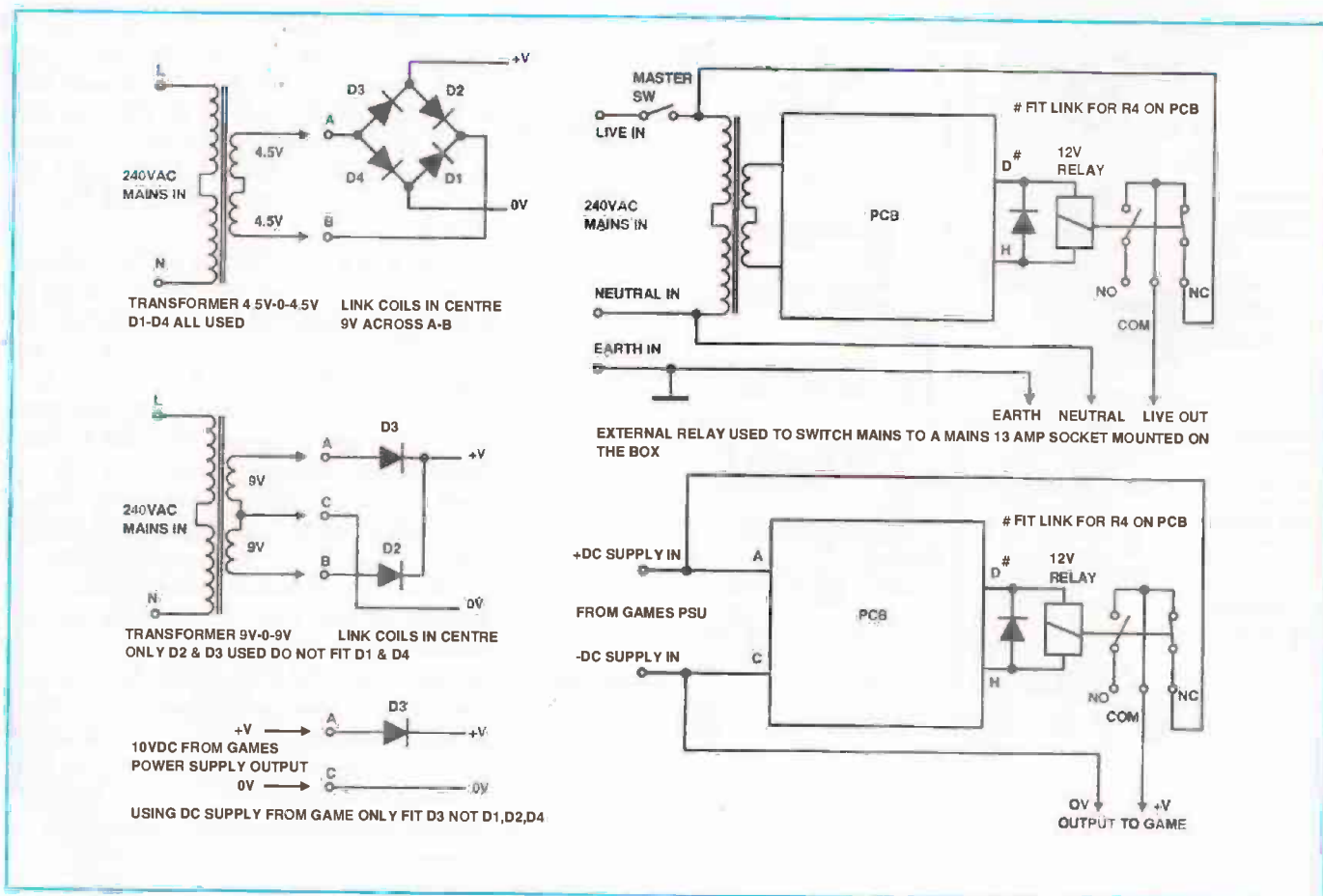

Other set-up options.

96 x 61/39mm. Here, a 2.1mm power socket is mounted on the plastic box, this is important as the mounting of the socket is normally at +ve 10V (see diagram). If Killjoy is going to switch the power DC to the game, great care should be taken that the output plug is wired in the same fashion as the plug already fitted on the power supply. I have installed Killjoy on a Sega Megadrive and Sega Master System, both of which had the outside of the power plug at +ve and the inside core 0V, as per diagram. Other systems must be tested and wired accordingly.

As previously mentioned, the time selector switch can be brought to the front panel, where the time selection can take place or can be hard wired, i.e. links put in for one time option as per time listing. If a piezo siren/buzzer is used, holes must be drilled in the box to let the sound out, several small holes rather than one large one being necessary to eliminate the risk of fingers getting into the circuitry.

No particular layout is required, but if mains is involved, connections should be sleeved and great care taken that nothing can short and touch. All metal work should be earthed. On the mains version shown, the mains 13A socket is mounted in a white mains box on top of the control box to ensure that the mounting bolts to the socket are securely fitted. If a hole is cut in the top of the control box and the socket mounted directly, great care must be taken to ensure that the mounting bolts are securely fitted.

The mounting of the flashing warning LED should be such that it shows up clearly, i.e. mounting it in a black LED clip for a good contrast. The lettering on the front panels was done with rub down print that you can get at WH Smith or any good stationers.

If a relay is not fitted and Killjoy is going to sound a piezo siren/buzzer at time up, a power-in LED can be fitted using R4 1K Ω 1/2W as the +ve supply output pin (D) of the PCB and the -ve of the LED taken to 0V.

If a relay is fitted, the R4 becomes a link and output pin (D) of the PCB goes to the relay and the +ve of a diode fitted across the relay coil.

In all options, the PCB is mounted on 4 bolts with spaces between the PCB and the base. The bolts used are countersunk so as not to protrude under the box. Rubber feet, either stick on or screw in types, can be used. If they are screw in, care should be taken that the screws don't touch any of the wiring or other parts mounted in the box.

The principle of operation is that, after power has been given to the PCB, the oscillator starts and the counter is zero'd by the switch on reset. The 4521 starts to count. If a relay is used, the normally closed contact and the 'common' connections provide power to the game. Once the selected time period is up the relay is activated, which means that the normally closed contact supplying the game with power is no longer connected to the common, thus power is removed from the game.

Killjoy has switched the game off on the mains option (2b). When the television is turned off, the switch on Killjoy should be turned off as well. This removes the mains supply from it so that when Killjoy is switched on again, some time later, the switch on reset will activate and the time period will start from scratch.

In option 2a, although the action of the PCB is exactly the same and power is removed from the game, the DC

supply should be switched off at the mains just as you would do if Killjoy wasn't there. This is basic safety practice.

I didn't expect to be the most popular Dad in the world when I installed Killjoy in my sons' computers and I'm not - my nice guy ratings are zero minus, but at least I feel I have some peace of mind in that I've done something positive to alleviate a possible health risk.

PARTS LIST

RESISTORS (1/4W Carbon Film)

R1	100K
R2	33K
R3	120k Ω
R4	1K Ω 1/2W for LED or link if relay used
R5	10K
R6	10K

CAPACITORS

C1	6.8nF Disc 25V
C2	0.1 μ F Disc 25V
C3	1000 μ F 25V Radial
C4	0.1 μ F Disc 25V
C5	0.1 μ F
C6	47 μ F 10V Radial/Axial

TRANSISTORS

Q1	BC 107
Q2	BC 107

ICs	
IC1	4521
IC2	7805
IC3	4081

DIODES

D1	IN 4001 *
D2	IN 4001 *
D3	IN 4001
D4	IN 4001 *
D5	IN 4001 *

* fit depending upon option required.
(See drawings).

RV	47K Ω 10-turn vertical
----	-------------------------------

MISCELLANEOUS

Not all these parts are required (see options).

Maplin part numbers given.

5V flashing LED, QY 986G.

PCB

Box for mains unit, LQ 09K

Box for non mains unit, LH 63T

Power plug for Sega 2.1mm, HH 61R

Power socket for Sega 2.1mm, JK 09K

Transformer (if own supply used), 9V type, WB 11M

Mains switch (if own supply used), FH 30H

12V relay suitable for mains or DC

Supply switching, JM 18U

Suitable siren, FK 84F

Nuts and bolts, M3, to suit options

Switch, 2 pole 6 way, FF74R (break before make)

Knob to suit switch

SEETRAx CAE - RANGER - PCB DESIGN

Ranger1 £100

- * Schematic capture linked to PCB
- * Parts and wiring list entry
- * Outline (footprint) library editor
- * Manual board layout
- * Full design rule checker
- * Back annotation (linked to schematic)
- * Power, memory and signal autorouter - £50

Ranger2 £599

- All the features of Ranger1 plus
- * Gate & pin swapping (linked to schematic)
 - * Track highlighting
 - * Auto track necking
 - * Copper flood fill
 - * Power planes (heat-relief & ann-pads)
 - * Rip-up & retry autorouter

Ranger3 £3500

- All the features of Ranger2 plus
- UNIX or DOS versions
 - 1 Micron resolution and angles to 1/10th degree
 - Hierarchical or flat schematic
 - Unlimited design size
 - Any-shaped pad
 - Split power planes
 - Optional on-line DRC
 - 100% rip-up & retry, push & shove autorouter

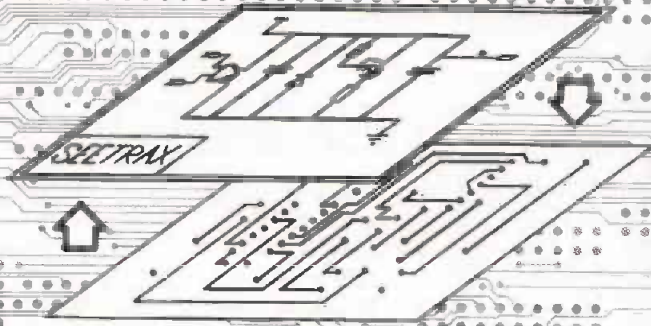

All systems upward compatible. Trade-in deals available.

Call **Seetrix CAE** for further information/demo packs.
Tel: 0705 591000 Fax: 0705 599086

Seetrix CAE, Hinton Dunbar House, Broadway Lane,
Lovedean, Hampshire, PO8 0SG

All trademarks acknowledged

Outputs to:

- * 8/9 and 24 pin dot-matrix printers
- * HP Desk/Laser Jet, Canon BJet, Postscript (R3 only)
- * HP GL, Houston Instruments plotters
- * Gerber photoplotters
- * NC Drill Excellon, Sieb & Meyer
- * AutoCAD DXF

BUILD YOUR OWN PC

Using our low cost component parts or we can assemble for you for only £25

386 MOTHERBOARDS

386SX-33MHz	£72
386DX-40MHz	128k Cache £99

486 MOTHERBOARDS With VESA Local Bus

2 Slots & Pentium P24T Socket.	
486SX-25MHz	256k Cache £159
486DX-33MHz	256k Cache £279
486DX-40MHz	256k Cache £299
486DX2-50MHz	256k Cache £290
486DX-50MHz	256k Cache £369
486DX2-66MHz	256k Cache £399
486DX-33MHz EISA	256k Cache £399
486DX-40MHz EISA	256k Cache £420
486DX2-60MHz EISA	256k Cache £425
486DX-60MHz EISA	256k Cache £480
486DX2-66MHz EISA	256k Cache £520

HARD DISK DRIVES

130MB	IDE 16ms	£150
170MB	IDE 15ms	£169
213MB	IDE 15ms	£179
250MB	IDE 12ms	£189
330MB	IDE 12ms	£229
420MB	IDE 12ms	£360
540MB	IDE 12ms	£430
1GB	SCSI-2 9ms	£699
2GB	SCSI-2 10ms	£980
Hard Disk Mounting Brackets		£5

FLOPPY DISK DRIVES

3½" 1.44Mb Floppy Disk Drive	£33
3½" 1.44Mb Floppy with 5¼" Frame	£36
5¼" 1.2Mb Floppy Disk Drive	£35

MONITOR

14" Mono VGA	£89
14" SVGA Colour (Interlaced) (0.28mm)	£175
14" SVGA Colour (Non Interlaced) (0.28mm) ..	£199
17" High Resolution (0.28mm)	£640

MEMORY

256K x 9 Simm 70ns	£13
1M x 9 Simm 70ns	£36
4M x 9 Simm 70ns	£142

DISPLAY CARDS

Oak 16-Bit SVGA Card 256k	£25
Oak 16-Bit SVGA Card 512k	£30
Oak 16-Bit SVGA Card 1MB	£49
VESA Local Bus SVGA 1MB	£70
VESA Local Bus SVGA 2MB	£99
VESA Local Bus S3 Windows Accel 1MB	£110
VESA Local Bus S3 Windows Accel 2MB	£140

KEYBOARDS

102 Key Standard	£22
102 Key Deluxe	£27



ADD-ON CARDS

I/O Card 2S/1P/1G	£12
IDE Card 2HD/2FD with Cables	£12
IDE I/O Card 2HD/2FD/2S/1P/1G with cables ..	£16
VL-Bus IDE I/O card as above	£29
VL-Bus IDE Caching controller 4HD/2FD	£129
VL-Bus SCSI-2 IDE I/O card	£125
SCSI-2 card with software	£89
Future Domain SCSI with cables	£45
Future Domain SCSI 2S/1P/1G with cables ..	£59
16-bit Ethernet card (NE2100 compatible)	£59

OTHER ITEMS

Microsoft Compatible Mouse	£12
Deluxe Desktop Case (200W PSU)	£55
Mini Tower Case (200W PSU)	£59
Tower Case (250W PSU)	£89
MS-DOS 6.2	£39
Windows 3.1	£35

CD ROM DRIVES

Mitsumi CD-ROM Drive with interface card	£129
Panasonic CR-562B Double speed CD-ROM	£165
Toshiba XM3401 D Speed SCSI CD-ROM	£295

Eurocom International Ltd

Telephone (035 388) 325

The Old School, Prickwillow, Ely, Cambridgeshire, CB7 4UN.

Call for free catalogue or send cheque with order.
Carriage £12.00 per order. All prices exclude VAT please add at current rate to total order.

PC Clinic

Nick Hampshire continues his series on maintaining, repairing, and upgrading PCs with a look at two vital components of any PC - the motherboard and the power supply.

Take the case off your PC and look inside. The first thing you will notice is an assortment of application boards, the power supply, the disk drives and an odd assortment of cables and wires. Then, as you look a bit closer, you will see at the back or bottom, of the case in the shadow, a large printed circuit board. A board which probably contains two or three very large rectangular integrated circuits, the sockets into which the applications boards plug and banks of memory chips.

This is what is popularly referred to as the motherboard, or more correctly the main system board. It contains all the main circuitry for the computer, the processor and associated control circuitry, system memory, cache memory, the BIOS EPROM chip, CMOS memory with its back-up battery, keyboard and serial I/O, plus all the clock, interrupt, and DMA circuitry.

The motherboard also contains the main expansion buses, ISA, EISA, VESA, etc., which allow the basic system board circuitry to be expanded by using plug in adapter boards. Typically, these would include the disk drive controller board, a display adapter board, an I/O board and perhaps a sound generation board (we examined these expansion buses in last month's issue of ETI, and will be looking at adapter cards in depth in two months time).

However, the motherboard does not need any of these adapter boards to work, it is after all a self contained and fully functional computer system, complete with memory, I/O, and some very low level software on the BIOS EPROM. Of course, without a video display board you will have to rely on a printer, or terminal, connected to the motherboard serial I/O port in order to generate any form of output, the keyboard can be used as a source of input. Input and output will be very limited since without disk drives the system will be unable to load DOS, relying instead on the very low level BIOS functions.

The independent nature of the main system board means that the power supply and the motherboard form the two most fundamental components in any personal computer. If the system is faulty then these two components should be the first to be checked out thoroughly.

We can check the motherboard for a range of faults by using a set of special routines built into the BIOS software. These routines are known as the Power On Self Test or POST code system and they generate a comprehensive set of diagnostic messages which can be displayed with the aid of a special adapter board. Repairing or replacing a motherboard is a lot cheaper than repairing or replacing an entire system.

Indeed, replacing the motherboard in a system is an excellent way to upgrade a system at minimum cost. If we change the motherboard and its in-built processor and control electronics, we can easily change, say an 8MHz 286 system into a 33MHz 486. We can keep the same case, same power supply, same adapter cards, perhaps even the same memory chips, the same disk drives, display and keyboard. In other words, by simply replacing the motherboard and processor it is possible to

convert an old system into an infinitely more powerful new system, for just a couple of hundred pounds.

This will not be necessary on newer 486 based systems, since they have been designed to be more easily upgradable and it should be possible to upgrade merely by replacing the CPU chip with a faster or more powerful version. Thus, if you have a 486SX running at 25MHz and want to upgrade it to a full DX system, complete with maths co-processor, then one simply replaces the 486SX with a 487SX. Similarly, if you have a 486DX system running at 33MHz and want one running at 66MHz, then all one has to do is change the processor chip, no need to change the motherboard (we will be looking at upgrading CPUs and the use of over drive chips next month).

This month we will, therefore, be looking at all the various constituent components of a typical motherboard, the different types of motherboard and how to choose and install the appropriate one for you. We will also see how to track down and cure motherboard faults, plus the power supply and the various cables which link them and the keyboard, display LEDs, switches and so forth.



Bus Types

A computer bus can be defined as the collection of data, address, and control lines which link the processor to memory and I/O circuitry. The use of a standard bus which can be accessed through one or more extension sockets allows one to add additional memory or I/O to a system, by means of plug in adapter cards.

There are currently five different bus types used on PC motherboards and these are as follows:

ISA (Industry Standard Architecture) - This is the most widely used PC bus and is found on all PC ATs, XTs and 100% compatible systems (with the exception of most portables). Because so many systems support the ISA bus there are a very large number of available commercial adapter boards. The only limitation with the ISA bus is that it has a fairly slow 16 bit data bus which can prove restricting in fast I/O applications.

EISA (Extended Industry Standard Architecture) - This is a much faster 32 bit version of the ISA bus. Unfortunately, although technically superior to the ISA bus, it has not been a commercial success and there are relatively few EISA adapter cards available.

MCA (Micro Channel Architecture) - This is a proprietary IBM bus which was developed for their PS/2 systems in response to the need for an improvement on the original ISA bus. As such, it is a competitor for the EISA bus, but like that bus it has not been a great commercial success and there are relatively few adapter cards available.

VESA Local Bus - Another approach to speeding up the ISA bus has been to develop an interconnection, or local bus, which allows some circuitry on the adapter board to communicate directly with the CPU, rather than via the ISA bus. This local bus is primarily used for memory to memory data transfers and has thus allowed the creation of high speed video and disk adapters which are significantly faster than their ISA equivalents. The VESA local bus has been a commercial success and most 486 motherboards now have one or two VESA bus slots.

PCI Local Bus - This is a new bus standard which maintains compatibility with the ISA bus, but offers the enormously enhanced performance benefit of a 64 bit local bus. This is a very new development and we have yet to find out whether it is a commercial success but it is, however, very well suited to the Pentium and will in the long run probably prove to be the natural bus for such systems.

If you want a good versatile bus system for your motherboard which will allow connection of a wide range of adapter cards as well as being able to take advantage of future developments, then an ISA bus system with VESA local bus is probably the best option.

Full technical specifications for the ISA and EISA bus, including pin specifications and bus timings, were included in part 1 of PC Clinic, published in the June 94 issue of ETI. We will be looking at the local bus in depth in three months time.

Installing a motherboard

Installing a new motherboard, or replacing an existing one, is quite easy. Indeed, by going through the following steps installation can be done in little more than thirty minutes:

● Before doing anything, it is important that you have a large clear space on which to work, a newspaper covered dining room or kitchen table is ideal. Also, because the motherboard and associated CPU and memory chips are expensive and easily damaged by static electricity, it is a good idea to discharge your static (see box on this page) before touching any of the electronic components.

Choosing a New Motherboard

It may sound obvious, but the first question one should ask when deciding which motherboard to buy, whether as a replacement for one that has failed or as an upgrade for one that is obsolescent, is which processor do I want and what processor speed do I need?

Most of us will have a natural tendency to go for the fastest and best that we can afford, but before doing so it is a good idea to sit down and carefully analyse what the system will be used for, how much money is available and whether you will want to further upgrade the system at a later date. After all, if the system is only being used for simple applications such as word-processing, then there is little need for a high powered system, but high power will be needed if applications involve CAD, multimedia, etc. These are all the sort of basic questions anyone buying a PC should ask themselves.

If you do not require lots of processing power, then a cheap 386 motherboard will be adequate. If you require lots of power then a 486DX running at 66MHz is the best option. This can be upgraded to a Pentium at a later date, if required. At the time of writing, a Pentium motherboard is probably not an economic option.

Having decided whether you want to use a 386 or 486 based motherboard, the next decision is what type of processor - a SX, a DX or a DX2. With the 386 family, the SX version has a 32 bit internal bus but only a 16 bit external bus, whereas the DX version has both a 32 bit internal and external bus. The result is that the DX version is considerably faster at the same clock speed. On the other hand SX chips have lower peripheral overheads and motherboards based on such chips are thus about £70 cheaper than their DX counterparts.

In the 486 family of processor chips, the difference between the SX and DX version depends not on the bus width, both use a 32 bit internal and external data bus, but rather on the presence or absence of a maths coprocessor on the chip. With 386 systems, a separate maths coprocessor will be needed in order to perform computationally intensive programming such as running a CAD program like AutoCAD. On the 486DX the maths coprocessor is actually built onto the main processor chip, but the SX does not have the coprocessor and therefore, although faster than a 386 system, is less suitable for applications like CAD.

If you want to add a maths coprocessor to a 486SX system, then depending on the motherboard design, this can be done by replacing the 486SX with a 487SX or inserting a 487SX into the spare socket provided for the purpose.

The next consideration when selecting a motherboard is processor speed, a critical choice since speed equates with

- Having discharged your static, open the static proof bag in which the motherboard is shipped. Try to handle the board by touching just the edges and do not touch any bare connections on the back of the board or any of the chips. Then place the board on a good flat surface, ideally covered with an anti-static mat, component side upwards.
- At this stage, the board should be checked for shipping damage.
- Get out the documentation that comes with the board and read it carefully, preferably two or three times!
- If the motherboard has cache memory, it should be checked to ensure that the cache is the right size and speed. If it is not, then you may have to remove the existing cache memory chips and replace them with the correct ones. The documentation which comes with the motherboard should tell you which chips to use.
- The next stage is to install the RAM on the motherboard. Today, RAM usually comes in the form of SIMMs, but on older boards the memory chips were either socket mounted or soldered in. If necessary you may need to set some DIP switches or

processing power. The standard CPU speeds available today are 25MHz, 33MHz, 50MHz and 66MHz. The rated speed of a motherboard is set by the clock circuitry and is often defined by a wire link or a special plug in clock generator. With a 486 system, it is possible to double the processor speed by using a clock doubler, or DX2, processor chip. Thus, with a 486DX2 processor a 33MHz 486DX can be made to run at 66MHz. The most powerful system one can buy without buying a Pentium motherboard is one based upon a 486DX2.

Processing power is also affected by memory access times, the use of slow memory will entail the use of wait states and thus a reduction in the number of instructions which can be processed per second. This means that the motherboard will have to be fitted with memory of sufficient speed to keep wait states to a minimum. The use of a block of between 64K and 256K of very fast memory, what is usually referred to as a secondary cache, will further speed up memory access and thus overall processing speed. If processing power is important, then fast secondary cache memory is essential (we will be looking at cache memory and different processor designs next month in ETI).

Besides having fast memory, the motherboard should also be capable of allowing memory expansion so that you will be able to add as much memory as necessary throughout the proposed life of the system. Most motherboards will support between 16MB and 64MB of RAM on the motherboard in SIMM sockets.

If you are upgrading or replacing a motherboard then it is also very important to ensure that the board is of the correct size to fit the case. Today, the majority of commercial motherboards conform to what is known as the mini-AT size form factor and measure 13.25 x 8.75in. This size motherboard will fit into most cases. However, some older systems used a standard XT sized board which measured 12 x 8.5in and some more compact systems were designed with a 2/3AT board, which measures just 8.5 x 9in. Note that Amstrad 1512/1640 systems used a totally non-standard board with built in video, serial and parallel I/O ports, such machines are best left alone since there is little to be gained in trying to upgrade them.

When upgrading a system with these smaller motherboard sizes it may prove necessary to buy a new, larger size case that will take one of the standard sized motherboards, which will cost about £75. When buying a new motherboard you should also check that the mounting holes are all in the correct place, however, these are fairly standard.

jumpers in order to tell the system how much memory is installed (we will be looking at memory in depth in a couple of months time).

- Your motherboard may have a jumper which determines whether the system uses a colour or monochrome video adapter - if it exists this should be set according to the documentation.
- If the motherboard has a 386, you may want to add a coprocessor, this should be added at this stage and the appropriate jumpers set.
- Next, depending on the system's case design, you may need to attach, with the supplied screws, a number of small brass or nylon spacers to the board. These slot into the chassis and keep it rigid, thus preventing damage when plugging in a new adapter card, or changing the processor chip. The position of the spacers should be shown in the documentation, otherwise compare the board to the case and select the correct holes. Always bear in mind that by bending a printed circuit board, you can easily crack the tracks and cause failure.
- The motherboard can now be positioned in the case with the bus slots towards the back. Position the spacer supports

Repair or replace?

When faced with a faulty motherboard, the big question is whether to try and repair the fault or simply replace the motherboard with a new one. Of course, this decision depends upon the nature of the fault and the way in which the motherboard is constructed. A simple fault such as a defective capacitor, or a dud IC can usually be corrected, once located, by carefully unsoldering and replacing the component. However, motherboards are increasingly being constructed using very high levels of integration, multilayer printed circuit boards and surface mount devices, which can make it very hard to successfully repair a board without access to a surface mount workstation.

The result is that the modern generation of motherboard has largely been designed as a disposable commodity. Indeed, if one looks at the actual price of motherboards compared with the price of a processor chip on its own, then one realises how little they actually cost. For example, a 25MHz 486SX motherboard costs about £180 and the processor chip by itself about £140. This means that if you are going to upgrade a system, it is almost as cheap to replace the entire motherboard as it is to change the processor chip.

The high price of the processor chip with respect to the motherboard means that if one has a defective board, it is well worth checking to see if the processor is still OK. If it is, then a bare CPU board without CPU can be acquired and the CPU chip and any transportable RAM and cache memory chips transferred from the old defective board to the new one. If you are upgrading a system, then it may also be possible to transfer some chips from the old board to the new, thereby saving money.

When upgrading a motherboard, there are a few procedures which should always be followed:

- First make a note of all the CMOS set-up settings on the old board, in particular those relating to the hard drive.
- Switch off the power, unplug and open the case.
- Make sure you have discharged the static from yourself, then disconnect and remove all the adapter cards.
- Identify and label all the cables which run from the motherboard to the front panel and power supply before unplugging them.
- Finally, unscrew the motherboard and save the screws and any nylon or brass spacers attached to the back of it. Put the old motherboard, minus any recycled components, into the static free bag which contained the new motherboard.

correctly, line up the mounting holes with the threaded studs in the chassis and then fix the motherboard in place, using the screws and washers provided with the chassis. Do not force anything to fit and do not overtighten screws - you might need to undo them later.

- With the motherboard installed, the power connectors can be attached (make sure that the PC is NOT connected to the mains before you do this, otherwise you could damage the system or yourself).
- Next, all the front panel connectors should be attached (a box showing cables and connectors is shown on pages 40 and 41).
- Connect the backup battery to the battery connector on the motherboard, making sure that the +ve terminal of the battery is connected to the +ve terminal lead on the board.
- Finally, double check everything before adding the video and disk controller adapter boards, reassemble the system and switch on. The system should power up, but will not boot directly into DOS since you will first of all have to set the system CMOS configuration (more about how to do this next month).

The Motherboard

In this centre spread diagram, the motherboard is a standard VESA Local Bus 486DX2, with ISA expansion slots, cache memory, and space for up to 32MB of main system RAM. Different boards will have components in slightly different locations, but they should be easily identifiable from this diagram

BIOS chip

The BIOS chip is just a standard EPROM memory chip, on which is stored all the fundamental low level programs which make the system work as a whole - the routines which scan the keyboard, output a character to the display, etc. The BIOS chip also contains the Power Up Self Test, or POST, diagnostic routines (more about them on page 42). It should be noted that there are several different types of BIOS chip in use, which have been developed by different manufacturers but are all more or less equivalent to each other.

Power LED and keylock connector

As its name implies, the power LED is used to indicate that the processor is switched on. On many systems the keylock, which can be used to prevent the keyboard being used, is on the same connector. The keyboard is inhibited when the keyboard inhibit line is connected to ground.

PSU connectors

The two power supply connectors are in a standard location on all motherboards and have a standard format, thereby allowing all motherboards to be connected to any PC power supply. The power supply connector pin outs are shown on page 41.

Keyboard connector

The keyboard connector on all PCs is of a standard form and in a standard location at the right hand rear edge of the board. This is so that all motherboards will fit into all cases. The keyboard connector is a standard 5 pin DIN - for the connections see page 40.

Expansion slots

A typical motherboard will probably have between six and eight bus expansion slots. These are put in a standard location so that all motherboards will fit all cases. The expansion slots on the average motherboard will all be capable of taking ISA standard bus adapter cards, with probably six 16 bit slots and two 8 bit slots. If the board supports a VESA local bus, then two of the 16 bit slots will also have VESA bus sockets (for full specifications of the ISA bus, see June ETI pages 40-42)

RAM

Since this is a 486 board, the main system RAM is stored on a number of 1Mb or 4MB SIMMs. By using the 4MB SIMMs, this board will take up to 32MB of RAM in eight SIMM sockets.

CMOS chip and battery

The CMOS chip is a small memory chip which is used to store the system set-up information required by BIOS when initialising the system during power up or reset, as well as information on current time and date. The data stored in this memory chip is retained, even though the system is switched off, thanks to a small battery, sometimes actually soldered to the motherboard. This battery will need replacing occasionally.

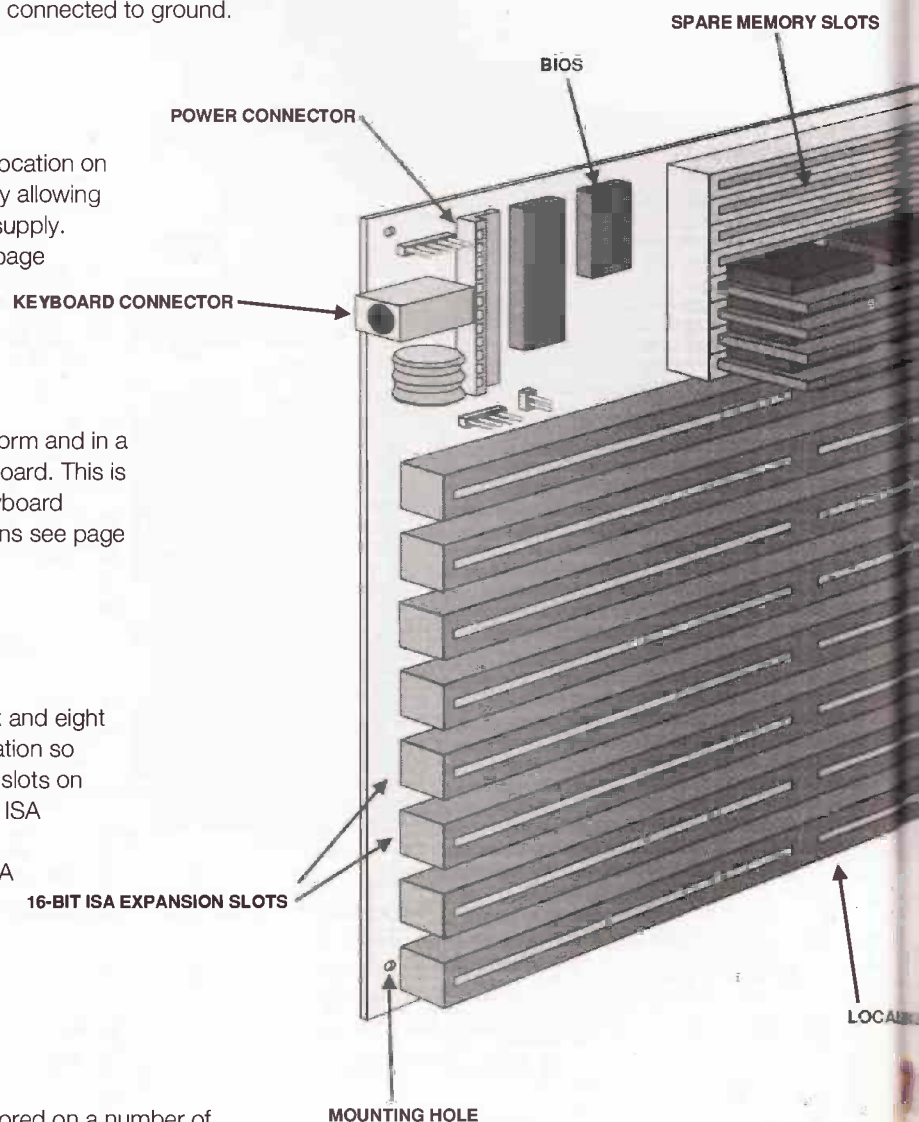

Cache memory

In order to overcome speed bottlenecks caused by memory being slower than processor access time, some high power systems have a special block of between 32 and 256K of very high speed RAM called cache memory (see ETI next month for a more detailed look at cache).

Overdrive socket

The 486 family and their motherboards are designed to be upgradable by simply changing processor chip. To allow for this, boards have an Overdrive upgrade socket. This socket can be either a separate socket, into which the upgrade processor can be plugged, or the existing processor can be mounted in a zero insertion force (ZIF) socket, so that it can be easily removed and replaced with the upgrade processor. A ZIF socket is identifiable by the small lever at the side of it. If there is an additional socket, then it is worth checking whether it is for an Overdrive chip or a Weitek coprocessor. If it is for an Overdrive, then the socket will have 169 pins and if for a Weitek, just 142 pins.

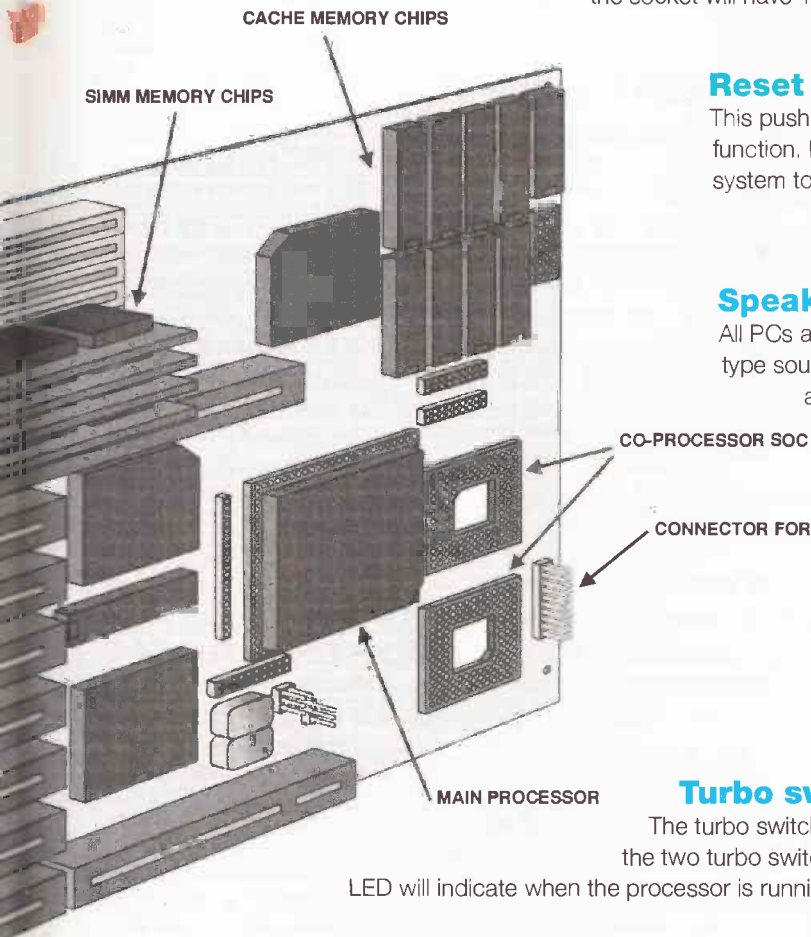

Reset switch

This push-button switch provides the system with a hardware reset function. Pushing this switch connects the two lines and causes the system to revert to a start up condition.

Speaker

All PCs are equipped with a simple speaker, usually a small Piezo electric type sounder. Output to this speaker is derived from a single output line and consists of a square wave of variable frequency. This means that the speaker is capable of outputting sounds of variable frequency but not of generating sounds of sufficient quality to produce good speech or music (both speech and music can be generated, but have a very coarse grating sound). To generate good quality sound output, an analogue waveform must be generated using a special adapter card, such as the popular SoundBlaster.

Turbo switch and LED

The turbo switch allows the user to change the processor speed. Connecting the two turbo switch wires together will cause the PC to run at a slow speed. The LED will indicate when the processor is running at high speed.

Clock circuitry

The system clock provides a regular synchronising signal for the entire system. It is derived from a crystal oscillator of a frequency which depends on the processor being used. The clock frequency is divided down to provide the processor clock, clocks for synchronous keyboard scanning and communications. The system's real time clock is derived from another clock source.

Processor

Since this board is for a 486DX2 you will find it as a large rectangular 105 pin chip with probably a large finned metal heat sink mounted on top. Older, lower power, processors may not have the heat sink (for a detailed look at processor chips see next month's ETI)

Serial port

On some, but not all, motherboards there is a built in serial RS232 communications port - COM1. It is usually located at the rear of the board and is connected to a proper 25 pin D type connector with a short length of ribbon cable.

Standard connections

The motherboard is connected to the power supply and front panel by a number of fairly standard connectors and cables. Although these standards are not universally adhered to, most manufacturers do use the same wire colours and of course all use the same cable connectors and the same connector configuration, in order to allow different motherboards to be used. You should find that your system has all of the following connectors:

Keyboard connector

The keyboard connector socket is actually soldered onto the motherboard in a standard position at the rear of the motherboard. This is so that the connector on any motherboard will always match up to the appropriate hole in any case. The connector is a 5 pin DIN with 45 degree angle between pins, and the pin designations are as follows:

pin 1 keyboard clock pin 2 keyboard data
pin 3 N/C pin 4 ground pin 5 +5V

The above pin configuration is for a standard AT keyboard, in other words all modern PC keyboards. The keyboards for XT's are different.

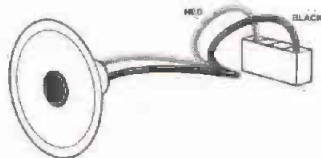

Speaker.

This is a 4 way socket with two wires connecting it to the speaker, the pin designations are as follows:

pin 1 data pin 2 N/C
pin 3 N/C pin 4 +5V

This socket can be connected either way round.

Hardware reset

Momentarily connecting these two lines together with the push button switch will initiate a hardware reset. This socket can be connected either way round.

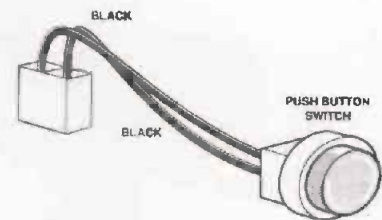

Power LED and Keylock

This five pin connector performs two functions, it indicates whether power is applied to the system and it also allows the user to disable the system by locking out the keyboard using a keyswitch. The pin designations for this connector are as follows:

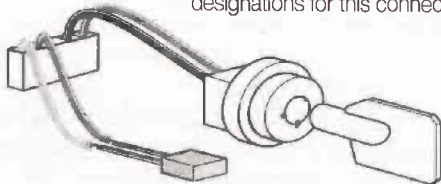

pin 1 +ve power to LED pin 2 N/C or polarising key
pin 3 ground pin 4 keyboard inhibit
pin 5 ground

It is important that this connector is inserted the right way round.

high or low. It uses a two pin connector and the pin designations are as follows:

pin 1 LED anode (+ve) pin 2 LED cathode (-ve)

It is important that this connector is the right way round. Note that on some larger cases the single LED is replaced with an LED display of the speed in numbers rather than a simple on/off indicator.

Turbo LED

This LED indicates the speed of the motherboard,

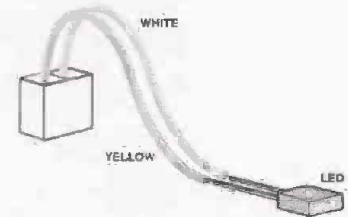

Turbo switch

The turbo switch connector is one of the least standard connectors. On some systems it uses two wires which, when connected together, will cause the system to run at slow speed. On other systems three wires are used, connecting lines 1 and 2 will make it run at one speed and lines 2 and 3 at the other speed. The three wire connector is the less common of the two forms, but with either sort, it does not matter which way round the connector is inserted.

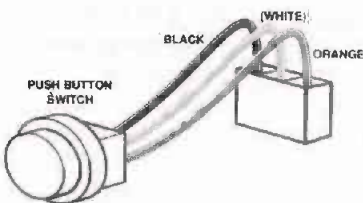

External CMOS backup battery

Some systems use an external battery to supplement the power of the on-board NiCad battery, which is used to retain the system set-up data and real time clock stored in the CMOS memory chip. It is usually a four pin connector and pin designations are as follows:

pin 1 +3.6 or 6V pin 2 N/C or polarising key
pin 3 ground pin 4 ground

It is of course very important that the battery is connected the right way round, usually the +ve connection has a red wire and the ground connections black wires. If you are in any doubt, it is better to leave the external battery unconnected, the system will still work with the on-board NiCad battery, so long as it is not left unused for long periods. It should also be noted that some systems use a 3.6V external battery whilst others use a 6V battery.

Some systems may have additional displays, for example a four digit status display, but since these are non standard they have not been included in the above list. In fact you may be unable to use them if you change motherboard. Unless otherwise specified all connectors are 0.1in PCB connectors with the socket on the end of the cable. When removing, always make sure that they are reinserted the right way round, not all of them use a polarising pin and incorrect reconnection can in some cases cause damage. N/C indicates that there is no connection to that pin

Jumpers and DIP switches

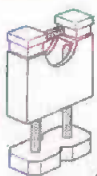

Every motherboard will need to be configured in some way or another and this usually done by carefully following the manual and setting the various jumpers and/or DIP switches so that the system has the desired configuration.

Jumpers are simply very small plugs which are used to short together two pins. The jumper is open when the plug is absent and closed when it is present. Fitting jumpers can be very fiddly, they are very small and often arranged in banks which can make setting them even harder. A small pair of tweezers is the best way of removing or inserting jumper plugs.

DIP switches are easier to set, they are in fact small banks of switches, usually eight in a bank. If you look carefully at them you will see that the individual switches are numbered and that one side is marked on and the other side off. There are two types of DIP switch, one has small rocker switches and the other has slide switches. Both types are best set by pushing the appropriate switch to the desired on or off setting using a small screwdriver.

Always carefully double check settings, they are all very small and it is all too easy to make a mistake. Errors in setting will probably not cause any damage but they will stop the system from working properly.

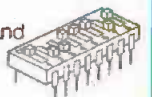

The power connectors

Power is delivered to the motherboard from the PSU via two 0.2in 6 pin connectors. The pin configuration and usual wire colours are as follows:

pin 1	power good signal	orange
pin 2	+5V	red
pin 3	+12V	yellow
pin 4	-12V	blue
pin 5	ground	black
pin 6	ground	black
pin 7	ground	black
pin 8	ground	black
pin 9	-5V	white
pin 10	+5V	red
pin 11	+5V	red
pin 12	+5V	red

The PSU

The power supply in a PC consists of a sealed unit which encloses a switched mode power supply capable of converting an AC mains input to a low voltage DC output. In standard systems, the CPU and main processor circuitry all need a 5V DC power supply to operate (with the exception of low power SL based systems where the CPU operates at 3.3V). In addition a 12V DC power supply is needed for motors in disk drives, etc.

The power supply in a modern 486 based system should be rated at about 200W, sufficient to power the system and any additional memory, adapter cards, disk drives, etc. The rating of a power supply is usually displayed on a label attached to the top of the PSU and with a 200W PSU the current available at each voltage is as follows:

+5V	20A
-5V	0.5A
+12V	8A
-12V	0.5A

It can be seen from this table that on a 200W PSU there is in fact only 100W of available power at +5V. With a lot of adapter cards installed, in particular modems and network cards which draw a lot of power, this may prove insufficient and give rise to intermittent faults. If this is the case, you may need to install a larger PSU.

Intermittent faults can also arise from an improperly grounded power supply producing a high level of bus noise. A good power supply will have a ground wire which is attached to the chassis. If one does not exist, it is a good idea to add one - simply solder a length of 20 gauge wire to the input ground wire going into the power supply and attach the wire to the chassis

PSU faults

As I have already stated, the power supply on a PC is a sealed unit and thus should not be considered an item which can be easily repaired. They are relatively cheap and it is better to replace a faulty power supply than run the risk of damaging the rest of the system. Replacing the PSU is a very simple operation and just involves undoing the connectors, removing a few fastening screws, sliding out the old unit and then inserting the new one (when working with the power supply, always make sure it is unplugged from the mains before doing anything).

The most common reason for a power supply to fail is that there has been a high voltage surge or spike on the line (these can totally destroy the PSU and may even destroy the whole system). We can define a spike as an over voltage of less than one millisecond and a surge as one lasting between several milliseconds and several seconds. The reverse situation is a short period of under voltage, a so called brown out, which is by and large not damaging to the system, but could cause it to reset with consequent loss of

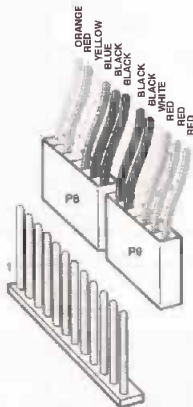

data.

There are two main causes of spikes and surges. One is as the result of fluctuations in the power supply, caused primarily by a large appliance on the same circuit cutting off and on. The other common cause is lightning strikes near to the PC or the power lines. If you think that there is a danger of spikes or surges, for example the PC is being used in a factory full of heavy electrical machinery, then a wise precaution is to invest in a surge protector inserted in the mains power supply to the PC, although even this may not protect you from the type of spike encountered in a lightning strike (it is said that putting a knot in the power cord will absorb the surge from a lightning strike and burn out the lead rather than the power supply, although, I have never had reason to test this idea out!). Conversely, if brown outs and power failures are a problem, then an uninterruptable power supply is a good investment.

It is always a good idea to check the mains power supply before attaching a PC, since if it has been wired incorrectly it could not only damage the PC but render the system dangerous to the user. It is also a good idea to ensure that your PC is the only device on a circuit and it should never share a circuit with devices with large electric motors (e.g. washing machines), photocopiers, or resistive heating devices, all of which can cause spikes and surges. It is also a good idea to make sure that your PC and its peripherals all share the same ground. This can be done by plugging them into the same outlet via a distribution block.

Lastly, keep your power supply clean. It generates a lot of heat and if cooling is prevented by insufficient airflow across it, the power supply can easily overheat and fail. The fan and air vent holes should be cleaned regularly, using a soft brush and/or a can of air duster. You will be surprised how much dust a PC can accumulate in a relatively short time.

Anti-Static Precautions

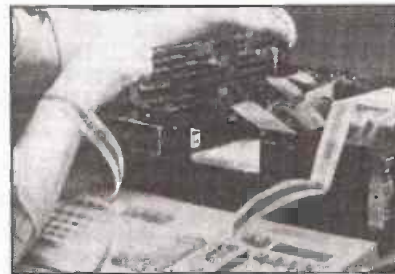

We all tend to build up a small static charge in our bodies as a result of moving around, the friction of clothes, etc.

Normally, such charges are small and quickly dissipated. However, the widespread use of synthetic fibres in clothing, carpets, and furnishing fabrics, plus the use of synthetic rubber soled shoes, means that there are fewer chances for the static charge to dissipate. Consequently the human body, acting as a large capacitor, can store quite a considerable charge.

Static electricity is an ever present hazard when handling electronic components, because the very high voltages present in the body of the handler, if discharged, can easily destroy sensitive integrated circuits.

The best way to eliminate this problem is to discharge the static from your body prior to handling any sensitive circuitry. This can be done by simply touching something conductive which is attached to earth, for example a mains water pipe, a metal central heating radiator, or electrical earth on the mains system.

The trouble is that it is not always convenient to have to keep touching an earthed metal object in order to discharge your static electricity. A better way is to use an anti-static wrist strap, which is a simple conductive band held onto the wrist by a Velcro fastener. The conductive strip is attached to a cable via a 1Mohm resistor for safety and the other end of the cable is attached via an insulated alligator clip to electrical earth. This simple little wrist strap will drain away all damaging static charge, however, be careful to remove the strap before working with live voltages.

Anti-static wrist straps are available from Maplin Electronics and cost £6.95 each.

Testing and Troubleshooting a Motherboard

If you are faced with a non-functioning motherboard, all is not necessarily lost. There can be a number of causes which if rectified will restore the board to full operation.

● The first step in testing and troubleshooting any electronic device is to thoroughly check the power supply. To do this, you will need a good multimeter set to measure DC at the next range above 12V. Then, using the power connector diagram on page 41 as a guide, check the voltages on the following pairs of connectors

Minimum voltage	Maximum voltage
Black -ve meter probe	Red +ve meter probe
+4.8 +5.2	P8 pin 5 P9 pin 4
+4.5 +5.4	P9 pin 3 P8 pin 6
+11.5	+12.6 P9 pin 1 P8 pin 3
+10.8	+12.9 P8 pin 4 P9 pin 2

Failure can also be caused by AC ripple getting through the power supply. This is a common source of intermittent failure, but we can test for this problem with a multimeter by setting it to read AC voltages in the range just above 12V and then checking the motherboard power connectors with power applied, thus:

Black probe	Red probe	Voltage
P8 pin 5	P9 pin 4	less than 0.25V
P9 pin 3	P8 pin 6	less than 0.25V
P9 pin 1	P8 pin 3	less than 0.6V
P8 pin 4	P9 pin 2	less than 0.6V

If all the measured voltages fall within the ranges in the above two tables, then the board power supply is OK. If not; then disconnect the power supply from the motherboard and recheck the voltages in order to isolate whether the fault lies in the PSU or on the motherboard.

- Next, unplug the system from the mains and check all the motherboard connectors and socket mounted ICs, to ensure that they are plugged in correctly.
- Look for any foreign object such as a screw, small piece of wire or solder which may have accidentally dropped onto the board.
- Check that all the system board switch and jumper settings are correct.
- Check for signs of overheating (a brown scorched board).
- Check for broken tracks and poorly

soldered joints.

● Then, remove all adapter cards and unplug the power connectors. Now set the multimeter to measure resistance and measure the resistance between the various pins on the motherboard power connectors in accordance with the following table:

Black -ve meter probe	Red +ve meter probe	Resistance
5	3	17ohms
6	4	17ohms
7	9	17ohms
8	10	0.8ohms
8	11	0.8ohms
8	12	0.8ohms

Improper resistance reading may indicate that the motherboard is defective, most likely a single defective component.

Unfortunately tracking down a fault on the motherboard can be very difficult without a little help.

Complete board failure is relatively rare and will only happen when the power supply is at fault or the CPU chip fail. In most situations the board will still work after a fashion and in such cases we can use the processor and the BIOS self test procedures to help us locate faults on the motherboard. To do this we need a special plug-in adapter board called a POST card, a typical example of which is POST Probe by Micro 2000.

With a POST tester, it is possible to track down most faults with a PC, including a large number of motherboard faults and it is an essential tool for anyone seriously involved in repairing and maintaining PCs. The Micro 2000 POST Probe card and its associated diagnostic software allows one to track down faults at all levels of functionality, even faults on boards unable to produce POST codes.

For more details on the POST Probe card contact Micro 2000 in Letchworth, on 0462 483483.

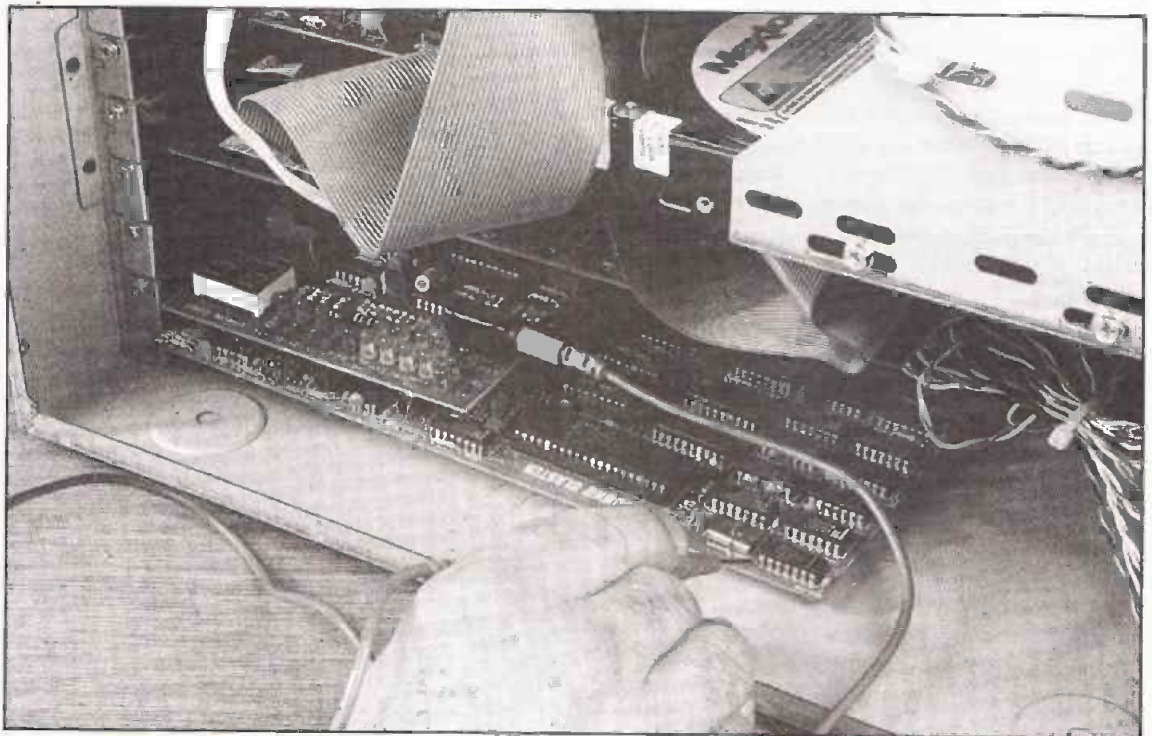

Using a POST probe cord.

Next Month...

We shall be looking at processors, co-processors, overdrive chips, cache memory and high speed bus systems.

Competition



WIN A SUPER SOPHISTICATED 'FOX' WIRELESS ALARM SYSTEM FROM MAPLIN ELECTRONICS

The Fox alarm system is an advanced way of protecting a home or business from intruders which does not require the installation of yards of ugly wiring around the building. There is no wiring, because the intrusion detectors and the control panel all communicate using small radio transmitters. This means that the system is very easy to install requiring just simple DIY skills.

This sophisticated alarm system can easily be moved or expanded and there is a wide range of additional sensors and accessories which can be added. Furthermore, because there are no wires, it is not so easy for a knowledgeable intruder to detect and disable.

The system has been ergonomically designed and is very easy to use - just one button controls arming, disarming and panic functions. The control panel is compact and attractively designed and included with the basic system is the wireless control panel, a wireless PIR intruder detector, a wireless contact transmitter for use on doors and windows and a two button key-fob transmitter for remote operation (note that the Fox alarm fob will also operate the Maplin Vixen car alarm). Highlight features include:

- 4 detection zones, part of full arming capability
 - Remote control panic alarm
 - Easy to install, simple instructions
 - No unsightly wiring between detectors
 - Fully DTI approved transmitters
 - Full remote control operation via key-fob transmitter, up to four transmitters can be used
 - Built-in 120dB siren
 - Fully expandable system
 - Automatic battery back-up during mains failure and low battery warning
 - Intrusion history display shows when alarm was triggered.
- The complete basic system costs £99.99 and can be won by one lucky ETI reader. That reader could be you!

To enter this competition all you need to do is find all the hidden words in the following puzzle. To make it easier we will give you one clue - *all the hidden words come from the text on this page.*

Send your list of the words you have found, written on a postcard or the back of an envelope, to:

ETI, FOX Competition, Argus House, Boundary Way, Hemel Hempstead, Herts., HP2 7ST.

All entries must be received before July 30th when a draw will be made from all correct entries to decide the winner.

Rules The competition is open to all UK residents other than employees or their families of ASP and Maplin. The prizes are as stated and there is no cash alternative. The editor's decision is final and no correspondence can be entered into.

T	H	M	G	V	D	Y	S	K	Y	R	V	M	I	O
Q	X	E	N	R	O	T	C	E	T	E	D	D	I	L
I	M	K	K	F	E	Y	H	A	E	T	K	G	W	J
I	B	K	T	I	W	D	S	L	C	T	W	T	E	V
O	L	J	W	Y	W	L	U	A	N	I	T	V	I	B
E	T	N	J	N	L	Y	Y	R	E	M	N	X	N	M
F	H	L	N	S	N	U	V	M	T	S	E	R	P	Q
H	V	G	O	R	V	E	O	K	O	N	R	W	T	S
V	O	L	Q	R	Q	C	F	S	T	A	I	D	T	V
D	S	Q	O	Y	T	R	K	H	D	R	S	V	M	I
Y	V	T	F	C	B	N	U	I	E	T	W	C	V	K
B	U	B	F	O	C	M	O	L	O	K	O	J	O	V
V	G	D	O	O	H	E	E	C	G	T	O	C	D	S
F	E	I	B	L	X	S	W	W	A	H	V	E	Y	I
M	F	X	P	N	S	B	D	R	X	R	U	X	L	O

Loop Alarm



Keep thieves at bay - build Terry Balbirnie's link alarm

This type of loop alarm may already be familiar to readers because it is often to be seen in camera shops and stores selling audio equipment. It works by passing a continuous link wire through the handles of any items that need to be protected. The ends of the wire are then plugged into the unit. If the loop is broken, either by cutting the wire or unplugging it, the alarm sounds. It is thus impossible for a potential thief to remove an item without setting it off. Replacing the plug, or re-connecting the wire does not silence the alarm - re-setting can only be achieved by using a key-operated switch.

This alarm will be of particular interest to shop owners and market traders since it provides good protection against theft, yet allows people to handle the goods freely. It will also be useful to anyone who needs to protect their valuable Hi-Fi and video equipment, cameras, etc. With a little ingenuity, most items can

and sounder. The key-operated arm/disarm switch is mounted on top and there are two phono sockets on the back, to which the ends of the wire loop are connected. The sounder used in the prototype has the familiar 'yelping' tone associated with alarms and the one specified is very loud, while having a reasonably low current requirement. Readers are advised not to use small, cheap buzzers which will not be loud enough for the purpose.

While armed, the circuit requires less than 15mA and the 12V battery pack may be expected to provide a life in excess of 1 year. While sounding, the current rises to 150mA but this will only happen occasionally and for short periods of time. It should therefore have little effect on battery life.

Circuit description

The circuit for the loop alarm is shown in Figure 1. The main component is IC1, a micropower CMOS op-amp which is used here as a voltage comparator. This particular device has been chosen because of its exceptionally small current requirement, which is essential for a long battery life.

Resistors R1 and R2, form a potential divider connected across the nominal 12V supply. Since the arms have equal values, this applies a steady voltage equal to one-half of this value (nominally 6V) to the op-amp inverting input, pin 2. With the loop connected, resistors R3 and R4 provide a further potential divider which (ignoring the effect of R5 for the moment) applies a voltage of 5V approximately to the non-inverting input, pin 3. Thus, the voltage applied to the inverting input is higher than that at the non-inverting one. Under these conditions, the op-amp is off with the output, pin 6, low. There will therefore be no effect on transistor Q1 and the rest of the circuit.

When the loop is broken, R4 is disconnected and R3 makes pin 3 high (+12V). The input

conditions are now reversed with the non-inverting input being at a higher voltage than the inverting one. The op-amp therefore switches on with the output high. Current enters the base of Darlington transistor Q1 via current-limiting resistor R6, so turning it on. This operates the sounder, BUZ1, in the collector circuit.

In fact, the operating conditions are more complicated than

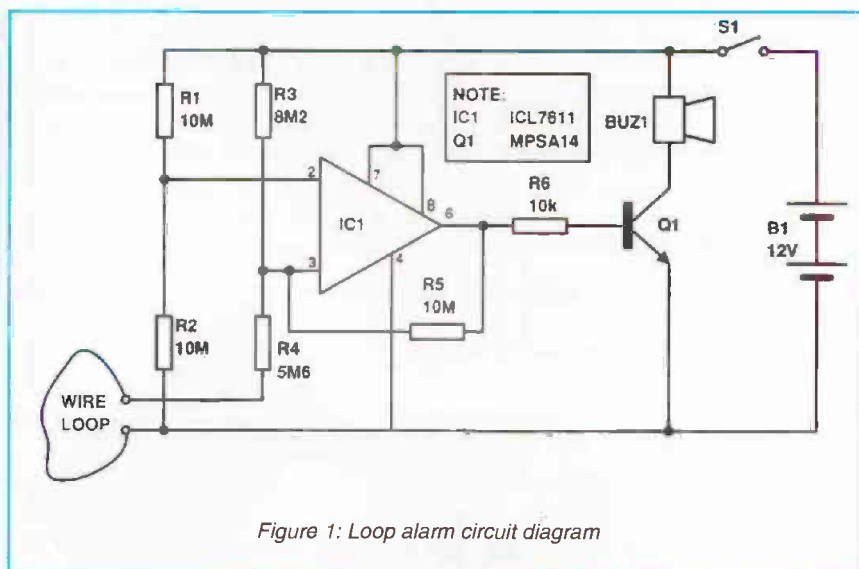
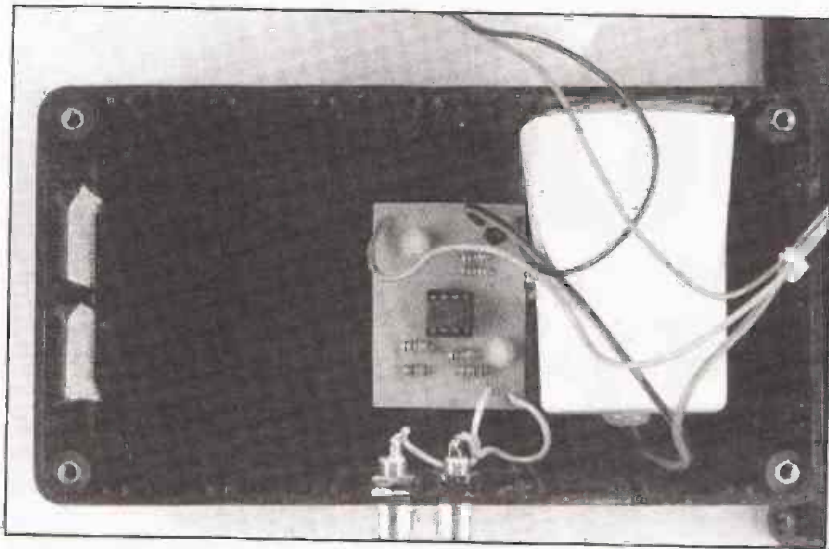

Figure 1: Loop alarm circuit diagram

be accommodated. Another use for the device is to provide a warning when drawers, doors, cupboards, windows, etc. are opened. For this type of purpose thin, breakable wire could be used. The link wire itself may be of any reasonable length so the alarm can be used to protect equipment over a very wide area.

The alarm is housed in a plastic box with integral battery pack



fall together and the operating point will be the same. Eventually the batteries will need to be replaced, simply because they will fail to operate the sounder loudly enough.

Construction

Construction of the loop alarm uses the single-sided PCB layout shown in Figure 2. Begin by drilling the two mounting holes in the positions indicated, then solder the IC socket into position. Follow with the resistors and transistor. Do not insert IC1 into its socket yet. Solder pieces of light-duty stranded connecting wire to the three pads marked loop and S1. If the battery holder has a PP3 type snap connector, solder the negative wire of this to the pad marked supply - if it is of the type having solder tags, use a piece of wire instead.

described above, due to the effect of resistor R5. This applies some positive feedback from the output to the non-inverting input. Taking this into account and with the loop intact, the voltage at pin 3 will be 3.6V approximately when the circuit is switched on. Being less than 6V, the output will be off. When the loop is broken, the voltage will rise to 6.6V, so triggering the alarm. With the output on, the non-inverting input voltage will immediately rise to 12V and maintain the on state. If the loop is re-made, the voltage will fall but only to 6.6V, so the alarm will remain triggered. Cancelling operation is effected by first re-connecting the loop, if this has not already been done. Key-operated switch S1 is then switched off to break the supply then on again. With the output low, the voltage at pin 3 will be 3.6V and the alarm will revert to standby mode.

Drill the hole in the lid of the case for the key switch. Drill holes for BUZ1 mounting bracket and one 35mm in diameter for the sound to pass through. Make holes in the back panel for the phono sockets and two in the base to correspond with those in the circuit panel. Solder the negative sounder wire to the pad marked BUZ- and mount the remaining components. Insert IC1 without touching the pins. Alternatively, touch something that is earthed before handling it. This is because IC1 is a CMOS device and could, in theory at least, be damaged by static charge which might exist on the body. When attaching the circuit panel, place some plastic washers on the bolt shanks to keep the soldered connections clear of the base of the box. Complete construction by wiring up the positive battery pack connection, the switch, positive sounder wire and the phono sockets as shown in Figure 3. The battery pack could be secured using Velcro pads or a block of foam plastic. Attach self-adhesive plastic feet to the base of the box if necessary.

Note that as the battery voltage falls with age, the input conditions remain the same. This is because the voltages at IC1 inverting and non-inverting inputs are derived from potential dividers connected across a common supply. They will therefore

Testing

Testing the loop alarm is simply a matter of checking for correct operation. It may be helpful to cover the sounder hole with cardboard during testing because it is very loud. Make a wire loop using a piece of wire with a phono plug soldered to each end. Note that only the centre (pin) connections are used. Plug the link wire into the sockets, insert eight alkaline AA size cells in the battery holder and switch on. The alarm should remain silent. Remove one of the plugs and the alarm should sound, continuing to do so even when it is replaced. Cancel operation by switching off, then on again. If the circuit works

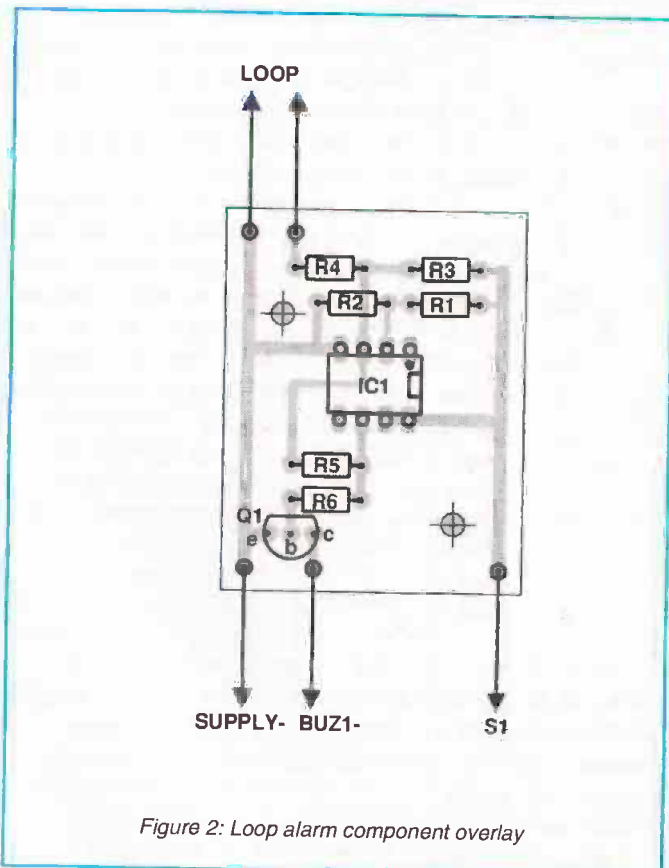
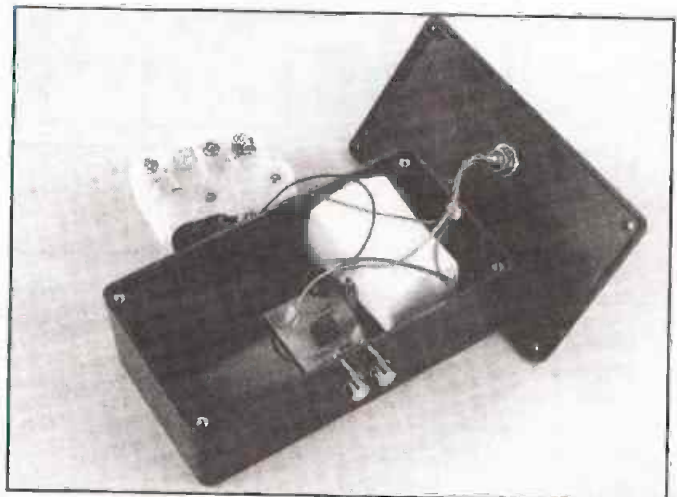

Figure 2: Loop alarm component overlay



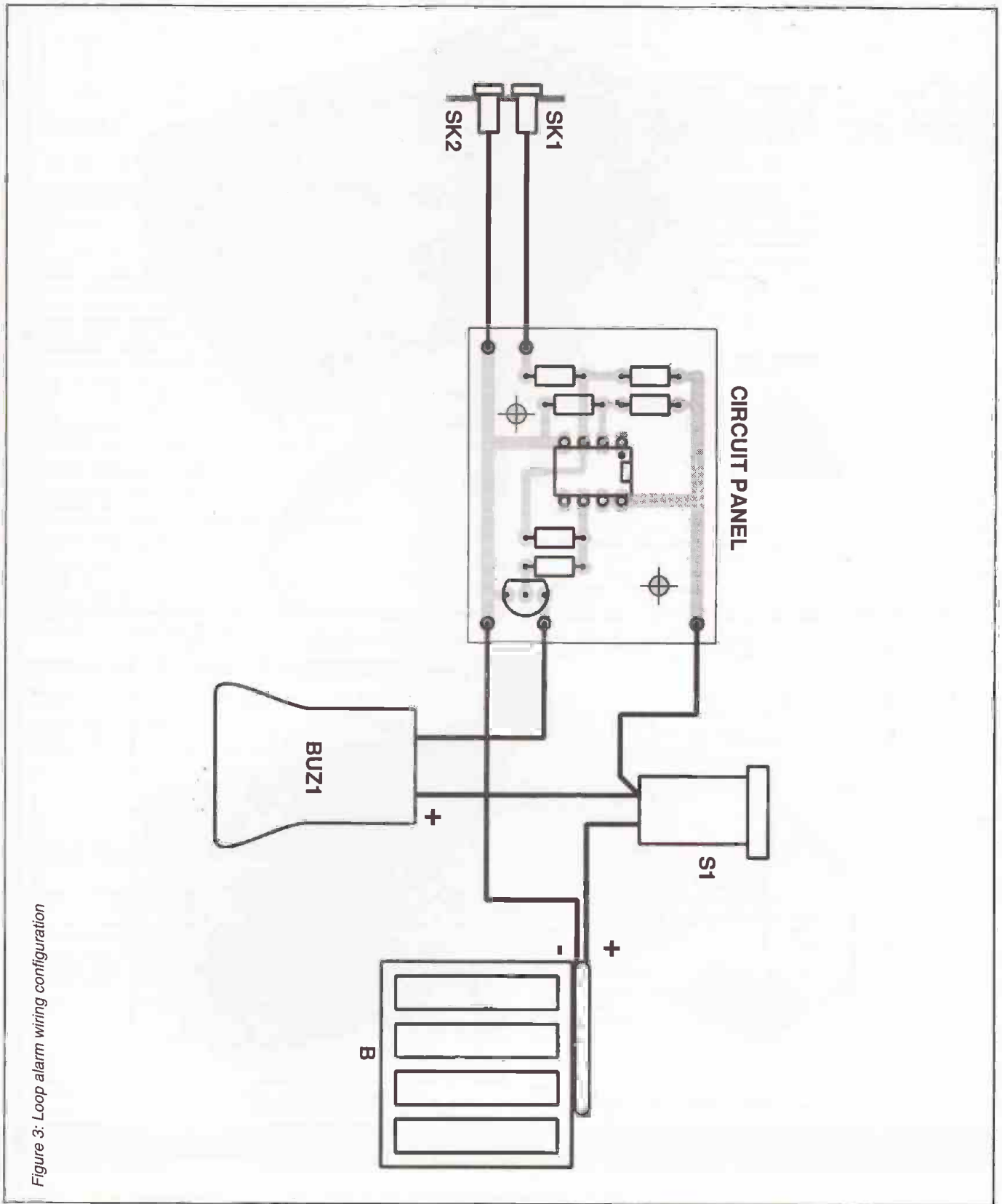

Figure 3: Loop alarm wiring configuration

correctly, it can be put into permanent service. It may be useful to make up several loops of different lengths to suit the application. Note that for best reliability, wire sold as 'extra flexible' should be used. Do not use single-core wire as this will break in service and trigger the alarm. S1 may be used to switch the unit off if it is not to be used for a long time. It will also be used when items need to be added or removed from the system.

The alarm should be checked every few weeks to ensure that the batteries will operate the sounder effectively. It is recommended that the batteries are replaced at least every year

and more frequently if the unit has been called upon to sound often.

BUYLINES

Most of the components for the loop alarm are freely available. The ICL7611 op-amp is not stocked by all suppliers but may be obtained from Electromail, Cricklewood Electronics and Greenweld. The sounder was obtained from Maplin (order code JK42V). Extra-flexible wire can also be obtained from Maplin.

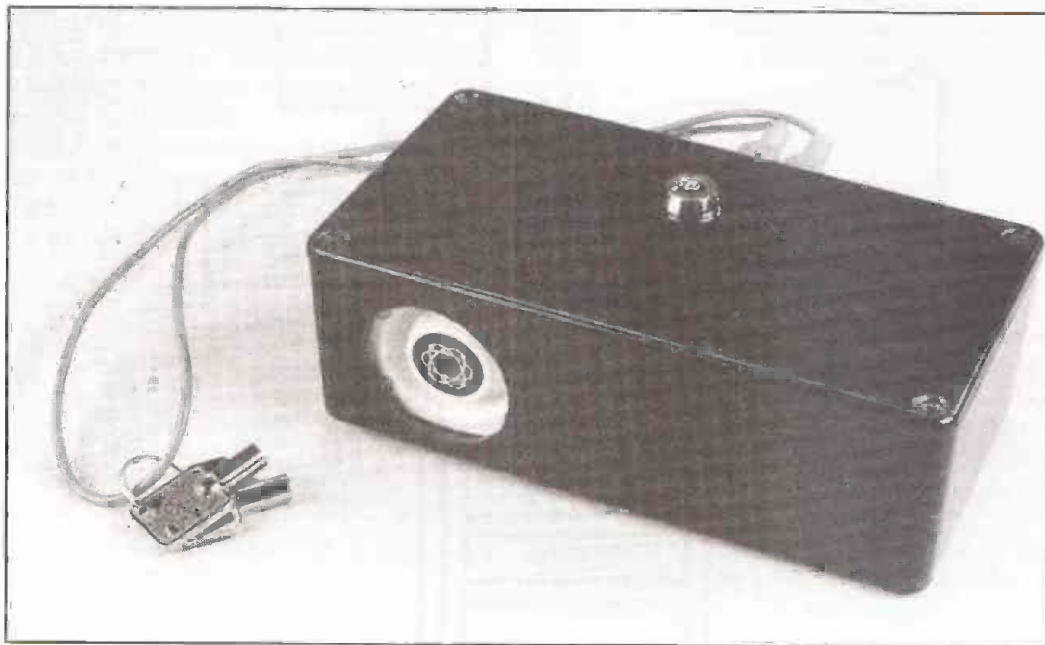
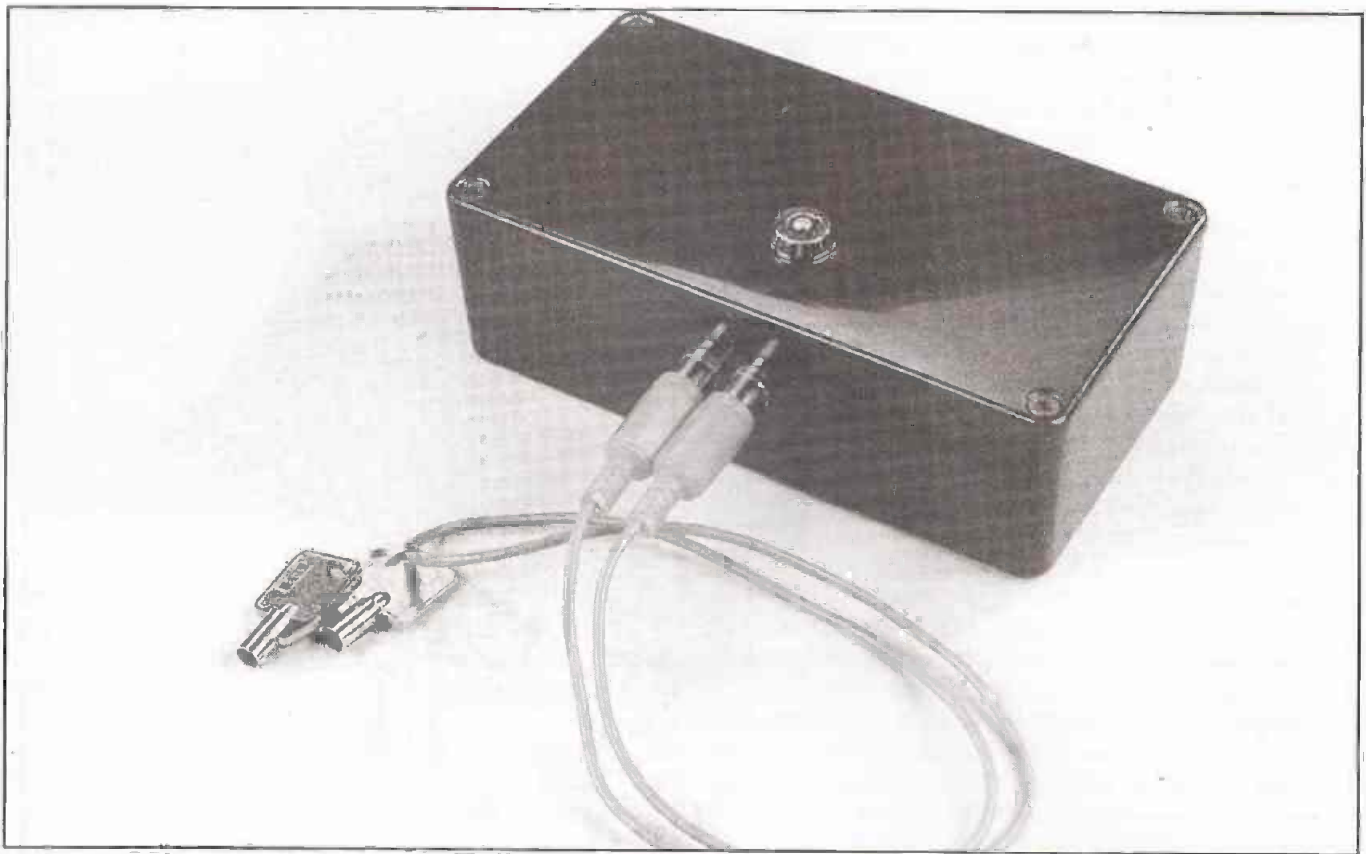

PARTS LIST

RESISTORS

R1,2,5	10M
R3	8M2
R4	5M6
R6	10k

All resistors should be of the metal film 1% type.

SEMICONDUCTORS

IC1	ICL7611
TR1	MPSA14

MISCELLANEOUS

S1	SPST Key-operated switch
BUZ1	Micro siren. 12V 150mA operation. Output 110dB at 1m.
PL1,2	Phono plugs
SK1,2	Chassis phono sockets.

PCB materials. 8-pin di1 IC socket. Plastic case size 150 x 80 x 50 mm external. Battery holder for 8 AA cells and alkaline cells to fit. PP3-type snap connector for battery holder (if needed). Extra-flexible wire for loop as required.



8 CAVANS WAY,
BINLEV INDUSTRIAL ESTATE,
COVENTRY CV3 2SF
Tel: 0203 650702
Fax: 0203 650773
Mobile: 0860 400683

(Premises situated close to Eastern-by-pass in Coventry with easy access to M1, M6, M40, M42, M45 and M69)

OSCILLOSCOPES

Gould 1602 - 2 Channel D.S O	£1300
Gould 1604 - 4 Channel D.S O	£1750
Gould 1421 - 2 Channel D.S O	£375
Gould OS4000, OS4200, OS4020, OS245	from £125
Hewlett Packard 1740A, 1741A, 17744A, 100MHz dual ch.	from £350
Hewlett Packard 182C - 100MHz 4 ch.	£350
Hewlett Packard 1707A, 1707B - 75MHz 2ch	from £275
Hitachi V.U22 - 40 MHz Dual Channel	£300
Nicolet 3091 - LF D.S O	£1100
Philips 3055 - 60 MHz Dual Channel	£550
Tektronix 2201 - 20MHz D.S O dual ch	£675
Tektronix 2213 - 60 MHz Dual Channel	£425
Tektronix 2246 100MHz-4 channel	(as new) £995
Tektronix 2215 60MHz dual trace	£450
Tektronix 2235 Dual trace 100MHz (portable)	£800
Tektronix 2335 Dual trace 100MHz (portable)	£750
Tektronix 2225 -50MHz dual ch.	£450
Tektronix 465/465B -100MHz dual ch	from £350
Tektronix 475 - 200MHz dual ch	£450
Tektronix 468 -100MHz D.S.O. dual ch.	£850
Tektronix 7313, 7603, 7613, 7623, 7633, 100MHz 4 ch	from £300
Tektronix 7704 - 250MHz 4 ch	from £650
Tektronix 7834/7844 - 400MHz 4 ch	from £750
Tektronix 7904 - 500MHz	from £850
Phillips 3070 -100MHz 2+ 1 channel + cursors, as new	£900
Phillips 3206, 3211, 3212, 3217, 3226, 3240, 3243, 3244, 3261, 3262 (2ch + 4 ch)	from £125 to £350
Solartron Schlumberger CD1740 - 20MHz 4 ch	£250

Other scopes available too

SPECTRUM ANALYSERS

Ailtech 727 -20GHz	£2200
Advantest TR4131 -10KHz - 3.5GHz	£4500
Hewlett Packard 3580A - -5Hz-50KHz	£1250
Hewlett Packard 8590A - 10KHz - 1.5GHz - (as new)	£4500
Hewlett Packard 182T with 8559A (10MHz - 21GHz)	£3750
Marconi 2370 - 110MHz	£1250
Hewlett Packard 4953 Protocol analyser	£2500
Tektronix 492 - 21GHz	£6000
Tektronix 7L18 with 7603 main frame 1.5 GHz - 18GHz	£3500
Texscan AL51A (4MHz - 1GHz)	£1300

MISCELLANEOUS

Anritsu ML93B/ML92B Optical power meter with sensor	£2000
Anritsu ME538C Microwave system analyser (BX + Tx)	£3500
B&K 2511 + 1621 Vibration test set	£2000
B&K 2511 Vibration meter	£1500
B&K 2515 Vibration analyser	£4500
Datron 1061A Autocal digital multimeter (6 1/2 digits)	£850
Daymarc 1735 Transistor tester/sorter (with all jigs)	£5000
Dranetz 305 Phase meter	£250
Dymar 1585 AF Power meter	£175
Dymar 2085 AF Power meter	£200
Farnell RB 1030-35 Electronic load 1Kw	£450
Farnell AMM/B Automatic modulation meter	£150
Farnell 2081 R/F Power meter	POA
Feedback TWG300 Test waveform generator	£200
Fischer Betascope 2040/2060 Coating thickness computer & non destructive coating measurement instrument & many jigs and extras	all for £2000
Fluke 8840A Multimeter (IEEE)	£450
Fluke 515A Portable calibrator	£500
Fluke 8010A Digital multimeter	£125
Fluke 8922A True RMS voltmeter	POA
Fluke 95020 Current shunt	POA
Gay Milano FTMIC/FTM3C - FTM - Fast transient monitor	£250
General Rad 1658 LCR DigiBridge	£250
General Rad 1621 Precision capacitance measurement system	POA
Hewlett Packard 180TR Display unit with 8755B swept. amp an.	£350
Hewlett Packard 3200B VHF oscillator, 10-5000MHz	£175
Hewlett Packard 3400A RMS voltmeter	£150
Hewlett Packard 3406A Broadband sampling voltmeter	£175
Hewlett Packard 3437A System voltmeter	£350
Hewlett Packard 3456A Digital voltmeter	£650
Hewlett Packard 3476 Digital multimeter	£100
Hewlett Packard 3478 Digital voltmeter, 4 wire system, 1EEE	£650
Hewlett Packard 3702B/3705A/3710A/3716A Microwave link analyser	£1500
Hewlett Packard 3730A Down converter (with 3738A or 3737A)	£200
Hewlett Packard 3760/3761 Data gen + error detector	each £300
Hewlett Packard 3762/3763 Data gen + error detector	each £350
Hewlett Packard 3777A Channel selector	£250

Hewlett Packard 3779A Primary multiplex analyser	£800
Hewlett Packard 400E/F AC voltmeter	£150
Hewlett Packard 4204A Oscillator 10Hz-1MHz	£250
Hewlett Packard 435A Power meter (less sensor)	£350
Hewlett Packard 456A AC current probe	POA
Hewlett Packard 415E SWR meter	£275
Hewlett Packard 4193A Vector impedance meter	£3500
Hewlett Packard 5335A Universal counter with 1EE	£1400
Hewlett Packard 5342A Microwave freq. count. 18GHz	£1400
Hewlett Packard 7402 Recorder with 17401A x 2 plug-ins	£300
Hewlett Packard 8005B Pulse generator	£250
Hewlett Packard 8011A Pulse gen. 0.1Hz-20MHz	£500
Hewlett Packard 8013B Pulse gen. 1Hz-50MHz	£750
Hewlett Packard 8012B Pulse generator	£750
Hewlett Packard 8406A Frequency comb generator	£500
Hewlett Packard 8443A Tracking gen/counter with 1EEE	£450
Hewlett Packard 8444A Tracking Generator	£750
Hewlett Packard 8445B Automatic presetter	£700
Hewlett Packard 8601A 110MHz Gen/sweeper 110MHz	£350
Hewlett Packard 8620C Sweep oscillator mainframe	£500
Hewlett Packard 8750A Storage normaliser	£400
Hewlett Packard 938A Freq doubler	£250
Keithley 197 20MHz with 1EEE	£400
Lyons PG73N/PG75/PG2B/PG Pulse generator	from £225
Marconi 2019A 80KHz-1040MHz sig gen	£1850
Marconi 2432A 500MHz digital freq. meter	£200
Marconi 2337 Automatic dist. meter	POA
Marconi 2356 20MHz level oscillator	£300
Marconi 2306 Programmable interface	£500
Marconi 2610 True RMS voltmeter	£900
Marconi 2830 Multiplex tester	£1250
Marconi 2831 Channel access switch	£500
Marconi 6920 Power sensor	£400
Philips 5390 1GHz signal gen	£1250
Philips PM 5167 10MHz function gen	£400
Philips 5190 LF synthesizer w/th G P I B	£800
Philips PM 5519 Colour TV pattern gen	£400
Philips PM 2525 Multimeter WF 1EEE	£850
Philips 5716 Pulse generator high freq. MOS	£600
Philips PM 5770 Pulse gen - 1MHz-100MHz	£150
Philips PM 6672 1GHz timer/counter WF 1EEE	£650
Philips PM 8272 XYT chart recorder	£500
Photodyne 800 Fibre optic attenuator	£350
Projectina CH9345 Microscope	£800
Racal 9009 Modulation meter	£225
Racal Dana 202 Logic analyser + 68000 disassembler	£250
Racal Dana 9242D Programmable PSU 25V-2A	£300
Racal Dana 9246S Programmable PSU 25V-10A	£400
Racal Dana 3100 40-130MHz synthesiser	£750
Racal Dana 5002 Wideband level meter	£650
Racal Dana 5003 Digital m/meter	£150
Racal Dana 9000 Microprocessing timer/count. 52MHz	£550
Racal Dana 9081 Synth. sig. gen. 520MHz	£550
Racal Dana 9084 Synth. sig. gen. 104MHz	£450
Racal Dana 9087 1.3 GHz low noise sig generator	£2750
Racal Dana 9303 True RMS/RF level meter	£650
Racal Dana 9341 LCR databridge	£250
Racal Dana 9500 Universal timer/counter 100MHz	£200
Racal Dana 9917 UHF frequency meter 560MHz	£175
Racal Dana 9919 UHF frequency meter 1GHz	£275
Rohde & Schwartz BN36711 Digital Q meter	£400
Rohde & Schwartz URV5 - 18 GHz R/F Millivolt-meter (with various probes)	£1850
Solartron Schlumb 1170 Freq. response analyser	£250
Tektronix TM503, SG503, PG506, TG501 Scope calibrator	£2000
Tektronix 834 Data comms analyser	£500
Tektronix TM5003 + AFG5101 arbitrary function generator	£1750
W&G SPM12 Level meter 200Hz-6MHz	£500
W&G PS12 level generator 200Hz-6MHz	£500
W&G SPM60 Level meter 6KHz-18.6MHz	£500
W&G PS60 Level meter 6KHz-18.6MHz	£500
W&G SPM6 Level meter 6KHz-18.6MHz	£250
W&G PS6 Level generator 6KHz-18.6MHz	£250
W&G SPM6 Level meter 6KHz-18.6MHz	£250
Wavetek 157 Programmable waveform synthesiser	£300
Wayne Kerr B424/N LCR Component meter set	£200
Wayne Kerr 4250 LCR meter	(as new) £1000
Wayne Kerr 642 Autobalance universal bridge	£200
Weller D801/D802 Desoldering station	£175
Weller D900 Desoldering station	£150
Wiltron 352 Low freq. differential input phase meter	£350
Hewlett Packard 8640B with OPT 001	£825
Marconi 2022E (10KHz - 1.01GHz) SIG GEN	£1850

SPECIAL OFFERS - Phoenix 5500A Telecoms analyser, ex. demo. as new with 12 months calibration + 12 months guarantee fitted with V24 interface. A variety of interface options available - Ring/Fax for details. Navtel 9440 Protocol analyser, ex. demo. as new £8000 new - cost now £3500. Navtel 9410 PCB based protocol analyser ex. demo. as new £3000 new - cost now £1500.

MANY MORE ITEMS AVAILABLE - SEND LARGE S.A.E. FOR LIST OF EQUIPMENT. ALL EQUIPMENT IS USED - WITH 30 DAYS GUARANTEE. PLEASE CHECK FOR AVAILABILITY BEFORE ORDERING - CARRIAGE & VAT TO BE ADDED TO ALL GOODS



PROJECT

BASIC
CIRCUITS

Logic Probe

In the first of a new series of low cost circuits which can be built by anyone in a couple of hours, using just a soldering iron and a few basic tools, Robert Penfold describes how to make a versatile logic probe

It is the generally accepted wisdom that a multi-range test meter ('multimeter') is the essential first piece of test gear. However, for someone who is primarily involved in digital electronics some form of simple logic tester could reasonably be deemed just as important as a multimeter. In fact, it could be judged more important, as it is likely to provide more useful information than the voltage

ranges, etc., of a test meter. The most common form of basic logic tester is a logic probe and the one featured here is CMOS compatible, but will also work quite well with circuits based on TTL devices, or devices which operate at standard TTL levels.

B: The logic state at the test point is indicated via a seven segment LED display. If the test point is at logic 0 (low) a '0' is displayed - if it is at logic 1 (high) a '1' is displayed. If the input is

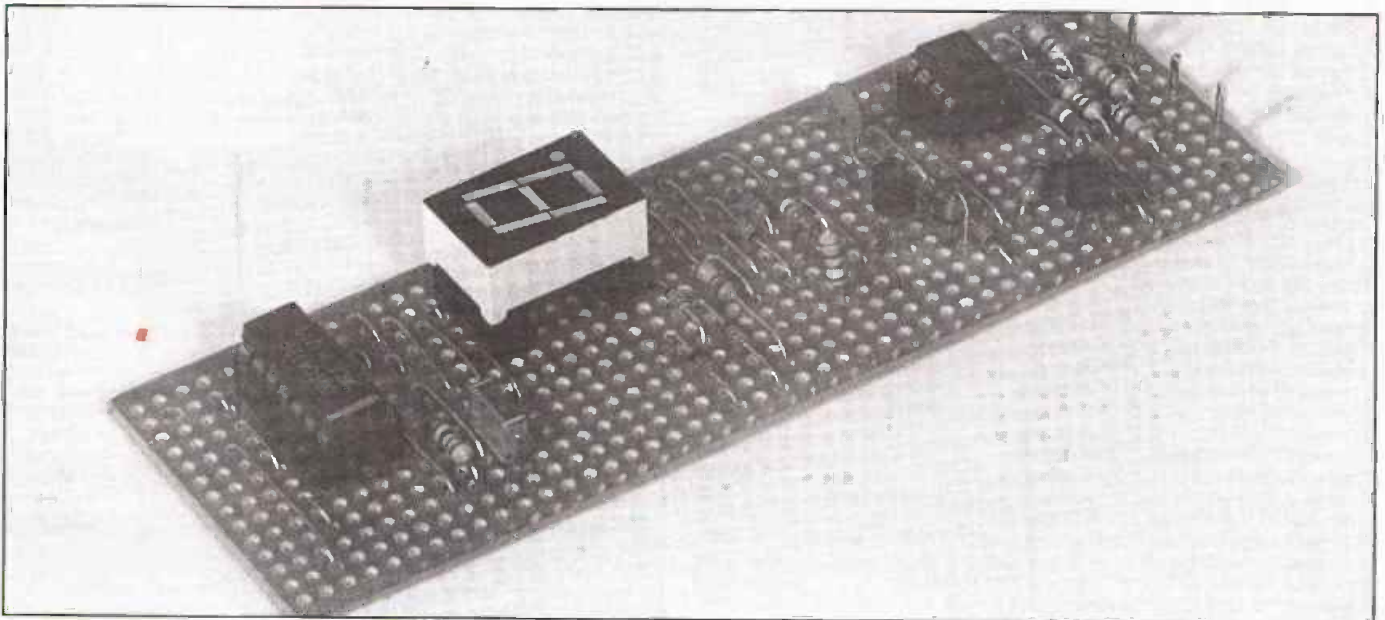
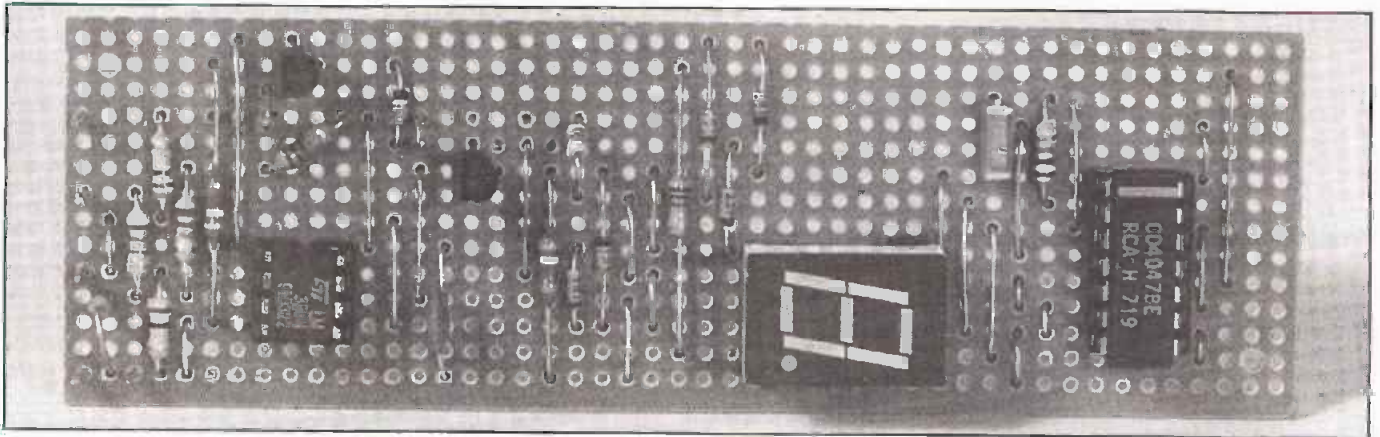
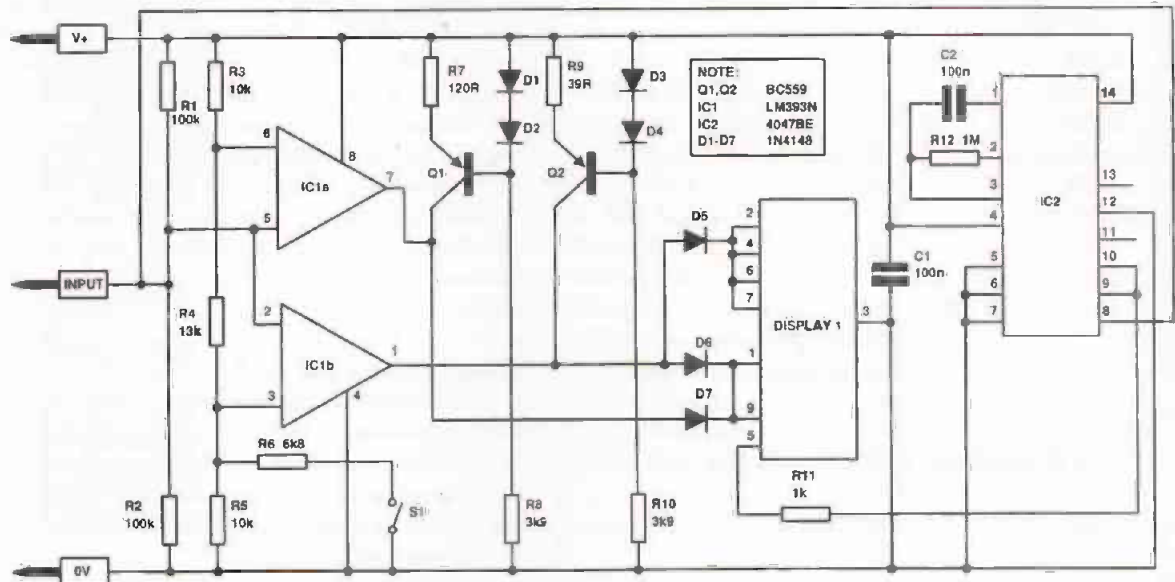

Figure 2:
The logic probe
circuit
diagram.



taken to an invalid voltage between the maximum low and minimum high levels, the display goes completely blank. If the test point is pulsing at a low frequency, the displayed number will be seen to change in sympathy with the input logic level.

At input frequencies of more than about 25Hz, the switching of the display will be too fast for the human eye to perceive it properly. A figure '0' will appear to be displayed continuously. The two left hand segments will be brighter than the other four if the input signal is at logic 1 for a greater percentage of the time than it is at logic 0. Apart from this, the main display will not give a clue that the test point is pulsing. To avoid confusing results, a pulse detector circuit flashes the decimal point when a pulsing input signal is present.

Construction

To make the construction of this project as easy and simple as possible, it is built on a piece of standard Veroboard. Details of the component panel are provided in Figure 3 (component side) and Figure 4 (copper side). This layout is based on a 0.1in pitch stripboard panel measuring 47 holes by 14 copper strips.

The first stage in construction is to cut the board to size and then cut the appropriate tracks. After cutting the board to size, drill the two mounting holes and make the breaks in the copper strips. These breaks can be made using the special cutter, or a hand held twist drill bit of about 5mm in diameter will do the job quite well.

Fitting the components is mainly straightforward, but the board is quite crowded in places. This makes it essential to use modern miniature components. C2 should be a printed circuit mounting

type having 7.5mm (0.3in) lead spacing. Be careful not to omit any of the link-wires, which can be made from about 22 s.w.g. tinned copper wire, or the trimmings from resistor leadout wires.

The integrated circuit, IC2, is a CMOS device and it therefore requires the standard anti-static handling precautions. It does not have full internal protection circuitry, making it more important than usual to take these precautions. This essentially means earthing yourself before handling this component in order to discharge any static electricity you may have picked up from wearing clothes made from synthetic fibres, walking across a carpet, etc. One can effectively earth oneself by touching any bare metal object which is 'connected' to the earth, such as a metal water pipe. It will then take some time for your body to re-acquire a static charge.

As a further precaution against damage, from either static electricity or overheating, the ICs should be fitted in a holder rather than being soldered directly to the circuit board. The ICs can then be inserted when the rest of the assembly is completed. When inserting the chips into their sockets, take great care not to bend any of the pins so that they fold under the IC, and also make sure that they are inserted the correct way round. The little notch in one end of the IC indicates the location of pin 1.

The display must be a common cathode type, not a common anode display. It must also be a 0.5 or 0.6in type, having the standard ten pin base and pin-out arrangement if it is to fit into this component layout properly. Ideally, it should be fitted into a holder, but a suitable ten pin holder will probably prove to be unobtainable. 'Soldercon' pins can be used to make up a suitable holder, or a standard 14 pin type can be carefully cut to produce two 5 pin s.i.l. holders which will take the display.

The probe draws its supply current from the circuit under test via a couple of leads, which are terminated in crocodile clips. It is advisable to use red and black crocodile clips and (or) leads to show the polarity of the supply leads, red on the +ve lead and black on the -ve lead. Getting the supply polarity wrong could easily result in one of the integrated circuits being damaged.

Units of this type are normally built as probe devices, but it is not

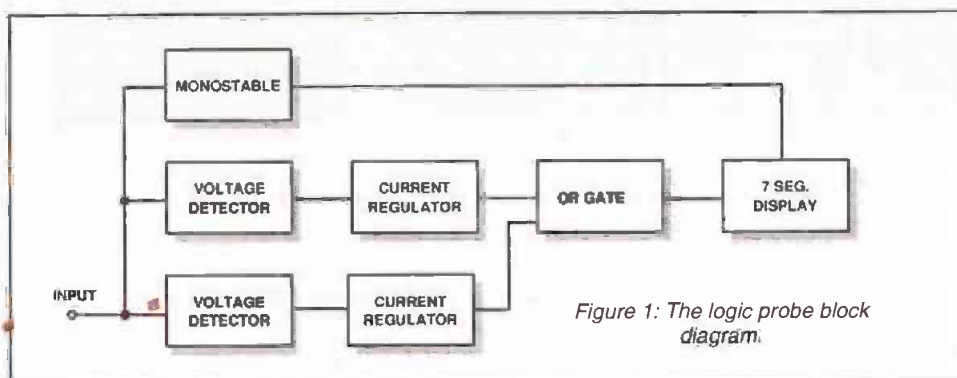

RESISTORS (All 0.25 watt 5% carbon film)

R1, R2	100k
R3, R5	10k
R4	13k
R6	6k8
R7	120R
R8,	R10 3k9
R9	39R
R11	1k
R12	1M

CAPACITORS

C1	100n ceramic
C2	100n polyester (7.5mm lead spacing)

SEMICONDUCTORS

IC1	LM393M
IC2	4047BE
TR1	BC549
TR2	BC549
D1 to D7	1N4148 (7 off)

DISPLAY

1 0.5 or 0.6in common cathode LED display

MISCELLANEOUS

S1 is a s.p.s.t. miniature toggle switch. Probe type case (carefully check inside dimensions to ensure board will fit before buying), available from suppliers such as Maplin. 1 piece of 0.1in pitch stripboard, having 47 holes by 14 copper strips. 1 off 8 pin d.i.l. IC holder. 1 off 14 pin d.i.l. IC holder. 1 off display holder (see text). Test leads made from 50cm of red multicore wire and 50 cm of black multicore wire with the appropriate red or black crocodile clip attached to one end of each wire. Tinned 22 s.w.g. single core copper wire for making wire links. Solder pins, etc.

Overall component cost is approximately £10

essential to build the unit in this form. However, the board has been made fairly long and thin so that it can be fitted into a probe type case of adequate dimensions. The input of the circuit must connect to the metal tip of the probe assembly. A probe tip can be improvised from a long 6BA or metric M3 bolt. This can be left in its raw form, or filed into the usual needle-like shape. The connection to the bolt can be made via a soldertag. Of course, a display 'window' must be cut at the appropriate place in the case and ideally, though not completely necessary, this would be fitted with a small piece of red display filter material.

Testing the circuit

The first stage after constructing the probe is to check that the unit actually works. Before applying power, first thoroughly recheck that you have the right components in the right places, that the tracks are cut in the right places and that the ICs are inserted the right way round. Also carefully check that no small pieces of solder are accidentally bridging two or more tracks, if such a solder bridge is found, remove it carefully with the soldering iron and a piece of solder wick. Do not rush this stage, faults picked up here can save you damaging the circuit. Having visually checked that the circuit is basically sound, it should be connected to a supply voltage in the range 3 to 15V (in the absence of a bench power supply, a standard 4.5V bell battery with screw terminals is a good power source for testing this type of circuit). Make sure that the polarity is correct with the red clip attached to the +ve and the black clip to the -ve power supply terminal. When power is connected, none of the display segments should be switched on at this stage. If one or more segments is lit up then something is wrong with the circuit, disconnect power immediately and recheck the circuit for faults in construction. We can now test whether the probe actually works. If the probe tip is connected to the positive supply, in other words the +ve or red power supply terminal, a '1' should be displayed and if connected to the 0 volt supply, the -ve or black terminal, then a '0' will be displayed. If these displays are generated, then the circuit works and you can finish the task of putting it in its case.

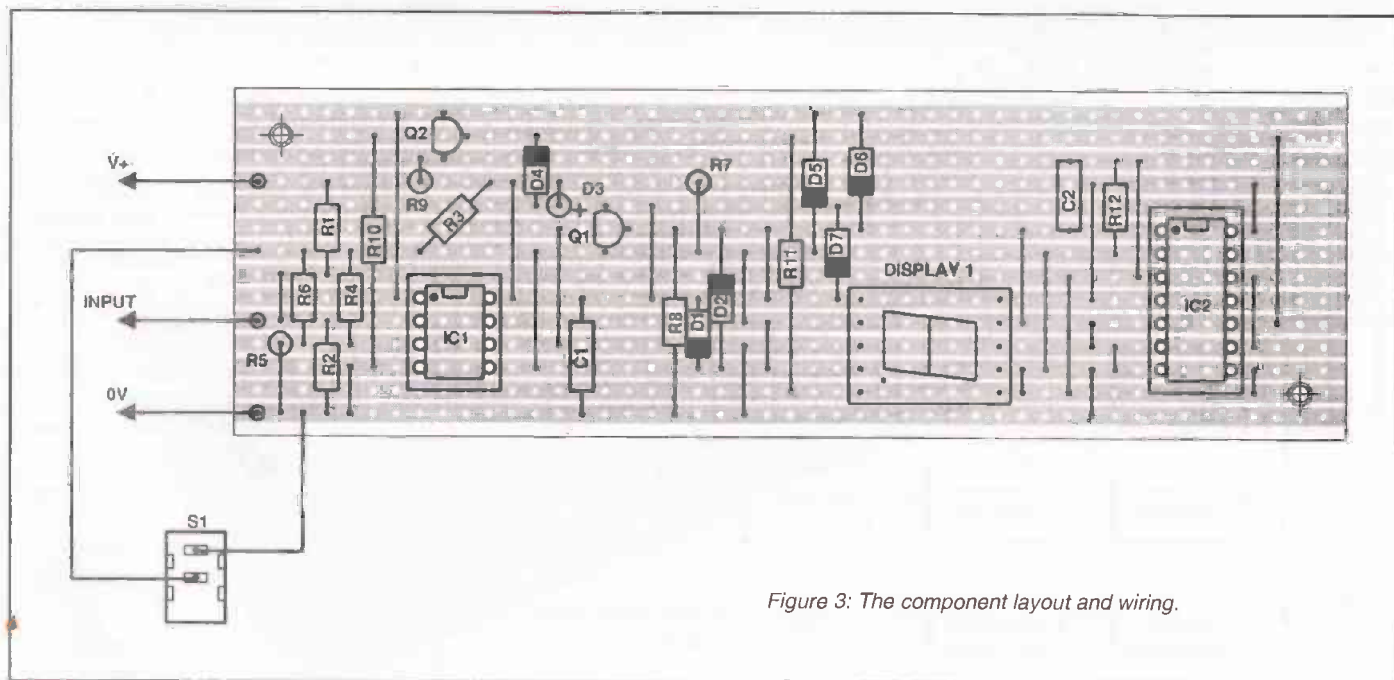
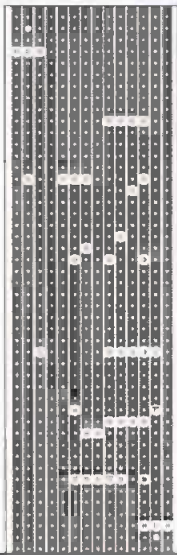

Figure 3: The component layout and wiring.

Figure 4: The underside of the component panel.



In Use

The completed device is very simple to use. Just connect the two probe power supply leads to the correct polarity power supply lines on the device under test and then use the probe to check the logic state of any track or component on the circuit under test. Obviously you will need to know what logic levels to expect in various parts of the test circuit, in order to perform any worthwhile troubleshooting and you may also need to have some means of injecting pulses into the test circuit. Even if you do not go this far a logic probe is an excellent way of checking the power supply in a circuit and the state of any output lines. Note that there should be a flash from the decimal point when connecting the probe tip to one of the supplies and when disconnecting it. This is because you effectively generate input pulses when connecting the probe tip to some test points. These trigger the monostable and produce a brief flash from the decimal point segment of the display. Therefore, in normal use you must ignore any pulse indications from the display when initially connecting the unit to a test point.

How It Works

A static logic output is either at logic 0 or logic 1. These are respectively represented by a potential of between about 0 and 30% of the supply voltage and a potential of between about 70 and 100% of the supply voltage. The main function of the unit is to check the input voltage and indicate whether it is at logic 0, logic 1, or an invalid intermediate voltage. As can be seen from the block diagram of Figure 1, there are two voltage detectors at the input of the unit. One of these detects whether or not the input is within the valid logic 0 voltage range and drives the appropriate segments of the display if it is. The other voltage detector provides the same basic function, but it checks for a valid logic 1 voltage and drives the appropriate two segments of the display. If the input voltage is between the two valid logic levels, neither detector will be activated and none of the LED segments will be switched on.

@B: The display is driven via a simple OR gate which prevents the output of one voltage detector interfering with the output of the other. Current regulators are also included at the outputs of voltage detectors. CMOS integrated circuits will operate over a supply range of 3 to 15V. Using resistors to set a reasonable display current with a 3V supply results in a rather high current drain when using a 15V supply. The current regulators prevent the display from being driven with an excessive current when the probe is used with supplies of about 10 to 15V.

A monostable is also driven by the input signal and this will be repeatedly triggered if the input is pulsing. This stage drives the decimal point segment of the display and the decimal point will therefore flash when a pulsing input signal is present. In fact, the decimal point will appear to light up continuously if the input frequency is fairly high. The output pulse from the monostable is quite long at around 250 milliseconds, so even very brief and intermittent pulse signals will produce a clear indication from the display.

The full circuit diagram for the logic probe is shown in Figure 2. The voltage detectors are based on the two voltage comparators in IC1. R4 and R5 provide reference voltages which are approximately equal to 30% and 70% of the supply potential. R1 and R2 bias the input to about half the supply voltage under quiescent conditions, which takes both outputs of IC1 low. If the input is taken above 70% of the supply potential, the voltage at the non-inverting input of IC1a is taken higher than the voltage at the inverting input, resulting in the output of IC1a going high. Segments E and F of the display are then driven with a current of a few milliamps via gate diode D7. This results in a '1' being displayed.

If the input voltage is taken below 30% of the supply potential, the inverting input of IC1b is taken lower than the reference voltage at the non-inverting input. This sends the output of IC1b high and drives a current through all but the G segment of the display. D5 and D6 act as the gating diodes when this happens and a '0' is displayed. The output stages of IC1 are open collector transistors and in this circuit their collector loads are constant current generators. These are conventional current regulators based on TR1 and TR2. The currents are set by R7 and R9. Two segments are switched on when a '1' is displayed, but six segments are turned on when a '0' is displayed. R9 has a lower value than R7, giving a higher drive current when a '0' is displayed, but approximately the same current per display segment.

IC2 is a CMOS 4047BE astable/monostable, which is used here in the positive edge triggered monostable mode. It is therefore triggered by low-to-high transitions at the input. C2 and R12 are the timing components and the output pulse duration is about 2.48 C2 R12 seconds. The Q output of IC2 drives the decimal point of the display via current limiting resistor R11. A constant current generator could be used to control the drive current, but as only one small segment is being driven in this case, a simple resistor gives acceptable results.

Although mainly intended for use with CMOS circuits, this probe will work quite well with TTL types. TTL and CMOS devices are largely incompatible for a number of reasons. The most important reason in this case is that they have different logic voltages. TTL circuits always operate from a 5V supply and they do not have the symmetry of CMOS devices. The valid logic 0 voltage range is 0 to 0.8V. Logic 1 outputs must be in the range 2.4 to 5V. Closing S1 gives improved compatibility with TTL switching levels by pulling both reference voltages much lower.

Although the monostable circuit is not properly TTL compatible, in practice it will usually trigger reliably from pulses at TTL levels. However, it must be borne in mind that the CMOS integrated circuits are quite slow by TTL standards. It will trigger reliably from a squarewave input at frequencies of up to a few megahertz, but do not expect it to detect narrow pulses at 20MHz or more.

Dear ETI

It is well known that free phase organs, in which each note has its own generator so that relative phases of the signals can drift like organ pipes, give a more natural pipe sound than modern organs, in which all the notes are phase locked. Hitherto, free phase organs have used inductors which make them big, heavy, expensive and difficult to build - reasons why they have unfortunately lost much of their former popularity.

The advent of stable, inexpensive, metal film resistors make possible the use of RC oscillators which are light, small, inexpensive and do not take long to build.

The simple sine to square converter (transistor, diode and resistor only), make possible the use of well established square wave gates and tone forming circuits, as shown in the accompanying circuit diagram.

The component schedule for this free phase electronic organ is as follows:

- L: R1 22k
- R2 47k (R4 = R3)
- 51K (R4 ≠ R3)
- $(R4+R3) \times C1 = 1/\pi F$
- F = frequency of note.
- R4 = R3 or next E24 step up.
- R1 through R4 should be 1% or 2% metal film
- C1, C2 Both the same value,
- value determined in above formulae.
- capacitors should be Mica, styrene,
- carbonate or ester.
- R5 100k
- R6 33k
- Rv 10% of R3 rounded up to next obtainable value.

I can supply values, answers to questions and low cost components for this project.

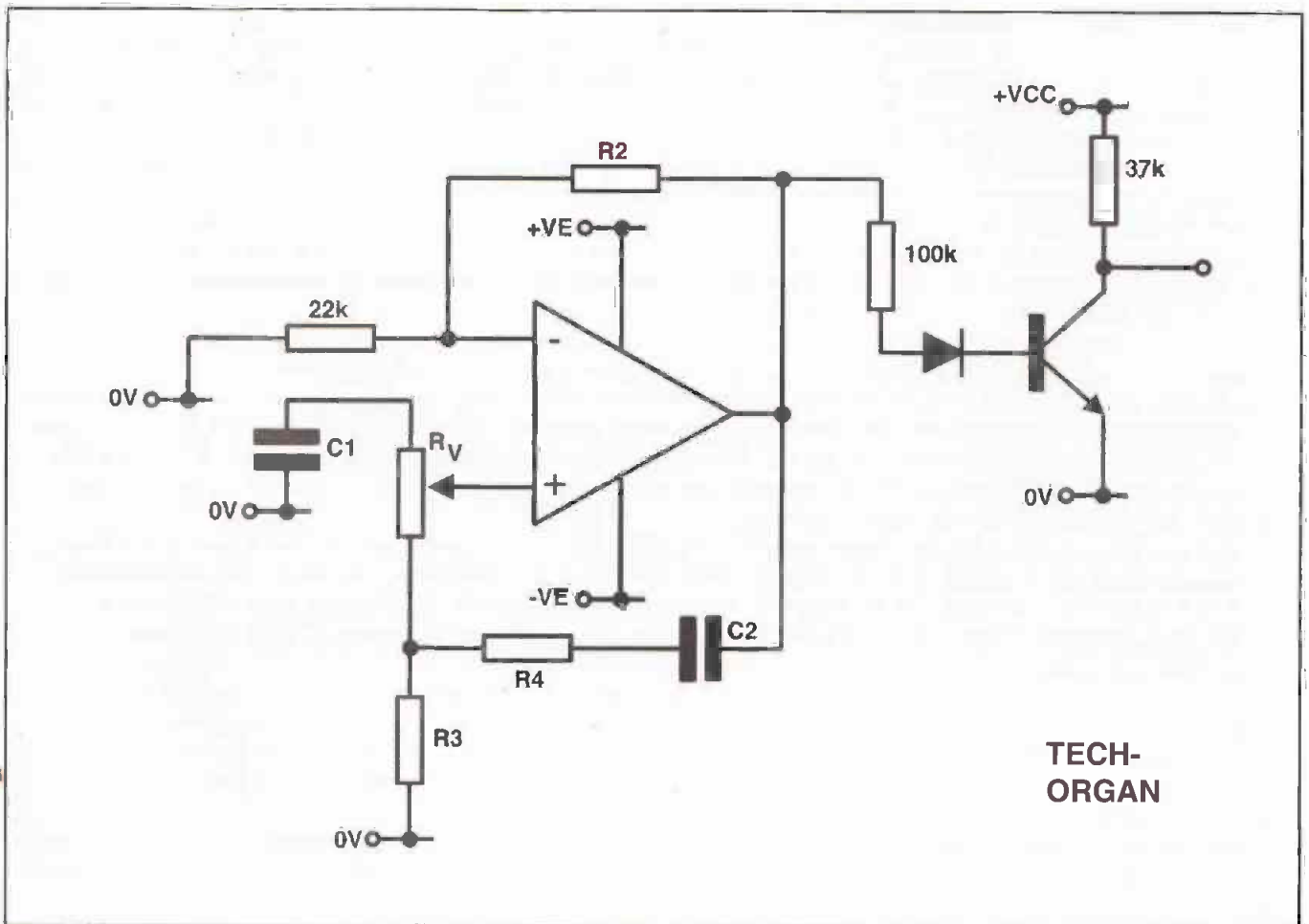

**TECH-
ORGAN**

Club News

We would like to bring readers' attention to the forthcoming Sussex Amateur Radio and Computer Fair, which is being held on Sunday 10th July between 10.30am and 4pm on Brighton Race Course. This is the thirteenth year that the event has been held and last year it was attended by over 2000 people. There will be trade stands, bring and buy stalls, refreshments and a free shuttle to Brighton sea front. It should be a great day out and for more details, contact the organisers on 0273 501100.

ETI has a large overseas readership, (we are a truly international magazine!) and we have had a recent request for help from the Amateur Electronics Club of Sierra Leone. They would like help in obtaining information on electronics magazines, books, data, etc. Any readers who would like to help should get in touch with the Club's President, Gabriel S Dabo, at the Dept. of Electrical

Engineering, Fourah Bay College, University of Sierra Leone, Mount Aureole, Freetown.

We have also had a letter from a Mr Wilkes of High Wycombe, who is looking for an electronics enthusiast club in his area. If anyone can help, please send details in to the editor and we will pass them on to Mr Wilkes.

Club contacts

British Amateur Electronics Club. Contact the club secretary Mr J.F.Davies on 0606 883742

Crystal Palace and District Radio Club, Tel: 081 699 5732.

Lincoln short Wave Radio Club, Lincoln, Tel: 0427 788356.

London Live DIY Hi-Fi Circle. Contact Launcelot Dow, 7 Pymmes Gardens South, Lower Edmonton, London N9 9NT.

Midland Amateur Radio Society, Tel: 021 422 9787 or 021 443 1189 (evenings only).

Sudbury and District Radio

Amateurs. Tel: 0787 313212. Thanet Electronics Club. A youth group for school age people in East Kent. Contact the club secretary Roy Ashley on 0304 812723.

If you run a club that is concerned with some aspects of electronics and computing we would like to hear from you.

If you have any problems, suggestions, or ideas which you would like to see printed in the pages of ETI then why not send them, we would love to hear from you.

continued from p15

users to transfer cash, with a highly sophisticated electronic security against fraud, without having to go via the bank. Using special pocket terminals supplied with the card it will be possible for one user to easily transfer cash to another user, automatically reducing the amount of cash on his card by the specified amount and increasing it on the other person's card by the same amount. Retailers will have similar terminals linked to their tills.

The cash stored on a card, which can be in sterling or up to five different foreign currencies, can be increased or reduced by withdrawing or depositing in a bank account. This can be done through any phone fitted with a Mondex card reader, thereby potentially turning any phone into a low cost automatic telling machine. This is a major step towards the all electronic bank and away from a cash based economy.

Into The Future With Smartcards

With the production of intelligent smartcards, the technology can truly be said to have come of age. By putting more memory and more intelligence on a card, a great many more applications are opened up and existing ones can be made much more sophisticated. At the moment, most intelligent smartcards use very simple processor chips, by and large details are not released, but it is probably fair to say that most are derived from one or other of the widely used families of eight bit micro-controller chips. Simple processors, operating at very low speed and with very small data and program storage areas.

Already designers are looking at systems which have more powerful processors and a lot more memory. Here once again, the UK is leading the field with the development of a smartcard that contains a very powerful 32 bit RISC processor and which runs state of the art neural network software, to create the 'thinking' smartcard.

The processor used in this smartcard is the Acorn ARM processor, the same processor which is at the heart of the British company's Archimedes range of computer workstations. The neural network software has come from Southampton based Neural Computer Sciences and the whole project, known as CASCADE, has been funded by the EEC (for once spending money on something worthwhile!).

The rationale behind the CASCADE project is the development of smartcards which can process biometric information, such as fingerprints and voice prints, which would make it almost impossible for anyone to fraudulently use cards designed for security and financial applications. The high security and large memory capacity of such cards means that they will open up many new applications for smartcards, such as storage of personal information, for example medical records.

Thus, not too many years in the future, we could all have two or three smartcards in our pockets starting with a money card such as Mondex, which we could use to pay for goods and services in the same way that we use cash today. Then there could be a medical record/identity/passport card. Finally, there could be an assortment of smart travel cards, motorway toll payment cards, and security access cards. But one thing that we can be absolutely certain of, smartcards are with us to stay, we are only just seeing the beginning of applications to which they can be applied.

Feedback

Here at the editorial offices of ETI we want to provide you, our readers, with the sort of magazine that you want to read. We can of course guess what you would like to see in each issue of ETI, but a far better way is to rely upon feedback from readers.

To help us in this process we are instituting a new concept, the 'Feedback Box'. We are asking readers to take a few minutes and write down on the back of a postcard the ratings which they would award to each article in this issue.

Ratings should vary between 1 and 10, with 1 being poor and 10 being brilliant.

- A - Goodbye Money Hello Smartcard
- B - Sending Your Data By Laser Beam
- C - PC Clinic
- D - The Experimenter's Computer
- E - An Introduction to MIDI
- F - An RS232 Break Out Box
- G - Basic Circuits - Logic Probe
- H - Loop Alarm
- I - Killjoy

Just write the article letter followed by your score for that article and send to

**Feedback Box,
July 94, ETI,
Argus House,
Boundary Way,
Hemel Hempstead, Herts. HP2 7ST.**

To add an extra incentive, all replies received before July 30th 1994 will go into a draw and the winner will receive a couple of the latest electronics books published by Bernard Babani.

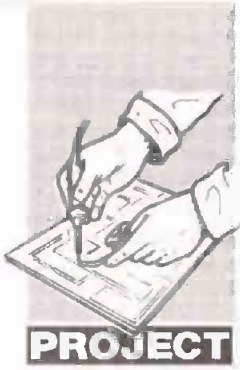

PROJECT

Send Your Data By Laser Beam

In part 2 of this fascinating project, Ken Gill shows how to link two computers and transfer data between them using no wires or cables, just a beam of infra-red light

Last month we looked at the design and construction of the circuitry for this project, this month we conclude with a look at the construction and setting up of an infra-red data communications link.

The range expected with this type of system is greater than that of a domestic television infra red system. The drive currents used here in this system should be capable of increasing the range over the prototype's distance of ten metres, which is the distance required to cover the ground between the two buildings. Here, using commonly available components, a peak pulsed current of 2A can be used to increase the range of the system considerably. With sense prevailing, it was thought best to have the current limited to a value considered appropriate to the range, so it is reduced to just under 1A peak. The current used in the prototype covers the required distance well, in fact the range during tests was

found to exceed the original working distance of ten metres.

What does it do?

The object of this system is to replace a conventional or optic cable system causing minimum disruption to property.

An AC mains supply carrier system could have been used to convey the data between the two buildings, but consider the case where the two ends of the system are on different phases. In such a circumstance, the carrier system would not work.

This system provides a full duplex serial data link at 1200 baud ASCII between two buildings at least ten metres apart. The proviso is that an optical system which is in use here has no permanent structures placed in the way of the Infra Red beam to attenuate the flow of data which will pass between the two halves of the system. The effects of temporary obstacles, i.e. passing structures, ladders for example, or flying birds, should have little effect on the performance of the system's

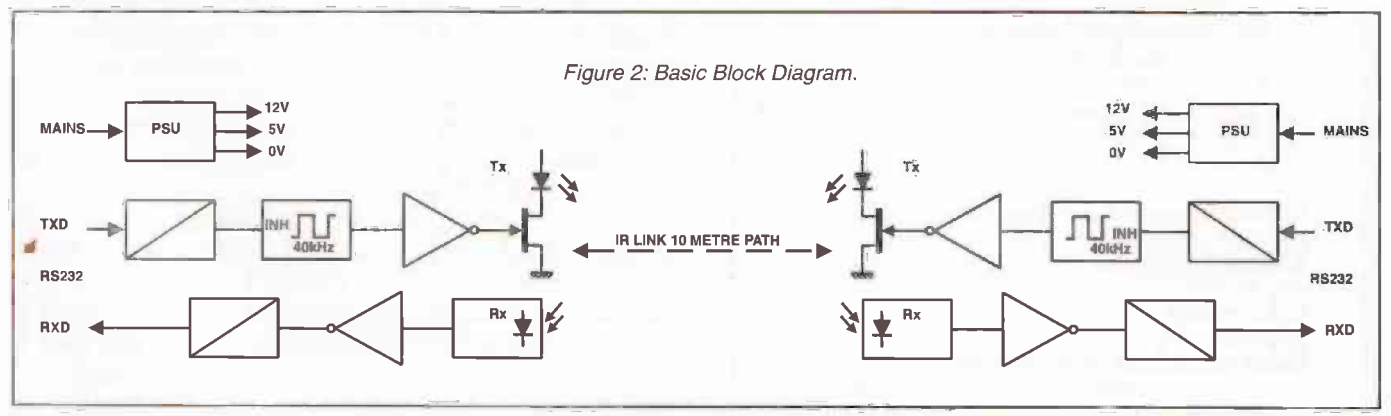
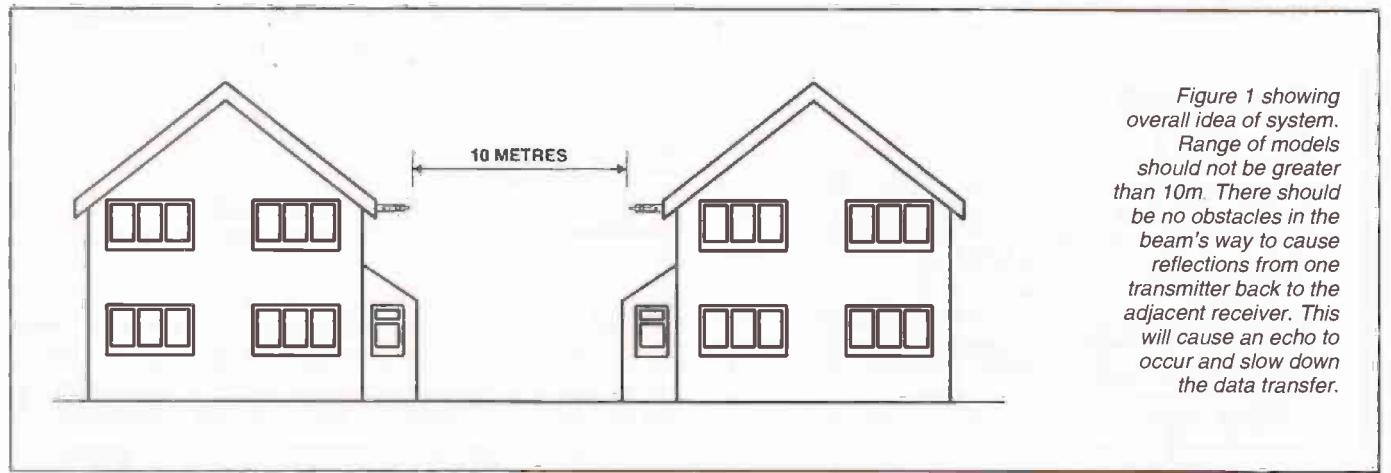

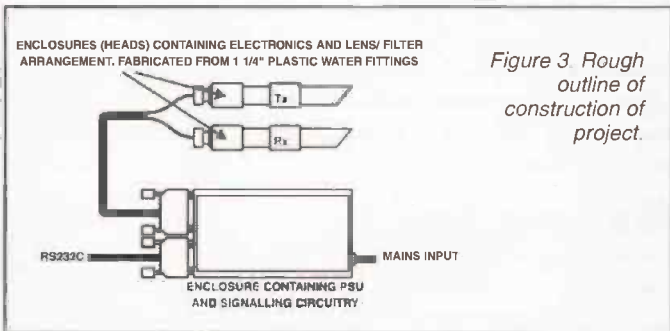
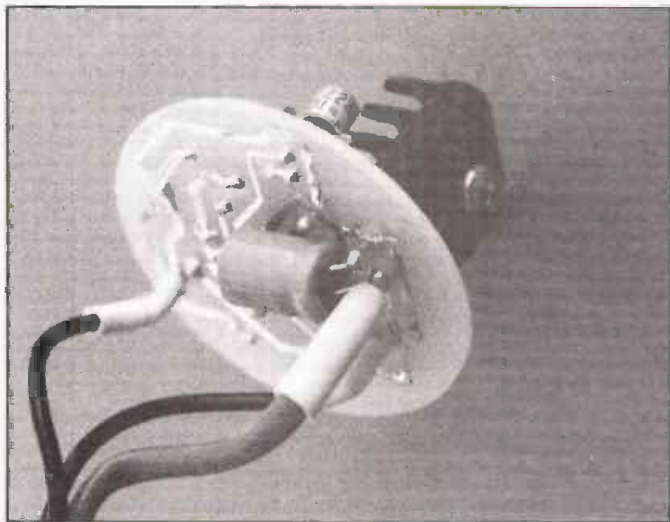

Figure 3. Rough outline of construction of project.



data transfer from one end to the other. Also, the effects of atmospheric conditions should have little, even in conditions of rain, snow and fog.

Errors may result from such conditions but tests have shown that these are small when the received IR power levels are high enough to overcome the absorption due to local atmospheric conditions.

The Mechanical Side

The same set of equipment can be found at either end of this serial link. It comprises a mains power supply and associated circuitry, and two remote heads, one head for the IR transmitter and optics, the second enclosing the IR receiver circuitry and optics. This makes for easy construction of the optical system, using mainly 1.1/2in plastic waste pipe and fittings to fabricate water tight enclosures which need to withstand the variations in weather. Additional metalwork is needed to make the supports for the optical assemblies, which is minimal. The power supplies and signal processing circuitry, including the serial equipment

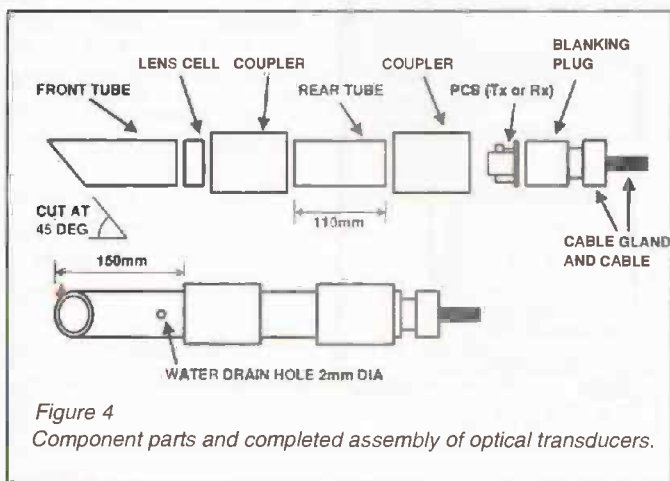

Figure 4. Component parts and completed assembly of optical transducers.

interface, are housed within a separate enclosure, making a total of three parts at each end of the system. Each end has to be duplicated, doubling the equipment, work and cost.

Mechanical Construction

Optics

The optical assemblies are fabricated from PVC waste pipe and fittings, available from most DIY outlets. This actually makes a convenient and water tight assembly for the electronics and the optics.

A number of components have to be manufactured prior to fitting, including the four lens cells - these are made from four 1 1/2in to 1 1/4in reducers cut down as shown in Figure 7. In addition, four 1.1/4in blanking plugs are used to complete the cell.

Both the reducer and the blanking plug, as shown in Figure 15, are cut down to 6mm in length. Any rough edges are removed at this stage, which will facilitate easy assembly prior to gluing the parts together.

Transmitter Lens Cell

The diameter of the lens has to be reduced to fit the internal diameter of the plastic reducer. It can be dropped into the reducer convex side up. The ring cut from the 1.1/4in blanking plug is now dropped on top of lens. This will retain the lens in the cell assembly. Check to see that all is well at this stage. Take these components apart, and re-assemble them once satisfied they are a good fit. A small amount of glue is applied to the internal surface of the reducer with the lens in situ. Push the lens retaining ring down the tube to secure the lens firmly and squarely in place. Follow the same technique for the other transmitter lens cell. The receiver lens cell has an addition, a filter, so the construction is slightly different. Remove any excess of the protruding inner lens retaining ring with fine sand paper or emery, which will make the inner ring flush with the outer ring.

Receiver Lens Cell

The remaining two lens cells have filters incorporated which reduces any effects of visible light on the IR receiver modules. The material needed for the filters is cut from a black plastic bin liner and is cut to the same diameter as the Maplin lens. A circle of 1mm plastic (Perspex) sheet is also required to hold the filter element in place. This second sheet of transparent

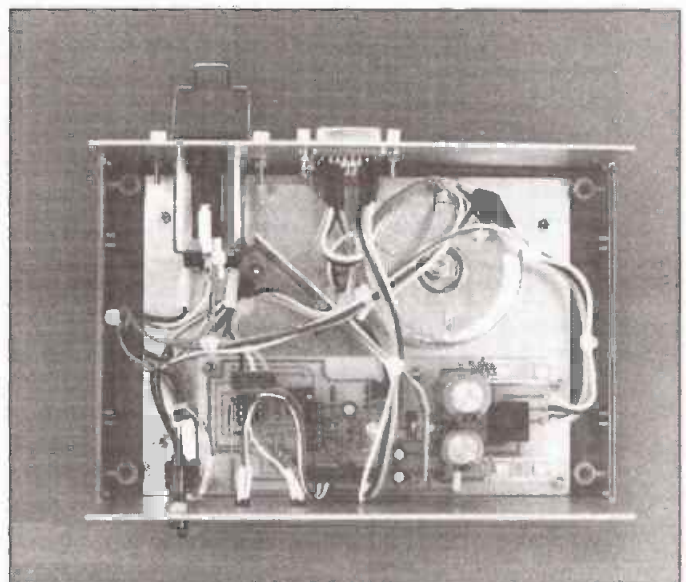

plastic sandwiches the filter between itself and the lens. The filter will reject visible light to a large degree and admit IR with very little loss.

Optical Head Construction

The remaining optical system is constructed from 1.1/2in grey PVC waste pipe and fittings. The waste components are all cut to length, as shown in Figure 4, before assembly. All burrs are removed and all cut ends cleaned with fine sand paper or Emery paper. Try fitting the optical components together before final assembly, as in the construction of the four lens cells, because any problems after this stage cannot be rectified and are best put to rights now, before the glue is applied.

Each of the lens cells is located in the front portion of the front tube coupler and is glued in place. The front tube cowl is therefore glued ahead of the lens cell and the rear tube behind the front coupler. The second (i.e. rear) tube couplers are glued in place at the rear of the second tube. The assembly is shown in Figure 7. The circular PCBs are located in the rear portion of this second coupler and are held in place with a 1.1/2in blanking plug. This is secured in place, once the electronics have been assembled and

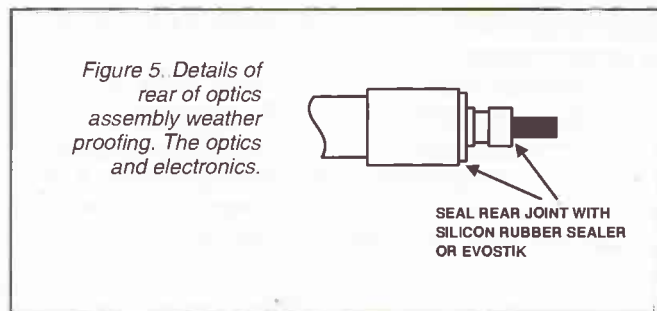

tested, with a silicon rubber type compound or an alternative adhesive such as Evo-stik - something which will seal against the weather but not as secure as the proprietary glue advised for the tubing. This is to help in the maintenance aspect should a fault occur. To gain access to either of the IR head's electronics may prove disastrous and may damage the housing for the sake perhaps of a broken wire.

Leave the PCB installation until last, that is after full circuit testing. When fitted into the lens cell, the flat surface of the Maplin plano-convex lens is facing outwards, away from the electronics. The convex surface of the lens is closest to the IR transducers. This is so for both the transmitter and the receiver optics.

PCB Construction

The system is made from two identical halves, two identical sets of boards need to be populated.

The round boards associated with the optics may need trimming to a small degree to fit the pipe used in this project. There should only be a tiny amount removed, certainly no more than a millimetre and this is best done before any of the round boards are populated with components.

Encapsulating

When the final assembly of the optics and testing of all the units is complete, the end plug which secures the cable into the gland is fixed with a silicon rubber sealing compound. Prior to securing the assembly and during testing, the boards can be put in place and the end plugs secured with PVC insulating tape. Weather proofing the unit comes later.

Final Checks

Check all the units for correct values and position of components and wiring prior to switching on. Once the unit has been powered, check all the regulator outputs for correct values. This includes the regulators in the main unit and those associated with the optics. Even the independent 5V supply for IC2 and Q1. The voltages should be well within the tolerance for these devices. Quiescent current drawn through either side of the power supply will be low, certainly no greater than 70mA.

Connect pin 1 and pin 2 together on PL1 and monitor pin 11 of IC2. There should be a square wave present at 5V amplitude when the multivibrator is enabled. This frequency should now be adjusted with RV1 to suit the frequency of the IR receiver components used, 38KHz for the RS chip and 40KHz for the Tandy module. RV1 will provide more than enough adjustment to accommodate the different IR receiver. Monitor the square wave at PL4 pin 1, a 12V square should now be observed when the multivibrator is again enabled.

Remove the link and ensure the subcarrier is disabled.

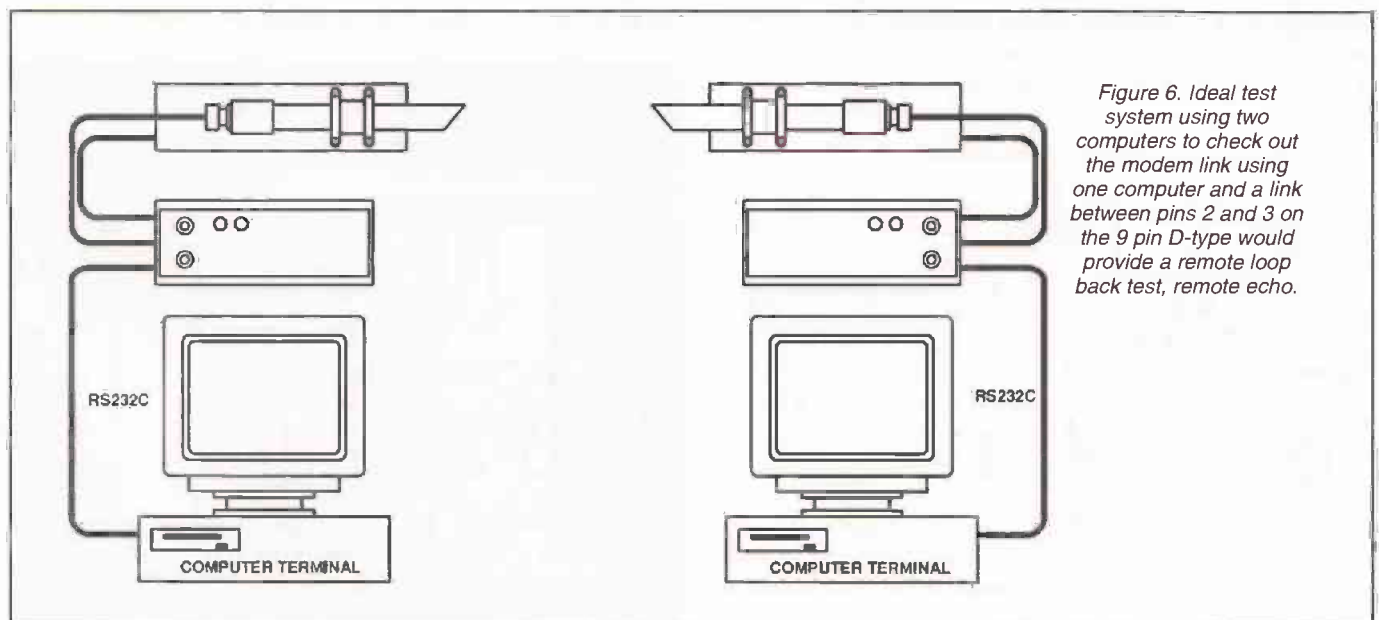



Set the two modules apart at a distance of about five metres and facing each other. Ensure there are no obstacles within a metre each side of the IR beam, otherwise reflections will occur and a local echo will arise.

Connect the system up as shown in Figure 6, using a suitable terminal program at one end with a data rate of 1200 baud. Parity, Stop Bits and Data Bits are of little consequence. Using an obstacle to obstruct the beam, you can now perform a local loop test, which is similar to an analogue loop test of a conventional modem. A large card, 12in from the units to be tested, will be sufficient. The characters sent out and shown on the transmit window of the terminal software should be echoed back on the received screen.

Perform the same test on the second part of the system and the same results should occur.

Now, with a clear path between the two ends of the system, a remote test can be initiated. Link pins two and three of the nine way D-type on the far modem. Link the computer with the terminal software to one modem. There should be only one echo (i.e. remote), two would indicate both a local and remote echo. If this occurs, then it should be possible to spot what obstacle is causing this, and remove it.

The system should now be ready for final installation.

Alignment

The entire optical system alignment is of great importance to ensure reliable performance of both modems. It is essential to ensure the axes of both optical systems are in line and form a common axis, transmitter to receiver and back. This will mean that as much power as possible is received at the remote end, assuming that the optical components have been correctly positioned within their housings.

Considering Figure 1 it can be seen that the two parts of the system are in plain view of each other and that they have no obstacles within thirty degrees of the axis of either transmitter, otherwise this would cause problems with echoes. This would ultimately slow the rate of data transfer considerably. The echo problem can be easily seen at each end of the modem link, with an instantaneous repeat of the transmitted data.

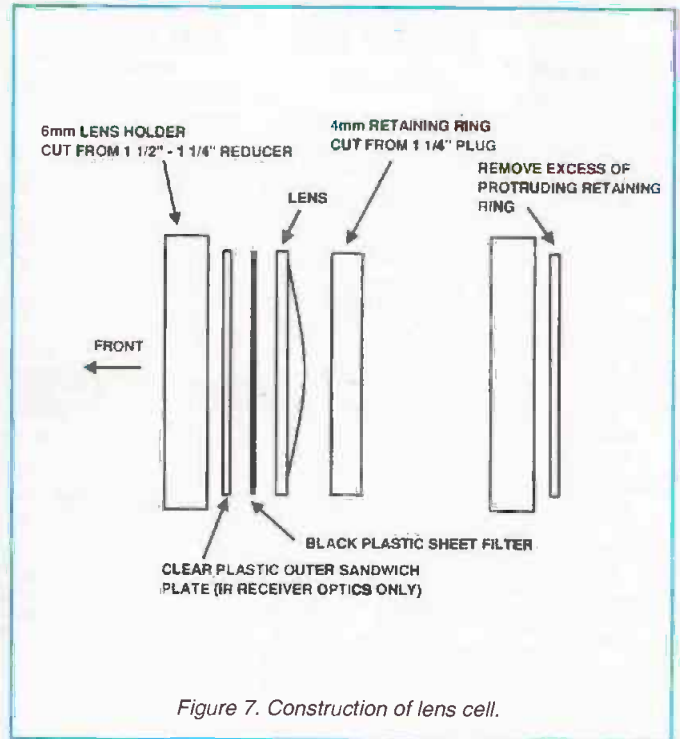

Figure 7. Construction of lens cell.

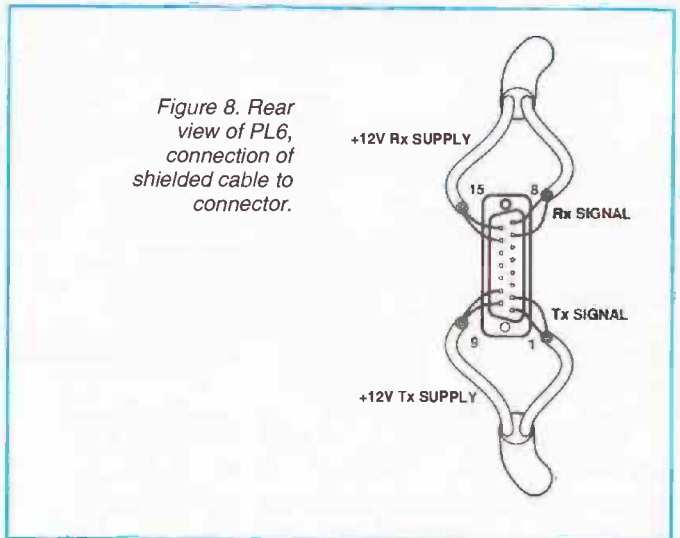

Figure 8. Rear view of PL6, connection of shielded cable to connector.

Notes for operation

Fluorescent lighting interference

When conducting various tests with the system, it was found that fluorescent lighting was a problem. Even though the IR receivers are designed to overcome it, they seem to be sensitive to this type of lighting. The IR radiation, however small, from these light sources was sufficient to introduce considerable errors in the optical chain. Therefore, direct or strong areas of radiation should be avoided at all costs.

The lens/filter arrangement used attenuates this problem to a large degree, but it would be wise to avoid aiming any of the optical paths along the line of any other strong IR emissions, for example the Sun.

One word of warning which has to be considered when the system is set up. Other people will be using IR controllers and it would be best not to have optical paths along an axis which is possibly going to correspond with an innocent source of IR radiation, such as a television remote controller.

This could either cause problems with the television remote controller being received with the link equipment or the link's data controlling the television or video. Avoid broadcasting the link IR into windows.

Surplus always wanted for cash!

THE ORIGINAL SURPLUS WONDERLAND!

THIS MONTH'S SELECTION FROM OUR VAST EVER CHANGING STOCKS

Surplus always wanted for cash!

LOW COST PC's - ALL EXPANDABLE - ALL PC COMPATIBLE

THE OFFER OF 1994!

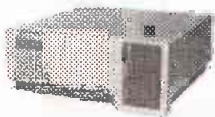

SPECIAL BUY
AT 286
40Mb HD + 3Mb Ram

LIMITED QUANTITY only of these 12Mhz HI GRADE 286 systems Made in the USA to an industrial specification, the system was designed for reliability. The compact case houses the motherboard, PSU and EGA video card with single 5 1/4" 1.2 Mb floppy disk drive & integral 40Mb hard disk drive to the front. Real time clock with battery backup is provided as standard. Supplied in good used condition complete with enhanced keyboard, 640k + 2Mb RAM, DOS 4.01 and 90 DAY Full Guarantee. *Only to Run!*
Order as HIGRADE 286

ONLY £169.00 (E)

Optional Fitted extras: VGA graphics card £29.00
1.4Mb 3 1/2" floppy disk drive (instead of 1.2 Mb) £32.95
NE2000 Ethernet (thick, thin or twisted) network card £49.00

PC SCOOP
COMPLETE
COLOUR SYSTEM
ONLY £99.00

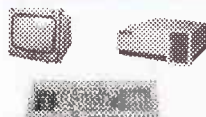

A massive bulk purchase enables us to bring you a COMPLETE ready to run colour PC system at an unheard of price! The Display Electronics PC99 system comprises of fully compatible and expandable XT PC with 256k of RAM, 5 1/4" 360k floppy disk drive, 12" CGA colour monitor, standard 84 key keyboard, MS DOS and all connecting cables - just plug in and go!! Ideal students, schools or anybody wishing to learn the world of PC's on an ultra low budget. Don't miss this opportunity. Fully guaranteed for 90 Days.

Order as PC99COL £99.00 (E)

Optional Fitted extras: 640K RAM £29.00
2nd floppy drive, specify 5 1/4" 360k or 3 1/2" 720k £29.95
Above prices for PC99 offer ONLY.



Computer Controlled
Laser Video Disk Player

One of the most amazing surplus deals that we ever been able to offer you! The Philips VP410 LaserVision player, in as new condition, unit features full computer control, Plays standard 12" LaserVision disks with startling visual and audio quality in two channel stereo or mono. When controlled by a computer, it may also be used as a versatile high quality storage / retrieval medium. It will play back either LaserVision CAV (active play) or CLV (Long Play) discs (which covers most types of commercially available video discs). Some of the many features of this incredible machine are:
RS-232 INTERFACE RGB / COMPOSITE VIDEO OUTPUT
BNC-SCART INTERFACE PAL / RGB DECODER
IR-WIRED REMOTE CONTROL FAST RANDOM ACCESS

SPECIAL PURCHASE Only **£399.00 (F)**

BBC Model B APM Board



£100 CASH FOR THE MOST NOVEL DEMONSTRABLE APPLICATION

BBC Model B type computer on a board. A major purchase allows us to offer you the PROFESSIONAL version of the BBC computer at a parts only price. Used as a front end graphics system on large network systems the architecture of the BBC board has so many similarities to the regular BBC model B that we are sure that with a bit of experimentation and ingenuity many useful applications will be found for this board!! It is supplied complete with a connector panel which brings all the I/O's to 'D' and BNC type connectors - all you have to do is provide +5 and +12 V DC. The APM consists of a single PCB with most major IC's socketed. The IC's are too numerous to list but include a 6502 / 6512 CPU, RAM and an SAA5050 teletext chip. Three 27128 EPROMS contain the custom operating system on which we have no data. On application of DC power the system boots and provides diagnostic information to the video output. On board DIP switches and jumpers select the ECONET address and enable the four extra EPROM sockets for user software. Approx. dims. main board 13" x 10", I/O board 14" x 3". Supplied tested with circuit diagram, data and competition entry form.

Only **£29.95**
2 for £53 (B)

FLOPPY DISK DRIVES 3.5" - 8"

5.25" from £22.95 - 3.5" from £24.95

Massive purchases of standard 5.25" and 3.5" drives enables us to present prime product at industry beating low prices! All units (unless stated) are BRAND NEW or removed from often brand new equipment and are fully tested, aligned and shipped to you with a 90 day guarantee and operate from standard voltages and are of standard size. All are IBM-PC compatible (if 3.5" supported on your PC).

3.5" Panasonic JU363/4 720K or equivalent £24.95 (B)
3.5" Mitsubishi MF355C-L, 1.4 Meg. Laptops only * £36.95 (B)
3.5" Mitsubishi MF355C-D, 1.4 Meg. Non laptop £22.95 (B)
5.25" Teac FD-55GFR 1.2 Meg £22.95 (B)
5.25" BRAND NEW Mitsubishi MF501B 360K £22.95 (B)
* Data cable included in price.
Shugart 800/801 B" SS refurb'ed & tested £195.00 (E)
Shugart 851 B" double sided refurb'ed & tested £250.00 (E)
Mitsubishi M2894-83 B" sided switchable NEW £250.00 (E)
Mitsubishi M2896-63-02U B" DS slimline NEW £285.00 (E)

Dual 8" drives with 2 mbYTE capacity housed in a smart case with built in power supply. Ideal as exterior drives! £499.00 (F)

HARD DISK DRIVES

End of line purchase scoop! Brand new NEC D2246 8" 85 Mbyte of hard disk storage! Full industry standard SMD Interface. Ultra hi speed data transfer and access time. replaces Fujitsu equivalent model. complete with manual. Only £299.00 (E)

3.5" FUJI FK-309-26 20mb MFM I/F RFE £59.95 (C)
3.5" CONNER CP3024 20 mb IDE I/F (or equiv) RFE £89.95 (C)
3.5" CONNER CP3044 40mb IDE I/F (or equiv) RFE £99.00 (C)
3.5" RODIME R03085S 70mb SCSI I/F (Mac & Acorn) £129.00 (C)
5.25" MINISCRIBE 3425 20mb MFM I/F (or equiv.) RFE £49.95 (C)
5.25" SEAGATE ST-238R 30 mb RLL I/F Refurb £69.95 (C)
5.25" CDC 94205-51 40mb HF MFM I/F RFE tested £89.95 (C)
8" FUJITSU M232K 160mb SMD I/F RFE tested £195.00 (E)
Hard disc controllers for MFM, IDE, SCSI, RLL etc. from £16.95

THE AMAZING TELEBOX

Converts your colour monitor into a QUALITY COLOUR TV!!



TV SOUND & VIDEO TUNER!

The TELEBOX consists of an attractive fully cased mains powered unit, containing all electronics ready to plug into a host of video monitors made by manufacturers such as MICROVITEC, ATARI, SANYO, SONY, COMMODORE, PHILIPS, TATUNG, AMSTRAD and many more. The composite video output will also plug directly into most video recorders, allowing reception of TV channels not normally receivable on most television receivers* (TELEBOX MB). Push button controls on the front panel allow reception of 8 fully tuneable 'off air' UHF colour television channels. TELEBOX MB covers virtually all television frequencies VHF and UHF including the HYPER-BAND as used by most cable TV operators. A composite video output is located on the rear panel for direct connection to most makes of monitor. For complete compatibility - even for monitors without sound - an integral 4 watt audio amplifier and low level Hi Fi audio output are provided as standard.

TELEBOX ST for composite video input type monitors £32.95
TELEBOX STL as ST but with integral speaker £36.50
TELEBOX MB Multiband VHF-UHF-Cable-Hyperband tuner £69.95
For overseas PAL versions state 5.5 or 6MHz sound specification.
*For cable / hyperband reception Telebox MB should be connected to cable type socket. Shipping code on all Teleboxes is (B)

FANS & BLOWERS

MITSUBUSHI MMF-D6D12DL 60 x 25 mm 12v DC £4.95 10 / £42
MITSUBUSHI MMF-09B12DH 92 x 25 mm 12v DC £5.95 10 / £53
PANCAKE 12-3.5 92 x 18 mm 12v DC £7.95 10 / £69
EX-EQUIP 120 x 38mm AC fans - tested specify 110 or 240 v £6.95
EX-EQUIP 80 x 38mm AC fans - tested specify 110 or 240v £5.95
VERO rack mount, 1U x 19" fan tray specify 110 or 240v £45.95
IMHO B26 1900 rack mnt 3U x 19" Blower 110/240v NEW £79.95
Shipping on all fans (A), Blowers (B), 50,000 Fans Ex Stock CALL

IC's TRANSISTORS DIODES

OBSELETE - SHORT SUPPLY - BULK

5,000,000 items EX STOCK

For MAJOR SAVINGS - SAE or CALL FOR LATEST LIST

Issue 12 of *Display News* now available - send large SAE - PACKED with bargains!



LONDON SHOP
Open Mon-Sat 9:00-5:30
215 Whitehorse Lane
South Norwood
LONDON SE25

DISTEL The Original
FREE On line Database
Info on 1000's of items
V21,V22, V22 BIS
081 679 1888

ALL MAIL & OFFICES
Open Mon-Fri 9.00-5:30
Dept ETI. 32 Biggin Way
Upper Norwood
LONDON SE19 3XF

ALL ENQUIRIES
081 679 4414
FAX 081 679 1927



All prices for UK Mainland. UK customers add 17.5% VAT to TOTAL order amount. Minimum order £10. Bona Fide account orders accepted from Government, Schools, Universities and Local Authorities - minimum account order £50. Carriage charges (A)=£3, (A1)=£4.00, (B)=£5.50, (C)=£8.50, (D)=£12.00, (E)=£15.00, (F)=£18.00, (G)=CALL Allow approx 6 days for shipping - faster CALL. Scottish surcharge CALL. All goods supplied to our Standard Conditions of Sale and unless stated guaranteed for 90 days. All quantities on a return to base basis. All rights reserved to change prices / specifications without prior notice. Orders subject to stock. Discounts for volume. Top CASH prices paid for surplus goods. All trademarks etc. acknowledged. © Display Electronics 1994. E & O E.

SUMMER 1993/94 CATALOGUE



NEW EDITION!

The new enlarged Catalogue is out now!

Included in this issue:

- A further 16 extra pages
- £200 worth discount vouchers
- 100's new products
- 256 pages, 26 sections, over 4000 products from some of the worlds finest manufactures and supplies
- Expanded entertainment section with in-car amps, speakers, crossovers and low cost disco equipment
- Further additions from Europe's leading kit manufacture - Velleman
- Published April 28th 1994
- Available from most large newsagents or direct from Cirkit
- **Send for your copy today!**

£1.90
+ 30p p&p



CIRKIT DISTRIBUTION LTD
Park Lane · Broxbourne · Hertfordshire · EN10 7NQ
Telephone (0992) 448899 · Fax (0992) 471314

Summer SUBSCRIPTION OFFER

13 ISSUES FOR THE PRICE OF 12! 13 ISSUES FOR THE PRICE OF 12! 13 ISSUES FOR THE PRICE OF 12! 13 ISSUES FOR THE PRICE OF 12! 13 ISSUES FOR THE PRICE OF 12!

ETI
ELECTRONICS TODAY INTERNATIONAL TOMORROW'S TECHNOLOGY

**THE ART OF ANIMATION
THE SCIENCE OF ROBOTICS**

May 1994 £1.90

BUILD ONE PALESAYER SPEAKER ATTENUATOR
DIGITAL SHUTTER TIMER FOR PHOTOGRAPHERS
BUILD A SOUND LIGHT MONITOR
THE MYSTERIES OF RS-232 COMMUNICATIONS

issues for the price of
12!

That's right, this summer saver offer means you can guarantee every issue of your favourite magazine will be delivered to your home for the next **13 MONTHS** and you only pay for **12 issues.**

So what are you waiting for?
Subscribe today!

Subscribe - 13 issues for the price of 12!

Yes! I would like to subscribe to **ETI** magazine for 1 year (13 issues) - **FREE** Please continue my subscription from the (if renew/expand, please quote subscription number)

Electronics Today International One Year Subscription Rate
UK £25.50 Europe & Euro £32.70
Sterling Overseas £53.90 US Dollars Overseas \$56

Enclose a cheque/M.O. for £/US\$ or make payable to ASP or debit my Access/ISA.

Signature _____ Expiry _____
Name _____
Address _____ Post Code _____
Home Telephone no. _____

Please post this coupon to: Argus Subscription Dept, Queensway House, 2 Queensway, Rush Hill, Surrey, RH1 1QS

If you've got a credit card it's faster by phone! Call us on 0737 76861

Please tick if you do not wish to receive information about offers and services from other companies. Offer closes 1/7/94. ETI

MIDI Explained

In part two of this series, Robert Penfold continues his look at the Musical Instrument Digital Interface

MIDI is basically just a means of sending rigidly coded messages from a master unit to one or more slave devices. These messages break down into two broad groups, which are the channel and system messages. Both types of message are important, but the channel messages are definitely the more important of the two. You can utilise MIDI fairly extensively just using the channel messages, but it would be difficult to get MIDI to do anything worthwhile using only the system messages. The channel messages are the ones that are used all the time in the everyday use of MIDI systems.

In order to use MIDI effectively it is essential to have at least a fundamental understanding of the system messages. If you are intending to undertake the design of MIDI hardware or MIDI software programming, a detailed understanding of these messages and their coding is absolutely essential. In this second article of the series we will look at the basics of channel messages and consider the related subject of MIDI operating modes.

Significant Nibbles

The primary difference between channel messages and system types is that the former are directed at one particular device in the system, or even one voice of one device, whereas

system messages are directed to every slave unit. This is not to say that everything in the system will respond to system messages, or even that something in the system will respond to every channel message.

MIDI is a framework within which every MIDI equipped unit must operate, but the MIDI specification does not lay down any minimum requirements. Some MIDI units respond to no more than a few of the more basic messages, while others have quite full implementations. There is probably no piece of MIDI equipment, apart perhaps from a few MIDI testing devices, which respond to every possible MIDI message. You have to consult the MIDI implementation charts in the manuals in order to determine which particular messages your instruments will recognise. These charts should also show which messages the units can transmit and it is quite

normal for there to be some differences between the sending and receiving capabilities.

A simple method of software channelling is used for channel messages. In other words, all the messages are sent down the same pair of wires and the channel numbers are contained within the code numbers of the messages. A MIDI device can operate on up to sixteen channels, which are simply numbered 1 to 16. All MIDI messages start

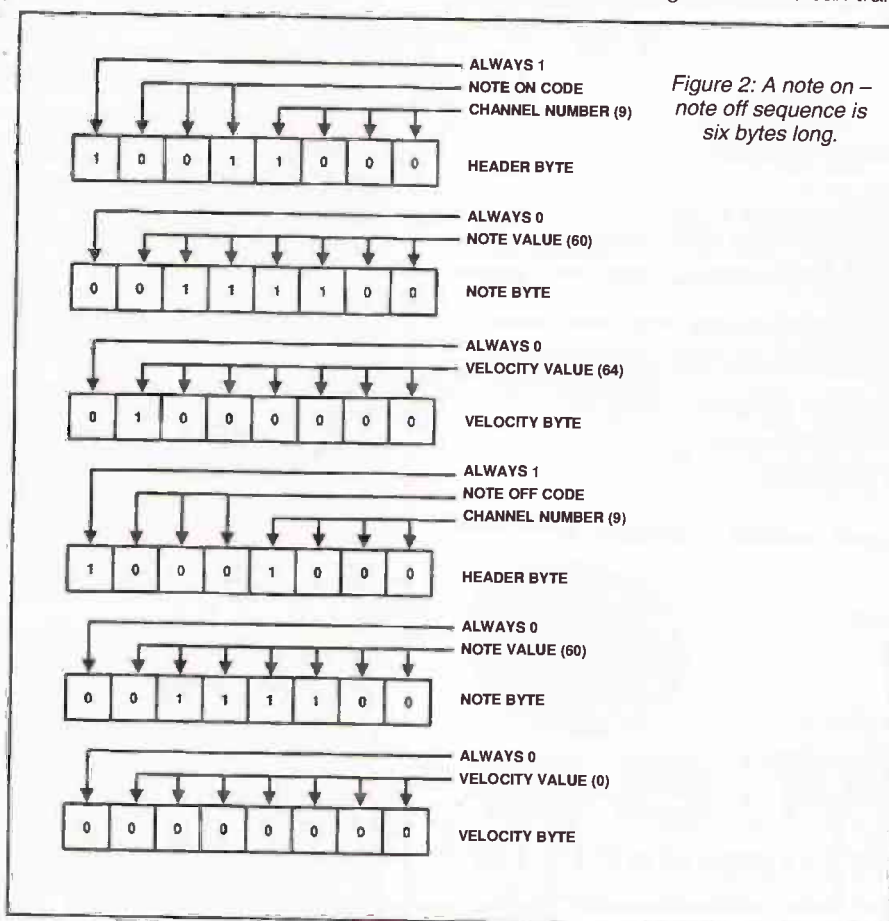

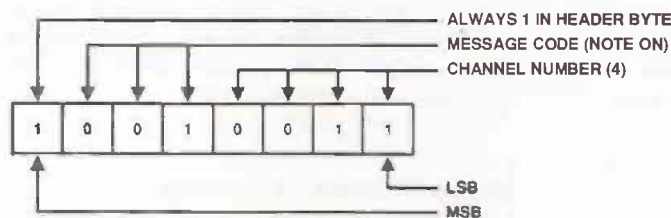

Figure 1: An example MIDI channel message header byte.

with a header byte that contains two vital pieces of information. For channel messages these are the channel number and the message type (note on, note off, etc.). In some cases the header byte is all that is needed, but with most messages some further bytes of information must be sent. These contain data, such as which note to switch on or off, or the amount of 'bend' to apply to a note.

MIDI sends messages as a series of 8 bit binary codes, or bytes as they are termed. Each header byte has to be considered as two separate four bit codes. In computer terminology, believe it or not, a four bit code (half a byte) is known as a 'nibble'. In standard serial interface fashion, MIDI sends the least significant bit first, working through in sequence to the most significant bit. The first four bits received (the least significant nibble) contain the channel number.

For those working on the design of MIDI hardware and software it is important to remember that there is a discrepancy between the value used in a MIDI message and the actual channel number. The binary codes run from 0000 to 1111, which is the decimal equivalent of 0 to 15. The convention is for MIDI channel numbers to run from 1 to 16. Therefore, the channel value used in the header byte is one less than the conventional MIDI channel number.

The most significant nibble in a header byte indicates the message type. In fact, the most significant bit is always set to 1 in a header byte and to 0 in a data byte, so that there is no risk of receiving devices mistaking one type for the other. There are then three bits to indicate the message type. Although this gives eight possible message codes, one of these is used to for system messages, limiting MIDI to seven types of channel message. Figure 1 shows the function of each bit in a header byte and it should help to clarify the coding method used. This example header byte is a note-on type on channel 4.

Exchanging Notes

Although MIDI can be used to control just about any aspect of an instrument, or any other piece of electronic music equipment (digital effects unit, audio mixer, etc.), its primary function is to play notes on the slave instruments. Notes are normally switched on and off via separate messages which take the same basic form. They consist of the header byte followed by two data bytes. The first data byte is the note value. All data bytes have the most significant bit set to 0, so only seven bits are available to carry the note value. In decimal terms, the note value is in the range 0 to 127. Middle C is at a value of 60 and there is an interval of one semitone from one value to the next.

This gives a range of over ten octaves, which should be sufficient for anything from ancient music to the latest avant-garde creations. MIDI accommodates a range of over ten octaves, but it is only fair to point out that most MIDI instruments have a somewhat narrower compass. The way in which out-of-range notes are treated varies from instrument to instrument and in some cases they are simply ignored, but with most instruments the right note will be played, but in the nearest octave that the instrument can manage. This

minimises the disruption to the reproduced music. Many instruments actually cover a wider note range via MIDI than that available by way of their keyboards.

The second data byte is the velocity value. For keyboards that are not touch sensitive a 'dummy' value (usually 64) is used here. For touch sensitive keyboards the velocity value reflects how hard the key was pressed. Slave units that implement touch sensitivity use these values to control the volume levels of the notes, and the filter circuits might also respond to them. Although rare at one time, virtually all new MIDI instruments implement touch sensitivity, although many only seem to have about half a dozen different velocity levels, not the full 128 supported by MIDI.

In note off messages, most keyboards simply use a velocity value of 0. Most slave units do not respond to velocity values in note off messages. Clearly the decay characteristic of a note could be related to this value, but as yet few 'real world' instruments have this feature. Figure 2 shows an example note on - note off sequence.

One of the less well understood aspects of MIDI is the use of note on messages to switch notes off. A note on message will act as a note off type if it has a velocity value of 0. MIDI permits somewhat streamlined operation where a single note on header byte can be followed by numerous pairs of data bytes. Using this system, plus velocity values of 0 to switch notes off, it is possible to play complete sequences using just one note on header byte plus numerous pairs of data bytes. In practice this method is limited by the fact that each change to a different channel requires a new header byte to be sent. This method is used in an increasing number of sequencers though, and it can help to reduce MIDI 'choke'.

In The Mode

MIDI receiving devices must operate in one of four modes. MIDI modes govern the way in which system messages are handled, and this is their sole function. They can sometimes seem like an unnecessary complication, but they enable a system to be organised in ways which fully exploit its capabilities. By changing modes it is possible to reconfigure the system to suit different pieces of music. The four official MIDI modes are identified by mode numbers and mode names, but in some cases old mode names as well.

Mode 1; Omni On/Poly (Previously Omni Mode)

Mode 1 is one of the most basic MIDI modes, and as such it is little used these days. The Omni On part of the name

indicates that channel numbers are not implemented in this mode. A device in Mode 1 will respond to any channel message regardless of its channel number. The Poly part of the name means that polyphonic operation is possible. In other words, more than one note at a time can be played. In a Poly mode, MIDI supports any number of notes playing simultaneously, but few MIDI instruments can have all their notes operating at once. It is up to the user of the system to ensure that each slave unit can cope with the notes it receives. This is a slight drawback to the MIDI version of multi-track recording as with the traditional method you can use one instrument to build up finished pieces of any complexity. The same is true when putting together MIDI sequences, but it is only possible to playback the finished piece if you have sufficient hardware to produce every note on every channel!

The other MIDI modes are optional, but all MIDI equipped units should include mode 1 and should default to this mode at switch-on. It is probable that all commercially produced MIDI equipment includes mode 1, but it is now quite rare for anything to default to this mode at switch-on. Usually, a modern MIDI equipped device will have built-in memory circuits which store a wide range of settings while the unit is switched off. Once switched on again, these settings are used as the defaults. At switch-on, a modern MIDI instrument is therefore likely to take up where it left off rather than simply defaulting to mode 1.

This mode is primarily intended to act as a sort of universal mode which will enable any MIDI device to communicate with any other. If you only wish to use MIDI in a fairly basic fashion, then Mode 1 might suffice and if it will, then it is the best choice. Whereas some of the other modes require some careful setting up in order to get the system operating properly, with Mode 1 you should need to do nothing more than set the right mode. Its easy going nature makes it a good choice when things are going wrong and you need to go back to basics in order to get the system functioning to some degree again.

The problem with Mode 1 is that it does not implement channel numbers. In effect, all messages become system types. If you simply wish to have one or two slave instruments following the notes played on a master instrument, it may do the job perfectly well but even with a set up as basic as this, Mode 1 might impose some limitations. Many MIDI keyboard instruments can have some form of split keyboard operation. Different parts of the keyboard can be assigned to different MIDI channels and can produce different sounds on both the master and slave instruments. However, if the slave instruments are set to Mode 1, they will ignore the fact that the note messages are on two or more channels and will play all notes using the same sound generator settings. For anything beyond simple slaving it is necessary to use one of the other modes.

Mode 2; Omni On/Mono (No Previous Name)

This mode does not implement channel numbers and it only permits monophonic operation. In other words, it provides what is effectively a single channel system that can only handle one note at a time. It provides such an elementary link that it would seem to be of no real practical value, but presumably it was included in the MIDI specification to accommodate monophonic synthesisers. These were quite common when MIDI was being formulated, but they have

now been out of commercial production for many years. Few monophonic synthesisers equipped with MIDI interfaces were ever built and it would seem that this mode no longer has any practical significance, and it is one that a modern MIDI user can simply disregard.

Mode 3; Omni Off/Poly (Previously Poly Mode)

This is one of the most useful MIDI modes. As the Omni Off part of the name indicates, it does implement channelling. An instrument in this mode must therefore be assigned to a particular MIDI channel and it will only respond to channel messages which are on that particular channel. It is also a Poly mode, which means that it supports polyphonic operation. If you only have one slave instrument, this mode is not really a great advance on Mode 1 but the situation is very different for a system which has several slave instruments. With this mode you can have up to sixteen different instruments operating polyphonically, with each one on its own channel and playing its own completely independent track. You can have what is effectively a MIDI controlled orchestra playing very complex sequences. Mode 3 is therefore a popular one for use in sequencing set-ups.

Its potential in 'live' performances should not be overlooked either. With a master unit set for split keyboard operation it is possible to have two or three slave instruments following different parts of the keyboard and playing different sounds. Although MIDI tends to be mainly associated with sequencing, it has a lot to offer the 'live' performer.

A modern instrument can usually be assigned to any MIDI channel when it is set to operate in mode 3. Many older instruments are far less accommodating. In some cases it is a case of any channel you like, provided it is Mode 1. If there is only one instrument of this type in the system there is no problem, since the other instruments can be assigned to something other than channel 1. With two or more instruments of this type in the system, it will not be possible to fully exploit mode 3.

Mode 4; Omni Off/Mono (Previously Mono Mode)

This is another powerful and useful MIDI mode. It is one which many regard as the most powerful, but I think it is true to say that it is slightly inferior to Mode 3. Channels are implemented in Mode 4, but only monophonic operation is possible. On the face of it, this makes Mode 4 of limited value, but the important point to bear in mind here is that Mode 4 is only monophonic in the sense that one note at a time can be played per channel. It is polyphonic in that up to sixteen channels can be used at once, giving sixteen note polyphony across all the channels. You do not necessarily need sixteen instruments to occupy all sixteen channels. In theory it is possible to have one instrument in Mode 4 occupying all sixteen channels, but in practice there are few instruments that can do this. Nevertheless, two modern MIDI instruments are usually enough to cover all or most of the available channels.

Mode 4 clearly has great potential for those who are into multi-track sequencing. Using a couple of fairly advanced instruments set to this mode you can sequence sixteen independent monophonic tracks, with each one using a different voice. This gives you a MIDI controlled orchestra of

sorts. It is not equal to sixteen Mode 3 instruments as it provides only monophonic operation on each track. A number of instruments in Mode 3 provide polyphonic operation on each channel and it is for this reason that Mode 3 has to be regarded as ultimately more powerful than Mode 4. Being realistic however, few musicians can afford the luxury of sixteen instruments in Mode 3. A couple of synthesisers operating in Mode 4 is a much more affordable option.

When selecting MIDI operating modes you should always bear in mind that the slave units do not have to operate in the same mode. A mixture of Modes 3 and 4 will often provide the greatest versatility. For example, you could have an electronic piano in mode 3 reproducing a polyphonic track, plus a Mode 4 instrument providing an eight track monophonic (per track) accompaniment. Most music consists of one or two polyphonic parts plus several monophonic parts and is well suited to a combination of Modes 3 and 4. With complex sequencing it is essential to give careful thought to the track assignments, as well as to the mode used for each instrument.

In theory, each channel of a Mode 4 instrument is independent of the other channels. In practice, particularly with older instruments, the channels might not always be completely separate. It is as well to read the fine print in the equipment manuals, particularly any notes in the MIDI implementation chart. Some instruments support Mode 4, but with certain types of message affecting all channels, not just the one they were transmitted on. For example, pitch bending on one channel might actually affect every channel. If my understanding of the MIDI specification is correct, this sort of thing is not actually within the MIDI standard. It means that the instrument is mainly operating in Mode 4, but that with certain types of channel message it operates in Mode 1! Although not strictly legitimate, I suppose it is better to have an instrument which supports a 'strings attached' version of Mode 4, rather than one which does not implement this mode at all.

Multi-Modes

The four official MIDI modes were barely adequate at the time MIDI came into being and they soon started to look more than a little inadequate. Suppose that you have a twenty four note polyphonic instrument. Using Modes 3 or 4 this instrument could provide twenty four note polyphonic operation on one channel, or monophonic operation on sixteen channels. In some circumstances twenty four note polyphonic operation could be very worthwhile, but in many situations it would be wasteful with no more than a few notes ever playing at the same time. In Mode 4 no more than sixteen notes could be played at once, meaning that eight sound generator circuits would be left totally unused.

In order to accommodate increasingly sophisticated instruments, a new and more powerful mode was badly needed. No MIDI Mode 5 has ever been introduced, but most modern instruments have what is effectively an additional mode. This additional mode has been given various names by the equipment manufacturers, but it is now generally known as 'multi-mode'. In points of detail multi-mode varies somewhat from one instrument to another and some instruments have more than one multi-mode available. All multi-modes have one basic property in common. They enable an instrument to operate polyphonically on two or more channels.

For example, a sixteen voice instrument could have multi-

modes which permit eight note polyphonic operation on two channels, four note polyphonic operation on four channels, or two note polyphonic operation on eight channels. In each case a sort of polyphonic Mode 4 is being provided and it might seem as though instruments offering multi-modes fall outside the MIDI standard specification. I suppose that this is really a matter of opinion, but multi-modes can be legitimised on the basis that they are really just Mode 3. With a multi-mode instrument you have what are effectively two or more instruments working in Mode 3, which just happen to be in the same case. These notional instruments are usually termed 'virtual' instruments.

As multi-modes have not been standardised, the only way to determine the exact multi-mode capabilities of a given instrument is to carefully read the relevant section of the instruction manual. In some cases, there may be only one fairly basic mode offering something like four note polyphonic operation on three channels. Most instruments seem to offer various modes, splitting the voices across (say) two, four, six, or eight MIDI channels in assorted ways.

The most versatile multi-modes use dynamic allocation of the voices. With a mode of this type you are offered something like eight channel operation with up to sixteen notes per channel. This might seem to be too good to be true, and it is. The usual flaw in a mode of this type is that there is a limit of perhaps sixteen notes playing simultaneously. If you use the full sixteen note polyphony on one channel, nothing can be played on any of the other channels.

Although this might seem to be no better than a normal multi-mode, it definitely offers greater versatility. You can change instantly from one extreme to another, such as sixteen notes on one channel to one note each on sixteen channels. It is possible to use endless chopping and changing of this type without having to change from one multi-mode to another. You just have to make sure that sequences stay within the limit of sixteen notes at once. Without dynamic note allocation, frequent mode changes would be required, which might not be a practical proposition.

It is perhaps worth making the point that MIDI modes only apply to receiving devices. You may sometimes find them applied to MIDI master units, particularly sequencers. I suppose a device that transmits polyphonically on one channel could be regarded as being in Mode 3, but this is not a strictly accurate way of looking at things. Modes govern the way received channel messages are handled, and should only be applied to slave units.

Summary Of Modes

Mode 1 - Polyphonic operation, but does not implement channels. Useful for troubleshooting or where very basic slaving is all that is needed.

Mode 2 - Monophonic operation with no channelling. Probably has no practical value.

Mode 3 - Polyphonic operation on one MIDI channel. A powerful mode, particularly in a system which has several instruments. Mode 4 - Monophonic operation on several channels. Ultimately less potent than Mode 3, but it can make very effective use of one or two instruments.

Multi-modes - Provide polyphonic operation on several channels. Unofficial modes, but more powerful than the standard modes. Ideal for complex sequencing with a few instruments.

Inventor toroidal transformers 225VA 10 5-0-10.5
 Primary 0-260-285 secondary £29.95
 LEDs 3mm or 5mm red or green 6p each
 yellow 11p each
 High intensity red, green or yellow 5mm 30p each
 Cable ties 1p each £5.95 per 1000
 £49.50 per 10,000
 High quality photo resist copper clad epoxy glass boards

Dimensions	single sided	double sided
3x4 inches	£1.09	£1.23
4x8 inches	£2.78	£2.99
6x12 inches	£6.20	£6.50
12x12 inches	£12.25	£12.50

Rechargeable batteries
 AA (HP7) 500mAh £0.99
 AA 700mAh £1.23
 C 2AH with solder tags £3.60
 4AH with solder tags £4.85
 12AA with solder tags £1.55
 AAA (HP16) 180mAh £1.75
 AA 500mAh with solder tags £1.55
 C (HP11) 1.8AH £2.20
 D (HP2) 1.2AH £2.60
 PP3 8.4V 110mAh £4.95
 Sub C with solder tags £2.50
 1/3 AA with solder tags (Philips CTV) £1.95

Standard charger charges 4 AA cells in 5 hours or 4 Cs or Ds in 12-14 hours 1xPP3 (1,2,3 or 4 cells may be charged at a time) £8.95
 High power charger as above but charges the Cs and Ds in 5 hours AAAs Cs and Ds must be charged in 2s or 4s £10.95
 Special offers please check for availability
 42 x 16mm dia 1.2v £1.45
 Stick of 4 17mm x 16mm dia with red & black leads 4.8v £5.95

Computer grade capacitors with screw terminals
 3800uf 20v £2.50
 8700uf 10v £1.95, 6800uf 15v £2.95, 1000uf 16v £1.50, 5800uf 60v £4.95
 7 segment common anode led display 12mm £0.45
 LM2931ATS.0 low drop out 5v regulator TO220 package £0.85
 7812 and 7912 12v 1A regulators £20.00 per 100
 LM337K TO3 case variable regulator £1.95
 £1.44 100+
 GaAs FET low leakage current S8873 £12.95 each £9.95 10-£7.95 100+
 BS250 P channel mosfet £0.45, BC558 transistor £3.95 per 100
 74LS05 hex inverter £10.00 per 100, used 8748 Microcontroller £3.50
 SL952 UHF limiting amplifier LC 16 surface mounting package with data sheet £1.95
 AM27502 £1.25 each 90p 100+, CD4007UB 10p 100+ 100p 100+
 Sinclair light gun terminated with a jack plug and PP3 clip gives a signal when pointed at 50Hz flickering light with output wave form chart £2.95
 DC-DC converter Reliability model V12P5 12v in 5v 200ma out 300v input to output isolation with data £4.95 each or pack of 10 £39.50
 Hour counter used 7 digit 2.40v ac 50 Hz £1.45
 QWERTY keyboard 58 key good quality switches new £5.00

Airpax A82903-C large stepping motor 14v 7.5' step 27ohm 68mm dia body 6.3mm shaft £8.95 or £200.00 for a box of 30
 Polyester capacitors box type 22.5mm lead pitch
 0.9uf 250vdc 18p each 14p 100+ 5p 1000+
 1uf 250vdc 20p each, 15p 100+ 10p 1000+
 2.2uf 250vdc (27.5mm pitch) 30p each, 20p 100+, 15p 1000+
 3.3uf 100vdc 30p each, 20p 100+, 15p 1000+
 1uf 50v bipolar electrolytic axial leads 7.5p 100+
 0.22uf 250v polyester axial leads 15p each, 7.5p 100+
 Polypropylene 1uf 400vdc (Wima MKP10) 27.5mm pitch
 32x29x17mm case 75p each 60p 100+
 Philips 123 series solid aluminium axial leads
 33uf 10v & 2.2uf 40v 40p each, 25p 100+
 Philips 108 series 22uf 63v axial 30p each, 15p 1000+
 Multilayer AVX ceramic capacitors all 5mm pitch
 100v 100uf, 150pf, 220pf, 10,000pf (10n) 10p each, 5p 100+
 3.5p 1000+
 500pf compression trimmer 60p
 40uf 370vac motor start capacitor (dielectric type containing no PCBs) £5.95 or £49.50 for 10
 Wavym W23 9W 120ohm 35p each 20p 100+
 680 ohm 2W metal film resistor 4p 100+, 5p 1000+
 Solid carbon resistors very low inductance ideal for RF circuits
 27ohm 2W, 68ohm 2W 25p each 15p each 100+ we have a range of 0.25w 0.5w 1w and 2w solid carbon resistors please send SAE for list
 P.C. 400W PSU (Intel part 201035-001) with standard motherboard and 5 disk drive connectors, fan and mains inlet/outlet connectors on back and switch on the side (top for tower case) dims 212 x 149 x 149mm excluding switch £26.00 each £138.00 for 6
 MX180 Digital multimeter 17 ranges 1000vdc 750vac 2Mohm 200mA transistor Hfe 9v and 1.5v battery test £12.95
 AMD 27256-3 Eproms £2.00 each, 1.25 100+
 DIP switch 3PCO 12 pin (ERG SDC-3-023) 60p each 40p 100+
 Disk drive boxes for 5 25 disk drive with room for a power supply light grey plastic 67x268x247mm £7.95 or £49.50 for 10
 Hand held ultrasonic remote control £3.95
 V2485 gas relay 30 x 10mm dia with 3 wire terminals will also work as a neon light 20p each or £7.50 per 100
 A23 12v battery for car alarms or lighters 75p each £50.00 per 100

All products advertised are new and unused unless otherwise stated
 wide range of CMOS TTL 74HC 74F Linear Transistors kits rechargeable batteries capacitors tools etc always in stock
 Please add £1.95 towards P&P vat included in all prices

JPG ELECTRONICS
 276-278 Chatsworth Road
 Chesterfield S40 2BH
 Access Visa Orders (0246) 211202
 Callers welcome

FIRENZA ELECTRONICS

HIGH POWER AMP BUILDERS

Special Offer

100 x 100 WATT MOSFET AMP	£200.00
200 x 200 WATT MOSFET AMP	£260.00
300 x 300 WATT AMP	£300.00
300 x 300 WATT MOSFET AMP	£360.00
600 x 600 WATT MOSFET AMP	£460.00
1000 x 1000 WATT MOSFET AMP	£700.00

GURANTEED FOR 1 YEAR PARTS & LABOUR
PHONE NOW AND PLACE YOUR ORDER ON
0908 - 670 903 OR 0831 212941

EPROM EMULATOR

Only 11mm high, it plugs directly into your Eprom socket. Compatible with standard Eproms. Allows faster product development.

Data is written to the emulator directly from your computer, via a 4mm cable which plugs into the emulator.

The MicroRom Eprom Emulator offers non-volatile storage and can download a 27256 file in only 1 SECOND. Prices from £99 + VAT

TEL / FAX 081 880 9889

SquareWave Electronics Ltd., Imperial House, 64 Willoughby Lane, LONDON N17 0SP

PCB Designer

For Windows 3.1
 Runs on any PC running Windows in standard or enhanced mode with 2MB RAM

Only
£49
All
Inclusive

'...If you need a basic PCB design package and don't want to spend a fortune, PCB Designer is the software you have been waiting for. It is extremely easy to use, quick to learn, and represents superb value for money...'

Paul Stenning
Electronics In Action

'...I must have tried over a dozen PCB design programs in the last few years and PCB Designer is certainly the easiest to learn and use...'

R A Penfold
Everyday with Practical Electronics

Credit card hotline (0432) 355 414

Niche Software

22 Tavistock drive, Belmont, Hereford, HR2 7XN
 Phone (0432) 264 800, FAX (0432) 264 800

Please Note: Since PCB designer is so easy to use, and to keep costs down, PCB Designer has an On-Line manual, in Windows Help format. A tutorial is also supplied online.

PHOTOCOPIING SERVICE

ETI has been published for over 20 years and in that time a great many interesting features and valuable projects have graced its pages. Although back numbers are available for only the last 12 month's issues we can supply photo-copies of any individual article ever published in ETI.

Photo-copies cost just £2.00 per article regardless of their length. Please note that projects published over several issues must be ordered as a series of individual articles, each for £2.00.

PCB foil patterns (where published) and any errata are included with all photo-copies where applicable.
 A £2.00 search fee is required if full information is not supplied.
 Please note delivery could be up to 28 working days.

Please supply photo-copies of the following articles from ETI (Complete in BLOCK CAPITALS)

Month _____ Year _____ Page (if known) _____

Title _____

Month _____ Year _____ Page (if known) _____

Title _____

Month _____ Year _____ Page (if known) _____

Title _____

I enclose a cheque/postal order made out to **Argus Specialist Publications** to the value of £2.00 per photocopy ordered.

Total remittance £ _____ Date _____

Name _____

Address _____

Postcode _____

Send the completed form and remittance to:
**ETI Photocopy Service, Argus House, Boundary Way
 Hemel Hempstead, Hertfordshire, HP23 7ST**

ATTENTION ALL NORTH AMERICAN READERS!

Did you know that you can order an annual subscription to this magazine direct from our official U.S. subscription representative?

For more information and rates contact:
Wise Owl Worldwide Publications,
4314 West 238th Street,
Torrance, CA 90505
Tel: (310) 375 6258

PROGRAMMER EPROM, EEPROM & FLASH for all types 2k (2716) to 8 meg (27C080) 12.5 to 25 volt. Connects to printer port on IBM. Fast program (7750 - 45 sec). Comprehensive editor software. Requires 15-30 volt AC or DC power supply (optional extra £6.50) only £99.95

RQM EMULATOR. Works on ANY computer with a printer port. Code sent to printer appears in rom on target board. Fast download, switchable to emulate up to 32k ROMs. only £39.95

PC SCOPE. Fast 8 bit A/D converter connects to printer port on IBM PC. Supplied with Scope and Voltmeter software with Data and A/D routines to write your own programs. only £29.95

PIC16C54/55/56/57/84/71 PROGRAMMER. Runs on IBM PC, with editor software. protection fuse blowing etc. requires 15-20 volt AC or DC power supply (optional extra £6.50) only £69.95

LOW COST PIC16C54/56/71/84 I.C.E. Connects to printer port on IBM PC. In circuit emulator with single step/go with breakpoints etc. only £89.95

Supplied with connection information and PIC DEV 94 or PIC DEV 71 software as below.

PIC DEV 54. Integrated Text editor, Assembler, Disassembler, Simulator for 54/55/56/57 Pics. Runs on IBM PC. Single step trace, go with breakpoints etc. etc. Everything you need to write and debug programs. Runs with or without the I.C.E. unit. Software only £29.95

PIC DEV 71. As above but for PIC16C71 84 controllers. Software only £29.95

ASM51 + SIM51. Text Editor, Assembler plus simulator for Micro controllers 8051/52. Runs on IBM PC. Full control of registers & memory. Label disassembly, program trace, single step etc. Software only £49.95

ASM48 + SIM48. Same as Asm51 but for 8048 Micro controller. Software only £19.95

All hardware carries a 12 month parts & labour Guarantee. S.A.E. or telephone for further details.

JOHN MORRISON (MICROS) Dept ETI
4 REIN GARDENS, TINGLEY, WEST YORKSHIRE WF3 1JR
Telephone 0532 537 507

PROTECT and TREASURE

your collection of
**Electronics Today
International
magazines.**

Keep up to 12 issues of
your favourite magazines
in pristine condition in our
smart, sturdy binders.

Top quality
binders

Order your binder and post this today!

PLEASE COMPLETE IN BLOCK CAPITALS

Please supply _____ binders at only £6.95 each, including p&p
(UK only; Overseas please add £1.50)

I enclose my cheque/P.O. for £_____ made payable to ASP or please
debit my Access/Visa

Signature..... Expiry..... Today's Date.....

Name.....

Address.....

Post Code.....

Post this coupon and payment to:

ASP, ETI Binders Offers, Argus House, Boundary Way, Hemel Hempstead, Herts,
HP2 7ST. Or if you've got a credit card, it's faster by phone: 0442 66551.

You may receive further information about offers and services which may be of
interest to you. Allow 28 days for delivery.

Enter a World of Electronics Hobby Information with

Popular Electronics®

Get the latest electronic technology and information!

Discover the high-voltage excitement of hobby electronics each month in Popular Electronics. Build sophisticated electronics projects from circuits and plans in each monthly issue. Whether it's add-ons or modifications for stereos, TV's, computers, radios, etc.; work savers for your home and car; or useful test gear for your workbench, you'll find it in Popular Electronics. Plus... you'll find informative features and theory articles, monthly columns, hobby-oriented departments, and much more in Popular Electronics.

POPULAR ELECTRONICS SUBSCRIPTION ORDER FORM

Popular Electronics, P.O. Box 338, Mt. Morris, IL 61054 U.S.A.

YES! I want to subscribe to Popular Electronics for 1 full year (12 issues)
for only \$26.45 (U.S. Funds only).

Please print clearly

Name _____

Address _____

City, etc. _____

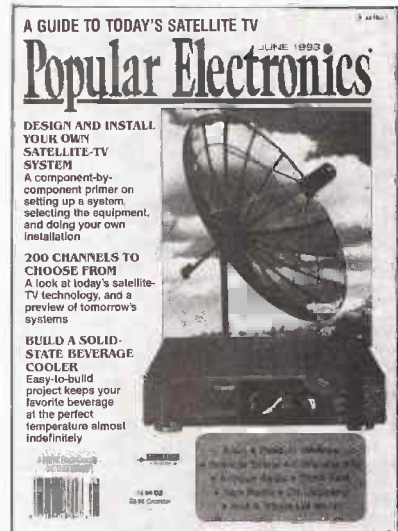

SPECIAL COLUMNS
—Circuit Circus, Think Tank,
Computer Bits, DX Listening,
Antique Radio, Amateur Radio,
Scanner Scene.

ETI1

Practically Speaking

by Terry Balbirnie

This is the first in a monthly series about general workshop matters. Over the months ahead it will take various forms - sometimes we will look at repair jobs which the electronics hobbyist is asked to carry out and, at other times, health and safety aspects or the use of test instruments. Theory will be introduced where it helps, but the maths will be kept as light as possible. Occasionally, there will be a link with a constructional project in a future issue.

Although chiefly aimed at the electronics enthusiast, much of Practically Speaking will be useful to anyone interested in electronics, whether educationalists or those engaged in industry, while some of the theory will be of value to those preparing for examinations. We begin by looking at the workshop itself and we'll be pursuing this theme over the next two months.

Working Environment

Some readers will be lucky enough to have a real workshop - perhaps using a spare bedroom, garden shed or section of the garage. However, to many, the 'workshop' will be a table in the kitchen and a cupboard or set of drawers.

Having to do electronics in the living room is far from ideal.

Apart from the likelihood of distractions from the TV, wife and children, there is the necessity to clear everything away at the end of a session. Flashing lights and beeps from experimental circuits - not to mention the smell of soldering flux - are all likely to make you very unpopular.

Using a spare room is much better, but this will rarely be possible. If you do have one, it will be necessary to up-rate the lighting and make the power supply more accessible and safe. A stable work bench is essential

and for this it is better to use a sturdy old table or desk rather than modern furniture. An old sideboard with a heavy top surface and plenty of storage space underneath for test instruments, small tools, etc., is ideal.

Components may be stored in a set of small drawers, which can be bought in DIY stores. Components which are too large for the drawers can be stored in plastic lunch boxes. Plenty of shelving is useful for often-used test instruments, tools and reference books.

The workbench should be placed close to a wall socket. A

four-way extension board may then be used so that a soldering iron, power supply unit, test instruments, etc., can be used at the same time. Keep the lead itself as short as possible for safety.

It is essential to fit extension sockets with an RCD (residual current device). This greatly reduces the chances of receiving an electric shock. The easiest way is to use one which replaces a standard mains plug and the illustration shows the H72 PowerBreaker Safety RCD Plug - these are available from DIY stores. The fuse in the RCD plug, individual plugs and in the extension board should be of 3A rating, which should be adequate for experimental equipment.

Illumination can be improved by using a fluorescent light. The type which plugs directly into the ceiling fitting is a good idea because it can be instantly removed if the need arises. You will need to provide ventilation to remove soldering flux fumes or the smell will soon permeate the house. A soldering iron station with fume extraction facility will be beyond the means of most readers, but a cheaper alternative is to use the free-standing Solder Fume Captor from Light Soldering Developments. This mains-operated unit sucks fumes into a filter and removes the tarry deposits. It costs about £50 and the address of the company is given at the end of the page.

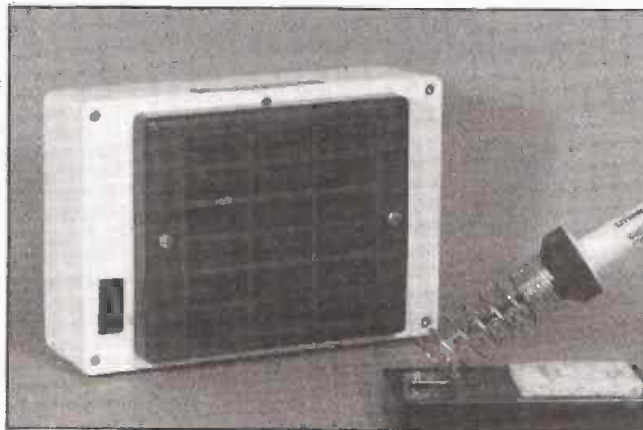

The Litesold Solder Fume Captor

Be sure to fit a smoke detector on the ceiling, but check that it can be heard around the house when the workshop door is closed. It will be triggered by such things as burning insulation if the soldering iron has been left switched on and in contact with a length of connecting wire.

Finally, but very importantly, there is the necessity to lock the door when the room is not in use. It could be disastrous for a child to play with equipment whether it be a soldering iron, high-voltage supply

unit or sharp tools. Even certain types of battery and low-voltage power pack can provide sufficient current to cause nasty burns, if short-circuited with a piece of wire.

That's all for this month. Next time we will look at using a shed or outbuilding as a workshop.

Light Soldering Developments
97-99 Gloucester Road
Croydon
CR0 2DN
Tel: 081 689 0574

Foils for this issue

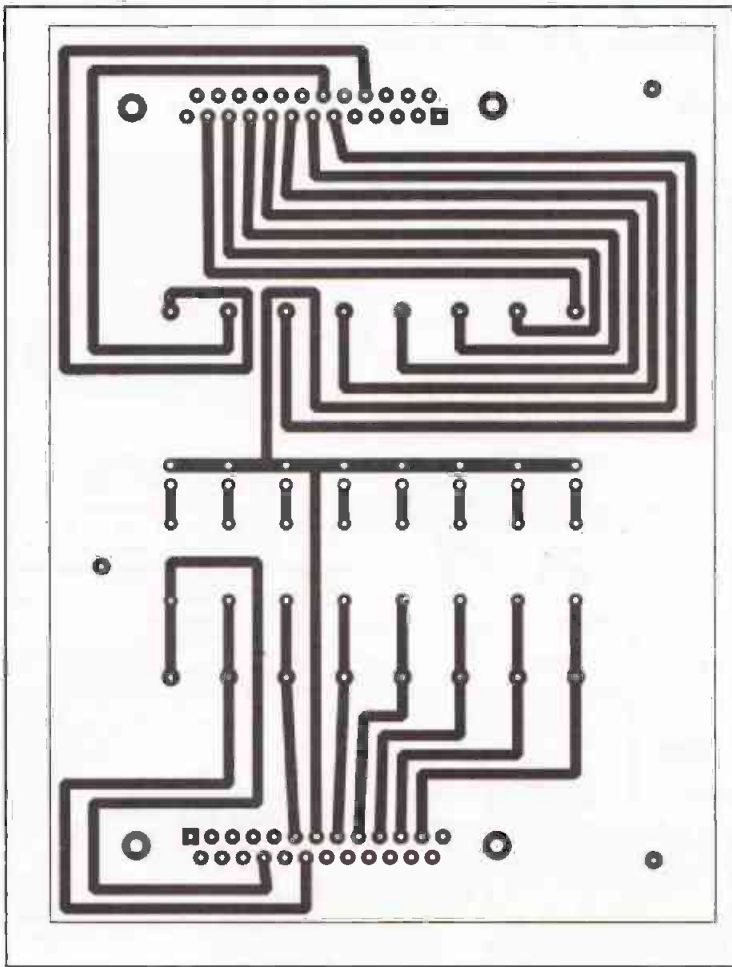

Breakout Box

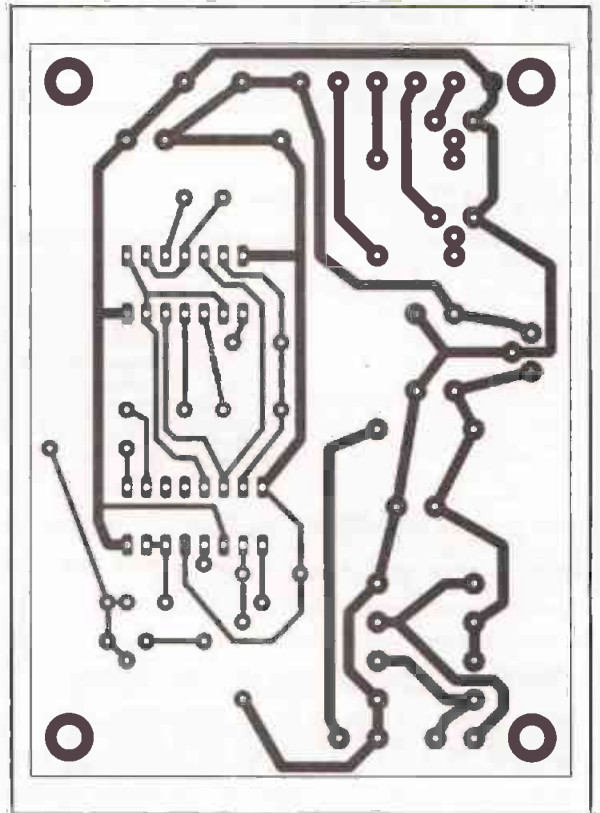

Killjoy

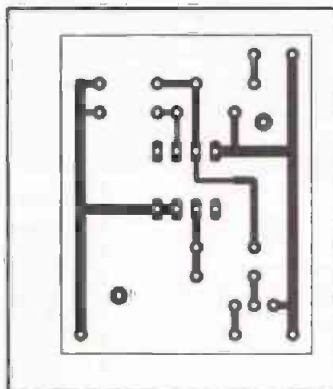

Loop Alarm

Corrected diagrams for JUNE issue:

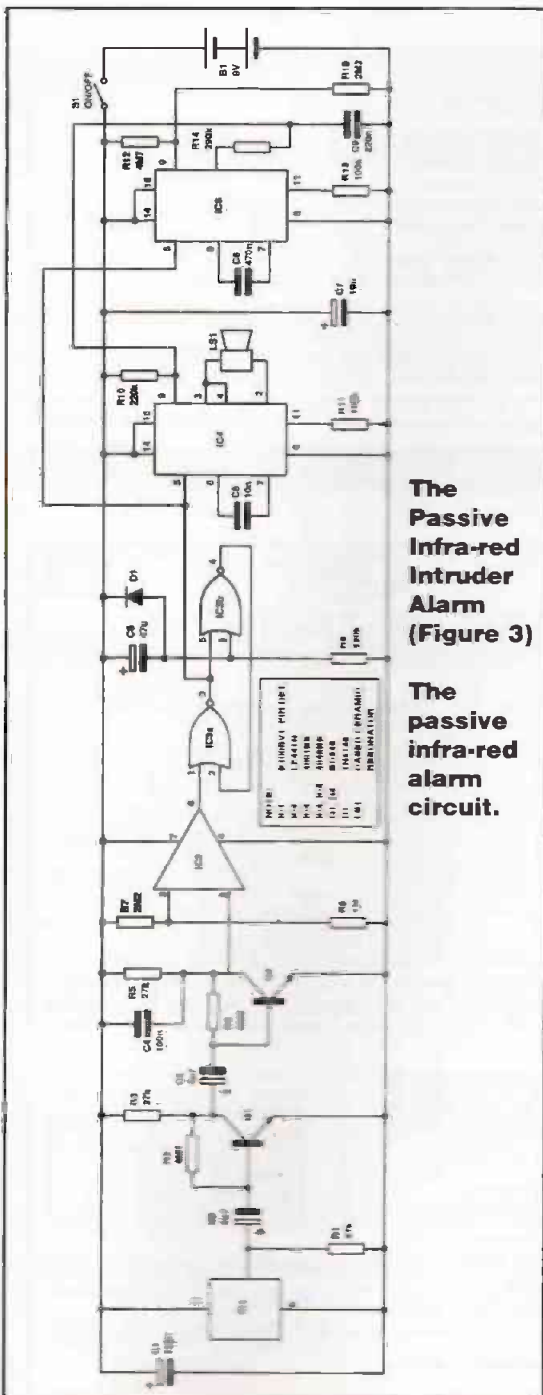

The Passive Infra-red Intruder Alarm (Figure 3)

The passive infra-red alarm circuit.

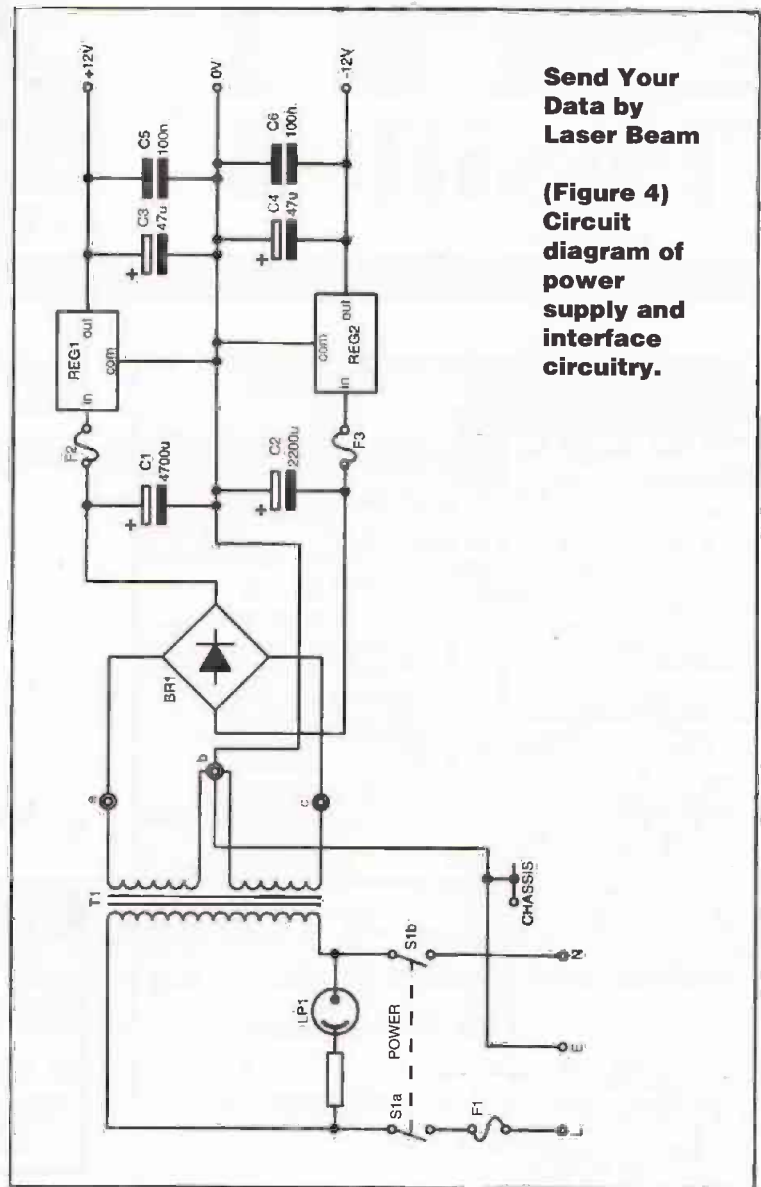

Send Your Data by Laser Beam

(Figure 4) Circuit diagram of power supply and interface circuitry.

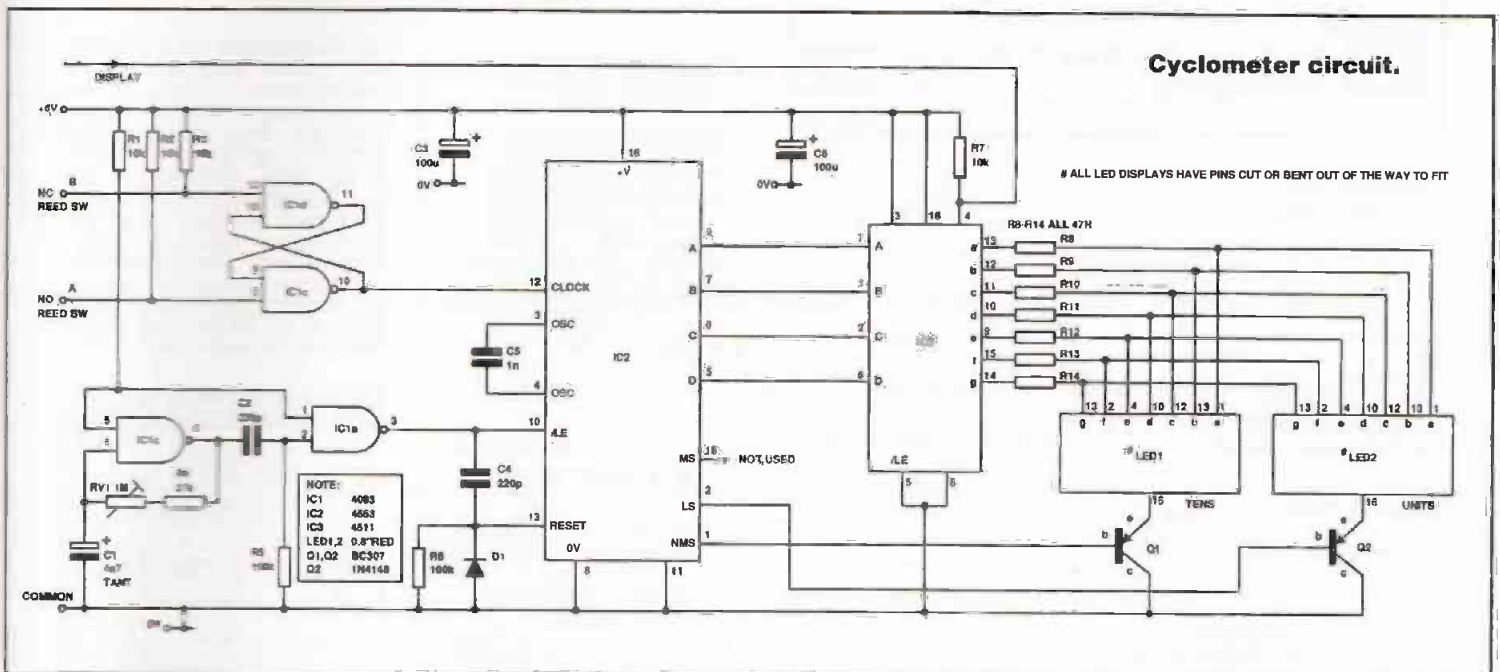

Cyclometer circuit.

Classified



James Gale
0442 66551

Send your requirements to:
ETI Classified Department, ASP, Argus House,
Boundary Way, Hemel Hempstead, HP2 7ST
Lineage: 65p per word (+ VAT) (minimum 15 words)
Semi display: (minimum 2.5cms)
£8.70 + VAT per single column centimetre



Ring for information on series bookings/discounts.
All advertisements in this section must be prepaid.
Advertisements are accepted subject to the terms and conditions
printed on the advertisement rate card (available on request).

FOR SALE

VARIABLE VOLTAGE TRANSFORMERS

INPUT 220/240V AC 50/60
OUTPUT 0-260V

	Price	P&P
0.5KVA 2.5 amp max	£31.90	£6.00
	£44.53 inc VAT	
1KVA 5 amp max	£41.15	£7.00
	£56.58 inc VAT	
2KVA 10 amp max	£59.40	£8.50
	£79.78 inc VAT	
3KVA 15 amp max	£78.66	£8.50
	£102.40 inc VAT	
5KVA 25 amp max	£139.15	
	(Plus Carriage)	

Buy direct from the Importers. Lowest prices in the country.
COMPREHENSIVE RANGE OF
TRANSFORMERS-LT-ISOLATION & AUTO
(110-240V Auto transfer, either cased with American socket and
mains lead or open frame type. Available for immediate delivery)

WIDE RANGE OF XENON FLASH TUBES

Write/Phone your enquiries

ULTRA VIOLET BLACK LIGHT

FLUORESCENT TUBES	(£14.10 inc VAT)
4ft 0 watt	£12.00 (callers only)
2ft 20 watt	£7.44 + £1.25 p&p
12in 8 watt	£4.80 + 75p p&p
9in 8 watt	£3.96 + 50p p&p
6in 4 watt	£3.96 + 50p p&p
	(£5.24 inc VAT)
	(£5.24 inc VAT)

230V AC BALLAST KIT

For either 6in, 9in or 12in tubes £6.05 + £1.40
p&p (£7.75 incl)

400 WATT UV LAMP

Only £34.00 - £2.50 p&p (£2.89 inc VAT)

160 WATT SELF BALLASTED BLACK LIGHT MERCURY BULB

Available with BC or ES fitting, price inc VAT
& p&p and VAT £26.66

12V D.C. BILGE PUMPS

500 GPH 15ft head 3 amp £19.98
1750 GPH 15ft head 9 amp £34.55
Also now available 24V D.C. 1750 GPH 15ft head
5 amp £36.55. All designed to be used
submerged. PRICES INCLUDE P&P & VAT

EPROM ERASURE KIT

Build your own EPROM ERASURE for a fraction of the price
of a made-up unit kit of parts less case includes
12in 8 watt 2537 Angstrom Tube Ballast unit, pair of bi-pin
leads, neon indicator, on/off switch, safety microswitch
and circuit £15.00-£2.00 p&p (£19.98 inc VAT)

SUPER HY-LIGHT STROBE KIT

Designed for Disco, Theatrical use etc.
Approx 16 joules Adjustable speed £60.00 + £3.00 p&p
(£62.28 inc VAT)

Case and reflector £24.00 + £3.00 p&p (£31.73 inc VAT)
SAE for further details including Hy-Light and industrial
Strobe Kits

SERVICE TRADING CO

57 BRIDGMAN ROAD, CHISWICK, LONDON W4 5BB

FAX 081 995 0549 081-995 1560

ACCOUNT CUSTOMERS MIN. ORDER £10

Showroom open
Monday/Friday



Ample
Parking Space

"BOFFINS SPECIAL" - UNIQUE OFFER

Surplus Precision Medical Unit. Internally in excellent
condition. Designed primarily to eject a precise
controllable amount of fluid from a medical syringe
(latter not supplied). Contains the following removable
components: Dual Micro Processor Boards and
EPROMS. Escap. Precision 12V DC Motor with
300:1 Gear Box and optical encoder coupled to a
precision threaded drive mechanism. Mains supply
with 6 x 1.5V Ni-Cad AA cells back-up L.C.D.
Digital read-out 17mm high with legends. Audible
warning.
These are sold for the dismantling of the exceptional
quality components right on Circuits available.
Radically low price: £20.00 + £4.00 p&p
(£28.20 inc VAT)

12V D.C. GEARED MOTOR

12V DC Reversible precision built Motor Output
speeds no load approx. 12V: 26 rpm; 9V: 20 rpm; 6V: 12
rpm. Will work at lower voltages and still retain a
reasonable torque. Ideal for robotics etc. Size: L
40mm W 29 mm H 33mm. Shaft: 3mm dia x 10mm
long. Price: £9.00 + 50p p&p (£10.00 inc VAT)

240V AC CENTRIFUGAL BLOWER

New Manuf. Surplus Skeleton Blower suitable for
mounting inside an enclosure to cool equipment. Overall
size 130x110x85mm Outer 80x35mm Impeller 60mm
dia x 60mm long. £14.10 incl. P&P & VAT

SEWING MACHINE MOTOR

Brand new 220/240V AC/DC SEW-TRIC 2 lead Brush
Motor. Size L 100mm x H 70mm x W 55mm. Spindle
1/4in. dia x 1in. long. £14.10 incl. P&P & VAT

GEARED MOTORS

71 RPM 20lb inch torque reversible 115V AC input
including capacitor and transformer for 240V AC
operation. Price inc VAT & p&p £23.60.

SOLID STATE EMT UNIT

Input 230/240V AC, Output approx 15KV.
Producing 10mm spark. Built-in 10 sec timer.
Easily modified for 20 sec, 30 sec to continuous.
Designed for boiler ignition. Dozens of uses in the
field of physics and electronics, eg. supplying neon
or argon tubes etc. Price less case £8.50 + £2.40
p&p (£12.81 inc VAT) NMS

SAVE POUNDS!!!

Build your own forged bank note detector. Can
detect counterfeit banknotes in a quantity of notes.
Complete kit of parts less case 240V a.c.
Including 5" uV black light tube, starter and
holder; a pair of 1" - pin tube holders. Total price
including p&p & VAT only £13.99

WASHING MACHINE WATER PUMP

Brand new 240V AC fan cooled. Can be used for a variety of
purposes (Inlet 1 1/2 in. outlet 1 in. dia. Price includes p&p &
VAT £11.20 each or 2 for £20.50 inclusive)

MICROSWITCH

Pye 15 amp changeover lever microswitch, type S171
Brand new price 5 for £7.05 inc VAT & p&p

SURPLUS COMPONENTS WANTED

- ★ COMPLETE CLEARANCE
- ★ BEST PRICES PAID
- ★ PCB BOARDS POPULATED

CONTACT
D.T.S. SERVICES
Tel: (0602) 208955
or Fax: (0602) 484530

1U HIGH 8255 compatible 24
relay or 24 opto cards £189.00.
Combination 241/0 £365.00.
Programmable interrupt
generator, PC plug-in, 1-999 uS/
mS. Sample code included
£249.00. Fettlegrave Ltd.
Telephone 0249 650839. Prices
include VAT and delivery.

LEN COOKE ENTERPRISES

For the best value in Used
Electronic Test Instruments

We buy, sell and repair Oscilloscopes,
Signal Generators, Frequency Counters,
Spectrum Analyzers, Power Meters,
Logic Testers etc.
Spare Parts available for most Tektronix
Scopes

Tel/Fax: 081 864 5551
Mobile: 0831 630820

Mail Order Address: 179 Northolt
Road, Harrow, Middx. HA2 0LY.

We engineer what we buy, we support
what we sell.

NICKEL CADMIUM Battery
Pack 24V 1.2AH Clansman
Range 20VR1.2 unused stores
price £49.95 incl. M. Prole, 48
Brendon Road, Watchet,
Somerset TA23 0HT.



COOKE INTERNATIONAL

SUPPLIER OF QUALITY USED TEST INSTRUMENTS

ANALYSERS, BRIDGES, CALIBRATORS, VOLTMETERS,
GENERATORS, OSCILLOSCOPES, POWER METERS, ETC
ALWAYS AVAILABLE

ORIGINAL SERVICE MANUALS FOR SALE
COPY SERVICE ALSO AVAILABLE

EXPORT, TRADE AND U.K. ENQUIRIES WELCOME
SEND LARGE S.A.E. FOR LISTS OF EQUIPMENT AND MANUALS
ALL PRICES EXCLUDE VAT AND CARRIAGE
DISCOUNT FOR BULK ORDERS SHIPPING ARRANGED

OPEN MONDAY TO FRIDAY 9AM - 5PM

COOKE INTERNATIONAL

ELECTRONIC TEST & MEASURING INSTRUMENTS

Unit Four, Fordingbridge Site, Main Road, Barnham, Bognor Regis,
West Sussex, PO22 0EB Tel (+44) 0243 545111/2 Fax (+44) 0243 542457

LIVERPOOL

PROGRESSIVE RADIO

87/93 Dale Street
Tel: 051 236 0982 051 236 0154

47 Whitechapel
Tel: 051 236 5489
Liverpool 2

'THE ELECTRONICS SPECIALISTS'

Open: Tues-Sat 9.30-5.30

TURN YOUR SURPLUS
TRANSISTORS, ICs ETC INTO
CASH immediate settlement.

We also welcome the
opportunity to quote for
complete factory clearance.

Contact:

COLES-HARDING & CO.

Unit 58, Queens Road, Wisbech,

Cambs PE13 7PQ

BUYERS OF SURPLUS INVENTORY

ESTABLISHED OVER 15 YEARS

Tel: 0945 584188

Fax: 0945 475216

EX CONCORDE PROTOTYPE
002 Flight Instrumentation
printed circuit modules. All the
same size but different
functions. Nice layouts. Size
approx 11 inches long by 3 1/2
inches wide. Connections via
rear 50 way D connector. Price
£9.95 each. Multiple orders will
be assorted where possible.
Please add £3.00 towards
postage and packing. Prices are
inclusive of VAT. Mayflower
Electronics, 48 Brendon Road,
Watchet, Somerset TA23 0HT.

SOFTWARE

SHAREWARE REFERENCE GUIDE

Find out what really is available in PD &
Shareware - ham radio, graphics, business,
scientific, electronics, maths, education, etc. You'll
find them all here, every thing you need in one
book. Thousands of the best PD & shareware
programs for DOS & Windows, described in
detail with the hardware requirements for each.
This is probably the most complete and up-to-
date shareware reference book available today.
For your copy, send £2.50 by cheque, PO, cash or
pay by Access/VISA to:
PDSL, Winscombe Hse, Beacon Rd.,
Crowborough, Sussex, TN6 1UL,
Tel 0892 663298 Fax 0892 667473

COMPELEC

1994 BARGAIN LIST
THE ELECTRONIC ESSENTIAL MILLIONS OF
COMPONENTS AT UNBEATABLE PRICES
FOR A FREE COPY PHONE, FAX OR WRITE
(TRADE ONLY)
COMPELEC,
14 CONSTABLE ROAD, ST IVES,
HUNTINGDON, CAMBS. PE17 6EQ
0480 300819

WE ALSO PURCHASE ALL TYPES OF
ELECTRONIC COMPONENTS, LISTS TO
ABOVE ADDRESS

FOR SALE

***MENDASCOPE**

REPAIR & RECALIBRATE
OSCILLOSCOPES
ALL MAKES AND MODELS
NATIONWIDE
COLLECTION & DELIVERY

FREE ESTIMATES

Llangollen, Clwyd, N. Wales LL20 7PB

PHONE: 0691 718597

COURSES

Start training now with the specialists for the following courses. Send for our brochure — without obligation or Telephone us on 0626 779398 ETI 3/94

Name _____

- Telecomms Tech C&G 2710
- Radio Amateur Licence C&G
- Micro-processor
- Introduction to Television

Radio & Telecommunications Correspondence School
12 Moor View Drive, Teignmouth, Devon TQ14 9UN

KITS

NEW VHS MICROTRANSMITTER KIT frequency 70-115MHz, 500 metre range, sensitive electret microphone, high quality PCB, SPECIAL OFFER complete kit ONLY £5.95 assembled and ready to use £9.95 inclusive P&P. 3 Watt FM transmitter kit £15.95. Credit card orders Telephone: 021 457 7254, Fax 021 457 9745. Cheques P.O.'s to: C.E.C. (Dept ETI), 1575 Bristol Road South, Birmingham B45 9TZ. Send 2 x 1st Class stamps for details of these and other kits.

HEATHKIT U.K. Spares and service centre / educational products distributor. Cedar Electronics, 12 Isbourne Way, Winchcombe, Cheltenham, GL5 5NS Tel: (0242) 602402.

SURVEILLANCE KITS

MTM MICRO TRANSMITTER, 25mm x 20mm including sensitive mic., tuneable 20-115MHz, 1000M range. Kit £4.95 Assembled £9.95.
MTM TELEPHONE TRANSMITTER 35mm x 10mm, powered 100m line, discreetly transmits all conversations 500M range, 50-100MHz. Kit £6.95 Assembled £11.95
All prices include 2 x 1st. Send 2x2nd class stamps for details. Cheques/P.O.'s payable to:
EXCELL PRODUCTS (Dept ETI)
Unit 14, Sunningdale,
Barnes, Uxbridge, Middlesex, UB8 3PA

PLANS

ELECTRONIC PLANS, laser designs, solar and wind generators, high voltage teslas, surveillance devices, pyrotechnics and computer graphics tablet. 150 projects. For catalogue. SAE to Plancentre Publications, Unit 7, Old Wharf Industrial Estate, Dymock Road, Ledbury, Herefordshire, HR8 2HS.

COMPONENTS

EPROM, PLDs + Microcontrollers copied or programmed. we supply devices/convert discrete logic to PLDs. PO Box 1561 Bath 0225 444467.

RACKS EQUIPMENT

19" RACK-MOUNT EQUIPMENT?

Frames, cabinets and flight cases for rack - and non-rack - equipment. A wide range of accessories available. For further information and brochure contact:

GROVESTREAM ENGINEERING SERVICES, 29 Silverdale Road, Tadley, Hants RG26 6JL. Tel/Fax: 0734 813395

CALL JAMES ON 0442 66551 TO ADVERTISE



ELECTRONICS TODAY INTERNATIONAL, CLASSIFIED ADVERTISEMENT DEPARTMENT, ARGUS HOUSE, BOUNDARY WAY, HEMEL HEMPSTEAD HP2 7ST

Rates: Lineage 65p per word + VAT minimum 15 words.
Semi-display £8.70 per single column cm plus VAT. No reimbursements for cancellations.
All ads must be pre-paid.

Name _____

Address _____

Daytime Tel. No: _____

Signature _____ Date _____

PLEASE DEBIT MY ACCESS/BARCLAYCARD No. []

Expiry Date _____

FOR SALE COMPONENTS PLANS OTHER - PLEASE STATE

Open Forum



about nine months, ago a friend of mine was made redundant. Now aged forty-three, he had worked for the same bank since he left university. He is one of about 100,000 people who have been made redundant in the UK banking industry, about a quarter of the industry's entire workforce.

In a middle management position and with a comfortable lifestyle, my friend now faces the fact that he is probably unemployable. The job he once thought would be a job for life is now just a memory, he has no alternative but to start all over again.

The reason that he and countless others in a whole range of different professions have lost their jobs is not just the recession in the UK, not just a turn down in world business. Although these factors have not helped, the truth is that most owe their unemployment to advances in technology.

The shake out of staff in the financial industries was inevitable, indeed I went on record predicting it nearly twenty years ago. Neither will it stop here as once the path to automation has begun it can not be easily stopped.

The same will happen to people with 'secure' jobs in the civil service, in retailing, in civil engineering and construction, in fact virtually every area of human activity with the exception of a handful of people in the creative professions, artists, writers and the designers of advanced technology.

All this points to the simple fact that advances in technology have eliminated the concept of the lifetime career, of the safe occupation which will carry one from the cradle to the grave. As observers like myself have said for years, people will have to learn to be flexible, to be prepared to change careers several times in their lives.

But one can only successfully do this if one is aware of what is happening around one, of the currents and eddies produced by the forward motion of that great engine of progress, technology. Despite what I had been telling him for years, my friend's redundancy came as a great shock to him. He and those around him had not seen, or chose to ignore, the creeping advance of the technology that was to take away their jobs.

Of course, some will take a crude Luddite view and insist that the progress of technology must be halted, or even reversed. Such views are futile and invariably self destructive. If society adopts such attitudes then it will inevitably hurl itself backwards into a bleak

and miserable third world existence.

If we want the benefits of technology, then we must learn to live with it. If we are to live with an ever changing technology then we must understand that technology and learn to chart its future development so that we, unlike my friend, are not caught unawares by some technology driven change.

In my opinion, this is one overwhelming reason for the importance of teaching science and technology in schools, and teaching it well. If we know something about science and technology then we are no longer afraid of, or in awe of, the products of science and technology - those products become our tools rather than our masters.

In this way we can, to a degree, control the course of technological development as it affects us and, at the very least, indulge in that rather pleasant game of predicting the future. If you have a keen observation and a good grounding in general technology then such prediction for the next ten, or even twenty, years is not hard and could protect you from many a nasty surprise.

We must all accept that the products of science and technology are so all pervasive that none of us can ignore them. This is despite the seeming protestations to the contrary of a former editor of the Times, Simon Jenkins, in a recent column in that paper discussing the merits or otherwise of the new national curriculum. He boldly states that 'there is nothing here that justifies the extraordinary status of maths and science' and continues 'there is no shred of evidence that Britain "needs" more mathematicians and scientists.' Sad comments indeed.

Even sadder was his conclusion - 'I believe that trying now to train a nation of mathematicians and scientists is like Thomas Arnold training a nation of clerks and clerics. The new curriculum seeks to push children out of school with a store of learning they are certain to forget and with precious little to prepare them for work or life.'

It is all right for Mr Jenkins, he is one of that small fortunate handful who are relatively immune to technological change. But for the rest of society, how wrong he is!

Science and technology is stimulating, exciting and creative. But like other stimulating, exciting and creative pursuits if you approach it with ignorance it can be dangerous and, when ignored, it can be dangerous, as my unemployed friend has found out to his cost.

now an important tool for archaeologists.

In next month's issue of ETI we will be continuing our PC Clinic series with a look at processor and co-processor chips, plus cache memory, the BIOS routines, POST codes and how to use them. For PC owners who want to know how fast their processor is running, there is a project to build a simple little display which shows the current turbo speed setting.

B: The main feature in the next issue will examine the technology behind and the future for global positioning systems. Systems which can accurately tell you where you are in the world to within a few metres.

Among the projects we will be running next month are a number of useful little devices - a car lights on tester, an angler's bite detector, a video light meter and, for the electronics workbench, a constant current transistor tester. We will also be continuing our series on an introduction to MIDI.

For the more experimentally inclined reader we will be looking at the design and construction of magnetometers, devices sufficiently sensitive to detect the change in the earth's magnetic field.



EDITORIAL

Editor *Nick Hampshire*

Sub Editor *Jim Bluck*

CREATIVE

Art Editor *Peter Kirby*

Technical Illustration *John Puczynski*

Photography *Manny Cefai*

ADVERTISEMENT SALES

Display Sales

Tony Hill

Advertisement Copy Control

Marie Quilter

Classified Sales

James Gale

MANAGEMENT

Managing Director

Terry Patisson

Circulation & Promotions Manager

Debra Stuppel

Production Manager

Tony Dowdeswell

Group Editor

Stuart Cooke

Group Advertisement Manager

Claire Jenkinson



ETI is normally published on the first Friday in the month preceding the cover date. The contents of this publication including all articles, plans, drawings and programs and all copyright and all other intellectual property rights therein belong to Argus Specialist Publications. All rights conferred by the Law of Copyright and other intellectual property rights and by virtue of international copyright conventions are specifically reserved to Argus Specialist Publications and reproduction requires the prior written consent of the company ©1990 Argus Specialist Publications. All reasonable care is taken in the preparation of the magazine contents, but the publishers cannot be held legally responsible for errors. Where mistakes do occur, a correction will normally be published as soon as possible afterwards. All prices and data contained in advertisements are accepted by us in good faith as correct at the time of going to press. Neither the advertisers nor the publishers can be held responsible, however, for any variations affecting price or availability which may occur after the publication has closed for press.

Subscription rates - UK £25.80 Europe & Eire £32.70 Sterling Overseas £33.90 US Dollars Overseas \$58.00

Published by Argus Specialist Publications, Argus House, Boundary Way, Hemel Hempstead HP2 7ST. Telephone (0442) 66551. UK newstrade distribution by SM Distribution Ltd, 6 Leigham Court Road, London SW16 2PG. Telephone 081-667 8111. Overseas and non-newstrade sales by Magazine Sales Department, Argus House, Boundary Way, Hemel Hempstead, HP2 7ST. Telephone (0442) 66551. Subscriptions by Argus Subscription Services, ETI, Queensway House, 2 Queensway, Redhill, Surrey RH1 1QS. Telephone (0737) 789611. US subscriptions by Wise Owl Worldwide Publications, 4314 West 238th Street, Torrance, CA90505 USA. For Visa/Mastercard orders in USA - Telephone (310) 376 6258 Fax (310) 375 0548. Pacific Time: 9am-5pm Weekdays. 10am-6pm Weekends. Typesetting and origination by Ebony, Liskeard, Cornwall. Printed by Wiltshire Ltd, Bristol.



Argus House, Boundary Way,
Hemel Hempstead HP2 7ST
Telephone (0442) 66551
Fax (0442) 66998

SURVEILLANCE SURVEILLANCE

A SMALL SAMPLE OF OUR RANGE	KIT	MODULE	PROF FINISHED
ROOM TRANSMITTER RT1 An extremely sensitive miniature transmitter with long battery life. Dimensions: 20 x 20mm	9.95	13.75	19.00
MAINS TRANSMITTER MT4 Can be connected inside any equipment that is mains powered. Dimensions: 35 x 20mm	19.75	31.50	45.00
TELEPHONE TRANSMITTER TTS Small enough to conceal within a telephone. Will transmit both sides of a conversation (series connection). Dimensions: 10 x 20mm	12.75	17.50	25.00
TELEPHONE SOCKET TRANSMITTER TSTS Replace your telephone socket with this one within which a transmitter has been concealed.	14.74	-	29.00
ROOM AND TELEPHONE TRANSMITTER RTT Operates as a room transmitter, then switches to telephone transmitter mode during telephone calls. Dimensions: 30 x 25mm	31.50	45.50	65.00
AUTOMATIC TELEPHONE RECORDER SWITCH TRS2 Record telephone conversations with this interface unit and your own tape recorder. Dimensions: 36 x 50mm	16.80	25.90	39.00
AUTOMATIC TELEPHONE RECORDER ATR1 Adapt the tape recorder included to record telephone calls automatically	34.95	-	59.00
TELEPHONE TAP ALERT TTA1 Visual warning of any invasions of privacy on your telephone line. Dimensions: 38 x 52mm	21.95	31.50	45.00
RF DETECTOR RFD1 Highly sensitive hand-held detector. Range between 10Mhz and 600Mhz. Silent operation. Dimensions: 70 x 50mm	42.75	69.00	95.00
CAMERA DETECTOR CD8 Detects hidden video cameras (even miniature CCD models). Dimensions: 63 x 38mm	69.00	89.00	125.00
RECORDING BRIEFCASE RBC1 Completely discreet recordings at a value for money price.	-	-	145.00
SHOTGUN MICROPHONE AMPLIFIER SMA Ideal for surveillance. The amplifier will pick up sounds from a long distance.	24.95	36.00	45.00
SIGNALLING TRANSMITTER SIGT Sends a continual audio pulse. Can be integrated into alarm, tracking or warning systems. Dimensions: 29 x 50mm	21.95	34.89	45.00
TELEPHONE AMPLIFIER TA5 Connected directly to the telephone, this unit will amplify both sides of a telephone call. Dimensions: 25 x 25mm	10.95	16.95	19.95
PROFESSIONAL SOUND TO LIGHT SK72 Custom built for disco or home use. Audio signal divided into bass, mid and treble bands, with internal microphone and spotlight option. Dimensions: 210 x 45mm	21.95	32.49	44.95
MICRO METAL DETECTOR MMD Detect the presence of ferrous and various non-ferrous metals. Useful for all those DIY jobs. Dimensions: 40 x 25mm	9.95	16.95	-

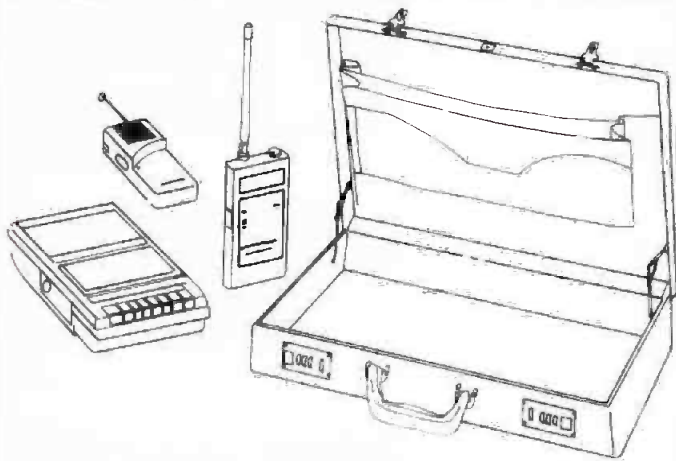

Please add £2.00 P & P to all orders and 17.5% VAT on all U.K. orders.

For full catalogue please send two 1st class stamps or 2 IRC'S

172 Caledonian Road
Dept ET

CANAL

London N1 0SG

BRIDGE AUDIO

071-837 4423



ETI Directory Database

FREE! 48 PAGE SALE

SUPER SENSATIONAL SUMMER SALE

BUDGET CD COMPANY

32 PAGE BUDGET CD & TAPE BROCHURE

Ring, Write or Fax for your copy NOW!

GREENWELD

27A Park Road
SOUTHAMPTON SO15 3UQ

Tel: (0703) 236363; Fax: (0703) 236307

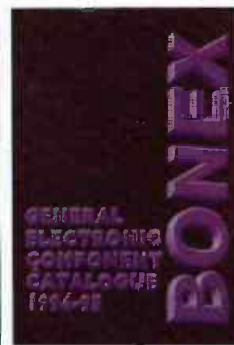

The new Bonex Components Catalogue is now available. Consisting of 84 A4 pages with over 500 photographic illustrations. At a price of £1.95 inc p+p. To obtain your copy, please send a cheque or your credit card details to:

**BONEX LTD, 12 ELDER WAY,
LANGLEY BUSINESS PARK,
SLOUGH, BERKSHIRE SL3 6EP**
Tel: 0753 549502
Fax: 0753 543812

THE NEW ENLARGED CIRKIT SUMMER 1994 CATALOGUE INCLUDES:

- A further 16 extra pages
- £200 worth discount vouchers
- 100's new products
- 256 pages, 26 section, over 4000 products from some of the worlds finest manufacturers and suppliers
- Expanded entertainment section with in-car amps, speakers, crossovers and low cost disco equipment
- Further additions from Europe's leading kit manufacture - Velleman

AVAILABLE FROM MOST LARGE NEWSAGENTS OR DIRECT FROM CIRKITS AT £1.90 + 30p P+P

Cirkit Distribution Ltd

Park Lane, Broxbourne, Herts EN10 7NQ
Tel: (0992) 448899 Fax: (0992) 471314



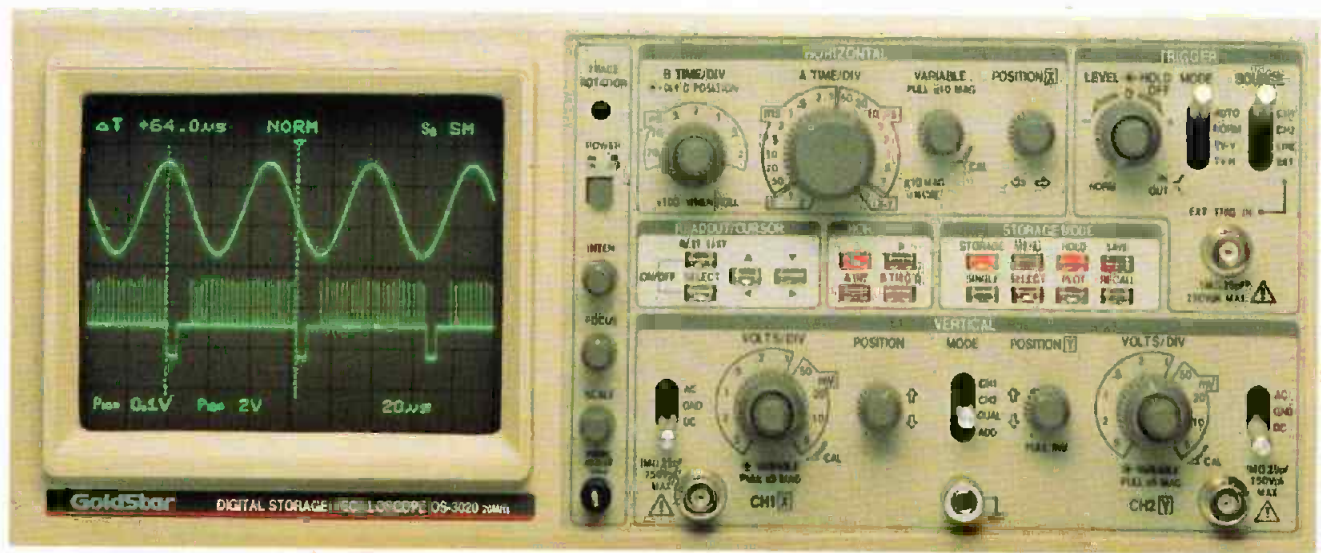

Model OS-3020 illustrated above

Star Quality, Reliability, and World Class Performance

from only **£269.95**

NEW Maplin Electronics are pleased to announce their superb new range of precision, laboratory grade Oscilloscopes from Goldstar.

NEW The range starts with the super value-for-money, 20MHz Dual-trace Oscilloscope, OS-9020A. Features include a large 6in., high luminance CRT with internal 8 x 10cm graticule, TV field or line triggering and X-Y mode producing Lissajous patterns for phase shift measurements.

NEW For higher frequency applications, the 40MHz Dual-trace Oscilloscope, OS-9040D, is ideal for TV and video signals and a trigger delay facility allows observation of fast leading edges.

NEW For RF signals and high-speed logic applications, the highly specified 100MHz triple-trace Oscilloscope, OS-9100D, has 3 independent input channels and is ideal for simultaneous display of 3 logic pulse trains for timing comparison.

NEW The dual-trace, 40MHz Oscilloscope, OS-904RD, is similar in specification to OS-9040D, but with the additional facility of a digital readout on the CRT. The readout displays information such as timebase and attenuator settings, and on-screen measurements can be performed using movable cursors, the value appearing on the CRT screen.

NEW Top-of-the-range is the excellent 20MHz Digital Storage Oscilloscope, OS-3020, with on-screen digital readout and measurement facilities. The digital storage function enables one-off events to be captured and stored for detailed analysis. Stored waveforms can be printed out on a suitable X-Y plotter via the built-in RS232 interface. Repetitive high-speed waveforms up to 20MHz can be digitised using equivalent sampling techniques and pre-trigger mode allows events occurring before the triggering point to be captured.

All models are supplied complete with probes, mains lead, spare fuses and detailed operating manual. Full details and specifications can be found in the 1994 **Maplin Full Colour Catalogue**, available from **WHSMITH** and selected branches of **RSMcColl** in Scotland for £2.95 (£3.45 by post direct from Maplin). To order, Phone the Credit Card Hotline, 0702 554161, or send your Mail Order to P.O. Box 3, Rayleigh, S86 2BR, or visit your local Maplin store. Please note latest models all now cream in colour as Model OS-3020.

Maplin ELECTRONICS. UK AGENTS FOR **GoldStar**

Visit our stores in: Birmingham, Brighton, Bristol, Cardiff, Chatham, Coventry, Dudley, Edinburgh, Glasgow, Ilford, Leeds, Leicester, London (Edgware, Forest Hill and Hammersmith), Manchester (Oxford Road and Cheetham Hill), Middlesbrough, Newcastle-upon-Tyne (The Metro Centre, Gateshead), Nottingham, Portsmouth, Reading, Sheffield, Slough, Southampton, Southend-on-Sea, Stockport, Milton Keynes plus new stores opening soon. Phone 0702 552911 for further details.

All items subject to availability, prices include VAT and are subject to change. Carriage charge per order £5.70, Handling charge £1.40 per order. Overseas customers please phone 0702 552911.



OS-9020A GW03D £269.95

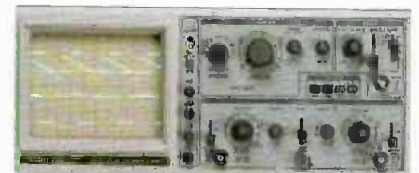

OS-9040D GW04E £399.95

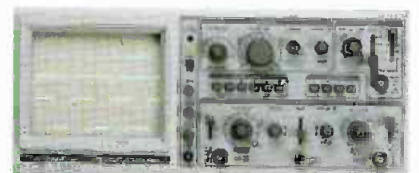

OS-904RD GW06G £499.95

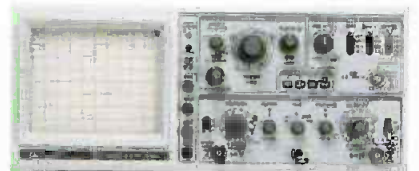

OS-9100D GW05F £699.95



OS-3020 GW07H £749.95

GoldStar
Technology with the human touch