

45W DIRECTLY COUPLED TRANSISTOR/ VALVE AMP

**INTERCOM
FOR LIGHT
AIRCRAFT**

**Build this Hybrid
Power Amplifier**

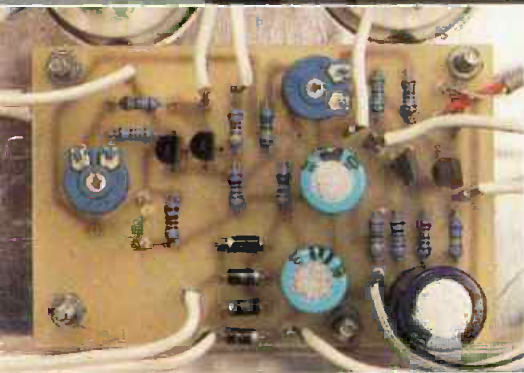

using our cover PCB

Please tell
your retailer if
the PCB
is missing

**ALARM
PROTECTOR UNIT**

**TECHNOLOGY AND
THE ENVIRONMENT**

**REMOTE CONTROLLED
WINDOW OPENER**

**TEMPERATURE
CONTROLLER**



OMP MOS-FET POWER AMPLIFIERS
HIGH POWER. TWO CHANNEL. 19 INCH RACK

THOUSANDS PURCHASED BY PROFESSIONAL USERS



THE RENOWNED MXF SERIES OF POWER AMPLIFIERS
FOUR MODELS:- MXF200 (100W + 100W) MXF400 (200W + 200W)
MXF600 (300W + 300W) MXF900 (450W + 450W)
ALL POWER RATINGS R.M.S. INTO 4 OHMS, BOTH CHANNELS DRIVEN

FEATURES: ★ Independent power supplies with two toroidal transformers ★ Twin LED Vu meters ★ Level controls ★ Illuminated on/off switch ★ XLR connectors ★ Standard 775mV inputs ★ Open and short circuit proof ★ Latest Mos-Fets for stress free power delivery into virtually any load ★ High slew rate ★ Very low distortion ★ Aluminium cases ★ MXF600 & MXF900 fan cooled with D.C. loudspeaker and thermal protection.

USED THE WORLD OVER IN CLUBS, PUBS, CINEMAS, DISCOS ETC.

SIZES:- MXF200 W19" x H3 1/2" (2U) x D11"
MXF400 W19" x H5 1/4" (3U) x D12"
MXF600 W19" x H5 1/4" (3U) x D13"
MXF900 W19" x H5 1/4" (3U) x D14 3/4"



PRICES:- MXF200 £175.00 MXF400 £233.85
MXF600 £329.00 MXF900 £449.15
SPECIALIST CARRIER DEL. £12.50 EACH

OMP VARISPEED TURNTABLE CHASSIS



★ Manual arm ★ Steel chassis ★ Electronic speed control 33 & 45 R.P.M. ★ Vari pitch control ★ High torque servo driven DC motor ★ Transit screws ★ 12" die cast platter ★ Neon strobe ★ Calibrated balance weight ★ Removable head shell ★ 1/2" cartridge fixings ★ Cue lever ★ 220/240V 50/60Hz ★ 390x305mm ★ Supplied with mounting cut-out template.

PRICE £61.30 + £3.70 P&P

OPTIONAL MAGNETIC CARTRIDGES

STANTON AL500mkII GOLDRING G950
PRICE £16.95 + 50P P&P PRICE £7.15 + 50P P&P

STEREO DISCO MIXER DJ6500

STEREO DISCO MIXER with 2 x 7 band L & R graphic equalisers with bar graph LED Vu meters. MANY OUTSTANDING FEATURES:- including Echo with repeat & speed control, DJ Mic with tone control & talk-over switch, 7 Channels with individual faders plus cross fade, Cue Headphone Monitor. Useful combination of the following inputs:- 3 turntables (mag), 3 mics, 5 Line for CD, Tape, Video etc.



★ WITH ECHO ★

Price £134.99 + £5.00 P&P

SIZE: 482 x 240 x 120mm

PIEZO ELECTRIC TWEETERS - MOTOROLA

Join the Piezo revolution! The low dynamic mass (no voice coil) of a Piezo tweeter produces an improved transient response with a lower distortion level than ordinary dynamic tweeters. As a crossover is not required these units can be added to existing speaker systems of up to 100 watts (more if two are put in series). FREE EXPLANATORY LEAFLETS ARE SUPPLIED WITH EACH TWEETER.

TYPE 'A' (KSN1036A) 3" round with protective wire mesh. Ideal for bookshelf and medium sized Hi-Fi speakers. Price £4.90 + 50p P&P.
TYPE 'B' (KSN1005A) 3 1/2" super horn for general purpose speakers, disco and P.A. systems etc. Price £5.99 + 50p P&P.
TYPE 'C' (KSN1016A) 2" x 5" wide dispersion horn for quality Hi-Fi systems and quality discos etc. Price £6.99 + 50p P&P.
TYPE 'D' (KSN1025A) 2" x 6" wide dispersion horn. Upper frequency response retained extending down to mid-range (2KHz). Suitable for high quality Hi-Fi systems and quality discos. Price £9.99 + 50p P&P.
TYPE 'E' (KSN1038A) 3 3/4" horn tweeter with attractive silver finish trim. Suitable for Hi-Fi monitor systems etc. Price £5.99 + 50p P&P.
LEVEL CONTROL Combines, on a recessed mounting plate, level control and cabinet input jack socket. 85x85mm. Price £4.10 + 50p P&P.

OMP LINNET LOUDSPEAKERS

THE VERY BEST IN QUALITY AND VALUE

Made especially to suit today's need for compactness with high output sound levels, finished in hard wearing black vinylite with protective corners, grille and carrying handle. Each unit incorporates a 12" driver plus high frequency horn for a full frequency range of 45Hz-20KHz. Both models are 8 Ohm impedance. Size: H20" x W15" x D12".



CHOICE OF TWO MODELS

POWER RATINGS QUOTED IN WATTS RMS FOR EACH CABINET

OMP 12-100WATTS (100dB) PRICE £163.50 PER PAIR
OMP 12-200WATTS (200dB) PRICE £214.55 PER PAIR

SPECIALIST CARRIER DEL. £12.50 PER PAIR

IN-CAR STEREO BOOSTER AMPS



THREE SUPERB HIGH POWER CAR STEREO BOOSTER AMPLIFIERS

150 WATTS (75 + 75) Stereo, 150W Bridged Mono
250 WATTS (125 + 125) Stereo, 250W Bridged Mono
400 WATTS (200 + 200) Stereo, 400W Bridged Mono
ALL POWERS INTO 4 OHMS

Features:
★ Stereo, bridged mono ★ Choice of high & low level inputs ★ L & R level controls ★ Remote on-off ★ Speaker & thermal protection

PRICES: 150W £49.99 250W £99.99
400W £109.95 P&P £2.00 EACH

OMP MOS-FET POWER AMPLIFIER MODULES SUPPLIED READY BUILT AND TESTED.

These modules now enjoy a world-wide reputation for quality, reliability and performance at a realistic price. Four models are available to suit the needs of the professional and hobby market (i.e. industry, Leisure, Instrumental and Hi-Fi etc). When comparing prices, NOTE that all models include toroidal power supply, integral heat sink, glass fibre P.C.B. and drive circuits to power a compatible Vu meter. All models are open and short circuit proof.

THOUSANDS OF MODULES PURCHASED BY PROFESSIONAL USERS



OMP/MF 100 Mos-Fet Output power 110 watts R.M.S. into 4 ohms, frequency response 1Hz - 100KHz -3dB, Damping Factor >300, Slew Rate 45V/uS, T.H.D. typical 0.002%, Input Sensitivity 500mV, S.N.R. -110 dB. Size 300 x 123 x 60mm.
PRICE £40.85 - £3.50 P&P



OMP/MF 200 Mos-Fet Output power 200 watts R.M.S. into 4 ohms, frequency response 1Hz - 100KHz -3dB, Damping Factor >300, Slew Rate 50V/uS, T.H.D. typical 0.001%, Input Sensitivity 500mV, S.N.R. -110 dB, Size 300 x 155 x 100mm.
PRICE £64.35 - £4.00 P&P



OMP/MF 300 Mos-Fet Output power 300 watts R.M.S. into 4 ohms, frequency response 1Hz - 100KHz -3dB, Damping Factor >300, Slew Rate 60V/uS, T.H.D. typical 0.001%, Input Sensitivity 500mV, S.N.R. -110 dB, Size 330 x 175 x 100mm.
PRICE £81.75 - £5.00 P&P



OMP/MF 450 Mos-Fet Output power 450 watts R.M.S. into 4 ohms, frequency response 1Hz - 100KHz -3dB, Damping Factor >300, Slew Rate 75V/uS, T.H.D. typical 0.001%, Input Sensitivity 500mV, S.N.R. -110 dB, Fan Cooled, D.C. Loudspeaker Protection, 2 Second Anti-Thump Delay, Size 355 x 210 x 105mm.
PRICE £132.85 - £5.00 P&P

NOTE: MOS-FET MODULES ARE AVAILABLE IN TWO VERSIONS: STANDARD - INPUT SENS 500mV, BAND WIDTH 100KHz. PEC (PROFESSIONAL EQUIPMENT COMPATIBLE) - INPUT SENS 775mV, BAND WIDTH 50KHz. ORDER STANDARD OR PEC.



Vu METER Compatible with our four amplifiers detailed above. A very accurate visual display employing 11 L.E.D.s (7 green, 4 red) plus an additional on/off indicator. Sophisticated logic control for very fast rise and decay times. Tough moulded plastic case, with acrylic tinted front. Size 34 x 27 x 45mm.
PRICE £8.70 + 50p P&P

LOUDSPEAKERS

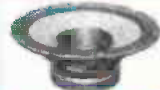

LARGE SELECTION OF SPECIALIST LOUDSPEAKERS AVAILABLE, INCLUDING CABINET FITTINGS, SPEAKER GRILLES, CROSS-OVERS AND HIGH POWER, HIGH FREQUENCY BULLETS AND HORNS. LARGE (A4) S.A.E. (50p STAMPED) FOR COMPLETE LIST.

P - From McKenzie Professional Series
S - From McKenzie Studio Series

MCKENZIE - INSTRUMENTS, P.A., DISCO, ETC

- ALL MCKENZIE UNITS 8 OHMS IMPEDANCE**
- 8" 100 WATT P.C.B.-100GP GEN. PURPOSE, LEAD GUITAR, EXCELLENT M.C. DISCO. PRICE £31.45 - £2.00 P&P
 - RES. FREQ. 80Hz, FREQ. RESP. TO 7KHz, SENS 96dB
 - 10" 100WATT S.C10-100GP GUITAR, VOICE, KEYBOARD DISCO, EXCELLENT M.C. PRICE £32.25 - £2.50 P&P
 - RES. FREQ. 72Hz, FREQ. RESP. TO 6KHz, SENS 97dB
 - 10" 200WATT S.C10-200GP GUITAR, KEYB'D, DISCO, EXCELLENT HIGH POWER M.C. PRICE £33.21 - £2.50 P&P
 - RES. FREQ. 69Hz, FREQ. RESP. TO 5KHz, SENS 97dB
 - 12" 100WATT P.C12-100GP HIGH POWER GEN. PURPOSE LEAD GUITAR, DISCO. PRICE £46.35 - £3.50 P&P
 - RES. FREQ. 49Hz, FREQ. RESP. TO 7KHz, SENS 98dB
 - 12" 100WATT P.C12-100TC (TWIN CONE) HIGH POWER WIDE RESPONSE P.A. VOICE DISCO. PRICE £41.25 - £3.50 P&P
 - RES. FREQ. 45Hz, FREQ. RESP. TO 12KHz, SENS 97dB
 - 12" 200WATT S.C12-200B HIGH POWER BASS, KEYBOARDS, DISCO, P.A. PRICE £71.31 - £3.50 P&P
 - RES. FREQ. 45Hz, FREQ. RESP. TO 5KHz, SENS 99dB
 - 12" 300WATT S.C12-300GP HIGH POWER BASS, LEAD GUITAR, KEYBOARDS, DISCO, ETC. PRICE £55.66 - £3.50 P&P
 - RES. FREQ. 49Hz, FREQ. RESP. TO 7KHz, SENS 100dB
 - 15" 100WATT P.C15-100BS BASS GUITAR, LOW FREQUENCY P.A. DISCO. PRICE £55.05 - £4.00 P&P
 - RES. FREQ. 40Hz, FREQ. RESP. TO 5KHz, SENS 98dB
 - 15" 200WATT P.C15-200BS VERY HIGH POWER BASS. PRICE £50.57 - £4.00 P&P
 - RES. FREQ. 40Hz, FREQ. RESP. TO 3KHz, SENS 98dB
 - 15" 250WATT S.C15-250BS VERY HIGH POWER BASS. PRICE £30.23 - £4.50 P&P
 - RES. FREQ. 39Hz, FREQ. RESP. TO 4KHz, SENS 99dB
 - 15" 400WATT S.C15-400BS VERY HIGH POWER, LOW FREQUENCY BASS. PRICE £125.46 - £4.50 P&P
 - RES. FREQ. 40Hz, FREQ. RESP. TO 4KHz, SENS 100dB
 - 18" 500WATT S.C18-500BS EXTREMELY HIGH POWER, LOW FREQUENCY BASS. PRICE £174.57 - £5.00 P&P
 - RES. FREQ. 27Hz, FREQ. RESP. TO 2KHz, SENS. 98dB

EARBENDERS:- HI-FI, STUDIO, IN-CAR, ETC

- ALL EARBENDER UNITS 8 OHMS (Except EB8-50 & EB10-50 which are dual impedance models: 4 & 8 Ohms)**
- BASS, SINGLE CONE, HIGH COMPLIANCE, ROLLED SURROUND**
 - 8" 50watt EB8-50 DUAL IMPEDANCE, TAPPED 4/8 OHM BASS, HI-FI, IN-CAR. PRICE £6.90 - £2.00 P&P
 - RES. FREQ. 40Hz, FREQ. RESP. TO 7KHz SENS 97dB
 - 10" 50watt EB10-50 DUAL IMPEDANCE, TAPPED 4/8 OHM BASS, HI-FI, IN-CAR. PRICE £13.65 - £2.50 P&P
 - RES. FREQ. 40Hz, FREQ. RESP. TO 5KHz, SENS. 99dB
 - 10" 100WATT EB10-100 BASS, HI-FI, STUDIO. PRICE £30.39 - £3.50 P&P
 - RES. FREQ. 35Hz, FREQ. RESP. TO 3KHz, SENS 96dB
 - 12" 100WATT EB12-100 BASS, STUDIO, HI-FI, EXCELLENT DISCO. PRICE £42.12 - £3.50 P&P
 - RES. FREQ. 26Hz, FREQ. RESP. TO 3KHz, SENS 93dB
 - FULL RANGE TWIN CONE, HIGH COMPLIANCE, ROLLED SURROUND**
 - 5 1/4" 60WATT EB5-60TC (TWIN CONE) HI-FI, MULTI-ARRAY DISCO ETC. PRICE £9.99 - £1.50 P&P
 - RES. FREQ. 63Hz, FREQ. RESP. TO 20KHz, SENS 92dB
 - 6 1/2" 60WATT EB6-60TC (TWIN CONE) HI-FI, MULTI-ARRAY DISCO ETC. PRICE £10.99 - 1.50 P&P
 - RES. FREQ. 38Hz, FREQ. RESP. TO 20KHz, SENS 94dB
 - 8" 60WATT EB8-60TC (TWIN CONE) HI-FI, MULTI-ARRAY DISCO ETC. PRICE £12.99 - £1.50 P&P
 - RES. FREQ. 40Hz, FREQ. RESP. TO 18KHz, SENS 89dB
 - 10" 60WATT EB10-60TC (TWIN CONE) HI-FI, MULTI ARRAY DISCO ETC. PRICE £16.49 - £2.00 P&P
 - RES. FREQ. 35Hz, FREQ. RESP. TO 12KHz, SENS 98dB.

TRANSMITTER HOBBY KITS

PROVEN TRANSMITTER DESIGNS INCLUDING GLASS FIBRE PRINTED CIRCUIT BOARD AND HIGH QUALITY COMPONENTS COMPLETE WITH CIRCUIT AND INSTRUCTIONS

3W TRANSMITTER 80-108MHz, VARICAP CONTROLLED PROFESSIONAL PERFORMANCE, RANGE UP TO 3 MILES, SIZE 38 x 123mm, SUPPLY 12V @ 0.5AMP
PRICE £14.85 - £1.00 P&P

FM MICRO TRANSMITTER 100-108MHz, VARICAP TUNED, COMPLETE WITH VERY SENS FET MIC, RANGE 100-300m, SIZE 56 x 46mm, SUPPLY 9V BATTERY.
PRICE £8.80 + £1.00 P&P



PHOTO: 3W FM TRANSMITTER

B.K. ELECTRONICS

UNITS 1 & 5 COMET WAY, SOUTHEND-ON-SEA, ESSEX, S52 6TR.

Tel.: 0702 - 627572 Fax: 0702 - 420243

POSTAL CHARGES PER ORDER £1.00 MINIMUM. OFFICIAL ORDERS FROM SCHOOLS, COLLEGES, GOVT. BODIES, PLCs ETC. PRICES INCLUSIVE OF V.A.T. SALES COUNTER, VISA AND ACCESS ACCEPTED BY POST, PHONE OR FAX.

Features & Projects

Intercom for Light Aircraft

If communicating within noisy environments is a problem, why not try to build this intercom. Glen Pitt-Pladdy has the details.

13

Why Waveguides

A P Stephenson outlines that higher frequency currents just have to be guided to stop them going astray.

20

45W Hybrid Valve/Transistor Power Amp

Jeff Macaulay provides a description of his directly coupled hi-fi amplifier.

26

Coping With A Paradox

Douglas Clarkson takes a global view of the way in which social, environmental and technological trends could be taking us.

32

Alarm Protector Unit

Dave Bradshaw makes sure that thieves have great difficulty disconnecting your alarm.

36

Digital TV 4

The latest developments in the digital world of TV. James Archer reports.

40

Window Opener

Ever wanted fresh air at night without getting out of bed? Then have a go at constructing this electromechanical arm using Terry Pinnell's ideas.

49

Temperature Controller

This controller can give you a closer indication of the required set temperature within a room in the house. Edward Barrow explains.

54

AutoMate Part 6

A description of op-amps takes a front seat in this issue. Mike Meechan explains.

60



**Volume 21 No.9
Sept 1992**

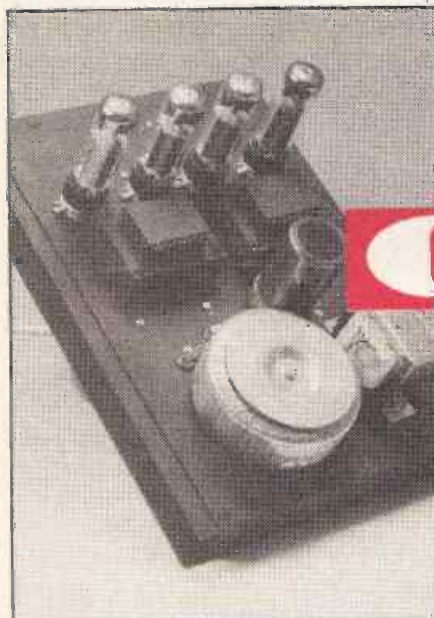

Page 26

Contents

Regulars

Open Channel	4
News	5
News Stateside	9
Read/Write	10
PCB Foils	77
Photocopy Service	18

Editorial

by Paul Freeman

Thanks for your comments regarding our restyling. We thought the cover PCB would be attractive to readers as it is still a major stumbling block for some. If only we could do it for all the projects! Rest assured ETI will come up with a variety of combinations in the way we present the board to give you as much as you can easily do at home.

Criticality

The boys in electronics R & D will often take years to produce reliable working systems. I include in this software development, now almost standard for 'intelligent' systems. Debugging is part of this process but bugs do seem to emerge in both software and hardware at much later times. Error checking systems improve operation but are only as good as the program and its creator. In the end we

compromise on 'soak testing' time, otherwise they would never get out the door.

There have been some expensive mistakes especially in space research, remember the Hubble Telescope problem of sharp focussing and then the stray minus sign in a program that produced unexpected events in an earlier rocket.

ETI is painfully aware of the pitfalls to emerge in getting an experimental prototype from a designer to publication in a short time. A dot missing on a theoretical circuit diagram can make all the difference to somebody who scratch builds from this diagram only. At least there is a back-up in the PCB design. The benefit of corrective feedback every month is very useful.

OPEN CHANNEL



Telecommunication's a wonderful thing, isn't it? There I was a couple of months' ago, telling you all about the state-of-the art fax/modem devices which you can connect up to your computer, to allow direct fax transmission, straight from your computer desktop, and now here I am using it for real.

It's the silly season, of course, which in journalistic terms means the summer hols. Now, every good column writer takes her or his computer away with the kids, the cat, the sun, the surf and the caravan, because it's nice to be thought conscientious. Actually, if truth be told, I'm not conscientious at all; I'm just behind in my work (as usual) and didn't get time to finish it all before we packed the car boot and hit the road. So, along comes my computer and, thankfully, my fax/modem which plugs neatly into the back of the machine.

While the kids are soaking in the surf, the missus is soaking in the sun, and the cat is snoring in the shade, I can be busily writing this month's column, just so I don't miss its deadline. Then, when it's all complete, all I need to do is find a temporarily unused 'phone socket, not too far from a temporarily unused mains outlet and Bob's your uncle.

I Know Small is Beautiful, But...

Apple computers Inc, recently gave an indication of the way computers of the future are going to look, when it displayed the first of its Newton pen-operated computers which it calls personal digital assistants (PDAs). The PDA, as envisaged by Apple, will be a hand-held and truly pocket-sized computer, taking the lead from the personal organizer type of clever calculator, but having the built-in capabilities of many current PCs.

First PDA off the line will be around the size of a VHS videocassette, with a flip-up cover revealing its display. This display is interactive in that users, write on it, draw on it, or click icons on it in much the same way that keyboard mice are currently employed on Apple Macintosh or other window-based computers.

It's not that such a device is that far ahead of current ways of thinking (most other computer manufacturers worth their salt are considering similar projects) but it's the fact that reduced instruction set computer (RISC) integrated circuits are to be incorporated which makes the Apple PD really significant.

As a secondary interest, you might like to know that the RISC chip used in Apple's first PDA will be designed and built here in the UK. Advanced RISC Machines (ARM) of Cambridge has launched the ARM6 RISC microprocessor family for use by Apple (which, incidentally, was a founder of ARM back in 1990) in its PDAs. The actual chip used in the prototype PDA displayed by Apple recently is the ARM610.

As a further secondary interest, you might like to know that ARM's other co-founders are Acorn computers and VLSI Technology. Acorn Computers as you should be aware markets, among others, the Archimedes range of computers

which uses the very first range of RISC-based integrated circuits.

Apple believes PDAs built along the lines they plan will spawn look-alikes and copy-cats giving rise to a \$3.5 trillion market by the turn of the century!

Interest is Pylon Up

The National Grid Company looks set to become one of a new breed of public telecommunications providers. It recently setup a subsidiary company Telecom Electric to organize and control communications aspects over its national network of power cables and pylons. Not that the National Grid Company is the only one to do so, mind you. There are now over 30 organizations which have applied for a public telecommunications licence, and only a handful so far have been granted.

Fact is, when you think about it, the electricity network is probably one of the best potential telecommunications networks currently (no pun intended) around. If you consider that there is a ready laid and distributed cable network all around the country which goes directly to every home already, complete with the possibility of highbandwidth add-on networks - even if existing electric cables can't carry that much traffic it won't take much to string up a few new cables across existing pylons - the national grid network has got to be an obvious front-runner.

Unlike the potential of laying optical fibre cables along railway tracks or along canal banks (both of which suffer from problems of vandalism), cables across pylons aren't usually prone to damage from human intervention. I've mentioned before in Open Channel how thieves are ripping out copper cables laid along railway tracks. Before they rip the cables out, though, thieves have to cut through them to see if they're copper or optical fibre - there's no point in 'nicking' optical fibre, after all! The fact they don't want optical fibre, though, is irrelevant - once they've cut the optical fibre the network is kaput! The National Grid has got to be on a winner.

Going cheap

There's a current spree of mobile 'phones, initiated by recent price drops to non-business users. These price drops are such that domestic users will actually be able to rent and use their cellular devices for only around half of what business users have to pay.

This is a deliberate strategy by cellphone operators to boost the market. Calls made during the peak rate periods are—charged more than business users, while calls during off-peak times are considerably reduced. So, it's not just yuppies who can have them, after all. Talking of 'phones in off-peak times, I'm sure I saw a 'phone socket around here somewhere so I can plug in my fax/modem! No? Oh well, it's back to the old pigeon-post.

Keith Brindley

Blue Chip Technology have added a rugged laptop PC to their industrial PC range. Manufactured by Victor Technologies, the Gridcase products provide a

386 PORTABLE

portable processing platform for the industrial environment.

Key to the laptop's ruggedness is a magnesium case providing a durable, resilient package which enables the unit to run in conditions of dust, vibration, high humidity and temperature fluctuations from -5°C to +40°C.

The range includes 386SX and 386DX versions with on-board RAM expandable to 8Mb. Hard disk drives are available up to 120Mb including a removable option of 60Mb, making the unit ideal for applications where sensitive data is being stored.

Battery power for the Gridcase is provided by a rechargeable Ni-Cd cell which gives up to 2.5 hours constant use. To save space a unique isopoint control device has been developed in place of a mouse, enabling the user to benefit from graphical environment software such as Windows.

Manufactured for the European market, the Grid laptop products are available in the UK from Blue Chip Technology as part of their range of industrial computing equipment.

For further details please contact:

**John Young
Blue Chip Technology
Tel:0244 520222**

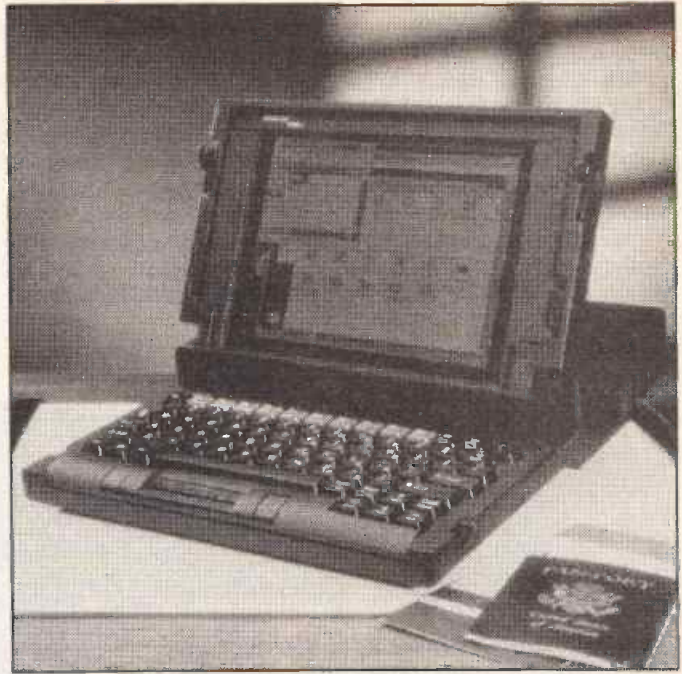

20MHz OSCILLOSCOPE

The Kenwood CS-4025 oscilloscope, is a low cost 20MHz model, featuring a full 8 x 10 division (1 division is 10 mm) screen. It is built to the same professional standards as Kenwood's high bandwidth oscilloscopes and CD test equipment.

Sensitivity is adjustable between, 5mV/division and 5V/division over the full bandwidth, and high sensitivity positions of 1 mV/division and 2 mV/division are available up to 5MHz.

The oscilloscope has a sweep time which can be varied from 0.5 μ s/division to 0.5s/division, and a maximum sweep speed of 50ns/division can be achieved, using the x10 magnifier. Sweep speeds are variable in 19 steps in 1-2-5 sequence with a fine control between steps.

An auto sweep facility allows the trace to free run in the absence of an input signal. Display modes are channel 1 only, channel 2 only, channel 1 and 2 added,

or channel 1 and 2 in alternate or chopped formats.

Crosstalk is specified as -40dB or less for a 1kHz sine wave. In X-Y mode, channel 1 becomes the Y axis and channel 2 becomes the X axis. This allows high sensitivity X-Y measurements.

A useful vertical amplifier signal output (channel 1) is available, giving 50mV/division output at 50R output impedance, and 100Hz to 10 MHz bandwidth. For example, a frequency counter could be connected for accurate measurement of a waveform at low frequency.

Vertical and horizontal parameters are specified at an accuracy of +/- 3% over a temperature range of 10°C to 35°C. However, the oscilloscope will operate between 0°C to 40°C.

The new model also features intensity modulation, TV line and frame triggering, scale illumination, and channel 2 inversion.

The CS-4025 costs £330.00 plus VAT including 2 probes.

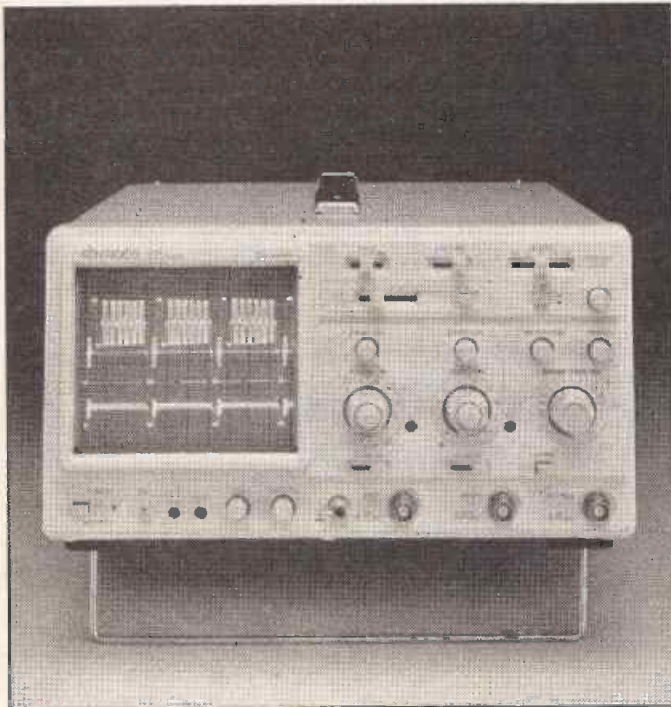

SOLID STATE DISC DRIVE

AT&T Microelectronics' can now provide an IDE Series memory card system uses flash memory technology to provide a direct replacement for existing 2.5 inch hard disk drives. The IDE Series provides the low weight, low power and shock resistance needed for mobile and portable computing and commu-

nications, yet is completely compatible with MS-DOS, system BIOS and firmware.

The IDE Series combines AT&T Microelectronics' advanced semiconductor processing capabilities with Sundisk Corp's solid state disk controller architecture. It consists of an IDE-compatible base controller,

and a range of flash memory cards with capacities of 2.5, 5, 10 and 20Mbyte. Each base controller can accommodate two flash cards, giving a maximum capacity of 40Mbyte.

The IDE Series has three times the MTBF (mean time between failures) of a conventional hard drive, whilst consuming less than

one third of the power. The use of solid state technology also means that access times are drastically reduced. Unlike competing flash products, however, AT&T's 1DB Series requires only a single 5V power supply, and, to the host computer and operating system, appears identical to a conventional hard drive.

Memory cards are equipped with AT&T Microelectronics' 4Mbit and 8Mbit file flash devices, which are designed specifically for mass-storage applications. Like magnetic drives, the devices produce a serial output, and are organised into 512 byte sectors: traditional flash designs produce parallel bitstreams, and are based on much larger block (sector) sizes. This has signifi-

cant impact on MTBF, because flash memory is written in blocks, and is degraded by high numbers of erase-write operations. Therefore, a smaller block size equates to a longer device lifetime.

The interface controller also contributes to system reliability, by implementing dynamic wear-leveling and spotting of bad sectors. The former technique gradually shifts frequently modified or

re-written data from sector to sector, ensuring that sectors are not overburdened with write operations. The ability to ignore bad sectors is used to eliminate the endurance problems associated with traditional flash architectures, ensuring that failure of a single memory block does not render the entire system useless.

Further integration of the

smart controller circuitry will provide an "IDE on a card" solution, compatible with PCMCIA Rev. 2.0, by the end of 1992. SunDisk and AT&T are currently designing a 16Mbit file flash chip, which will extend the capacity of IDE Series drives to 80Mbyte before the end of 1993.

Contact Keith Allen,
AT&T Microelectronics,
Tel: 0344 865927.

NEW DTI APPROVED WIRELESS DOORCHIME

Innovations International Ltd, a subsidiary of The NSP Group, has launched their own Matrix Portachime, a wireless doorchime which has full DTI approval.

This system consists of two wire free battery operated units, a transmitter and a chiming receiver control. The transmitter emits a radio frequency signal to the portable receiver control unit.

The Matrix Portachime has an operating range of up to 90ft. The receiver control unit incorporates an integral belt/pocket clip and stand, an on/off and two level volume switch and both units have indicator lights to ensure units are working. These fea-

tures may be helpful to the hard of hearing.

Both units require a 9 volt (PP3) battery (not supplied) and come complete with fixing accessories and insert cards for name, address or house number indication.

The Matrix portachime retails for £19.95 and the product code is PE755. *Trade enquiries, contact:*

**Mike Telford,
Innovations
International,
Tel: 081 878 9111.**



BNR LASER BREAKTHROUGH SETS STAGE FOR FIBRE TO THE HOME

Bell-Northern Research (BNR), the research and development subsidiary of Northern Telecom, has announced that a team of its scientists and engineers has produced a semiconductor laser that can make fibre-optic telecommunications to the home an affordable reality.

A world first, this new laser could enable the crucial components in fibre-optic telecommunications systems, the electronic-to-light interface modules, to be manufactured for a fraction of today's costs. A single fully tested transmitter module today can cost hundreds of dollars. An end-to-end fibre-optic network to businesses and residences would eventually require millions of these modules.

"Fibre-optic networks are rapidly entrenching themselves as

the technology platform essential to serve the capacity-intensive, high-reliability telecommunications requirements of this decade and into the next century," said George Smyth, president, BNR. "High value, cost effective innovation is fundamental to delivering Northern Telecom's FiberWorld vision of these end-to-end fibre networks."

The new device, smaller than a grain of salt, is called a circular-grating surface emitting laser. It emits a powerful circular column of light from its top surface that notably improves the efficiency of coupling laser light to optical fibres. In contrast, conventional lasers generate a divergent light beam that requires a precise positioning of the fibre to efficiently capture the light.

Lasers are the light emitting

components in optoelectronic transmitter modules, units about the size of a postage stamp, that combine lasers and the micro-electronic circuitry to control them. These modules are the key system components that convert electrical signals to light pulses so digital information can be put onto optical fibres.

Such modules, already in use, are critical components in transporting most long-distance voice and data traffic as well as urban traffic between telephone company central offices. Fibre-optic transmission is also the technology of choice for current and future generations of trans-oceanic cable systems. And fibre links to the home are seen as essential to deliver a vast number of advanced home services such as dial-up movies and high definition 3-D

video libraries, as well as futuristic services such as consumer retailing using virtual reality techniques.

However, the barrier to end-to-end fibre links for home and office has been the need to substantially cost-reduce optoelectronic modules for high-volume production.

"Although BNR scientists and engineers have developed processing and fabrication techniques that have already reduced the cost of the elementary laser chip to a few dollars, packaging still represents more than 70 percent of the final cost," said Peter Scovell, vice-president, advanced systems and technology, BNR. "These costs are related mainly to attaining the precision necessary to align the fibre to the laser, and maintaining these submicron

tolerances over extended years of operation at widely varying temperatures."

The latest BNR development makes it possible to relax these tolerances. Furthermore, the new technology allows the use of standard, automated batch testing of newly processed lasers, instead of the conventional method of labour and time-intensive laser-by-laser testing in customised jigs.

The new laser uses a circular

grating, similar in appearance to the tracks of a compact disk (CD), to reflect light upward. The grating, only a fraction of a millimetre in diameter, consists of hundreds of concentric grooves, critically spaced to collimate the beam from an area 10,000 times larger than conventional lasers.

The device is a multilayer laser structure of indium-gallium-arsenide-phosphide (InGaAsP), grown on an indium phosphide (InP) substrate that produces a

wavelength of 1.3 microns, in the near-infrared part of the electromagnetic spectrum.

The scientists processed the laser at BNR's Advanced Technology Laboratory in Ottawa, except for the circular grating, which was patterned with a focused ion beam writer at Canada's National Research Council Microstructural Sciences Institute in Ottawa.

"Although this new laser technology is still at an early stage in

its applications development, it holds the potential for far-reaching implications in both consumer and business applications beyond fibre-optic telecommunications networks," said Vlikelis Svilans, one of the BNR scientists on the team. "Because its surface emitting design can be fabricated as arrays of lasers, BNR's circular grating lasers could be integrated into advanced applications such as optical switching, optical computing, and optical backplanes."

NEW LCR METER

The MIC-4070D LCD digital LCR meter, now available from SAJE Electronics, provides capacitance, inductance, resistance and dissipation measurement.

In capacitance mode 9 ranges are available covering from 0.1p to 20,000µ and dissipation with digital readout of 0-1.999.

Inductance is measured in 7 ranges from 0.1µH to 200H with

a digital readout of dissipation.

Resistance is measured in 8 ranges from 1mR to 20M.

The MIC4070D is supplied complete with battery and probes at a price of only £85.00 plus VAT.

For further information on this or any other products in the SAJE range please contact:

SAJE ELECTRONICS,
Tel: 0223 425440

NEW 4-CHANNEL FM WIRELESS INTERCOM

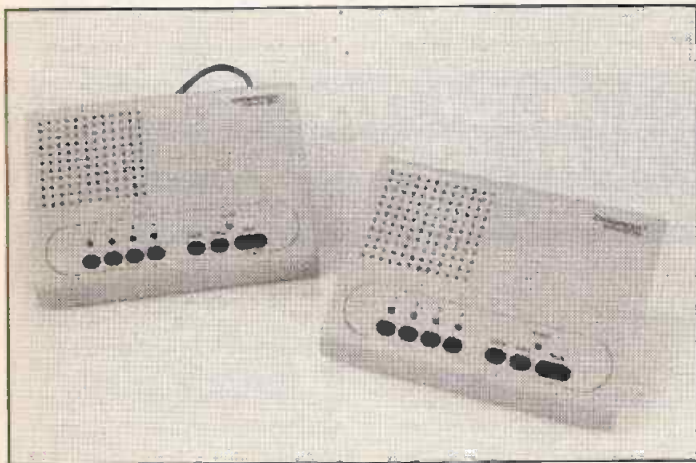

New from MAPLIN ELECTRONICS is the 4-Channel FM Wireless Intercom. This transmits and receives via the mains wiring, with no additional wiring needed. Just simply plug each unit into a 240V AC mains outlet socket.

The communication system is FM modulated low frequency RF with phase locked loop receivers giving a high quality sound without interference from the mains. Each unit can transmit or receive on either of four channels which are selected by a switch. Up to

four stations can be connected via the same main ring, and any one unit can talk or listen to any one other unit.

A call is made by selecting the appropriate channel (1 to 4) and pressing the call button, sounding a buzzer at the selected unit.

The carrier frequencies are 80kHz, 100kHz, 120kHz and 140kHz. RF output power is 100mW with an audio output of 500mW. They are supplied individually only and cost £24.95. (2+ £19.95.)incl VAT



MUSIC IN A BOX

A new range of high quality recording and PA gear is now available in kit form from Total Control.

So far, products include a dual compressor, parametric EQ, dual noise gate, DI Box, rack mixer, splitter and a Mega EQ. All kits

come with cases (optional 19" rack-mount) and PCBs. These will be of interest to anyone associated with recording or playing music. Prices start at £9 for a dual rail 15V power supply at 100mA. For more information and catalogue call 081 808 7323.

50MHz 486 SINGLE BOARD COMPUTER

Advanced Modular Computers Ltd are now shipping the new CAT1011 486 Single Board Computer with the 80486DX/2 device operating at 50MHz currently and shortly 66MHz.

The card is designed to offer a high level of performance on a full-size/AT expansion card form factor. Page mode DRAM, up to 32 MBytes, in conjunction with the 8Kb internal cache of the

80486, provides near zero wait state performance.

The CAT1011 includes a Future Domain SCSI interface which supports several of the popular operating systems including Interactive UNIX and SCO UNIX together with SCO Xenix, DOS, OS/2 and Novell Netware 286 and 386.

The IDE hard drive interface and Floppy interface onboard provide IBM compatibility. Each interface supports up to two drives.

Two serial ports and one bi-directional parallel printer inter-

face are also included along with keyboard and mouse ports.

An onboard PROM disk offers industrial designers with a solid state boot source unhampered by the hazards of the factory environment which effect rotating media. Two sockets provide up to 512K of PROM, which can be configured as disk emulator. BIOS support is included for disk emulation.

For more information on Advanced Modular Computers Ltd, call:- Andy Cox
Tel 0753 580 660.

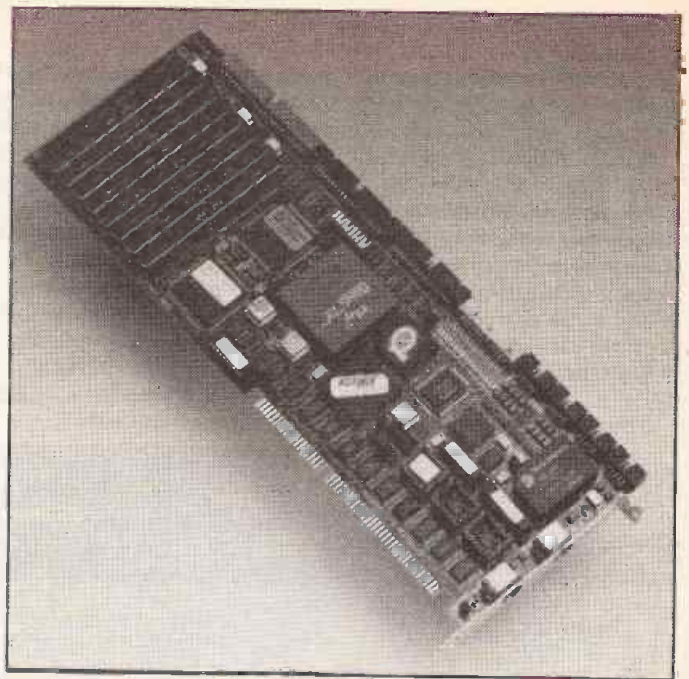

CURRENT CALIBRATOR



A portable Current Calibrator with a range from 0 to 20mA is now available from Alpha Electronics. CALTEK 300, designed and manufactured by Alpha Electronics in the UK, is best suited for all Process Control applications and as a general purpose signal injector. This hand-held, battery powered unit can operate as a Current Source, Current Sink or as a Monitor for the current in a process loop. Readings are set and indicated on a large 3-digit liquid crystal display with sepa-

rate LED indication of battery state and operational error.

Current range for Source, Sink & Monitor is adjustable from 0 to 20mA with an accuracy of +/- 1% and a resolution of 10µA. Output connection is via two 4mm posts and the operating temperature range is from 0° to +50°C.

For further information please contact:

Fred Hutchinson
Quiswood Ltd
(0756) 799737.

IC TEST GOES COMPACT

ABI Electronics has launched a new handheld chip tester based on the successful 40 pin benchtop ChipMaster. For the first time, 40 pin full functional IC test is incorporated into a battery operated handheld unit.



The ChipMaster Compact features a single wide entry zero insertion force socket which accommodates all DIL packages while the integral dot matrix LCD display shows test results, IC function and pin data. The unit accepts IC codes directly from the keypad or will perform a search to identify the device from their characteristics. Unknown, unmarked and housecoded devices can thus easily be identified and tested. Intermittent and temperature related faults are easily found using conditional loop modes. The

ChipMaster Compact has many applications anywhere where verification of an IC is required eg. goods inward inspection, research and development, education, quality and maintenance. It costs less than £300.

For more info, please contact
Alan Woolhouse,
Marketing Engineer
ABI Electronics Ltd
Tel:0226 350145

CASIO LAUNCH NEW fx6300G GRAPHIC SCIENTIFIC CALCULATOR

Casio Electronics has launched a new graphic calculator - the fx6300G - which contains basic scientific functions and graphing capabilities.

Graphic capabilities include 20 Built-in Graphs such as Sine curve; User Generated Graphs which can be drawn simply by entering the appropriate formula; and Statistical Graphs for bar graphs and normal distribution curves for single-variable statistical calculations, and regression lines for paired-variable statistical calculations and there is selection of graph data analysis tools such as Trace, Zoom, PlotLine and Graph Scroll functions to help pinpoint the information required.

The fx6300G incorporates 200 functions for top level application in science and technology.

Trigonometric, inverse trigonometric, hyperbolic, inverse hyperbolic and coordinate conversion functions are all built in. Binary, octal and hexadecimal based numbers can be converted and combined.

A 400-step program area provides plenty of room for storage of often-repeated programs, and formulae are input just as they are written. The fx6300G automatically assigns priority according to the locations of arithmetic operations, exponents, functions and parenthesis, enabling quick, easy and accurate input of formulae. Up to 10 programs can be stored in memory simultaneously.

Retailing at £49.99, the fx6300G is protected from school bag bumps and knocks by a slide-on hard case that fits over the front or back of the calculator.

New sputtering process

A DC magnetron sputtering process for depositing material on the inside surface of tube and pipe has been developed. Conventional planar sputtering processes require a fixed-magnet assembly too large to fit inside small-ID tubes. Sputtering equipment used in the new process is relatively simple. Instead of a fixed magnet, the new process generates a magnetic field electrically around a cathode that fits inside the tube to be coated. The plasma vapour deposition process also does not always re-

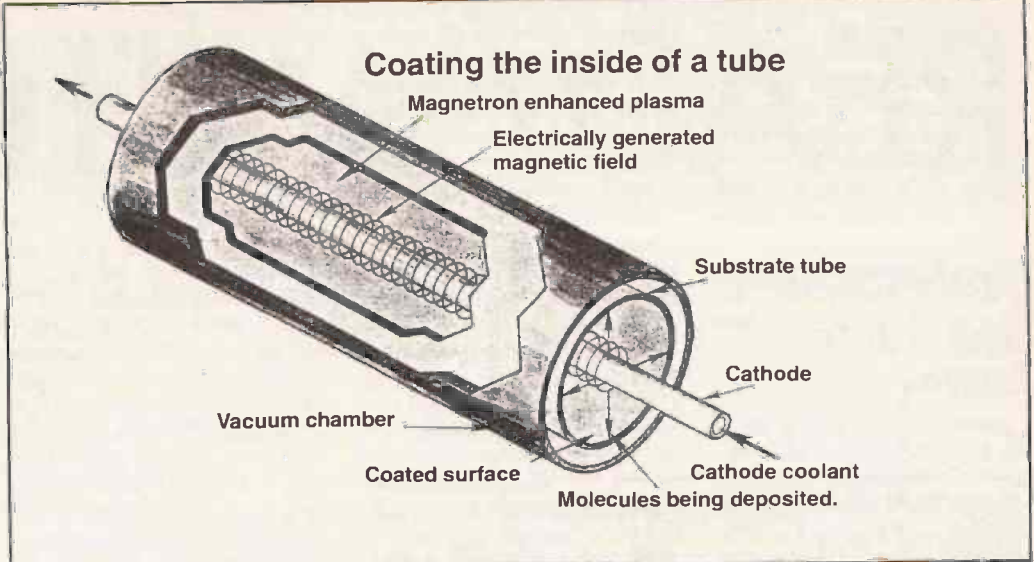

quire a separate vacuum chamber because in many cases the tube itself can be closed at both ends to form the chamber. The sputter-coating process can be used on tubes from 0.5-5in in diameter, with lengths up to 4ft. Longer lengths are possible. Any tubular substrate that can withstand temperatures ap-

proaching 200+°C in a vacuum without severely outgassing is a candidate. Ferrous and non-ferrous metals, ceramics, and glass have all been successfully coated using the process. Coating materials include all elements that can be used in conventional DC planar magnetron sputtering, as well

as some alloys. Reactive sputtering to form oxides, nitrides, and some carbides is also possible. One application that is especially promising is sputtering high temperature lubricating metals on the inside of bearings. The process has been developed by Surface Solutions Inc. of Boulder, Colorado.

Virtual reality research project

Patents have been applied for by Digital Equipment Corp. for

two input devices developed for its virtual-reality research project. Its Presence Project developed the "magic wand" in cooperation with the Virtual Worlds Consortium at the Human Interface Technology Lab at the University of Washington, where the device

was conceived. Digital's magic wand is a six-dimensional cordless input device that is held like a music conductor's baton. It uses gestures to control computerscreen activity. Digital's other application cov-

ers a portable input/output device that users twist like a knob. The knob provides feedback to the user by twisting back when obstacles are encountered (like the steering wheel of a car bumping into the curb).

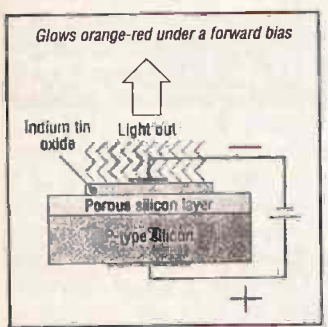

First silicon LED

A silicon light-emitting diode could be the first spin off from a recent discovery that silicon, when etched with hydrofluoric acid, becomes an efficient light emitter. The possibility of a direct route to integrated optoelectronic circuits has stimulated a flurry of research. "The pay off from practical silicon LEDs would be so enormous that virtually any research investment

in achieving that goal is justified," said Nader Kalkhoran, who leads research at Spire Corp. of Bedford, Massachusetts. Until recently, building a silicon LED had never been considered because silicon is such a poor optical performer. While it does emit light in the near-infrared range, the effect is weak. In Spire's LED, a layer of indium tin oxide (InSnO) is deposited on p-type silicon that has been etched with hydrofluoric acid. The InSnO/silicon interface forms an n-p rectifier that glows orange-red under a forward bias. Electrons are injected into the porous silicon where they combine with holes to generate photons. InSnO is transparent to visible light, allowing photons generated at the interface to escape. "So far, the device seems to be stable and predictable. We have operated these silicon LEDs without any signs of degradation," Kalkhoran said. Stability is im-

portant. Another all-silicon LED built at IBM Corp.'s T.J. Watson Research Centre rapidly degrades under ambient conditions. "The IBM researchers were forced to isolate the device in a vacuum to get sustained operations," he noted. "It appears that [InSnO] also plays the role of a passivation layer for the etched silicon."

Computer pointing device

A prototype of a computer pointing device that is operated from a keyboard using an index finger has been developed by scientists at the IBM Thomas J. Watson Research Centre in Yorktown Heights, New York. Called the Pointing Stick, the device provides the functions of a mouse without requiring that a user's hand be removed from the

keyboard. With the pointing stick, the time needed to make the first selection from an on-screen menu is about one-half that required using a mouse. Bar keys below the keyboard's space bar are used for clicking on an object. The pointing stick is located between the G and H keys, and protrudes about 2 mm above the surface of the keys. Unlike a typical joystick, which can be rotated, the pointing stick remains upright and rigid, responding to finger pressure. Piezoelectric strain gauges in the stick translate the applied force into electrical impulses which cause the on-screen icon to move. Pressure in any direction causes the icon to move in that direction. The stick also responds to the amount of force applied, with more force moving the icon faster. Maximum force causes the cursor to move almost instantaneously to the edge of the screen where menu items are typically located.

Stroboscopic Rear Cycle Lamps

Recent articles on LED bicycle lamps, have appealed to my curiosity, as some years ago I had been experimenting with gimmick lights on a motorcycle. This started some interest locally, particularly with a friend who occupies his spare time with occasional design projects.

Efficiency as with the fact that LEDs withstand vibration much better than incandescent lamps. Road surface on motorways are not necessarily any better than minor roads for an undulation in the road surface on the northbound carriageway of the A1 just north of the Borehamwood junction used to cost me a headlamp bulb everytime I crossed it.

One interesting finding from my experiments, which could well be of use to those constructors wishing to use LEDs for cycle

virtually eliminate the appearance of the strobe effect.

The author of the article 'Improved LED Bicycle rear lamp' in the July issue makes an excellent point that cylindrical cell batteries have a far superior energy density to sintered plate types such as PP3s and with suitable design this can be taken further by using a transistorised inverter to that uses a single or double cell although there is a point where $V_{cc(sat)}$ of the switching transistor curtails this advantage. The design shown looks like the version of a 'bucking regulator', whilst there is nothing wrong with this approach, my own preference is for the blocking oscillator type inverter as this can easily have multiple secondaries, eliminating parallel chains of LEDs and any need for equalising resistors.

For 6V operation both primaries should be about 18-25T, the turns per secondaries will depend upon the number of LEDs and for 3-4 LEDs would be similar to the primary (1:1 approx). Q2 provides regulation, connection A regulates power by reducing the PRF, connection B regulates primary peak pulse current. Initially R1 should be selected to prevent core saturation used in B connection mode. Once the secondary have been approximately determined, R1 value is useful for estimating LED peak pulse current.

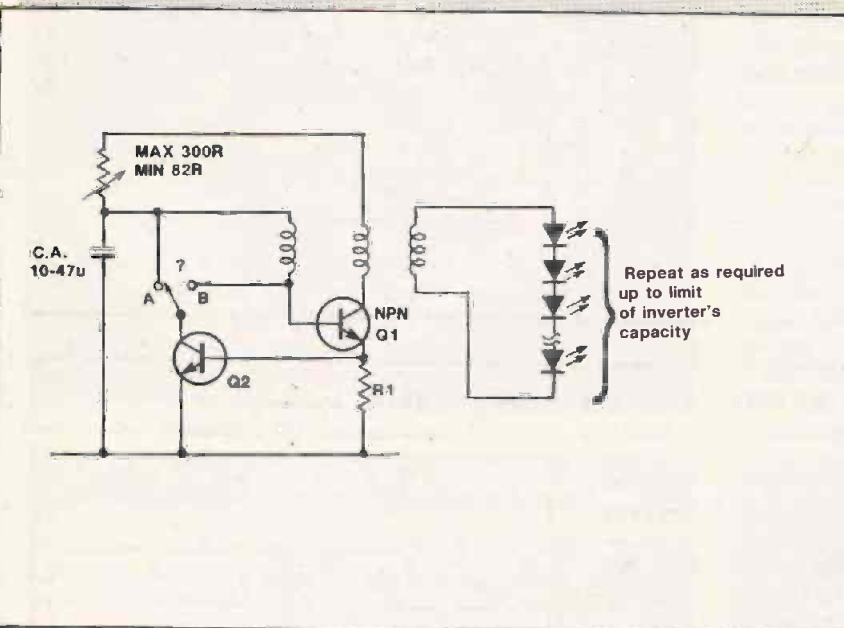

My original experiment consisted of poster lamp (Philips PL-S 9W fluorescent) with starter removed. This was glued to the side of the fuel tank and had one of the HT leads routed through it. Whilst the vehicle was stationary, the lamp gave the impression of being steadily illuminated at any RPM above tick-over. When in motion, the stroboscopic effect became quite interesting. I do not recommend anyone try this, for one thing the local police were not entirely happy about this although I suspect that they were a little uncertain about cruise light laws. In any event the experiment proved to be unsatisfactory from a reliability point of view.

Another thing that I had experimented with was replacing the rear lamp with LEDs. This was not so much to do with effi-

rearlamps, is the stroboscopic effect which may well be permissible on a non motorised vehicle. The human eye is peak sensitive and pulsing an LED will make the lamp more conspicuous, possibly at a lower average brightness and correspondingly lower power consumption. Another point is the LEDs are within their safe operating area region most sensitive from a reliability point of view to average current.

Most LEDs can be pulsed at up to 100mA and some types will withstand pulsed current in excess of 500mA provided the SOAR is not exceeded nor the average maximum dissipation.

Legal difficulties are most unlikely due to the relatively low typical speeds of pedal cycles and at first consideration, selection of a high pulse repetition rate would

I hope these suggestions are useful to other constructors. One thing that I would like to find out is how to estimate approximate equivalences between LEDs and lamps, as LEDs are always quoted in candelas or milli-candelas and lamps in Lux or Lumens.

I Field,
Letchworth, Herts

Brighter LEDs For Bike Lamp

The superbright LEDs (0.1-0.2Cd) specified in the Rear LED bike Lamp are not as bright as those in the Exide Vistalite rear lamp. BS6102 (part 3) requires a brightness of 4Cd at the optical centre of the lamp (Although the Vistalite doesn't comply with BS6102 part 3). The Vistalite has most of its light focused into a fairly narrow high intensity beam (similar to conventional battery lamps). The beam does not spread enough vertically to satisfy the British standard.

I noticed that a company called Jermyn make LEDs rated at 15Cd (at 20mA). These LEDs could be used to upgrade the ETI Rear Lamp.

A Bradley,
Belfast

Programmable Radio Recorder

I would like to build a 'Radio recorder' - a piece of equipment which would do for a radio what a video recorder has done for TV. The transport mechanism of a video recorder could be used but would require modification to the channel selection circuits and a means of interfacing to operate a radio. There is no suitable equipment around on the market - a radio timer with a device does not meet my requirement because it is limited to one channel, cannot be programmed to go more than 24 hours ahead and is limited to 30 mins (or possible 1 hour). Have you any projects past or planned which might meet my requirement?

Mr E A Little,
Penzance, Cornwall

Although we have published timers of various types, they are limited to just as you describe. It looks like a potentially good project for ETI (Any readers out there built one?). I suspect the reason it would not make a commercially viable product is that the appeal for multi-radio programme time shifted playback has

long gone having been almost totally suppressed by TV viewing. As an example, who listens to the radio in the evening as opposed to watching the box. Had the technology to do what you are asking been around in the 1930s and 40s, I'm sure it would have sold well. It is also a strange irony that there are far more radio channels providing information than TV channels, and arguably a greater need for such a device - Ed

South African Bats

Thank you for an interesting Bat Detector project. I'm a great fan of such simple, interesting projects that one can build with a couple of ICs and a handful of other components.

Most nights in Capetown, we have large bats circling the street light catching insects. Last year our cat bought one in, so my young son and I were delighted at the opportunity of examining it. They are large brown bats, with handsome features, large ears and a wingspan of around 2 feet.

I found a new application for your circuit - namely testing the power of different designs of ultrasonic dog repeller. What surprised me when using your bat detector is the volume of a bat's RADAR. They appear to be on par with the best of dog repellents. Frequency might have something to do with it too, though.

Rev. Thomas Scarborough,
Port Elizabeth, South Africa.

Chip Stereo Amp Hints

Many thanks from a regular reader for putting the amplifier PCB on the front cover. It was an incentive to buy this issue as even though I am a bit deaf I was looking for such a project.

The main amplifier chips were purchased from a Radio Rally for 30p each and it so happened that I had the darlington transistors in stock therefore assembly commenced. At this stage some problems were encountered which you may like to consider in the way of feedback.

It would have been nice if the component overlay had been silk screened on. I inserted the main part locations on my board with a felt pen to save making errors. I know what you will say in regard to cost.

No value is given for C11 and C12. As they only decouple the supply rails I assume it to be 100n. C1 & C2 are shown on the overlay in what appears to be tubular polarity conscious form. In the parts list they are just ordinary 100n Caps.

The plug-in electrolytics are expensive at over a pound each but I did find alternatives from Rapid. However the 4700µ ones have slightly greater pitch centres for the leads. A slight board mod would accommodate both types.

The darlington transistors are expensive therefore the alternative is to build up two from a TIP36 and ZTX109 (first seen in ETI Tech Tips. It saves pounds.

On a slightly different note, I can program, verify, erase and generally mess about with all types of EPROMS. I can even change the functions of some of the pins if anyone is daft enough.

I don't usually bother with all the 2764, 128, 256, 512 stuff as I put the code on to whatever is at hand and is big enough. If it isn't then I spread it over 2 chips. One person mentioned the expensive 27128 chips. Ask him how many does he need as they are around for less than a pound each. 2764s are 50p whilst the huge 27512 are £1.50. Code on a PC or QL disc plus four quid gets the job done.

Dennis Briggs,
Telford, Shropshire

Thank you for your comments Mr Briggs, I'm glad you like the idea. Any errors occurring in the chip stereo amplifier were published in the July '92 edition page 76). It has to said that one extreme advantage of a monthly magazine is that any project can be updated and amended. This is slightly more difficult with a book, where one hopes there are no mistakes (This might seem an impossibility in electronics!). Ed

EASY-PC PCB and Circuit Diagram CAD

Forget using tapes and lightbox! Create your Circuit Boards using CAD - like the professionals.

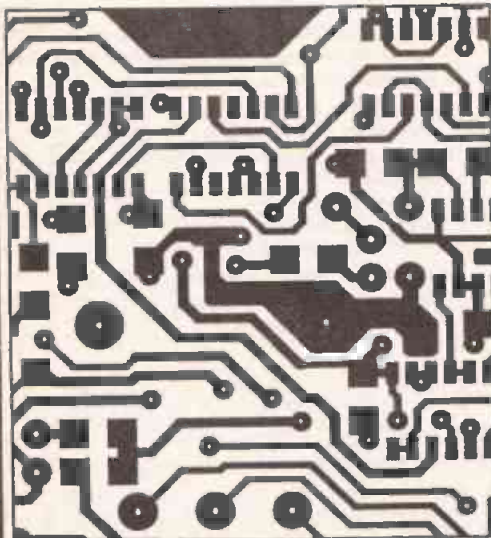

- Runs on PC/XT/AT etc. with Hercules, CGA, EGA or VGA display and many DOS emulations.
- Design Schematics Single and Double sided and Multilayer boards including Surface Mount.
- Standard output includes Dot Matrix / Laser / Inkjet Printer, Pen Plotter, Photo-plotter and N.C. Drill.
- Extremely powerful.
- Very easy to use.
- Not copy protected.

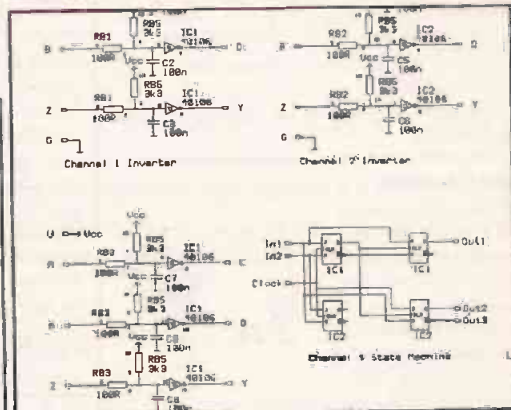

EASY-PC

Technical support is free, for life!

Only £98.00!

Plus P&P+VAT

Over 13,000 Installations in 70 Countries Worldwide!

For full info please Write, Phone, or Fax!
Number One Systems Ltd.

The Electronics CAD Specialists.

REF: ETI, HARDING WAY, ST. IVES, HUNTINGDON, CAMBS, PE17 4WR, ENGLAND.

Telephone: 0480 61778 (7lines) Fax: 0480 494042 ACCESS, AMEX, MASTERCARD and VISA Welcome.

AMAZING ADAPTER BUG

Built into a standard 13A adapter, plugs into any 13A socket and transmits to a normal FM radio. Directly powered from the mains the unit will transmit conversations etc indefinitely! Price is £26.00 ref M26P1

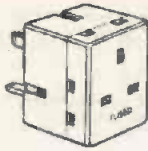

AMSTRAD 464 COMPUTERS

Customer returned units complete with a monitor and circuit diagrams. These units are generally not working and are not returnable. Price is £35.00 ref M35P1.



PC CASES

Full size off white metal cases ideal for building your own PC four drive bays, attractive plastic front panel. £24.00 ref M24P1



WALKIE TALKIES 1 MILE RANGE

Pair of small pocket sized walkie talkies complete with cases etc. They will operate (subject to buildings etc) up to 1 mile apart. 2 PP3 9v batteries required. £30.00 ref M30P1

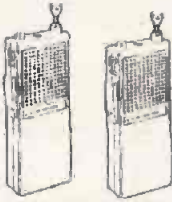

AMSTRAD 6128 COMPUTERS

Customer returned units complete with a circuit diagram and built in 3" disc drive. These units are generally not working and are not returnable. Price is £29.00 ref M29P1.



VIEWDATA SYSTEMS

Made by Tandata these contain everything you need to start dialling into databases and bulletin boards such as Prestel etc just plugs into a standard tv or monitor. Complete with modem, infrared remote controlled keyboard and console. £20.00 ref M20P2

SPECTRUM +2 COMPUTERS

Refurbished popular computer with built in cassette deck and 128K of memory £32.00 each ref M32P1 PSU £15.00 ref M15P4



We also have some requiring attention at £19.00 (non returnable) ref M19P3

SPECTRUM +3 COMPUTERS

Refurbished popular computer with built in disc drive and 128k of memory £45.00 each ref M45P1 PSU £15.00 ref M15P5. We also have some requiring attention at £25.00 (non returnable) ref M25P4.



CAR STEREO AND SPEAKERS

Complete system comprising of stereo cassette player, stereo FM radio plus AM band, Pair of good quality speakers all for just £19.00 ref M19P1



CORDLESS MICROPHONE

Small hand held battery operated microphone that transmits to a standard FM radio, good range. Our price £15.00 ref M15P3



VIDEO SENDER

Transmits video pictures from a video recorder or cam corder to any television in the house. Can also be used to transmit from cam corder to video recorder, no more trailing wires! £15.00 (ex psu) ref M15P4 £20.00 (inc psu) ref M20P1.

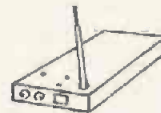

AMBER MONITORS

12" high res screen 12v 1A supply needed. Hercules/TTL input ie sep HOR and VER sync plus video required. Brand new and housed in an off white plastic case. £22.00 ref M22P1.

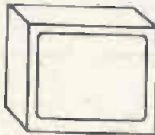

12V SOLAR PANEL

Ideal for trickle charging car batteries etc. Panel is made from amorphous silicon, is waterproof and comes with fly leads. Size is 30cm x 30cm x 4mm. £15.00 ref M15P1. Other sizes stocked



EPROMS

Clean erased eproms at bargain prices! 27C64 pack of 10 for £7 ref M7P1, 27C256 pack of 10 for £9 ref M9P1, 27C512 pack of 10 for £10 ref M10P1.



BUILT BUG

Built and tested superior FM bug 100m range, fits in match box all you need is a 9v battery and an ordinary FM radio! £14.00 ref M14P1.



ULTRASONIC ALARM SYSTEM

Complete alarm system that comprises a detector that simply plugs into a 13A socket in the area you wish to protect and a receiver which plugs into a 13A socket where you wish the alarm to sound. You could put one in the garage and one indoors or perhaps protect your neighbours house etc. Fully adjustable sensitivity. £25.00 for complete system ref M25P3.



WINDUP SOLAR POWERED RADIO

Compact unit with built in hand charger and solar panel just a few turns of the handle powers the radio for some time! Our price is just £14.00 ref M14P2



C64 TAPE STREAMER

Originally made for the Commodore 64 Computer but may be adaptable for other machines. Unit is supplied with its own operating system, and two tapes. Approx 20 times faster than normal tape systems! £25.00 ref M25P1.



Extra tapes are available at £4.00 each ref M4P1 or 10 for £25.00 ref M25P2.

PC POWER SUPPLIES

Brand new units made by Aztec either 110v or 240v input giving 5v at 15A, 12v at 5A, -5v at .3A and -12 at .5A. Fully cased with on/off switch and built in fan. £15.00 ref M15P2 Also available is a 200 watt version at £22.00 ref M22P2.



Both types have standard PC fly leads.

TALKING TELEPHONE COIN BOXES

Phone bill too high? fit one of these and save. Fully programmable for different call rates, chargebands, time of day etc. accepts 10p, 50p and £1.00 coins. Phone box actually speaks to you with built in voice synthesiser.

Wall or desk mounting. Two types available 1 with built in lock at £29.00 ref M29P2 the other with no lock but easily adaptable is just £23.00 ref M23P1. Unit takes 4 C cells and is used in conjunction with an ordinary phone. Supplied with full instructions, BT approved.

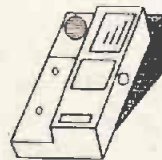

BUGGING TAPE RECORDER

Contains voice activated switch so only actual conversations are recorded! takes a standard audio cassette and uses AA batteries. £20.00 ref M20P3



TALKING ALARM CLOCK

Wakes you up by telling you the time also speaks the time at the push of a button! Battery operated £14.00 ref M14P3.



BROADBAND RADIO RECEIVER

Covers VHF 54-176 mhz (CB, air FM, TV, PB, WB etc etc) hand held unit with squelch control and carrying strap £15.00 ref M15P6 Superb value



12 BAND WORLD COMMUNICATIONS RECEIVER

Mains or battery operated covers 9 short wave bands plus FM, LW and AM bands. Exceptional value at £19. ref M19P4



SINCLAIR C5 MOTORS

12v 29A (full load) complete with 4 to 1 reduction gearbox giving 800 rpm output. Motor measures 8" x 4" with toothed pulley output. £40 ref M40P1. We also stock 13" wheels with tyres at £6 each ref M6P1, 16" at £6.00 ref M6P2 and an electronic speed controller kit at £17 ref M17P1

40 PAGE CATALOGUE AVAILABLE CONTAINING OVER 1,500 SIMILAR PRODUCTS FREE ON REQUEST!

EMERGENCY LIGHTING SYSTEM

Complete system give sup to 3 hours light from an integral 10AH sealed lead acid battery. The battery is kept fully charged by the mains, as soon as the mains fails the two powerful lamps are switched on and remain on until power is restored. Maintenance free. £19.00 complete with battery. ref M19P2

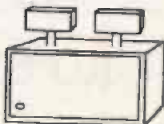

BULL ELECTRICAL
 250, PORTLAND ROAD HOVE SUSSEX
 BN3 3QT TELEPHONE: 0273 203500
 MAIL ORDER TERMS: CASH PO OR CHEQUE
 WITH ORDER PLUS £3.00 POST PLUS VAT.
 PLEASE ALLOW 7 - 10 DAYS FOR DELIVERY

NEXT DAY DELIVERY £1.00
 SHOP OPEN MON-SAT
 FAX: 0273 23877

NOTE: SOME OF OUR PRODUCTS MAY NOT BE LICENSABLE FOR UK

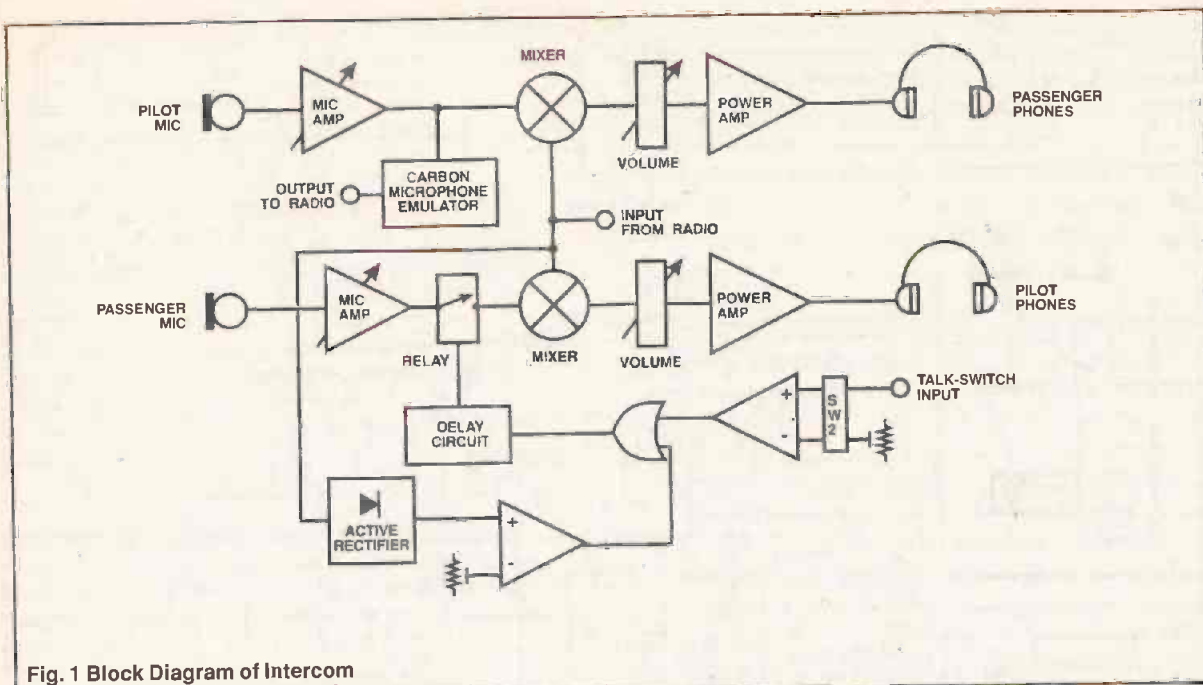

Fig. 1 Block Diagram of Intercom

A handy communication system for noisy environments by Glen Pitt-Pladdy.

Intercom for Light Aircraft

Recently a teacher (and pilot) at the school that I attended, knowing of my experience, asked me to build an intercom system for his light aircraft which could connect to the radio. The pilot and passenger should be able to talk to each other freely, but the important thing was that while the pilot was using the radio the passenger should not be able to interrupt or transmit.

The system had to be flexible and versatile enough to be fitted quickly to the plane without knowing anything other than the supply voltage is 12V and the radio normally operates off a carbon microphone (approx 4k resistance). The rest was up to me.

The Circuit

The radio-in-use sensor was obviously a priority switch type thing ORed with a talk-switch - comparator arrangement. There would also have to be a delay to prevent the switch cutting in and out during the radio communication between transmitting and receiving. The simplest way to switch the passenger microphone circuit in and out is with a relay (which I had in my second hand components). The radio-in-use revolves around an LM349 quad op-amp. The four amps are used for: talk-switch comparator, active rectifier, comparator and delay. The majority of the noise in light aircraft is low frequency (low revving high torque engines) and the resonance of the airframe, thus it's wise not to get too enthusiastic about getting a good bass response. The microphone amps are built round the TL072 dual FET input op-amp. These are fairly low noise high input impedance devices which allows the use of many different types of microphone without redesign. The gain is independently variable for each microphone and a biasing resistor is also provided for carbon and electret microphones, though the electrets performance was not satisfactory as they produced high levels of harmonics with high levels of low frequency. Without the bias

resistor the unit can be used with crystal or dynamic microphones.

Next is the mixer which simply mixes the microphone signal with the radio input. This too is built round a TL072 device. The pilots mixer has the contacts from the relay connected in the input from the passenger microphone amp. The outputs to the phones use LM380 power amps which can be used with minimal external components, thus keeping the size small. A 33R is put in series for protection should the phones cable short and while also reducing the gain to a more useful level.

Optional Components

R1,R3,R27,C19,ZD2:

These are used for microphones requiring biasing of some kind (eg. electrets). For Crystal types and dynamic microphones these should be omitted.

R10,R12:

These are optional to add 'side tone' if you feel it is necessary. Bear in mind that this will increase the background noise, even during radio communications. The value of these depends partly on the amount of background noise picked up by the microphones and so will vary with the type of microphone and the level of background noise. The value of this should be chosen so that you don't tend to shout or talk quietly during flight.

R19, C14:

These determine the delay after the radio has been used after which the passenger is connected again. If you find the delay

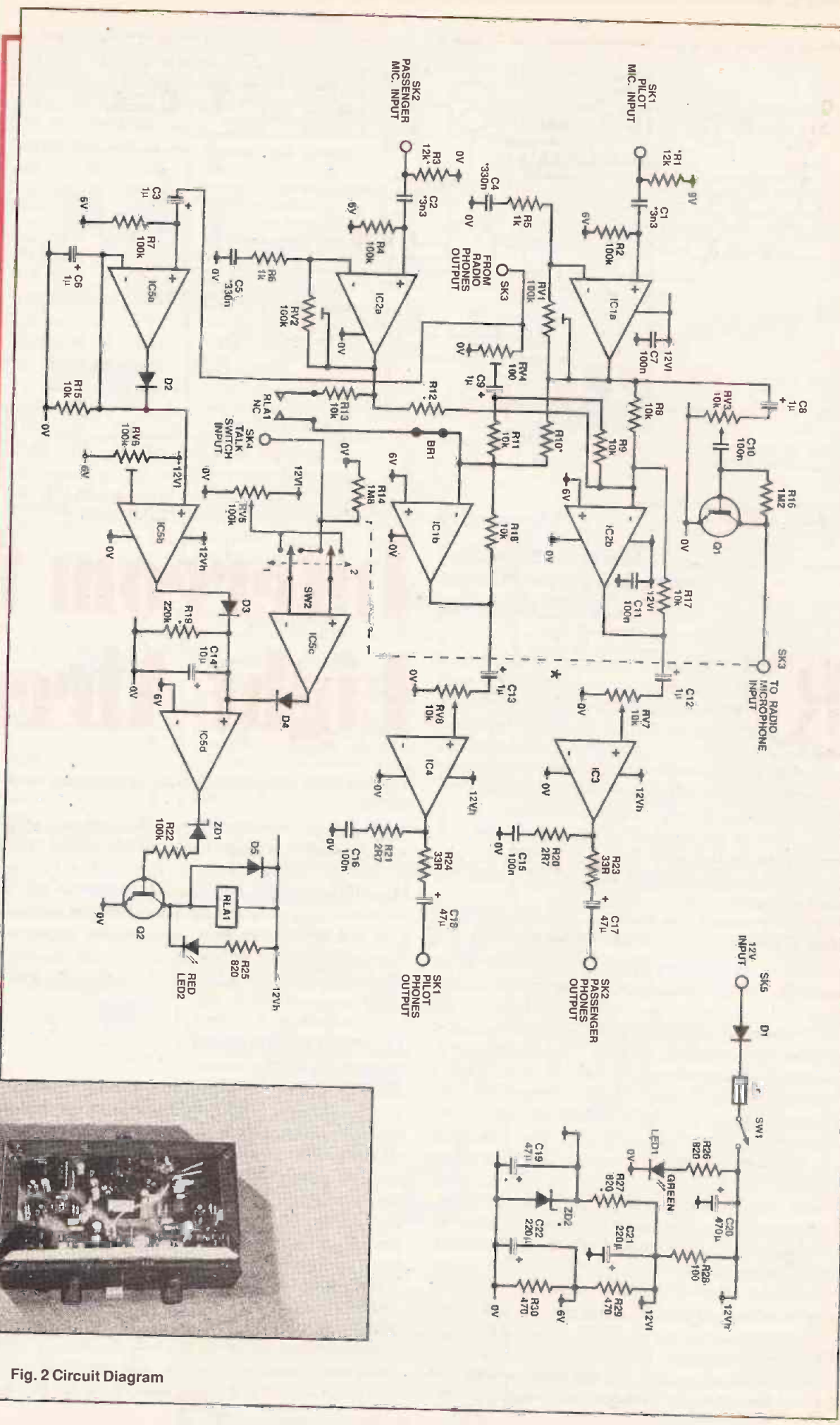
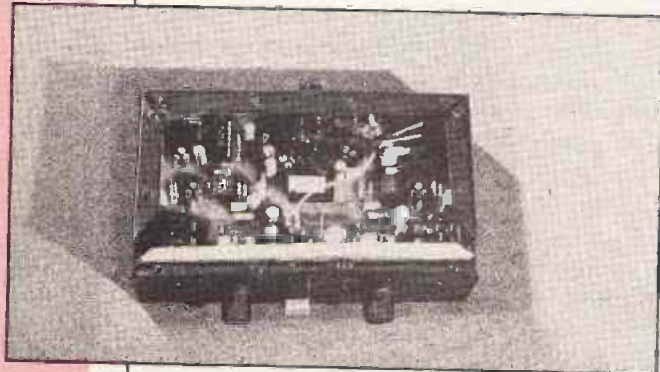

Fig. 2 Circuit Diagram



AUDIO

Both the audio sections are identical so I will only describe one section. The microphone amp is built round a TL072 FET input op-amp. For electrets etc. which require a bias current, R1,3 has been provided. C1,2 are used for DC blocking, while also reducing the bass response as a HPF with R2,4 which also set the DC conditions. Feedback is applied via RV1,2, allowing it to be varied for different microphones. C4/5 decouple the loop and also again reduce bass response.

The mixers are built around TL072s as well and mix the microphone and radio signals (the passenger input to the pilots mixer is switched to prevent interruption).

The power amps are LM380s. These are ideal as they require minimal external components. Their inputs are at 0V potential thus no DC blocking should be necessary between the volume controls and the inputs and their gain is internally set. C17,16 are provided for DC blocking while R23,24 give short circuit protection as well as reducing the gain to a more usable level. A Carbon microphone emulator has been built round Q1. R16 sets the DC conditions and the modulation is supplied via RV3 (to set the output level) from the output of the pilots microphone amp.

The Radio - In Use

The signal from the radio (normal phones output is rectified actively by IC5a along with its associated components. IC5b is used as a comparator with the reference level set by RV6. The talk-switch input goes to IC5c which is again arranged as a comparator with the reference set by RV4. SW2 serves as a polarity change-over to allow for different talk-switch arrangements. The outputs of IC5b and IC5c are ORed by D3 and D4 and fed into the input of IC5d which is arranged to give a turn-off delay. Q2 drives the relay, RL1. As the outputs of IC5 cannot operate to 0V, ZD1 is used to reduce the off drive current to zero and thus prevent the relay staying on.

Power

D1 has been provided at the 12V input to protect against possible reverse polarity. The incoming 12V is decoupled by C21. At this stage the power supply is suitable for the high current stages (12Vh). R28 along with C22 filter 12Vh for the low current stages (12Vl). R29 and R30 divide 12Vl to provide the 6V reference voltage (6V). Also R27, ZD1 and C20 provide the supply for the microphones if necessary. The reason for all the attention to the power supply is that when using microphones such as electrets where a bias current is necessary, oscillation may occur due to feedback through the power supply from the higher power stages, as I have encountered previously in some designs.

is too long then the value of these may be reduced

but it should not be so small that the passenger microphone cuts in and out between transmitting and receiving as this will reduce the life of the relay.

C1,C2,C4,C5:

These may be reduced to reduce the bass response (as a LPF) if it is found that bass background noise is above an acceptable limit.

BR1:

This is a wire bridge, however can be removed for a capacitor (1 μ), if there is a sufficient voltage difference between the output of the passenger microphone amp and the input of the mixer to cause loud clicks when the relay switches. This will serve to block the DC and thus eliminate the clicks.

PCB Construction

As usual get all the passive components mounted first (resistors then caps etc...). The two TL072s and the LM349

can be mounted in sockets while the LM380 should be soldered in to provide some sort of heatsinking. The PCB construction is much the same as with other designs and is not complicated. It should be noted that the Headset sockets should be wired in a specific standard way shown in Figure 3. The DC connector may be wired as you like as there doesn't appear to be any standard here. I prefer to use a positive centre as there is less chance of this accidentally shorting to ground.

Testing

Once the board is assembled check once again that the electrolytics and diodes are the correct way round and set the presets to the centre, the volume controls (RV7 and RV8) to minimum and SW2 to position 1. Then tack the other components on and connect it up to a power supply with the current limit (if available) on about 250mA. The unit should come alive. First check to see that none of the components are getting hot. If they are, switch off immediately and check the unit over again. If all seems well check that the outputs of the TL072s and LM380s are approximately 6V (half supply). Also check that the priority switch is working correctly by playing some music to it (you may have to adjust RV5) as well as switching the input from the talk-switch from 12V to 0V (remember there is a delay).

If all seems OK connect up some headsets (make sure the volume is on minimum first) and try it.

Housing The Unit

It will require a strong box (depending on how hard the landings will be (ie if the aircraft is being used for training, the box should be strong and well secured). Mounting the unit was done with Velcro on the first one so it would be easily removed (also the pilot is experienced and lands nicely).

The box I used is made from metal sheeting (normally easy to find in hardware shops and cheap). The sheet can be cut into the correct size panels and bent easily in a vice (a hammer is useful to get good square edges by taping along the bend while in the vice). The details are shown in Figure 9.

Installation And Setting Up

Before mounting the unit the presets should be adjusted.

RV1 and RV2 set the gain of the microphone amps. These should be adjusted for a comfortable level on a volume setting a bit below where you will normally run it (In the 'plane more volume will be necessary to overcome noise).

Next connect it to the radio (not the talk-switch at this stage)

and select a busy channel. Set the volume on the radio to the normal level and again the volumes on the unit to slightly below normal, and set RV4 for a comfortable level. Now switch to an unused channel (if available) and squelch it heavily. Next set RV6 so the priority LED just goes out (don't get caught by the delay). The squelch can be reduced and when the noise comes on the LED should also light.

If not, continue adjusting the preset until it does. Now check the voltage with a DMM at the talk-switch (radio end - you may be able to connect the talk-switch input to the microphone connection to the radio and sense the biasing of the microphone - this reduces connections and wiring be-

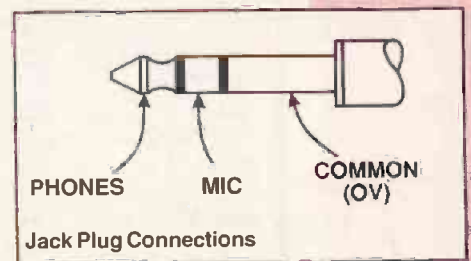

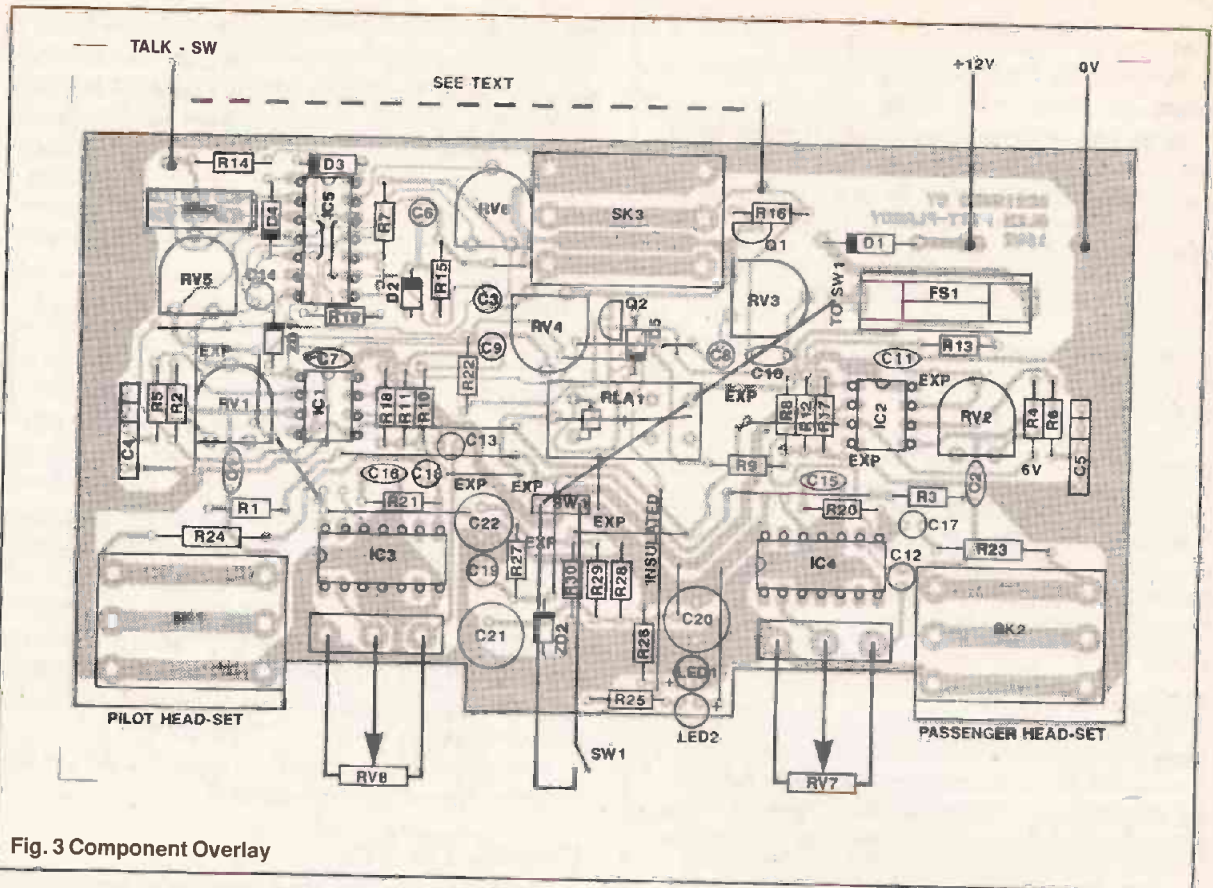

Fig. 3 Component Overlay

tween the unit and radio). Also check the voltage with the talk-switch depressed. Now set RV5 so the voltage at the slider of RV5 is between these voltages. You may now

connect the talk-switch. If the LED remains on then change the position of SW2. The LED should only light when the talk-switch is operated or a transmission received. If not,

PARTS LIST

RESISTORS

ALL 1/4W unless otherwise specified

R1,3	12k	SEE TEXT
R2,4,7,22	100k	
R5,6	1k	
R8,9,11,13,15,17,18	10k	
R10,12	SEE TEXT	
R14	1M8	
R16	1M2	
R19	220k	SEE TEXT
R20,21	2R7	W
R23,24	33R	W
R25,26,27	820R	SEE TEXT
R28	100R	
R29,30	470R	
RV1,2,5,6	100k	Horiz preset
RV3	10k	Horiz preset
RV4	100R	Horiz preset
RV7,8	10k	Log pot

CAPACITORS

C1,9	3n3	SEE TEXT
C3,6,8,9,12,13	1 μ	25V
C4,5	330n	SEE TEXT
C7,10,11,15,16	100n	
C14	10 μ	SEE TEXT
C17,18	47 μ	25V
C19	47 μ	25V SEE TEXT
C20	470 μ	25V
C21,22	220 μ	25V

SEMICONDUCTORS

IC1,2	TL072CP
IC3,4	LM380N
IC5	LM349N or LM348N
Q1,2	BC548 etc
D1	1N4001 etc
D2,3,4,5	1N4148
LED1	GREEN 5mm
LED2	RED 5mm
ZD1	3V3 400mW
ZD2	9V1 400mW SEE TEXT

MISCELLANEOUS

SW1	SPST 1A TOGGLE
SW2	DPDT SLIDE
RLA1	12V NC CONTACTS
FS1	50mA 20mm
SK1,2,3	6.3mm STEREO SOCKET
SK4	2.5mm SOCKET OR SIMILAR (FOR TALK-SWITCH)
SK5	DC SOCKET
Fuse holder, LED holders, IC sockets, Case, Knobs, Headsets	

BUYLINES

None of the components should be any problem. Any reasonable supplier should be able to supply everything.

PHOTO-COPIES

ETI has been published for over 19 years and in this time a great many interesting and valuable projects and features have graced its pages. Although backnumbers are available for only the past 12 month's issues we can supply photocopies of any individual article ever published in ETI.

Photocopies cost £1.50 per article regardless of their length. Please note that projects published over several issues must be ordered as a series of individual articles, each for £1.50.

PCB foil patterns (where published) and any errata are included with all photocopies as applicable.

BACK NUMBERS

- Missed part one of your favourite project?
- Lost that all-important article on circuit design?
- Desperately need that Tech Tip to get your latest masterpiece going?
- Pining for that one issue to complete your valuable collection?

ETI Backnumbers Department to the rescue!

Please note that backnumbers are only held for 12 months. Articles published previous to this must be obtained through our photocopy service.

Please supply photocopies of the following articles from ETI (complete in block capitals):

Month Year Page (if known)

Title

Month Year Page (if known)

Title

Month Year Page (if known)

Title

I enclose a cheque/postal order made out to ASP Ltd. to the value of £1.50 per photocopy ordered.

Total remittance £ Date

Name

Address

..... Postcode

Send the completed form and your remittance to:

ETI Photocopy Service
Argus House
Boundary Way
Hemel Hempstead
Herts HP2 7ST



Please supply photocopies of the following back-numbers of ETI.

Note: Backnumbers are held for 12 months only (complete in block capitals)

Month Year Moth Year

Month Year Month Year

Month Year Month Year

Month Year Month Year

I enclose a cheque/postal order made out to ASP Ltd. to the value of £2.20 per issue ordered.

Total remittance £ Date

Name

Address

..... Postcode

Send the completed form and your remittance to:

ETI Backnumbers Department
Argus Subscription Services
Queensway House
2 Queensway
Redhill
Surrey RH1 1QS



ESR

ESR ELECTRONIC COMPONENTS

Station Road, Cullercoats,
Tyne & Wear NE30 4PQ

Tel: 091 251 4363

Fax: 091 252 2296

TEST AND MEASUREMENT

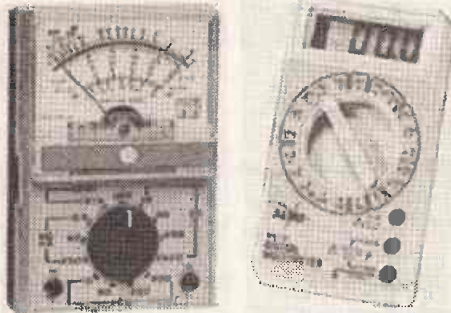

HC213 ANALOGUE METER:
12 ranges, diode protection, mirrored scale, 2mm leads. Pocket sized, supplied with battery and instructions.
Dim. 90 x 60 x 30mm **£5.96**

HM103S ANALOGUE METER
19 ranges (inc 10A ac), fuse and diode protection, battery test, shock resistant hinged case, mirrored scale, supplied with battery, leads and instructions.
Dim. 154 x 77 x 43mm **£11.47**

HC2020S ANALOGUE METER
20 Ranges (inc 10A dc), fuse and diode protection, transistor and diode testing, polarity reverse switch, high impact shock resistant case, supplied with battery, leads, stand and instructions.
Dim. 150 x 102 x 45mm **£18.45**

NX190 DIGITAL METER
19 ranges, 3.5 digit 12mm LCD, signal injector, diode test, fuse protection, auto polarity and zero, supplied with battery, leads and instruction manual.
Dim. 126 x 70 x 24mm **£14.73**

M2315B DIGITAL METER
17 ranges (inc 10A dc), 3.5 digit 12mm LCD, diode test, buzzer, auto polarity and zero, over-range and low battery indication, supplied with battery, leads and instructions.
Dim. 130 x 72 x 33mm **£23.40**

TL34 DIGITAL METER
33 ranges (inc 20A ac/dc) PTC and fuse protection, 5 capacitance ranges, transistor test, 3.5 digit large 24mm display, Heavy duty case with tilt stand, supplied with battery, leads and instructions.
Dim. 191 x 88 x 36mm **£27.59**

We stock a full range of test equipment from leading manufacturers HITACHI · KENWOOD · LEADER · THURLBY · THANDAR

Full product material is available. Why not call and see our extensive range of equipment.

HYT07 Logic Probe £7.72
TM357 Digital Meter £36.06
TM452 Digital Meter £138.50
TM355 Digital Meter £69.50
TM301 Digital Thermometer £59.50

V665 60MHz Scope £345.00
LC0100 DMM Scope £399.00
SC110A 10MHz Scope £249.00
TD201 Digital Storage Unit £195.00
20MHz LCD Generator £249.00

V6165 5MHz Pulse Gen £119.00
17A Signal Generator £122.00
LPM000 Laser P/Meter £174.00
TPI Logic Probe £23.00
TP2 Logic Puffer £23.00

SWITCHES

Miniature Toggle Switches Ramp 250V 6Amin mounting

SPST Toggle £0.58
SPDT Toggle £0.54
SPDT CO Toggle £0.62
DPDT Toggle £0.68
DPDT CO Toggle £0.74
DPDT CO Toggle (based) £1.20
DPDT CO Toggle (based 1 way) £1.20

DIPST min slide £0.15

ROTARY SWITCHES

1 POLE 12 WAY £0.70
2 POLE 6 WAY £0.78
3 POLE 4 WAY £0.78
4 POLE 3 WAY £0.78

Key Switch SPST £0.25
Push to make £0.24
Push to break £0.58
Latching Push Swr £0.25
PCB Tact 6 x 6mm

CA3140 £0.56
CA3240 £1.22
LM3900 £0.72
LM3914 £2.70
LM3915 £1.70
MC4558 £0.36
NE5532 £0.80
ICL7621 £1.70
ICM7555 £0.43
ICM7558 £0.96
ZNA 14Z £1.04
ZNA25E £4.68
ZNA26E £2.61
ZNA27E £8.82
ZNA28E £6.12
ZN435E £5.31
ZN440E £7.92
MC3340 £1.80

74LS257 £0.24
74LS258 £0.24
74LS26 £0.14
74LS266 £0.14
74LS27 £0.14
74LS279 £0.32
74LS30 £0.25
74LS32 £0.14
74LS33 £0.21
74LS365 £0.21
74LS367 £0.21
74LS368 £0.21
74LS37 £0.14
74LS373 £0.32
74LS374 £0.32
74LS375 £0.34
74LS377 £0.32
74LS378 £0.62
74LS38 £0.14
74LS390 £0.25
74LS393 £0.24
74LS399 £0.26
74LS40 £0.62
74LS42 £0.14
74LS44 £0.25
74LS47 £0.42
74LS51 £0.14
74LS670 £0.69
74LS73 £0.17
74LS74 £0.19
74LS75 £0.19
74LS76 £0.25
74LS83 £0.31
74LS85 £0.35
74LS86 £0.20
74LS90 £0.23
74LS92 £0.35
74LS93 £0.25

4019 £0.19
4020 £0.31
4021 £0.31
4022 £0.32
4023 £0.16
4024 £0.21
4025 £0.15
4028 £0.40
4027 £0.18
4028 £0.22
4029 £0.27
4030 £0.17
4031 £0.70
4035 £0.56
4040 £0.29
4041 £0.31
4042 £0.22
4043 £0.28
4044 £0.31
4046 £0.31
4047 £0.25
4048 £0.31
4049 £0.20
4050 £0.20
4051 £0.25
4052 £0.25
4053 £0.30
4054 £0.56
4055 £0.30
4060 £0.31
4063 £0.29
4066 £0.18
4067 £1.91
4068 £0.16
4069 £0.20
4070 £0.17
4071 £0.20
4072 £0.17
4075 £0.17
4078 £0.30
4077 £0.17
4081 £0.14
4082 £0.17
4085 £0.28
4086 £0.26
4089 £0.55
4093 £0.15
4094 £0.31
4095 £0.56
4097 £1.20

2N2222A £0.16
2N2646 £0.80
2N2904A £0.25
2N2905A £0.23
2N2907 £0.20
2N2926 £0.16
2N3053 £0.27
2N3054 £0.90
2N3055 £0.62
2N3440 £0.50
2N3702 £0.09
2N3703 £0.10
2N3704 £0.10
2N3705 £0.10
2N3772 £1.44
2N3771 £1.51
2N3773 £1.79
2N3819 £0.40
2N3820 £0.58
2N3904 £0.10
2N3905 £0.10
2N3906 £0.10
2N3908 £0.31
2N4036 £0.31
2N5296 £0.57
2N5321 £0.60
2N6107 £0.30
AC126 £0.30
AC127 £0.30
AC128 £0.28
AC187 £0.37
AC188 £0.37
AC17 £3.84
AD149 £1.67
AD161 £0.92
AD162 £0.92
BC107 £0.14
BC107B £0.15
BC108 £0.12
BC108A £0.14
BC109 £0.14
BC109C £0.15
BC114 £0.41
BC115 £0.41
BC116 £0.41
BC118 £0.41
BC132 £0.36
BC134 £0.36
BC135 £0.36
BC140 £0.29
BC141 £0.27
BC142 £0.31
BC143 £0.34
BC149 £0.12
BC154 £0.36
BC157 £0.12
BC159 £1.12
BC160 £0.28
BC170 £0.16
BC171 £0.11
BC171B £0.16
BC172 £0.13
BC172B £0.13
BC177 £0.17
BC178 £0.17
BC179 £0.17
BC182 £0.08
BC182L £0.08
BC182LB 90.08
BC183 £0.08
BC183L £0.08
BC183LB £0.08
BC184 £0.08
BC186 £0.33
BC204C £0.72
BC206B £0.72
BC207C £0.72
BC208 £0.72
BC209A £0.72
BC212 £0.08
BC212L £0.08
BC212LB £0.08
BC213 £0.08
BC213LC £0.08
BC214 £0.08
BC214L £0.08
BC237B £0.09
BC238C £0.09
BC239C £0.10
BC251 £0.13
BC252 £0.13
BC261B £0.24

RF CONNECTORS

EMC Shield Plug £0.65
EMC Crimp Plug £0.68
EMC Solder Sto £1.06
PL259 9.2mm £0.70
PL259 11mm £0.54
SO UNF socket £0.53
SMD UNF socket £0.40
F Plug RG55 £0.27
F Plug RG6 £0.27
N Plug RG8 £1.64

REG'S

78L05 £0.24
78L12 £0.24
78L15 £0.24
78L24 £0.28
78L34 £0.28
78L47 £0.42
78L51 £0.28
78L50 £0.28
78L52 £0.28
78L53 £0.28
78L54 £0.28
78L55 £0.28
78L56 £0.28
78L57 £0.28
78L58 £0.28
78L59 £0.28
78L60 £0.28

BRIDGE RECTIFIERS

WD05 1.5A 50V £0.19
WD2 1.5A 200V £0.20
WD10 1.5A 1000V £0.24
BP32 3.0A 200V £0.36
BP32 6.0A 200V £0.84
1504 1.0A 400V £1.39

74LS-SERIES

74LS00 £0.14
74LS01 £0.14
74LS02 £0.14
74LS03 £0.14
74LS04 £0.14
74LS05 £0.14
74LS08 £0.14
74LS09 £0.14
74LS10 £0.14
74LS107 £0.23
74LS109 £0.21
74LS11 £0.17
74LS112 £0.21
74LS113 £0.21
74LS114 £0.21
74LS12 £0.14
74LS122 £0.31
74LS123 £0.31
74LS125 £0.21
74LS126 £0.21
74LS13 £0.14
74LS132 £0.21
74LS133 £0.18
74LS136 £0.16
74LS138 £0.24
74LS139 £0.25
74LS14 £0.18
74LS145 £0.56
74LS147 £1.26
74LS148 £0.70
74LS15 £0.14
74LS151 £0.25
74LS153 £0.25
74LS154 £0.70
74LS155 £0.25
74LS156 £0.25
74LS157 £0.25
74LS158 £0.25
74LS160 £0.32
74LS161 £0.32
74LS162 £0.32
74LS163 £0.32
74LS164 £0.26
74LS165 £0.48
74LS179 £0.30
74LS173 £0.24
74LS174 £0.24
74LS175 £0.24
74LS190 £0.25
74LS191 £0.24
74LS192 £0.24
74LS193 £0.24
74LS195 £0.24
74LS196 £0.24
74LS197 £0.24
74LS20 £0.16
74LS21 £0.14
74LS22 £0.14
74LS221 £0.36
74LS240 £0.32
74LS241 £0.32
74LS242 £0.32
74LS243 £0.32
74LS244 £0.32
74LS245 £0.33
74LS247 £0.32
74LS251 £0.24

DIL SOCK'S

8 Pin £0.07
14 Pin £0.11
16 Pin £0.15
18 Pin £0.15
20 Pin £0.16
24 Pin £0.19
28 Pin £0.22
40 Pin £0.25

DIODES

Zener Diodes 2V7 to 33v £0.08
BY848DMMw £0.08
BZY85T3W £0.14
IN4001 £0.06
IN4002 £0.07
IN4003 £0.07
IN4004 £0.07
IN4005 £0.07
IN4006 £0.08
IN4007 £0.08
IN5400 £0.09
IN5401 £0.09
IN5402 £0.09
IN5404 £0.11
IN5406 £0.11
IN5407 £0.14
IN5408 £0.06
IN914 £1.26
IN916 £0.70
IN4148 £0.14
BY133 £0.25
OA47 £0.28
OA90 £0.07
OA91 £0.10
OA202 £0.14
BA157 £0.10
BA158 £0.10
BA159 £0.10
IN4149 £0.06
OA200 £0.10

D CONNECTORS



SOLDER BUCKET TERMINALS

Plug Socket

9 Pin £0.29 £0.30
15 Pin £0.39 £0.39
15 Pin HD £0.31 £0.31
23 Pin £0.40 £0.40
25 Pin £0.48 £0.48

9 Way plastic cover £0.30
15 Way plastic cover £0.33
23 Way plastic cover £0.36
25 Way plastic cover £0.36

LINEAR IC's

TL061 £0.35
TL062 £0.42
TL064 £0.46
TL071CP £0.32
TL072CP £0.34
TL074CN £0.48
TL081 £0.33
TL082CP £0.34
TL084CN £0.46
TBA120S £0.77
LM301A £0.25
CA314E £0.28
CA324 £0.23
LM348N £0.31
LF351N £0.36
LM358N £0.36
LM377 £2.57
LM380N £1.12
LM381 £2.70
LM386 £0.48
LM387 £1.60
LM392N £0.79
LM393N £0.28
LM394 £3.98
CA555 £0.22
NE531 £1.56
NE5534 £0.66
NE5536 £0.36
NE5567N £0.36
UA733 £0.64
CA741CE £0.18
CA747CE £0.39
CA3130E £0.98
LM748CN £0.31
TBA810S £0.68
TBA820M £0.39
LM1458 £0.28
TLC2004 £0.46
TLC2030 £1.35
CA3046 £0.37
CA3080 £0.72
CA1310 £0.98

4000 Series

4000 £0.17
4001 £0.17
4002 £0.17
4006 £0.32
4007 £0.17
4008 £0.31
4010 £0.23
4011 £0.16
4012 £0.16
4013 £0.17
4014 £0.30
4015 £0.31
4016 £0.18
4017 £0.25
4018 £0.27

TRANSISTORS

2N1613 £0.31
2N1711 £0.26
2N1893 £0.29
2N2218A £0.28
2N2219A £0.25

THYRISTORS

PN02AA £0.30
TIC1660 £0.40
TIC1160 £0.66
TIC1260 £0.77

ORDERING INFORMATION

All prices exclude VAT.
Please add £1.25p carriage to all orders and VAT (17.5%). No minimum order charge. FREE Computer listing with all orders over £5.00.
Please send payment with your order. PO/Cheques made payable to ESR Electronic Components
Access and Visa cards accepted. Official orders from schools and colleges welcome.

CALL IN — OPEN: MON-FRI 8.30-5.00 SAT 10.00-5.00

Why Waveguides?

Reasonable Frequencies

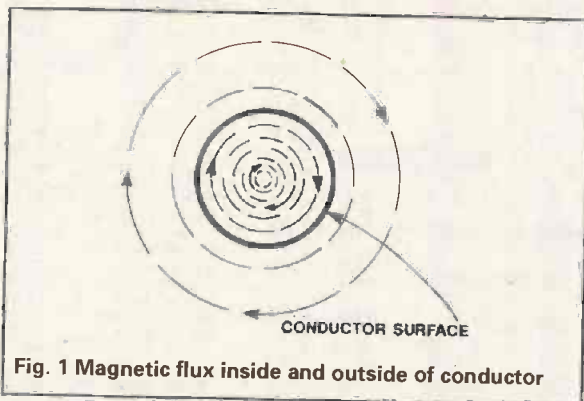

Fig. 1 Magnetic flux inside and outside of conductor

by A P Stephenson

Persuading alternating currents of reasonable frequency to travel along a pair of wires is a straightforward task. Providing the wires are good conductors and the material in between the wires is a good insulator then a substantial part of the electrical energy injected at one end is available for use at the other end. There may be small losses due to the finite conductivity of the wires and even smaller losses due to leakage across the insulation but these are second-order effects and seldom justify their intrusion into the calculations.

Of course, it all depends on what is meant by reasonable frequency or, more appropriately, reasonable wavelength. In general, certain additional complications arise when the length of the conductors is greater than about one tenth of the transmission wavelength. For example, a frequency of 300MHz has a wavelength of one metre which means that a pair of wires greater than about 100mm long are no longer content to be left out of the calculations because the time taken for currents to pass down the line is no longer negligible. Unless steps are taken to allow for this, all manner of irritating effects can be expected – in short, the previously humble pair of wires must be elevated to the status of a Transmission Line and designed accordingly. The set of rules which deal with things like reflections, standing waves, nodes and antinodes come under the general heading of Transmission Line Theory.

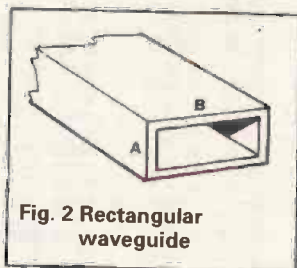

Fig. 2 Rectangular waveguide

Losses In Transmission Lines

However careful transmission line theory is applied, there

is always a certain fraction of transmitted energy lost on its way down the line. Irrespective of whether the line is 'parallel twin' or 'coaxial', the losses can be grouped as follows:

1. Dielectric losses

The dielectric material used to insulate the space between the wires can never be a perfect insulator so there will be a tiny amount of shunt leakage. There is an additional and more serious loss at the higher frequencies due to dielectric heating. The rapid reversals of electric lines of force cause the molecules of the dielectric to vibrate which, in turn, produce heat – an interior 'microwave oven' effect! Since dielectric heating increases rapidly with frequency there must be an upper frequency limit where a practical length transmission line squanders more energy within itself that it delivers.

2. Skin effect in conductors

As shown in Figure 1, the magnetic flux lines which surround a current-carrying conductor also extend within the core, reaching their maximum density at the centre. When the current is alternating, the changing magnetic fields induce EMFs

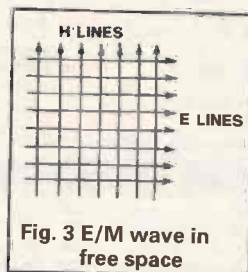

Fig. 3 E/M wave in free space

which, by Lenz's Law, must oppose the original cause. The majority of the current is thus forced to the outside skin of the conductor, thereby reducing the effective cross-sectional area and hence, the effective resistance. The inner conductor of a coax, being the smaller in cross section, is responsible for most of the total skin resistance.

Transmission line losses can become serious at frequencies in the hundred MHz range. At frequencies in the thousand MHz range (1GHz = 1,000MHz) the losses can be intolerable.

Removing the lossy components

Since the inner conductor of a coax is responsible for most of the losses, why not leave it out altogether? If it comes to that, why not leave out the dielectric as well? It was only there to support the inner so its presence is superfluous!

By getting rid of these two offending parts, dielectric and skin resistance losses could be abolished at a stroke. This sounds an attractive solution but there is something worrying about it - something not quite right.

Two conductors are needed to pass a continuous current but now there is only one – the outer of the coax which is nothing more than a metal tube. Now this is where lateral thinking can bring results. Transmitting the energy

by normal current flow down a hollow tube is of course a non-starter but transmitting the energy in the form of an electro-magnetic wave is certainly possible. An e/m wave doesn't require two conductors – in fact it doesn't even require one so, in theory at least, it should be possible to persuade the wave to pass down a metal tube. In other words, the tube could become a 'waveguide'.

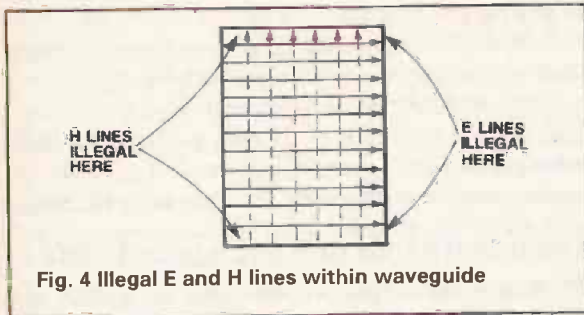

Fig. 4 Illegal E and H lines within waveguide

Waveguide Shape

It is not sufficient to just pass an e/m wave down a metal tube, it is vitally important that the direction of the electric and magnetic field at any point further along the guide is predictable. For example, if the energy at the far end of the waveguide is to be extracted by a short metal probe 'aerial' it is essential that the probe is positioned at a point where the electric field strength is maximum. On the other hand, if the energy is to be extracted by means of a small closed loop aerial, it is essential to position it at a point where the magnetic field is maximum. It may also be necessary to insert probes at certain points in order to measure the field strength within the guide.

For these reasons, long lengths of waveguide are always rectangular in cross-section rather than circular with one dimension longer than the other as shown in Figure 2. As will be seen later, the unequal dimensions force the wave to propagate in a certain, and therefore predictable, field pattern.

We shall call the shorter side the 'A' dimensions and the longer side the 'B' dimension.

The field directions in circular waveguides tend to be unpredictable because there is always a danger that the field lines, because of the cross-sectional symmetry, may slip round a short distance away from the point of injection. Consequently, such guides are only used where absolutely necessary and only then in very short lengths. In radar systems using a scanner, there is a need for some form of a rotating joint so a short length of circular guide becomes unavoidable – rectangular bearings are not too popular with engineers.

Boundary Conditions

Certain problems arise when an attempt is made to pass an e/m wave straight down a metal guide. To understand these problems, it is necessary to consider the structure of such a wave in free space. According to Figure 3, the electric field lines, (E lines) are always at right angles to the magnetic field lines (H lines) and the direction of propagation is always at right angles to both of them. At first sight, there seems no reason why a wave can't be persuaded to pass straight down a rectangular waveguide. There is a reason – in fact an extremely powerful reason why such an

attempt would fail. It would offend the 'boundary laws' of both the magnetic and electric fields which are:

1. The Boundary Law for E lines (Figure 4)

An E line, or its vector resultant, can never be parallel with, when close to, a perfectly conducting surface.

(If an E line was parallel and close to a perfectly conducting surface, there must have been a difference in potential between two points on the surface – a condition which is patently impossible!)

2. The Boundary Law for H lines (Figure 5)

An H line, or its vector resultant, can never leave or enter a perfectly conducting surface at right angles.

(As shown earlier in Figure 1, H lines always surround a conductor at the surface, i.e. they must lie parallel to the surface.)

For the purposes of these two laws, the waveguide walls can be considered perfect conductors so, as Figure 6 shows, an e/m wave cannot possibly travel straight down the guide without offending both laws.

The Bouncing Wave

An e/m wave can travel down a waveguide without offending either of the two boundary laws by bouncing between the top and bottom walls as it travels. The E lines point into, or away, from the paper so to avoid unnecessary clutter, Figure 5 is showing only the relation between the H lines and the direction of travel.

Note that the horizontal components of the H vector are additive but the vertical components are in opposition and so cancel each other out. The H line boundary rules are therefore not infringed.

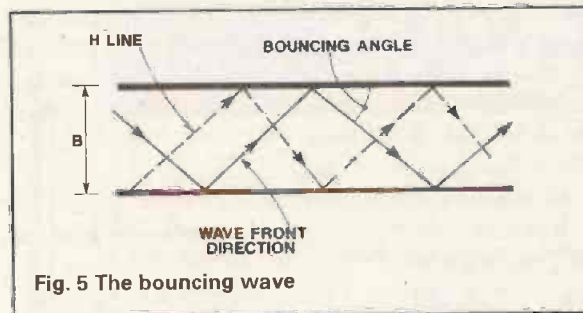

Fig. 5 The bouncing wave

The Bouncing Angle

The angle which the direction of travel vector makes with the wall of the guide is called the 'bouncing angle'. As this angle is increased towards 90 degrees, the number of bounces per unit length increases. The relation between the free-space wavelength (λ_0) and the B dimension of the guide determines the bounding angle.

The Guide Wavelength

Because the wave travels along the guide by a series of up and down bounces, it follows that the effective velocity of the wave as measured along the guide axis is slower than it would be in free space. Because the concept of 'wavelength' is velocity over frequency, then it is to be expected that the guide wavelength (λ_g) will always be longer than the free space wavelength. If the bouncing angle is small, there will be few bounces per unit length and so the guide wavelength will not be much greater than it would be in free-space. However, if the bouncing angle is increased the

guide wavelength will also increase. Taking this to the extreme, if the bouncing angle were to reach 90° the wave would keep bouncing back and forth at the same point without progressing. The wave would then be a stationary wave, or, to give it its proper technical title, an 'evanescent' wave.

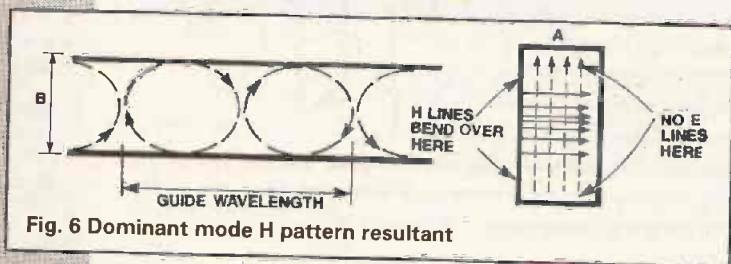

Fig. 6 Dominant mode H pattern resultant

The Guide Dimensions

The longer dimension, (the B side) of waveguides is the more important of the two. It should be greater than half but less than a full free-space wavelength.

Example: If the frequency is 3GHz, the free-space wavelength is 100mm so the B dimension of the guide should be greater than 50mm but less than 100mm. There are two reasons why the guide dimensions should be within these limits:

1. To ensure the Wave Travels
The bouncing angle would be 90° if the B dimension was reduced to half a free-space wavelength so, as mentioned above, the wave would not travel down the guide.

2. To trap the dominant mode
Depending on the B dimension, the wave pattern within the guide can take many forms. The so-called 'Dominant Mode' is not only the simplest pattern possible, it is also the one which requires the smallest B dimension. By ensuring the dimension is less than one full free-space wavelength, only the dominant mode can travel since the higher order modes would be evanescent.

The A dimension is not critical providing:

1. It is narrower than the B dimension
2. It is wide enough to prevent arcing when the guide is carrying high power.

The Cut-off Wavelength (λ_{co})

It follows from the above that a guide with a given B dimension will allow all frequencies to pass providing the free-space wavelength is less than 2B. So, $(\lambda_{co}) = 2B$

Example: The cut-off frequency of a guide with a B dimension of 20mm would have a cut-off wavelength of 40mm. This means that only wavelengths less than 40mm could travel down the guide.

The usual compromise is to make the B dimension equal to about three quarters of the free-space wavelength. This ensures a good safety margin between cut-off conditions and the possibility of allowing access to higher order modes.

Wave Classification

The labelling procedures for the various wave patterns can be a little confusing due to lack of standardisation in the early days. Waveguides received prominence during the World War II when most of the radar research was carried out by UK boffins. Unfortunately, their method of wave classification conflicted with later work carried out by

their USA counterparts – hence the confusion. Anyway, what's in a label? The relative merits of various labels and symbols is of little importance providing they are used consistently in the same text.

1. Transverse Electric (TE Waves)

If the pattern is such that an E line never points along the guide axis, then it is said, by some authorities to be a Transverse Electric wave. TE waves are the most popular in long lengths of guide.

Other authorities call a TE wave an H wave because the H lines sometimes point along the guide axis.

2. Transverse Magnetic (TM Waves)

This label is applied if no H lines point in the guide direction.

Again, other authorities call a TM wave an H wave.

Dominant Mode in Rectangular Guide

The term 'mode' is used to define particular E and H line patterns which emerge as the result of the wave bouncing action. In particular, the Dominant Mode is that which requires the smallest cross-sectional guide dimension. In rectangular guides, the dominant mode is called either the TE₁₀ or the H₀₁, depending on which labelling method is employed.

Irrespective of the labelling fashion in use, the pattern of the dominant mode in rectangular guides is shown in Figure 6. It is clearly a transverse electric wave since the electric field line (the E lines) always point across the guide, never along the guide axis. The magnetic lines (the H lines) form closed loops parallel with the longer side, each loop occupying half a guide wavelength.

Dominant Mode in Circular Guides

As mentioned earlier, the use of circular guides is restricted to short lengths only because of the tendency of the field pattern to slip round.

The dominant mode in circular guides, shown in Figure 7, is the E₀₁ mode. It is best understood by relating it to the kind of pattern which would result from a coaxial with the inner conductor removed. Note that the pattern is symmetrical around the guide axis, a characteristic which is ideally suited for rotating joints. Although not shown in Figure 7, the E lines, which appear to end on nothing, actually bend inwards along the guides axis and enter the walls again a half guide wavelength away.

Waveguide Impedance

Like coaxial and parallel twin transmission lines, waveguides also have a characteristic impedance (Zo) depending on the cross-sectional geometry. Rectangular guides have a relatively high Zo of around 600R so they have more in common with parallel twin lines than coax. In fact it is possible to explain the action of a rectangular guide by considering it to be constructed from a pair of parallel twin ribbons with an infinite number of 1/4 wave shorted stubs as shown in Figure 8.

1/4 wave stubs present an infinite impedance at their open ends so they have no short-circuiting effect on the parallel twin line. In the limit, as the number of stubs is increased towards infinity, we end up with a closed metal 'waveguide'. It would appear from this that the correct stub action would depend on one critical frequency – that which possessed the one correct 1/4 wave length. However,



Fig. 7 Dominant mode in circular guides

MICROWAVES

the main transmission ribbons can be assumed to vary in width so the effective stub length can, within limits, be self correcting.

Like all well-behaved transmission lines, they should disgorge their energy into a matched termination, ie. the load ZL should match the line Zo.

The Horn Antenna

The energy in a waveguide is often 'let out' into some form of dish to ensure a highly directional radiation beam. Irrespective of the type of dish, whether parabolic or some other queer shape, there remains the problem of impedance matching.

It is not always appreciated that free-space is something more than 'just a lot of nothing'. It has several physical properties but the one that concerns us here is its characteristic impedance (Zo) which is 377R.

If the wave is just let out of an open ended guide there will be a severe mismatch unless the guide impedance is lowered in some way - which is where the horn aerial comes in. The impedance of a guide is lowered if the walls are flared out as in Figure 9 so the horn, apart from providing improved illumination of a dish antenna, acts as an impedance matching device.

Summary

1. The losses in coaxial lines carrying GHz frequencies are unacceptable.
2. Rectangular guides are used wherever possible.
3. In order to satisfy boundary laws, e/m waves can not

pass straight down a guide - they must bounce along from wall to wall.

4. The wavelength within a waveguide is always longer than its free-space equivalent - the larger the bouncing angle with respect to the wall the longer the guide wavelength.

5. If the bouncing angle reaches 90 degrees, the wave is stationary because the wavelength will reach infinity.

6. The dominant mode is that which requires the smallest waveguide cross-section.

7. The dominant mode in rectangular guides called the TE₁₀ or sometimes the H₀₁.

8. The dominant mode in circular guides is called the E₀₁.

9. The characteristic impedance of a rectangular waveguide depends on the cross-sectional dimensions but is normally around 600ohms.

10. Flaring the waveguide out to form a horn can match the waveguide impedance to free-space (377ohms).

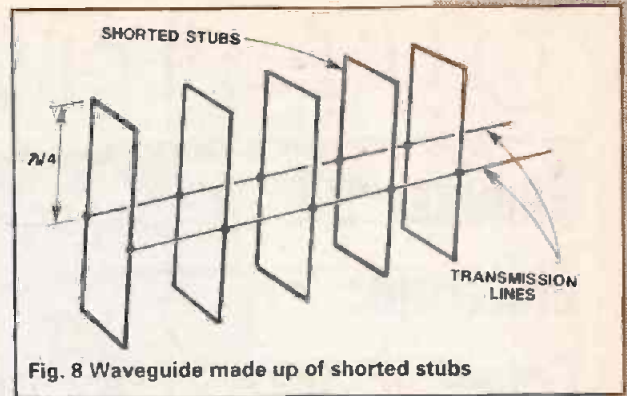

Fig. 8 Waveguide made up of shorted stubs

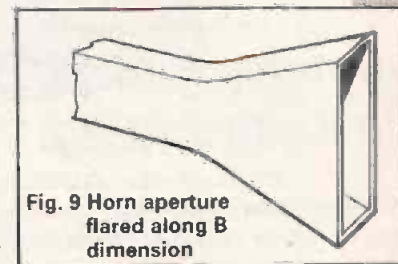

Fig. 9 Horn aperture flared along B dimension

LASER SCIENCE

We supply all Laser and associated optical components at low, low prices.

SPECIAL OFFER

HIGH POWERED
5mW Visible HeNe Laser Tubes,
£60 each. (including - VAT,
carriage & PSU Plans)

Easy to set up and operate.
These are new & direct
from the factory.
Not to be confused with
the usual lower powered
devices on offer.

For all your Laser requirements
Send S.A.E. To:- Laser Science Ltd.
P.O. Box 79, Prestwich,
Manchester M25 5AT
TEL: 061 773 0911. FAX: 061 773 0912

ETI

HALCYON ELECTRONICS

Test equipment, video monitors, amateur radio gear, printers, power supplies, communications, disk drives, multimeters, oscilloscopes, scientific instruments, connectors, component bridges, frequency counters, signal generators, computers.

<p>BECKMAN 9020 20MHZ DUAL TRACE £249</p> <p>CROTECH 3030 1 TRACE 15MHZ COMP TESTER £99</p> <p>DATA PRECISION 6000 WITH 6111 PLUG-IN AND 681 DISK DRIVE UNIT £3995</p> <p>GOULD OS3000A 40MHZ 2 TRACE, DEL T/B £249</p> <p>HAMEG 203-5 20MHZ, 2 TRACE, COMP TESTER £249</p> <p>HAMEG 203 20MHZ DUAL TRACE £199</p> <p>HITACHI VC6015 10MHZ DIGITAL STORAGE £395</p> <p>HITACHI V422 40MHZ DUAL TRACE £295</p> <p>H.P. 1340A X-Y DISPLAYS £99</p> <p>LEADER LBO-9C ALIGNMENT SCOPE £195</p> <p>PHILIPS PM3400 SAMPLING SCOPE £125</p> <p>TEK 5L4N 100KHZ SPECT ANAL WITH 5110 M/F, 2x 5A18N, 5B10N TIME BASE £750</p> <p>TELEQUIPMENT D75 50MHZ 2 TRACE DEL T/B £225</p> <p>TELEQUIPMENT D83 50MHZ 2 TRACE DEL T/B £249</p> <p>TEKTRONIX 7403N, DF1, 7D01 LOGIC ANAL £495</p>	<p>OERTLING V20 SINGLE PAN BALANCES 200GM £95</p> <p>MAGNIFYING BENCH LAMPS FROM £225</p> <p>RHODE & SCHWARZ PZN PHASE METER £125</p> <p>R&S SDR UHF SIG GEN 290-1020MHz £175</p> <p>WIRELESS WORLD CIRCARDS SER 1-25 cased £49</p> <p>SAGE 2-WAY CO-AX SWITCHES SAN2120 N CONNS £95</p> <p>UDI 2026 SONAR SCANNER, SURFACE UNIT £995</p> <p>B&K 1013 BFO & 2305 LEVEL RECORDER £195</p> <p>UPA CAVIDERM CD6 P.T.H. TESTER £750</p> <p>GOULD BRUSH 260 8-PEN CHART RECORDER £95</p> <p>CANNON ZOOM LENS C-MOUNT V6x17 17-102mm £95</p> <p>SONY HVC2010P COLOUR CAMERA £95</p> <p>MARCONI MARINE KESTREL 3 POA</p> <p>LOGIC ANALYSERS, VARIOUS From £45 to £95</p> <p>AVO CZ457/5 LCR COMPONENT COMPARATOR £75</p> <p>ANALYTICAL BALANCES WITH WEIGHTS £99</p> <p>LIGHT BOXES 230V 10x12" area £49</p>
--	---

SUMMER CLEARANCE

MANY UNLISTED ITEMS AT GREATLY REDUCED PRICES FOR CALLERS ONLY

<p>TEK 545B, 585, 535A, 541A etc From £49</p> <p>TEK 545/585 SERIES PLUG-INS From £10</p> <p>CONSTANT VOLTAGE TRANSFS 150VA-2KV POA</p> <p>18W POLAROID PALETTE, CGA £195</p> <p>COMMUNICATIONS RECEIVERS, VARIOUS POA</p> <p>VALRADIO FC8230/200 50Hz TO 60Hz 200W £95</p> <p>WANDAL/GOLTERMAN SPM-2 SEL LEVEL METER £169</p> <p>GUAGE BLOCKS (SLIP GJAGES) VARIOUS From £5</p> <p>MARCONI TP2331 DISTN FACTOR METER £175</p> <p>BBC-B & MASTER COMPUTERS From £99</p> <p>MARCONI TP2300 FM/AM MODULATION METER £195</p> <p>TEKTRONIX 834 PROG DATACOMMS TESTER £395</p> <p>VARIABLE OUTPUT PSUs HV & LV From £29</p> <p>TEKTRONIX 520 521A PAL VISCOPES From £475</p>	<p>DECADE R/C/W BOXES From £15</p> <p>KAYE DEE PNEUMO UV EXP UNIT 330x260mm £175</p> <p>VACUUM PUMPS TYP 100MBAR (28L/MIN) £95</p> <p>CALIBRATION STANDARDS CV/LR POA</p> <p>COSSOR CRM633A VHF NAVICOM AF SIG GEN } £750</p> <p>COSSOR CRM511 ILS/VOR AUDIO SIG GEN }</p> <p>TOPAZ 01007-11 7.5kVA 120/240-120/240 150L £249</p> <p>KINGSHILL NS1540 15V 40A PSU CASED £295</p> <p>MARCONI TF2300 AM/FM MOD METER 520MHz £245</p> <p>ROBIN 4112 PHASE EARTH LOOP TESTER £75</p> <p>ROBIN 5402 DIGITAL RCCB (ELCB) TESTER £75</p> <p>MARCONI TP2330 WAVE ANALYSER £150</p> <p>HP 618C, 626A, 628A SIG GEN £35 ea</p> <p>SIGNAL GENERATORS AF TO 21GHz From £15</p>
---	--

LIST AVAILABLE, BUT 1000's OF UNLISTED BARGAINS FOR CALLERS QUALITY ELECTRONIC EQUIPMENT BOUGHT. ALL PRICE EXC. OF P&P AND VAT

423, KINGSTON ROAD, WIMBLEDON CHASE, LONDON SW20 8JR
SHOP HOURS 9-5.30 MON-SAT. TEL 081-542 6383

OUT NOW!

Summer '92 Electronic Constructors Catalogue



Many new
products including:

- **Audio Amplifier Modules**
Range of 14 high power audio modules, encapsulated to an integral heatsink in Bi-polar, MOSFET and Class A formats with power outputs from 15 to 180 watts.
- **Books**
18 new titles from the top electronics publishers.
- **Burglar Alarm**
Volumetric alarm triggered by change in air pressure eg an opening door, easy to install - no wiring required.
- **Spectrum Analyser Adaptor**
Converts a conventional scope into a low cost, 250MHz spectrum analyser.
- **Low Profile Mains Transformers**
Encapsulated, top quality PCB mounting mains transformers.
- **Airband Scanning Receiver**
100 programmable channels, covering civil and military frequencies.
- **Stereo Valve Amplifier**
Top quality stereo hi-fi amp from Velleman - at a very competitive price!
- **Extended Ranges**
of connectors, equipment cases, filters, crystals, fuses, fans, kits, ATUs, semiconductors, loudspeakers, sounders and toroidal transformers.

With 24 product sections, 192 pages, 3000+ lines and £££s of discount vouchers, be sure to get your copy now!

Available from most newsagents or directly from Cirkit.

£1.70
+ 30p p&p

Cirkit



CIRKIT DISTRIBUTION LTD

Park Lane · Broxbourne · Hertfordshire · EN10 7NQ
Telephone (0992) 444111 · Fax (0992) 464457

OMNI ELECTRONICS

174 Dalkeith Road, Edinburgh EH16 5DX · 031 667 2611



A COMPREHENSIVE RANGE WITH SERVICE SECOND TO NONE OUR MUCH EXPANDED, BETTER ILLUSTRATED CATALOGUE WILL COST £1.50 - TO INCLUDE VOUCHERS TO USE AGAINST FUTURE PURCHASES. TO RECEIVE A COPY, PLEASE SEND YOUR REMITTANCE WITH YOUR NAME, ADDRESS AND TELEPHONE NUMBER REQUESTING A COPY OF THE 1990/91 OMNI CATALOGUE.



Open: Monday-Thursday 9.15-6.00
Friday 9.15-5.00 Saturday 9.30-5.00



MILLIONS OF QUALITY COMPONENTS AT LOWEST EVER PRICES

Plus Tools, Watches, Fancy Goods, Toys.
Mail order only. UK only.

All inclusive prices
NO post, or VAT etc to add on.

Send 34p stamped self-addressed label or envelope for catalogue/clearance list.
At least 2,100 offers to amaze you.

Brian J Reed Electronics
6 Queensmead Avenue, East Ewell
Epsom, Surrey KT17 3EQ
Tel: 081-393 9055

ARGUS BOOKS PUBLISHING FOR THE SPECIALIST

THE FULL RANGE OF ARGUS BOOKS

are available from
all good book
and hobby
shops or con-
tact Argus
Books direct
for an Autumn
1991 catalogue.

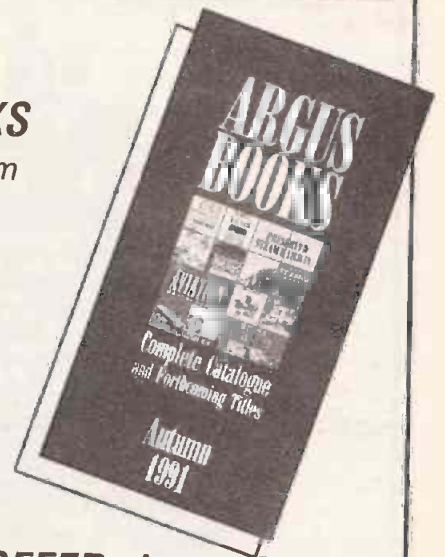

CATALOGUE OFFER, Argus Books,
Argus House, Boundary Way,
Hemel Hempstead, Herts.
OR PHONE 0442 66551 EXT. 204

Low cost data acquisition for IBM PCs & compatibles...

All our products are easy to install - they connect directly to either the printer or serial port and require no power supply. They are supplied with easy to use software which collects data for either display or print-out.

ADC-10

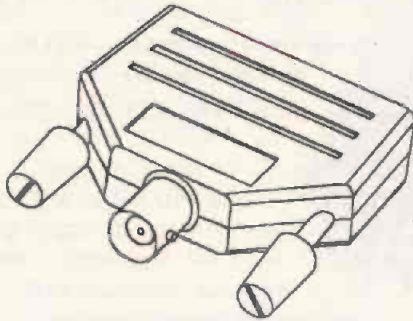

- 8-bit resolution
- One channel
- 10-25k samples per second
- Oscilloscope/Voltmeter software
- 0-5 V input range
- Connects to printer port

£49

ADC-11

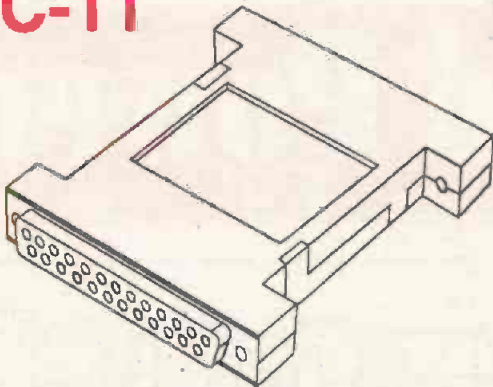

- 8-bit resolution
- 11 channels
- 5-20k samples per second
- Data logger software
- 0-2.5V input range
- Connects to printer port

£69

ADC-16

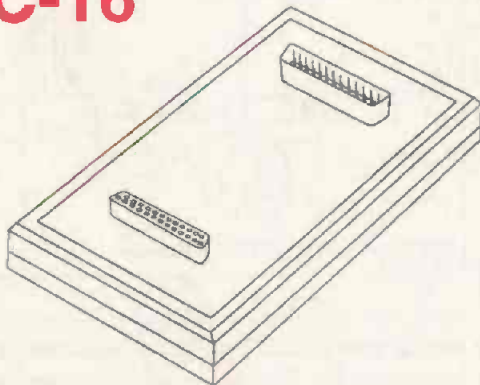

- 8,12,16-bit resolution + sign
- 8 s/e or 4 differential inputs
- 1 16 bit or 200 8-bit samples per second
- $\pm 2.5V$ input range
- Data logger software
- Connects to serial port

£99

Pico Technology Ltd
Broadway House,
149-151 St Neots Road
Hardwick, Cambridge, CB3 7QJ



Tel: 0954-211716
Fax: 0954-211880



All prices exclusive of V.A.T.

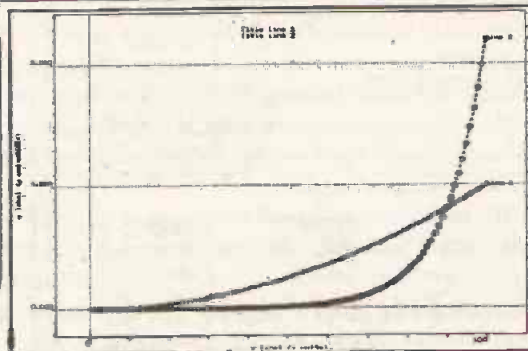

PICO TECHNOLOGY



ETI
Cover PCB Project

also transformer coupled which means that in the unlikely effect of catastrophic failure of the valves the speaker system is spared the damaging DC currents that would flow in a solid state amp. Considering the cost of a good speaker system this is no small advantage! Direct coupling reduces component count, improves transient response and allows a straightforward high performance design to be realised that can be tailored to modern requirements. Also high levels of performance can be realised without recourse to expensive components, especially coupling capacitors.

I listen extensively to CD's and to realise the optimum performance of this medium the specification of the amp must comply with stringent requirements. In particular I don't want hum or noise to detract from my enjoyment. Frequency response must extend to at least 15Hz at the low end and 50kHz at the top. THD must be firmly below 0.1% at all levels and frequencies below clipping level. The proper reproduction of low level detail and ambience effects require class A operation at least at levels of a few watts. In many ways S/N ratio and low level reproduction are closely related. Bearing in mind the rela-

45w Hybrid Power Amp

Use our free PCB to help you construct this transistor/valve amp. Presented by Jeff Macaulay

Although transistor power amplifiers have ruled the roost since the late 60's there are many, myself included, who have yet to hear anything sounding better than a pair of EL34s working in push pull. The EL34 was first introduced by Philips in 1956. With an anode dissipation of 25W this valve produced something of a revolution in the design of audio amps. After all, in those days a 10W amp was considered high powered. A pair of EL34's, correctly biased, can produce 45W of power. Whats more the valve is vastly more linear than a transistor output stage and can be operated with considerably more bias, relatively speaking than a transistor output stage.

Traditionally valve amplifiers have been designed around cascaded small signal triode amplifiers. This well tried and tested method is simple to implement but requires extensive capacitive coupling. In an audio amplifier based on valves the ammount of feedback that can be applied depends on the phase shifts imposed by the various stages, coupling capacitors and the output transformer. However it is possible to build a power amp taking advantage of the standard push pull valve output stage that has very little phase shift and that can be directly coupled together.

The main gains to be had from a valve amplifier stage include class A operation without the need for huge mains transformers and heatsinks. The ability to cope with very awkward speaker loads without distress, plus the ability to shrug off short circuit at the output. Valve output stages are

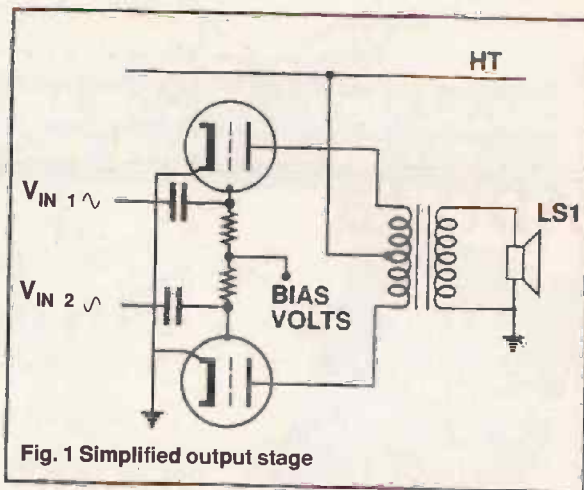

Fig. 1 Simplified output stage

tively high impedances and supply voltages required in a valve amp some method must be devised to keep noise pickup below audibility. Here silicon transistors score heavily. Apart from not requiring heaters they are generally much quieter devices.

To achieve quiet operation of the circuit a fully balanced design is used. As there is no such thing as a PNP valve, valve output stages tend to look wierd to our eyes. In fact the output stage is quite straightforward when broken down into it's component parts.

A simplified valve push pull output stage is shown in Figure 1. First the output transformer. Output valves are capable of producing plenty of power but unlike transistors they are high voltage high output impedance devices. The output impedance of an EL34 varies with bias but is of the

mp

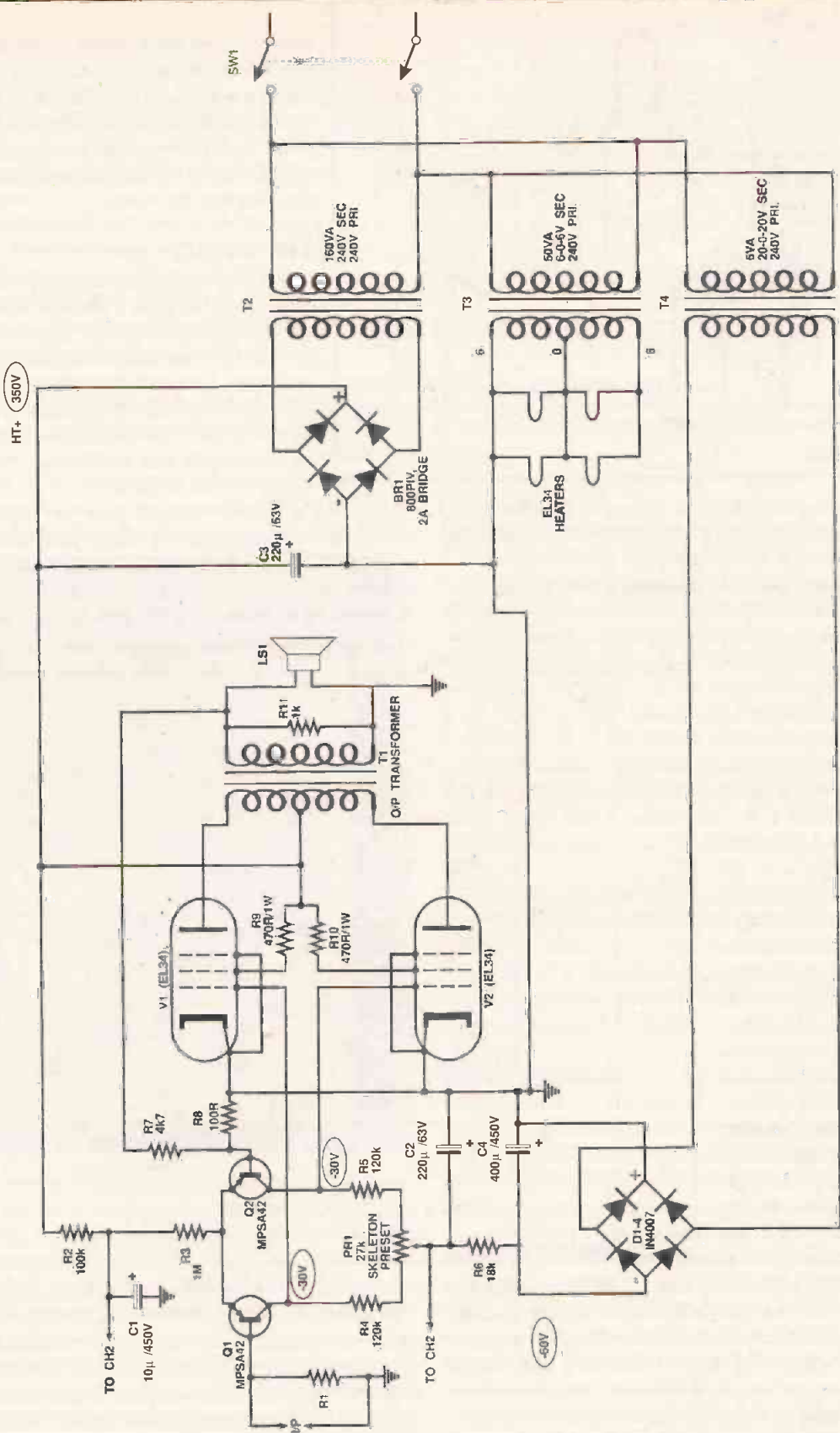

Fig. 2 Circuit diagram of Hybrid Power amp

order of several kilo-ohm. To produce a drive suitable for feeding into a speaker a stepdown transformer is required. This not only steps down the voltage but also steps up the current available. By suitable choice of primary and secondary windings the correct ratio is obtained. Notice that the

centre tap of the transformer primary is connected to the HT voltage. This has several ramifications. Firstly the anode current flows through both halves of the transformer. When the stage is correctly biased these currents are equal. The transformer coil therefore doesn't magnetise or saturate as it

than transistors in regard to parameters. The voltage gain of the stage can be made identical by varying the load resistors. This works because although the transistors will have different operating currents the voltage gain of the transistor stage is dependent only upon the voltage across these resistors.

It is common practice to place a small series resistor in the grid circuit. These components, called grid stoppers form a filter at RF with the valve's input capacitance. However as the amplifier is unconditionally stable without these devices their inclusion confers no benefit and are thus omitted.

Fixed bias is used for the valves. That is to say the cathodes are directly connected to ground. This method of biasing requires the negative grid bias voltage but allows more output to be obtained before clipping sets in.

The output devices are the venerable EL34s. This valve, an output pentode first made its appearance in 1956. When

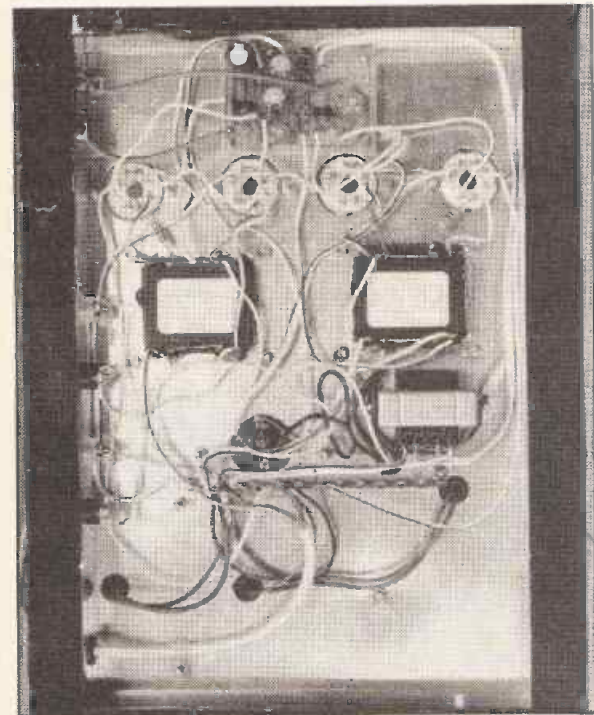

yours truly was in short pants. Despite the intervening years, or maybe because of them no worthwhile alternative has been forthcoming. To operate as a pentode the screen grid [g2] has to be fed with current from the HT supply. This is the function of R9 and R10. An alternative method of operating the valves is to tie the anode and g2 together to form a power triode. However, although believed to be audibly superior to pentodes by some, the output power produced is very much lower than with the standard pentode connection. As previously mentioned the output transformer is connected across the valve anodes with the centre tap being connected to HT. The voltage gain of the output stage just about compensates for the step down ratio of the transformer. Most of the open loop gain of the amplifier is contributed by Q1 and Q2. The output proper is obtained by connecting the speaker across the output transformer's secondary. Overall negative feedback is taken from the hot side of the secondary and applied to the base of Q2 biasing its base to ground at the same time.

The overall voltage gain of the circuit is set by the ratio of

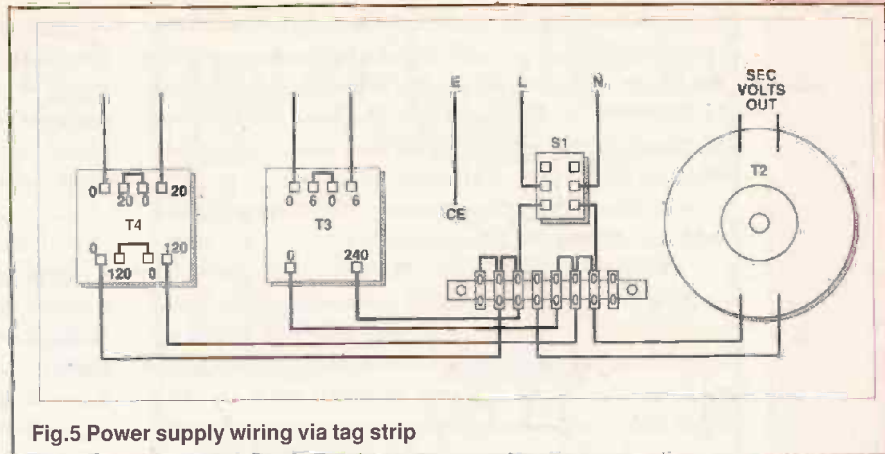

Fig. 5 Power supply wiring via tag strip

R7 to R8 at 22, 13dB and sets the sensitivity to 650mV for full output.

Power Supply

Three voltages are required by the amplifier. The HT voltage of 350V is obtained by rectifying the secondary voltage of T1 by B1 and subsequent smoothing by C3. The valve heaters require 6.3V AC and this is obtained from a separate 6-0-6V AC secondary transformer whose primary is connected in parallel with T1's. One side of the heater supply must be connected to the negative power supply line. Otherwise the circuit will be prone to hum pickup. The 6V secondaries are connected in series and the valve heaters are connected in series parallel across the resulting 12V AC. The connection between heaters is connected to common ground. EL34's need 1.5A of heater current each so a reasonably rated transformer is required for this task. A 50VA type proved ideal.

Lastly the transistor circuitry requires its own separate negative supply rail. In this design, a small transformer, T4 is used. the secondary voltage is full wave rectified and smoothed by C4. One side of the supply the positive side, is connected to system ground and the requisite negative bias voltage is thus made available.

Constructional Details

As usual the construction of a project such as this can be broken down into two parts, mechanical and electronic. In this case the mechanical side should be tackled first. Start by marking out and drilling the case as shown in Figure 4. The case consists of six separate pieces. The top and bottom panels are of 2mm thick aluminium. The side panels are 3mm thick aluminium channel sections 25mm by 37mm. The usual flimsy 18SWG of the shelf cases cannot be used because of the amount of weight that has to be carried. Once the main apertures have been drilled or punched up attention can be turned to the partial assembly of the case.

First drill out the 3mm dia holes around the periphery as shown in the figure. Bring the drilled top panel together with the side panels and, using the top panel as a template mark out the mounting holes on the sides. Screw the top panel and sides together using the self tapping screws provided. At this stage drill the peripheral screw mounting holes into the bottom panel. Turning your assembly top panel down mark out and drill pilot holes to take the self tapping screws. At this stage don't screw the bottom panel into position. Now attention can be turned to the output valve holder apertures. The best way to

cut these in the panel is to use a Qmax cutter. Alternatively a saw hole cutter can be used fitted into an electric drill chuck. Whichever method is chosen the hole diameter should be 1.125", 29mm in diameter. Once you have cut these out position the holders in the holes and mark out the fixing screw positions. Drill these with a 3mm, drill.

Now take the PCB and position it on the panel as detailed, mark out and drill the fitting screw holes.

Lastly cut the 0.375", 10mm Diameter holes and fit the grommets into place. Next fit the main components, output transformers and input/output sockets into place. Mount the holders with 6BA or M3 screws and nuts. Be sure to mount them so that the locating slots point toward the PCB. Don't forget to fit T4 into position. This component is sufficiently small to fit 'dead insect' fashion inside the chassis so avoiding the chore of having to insulate terminals etc.

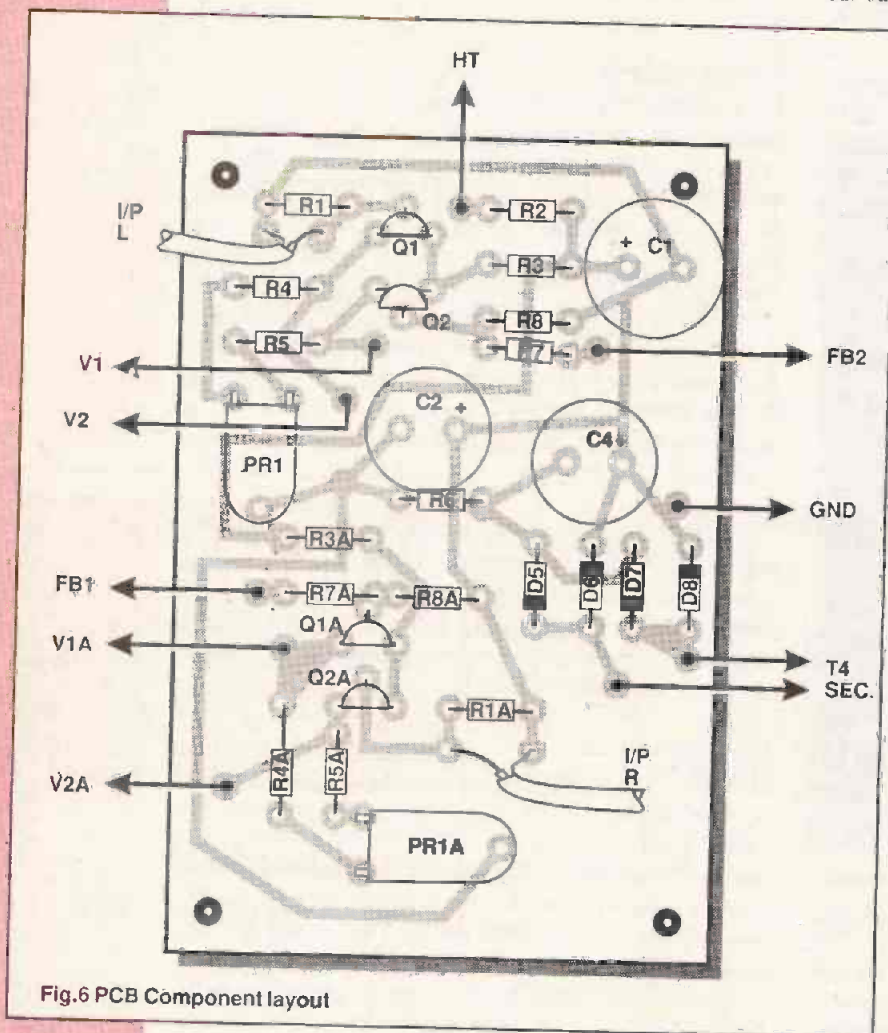

Fig.6 PCB Component layout

Having got this far the PCB can be wired up prior to fitting into position. No real comment is required about this just ensure that all the polarised components are correctly orientated before soldering them into position (See Figure 6). This done solder Veropins to the input and output pads. The board can then be mounted underneath the top panel spaced away by 4 x 6mm insulated spacers.

Before commencing the panel wiring now is the time to finish the panels in the manner of your choice. The prototype was sprayed matt black and legends were applied with white rub down lettering. The latter being fixed into place with a clear varnish spray. Both the paint and spray were obtained from my local modelling supply shop.

Panel wiring is done with 5A twin speaker wire obtainable from Halfords. A £1.35 reel being sufficient to wire the whole circuit. With reference to the wiring diagram start by wiring the power supply up via the tagstrip, as shown in Figure 5. Having done this the output stage can be wired up to the power supply and output transformers. The figure shows one channel the other being identical. The wires marked 'CE' are connected to a common point on the chassis.

Although it's location is unimportant a suitable place is on a solder tag on one of C3's mounting screws. Don't be tempted to join all the nearby CE wires on the schematic together. To maintain stability they must be separately run to the earthing point. Similarly note the heater wiring. The valve heaters are connected in series across the 12V AC secondary of T3. The centre tap of the winding is unused and should be cut back. Pull it through the grommet and wrap a copious layer of insulating tape around it, to keep it out of harms way. The last bit of wiring is to connect the various flying leads to the board pins. Notice that R9 and R10 are not mounted on the board but are directly connected from valve to transformer T1 (Figure 3). Leave the bottom panel off to facilitate testing.

Setting Up

Once the circuit has been completed it only requires setting up to be fully functional. This is a quite simple procedure that may be done with the aid of a multimeter, a screwdriver and a pair of ears!

Before applying power run a thorough check of all your wiring. Look especially that the electrolytics are correctly orientated, especially C3 which if reversed could have disastrous consequences. Once satisfied that all is well the next stage is to power up the circuit. Make sure that the valves are fitted and temporarily disconnect the earth lead from the mains plug. The valves will have to be eased in gently. Octal holders are notoriously tight fitting especially when first used. Line up the valve with the socket and applying gentle pressure rock the valves into position. Prop the circuit up securely on its side. Firmly lodge the negative lead of your multimeter in the case so that it makes a good connection with the metalwork.

With your multimeter switched to a range that will give a good indication of 350V you are ready to start. Remember that high voltages are present on the chassis. The golden rule is not to let yourself come in contact with the circuit whilst it is switched on. A habit that is well worth cultivating is to keep

one hand behind your back while testing.

With SW1 switched on apply power to the circuit. Watch for the heaters to start glowing after a few seconds. You can ignore the odd crackling sound as the glass envelopes heat up! If they don't you have a problem. In this eventuality switch the circuit off and monitor the voltage across C3. Before touching the circuit you will have to allow sufficient time for the voltage across this component to fall to a safe level. At least half an hour! Assuming all is well measure the voltages at Q1 and Q2 collectors, across R4 and R5. They should read approximately -30V. Don't worry if the the two voltages are different they probably will be. Setting up consists of matching them both up. With your testmeter set to a suitable low

voltage range adjust PR1 until you get the two voltages approximately in balance. Switch off the power. Check that the voltage across C2 falls rapidly.

Temporarily disconnect the feedback wire from the board. Short out the input - attach a speaker and power up the circuit. After a few seconds the valves should begin to glow. After a few seconds more a slight hum accompanied by a low level hiss should emanate from your speaker. A few seconds more should see the hum subside to a much lower level. This initial hum is quite normal and coincides with the valves turning on. As this happens the anode currents are unbalanced hence the hum. Now getting your ear as close as possible to the speaker adjust PR1 slowly a quarter of a turn first in one direction then the other. What you are searching for is a null where the remaining hum disappears indicating perfect output balance. Once you've found it repeat the adjustment for the other channel then leave well alone! Remeasuring the collector voltages of Q1 and Q2 you should find that they are now closely balanced within 0.5V of each other and about -30V.

Now comes the bit where you need nerves of steel. Switch off and reconnect the feedback wire. Switch on again. If after the few seconds the circuit wails like a Banshee switch off quickly, not that you'd need much persuasion! What has happened is that the feedback is positive instead of negative. To cure the problem simply swap over the wires to the grids at Q1 and Q2 collector end. Now when you switch on or if you were lucky the first time all you should get from your speaker is silence! Having got to this stage the construction is complete. All that remains is to connect a signal source to your brand new amplifier and enjoy! Not forgetting of course to screw the bottom panel into position.

PARTS LIST

RESISTORS

R1 47k
R2 100k
R3 1M
R4,5 120k
R6 18k
R7 4k7
R8 100R
R9,10 470R/1W
R11 1k
PR1 27k preset

CAPACITORS

C1 10 μ 450V
C2,3 220 μ 63V
C4 400 μ 450V

ACTIVE DEVICES

V1,2 EL34

Q1,2 MPSA42
D1-4 1N4007
BR1 800PIV, 2A Bridge

TRANSFORMERS

T1 Output transformer
T2 160VA 240V sec, 240V pri
T3 50VA 6-0-6V sec, 240V pri
T4 6VA, 20-0-20V sec, 240V pri

MISCELLANEOUS

Tagstrip
4 Octal valve holders
Case
PCB
Dual phono socket
4 x 4mm output sockets
Wire

BUYLINES

EL34's are available from Cricklewood Electronics.
The output transformer is available from the author at HOBTEK
A full designer approved kit for this project is available for £169.99 inclusive from:
HOBTEK, The Cottage, 8 Bartholomews,
Brighton, E.Sussex, BN1 1HG



FROM

New for 1992

- ★ **New MOSFET Amplifiers**
improved range of SMOS modules
30W, 30+30W, 60W, 120W
- ★ **20 watt Class A Amplifier**
- ★ **Low profile PCB Transformers**
a range of encapsulated transformers
4VA, 6VA, 10VA, 18VA, 24VA, 30VA

Write or phone for data and prices...
which include details of standard range of toroidal transformers and audio modules.

No price increase for 1992

Jaytee Electronic Services

143 Reculver Road, Beltinge, Herne Bay, Kent CT6 6PL
Telephone: (0227) 375254. Fax: (0227) 365104



FROM

UK DISTRIBUTOR AND STOCKIST FOR THE COMPLETE ILP RANGE

- ★ AMPLIFIER MODULES
- ★ PRE-AMPLIFIERS
- ★ 100V LINE TRANSFORMERS
- ★ TOROIDAL TRANSFORMERS
- ★ LIGHTING TRANSFORMERS

**Write, phone or fax
for data and prices**

Jaytee Electronic Services

143 Reculver Road, Beltinge, Herne Bay, Kent CT6 6PL
Telephone: (0227) 375254. Fax: (0227) 365104

Coping with a Paradox

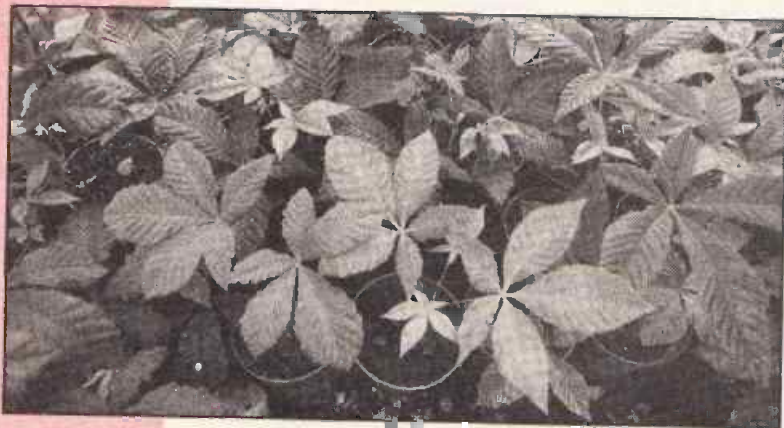

▲ Author's fledgeling trees

by Douglas Clarkson

The Paradox

The immortal lines of Charles Dickens in *A Tale of Two Cities* 'It was the best of times it was the worst of times' can also be applied to the environmental catastrophe now unfolding. Never at any time has there been such a risk of ultimate catastrophe and yet again there is so much which could happen to ensure that a safe, balanced and happy future is assured for all on planet earth.

It is perhaps relevant to examine the role of technology in all of this to see if technology is the answer to the problem. Are we in such a mess because we do not have enough technology or because we have too much? Is the balance of our technology wrong is it being developed in an inappropriate way? Should we modify the way in which technology functions? Can we control it? Should we have to? If terra firma remains under our feet for another 50 years, then the ability of man by technological means to influence the life systems on the planet will have increased by another quantum leap. So the problem about how technology can influence the future is one which although pressing now is likely to become all the more compelling in years to come. What is of importance is perhaps the motivation behind technology. Is it to make more money, is it to dominate through military means or is it to apply thinking so that systems can work amicably together?

To a large extent, the bulk of technology is neither good nor bad. True, a project to develop guided offensive missiles against peaceful countries is inherently bad though the same technology could be harnessed to place satellites in orbit to monitor environmental factors.

In another 50 years there will certainly be the vantage point to assess the impact of genetically engineered plants (and animals) on the environment. Will this prove to be a curse of or a cureall? Time will only tell.

The fact that over 150 world leaders came to Rio to agree on a consensus on environmental factors is a sign in itself of the importance attached to such a debate. It was not a military pact meeting it was not an arena for political ideologies and it was not overtly about money although this was often the stark reality that stalked the negotiations. It was about living in balance with the planet. It was about sharing its undoubted ecological wealth with future unborn generations it was in many ways recognising what a good deal homo sapiens had been given on planet earth.

Of Economics

The great truth about human society is that it is so much dominated by what has gone on in the past that it is not wildly receptive to what the future can bring. In terms of structures now in place, and concepts of social, economic and political thought, it is perhaps economic thinking which is lagging behind. The modern state has managed to emerge in the developed world out of a long cyclic process of change and adjustment to change. Modern states have their economies which they use to fund the complexity of their function. So it could be said that modern nations have their roots deep within the muddy pool of economic expansion. Without the necessary growth in the economy, politicians are always reminding us that we cannot have that extra perk by way of social services or health care. This is why the foot on the accelerator for expanding economies always seems to be hard down.

In the heady days of colonial expansion written in tablets of stone by Adam Smith in his *Wealth of Nations*, the drive for economic expansion was a simple, uncomplicated goal in which the only limitation factors were wits, will and the competition of others. The conflict which we are now witnessing between the fabric of the planet and the use we wish to make of it in sustaining our lifestyle is basically one which stems from a lack of realisation of the facts of the situation. In so many ways, we are all Adam Smiths trading in a infinite way with the planet, expecting it to meet all our needs, whereas in fact its resources are finite.

Eco Models

It is quite an amazing fact that the green community has not done more to illustrate these arguments with some simple models of the world's viability even at the simplest level. Perhaps because the world system is so vast, so extensive that the complexity of such a model is considered unwieldy.

One place to begin is probably with a single species eg herring in the North Sea. Where the species is fished 'sensibly' so that the fish stocks are not depleted, then a sensible status quo as shown in Figure 1 can be achieved (scenario A). Where overfishing is undertaken, stocks rapidly decline but

after a cessation in fishing they recover (scenario B), Figure 2. In scenario C (Figure 3), however, the overfishing is so severe that the fish never recover their stock.

The problem is that it is possible to monitor extensively the rise and fall of one species such as the herring and advise ministers about the levels which are necessary to preserve stocks though this is only for one species within a small but diverse eco-system. It demonstrates the phases of eco stability, eco recovery and eco extinction.

On a much larger scale however, across countless numbers of species of plant and animal, the principle of eco stability exists in as much as there is a finite way in which all of the resources of the planet can be exploited. The phase of eco recovery will apply as the use of a resource is reduced in order to replenish its stock. The phase of eco extinction can also be considered to be relevant as globally important species and genetic infrastructure are lost.

In the present day state of all the world's species and the relative numbers of each species, line A could well describe where we are now. Although some species are lost, numbers depleted in the surviving ones and large tracts of living space removed, recovery is still possible. (Nature is basically resilient.) In line B, however, where things are slipping out of control, there will be a line beyond which recovery will not be viable, either because the interdependencies of life species to species have been broken and/or because the environment is polluted beyond its ability to recover. This is a line of no return. We are not here yet but it will only be a matter of time before this becomes the reality if nothing is changed.

Perhaps we should explain to the advocate of continual

scientific research, such facilities do not seem to have been made available for ecosystem modelling. It seems a sad oversight that super computers which were developed as part of a doomsday weapons development programme cannot be used to model software to help predict eco outcomes based on a series of responses.

It could also be said that governments are not rushing to give eco scientists resources they need. Could it be that they are hesitant about what the outcomes could show? It seems strange that in an age when scientists have resources to model the space time continuum within black holes or the fission trigger mechanisms for Hydrogen bombs there does not seem to be similar resources provided for ecoscientists both in the development of planet earth models and resources to implement them. It could be argued that there is the need to harness available technology of a very advanced nature to try and model these factors. The fact that this has not taken place is an indication of the low priority given to such initiatives. Perhaps governments would not wish the outcomes of the models to be divulged too widely.

For the moment, therefore, there is the awareness of looming problems but with no highly accurate assessment of the magnitude of problems. Yet in this assessment it is not a case of yes/no in relation to ecological disaster, it a case of how long have we got and what should we do now which would be most effective in changing the outcome of future events.

The benefits, or otherwise of technology all relate to its impact on the global structure. New processes may be developed with lower energy requirements or which produce lower pollution levels. If a new form of energy is developed which was cheaper and less polluting, would this ultimately reduce the upheaval to the eco sphere or increase it.

Game Playing

One of the more obvious scenarios being played out at present is the 'if you won't play we won't play' attitude where an action really requires to be adopted by everyone but no one wants to be the first to do so. An excellent example of this recently was the proposed Carbon Tax within

the European Community on fossil fuels. When it was considered there would be no parallel adoption of such a tax within the other major trading groups the idea of a Carbon Tax fell by the wayside. The very fact that such a tax was proposed, however, was a healthy indication that within the higher echelons of a major political/administrative block there was the wish to adopt such a tax.

There is a curious paradox in the drive to reduce carbon dioxide emissions which contribute to the Greenhouse Effect. Those countries which manage to improve their general energy efficiency ie the utilisation of their energy requirements are moving directly towards reducing their CO₂ emissions and also reducing their energy costs. The economies which make progress in reducing CO₂ emission will be the very ones with lower manufacturing costs and hence will have a trading advantage. The USA, for example, is probably very wasteful of energy in the way its economy is structured. Europe and Japan, however, have a clearer perception of where progress could be made. It is a nonsense to say at an

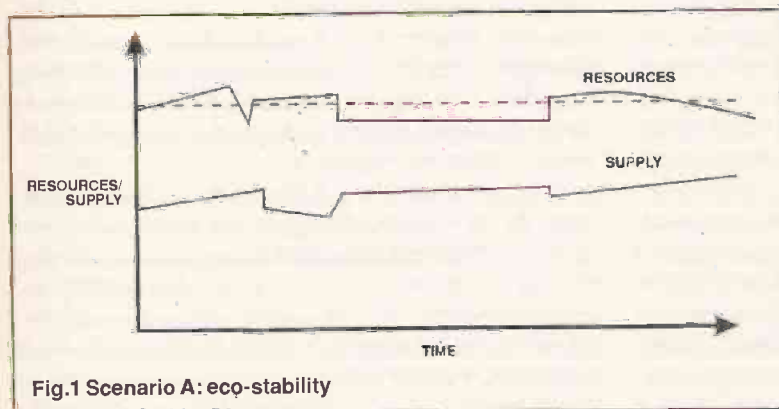

economic growth what the ecoextinction curve means at an economic level.

It means spiralling global economic recession. It means global starvation with associated military conflicts triggered by the need to scramble for what resources which are still available. Now it is not a choice that anyone would consciously make though it can be argued it is the natural consequence of a 'do nothing' scenario. Those who argue that this is not the case are not availing themselves of the facts of the situation. It can also be shown that there are a range of forms of economic policy in the utilisation of earth resources. Some are sustainable others are not. Perhaps some of our brightest thoughts of the 20th century still to be unfurled will relate to diversity within economic policy.

What Models?

It is also a curious paradox that in an age of super computers which can predict outcomes for complex mathematical modelling scenarios related to military and 'pure'

economic level that meeting a commitment to reduce CO₂ emissions is going to be a unbearable burden on the back of struggling economy. In many ways it will be a lightening of the load. Efficiency in using energy at any level is contributing to cost reduction and indirectly reducing CO₂ emissions.

A basic philosophy of western capitalism is that 'the fewer restrictions the better' in as much as the less red tape there is the more time people spend making things which in turn makes more money and so on. This was certainly the basics of 'Reaganomics' and the cloned version of 'Thatcherism'. This is not a mature way to do business.

At present there is no great drive or directive from commerce to undertake 'green' policies. It may be a gimmick to sell more if a product is shown to have 'green' features. Is a high portion of its contents able to be recycled? Is it shown to be safe for the environment? Is it promoted by 'green' personalities. This is taking place without a backdrop of regulatory directives which could for example specify minimum levels of reuse of materials of a specific product.

There has been, at least in the UK, a failure to focus on opportunities for implementing 'green' policies which would reduce waste of natural resources and also help with the import/export balance of payments. On the issue of recycling of waste paper, there is an obvious shortfall of potential for reducing waste compared to the amount which is actually recycled. This is in marked contrast to Germany where there is no 'white' paper in all of the government ministries it is all recycled 'slightly grey' paper. Having seen it at first hand it is still entirely readable.

Perhaps therefore if the UK could make more sensible use of the materials it uses for manufacture it could reduce the large trading deficit it has at present.

To meet the challenge of working within a sustainable environment, there must be two levels of functioning. One is from government down to the public and industry and the other is in the reverse direction. There is little awareness that if changes in processes are adopted by individuals, groups, companies and corporations, then it makes it easier for politicians to see a way forward. Politicians are very good at playing safe games where the outcome is going to help rather than hinder voters. It cannot be denied that actions among individuals can have far reaching consequences particularly if they are shown to introduce superior ways of managing change.

So it is important for governments to manage change but vitally important that individuals begin the process of meeting change within their own framework first. Thus the jigsaw of environmental responsibility in many ways lies strewn about, there is the awareness, there is the technology, there is the wish to do something all it needs is momentum and clarity of thought to carry it forward.

At the same time, the great skill required is one of transformation to take existing resources and expertise and channel it in a new direction.

There is the indication that once understanding of a problem dawns, then action follows. In the example of modern antiseptic surgery, the day was when surgeons operated in the lounge suits that they wore all day in the hospital.

Once the problem of unsterile ways of working was perceived, steps were gradually taken to take appropriate precautions. The transition did not take place overnight. There was a steady movement to rectify the situation.

Where are the Monitors

There is no indication at present how far society as a whole can lead itself or be pushed in a 'green' direction. The level of awareness of 'green' issues is certainly much higher than it was 10 years ago. There is one thing, however which is very clear from experience in our European back yard. It is one thing to adopt guidelines, safety limits, approve safe procedures for environmental policies but quite another to 'police'

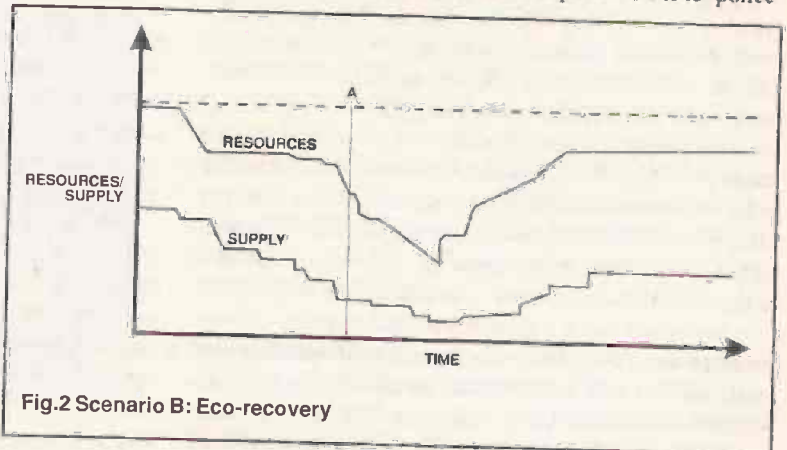

Fig.2 Scenario B: Eco-recovery

them. It is quite clear that a great many of the European agreements on agricultural policy and environmental controls cannot be 'policed' because there are simply not enough trained individuals and associated resources to monitor levels of pollutants. This in itself forces a resource issue. If the world as a whole wants cleaner air, land and seas it will have to invest very significantly in personnel and appropriate technology to monitor pollution.

In an age where it is possible to track caribou herds by satellites which detect radio signals, it is possible to install a network of global environmental monitoring stations to monitor key pollutant agents. This will provide both the facility for aggregation of data over large areas but also indicate local 'alarm' conditions arising from specific local problems eg oil spills. Thus it should become possible to maintain a global picture to evaluate 'how we are doing'. It is in many ways part of the paradox that science can gather data of how the universe was structured just after the Big Bang but it does not have the resources to monitor at an appropriate level the present plight of the world's ecosphere. Necessity is very much the mother of scientific invention. Nothing, apparently, succeeds in focusing the diffuse scientific mind than military developments. This has been the legacy of the 20th century. But it also proves another point of the ability of science, appropriately resourced, to work towards a clearly defined goal. There is no doubt that if all the key scientists of the world were appropriately resourced for say 20 years in ways of using technology to develop 'clean' energy, 'clean' food production, 'clean' industrial production and so on then probably everything could be achieved that was required. So, it can be asked, what is holding everyone back?

The major challenge facing society is the great range of problems which have apparently all got to be unravelled at the one time. It is perhaps here that technology, warts and all, can help.

Fair and Foul

In looking at different types of economic practices, especially between the developed and the developing world, nothing can be more illuminating than the range of 'reward' practices for extracting tropical hardwoods. The Ecological Trading Company Ltd of NewcastleUponTyne is the only timber importer to import timber from sustainably managed tropical sources and can supply details of the contrasting ways in which communities in the rain forests can be rewarded for their hardwood timber resources. One typical scenario relates to Ecuador where a community was offered a once and for all payment of \$5000 to cut and burn its local forest area by a logging company. The Newcastle company proposed a yearly payment of \$5000 to extract the timber in a sustainable way. Needless to say the community were very happy to choose to have income from a sustainable resource. The logging company, intent on short term gain would eventually be out of business. Part of the loss of the world's forests has taken place by doing deals over the heads of the individuals who inhabit the lands which are denuded. Perhaps then many disaster stories of the developing world would rectify themselves if resource management policies were introduced which better rewarded local inhabitants for their produce.

The public would be more than interested to know if tropical timber in a broad range of household items was from sustainable or non sustainable sources of supply. If people wanted only sustainable tropical timber products, then they would force down the price of the other type making its extraction uneconomic. The 'timber tale' scenario is surely typical of widespread custom and practice in the developing world. All the talk of increasing the percentage of Gross National Product of countries in the developed world to be spent helping the developing world can be made to look ever so foolish if the inflow of money is used to destabilise the fragile eco systems present there. This aspect of managing aid to the developing world is not so much about technology as about maintaining a balanced view of how best the aid needs to be administered. The viewpoints of bankers, businessmen, politicians may not necessarily coincide with the best interests of the locals.

Those who assert therefore, that all is required is more technology are not seeing the complete picture. Technology can help provide solutions where the will to find a solution exists.

Challenge of Change

Society has no clear idea of where it is heading in a range of issues. It cannot anticipate technology in 50 years, it cannot

predict if the earth will still be viable in another 50 years. Perhaps the greatest unknown is the shift that could take place in society is the awareness of the environment and the steps taken to move towards a balanced existence. This shift could in its own way change society more in the way it functions than the impact of technology in general. This is not a shift in attitude on behalf of a few, it will be a collective shift perhaps stimulated by example of a few but taken up as a change in fundamental viewpoints.

It is always a pertinent question to ask 'What am I doing?' in all of this. I hope to plant at least 1000 trees over the next few years. Witness the collection of some of these which now totally dominate my greenhouse (see photograph). This might go some way to compensate for the many tons of CO₂ I will release into the atmosphere through the burning of fossil fuels. If 10,000 people did this, it would equate to 10 million trees. I would not recognise this as particularly difficult or something which required a lot of technology. In fact at this point in time to be planting the usual set of border plants in such facilities is a bit like fiddling while Rome burns.

I very much appreciated visiting the Green Show at the NEC in May 1991. All those there from a great range of initiatives, ventures and interest groups all seemed to be in some way 'content' in what they were doing as if the 'reward' they were achieving by way of helping in some way to adjust the balance of things was of a deep 'psychological' type some kind of being aware of doing the 'right' thing. It was an ideal opportunity to be aware of the 'attitude shift' that had taken place and the diverse ways in which people were seeking to make their contribution towards it.

The great fear of the individual is to be denied to be made to do without. The great paradox is that by refusing to be more flexible about the way things are used and taken on the planet everything could end up being lost. There has never been a phase of human history where the ability of the earth to provide forever more has been openly questioned. It is refreshing to see young people intuitively accept such as basic thought.

Looking back on over the last 50 years, mankind appears to have moved sideways from global thermonuclear war. Was this a lesson learned that there could only be losers? The ability to make the right set of decisions on living within our means on planet earth is also possible. All the changes which need to come about must work though individual people in all their respective roles in society. It is time therefore to move the collective shift in society that bit closer to where it should be by action. Technology is invited to play its special part.

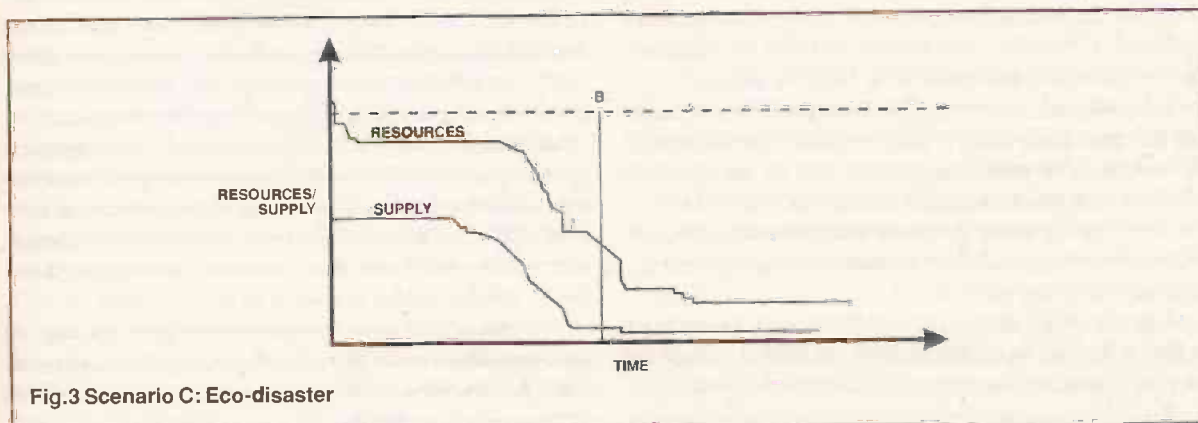

Fig.3 Scenario C: Eco-disaster

Alarm Protector

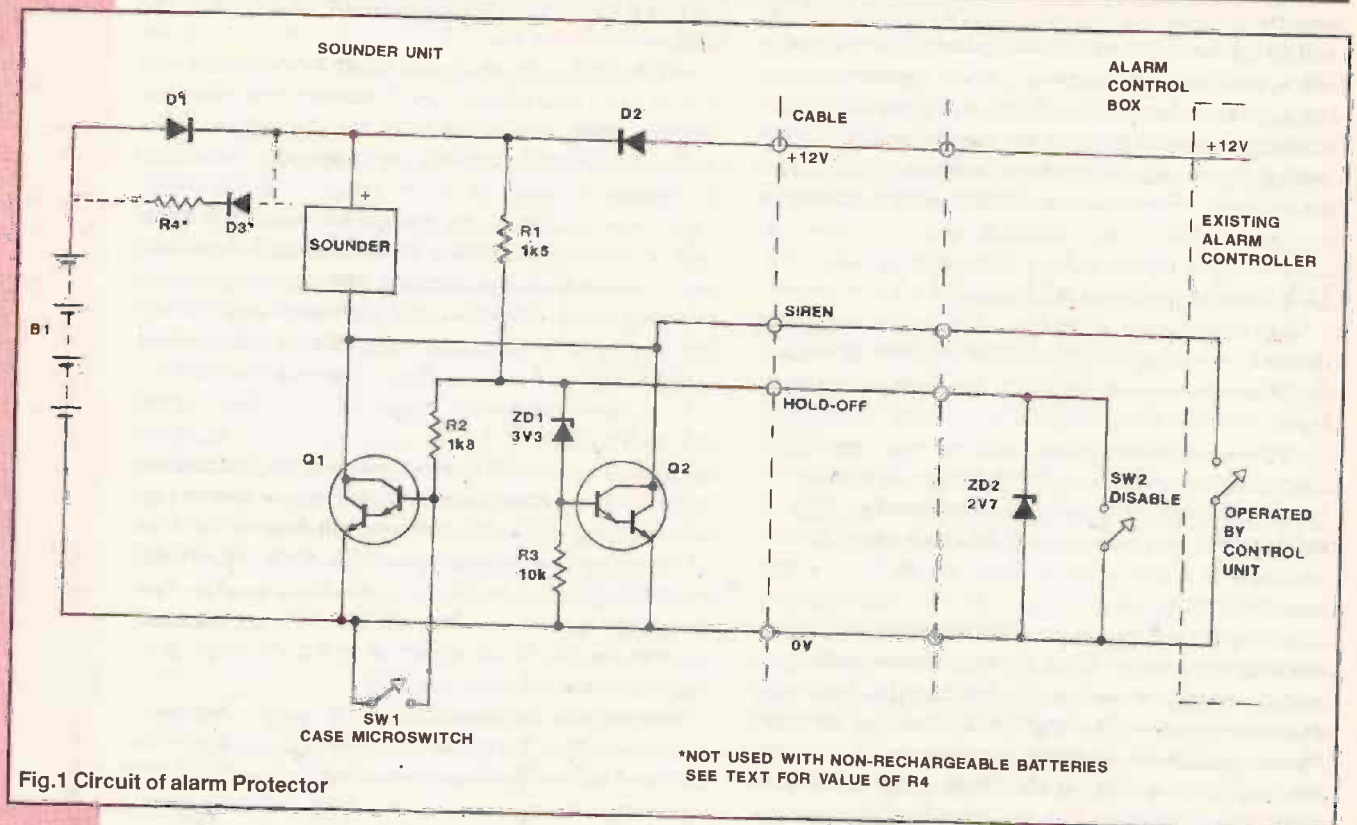

Fig.1 Circuit of alarm Protector

By Dave Bradshaw

This project could be used to improve the security of many simpler alarm systems which use only two wires to connect the alarm sounder (siren or bell) to the control unit. The problem with this set-up is that if a burglar cuts the cable to the sounder, the alarm is completely disabled.

The circuit diagram of the project is shown in Figure 1. Two transistors act as switches to connect the -ve terminal of the alarm sounder to the 0V supply, so making the circuit and activating the sounder. These two transistor switches, Q1 and Q2, are in parallel with each other and also with the alarm control unit's own switch in the control box, so that it takes only one of these switches to close for the sounder to be energised. (The control unit's switch may also be a transistor like Q1 and Q2, but it may also be a relay contact.)

Transistor Q1 is used to defend the sounder unit box. Current comes to the base of this transistor via resistors R1 and R2, and this will flow into the base of the transistor turning it on which connects the sounder negative terminal to the 0V line. However, if the case microswitch, SW1, is closed, the current will flow through here instead, and the transistor will stay off.

Transistor Q2 is used to defend the cable. Current flows to the base of Q2 via resistor R1 and zener diode ZD1, so the transistor turns on. However, when the cable is intact, zener diode ZD2 is connected between point A and 0V, which will

bring the voltage at point A down to about 2.7 volts (actually, a bit below this due to the relatively small currents flowing). Because of this, no current should flow through zener diode ZD1 because there is not sufficient voltage across it, so the transistor's base should get no current. Actually, a small amount of current (the leakage current) will flow through ZD1, and R3 is included to take this away from the base of Q2. It is possible that the sounder may come on very faintly without the alarm being triggered and this can be solved by reducing the value of Q2.

To make it possible to get inside the sounder box for installation and servicing, a switch, SW2, is included at the control box end of the cable. This shorts point A to ground so that neither Q1 nor Q2 can turn on.

I have cheated slightly with transistors Q1 and Q2: they are actually Darlington transistors, which means that they need much lower base currents to activate them than conventional transistors. As a result, the standing current through the circuit when it is inactive is only about 3mA (if conventional transistors were used, the standing current would have to be at least ten times this). However, this standing current does mean that the alarm defender must have a suitable voltage supply from the main unit, as otherwise the batteries would be drained in a matter of a week or so.

If a thief cuts the sounder cable, the supply from the control box is no longer available, so the alarm protector has its own battery. This can be either a non-rechargeable type (9V PP9 is recommended) or rechargeable (expensive to buy, but cheaper

possibly in the long-run). Diode D1 allows the battery to supply the alarm protector circuitry when the 12 volts from the alarm control box is disconnected for any reason. R4 and D2 should be included to trickle-charge the rechargeable batteries if these are used.

There is no timer on the alarm protector, so the alarm sounder will keep going until the batteries run out. Most sounders seem to take several hundred milliamps and this will take around an hour to drain the batteries to the point where the circuit will cease to function. In the case of rechargeable batteries, the capacity in ampere hours of the batteries is almost invariably stated. So it is easy to get a rough guide to how long the sounder will carry on going by dividing the capacity in ampere hours by the current needed by the sounder.

Is Your Alarm Suitable?

The alarm defender will not necessarily work with every design of alarm control unit, so if you are not particularly familiar with your alarm, now is the time to begin finding out about it!

The main criteria are that the alarm control unit must have a supply of about 12 to 15 volts, and the alarm sounder must be connected so as to have its positive terminal permanently connected to the positive supply and its negative terminal switched by the control unit to the 0V line when it makes the sounder go off.

To find out if this is the case, you will need to open up the alarm control box; if it is a sealed unit, as some of the more modern alarms are, then this is the stage to abandon the project because you will almost certainly break the alarm by trying to get inside it. However, if it has a hinged front panel held shut by a couple of screws, there isn't a problem yet! Before you open the case, check that you have the alarm keys inserted into the appropriate place. You will probably find if you haven't already discovered it that the key has to be in a particular position, perhaps marked 'test', to prevent the sounder awakening the neighbourhood as soon as you open up the case. However, designs do vary, and you may need to experiment here.

Once inside the box, have a good look around it. You should be able to identify the mains transformer; check that the mains connection to it isn't dangerously exposed, with bare terminals that you can brush against all too easily. If it is a problem, disconnect the mains supply; the alarm unit will then run on its own batteries, if these are present.

You should be able to see a connector strip, probably mounted on the PCB of the unit. Identify the connections to the sounder: they should be marked in some way. Also look for a large electrolytic capacitor mounted on the PCB; this will almost certainly be the supply smoothing capacitor, and the negative end will be connected to the 0V line.

Connect the negative probe of your multimeter to the negative end of this capacitor. Then switch the meter to a suitable range for reading 12 volts DC. Measure the voltage at the other end of the capacitor; for our purposes it should be somewhere between 12 and 20 volts. Any less or any more, and you may have the wrong capacitor, or the alarm unit may not be usable.

Now measure the voltage at the connector points for the sounder; they should both be around 12 to 15 volts positive of the negative end of the capacitor. If they are at all different, then the alarm unit is more sophisticated than you thought,

and the alarm protector is not needed. If the sounder connections are at the same voltage then disconnect one of the two ends of the cable going to the sounder. Now do something that would normally make the alarm go off, (moving the key in the alarm switch as necessary) so that the sounder if connected would be making its noise. Measure the voltages at the connectors for the sounder cable. One should now be at or close to 0V. If this is the case, the alarm protector can be used here.

Alternatively, if both the connections to the sounder were initially at 0V, and one went up to 12 to 15 volts when you made the alarm go off, you will have to use the modified positive-switching version of the alarm protector as described later.

Remove your multimeter and put back whatever you used to set off the alarm, then re-connect the sounder unit, close the case and re-connect the mains. If your alarm doesn't now work properly, re-insert your key to disable it, open the case and check that you haven't accidentally disconnected any wires.

Construction

Most of the components are mounted on a printed circuit board; this and the connections to other components are shown in Figure 2. Note that you will have to check the connections to the microswitch, SW1, with a multimeter:

make sure that the terminals you are using are connected together when the arm of the microswitch is pushed toward the body of the switch.

Switch SW2 and zener diode ZD2 have to be mounted at the other end of the cable to the siren unit; probably the best place to put them is inside the control box, if there is room.

As usual, start by mounting the PCB pins and the connecting strip on the PCB, then the resistors and the zener diodes (note that you will need to mount the diode D3 and the resistor R4 if you are going to use rechargeable batteries - see later for how to calculate the value of R4).

The transistors may now be soldered into position, then the connecting wires for the battery and for the alarm case switch.

Obviously the unit needs a case, and if the alarm sounder doesn't already have a case large enough to accommodate the alarm protector and the battery, you will need to buy one. Planning carefully where the case microswitch will be mounted is important; it is a good idea to avoid mounting the microswitch anywhere that might encourage water entry into the case. In the prototype, the microswitch is mounted on the base of the sounder case, and the end of one of the case screws activates the switch. You may find that some cases already have mounting positions for microswitches; I was not so lucky.

Also you will have to position the circuit board, the sounder and the battery.

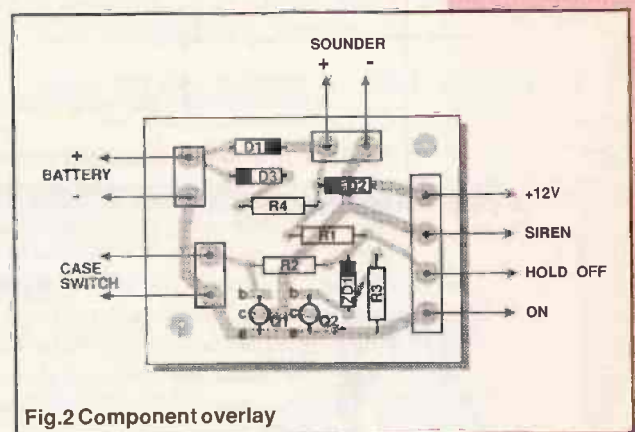

Fig.2 Component overlay

Probably one of the most difficult tasks will be replacing the cable between the control box and the sounder with four core cable (if you're lucky, the cable may already be four core, but don't count on it!). Special four core burglar alarm cable is available and this should be used.

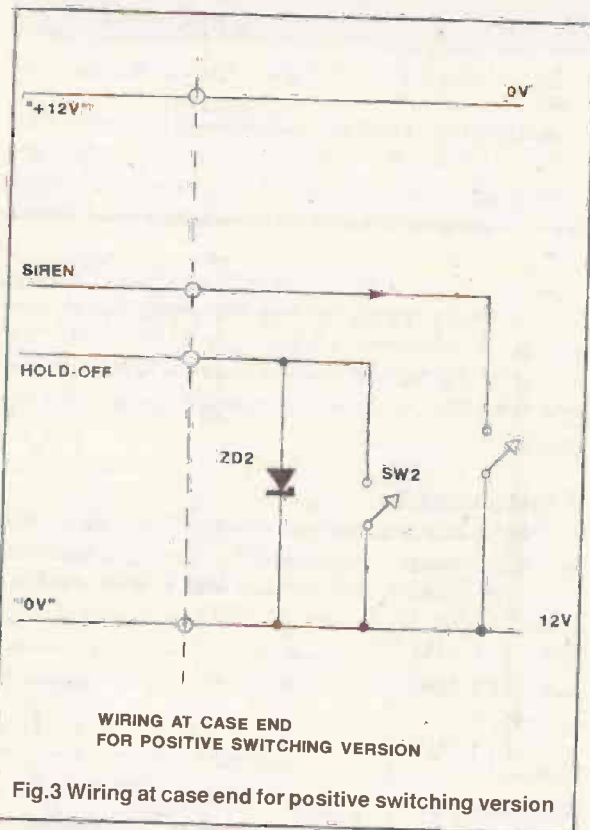

Fig.3 Wiring at case end for positive switching version

Inside the control box (or wherever you have decided to position SW2 and ZD2) you will need to find some way of mounting SW2; the control box may already have a suitable position, or it may be necessary to make and fix a small bracket to take the switch, as shown in the diagram.

ZD2 has to be mounted on SW2 as shown; note the polarity of ZD2 when connecting the 0V line to the switch. The colours of the leads are not shown in the diagram because they may vary, and also because it may be worthwhile not using obvious colours for positive and negative; however, note that the wires are numbered and so if you use red for wire 1 at the circuit board end, you must use red for wire 1 at the alarm box end.

Positive Switching Version

If the alarm control box normally keeps both wires to the alarm sounder at 0V, and takes one of them to around +12V to make the alarm go off, then you can use the positive switching version of the alarm defender. This is very similar to the standard version with the following very important differences:

1. Use TIP127 transistors for Q1 and Q2 (these are PNP transistors, not NPN transistors);
2. All the diodes must be put in the opposite way round to the way they are shown on the overlay diagram for the PCB;
3. The connections to the battery also must be reversed.
4. Connections to the sounder must also be reversed from those shown on the overlay diagram.
5. The connections at the control box end have to be

changed: see Figure 3.

The positive switching version works in exactly the same way as the standard version, but with the whole circuit turned upside-down to operate with reversed voltages.

Using Rechargeable Batteries

If you decide to use rechargeable batteries, make sure that you get batteries that have a voltage of at least 7V; if the voltage is much lower than this, the alarm protector will not work.

The problem is due to the factor that nickel-cadmium cells have a voltage of 1.25 volts when charged, unlike zinc-carbon, which will give almost exactly 1.5 volts when fresh. So although six zinc carbon cells will give 9 volts, six nicads will give only 7.2 volts which is close to the limit for the lowest usable voltage. So actually seven nicad cells will be required, which will give 8.4V.

You can buy nicads as single cells, and the AA size are the most economic usually in this form; you will need seven of these and a special holder for them as well, or you can buy rechargeable PP9 substitutes (the type I have seen has a capacity of 1.2 ampere-hours) or ready-assembled stacks of 'button' cells (the type I have seen has a capacity of 170 milliamp-hours). In both these cases the voltage is 8.4 volts.

Which type you choose depends on the current that your sounder draws; for example suppose that the sounder draws 0.5A or 500mA when it is operating. Then the AA size batteries will last about 500 mA hours ÷ 500 mA = 1 hour, the PP9 substitute will last 1.2 ampere-hours ÷ 0.5 A = 2.4 hours and the stack of button cells will last 170 mA-h ÷ 500 mA = 0.34 hours or 20 minutes. These figures are very approximate, because the sounder will take less current at 8.4V than it will at 12V, and it will not drain the battery completely, however they do indicate that the button cells would give ample time to scare off the thief who cuts the cable or tries to get into the sounder box.

Nicad batteries are normally supplied discharged and have to be charged before they can be used. The circuit of the alarm defender is designed just to maintain the charge in the

Cell Type	Capacity (Ampere-hours)	Rq (Ohms)	R4 (Ohms)
AA	0.5	56*	390
PP9	1.2	36*	270
Button cells/8.4V	170 mA-hr	220	1k5

*Use a 1W resistor

battery, so it is a good idea to charge up the battery before it is used. This can be done using the simple circuit, which uses the alarm unit's 12V supply. Using the appropriate value from the Table will give a charging time of about 12 hours (it is not important if the battery is not fully charged, because of the 'top up' action of the alarm defender).

The above table also gives the appropriate values for resistor R4, based on the capacity of the battery used. If you use a battery with a different capacity, calculate the values for the 'quick-charging' resistor Rq and R4 from the capacity Q as follows:

$Rq = 36/Q$; $R4 = 240/Q$
and take the nearest E12 resistor value above the result you get.

PARTS LIST

RESISTORS (all 1/4W 5%)

R1	1k5
R2	1k8
R3	10k
R4	see text

SEMICONDUCTORS

Q1,2	TIP122 (TIP127 for positive switching version)
D1,2,3	1N4001
ZD1	BZY88C3V3 (3V3 500 mW zener diode)
ZD2	BZY88C2V7 (2V7 500 mW zener diode)

MISCELLANEOUS

SW1	Case microswitch, closed when case is closed
SW2	Single pole single throw miniature switch, to choice
BAT 1	Battery - see text
Sounder	12V alarm sounder, should already be fitted to alarm system

PCB connectors (one 4 way, 3 (optional) 2 way, all 0.2 inch pin pitch); PCB; bell case for sounder (if not already cased); four core alarm cable (if not already fitted between control unit and sounder).

GET SMART!

YOU CAN MAKE IT HAPPEN WITH HOME AUTOMATION COMPONENTS FROM US

Remote control lighting / appliance modules, timers, computer interfaces, telephone diallers motorised curtain tracks, powered radiator valves. Details from -

SMART HOUSE SYSTEMS LTD

3 Buchanan Street, Largs, Ayrshire KA30 8PP
Fax: 0475 672589

BUILD YOUR OWN RECORDING AND PA EQUIPMENT

— AND SAVE HUNDREDS OF POUNDS!

Genuine professional quality studio equipment in kit form (with cases, optional rackmount).

NOISEGATE £67 (dual) controls for level, trigger, attack, decay, depth and hold. Insert points and quiet operation.

COMPRESSOR DUAL £65 • PARAMETRIC EQ £9.50

VALVE DISTORTION BOX £19 • DI BOX £18 Four £49

MIXER: 4 chan £115 6 chan £140 8 chan £160

ALSO: Power amps, splitters, balanced mic amps, etc . . .

For complete catalogue call: **081 808 7323**

Great news for fishkeepers!



AQUARIUM

is the **NEW** monthly fish-keeping magazine offering the best in the world of aquatics for beginners and experts alike.

There are expert tips, step by step guides and dazzling pictorial displays of aquarium fish in 100 pages bursting with glorious colour detail. *And it's only £1.75.*

Why not order a copy from your newsagent?

You'll be glad you did!



PUT YOUR AGENT ON THE TRAIL

You need the facts, just the facts man. You need a steady source to feed you information. Don't settle for a second-rate squealer. You need ETI and you need it good. Put your newsagent on the trail — clip the coupon and hand it to your neighbourhood shop.

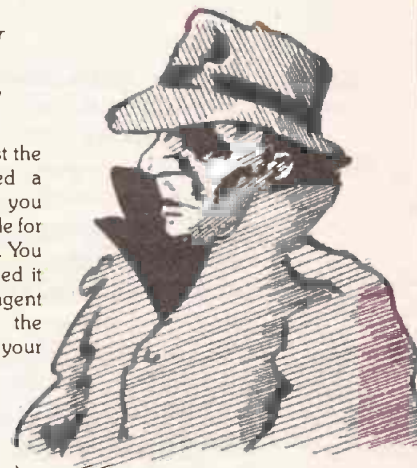

Dear Mr Newsagent
Please order me a copy of ETI and reserve/deliver me a copy every month.



Note this magazine is available to your wholesaler through: SM Distribution, 6 Leigham Court Road, Streatham, London SW16 2PG Tel: 01-677 8111.

Name _____

Address _____

Digital Television

Plug-free TV - The Philips DVS approach

4

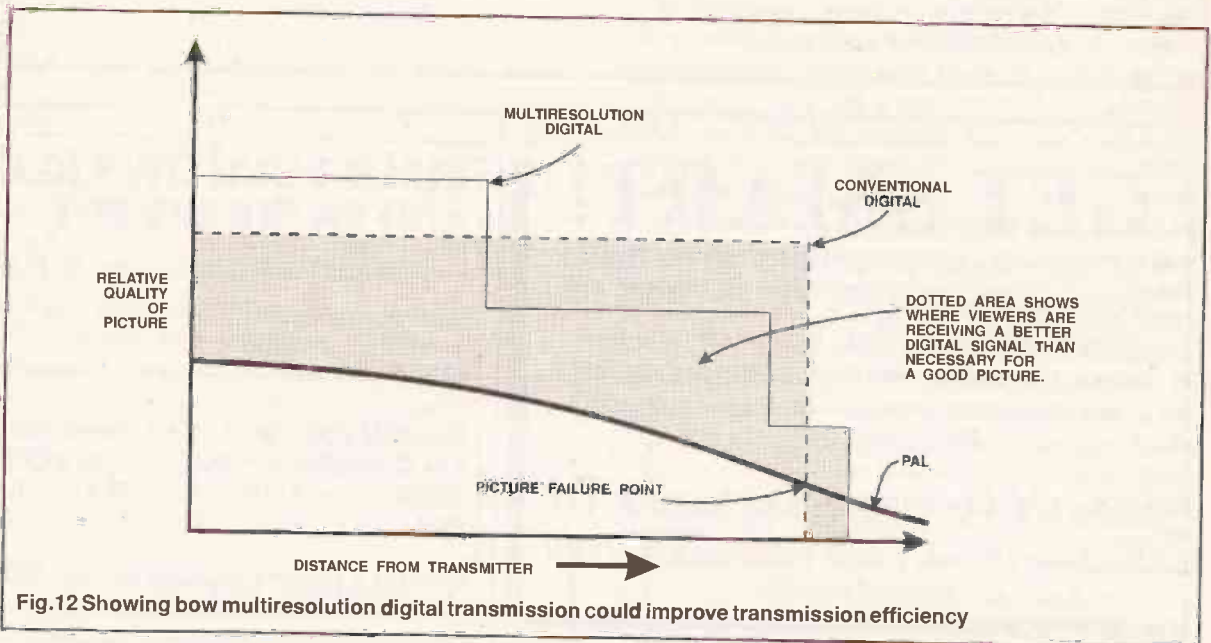

Fig.12 Showing how multiresolution digital transmission could improve transmission efficiency

More on the latest developments from James Archer

The Philips company is suggesting a very different approach to the use of digits for television transmission. We have noted already the rugged nature of digital signals, which allows a very weak Morse code message to be deciphered even when it is accompanied by large amounts of background noise. Philips are suggesting that one use for digital television would be to provide TV signals that are so rugged and resistant to errors that they could be received on 'go-anywhere' portable TV receivers, with no need for anything more than an in-built aerial. They are calling the system 'plug-free' TV, but I am afraid that this definitely does not mean that you can avoid the adverts! The aim of the Philips Digital Video Broadcasting system would be to provide first class reception in every nook and cranny of the service area, a boon not only to those who live in far-flung areas of the country, but also to those who live in flats in towns where it is difficult to provide a proper aerial.

The current aim is to provide high-quality 625-line pictures at a data rate of around 7 to 8Mbit/s, using algorithms of the type agreed upon by the Moving Picture Experts Group (MPEG), and these pictures would also be accompanied by digital audio and data signals with a capacity of about 1Mbit/s. Very heavy error-protection is applied to these digital signals using the rather frighteningly named 'concatenated Reed-Solomon' coding, followed by multiple parity-check codes, and all the data is interleaved in both frequency and in time so as to enable virtually perfect picture

signals to be retrieved even when the incoming data has been subjected to passing over the most difficult transmission paths.

DVB uses an OFDM system like that described for the SPECTRE system, and in its initial form makes use of 1024 separate but overlapping carriers, 800 of which are actually used to handle the data, the rest being left free in order to ensure optimum interference performance throughout the occupied spectrum. The system employs guard bands occupying about 20% of the 160 microsecond symbol period, to reduce intersymbol interference in the presence of multipath interference.

This Philips idea is interesting because it eschews the use of digits for higher definition systems, deliberately choosing to create a market for highly-portable TV receivers that can be used anywhere. It is also interesting to note that many of the techniques used are similar to those that have already been developed for Digital Audio Broadcasting - once you have signals in digital form there is little difference whether the datastream represents audio or video signals.

The Transmission Efficiency Of Digital Systems

Most of us have come to accept as perfectly normal the fact that the signal to noise ratio of our normal analogue transmissions, and therefore the picture quality, gets worse as the distance from the transmitter increases, and we usually regard this graceful service failure characteristic as making fairly efficient use of the spectrum. The situation for digital transmissions is, very different. Signal strengths, or more accurately carrier to noise ratios, are either good enough to

provide virtually perfect reception, or they are not, in which case the digital picture breaks up completely. Whether or not a picture is satisfactory depends upon the bit error rate of the received signal. This effectively means that over much of the service area the viewer will be receiving digital signals with a signal to noise ratio and bit error rate (BER) that is actually better than that required for a perfect picture, and this is sometimes considered to be an inefficient use of the spectrum. What we are doing is to provide most viewers with a considerably better signal than is required in order to ensure that those at the limit of the service area get a signal whose BER is just enough to give them a picture. To overcome this perhaps undesirable feature of digital systems, investigations are going on to determine whether it would be feasible to use some form of flexible digital multiplex which would allow viewers in different parts of the service area to receive different parts of the multiplex to provide different qualities of service; those relatively close to the transmitter would make use of all the transmitted data to obtain the best possible, highest resolution pictures, whereas those closer to the edges of the service would receive enough data to enable a watchable picture to be constructed, but would not be able to make use of the extra data providing further picture detail. Figure 12 shows how a multi-resolution system could reduce the amount of 'surplus' digital energy needed to serve viewers at different distances from the transmitter.

An example of this approach has been shown by Zenith Electronics and ITT, one of the groups currently submitting their HDTV system plans to the US Federal Communications Commission. Their Bi-rate coding system multiplexes together two different digitally coded signals, generated from appropriate algorithms. The most important basic elements of each TV picture are transmitted as a rugged but simple two level code, whilst the higher resolution more detailed parts of the picture are transmitted using a less rugged four-level code. By combining the two signals the system can broadcast usable pictures

over a wider service area than would otherwise be possible; those at the edge of the service area get a stable but lower resolution picture than those closer in to the transmitter.

The latest developments in the DigiCipher system, described in some detail later in this article, make use of similar techniques. DigiCipher can provide two different transmission modes, 32-state Quadrature Amplitude Modulation (32-QAM) at a transmitted data rate of 24.39Mbit/s, and the less complex 16-QAM at the lower data rate of 19.51Mbit/s. The broadcaster can select the mode that is required for the particular service area sought, and it is claimed that error free reception can be obtained with 16-QAM at a carrier to noise ratio of 12.5dB, whereas perfect pictures using the 32-QAM system will need a carrier to noise ratio of at least 16.5dB. The 16-QAM signals therefore have a wider coverage area, whilst the 32-QAM signals provide higher quality pictures over a smaller area. DigiCipher receivers automatically configure

themselves to receive whichever signal is transmitted.

Scalable Digital Technology

Other researchers are looking at different methods of using digital techniques to get the maximum possible utility from the spectrum, and one interesting area is that of scalable technological encoding a multiplexed digital signal so that it can be displayed on different receivers with different resolutions, according to the viewers requirements. Using these techniques we might envisage a transmitted signal which could be used at one end of the quality scale to enable the cinema owner equipped with a complex high-gain receiving antenna to extra cinema quality HDTV pictures from the signal, whilst the same signal is being used by the viewer with a pocket television to receive a noise and ghost free picture of more limited resolution, but great ruggedness

Spectrum efficiency is always difficult to define, and although UK broadcasters pride themselves on the way in which they have shared out the existing UHF band between thousands of transmitters in the UK, the unavoidable truth is that we have managed to use 44 radio frequency channels, each 8MHz wide, to carry just four television programmes to most of the population. This might have been acceptable

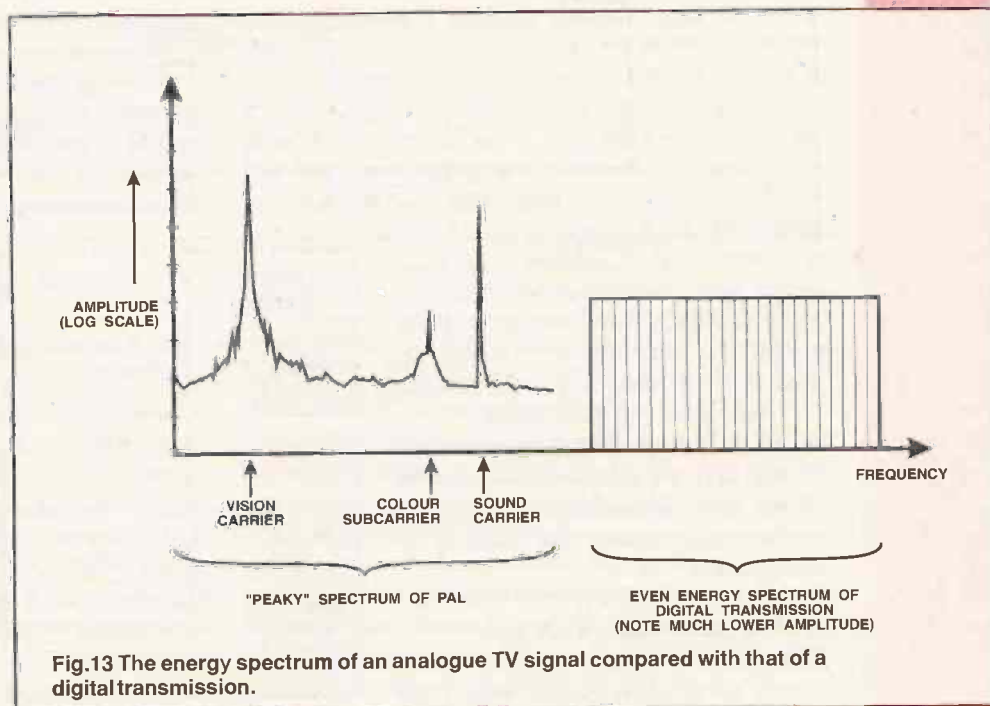

Fig.13 The energy spectrum of an analogue TV signal compared with that of a digital transmission.

using 1960s technology, but we will certainly be able to do very much better once digital techniques are introduced. The root cause of the problems with our analogue transmission system is that the TV signals which we use are just too prone to interfere with each other, primarily because the energy distribution over the transmission spectrum is extremely uneven. Most of the energy is centred on the vision and sound carriers, and because of the scanning system that is used, the power which is transmitted varies according to the picture content. The higher frequency, fine detail components of the picture are actually transmitted at very low power, and are therefore easily disturbed or interfered with, whereas the lower frequency parts of the picture, which are made up of larger blocks of pixels, are transmitted at higher power, which means that they are likely to interfere with other television signals in the vicinity. This non-uniform energy spectrum means that we are unable to use the adjacent

ATV System	Proposing Group	System details
Narrow MUSE	NHK, Japan	Analogue 1125 line HDTV, progressive scanning
ACTV - Advanced Compatible TV	ATRC - The Advanced Television Research Consortium	Enhanced 525 line analogue system, progressive scanning
Advanced Digital TV	ATRC	Digital 1050 line HDTV, interlaced
DigiCipher	ATVA - The American Television Alliance	Digital 1050 line HDTV, interlaced
Channel Compatible TV	ATVA	Digital 787.5 line HDTV, progressive scanning
DSC - Spectrum compatible HDTV	Zenith/ AT&T	Digital 787.5 line HDTV, progressive scanning

Fig.14 The American AN finalists-four out of six are digital

channels, and as explained in the section of this article which deals with 'taboo' channels, the threat of potential interference means that we can use only about a third of the channels that should theoretically be available in an area.

A change to a digital system could enable us to decide from the start that the transmitted energy spectrum would be far more uniform, more noise-like in its appearance, and splitting the video signal into large numbers of sub-bands and coding each of these separately could enable us to achieve this. In addition, since digital signals can be resolved into perfect pictures at very low signal to noise ratios, the digital transmissions would need to be radiated with much less power than our existing analogue ones, yet again reducing the chances of interference. It is these exciting ideas that will allow us to pack more transmissions into the existing spectrum space, providing a genuine increase in the efficiency with which we use the spectrum.

And meanwhile, over the Atlantic

It is interesting to compare these European ideas with those of broadcasting engineers in the United States, who are looking at similar techniques in order to develop Advanced Television systems. The original invitation to manufacturers and research groups to come up with new designs for the American television system of the future led to more than twenty different submissions being made, most using analogue techniques, a few using digital techniques, and some even suggesting a mixture of the two. The field has thinned out, however, as the time to submit the various systems for test has drawn near, and apart from the much-modified Japanese Narrow-MUSE system and the Sarnoff Research laboratories enhanced 525-line system called Analogue Compatible TV, the remaining four contenders are all digital. Three US manufacturing and research groups are putting forward the four digital transmission proposals, which could conceivably be brought to commercial fruition by about 1995:

The American Television Alliance is made up of General

Instruments and the Massachusetts Institute of Technology (MIT, and is promoting the DigiCipher system, is described later.

Zenith, AT&T, and Scientific Atlanta have joined together to develop a single system suitable for transmitting digitally compressed HDTV pictures and NTSC quality pictures over satellite and cable systems.

The Advanced Television Research Consortium consists of North American Philips Consumer Electronics, Thompson

Consumer Electronics, the David Sarnoff research centre, NBC, and Compression labs Inc.(CLI). Notice that members of this group are putting forward both analogue and digital proposals.

There are significant differences between the detailed design of the four digital systems, but they do have much in common. The requirement to squeeze a digital HDTV signal with an original data rate of around 1000 Mbit/s into the narrow 6MHz bandwidth available over the American terrestrial networks means that the data rate must be compressed

HDTV System	Video data rate	Over-air data transmission rate	Modulation system
Advanced Digital TV	15Mbits/s	21Mbits/s	16-QAM
Channel compatible TV	16.4Mbits/s	19.4Mbits/s	QPSK
DigiCipher	12.6Mbits/s 17.5Mbits/s	19.51Mbits/s 24.93Mbits/s	16-QAM 32-QAM
DSC Spectrum Compatible HDTV	17Mbits/s max (dual rate)	21Mbits/s max (dual rate)	VSB/PAM

Fig.15 American digital TV contenders - Data rates & modulation used

by a factor of around 100:1. All the systems use the sort of techniques which we have discussed earlier in order to achieve this. The redundancy, or unnecessary detail in images is thrown away, and the various image processing and signal processing techniques are utilised in order to generate digital signals with the minimum possible number of bits. Consideration then has to be given to how such signals can best be sent along the transmission path, and so-called channel coding schemes have been developed to ensure that noise, interference, and multipath interference picked up along the way will be detected and corrected for, so that the viewer receives a near-perfect picture. The way in which the digital signals are modulated onto the radio frequency carrier also has to be considered. Multi-level multi-phase coding systems such as 16-QAM (Quadrature Amplitude Modulation) allow

for the transmission of the maximum possible number of bits per cycle of the RF carrier, giving maximum information density in the transmitted signal, but the limited transmission power which can be used also has to be taken into account. A comparison of the data rate and modulation systems used by the four American digital contenders is shown below.

Progress and delay

Although the Americans were originally expecting to have decided upon a standard for their Advanced Television System by the end of 1992, delays in the testing of the various systems, many of which are related to the fact that those submitting their systems for test have decided to change to all digital systems, mean that the schedule is likely to be delayed by almost a year. Even then it will be necessary to carry out further tests to establish the over air performance of the chosen system, and only after this stage is complete can broadcasters proceed to construct the necessary transmitting infrastructure. It seems unlikely that this can all be in place much before the end of 1995, which gives the lie to those who are claiming much earlier implementation dates.

A digital TV broadcasting system for the USA - will it happen?

With all the major contenders except NHK having an interest in a digital solution to the problem of providing the USA with a 'compatible' way forward to terrestrial HDTV, and four of the six 'finalist' systems using digits, it seems likely that the Federal Communications Commission (FCC) will eventually come up with a decision to go digital, since the advantages in terms of image quality, signal regeneration, and recording are clear, and it also undoubtedly true that the adoption of a digital transmission system would pave the way for the future introduction of new technical developments as these come along. The only real disadvantages to the adoption of a digital system are that the exact technology is still somewhat uncertain, especially if we include a jump to HDTV with the move to digital, and that enormous investments will be required in the transmitting infrastructure. It seems, however, that the time is coming when viewers will demand better quality pictures than NTSC can provide, and since satellite broadcasters and cable operators are better placed to provide these improved services than the terrestrial operators, it is inevitable that the terrestrial providers will have to do something if they are not to be seen as the poor relations. This 'doing something' will inevitably cost money, and a change to digital would at least put these broadcasters on an equal footing with their satellite competitors. In the meantime, the testing of the various systems is progressing, and we can only await with interest the recommendations of the ACATS advisory committee at the end of this year, and the outcome of the FCC's deliberations on the selection of a

standard, which should be in mid-1993, if no further delays occur.

Digicipher Goes Live Over Air Demonstrations

The first of the digital systems to undergo testing in the United States was the Digicipher system, developed by General Instruments and the Massachusetts Institute of Technology, MIT. Testing was completed at the US ATTC (Advanced Television Test Centre) at the end of February 1992, but this did not include over the air terrestrial broadcast tests. Although many simulated demonstrations of Digicipher have been shown in the past, and demonstrations of how the signals could be passed over a satellite link have been given, it was

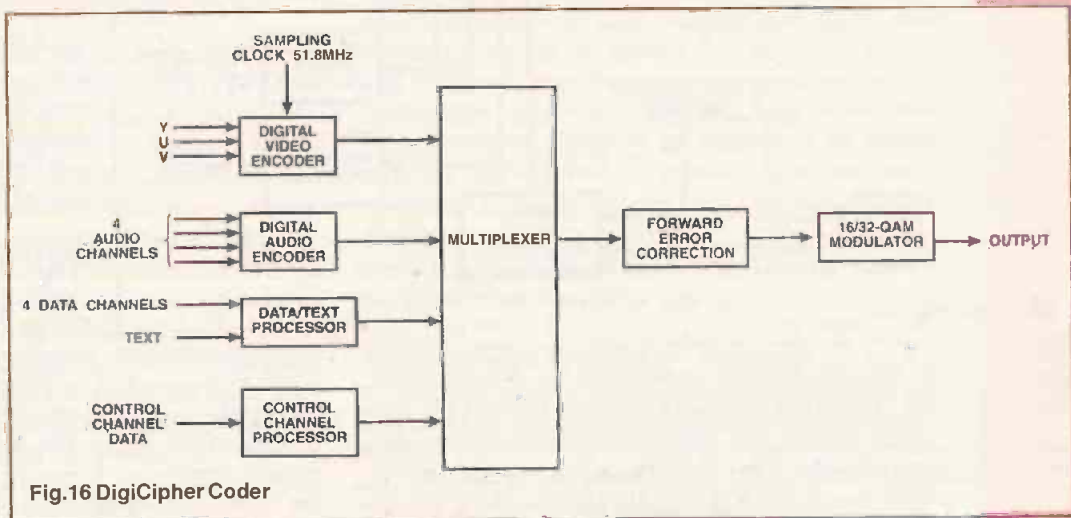

only on 23rd March 1992 that terrestrial digital HDTV broadcasting became a reality, as experimental Digicipher transmissions were broadcast over a distance of 10 miles via the public broadcasting station WETA, in Bethesda, Maryland. The transmission used a standard American 6MHz wide transmission channel, and was radiated using only 2% of the power used by the analogue NTSC signals from the same station. The signals were received from standard TV aerials on the roof of the US Capitol building, and were displayed on HDTV monitors. In April 1992 these same signals were relayed to Las Vegas for demonstration to those attending the National Association of Broadcasters annual convention. The fact that excellent picture quality was received from such low power transmissions confirmed the theoretical arguments that digital signals with very low signal to noise ratios can still provide first class results.

The DigiCipher HDTV system

DigiCipher is an all-digital HDTV system that, it is claimed, can be transmitted over a standard 6MHz wide television channel, in either the VHF or UHF bands. Additional advantages claimed are that the decoder complexity is low, and that low transmitting power can be used, allowing the transmissions to make use of otherwise 'taboo' channels. Compatibility is achieved by simulcasting the DigiCipher information with a standard NTSC signal on another channel.

In order to achieve the miracle of squeezing a digital television signal through a 6MHz channel a 'highly efficient unique compression algorithm' is used to vastly reduce the data rate that is required. In common with many other researchers in this field, GI have decided to use a coding system based on motion-compensated discrete cosine trans-

form (DCT) coding to achieve this. Such a system can only work because successive television images nearly always contain a large amount of similar information, so that by cutting out the redundant information, ie the information which is repeated from one image to the next, only essential data, giving the details of the changes which have taken place from one field to the next, need be sent. As we with some other systems, the DigiCipher system compresses the signal by first predicting how the next frame will appear, and then sending

fore better resistance to errors. The multi-level, multi-phase 16-QAM signal can then carry the complete audio and video data stream within a bandwidth of well under 5MHz. When the 32-QAM transmission option is to be used, the total data rate rises to 24.39Mbit/s.

In the DigiCipher decoder the 16-QAM demodulator receives the incoming signal from the tuner, demodulates it and provides a 19.51 Mbit/s data stream. The demodulator circuitry contains an adaptive equaliser which can compensate for distortions to the off-air signal caused by multi-path reception.

The data then passes to the forward error correction circuitry, which can correct random and burst errors and which should provide error-free data to the sync/data selector, which maintains overall synchronisation and demultiplexes the data stream to provide separate streams for video, audio, and data.

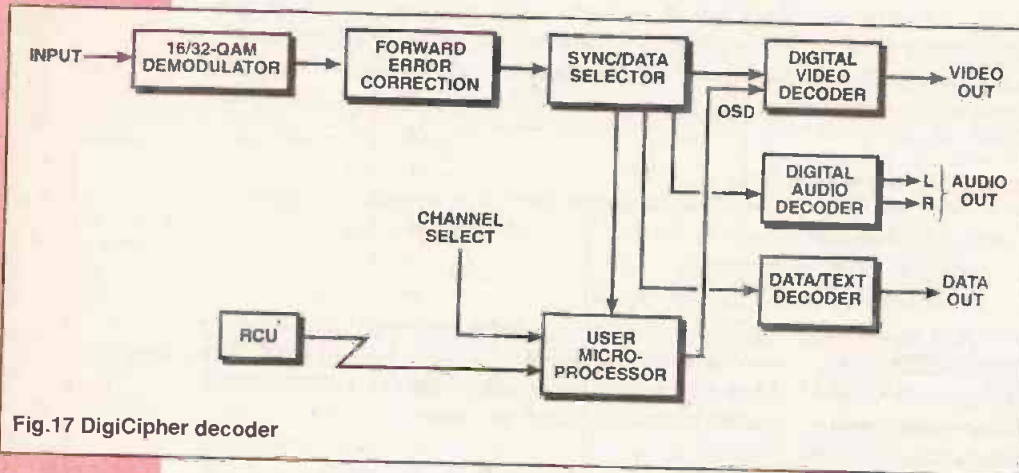

Fig.17 DigiCipher decoder

Digital Transmission

As was explained earlier, for transmission the use of digital modulation permits a much lower transmitter

power, perhaps as much as 30dB less, to achieve the equivalent signal to noise ratio and therefore coverage area as for analogue NTSC signals. This helps enormously in limiting potential interference to existing transmissions, and allows the system to make use of the 'taboo' channels. Since the digital signals take up only a 6MHz bandwidth, there should be no problems in passing them along existing cable networks, allowing them to carry HDTV signals with the minimum of modifications, and the signals should also be suitable for use over Multichannel Microwave Video Distribution Systems (MVDS) and over satellite links. GI even claims that 'all-digital recording and playback of its HDTV signals is within the reach of current technology for consumer use, since the total data rate is less than 20Mbit/s'. DigiCipher is also currently offering its digital compression system to United Kingdom cable television operators, claiming that from four to ten standard PAL television programmes can be squeezed into one 8 MHz wide cable channel, and that digital sound plus encryption can also be included.

the difference between the prediction and the actual image. The simplest way to predict what the next image will be is to use the previous field. Since some parts of pictures contain less redundancy than others, the result is a variable data rate which can sometimes be difficult to handle. This differential pulse code modulation (DPCM) idea works well if there is little movement present or if there is little spatial detail, but can collapse completely under some conditions.

As with many of the other systems using temporal compression, motion estimation and compensation techniques are used with the coding process. The DigiCipher motion estimation system uses large blocks of pixels, called 'superblocks', and provides a motion vector to give information about each of these blocks.

When reading the following description it should be remembered that, like the other systems competing for the attention of the US FCC, the DigiCipher system is still being 'tweaked' to achieve the maximum performance, so some of the data rates, which have already been changed since the original demonstrations were given, may well be slightly different by the time the system comes on the air. In addition, the recently introduced multi-resolution options mentioned earlier in this article, whereby both 16-QAM and 32-QAM signals may be radiated, have necessitated some small changes. Using as its source a 1050 line/59.94 f.p.s. interlaced picture, the DigiCipher digital video encoder takes the Y,U,V signals and samples them at 51.8MHz, implements the compression algorithm, and generates a video data stream. Four channels of digital audio plus four 9600 baud data channels and the necessary control and synchronising data are then multiplexed together with the video data, to provide a 15.84 Mbit/s data stream. Forward error correction data is then added, bringing the data rate up to 19.51Mbit/s, and this data is then fed to a 16-state Quadrature Amplitude Modulator (16-QAM), in which the amplitude and the phase of the transmitted signal are varied. With 16-QAM four amplitudes and four phases are usually used, and QAM was probably chosen in preference to PSK because it has better noise tolerance and there-

Digital Terrestrial Television - The future in Europe The many known advantages of digital television, including its reduced susceptibility to noise and interference, and the fact that errors incurred during transmission can be detected and corrected or concealed, together with the ability to pack more signals into the spectrum using interleaving techniques and data compression, have led European broadcasters to start thinking seriously about their future plans. A group of broadcasters has now come together in a major collaborative project to coordinate the work of their laboratories, and the dTTb (Digital terrestrial television broadcasting) consortium is asking the European Commission for tens of millions of ECUs to pursue this research. The original proposal was that the work should form a major RACE project (Research into Advanced Communications in Europe), but its initial scope is likely to be cut down to a one year feasibility project, funding being restricted to about one tenth of that originally requested. Current thinking is that the feasibility project will

subsequently lead to a full RACE project.

The project is being led by prime contractor CCETT (Centre Commun d'Etudes de Telediffusion et Telecommunications), a major French research centre, and the fact that 23 other groups are participating shows the importance that is attached to this project. Some of the major participants include BBC, ITC/NTL, IRT, RAI, TDF, Philips, Thomson, Retelevision (Spain), the European Broadcasting Union, and the Deutsches Bundespost.

The group will look into a wide range of terrestrial transmission issues, including modulation, digital channel coding, and spectrum allocation, and existing projects such as the UK SPECTRE project and Philips 'plug-free' DTV will be included within the dTTb work.

Studies will concentrate on widescreen enhanced quality pictures, not necessarily High Definition, and topics to be addressed will include how best to squeeze the maximum number of digital TV channels into the existing UHF and VHF networks throughout Europe, how to eliminate ghosting, and how to use the ruggedness of digital transmissions to provide perfect pictures throughout the service area. The flexibility of digital signals could allow the same transmitted digital bit stream to be received as an HDTV picture with a domestic roof-top antenna, or as a noise and interference free 625-line picture on a portable receiver. Higher order modulation schemes using multi-level coding that could allow HDTV pictures to be transmitted in standard 8MHz wide terrestrial channels will also be examined and tested. The target date for the dTTb project is given as 1998, which seems far enough away to be realistic, although the enormous costs of re-engineering the transmitting networks of Europe for digital transmissions might well act as something of a damper to the introduction of Europewide enhanced television services. Broadcasting engineers have a long history of developing systems that take an awful long time for the market to accept, and whether or not these proposed new technologies do succeed will depend more upon whether the customer can be convinced that he is getting something worthwhile for his money than on the technical sophistication of the system. The really important feature of the European dTTb work, however, is the intention to establish a common European Strategy for the introduction and the orderly development of digital terrestrial television broadcasting, and this just has to be a laudable aim.

On a world-wide basis the CCIR (International Radio Consultative Committee) has announced that it too will be studying the whole question of digital terrestrial television transmission, including bit rate reduction strategies, and one CCIR task group is aiming to provide a standard for 6MHz bandwidth digital terrestrial transmissions by 1995.

Digits and Cable

Cable television has been around for almost as long as

television itself, and modern, properly engineered cable systems are capable of providing a wide range of programmes of superb technical quality. It is unfortunate then that in many parts of the world, including the UK, cable has often acquired a rather dated image. This is probably because in many towns the cable system was originally installed before transmissions were readily available off-air, in order to enable the local TV dealer to sell receivers, and once off-air transmissions from local relay stations became available there was no incentive for the cable operator to update and upgrade the system. Systems designed to carry three or four programmes were often difficult to upgrade to carry extra channels, since the original amplifiers would suffer from overloading and cause distortion when extra channels were added. Even modern systems are not immune from problems. Although tales of the 'unlimited' bandwidth supposedly available with modern fibre optic cable systems have been current in the technical press for perhaps the last twenty years, any operator of such a system will tell you that there is no such thing as 'unlimited' bandwidth, and that even if the fibre optic cable itself has a very wide bandwidth, the usable bandwidth is likely to be limited by the capabilities of the opto-electronic equipment at each end of the cable.

Gallons Into Pint Pots

Any cable operator would therefore be delighted to find a method of allowing him to carry several extra programmes

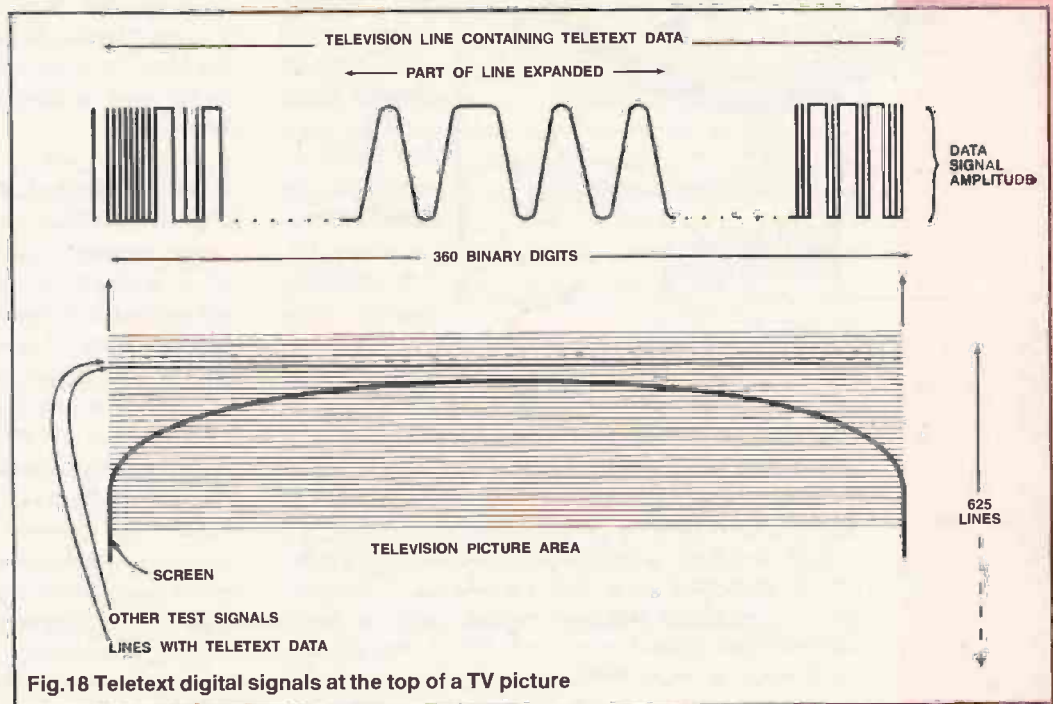

Fig.18 Teletext digital signals at the top of a TV picture

down his existing network, and it looks as though the latest digital techniques that we have been discussing could provide the answer.

Advanced digital video compression techniques that are now being demonstrated in America can squeeze up to ten new television programme services onto each existing cable channel, so that an existing four channel system could perhaps carry forty programmes, and an existing thirty channel system could be upgraded to an astonishing three-hundred channels - if only we could find the programmes! In fact, filling such a large capacity would not be very difficult; it would also be possible to carry enhanced quality widescreen

films, perhaps on a pay per view system, allowing you to call up and request the film of your choice, and there would be ample room for interactive services and for hundreds of channels of high quality digital radio, as well as telephone, FAX, and data transmission services.

Cable operators have the big advantage that since their systems are relatively self-contained they can more or less do as they like with the few hundred MHz of frequency spectrum that they are allowed to use over their cables, and this means that if they decide to make a change to a new digital system they can make the change quickly, and without having to

consult the rest of the broadcasting world. Since any changes which broadcasters try to make will obviously affect the operations of other users of the over-air radio spectrum, with the strong possibility that some form of mutual interference will be caused, broadcasters who wish to transmit digital signals must first obtain approval from the transmission authorities. The large number of existing broad-

casters who will need to be consulted, many of whom will have no interest in the new technology and would prefer the status quo, will inevitably mean that this will be a long drawn out process, and we can see how the US Federal Communications Commission has taken much longer than originally planned to decide upon a scenario for the introduction of Advanced Television.

Cable operators are under no such constraints, and at the 1991 Western Cable Show, held in California late last year, several companies demonstrated systems that could fit 10 standard NTSC pictures into a single NTSC cable channel, which takes up about 6MHz of bandwidth. The digital compression techniques that the cable operators will use are broadly similar to those being used for HDTV, where you will remember that four or five times as much information as is needed for a standard quality picture must be carried over a normal radio-frequency channel. The cable operator will need to install the digital compression equipment at the 'head-end' of the cable system, where the programme material is gathered from its various terrestrial and satellite sources, and the resulting digital multiplex will then be sent along the cables direct to subscribers' homes. Although the head-end compression equipment will be costly, this cost can effectively be divided up amongst the thousands of subscribers, so is not likely to be too significant, but the equipment at

the subscribers end is a different story. The digital signal processing boxes that would be required in every cable home need extremely complex circuitry to perform the decompression and reassembly of the digital signals into television pictures and sound, and at the present time this requires whole racks of equipment. Semiconductor manufacturers are busy considering how best to partition this circuitry so that it can be fitted into the smallest possible number of chips, or as they say, the minimum area of silicon. If they can achieve a cost-effective solution there is no doubt that a vast potential market exists, with every cable home eventually needing a digital converter box, and cable homes making up almost 70% of the US television market. The ideal digital cable system at this stage of cable system development would allow standard uncompressed television signals to be passed through it, to serve standard receivers, whilst at the same time carrying a digital multiplex of several compressed video and audio signals. The digital converter box would need to identify the different types of service and provide the receiver with the necessary inputs, quite a challenge for a box that must cost less than a hundred pounds if the financial goals are to be achievable.

I have no doubt that digital compression techniques will bring a revolution to US cable systems, and maybe to those of other countries as well, but once again I would urge caution when considering the time scale. In 1991 an international electronics magazine quoted '... Many of these new services will reach cable subscribers next year, well ahead of the FCC's schedule for their appearance on US broadcast television. How can digital cable services possibly be provided so quickly when the necessary integrated circuits are still at the design stage?

Time compression - An hour-long programme in five minutes!

Speed-reading, where you learn to read a book in only a fifth of the time it would take a normal human being, has long been popular with management whizz-kids who just can't resist cramming the concentrated wisdom of some industry guru into their already overtaxed brains, although I suspect that whether they ever actually enjoy a book they have 'read' in this way is a very different question! Similarly, subconsciously learning from a tape recorder whilst you sleep has its own band of adherents. Can you really believe, though, that an American 'entrepreneur' has announced firm plans for transmitting digital television signals in truly 'time-compressed' form, whereby you ring up the aptly named 'Entertainment Made Convenient' (EMC2), and they immediately send you the video film or television programme of your choice, down the cable system, or over a satellite channel, in the form of a five-minute burst of digital data? Now the idea is not, of course, that you watch the programme at high speed, but that the time compressed programme is stored in your video recorder for playback at normal speed. The advantage of being able to send programmes in less than real time is that the cable or satellite company can send you any programme you request, because you will only be taking up the transmission capacity of the cable or satellite channel for a few minutes, whereas with real-time systems it is would just not be possible to simultaneously distribute more than a very limited number of programmes. The concept is being promoted as "The Electronic Video Rental Store", and the security coding built into the digital system allows you to

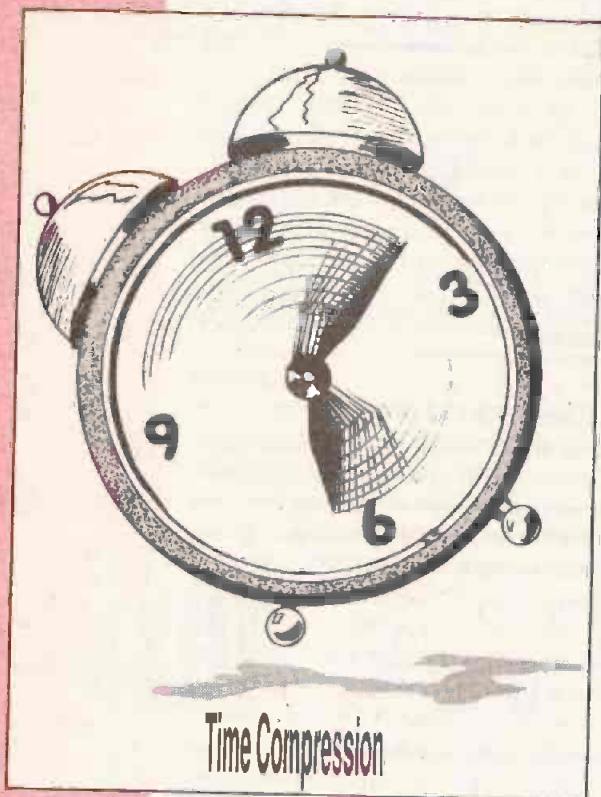

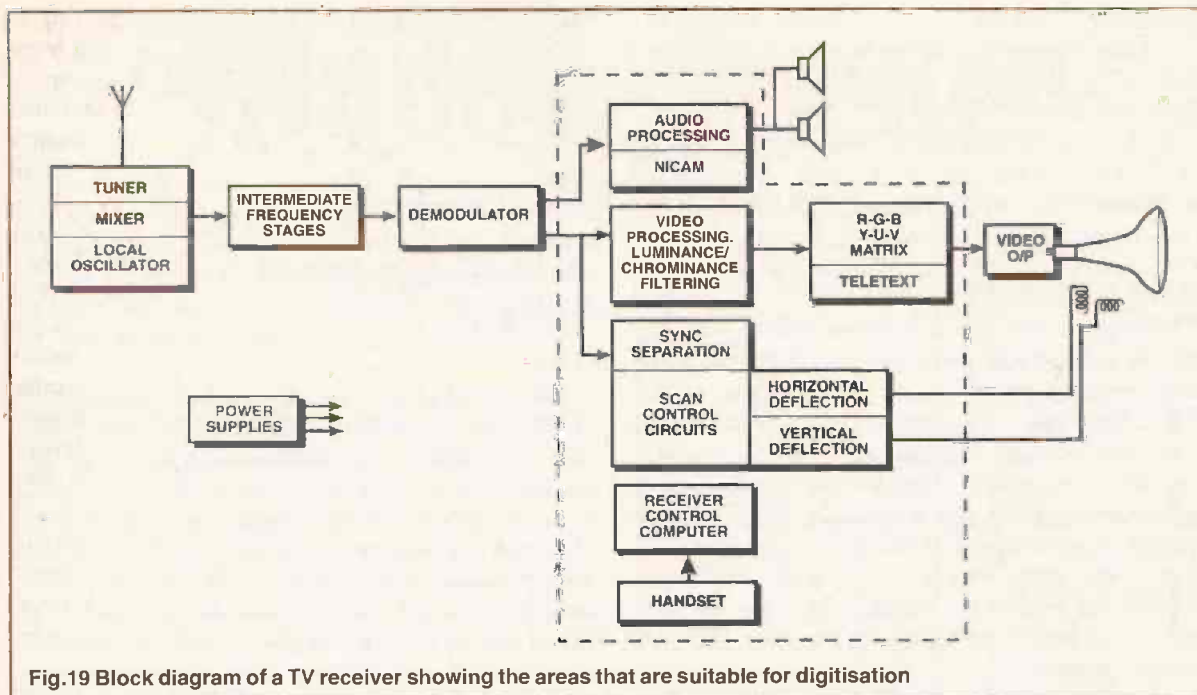

Fig.19 Block diagram of a TV receiver showing the areas that are suitable for digitisation

watch the programme no more than twice before it automatically erases itself; the company claims that 'the customer doesn't even have the trouble of returning the electronic video tape to the rental store!' Whilst those of us in the industry are well used to the American 'hype' that goes along with all new ideas, and at first sight this one really takes some believing, in reality all the technologies that are being proposed already exist, and it is only in matters of detail that one can quibble with the ideas.

The claim is that a full length movie, perhaps 100 minutes long, could be digitised and then compressed to a data rate of about 10Mbit/s. With present day technology the quality of such pictures is likely to approximate to that of a picture from VHS tape, and it is only when the company starts to claim that S-VHS quality will be possible that I start to have doubts, although even these are only about the time scales involved. There is no doubt that the current research work being carried out by the members of the international MPEG (Motion Picture Experts Group) to try to agree on an international standard for moving pictures at bit rates of between 5 and 10 Mbit/s is showing that surprisingly good quality can be obtained at these rates. The hope would be that once the groups have agreed on the optimum digital processing algorithm, mass produced MPEG-2 chips would appear on the market at reasonable prices, thus making the sort of techniques we are discussing not only possible, but practical.

The Entertainment Made Convenient scheme might also have problems in obtaining sufficient bandwidth over a satellite to direct enough different digital programmes to many individual homes. This is relatively easy over a cable system where numbers are limited, but the thought of transmitting enough data to send individually addressed timecompressed programmes to thousands or even millions of viewers via satellite conjures up requirements for data transmission rates that are far in excess of anything that a current satellite data channel, typically 24 MHz wide, could cope with. As an example of current thinking, the plans which the Thomson company is putting forward for a digital DBS service in the United States assume that it will be possible to transmit eight film channels per 24 MHz satellite channel.

In parallel with the transmission side of the Entertainment Made Convenient scheme, work is progressing on digital domestic videotape recorders based on VHS machines, but especially tailored to suit the EMC2 system. The idea is that the VCR could receive the compressed signals from the satellite, and store them on tape in compressed form. When playing back the signals, the VCR would pass a huge block of data, perhaps 10 Mbits, into a solid state buffer store, and the stored data would then be passed through decompression circuits before being fed to the receiver. Much work still remains to be done on this, and I am somewhat sceptical about the costs of such a huge store in the short term, but one suggestion is that the tape machine would only play back intermittently, stopping and starting automatically as the buffer store requires replenishing. It would, of course, be important for the VCR to be able to record and playback normal VHS tapes as well.

Before we leave the topic of time compressed programmes, it may be worth pointing out that the Sanyo Electric company has just introduced a new model videocassette recorder which it is marketing under the name 'Digest'. Targeted at the businessman who is too busy to watch TV at normal rates, this machine does actually play back its tapes at twice the normal speed, with special digital sound processing being used to shift the audio frequencies so that the reproduced sound is intelligible!

Digits in Receivers

Digital techniques are not entirely new on the domestic television receiver scene, and there are several areas where we have already become familiar with digital technology in our receivers.

1. Teletext signals are digital, transmitted and received at 6.9375 Mbit/s, and require digital processing, all of which is nowadays achieved in a handful of chips, the latest designs needing only a single chip to provide all the functions.
2. All the remote control systems with which we have become lazily familiar use digital techniques; the commands from the remote control handset unit are in digital form, require digital decoding and digital to analogue conversion in

the receiver.

3. Modern tuning systems which can pick out individual channels and auto-tune to the channels of our choice use digital techniques.

So far, most of the receiver circuits still use analogue circuits, primarily because most manufacturers have not seen any financial advantages in a change to digital processing, but it may be that things are about to change in this field, and it is important to have some idea of the ways in which digital circuitry can be used in receivers.

Even if we could transmit television signals digitally, and we have seen in earlier parts of this article that this is only likely to become possible in the next few years, modern receiver integrated circuits would not be able to deal with the type of radio frequency digital data that we would be transmitting - there is too much of it, and it's too fast for even the highest-speed semiconductor technologies that are at present available. With the present technology it is also not feasible to use digital signals even at the IF frequencies of around 39.5MHz that are normally received in receivers, and so we shall see that the most useful places in a receiver to make use of digital processing are after the video and sound signals have been demodulated.

receiver. They, and other manufacturers, have since developed later circuitry based on similar techniques, but the early ITT chipset will serve as a useful example of how digital receivers can be designed and built.

The first advantage for the setmaker, is that some of these VLSI's contain up to 200,000 transistors, so there is a tremendous reduction in the number of components used, and so the automated construction of the receiver is much simplified. This reduction in the component count should also provide a reliability bonus for the viewer, since there will be less heat dissipation from fewer components and, hopefully, less to go wrong.

The second advantage for the setmaker is that the digital circuitry makes possible simpler, automated receiver alignment. It would be very difficult and expensive to install equipment to automatically adjust the dust-cores of the inductors and to automatically turn the various potentiometers that a conventional analogue receiver needs if it is to be properly aligned. In a digital receiver all we need to do is to enter alignment data into a programmable memory, and the digital circuits will automatically be set-up as we require. Signals can then be obtained from test points at many locations around the receiver, and fed back to the control

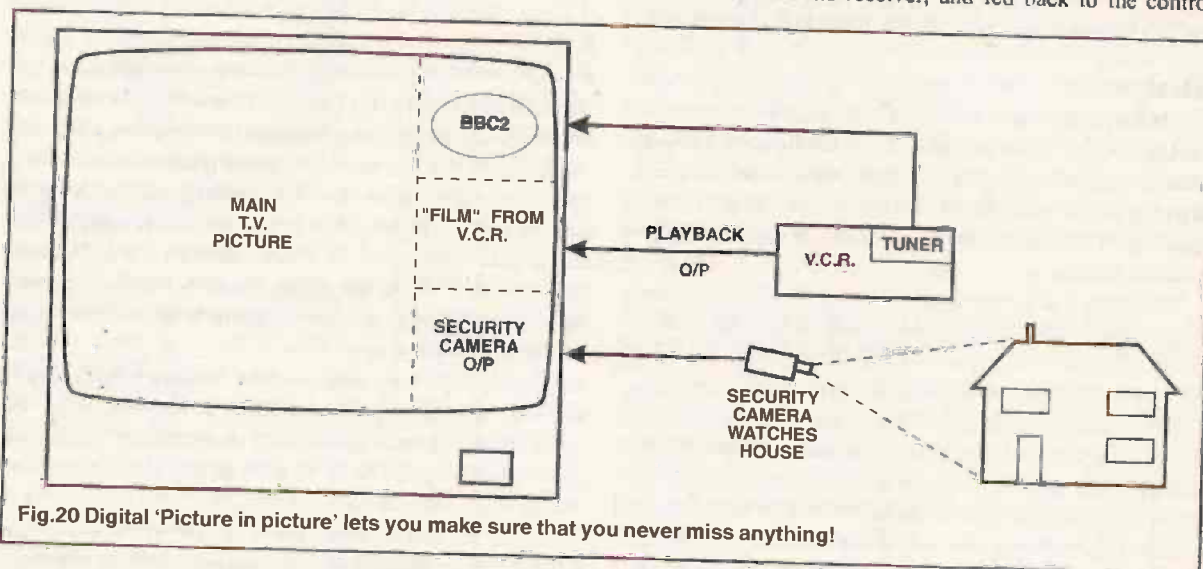

Fig.20 Digital 'Picture in picture' lets you make sure that you never miss anything!

Since the signals at demodulator outputs are in analogue form, the first step must, obviously, be analogue to digital conversion, before any digital processing is possible.

It is worth pointing out at this stage that since the cathode ray tube is an analogue device requiring analogue driving signals, we are inevitably going to need digital to analogue conversion before the signal gets to drive the RGB output stages. Similarly the sound signals will eventually need to drive an analogue loudspeaker. Some backward, Luddite engineers might raise the totally irrelevant point that it might seem ridiculous to bother using digital processing when you have to start off in analogue and finish in analogue, so, just to satisfy these unreasonable people, let's have a look at whether there are, in fact, any advantages and who will gain from the use of digital techniques.

The West German branch of ITT, ITT Intermetall, has been working on the application of digital processing techniques for receivers for some years, and their engineers know as much as anyone about the subject. They came up some time ago with a set of eight chips for processing the video signal, the audio signal and the deflection signals in a television

computer IC to ensure that optimum alignment of all stages is maintained even if some of the equipment parameters change, perhaps due to heating or just old age. The reduction in receiver assembly and setting up costs that these techniques bring about will be of vital importance to manufacturers in an ever more competitive market.

The advantages for the viewer are that the picture quality will be immaculate, since receiver alignment will always be optimised, and the digital techniques make possible such things as the complete elimination of ghosts and noise, and "magic" features like one picture within another, or bild-in-bild as the Germans call it. I have seen several receivers which allow you to watch the channel of your choice on the big screen, with the pictures on the other channels inset, so that the keen viewer needn't miss anything. It is rare, however, for such receivers to be equipped with more than one tuner, so you often have to provide your own video sources, whether from a video recorder with its own tuner, or from a security camera keeping an eye on undesirable visitors to your front door whilst you lose yourself in the latest episode of your favourite 'soap'.

Window Opener

Some circuit and mechanical designs for remote unshuttered fenestration by Terry Pinnel

Both my wife and I are keen bedtime readers. But we also both like to sleep with a window open. Unfortunately the local population of moths and bugs appreciate this combination and are fluttering and buzzing around within minutes of our bedside lamps being switched on. So the routine used to be that I'd open the window only after we'd finished reading and had switched the lights off. Which meant getting out of a snug bed and losing the delicious drowsiness that reading had usually induced.

Soon after my obsession with electronics took hold, the answer became obvious. A bedside-controlled window opener.

Design

The requirements were simple. A bedside control which would open or close the window. A toggle switch was the clear choice, as its status would then always be obvious in the dark. A motor, probably DC supplied, would perform the opening. The motor would have to be stopped at the two

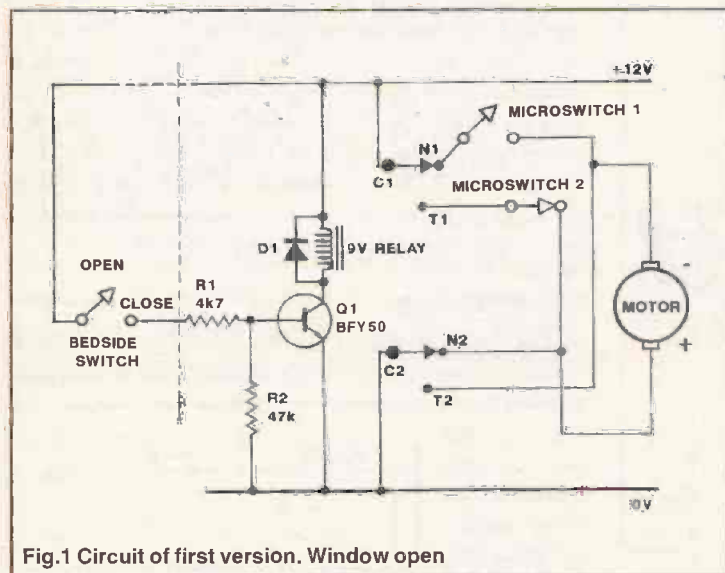

Fig.1 Circuit of first version. Window open

extremes, fully open and fully closed. And, whatever the actual mechanics, the motor's direction would have to be reversed between opening and closing.

In the ten years or so since then, I have designed and installed three different devices.

Primitive Version

Despite its shortcomings, my first design performed its intended task reliably for several years. The layout is illustrated in Figure 7. I used a few components from my son's old Meccano set to take the power from a cheap, high-revving, reversible DC motor to a slowly-turning spindle. To this was

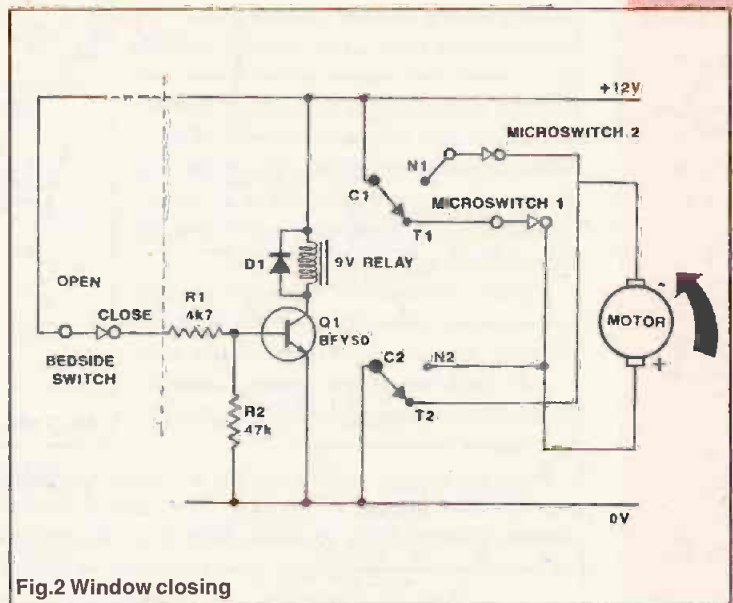

Fig.2 Window closing

tied strong nylon fishing line, which was then secured to the window after routing via two small guide-pulleys. Closing the window was therefore a matter of powering the motor in the appropriate direction, while opening was achieved by reversing the motor and allowing the strong rubber bands

outside to pull the window outwards. By using long rubber bands, the tension could be maintained at a fairly steady level throughout the operation.

The simple circuit is shown in Figure 1. Although it was clear at the outset that the electronics would be simpler than the mechanics, it took a lot of doodling and playing with relays before I finally came up with this. It only just qualifies as electronics by virtue of its single transistor. But after an excursion into the more complex circuit of the single microswitch version (described later) I finally returned to almost exactly this same simple and highly reliable circuit for the unit that is in use today. It is also versatile and could be used virtually as it stands for any reversible mechanism operating between two positions, such as opening and closing curtains or a garage door, or, at the light-weight end of the scale, for toys and models.

Figure 1 shows the status with the window fully open. The bedside switch is in the Open position, so that the base of transistor Q1 is low and the relay is off. The relay contacts therefore connect Common to Normal. Microswitch 1 is closed (ie the two wired contacts are connected) because it is only open when the window is fully closed, depressing the switch. So there is no path for current flow and the motor is therefore off, with the system quiescent.

Incidentally, beware of potential confusion here. We have toggles, microswitches, switch contacts and relays being open or closed, as well as the window itself!

The transistor Q1 is not critical. Virtually any general

purpose medium gain NPN type could be used instead of the BFY50. The protective silicon diode D1 was also non critical; I used a 1N4001. These active components, together with the two resistors R1 and R2, were mounted on a small piece of stripboard, soldered directly to the relay supply contacts. The relay itself was mounted inside a strip of tin secured to the side of a wooden box containing the motor and Meccano assembly. Use of insulated connectors made it easy to experiment with the relay and microswitch wiring until I got it right. The two thin wires to the miniature bedside toggle switch were tucked neatly down the side of the skirting board underneath the carpet.

Figure 2 shows what happens when the bedside switch is moved to the Close position. The relay is activated and current flows from +V to C1 to T1 through microswitch 1 to Motor positive and Motor negative to T2 to C2 to 0V. The window therefore closes.

When the window is fully closed, microswitch 1 is depressed, disconnecting the contacts. The current flow is therefore prevented and the motor stops with the window quiescent in the closed position, as shown in Figure 3. With the commonplace SPDT type that I used, in practice it was a matter of checking that the correct two terminals were wired, so that an open circuit resulted when the switch was depressed.

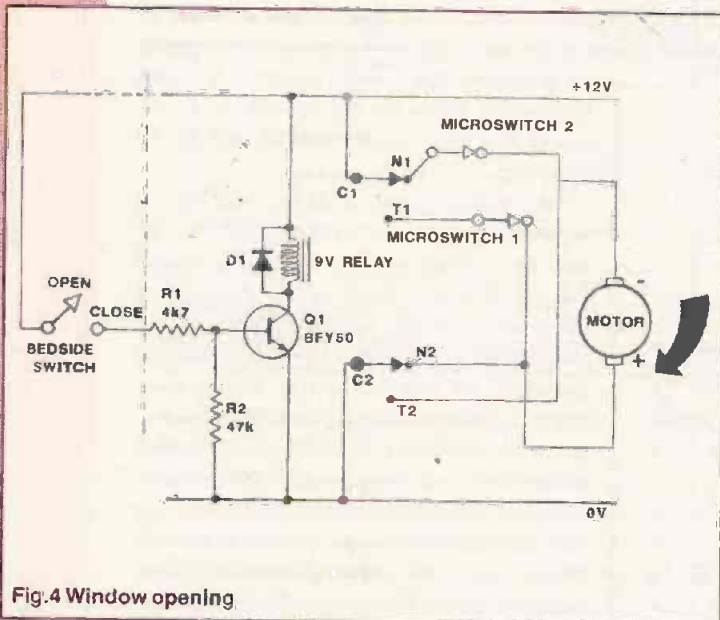

Fig.4 Window opening

If the bedside switch is now moved to the Open position, the relay drops out and current flows from +V to C1 to N1 through microswitch 2 to Motor negative and Motor positive to N2 to C2 to 0V. The motor therefore operates in the reverse direction and the window opens, as shown in Figure 4.

Finally, the status returns to that shown in Figure 1, with microswitch 2 now depressed, so that its connections are broken, stopping current flow with the window in its fully open position.

Note that if for some reason (such as wind or window-cleaning) the window is physically moved while the circuit is in a quiescent state, so that pressure on one of the microswitches is released, the circuit immediately corrects this by operating

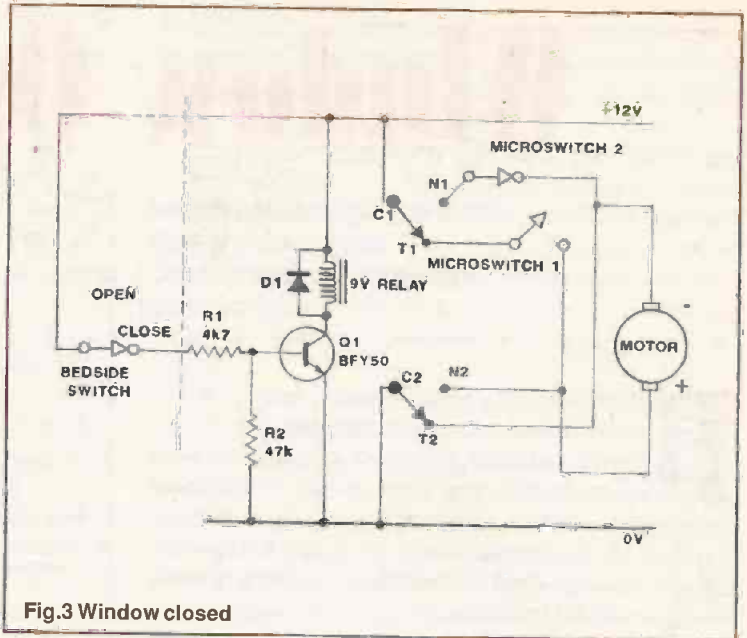

Fig.3 Window closed

the motor automatically in the appropriate direction. When the bedside switch is at its closed position in particular, this feedback feature proves very useful in ensuring that the window really does remain firmly closed.

I could even have dispensed with the transistor and relay, by using instead a DPDT switch at the bedside to perform the polarity switching instead of a relay. But as Figure 5 shows, this would have needed six wires running around the bedroom instead of two. And they would have had to carry the full motor current. So this option was not seriously considered.

The supply voltage needed was dependent on the motor used and could have been anything from 3V to 12V for the sort of miniature surplus DC motors I had available. Given its infrequent use (typically a couple of times a day) it could even have been battery powered. I actually used an existing power source supplying another of the many circuits in our gadget-strewn bedroom. It was a conventional mains powered bridge circuit as shown in Figure 6. I also used this with the much heavier duty motor of the final design described later.

Shortcomings

The most obvious snag with this initial design was that the window took about 30 seconds to close! And despite some sound-proofing of the wooden case housing the motor and rubber band type gearing, it was fairly noisy. I was always very conscious too of the possibilities for mechanical failure, such as a broken rubber band (inside or outside) or the nylon line snapping. But in fact none of these happened in practice. The real flaw was one that should have been obvious to me at the start. The externally mounted microswitch 2 was exposed to all weath-

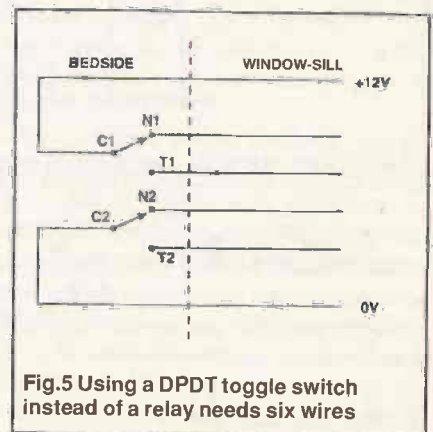

Fig.5 Using a DPDT toggle switch instead of a relay needs six wires

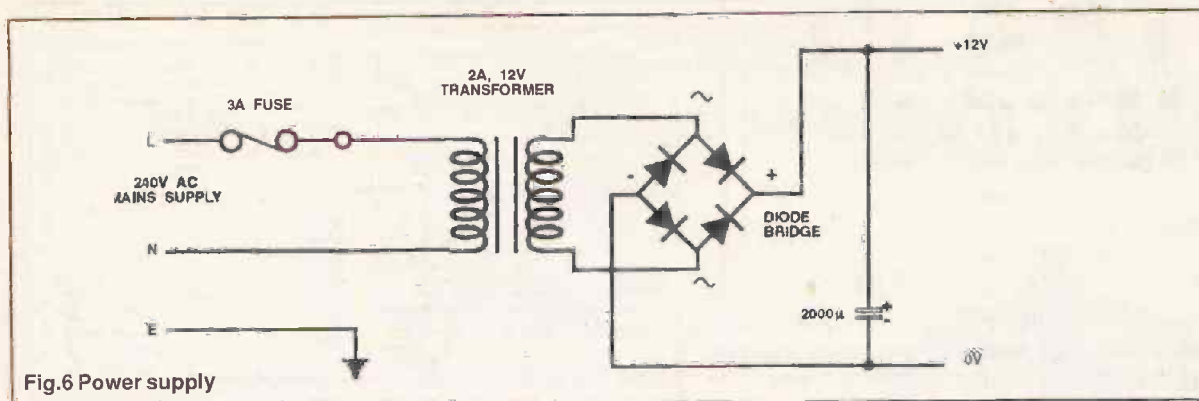

Fig.6 Power supply

ers, and eventually gave up due to corrosion. After one or two replacements (a ladder job, as access from inside proved virtually impossible) I gave up as well and went back to the drawing board for a rethink.

Single Microswitch Version

Apart from eliminating microswitch 2, I decided to abandon the Meccano and rubber band approach and move up-market. A visit to a local car wrecker yielded a heavy duty 12V windscreen wiper motor which became the power source for the next versions.

I'm sure there was a much simpler way to achieve my aim of using only one microswitch and someday I'll have a crack at finding it. But the circuit I came up with at the time is shown in Figure 11.

The principle remains simple. A relay is again used to reverse polarity of the motor. But instead of detecting the fully open state with a second microswitch, in this version I used a monostable and a small power transistor to apply opening power for a specific time. This lost the 'symmetry' of the simple design. Opening effectively needs one circuit and closing another.

Assume the window is initially closed. If the bedside switch is now moved to Open, this sets Bistable 1 by applying at least one positive-going pulse to pin 5, so the output at pin 3 goes high. This drives the relay, via Q1, so current flows

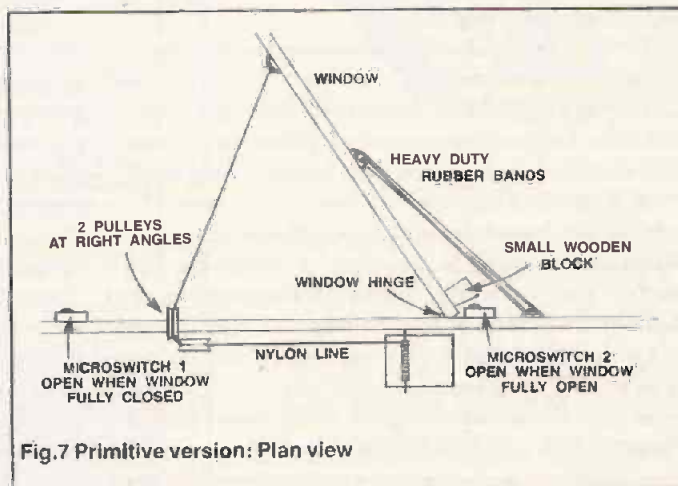

Fig.7 Primitive version: Plan view

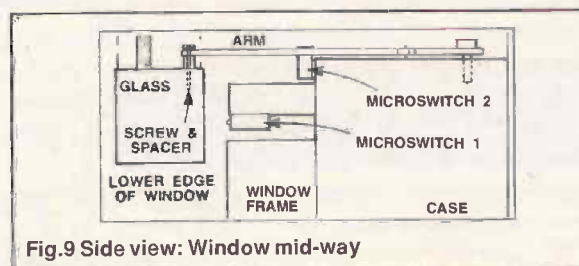

Fig.9 Side view: Window mid-way

from +12V through the 6R limiting resistor to C1 to T1 to Motor negative and positive to T2 to C2 to T3 and then to QV. Q2 and Q3 are switched on, allowing this current flow, because the monostable is triggered by the positive-going output from Bistable 1, ie the same signal that goes to Q1's base. So the window opens, until the monostable period has ended. Its duration is determined by the 5µ electrolytic capacitor and the setting of the 470k preset. Trial and error produced the correct result, of the order of about half a second.

If the bedside switch is now moved to Close, Bistable 1 is reset and its outputs at pins 3 and 4 go low and high respectively. Q1 therefore switches off and the relay drops out, so its contacts are now in the Normal position, with C1 connected to N1 and C2 to N2. But the monostable is not triggered and instead the power transistor Q1 and its driver Q2 now get current from Bistable 2. This is reset by the high-going output signal from pin 4 of Bistable 1. So the motor current now flows from +12V to C1 to N1 to T2 to Motor positive and negative to T1 to N2 to T3 and then to 0V. The window therefore closes. When it is fully closed, the microswitch contacts are closed, setting Bistable 2, so that pin 4 goes low,

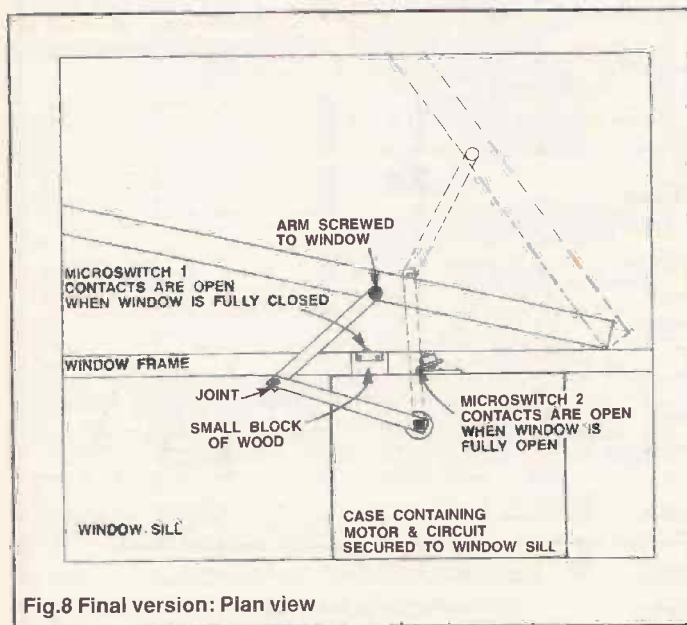

Fig.8 Final version: Plan view

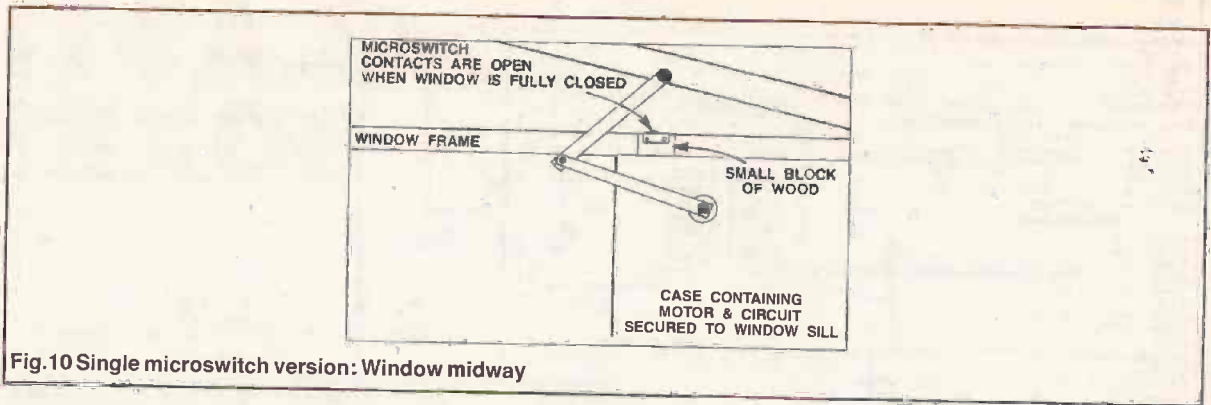

Fig. 10 Single microswitch version: Window midway

removing the drive current to Q2 and hence stopping the motor.

Note that the self-correcting action of the simpler version is no longer in operation.

This design worked well mechanically and electronically for a number of years. One snag arose from the fact that I had been thoughtless in using a separate power supply to the bedside switch. This was simply because I had another 12V supply line conveniently wired to the bedside for a completely different circuit (a Surf Simulator) and I thought I'd save myself the trouble of another long wire from the window-sill to bedside unit. I therefore zapped several 4001s over time, by occasionally switching off the main power supply before first disconnecting the bedside input signal.

This apart, the unit was still going strong when I decided to change it. One day (probably while replacing yet another 4001) it dawned on me that I had been too hasty in abandoning my two-microswitch approach. Because of the trouble with the exposed exterior microswitch in the simple version I had focussed myopically on redesigning the circuit so that it would use only one microswitch. The far preferable alternative was of course to find a new place for microswitch 2 that was not exposed!

Final Version

This new position can be seen from Figures 8 and 9. A piece of aluminium was used as a bracket and the microswitch mounted on the outer edge of the case. Another piece of thinner aluminium about 1" long by 1/2" wide was bent into an L shape and glued to the activating arm to make a small striker plate. When the window reached its required extreme open position, which was roughly when the arm was at right angles to the window, the microswitch was depressed and the current interrupted.

I was therefore able to revert to exactly the same circuit as that of the earliest version, apart from the inclusion of a 6R limiting resistor in series with the larger motor. This was added to tame the action a bit. Otherwise the motor closed the window with a violent slam. Some compromise was necessary because if the current to the motor was reduced too much, then the window would not be pulled securely into its closed position, with consequent drafts and rattles.

This new and hopefully final version is potentially both electronically simple and mechanically reliable. It has only been in service for a couple of weeks at the time of writing but I am optimistic that both it and our bedroom will now remain bug free for many a year.

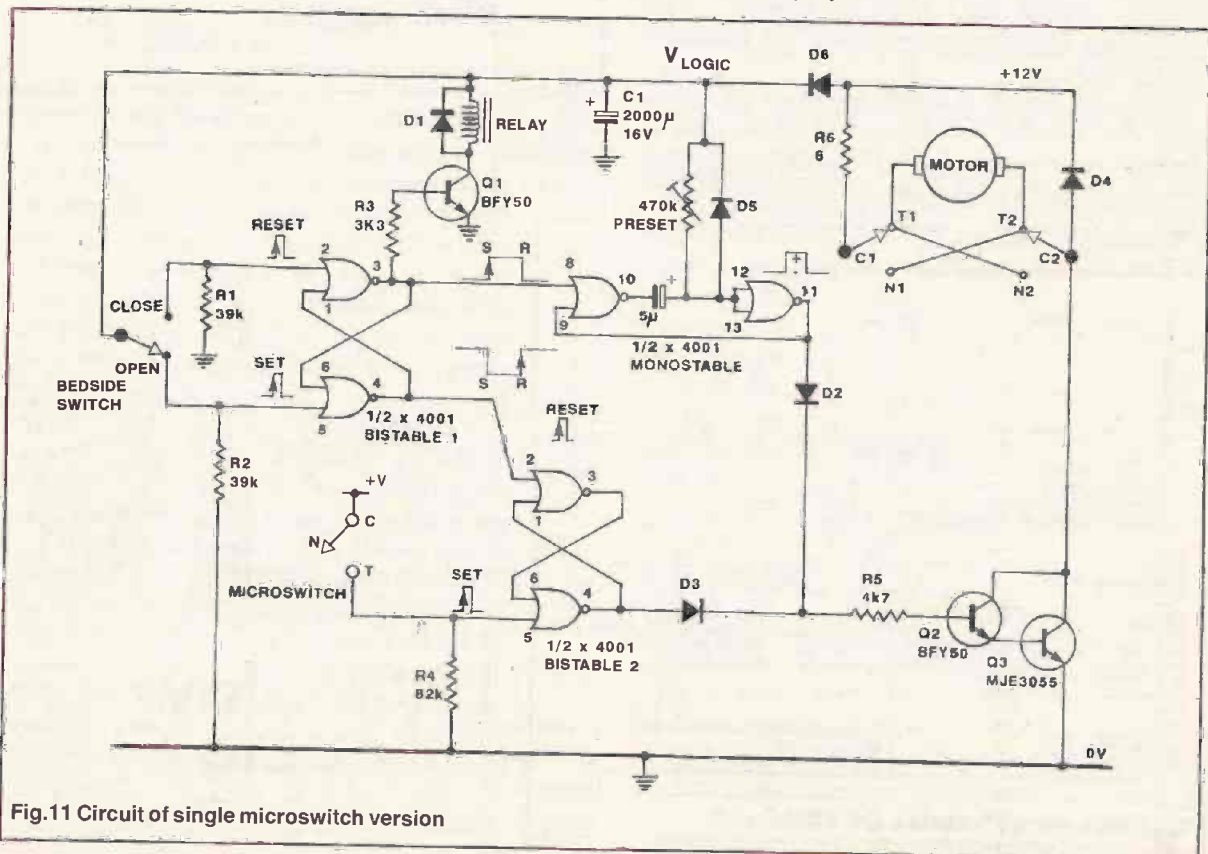

Fig. 11 Circuit of single microswitch version

LEDs 3mm or 5mm red or green 6p each, yellow 11p each. High intensity red, green or yellow, 5mm 30p each.

Cabinet bias 1p each, £5.95 per 1000, £49.50 per 10000

Stepping motor 4 phase 12V 7.8 step 50 ohms £28.95

5AA1027 stepping motor driver chip, £3.95

FM Transmitter kit, good quality sound, £8.60

High quality photo resist copper clad epoxy

Dimensions	glass boards single sided	double sided
3x4 inches	£0.95	£1.07
4x8 inches	£2.40	£2.88
6x12 inches	£5.37	-
12x12 inches	£10.66	-

Rechargeable Batteries

AA (HP7) 500mAh	£0.99
AA 700mAh	£1.95
C 2AH with solder tags	£3.80
D 4AH with solder tags	£4.95
1/2AA with solder tags	£1.55
AAA (HP18) 180mAh	£1.75
AA 500mAh with solder tags	£1.55
C (HP21) 1.8AH	£2.20
D (HP22) 2.4AH	£2.60
PP3 8.4V 110mAh	£4.95
Sub C with solder tags	£2.50
1/3 AA with tags (Philips CTV)	£1.95

Standard charger, charges 4 AA cells in 5 hours or 4 Cs or Ds in 12-14 hours + 1xPP3 (1, 2, 3 or 4 cells may be charged at a time), £5.95

High power charger, as above but charges the Cs and Ds in 5 hours; AAAs, Cs and Ds must be charged in 2s or 4s, £10.95

Special offers - please check for availability

F cells 32dia x 87mm	£3.95
F cell with solder tags, 1.2V	£4.30
42mm x 18mm dia, 1.2V	£1.45
Stick of 4 1.71mm x 16mm dia, with red & black leads 4 BV	£6.95
4 cell battery 94mm x 25mm dia (1/2C cells)	£3.50

Computer grade capacitors with screw terminals.

39000pF 20V	£2.80
68000pF 15V	£2.95
100000pF 18V	£1.50

7 segment common anode led display, £1.60

12mm	£0.45
LM2931 AT 5.0 low drop out 5V regulator TO220 package	£0.85
7812 and 7912 12V 1A regulators	£20.00 per 100
LM337A TO3 case variable regulator	100 + £1.10
BS260 P channel mosfet 45p, BC559 transistor per 100	£3.95
74LS06 hex inverter	£10.00 per 100
Used 8748 Microcontroller	£3.50
SL952 LMH Line driver amplifier LC 16 surface mounting package with data sheet	£1.95
AM27602	£1.25 each, 90p 100 +
CD4007UB	10p 100 +, 8p 1000 +

TV Mains switch, 4A double pole with momentary contacts for remote control, pack of 10 £9.95

Box of 60 £19.95

DC-DC converter, Reliability model, V12PE, 12V in 5V 200mA out, 300V input to output, isolation with data, £4.95 each or pack of 10 - £39.50

Hour counter used 7 digit 240V ac 50Hz, £1.45

Resistor pack 2500 resistors 1/8-2W 50 different values, £8.95

Resistor jumbo pack 25000, 1/4 and 1/2W resistors our choice of values and size, will be mainly in boxes or rolls of 1000, 2000 and 5000 of one type, £25.00

Qwerty keyboard, 58 key good quality switches, new, £5.00

Qwerty keyboard with serial output, no data (used), £8.00

Polyester capacitors, Box type, 22 5mm lead pitch

1x1 250V dc 20p each	15p 100 +	10p 1000 +
2.2uF 250V dc 30p each	10p 100 +	15p 1000 +
3.3uF 100V dc 30p each	15p 100 +	10p 1000 +
1uF 50V bipolar electrolytic axial leads	15p each, 7.5p 1000 +	
0.22uF 250V polyester axial leads	15p each, 100 + 7.5p each	

Philips 123 series solid aluminium axial leads.

33pF 10V & 2.2uF 40V 40p each	25p 100 +
-------------------------------	-----------

Multilayer AVX ceramic capacitors, all 5mm pitch.

100V 100pF, 150pF, 220pF	10,000pF (10n)
10p each	5p 100 +, 3.5p 1000 +

Welwyn W23 9W 120 ohm 35p each, 20p 100 + 680 ohm 2W metal film resistor, 4p 100 +, 2p 1000 +

Solid carbon resistors, very low inductance, ideal for RF circuits, 27ohm 2W, 68ohm 2W 25p each, 15p each 100 +, we have a range of 0.25W, 0.5W, 1W and 2W solid carbon resistors - please send SAE for list

Intelligent 4 digit alphanumeric (5x7 dot 0.145") red LED display, 12 pin 0.6 inch wide package, Siemens type DLR1414 £2.50 each, £2.00 30 +, data sheets £1.00

AMD 27256-3 Eproms £2.00 each, £1.25 100 + DIP switch 3PCO 12 pin (ERG SDC-3-023) 60p each, 40p 100 +

MODEMS

V22/V22bis IBM PC internal full length card modem, BT approved, can be set to com 1 or 2, 1200/2400 baud with software and manual, not Hayes compatible, made by Plessey, £56.00

V32 9600 baud and 4800 baud GEC Plessey telecom external modem, model 9632, Hayes compatible and BT approved, with auto call, auto answer, using V22, V22bis and Hayes AT protocols and V54 remote - local diagnostics it does not work on slower speeds, V22/1200 baud etc. and needs internal dip switch to be switched on to select Hayes commands. It comes with a 100+ page comprehensive A4 size manual, An all together brilliant machine for only £1199 + VAT = £233.83

All products advertised are new and unused unless otherwise stated.

Wide range of CMOS TTL 74HC 74F Linear Transistors kits, rechargeable batteries, capacitors, tools etc. always in stock

Please add 95p towards P&P VAT included in all prices

JPG ELECTRONICS
276 278 Chatsworth Road
Chesterfield S40 2BH
Access Visa Orders
(0246) 211202
Callers welcome

PLASTIC BOXES



A RANGE OF SMALL PLASTIC BOXES, CASES AND POTTING BOXES AVAILABLE IN ANY QUANTITY.

SEND FOR FREE CATALOGUE

SLM (MODEL) ENGINEERS
CHILTERN ROAD, PRESTBURY,
CHELTENHAM, GLOS GL52 5JQ
FAX: 0242 226288

WE HAVE THE WIDEST CHOICE OF USED OSCILLOSCOPES IN THE COUNTRY

TEKTRONIX 2445B Four Channel 150MHz Delay Sweep with Cursors	£1750
TEKTRONIX 2445A Four Channel 150MHz Delay Sweep with Cursors	£1900
IWATSU 5567 11 Four Channel 100MHz Delay Sweep	£700
TEKTRONIX 2236 Dual Trace 100MHz Delay Sweep Triggered	£1000
TEKTRONIX 2235 Dual Trace 100MHz Delay Sweep	£800
TEKTRONIX 7600 Dual Trace 100MHz Delay Sweep with Cursors	£500
HITACHI 17050P Dual Trace 100MHz or Dual 15 with 4 Channel Model 8500	£550
TEKTRONIX 476 Dual Trace 20MHz Delay Sweep	£450
TEKTRONIX 484 Dual Trace 100MHz Delay Sweep	£500
TEKTRONIX 2215A Dual Trace 50MHz Delay Sweep	£400
TEKTRONIX 7600 Dual Trace 50MHz Delay Sweep	£375
HUMM CHANGING ORES60 Dual Trace 50MHz Delay Sweep Untriggered	£350
PHILIPS PRO312 Dual Trace 50MHz Delay Sweep	£500
TEKTRONIX 2225 Dual Trace 50MHz Delay Sweep	£400
HAMEG 605 Dual Trace 50MHz Delay Sweep	£400
GOULD CS1 100 Dual Trace 30MHz	£180
BECKMAN 9020 Dual Trace 20MHz Delay Sweep	£250
IWATSU CS5070 Dual Trace 20MHz	£225
GOULD CS3019 Dual Trace 15MHz	£200
THIS IS JUST A SAMPLE - MANY OTHERS AVAILABLE	£150

ELECTRON MICROSCOPES

AEL Cornish 500 - Transmitter	£1500
USA Super 115 - Scanner	£800
MARCONI 2440 20MHz Microwave Counter	£1750
MARCONI 2610 True RMS Voltmeter	£275
FARNELL SSG 1000 Sig Gen 10MHz - 1GHz Synthesised	£250
FARNELL Synthesised Oscillator CS61 - 0-400MHz-99.99KHz	£250
MARCONI TF2015 AM/FM 10-250MHz Sig Gen with TF2171	£250
MARCONI TF2015 without Synchroniser TF2171	£350
MARCONI TF2016 AM/FM 10kHz-120MHz with TF2173	£175
MARCONI TF2016 without Synchroniser TF2173	the pair £950
MARCONI TF2356 2357 Level Osc/Meter 20MHz	
MARCONI SANDERS Sig Sources, Various models Covering 400MHz - 8.5GHz	from £300
RACAL 9039 Mod Meter 10MHz-150Hz	£300
RACAL Instrumental Recorders Store AD and Store 7D	from £500
KETLEY 234 Programmable Current Source	£1000
FERRISGRAPH RT30 Recorder Test Set	from £150
FARNELL SSG520 Synthesised Sig Gen 0-400MHz	£600
FARNELL TTS520 Transmitter Test Set consisting of RF/AF Counter, RF Mod Meter, RF Power Meter, AF Voltmeter, AF Distortion Meter, AF Synthesiser	£600
SOLD as a Pair for ONLY	£1080

SPECTRUM ANALYSERS

TEKTRONIX 484P 100kHz-20MHz	£400
ANRITSU MS666 10kHz - 4.4GHz	£3000
ANRITSU MS626 10kHz - 700MHz	£2500
HP 1411 with BS55A & IF Plug-in 10MHz-18GHz	£2500
HP 1411 with BS54B & BS52B 300kHz - 1250MHz	£1500
HP 1401 with BS54A & BS52A 300kHz - 1250MHz	£1200
HP 1411 with BS55A & BS52B 200Hz - 300kHz	£1250
TEKTRONIX 491 Option 01 10MHz to 20Hz	£1400

PHILIPS PM3225 Multi Function DMM 4.5-5.5 digit with GP/IEEE-488 only £300

THURLBY PL320T GP Bench PSU 0-30V 2 Amp Twice with GP16 only £350

HAND HELD MULTIMETERS - 3.5 digit DM105-14 Ranges DC 2Amp only £18

M2355-32 ranges AC/DC 10 Amps Diode/Transistor Tester, Price Quoted sep. £32.99

RACAL/DANA Syn Sig Gen 9084 0.01-104MHz £800

RACAL/DANA RF Power Meter 9104 £500

RACAL/DANA 202 Logic State Analyser with 68000 Disassembler £900

WAINE KE99 LCR Meter 42Hz Accuracy 0.1% £680

WAINE KE99 LCR Meter 42Hz Accuracy 0.1% £680

AVO AC/DC Breakdown Leakage & Insulation Tester RM215/2 £600

MARCONI DIGITAL FREQUENCY METERS

Type 2403A 10MHz-300MHz	£125
Type 2401A 10MHz-200MHz	£130

MARCONI UNIVERSAL COUNTER TIMERS

Type 2437 DC-100MHz	£175
Type 2438 DC-300MHz	£225

THORN PSU 0-40V 0-50Amps Metered £300

FARNELL PSU H60/25 0-60V 0-25Amps Metered £400

FARNELL PSU L30E 0-30V 0-3Amps Metered £80

TELEQUIPMENT C771 Curve Tracer from £250

MARCONI TF2700 Universal LCR Bridge Battery £125

MARCONI TF2337A Auto Distort Meter 400Hz/1KHz 0.01% £175

RACAL 9715 Freq Counter 10MHz-50MHz (Crystal Drive) £150

MANHESMAN TALLY Pery-Sily Plomer PS232 £100

AVO MULTIMETERS

MODEL: 8 or 9 (both available)	£40 each
Test Set Incl. Box, 95X	from £45
8 MHz 5 with Carrying Case	£30
8 MHz 5 with Carrying Case	£180

All Meter Sources with Batteries & Leads

NEW EQUIPMENT

HAMEG OSCILLOSCOPE HM1006 Triple Trace 100MHz Delay Timebase £792

HAMEG OSCILLOSCOPE HM604 Dual Trace 60MHz Delay Sweep £610

HAMEG OSCILLOSCOPE HM603P Dual Trace 20MHz Component Tester £336

HAMEG OSCILLOSCOPE HM205 3 Dual Trace 20MHz Digital Storage £610

All other models available - all oscilloscopes supplied with 2 probes

BLACK STAR EQUIPMENT (p&p all units £5)

APOLLO 10 - 100MHz Counter Timer Ratio/Period/Time Interval etc. £222

APOLLO 100 - 100MHz (as above with more functions) £325

METEOR 100 FREQUENCY COUNTER 100MHz £109

METEOR 600 FREQUENCY COUNTER 600MHz £135

METEOR 1000 FREQUENCY COUNTER 10GHz £118

JUPITOR 500 FUNCTION GENERATOR 0.1Hz-500KHz Sine/Sqr/Tri £229

ORION COLOUR BAR GENERATOR Pal/NTSC £229

All other Black Star Equipment available

OSCILLOSCOPE PROBES Switchable x1 x10 (p&p £3) £11

THE DIGITAL 90

A reflex design optimized for CD, the Digital 90 loudspeaker was developed to compete with the best of ready made compact speakers but at a 'DIY' price. Ideal for use where space is at a premium, the Digital 90 uses Scanspeak's latest Hitech bass unit teamed with the acclaimed Seas metal dome tweeter in a cabinet of only 15 litres. The split-circuit crossover allows biwiring without further modification.

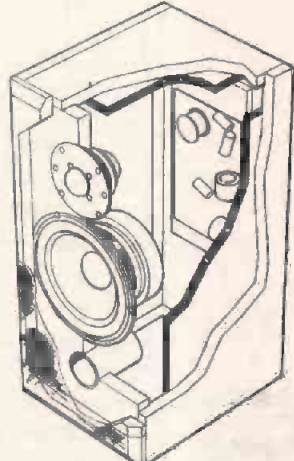

The kit comprises of the drive units, crossovers, reflex ports, binding posts (8), wadding, grille fabric, flatpack cabinets, (accurately machined from 18mm MDF with all rebates etc. readycut)

Dimensions:
480 x 220 x 250mm

Response:
45 HZ - 20 KHZ

Sensitivity:
87db/1w/1m

AMP Suitability: 20-100w

£279.00 per pair inc VAT carriage/Ins. £15.00.

Wilmslow Audio

Wellington Close,
Parkgate Trading Estate
Knutsford, Cheshire
WA16 8DX
Tel: (0565) 650605
Fax: (0565) 650080

DIY Speaker catalogue £2.00 post free (export £3.50)

Open Tuesday to Saturday, 4 demonstration rooms available.

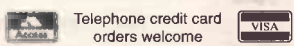

Used equipment - with 30 days guarantee. Manuals supplied if possible. This is a VERY SMALL SAMPLE OF STOCK. SAE or telephone for lists. Please check availability before ordering. CARRIAGE all units £16. VAT to be added to Total of Goods & Carriage

STEWART OF READING
110 WYKEHAM ROAD, READING, BERKS RG6 1PL
Tel: 0734 268041 Fax: 0734 351696 Callers welcome 9am-5.30pm Mon-Fri (until 8pm Thurs)

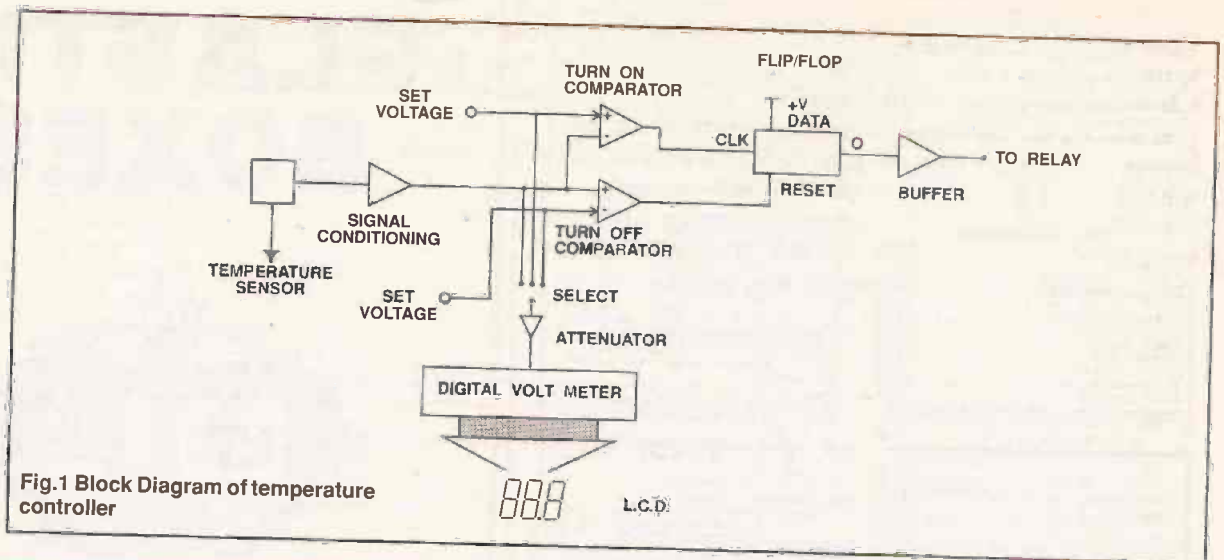

Fig.1 Block Diagram of temperature controller

Temperature Controller

by Edward Barrow

In the average home, temperature control usually translates into a dial numbered from 1 to 10. At best these dials are ambiguous and at worst complete enigmas. Secrets such as what temperature corresponds with the number 6 setting are hidden in manufacturers files far from customers eyes. Controlling these beasts is not a science but rather alchemy, with the owner needing to develop a relationship with the dial, constantly tweaking it to find some level

Celsius. An on-board thermometer also gives confirmation of the actual temperature as well as controlling the turn on and turn off temperatures. A heavy duty relay is used to switch the heater on and off handling up to 20 amps mains current. As the unit is switching mains, an on-board transformer is used to power it permanently thus removing the need for batteries.

Theory

For the benefit of readers a simplified block diagram has been included in Figure 1 to help explain this section. It makes sense to start with the on-board thermometer as it is this that controls the rest of the circuitry. A semiconductor sensor was used in preference to a thermistor or similar passive devices mainly because of its superior performance in terms of linearity, predictability and accuracy. On the negative side its output change per degree is small, only a paltry 10mV per degree Celsius. The sensor acts as a zener diode whose breakdown voltage is proportional to its Kelvin temperature (absolute temperature). So at 0° Celsius (273.15 Kelvin) the breakdown voltage is 2.732 volts

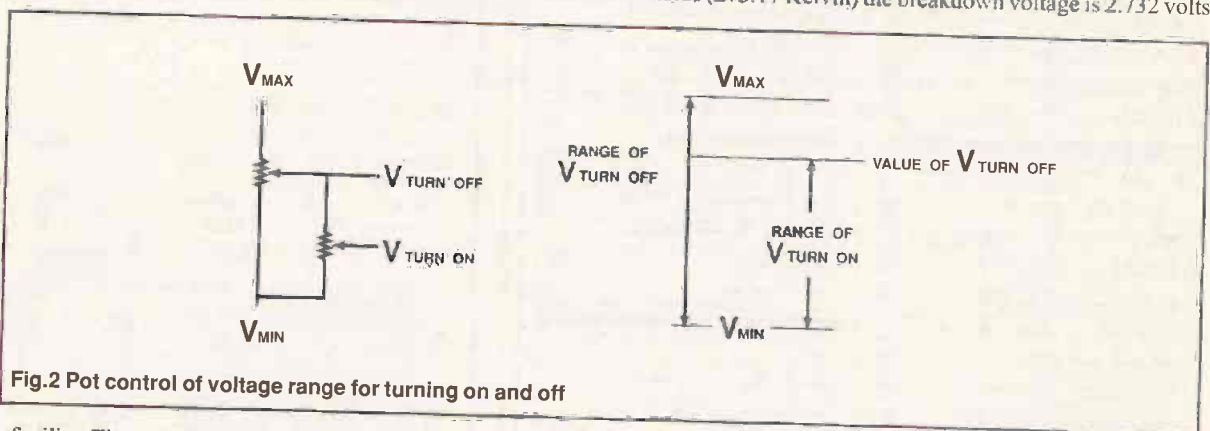

Fig.2 Pot control of voltage range for turning on and off

of utility. The trusting may well leave their room at the mercy of one of these unpredictable machines only to return to find their room at one of the climatic extremes found on this planet. With the end of the days of slavery we cannot afford to employ a servant to sit and act as a human thermo-stat, we must turn to technology as a substitute.

This project offers easy control of your room's temperature, settable by two potentiometers. But more importantly these settings are confirmed by a digital read-out in degrees

Because of this some signal conditioning is necessary, firstly to remove any offset voltages and thus convert it to a Celsius voltage. And secondly to amplify the signal and so bring it into the manageable regions for the proceeding electronics. The resulting signal is now a direct representation of temperature with 0 volts representing 0° Celsius and 4 volts representing 40° Celsius. This makes life very simple from now on.

Comparators are used to make intelligence of the above

signal and as we have differing on and off thresholds (ie hysteresis) we need two comparators. This requires two reference signals to feed the comparators, both of which are generated by pots. The highest of these is obviously the "off voltage", ie the corresponding voltage to the temperature you want the heater to switch off at. As the second reference voltage, the "on voltage", will always be less than the "off voltage", we have used the latter and divided it using a pot and thus prevented any anomalies occurring. See Figure 2.

Both these comparators control a simple memory device, a flip/flop. On this, the data input is tied high and the "on comparator's" output used as a clock input. So when the temperature falls below the preset level the comparator's

The counter used has a maximum count of 1999 and so this represents the full scale reading. A simple graph and schematic in Figure 4 illustrates its workings.

Construction

On the main PCB, solder link wires, resistors and diodes first. It is best to use IC sockets as the CMOS ICs are very sensitive devices. Next the capacitors and presets note that the 20 turn variety can only fit one way into the PCB and are horizontally adjustable). Lastly solder the transistors, regulators and other components that stand up. The temperature sensor needs a little thought before it is mounted. There is little point boxing it inside with the PCB as it will only read

the temperature inside the box. If the box is to be mounted away from the heater for example on a wall, then some ventilation will be needed to allow the sensor to read the temperature of the air in the room. An all together better way is to mount the sensor out of the box completely. This means that any heat generated by the ICs and transistors will not adversely affect the sensor. Also the sensor can be placed in an optimum position to measure the room's temperature. If you do use it this way then remember to use screened wire for connection. This will help to keep pick up and noise to a minimum.

The LCD display I used came with a bezel, mounting connectors and a miniature PCB already included. This is very useful for con-

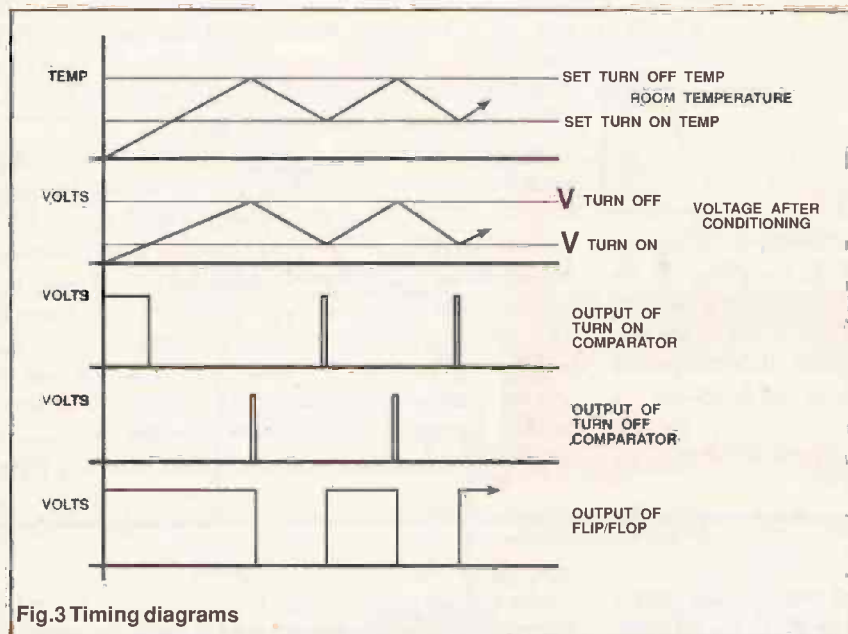

Fig.3 Timing diagrams

output goes high triggering the flip/flop which clocks in a state 1. This appears on the output line (O) which is indirectly responsible for turning on and off the heater and so the heating is turned on. As the temperature raises it will eventually reach the higher preset level and the 'off comparator's' output will now go high. The output of this comparator is tied to the flip/flop's reset pin so at this point it will be reset and the output line will return to state 0. This will turn off the heat. A diagram showing how the temperature of your room will vary and how this effects the electronics has been included in Figure 3.

Separate from the above is the measurement side of the project. The heart of this is a LCD DVM chip. If you unravel all the acronyms its purpose becomes self-evident; Liquid Crystal Display Digital Volt Meter. This is where the hassle of creating a signal directly proportional to the temperature pays off as a direct measurement yields a direct read-out of temperature. Similarly if the two preset voltages are measured they yield the switch on and off temperatures. Only some attenuation is needed to bring the voltage into the range of the DVM.

This particular DVM chip uses a process called dual ramp integration. In this process the unknown voltage is used to charge a capacitor for a fixed time. After this is completed the unknown voltage is replaced by a reference voltage which is used to discharge the capacitor. The time taken for this operation is a direct measure of the unknown voltage. A linear integrator is used to ensure linearity of charge and discharge.

With the main PCB as ribbon cable can be used. The bezel also makes mounting the display to the box easy and neat.

When all is in place then proceed to insert the ICs into their sockets. Take extra care with the 7106 as it is not only sensitive but also expensive.

Testing

Before connecting the transformer it is best to experiment by using an alternative low voltage source. A ± 12 volt power supply or 29volt PP3 batteries can be connected to the inputs of the bridge rectifier. This will supply the regulators comfortably. Before proceeding also set all the presets to mid way. When power is connected the LCD display should spring to life with some meaningful reading. If not switch off the power and start probing around for a fault in the wiring or soldering on the DVM and/or the LCD.

To check the sensor it is best to have two water baths, one with ice and one with warm water. Immerse the sensor in the ice bath and monitor the voltage at pin 2. It should drop. Dip it in the warm water and it should rise. The difference should be in the region of 0.4 volts. While you are at it the output of ICI (pin 6) should also rise and fall but this time the swing should be larger, around 4 volts.

Next check the wipers of the pots RV1 and RV2, the former should vary from 1 to 4 volts while the second should vary from the one set before to 1 volt.

To test the comparators set RV1 to about 2.5 volts and RV2

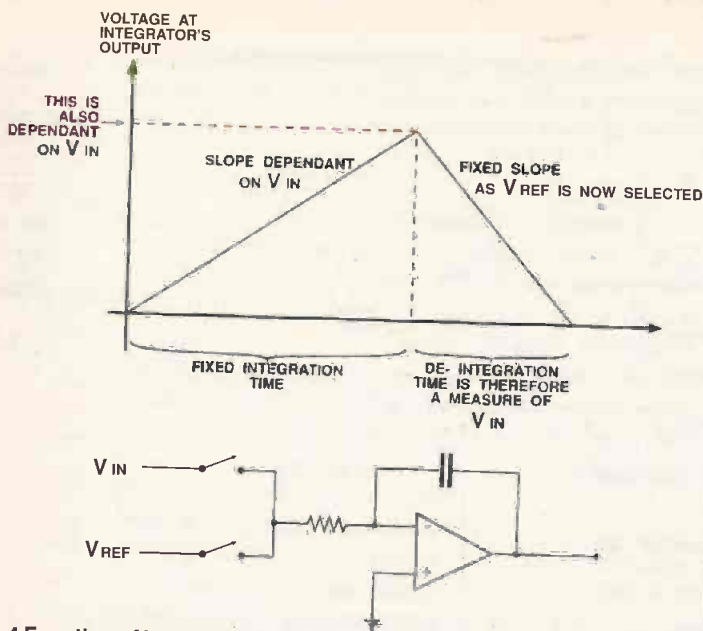

Fig.4 Function of integrator

to 2 volts. The monitor pin 1 on IC2 as you place the probe in the ice bath, it should go low regardless, then place it in the warm water, it should now go high. If this is so then the 'off comparator' is working. Next monitor pin 7 while repeating the process. In the ice bath it should go high while in the warm it should go low. If this happens then the 'on comparator' is working.

There are very few points on the DVM to test if there are

HOW IT WORKS

The temperature sensor being a zener diode in essence needs a current source to activate it, here a simple resistor is used. This combination on its own will give an overall accuracy of 2°C but if the calibration facility is used this can be halved to less than 1°C. A 20 turn preset is used for this purpose but for this and finer points of calibration turn to the Setting Up section. The offset voltage is removed by a differential amplifier set at a gain of 10. As its name suggested its output is given by the equation:

$$V_{out} = \text{Gain} \times (V^+ - V^-)$$

Here V^+ is our own temperature signal while a second preset is used to set the level of offset voltage needed to be subtracted (V^-). At this point the signal changes 0.1 volts for every 1°C change with 0°C being 0 volts.

For the turn off temperature a pot is used to generate a voltage between 1 volt and 4 volts, i.e. 10°C and 40°C. The comparators are both configured with a little positive feedback to ensure clean switching. Note that the comparators outputs are open collector so they need pull up resistors to make them work.

The 'turn off voltage' is buffered by an op-amp, as is the low end of the previous pot. A second pot is driven at both ends by these voltages. Thus the turn on temperature range is $>10^\circ\text{C}$ but $< T_{turn\ off}$.

The flip/flop's output is used to operate a transistor switch which is more suited for energising a relay. The BC140 transistor can be used to switch loads of up to 1 amp, but at this level do include a heatsink. Also use the unregulated voltage supply to drive the relay as the regulators will also need heatsinks to keep them cool. The relay I fitted was a 20A variety (see Buylines). A diode, D1 is included to prevent any back-emf formed by the collapsing magnetic field of the relay's coil destroying the transistor.

Despite the simple theory of operation the 7106 does need a little additional circuitry around it to bring it up and running. In the main the components are capacitors which are too large to be fabricated internally. But firstly it has been set to operate at 2 volts full scale. Thus we must drop our temperature signal by 1/10 to bring the full temperature range within that of the chip. A voltage divider (R17-R18) does the trick.

The DVM needs some clock signal to perform its timing duties:

problems. The easiest way is to select the 'off temperature' with SW1 and vary RV1. The display should vary from 40.0 to 10.0 (roughly as it is not yet calibrated). The same is true of the 'on temperature' but this is restricted by the position of RV1.

If there are any problems here you can check the reference voltage, pin 36, which should be in the region of 1 volt. Or check the input, pin 31, which should be varying in the region of 0 volts to 0.4 volts.

Setting up

For precise calibration you will need at least an accurate voltmeter and if possible an accurate thermometer. The first thing to do is set PR1. The best way requires a temperature bath at 25 C to immerse the sensor. At this temperature PR1 should be set so the output voltage is 2.982 volts. Then PR2 should be set so pin 6 on IC1 reads 2.500 volts. Finally adjust PR3 so the digital display reads 25.0.

For those of you who do not have access to an accurate thermometer there is a somewhat simpler method of calibration. The only requirement is an ice bath made up of a 50% ice/water mixture. If this is left to stand for a few moments then the resulting equilibrium is defined as 0° C. If the probe is immersed in this then its output should read 2.732 volts if PR1 is correctly set. Then PR2 can be set so the output of IC1 (pin 6) is at zero volts. PR3 cannot be set using this bath as we need a positive temperature to get a reading on the display. So you will have to use your voltmeter to confirm the accuracy of the DVM by matching up the input voltage with the display

Internally there are invertors designed to act as oscillators, they do however need a simple R-C combination to act as a delay. The resistor in question is a preset, the setting of which is handled in the 'Setting Up' section. Also the integrator needs an external capacitor this is C6. While to prevent noise affecting the readings a capacitor C5 is included on the auto-zero line to act as a dampener. Nothing special is required for the reference capacitor, only that its stable and has minimal dielectric leakage (this precludes electrolytics).

As this is a ground based system the input(-) pin 30, the test input pin 37, the ref(-) pin 35, and the common pin 32 are all grounded.

All that is needed to complete the circuit is a suitable reference voltage. As the maximum input voltage is twice the reference voltage then for 2 volts FSD we need a 1.000 volt reference. A 20 turn preset produces this for us.

Connection to the LCD is straight forward enough, just follow the circuit diagram. To generate a decimal point we do however need a little help from a transistor. Firstly we must remember that no DC voltage should be applied to a LCD as this will cause breakdown of the crystals. So the backplane (the LCD equivalent of ground) is a square wave. To blacken a segment the input signal must be 180° out of phase with this. The transistor Q2 does the inversion for us and its signal is connected to the decimal point.

It should be noted that as we are only using 3 digits then if you use a 4 digit display the last one can be used to generate the letter C signifying that the scale used is in Celsius. To do this connect the same transistors output to segments A,D,E,F, which will darken forming the letter C.

A small transformer was wired to the mains and provided a 6-0-6 volt output. A bridge rectifier converted this to a DC voltage with the help of two smoothing capacitors. Two regulators, one positive and one negative, use this raw DC voltage to provide a stable + and - 5 volt supply to power the circuit.

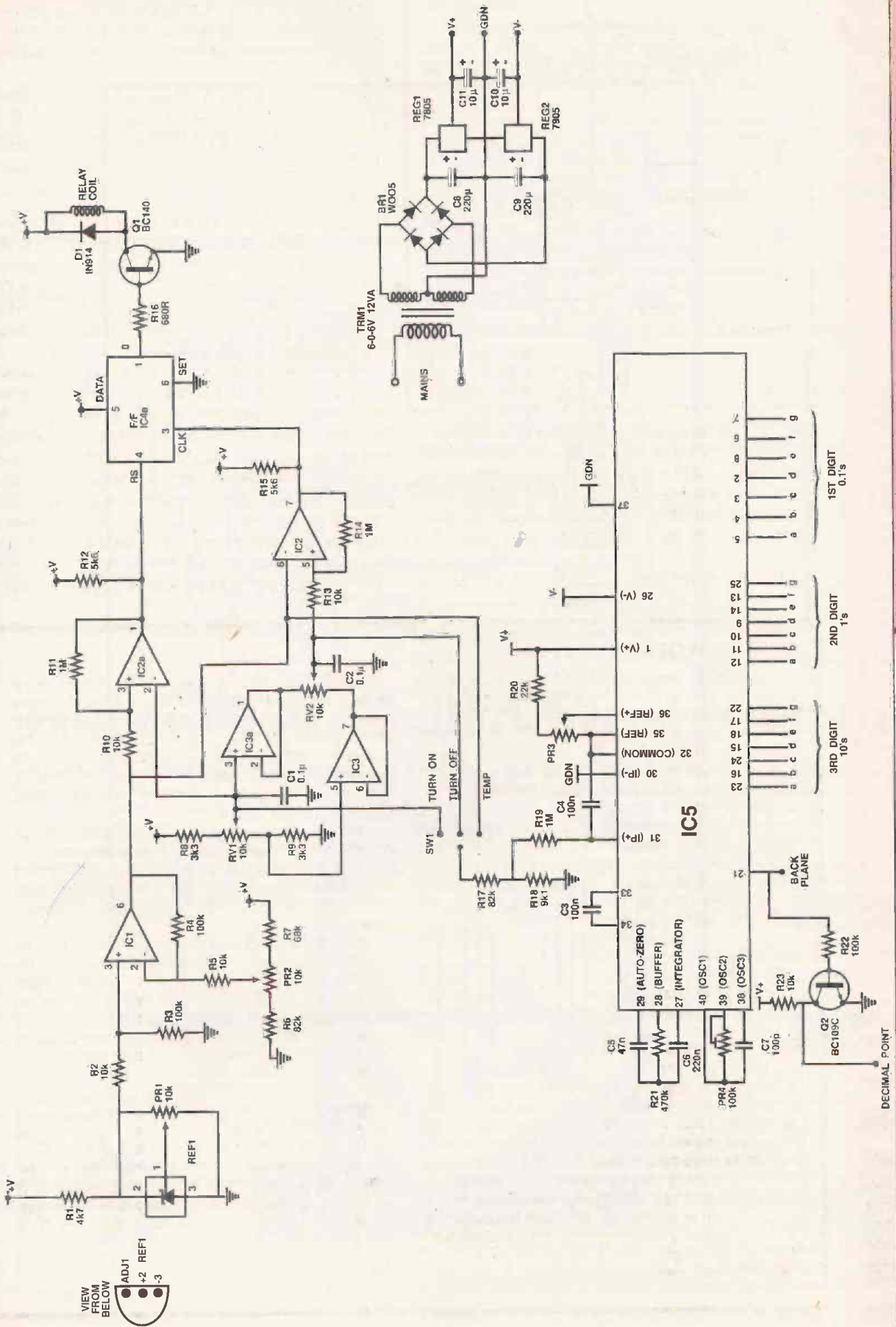

Fig.5 Circuit diagram of controller

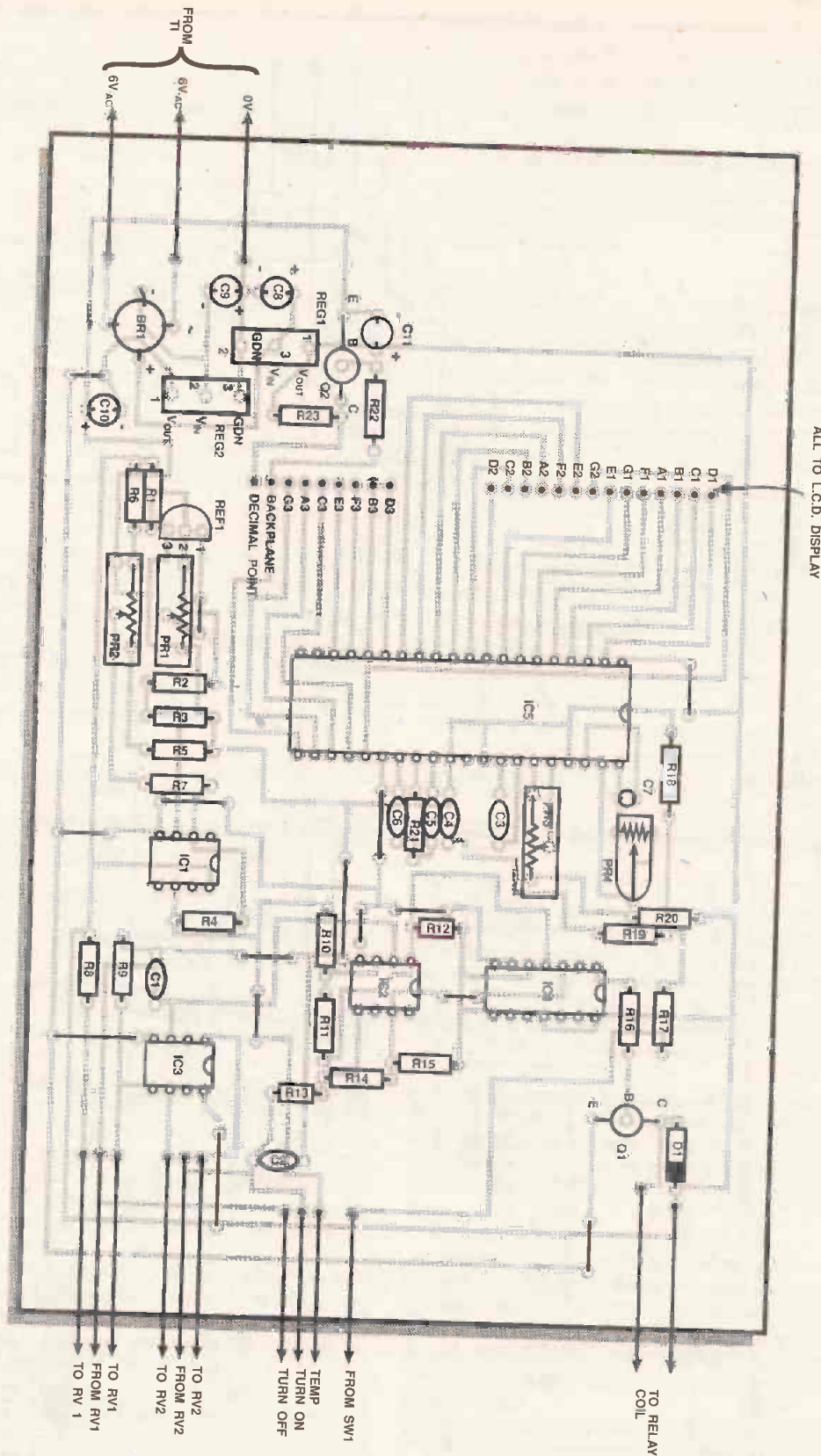

Fig.6 Component overlay for controller

at some temperature above 0°C.

PR4's value is not too significant, it only adjusts the number conversions per second. Here should be set so you achieve about 3 conversions per second.

After calibration the unit can be wired up to the transformer. It is prudent to include a fuse in the transformer's

circuit as there is no power switch. A 0.1 amp one is a suitable value.

In Use

The use of the unit depends heavily on the size of the relay used. Applications range from the control of a single bar

heater to the complete house system. When being used with single heaters remember you must somehow by-pass the existing thermo-stat. I think the easiest way is to leave the heaters dial on the maximum setting, which is usually permanently on.

If you want to use the unit for grander things such as full house control, then remember to place the thermometer in an average room. Or alternatively use a few of the units to tailor the heating to your needs.

Also bear in mind the points mentioned in the Construction part of the project about placing the sensor.

BUYLINES

All resistors should be of the 1% metal oxide variety, to keep errors to a minimum. Also all small capacitors should be polycarbonate especially on the DVM, which exhibits good dielectric properties. The other capacitors need no special requirements.

The sensor I used, the LM335Z, is widely available, do not confuse it with the LM35CZ or the LM35DZ, which despite being temperature sensors will not work in this circuit.

The ICL7106 is also widely available but the LCD display, with bezel and PCB were obtained from Rapid Electronics in Colchester.

Finding a relay to fulfil your needs may be a problem. I only managed to find one handling 20A from Farnell Electronics which do not supply to the general public. A word in the ear of the owner of your local electronics shop may be sufficient to surmount this problem.

PARTS LIST

RESISTORS

R1	4k7
R2,5,10,13,23	10k
R3,4,12,22	100k
R6,17	82k
R7	68k
R8,9	3k3
R11,14,19	1M
R12,15	5k6
R16	680R
R18	9k1
R20	22k
R21	470k
PR1,2	10k 20turn horiz
PR3	20k 20turn horiz
PR4	100k horiz
RV1,2	10k lin

CAPACITORS

C1,2,3	100n poly
C4	10n poly
C5	47n
C6	220n
C7	100p
C8,9	220µ
C10,11	10µ

SEMICONDUCTORS

IC1	TL081 Single Op-amp
IC2	LM393 Dual Comparator
IC3	TL082 Dual Op-amp
IC4	4013 CMOS Dual flip-flop
IC5	ICL7106 3+ digit LCD DVM
REG1	7805 +5V Regulator
REG2	7905 -5V Regulator

Q1	BC140
Q2	BC109C
BR1	W005 Bridge rectifier
D1	1N914

MISCELLANEOUS

REF1	LM335Z Linear temperature sensor
T1	6-0-6V 12VA transformer
SW1	1-3 way rotary switch
	LCD display (any 3+ digit display)

PROGRAMMING FLEXIBILITY FOR PROFESSIONALS

HARDWARE FEATURES

- PC-BASED PROGRAMMERS
- UK DESIGN, MANUFACTURE AND *SUPPORT*
- NO MESSY INTERNAL CARD
- PLUGS DIRECTLY INTO PARALLEL PORT (LPT1-3)
- EASILY TRANSPORTABLE BETWEEN MACHINES
- WORKS WITH XT, AT, 386, & 486. EVEN LAPTOPS!
- INCREDIBLY FAST PROGRAMMING TIMES
- FLEXIBLE DESIGN MEANS NO ADAPTORS NEEDED FOR MOST DIP PACKAGES
- UPGRADES BY FLOPPY

SOFTWARE FEATURES

- MENU DRIVEN
- FLEXIBLE FILE LOADING (HEX, BINARY, JEDEC)
- READS, VERIFIES, BLANK CHECKS, BIT TESTS, OVER-PROGRAMMES AND AUTO-PROGRAMMES
- CAN MODIFY PARAMETERS OF EXISTING MEMORY DEVICES AND STORE IN USER DATABASE
- HANDLES SECURITY FEATURES OF ALL DEVICES
- AUTOMATIC PAL TO GAL CONVERSIONS
- FULL BUFFER EDITING CAPABILITIES
- TEST VECTOR SUPPORT



SPEEDMASTER 1000

- LOW COST, UNIVERSAL PROGRAMMER
- EPROMS, EEPROMS, FLASH EPROMS, NVRAMS, SERIAL EEPROMS, PALS, GALS, PEELS, EPLDS
- SUPER FAST PROGRAMMING e.g. 27C256 (32Kx8) IN 4.5 Seconds
- JEDEC TEST VECTOR SUPPORT FOR PALS
- INCLUDES PAL DEVELOPMENT SOFTWARE
- UP TO 40 PIN DIPS WITHOUT ADAPTORS

£445

MICROMASTER 1000

- ALL FUNCTIONS OF SPEEDMASTER 1000
- MICROCONTROLLERS FROM T.I. (including TMS370 SERIES, TMS77C82), INTEL, ZILOG, MICROCHIP (MCS), MOTOROLA, PHILIPS AND OTHERS

£575

SPEEDMASTER 8000

- 8 WAY GANG/SET PROGRAMMER
- MASTER SOCKET
- EPROMS, EEPROMS, FLASH EPROMS
- UP TO 32 PIN
- PC OR STAND ALONE MODE
- SUPER FAST PROGRAMMING e.g. 8x27c256 (32Kx8) IN 6 Seconds

£645

Prices exclude VAT & delivery



ICE TECHNOLOGY LTD UNIT 4, PENISTONE COURT, STATION BUILDINGS, PENISTONE, SOUTH YORKSHIRE S30 6HG

TEL (+44) 0226 767404 FAX (+44) 0226 370434

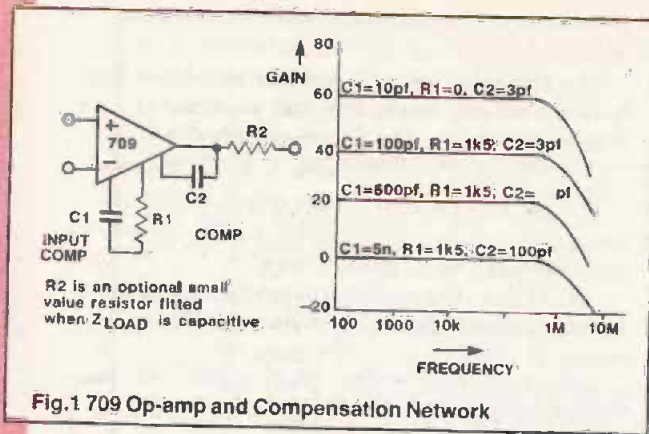

around these in any circuitry where they are employed. From an amateur designer's point of view, I find it difficult to understand that a device such as the op-amp is often the butt of so much hi-fi reviewer-fuelled criticism. Many music listeners will go to quite extraordinary lengths - usually in monetary terms and on the advice of some of the popular hi-fi periodicals - to purchase equipment which uses valve and discrete transistor technology as opposed to that which uses an op-amp. It is not my wish to criticise this choice of approach since it has to be said that there are many pre and power amplifiers par excellence which adopt this valve/discrete approach. Nevertheless, it seems strange to go to such extremes to avoid the op-amp when a very large percentage of recorded music will have passed through perhaps tens

Anniversary AutoMate

6

by Mike Meehan

Six months have elapsed already and we're now ready to look at the topic of equalisation held over from last month. Equalisation on a mixer ranges from the sublime to the ridiculous. It consists at one extreme of a simple two band shelving-type equaliser placed permanently across the output and at the other of the full-blown, five band parametric-type on each channel. Between these two there lies an infinite number of variables, most consoles featuring equalisation sections with components of each philosophy. More complicated topologies, understandably, are more prevalent on more expensive and upmarket desks. The equalisation section available on the AutoMate console could reasonably and accurately be termed as 'comprehensive'. It includes some unusual and interesting design features and methods worthy of inclusion in the highest of fi! There has always been, to my mind anyway, some sort of aura of mystery surrounding large-scale equalisation processes. I propose, therefore, in the manner of the preceding parts of the AutoMate series, to thoroughly dissect the whole subject.

In Defence of the Humble Op-Amp

However, before we progress further and undertake any open-heart surgery of the EQ, some mention should be made - as I last month said that it would - of the widespread use of the operational amplifier within professional audio applications. Doubtless, there will be many audiophiles, purists and probably engineers in our readership somewhat aghast at the prospect of supposedly high quality audio passing through literally hundreds of these little critters. To many, the idea of the coupling of the op-amp to high fidelity sound is completely alien. Regrettably, the two seem, in all aspects, to be completely and mutually exclusive. The purist believes that there is no place whatsoever for such a device in any quality audio signal pathway.

The pragmatist, on the other hand - who very probably also happens to be the designer - will realise the electronic shortcomings of the device. He or she should then, using clever techniques (of a damage limitation nature), design

and in some cases hundreds of such examples of semiconductor IC. This device and the input signal are inseparable as audio traverses the mixing console during the recording/mastering process. This includes the so-called DDD compact disc recordings (Digital recording, Digital Mixing, Digital Mastering) since it is most likely that the highest quality mic-amp will include an op-amp of some description in its architecture. This unavoidable journey through the mixing desk will at least be a 'single' if the source is recorded directly onto tape. More likely, it will be a 'return' if a secondary 'mixing' as well as 'recording' process is involved. I am, perhaps, one of the 'old school' of engineers/critical listeners, having been a vinyl aficionado for more than a few years, and a very late, though completely-convicted, convert to the digital domain!

Consequently, it will probably be of some background interest if I put my money where my mouth is - no rude comments at the back, please - and place on trial the device in question. We can then analyse some of its failings and shortcomings, reputed, deserved and unfair! This subject is, quite possibly, of foreground interest, too, since the op-amp enables consoles of compact size to exist at all. It is not intended that this is an audio 'sermon on the mount', but an objective appraisal of an IC which has, in many ways, revolutionised circuit design. Nonetheless, I am braced for a long-running debate forum on the subject from both purists and pragmatists alike! An early approach such as this to op-amp specifications and quirks is very worthwhile. It will mean that when we come to analyse the real op-amp circuitry of the AutoMate, it will be necessary only for me to say, for

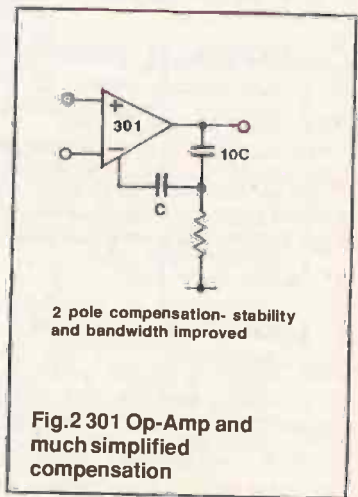

example, that capacitor C1001 is placed where it is in the circuit to provide phase-leading feedback. The reader can then refer to the appropriate section of this part of the series to understand why this is necessary and/or desirable. Time and text are thus saved in massive quantities since I will never be repeating myself..click.. never be repeating myself. Many of the parameters listed are inter-related or interconnected and it will be seen that in many instances, curing one particular problem also effects cure of another. This is an ideal, best case situation and one which, it has to be said, is not entirely realistic. More often, it will be found that curing one problem in a particular area creates or exacerbates another in a different part of the design and some compromise becomes necessary.

could be made available to guarantee the elimination of high frequency distortion. The variable nature of the conditions under which any gain stage blocks had to operate within a console meant that optimising performance of a given parameter was a difficult, if not impossible task. Compensation then debuted on the design stage, this approach entailing the definition of bandwidth of the overall loop around the amplifier, or stage, or both. Widlar moved to National and developed the 301. This was a second generation example of the op-amp and had improved short-circuit protection, freedom from latch-up, improved and simplified external frequency compensation (see Figure 2) and much wider differential input voltage range. All of these were in fact brought about by the need to eliminate all of the problem areas associated with the 709. Meanwhile, over at the Fairchild laboratories, IC history was slowly but surely being made.

The 709 was superseded by the famous (or infamous depending on your point of view!) but nonetheless, classic op-amp, the μ A 741. This improved on many aspects of the 709, (and the 301), having a short-circuit protected output stage and internal compensation which guaranteed a modicum of stability. This stability was gained at a high price, though,

ate Mixer

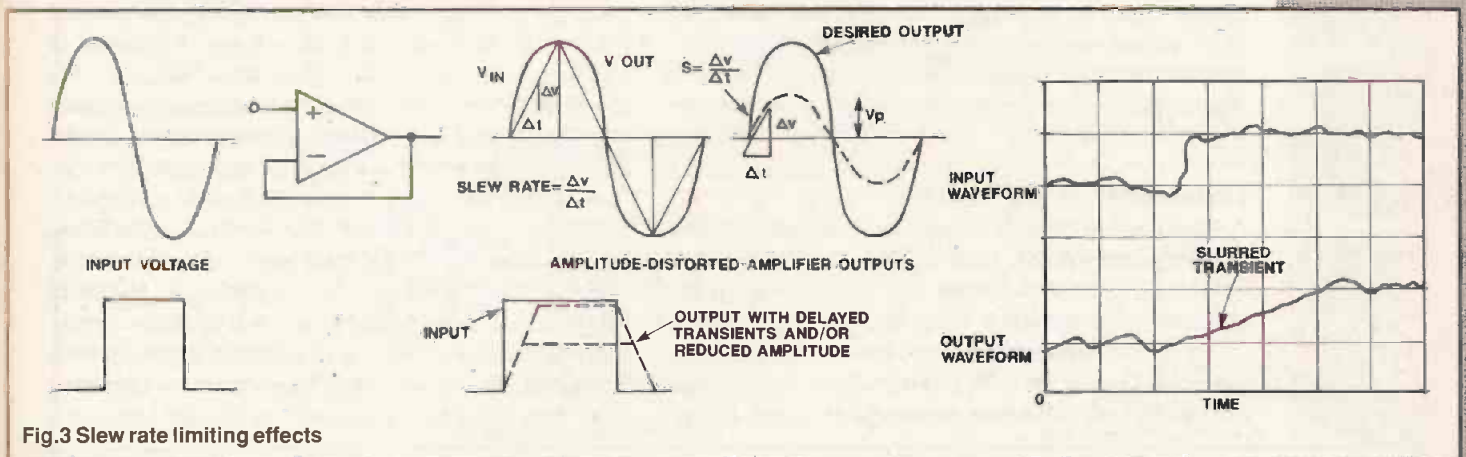

Fig.3 Slew rate limiting effects

Case No 741 - Op-Amp versus The People

Although the term 'operational amplifier' first appeared in a 1947 article (proceedings of the IRE) by Raggazini, the foundation for IC op-amp design really began with the μ 702. This was the first generally-accepted IC op-amp and was introduced by Fairchild Semiconductor. It was not, however, universally applicable since it had limited common-mode input voltage range, low voltage gain and odd supply voltage requirements. A major milestone IC evolution came with the introduction in 1965 of the next generation of op-amp. This was when Bob Widlar developed the world's first commercially-recognised op-amp, the Fairchild μ A709. It was expensive, had a tendency to oscillate, to latch-up when over-driven on the input and had no output stage protection. Frequency compensation was external and heavy in component count, requiring two capacitors and a resistor. So universal was the acceptance of the 709 that it must be regarded as a classic among IC op-amps. Although many of its individual performance parameters have long since been eclipsed, this IC remains a unique blend of performance, versatility and economy, a recipe which has proven hard to beat. See Figure 1.

Techniques were developed to overcome the instability problem but the devices remained noisy. Also, the lack of loop gain at high frequencies meant that insufficient feedback

specifically in the way that open-loop gain diminished rapidly with increasing frequency. In audio terms, the maximum gain - noisy as it was - which could be squeezed from the device when operated within a 20kHz bandwidth was a completely underwhelming - by today's standards - 20dB. Nonetheless, the IC became firmly entrenched in the consciousness of the design engineering fraternity, and despite its many limitations, found its way into many audio circuits for a good number of years.

Slew Rate Limiting - Fast In, Fast Out?

All of the early operational amplifiers had a common, major failing (if we neglect those just mentioned as being 'major'!), that being slew rate limiting. Slew rate is a measure of the ability of the amplifier output stage to shift or change in response to a high speed step-type waveform at the input - this parameter is usually measured in terms of Volts/microsecond or $V/\mu s$ and a typical value for the early devices might have been $0.5V/\mu s$. More recent devices, typically BiFET types of the TL0 family of IC's, offer quite reasonable figures in this department - around $13V/\mu s$. To achieve this, conventional bipolar differential input and level-shifting circuitry is replaced with FET designs. Audio-specific, so-called 'fast' op-amps such as the bipolar NE5534 also have slew-rate values in this region. As such, slew-rate

limiting is a source of error from dynamic effects, and in common with small signal bandwidth, is another aspect of op-amp performance with frequency.

Any compensation placed around the amplifier limits the rate at which the output stage of the op-amp can change in response to a step input. This is because there will exist a finite limit to the current sourcing capability of this stage in relation to the charging of this capacitor, no matter how small in value it might be. Internal compensation has a similar effect, as does any capacitance presented to the op-amp output as a load. These are the most common causes of slew rate limiting. Shortcomings in this area manifest themselves as transient intermodulation products superimposed on the output signal. High gain stages or high input frequencies or both require the use of op-amps with large slew rates - the so-called 'fast' op-amp. Any increase in frequency above that pre-determined by the slew-rate (amplitude/frequency) value of the op-amp results in an output at that frequency which is of much-reduced amplitude. This phenomena is, of course, not relegated uniquely to preamplifier-type circuitry and is a major cause for concern within the design of power amplifier stages. See Figure 3.

Instability

Slew rate brings us on, rather nicely, to instability. The rate at which the newer, faster op-amps were implemented within more up-to-date circuitry was equalled only by the speed with which previously stable designs - using the older, slower IC's - burst into oscillation. In many instances, the faster speed turned out to be a double-edged sword. Engineers at this time had become accustomed to treating the op-

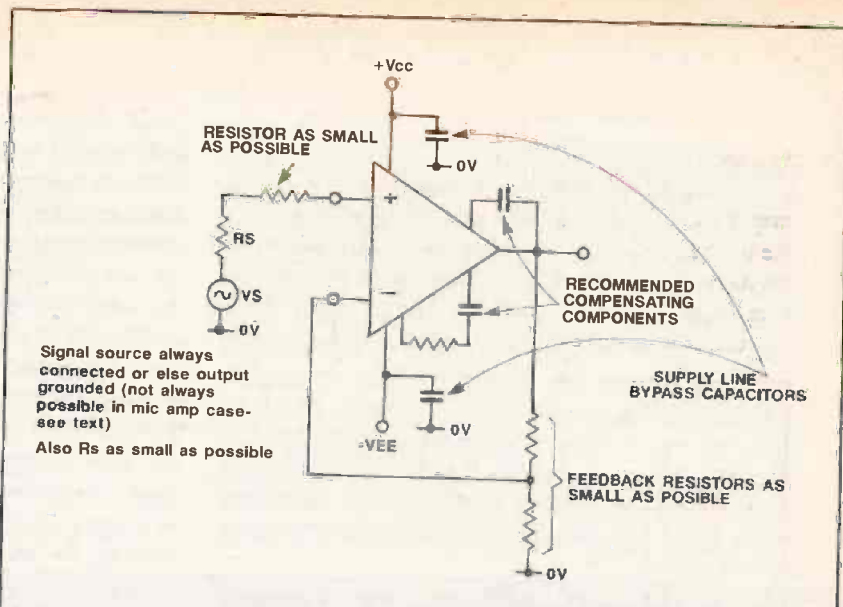

Fig.4 Diagram to summarise rules for achieving Op-Amp stability

Transient Intermodulation Distortion (TID)

TID has been an appreciated problem of all types of amplifiers since the advent of the introduction of negative feedback into such designs. Unfortunately, it is an effect to which the ear is particularly sensitive. This type of dynamic distortion is a by-product of the servo nature of all amplifiers with large quantities of applied negative feedback. We should all by now know that NFB is a circuit mechanism whereby an output-derived signal is added in antiphase to the input signal and is used as a means of correction.

As with all servo systems, there is a small but nevertheless finite delay between cause and effect, ie the time taken for the input to respond to the feedback signal and so correct the output. In control parlance, this is commonly known as damping. Any well-adjusted system will be neither over or under-damped but will be critically damped. However, even with a perfectly adjusted system there will always exist some small time delay before corrective information from the

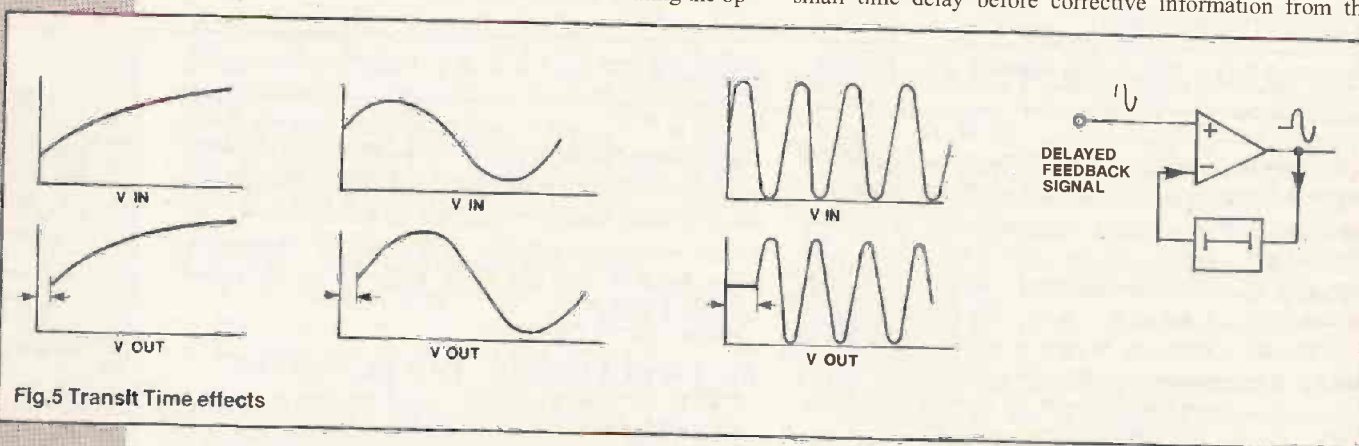

Fig.5 Transft Time effects

amp as an almost-perfect, three-terminal, black box gain block which was impervious to mis-use or designer-originated malpractice. Familiarity with the 741 series op-amps had bred contempt. The 741 device was stable, but tediously so, under just about all operating conditions. Audio design engineers had to re-acustom themselves to the stark reality that the op-amp black box was stuffed full of real, active components just waiting to burst into oscillation at the first hint of wrongly-applied feedback or poor compensation! This was particularly true of the critical unity gain configuration (See Figure 4).

feedback loop is acted upon. During this time, the output will be in a transient and undetermined state, tending towards the input signal but not under complete control. This is known as 'hunting'. The effect is most noticeable with high level, high frequency input signals.

Modern-day, faster-speed devices circumvent these attendant problems to a large extent since the amplifier settling times become insignificant when compared to any expected input signal transients. See Figures 3 & 5. As an aside, this particular topic has been the subject of much debate in the 'subjective' versus 'scientific' circles. More of

this later)

For a simple transient such as a step function, the result is merely a slowing down of the step at the output. If, however, the input consists of a continuous tone plus a transient, then the momentary overload will cause a loss of the continuous tone during the overload. This brief loss of signal, while not obvious as such to a listener, can result in a loss of quality.

output signal transition. Again, this time constant effect is of most objection at the HF end of the spectrum since there will exist some point where the input lags the output by a half-wavelength. This magical - or cursed -180° figure which means that feedback around the loop is now positive and oscillation can occur. See Figure 5. Transients occur at the beginning and end of sounds and contribute to the subjective

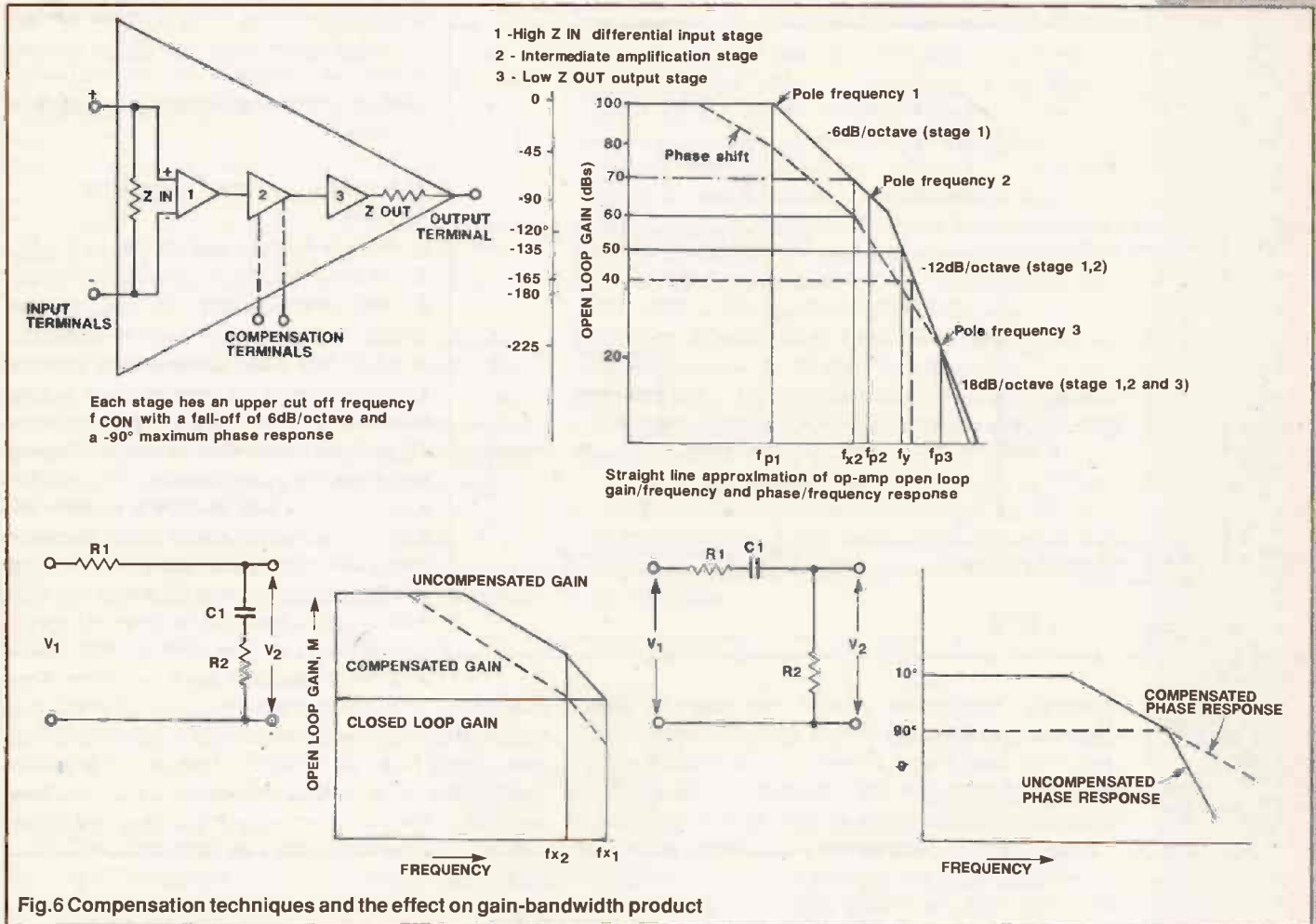

Fig.6 Compensation techniques and the effect on gain-bandwidth product

Overshoot and ringing are related errors in this field, both being a measure or effect of the amplifier's inability to handle transients. These manifest themselves as an 'overbright' quality in the perceived sound. It is perhaps significant that in the quest of the audio designer to reduce harmonic distortion to ever-lower and inaudible levels, the mechanisms introduced to achieve enhanced performance in this aspect - compensation and slew-rate limiting - do, in fact, exacerbate the much more insidious problem of TID. This, to my mind, is an unacceptable performance compromise since TID degrades the signal to a much worse extent. Subjectively, it is more objectionable than a similar amount of harmonic distortion (so long as the distortion is composed of the lower order harmonic products). Some designers now hold the view that in current designs, harmonic and IMD levels are so low that it is the transient behaviour of the amplifier which is the cause of audible differences between designs.

TID is also closely related to so-called 'Time Domain Effects'. Even the smallest capacitance internal to the chip architecture will introduce a time constant network. This means that there can no longer be an instantaneous input to

quality to a considerable extent. The transient behaviour of a system can, in theory, be calculated from a knowledge of the frequency and phase response although this may not be practicable. Audio signals consist of many complex and irregular phase and frequency responses. Good transient response requires a wide frequency range, a flat frequency response and no phase distortion.

Phase Margin

The previous is inextricably linked to this next topic. Phase margin is defined as the difference between 360° and the actual phase shift of the amplifier at MB. It is vitally important to maintain a large difference between the internally-structured GBW rolloff set for loop gain and the rolloff around the external components determining the closed loop gain. Failure to do so can mean that the feedback component can become so shifted in phase that it constitutes positive feedback. Long before oscillation occurs, this positive feedback component has a very noticeable and detrimental effect on the amplified signal, exhibiting itself as ringing on transients. Minimum phase margin is typically specified as more than 45° (-315°) in any conservative design.

A simple and elegant solution to the phase margin problem is to close down the bandwidth of the amplifier outside that which is deemed to constitute the normal audio spectrum.

Shock, horror, gas! I can sense slight feelings of discontent from some, and shock waves of incredulity and disbelief emanating from others ie those audiophiles and hi-fi purists seated at the back! What about the much-vaunted requirement for amplifier frequency responses extending to the

limiting characteristics of the feedback network will be nulled by the inverting input stray capacitance. See Figure 7. Quite simply, small resistor values around the op-amp are a good ploy. Low values mean that correspondingly larger values of stray capacitance need to be in existence before the network can become unstable.

A further dodge is to include a small value resistor or inductor in series with the input as shown. This gives some measure of rejection of RF demodulation and out-of-band signal amplification. This is advantageous, also, in the way that the other console quibbling (namely thermal noise) is minimised at the same time.

Intermodulation Distortion (IMD)

This is very much related to the GBP (Gain Bandwidth Product) argument/discussion touted in Part 1. If we can remember back some four months, I mentioned that since op-amps were linear devices with neither infinite gain nor infinite bandwidth, there had to be some interaction between the two parameters. We saw that gain and bandwidth were traded-off against each other, high gain meaning low bandwidth and conversely, high bandwidth meaning low gain. Typical figures were around 40dB gain at bandwidths extending to 20kHz. Above a certain frequency, the gain would start to roll off at 6dB/octave. Considering the graph in Figure 9 can see that up to around 20kHz, 40dB gain is available to the input signal and above this,

gain rolls off. It should be noted that gain is still available at frequencies in excess of the 20kHz audible frequency ceiling, there just isn't quite so much of it. Basically, although the op-amp will amplify signals above this, it does so with much-degraded performance when compared to those frequencies within the defined bandwidth. Less loop gain is available at these higher frequencies to maintain linearity. A perfectly linear system will perfectly reproduce the shape of any input waveform without alteration. In practice, all systems involve some degree of non-linearity ie curvature and will therefore modify any waveform passing through the system.

At first sight, we might not too much care whether out-of-band frequencies are harmonically distorted (by dint of the amplifier's non-linear transfer characteristic at these frequencies) since we cannot hear them. Unfortunately, intermodulation between in-band (audible) and out of band (ultrasonic) frequencies will occur, rendering sum and difference frequencies. These will include $f_1 + f_2$, $f_1 - f_2$ (where f_1 and f_2 are the fundamental frequencies) and $2f_1 + f_2$, $2f_1 - f_2$, $f_1 + 2f_2$, $f_1 - 2f_2$. Some of these WILL be within the audio band. None of these is harmonically related to the original components in the signal except by accident, and therefore, if audible, will be unpleasantly discordant.

Again, as in the instance of phase margin, bandwidth-limiting may be used to filter the input signal. Only signals within the defined frequency spectrum will then be amplified. This means that no high frequency, out-of-band signals can distort the audio signal through intermodulation and cross modulation processes caused by the amplifier's non-linear out of band response. This is important. If we pause to consider a typical multitrack tape machine return or live

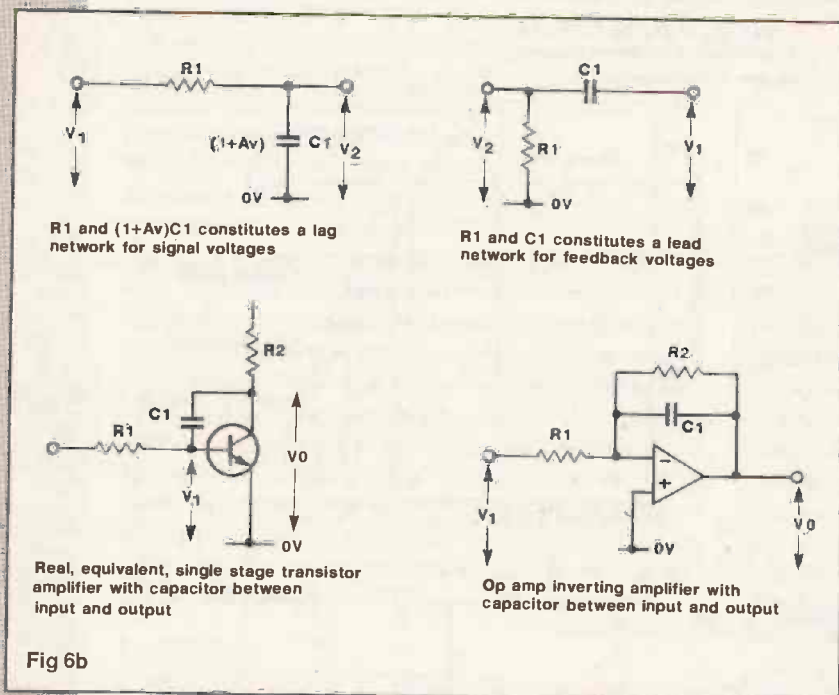

Fig 6b

supersonic region? This putative requirement to allow bandwidth extending well into the ultrasonic region - typically in the range 3Hz to 150kHz - (and to simultaneously tempt instability) is often justified because of the excellent in-band phase linearity which such an approach can yield.

Again, the word 'compromise' rears its ugly head. This compromise is in the already mentioned guise of compensation in the form of feedback, phase leading capacitor in parallel with the main feedback-determining resistor. See Figure 6.

One of the main causes of the erosion of phase margin is the existence of stray capacitance at the op-amp inverting input. This may be caused by a number of different factors - device characteristics, pinout or circuit board layout - and it interferes with the compensation capacitor, acting in direct opposition to it. In a mixing console, the worst case situation exists in the mixing bus of a virtual earth mixer. In this instance, the inverting input is effectively stretched across the full width of the console. This can mean that the compensation-cancelling capacitance present at the inverting input can be in the order of nanofarads rather than picofarads. Any compensation capacitor must be of a correspondingly proportional value. $C_f - R_f$ and $R_{in} - C_s$ are in effect, a frequency-compensated divider. Consequently - and we'll talk about it more fully in the thorough description of the mix bus - the compensation capacitor cannot be fitted until the complete console is up and running. The size of the bus presented to the inverting input will modify impedance and hence frequency response/ phase characteristics of the mix amp. Ultimately, the size of the compensation capacitor may be in the much larger than at first seems prudent. Happily, any bandwidth-

microphone input, there will doubtless be some vestigial content of bias and other ultrasonic frequencies.

Front-end filtering isn't so bad when considered within the context of other high fidelity audio pathways. CD has its brickwall, anti-aliasing input filters and FM stereo radio transmit broadcasts whose frequency extends to only 15kHz.

Compensation

No, not the type awarded by courts when a celebrity is libelled or called boring by the press! Rather, that which was mentioned briefly at the beginning of the chapter. For completeness within this framework of explanations of terminology and effects, and because of the importance of compensation, this particular topic deserves a paragraph to itself.

Put simply, compensation stabilises the amplifier under the conditions where closed loop gain is at its lowest extreme - and bandwidth at its most extreme also - by slowing the amplifier down.

The compensation terminals are generally arranged to 'scuttle' only one of the gain blocks within the amplifier package. If it is this outside-world-accessible stage which is causing the problem, the compensation component placing generally is effective. Oscillation is damped out of existence. However, if it is a preceeding or following stage, the compensation merely slugs the speed of the overall amplifier to such an extent that the instability/tendency to oscillate is suppressed before the output terminals. The internal gain block which is unstable is still present and actively oscillating

off of gain, done in such a manner that it controls the overall phase characteristics of the package.

Phase Lag

Lag compensation and lead compensation are the two methods often employed to stabilise op-amp circuits. In each case, an RC network is connected into the circuit so that it is part of the loop. Referring to the phase lag network, it can be shown that at frequencies where $X_c \gg R_2$, the voltage V_2 lags V_1 . A phase lag as great as -90° might be introduced. However, at higher frequencies where $X_c \ll R_2$, the network is largely resistive and no significant phase lag occurs. At these frequencies, the lag network merely introduces some attenuation. The components are calculated to introduce additional phase lag at some low frequency where the op-amp open loop phase shift is so small that additional phase shift has no effect on circuit stability. Then, at higher frequencies, there is only the attenuation without any additional phase lag.

The effect of the lag network attenuation is to move the frequency f_{x_1} at which $MB = 1$ for a given closed loop gain A_v , to a lower frequency, f_{x_2} . Because f_{x_2} is less than f_{x_1} , the op-amp phase shift at $f_{x_2} < \text{phase shift at } f_{x_1}$. The circuit is likely to be stable since no additional phase shift is introduced by the network at HF.

The network is not used to introduce a phase lag (which would increase the total phase lag in the loop). Instead, it is used to attenuate loop gain so that $MB = 1$ occurs at a frequency at which the amplifier phase shift is too small to cause oscillation.

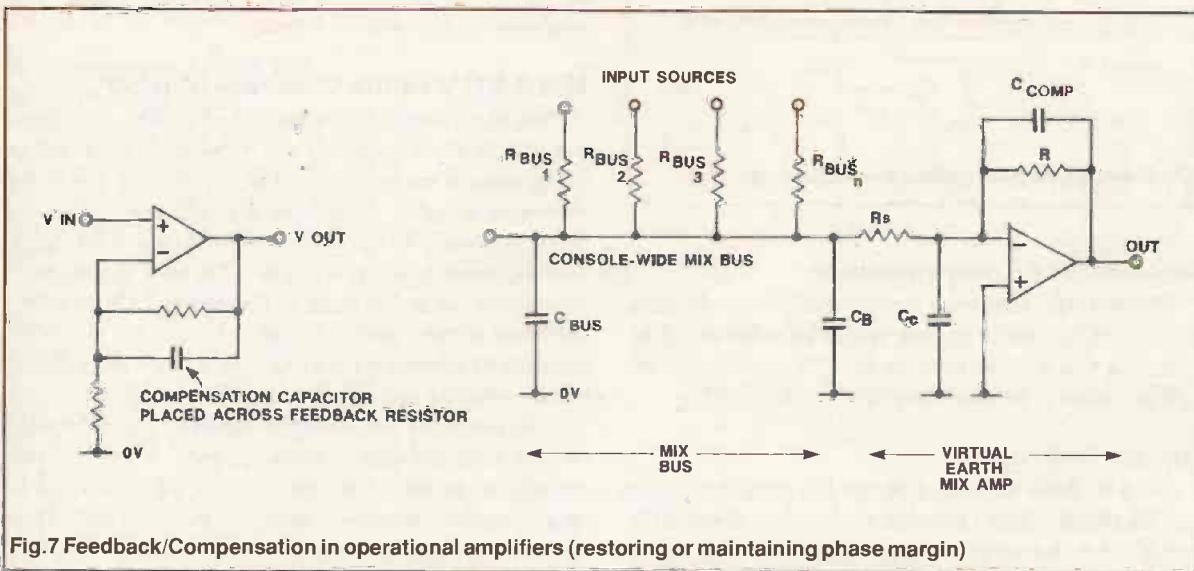

Fig.7 Feedback/Compensation in operational amplifiers (restoring or maintaining phase margin)

within the package, it just isn't visible at the output terminals (if the output is viewed on a 'scope). It is, nevertheless, audible and manifests itself as poor sound with perhaps some DC offset at the amplifier output.

Again, Figures 6,9 and 10 shows a typical arrangement. Moreover, the situation is almost certain to exist with the voltage follower configuration. There is no provision for the inclusion of phase leading around the amplifier and one of the criterion for oscillation - gain approaching or equal to unity - is already fulfilled. For this reason, the follower circuit is most definitely not a preferred one. It is not for nothing that compensation is known as a 'brute-force technique'. In many instances, it ruins practically all of the useful HF response of the amplifier by virtue of the fact that it is, indeed, a roll-

Phase Lead

When $X_c \gg R$, V_2 leads V_1 . Unlike the case of the lag network, this one does as its name suggests and is employed to introduce phase lead. The phase lead cancels some of the unwanted phase lag in the op-amp and so increases the phase margin at $MB = 1$.

Miller Effect

In the case of the externally connected Miller effect capacitor, C_1 and R_1 behave as a phase lead network within the feedback loop. The capacitance amplification is not a factor here because the direction of feedback is from the output to the input and there is no capacitance amplification in that direction. The network cancels some of the phase lag

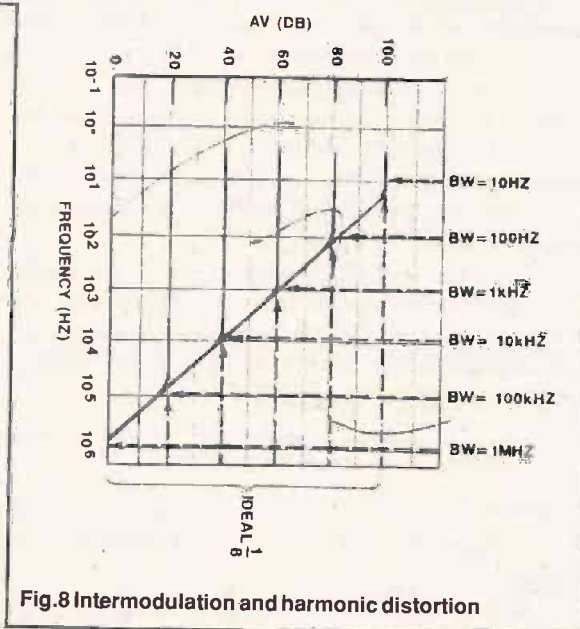
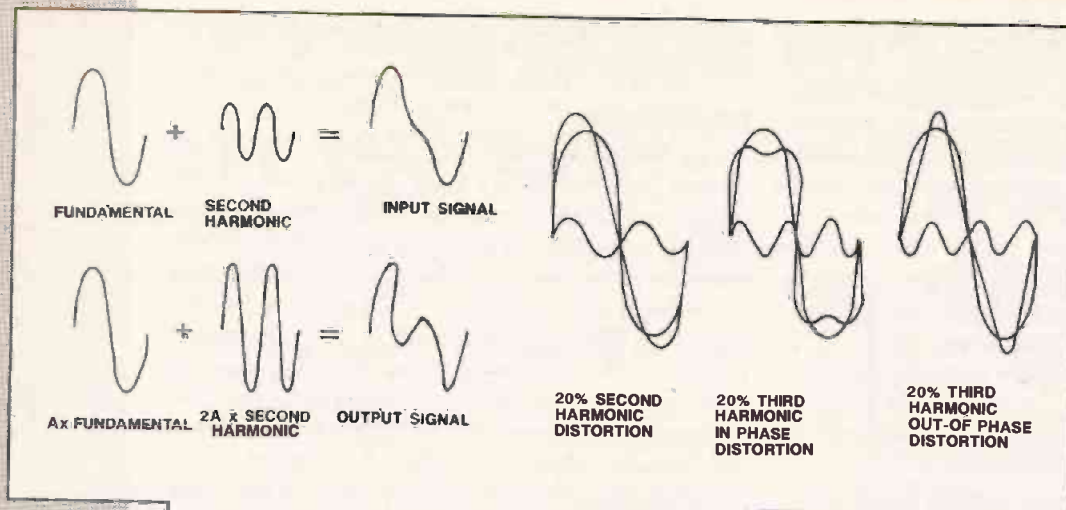

Fig.8 Intermodulation and harmonic distortion

in the loop.

Feedforward Compensation

With this type, a capacitor is connected between the input and output terminals of the high-gain stage of the amplifier. Bypassing with a capacitor suppresses the tendency for the high gain stage to introduce large phase shifts at HF.

Output Impedance

All of the afore-mentioned parameters are all to do with dynamic effects. Output impedance has to do with one of the op-amps static parameters. Output impedance is an important parameter to consider at the design stage. Modern op-amp designs implement the output current-limiting function using a simple resistor in series with the output. Whilst the application of NFB effectively reduces the value of this resistor to zero ohms, it is, however, a real component which must be considered and included in the feedback path and in any connection at the output of a reactive (capacitive) load. This is because the CR network will then have an effect on the phase margin and feedback phase characteristics of the amplifier. This inadvertently-created time constant network produces an effective phase-lagging configuration which will phase-shift any feedback inexorably towards the point of positive feedback. At this point, both of the Barkhausen criteria are fulfilled and circuit oscillation can occur. Similarly, connection to the output of a long piece of screened

wire (resistance and inductance) makes the resultant RCL network look like a mismatched tuned stub. When this happens, the amplifier is magically transformed into a rather effective RF signal generator. See Figure 11.

A proven way of curing this problem is to buffer the load away from the amplifier output terminal using a small-value series resistor. Values are typically in the order of 30 - 200R. Unfortunately, this arrangement reduces the headroom of the stage since

the series resistor, in conjunction with the load impedance, forms a potential divider. The divider then attenuates the output signal. Under normal operating conditions, with the amplifier output looking into a load impedance of 2k or more (typical minimum value for maintaining an output which is not current-limited), the degree of attenuation and hence the loss of headroom is in the order of fractions of a dB and so, in real terms, insignificant. An improvement on this method is to use an inductor. This creates a much more attractive phase-leading network to counteract load capacitance/phase lag but remains virtually transparent at audio frequencies. A low inductive reactance means that the connected load sees only the very low dynamic output impedance of the op-amp. This configuration also aids RF stability.

Hard EQ's in the Common Market

Now that a thorough investigation of op-amp characteristics has been had by all, we can move on to equalisation. Equalisation is the term applied to any circuitry within the input channel audio pathway used to deliberately alter the phase and amplitude versus frequency response of the signal, a tonal correction section, if you like. The term 'equalisation' was initially coined to describe the passive LCR networks employed to bend and subsequently correct the frequency response of telephone lines and similar such transmission media so that the response from end to end of the line would then be ostensibly flat or within specified limits between defined lower and upper frequency points. They were true 'equalisers' in that usually they created a tolerably flat or equal frequency response within the passband end of the transmission line. I say end-to-end because the frequency response measured at points along the line would usually return a plot which was anything but flat. These passive equalisation networks are today still used extensively with audio, video and data transmission lines and similar techniques exist in any magnetic recording or playback apparatus.

Size Isn't Everything...

Equalisation within a hi-fi or audio context is a somewhat different entity. As a noun, EQ - a contraction of equalisation - refers to the section within the console used to correct, modify, enhance or de-emphasise the input signal frequency response. It encompasses the simple rumble, scratch and Baxandall or shelving type control sections found on domestic audio equipment and also the complex 4 and 5 band parametric-type equalisation found on consoles. This type

usually has sweepable LF and HF sections, bell or shelving response selection, adjustable Q, centre frequency and boost/cut.

Equalisation can be sub-divided into three broad categories of usage;

Complementary (or de-emphasis) Corrective Creative

Complementary EQ - for want of a better term - refers to any equalisation network used to counteract the 'frequency-bending' or pre-emphasis which might have been required for the signal when recorded and placed on a particular storage medium such vinyl disc or magnetic tape. Examples which immediately spring to mind are the RIAA gramophone equalisation and NAB or CCIR types used in tape recording.

Corrective refers to high and low pass and notch type filters used to remove or attenuate turntable rumble, hum, hiss, mic-handling noise, the MPX tones on stereo FM radio broadcasts and other such unwanted aural intrusions.

Creative EQ might refer to graphic or parametric sections, used, for example, to simulate the response of a telephone line, or to add 'presence' to a particular instrument so that it stands out more within a collage of instruments. It might also be used to 'warm-up' a male voice or to counteract the overuse of a particular effect in the original recording.

Subjectively Good but Objectively Bad?

Equalisation, like operational amplifiers or band-limiting, is another hoary chestnut and dirty word within the higher echelons of domestic audiophile circles. It is accepted as a necessary evil in the world of the professional recording studio. There are those golden-eared individuals who prefer their preamps to have nothing more exotic than an input source selector - directly switched, of course - and a volume control. These people believe any type of tone control to be an unwelcome and unnecessary intrusion upon the ultimate fidelity of the perceived audio signal. (It is claimed, with no hard or otherwise objective evidence, that any tone control must introduce phase distortions even in the 'flat' position). This minimalist approach is particularly prevalent in preamplifiers and amplifiers at the top end of the market and is one which has been applauded by the subjective fraternity of the sycophantic reviewers of the popular hi-fi press. Other fickle topics such as oxygen-free copper cabling, hard-wired mains supplies, gold-plated connectors and the relative merits of solid versus stranded wire come and go in a similar contrived fashion.

Conversely, there are those among the club fraternity - especially reggae or house music aficionados - who, given a studio-quality, 1/3rd octave graphic equaliser, might then move the first three and the last three sliders to maximum, the intervening faders to minimum. The party would then quite

happily groove the night away, blissfully content with the resultant flat-to-100Hz frequency response. As a slight aside, this reminds me of a mixer produced by a company called TUAC and manufactured specifically for the reggae market. It achieved a similar type of frequency response to that just mentioned using just two controls, aptly named 'weight' and 'treble'.

Between these two extremes of the listening populace, there exist those who know or believe that the average living room is a non-ideal acoustic enclosure. It is incorrectly dimensioned, structured and furnished to provide a perfect listening environment. These types will make judicious adjustment of the tone controls and, perhaps, compensate for slight abnormalities in perceived phase or frequency response. They might also be used to or counteract room resonance or achieve better tonal balance of the chosen

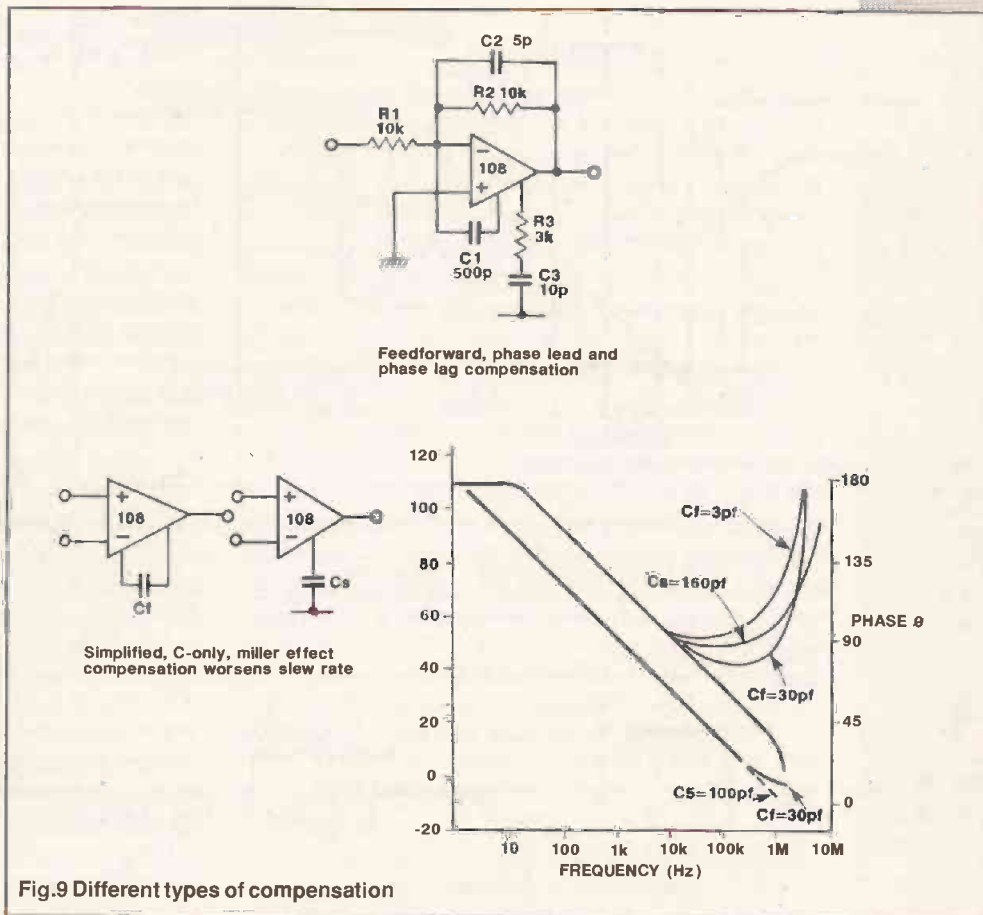

programme material. In this way, their use can only enhance listening pleasure. This is, I believe, a sensible approach to a non-ideal situation although. It has to be said, as a closing aside, that the straight-through, no-frills audio pathway approach is to be commended in those instances where a very good listening environment and excellent source material is being used.

MFP (Music for Pleasure) or SOB (Standard Operational Bull)?

Sound and the enjoyment of it is a very subjective pleasure. In a technological sense, and to paraphrase a very well-known saying, 'One man's Meatloaf is another man's spoisson'. Many of the population still derive great pleasure from listening to medium wave radio or old, scratchy recordings. Both types of sound transmission are considered by many

technologists as quaint or obsolete. As technologists and engineers, we become enmeshed in a process of constant evolution and improvement (although the 'improvement' argument might be debated). Sometimes sight is lost of whether we really do listen more carefully to the music or to the noise between the tracks? Does the person with

technical or mathematical terms, is easy to gauge by its absence or presence from said circuitry. All aspects and parameters of the performance of any audio circuitry are measurable to a certain extent, despite the protestations of the subjective fraternity. The measuring apparatus does, however, put a very real limit to the lowest measurement which we are

able to quantify. It may be because of this that different pieces of equipment with identical paper specifications - albeit to the limits of the measuring equipment - sounds different to the listener. Ultimately, this is the sole governing fact of the need to constantly improve designs. The very small percentage of the populace who will be able to hear the difference in performance then become the absolute reference. This is a very important fact. The equipment and of whatever elements it may be comprised is merely a means to an end, its existence justified purely by the need and desire to impart realism into recorded music. The output of the mixing desk will become, for most people, the reference source. If the reference becomes flawed, upon what are we to base judgement of fidelity? This science versus pseudo-science/subjectivism argument will rage quite happily - or unhappily as the case may be - for years to come without further fuel or fanning of the flames on my part.

Modern Day Studio Recording Techniques

Although all of the afore-mentioned might seem somewhat remote from sound console design, it should be remembered that modern-day multi-track recording techniques mean that most of the material is recorded piece-by-piece in an acoustically dead studio. Rhythm, percussion, vocals, strings and brass are all recorded and added sepa-

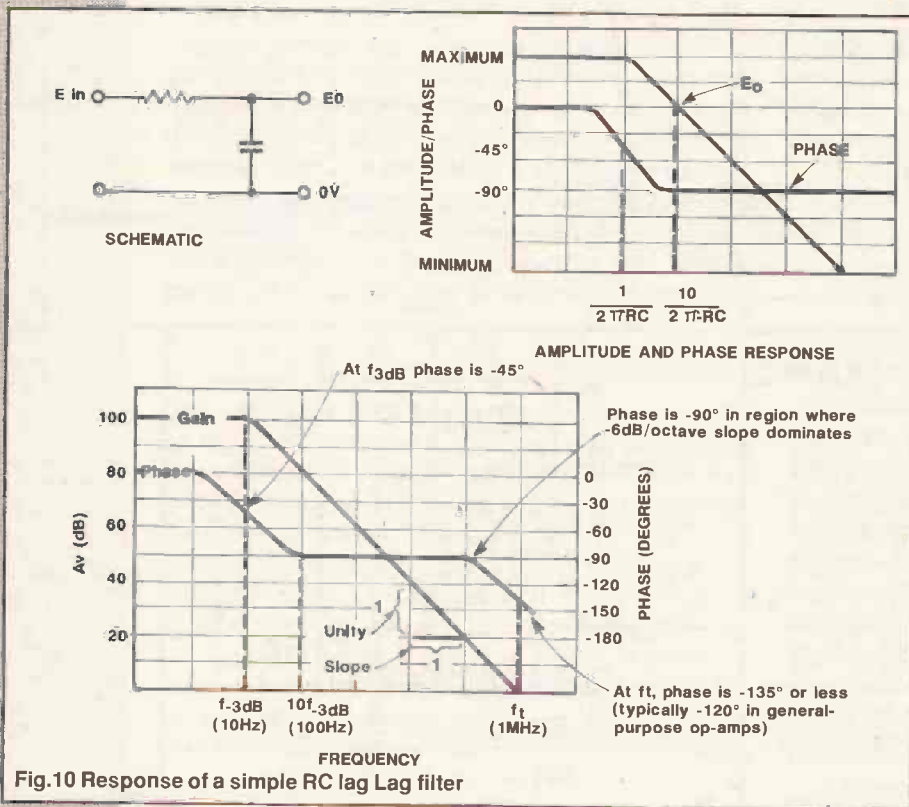
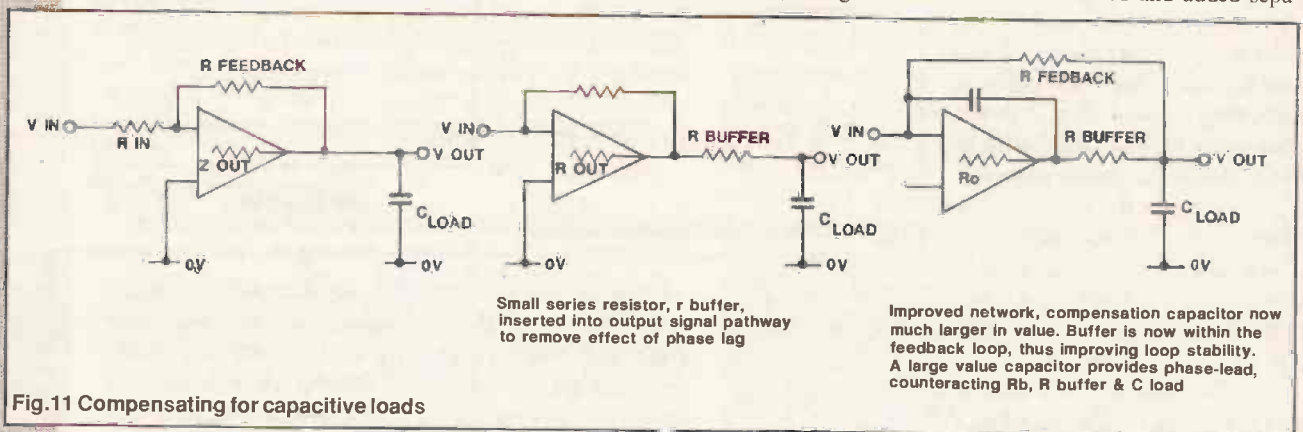

Fig.10 Response of a simple RC lag filter

better listening acuity and acoustic perception enjoy music more? Is the pleasure gained from having technically perfect equipment or from hearing a sound reproduced through it? This is not to say that the two can't co-exist and marry quite happily.



As far as music and sound and allied media are concerned, people indulge in the pastime of listening because it should be joyous experience. That good-sounding equipment possesses technically-advanced and measurable attributes is almost without doubt. The fact that equipment is a means to an end and not a tabernacle or monument to technical perfection is sometimes lost in the mists of the lab environment and more easily forgotten. In simple terms, and this applies especially to EQ, any circuitry should sound musical, a term which, although sometimes difficult to quantify in

rately. EQ and off-board effects such as reverb are used to minimise the artificiality of the sound and make it more 'live' and believable, perverse as this approach may appear (or rather, sound)! The use of artificial means to recreate a live performance and to impart a sense of intimacy into the piece is now an accepted part of the recording process. Regrettably, this departing exodus from natural performing acoustic environments to the more cultured, drier close-mic'd studio is seen by many as objectionable and a betrayal of the philosophy of the purpose of live music

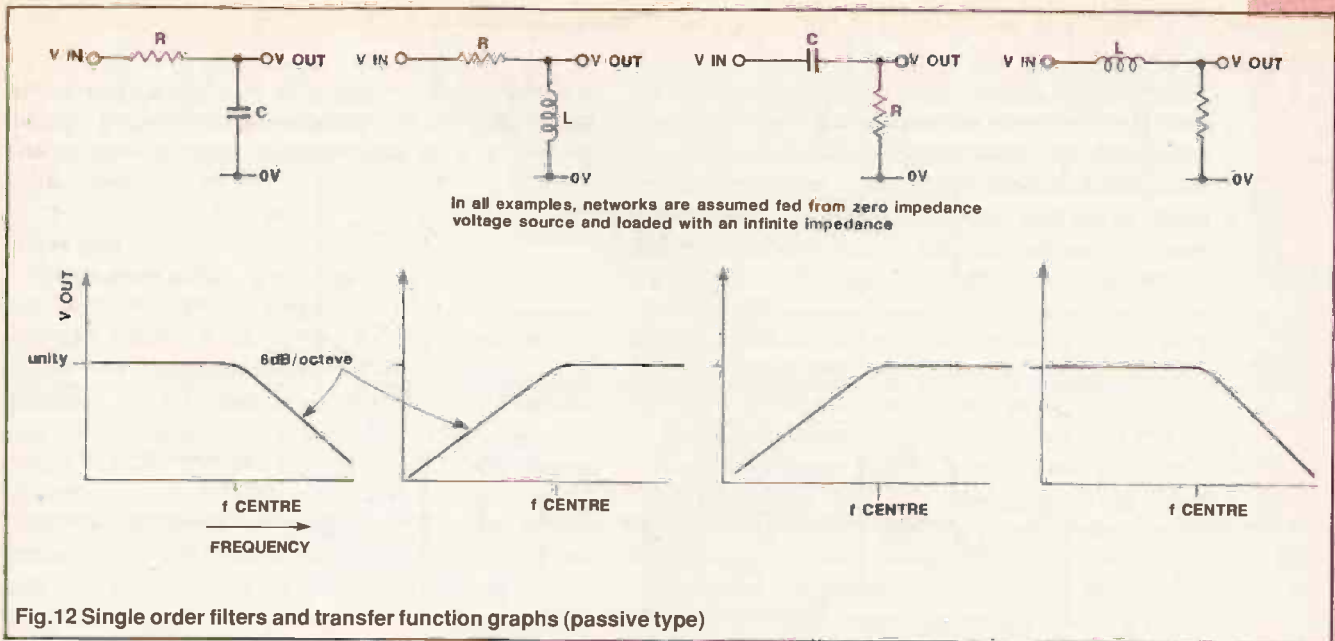

Fig.12 Single order filters and transfer function graphs (passive type)

recording.

A friend who at one time worked on an SSL, 112 inputs-at-mixdown type desk (and subsequently became a bit of an acknowledged expert) then moved to a jazz broadcasting radio station and was heard to remark that, despite the thrill of working on such a state-of-the-art piece of kit, nothing whatsoever could compare with the feeling of having captured live on a coincident stereo pair of mics a good performance, any 'fixes' being done not in the mix but as you mixed. Sometimes less can be more!

It is paradoxical to reflect that some of the finest jazz recordings were made using tube-technology mixing consoles. Because of size and cost considerations, facilities on valve desks were minimal and EQ almost non-existent. Contrast this to the 18-knob, 5 pushbutton types on modern-day consoles....

With all of the afore-mentioned firmly in mind, we can now look at the various types of filters and equalisers to be found within a console. Some notion and appreciation of what is required and of some of the problems or advantages which the use of the op-amp will cause or cure in this area of circuit design should have been gained. Most importantly, any applied equalisation should sound natural with great care taken to ensure that its application is in fact to create a given effect, or to either remove unwanted sounds from the signal or to add that which is lacking. It should rarely be used as an effect or 'toy' in its own right.

We mentioned briefly, high pass, low pass and bandpass filters, shelving and bell type responses and resonators. Each of the different response curves require different electronic techniques to generate them.

Parametric or Paranormal?

The true parametric equaliser, with frequency, boost/cut and Q all independently variable, is difficult to implement if interaction between the various controls is to be avoided. In any implementation, we also have other, console-wide considerations to consider. These are, of course, the minimising of noise and distortion whilst maximising headroom. Where two or more parametric or filter sections are cascaded, interaction between the different sections must also be avoided. (As in front-end amplifier design, it is a juggling exercise of a seemingly endless number of conflicting electronic variables). Typically, the centre frequency for the given band of

interest - usually somewhere in the MF part of the spectrum in parametric-type equalisers - is adjustable over a 10:1 to 25:1 range, with the centre frequency of each band set differently. Typical boost and cut is in the order of +/-12dB to +/-15dB. Commonly, designs use constant Q filters meaning that the frequency range of the boost is larger than the range of the cut (for similar amounts of boost and cut at the centre frequency, obviously, and with no change in Q). Q adjustment is typically 10:1, ranging from 0.29 to 2.9. An ideal approach to the problem of easily understood explanations in what is, quite frankly, a complex subject, is to introduce the basic filter sections as simple building blocks. We then continue with an expansion and exploration of these constituent parts. In this way, it should be possible (with the information given in the following sections) for any interested parties not only to alter Q's, boost and cut ratios and swept frequency ranges of the published designs, but to take this approach to its logical conclusion and design from scratch for oneself. We'll also try to avoid, where at all possible, the publication of double-line equations and other complicated (and usually unnecessary) mathematics and retain an approachable and practical technique of explanation.

From A to Z of EQ

We'll start at the very beginning - to paraphrase Julie Andrews- and look at the various configurations of passive components which can be made to create high pass, low pass and band pass responses. Figs 12 & 13 show various permutations of networks with the associated transfer functions shown alongside. Changing just one of the components in each of the networks alters the turnover frequency, whilst increasing the value of one and reducing that of the other by a proportionate amount yields an identical frequency response. The new network, will have a different impedance (since the resistance/reactance ratio has been altered).

Getting Shifty with Phase

Not only do all of these filters effect amplitude changes but they also alter phase because of the way that LR and CR networks produce phase leading and phase lagging effects respectively. All of the networks shown in Figures 12 & 13 are first order filters ie 6dB/octave. Within the field of active filter design, there exist some important phase/frequency trends of which we must be aware if easy and trouble-free

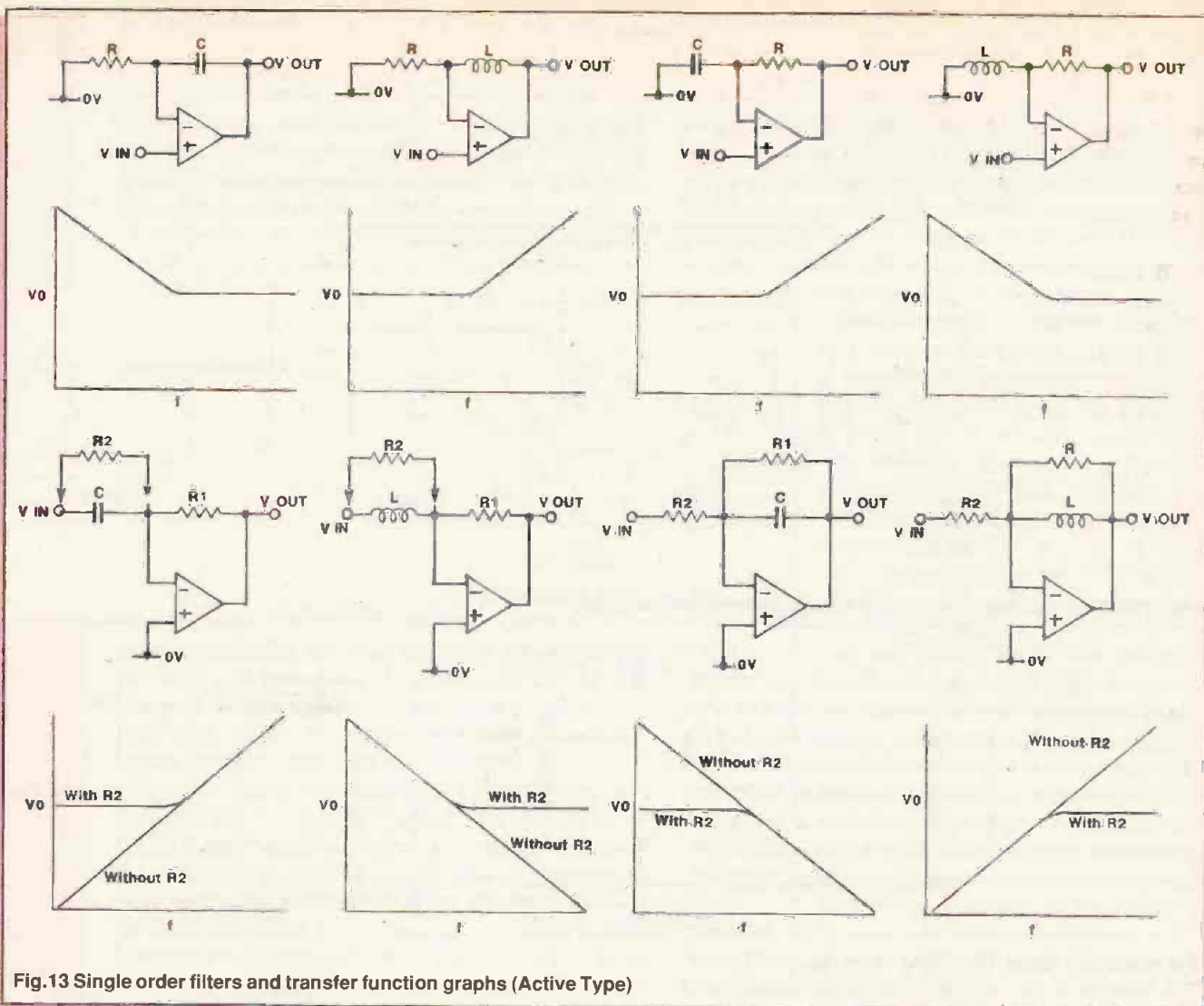

Fig.13 Single order filters and transfer function graphs (Active Type)

progress is to be made through the subject. Certain buzzwords and jargon are also of limited use in this aspects.

We have already said that there is a corresponding phase shift as well as a frequency/amplitude change in the response of the network. Typically, there is a 45° phase shift at the '3dB down point' in the frequency /amplitude response. (The frequency where the amplitude is 3dB down on the flat response). Further, this shift can be leading or lagging depending upon the prevailing reactive nature of the network, an inductive network effecting a $+90^\circ$ phase leading charac-

teristic and a capacitive one yielding a -90° phase lagging effect. This is, of course, the output voltage with reference to the input. It is easy to see that both types of reactances act in opposition. In any network containing both types of reactance, the larger of the two will dictate the predominant reactive character of said network. Any such arrangement is said to be 'second order' in nature. Should both inductive and capacitive reactances be equal in magnitude, we have a resonant state with each of the two reactances effectively cancelled out at the resonant frequency. It is at this state of resonance (and at the frequencies immediately above and below this frequency) that the dynamic impedance of the network becomes of some significance because of the way that a percentage change in frequency above or below resonance effects a corresponding percentage change in the dynamic impedance/reactance of the network. The higher the change in impedance between in-tune and out of tune condi-

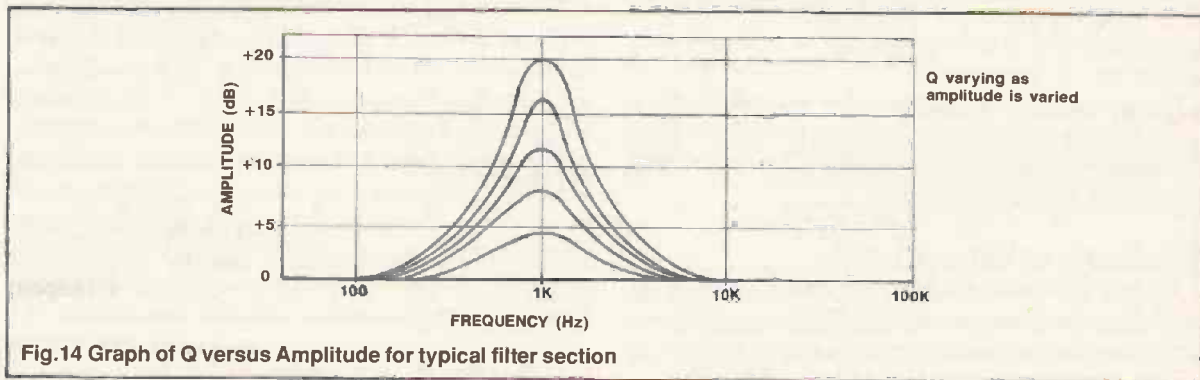

Fig.14 Graph of Q versus Amplitude for typical filter section

tions ie resonance and non resonance, the steeper the slope of the curve - the 'skirts' - either side of the point of resonance on the amplitude/frequency plot. This steepness or shallowness is known as the quality or Q of the network. It both determines and quantifies the extent of the notch effect - and hence selectivity - and bandwidth of the filter. Figure 14 shows a plot of amplitude versus frequency for a filter

tions ie resonance and non resonance, the steeper the slope of the curve - the 'skirts' - either side of the point of resonance on the amplitude/frequency plot. This steepness or shallowness is known as the quality or Q of the network. It both determines and quantifies the extent of the notch effect - and hence selectivity - and bandwidth of the filter. Figure 14 shows a plot of amplitude versus frequency for a filter

section whose value of Q varies with the boost/cut control setting. Figure 15 shows a similar plot for another filter section where Q remains constant irrespective of boost/cut control setting.

Join the Q

Q bandwidth and relative network resistances and reactances are all directly related. From a practical viewpoint which, as sound engineers, is the point of most interest - $Q = f/BW$, with bandwidth defined as being the difference in frequency between the upper and lower 3dB down frequencies. It follows that a filter with $f_{\text{centre}} = 10\text{kHz}$ and $Q = 4$ would have a bandwidth of 2.5kHz. Q is also usually proportional to overall filter gain, ie a filter with a Q of 3.2 would have an overall voltage gain of 10dB at its resonant frequency. Specific gain at any particular frequency robs console headroom across the whole audio spectrum. Anything other than the very judicious use of any equalisation

maxim prevalent in the computer industry holds true here. The output being a true complementary transmutation of the input. It therefore follows that a capacitor with a large ESR (equivalent series resistance) will affect adversely the quality of the inductor created at the output. This loss of quality manifests itself - as it does in a real, lossy inductor - as a series loss resistance which in turn affects circuit Q. Since perfect capacitors (composed solely of X_c) do not exist in the real world but have a small but finite series resistance, this too is transferred across. Quality of inductance is also governed by the loading effect of the gyrator (see Figure 16).

It should be obvious that this arrangement of simulated inductances lends itself readily to continuous tuning of the centre frequency of any series or parallel tuned circuits. In practise, this gyrator arrangement is not adopted because moving f_{centre} by altering the gyrated L or C causes a change in the reactances at resonance. This is to such an extent that different frequencies create different network dynamic im-

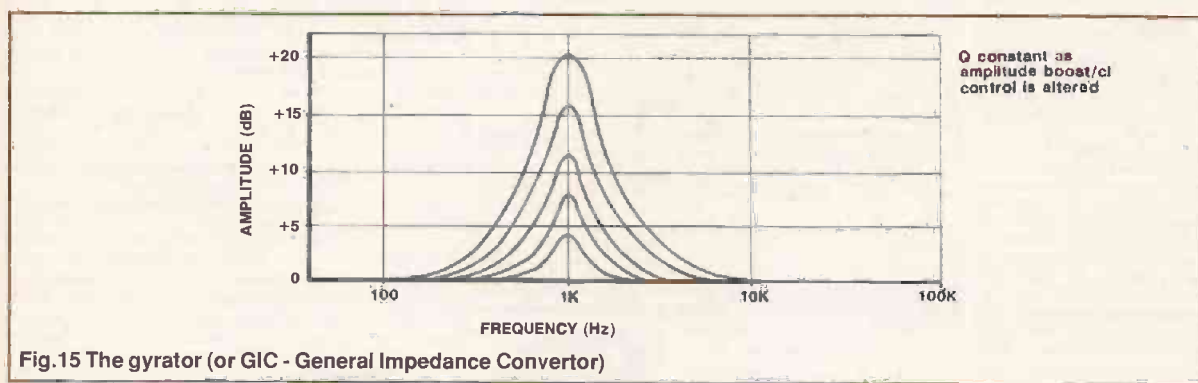

Fig.15 The gyrator (or GIC - General Impedance Converter)

control can quickly overload the channel circuitry. Various compromise solutions do exist. Q and gain controls can be arranged to operate in a ganged and complementary fashion such that as Q is increased, the input signal to the filter is attenuated. Unfortunately, attenuator impedance values are necessarily large to avoid detrimental loading effects and as such, create problems of their own.

Welcome to the Real World

The inductor as a device is fine as far as it goes in its use in simple filter analysis. However, for much the same reasons as the transformer before it. The inductor loses much of its attraction when we wish to utilise its reactive characteristics in practical circuit design with real and tangible specifications and electronic limitations. At audio frequencies, inductors must, of necessity, be physically large, bulky and expensive. Like the transformer, the inductor, being of wound construction, suffers from core-hysteresis induced distortion, saturation and also hum and other electro-magnetic field pick-up. Happily, there now exist modern and easily-implemented circuit techniques which can, using active op-amp networks, be made to simulate or generate the frequency/amplitude and phase-shifting properties of the true and pure inductor. A circuit called a gyrator is used to simulate this inductive effect. Very simplistically, the gyrator is an active electronic device with input and output terminals which transmutes or converts the reactive impedance presented at its input to its corresponding complement at its output terminals. We can therefore 'create' an inductor using a capacitor/gyrator combination. Lest we should become complacent, the GIGO - garbage in/garbage out -

pedances and hence Q's. This undesirable tendency could be counteracted by simultaneously altering a secondary, Q-determining series resistor. This approach, particularly if Q is to be an accessible and independently variable parameter - as well it might in any real console equaliser - would necessitate a multitude of ganged and closely interactive controls. In practise is neither easy to implement, inexpensive or desirable.

Once again I can feel the editorial crooked staff of page constraint approaching fast on the starboard bow and so we shall have to draw this month's discussion to a close. Next month, we can look further at EQ and conclude with an explanation and description of the AutoMate equalisation section. Moving on from EQ, audio switching within the console will be covered in some depth.

References

Audio Electronics Handbook (edited by Ian R Sinclair) - Sound Recording Techniques (Don Aldous), Preamps and Inputs, Voltage Amplifiers and Controls, Power Output Stages (John Linsley Hood), Sound Waves (Dr W Tempest) - BSP Professional Books

The New Audio Cyclopedia (edited by Glen M. Ballou) - Preamplifiers and Mixers, Filters and Equalisers (Mahlon Burkhard), Consoles and Systems (Steve Dove), Details of the Session (Chips Davies with Linda Jacobson) - Howard W Sams

Operational Amplifiers (Applications, Troubleshooting and Design) - Operational Amplifier Parameters, op-Amps as AC Amplifiers, Op-Amp Frequency Response and Compensation, Active Filters (David A. Bell) - Prentice Hall

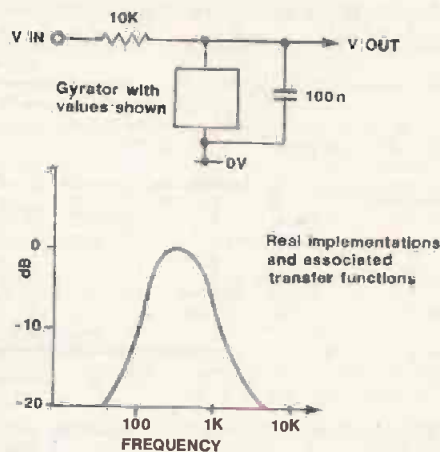
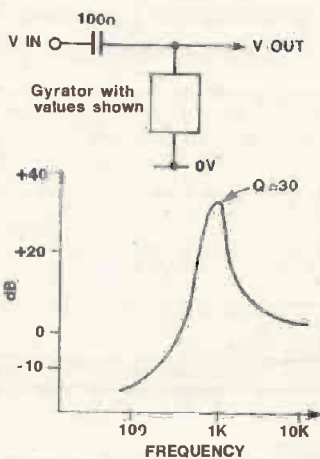
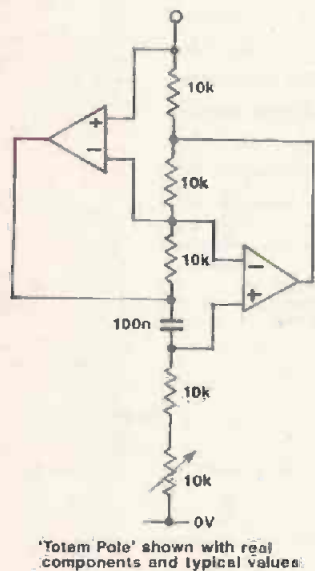
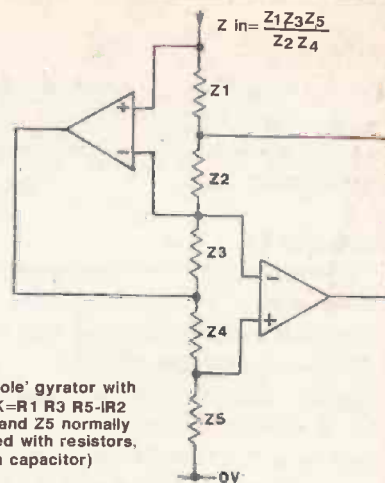
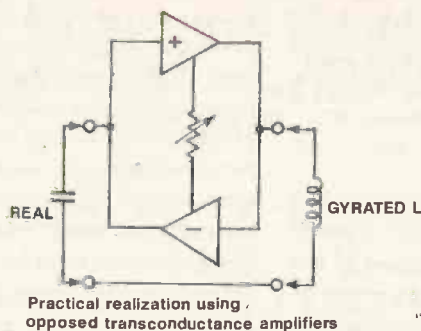
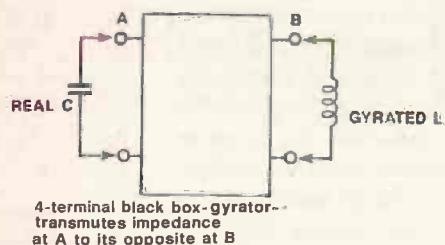

Fig. 16

Analog Electronics Handbook - Feedback, DC Amplifiers, Active Filters, Power Amplifiers, Resonant Circuits, Distortion and Noise (TH Collins) - Prentice Hall

The Art of Electronics - Feedback and Operational Amplifiers, Active Filters and Oscillators, Precision Circuits and Low Noise Techniques (Horowitz and Hill) - Cambridge University Press

A Practical Introduction to Electronic Circuits - Integrated Circuit Building Blocks (Martin Hartley Jones) - Cambridge University Press

IC Op-Amp Cookbook - Op-amp basics, Ic Op-amps: The Evolution of general purpose and specialized types (Walter G

Jung) - Howard W Sams

Active Filter Cookbook - The Operational Amplifier, First and Second Order Networks, Bandpass Filter Design, Bandpass Filter Circuits (Don Lancaster) - Howard W Sams
Understanding IC Op-Amps - Monolithic Op-Amp Circuitry, The Integrated Circuit Op-Amp (Roger Melen, Harry Garland) - Howard W Sams

Electronic Filter Design Handbook (LC, Active and Digital Filters) - Selecting the Response Characteristic, Bandpass Filters, Networks for the Time Domain, Component Selection for LC and Active Filters (Arthur B. Williams, Fred J. Taylor) - McGraw-Hill

1992 CATALOGUE
NOW FREE!

CRICKLEWOOD ELECTRONICS

CRICKLEWOOD ELECTRONICS LTD, 40 CRICKLEWOOD BROADWAY, LONDON NW 2 3ET
Tel: 081 452 0161 Fax: 081 208 1441

BOOKS 	BOXES & CASES 	CABLE & WIRE 	CAPACITORS 	CONNECTORS 	KITS
RESISTORS 	SEMI-CONDUCTORS 	SPEAKERS 	VIDEO HEADS 	SWITCHES 	TOOLS & BENCHWARE

SEND NOW FOR THE **CRICKLEWOOD ELECTRONICS** COMPONENT CATALOGUE
ONE OF THE BEST RANGES AVAILABLE

Name.....
Address.....
.....
Please send me my free copies of Cricklewood Electronics Catalogue

Surplus always wanted for cash!

THE ORIGINAL SURPLUS WONDERLAND!

Surplus always wanted for cash!

COMPUTER SCOOPS

PC-AT 386 20-DX FULLY LOADED FOR £499!

- 20 Mhz DX processor
- 2 megs RAM. Exp 10 meg
- 40 meg hard drive
- 1.2 meg 5-1/4" floppy
- 32K cache exp. 64K
- Installed VGA card
- Enhanced 102 key k/board
- Complete with MS-DOS 3.3
- 2 serial 1 parallel ports
- 8 free slots- 6 off 16 bit!



The MP386 quality made by Mitsubishi to last a lifetime! Brand new with all manuals and software plus Super PC-Quick Disk Accelerator for lightning disk access.

£499 (F)

A COMPLETE IBM PC COMPAT SYSTEM FOR ONLY £99!!

Just plug in and go - fully expandable - the Display PC-991 System supplied complete with 12" mono monitor, 84 key keyboard, 360K 5-1/4" floppy disk drive, 128K RAM, 2 serial and 1 parallel port plus DOS with manual. Many other features include 7 slot backplane, all metal case, 150 watt PSU and US made motherboard. In very good used condition with 90 day guarantee. At the unique price of:

£99 (E)
Optional FITTED extras: 256K RAM £15; 640K RAM £39, 12" CGA colour monitor with card £89, 2nd 5-1/4" 720K floppy (or 360K if preferred) £29.95. 20 mbyte hard drive £99.



MONITORS

MONOCHROME MONITORS

THIS MONTH'S SPECIAL!



There has never been a deal like this one! Brand spanking new & boxed monitors from NEC, normally selling at about £140! These are over-engineered for ultra reliability. 9" green screen composite input with etched non-glare screen plus switchable hightow impedance input and output for daisy-chaining. 3 front controls and 6 at rear. Standard BNC sockets. Beautiful high contrast screen and attractive case with carrying ledge. Perfect as a main or backup monitor and for quality users!

£39.95 each (D) or 5 for £185 (G)

CALL FOR DISCOUNTS ON HIGHER QUANTITIES!

COLOUR MONITORS

HI-DEFINITION COLOUR MONITORS

JUST ARRIVED! MULTISYNC - VGA -

14" Philips Model CM8873 VGA multisync all the way up to 34Khz with 640 x 480 resolution. This one has everything! Two switches enable you to select CGA, EGA or VGA and digital/analog. Unusual for a professional monitor, sound is also provided, with a volume control. There is also a special "Text" switch for word processing, spreadsheets and the like. Compatible with virtually all computers including IBM PC's, Amiga, Atari, BBC, Archimedes etc. Good used condition (possible minor screen bums) 90 day guarantee. 15" x 14" x 12". **£150 (E)**

Brand new 12" multiline high definition colour monitors by KME. Nice light 0.28" dot pitch for superb clarity and modern two tone plastic styling. Operates from any 15.625 kHz sync RGB video source, with either Individual H & V syncs such as CGA IBM PC's or RGB analog with composite sync such as Atari, Commodore Amiga, Acorn Archimedes & BBC. Measures only 13.5" x 12" x 11". Also functions as quality TV with our RGB Telexbox. Excellent used condition with 90 day guarantee. In nice two tone beige and brown case. Only **£149 (E)**

Brand new Centronic 14" monitor for IBM PC and compatibles at a lower than ever price! Completely CGA equivalent. Hi-res Mitsubishi 0.42 dot pitch giving 669 x 507 pixels. Big 28 Mhz bandwidth. A super monitor in attractive style moulded case. Full 90 day guarantee. Only **£129 (E)**

NEC CGA 12" IBM-PC compatible. High quality ex-equipment fully tested with a 90 day guarantee. In an attractive two tone ribbed grey plastic case measuring 15" L x 13" W x 12" H. The front cosmetic bezel has been removed for contractual reasons. Only **£79**



FLOPPY DISK DRIVES

5 1/4" from £22.95 - 3 1/2" from £21.95!

Massive purchases of standard 5 1/4" and 3 1/2" drives enables us to present prime product at industry beating low prices! All units (unless stated) are removed from often brand new equipment and are fully tested, aligned and shipped to you with a 90 day guarantee and operate from standard voltages and are of standard size. All are IBM-PC compatible (if 3 1/2" supported).

- 3.5" Panasonic JU364 720K **£21.95 (B)**
- 3.5" Mitsubishi MF353C-D 1.4 Meg. Laptops only **£29.95 (B)**
- 3.5" Mitsubishi MF353C-D 1.4 Meg. Non laptop **£29.95 (B)**
- 5.25" Teac FD-55(36). 360K half height **£22.95 (B)**
- 5.25" Teac FD-55(72). 720K half height **£24.95 (B)**

* Data cable included in price.

- Shugart 800/801 SS refurbished & tested **£175.00 (E)**
- Shugart 851 double sided refurbished & tested **£275.00 (E)**
- Mitsubishi M2994-63 double sided switchable hard or soft sectors- BRAND NEW **£250.00 (E)**

Dual 8" drives with 2 mbyte capacity housed in a smart case with built in power supply! Ideal as exterior drives! **£499.00 (F)**

End of line purchase scoop! Brand new NEC D2248 8" 85 megabyte of hard disk storage! Full CPU control and industry standard SMD interface. Ultra hi speed transfer and access time leaves the good old ST506 interface standing. In mint condition and comes complete with manual. Only **£299 (E)**

THE AMAZING TELEBOX!

Converts your colour monitor into a

QUALITY COLOUR TV!

TV SOUND & VIDEO TUNER!



The TELEBOX consists of an attractive fully cased mains powered unit, containing all electronics ready to plug into a host of video monitors made by manufacturers such as MICROVITEC, ATARI, SANYO, SONY, COMMODORE, PHILIPS, TATUNG, AMSTRAD and many more. The composite video output will also plug directly into most video recorders, allowing reception of TV channels not normally receivable on most television receivers (TELEBOX MB). Push button controls on the front panel allow reception of 8 fully tuneable 'off air' UHF colour television or video channels. TELEBOX MB covers virtually all television frequencies VHF and UHF including the HYPERBAND as used by most cable TV operators. Composite and RGB video outputs are located on the rear panel for direct connection to most makes of monitor. For complete compatibility - even for monitors without sound - an integral 4 watt audio amplifier and low level Hi Fi audio output are provided as standard.

- Telebox ST for composite video input monitors **£32.95**
- Telebox STL as ST but with integral speaker **£36.50**
- Telebox MB as ST with Multiband tuner VHF-UHF-Cable, & hyperband for overseas PAL versions state 5.5 or 6mhz sound specification. **£69.95**
- Telebox RGB for analogue RGB monitors (15khz) **£69.95**

Shipping code on all Teleboxes is (B)

RGB Telebox also suitable for IBM multisync monitors with RGB analog and composite sync. Overseas versions VHF & UHF call. SECAM/NTSC not available.

No Break Uninterruptable PSU's

Brand new and boxed 230 volts uninterruptable power supplies from Densel. Model MUK 0585-AUAF is 0.5 kva and MUD 1085-AHBH is 1 kva. Both have sealed lead acid batteries. MUK are internal, MUD has them in a matching case. Times from interrupt are 5 and 15 minutes respectively. Complete with full operation manuals. MUK **£249 (F)** MUD **£525 (G)**

POWER SUPPLIES

Power One SPL200-6200P 200 watt (250 w peak). Semi open frame giving +5v 35a, -5v 1.5a, +12v 4a (8a peak), -12v 1.5a, +24v 4a (6a peak). All outputs fully regulated with over voltage protection on the +5v output. AC input selectable for 110/240 vac. Dims 13" x 5" x 2.5". Fully guaranteed RFE. **£85.00 (B)**

Power One SPL130. 130 watts. Selectable for 12v (4A) or 24v (2A). 5v @ 20A. ±12v @ 1.5A. Switch mode. New. **£59.95 (B)**

Astec AC-8151 40 watts. Switch mode. +5v @ 2.5a. +12v @ 2a. -12v @ 0.1a. 6-1/4" x 4" x 1-3/4". New. **£19.95 (B)**

Greenlake 19ABOE 60 watts switch mode. +5v @ 6a. ±12v @ 1a. ±15v @ 1a. RFE and fully tested. 11 x 20 x 5.5cm. **£24.95 (C)**

Conver AC130. 130 watt hi-grade VDE spec. Switch mode. +5v @ 15a. -5v @ 1a. ±12v @ 6a. 27 x 12.5 x 6.5cm. New. **£49.95 (C)**

Boshart 13090. Switch mode. Ideal for drives & system. +5v @ 6a. +12v @ 2.5a. -12v @ 0.5a. -5v @ 0.5a. **£29.95 (B)**

Farnell G6/40A. Switch mode. 5v @ 40a. Encased. **£95.00 (C)**

BBC Model B APM Board

£100 CASH FOR THE MOST NOVEL DEMONSTRATION APPLICATION!

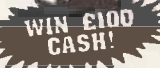

BBC Model B type computer on a board. A major purchase allows us to offer you the PROFESSIONAL version of the BBC computer at a parts only price. Used as a front end graphics system on large networked systems the architecture of the BBC board has so many similarities to the regular BBC model B that we are sure that with a bit of experimentation and ingenuity many useful applications will be found for this board! It is supplied complete with a connector panel which brings all the I/O to 'D' and BNC type connectors - all you have to do is provide +5 and ±12 v DC. The APM consists of a single PCB with most major IC's socketed. The IC's are too numerous to list but include a 6502, RAM and an SAA5050 teletext chip. Three 27128 EPROMS contain the custom operating system on which we have no data. On application of DC power the system boots and provides diagnostic information on the video output. On board DIP switches and jumpers select the ECONET address and enable the four extra EPROM sockets for user software. Appx. dims: main board 13" x 10". IO board 14" x 3". Supplied tested with circuit diagram, data and competition entry form.

Only **£29.95 or 2 for £53 (B)**

SPECIAL INTEREST

- Trio 0-16 vdc bench PSU. 30 amps. New **£ 470**
- Fujitsu M3041 600 LPM band printer **£2950**
- DEC LS/02 CPU board **£ 150**
- Rhodes & Schwarz SBUF TV test transmitter 25-1000mhz. Complete with SBTFT Modulator **£6500**
- Calcomp 1036 large drum 3 pen plotter **£ 650**
- Thurby LA 160B logic analyser **£ 375**
- 1.5kw 115v 60hz power source **£ 950**
- Anton Pillar 400 Hz 3 phase frequency converter 75kw **POA**
- Sony KTX 1000 Videolex system - brand new **£ 650**
- ADDS 2020 VDU terminals - brand new **£ 225**
- Sekonic SD 150H 18 channel Hybrid recorder **£2000**
- HP 7590A A1 8 pen high speed drum plotter **£1850**
- Kenwood DA-3501 CD tester, laser pickup simulator **£ 350**

BRAND NEW PRINTERS

- Microline 183. NLO 17x17 dot matrix. Full width. **£199 (D)**
- Hyundai HDP-920. NLO 24x18 dot matrix full width. **£149 (D)**
- Qume LetterPro 20 daisy. Qume QS-3 interface. **£39.95 (D)**
- Centronics 152-2 9 x 7 dot matrix. Full width. **£149 (D)**
- Centronics 159-4 9 x 7 dot matrix. Serial. 9-1/2" width **£ 99 (D)**

20", 22" and 26" AV SPECIALS
Superbly made UK manufacture. PIL all solid state colour monitors, complete with composite video & sound inputs. Attractive leak style case. Perfect for Schools, Shops, Disco, Clubs. In EXCELLENT little used condition with full 90 day guarantee.

20"....£135 22"....£155 26"....£185 (F)

CALL FOR PRICING ON NTSC VERSIONS!

Superb Quality 6 foot 40U

19" Rack Cabinets

Massive Reductions

Virtually New, Ultra Smart!

Less Than Half Price!



Top quality 19" rack cabinets made in UK by Optima Enclosures Ltd. Units feature designer, smoked acrylic lockable front door, full height lockable half louvered back door and removable side panels. Fully adjustable internal fixing struts, ready punched for any configuration of equipment mounting plus ready mounted integral 12 way 13 amp socket switched mains distribution strip make these racks some of the most versatile we have ever sold. Racks may be stacked side by side and therefore require only two side panels or stand singly. Overall dimensions are 77-1/2"H x 32-1/2"D x 22"W. Order as:

- £ 650 Rack 1 Complete with removable side panels. **£275.00 (G)**
- £ 375 Rack 2 Less side panels **£145.00 (G)**

COOLING FANS

- 3 inch AC 1 1/2" thick **£ 8.50 (B)**
- 92 mm AC 230 v. 18mm thick **£12.95 (B)**
- 3 1/2 inch AC ETRI silimline. Only 1" thick. **£ 9.95 (B)**
- 3 1/2 inch AC 230 v 8 watts. Only 3/4" thick **£12.95 (A)**
- 4 inch AC 110/240v 1 1/2" thick. **£10.95 (B)**
- 10 inch AC round. 3 1/2" thick. Roltron 110v As above but 230 volts **£10.95 (B)**
- 60 mm DC 1" thick. No.812 for 5/12v.814 24v. **£15.95 (A)**
- 80 mm DC 5 v. Papst 8105G 4w. 38mm. RFE. **£19.95 (A)**
- 92 mm DC 12v. 18 mm thick. **£14.95 (A)**
- 4 inch DC 12v. 12w 1 1/2" thick **£12.50 (B)**
- 4 inch DC 24v 9w. 1" thick. **£14.50 (B)**

LARGE QUANTITIES OF OSCILLOSCOPES AND TEST GEAR ALWAYS AVAILABLE - CALL NOW!

DISPLAY

MAIL ORDER & OFFICES
Open Mon-Fri 9.00-5.30
Dept ET, 32 Biggin Way,
Upper Norwood,
London SE19 3XF.

LONDON SHOP
Open Mon-Sat 9-5.30
Thursday till 9.00pm
215 Whitehorse Lane,
South Norwood,
London, SE25.

DISTEL® The Original
Free dial-up database!
1000's of items+info On Line
V21, V22 & V22 bis
081-679-1888

ALL ENQUIRIES
081-679-4414
Fax-081-679-1927



All prices for UK Mainland. UK customers add 17.5% VAT to TOTAL order amount. Minimum order £10. PO orders from Government, Universities, Schools & Local Authorities welcome - minimum account order £30. Carriage charges (A)=£2.00 (B)=£3.75 (C)=£5.50 (D)=£8.50 (E)=£11.50 (F)=£14.00 (G)=£18.00 (H)=Call. Scotland surcharge: call. All goods supplied subject to our standard Conditions of Sale and unless otherwise stated guaranteed for 90 days. All guarantees on a return to base basis. Rights reserved to change prices & specifications without prior notice. Orders subject to stock. Quotations willingly given for higher quantities than those stated. Bulk surplus always wanted for cash.



**ELECTRONICS
TODAY INTERNATIONAL**

PCB SERVICE September

E9209-1	Intercom for light aircraft	_____	H
E9209-2	Alarm protector	_____	C
E9209-3	Temperature controller	_____	M
E9209-FC	45W Hybrid power amp	_____	F

PCBs for the remaining projects are available from the companies lists in Buylines

Use the form or a photocopy for your order. Please fill out all parts of the form. Make sure you use the board reference numbers. This not only identifies the board but also tells you when the project was published. The first two numbers are the year, the next two are the month.

Terms are strictly payment with order. We cannot accept official orders but we can supply a proforma invoice if required.

Such orders will not be processed until payment is received.

E8807-5	Updated FM Stereo Decoder	_____	J	E8906-1	PC edge connector	_____	F
E8807-6	Breath Rate Display Board	_____	F	E8906-2	MIDI converter CPU	_____	N
E8808-1	Breath Rate Main Board	_____	H	E8906-3	MIDI converter keyboard	_____	N
E8808-2	Breath Rate Switch Board	_____	C	E8906-4	MIDI converter control	_____	M
E8808-3	Telephone Recorder	_____	D	E8906-5	AF signal generator	_____	G
E8808-4	Analogue Computer Main Board (2 bds)	_____	M	E8906-6	Mini bleeper	_____	C
E8809-1	Spectrum EPROM Emulator	_____	M	E8906-7	Caravan heater controller	_____	G
E8809-2	Frequency Meter (2 boards)	_____	P	E8907-1	MIDI Patch Bay	_____	G
E8809-3	Travellers' aerial Amp	_____	E	E8907-2	Priority Quiz Switch	_____	E
E8810-1	GerradaMarweh Bikebell	_____	E	E8907-3	Camera Trigger Infra red (2 boards)	_____	G
E8810-2	Peak Programme Meter (2 boards)	_____	N	E8907-4	Aerial Amplifier main board	_____	E
E8810-4	TV to RGB Converter	_____	E	E8907-5	Aerial Amplifier power supply	_____	E
E8810-5	Electron RGB Buffer	_____	C	E8908-1	Intercom master station	_____	L
E8811-1	Ni-Cd Charger	_____	E	E8908-2	Intercom slave station	_____	F
E8811-2	Chronoscope(3boards)	_____	P	E8908-3	Intercom power mixer	_____	E
E8811-3	Digital Transistor Tester	_____	G	E8908-4	Digital joystick to mouse conversion	_____	H
E8812-1	Doppler Speed Gun (2 boards)	_____	K	E8909-1	Twin Loop Metal Locator	_____	H
E8812-2	Small Fry Mini Amp	_____	D	E8909-2	Trembler movement detector	_____	D
E8812-3	Thermostat	_____	E	E8909-3	Field power supply (spec 3)	_____	C
E8812-4	Burglar buster Free PCB	_____	D	E8909-4	Micro monitors active filter	_____	F
E8812-5	Burglar Buster Power/relay Board	_____	E	E8909-5	Chronoscope auto-reset	_____	C
E8812-6	Burglar Buster Alarm Board	_____	C	E8910-1	Multimeter	_____	H
E8812-7	Burglar Buster Bleeper Board	_____	C	E8910-2	MIDI Mapper	_____	M
E8901-1	EPROM Programmer mother board	_____	M	E8911-1	Smoke Alarm main board	_____	F
E8901-2	Variat-Ion updated Main Board	_____	H	E8911-2	Smoke Alarm power supply	_____	F
E8901-3	Variat-Ion Emitter Board	_____	E	E8911-3	Frequency Meter (3 board)	_____	O
E9001-4	In-car Power Supply	_____	C	E8911-4	Serial Logic Scope	_____	L
E8901-5	Granny's Hearing Booster	_____	E	E8912-1	Mains Failure Alarm	_____	D
E8902-1	Compressor/Limiter/Gate	_____	L	E8912-2	Surveillance PCB	_____	D
E8902-2	Ultrasonic Horn	_____	D	E8912-3	Slide/tape Sync	_____	E
E8902-3	Stepper Motor Driver Board	_____	L	E8912-4	Pedal Power	_____	L
E8902-4	Quest-Ion (2 boards)	_____	K	E8912-5	Digital Noise Generator	_____	K
E8903-1	Intelligent Plotter Solenoid Board	_____	H	E9001-1	20 metre Receiver	_____	I
E8903-2	MIDI Programmer	_____	L	E9001-2	Wavemaker FG	_____	L
E8903-3	Balanced Disc Input Stage	_____	F	E9001-3	Motorcycle Intercom	_____	F
E8903-4	Digitally Tuned Radio	_____	G	E9001-4	Low Voltage Alarm	_____	C
E8904-1	Camera Trigger	_____	E	E9002-1	EPROM Emulator	_____	N
E8904-3	Intelligent Plotter Main Board	_____	O	E9002-2	Superscope Mother Board	_____	M
E8904-4	Kinetotie Tie Board	_____	N	E9002-3	Superscope CRT Driver Board	_____	K
E8904-5	Kinetotie Control Board	_____	E	E9002-4	Superscope Timebase Board	_____	K
E8905-1	Guitar Tuner	_____	H	E9003-1	Superscope Y1 input board	_____	J
E8905-2	Camera Trigger Ultrasonics (2 boards)	_____	F	E9003-2	Superscope Y2 input board	_____	J
E8905-3	Bench Power Supply (2 boards)	_____	H	E9003-3	Superscope switch generator	_____	E

E9003-4	Business power amp board	L	E9110-8	Nightfighter - 8 Channel Triac Board	N
E9003-5	Business power supply board	J	E9111-1	Digital Code Lock	L
E9003-7	Water hole	G	E9111-2	Switched Mode Power Supply	E
E9003-8	Super Siren	D	E9111-3	Nightfighter Mode Selection (2 sided)	J
E9003-9	Val's badge	F	E9111-4	Nightfighter- Display Board (2 sided)	M
E9004-1	Bass Amplifier DC Protection	F	E9111-5	Nightfighter - Bass Beat Trigger (2 sided)	L
E9004-2	Bass Amplifier Graphic equaliser	L	E9111-6	Nightfighter- Sequence Select (2 sided)	H
E9004-3	Bass amplifier Micro	N	E9111-7	Nightfighter - Master Controller PSU	K
E9004-4	Quad Power Supply	O	E9111-8	Nightfighter- Output Switch (2 sided)	M
E9005-1	Business Display	O	E9112-1	Nightfighter Sensor Switch Master Control (2 sided)	L
E9005-2	Phone Lock and Logger	F	E9112-2	Nightfighter Sensor Switch Channel Control (2 sided)	L
E9006-1	Dark Room Timer	G	E9112-3	Nightfighter Sensor Switch Sound Trigger	H
E9006-2	Telephone Extension Bell	C	E9112-4	Nightfighter Connector Board	F
E9006-3	Telephone External Bell	D	E9112-5	Nightfighter Sensor Switch PSU	K
E9006-4	Fecko Box	G	E9112-6	Nightfighter 8-Channel Input Interface (2 sided)	P
E9006-5	Bug Spotter	E	E9112-7	Power On and Overload Regulator	P
E9007-1	Guitar Practice Amp	G	E9201-1	Laboratory Power Supply	F
E9007-2	Digital Frequency Meter	M	E9201-2	Test Card Generator Board	M
E9007-3	Footstep Alarm	E	E9201-3	LED Star (2 sided)	L
E9007-4	Transistor Tester	C	E9201-4	Enlarger Timer Main PCB (2 sided)	N
E9007-5	Decision Maker	J	E9201-5	Enlarger Timer Selector Board (2 sided)	K
E9008-1	AC Millivoltmeter	K	E9201-6	Enlarger Timer Switch PCB	E
E9008-2	Temperature Controller	N	E9203-1	MIDI Switcher- Main Board	L
E9008-3	FM Generator	L	E9203-2	MIDI Switcher- Power Supply	E
E9009-1	Slide Projector Controller	E	E9203-3	Sine Wave Generator (surface mount)	F
E9009-2	Ultimate Diode Tester	D	E9204-1	Auto Car Lights	F
E9009-3	The Entertainer	G	E9205-1	Bat Detector	E
E9010-1	Component Tester	F	E9205-2	Pond Controller	F
E9010-2	Active Contact Pickup	E	E9206-FC	Stereo amplifier	G
E9010-3	R4X Longwave Receiver	C	E9206-2	Xenon flash trigger Main Board	J
E9011-1	The Autocue (2 boards, 1 double sided)	N	E9206-3	Xenon flash trigger Flash Board	F
E9011-2	Infra-lock transmitter (2 boards)	K	E9206-4	Scanner for audio generator	D
E9011-3	Infra-lock receiver	H	E9207-1	Improved Rear Bike Lamp	D
E9011-4	Four-track cassette recorder (record/playback one channel)	F	E9207-2	Mini Baby Bug Monitor	C
E9011-5	Four-track cassette recorder (Bias/erase oscillator board)	K	E9207-3	Ultrasonic Audio Sender (2 boards)	H
E9012-1	Infra Switch	F	E9207-4	Camera Add-on unit (4 boards)	O
E9101-1	Remote Control - Main Board	J	E9207-5	AutoMate 5V/48V Mixer power supply	J
E9101-2	Remote Control - Display Board	H	E9207-6	AutoMate Precision 17V power supply	J
E9101-3	Remote Control Timeswitch - Transmitter board	E	E9207-FC	Surround Sound Decoder	F
E9101-4	SBC Micro Controller Board	F	E9208-1	Dynamic Noise Limiter	F
E9101-5	SBC Practice Interface Board	F	E9208-2	Touch Controlled Intercom (2 boards)	H
E9101-6	5 in 1 Remote Sensing Switch	E	E9208-3	MIDI Keyboard	K
E9102-1	Remote Control Timeswitch - receiver board	F	E9208-FC	Battery charger	F
E9102-2	Anti theft Alarm (2 boards)	H			
E9103-1	Ariennes Lights	L			
E9103-2	64K EPROM Emulator	N			
E9103-3	SSB Radio Receiver	G			
E9103-4	Active Loudspeaker board	H			
E9104-1	Testmeter (Voltage)	E			
E9104-2	Active Direct Injection Box	F			
E9104-3	EPROM Eraser	F			
E9104-4	Digital Tachometer	F			
E9104-5	Radio Calibrator	F			
E9105-1	Modulated Laser (2 boards)	H			
E9105-2	Thyristor Tester	F			
E9105-3	Frequency plotter	K			
E9106-1	Laser Receiver	F			
E9106-2	Temperature Controller - Power Supply	G			
E9107-1	Temperature Controller - Main Board	K			
E9107-2	Temperature Controller - Probe PCB	F			
E9107-3	The Foot Tapper - Volume Control (2 sided)	J			
E9107-4	The Consort Loudspeaker	H			
E9108-1	Pulsed Width Train Controller	E			
E9108-2	Model Speed Controller - Main Board	F			
E9108-3	Model Speed Controller - Power Supply	F			
E9109-1	Geiger Counter	E			
E9109-2	Hemisync Waveform Generator Board	G			
E9109-3	Hemisync Pulse Generator Board	F			
E9109-4	Hemisync Power Supply Board	C			
E9109-5	Nightfighter Main Processor Board	O			
E9110-1	Freeze Alarm	E			
E9110-2	Document Saver	E			
E9110-3	Prototype Designer	J			
E9110-4	Nightfighter - Sound to Light (2 sided)	L			
E9110-5	Nightfighter - Ramp Generator Board	F			
E9110-6	Nightfighter - Cyclic Crossfade (2 sided)	M			
E9110-7	Nightfighter- Strobe Board (2 sided)	J			

TELEPHONE
ORDERS
may be made on
(0442)
66551
ACCESS or VISA

Price code	Price (inc. VAT)
C	£1.80
D	£2.50
E	£3.25
F	£4.00
G	£4.75
H	£5.50
J	£6.62
K	£7.20
L	£8.80
M	£10.60
N	£13.10
O	£15.80
P	£17.90
Q	£21.80
R	£23.90
S	£25.90
T	£29.00
U	£32.20
V	£35.80
W	£37.90
X	£40.70

**ETI PCB SERVICE, READER'S SERVICES,
ARGUS HOUSE, BOUNDARY WAY,
HEMEL HEMPSTEAD HP2 7ST**

Please supply:

Quantity	Ref. No.	Price Code	Price	Total Price
----------	----------	------------	-------	-------------

Post & Packing £0.75

Total Enclosed £

Please send my PCBs to:

Name

Address

.....

.....

.....

.....

.....

.....

.....

.....

.....

.....

.....

.....

E.T.I. BOOK OFFER

Here's a **FIRST** you can't afford to miss. E.T.I. have managed to arrange a super pre-publication offer for it's reader
ELECTRONIC PROJECTS FOR GUITAR
R.A. Penfold

- ★ Make your own effects at a fraction of the cost ★
- ★ Assumes no previous knowledge of electronics ★
- ★ Complete instruction on assembly ★ Easy setting up-no test gear required ★

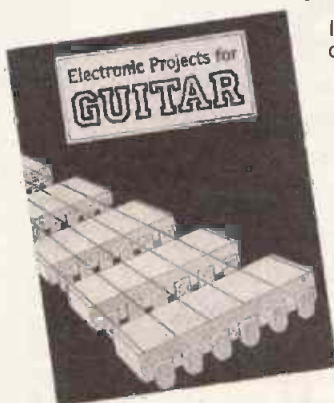

If you're a guitarist with more sense than money, you'll find this book a goldmine. It's a collection of 16 guitar and general purpose effects units that you can build yourself at a fraction of the shop price.

And even if you don't know one end of a soldering iron from the other, don't worry, many of the projects are suitable for anyone new to project building. And once you've built one, the rest will be plain sailing.

Each project has an introduction, an explanation of how it works, a circuit diagram, complete instructions on strip-board layout and assembly, as well as notes on setting up and using.

So if you need a guitar tuner or a preamp, a headphone amplifier or a distortion unit, a compressor or DI box, or any of the other units described in this book, this is the place to start.

Well-what are you waiting for?

Pre-publication price is just **£7.95** and we will pay postage and packing (publication price £8.85) **OFFER CLOSSES 18th SEPTEMBER 1992**

Please supply ROET/26 @ £7.95

I enclose my cheque/P.O. for £.....

payable to ASP or please debit my Access/Visa

<input type="checkbox"/>	<input type="checkbox"/>	<input type="checkbox"/>	<input type="checkbox"/>	<input type="checkbox"/>	<input type="checkbox"/>	<input type="checkbox"/>	<input type="checkbox"/>	<input type="checkbox"/>	<input type="checkbox"/>
--------------------------	--------------------------	--------------------------	--------------------------	--------------------------	--------------------------	--------------------------	--------------------------	--------------------------	--------------------------

Signature Expiry

Name

Address

..... Post Code

Coupon to: ETI Book Offer, ASP, Argus House, Boundary Way, Hemel Hempstead, Herts. HP2 7ST.

Please allow 28 days for delivery U.K. only (Overseas upon request)
 Please note the above information may be used for marketing purposes.

- Projects included**
- ★ Guitar preamplifier ★
 - ★ Headphone amplifier ★
 - ★ Soft distortion unit ★
 - ★ Compressor ★ Auto-waa ★
 - ★ Waa-waa pedal ★

- Projects included**
- ★ Expander ★ Treble booster ★
 - ★ Dynamic treble booster ★
 - ★ Dynamic tremolo ★ DI box ★
 - ★ Thin distortion unit ★
 - ★ Guitar tuner ★

Telephone orders 0442 66551 (24 HRS)

DON'T MISS OUT!

SUBSCRIBE!

Guarantee your home delivery of
ELECTRONICS TODAY INTERNATIONAL
 at no extra cost to you,
SUBSCRIBE NOW
 - make SURE of your post-free* copy.

Get inside every issue!

*U.K. only.

GET IT DELIVERED!

Please commence my subscription to *ELECTRONICS TODAY INTERNATIONAL* with the issue. (If renewal please quote subscription number).....

I enclose my cheque/MO for £..... made payable to ASP or please debit my Access/Visa

<input type="checkbox"/>	<input type="checkbox"/>	<input type="checkbox"/>	<input type="checkbox"/>	<input type="checkbox"/>	<input type="checkbox"/>	<input type="checkbox"/>	<input type="checkbox"/>
--------------------------	--------------------------	--------------------------	--------------------------	--------------------------	--------------------------	--------------------------	--------------------------

Card No. Expiry Date

Signature Name

Address

..... Post Code

SUBSCRIPTION RATES: UK £23.40, Europe £29.50, Sterling Overseas £31.00, US Dollars \$56

Please return coupon to: Argus Subscription Services, QUEENSWAY, REDHILL, SURREY RH11 0QS

Please note you may receive further information about offers and services which may be of particular interest to you.

**CREDIT CARD
HOTLINE
0737 768611**

DMO

PCB Foils

The PCB foil patterns presented here are intended as a guide only. They can be used as a template when using tape and transfer for the creation of a foil.

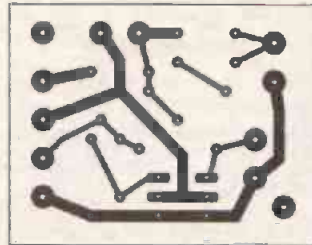

Alarm Protector

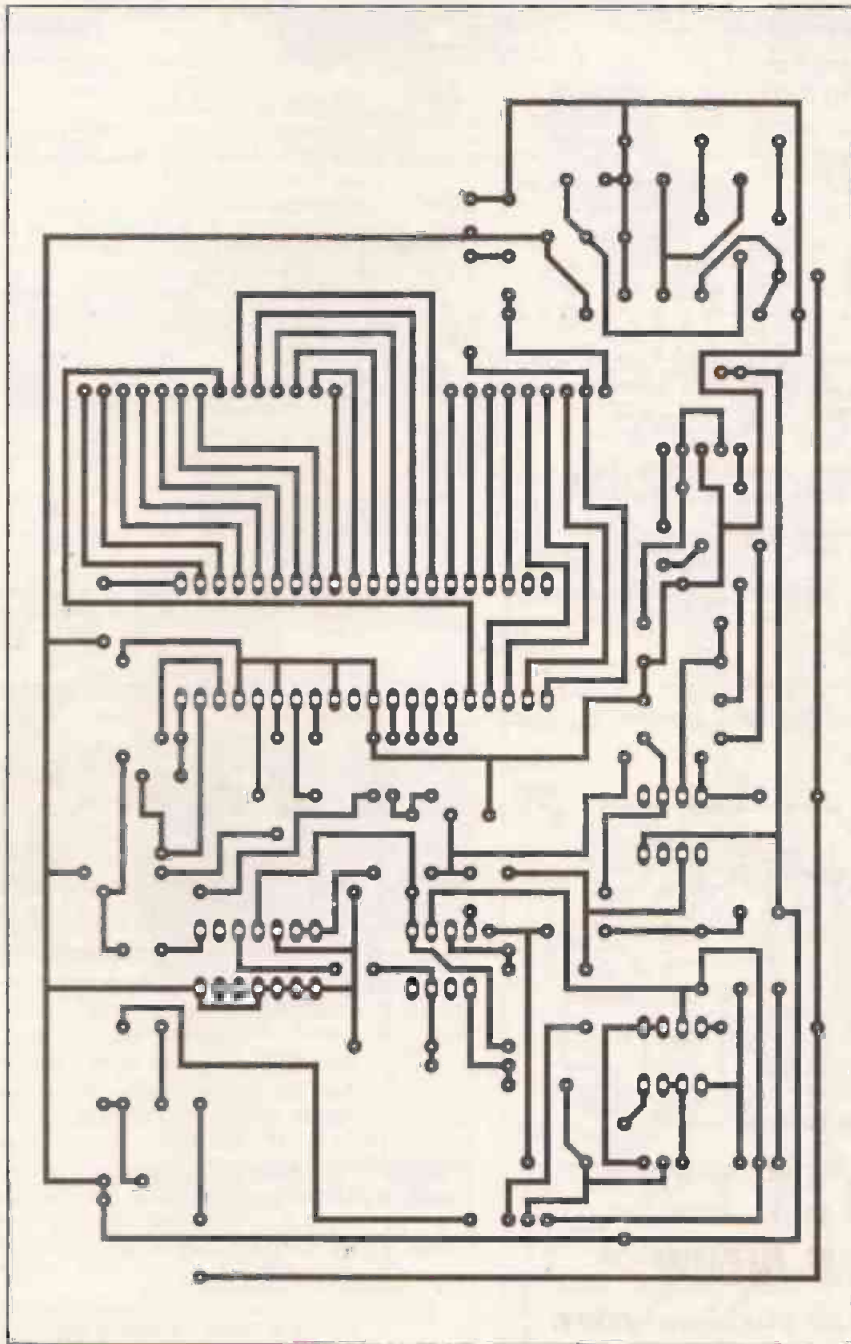

Temperature Controller

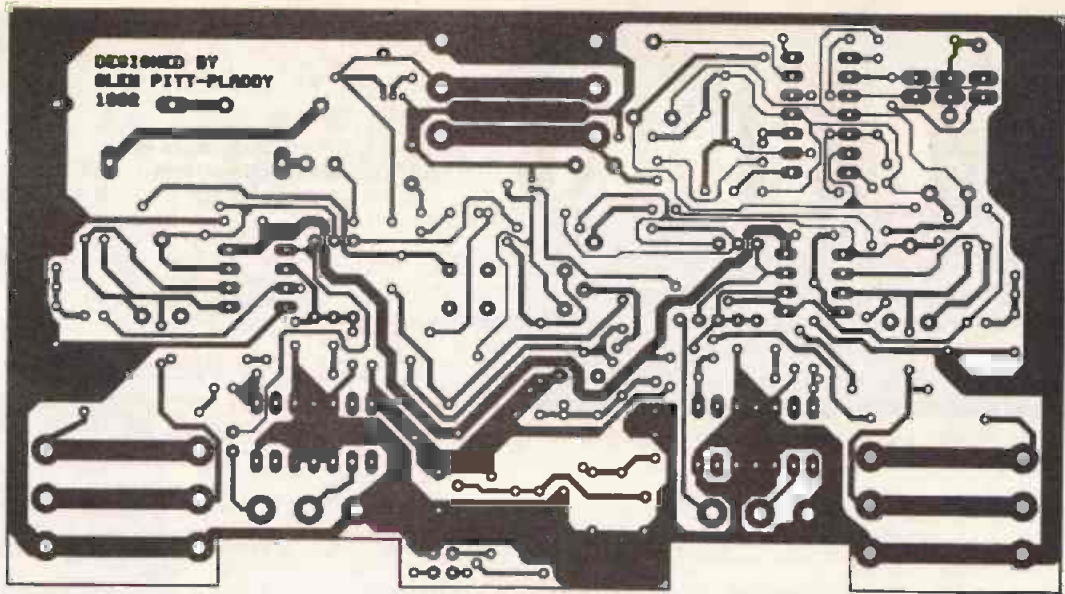

Intercom for Light Aircraft

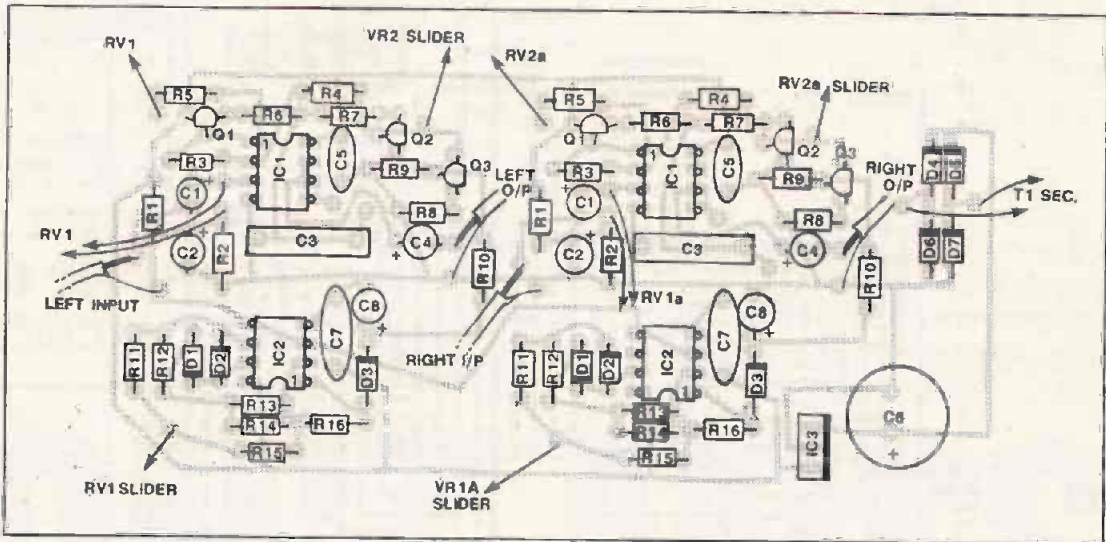

Dynamic Noise Limiter (See OOPS Below)

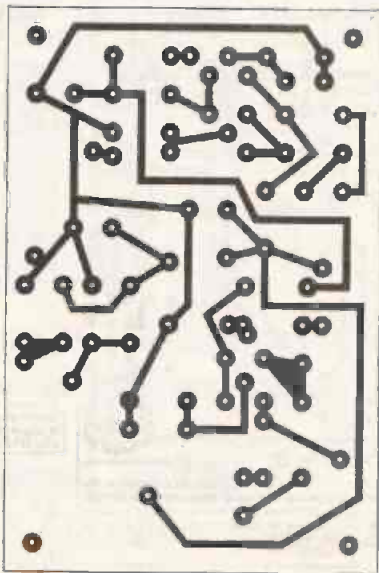

Hybrid Power Amp

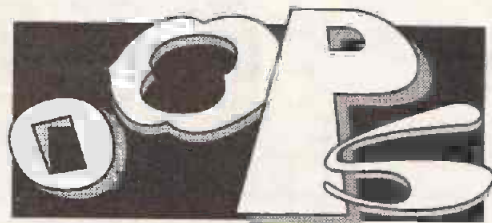

Smart Charger August '92

Mains transformer was not quoted in the parts list. This should be 18V output 50VA type. The Bridge rectifier is a 6A 50V type and the parts list should read Q1,2 BC212 Q3 BC182. C3,4 are 47 μ and Thyristor is CR1. Fig.6 the component overlay should have a wire link shown directly below R9. Fig.4 above D2 should also say: To pin 14 IC1. In How It Works 12 μ A flows through R1 not 12A!

Dynamic Noise Limiter August '92

Fig.4 R5,6,7 should be labelled 100R as in the Parts list. IC3,4 in the Parts list are for the other channel and IC5 should be a 7812 regulator. The component overlay in Fig.5 shows the foil displaced to the left by 8mm. We have reproduced the correct version above.

ETI

ELECTRONICS TODAY INTERNATIONAL



CLASSIFIED

0442 66551

Send your requirements to:
ETI Classified Department, ASP, Argus House,
Boundary Way, Hemel Hempstead, HP2 7ST.

Lineage: 60p per word (+VAT) (minimum 15 words)
Semi display: (minimum 2.5cms)
£15.00 per single column centimetre (+VAT) per
Electromart £24.00 per insertion (+VAT) insertion

Ring for information on series bookings/discounts.
All advertisements in this section must be prepaid.
Advertisements are accepted subject to the terms and conditions
printed on the advertisement rate card (available on request).

FOR SALE

Metal detector boards with data, has
tuner, mode, discriminate, headphone
jack, on/off/volume and push button
facilities. £7.95 ea
Dictaphone cassette, mech/record erase
playback heads, 6V solenoid, motor, hall
effect switch. £2.00 ea*
TV/Printer stabds. £2.95 ea
Bicc-Vero Easiwire
construction kit. £4.95 ea*
Cabinet Speakers fro NI-cam TV/Video
use. £14.95 pair
PCB with Lithium Battery, 2732, 34 IC's +
Transisto Fuse, Crystal
R's + C's. £4.95 ea*
TTL/CMOS short circuit snopper. £4.05*
Dot matrix LCD 10x2 lines. £3.75 ea*
Dot matrix LCD 16x1 lines
with Dots. £4.95*
40 character x 1 line dot matrix display
with data. £14.95 ea
2 digit 16 segment VF display
with data. £2.95 ea*
4 digit intelligent dot matrix display. £8.00*
17 segment VF display with driver
board and data. £2.99 ea*
8 digit liquid crystal display. £1.75 ea*
4 digit LCD with
7211 driver chip. £3.50 ea*
Digital clock display. £2.50*
11 key membrane keypad. £1.50 ea*
Keyboard 392mm x 180mm/100 keys
on board + LCD + 74HC05/
80C49 easily removable. £4.95
19" 3U sub rack enclosures. £8.95
12V stepped motor board with slotted
opto+2 mercury tilt switches. £3.95 ea*
1000 mixed 1/4 watt 1% resistors. £4.95 ea
250 electrolytic axial/radial caps. £4.95 ea
200 off mixed polyester caps. £7.95
100 Mixed trimmer caps popular
values. £4.95*
Cable box UHF modulator/video preamp/
transformers/R's + C's/leads. £6.95
1000 off mixed Multilayer Ceramic
Caps. £7.95
25 off Mixed crystal oscillators. £9.95*
Audio Cassette Cleaning +
De-magnetizing Kit. £1.50*
Car Burglar alarm vibration auto entry/
exit delay. £5.95 ea*
Single zone alarm panel auto entry/
exit delay housed in domestic light
socket. £9.95 ea

P.C. P.S.U. 50 watt 115-230V input-5V
4A+12V 2.5A output with built-in fan,
IEC inlet-on off. £9.95 ea
STC P.S.U. 240V input 5V 6A output
(converts to 12V 3A details
available). £5.95 ea
240V input 5V 10A output (converts to
12V 5A no details). £5.95 ea
600 line output transformers. £1.25 ea
240V in 0-28V 62VA out transformer. £2.75
Transformer+PCB gives 2-7.5V 32VA with
ski for 5 or 12V regulator, will power
floppy drive. £3.75 ea
Ultrasonic transducer (transmit+
receive). £1.50 pair
3 to 16V Piezoelectric sounders. £50p
9V DC electromechanical sounder. £50p
24V DC electromechanical sounder. £50p
2A 250V keyswitch 3 position key
removeable in two positions. £1.50*
DIL switches PCB MT 3/4/6 way. £35p
5V SPCO SIL reed relay. £40p
5V 2PCO DIL miniature relay. £60p
12V 2PCO or 4PCO continental relay. £60p
12V 10A PCB MT (to make contact)
relay. £95p
3 to 12V electro magnetic acoustic
transducer with data. £75p
2.4578/8.8329/21.10 MHz
crystals. £50p ea*
Bridges 25A 200V. £1.00*
2A 100V. £50p
31b Mixed components pack. £4.95
25 off mixed relays. £5.95
40 off mixed toggle switches. £9.95
50 off mixed switches, toggle, rocker,
micro, slide. £9.95
miniature axial chokes, 0.1, 0.18, 0.12, 0.33,
0.39, 0.15, 1, 3.30H 10p ea 100 for. £7.50
50 Mixed terminal blocks. £2.95
250 off 16/22/24/40 way IC Skits. £4.95*
Crystal Oscillators 10/24/48 MHz. £1.00 ea*
Spider Plug Leads. £75p
100 off Phono plugs (red/bk/grey). £3.50*
QUANTITY DISCOUNTS AVAILABLE - PLEASE RING
WE ALSO BUY ALL FORMS OF ELECTRONIC
COMPONENTS, P.S.U.'S, DISK DRIVES ETC; LISTS
TO BELOW ADDRESS

ALL PRICES INCLUDE V.A.T.
PLEASE ADD £2.00 p&p EXCEPT ITEMS MARKED*
WHICH ARE 50p SAE FOR BULK BUYING LIST
PAYMENT WITH ORDER TO:

Dept ETI, COMPELEC,
14 Constable Road, St Ives,
Huntingdon, Cambs PE17 6EQ
Tel/Fax: 0480.300819

DIGITAL RECORDER, records up to
20 secs, of speech, or music on one
I.C. devices can be cascaded for
longer duration. Also device can be
controlled by external logic P.C.
External switches so that several
messages can be stored on one I.C.
Ideal for home security systems, door
annunciator and general analogue
recorded information, device can be
re-recorded thousand of times even if
unit is switched off the information is
permanently retained in memory.
Send P/O Cheques for £39.95p for
complete kit of parts or £49.95p fully
assembled to A.B. Alarms Ltd 111
Macaulay Road, Luton Beds. LU4
0LP, Mail Order only.

MISCELLANEOUS

9 WATT Infrared laser diodes,
driver circuit plan included
£69.00 Laser pens, 1mw (red)
£149.00 Laser diode modules
(red) 2mw £99.00, 5mw £159.00.
A. McKeeve, 6 Grange Farm,
Kirkcaldy, Fife, KY2 5UH.

KITS

MICROTRANSMITTERS,
Telephone Bugs, Electronic
Defence, Alternative Technology
Plans, Kits, Locksmithing
information and tools. 4x1st class
stamps for catalogue. ACE (T1), 53
Woodland Way, Burntwood, Staffs.

WANTED

TURN YOUR SURPLUS
TRANSISTORS, ICs ETC INTO CASH
immediate settlement
We also welcome the opportunity
to quote for complete factory
clearance

Contact:
COLES-HARDING & CO.
103 South Brink
Wisbech, Cambs. PE14 0RJ
BUYERS OF SURPLUS INVENTORY
ESTABLISHED OVER 15 YEARS
Tel: 0945 584188
Fax: 0945 475216

PARTRIDGE REPORTER ELECTRONICS Model T26

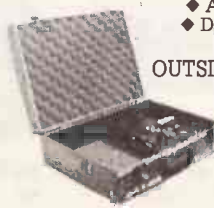

- ◆ Two Mic. Inputs + Line Input ◆
- ◆ Auto — Manual Control ◆
- ◆ D.T.M.F. or L.D./Dialing ◆

OUTSIDE BROADCAST UNIT

EASY TO CARRY

FLIGHT CASE

BROADCAST OVER

STANDARD PHONE NETWORK

UNIT D
318 HIGH ROAD
BENFLEET
ESSEX SS7 5HB
TELEPHONE: 0268 793381

TO ADVERTISE IN ETI TELEPHONE LUCY HUGHES ON 0442 66551

VARIABLE VOLTAGE TRANSFORMERS

INPUT 220/240V AC 50/60
OUTPUT 0-260V

	Price	P&P
0.5KVA 2.5 amp max	£29.00	£4.65
	(£39.54 inc VAT)	
1KVA 5 amp max	£37.40	£6.25
	(£51.29 inc VAT)	
2KVA 10 amp max	£54.00	£7.80
	(£72.62 inc VAT)	
3KVA 15 amp max	£71.50	£7.80
	(£93.18 inc VAT)	
5KVA 25 amp max	£126.50	
	(Plus Carriage)	

Buy direct from the Importers. Keenest prices in the country

**COMPREHENSIVE RANGE OF
TRANSFORMERS - I.T. ISOLATION & AUTO**
(110-240V Auto transfer either cased with American socket and
mains lead or open frame type. Available for immediate delivery

**ULTRA VIOLET BLACK LIGHT
FLUORESCENT TUBES**
4ft 40 watt £12.00 (callers only) (£14.10 inc VAT)
2ft 20 watt £7.44 + £1.25 p&p (£10.21 inc VAT)
13in 10 watt £5.80 + 75p p&p (£7.70 inc VAT)
12in 8 watt £4.90 + 75p p&p (£6.62 inc VAT)
9in 6 watt £3.96 + 50p p&p (£5.24 inc VAT)
6in 4 watt £3.96 + 50p p&p (£5.24 inc VAT)

230V AC BALLAST KIT
For either 6in, 9in or 12in tubes £5.50 + £1.15
p&p (£7.81 inc VAT)
For 13in tubes £6.00 + £1.35 p&p (£8.64 inc VAT)

400 WATT UV LAMP
Only £34.00 + £2.50 p&p (£42.89 inc VAT)
**175 WATT SELF BALLASTED BLACK
LIGHT MERCURY LAMP**
Available with BC or ES fitting. Price inc VAT
& p&p and VAT £20.86

12V D.C. BILGE PUMPS

Buy direct from the importers
500 GPH 15ft head 3 amp £16.36
1750 GPH 15ft head 9 amp £27.41
PRICES INCLUDE P&P & VAT

EPROM ERASURE KIT
Build your own EPROM ERASURE for a fraction of the
price of a made up unit kit of parts less case includes
12in 8 watt 2537 Argon Tube Ballast unit, pair of bi-pin
leads, neon indicator, on/off switch, safety microswitch and
circuit £14.00 + £2.00 p&p (£18.80 inc VAT)

SUPER HY-LIGHT STROBE KIT
Designed for Disco, Theatrical use etc.
Approx 16 joules Adjustable speed £50.00 + £3.00 p&p
(£52.26 inc VAT)
Case and reflector £24.00 + £3.00 p&p (£31.73 inc VAT)
SAE for further details including Hy-Light and
Industrial Strobe Kits



SERVICE TRADING CO

57 BRIDGMAN ROAD, CHISWICK, LONDON W4 5BB
081-995 1560

Showroom open
Monday/Friday

ACCOUNT CUSTOMERS MIN. ORDER £10



Ample
Parking Space

FOR SALE

OPTO ELECTRONICS COMPONENTS INCLUDING LASER DIODES, DRIVERS, AND OPTICS

Laser Diodes from 1mW to 1W C.W., and BOW pulsed.
SHARP 780nm 5mW I.R. Laser £7.75
Hitachi 670nm 5mW Visible Laser £29.00
Latest HITACHI gain guided Visible Laser, 670nm, 5mW £42.30

Laser Diode Pens with Collimator Optics to produce 3.5mm Dia. Light Beam
9620 + SHARP 780nm 5mW Laser Diode + Driver I.C. Versatile Collimator £44.65
6701G 670nm 1mW. HITACHI Laser Diode. Unit 25.5mm long by 11mm dia. £77.55
6704G 670nm HITACHI Laser Diode. Latest gain guided unit. £136.30
Range also includes 670-830nm types up to 40mW output. Use SK 511 Driver.

Advanced Collimator Systems for Scientific, Research and Experimental use
9620 + SHARP 780nm 5mW Laser Diode + Driver I.C. Versatile Collimator £149.00
9650 + SHARP 780nm 5mW Laser Diode + Driver I.C. High Quality beam £199.00
Both take extensive Accessory range to generate lines, ellipses, and spots.

Drivers and Power Supplies
For SHARP/TOSHIBA, Driver I.C. £5.88
Comprehensive Driver SK 9609 £115.00
For HITACHI/PHILIPS/NEC, SK 511 £19.00
Versatile A.C. unit SK 9710 £131.00

Optocouplers/Photocouplers, including singles, duals, and quads. Sensors.
Darlington, high voltage 300V, high CTR 1000%, 6 pin £1.33
Phototriac, 600V, 100mA, zero cross over circuit, 6 pin £0.98
Phototriac, 600V, 100mA, without zero cross, 6 pin £0.78
PIN Photodiode, detects Laser beam, high speed 1nS, 500nm to 1um £23.50

Safety glasses, 750-2200nm. High Quality £230.00 I.R. Sensorcard large £69.00

DM1's. Full range of low cost instruments.
MX200 3 1/2 Digit. 18 range Diode Test. Signal Injector. 10A DC £17.51
OM3310 True RMS. Freq. to 20KHz. Auto/Man .25mm LCD + Bargraph, 20A DC £70.50
OM3400 5 in 1 DMM Freq. to 4MHz. Cap. to 4UF R to 40Mohm. Temp. & Logic £66.98
MX07 Logic Probe. 20MHz/25nS. TTL/LSI/CMOS/PMOS. LED & Audio Ind. £11.16

**ACCESS PACIFIC LTD, KYMBROOK SCHOOL HOUSE,
KIMBOLTON ROAD, KEYSOE, BEDFORD MK44 2HH**
All prices include VAT and postage. Make cheques to Access Pacific Ltd

OPTO 22 Solid State Relays

Switch 240 V a.c. mains from low voltage circuits.

Out put switches 24-240 V a.c.
Input control is 3-32 V d.c. opto isolated
TTL compatible. Zero crossing switching for noise free electrical operation. No moving parts give trouble free long life operation.

Type Z240D10 (10Amp output) £7.34 ea

Chassis mount, size 48mm x 38mm x 14mm.
1/4" Tag Connectors.

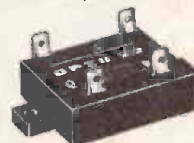

Type MP240D4 (4 Amp output) £5.33 ea

Single In Line for PCB mount, 43mm x 10mm x 24mm
Solder pins.



Also D.C. and high power versions available
(Prices include VAT and P & P. Cheque or Postal order allow 10 days delivery)

MODULATOR INPUT/OUTPUT INTERFACING

Input/Output modules and mounting racks for load switching and conditioning A.C./D.C. power/high level inputs to logic levels. Modules are chosen for Input/output, low/high voltage then plugged into a mounting rack. Small sample of range below, also serial and parallel multiplex systems for P.C.'s. Send for full details

G40AC5 ac output module £6.50
G40DC5 dc output module £6.50
G41AC5 ac input module £6.50
G41DC5 dc input module £6.50
G4PB4 4 point rack £24.44
G4PB8 8 point rack £36.48



MESSAGE CENTRES and DISPLAYS

Model 5003 - Stores 99 messages, 20 character display, parallel message select interface £335.00

Model 5209 - RS232 or RS422 serial ascii interface displays ascii information from electronic circuit or P.C. computer £470.00
S.A.E. for details on above products.

Gemini Electrosystems

Bridgegate Business Centre, Martinefield, Welwyn Garden City, Herts. AL7 1JG
Tel 070 726 5936 Fax 070 727 0877 Contact Eric Jones

COURSES

Start training now for the following courses. Send for our brochure — without obligation or Telephone us on 0626 779398

ETI/992

Name _____ **Telecomms Tech C&G 271**
_____ **Radio Amateur Licence C&G**
_____ **Micro-processor**
_____ **Introduction to Television**

**Radio & Telecommunications Correspondence School
12 Moor View Drive, Teignmouth, Devon TQ14 9UN**

STUDY ELECTRONICS ON THE BBC MICRO.

An interactive approach to learning. Four program titles available. 'Introduction to Electronics Principles', 'Electronics Mathematics', 'Digital Techniques' and now 'Programming for Electronics'. Programs include theory, examples, self test questions, formulae, charts and circuit diagrams. User inputs and calculated outputs. £29.95 each + £2.00 p&p. Cheque or Postal Order to E.P.T. educational software, Pump House Lockram Lane, Witham Essex CM8 2BJ Please state BBC 'B' or Master series and disc size.

ELECTRONIC COMPONENTS

RF & General Purpose electronic components for constructors projects.

Our mail order catalogue shows it. Send 75p for your copy now. £3.00 of discount vouchers supplied.

Or call us today for the parts you need, or ask about kits for your magazine project.

**J.A.B Electronic Components
Rear of Queslett Motors
1180 Aldridge Road
Great Barr, Birmingham
B44 8PE
Tel: 021-366 6928**



PLANS

ELECTRONIC PLANS, laser designs, solar and wind generators, high voltage teslas, surveillance devices, pyrotechnics and computer graphics tablet. 150 projects. For catalogue SAE to Plancentre Publications, Unit 7, Old Wharf Industrial Estate, Dymock Road, Ledbury, Herefordshire, HR8 2HS.

KITS

NEW VHF MICROTRANSMITTER KIT tuneable 80-135MHz, 500 metre range sensitive electret microphone, high quality PCB, **SPECIAL OFFER** complete kit **ONLY £5.95** assembled and ready to use £9.95 post free. Access/Visa orders telephone 021-411 1821. Cheques/POs to: Quantek Electronics Ltd, Kits Dept (ETI), 3 Houldrey Road, West Heath Birmingham B31 3HL. For details on this and other kits. Shop now open — callers welcome.

KITS AND COMPONENTS

MOSFET AMP KIT.

(MAFLIN CAT NO LP56L)
150 Watts into 4 ohm
£16.45 (+ 75p p&p per order)

PRINTECH

158 Wrenthorpe Lane, Wrenthorpe, Wakefield, W. Yorkshire WF2 0PF.
Tel 0924 3869500 after 6pm.

SPECIAL OFFERS

SPECIAL OFFER TO ETI READERS!

only £17.99 (inc P&P)
A must for all students and hobbyists learning how common electric components work

THE VIDEO

ELECTRONICS FOR THE HOBBYIST
(An excellent 90 minute video using computer-graphic simulations)

Send cheques/PO payable to:

ON-LINE VIDEO MARKETING (DEPT EV.3)
The Cottage, Tredown Farm, Bradstone, Milton Abbot, Tavistock, Devon PL19 0QT.

Other titles available SAE for list Allow 14 days for delivery

CATALOGUE £1.00 + 25p P&P

1.575 Ohm or 5mm red or green 8p each yellow 11p each
High intensity red, green or yellow 1mm 50p each
Cable tie to each £5.95 per 100G £48.50 per 10,000
Secondary meter 4 phase 12v 7.5 amp 50 ohms £8.95
SAW 127 stepping motor driver chip £3.95
741 Transistor kit good quality sound £8.60
High quality photo resist copper clad epoxy glass boards
Dimensions single sided double sided
36inches £1.97 £1.07
48inches £2.40 £1.66
6x12 inches £5.97 £2.66
12x12 inches £10.66

Special Offers
Computer grade capacitors with screw terminals 38000uf 20v £2.50
8700uf 10v £1.95, 68000uf 15v £2.35, 10000uf 15v £1.50
Segment common anode led display 12mm £0.45
MCS23A75 9 low drop out 5v regulator 1000 package £9.68
80525 P channel mosfet £3.45, 80526 transistor £3.95 per 100
741.555 met inverter £10.00 per 100, used 8746 Microcontroller £3.50
TV Mains switch 4A socket pole with momentary contacts for remote control pack of 10 £2.95 each or £3 £19.95
DC-DC converter frequency model V12P5 12v at 5v 200ma out 300v input to output regulator with data £4.95 each or pack of 10 £39.50
Hour counter used 7.5v 1 240v ac 50Hz £1.45
Resistor pack 2500 resistors 1/2 1/4 1/8 watt different resistors £9.95
CONVERTY keyboard with serial output no cable (serial) £5.00
Wide range of CMOS TTL, 7400 74F Linear Transistors kits rechargeable batteries components tools etc always in stock. Please add 95p towards P&P val included

JPG ELECTRONICS

276-278 Chatsworth Road Chesterfield S40 2BH

Access/Visa Orders (0246) 211202 callers welcome

**FAX YOUR ADVERT
0442 66998**

ETI

ELECTRONICS

TODAY INTERNATIONAL

EDITORIAL

Editor *Paul Freeman*

CREATIVE

Art Editor *Peter Kirby*

Designer *Iain Houston*

Technical Illustration *Tony Burlinson*

Photography *Manny Cefai*

ADVERTISEMENT SALES

Advertisement Manager

Mark Linacre

Advertisement Sales

Michele Donovan

Advertisement Copy Control

Marie Quilter

Key Accounts Manager

Donna Wells

MANAGEMENT

Managing Director

Terry Patisson

Circulation & Promotions Manager

Debra Stupple

Production Manager

Tony Dowdeswell

Group Editor

Stuart Cooke

Group Advertisement Manager

Claire Jenkinson

ISSN
0142-7229



Member of the
Audit Bureau
of Circulation

ETI is normally published on the first Friday in the month preceding the cover date. The contents of this publication including all articles, designs, plans, drawings and programs and all copyright and all other intellectual property rights therein belong to Argus Specialist Publications. All rights conferred by the Law of Copyright and other intellectual property rights and by virtue of international copyright conventions are specifically reserved to Argus Specialist Publications and any reproduction requires the prior written consent of the company ©1990 Argus Specialist Publications. All reasonable care is taken in the preparation of the magazine contents, but the publishers cannot be held legally responsible for errors. Where mistakes do occur, a correction will normally be published as soon as possible afterwards. All prices and data contained in advertisements are accepted by us in good faith as correct at the time of going to press. Neither the advertisers nor the publishers can be held responsible, however, for any variations affecting price or availability which may occur after the publication has closed for press.

●Subscription rates—UK £19.20 Europe £24.90 Sterling Overseas £26.80 US Dollars Overseas \$49.00

Published by Argus Specialist Publications, Argus House, Boundary Way, Hemel Hempstead HP2 7ST. Telephone (0442) 66551. UK newstrade distribution by SM Distribution Ltd, 6 Leigham Court Road, London SW16 2PG. Telephone 081-877 8111. Overseas and non-newstrade sales by Magazine Sales Department, Argus House, Boundary Way, Hemel Hempstead, HP2 7ST. Telephone (0442) 66551. Subscriptions by Argus Subscription Services, ETI, Queensway House, 2 Queensway, Redhill, Surrey RH1 1QS. US subscriptions by Wise Owl Worldwide Publications, 4314 West 238th Street, Torrance, CA90505 USA. Telephone (213) 3756258. Typesetting and origination by Ebony, Liskeard, Cornwall. Printed by Willshire Ltd, Bristol.



Argus House, Boundary Way,
Hemel Hempstead HP2 7ST
Telephone (0442) 66551 Fax (0442) 66998

Next Month

The October issue of ETI brings you a party surprise project - An electronic wizards hat. Why not be the centre of attraction at your next party with this sequentially illuminated display and 'top' the party physically and socially. The PCB comes with our compliments and with the magazine. For a more dazzling display, why not buy two magazines and PCBs.

We also have a treat for music and computer fans as well as a host of other uses - A universal interface board for an IBM PC. This project could stimulate many other ideas from readers, and would be published at later dates.

Other projects include a heartbeat monitor, an aerial tuner unit and a rapid fuse checker.

Go in to your newsagents and pick up a copy on September 4th.

The above articles are in preparation but circumstances may prevent publication

Last Month

Our August issue featured:

Touch Intercom
Smart Battery Charger
Adding MIDI to a keyboard
DIY Aerial system
Dynamic Noise Limiter
Solar Secrets
Digital TV Pt3

Back issues can be obtained from Argus Subscription Services. Address in column to left.

ADVERTISERS' INDEX

BK ELECTRONICS	IFC	LASERSCIENCE.....	23
CIRKIT HOLDINGS	24	MAPLIN ELECTRONICS	OBG
CITADEL PRODUCTS	IBC	NUMBER ONE SYSTEMS	11
CRICKLEWOOD ELECTRONICS	72	OMNI ELECTRONICS	24
DISPLAY ELECTRONICS	73	PICO TECHNOLOGY	25
ESR ELECTRONICS	19	REED ELECTRONICS	24
HALCYON ELECTRONICS	23	S.L.M. MODEL ENGINEERING	53
ICE TECHNOLOGY.....	59	SMARTHOUSE.....	39
J&N BULL	12	STEWARTS	53
JAY TEE ELECTRONICS.....	31	TOTAL CONTROL.....	39
JPG ELECTRONICS	53	WILMSLOW AUDIO	53

TOTAL PROGRAMMING SOLUTIONS FROM CITADEL

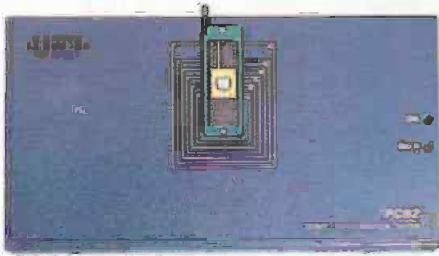

PC82 UNIVERSAL PROGRAMMER £449.00

- Universal programmer – the complete designers kit.
- Over 1,500 devices – call for list on FREE disk.
- EPROM, EEPROM, Flash, BPROM, GAL, PAL, MPU etc.
- Serial EEPROM, EPLD, MACH, MAX, MAPL, CMOS EPAL.
- Device testing – 74XX, 40XX, 45XX, DRAM, SRAM.
- PAL vector test.
- Clear menu driven software.
- Text mode only, suits any video card.
- 40 pin Zero insertion force socket.
- Device testing – 74XX, 40XX, 45XX, DRAM, SRAM.
- Small half card to install in PC may be left in place.
- Secure round cable and locking D connectors.
- Proven reliability – over 100,000 units sold.
- Programmer pod size – 260 x 140 x 35mm.



ADAPTERS FOR THE PC82 From £85.00

- Extend programming facility for special devices.
- Allows alternative socket types eg PLOC.
- Multi-gang adapters for fast programming of EPROMS, GAL, PAL and popular CPU types.

FEATURES ALL PROGRAMMERS

For the IBM PC, install the interface card and programming socket, load the menu-driven software and you have a complete design system at your fingertips. The programmers will run on any compatible IBM machines such as XT, AT, 386 or 486. Whether it be an Amstrad or Compaq the system will work. All features are software driven and supplied on 5 1/4" disks, these may be copied onto your hard disk using the DOS copy command. All control of the programmer, programme voltages etc are menu driven by selecting manufacture, type number, and selection of a suitable speed algorithm. Blank check, read & modify, verify, programme, auto programme, security blow etc.

FREE SOFTWARE UPDATES as new devices become available.

FILE CONVERSION FACILITIES

- HEX to BIN File conversions for Intel, Motorola and Tektronics.
- 2 way/4 way Bin file splitter for 16/32 bit data.
- Dump file to Console, modify and re-programme.



For further information and your FREE PC82 Simulation and device disk.

PHONE SAMANTHA
NOW ON:
081 951 1848
081 951 1849



M25 BULK FAST ERASER £199.00

- Same advanced UV source as the M1 but 4 lamps.
- Very large capacity 64x32 pin chips or one double Eurocard.
- All other features as M1.
- Low profile steel case finished in powder coat.
- Size 365x240x65mm high.

M1 FAST ERASER £99.00

- Advanced UV source.
- Typical erase time three minutes.
- LED display of set time and countdown.
- End of time indicated by beep and display.
- Large capacity 13x28 pin devices.
- Sturdy construction, plated steel & aluminium.
- Small footprint only 65x225x100mm high.



PC86 HANDY POCKET DEVICE TESTER £99.00



- Tests and identifies virtually all TTL & CMOS.
- Test many DRAM and SRAM memory chips.
- LCD display of type number and results.
- Battery operated (PP3) and completely self-contained.
- Zero insertion force test socket.
- Dimensions 90x140x30mm.



PC84-1 to -8 ROM PROGRAMMERS From £139.00

- Low cost EPROM programmer – devices up to 1Mb CMOS and NMOS.
- One to eight gang versions.
- To program 2716 to 271000.
- 32 pin Zero insertion force sockets.



ORDER INFORMATION

Please include £7 for carriage by overnight courier (£20 for exports) and VAT on all UK orders. ACCESS, VISA or CWO. Official orders welcome from Government bodies and local authorities.



CITADEL PRODUCTS LTD
DEPT ETI, 50 HIGH STREET,
EDGWARE,
MIDDLESEX HA8 7EP

BUYER'S GUIDE TO ELECTRONIC COMPONENTS 1993

Maplin



BS 5750
Part 2 1987
Level 8:
Quality Assurance
RS12750

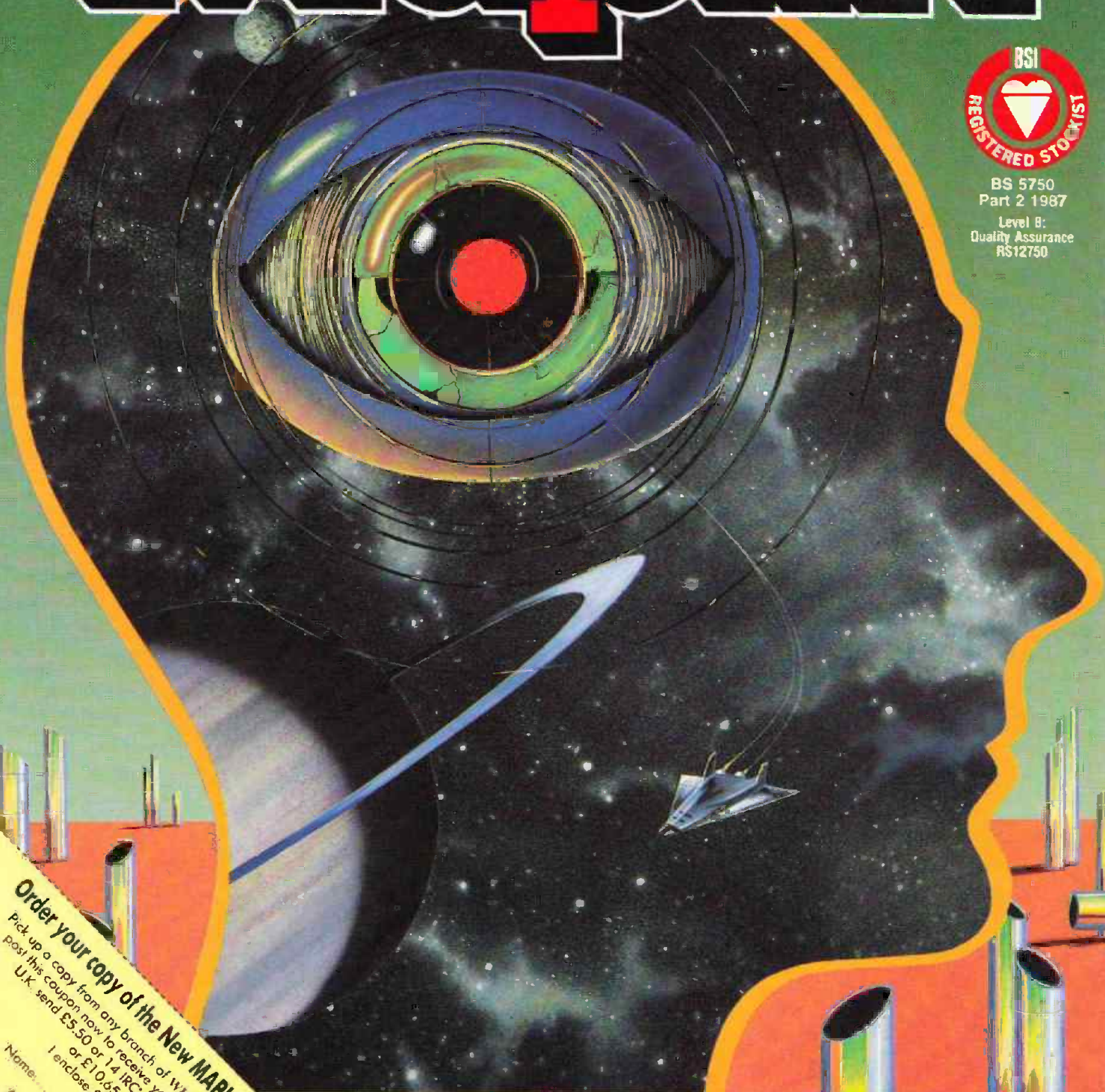

Order your copy of the New MAPLIN Catalogue on sale 4th September!
Pick up a copy from any branch of WHSMITH or from our chain of shops for just £2.95 or
post this coupon now to receive your copy for just £3.45 inc. p&p. If you live outside the
U.K. send £5.50 or 14 IRC's for Airmail in Europe/surface mail outside Europe.
or £10.65 or 27 IRC's for Airmail outside Europe.
I enclose £3.45/£5.50/£10.65 (delete as applicable).

Name:
Address:
Post Code:

Send to Maplin Electronics
P.O. Box 3, Royleigh,
Essex, England,
SS6 8LR
ET93

**Over 700 product packed pages with
hundreds of brand new products.
On sale from September 4th, only £2.95**

Available from all branches of WHSMITH and
Maplin shops nationwide. Hundreds of new
products at super low prices!