



THE ELECTRONICS, SCIENCE & TECHNOLOGY MONTHLY

OCTOBER 1990 £1.60

ELECTROSTATIC LOUDSPEAKER DESIGN

**A different approach
to hi-fi sound**

SOLAR POWER

Making better use
of the sun

HDTV

A new TV system
on the way



**GUITAR PICK-UP
R4X SURFACE MOUNT PROJECT**



OMP POWER AMPLIFIER MODULES-TURNABLES-DIMMERS-LOUDSPEAKERS-19 INCH STEREO RACK AMPLIFIERS

OMP POWER AMPLIFIER MODULES

Supplied ready built and tested.

OMP POWER AMPLIFIER MODULES Now enjoy a world-wide reputation for quality, reliability and performance at a realistic price. Four models available to suit the needs of the professional and hobby market, i.e. Industry, Leisure, Instrumental and Hi-Fi etc. When comparing prices, NOTE all models include Toroidal power supply, Integral heat sink, Glass fibre P.C.B., and Drive circuits to power compatible Vu meter. Open and short circuit proof.

THOUSANDS OF MODULES PURCHASED BY PROFESSIONAL USERS



OMP100 Mk 11 Bi-Polar Output power 110 watts R.M.S. into 4 ohms, Frequency Response 15Hz - 30KHz - 3dB, T.H.D. 0.01%, S.N.R. -118dB, Sens. for Max. output 500mV at 10K, Size 355 x 115x65mm, **PRICE £33.99 + £3.00 P&P.**

NEW SERIES II MOS-FET MODULES



OMP/MF 100 Mos-Fet Output power 110 watts R.M.S. into 4 ohms, Frequency Response 1Hz - 100KHz - 3dB, Damping Factor >300, Slew Rate 45V/uS, T.H.D. Typical 0.002%, Input Sensitivity 500mV, S.N.R. -125dB, Size 300 x 123 x 60mm. **PRICE £39.99 + £3.00 P&P.**



OMP/MF200 Mos-Fet Output power 200 watts R.M.S. into 4 ohms, Frequency Response 1Hz - 100KHz - 3dB, Damping Factor >300, Slew Rate 60V/uS, T.H.D. Typical 0.001%, Input Sensitivity 500mV, S.N.R. -130dB, Size 300 x 155 x 100mm. **PRICE £62.99 + £3.50 P&P.**



OMP/MF300 Mos-Fet Output power 300 watts R.M.S. into 4 ohms, Frequency Response 1Hz - 100KHz - 3dB, Damping Factor >300, Slew Rate 60V/uS, T.H.D. Typical 0.0008%, Input Sensitivity 500mV, S.N.R. -130dB, Size 330 x 175 x 100mm. **PRICE £79.99 + £4.50 P&P.**

NOTE— MOS-FET MODULES ARE AVAILABLE IN TWO VERSIONS: STANDARD — INPUT SENS. 500mV BAND WIDTH 100KHz, PEC (PROFESSIONAL EQUIPMENT COMPATIBLE) — INPUT SENS. 775mV, BAND WIDTH 50KHz, ORDER STANDARD OR PEC

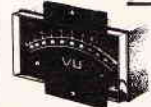

Vu METER Compatible with our four amplifiers detailed above. A very accurate visual display employing 11 L.E.D. diodes (7 green, 4 red) plus an additional on/off indicator. Sophisticated logic control circuits for very fast rise and decay times. Tough moulded plastic case, with tinted acrylic front. Size 84 x 27 x 45mm. **PRICE £8.50 + 50p P&P.**

LOUDSPEAKERS



LARGE SELECTION OF SPECIALIST LOUDSPEAKERS AVAILABLE, INCLUDING CABINET FITTINGS, SPEAKER GRILLES, CROSS-OVERS AND HIGH POWER, HIGH FREQUENCY BULLETS AND HORNS, LARGE S.A.E. (30p STAMPED) FOR COMPLETE LIST.

McKENZIE:— INSTRUMENTS, P.A., DISCO, ETC.

- ALL MCKENZIE UNITS 8 OHMS IMPEDANCE**
- 8" 100 WATT C8100GPM GEN. PURPOSE, LEAD GUITAR, EXCELLENT MID, DISCO. RES, FREQ. 80Hz, FREQ. RESP. TO 14KHz, SENS. 99dB. **PRICE £29.30 + £2.00 P&P**
 - 10" 100 WATT C10100GPP GUITAR, VOICE, ORGAN, KEYBOARD, DISCO, EXCELLENT MID. RES, FREQ. 70Hz, FREQ. RESP. TO 6KHz, SENS. 100dB. **PRICE £35.58 + £2.50 P&P**
 - 10" 200 WATT C10200GPP GUITAR, KEYBOARD, DISCO, EXCELLENT HIGH POWER MID. RES, FREQ. 45Hz, FREQ. RESP. TO 7KHz, SENS. 103dB. **PRICE £48.67 + £2.50 P&P**
 - 12" 100 WATT C12100GPP HIGH POWER GEN. PURPOSE, LEAD GUITAR, DISCO. RES, FREQ. 45Hz, FREQ. RESP. TO 7KHz, SENS. 98dB. **PRICE £37.59 + £3.50 P&P**
 - 12" 100 WATT C12100TC TWIN CONE, HIGH POWER WIDE RESPONSE, P.A., VOICE, DISCO. RES, FREQ. 45Hz, FREQ. RESP. TO 14KHz, SENS. 100dB. **PRICE £38.58 + £3.50 P&P**
 - 12" 200 WATT C12200B HIGH POWER BASS, KEYBOARDS, DISCO, P.A. RES, FREQ. 40Hz, FREQ. RESP. TO 7KHz, SENS. 100dB. **PRICE £65.79 + £3.50 P&P**
 - 12" 300 WATT C12300GP HIGH POWER BASS LEAD GUITAR, KEYBOARDS, DISCO, ETC. RES, FREQ. 45Hz, FREQ. RESP. TO 5KHz, SENS. 100dB. **PRICE £87.51 + £3.50 P&P**
 - 15" 100 WATT C15100BS BASS GUITAR, LOW FREQUENCY, P.A., DISCO. RES, FREQ. 40Hz, FREQ. RESP. TO 5KHz, SENS. 98dB. **PRICE £55.05 + £4.00 P&P**
 - 15" 200 WATT C15200BS VERY HIGH POWER BASS. RES, FREQ. 40Hz, FREQ. RESP. TO 4KHz, SENS. 98dB. **PRICE £75.10 + £4.00 P&P**
 - 15" 250 WATT C15200BS VERY HIGH POWER BASS. RES, FREQ. 40Hz, FREQ. RESP. TO 4KHz, SENS. 99dB. **PRICE £82.54 + £4.50 P&P**
 - 15" 400 WATT C15400BS VERY HIGH POWER, LOW FREQUENCY BASS. RES, FREQ. 40Hz, FREQ. RESP. TO 4KHz, SENS. 102dB. **PRICE £96.47 + £4.50 P&P**
 - 18" 400 WATT C18404BS EXTREMELY HIGH POWER, LOW FREQUENCY BASS. RES, FREQ. 27Hz, FREQ. RESP. TO 3KHz, SENS. 99dB. **PRICE £172.06 + £5.00 P&P**

EARBENDERS:— HI-FI, STUDIO, IN-CAR, ETC.

- ALL EARBENDER UNITS 8 OHMS (Except EB8-50 & EB10-50 which are dual impedance tapped @ 4 & 8 ohm)**
- BASS, SINGLE CONE, HIGH COMPLIANCE, ROLLED FOAM SURROUND**
- 8" 50 WATT EB8-50 DUAL IMPEDANCE, TAPPED 4/8 OHM BASS, HI-FI, IN-CAR. RES, FREQ. 40Hz, FREQ. RESP. TO 7KHz, SENS. 97dB. **PRICE £8.90 + £2.00 P&P**
 - 10" 50 WATT EB10-50 DUAL IMPEDANCE, TAPPED 4/8 OHM BASS, HI-FI, IN-CAR. RES, FREQ. 40Hz, FREQ. RESP. TO 5KHz, SENS. 99dB. **PRICE £12.00 + £2.50 P&P**
 - 10" 100 WATT EB10-100 BASS, HI-FI, STUDIO. RES, FREQ. 35Hz, FREQ. RESP. TO 3KHz, SENS. 96dB. **PRICE £27.76 + £3.50 P&P**
 - 12" 60 WATT EB12-60 BASS, HI-FI, STUDIO. RES, FREQ. 28Hz, FREQ. RESP. TO 3KHz, SENS. 92dB. **PRICE £21.00 + £3.00 P&P**
 - 12" 100 WATT EB12-100 BASS, STUDIO, HI-FI, EXCELLENT DISCO. RES, FREQ. 26Hz, FREQ. RESP. TO 3KHz, SENS. 93dB. **PRICE £38.75 + £3.50 P&P**
- FULL RANGE TWIN CONE, HIGH COMPLIANCE, ROLLED SURROUND**
- 5 1/2" 60 WATT EB5-60TC (TWIN CONE) HI-FI, MULTI-ARRAY DISCO ETC. RES, FREQ. 63Hz, FREQ. RESP. TO 20KHz, SENS. 92dB. **PRICE £9.99 + £1.50 P&P**
 - 6 1/2" 60 WATT EB6-60TC (TWIN CONE) HI-FI, MULTI-ARRAY DISCO ETC. RES, FREQ. 38Hz, FREQ. RESP. TO 20KHz, SENS. 94dB. **PRICE £10.99 + £1.50 P&P**
 - 8" 60 WATT EB8-60TC (TWIN CONE) HI-FI, MULTI-ARRAY DISCO ETC. RES, FREQ. 40Hz, FREQ. RESP. TO 18KHz, SENS. 99dB. **PRICE £12.99 + £1.50 P&P**
 - 10" 60 WATT EB10-60TC (TWIN CONE) HI-FI, MULTI-ARRAY DISCO ETC. RES, FREQ. 35Hz, FREQ. RESP. TO 12KHz, SENS. 86dB. **PRICE £16.49 + £2.00 P&P**

TRANSMITTER HOBBY KITS

PROVEN TRANSMITTER DESIGNS INCLUDING GLASS FIBRE PRINTED CIRCUIT BOARD AND HIGH QUALITY COMPONENTS COMPLETE WITH CIRCUIT AND INSTRUCTIONS

- 3W FM TRANSMITTER** 80-108MHz, VARICAP CONTROLLED PROFESSIONAL PERFORMANCE, RANGE UP TO 3 MILES, SIZE 38 x 123mm, SUPPLY 12V @ 0.5AMP, **PRICE £14.49 + £1.00 P&P**
- FM MICRO TRANSMITTER (BLU)** 100-108MHz VARICAP TUNED COMPLETE WITH VERY SENS FET MIC, RANGE 100-300m, SIZE 56 x 46mm, SUPPLY 9V BATT, **PRICE £8.82 + £1.00 P&P**

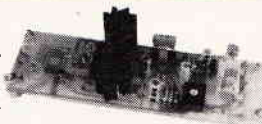

3 watt FM Transmitter

* PRICES INCLUDE V.A.T. * PROMPT DELIVERIES * FRIENDLY SERVICE * LARGE S.A.E., 30p STAMPED FOR CURRENT LIST.

OMP VARISPEED TURNTABLE CHASSIS

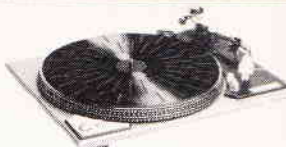

* MANUAL ARM * STEEL CHASSIS * ELECTRONIC SPEED CONTROL 33 & 45 * VARI POSITION CONTROL * HIGH TORQUE SERVO DRIVEN DC MOTOR * TRANSISTOR STABILIZER * CAST PLATTER * NEON STROBE * CALIBRATED BAL. WEIGHT * REMOVABLE HEAD SHELL * 1/4 CARTRIDGE FIXINGS * CUE LEVER * POWER 220/240V 50/60Hz * 390 x 305mm * SUPPLIED WITH MOUNTING CUT-OUT TEMPLATE. **PRICE £59.99 + £3.50 P&P.**

OPTIONAL MAGNETIC CARTRIDGES

STANTON AL500 **GOLDRING G850**
PRICE £16.99 + 50p P&P **PRICE £6.99 + 50p P&P**

OMP MOS-FET POWER AMPLIFIERS, HIGH POWER, TWO CHANNEL 19 INCH RACK

THOUSANDS PURCHASED BY PROFESSIONAL USERS



NEW MXF SERIES OF POWER AMPLIFIERS

THREE MODELS:— **MXF200 (100w + 100w)**
MXF400 (200w + 200w) **MXF600 (300w + 300w)**

All power ratings R.M.S. into 4 ohms.

FEATURES: * Independent power supplies with two Toroidal Transformers * Twin L.E.D. Vu meters * Rotary indexed level controls * Illuminated on/off switch * XLR connectors * Standard 19 inch rack * Open and short circuit proof * Latest Mos-Fets for stress free power delivery into virtually any load * High voltage rate * Very low distortion * Aluminium cases * MXF600 Fan Cooled with D.C. Loudspeaker and Thermal Protection.

USED THE WORLD OVER IN CLUBS, PUBS, CINEMAS, DISCOS ETC.

SIZES:— MXF 200 W19 x H3 1/2" (2U) x D11"
 MXF 400 W19 x H5 1/4" (3U) x D12"
 MXF 600 W19 x H5 1/4" (3U) x D13"

PRICES: MXF200 £171.35
MXF400 £228.85
MXF600 £322.00

SECURICOR DELIVERY £12.00 EACH



OMP LINNET LOUDSPEAKERS

THE VERY BEST IN QUALITY AND VALUE



MADE ESPECIALLY TO SUIT TODAY'S NEED FOR COMPACTNESS WITH HIGH OUTPUT SOUND LEVELS. FINISHED IN HARDWEARING BLACK VINYL WITH PROTECTIVE COPPER GRILLE AND CARRYING HANDLE INCORPORATES 12" DRIVER PLUS HIGH FREQ. HORN FOR FULL FREQ. RANGE. 45Hz-20KHz 80% MODELS 8 OHM. SIZE 11 1/2" x 11 1/2" x D12".

CHOICE OF TWO MODELS

POWER RATINGS QUOTED IN WATTS RMS FOR EACH CABINET

OMP 12-100 (100W 100dB) PRICE £159.99 PER PAIR
OMP 12-200 (200W 102dB) PRICE £209.99 PER PAIR

SECURICOR DEL.— £12.00 PER PAIR

IN-CAR STEREO BOOSTER AMPLIFIER



TWO SUPERB HIGH POWER CAR STEREO BOOSTER AMPLIFIERS

- DESIGNED TO FIT INTO 4 OHMS 300 WATT (150-150) INTO 4 OHMS 300 WATT
- HIGH LOW INPUT IMPEDANCES
- HIGH LOW INPUT SENSITIVITIES
- REMOVABLE 100 WATT GAIN CONTROL
- SHORT CIRCUIT OUTPUT PROTECTION
- POWER REQUIREMENT 12V D.C. SUPPLY 150 WATT 542.90
- SEE WATT 542.90 + £3.00 P&P EACH

PIEZO ELECTRIC TWEETERS—MOTOROLA

PIEZO ELECTRIC TWEETERS—MOTOROLA Join the Piezo revolution. The low dynamic mass (no voice coil) of a Piezo tweeter produces an improved transient response with a lower distortion level than ordinary dynamic tweeters. As a crossover is not required these units can be added to existing speaker systems of up to 100 watts (more if 2 out in series). **FREE EXPLANATORY LEAFLETS SUPPLIED WITH EACH TWEETER.**

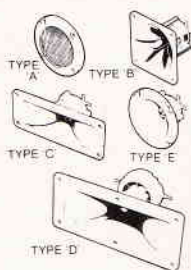

TYPE 'A' (KSN2036A) 3" round with protective wire mesh, ideal for bookshelf and medium sized Hi-Fi speakers. Price £4.90 each + 50p P&P

TYPE 'B' (KSN1005A) 3 1/2" super horn. For general purpose speakers, disco and P.A. systems etc. Price £5.99 each + 50p P&P

TYPE 'C' (KSN6016A) 2 1/2" x 5" wide dispersion horn. For quality Hi-Fi systems and quality disco etc. Price £8.99 each + 50p P&P

TYPE 'D' (KSN1025A) 2 1/2" x 5" wide dispersion horn. Upper frequency response retained extending down to mid range (2KHz). Suitable for high quality Hi-Fi systems and quality discos. Price £8.99 each + 50p P&P

TYPE 'E' (KSN1038A) 3 1/2" horn tweeter with attractive silver finish trim. Suitable for Hi-Fi monitor systems etc. Price £5.99 each + 50p P&P

LEVEL CONTROL Combines on a recessed mounting plate, level control and cabinet input jack socket. 85 x 85mm. Price £3.99 + 50p P&P

STEREO DISCO MIXER

STEREO DISCO MIXER with 2 x 5 band L & R graphic equalisers and twin 10 segment L.E.D. Vu Meters. Many outstanding features 5 inputs with individual faders providing a useful combination of the following:—
 3 Turntables (Mag), 3 Mics, 4 Line including CD plus Mic with talk over switch Headphone Monitor, Pan Pot L. & R, Master Output controls. Output 775mV. Size 360 x 280 x 90mm. Supply 220-240V.
Price £134.99 — £4.00 P&P

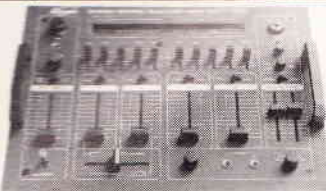

B. K. ELECTRONICS Dept EE
 UNIT 5, COMET WAY, SOUTHEND-ON-SEA, ESSEX, SS2 6TR
 TEL: 0702-527572 FAX: 0702-420243



POSTAL CHARGES PER ORDER £1.00 MINIMUM. OFFICIAL ORDERS WELCOME FROM SCHOOLS, COLLEGES, GOVT. BODIES, ETC. PRICES INCLUSIVE OF V.A.T. SALES COUNTER, VISA ACCESS ACCEPTED BY POST, PHONE OR FAX.



NOW IS THE TIME

TO CATCH UP ON ISSUES YOU HAVE MISSED



NOVEMBER 1989
£1.50
Neural Networking Explained



DECEMBER 1989
£1.50
Build a Surveillance Bug



JANUARY 1990
£1.50
Motorcycle Intercom Project

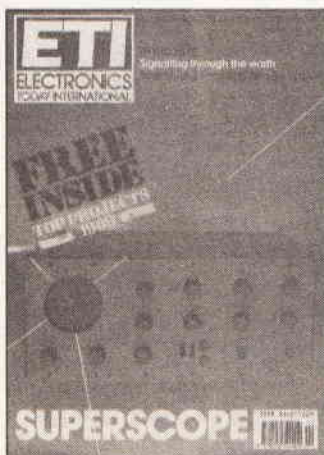

FEBRUARY 1990
£1.50
Superscope - Part 1

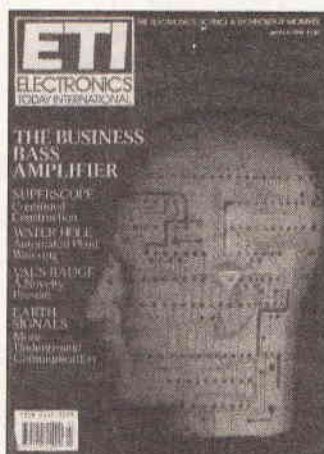

MARCH 1990
£1.50
SOLD OUT



APRIL 1990
£1.50
SOLD OUT

Back numbers cost cover price plus 60p postage and packaging and are available from E.T.I. Back Numbers, Select Subscriptions, 5 River Park Estate, Berkhamsted, Herts HP4 1HL. Cheques should be made payable to Argus Specialist Publications. As some issues are in very short supply you should check availability on 0442 876661 so as to avoid disappointment. May, June, July, August and September issues are available but not shown. March and April 1990 are now **SOLD OUT**.

October
1990

VOLUME 19 No 10

Paul Freeman: Editor
Mark Webb: Group Editor
Ian Houston: Design
Jerry Fowler: Technical Illustration

Cass Gilroy: Ad Manager
Ben Adewole: Executive Sales
Mannie Cefai: Photography

REGULARS

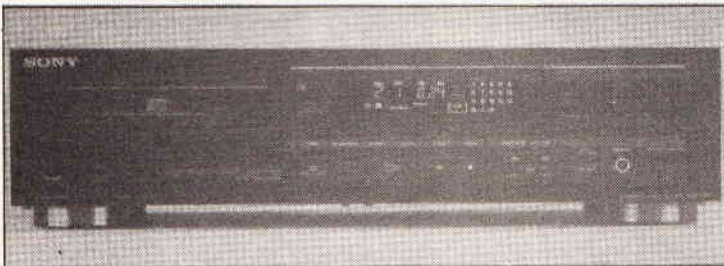

Page 48



Page 33

ISSN
0142-7229



Member of the
Audit Bureau
of Circulation

ETI is normally published on the first Friday in the month preceding the cover date. The contents of this publication including all articles, designs, plans, drawings and programs and all copyright and other intellectual property rights therein belong to Argus Specialist Publications. All rights conferred by the Law of Copyright and other intellectual property rights and by virtue of international copyright conventions are specifically reserved to Argus Specialist Publications and any reproduction requires the prior written consent of the Company © 1990 Argus Specialist Publications. All reasonable care is taken in the preparation of the magazine contents, but the publishers cannot be held legally responsible for errors. Where mistakes do occur, a correction will normally be published as soon as possible afterwards. All prices and data contained in advertisements are accepted by us in good faith as correct at the time of going to press. Neither the advertisers nor the publishers can be held responsible, however, for any variations affecting price or availability which may occur after the publication has closed for press.

● Subscription rates — UK: £19.20, Europe: £24.10, Middle East: £24.40, Far East: £26.80, Rest: £25.85 or US\$45.00.



Argus House, Boundary Way,
Hemel Hempstead HP2 7ST
Tel: (0442) 66551 Fax: (0442) 66998

Subscriptions
Back Issues

3

Read/Write

6

Open Channel

8

News

9

News from the
States

13

News from
Cardigan Island

14

ASP Reader
Offer

16

Subscriptions

16

Blueprint

17

PCB Service

43

PCB Foil
Patterns

62

Classified Ads

64

Courses

65

ASP Reader
Service

66

Ad Index

66

Next Month

66

Last Month

66

FEATURES/PROJECTS

Component Tester

A valuable piece of test equipment for any experimenter. Mark Daniels tells of how its put together.

18

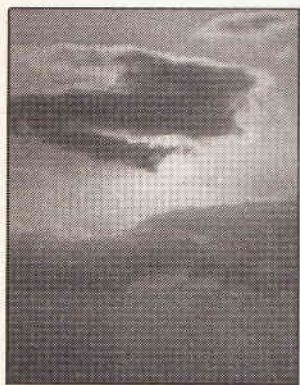

Solar Power

Solar energy can play an important role in reducing our energy bills. Paul Freeman assesses the current situation regarding the passive and active sides to the technology.

21

High Definition Television

In the start of a major new series, Jim Archer assesses the future of our viewing habits and asks if we are ready for a higher technical quality of television.

26

Microwaves

Colin White continues his look at the technological applications of electromagnetic waves in the SHF region.

33

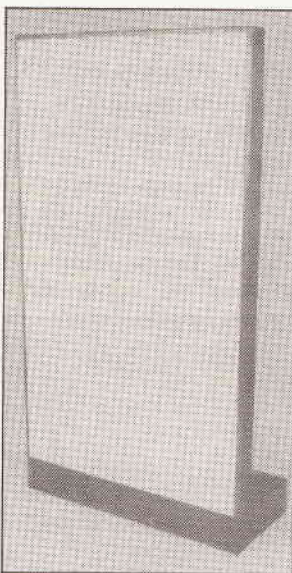

Serial or Parallel Loudspeakers

Ronald Wagner presents the theory and practical details of Electrostatic loudspeaker design.

37

Guitar Pick-up

Keith Brindley constructs this piezo-electric pick-up for your acoustic guitar.

45

The Sony High Density Linear Converter

Bitstream is the latest buzzword in hi-fi technology. Eric Kingdon reports on the latest chip from Sony that interprets serial digital audio at high speed.

48

Data Communications 2

Mike Bedford continues to give us a fascinating insight into how computers talk to each other.

54

R4X

Build this miniature Tuned Radio Receiver and impress your friends with this first Surface Mount technology project. Bill Mooney turns his hand to articulate soldering.

58

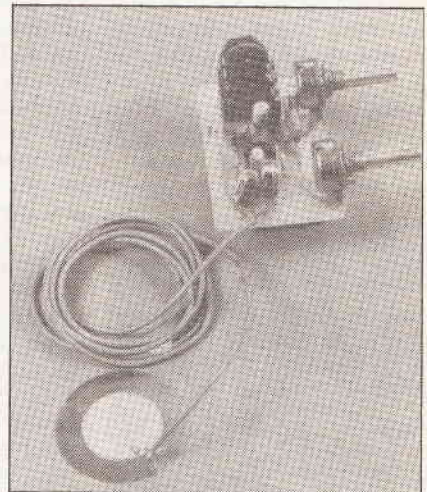
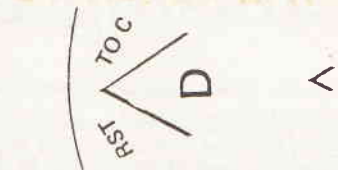

Page 45

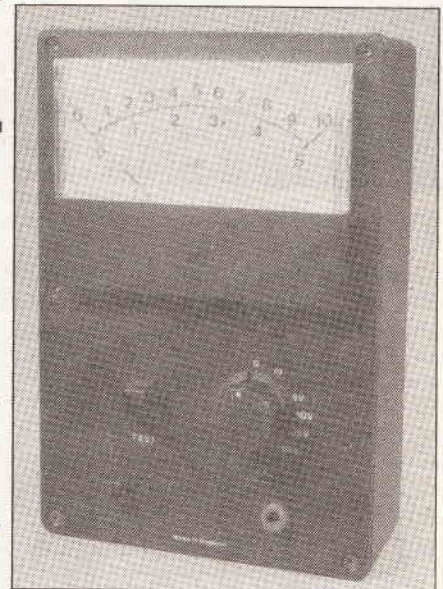

Page 18

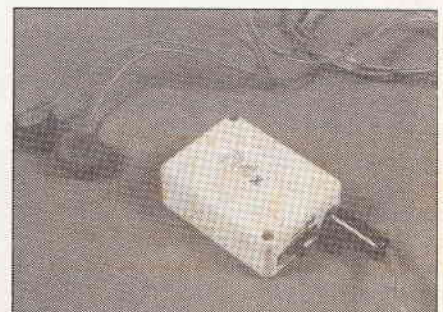

Page 58

'Promising Trials on Cardigan Island'

The story so far: Manx Shearwater birds have not been seen on Cardigan Island for some time. To rectify the situation Dyfed Wildlife Trust have devised a plan to lure them back. A tape recording of Shearwaters calling can now be heard periodically from loud-speakers on the island. ETI, amongst many other businesses have contributed to the project. Rod Penrose takes up the story:



The Amplifier was eagerly received from ETI, courtesy of Andrew Armstrong/Blueprint Column. It was uncased as expected, and quite obviously needed protection from the severe maritime environment and extremes of temperatures causing condensation. West Hyde Developments Ltd on hearing of our project, donated a die-cast aluminium enclosure. This enclosure is hose-proof to environmental protection standard IP65 and is extremely rugged, offering good mechanical strength and electrical screening. The ETI amplifier was mounted onto an aluminium chassis plate and fixed into the case by the 6mm screw fixings provided in the base.

Good quality weatherproof connectors were now needed. A quick scan through various electrical catalogues revealed, to my mind that the Bulgin Buccaneer series, for wet or hostile environments, was the most appropriate.

We asked AF Bulgin and Company PLC for their advice, they were extremely helpful supplying free of charge all the connectors we needed including those for mating to the recorder. With the transit caps fitted to the connectors I felt confident that the finished cased amplifier could survive the extremes, even being dropped overboard!

The timer for the equipment was designed using the excellent Easy PC CAD system which was also donated to the project by Number One System Ltd. After the air-lift in August the equipment remained on the island under-going trials until it was shut down for the winter. Luckily a second air-lift by the Rotary Wing Test Sqn. from A+AEE Boscombe Down was arranged to ferry sand bags over to hold the equipment down. This insurance paid off as the storms of the 1989-90 winter were incredibly severe. On the 25th of January a wind speed indicator on the mainland at nearby Aberporth weather station recorded gusts of up to 110mph until the power lines supplying it were brought down. The switch-on was planned for February but it wasn't until March that the sea swell had

subsided sufficiently for the launch of our borrowed dinghy.

Early morning on the 13th March we approached the equipment after a steep climb on the east side of the island. The equipment is in an extremely exposed position with no shelter and had obviously been subjected to very severe conditions. One speaker had suffered an impact with something, causing a hole through the side of the plastic horn. Salt water picked up by the winds had washed the grease from the adjustable legs of the cabinet leaving a red coating of rust. It had coated everything with sand, dirt and salt. We were amazed, when, after opening the cabinet and pressing the test button the equipment sprang into life with everything functioning correctly. The circuit breakers were reset and the equipment was now up and running in earnest.

The Manx-Shearwater has enforced nocturnal habits, it is an anti-predator, and to monitor the effects of our bird sound on passing Shearwaters, (Shearwaters can be seen passing to and fro close by on feeding runs from Skomer island), Ferranti defence systems loaned us a pair of

aviator's night viewing goggles that turn night into day. These goggles allow you to see to the horizon in total darkness. To enhance this device, STC defence systems have given us an infrared Laser Illuminator. This is invisible unless viewed through the night viewing goggles. Armed with these sophisticated devices we should be able to update and change the bird-call transmissions to the best advantage.

200 polymer concrete Puffins will shortly be joining the equipment on the island to try and lure this species back. Puffins and Manx-Shearwaters both require similar habits and are often found in close proximity. ACO of Shefford, world leaders in polymer concrete castings, have kindly offered to cast these free of charge, their normal products being road and airport runway drainage systems and complex machine castings. This polymer concrete is a durable and immensely strong engineering material. A similar project on Egg Rock off the coast of North America also used 3D decoys and proved to be successful resulting in the re-colonisation of the island by puffins.



Sunday 24th June, New Moon

Sunday 24th June was chosen as the night-time stop-over, there was extensive cloud cover making it very dark, just the way shearwaters like it. We positioned ourselves 20 feet (6m) down the steep grassy slope from the equipment, and scanned the sea with the night viewing goggles and laser. Owing to limited funds being available for this project, the Solar Voltaic system is not large enough for our full requirements, therefore a timer in the equipment turns the bird-call on and off every 3 minutes throughout the night to conserve power. After a period of perhaps twenty minutes a Shearwater was heard coming in fast and low following the cliff edge about 30 yds (28m) in front and below us. This was fantastic, we had expected to watch the reactions of birds several hundred yards out to sea. Had the transmissions already had an effect since March! The Shearwater cleared the island and stopped calling. The equipment started up but it was too late! The bird was now out of range and the sound was drowned by the strong winds and crashing sea. This was most frustrating as it happened some 5

times. At about 1 o'clock in the morning a Shearwater approached us. It called out, and coincidentally the equipment responded. What happened next was beyond our wildest dreams, the bird changed course and rapidly landed 7 ft. (2m) to our left, we turned stunned, while a second shearwater just missed the top of my head and landed 6ft. uphill from us. The grouping was impressive, obviously making for the source of the sound. This was repeated, confirming to us that the positioning of the equipment and the bird-call were correct. Although it's a long way from re-colonisation, the results witnessed were incredibly encouraging. The thought of this activity happening un-monitored on most evenings is most frustrating. If ETI is working on a marinised radio controlled 12 volt intensified video camera capable of transmitting a couple of miles please let us know!

Many many thanks to the following companies, who without their help this project would not be showing such promising results: — ACO Polymer Pro-

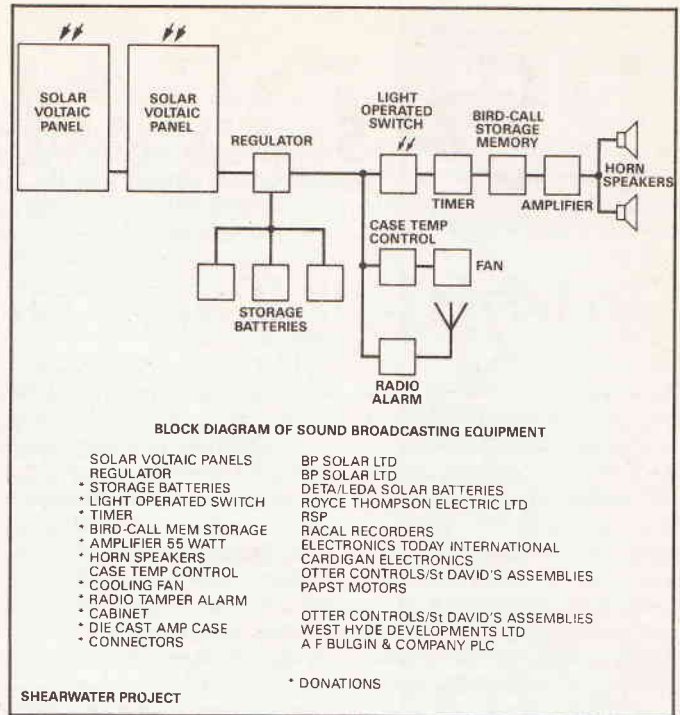

ducts, Andrew Armstrong, BP Solar, AF Bulgin + Company plc, John Lawrence of Cilgerran TV, Creft Cwmeri, Cresta Holdings, St David's Assemblies, Deta/Leda, Douglas Gill International, Draper Tools Ltd, Electronics Today International, Ferranti Defence Systems,

Graphic Facilities, Number 1 Systems Ltd, Otter Controls, Papst Fans, Racal Recorders, The RAF, Royce Thompson Electric, STC Defence Systems, Weir Electronics and West Hyde Developments.
Rod Penrose.
Dyfed Wildlife Trust

A HANDY NEW ADDITION TO OUR VERSATILE MULTIMETER RANGE

£38.⁹⁸ inc. VAT
please add £1.00 for p + p

DIGITAL CAPACITANCE METER

An extremely useful hand-held capacitance meter measuring from 1pF to 20,000µF in nine ranges.

Features include:

- 13mm, 3.5 digit LCD
- Zero adjustment
- Low battery indicator
- One year warranty
- Supplied with battery (PP3), manual and test leads
- Just one of our many low cost Digital Multimeters - send for full details

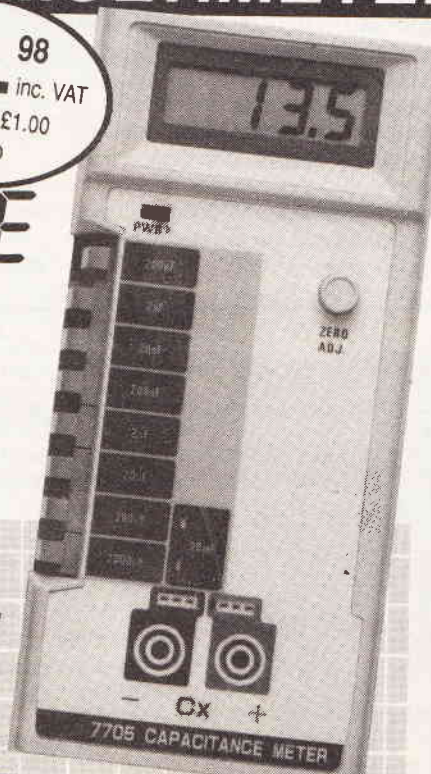

Specification

ranges	res.	accuracy
200pF	0.1pF	+ (0.5% + 1 digit + 0.5pF)
2nF	1.0pF	+ (0.5% + 1 digit)
20nF	10pF	+ (0.5% + 1 digit)
200nF	100pF	+ (0.5% + 1 digit)
2µF	1.0nF	+ (0.5% + 1 digit)
20µF	10nF	+ (0.5% + 1 digit)
200µF	100nF	+ (0.5% + 1 digit)
2000µF	1µF	± (1.0% + 1 digit)
20,000µF	10µF	+ (2.0% + 1 digit)

Overload protection	0.25A 250V fuse
Excitation voltage	3.2V, all ranges
Dimensions	180 x 85 x 38mm

OUT NOW!

- The new Cirkit Catalogue
- 184 pages
- Discount vouchers
- 1,000's of products

Cirkit

£1.60 inc.

SAME DAY DESPATCH - 0992 444111

Cirkit Distribution Ltd.

Park Lane, Broxbourne, Herts. EN10 7NQ

Tel. Enquiries (0992) 441306 Fax. (0992) 464457

OPEN CHANNEL

Seems like European plans to have our own form of high definition television systems have been boosted recently with the formation of a consortium to promote its benefits above those of rival systems. In a long and winding story comparable to TV soaps of epic proportions, European HDTV is never ending, and summarising the current situation is like rewriting and editing a Jeffrey Archer novel — over and over again.

In the beginning the Japanese created a word; and that was *Muse* — Multiple sub-Nyquist Sampling Encoding. Obvious really! — a sunrise adaptation of the Japanese existing television system to give a field frequency of 60Hz comprising pictures of 1125 lines and an aspect ratio of 16:9. Since then, *Muse* has become *hi-vision* and European manufacturers and broadcasters alike have argued against its acceptance over the continent. *Hi-vision* became a commercial reality and is now marketed in Japan and appears to be doing acceptably well.

H-vision, mind you is incompatible with all existing systems. In other words, no existing television is capable of receiving a hi-vision signal and displaying it as a picture; new and highly expensive televisions need to be bought!

Stateside of the Pacific, the hi-vision system looked set to be a standard, too. Manufacturers there seemed, dreamlike, to accept its consequence readily. Last year however, the eagle awoke and realised if it standardised on hi-vision, all its TV manufacturing base would be undermined by the new, incompatible system.

Here in Europe, thanks to the IBA mainly, an incompatible system has always been reviled. Yet, until recently, no comparable system had been shown to be viable. The *Eureka 95* project, was set up to develop a compatible system, which it has done.

Developing the accepted MAC (Multiplexed Analogue Component) television standard which is to be incorporated into direct broadcast satellite (DBS), *Eureka 95* now has a high definition system which is acceptable to all European manufacturers. HD-MAC comprises pictures of 1250 lines, with the required 16:9 aspect ratio and our European 50 Hz field ratio.

To promote the HD-MAC system, the consortium briefly mentioned before, made up of manufacturers Philips, Nokia, Thomson and Unitel along with broadcasters including BBC, BSB and Thames Television, has been set up to show European HDTV system is feasible. Known as *Vision 1250*, the consortium aims to demonstrate a European standard should be based on European research, development and production; not Japanese.

In a parallel, ITT has plans to develop a single integrated circuit to replace all chips currently inside its television circuits. Single-chip TVs can thus be expected, within a year, while CMOS low-power versions are expected shortly after. ITT multi-MAC decoding chips are to be used, coincidentally by Thomson in its new 16:9 screen ratio wide-screen television receivers.

The Rock Island Line?

A few years' ago British Telecom's monopoly on the national telephone system (excluding existence of Hull's private local telephone network) was challenged by Mercury. I've reported on how the Mercury network can be used to effectively reduce telephone charges — I have a Mercury phone which I estimate saves me a considerable amount each year. This year, though, the resultant *duopoly* between BT and Mercury looks set to be shattered by Government approval of other network operators. One of a likely set of candidates is British Rail, whose own communications system may be used as the basis of a private network; supplying public telecommunications needs. British Rail's existing communications link-up is in fact, the UK's largest existing private network.

But that's not all! British Aerospace wants to do the same and is currently lobbying the Government to break the BT/Mercury duopoly. Other, smaller organisations are putting on the pressure, too.

In November a review of national telecommunications policies is to be undertaken by the Department of Trade and Industry, and it is perfectly possible one of the conclusions will be to demand other network operators join BT and Mercury.



BLUE ROSE ELECTRONICS

SMD KITS: A growing range of PCB kits to get you into surface mount.

SMD Protoboard: To experiment with your SMD circuits.. £1.65

SMD Tweezers.. £2.62

Assembly Jig to hold SMDs in place whilst soldering.. £16.50

SURFACE MOUNT COMPONENTS

Surface Mount Technology makes circuit fabrication easier and quicker and is "the" construction technique of the '90's.

CW 2-pole filter, PCB & all comps.. £5.50

SAE FOR KIT LIST.

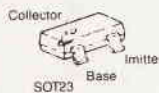

SUPER NEW SMD VERSION OF FAMOUS SUDDEN RECEIVER 80M & 40M VERSIONS AVAILABLE PRICE £22.95

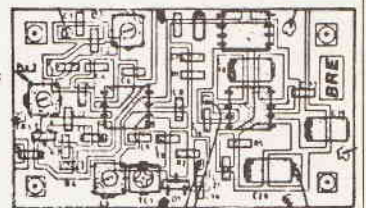

SMD Catalogue & Kit List. Send £1 to cover Postage etc.

Mail Order Address: 538 Liverpool Rd, Great Sankey, Warrington, Cheshire, WA5 3LU.
Telephone: 0925 72 7848 Evenings. (Callers by Appointment).



LASER DIODE MODULE

The new Imatronic LDM135 module from Lambda Photonics comprises a laser diode, collimating optics and drive electronics in a single compact housing measuring 16mm diameter by 49mm. Power (from 3 to 5.25V DC) is applied via two, colour-coded flying leads.

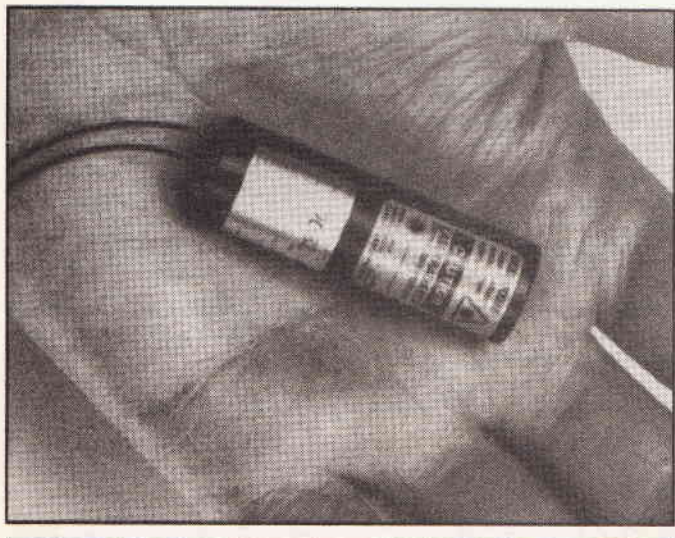

ALTERNATIVES TO REGULATED SOLVENTS

ICI is investing £100 million in an innovative research programme to find alternatives to products implicated in ozone depletion. Alternative products to replace these solvents will need to replicate the unique properties which make them such highly effective cleaning agents and the industry standard in the electronics, engineering and dry-cleaning businesses, as well as to meet exacting environmental and health standards.

ICI has a full portfolio of solvents products. 'Triklone', 'Perklone' and 'Methoklone' are not implicated in ozone depletion and can be substituted where appropriate.

ICI is also investigating the

potential of HCFC 123 in cleaning applications and the design of new cleaning plant with which to use them. Other HCFCs with promising characteristics include HCFC 225 and HCFC 1111.

There are four basic versions in the range offering powers of 0.5mW, 1mW, 2mW and 3mW at 660-685nm.

The circuitry includes output power stabilization by means of an internal monitor photodiode, and TTL logic level compatibility.

This compact unit is suitable for applications which would have used He:Ne lasers and may sometimes be better, as it is rugged and small.

All of these LDM135 modules have an MTBF of more than 10,000 hours when operated within their maximum ratings.

The 0.5mW and 1mW versions cost £195, one off the 2mW version costs £225, and the 3mW £2.90.

Contact Lambda Photonics. Telephone 0582 764334.

ICI's research has also identified a number of novel solvents whose performance could prove superior to the compounds of which we are already aware. Further research into these Chemicals and the development of aqueous based cleaning systems will be a high priority in the coming months.

For further information contact Dianne Nevin, ICI Chlor-Chemicals. Telephone: 0928 513065.

BRITAIN FOSTERS LOW-TECH CULTURE

A remarkable new study not only removes the mystery behind the low status of Britain's engineers, but identifies a low-tech 'overculture' as the main source of our economic ills. The report was sponsored by the Institution of Electrical Engineers and researched by three 'Engineering and society' students from Worcester Polytechnic Institute, Massachusetts.

The low status of UK technologists stems from their involvement in the extensive social and political changes of the last century, the report argues. Engineers helped to extend the franchise and have been viewed with suspicion ever since. Instead, we now have a low-tech 'overculture', a top echelon of administrators with no training in technology. Many of them are proud of this situation, which is unique to Britain. The top two civil service grades contain one engineer.

Britain has a quarter as many engineers in politics as France or Germany. According to the report, the overculture damages not just the engineering profession, but industry, education and the workings of Government. Particularly destructive is the failure to check hostile takeovers and the growth of short-termism in the City.

Coming ten years after Finiston, the report looks at the work of the Engineering Council. Although progress has been made, a brain drain after 1992 is still predicted.

Finally it advises engineers to speak out on the environment. Demanding tougher pollution laws would not only help Britain's image, but increase public respect for technologies and create more jobs. 'Industry must change its image from the monster who created the environmental problems to the hero who can help solve them', say the authors.

DIGITAL SPEECH RECORDER

The latest kit from Maplin is Digital Speech Record and Playback module which can store speech digitally and then can be played back at the push of a button. The kit is based around the UM5100 digital voice recorder and playback IC.

Digital recording has the advantage over tape recording in that there is no mechanical wear and tear. Applications include voice message pads, security systems and telecommunications. The board-mounted 32K SRAM memory will store between 5 and 20 seconds of speech

(depending on the sample rate).

The module can be further expanded with an EPROM programmer module, which will allow non-volatile storage of speech in EPROM. An additional playback-only module is available, which does not incorporate the record circuitry, and is intended for use with speech stored in EPROM.

A complete kit of parts is available at £35.95 Cat.No. LM80B.

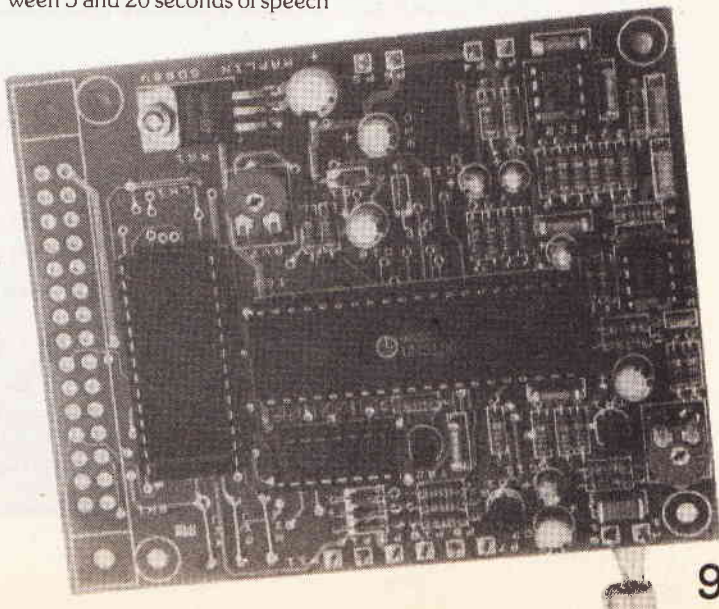

DESIGNING FOR MANUFACTURE

There are sharp contrasts between manufacturing industry in the Far East and its counterpart in the USA and Europe. The popular view is that while the Western world leads in designer creativity and design innovation, it is the Eastern hemisphere which reaps the profit and benefits in its manufacturing industry. Although the popular view may unfairly present the difference as a matter of black and white there are certainly elements of truth to it.

In efforts to correct this situation, American and European manufacturing industry has begun to look at the methodologies it employs for getting innovative new products to market quickly, profitably and with levels of quality to match or exceed those of the East. 'Design for Manufacture' (DFM) is the term coined to describe the corporate strategies which are beginning to be adopted and the methods being employed in the design departments to bring about these improvements.

The key point of a DFM strategy is that whereas manu-

facturing problems have classically been addressed by improving or re-tuning manufacturing processes, they are now better addressed by designing or re-designing products to take the capabilities and limitations of those processes into account at an earlier stage.

The benefits are clear. An example often cited is that of an automobile manufacturer who wished to reduce the manufactured cost of a particular model. Like many before him, he embarked upon a series of expensive studies of assembly processes which led to a major investment programme for new automated assembly tools. After spending millions of dollars, he got the manufactured costs down by 6 percent.

The next year he re-designed the car to use 42 percent fewer parts. Using the same manufacturing system, his manufactured costs fell by 30 percent. The cash spent in the design of the new car was far less than that spent the year before on production line equipment. This observation led consultant

Geoffrey Boothroyd of Boothroyd-Dewhurst Inc. to make the comment that: 'While design is a minor factor in the total cost of a product, the design process fixes between 70 percent and 95 percent of all costs'. In other words, by putting the emphasis on the design process rather than on manufacture, great benefits can accrue in terms of reduced product cost.

The DFM strategy contains elements which have implications for the way businesses are organised and budgeted. In particular, engineering department heads have to be prepared to accept a brief which may be wider than the one they have had in the past; they must be prepared to accept responsibility for the manufacturability and testability of their designs. The approach of having designers design, production engineers carry designs into manufacture and test engineers figure out how to test the designs is not sustainable. In this area the Japanese have shown the way for some time; a project team in Japan typically includes production and test engineers from its inception.

The decision to adopt a DFM strategy is likely to be made at a very senior level because of the organisational and budgetary

implications. Nevertheless, it is possible for an engineering manager to adopt elements of the DFM strategy unilaterally, provided he has the tools to support his decision.

Electronics manufacturing benefits far more than the automobile industry from a DFM strategy because of the relative ease with which component counts can be reduced by greater levels of integration, but this is clearly only a part of the story. A key issue in electronics is that the principal product cost benefits accrue from the ability of the engineer to innovate new technologies, new circuit techniques, new dense board and IC manufacturing methods and new test technologies, and to do this in an environment which provides the necessary security to ensure that products can be manufactured, tested and shipped with the minimum of delay.

Racal-Redac, a unit of Racal Electronics plc, has announced a software product suite, VISULA, which supports the product design cycle from architectural design entry, simulation and computer modelling, to test generation and manufacturing output.

TESTING INTERMITTENT FAULTS

A new board repair and diagnosis system capable of handling the engineer's nightmare — intermittent faults — has been introduced by ABI Electronics. Known as the BoardMaster 4000, the system uses loop testing to enable these elusive faults to be detected.

The BoardMaster is designed to test digital ICs in or out of circuit and can handle devices with up to 40 pins — including surface mount packages. In addition, the system's manufacturing defects analysis (MDA) capability allows rapid location of PCB production faults.

By attaching the test clip to the device under test, typing in the component number and initiating the test sequence, the operator is provided with detailed information about the device and the circuit conditions surrounding it.

If the device is unmarked, the BoardMaster's 'search mode' feature enables it to identify the part and give a functional equivalent for replacement.

The system includes a comprehensive library of test programs for standard devices, and this can be readily expanded as new devices appear.

In operation, the BoardMaster rapidly determines whether IC pins are connected to each other, to the supply or ground rails, or are undriven and electrically dis-

connected. It also provides quick identification of components which have been inserted incorrectly.

Test threshold levels can be adjusted to suit user requirements, and a 'save and compare' facility allows results from a known-good board to be saved to floppy disk via the integral drive unit for later comparison with a suspect board.

For more information, contact Andrew Myers on 0226 350145.

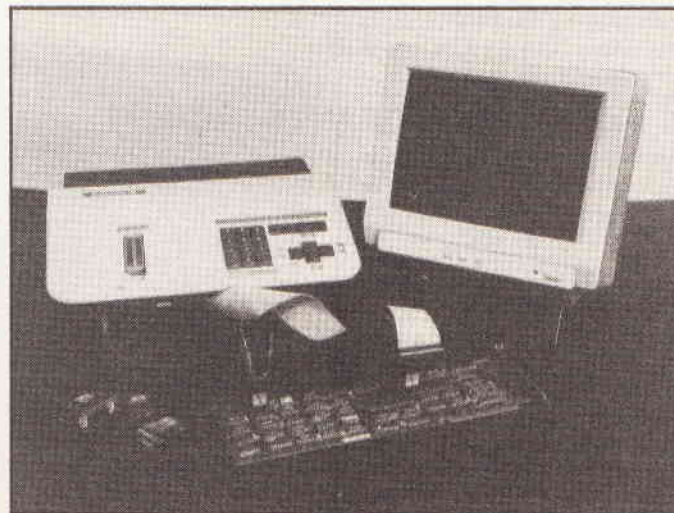

SOUND RECORDING COURSE

South Thames College, Wandsworth, London is running an evening course entitled 'Introduction to sound recording'. It is aimed at audio/video/electronics enthusiasts, and was so popular last year that they are intending to run several of them this year.

The course covers multi-tracking, using microphones, effects units, etc., as well as looking at digital audio and MIDI.

Courses will run once a week for ten sessions, commencing in September, on Monday, Tuesday, and Thursday evenings and Wednesday afternoons. The course fee for ten sessions is £50.

Those interested should contact Des Lyver or John Dodd on 081 870 2241, ext. 340 or 405, or 0732 354665.

HIGH TECH INFO FROM RAIN FOREST



GRiD Computer Systems is supplying equipment that is forming the backbone of a ten

week expedition in the rain forests of Venezuela. The Orinoco Information Technology Project is

exploring new methods of using information technology to distribute endangered knowledge.

The team consists of eight Cambridge undergraduates and a trained medical officer. They are using the GRiD laptop computers to record information on how tribal people use the forest around them and their customs. The information will then be made available to schools, colleges, environmental groups and individuals around the world via a Venezuelan relay centre.

GRiD field computers were chosen because they were the only product capable of offering the processing power required as well as the ruggedness to withstand the trip. They have taken three GRiD 1520 computers with magnesium alloy cases.

The team hopes to discover and record which plants are used as medicines and bring samples of these back to the UK for analysis.

The information will be collected and stored on the laptop computers in both structured and 'free text' formats. The 'free text' is essentially a transcript of the tribespeoples' descriptions of how the plants are used.

It is particularly important that western views do not distort the data, something filling in the blanks on forms automatically does.

This information will be trans-

mitted between the three field groups and the Venezuelan database using a 'packet radio' technique, developed by radio amateurs.

From Venezuela, information will be exchanged with the UK. This will allow experts to check the data and advise the field teams. This know-how is multiplied as organisations around the world will have access to the same database.

The expedition has received help from the Chatback Project, a charity for disabled children, which will put the GRiD computers and their information in direct contact with hundreds of schools all around the world.

The project is the first to visit this remote region making use of such sophisticated technology, as James Delap, expedition leader, explained: "If we achieve our aims, less than 20 minutes after we enter any data almost anyone around the world can access it. We will be making our experiences of the rain forests immediately accessible. It is important people and especially schools can share this information with us. It makes a while topic of our environment and what we are doing to help it off the television and into peoples' lives," he continues.

Further information, contact: Mike Daly, GRiD Computer Systems Ltd. Tel: 0372 60266.

LODESTONES TO LOAD CARRIERS

The Universities of Bath and Sussex are to be the co-presenters of the 1990/91 IEE Faraday Lecture. Entitled 'Lodestones to Load Carriers', the Lecture will visit 16 towns and cities in the UK.

The Faraday tour will begin in Brighton on 17 October and end in Bath on 14 March 1991. The Lecturing team will be led by Professor Fred Eastham (University of Bath) and Professor 'Jay' Jayawant (University of Sussex).

The Faraday Lecture was inaugurated by the Institution of Electrical Engineers (IEE) in 1924 to promote public interest in electrical science and technology and to commemorate the life and work of Michael Faraday as the 'father' of electromagnetism and a pioneer in the field of electricity, his work laid the foundation for many of today's advances.

This years presentation will

trace the history of electromagnetism from the discovery of the magnetic properties of lodestones and the invention of the compass to the applications of modern magnetic materials in such exciting developments as high speed levitating trains and space exploration with the use of video, slides and live on-stage demonstrations of electrical machines, suspension systems, linear propulsion and levitation 'Lodestones to Load Carriers' will both inform and entertain.

The one-hour presentation will end with an exciting look at further advances predicted for the 21st Century.

Admission to the lecture is free and by ticket only. Morning and afternoon performances are for schools.

Further information from Christina Dagnall IEE: Tel: 071-240 1871.

TEMPERATURE MODULE

The new, highly versatile minimum/maximum temperature module from Maplin Electronics, features LCD display and circuitry on one small PCB mounted on a battery holder, with a 17 way edge connector. The module uses an external probe to display temperatures in the range -10°C to $+110^{\circ}\text{C}$ with a resolution of one tenth of a degree, in centigrade or fahrenheit.

The module records the

highest and lowest temperatures measured by the probe, being stored and updated and displayed on screen when required. The max/min threshold values are fully programmable.

Also included is a 12 hour digital clock, 4kHz alarm output, separate outputs for relay drivers or similar connections. The external probe is included together with a comprehensive manual. The temperature module retails at £9.45.

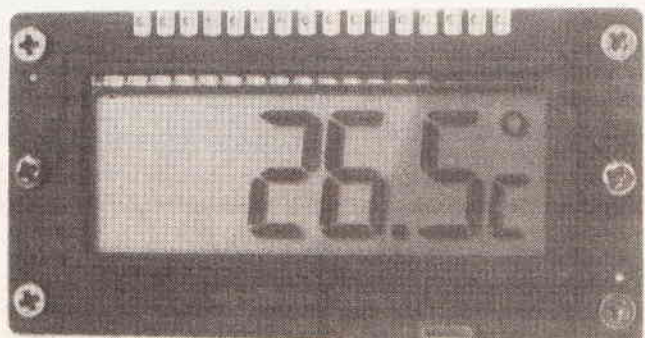

A DMM — VIRTUALLY!

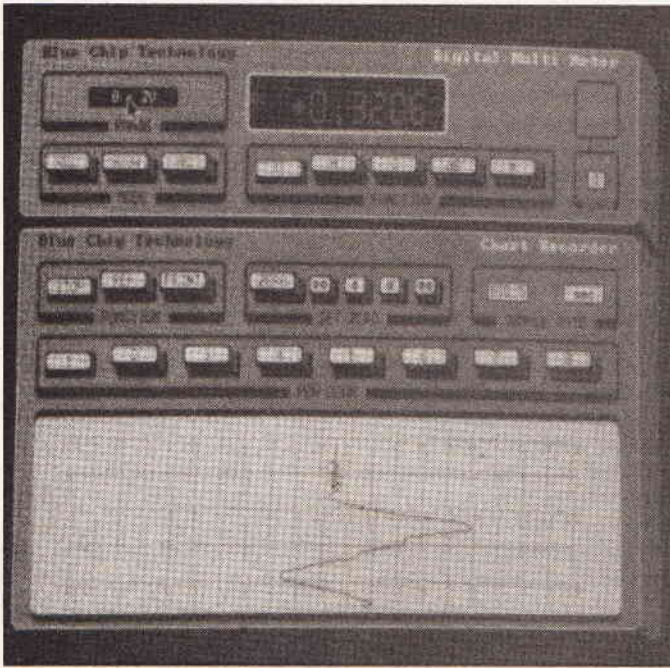

A new plug-in board to turn any IBM-PC compatible into an intelligent digital multimeter, data logger and chart recorder has been launched by Blue Chip Technology.

The Digital Multimeter — Virtual Instrument Product

(DMM-VIP) uses the PC together with a special plug-in card and software package to reproduce the functions of a digital multimeter, data logger and chart recorder. It utilises the data storage, intelligence of graphics capability of the PC in addition to

providing all the functions of a traditional bench-top instrument.

The screen display re-creates a picture of a multimeter front panel complete with push buttons, range selector switches and display. A mouse is used to operate the buttons on the screen to select volts, amps, ohms, decibels or capacitance measurements. The result is displayed in 4.5 digit resolution in the display window.

The DMM-VIP will measure AC or DC voltages up to 300 volts with four selectable ranges. Input impedance is 11 megohms on the DC range, and measurement timing can be synchronised to the mains frequency for improved stability.

Other ranges include AC/DC current up to 2 amps, resistance up to 20 megohms, capacitance up to 2 microfarads and decibels up to ± 55 decibels. All ranges are protected against overload by thermally operated self re-setting fuses. Calibration data is held in EEPROM allowing the card to be re-calibrated by the user at any time.

Below the digital multimeter display is the chart recorder emulation. This section of the screen shows buttons to start and

stop the recorder, zero the readings and select a sample rate as well as a display area showing the analogue trace. Once started, all data may be logged to disk and displayed graphically on the screen. Recorded information can be recalled and displayed at any time and a matrix printer can be attached for a continuous hard copy print-out.

For users wishing to make more of the DMM-VIP functions, external scanning units are available which allow up to 32 channels to be used. Each of the channels can be set up via the DMM display for different functions and ranges. These can also be used by the chart recorder to display the values and log the readings to disk at intervals up to 25 per second.

Applications for the DMM-VIP include simple bench-top measurements, Quality Assurance (where measurements need to be stored), low cost automatic test (ATE) and data logging. It can also be used to replace an intelligent DMM already linked to a PC via an interface card.

The DMM-VIP package costs £399.00 and is available from Blue Chip Technology, telephone 0244 520222.

FOUR-IN-ONE TEST UNIT

If your lab or workshop is short of space, instruments which combine several functions are very useful. One instrument with four separate test and measuring systems is now available from Alpha Electronics. DOA 141 combines a DMM, Function Generator, Frequency Counter and Power Supply into compact instrument.

An auto ranging 3½ digit LCD multimeter features both AC and DC voltage and current. Other functions include Ohms, Diode test and Continuity check with audible alarm. A basic DC accuracy of 0.5% is enhanced by Measured Data Hold and Memory Mode for relative measurements. The power supply displays both voltage and current on a dedicated 3½ digit LCD. Triple outputs are 0-5V at 0.5A,

15V at 1A and 5V at 2A. Full over current protection is provided. Measuring from 1Hz to 100MHz, the eight digit frequency counter is housed at the

top of the centre section with a best resolution of 0.1Hz and a sensitivity of 15mV. The LED display also indicates units of measurement with annunciators and the 10MHz reference oscillator has a stability of less than 5ppm. Bottom centre is the function generator covering from

0.02Hz to 2MHz with up to 20Vpp output. Waveforms include sine, square, triangle, ramp, pulse and TTL. This adaptable signal source also had both lin and log sweep modes.

For further information telephone 0756 799737.

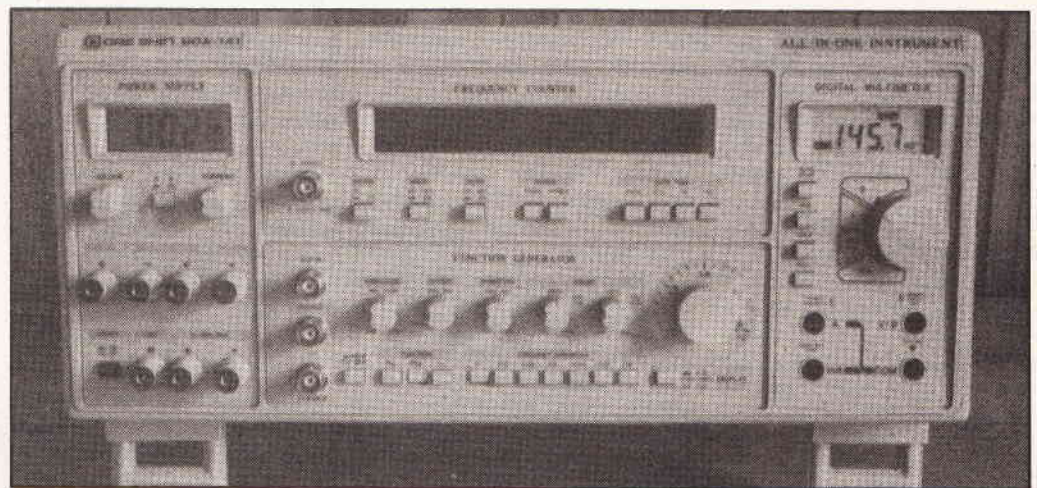

RARE-EARTH MAGNETS

New magnetic materials which have greater corrosion resistance and thermal stability than others before are

now available in the UK from IG Technologies Ltd.

They also have a greater coercivity, making them more

stable over a wide range of temperatures.

Combined with suitable protective coating, the new Nd-Fe-B grades will give design engineers greater scope in advanced electric motor and computer peripheral

applications.

The materials — new grades of neodymium-iron-boron (Nd-Fe-B) — marketed under the name UGISTAB have been developed by IG's parent company Aimants Ugimag.

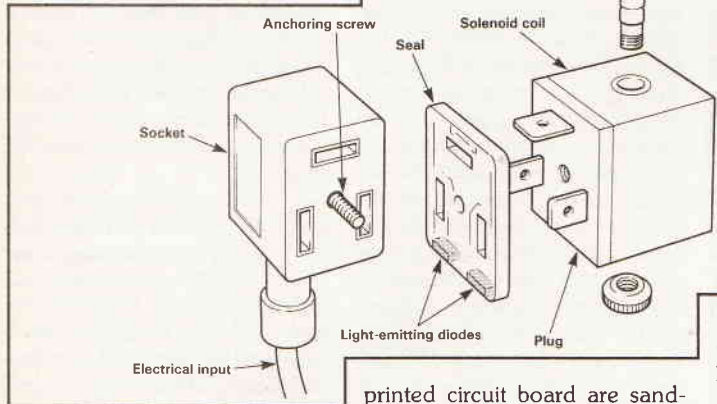

Light emitting seal

In a new patented invention light-emitting diodes and

printed circuit board are sandwiched within a seal that is both a gasket and a power-indicator light for a solenoid-valve assembly. The seal fits between the plug and its socket. An anchoring screw extends through the socket

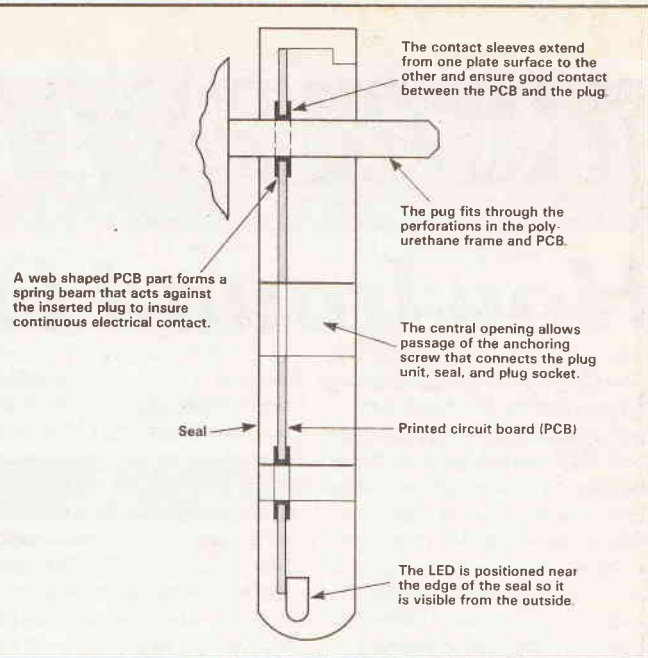

and threads into the seal and plug.

The PCB within the seal contacts the plug, causing the LEDs to light whenever the power is on, indicating that the valve is operating. The seal assembly requires no wiring and eliminates the need for hard-

wired solenoid indicator lights. Called the Light Emitting Seal it is made by the Aro Corp, Bryan, Ohio. It is constructed of a flexible polyurethane gasket that snaps together over the PCB. The light diodes are positioned in the corners of the PCB and are supported in recesses inside the seal.

New form of solid matter

A new form of solid matter, called quasicrystals, could lead to a host of materials with special industrial and electronic applications.

For centuries, scientists thought there were only two types of solids: crystalline and glassy. In crystalline matter, such as diamonds, atoms are arranged in a regular, repeating manner. In glass solids, which range from some metal alloys to window glass, atoms are randomly arranged. The atoms in quasicrystals are arranged in symmetric pentagon-shaped patterns, which scientists previously assumed could not fit together in an orderly manner.

The breakthrough resulted from advances in materials processing that yielded high-quality crystals for the first time, according to research workers at AT&T Bell Laboratories of Murray Hill, New Jersey. Quasicrystal existence was confirmed by comparing images of the solid, obtained with a scanning-tunnelling microscope, to high-resolution atomic-structure measurements taken by X-ray diffraction.

It is reported that compounds of the material made of aluminium, cobalt, and copper are extremely strong, hard as quartz and resistant to surface wear, and maintain a constant electrical resistance over a wide range of temperature variation. "The electrical conduction mechanism is not understood" says Refik Kortan, a researcher in the Materials Interface Research Department at Bell Labs, "but now that the atomic structure is known and high-quality samples are available, we are eager to perform additional experiments and construct new theories."

The work is part of a programme that focuses on unusual intermetallic compounds and alloys for electronic applications. Initial research indicates that quasi-crystals may someday be useful as fuse links and high-quality electrical resistors.

Aluminium-air fuel cell

A new system for use as an emergency power supply combines lead-acid batteries for short-duration outages and aluminium air fuel cells for longer-term power generation. It was

developed as backup power for telecommunication networks, but the technology can be used for other applications, including electric vehicles and boats.

The aluminium-air fuel cell, a spin-off from technology developed by Alcan's Kingston, Ontario, Research and Development Centre, generates electricity by the electro-chemical reaction between aluminium and oxygen. An alkaline solution or saltwater is used as an electrolyte. The caustic electrolyte is pumped through the cell stack between the aluminium anodes and air cathodes.

Electricity is produced as the aluminium oxidizes, and aluminium hydroxide is formed as a by-product. The aluminium hydro-

xide precipitates out and is collected in a sump. An air stream is blown through the cell stack to supply the oxygen for the electro-chemical reaction.

Because the aluminium is eventually consumed, the cell is recharged by replacing the aluminium anode plates; the electrolyte is replenished at the same time. Aluminium hydroxide can be collected and recycled back into metallic aluminium, making it a clean and non-polluting renewable power source.

The lead-acid battery is used for power during the 30-minute period required for the aluminium-air battery to reach full power output. Once operating, the aluminium-air battery can supply continuous power for 50 hours or more. By using a modular approach, reserve systems with capabilities of up to 250 hours are possible. For example, aluminium air modules would be activated sequentially at 50-hour intervals. The system has a potential storage life of 10 years.

A possible application for the telecommunications power-supply system is as a range extender in an electric vehicle. The aluminium-air battery's energy density of approximately 159 Wh/lb is comparable to that of an internal combustion engine.

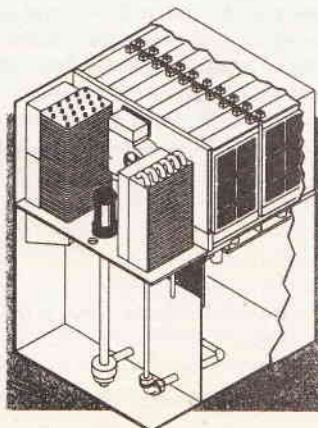

Howlround Forum

I can understand the frustration expressed by Mr. Metherell in the August Read/Write regarding 'howl-back' on PA systems. It is a problem which plagues every sound engineer, and unfortunately has no 'magic-formula' cure.

'Howl-back' or as it is more commonly known feedback occurs because the sound being emitted from the loudspeakers in a PA system, is picked up by the microphones, and re-amplified by the system. This amplified signal is then re-emitted, and the process continues ad-infinitum.

There are many factors which influence whether or not feedback occurs, and if so, at what frequency. Dips or peaks in the overall frequency response of the total system, from microphone and speakers, the size of the room or hall, the distance from the microphones to the speakers, the height of the roof, whether or not the stage is of the closed-in or open style, any equalization which has been made to the microphone signal, the number of people in the audience, (bodies absorb sound!), the material used to finish the building, (i.e. is it absorbant or reflective?) are a few of the influencing factors!

Having never been to the Adelphi Theatre, I cannot comment on the PA system there, other than to say that Mr. Metherells estimate of hundreds of watts is probably very conservative. A few kilowatts would be more like the thing! In general it is actually easier to avoid feedback in a large theatre than in a small hall. In a large venue, the distance from the microphones to the speakers is comparatively great compared with that in a smaller building. This means that although the volume from the

speakers is high, it has dropped considerably by the time the sound reaches the microphones. More importantly, a large theatre or production company can afford to use equipment and techniques which minimise the chances of feedback. They may employ directional microphones with a smooth frequency responses, high quality mixing and processing equipment, and good quality amps and speakers, again having a smooth frequency response.

If a particular frequency gives feedback problems, a graphic equalizer may be used to remove this frequency from the audio signal. A 31 band graphic could remove a specific frequency without noticeable deterioration in the overall sound quality. Such an equalizer could cost many hundreds of pounds, but this is a small price to pay for good sound quality in a professional theatre production!

Mr Metherell should also take into consideration that he was listening to professional performers. Trained actors and singers can project their voices and produce a considerable volume without any amplification. This is very important for PA work because to produce a certain volume level at the speakers, less gain is required if the source is loud rather than quiet. Less gain in the system means less chance of feedback.

There are a number of means of curing feedback. I have already mentioned the use of graphic equalizers. Any materials which can be used to dampen the sound will also help, i.e. if a theatrical production can use carpet on the

stage floor to prevent reflection of sound, it is of great benefit. Curtains, suspended ceilings, soft coverings on seats and other furnishings also have a great influence — architects take note! The sound engineer should endeavour to place his loudspeakers as far from the microphones as possible — but not to the extent where he creates a 'hole in the middle' effect where people in the middle-front of the audience are not covered by the speakers. Using multiple cabinets at each side of the stage to spread out the sound is a useful technique. Choose microphones which reject distant sounds. The Shure SM58 is an excellent 'close-up' microphone, and in my experience out performs many more expensive microphones as a hand held vocalists mic. Try to use microphones as close to the sound source as possible.

In suggesting a delay Mr Metherell is partly correct in his thinking. This should certainly reduce the onset of feedback, but once 'ringing' starts, the delay will do nothing, other than possibly change the feedback frequency.

Remember that the sound system already has a natural delay built in, because there is a finite and significant time for the sound to travel from the speaker back to the microphone. Introducing a very long delay will cure feedback completely, but then who wants to hear an actors words five seconds after he says them? In any case I would not suggest the use of bucket brigade delay lines. The sound quality would be significantly reduced by employing these devices. By todays sound quality standards they are barely of high enough quality to use in effects, which are

applied not to the full sound signal, but to part of it via a side chain, such as an effects send from a mixing desk. 12 and even 16 bit digital delays are now commercially available at reasonable prices.

There are electronic devices available to reduce feedback, but these are generally expensive. The ones which I know of use a frequency shifting technique to actually change the frequency of the sound being emitted from the speakers. Since the sound emitted is not the same frequency as that being picked up by the mic, feedback does not occur. This technique should be used with care, since even a change of a few hertz in a note can disturb musicians who can hear the sound from the speakers, as well as the natural frequency from their instruments. If the microphones are too close to the speakers, a ringing sound, increasing in frequency, can be heard which is just as disturbing as normal feedback. I have used such a device on one occasion, and a significant gain in volume without feedback is possible — but electronics cannot solve the problem completely. A circuit for one of these units was published quite a few years ago by one of the hobby electronics magazines — I actually thought that it was ETI. (It was — *Frequency Shifter*, March 1978 — Ed).

By now Mr Metherell you should be totally confused! I am sorry I can't offer a perfect solution to your problem, however I hope I have given you food for thought!

**Brian Adams,
Ballymena, Co. Antrim**

To reduce the possibility of acoustic feed-back or howl back, may I suggest two areas for examination.

Speakers, Position and Type
These days, the idea is to create a natural sound with little echo, and this is achieved by placing the main speakers in a position which

is similar in distance from the audience as the performers (or stage microphones) are from the audience. This way, what the audience hears is acoustically in phase with the performers, ie the time taken for the real sound from the performers to reach the audience is the same as that from

the speakers. (The old system of having smaller local speakers is used less today because of the echo effect and unnatural sound this can have, although, local speakers with delay lines can be used in addition to the main speakers with good effect, this is by the way).

It is essential that the sound produced by the main speakers reaches the audience with good volume, and good quality, but at the same time it must not significantly reach the performers. This is achieved by using special high quality DIRECTIONAL speakers, mounted usually quite high, and

probably each side of the performers. Directional speakers will emit most of the sound in a band or corridor from the front of the speaker, and outside this corridor the sound produced falls off. With the speakers directed towards the back of the audience, the main sound reaches the back, and those towards the front in theory are out of the corridor and

therefore hear less from the speakers and possibly more from the performers themselves depending on the situation.

The performers themselves being well out of the corridor hear little or relatively little of the sound produced from the main speakers, and there is large volume for the audience, but insufficient onstage to produce

feed back or howl.

Notch Filter

This is an electronic filter which can be built into an amplifier system, and it is designed to eliminate or attenuate a very narrow band of frequencies, it is sometimes used to eliminate mains hum 50Hz for example. In this case it would be set to attenuate the frequency at which

the speaker is in phase with the microphone signal, or the feedback frequency.

I don't think delay lines in the main speaker circuits would be an answer, since it would probably only alter the pitch of the howl, and would give a very unnatural effect.

C. Moore, Reading.

In answer to the Read/Write, Non howling mic question, feedback in sound systems is not only caused by direct sound radiated from the loudspeaker to the microphone, it also involves reflections of sound from walls, ceilings, and any other surfaces within the room. The phase of the frequencies involved do not remain constant and depend on the distance travelled. Therefore a delay could only remove (by phase shift) one frequency and its harmonically related frequencies from only one of the many feedback paths.

To avoid feedback, the system in use must be chosen and used correctly. This involves speaker quality, directivity and placement, microphone choice and placement for the application, and avoiding excessive boost on tone controls. A number of methods or devices are available to the engineer which help avoid feedback. The one nearly always used is the 1/3 Octave graphic equaliser. This allows us to not only equalise the system but to also take out any peaks in the system/room response, thus giving us further gain before the

onset of the dreaded howl.

**Ian Grant,
NUREMBURG LIGHT
& SOUND, Bolton.**

I have always used a frequency shift circuit to cut down the feedback loop that is the problem with all PA systems.

The idea is that the overall frequency of the microphone signal is raised or lowered by a small fraction. This breaks the feedback loop as the signal from the speakers is not identical to the

original received from the microphone.

The frequency shift does not have to be very great or it would become noticeable by the audience, it just has to be enough to counteract the feedback loop. I have found that a very small increase or decrease is enough to give a substantial increase in the available useable sound level.

The frequency shift circuit can of course be either digital or analogue in design.

I hope this is of some use.

**J.G. Wilkinson,
Southampton.**

Correspondent E.T. Metherall of Longport, Somerset writes about the problems of microphone 'howl-back' and how can it be eliminated, in August. It cannot be eliminated, but only alleviated!

After spending thirty years in sound reinforcement I can claim to know just a little about this phenomena. But first let us look at the suggestion which is to use a bucket brigade delay line 'to put the sound so out of phase that the trouble would be overcome.' This is not workable for one reason. The person speaking or singing would hear their own voice coming back with a delay and research has shown that under these circumstances the speaker/singer will quickly dry up!

To tackle the problem of acoustic feedback, to give it its correct title, it is necessary to analyse what is happening and why. To state a couple of facts, the sound pressure levels measured 1m from a loudspeaker in the open air, with no buildings, trees or shrubs to reflect sound, will be considerably greater than the same system in say a village hall with no furnishings, a solid floor and reflective ceiling, prior to the onset of acoustic feedback. Internal reflections within the hall aid acoustic feedback.

Feedback will start at some principal frequency. The actual frequency will depend on the acoustic environment and the

quality or otherwise of the amplifying equipment, including the mic, amp and loudspeakers. Equipment used such as a graphic equalizer will also have an effect. The use of any type of compressor will make it virtually impossible to eliminate feedback if reasonably high sound pressure levels are required. This latter point is the reason why some early types of radio mic were unusable in a live situation. It is only with the advent of peak limiters, as opposed to compressors, that radio mics became a practical instrument. Compressors allow higher gains when the signal level is low and low gains when the signal level is high. So when a performer stops talking into a mic the gain increases, and does so quite rapidly, it is this gain increase which causes the feedback. Peak limiters on the other hand have no effect below a preset threshold, and only take effect when that threshold is reached.

So what about the acoustic environment? Let's take for example a mobile discothèque. The operator has no idea from week to week what environment he will be working in next. One week a marquee, the next a concrete box of a village hall. The former has little in the way of reflections as the tent is made of canvas and absorbs sound or allows it pass through. The concrete box hall, has so much sound

reflected from the walls, ceiling and floor that it is impossible to get sufficient sound from a mic with acceptable quality.

In these latter conditions one can only do so much. All equipment needs to be top quality with no peaks in its frequency response, and the use of a 31 channel stereo graphic equalizer to filter out the predominant reflections. In this situation there is just one piece of equipment which will assist, it won't cure the problem but it can help if used intelligently, and that is a frequency shifter. What this does is to shift every frequency by a small amount, usually 5Hz and so the feedback frequency no longer matches the feedback frequency. This is acceptable for speech, but out of the question for music. (See Blueprint — Ed).

In the case of Starlight Express, which I have also seen, the reason it works is that the acoustic environment is excellent. There are few if any parallel surfaces (consider the shape of the auditorium), plenty of plush furnishings, and bodies to absorb sound rather than reflect it. You can also be sure that all the sound equipment is top quality.

Turning now to equipment, it is highly unlikely that the Tinlid Microphone from Teipei costing £3.24 will work without horrible results. So what is the difference between that and a good mic, which will cost a lot of bread

certainly not less than £100. The difference will be in the smoothness of the frequency response.

A good mic will typically have a response which is within a couple of dB over its full range from 30Hz to 18kHz. Mics I use on my roadshow are flat within 1dB from 20Hz to 20kHz. Feedback with these is much reduced. At full power I run 2kW of audio and it is not uncommon to walk in front of the loudspeakers within a couple of metres and still not get feedback. The use of a unidirectional mic rather than an omnidirectional type will minimize the problem. A unidirectional mic will have much less sensitivity from behind the mic than from the front, the response being one with a cardioid pickup pattern.

The same argument applies to the amplifier and the loudspeakers. The frequency response must be substantially flat in order to achieve these kinds of results. This quality does not come cheap and here is the rub, a mic costing say £350, used with amps costing £750 and loudspeakers costing around £2,000 will get you results. A £250 disco console with built in 100W power amps feeding home-brew loudspeakers is not likely to work at high sound levels without feedback.

**Brian Davies,
Lingfield, Surrey**

BLUEPRINT

Blueprint is a column intended to provide suggested answers to readers' electronics design problems. Designs are only carried out for items to be published, and will not be prototyped by the columnist. Circuits published in Blueprint are believed to work, but may need minor alteration by the reader after prototyping. Individual correspondence will not be entered into, save as necessary to prepare items for publication.

In ETI August, a reader asks how to stop howlround with microphones and PA systems. This is an interesting problem, so I decided to look at possible answers.

One standard approach is to shift the frequency of the sound by a few Hertz using a pair of ring modulators. This approach is illustrated in Figure 1, which those familiar with amateur radio will recognise as a type of single sideband generator. The effect it has on the signal is to raise its frequency by the frequency of the quadrature oscillator. If the quadrature outputs were exchanged, then the signal frequency would be lowered instead.

How does this help? Well, howlround takes place at a particular frequency, determined by the frequency response of the whole feedback system including the room. The system has peaks and troughs of response that would do the Alps proud, and oscillation normally takes place at the biggest peak. With the frequency shifter in circuit, the next time a sound passes round the loop it will no longer fall on the peak, and so will be attenuated (or at least not amplified so much). This lowers the effective gain of the oscillatory system to the average rather than the peak loop gain, and can easily give 6dB improvement in stability.

Two snags exist. The first is that frequency shifted speech is not natural sounding because harmonic relationships between voice frequency components are not maintained. A small frequency shift may be helpful for speech, but might impair the sound of singing too much (Would you like to be 10Hz out of tune?)

The other problem is that it is very difficult to maintain a 90° phase difference over a wide range of audio frequencies. The way to achieve this is to use two phase shifters which give a frequency dependent phase shift,

and choose component values so that the phase shifts start at different frequencies and track at a phase difference of 90°. Either a Wien bridge network or cascaded all pass filters (using op-amps) will do the job.

Other circuit blocks are relatively straightforward to design. I have seen several similar application notes in IC manufacturers data books for sine/cosine oscillators, and double balanced modulator data sheets give most of what is required to design the multipliers. The main difficulty is to keep the dynamic range (between noise level and clipping level) adequate for the purpose.

Different Approaches

Another approach is to use two microphone capsules in a "noise cancelling" arrangement. The two microphones are connected in antiphase, so that any signal arriving at both microphones with equal strength is completely cancelled. The separation of the microphones is such

that the voice of the person using the microphone is received much more strongly by one than the other, and is therefore not cancelled. This cancellation is often used in communications microphones to cut out background noise.

Room acoustics and loudspeaker placement are crucial in cutting howlround, regardless of other solutions applied. The sound level behind the speakers is less than that in front of them, and the use of directional loudspeakers helps still more.

In a very reverberant room, it can be better to use a number of loudspeaker banks run at a modest power to distribute the sound where needed, rather than a single high power wall of speakers at one point. The former gets the sound closer to peoples ears rather than exciting room resonances.

If possible, room resonances should be damped by sound absorbing objects, and for this, upholstered seats and people are both helpful. Graphic, or even better parametric equalisers can be used to insert a dip at the frequency of any really severe

room resonance, but this is only effective if one or two resonances are much worse than the rest.

In his letter, the reader suggested the use of a bucket brigade delay line to put the sound out of phase. This would probably help to some extent, but would, I suspect, prove more confusing to performers than the frequency shifter, unless the delay was very short. It might also do little more than slightly delay the onset of oscillation. I think that the frequency shift approach is likely to be the most effective in general.

Next month I will show detailed circuitry for the frequency shifter, because this is likely to be useful in many circumstances even when other approaches to the problem are also used.

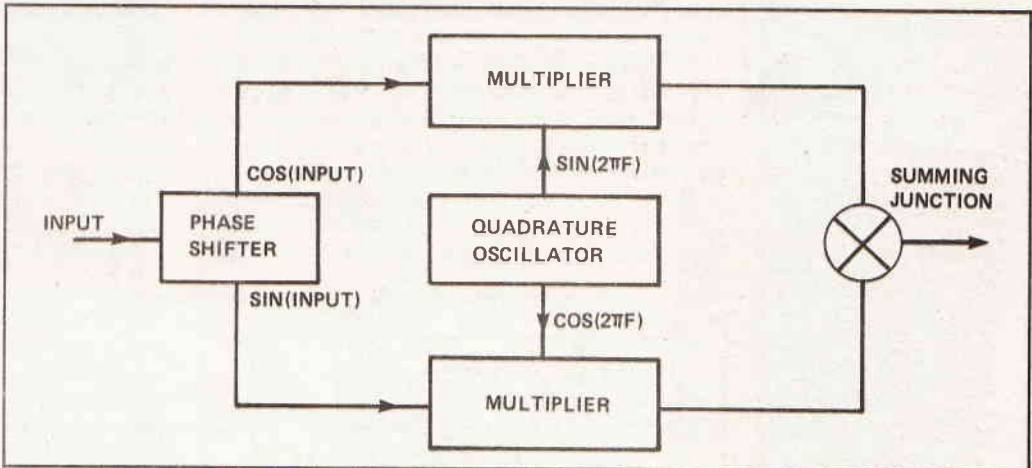

19" RACK CASES

* Suitable for instruments, high quality amplifiers and many other applications that demand strength and professional finish * New improved construction and finish * Black anodised aluminium front panels * Separate front mounting plate, no fixing screws visible on the front and the side of the enclosure * Heavy gauge front panel * Brushed aluminium finish enhanced with two professional handles * With ventilation slits and plastic feet * Rear box manufactured from 1.1mm steel finished in black. Rack mounting or free standing. Comes in quick assembly flat package.

Order Code	Panel Size WH (inch)	Rear Box W H D	Weight	Price £
U101	19 x 1.75	17 x 1.5 x 10	2.4kg	26.95
U103	19 x 5.25	17 x 5.0 x 10	3.5kg	29.95
U212	19 x 3.5	17 x 3.0 x 12	3.3kg	29.75
U312	19 x 5.25	17 x 5.0 x 12	4.0kg	31.95
U412	19 x 7.0	17 x 6.5 x 12	4.6kg	34.95

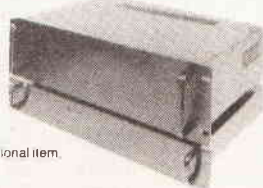

Please add £3.00 P&P for the first item and £1.50 for each additional item.

Please add VAT to above prices. Overseas orders welcome.

CRICKLEWOOD ELECTRONICS LTD
40 CRICKLEWOOD BROADWAY, LONDON NW2 3ET
Tel: 081-452 0161 Fax: 081-208 1441

Millions of quality components
at lowest ever prices.

Mail order only.

Send 30p stamped addressed label
for catalogue/clearance lists.
All inclusive prices **NO** post, packing,
VAT etc to work out and add on.

Brian J Reed Electrical
6 Queensmead Avenue, East Ewell
Epsom, Surrey KT17 3EQ
Tel: 0(7)1 223 5016

COMPONENT TESTER

Mark Daniels builds this project for testing various types of component, including zener diodes.

Many components, such as resistors and rectifier diodes, can often be adequately tested using an ordinary multimeter set to its ohms range. This, however, only gives a limited amount of information regarding the serviceability or specification of a device and may in many cases give misleading or inconclusive results. Zener diodes can cause numerous problems when it becomes necessary to test them: a variable voltage power supply, a milli-ammeter and a voltmeter are virtually essential if meaningful results are to be obtained. In-circuit testing of zeners is not ordinarily a very practical proposition using conventional test equipment and substitution is the method often resorted to.

The Component Tester described in this article can perform tests on many modern components and give information about them that would ordinarily be missed using more conventional techniques and equipment. It is also extremely easy to use on devices that are still in circuit.

Design Considerations

Most multimeters, including the more expensive ones, use no more than about 15V for the ohms test, and it is this that gives them some of their more severe limitations. A backward reading, non-linear scale does no more than compound the problems associated with them.

What is needed is a self-powered test meter which can produce a high test voltage when necessary and has a linear, forward reading scale. The Component Tester offers these benefits and is portable.

There are many ways of obtaining a high voltage, each with its own advantages and disadvantages. A mains derived power supply is an obvious one, but it restricts the portability of the device. High voltage batteries are not a very practical proposition either, owing to their high cost and possible problems obtaining replacements. A self oscillating inverter offers big advantages over both of these and could be



used very effectively with just a 9V battery supply. This method was given considerable investigation during research for this project and rejected in favour of the present approach, because of the lack of ready availability of suitable pot cores for the transformer and the hassle of having to wind such a device by hand. The final choice of voltage multiplier may seem a somewhat unorthodox approach to the problem, but it offers many advantages. Low cost, low weight, no transformer (and the attendant magnetic fields to interfere with the moving coil meter) and readily available components, to name but a few.

A voltage multiplier is not without its drawbacks, albeit minor ones. Firstly, as with transformers voltage multipliers will not work on DC and we therefore have

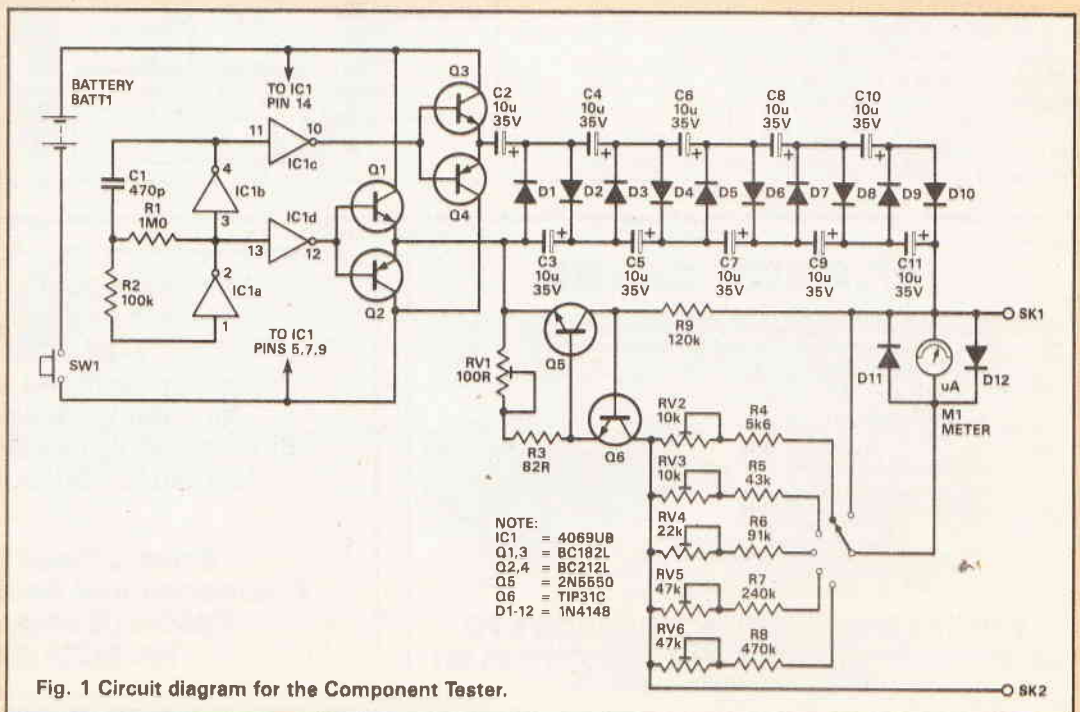

Fig. 1 Circuit diagram for the Component Tester.

PROJECT

to produce AC from a battery. Secondly, unless the operating frequency is sufficiently high a voltage multiplier can be both bulky and inefficient. Which means expensive to build and run! However since the primary source of current is DC, and will therefore need to be converted to AC, the frequency can be freely chosen in order to optimise the voltage multiplier operation.

Construction

Most of the components are mounted on a PCB which should be etched and drilled in accordance with Figure 2. The PCB must be assembled in the following

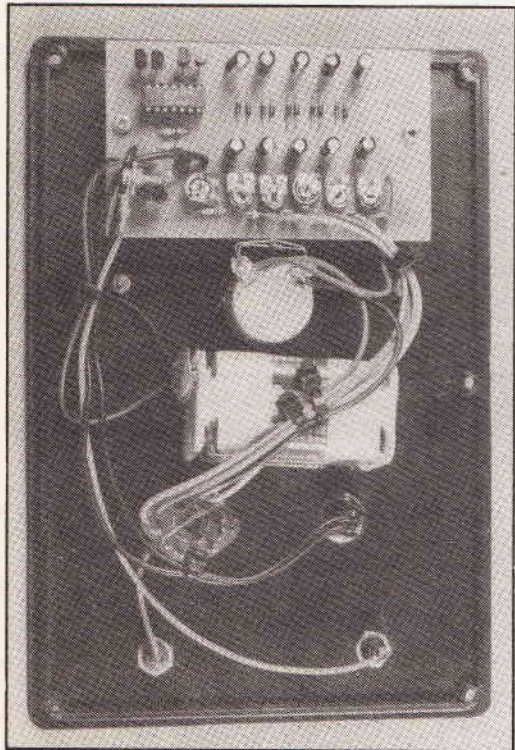

front glass and scale should be carefully removed and new scales marked on using transfers or very carefully writing on with a drawing pen and black ink. Replace the scale and front glass. A suggested arrangement is shown in Figure 3, but remember to allow room for the battery pack as this is rather bulky. If space is at a premium then a PP6 may be used in place of the six AA cells and their holder. All interwiring is also shown in Figure 3. Note that D11 and D12 are connected across the meter in opposite directions. The battery pack should be well secured before final assembly of lid to case, as it is rather heavy and could do considerable damage if left unrestrained!

Setting Up And Testing

An initial test can be performed by turning SW2 fully clockwise and pressing SW1. The pointer of the meter scale should move fairly quickly and smoothly across its scale and come to rest against its end stop. Releasing SW1 will allow the capacitors to slowly discharge through the meter (and anything connected across the test sockets) and the reading will eventually fall to zero.

If nothing happens check for incorrect wiring, bad solder joints or diodes fitted back to front. If METER1 does not fully deflect check the values of R8 and RV6 first, since if these are too high METER1 will read low. Also check battery voltage under load as this can cause low readings (if Ni-Cads are used eight will be required to give 9.6V). If any of the transistors Q1 to Q2 are faulty this will give a zero or low reading.

If everything is OK the constant current source may now be set up. Connect a milli-ammeter across the output and adjust RV1 to give exactly 5mA while pressing SW1. Allow the capacitors to discharge through the milli-ammeter before continuing. Assuming that the constant current has been set correctly the voltage ranges may be calibrated using close tolerance resistors. Starting with the 1V range connect a pair of 100R resistors in series across the test terminals and press SW1. Adjust RV2 so that the meter reads full scale. Switch to the 5V range, connect

order if difficulties are to be avoided.

Fit and solder the socket for IC1 and resistors R1, R2 and R9. Next insert and solder all the presets, then C1. Diodes D1 to D10 should now be fitted and soldered, followed by capacitors C2 to C11. Take care to ensure that the orientation of these components is correct as they are all polarised. Each capacitor and diode should be fitted the opposite way round to its neighbour in accordance with the layout of Figure 2. Mistakes here could result in electrolytic capacitors exploding! So check carefully. Also take care not to overheat the diodes when soldering them or their neighbouring components. R3 to R8 are mounted vertically and should be fitted before the remaining semiconductors.

Note that the Q5 pinout is not in the usual order for a T092 package and this must be remembered if fault finding becomes necessary. Also it is not possible to use more common devices such as BC182L as substitutes, because of their lower voltage rating. Q6 must be a TIP31C or TIP41C and not the lower voltage versions with an 'A' suffix or no suffix at all.

Take care with IC1 as it is an unbuffered CMOS type, which means that it is more susceptible to damage by static electricity than the more common buffered versions, so we recommend that a socket is used.

The remaining components are fitted to the case lid and the layout should be carefully considered before any holes are made. No case dimensions are given as this will largely depend on the size of the meter used for METER1. Before fitting the meter the

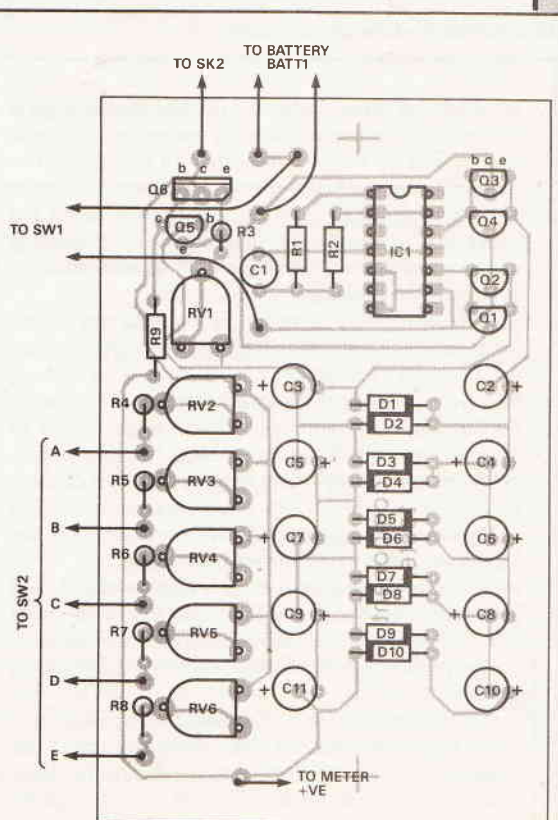

Fig. 2 Component overlay for the Component Tester.

a 1k resistor across the test terminals RV3 for full scale. The 10V, 25V and 50V ranges are adjusted in the same manner with RV4, RV5 and RV6 using total values of resistance of 2k, 5k and 10k respectively.

Using The Component Tester

The unit should be now be fully functional and calibrated. Its primary design function is the testing of zener diodes, which may be tested as follows.

Connect the cathode of the zener to the positive terminal of the Component Tester and the anode to the negative. Select the 50V range and press the test button. The zener voltage may be read directly from the meter scale. If the reading is toward the left hand end of the scale select a lower range and test again. Read the voltage off the appropriate scale. The test current of 5mA is approximately equal to the current

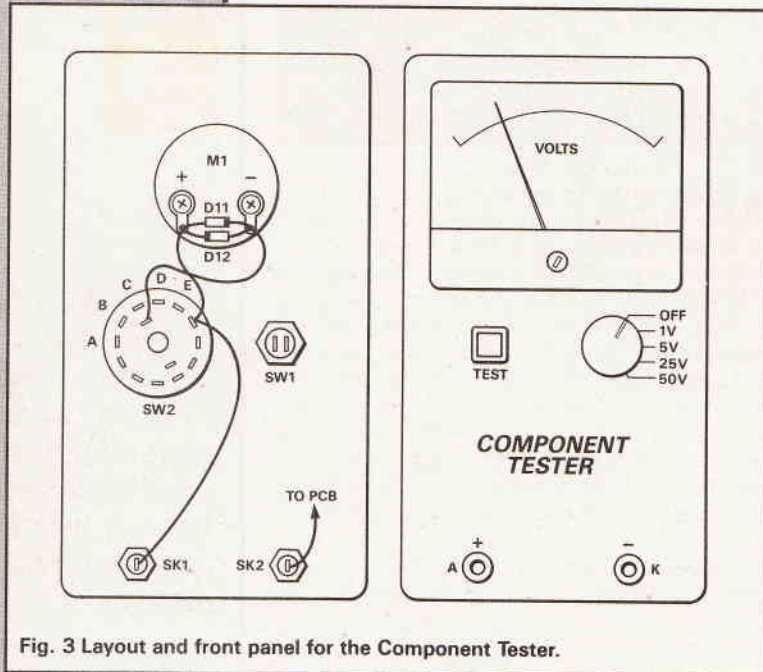

Fig. 3 Layout and front panel for the Component Tester.

at which the zener voltage is usually specified for a 400mW device and should give reasonably accurate results. The 1V range is intended for measuring the forward voltage drop of silicon or germanium signal or rectifier diodes. These should be connected the opposite way round to zener diodes or false readings will be obtained and sensitive devices may even be destroyed by excessive reverse voltage.

Resistors may be tested in a similar manner to zeners and the full scale readings are as given under the heading 'Setting Up and Testing'. The scale is forward reading and linear. Resistances in the range 20R to 10k may be measured with a fair degree of accuracy and also below this range to some extent. While zeners and rectifiers may be tested in circuits, you should not do this with other components as the voltage may rise high enough to destroy some of the semiconductors in the circuit under test.

Electrolytic capacitors may also be tested, but here great care should be taken not to charge them to a voltage higher than their rated one. An indication of capacitance may be obtained by timing the charging period.

The Component Tester may also be used as a fairly high impedance DC voltmeter and will measure voltages up to 50V. Care should be taken to connect the meter the correct way round to avoid damaging its internal semiconductors. The test button should not be pressed when the unit is being used in this mode.

HOW IT WORKS

IC1 is a CMOS Hex inverter which in this application has two of its gates, IC1a and IC1b, connected to form a square wave oscillator, the operating frequency of which is determined by R2 and C1. R1 is included to give the circuit some stability.

IC1c and IC1d are used to buffer the complimentary outputs from the oscillator and thus prevent loading of the oscillator. The outputs at pins 10 and 12 are fed to two single stage push-pull amplifiers which are configured to give large current gain but only unity voltage gain.

The derived AC is used to supply a standard Cockcroft-Walton voltage multiplier arrangement, consisting of D1 to D10 and C2 to C11. This works by steering the current into capacitors via the diodes, such that C2, C4, C6, C8 and C10 all charge up to the peak AC voltage of around 7.5V. The diodes direct this voltage to the remaining five capacitors, but this voltage is now also in series with the supply voltage, so each of these capacitors charge up to twice the supply voltage. Since C3, C5, C7, C9 and C11 are connected in series, the total voltage available across the ends of the chain is ten times the supply voltage of 7.5V, i.e. 75V.

A constant current circuit consisting of Q5, Q6, RV1, R3 and R9 is used to provide a stable current of 5mA, at a maximum voltage of 80V or so. This works passing the current to be regulated through RV1, R3 and Q6. When the voltage across RV1 and R3 reaches a level sufficiently high to turn Q5 on (usually about 0.65V) the transistor begins to conduct, pulling the bias voltage, (provided by R9) and Q6 base down to a lower voltage, thus reducing the current through RV1 and R3. As this happens Q5 begins to turn off and the current remains at a level predetermined by the combined values of RV1 and R3.

PARTS LIST

RESISTORS (all 1/4W 5%)

R1	1M 5% carbon film
R2	100k 5% carbon film
R3	82R 5% carbon film
R4	5k6 1% metal film
R5	43k 1% metal film
R6	91k 1% metal film
R7	240k 1% metal film
R8	470k 1% metal film
R9	120k 5% carbon film
RV1	100R Min horizontal preset
RV2,3	10k Min horizontal preset
RV4	22k Min horizontal preset
RV5,6	47k Min horizontal preset

CAPACITORS

C1	470p polycarbonate
C2-11	10µ, 35V electrolytic, PCB mounting radial

SEMICONDUCTORS

D1-12	1N4148
Q1,3	BC182
Q2,4	BC2112L
Q5	2N5550
Q6	TIP31C
IC1	4069UB

MISCELLANEOUS

METER1	100µA panel meter
SK1	4mm red socket
SK2	4mm black socket
B1	Six AA cells and holder
SW1	Push-to-make panel mounting switch
SW2	2-pole 6-way rotary switch
	14-pin dill IC socket
	Plastic case to suit
	Materials for test leads
	Knob to suit SW2
	PP3 battery clips
	Connecting wire
	Printed circuit board

PROJECT



SOLAR POWER

Direct solar energy is there for the taking in all its abundance and yet we are only just waking to the fact. The recent energy crisis of the 70s and the polluting effects throughout the 80s and 90s has caused the world to think seriously about alternative non polluting energy sources. Our free ride on mother Earth, taking its long term storage of solar energy in the form of fossil fuels, may soon be over. And so it is now that we all should be seriously thinking of the alternatives. So if man can devise and adopt a technology to use solar energy in real time which means getting the energy where we want it at the time of asking or even over the short term converting it efficiently to other forms through biological growth, we are well on the way to what the Greens call sustainability.

Saving energy by using it more efficiently is actually cheaper than creating the extra supply, in other words it is actually cheaper to save 1 Watt of power than it is to make it available say from a power station. And that is where solar energy can be used passively to make the savings on electricity consumption, be it for industrial or domestic use.

Solar collection and conversion is still in its infancy and falls into two basic types: Active collectors will convert the sun's rays directly into another form of energy, say electricity. The general name for these devices are called transducers. The collection of solar heat in water-piped solar panels is also loosely termed an 'active' system but should not be confused with a transducer. Passive types of solar collector are where we try to store the heat and use the light directly from the sun, the most obvious example being a carefully designed house.

Photo-voltaic cells

Research into active conversion of solar energy into other forms has not been intensive in the past. Photo-voltaics, those that convert light directly into electricity are still inefficient, only 10% of the sun's energy being converted at peak output and 7.5% over a yearly working average. They are still expensive to manufacture, but cost predictions in the 70s had indicated that there should be a continual reduction up to the turn of the century. Although partially true, for there

has been a ten fold reduction in cost in the 10 years between the early 70s and 80s, the targets so far have not been met. The general consensus is that mass-production will produce only a two to three fold decrease in the present \$10 per peak watt of generated output power, a figure which European countries still do not consider as being cost effective. Final predictions are that we should see a ten fold decrease on the \$10 figure per watt for a system by the year 2000.

The manufacturing process uses more energy to create the cell than the cell gives back in its lifetime. Life expectancy has increased with its development and the lifetime of the cell is now around 20 years.

Solar power is a greatly under utilised resource. Paul Freeman looks at the technology and highlights some of the ways in which simple improvements can be made.

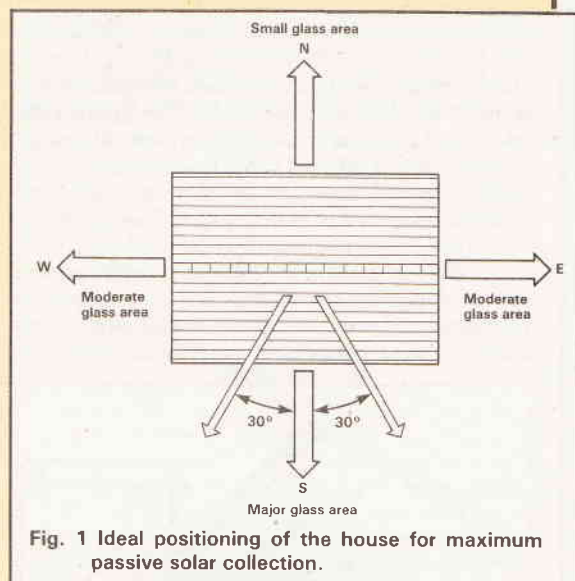

Greatest experimental use of Photo-voltaics has been in the US and Japan. California, with its wealth of resources and open spaces has the most to gain from solar power. The south-western state receives about twice as much solar energy over the year compared to central Europe, so it should come as no surprise that the technology has been exploited.

The single most significant advancement has been in the reduction in its own weight, a serious

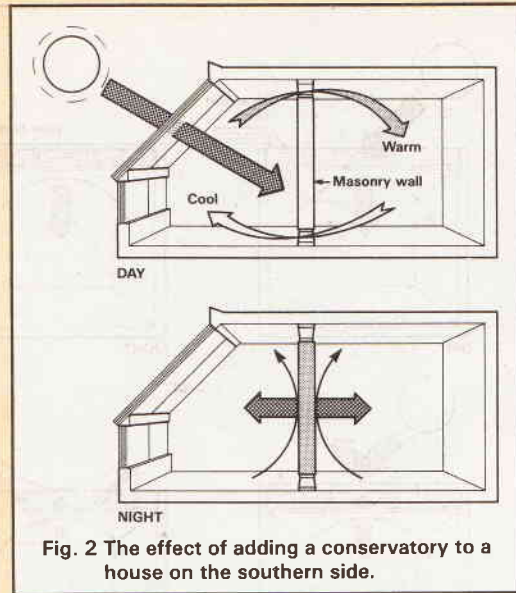

Fig. 2 The effect of adding a conservatory to a house on the southern side.

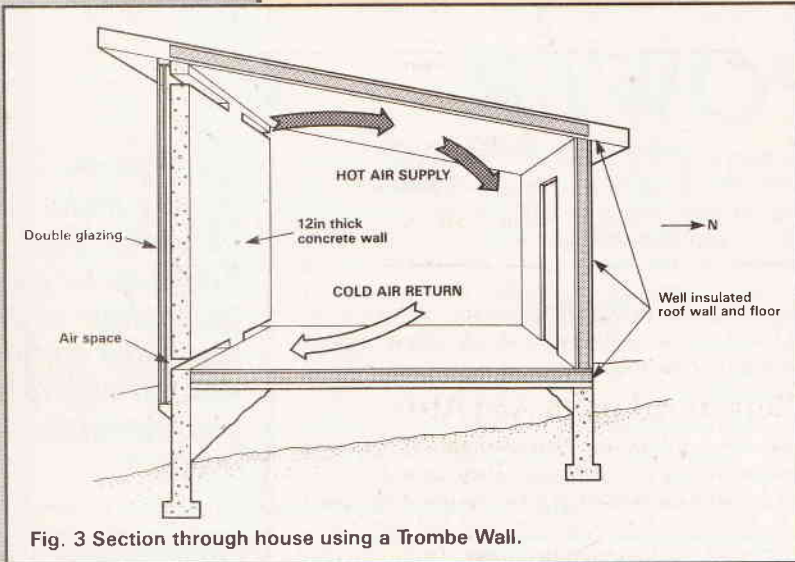

Fig. 3 Section through house using a Trombe Wall.

consideration when photo-voltaics are used as on-board power sources for transport. This most recent advance in mass reduction has been combined with flexibility so that the cells can be curved around into a tube or around edges. The new materials give typical power to weight ratios of 200milliwatts per gram, 10 times that of conventional glass covered cells.

Although extremely useful for satellite power, photo-voltaics still remain a poor contender for an alternative large-scale terrestrial energy source and show little signs of making an economic contribution

to UK energy needs according to the Department of Energy, until the cost per watt of generation is reduced to what is considered to be a cost effective level.

Passive Solar Collecting

Passive solar energy collection has been found to be cost effective and is most economically attractive. If adopted on a wide scale through a process of thoughtful house design, it could make significant savings on the energy consumption of a typical household. Well planned house design for effective solar collection of heat and light would add little or no extra cost to the building.

Firstly, the general sighting and orientation of the house is important. Maximum collection of the sun's rays in the northern hemisphere is for the main window area of the house to be southfacing, with minimum window area on the northern side (Figure 1). This is to take advantage of the real and useable greenhouse effect, trapping the lower grade energy infra red waves within the building. It should go without saying, that all standard house windows should at least be double glazed, trapping the insulating layer of air between the glass to prevent heat escape. Latest developments in glass technology has reduced the radiant heat escape still further by depositing metallic or compound molecular layers on the inside surface of the glass, but it remains to be seen how long it will take for this 'high-tech' glass to become affordable and standard.

The next and most fashionable way to add solar heating is to integrate a highly glazed unheated area, more commonly known as a conservatory, to the south side of the building. The conservatory produces two effects. It minimises heat loss from the house wall and secondly the greenhouse heating effect can be used to store the heat within the fabric of the building over a longer period. This evens out the temperature fluctuations inside the building (Figure 2).

The heat can be taken away from a heated wall-space by convector vents at the top and bottom of the wall during the second half of the day. It must be closed at night to prevent a reverse cycle coming into operation.

If space is at a premium, then an alternative to a conservatory is the use of a Trombe wall. Designed by Felix Trombe in 1967, the double-glazed thermal wall is made of a thick, black painted concrete wall. The absorbed sunlight and heat is radiated and convected by vents throughout the room (Figure 3). The Trombe house shows that 70% of its annual heating requirements are supplied by solar energy.

Water Walls And Roof Ponds

Although unusual, a water wall has many advantages over a masonry thermal wall for storing heat. A masonry wall will transfer heat by conduction and

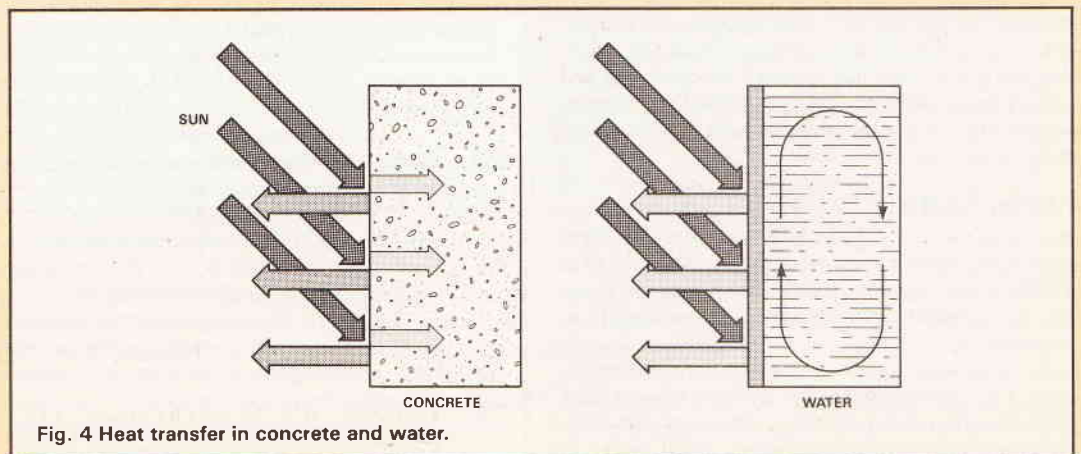

Fig. 4 Heat transfer in concrete and water.

takes a long time to heat up owing to its low thermal conductivity, whereas water will transfer heat throughout itself principally by convection (Figure 4). Water stirs itself by this method and heats up more uniformly using all of its mass for storage. It should also be emphasised that water is a poor conductor of heat and in certain circumstances will produce hot spots (when swimming in the sea, the body feels these hot spots), but if the container is taller than it is wide, this is not much of a problem.

Another advantage over concrete is that water will store over twice as much energy for the same

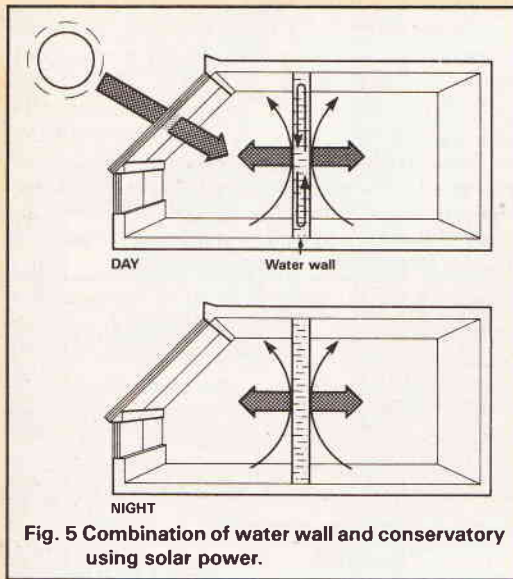

Fig. 5 Combination of water wall and conservatory using solar power.

volume and for the same temperature rise. The effect of this in broad terms means that inside temperature fluctuations are reduced owing to a larger energy store. Combining a water wall or a material with high heat capacity with a conservatory (Figure 5) would optimise conditions on the south facing side of the house. It is at this point, building designers might consider an alternative to brick, having the same strength and durability but with a higher specific heat capacity.

Rather than having the dubious task of filling the cavity wall with large plastic bags full with water and hoping the seal will not break, is to use drums or cylindrical cannisters painted black. The 'tin-can' idea might be adopted in a greenhouse to reduce temperature changes from day to night and thus save on heating bills. A matt black surface will absorb 95% of solar radiation and surprisingly, blue follows a close second at around 90%.

A roof pond (Figure 6) can provide some back-up heating in winter and cooling in summer. Sunlight is collected during the day in winter to heat the water. At night when the covers are over the water, heat escapes through the ceiling by radiation. In summer the reverse effect can be adopted, keeping the white insulating covers over by day, the cool water will absorb heat from the room. The water then releases its energy to the cool atmosphere at night with the covers removed.

An essential design consideration for a roof pond is the strength of the ceiling and the water seal. Ribbed steel could be used as it serves the purposes of strength and an increased surface area for re-radiation of heat into the building. Again it would be advisable to segment and contain the water in black vessels or bags to minimise the problems of leaks and to ensure maximum absorption from the sun. Open water not only has the disadvantage of evaporation and deposition from rain but suffers from an unacceptably high reflectivity, what physicists might call an

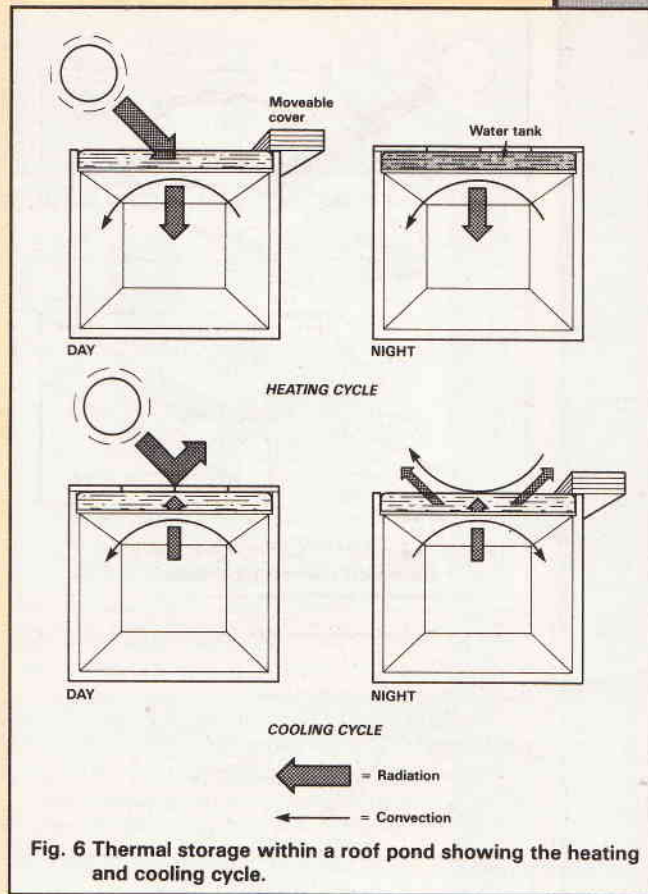

Fig. 6 Thermal storage within a roof pond showing the heating and cooling cycle.

impedance mismatch. A thin black layer over the surface of the water should go some way to compensate for this.

Clerestory Lights And Atria

Clerestory windows are vertical windows in roof lines and provide two functions. They provide much needed light for interiors of buildings and also passive solar heat. Much to be gained from the winter sun, the clerestory is an under-used component in a typical structure. Figure 7 shows that the winter sun will provide the light for the room and the heat within a rear storage wall. A shading lip over the window

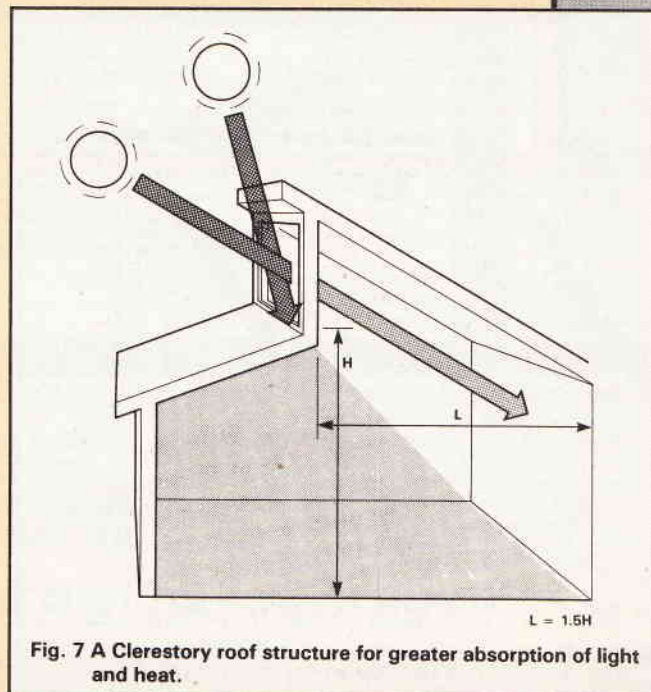
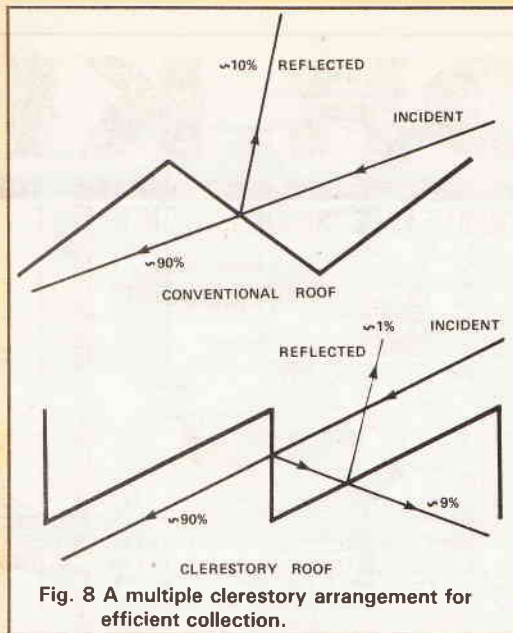

Fig. 7 A Clerestory roof structure for greater absorption of light and heat.



minimises entry of the midday summer sun and the ratio of L to H is adjusted to give maximum sun coverage over the rear wall.

Multiple clerestories will gain an extra 9% of collected energy from the sun in roof structures by using a sawtooth arrangement (Figure 8). The initial reflected energy is captured by the adjoining glass.

Simple shading of windows for the noonday

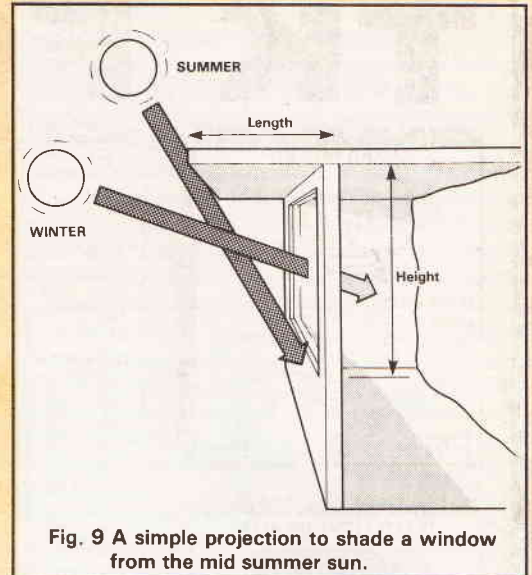

summer sun can be incorporated into a building. A horizontal projection over the window (Figure 9) will allow winter sunlight to enter the window and curtail some of the maximum heat in the peak of summer.

Traditional shutters over windows could be utilised to reflect sunlight into the house. The same goes for reflective covers over rooflights (Figure 10). A finer point when designing houses, can be through

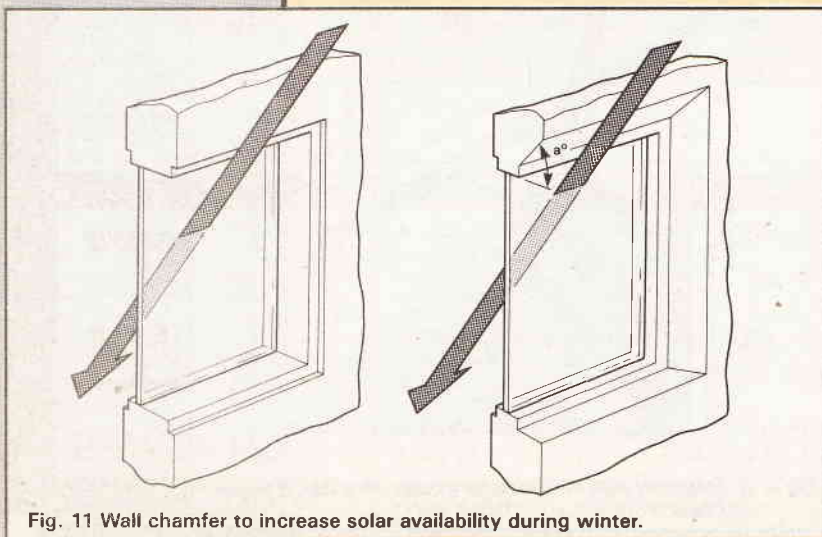
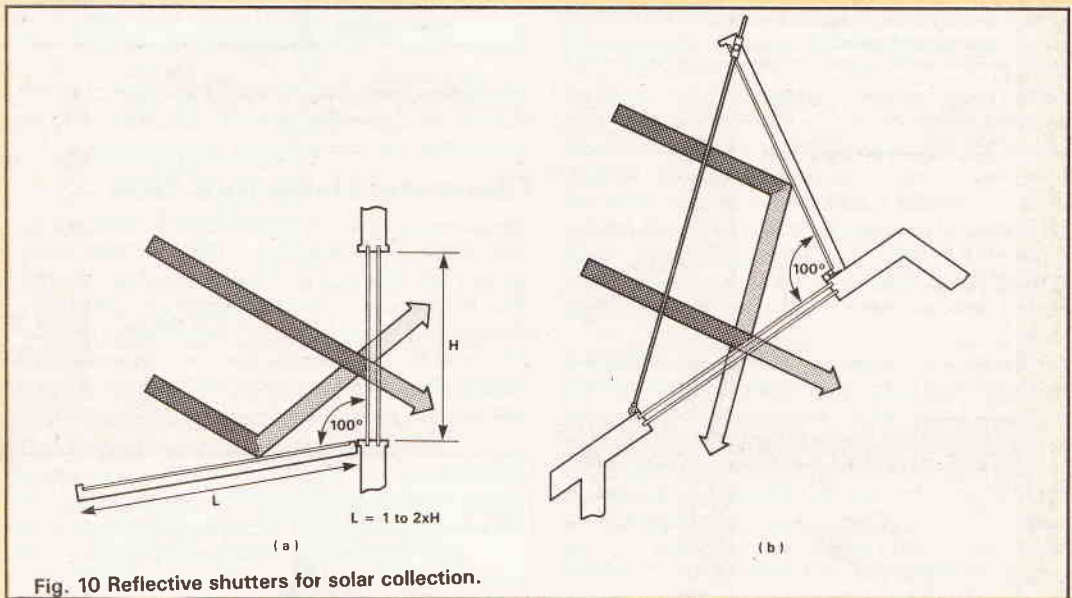

sloping the wall above a window (Figure 11). This increases the available sunlight in winter.

We might also see the rise in popularity of atria in domestic houses, where considerable energy savings can be made in electric lighting. By making central parts of the roof line transparent usually with structures of glass, the inner parts of the building are opened up to receive the extra heat and light. Further innovative research into light-ducting and light-guide, getting the much needed light into difficult central areas and underground, would complete a chapter in saving energy within buildings.

If Britain is to make serious energy savings in the hope of reducing electric power consumption and thus pollution, then we need to think carefully about incorporating carefully designed solar houses as standard. For the generating companies, it will pay to conserve in every aspect of electricity consumption, and delay the day when the 'Greens' say, "We told you so" regarding the 'greenhouse effect'.

TK FOR KITS

GUARD DOG KIT



One of the best burglar deterrents is a guard dog and this kit provides the barking without the bite! Can be connected to a doorbell, pressure mat or any other intruder detector and produces random threatening barks. Includes mains supply and horn speaker.

XK125

£21.95

PROGRAMMABLE ELECTRONIC LOCK KIT

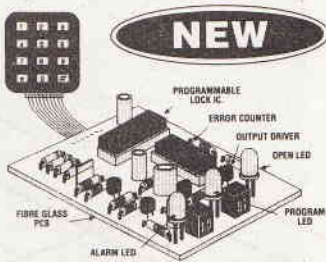

Keys could be a thing of the past with this new high security lock. Secure doors to sheds, garages, even your home or prevent the unauthorised use of computers, burglar alarms or cars. One 4-digit sequence will operate the lock while incorrect entries will sound an alarm. The number of incorrect entries allowed before the alarm is triggered is selected by you. Further entries will be ignored for a time also set by you. Only the correct sequence will open the lock and switch off the alarm. The sequence may easily be changed by entering a special number and code on the supplied keyboard. Kit includes; keyboard, alarm buzzer, high quality PCB and all electronic components. Supply 5-15V DC. Will drive our Latch Mechanism (701 150 @ £16.50) or relay directly.

XK131

£19.95

SUPER-SENSITIVE MICROBUG

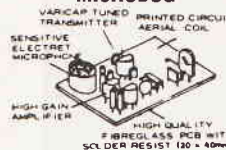

Only 45x25x15mm, including built-in mic. 88-100MHz (standard FM radio). Range approx. 300m depending on terrain. Powered by 9V PP3 (7mA). Ideal for surveillance, baby alarm etc.

£6.35

DISCO LIGHTING KITS



DL8000K 8-way sequencer kit with built-in opto-isolated sound to light input. Only requires a box and control knob to complete **£39.95**
DL1000K 4-way chaser features bi-directional sequence and dimming 1kW per channel .. **£23.95**
DLA/1 (for DL & 1000K) Optional op-to input allowing audio 'beat/light response' **95p**
DL3000K 3-channel sound to light kit, zero voltage switching, automatic level control and built-in mic. 1kW per channel **£19.55**
XK139 Unidirectional chaser zero voltage switching and built-in audio input **£12.95**

POWER STROBE KIT

Produces an intense light pulse at a variable frequency of 1 to 15Hz. Includes high quality PCB, components, connectors, 5Ws strobe tube and assembly instructions. Supply: 240V ac. Size: 80x50x45.
XK124 STROBOSCOPE KIT. £17.25

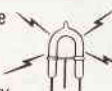

SIMPLE KITS FOR BEGINNERS

Especially aimed at the beginner. Have fun with your project even after you have built it and also learn a little from building it. These kits include high quality solder resist printed circuit boards, all electronic components (including speaker where used) and full construction instructions with circuit description.



SK1 DOOR CHIME plays a tune when activated by a pushbutton **£4.50**
SK2 WHISTLE SWITCH switches a relay on and off in response to whistle command **£4.50**
SK3 SOUND GENERATOR produces FOUR different sounds, including police/ambulance/fire-engine siren and machine gun **£4.50**

XK118 TEN EXCITING PROJECTS FOR BEGINNERS this kit contains a solderless breadboard, components and a booklet with instructions to enable the absolute novice to build ten fascinating projects including a light operated switch, intercom, burglar alarm and electronic lock. Each project includes a circuit diagram, description of operation and an easy to follow layout diagram. A section component identification and function is included, enabling the beginner to build the circuits with confidence **£17.25**

REMOTE CONTROL DIMMER KIT

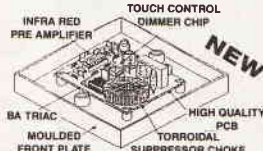

Imagine controlling the brightness of your lights or switching them on or off from the comfort of your armchair! This kit contains all the components from front panel to the last screw to enable you to do just that and fit the shallowest wall boxes. Max power 300W (not fluorescent).
XK132 £19.95

IR TRANSMITTER KIT

Designed for use with the XK132 and comes complete with a pre-filled box. A PP3 9 volt battery is required.
Mk 6 £4.95

XK136 TOUCH DIMMER KIT £12.96

VERSATILE REMOTE CONTROL SYSTEM

These kits can switch up to 16 pieces of equipment on and off or control 16 functions depending on the keyboard selected for the MK18 transmitter. MK12 receiver has 16 logic outputs and operates from 12 to 24V dc or 240V ac via the transformer supplied. The MK18 requires a 9V battery and keyboard. Great for controlling lights, TVs, garage doors etc.
MK12 IR Receiver £19.55
MK18 Transmitter £8.95
MK9 4-Way Keyboard £2.75
MK10 16-Way Keyboard £7.95
601 133 Box for transmitter £2.95

ELECTRONIC WEIGHING SCALE



Kit contains a single chip microprocessor. PCB, displays and all electronics to produce a digital LED readout of weight in Kgs or Sts/Lbs. A PCB link selects the scale-bathroom/two types of kitchen scales. A low cost digital ruler could also be made.
ES1 £8.25

VOICE RECORD/PLAYBACK KIT

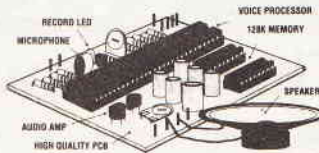

This simple to construct and even simpler to operate kit will record and playback short messages or tunes. It has many uses - seatbelt or light reminder in the car, welcome messages to visitors at home or at work, warning messages in factories and public places. In fact anywhere where a spoken message is announced and which needs to be changed from time to time. Also suitable for toys - why not convert your daughter's £8 doll to an £80 taking doll!!
 Size 76 x 60 x 15mm
 Message time 1-5 secs normal speed, 2-10 secs slow speed
XK129 £25.95

PROPORTIONAL TEMPERATURE CONTROLLER KIT



Uses 'burst fire' technique to maintain temperature to within 0.5°C. Ideal for photography, incubators, wine making, etc.
 Maximum load 3KW (240V AC). Temperature range up to 60°C.
 Size: 7x4x2.5cms. **XK140 £8.95**

TK ELECTRONICS

TK ELECTRONICS
13 Boston Road
London W7 3SJ
Tel: 081-579 9794
Fax: 081-566 1916

ORDERING INFORMATION All prices INCLUDE VAT. Free P & P on orders over £60 (UK only), otherwise add £1.15. Overseas Customers divide total order by 1.15 then add P & P: Europe £3.50, elsewhere £10.00. Send cheque/PO/Visa/Access No. with order. Giro No. 529314002. Local Authority and educational institutions orders welcome. Shop Open: Tuesday-Thursday 10 am - 5 pm. Saturday 10 am - 4 pm.



ORDERS: 081-567 8910 24 HOURS

1

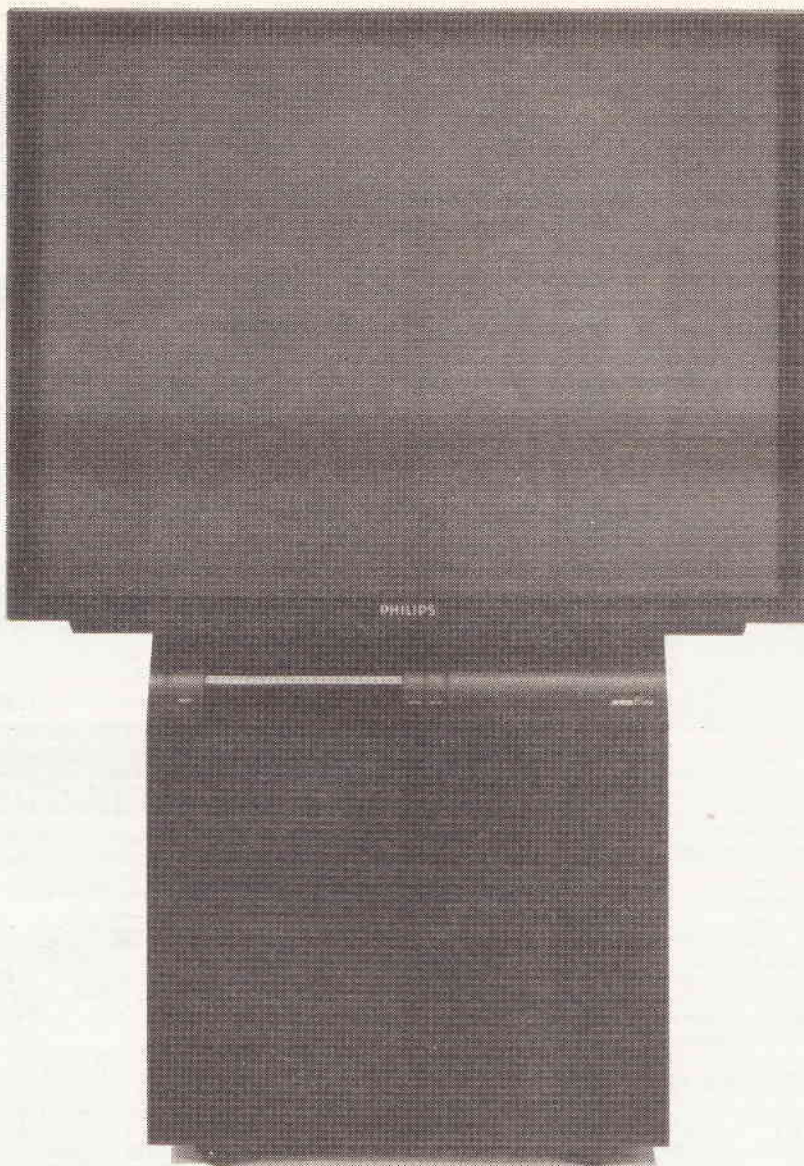

HIGH DEFINITION TELEVISION

The road towards a better system

Is there a need for better quality television? It is probably true to say that most present-day television viewers are quite satisfied with the technical quality of their television reception, although their views on the quality of the programme material would be very much more diverse. It is even true to say that most viewers are satisfied with a quality rather less good than that provided by the broadcasters. The CCIR grading scale for the subjective assessment of pictures grades pictures from one to five, using the following definitions:

Grade	Quality	Impairment
5	Excellent	Imperceptible
4	Good	Perceptible but not annoying
3	Fair	Slightly annoying
2	Poor	Annoying
1	Bad	Very annoying

Whereas broadcasters strive to provide pictures of as near to grade five as possible, and viewers can usually achieve something better than grade four in a domestic environment fitted with a good-quality receiving aerial and properly adjusted receiver, many viewers are equally happy to watch programmes that have been recorded on a VHS video recorder. The typical VHS machine provides pictures that are no better than grade three, and yet viewers regularly demonstrate that they are content with this quality of picture by repeatedly going along to the local video shop and renting a tape, handing over real money on each occasion. In these circumstances one has to ask whether there is a demand from viewers for something better than they have now, and the probable answer is that currently there is not; the average viewer, watching television in the living room on a 59cm diagonal screen, is quite content with the quality of the picture signals received from the broadcasters.

If the size of the television display is increased,

In the first of a series, James Archer presents the case for HDTV.

however, whether by using larger tubes or projection techniques, even the least expert viewer starts to notice that the picture quality seems worse; the scanning lines are visible, and the colour appears fuzzy. This suggests that it would probably be possible for the television industry to sell a higher quality system to viewers, if the assumption could be made that the screen sizes of future television receivers are going to be larger than they are at present.

This is not a straightforward assumption, since fashion and the size of modern homes, as well as the receivers that are available in the shops, play a part in the viewer's choice of receiver. When colour television was first introduced into the UK in the late 1960s, the colour television receiver was an item to show off and to boast about, and many families who could afford a large screen receiver would ensure that it was placed in a prominent position in the room.

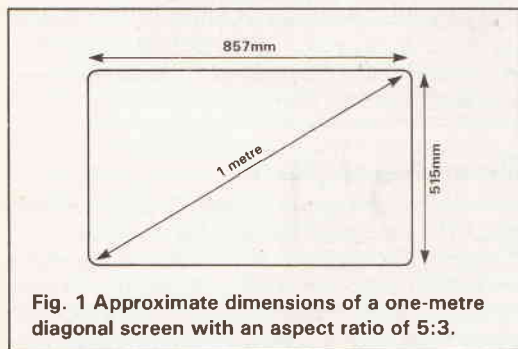

Fig. 1 Approximate dimensions of a one-metre diagonal screen with an aspect ratio of 5:3.

Since the late 1970s, however, there has been a falling off of large screen (26" or 66cm) sales in the UK, but it is difficult to decide whether this is because smaller sets are significantly cheaper, or whether it is merely that the fashion has changed, and that it has now become socially more acceptable to relegate the television receiver to a less prominent position in the home: rising sales of 14" portable colour receivers suggest that more and more families are buying several sets, so that teenagers can watch their own programmes in their own rooms, for example.

Recent trends from the United States and demonstrations of larger screen television receivers in stores and at exhibitions are suggesting that the time may now be right for an increase in the sales of larger screen receivers. Some European manufacturers have reported that they have sold significant numbers of 32" receivers in the last couple of years, but even so, it is believed that these sales represent less than one percent of all colour receiver sales, and most of these large receivers have gone into hotels and industrial training areas.

In 1989 the IBA carried out a small survey of about 1000 people who watched enhanced and high-definition television pictures on large screen monitors at an exhibition. It was interesting to find that in spite of the fact that many people said that they would like large screens, in general; the viewers placed improved quality (clearer, sharper pictures) before larger pictures in their order of preference.

The acceptability of television pictures in terms of quality is a fairly complex matter, and much work has gone into investigating it. Some of the important factors, in relative order of significance, are:

1. Programme content
2. Display phosphor resolution
3. Display persistence
4. Viewing distance
5. Numbers of scanning lines

It is interesting to see that by no means all of these factors are technical; if the programme material is attractive enough to the viewer, the actually technical

quality may be disregarded. Examples of this have been noted when audiences have shown themselves very willing to watch pornographic material that has been recorded by amateurs and is of very poor technical quality, and when low-quality 'pirated' versions of the latest movies have been available on the video black-market. Time and again it has been found that it is the programme content which matters, and those engineers who are convinced that high definition television will succeed purely because of its technical brilliance should continuously remind themselves of this basic fact.

Satellite broadcasting will provide the first real test of whether viewers will be prepared to pay for an improved quality picture. Viewers in the UK have just been given the choice between receiving satellite programmes radiated in the PAL system, and those radiated using the higher-quality MAC system, and similar situations are occurring in some parts of Europe. The Astra satellite, a medium power (45 watts) distribution satellite, radiates six PAL channels in English, and viewers have been able to buy 60cm dishes and suitable receiving equipment for about £199 since early 1989. Since the spring of 1990 the official UK Direct Broadcast Satellite, Marcopolo I, owned by the British Satellite Broadcasting company, BSB, provides five different programme channels using the higher-quality MAC system, and its film channel can actually broadcast wide-screen MAC pictures to the very few viewers who currently have the necessary special widescreen receivers. The French company Thomson has plans to make these receivers more widely available during the next couple of years, but it seems that they will inevitably be rather expensive.

Wide-screen viewers apart, BSB viewers will have the chance to watch MAC pictures in their own home, and should be able to take advantage of the

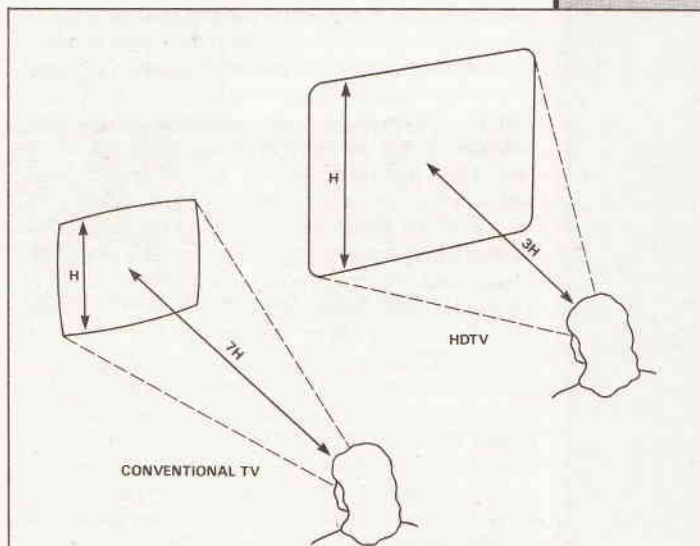

Fig. 2 Comparison between viewing distances of standard television and large screen television in terms of screen heights.

improvements which this system can bring. The most obvious improvement over PAL is the lack of spurious cross-colour patterns, but broadcasters rarely get any complaints about this from viewers using the terrestrial PAL transmitters, and it remains to be seen whether the better picture quality available will actually make viewers choose MAC rather than PAL. It seems to me to be far more likely that their choice will be made on the basis of the programmes that the two competing satellites offer, rather than on any difference in technical standards.

HDTV – WHAT DO WE MEAN

Before we go on to examine various possible systems in detail, it is sensible to ask what is meant by HDTV, and rather than looking at the various official definitions, it is perhaps appropriate to ask what we would expect of an HDTV system that our current systems do not provide. The four major features that any HDTV system would require can be summarised as:

1. Large screen size
2. Wider aspect ratio
3. Better resolution
4. Lack of spurious effects

We shall now consider these points in turn.

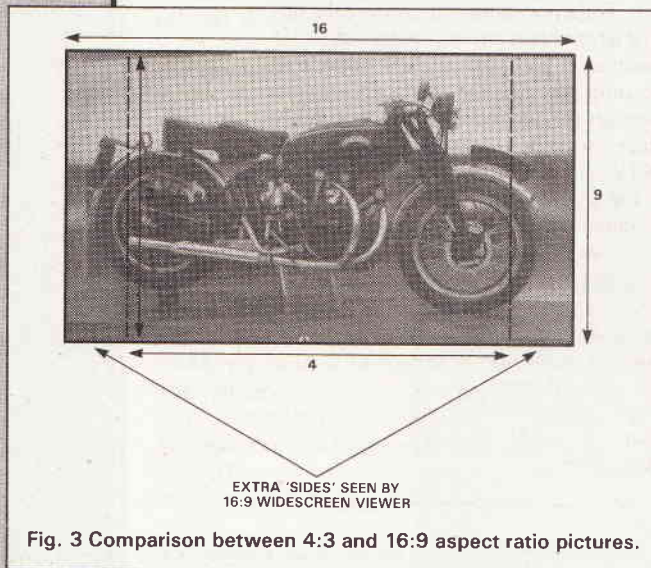

Fig. 3 Comparison between 4:3 and 16:9 aspect ratio pictures.

Large Screen

Although at the present time the practicability of achieving large screen displays in the home at prices that the consumer will be prepared to pay is a subject of much discussion, those who believe in HDTV are convinced that large screen displays will become available. Just how large is another question; it seems that there may well be two distinct large screen markets, the first using money-no-object giant screens for use in the electronic cinemas of the future, the second using screens of perhaps 1 metre diagonal, which would become the norm in the living rooms of the future. Most experimenters in the field of HDTV have chosen this size as representative of what may be both practicable to manufacture and acceptable in the home within the next few years. If we assume that the cathode ray tube display will continue to be the norm, and that is by no means certain, then an extension to perhaps 1 metre from the largest present day 68cm tubes seems feasible, and if the development of flat screen displays should make screens of this size practicable within the next few years, then a 'picture on the wall' with a 1 metre diagonal is probably as large as most people would want. If such a screen had an aspect ratio (the ratio of the width to the height of the picture) of 5:3, as will be suggested later, then the screen would be about 86cm wide by 52cm high.

Viewing Distance

The size of picture that is acceptable in the home is intimately connected with the viewing distance. The most popular screen size in the UK throughout the 1980s has been 56cm (22 inch), the figures representing the size of the diagonal of the picture tube. The height of such a screen is about 36cm, and the aspect ratio is 4:3. In current television systems it is

recommended by the CCIR that for critical viewing the viewer should sit between four and six times the screen height (4H-6H) from the television screen. These figures are intended to apply to professional viewers who are assessing the technical quality of pictures, but a survey in the early 1980s showed that the average domestic viewer actually watched from a distance of more than 7H. If we make the reasonable assumption that our room sizes are unlikely to change in the short term, then if larger screens are introduced into our living rooms we will be unable to avoid effectively sitting nearer to the screen in terms of screen heights. Practical tests suggest that if a viewer is watching a 1-metre screen in the home, the most pleasing results are obtained when the screen is at a distance of 3H from the viewer, and interestingly enough, cinema buffs say that it has long been known that the best seats in the cinema, the stalls, are those which are situated at a distance of about 3H from the screen. Research into cinema layouts in the USA that was carried out way back in the 1950s confirms this, since it showed that the centre of the auditorium was on average just over 3H from the screen.

Wider Aspect Ratio

Those involved in research into HDTV are convinced that any future system must provide the viewer with an experience closer to that which is currently obtained at the cinema. Work in Japan showed that when people were shown a selection of pictures with different aspect ratios, then, in general, the larger the screen, the wider the aspect ratio that was preferred. In particular, when viewers watching one metre diagonal screens from a distance of 3H were offered pictures with various different aspect ratios, they chose aspect ratios of around 5:3 as the most pleasing. The first experimental HDTV systems therefore used 5:3, but following subsequent work in America which also took into account the various aspect ratios currently used for cinema film displays, this has now been superseded by the slightly wider-screen aspect ratio of 5.33:3, or 16:9. It is believed that 16:9 will make the best use of the numerous existing cinema film formats when these films are used as HDTV source material.

It is interesting to note that the classical artists of ancient Greece used a ratio of 1:0.618 as the one found most pleasing to the eye, based upon their so-called 'golden section', and this ratio turns out to be just a little over 5:3.

Watching a 16:9 aspect ratio picture at a distance of 3H gives a far more cinema-like effect than watching a relatively small screen from 6H.

One other factor about receivers with different aspect ratios that is relevant to the commercial market, although rarely mentioned in the technical pages, is that such receivers will actually look noticeably different from normal standard receivers. Marketing people think that this would appeal first to the 'Super-Joneses' and then to the 'Joneses', and they like to think that this will be a significant factor in developing wide-screen receiver sales; "Widescreen is great — you can tell the difference even when the receiver is switched off!" said one salesman at a recent seminar.

Better Resolution

Present-day pictures run out of resolution when it comes to very fine detail, and if 525 or 625-line pictures are shown on large screen, by projection for example, this lack of resolution becomes obvious and annoying. We could make use of more detail in pictures if some means could be found of providing this.

In order to try to calculate the amount of detail that the human eye/brain combination can actually make use of, we have to first of all look at the characteristics of the eye. Under conditions where a test chart is well illuminated the resolving power of the eye is limited to about 30 seconds of arc, or an angle of one half-minute. This is equivalent to saying that the eye can resolve about 60 cycles per degree of arc, which is the more usual method for television engineers to measure resolution.

At a distance of 3H from a one-metre diagonal screen the vertical angle subtended by the eye will be about 19°, as shown in Figure 4.

If we are to design a television system to match this resolution on our screen we therefore need 19° × 60 cycles per degree, which equals about 1140 cycles per picture height. In order to display this number of cycles we need a minimum of two lines per cycle, so that a minimum of about 2280 lines would seem to be required for an HDTV system that matches the resolution of the eye.

Fortunately, it turns out in practice that this number of lines is not actually necessary. Subjective tests have been carried out to determine the optimum number of scanning lines required and these have shown that, under the viewing condition described earlier, the line structure cannot actually be seen when the number of lines is greater than about 1000. Very small improvements in the sharpness and detail visible in the picture were noticed when the number of lines was increased further, but virtually all expert observers now agree that if a viewing distance of 3H is used, a figure of just over 1000 lines will be very acceptable.

Picture Frequency – Temporal Resolution

A television receiver displays what appear to the eye to be moving images, but these are actually a series of individual fields or frames which can be considered as samples of the complete picture taken at regular intervals of time. For any acceptable television system, and certainly for a high definition system, the series of samples must be capable of reproducing movement without jerkiness, and must also provide pictures without flicker and without annoying effects such as interline flicker, which is caused on an interlaced picture by the scanning lines of the two different fields interacting with horizontal edges in the picture.

For smooth motion portrayal it has been found that a repetition rate of greater than 45Hz is required. Television pictures to date have used interlaced scanning to give the effect of a greater number of pictures per second whilst using a smaller bandwidth than would be required without interlace. Both the 50Hz and 60Hz field rates used in the different parts of the world will therefore satisfy the motion portrayal requirement under most circumstances, although some work has been done which suggests that the relatively long exposure period of each television field can lead to a form of blurring which is particularly noticeable when the eye tries to follow moving objects such as a racing car speeding around a track. In general, however, the eye/brain combination does not try to resolve fine detail in fast moving objects, so that the 50Hz and 60Hz field rates should be satisfactory.

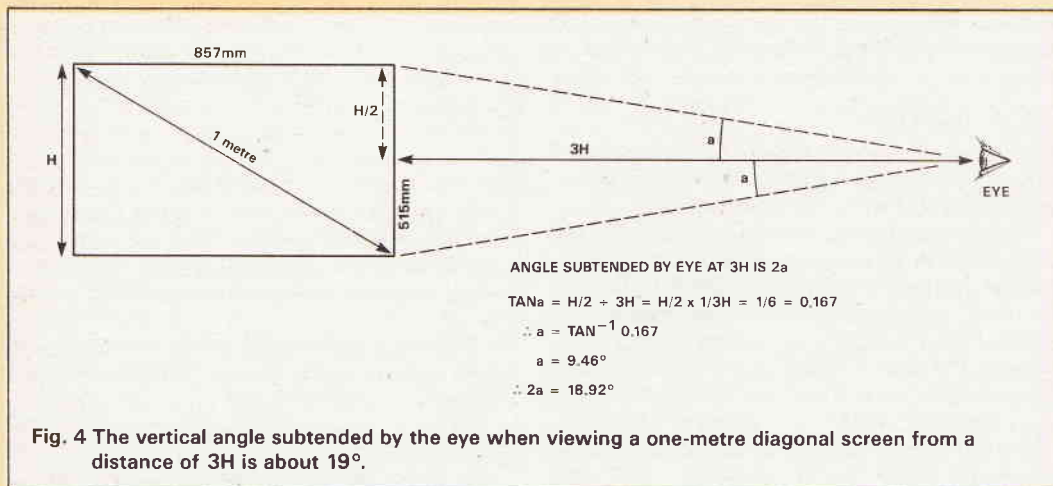

In general, it is found that the sharpest pictures are obtained when the horizontal resolution matches the vertical resolution, and the two are usually related by a simple formula which takes the aspect ratio of the picture into account.

Chrominance Resolution

Another resolution problem with our present system comes about as a result of the low chrominance bandwidth that systems like PAL use. The PAL system effectively provides a detailed black and white picture with a much fuzzier colour image superimposed, and this is a state that the eye normally finds quite acceptable. There are some occasions, however, notably when red captions are shown on a green background, for example, where the chrominance bandwidth can be seen to be short of something — the edges of the coloured captions appear all fuzzy. An increase in chrominance resolution would provide a useful improvement in this case, and in pictures of flower gardens and the like.

Large area flicker is a different matter, however, since tests have shown that for very bright images it is necessary to use a field frequency of around 80Hz if flicker is to be completely eliminated. The increased cost of using 80Hz in terms of bandwidth and the increased complexity of production equipment have led most workers in this field to conclude that 60Hz, and even perhaps 50Hz, will represent the same sort of workable compromise as did 1000 lines rather than the 2200 theoretically required. Technical improvements in receivers will soon allow for several incoming fields to be stored in a semiconductor memory, and for the actual displayed picture to be read out from the store at perhaps 100Hz, after some processing of the moving parts of the picture. The display frequency will therefore be independent of the transmitted signal frequency.

Interline flicker, which is seen as a series of small vertical movements on horizontal edges in interlaced displays, is noticeable even on 50Hz and 60Hz displays, and although the annoyance value reduced as the number of lines is increased it may well be that

the eventual goal of an HDTV picture should be to display a non-interlaced, sequentially scanned picture.

Kell Factor

In 1940, Kell of RCA carried out work on the subjective and objective resolution of television displays, and we now describe the result of a combination of features at both source and display which limit resolution as the Kell Effect. This is defined in the International Electrotechnical Vocabulary as 'the ratio between the maximum number of horizontal lines distinguishable in the reproduced picture and the number of scanning lines in the raster'. This effect on vertical resolution has come to be seen as particularly relevant to HDTV studies, and it is important to notice that we are not referring just to the physical limitations of a system, but also to the perceived effect of those limitations, in essence, what the visual system can distinguish. One of the most significant aspects of these limitations is line interlace.

Interlace

All other features of a television display being equal, a sequential display will provide a subjectively sharper picture than an interlaced display, and the difference is surprisingly large, meaning that an interlaced display needs about 1.5 times more lines to subjectively produce the same resolution as a sequentially scanned display. As an example, a 625-line per frame display with sequential scanning (all 625 lines scanned one after the other at twice the normal rate) will give the same subjective effect as a standard interlaced display with some 940 lines. This is an important feature which is largely based on the averaging that the eye performs between lines and over fields. The process is believed to be largely to do with the persistence of vision, and the inability of our visual system to distinguish between the interlaced lines from alternate fields presented every fiftieth of a second. In practical terms if the viewer is presented with a grating which has progressively finer and finer detail in the vertical plane, there will be a limit at which the eye can no longer distinguish detail, i.e. the difference between adjacent lines in the grating. This threshold is extended if sequential scanning is used. This is the basis of some of the European arguments for an extended definition television system which uses the advantages of sequential scanning to provide an improved system compatible with the existing 625-line services.

Lack Of Spurious Effects

The most noticeable effect of this type is cross-colour. The PAL television system transmits both the colour and the black and white parts of the picture at the same time, using frequency - division multiplexing. The colour information is effectively interleaved with the black and white picture as it is transmitted, and the receiver has the job of sorting out the colour signals from the black and white and then reassembling them to form a complete colour picture. Most viewers are familiar with this effect when finely striped shirts or checked suits cause spurious coloured patterns which move about with any picture movement. The same problem in reverse, so to speak, occurs when there are sharp colour transitions in the picture. The luminance information breaks through into the chrominance channel, causing a fine crawling dot pattern, known as cross - luminance.

Any higher quality television system should ideally be free of both of these effects.

The Beginnings Of HDTV

It was as long ago as 1974 that the Japanese broadcaster NHK, the public service broadcasting equivalent of the BBC in the UK, began work on a system of high-definition television, and they were joined by Japanese broadcasting equipment manufacturers shortly afterwards. Their system, developments of which have come to be known as Hi-Vision, uses 1125 interlaced scanning lines and 60 fields per second.

In essence this system provides extremely high quality pictures even on cinema-sized screens, and by the early 1980s the Japanese were able to offer a complete range of broadcast equipment using this system. Cameras, telecines, videorecorders, mixers, monitors, and projectors were all designed and developed to work with the 1125/60 system, but although the 1125/60 system represented a huge leap forward in picture quality, it also had and still has two major disadvantages. Firstly, and probably most importantly, the system is significantly different from any of the world's existing television standards, which means that anyone wishing to make use of the better quality pictures needs to buy an expensive new receiver, and also that viewers with existing receivers will not be able to make use of the 1125/60 pictures, without very complex conversion equipment which seems unlikely to be economically practicable.

The second problem with this HDTV system is that it requires large amounts of bandwidth to carry all the extra information that is needed to provide the excellent pictures which the system can undoubtedly provide. For the highest quality transmission a video bandwidth of around 30MHz is required, compared with the 5 MHz needed for most European PAL and SECAM systems. In radio frequency transmission terms this means that an HDTV picture of this type would take up four to five times the transmission bandwidth required by conventional systems, so allowing a typical DBS satellite, which has the bandwidth to carry five standard pictures, to carry only one HDTV channel instead. As we shall see later, the Japanese have worked hard on this problem, and have developed a 'black-box' known as MUSE, which can overcome this bandwidth problem at the cost of some deterioration in the final picture quality; whether this will provide an acceptable solution in the long term still remains to be seen.

Several other broadcasting organisations around the world, and notably the BBC in the UK, had research programmes looking at future HDTV possibilities, but only the Japanese actually went ahead and developed a complete working system. NHK is compelled by the Japanese government to spend around 1.8% of its total turnover on research; it has been estimated that up to the present time NHK has invested some \$300,000,000 in its Hi-Vision project, and that the various Japanese manufacturers have also spent a similar amount. The fact that only Japanese HDTV equipment was available for sale led to a situation where in 1984 the Japanese submitted their 1125/60 HDTV system to the world standards making body for broadcasting, the CCIR, asking for it to be ratified as *the* world standard for high definition television.

This concentrated the minds of the rest of the world's broadcasters who had an interest in HDTV and encouraged them to focus upon what the acceptance of the Japanese standard would mean in real terms. It was felt by many that the acceptance of the Japanese system would inevitably give the Japanese manufacturers an unassailable advantage when it came to the supply of broadcasting equipment, right through from studios to transmitters, and in a world

where many of the television receivers already come from Japanese sources, this would be going too far. Several of the most influential American broadcasters originally supported the adoption of the Japanese system as a world standard, on the practical grounds that it was the only system actually up and running, as opposed to the various laboratory concepts favoured by other broadcasters. The system was actually officially adopted in 1988 as the recommended HDTV production standard by the American Advanced Television Standards Committee, which accepted the proposals prepared by an SMPTE working group and proposed to submit the decision to the American National Standards Institute. Although this proposal was agreed by a majority of the forty-five organisations in membership of the ATSC, the support from some of the other major broadcasters was, however, lukewarm, and the National Association of Broadcasters refused its approval; it was quickly realised that the decision to adopt 1125/60 was something of a red-herring. The Japanese based system might be acceptable as a production standard, but as a transmission standard to provide the population of America with higher definition pictures it definitely left a lot to be desired. American companies woke up to the fact that the commercial outcome of accepting the Japanese system might be disastrous for the US economy, and finally decided to look for an improved television system which would be particularly well suited to the needs of the United States.

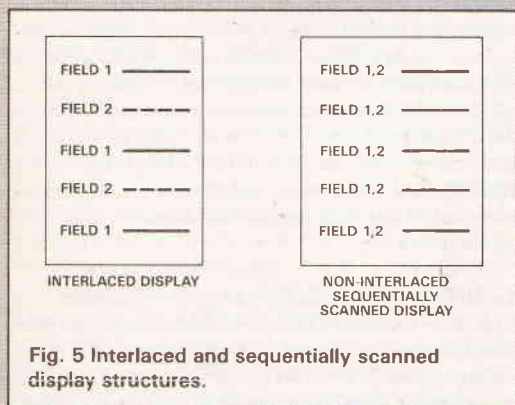

Fig. 5 Interlaced and sequentially scanned display structures.

European broadcasters realised the problems that accepting a Japanese standard would bring commercially, but they were also able to play a technical card to avoid having to vote for the adoption of the 1125/60 system. All European television systems, and about 60% of all the world's viewers use 50Hz (50 fields of 312½ lines per second) a number that was originally related to the 50Hz mains electricity frequency, although there is now no longer any need for a direct relationship between the two. European broadcasters were able to claim that the use of the Japanese 60Hz system would cause various problems, including a 10Hz flicker between mains-powered studio lighting and 60Hz studio production equipment. Although the Japanese explained that they had been using the 60Hz NTSC system in parts of Japan that use 50Hz electricity for over thirty years without any noticeable problems, and although they even designed, built and demonstrated a reasonably effective adaptive 10Hz filter, known as a 'flicker - flicker', it became obvious that Europe was not going to be in favour of adopting the 1125/60 system as the world HDTV standard.

The biggest argument against the adoption of 1125/60 was and is that the system is so vastly different from any existing system, that its lack of compatibility would be a very real problem. This could

mean that those viewers who want and can afford the HDTV services would need to have two television receivers in the same room, since although it will be possible, technically, to include the circuitry for a conventional receiver within the cabinet of the HDTV receiver, this is likely to add a substantial amount to the already considerable cost of an HDTV receiver. Preliminary work in the United States has concluded that a one-metre diagonal receiver is likely to cost more than \$5000 initially, and it suggests that because the single most expensive component will be the cathode-ray tube, the price cannot be expected to fall as quickly as for most electronic equipment, and that receivers with one-metre screens may still cost over \$3000 after five years of production. As far as the price of the receiver is concerned the actual electronic circuitry included in the receiver is considered to be relatively unimportant, so that the price may be little different whether a full HDTV system or one of the many proposed enhanced systems is used.

Reports such as this naturally do their best to extrapolate from the currently known facts, but can take no account of some completely new technology that may, unknown to us, be just around the corner. A lovely example of a new technology changing all previous conceptions came about in the last few years of the last century. From 1850 onwards people were complaining about the rapidly growing amount of horse-manure clogging the streets, and there were various dire predictions that if road traffic kept on growing the streets would be rendered impassable by the depth of the ordure. With hindsight we know that the motor-car came along so that the predicted problem never materialised, although nearly a century later we are finding very different problems due to the growth in the numbers of cars. Let us hope that the television industry can come up with some brand new, cheap and simple method of producing large area displays that will confound those who are predicting that the HDTV receiver will always be a high-cost item.

There are very great difficulties involved in introducing a completely new television system, even if we ignore the technical complications. In order to provide a high-quality service that the viewer would find desirable enough to pay for, any HDTV service will need to provide high-quality programming, and experience with subscription services elsewhere shows that this generally means that recently-released feature films must be offered. Such programme material is very expensive, because of the competition from cinema chains, and it would not be realistic to broadcast HDTV programmes using this material if, in the initial stages, there were no more than a few thousand viewers equipped to receive the service; the cost per viewer would be phenomenal. Far more desirable would be a scenario in which the HDTV transmissions could also be received by the millions of existing viewers on their existing receivers; although they would not gain the benefits of HDTV they would be able to watch the expensive programme material to the normal viewing standards that they expect, and this would enable the programme provider to spread the cost of the film material over millions of ordinary viewers, as well as the relatively small number of those watching in HDTV. Such an approach would also appeal to advertisers, who need to be assured that large numbers of people are watching the programmes which they sponsor or during which they buy advertising time.

It was no surprise, therefore, that the Japanese failed to have their system adopted as the world standard for HDTV, and instead it took its place in the CCIR Reports and Recommendations as a Report.

As indicated earlier, the Japanese proposal stirred Europe and America into action to develop

their own individual proposals. An enormous amount of work has been put into trying to find a common standard for HDTV which all the world's broadcasters will be able to agree upon, but it now looks very unlikely that the members of the CCIR will be able to reach such an agreement, and the most likely scenario for the next few years is that there will be three HDTV standards. These will be the original Japanese 1125/60 standard, a European 1250-line 50Hz standard, and an American standard, possibly 1050-line 60 Hz, which still has to be decided upon. Both the European and American systems have been designed from the outset to provide a substantial degree of compatibility with existing receivers, in order to try to ease the problems of introducing a completely new high-definition system. The European system offers a step-by-step approach to HDTV, with the various intermediate steps providing different amounts of enhancement to the television picture, depending upon the complexity of the receiver being used. In subsequent articles we shall be taking a look at various systems, and also considering the ongoing work to try to bring at least some degree of commonality to the multiplicity of different standards that are to be used.

Terminology

We will end with a look at some of the terminology and definitions which are applied to the various enhanced and high-definition television services, although it must be stressed that in such a fast developing field as this the vocabulary is also changing fast, and some standards bodies have not yet adopted exactly the same definitions as others, which can lead to confusion.

CCIR Definitions:

Enhanced Television

The term Enhanced Television designates a number of different improvements applicable to 525/60 and 625/50 television systems, providing an aspect ratio of 4:3, either with unchanged or new emission standards.

Extended Definition Television

The term Extended Definition Television implies new systems that are based upon 525/60 or 625/50 scanning, but providing a wider aspect ratio and increased resolution.

High Definition Television

A high-definition system is a system designed to allow viewing at about three times the picture height, such that the system is virtually, or nearly, transparent to the quality of portrayal that would have been perceived in the original scene or performance by a discerning viewer with normal visual acuity. Such factors include improved motion portrayal and improved perception of depth.

This generally implies in comparison with conventional television systems:

1. Spatial resolution in the vertical and horizontal directions of at least twice that available with Recommendation 601.
2. Any worthwhile improvements in temporal resolution beyond that achievable with Recommendation 601.
3. Improved colour rendition.
4. A wider aspect ratio.
5. Multi-channel high fidelity sound

Definitions from the International Electrotechnical Vocabulary:

Enhanced Television System

Television system which retains the scanning standards of the existing 625 line 50 field or 525 line 60 field systems, whilst providing various improvements in the quality of the picture and additional features as a result of new processes of analysis, synthesis, and signal processing, with or without modification of the transmission standards.

Extended Definition Television System

Enhanced television system which may include a change in the transmission standards, to obtain effectively greater resolution than existing systems.

High Definition Television System: HDTV

Television system in which the scanning standards are improved over those of the existing 625 line 50 field or 525 line 60 field systems, and in particular the number of scanning lines per image is appreciably higher than in these existing systems and, in principle, higher than 1000.

Definitions from the United States Advanced Television Systems Committee. These definitions refer specifically to developments taking place in the USA, as references to NTSC and to the FCC (Federal Communications Commission) imply.

IDTV – Improved Definition Television

The term Improved Definition Television refers to improvements to NTSC television which remain within the general parameters of the NTSC emission standards and, as such, would require little or no FCC action. Improvements may be made at the source and/or at the television receiver and may include improvements in encoding, filtering, ghost cancellation, and other parameters that may be transmitted and received as standard NTSC in a 4:3 aspect ratio.

EDTV – Extended Definition Television

The term Extended Definition Television refers to a number of different improvements that modify NTSC emissions but that are NTSC receiver-compatible (as either standard 4:3 or 'letter-box' format). These changes may include one or more of the following:

1. Wide aspect ratio.
2. Extended picture definition at a level less than twice the horizontal and vertical emitted resolution of standard NTSC.
3. Any applicable improvements of IDTV.

HDTV – High Definition Television

The term High Definition Television refers to television systems with approximately twice the horizontal and vertical emitted resolution of standard NTSC. HDTV systems are wide aspect ratio systems and may include applicable improvements from IDTV and EDTV. Terrestrial HDTV systems must be NTSC receiver-compatible. This may be achieved through simulcasting or through the use of an NTSC-compatible main channel accompanied by an augmentation channel.

Note that improvements in audio may be incorporated in IDTV, EDTV, and HDTV.

ATV – Advanced Television

A collective term embracing the terms IDTV, EDTV, and HDTV, described above.

TO BE CONTINUED

HDTV

MICROWAVES

2

Last month we began our look at the world of microwaves by explaining the significance of this particular frequency band and indicating some of the more important landmarks in its one hundred year history. Two important applications of the technology were also discussed; microwave ovens and communication equipment. This month we will be concentrating on more applications in such fields as RADAR, astronomy and medicine, to mention but three. The article concludes with a somewhat personal prediction of what I believe the future may hold for the microwave industry.

Radar

Probably the most famous acronym of all standing for Radio Detection And Ranging. It is based on the position, strength, time delay and Doppler frequency shift of the return echo of a transmitted microwave pulse from the target. Radar equipment ranges in size from the enormous military surveillance equipment capable of detecting aircraft from hundreds of miles away, or indeed a bee from hundreds of feet away, down to portable hand-held equipment used by the constabulary or, for use at the sharp end of guided missiles (the radar, not the constabulary!).

The method of operation of the radar is fundamentally quite simple. If a pulse of microwave energy is transmitted from an antenna, and hits some target, a small fraction of that energy will be reflected back to the same antenna. By the time the pulse returns to the antenna, the transmitter is switched off and a very sensitive receiver is switched onto the antenna. Analysis of the returned pulse gives us a considerable amount of information about the target. Firstly, we know the direction of the returned signal. We therefore know the angular (azimuthal as it is known) position of the target with respect to the radar. It is also possible to calculate the height of the target from this information. Secondly, there will be a time delay between the transmitted and the received pulses. From this the distance of the target from the radar can be calculated. Thirdly, there may be a Doppler frequency shift. Hence one can assess the radial velocity of the target. Finally, having obtained all this information, the strength of the returned signal can be measured, and an estimate of the size, and even possibly the shape of the target may be obtained.

With regard to military applications, the question of whether the target is a 'goodie' or a 'baddie' is obviously of some consequence. The usual method is to transmit from the radar antenna an additional signal known as an 'Identify Friend or Foe' or IFF signal. This takes the form of a digitally coded data stream which will be recognised by a friend, but not by a foe. The friend re-transmits a return signal which will be recognised by the radar receiver and any attack procedure would then be aborted. A simple, but extremely effective technique.

One major advance of the last decade has been the implementation of Phased Array Antennas in radar applications. Phased arrays allow the microwave beam to rotate 360°, or 'nod' up and down, electronically. The advantages are enormous. There are no moving parts like motors or bearings. To appreciate the significance, consider the case of a ship-borne radar. The rotating joint supporting the half-tonne

antenna must be able to support the weight as its centre-of-gravity rolls and yaws with the ship's movement; any wear in the bearings will reflect in the inaccuracy of target location. Furthermore, the bearing must be impervious to salt-water corrosion. If that is not enough, the joint must carry, simultaneously, up to three independent microwave signals with negligible reflection or loss at the joint.

The phased-array negates these requirements. The antenna no longer physically moves — only the beam swings. Since it is electronic, the period of rotation is governed by electronic rather than mechanical processes. A rotation speed of one turn per millisecond would be a reasonable expectation from a phased array system, as opposed to one turn

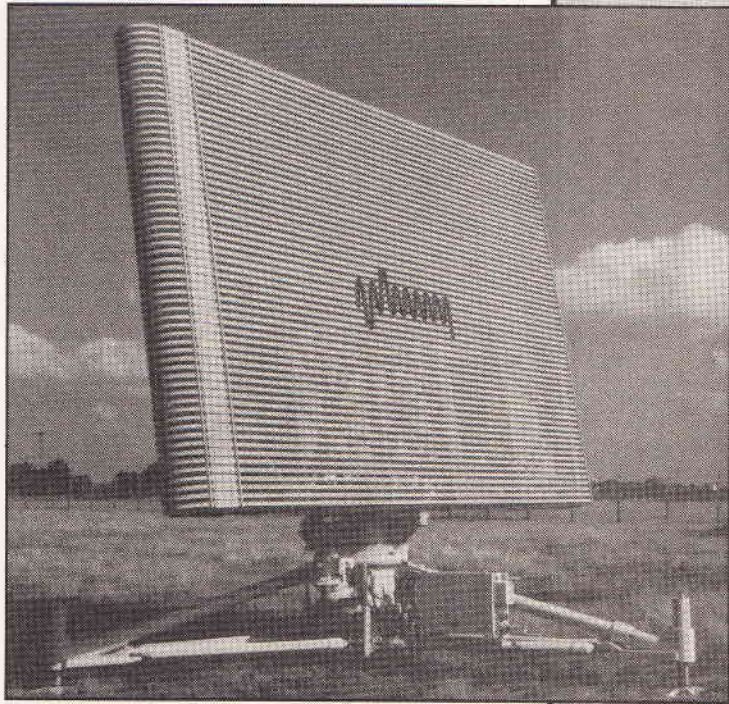

AR 325 'Commander' RADAR

every four seconds from a mechanical system — fast enough to update a computer memory bank at a rate at which it would not get bored!

It is not only the direction of the beam which may be controlled electronically. The beamwidth, or how concentrated the beam is in one direction, can also be controlled. In a purely mechanical system this can only be achieved by shrinking, or expanding the dish! One may be forgiven for thinking that, for radar applications, the more pointed the beam, the better. However if this parameter can be varied electronically, we can totally rethink our target search regime. Instead of searching for the target in a sequential manner at each degree of rotation in turn, we may commence the search with a fast, wide angle, sweep. When suspicion falls on a particular area of the sky due to a weak return signal being detected, a narrower beam may be used, just to check the suspicious area. Change of beam direction can take place near instantaneously — there is no inertia in an electronically swinging beam. By this means, close, fast-moving targets may be detected quickly, and also the possibility of multiple-target detection becomes a reality.

From cooking to television, microwaves are fast becoming an important part of our lives. Colin White looks at the past, the present and the future of the technology



Thematic Mapper image for the Isle of Wight

The operation of phased array antennae are conceptually fairly simple to understand. They consist, not of one antenna, but many (up to 10,000) small antenna elements, normally mounted on the surface of a flat plate, each fed from the one transmitter. If each element is fed with a signal of equal amplitude and equal phase from the transmitter the combined beam from all the elements produces a main beam at right angles to the elements. If the phase of the signal feeding each element is changed, (achieved electronically) the resultant beam will then turn to produce a new equal-phase beam at an angle to the original beam.

With regard to electronic control of the beamwidth, we know that a small antenna (with respect to the wavelength) produces a wide beamwidth while a large antenna produces a narrow beamwidth. We can effectively alter the 'size' of our phased array antenna by attenuating the signals to the outer elements of the array, thus electronically making the antenna smaller and hence producing a wider beam.

Remote Sensing

Remote sensing is principally concerned with attempting to investigate aspects of the earth from space-borne satellites. The technology matured, originally due to the United States' desire to have knowledge of the Russian grain harvest. From this early requirement, remote sensing has turned into a series of techniques and technology which can provide low cost detailed information about almost all parts of the world.

Microwave technology forms but one aspect of the science of remote sensing. Often three types of sensors are used. The first and main sensor will be optical. This usually consists of three cameras, one for each primary colour. This is the only sensor capable of providing a real colour image. The second sensor will be sensitive to only the infra-red part of the spectrum. This camera will detect, primarily 'hot' objects such as cars, buildings, tanks, or large groups of people. The final sensor, the microwave camera,

(an ultra-sensitive microwave receiver) can pick up some hot objects, but is especially sensitive to any form of electromagnetic radiation emissions such as power lines, radar and communication equipment, or even telephone cables. The sensors can detect these emissions within buildings, under water or even from cables buried underground.

Remote sensing satellites are not usually geostationary since there's not much interest in taking pictures of the same spot on the earth's surface! They are normally in what are known as sun synchronous orbit, which means they fly over the earth's surface in such a manner that, to the satellite, it is always the same time of the day. In other words the satellite and the sun appear to move around the earth at the same speed. The time chosen for the Land-Sat family of remote sensing satellites was 9.30am, this being considered as providing the best lighting conditions for the colour photography.

There is much argument over the resolution capabilities of such satellites, it being reported that such military craft can read newspapers, recognise faces, or read the regimental numbers from the uniforms of earthbound soldiers. I do not propose to enter into the theoretical capabilities of such systems, only to report what I have seen. Certainly individual cars (or tanks!) can be seen, as can large (greater than 30) groups of people. River bridges are easily recognisable, and power cables running under water and/or land are observable.

The key to the success of remote sensing technology is not only in the use of high resolution cameras, but also in the data processing of the information once it is beamed down to earth (by microwave link, of course!). Firstly, software error detection techniques are applied to the raw data before any attempt is made to display the picture. Secondly, because all the information is held as data in a computer memory, it can be manipulated in much the same way as pop video effects. All the data from the various sensors are merged to produce a combined microwave/infra-red/optical image in a ratio that gives the best picture for the required purpose. Computer generated artificial colouring is often applied to the picture. Aesthetically, we like the land to be green and the sea to be a lovely shade of blue for instance. If one

is particularly looking for a field of wheat, for instance, once found, it can be highlighted in any suitable bright colour.

One of the more remarkable data processing effects, particularly with the advent of artificial intelligence techniques, is that of pattern recognition. This enables one to locate, say, all the golf courses in a particular area from knowledge of the location of one golf course. The computer merely searches for a match in the radiation spectrum profile of the known area, over the larger search area.

Remote sensing is no longer exclusively used by the military. It is used to aid weather forecasting, to analyse crop harvests, as an aid to navigation, and is also used by city planners and geologists. Recently, with the increased interest in Green issues, Landsat IV has been used to monitor pollution levels, assess levels of fish and livestock and look into the extent of deforestation. The polar ice caps can be seen, thereby monitoring the extent of the 'greenhouse effect'. Landsat IV is in orbit at only 700km and at this height can even resolve the difference between a field of wheat and a field of barley — something I'm not convinced I could even manage at ground level.

Medical Applications

Microwave medical applications employ, in the main, techniques which were developed from other applications such as ovens, radar and remote sensing.

Therapeutic applications involve applying microwave energy to patients such that the affected region of the body warms rather like the microwave oven. Treatment falls into two principle categories, diathermy and hyperthermia.

Diathermy treatment is concerned with the gentle warming of tissue for the treatment of joint and muscle disorders, principally rheumatism and arthritis. The application of heat is a therapeutic procedure commonly used in medicine. A local temperature rise speeds up the metabolic processes, producing a dilation of blood vessels. An increase in blood flow results, together with a better irrigation of the tissues, and a faster removal of wastes and heat. Tissues warmed up in this manner receive more nutrients and antibodies, and the healing process is thus speeded up. At the same time, the pain is reduced and sedative effects are noted. Classical ways to apply heat such as hot packs, baths or paraffin baths reach the surface only — it takes microwaves to reach those parts others cannot reach! The power level and exposure duration are critical factors determined by medical staff with much experience. The moral: don't stick your tennis elbow in your microwave oven, skin burns would be the least of your problems!

Hyperthermia, on the other hand uses higher powers and is used with increasing success for the treatment of cancer. Body cells, whether healthy or malignant, are killed if their temperature is elevated to 43° for 10-15 minutes. It follows that tumours might be destroyed by focusing microwaves on them while cooling the surrounding tissues. Unfortunately matters are not so simple. If a low frequency is utilised, good penetration of the tissue is obtained, but as discussed in the radar section above, efficient focusing of the beam, so important for preventing damage to the surrounding tissue, is impossible. A higher frequency which allows good focusing facilities will not penetrate so deeply due to the high water content of the tissue and blood. Best results of hyperthermia treatment have been reported when combined with other, more established cancer treatments such as chemotherapy and radiotherapy.

The heat of a therapeutic X-ray machine is that of an electron accelerator and a microwave generator,

either a klystron or a magnetron. The microwave power helps accelerate electrons to a high enough energy to generate X-rays when the electrons strike a target. Electron linear accelerators have been widely used for radiation therapy and industrial radiography (a technique employed to detect fatigue and cracks in industrial materials). Modern therapeutic machines are used for cancer treatment by using electrons as well as high energy X-rays.

Microwave Medical Thermometry is a technique, presently in the early stages of development, of measuring the patient's temperature non-invasively (ie without sticking anything into the body!). All material held at a temperature above absolute zero (-273°C) will radiate electromagnetic energy over a broad range of frequencies centred on a frequency dependent on the temperature. Incandescent light bulbs radiate in the visible region for instance. At about 23°C the human body produces measurable radiation in the microwave region which can be detected using sensitive receivers in a similar manner to remote sensing satellites. Because malignant tissue tends to lie at a somewhat elevated temperature, this may be detected without recourse to the more usual invasive methods such as X-ray or ultrasound.

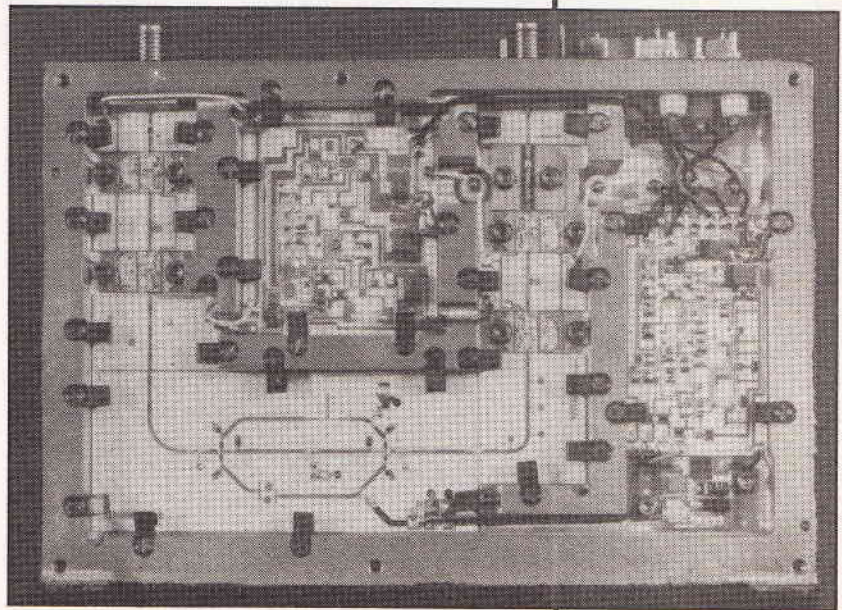

Photo courtesy Racal Electronics

Into The Future

Having charted the progress of the microwave industry over the past 100 years or so, I will now attempt to predict microwave developments up to the turn of the century, and allowing for some scientific licence, into the 21st.

In order to consider these aspects it is necessary to examine in more detail the design and engineering changes which have occurred in the industry over the last 10 years. First, and foremost, the use of computers in the design of microwave circuits and components has changed from an academic concept 10 years ago to an essential design tool of the microwave engineer. Even so, more research must continue in this field. Many fundamental analysis techniques are still not accurately modellable on PCs. Secondly, microwave engineers have had to become far more interdisciplinary than of old. This trend must continue if we are to design some of the equipment I will be alluding to later in this section. Finally, the progress we have seen in the field of materials technology must continue. The 1980s have seen major advancements in the manu-

ufacture of ultra-pure semiconductor materials for use in microwave integrated circuits and very low noise devices. Possible emphasis in the 90s will be on room temperature superconductor devices, and what have become known as quantum devices.

On a somewhat pessimistic note, I predict that the 90s will bring a decimation of the industry. Many microwave companies will simply not be here at the turn of the century. The reason for this funereal attitude is the proportion of the industry which presently lies in the military sector — currently about 90% world-wide, approximately 80% in Britain.

The military electronic market has been hit with two blows. The first was the demise of the 'Nimrod' project. This was an enormous military contract which went enormously wrong! The aim was to develop an aircraft based submarine detection system. However, after years of overspending and extensions to time-scales, the government eventually called a halt to the contract, but only after billions of defence pounds had been wasted. Following the bad publicity this



Central London from remote sensing satellite
Photo courtesy NRSC Farnborough

produced, the whole military contracting system was tightened up. Although in my opinion this was long overdue, unfortunately as a consequence, less money became available for research. We are five years on from the 'Nimrod' affair, but the full repercussions have yet to filter through and reflect in company profits.

Secondly, the changes seen in the USSR and Eastern Europe recently will no doubt, result in a change in attitude in the West which will be reflected in the amount of money required to be spent on defence. The massive defence budgets of the 1950-80s could be a thing of the past.

Which companies survive will depend on how quickly they can change their image, marketing and sales strategy, as well as how accurately they can predict the changing popularities of the various microwave applications. I believe company size will be no advantage during this atrophy — the larger companies, in order to survive, must reduce their administrative inertia and be prepared to plough what resources they have quickly into new and challenging research ventures. They must be capable of gearing up for large production runs of tens of thousands of

units within short timescales, then crash them down at the whim of market forces, ready to begin on other projects. Production lines for military contracts typically took many man-hours to set up, were extremely costly and production runs were often only tens or hundreds of units. This expense was justified on the grounds of military reliability requirements. Each unit was heated, cooled, vibrated, dropped, subjected to nuclear and thermal flashes, and only then, if it was still functional, was it shipped. In contrast, commercial quality control often entails shipping the wretched thing, and if the customer moans, exchange it.

Until recently, microwave electronics has been one of the most expensive technologies. A bipolar transistor costing 8p in the pages of an electronics magazine would cost at least £40 when operation at 4GHz is required. A simple thing like a piece of wire, say, 200mm long, has a negligible cost at dc, but when operation is required at 10GHz, a length of waveguide may be required, costing in the region of £10; at 100GHz, getting on for £100. To be fair, these prices reflect the research and technology costs and also high raw material costs. The fact is, the military market could afford it, the domestic market most definitely cannot.

There is light at the end of the tunnel. Our Rupert, bless his cotton socks, has done to the microwave industry what Sir Clive Sinclair (remember him?) did to the computer industry. A Satcom system for under £200 would have been totally unbelievable even five years ago — the fact that the standard of programmes beamed down are also unbelievable is a shame, but should not detract from the future technical capabilities.

Consequently, I see microwave equipment becoming increasing accessible to the public sector and not just available to those who deal with the sharp end of missiles. The question is, are there sufficient applications to go around once the military market has been pruned to the roots? I believe the answer to be positive if the correct attitude is taken by industry and the Government.

Most of this article has been paying compliment to the remarkable achievements of the last century, but let us stop for one moment and consider what has not been achieved. Some of the non-accomplishments of science are equally remarkable!

We may, for example be able to detect many missiles approaching a target simultaneously, but a vacuum cleaner is yet to be marketed which can successfully detect comparatively static furnishings in a typical lounge and thereby automate the tedium of housework. We can monitor troop and tank movement from space, but, as yet, do not have the technology to warn a driver when he is about to collide with another vehicle. Using direction finding technology from space we can locate, to within metres, an inflatable dinghy in the vastness of the Pacific, yet 5% of all city traffic, at any one time is, in fact, lost! Information transfer of a military, or business nature is incredible, both in terms of quality and quantity, but many areas of the third world are unable to inform us of their plight by any means of communication.

The secret to be the continuance of a successful microwave industry lies in reduction of costs, mass production and research into applications which will appear in the high street store, not military exhibitions. Applications to the end of the century will, however, maintain the methodologies currently used in heating, radar, remote sensing and communications.

Colin White is a lecturer in microwave technology at Portsmouth Polytechnic.

ETI

SERIAL OR PARALLEL LOUDSPEAKERS

When the terms *serial* or *parallel* are applied to a loud speaker it is usually related to the speaker's electrical connections. In this article, however, the terms are used to denote the speaker's acoustic output. To clarify this, most people have heard a speaker system that uses more than one driver for the same frequency. This configuration is an example of the parallel function.

The reason that most listeners are not familiar with the serial function is that it is relatively new and can only be found in speaker systems that use a plastic film for the moving element. To illustrate this technology, this article will describe the theory, operation and construction of an electrostatic or ESL speaker. This knowledge will then be used to show the advantages of a serial speaker.

The primary purpose of a loudspeaker is to convert electrical into acoustic energy. This transfer, in a conventional or electromagnetic speaker, is a function of the force produced by a magnetic field. Basically this type of speaker is made by connecting a coil of wire that has been wound on a form, to a paper or plastic cone. Following this, the coil is positioned inside a magnetic field that is produced by a permanent magnet. As the current from an audio amplifier flows through the coil, it will create another magnetic field. This field, will either produce a force of attraction or one of repulsion. The cone, which is attached to the coil, will follow this movement and the air molecules next to its surface will be excited by the moving cone. As time passes this molecular movement will travel away from the source and be detected by our ears. Our brain will interpret this motion as a sound coming from the speaker.

While the above method of sound reproduction is the most common it is not the only type of transducer that can shift energy from one form to another. Many experts in sound reproduction have discovered the outstanding performance of an electrostatic speaker.

Without knowing anything else about it, the name implies there is a difference between it and the electromagnetic speaker. While a conventional speaker relies on the force produced by a magnetic field, the ESL uses an electric field to accomplish a similar task. Because the electrostatic forces are usually smaller than its electromagnetic counterpart, the material that moves the air molecules is also much lighter.

Historical

The principles which govern the performance of an ESL have been known for many years. Their development, however, was hindered by many problems. In the early days (before the second world war) the limitations were mainly in the materials needed to make the diaphragm. While this problem reduced their commercialisation, it did not stop their development. One inventor solved this dilemma by making the diaphragm out of a cloth that had been impregnated with metallic thread.

The most significant contribution to the development of the ESL was the invention of mylar by the El

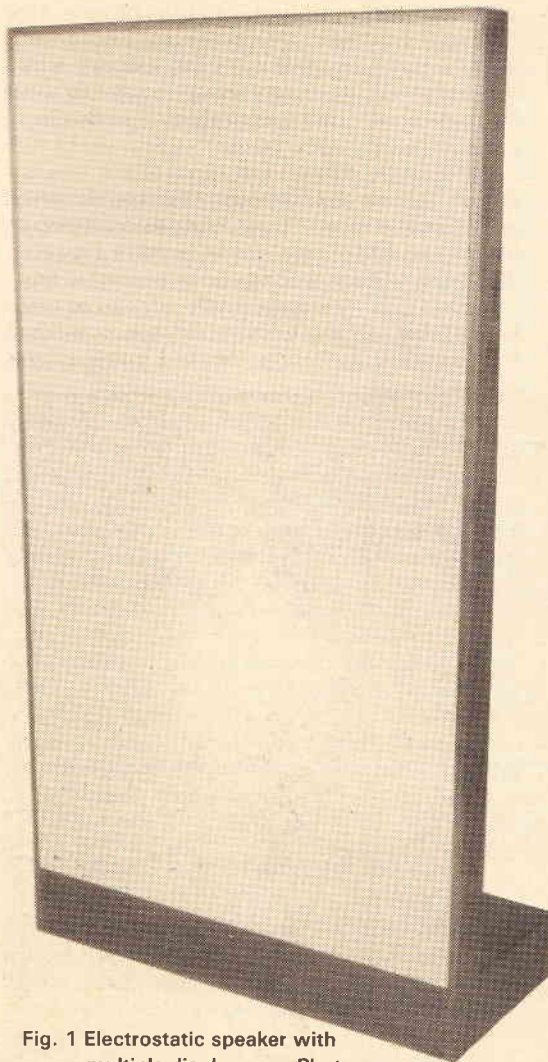

Fig. 1 Electrostatic speaker with multiple diaphragms. Photo courtesy of the Sound Lab. Co. Utah.

Dupont Corporation. This material was patented in 1949. Since that time, most commercial electrostatic speakers have used it for a diaphragm. One of the first was a speaker made by Arthur Janszen. In the early fifties Janszen produced an electrostatic tweeter array. His product was usually paired with a book shelf speaker from Acoustic Research. Later Janszen produced a full range speaker, and it became well-known as the KLH-9.

Another well-known speaker of that era was the Pickering Isophase. It was produced by the Pickering Company, which also made the best and most widely accepted phonograph cartridge. Unfortunately, their electrostatic speaker never enjoyed the same popularity.

In the United Kingdom, Peter Walker, of the Acoustical Manufacturing Company, and DTN Williamson, of Ferranti Wireless Works, designed the first Quad electrostatic speaker. This ESL enjoyed many years of successful production, but it was eventually replaced (in 1982) by a newer and improved model called the Quad 63.

Although each of the early speakers had some unique characteristic, they had trouble competing with the conventional speaker. Besides their cost, they



From the US, Ronald Wagner explores the theory of Electrostatic Loudspeakers and shows the advantages of serial types

1



lacked the power needed to reproduce adequately the bass frequencies. Another factor in their acceptance was public opinion about what represented good bass response. Most listeners of that time associated good bass with the boom boxes that were popular in the fifties and early sixties.

Gradually as the public's appreciation for high-quality sound improved, so did the technology of the electrostatic speaker. Besides an increase in the diaphragm area, the Quad 63 uses an electrical delay line to create a sound field with a spherical wavefront. Not only is this a significant accomplishment from a flat diaphragm, but the results closely resembles how a sound is produced by an ideal source.

In the early 70s the engineers at Koss Inc. came up with another interesting idea for improving the performance of an ESL. Their concept was to increase the number of diaphragms. Many years later in 1985 Harold Beveridge patented a technique for making a speaker with a multiple diaphragm. Today, the Sound Lab Company, of Park City Utah, makes an ESL that uses a multiple diaphragm (see Figure 1). It is this configuration that produces the serial function.

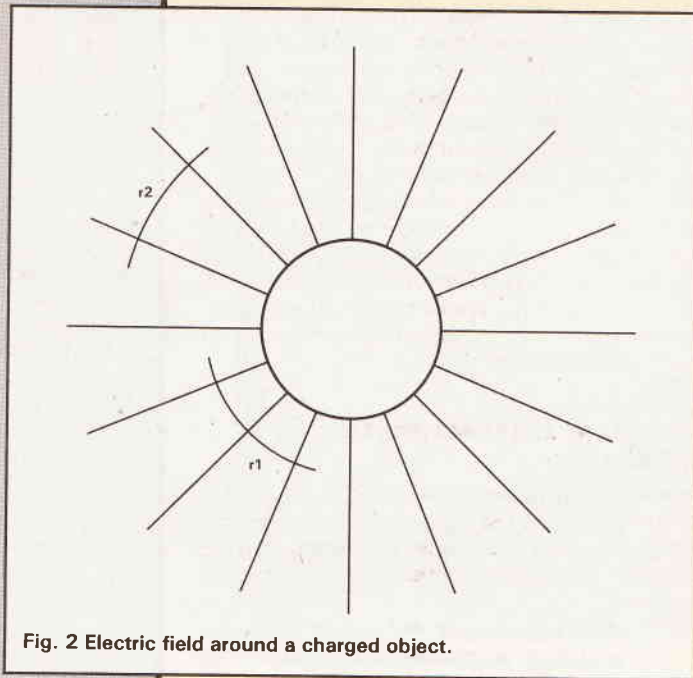

Fig. 2 Electric field around a charged object.

how many electrons revolve around the nucleus. In most materials the positive charge on the nucleus is equal to the negative charge produced by the electrons, and the atom remains neutral.

One important characteristic of an atom is its ability to gain or lose an electron. When it gains an electron it is called a negative ion. This means that it will have a negative charge. Similarly if an atom loses an electron it becomes a positive ion, and it will have a positive charge.

The charge acquired by an object is determined by the total number of electrons revolving around the nucleus of each atom. Normally this charge is very small and it makes them inconvenient to use in calculations. To overcome this situation, electrical charge is measured in coulombs, and one coulomb is equal to 6.28×10^{18} electrons.

Electric Field

If a spherical object is electrically charged, there will be a uniform electric field surrounding it. This is shown in Figure 2. The lines spreading out from the sphere represent the lines of an electric field. As they diverge, they get farther apart. The strength of the field, at any distance, is dependent on the number of lines per unit area. At the inner radius (r1) the electric field is greater than it is at the outer radius (r2). For any position around the charged sphere the strength of the electric field can be calculated by:

$$F_s = (k \times Q) / R^2$$

where F_s is the field strength in newtons/coulomb and k is a value that depends upon the units of measurement.

Q is the electric charge in coulombs and R is the radial distance from the sphere in metres.

Force Produced By An Electric Field

If an object is located some distance from a charged sphere, it will be influenced by the force of the electric field. This force can be calculated by:

$$F = F_s \times Q$$

where F is the force in newtons.

The above formula only applies to a single object that has been placed in an electric field. It also assumes that the object is small and does not disturb the electric field produced by the sphere. When two charged objects are near each other the force between them is equal to:

$$F = k \times (Q_1 \times Q_2) / R^2$$

where Q_1 is the charge on one object, Q_2 is the charge on the other object and R is the distance between objects in metres.

As an example of this last equation, suppose two spheres are located one metre apart. Each of the spheres has a negative charge of one coulomb. The force between the spheres is equal to:

$$F = 9.07 \times (-1 \times -1) / (1)^2 \\ = 9.07 \text{ newtons}$$

(Multiplying this result by 0.248 will produce an answer in pounds.) Because both spheres have the same polarity, the force between them is one of repulsion. Changing the charge polarity on either one of the spheres will produce a force of attraction.

Electrostatic Principles

Electrostatics is the science of electricity that deals with objects that have been electrically charged. When an object is charged, it will be surrounded by an electric field. This field in turn produces a corresponding electrostatic force. If an uncharged object is brought near one that has been charged, it will be influenced by the force that surrounds the charged object. When two charged objects are situated near each other they will produce an interactive force. The direction of this force is determined by the polarity of the charges, and it is similar to the force that exists around two magnets. That is, like charges will repel each other and unlike charges will have a force of attraction.

Electric Charge

People are usually aware that liquids, gases and solids are made up of many atoms. Every atom, in turn, has two basic parts. In the centre is the core or nucleus. It has a positive charge. Orbiting around this core is one or more electrons. Each electron has a negative charge. The material's characteristic will determine

Speaker Capacity

In electronics, a device that has two or more plates and stores energy in an electric field is called a capacitor. An electrostatic speaker is analogous in the respect because it will store energy in the electric field between the plates and the diaphragm.

ETI

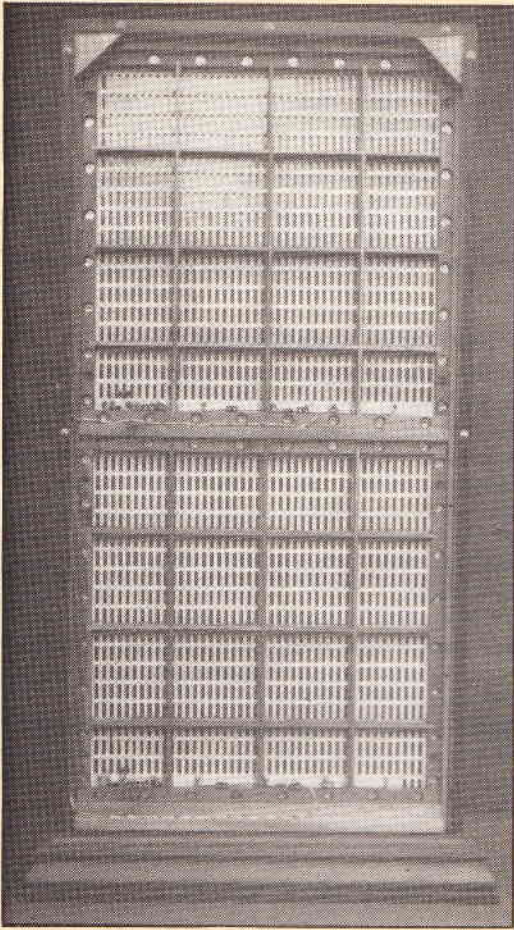

Fig. 3 Electrostatic speaker with grille cloth removed.

Storing energy is similar to stockpiling something in a glass jar. The storage capacity of a glass jar is determined by the diameter and height of the jar. Its capacity is measured in such terms as pints, quarts or gallons. In an ESL the storage capacity is determined by the size of the plates, and the distance between them and the diaphragm. This capacity is measured in an electrical unit called the Farad.

One of the difficulties associated with this unit of measurement is that it is too coarse, and does not provide an accurate indication of the storage capability. To illustrate, suppose the measuring system for the jars did not have a smaller unit. All measurements had to be made in gallons. A half pint, for instance, would be 1/16 of a gallon. Such a system is not very convenient or accurate and fortunately the other sizes are available.

Because the Farad is also a large unit of measurement the storage capacity for a capacitor or an electrostatic speaker is indicated in smaller units such as the micro or pico farad. The microfarad is one millionth of a Farad, while the picofarad is one millionth of a microfarad.

The storage capacity of an ESL is also dependent on the material that separates the plate from the diaphragm. Usually this space is filled with air, and the capacity can be determined by:

$$C = (k \times A) / d$$

$$= (8.85 \times 10^{-12} \times A) / d$$

where C is the storage capacity in Farads, k is a constant that assumes the separation is filled with air (8.85×10^{-12}) and A is plate area in square metres. d is the distance between the plate and the diaphragm in metres.

For a speaker with a plate size of 24 by 24 inches, the equivalent area is 0.372 square metres. If the distance between either one of the plates and the

diaphragm is 0.0625 inches, this corresponds to 1.5875×10^{-3} metres. Using the metric values the storage capacity for this speaker is:

$$C = [(8.85 \times 10^{-12}) \times (0.372)] / (1.5875 \times 10^{-3})$$

$$= 2074 \text{ picofarads}$$

This is the capacity between the diaphragm and either one of the plates.

At this point most of the basic factors pertinent to the fields of electrostatic have been defined. This information can now be used to describe how they are incorporated into an electrostatic speaker. Before doing this, however, the following section will briefly describe how an ESL is made.

Electrostatic Speaker Construction

The photograph shown in Figure 3 is an ESL with its grille cloth removed. This particular speaker system consists of two speaker panels plus some associated electronics. Because the two panels are the same, the following description can be applied to either one.

The easiest way to visualize how an electrostatic speaker is made is to think of it as a cheese sandwich. On the outside the bread is replaced by a pair of conductive plates. In addition to their conductivity the plates must also be acoustically transparent. This is accomplished by using a perforated material. The open area is approximately 50% of the plate area.

The cheese, in the sandwich, is replaced by a thin, moveable, conductive diaphragm. Although the cheese and the bread are often separated by butter, the diaphragm and the plates are isolated by a layer of air. Support for the diaphragm is provided by stretching it over a set of spacers. They are located on the outer edge of the speaker panel. The diagram shown in Figure 4 illustrates the basic construction of an electrostatic speaker.

Electrical Characteristics Of A Speaker

The electrical characteristics of an ESL can be divided into two parts. The first will cover those factors that are associated with a stationary diaphragm, and the second will address what happens when the diaphragm is moving.

The charge used in an electrostatic speaker is produced by a high voltage power supply. Its purpose is to establish a linear electric field between each of the plates and the diaphragm. Its output voltage is

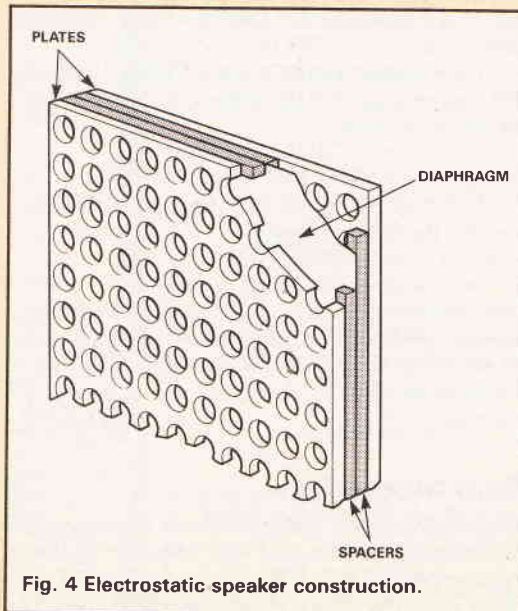

Fig. 4 Electrostatic speaker construction.



ESTL



determined by the type of speaker. A bass speaker, for instance, has a large plate-to-plate diaphragm separation. It will require a greater voltage than either a mid-range or tweeter speaker, to establish the same linear electric field. As shown in Figure 5a, this power supply is connected between the two plates and the diaphragm.

Diaphragm Force

When the high voltage, shown in Figure 5a, is supplied each plate produces a force of attraction for the charge on the diaphragm. This force is equal to:

$$F = (9.07 \times Q) / d^2$$

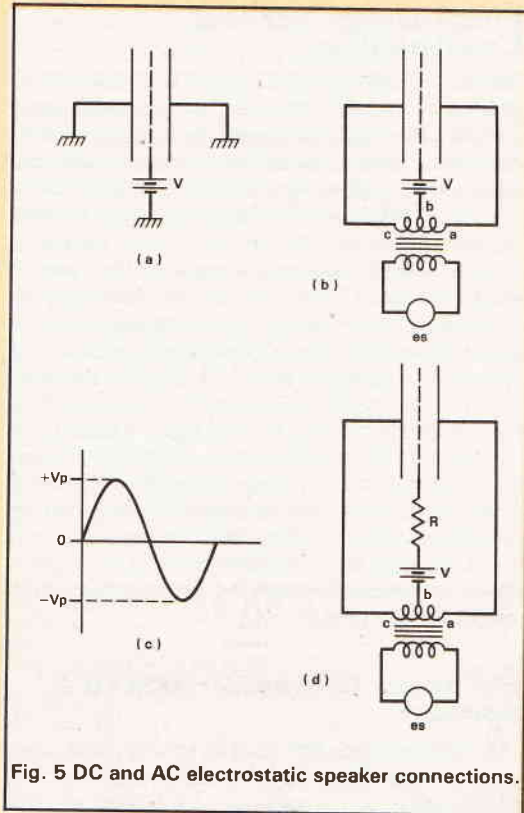

Fig. 5 DC and AC electrostatic speaker connections.

This equation is similar to the one shown in the section on the electric field. The Q in this case is the charge between either of the plates and the diaphragm. Its value can be determined by:

$$Q = C \times V$$

where C is the plate to diaphragm capacity in farads and V is the voltage between the plates and the diaphragm.

For a speaker with a capacity of 2074 picofarads and a power supply or bias voltage, V, of 3000 volts, the charge is equal to:

$$\begin{aligned} &= 2.074 \times 10^{-9} \times 3000 \\ &= 6.22 \times 10^{-6} \text{ coulombs} \end{aligned}$$

Inserting this value into the force equation provides the following result.

$$\begin{aligned} F &= [9.07 \times (C \times V)] / d^2 \\ &= 22.4 \text{ newtons or } 5.55 \text{ pounds} \end{aligned}$$

Because the diaphragm and the plates have opposite polarities, the force is one of attraction. It tends to draw the diaphragm toward one of the plates. The status condition is due to the speaker's symmetrical construction.

Field Strength

The application of a voltage between the plate and the diaphragm, produces another important speaker characteristic. In this case, it is the strength of the electric field. This value is usually specified in volts/mil

(where a mil is 0.001 inches) and can be calculated by:
 $E = V/d$

where E is the field strength in volts/mil, V is the voltage between the plates and the diaphragm and d is the distance between the plates and the diaphragm in mils.

For a speaker with a plate to diaphragm spacing of 0.0625 inches and a polarizing voltage of 3000 volts the field strength is 3000/62.5 or 48 volts/mil. The significance of this parameter is shown in Figure 6.

Field Strength Limits

The maximum limit to the field strength is determined by the material used to separate the charged surfaces. People who have witnessed an electrical storm have seen what happens when this material limit is exceeded. In this case, the two charged bodies have produced a very large electric field. When the strength of this field exceeds the limits of the material that separates them, in this case the air, there is a flash of lightning.

For an ESL the maximum limit is determined by the strength of their air gap. If enough voltage is applied across the plate to diaphragm spacing, the air between them will also break down. When that happens a spark will jump between the two charged surfaces. The maximum voltage that can be placed across the air gap of an electrostatic speaker is 75 volts/mil.

The Dynamic Speaker

Although a conventional speaker has been referred to as a dynamic speaker, in this instance the word dynamic is used to indicate an ESL with a moving diaphragm.

The preceding material has described some of the factors that affect an ESL with a stationary diaphragm. To make the diaphragm move, and achieve dynamic performance, the plates must be connected to a source of AC voltage. The method for applying this voltage is shown in Figure 5b. When the AC voltage from the source (es) is zero, the diaphragm will be in its centred position. As the source voltage increases it will produce an AC voltage between points a and c in Figure 5b.

The polarity of the voltage on the plates is determined by both the transformer connections and by the AC signal. If the voltage between a and b has a positive polarity, then b and c will have an equal amplitude but a negative polarity. When the alternating voltage shown in Figure 5c has reached its positive peak (Vp) the diaphragm will have reached the maximum limit of its excursion. In Figure 5b it will be closest to the plate connected to terminal c of the transformer. When the voltage reverses itself and the input reaches its negative peak (-Vp) the diaphragm will be closest to the opposite plate.

In 1954 Professor FV Hunt of Harvard, wrote a book on Electro-acoustics. In it he mathematically defined the relationship between the alternating voltage and the force on the diaphragm. The book states that if an ESL uses a constant potential difference to establish a force on a moving diaphragm, it will have a non-linear output. In other words the output will be distorted. The solution proposed by Professor Hunt was to create a constant charge on the diaphragm. This is achieved by placing a very large resistor in the output of the power supply (see Figure 5d). The resistor does not affect the static force produced by the bias voltage, V.

To maintain a constant charge, the moving diaphragm must not produce a current flow in the

ESL

resistor. This is accomplished by making the time constant (RC) very long. The R in this equation is the value of the resistor and C is the speaker's capacity. If the time constant is greater than the half period of the speaker's lowest frequency there will be no current flow through the resistor, and the diaphragm will have a constant charge.

After the diaphragm has been charged, the AC voltage between a and c will produce an alternating force. When this voltage reaches its peak value the force of attraction on the charged diaphragm is equal to:

$$F = E \times Q$$

where F is the force in newtons, E is the field strength in volts/metre and Q the charge on the diaphragm.

To obtain the maximum acoustic output the peak-to-peak value of the AC voltage must be equal to the field intensity set by the charging voltage. Because the plate-to-plate separation is twice the plate to diaphragm spacing, the AC voltage must be at least twice the charging voltage. For a field intensity of 50 volts per mil and a spacing (plate-to-plate) of 0.125 inches, the AC voltage must be 6250 volts. This will make the field intensity, in metres, equal to:

$$E = V/d$$

where V is the voltage difference between the two plates and d is the distance between the two plates, in metres.

Therefore:

$$E = 6250 / (0.125 \times 2.54 \times 10^{-2}) \\ = 1.969 \times 10^6 \text{ volts/metre}$$

Multiplying this by the charge on the diaphragm produces a force that is equal to:

$$F = (1.969 \times 10^6) \times (6.22 \times 10^{-6}) \\ = 12.25 \text{ newtons}$$

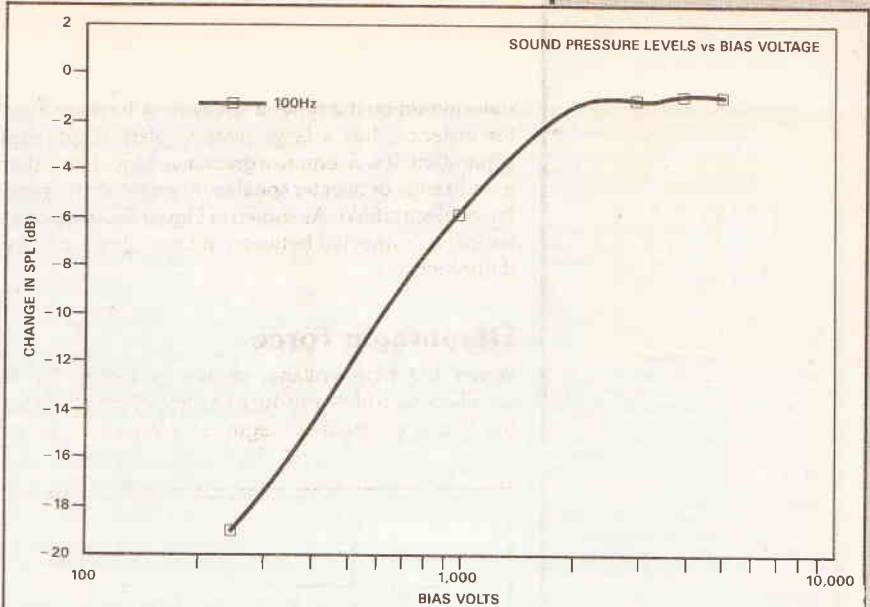

Fig. 6 Speaker output against bias voltage.

Diaphragm Power

When an object is moved over a distance in a specified time, it requires some expenditure of energy. The power required to move the diaphragm can be determined by using the RMS value of both the force and the distance. That is:

$$P = (F_{rms} \times d_{rms}) / t$$

where P is the power required to move the diaphragm (in watts) and t is the time required to move the diaphragm.

For a frequency of 100Hz, this power is equal to:
 $P = \frac{(12.25/2 \times 0.707) [(0.125 \times 2.54 \times 10^{-2} / 2) \times 0.707]}{0.01}$
 = 0.486 watts or 486 milliwatts

TO BE CONTINUED

ETI

HENRY'S

ELECTRONICS DISTRIBUTORS

ELECTRONICS DISTRIBUTORS FOR TRADE, INDUSTRY, EXPORT, EDUCATION AND HOBBYISTS

BIG DISCOUNTS FOR EDUCATION AND QUANTITY

- Tools/Service Aids
- Test Instruments (UK's largest in-stock Range)
- Communications
- Public Address/Disco Equipment
- Security/CCTV/Doorphones/Alarm Systems
- TV, Video Distribution
- Speakers for HI-FI, in car, PA and Disco
- Components, Audio, TV, Video, Telephone and Computer Accessories

SPECIAL OFFERS

Dmm was (£18.95) **£13.95** (30 models stocked)
 1 kw outdoor PIR Lights controller was (£32.95) **£19.95**
 VHF/UHF TV/FM Amplifier was (£11.95) **£9.95**
 Analogue MM 27 Ranges CAP/Hfe/Temp/10A AC/DC etc. was (£39.95) **£29.95**
 ALL PRICES INCLUDE VAT

FREE CAR PARKING

Two Car Parks (Bell and Church Streets). Present your ticket when purchasing and get one hour as discount.

OPEN 6 DAYS A WEEK FOR CALLERS AND TELEPHONED ORDERS

CATALOGUES IN COLOUR

- Instruments
- Security
- Supplements
- Components
- Ask Henry's first
- £1 for callers: large SAE £2 stamp UK by post. (Export £5.00) Free to Education with Trade Prices

HENRY'S AUDIO ELECTRONICS

404 Edgware Road, London W2 1ED
 Instruments/Audio 071-724 3564
 Security/Communications/CCTV 071-724 0323
 Components 071-723 1008 Fax: 071-724 0322
 Trade/Education/Export 071-258 1831
 Account facilities available.

Peerless CC FORCE

Wilmslow Audio's NEW range of speaker kits from Peerless.

This new range of four kits utilise CC technology drive units for optimum performance.

The kit contains all the cabinet components (accurately machined from smooth MDF for easy assembly).

Pictured here the Force 6, a large floor standing design.

Dimensions:
 800 x 275 x 335 mm
 Response:
 32 HZ - 20 KHZ
 AMP Suitability: 30-120w
 Impedence: 8 ohms

Price	carr./ins.	
Force 2	£159	£13 pr.
Force 4	£179	£13 pr.
Force 6	£199	£15 pr.
Force 8	£245	£15 pr.

All kits are available in Plus and Basic forms.

Wilmslow Audio

Wellington Close,
 Parkgate Trading Estate
 Knutsford, Cheshire
 WA16 8DX
 Tel: (0565) 50605

DIY Speaker catalogue £1.50 post free (export £3.50)



Telephone credit card orders welcome



ONE POUND BARGAIN PACKS

All packs are £1 each. Note the figure on the extreme left is the pack ref number and the next figures is the quantity of items in the pack, finally a short description.

BD2	5	13A spurs provide a fused outlet to a ring main where device such as a clock must not be switched off
BD9	2	6v. 1A mains transformers upright mounting with fixing clamps
BD13	12	30 watt reed switches, it's surprising what you can make with these — burglar alarms, secret switches, relay etc. etc
BD22	2	25 watt loud speaker two unit cross — overs
BD30	2	Nicad constant current charges adapt to charge almost any nicad battery
BD32	2	Humidity switches, as the air becomes damper the membrane stretches and operates a microswitch
BD42	5	13A rocker switch three tag so on/off, or change over with centre off
BD45	1	24hr time switch, ex — Electricity Board, automatically adjust for lengthening and shortening day.
BD49	5	Neon valves, with series resistors, these make good night lights
BD56	1	Mini uniselector, one use is for an electric jigsaw puzzle, we give circuit diagram for this. One pulse into motor, moves switch through on pole
BD67	1	Suck or blow operated pressure switch, or it can be operated by any low pressure variations such as water level in water tanks
BD103A	1	6V 750mA power supply, nicely cased with input and output leads
BD120	2	Stripper boards each contains a 400v 2A bridge rectifier and 14 other diodes and rectifiers as well as dozens of condensers etc
BD132	2	Plastic boxes approx. 3" cube with square hole through top so ideal for interrupted beam switch
BD134	10	Motors for model aeroplanes, spin to start so needs no switch
BD137	1	6½" 40HM Speaker 10 watt rating
BD139	6	Microphone inserts — magnetic 490 ohm also act as speakers
BD148	4	Reed relay kits you get 16 reed switches and 4 coil sets with notes on making c/o relays and other gadgets
BD149	6	Safety cover for 13A sockets — prevent those inquisitive little fingers getting nasty shocks
BD180	6	Neon indicators in panel mounting holders with lens
BD193	6	5 amp 3 pin flush mounting sockets makes a low cost disco panel — need cable clips
BD199	1	Mains solenoid very powerful has 1" pull or could push if modified
BD201	8	Keyboard switches — made for computers but have many other applications
BD211	1	Electric clock mains operated put this in a box and you need never be late
BD221	5	12v alarms make a noise about as loud as a car horn. Slightly solid but OK
BD252	1	Panostat, controls output of boiling ring from simmer to boil
BD259	50	Leads with push on ¼" lags — a must for hook ups — mains connections etc
BD263	2	Oblong push switches for bell or chimes, these can mains up to 5 amps so could be foot switch if fitted into pattress
BD268	1	Mini 1 watt amp for record player. Will also change speed of record player motor
BD305	1	Tubular dynamic mic with optional table rest
BD653	2	Miniature driver transformers. Ref LT44. 20k to 1k, centre tapped
BD548	2	3.5 volt relays, each with two pairs changeover contacts
BD667	2	4.7uf, non — polarised block capacitors, pcb mounting

There are over 1,000 items in our catalogue. If you want a complete copy please request this when ordering.

PERSONAL STEREO Again customer returns but complete and with stereo head phones. A bargain at only £3 each. Our ref 3P83.

MAINS OPERATED MICROWAVE CONTROL PANEL WITH TOUCH SWITCHES This has a 4-digit display with a built-in clock and 2 relay outputs, 1 for power and 1 for pulsed power level. Could be used for all sorts of timer control applications. Only £6. Ref 6P18.

EQUIPMENT WALL MOUNT. Multi-adjustable metal bracket for speak, etc. 2 for £5. Our ref 5P152.

STABILISED POWER SUPPLY KIT. +—/V2.0A. Contains PCB, transformer and all components excluding case, etc. Our price is £20. Ref 20P25.

KEYBOARDS. Brand new uncased with 84 keys plus PCB with several ICs. Only £3. Ref 3P89.

SUB-MIN TOGGLE SWITCH. Body size 8mm x 4mm x 7mm SBDT with chrome dolly fixing nuts. 3 for £1. Order ref BD649.

COPPER CLAD PANEL. For making PCB. Size approx 12in long x 8½in wide. Double-sided on fibreglass middle which is quite thick (about 1/16in) so this would support quite heavy components and could even form a chassis to hold a mains transformer, etc. Price £1 each. Our ref BD633.

POWERFUL IONISER

Generates approx. 10 times more IONS than the ETI and similar circuits. Will refresh your home, office, workroom etc. Makes you feel better and work harder — a complete mains operated kit, case included. £18. Our ref 18P2.

REAL POWER AMPLIFIER. For your car, it has 150 watts output. Frequency response 20hz to 20Khz and signal to noise ratio better than 60db. Has built in short circuit protection and adjustable input level to suit your existing car stereo, so needs no pre-amp. Works into speakers ref. 30P7 described below. A real bargain at only £57.00. Order ref. 57P1.

REAL POWER CAR SPEAKERS. Stereo pair output 100w each 4-Ohm impedance and consisting of 6½" woofer, 2" mid range and 1" tweeter. Ideal to work with the amplifier described above. Price per pair £30.00. Order ref. 30P7.

TV SOUND DECODER. Nicely cased, mains powered with 8 channels. Will drive a small speaker directly or could be fed into Hi Fi system etc. £12.00 each. Ref: 12P22.

VIDEO TAPES These are three hour tapes of superior quality, made under licence from the famous JVC Company. Offered at only £3 each. Our ref 3P63. Or 5 for £11. Our ref 11P3. Or for the really big user 10 for £20. Our ref 20P20.



ELECTRONIC SPACESHIP.

Sound and impact controlled, responds to claps and shouts and reverses when it hits anything. Kit with really detailed instructions. Ideal present for budding young electrician. A youngster should be able to assemble but you may have to help with the soldering of the components on the pcb. Complete kit £10. Our ref 10P81.

2KV 500 WATT MAINS TRANSFORMERS. Suitable for high voltage experiments or as a spare for a microwave oven etc. £10.00. Ref: 10P93.

12" HIGH RESOLUTION MONITOR. Amber screen, beautifully cased for free standing, needs only a 12v 1.5 amp supply. Technical data is on its way but we understand these are TTL input. Brand new in maker's cartons. Price: £22. Order ref 22P2.

STC SWITCHED MODE POWER SUPPLY 220V or 110V operation giving 5V at 2A + 24 at 25A + 12 at .15A and +90V at 4A. £12.00 each. Ref: 12P27.

COMPOSITE VIDEO KITS. These convert composite video into separate h-sync, v-sync and video. Price £8. Our ref 8P39.

BUSH RADIO MIDI SPEAKERS. Stereo pair. BASS reflex system, using a full range 4in driver of 4ohms impedance. Mounted in very nicely made black fronted walnut finish cabinets. Cabinet size approx 8½in wide, 14in high and 3½in deep. Fitted with a good length of speaker flex and terminating with a normal audio plug. Price £5 the pair. Our ref 5P141.

3½in FLOPPY DRIVES. We still have two models in stock. Single sided, 80 track, by Chicon. This is in the manufacturers metal case with leads and IDC connectors. Price £40, reference 40P1. Also a double sided, 80 track, by NEC. This is uncased. Price £60, reference 60P2. Both are brand new.

YUASA SEALED LEAD ACID BATTERIES 6V 10AH only £9.00 each or 2 for £15.00. Ref: 15P37.

SINCLAIR C5 WHEELS

Including inner tubes and tyres. 13" and 16" diameter spoked polycarbonate wheels finished in black. Only £6 each. 13" ref 6P20. 16" ref 6P21.

PC STYLE CASES 18" x 18" x 6". Complete with fan and grill illuminated power switch and IEC filtered power input plug. Price at £15.00. Ref: 15P38.

VERY POWERFUL 12 VOLT MOTORS. 1/3rd Horsepower. Made to drive the Sinclair C5 electric car but adaptable to power a go — kart, a mower, a rail car, model railway, etc. Brand new. Price £20. Our ref 20P22.

PC POWER SUPPLIES. Brand new with built in fan and power switch on the back +5 — 5 +12 — 12 150 watt made by AZTEC. £25.00 each. Ref: 25P18.

PHILIPS LASER

This is helium — neon and has a power rating of 2mW. Completely safe so long as you do not look directly into the beam when eye damage could result. Brand new, full spec, £35. Mains operated power supply for this tube gives 8kv striking and 1.25kv at 5mA running. Complete kit with case £15.

ORGAN MASTER is a three octave musical keyboard. It is beautifully made, has full size (piano size) keys, has gold plated contacts and is complete with ribbon cable and edge connector. Can be used with many computers, request information sheet. Brand new, only £15 plus £3 postage. Our ref 15P15.

HIGH RESOLUTION MONITOR. 9in black and white, used Philips tube M24/306W. Made up in a lacquered frame and has open top. Made for use with OPD computer but suitable for most others. Brand new, £20. Ref 20P6.

12 VOLT BRUSHLESS FAN. Japanese made. The popular square shape 41/2in x 41/2in x 13/4in. The electronically run fans not only consume very little current but also they do not cause interference as the brush type motors do. Ideal for cooling computers, etc., or for a caravan. £8 each. Our ref 8P28.

MINI MONO AMP on p.c.b. size 4" x 2" (app.)

Fitted Volume control. The amplifier has three transistors and we estimate the output to be 2W rms. More technical data will be included with the amp. Brand new, perfect condition, offered at the very low price of £1.15 each, or 13 for £12.

NEW MAINS MOTORS. 25 watt 3000 rpm made by Framco approx 6" x 4" x 3" priced at only £4. Ref 4P54.

SHADED POLE MOTORS. Approx 3" square available in 24V AC or 240V AC, both with threaded output shaft and 2 fixing bolts. Price is £2 each. 24V ref 2P65. 240V ref 2P66.

MICROWAVE TURNTABLE MOTORS. Complete with weight sensing electronics that would have varied the cooking time. Ideal for window displays etc. Only £5. Ref 5P165.

SURFACE MOUNT KIT. Makes a super high gain snoothing amplifier on a PCB less than an inch square! £7. Ref 7P15.

INDUCTIVE PROXIMITY SWITCHES. Made by Honeywell these units are brand new and offered at only £12 each which is a fraction of their normal price. 10-36V DC model ref 12P19 or main version 12P20.

1990 CATALOGUE NOW AVAILABLE PLEASE SEND 6" x 9" SAE FOR FREE COPY

BULL ELECTRICAL

Dept. ETI, 250 PORTLAND ROAD, HOVE, BRIGHTON, SUSSEX BN3 5QT.

MAIL ORDER TERMS: Cash, P.O. or cheque with order. Please add £2.50 service charge. Monthly account orders accept from schools and public companies. Access & Barclaycard orders are accepted — minimum £5. Phone (0273) 203500. Fax 23077

POPULAR ITEMS — MANY NEW THIS MONTH

1990 CATALOGUE now available — phone for copy.

YUASA LEAD ACID RECHARGEABLE BATTERIES. 1.9AH 12v, £6.00 each.

JOYSTICKS for BBC, Atari, Dragon, Commodore, C64 only. All £5 each. All brand new, state which required.

BOSCHERT SWITCHED MODE POWER SUPPLIER. +5 at 15A +12 at 3A — 12 at 2A + 24 at 2A 220v or 110v input. Brand new and guaranteed. Retail price is £180! ours £20. Ref: 20P30.

SUB-MIN PUSH SWITCHES Not much bigger than a plastic transistor but double pole. PCB mounting. Three for £1. Our ref BD688.

AA CELLS. Probably the most popular of the rechargeable NICAD types. 4 for £4. Our ref 4P44.

20 WATT 40HM SPEAKER With built in tweeter. Really well made unit which has the power and the quality for hi-fi. 6½in dia. Price £5. Our ref 5P155 or 10 for £40 ref 40P7.

MINI RADIO MODULE Only 2in square with ferrite aerial and solid dia tuner with own knob. It is superhet and operates from a PP3 battery and would drive a crystal headphone. Price £1. Our ref BD716.

BULGIN MAINS PLUG AND SOCKET. The old faithful 3 pin with screw terminals. The plug is panel mounted and the socket is cable mounted. 2 pairs for £1 or 4 plugs or 4 sockets for £1. Our ref BD715, BD715P or BD715S.

MICROPHONE. Low cost hand held microphone with on/off switch in handle, lead terminates in one 3.5 plug and one 2.5 plug. Only £1. Ref BD711.

MOSFETS FOR POWER AMPLIFIERS AND HIGH CURRENT DEVICES 40v 100w pair made by Hitachi. Available in H pack Ref 2S J99 and 2SK343 £4 a pair. Ref 4P51.

TIME AND TEMPERATURE LCD MODULE. A 12 hour clock, a Celcius and Fahrenheit thermometer, a too hot alarm and a too cold alarm. Approx 50 x 20mm with 12.7mm digits. Requires one AA battery and a few switches. Comes complete with full data and diagram. Price £9. Our ref 9P5.

REMOTE TEMPERATURE PROBE FOR ABOVE. £3. Our ref 3P60.

600 WATT AIR OR LIQUID MAINS HEATER. Small coil heater made for heating air or liquids. Will not corrode, lasts for years, coil size 3in x 2in mounted on a metal plate for easy fixing, 4in dia. Price £3. Ref 3P78 or 4 for £10. Our ref 10P76.

EX EQUIPMENT SWITCHED MODE POWER SUPPLIES. Various makes and specs but generally ±5, ±12v, ideal bench supply. Only £8. Our ref 8P36.

ACORN DATA RECORDER. Made for Electron or BBC computer but suitable for others. Includes mains adaptor, leads and book. £12. Ref 12P15.

PTFE COATED SILVER PLATED CABLE. 19 strands of .45mm copper, will carry up to 30A and is virtually indestructible. Available in red or black. Regular prices over £120 per reel, our price only £20 for 100m reel. Ref 20P21 or 1 of each for £35. Ref 35P2. Makes absolutely superb speaker cable!

NEW PIR SENSORS. Infra red movement sensors will switch up to 1000W mains. UK made, 12 months manufacturers warranty. 15-20m range with a 0-10min timer, adjustable wall bracket, daylight sensor. Only £25.00. Ref 25P16.

GEIGER COUNTER KIT. Includes tube, PCB and all components to build a 9V operation geiger counter. Only £39. Ref 39P1.

BBC JOYSTICK INTERFACE. Converts a BBC joystick port to an Atari type port. Price £2. Our ref 2P261.

TELEPHONE EXTENSION LEAD. 5M phone extension lead with plug on one and socket on the other. White. Price £3. Our ref 3P70 or 10 leads for only £19! Ref 19P2.

LCD DISPLAY. 4½in digits supplied with connection data £3. Ref 3P77 or 5 for £10 Ref 10P78.

CROSS OVER NETWORK. 8 ohm 3-way for tweeter midrange and woofer. Nicely cased with connections marked. Only £2. Our ref 2P255 or 10 for £15 ref 15P32.

BASE STATION MICROPHONE. Top quality uni-directional electret condenser mic 600r impedance sensitivity 16-18K-Hz — 68db built in chime, complete with mic stand bracket. £15. Ref 15P28.

MICROPHONE STAND. Very heavy chromed mic stand, magnetic base. 4in high. £3 if ordered with above mic. Our ref 3P80.

SOLAR POWERED NI-CAD CHARGER. 4 Nicad AA battery charger charges 4 batteries in 8 hours. Price £6. Our ref 6P3.

MAINS SOLDERING IRON. Price £3. Our ref 3P65.

SOLDERING IRON STAND. Price £3. Our ref 3P66.

C5 GEARED MOTORS. Please phone for Price and Availability.

CAR IONIZER KIT. Improve the air in your car, clears smoke and helps prevent fatigue. Case ref. Price £12. Our ref 12P8.

NEW FM BUG KIT. New design with PCB embedded coil 9v operation. Priced at £5. Our ref 5P158.

NEW PANEL METERS. 50uA movement with three different scales that are brought into view with a lever. Price only £3. Ref 3P81.

STROBE LIGHTS. Fit a standard Edison screw light fitting 240v 40/min flash rate, available in yellow, green, complete with socket. Price £10 each. Ref 10P80 (state colour reqd).

ELECTRIC SPEED CONTROL KIT. Suitable for controlling our powerful 12v motors. Price £17. Ref 17P3 (heatsink required).

EXTENSION CABLE WITH A DIFFERENCE. It is flat on one side, making it easy to fix and look tidy. 4 core, suitable for alarms, phones etc. Our price only £5 for 50m reel. Ref 5P153.

METAL PROJECT BOX. Ideal for battery charger, power supply etc., sprayed grey, size 8" x 4" x 4½", louvred for ventilation. Price £3. Ref 3P75.



PCB

SERVICE

October

TELEPHONE
ORDERS
may be made on
(0442)
66551
ACCESS or VISA

- E9010-1 Component Tester F
E9010-2 Active Contact Pickup E
E9010-3 R4X Longwave Receiver C

PCBs for the remaining projects are available from the companies listed in Buylines.

Use the form or a photocopy for your order. Please fill out all parts of the form. Make sure you use the board reference numbers. This not only identifies the board but also tells you when the project was published. The first two numbers are the year, the next two are the month.

Terms are strictly payment with order. We cannot accept official orders but we can supply a proforma invoice if required. Such orders will not be processed until payment is received.

Price code	Price (inc. VAT)
C	£1.80
D	£2.50
E	£3.25
F	£4.00
G	£4.75
H	£5.50
J	£6.62
K	£7.20
L	£8.80
M	£10.60
N	£13.10
O	£15.80
P	£17.90
Q	£21.80
R	£23.90
S	£25.90
T	£29.00
U	£32.20
V	£35.80
W	£37.90
X	£40.70

- | | | | | | |
|---------|----------------------------------|---|---------|----------------------------|---|
| E8909-3 | Field power supply (spec 3) | C | E9007-3 | Footstep Alarm | E |
| E8909-4 | Micro monitors active filter | F | E9007-4 | Transistor Tester | C |
| E8909-5 | Chronoscope auto-reset | C | E9007-5 | Decision Maker | J |
| E8910-1 | Multimeter | H | E9008-1 | AC Millivoltmeter | K |
| E8910-2 | MIDI Mapper | M | E9008-2 | Temperature Controller | N |
| E8911-1 | Smoke Alarm main board | F | E9008-3 | FM Generator | L |
| E8911-2 | Smoke Alarm power supply | F | E9009-2 | Slide Projector Controller | E |
| E8911-3 | Frequency Meter (3 boards) | O | E9009-2 | Ultimate Diode Tester | D |
| E8911-4 | Serial Logic Scope | L | E9009-3 | The Entertainer | G |
| E8912-1 | Mains Failure Alarm | D | | | |
| E8912-2 | Surveillance PCB | D | | | |
| E8912-3 | Slide/Tape Synch | E | | | |
| E8912-4 | Pedal Power | L | | | |
| E8912-5 | Digital Noise Generator | K | | | |
| E9001-1 | 20 metre Receiver | J | | | |
| E9001-2 | Wavemaker FG | L | | | |
| E9001-3 | Motorcycle Intercom | F | | | |
| E9001-4 | Low Voltage Alarm | C | | | |
| E9002-1 | EPROM Emulator | N | | | |
| E9002-2 | Superscope Mother Board | M | | | |
| E9002-3 | Superscope CRT Driver Board | K | | | |
| E9002-4 | Superscope Timebase Board | K | | | |
| E9003-1 | Superscope Y1 input board | J | | | |
| E9003-2 | Superscope Y2 input board | J | | | |
| E9003-3 | Superscope switch generator | E | | | |
| E9003-4 | Business power amp board | L | | | |
| E9003-5 | Business power supply board | J | | | |
| E9003-6 | Business pre-amplifier board | L | | | |
| E9003-7 | Water hole | G | | | |
| E9003-8 | Super Siren | D | | | |
| E9003-9 | Val's badge | F | | | |
| E9004-1 | Bass Amplifier DC Protection | F | | | |
| E9004-2 | Bass Amplifier Graphic Equaliser | L | | | |
| E9004-3 | Bass Amplifier Micro | N | | | |
| E9004-4 | Quad Power Supply | O | | | |
| E9005-1 | Business Display | O | | | |
| E9005-2 | Phone Lock and Logger | F | | | |
| E9006-1 | Dark Room Timer | G | | | |
| E9006-2 | Telephone Extension Bell | C | | | |
| E9006-3 | Telephone External Bell | D | | | |
| E9006-4 | Fecko Box | G | | | |
| E9006-5 | Bug Spotter | E | | | |
| E9007-1 | Guitar Practice Amp | G | | | |
| E9007-2 | Digital Frequency Meter | M | | | |

**TO: ETI PCB SERVICE, READERS' SERVICES,
ARGUS HOUSE, BOUNDARY WAY,
HEMEL HEMPSTEAD HP2 7ST**

Please supply:

Quantity	Ref. no.	Price Code	Price	Total Price
----------	----------	------------	-------	-------------

Post and packing £0.75

Total enclosed £

Please send my PCBs to: (BLOCK CAPITALS PLEASE)

Name

Address

..... **Postcode**

CHEQUES SHOULD BE MADE PAYABLE TO ASP Ltd.

Interak 1

BUILD YOUR OWN COMPUTER

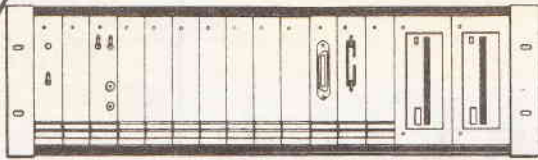

INTERAK can be commenced with the minimum of outlay. Bare boards from £10.95, beg borrow or steal the components, or buy from us - all parts available separately. No special or custom chips (ie PALs, ULAs, ASICs etc) used - no secrets.

Go as fast or as slowly as your funds and enthusiasm permit.

Made for those who must know what goes inside. Full circuit diagrams and descriptions are provided. And honestly, can you really use a computer effectively if you don't know what's inside and nobody will tell you?

Solid engineering construction - something to be proud of. 19" 3U rack mounting, plus in circuit boards and modular construction keeps obsolescence at bay.

Flourishing Independent Users Group, and newsletter. Hundreds of programmes on disk at little or no cost from the Users Group. Program in machine code (Assembler), Basic, "C", Forth, etc. Database, Word Processing, Scientific applications.

Cassette tape operation or disk (up to 4 drives, 1 Megabyte 3.5" available from us, but you can add 3", 5.25", 8" if you want). Disk operating system CP/M Plus.

64K RAM, Z80 based at present with potential for expansion to a 16 Megabytes address space and Zilog's latest Z80280 in the future. Needs no specialised knowledge to construct, and we will happily get you out of a jam if you get into one.

Availability of personal and individual after sales service, impossible to obtain from large companies, who are only after your money. Security of supply - from Greenbank Electronics, established in 1970.

Greenbank

For more details write or phone us:
Greenbank Electronics, Dept. (T10E), 460 New Chester Road, Rock Ferry, Birkenhead, Merseyside L42 2AE. Tel: 051-645 3391.



ELECTRONICS

EDISON ROAD INDUSTRIAL ESTATE
ST IVES, CAMBS. PE17 4LF
TEL: ST IVES (0480) 495868 FAX: (0480) 68012

HIGH GRADE AUDIO POWER COMPONENTS

End of Production Run Surplus at Never to be Repeated Prices

Toroidal Power Transformers

- 300w Type** 38-0-38v @ 4 amp 15-0-15 @ 1.5a 0-15 @ 200m/a Reg 10% (wt 3¼kg) 165mm Dia x 32mm High **Price £18.00**
- 500w Type** 42-0-42 @ 5.6a 15-0-15 @ 1.5a 0-15 @ 200m/a Reg 6.5% (wt 4kg) 180mm Dia x 36mm High **Price £22.00**
- 800w Type** 58-0-58 @ 13 amp 15-0-15 @ 1.5a 0-15 @ 200m/a (wt 5¼kg) Primary Taps @ 115/125/240 163mm Dia x 65mm High **Price £28.00**
- 1200w Type** 68-0-68 @ 17 amp 15-0-15 @ 1.5a 0-15 @ 200m/a (wt 6kg) Primary Taps @ 115/125/240 165mm Dia x 70mm High **Price £35.00**

ELECTROLYTICS

- 15000 MFD 100v dc Screw Terminal 104mm High x 51mm Dia **Price £4.00**
- 13000 MFD 65v Low Profile 32mm High x 65mm Dia **Price £3.00**

NOTE:— All our prices include Delivery and VAT

SURVEILLANCE PROFESSIONAL QUALITY KITS

A range of high quality kits as supplied to leading UK security companies, all in-house designed and produced, not to be confused with cheap imports. All kits come fully documented with concise assembly and setting up instructions, glass PCB and all components. All transmitters are fully tuneable and can be monitored on a normal VHF radio or tuned higher for greater security. Build-up service available if required.

- MTX** Micro-miniature audio transmitter. 17mm x 17mm. 9V operation. 1000m range **£12.95**
- VT500** Hi-power audio transmitter. 250mW output. 20mm x 40mm. 9-12V operation. 2-3000m range **£15.95**
- VOX75** Voice activated transmitter. Variable sensitivity. 30mm x 40mm. 9V operation. 1000m range **£18.95**
- CTX900** Sub-carrier scrambled audio transmitter. Cannot be monitored without decoder fitted to radio. 30mm x 40mm. 9V operation. 1000m range **£21.95**
- DSX900** Sub-carrier decoder unit for monitoring CTX900. Connects to radio earphone socket. Provides output for headphones. 35mm x 50mm. 9-12V operation **£21.95**
- HVX400** Mains powered audio transmitter. Connects directly to 240v AC supply. 30mm x 35mm. 500m range **£18.95**
- XT89** Crystal controlled audio transmitter. High performance. 100mW output. Supplied with xtal for 108MHz. Others available to 116MHz. 85mm x 28mm. 9V operation. 2-3000m range **£36.95**
- TKX900** Tracker/Beeper transmitter. Transmits continuous stream of audio pulses. Variable tone and rate. Powerful 200mW output. 63mm x 25mm. 9V operation. 2-3000m range **£21.95**
- ATR2** Micro size telephone recording interface. Connects between telephone lines (anywhere) and cassette recorder. Tape switches automatically with use of phone. All conversations recorded. Powered from line. 10mm x 35mm **£12.95**
- TLX700** Micro miniature telephone transmitter. Connects to line (anywhere) switches on and off with phone use. All conversations transmitted. 20mm x 20mm. Powered from line. 1000m range **£12.95**
- XML900** RF bug detector. Variable sensitivity. Triggers LED and beeper when in presence of RF field. Detects MTX 15-20 feet. 55mm x 55mm. 9V operation **£26.95**
- XL7000** Professional bug detector/locator. Variable sensitivity. Twin mode LED readout of signal strength with variable rate beeper. Second mode AUDIO CONFIRM distinguishes between localised bug transmission and normal legitimate signal such as pagers, cellular etc. 70mm x 100mm. 9V operation **£54.95**

UK customers please send cheques. PO's or registered cash. Please add £1.50 per order for P&P. Goods despatched ASAP allowing for cheque clearance. Overseas customers send sterling bank draft or Eurocheque and add £5.00 per order for shipment. Credit card orders accepted on 0827 714476. Trade enquiries welcome. Send 30p stamp for full 1990 Catalogue.



THE WORKSHOPS
95 MAIN RD, BAXTERLEY
NR. ATHERSTONE
WARKS CV9 2LE



0827 714476

WE HAVE THE WIDEST CHOICE OF USED OSCILLOSCOPES IN THE COUNTRY

TEKTRONIX 2235 Dual Trace 100MHz Delay Sweep	£650
PHILIPS PM3217 Dual Trace 50MHz Delay Sweep	£425
GOULD OS300 Oscilloscope Dual Trace 25MHz	£250
H.P.170A Dual Trace 100MHz Delay Sweep Trig	£350
TELEQUIPMENT D83 Dual Trace 50MHz Delay Sweep	£300
GOULD OS300A Dual Trace 40MHz Delay Sweep TV Trig	£275
TELEQUIPMENT D755 Dual Trace 50MHz Delay Sweep	£275
S.E. LABS SM111 Dual Trace 18MHz	£130
GOULD OS255 Dual Trace 15MHz TV Trig	£180
PHILIPS PM3233 Dual Beam 10MHz TV Trig	£150
GOULD OS250B Dual Trace 15MHz TV Trig	£120
TELEQUIPMENT D61A Dual Trace 10MHz	£120
SCOPEX 4D10 Dual Trace 10MHz	£90

TEKTRONIX 2215 Dual Trace 80MHz Sweep Delay with manual, probes, front cover, pouch only £450

THIS IS JUST A SAMPLE - MANY OTHERS AVAILABLE

MARCONI TF2015 AM/FM 10-50MHz Sig Gen with TF2171	£250
MARCONI TF2016 AM/FM 10KHz-120MHz Sig Gen with TF2171	£400
MARCONI TF2016 without Synchroniser TF2171	£175
FERRORGRAPH RTS2 Record Test Set	from £200
LEADER LMV186A Two Channel Millivoltmeter 5Hz-500KHz 1mV-300V	£100
MARCONI TF237A Automatic Distortion Meter 400Hz-1200Hz	£100
MARCONI TF2700 UNIVERSAL LCR Bridge Battery	from £125

TEKTRONIX 491 Spectrum Analyser 1.5-12.4GHz £1,600

SYSTRON DONNER 1702 Sig Gen 100Hz-1GHz £950

MARCONI Sig Gen TF2018 AM/FM 80KHz-520MHz £1,000

RACAL-DANA Synthesised Sig Gen 5-520MHz £650

H.P. Sweep Oscillator 86200 with 86220A RF Plug-in 10-1500MHz £1500

POLARAD Sig Gen type 1105B 0.8-2.4GHz £500

POLARAD Sig Gen type 1106B 1.8-4.6GHz £500

POLARAD Sig Gen type 1170A 3.7-8.4GHz £500

POLARAD Sig Gen 1208A 8.95-11GHz with Freq Doubler 1510 15-21GHz £750

POLARAD 1207A Sig Gen 3.7-8.4GHz with Freq Doubler 1509 10-15.5GHz £750

THURLEBY PL320QMD 0-30V/2A Twice Quad Mode Digital Meters £200

FEEDBACK F5960G Sweep Function Generator 0.01Hz - 1MHz (P&P £7) £175

LABGEAR CROSSHATCH GENERATOR Type CM6038.06 Crosshatch Grey Seal Blank Raster. Mains or BATTERY Unused £18. Used £12 (P&P £3)

TRIO RF GENERATOR Type SG402 100KHz-30MHz Unused (P&P £7) only £50

ADVANCE S662B AM 150KHz-220MHz £45 (P&P £7)

FARNELL QUS50 SCALING TRANSFORMER £45 (P&P £7)

240V in-240V out 500VA. Cased with lead acid 13amp socket (P&P £7) only £45 each

VARIACS 2 amps from £20 (P&P £5) 6 amps from £30 (P&P £7)

VARIOUS BENCH PSUs - Please Enquire

TELEPHONES

Yes real dial type telephones that don't slide around the desk. Type no. 745 supplied with standard BT plug (used). Quantity discount only £5 (p&p £3)

Used equipment - with 30 days guarantee. Manuals supplied if possible. This is a VERY SMALL SAMPLE OF STOCK. SAE or Telephone for lists. Please check availability before ordering. CARRIAGE all units £16. VAT to be added to Total of Goods & Carriage

TEKTRONIX 475 Dual Trace 200MHz Delay Sweep	£550
TEKTRONIX 465 Dual Trace 100MHz Delay Sweep	£400
GOULD OS100 Dual Trace 30MHz TV Trig	£180
COSSOR ODU150 Dual Trace 35MHz Delay Sweep	from £100-£150
TELEQUIPMENT C71 Curve Tracer 1mV-3V FSD	£175
MARCONI TF2603 RF Millivoltmeter 50KHz-1.5GHz	£75
MARCONI TF2430 Digital Freq Counter: 10Hz-80MHz	£80
MARCONI RF Power Meter TF830A 20Hz-35Hz 2.5mV-10W	£60
MARCONI RF Power Meter TF11521 DC-500MHz 0.5-25W 50 ohm	£25
FARNELL Pulse Generator System 1Hz-10MHz Single/Double	£40
HIKUSU AM283 AC Voltmeter Dual Chan 10Hz-500KHz 300uV-100V	£75
SOLARTRON 7045 Multimeter 4.5 digit LED 30 ranges Auto/Manual	£95
AVO CT446 Transistor Analyser Mk2 Suitcase style. With Batteries & operation instructions	£20

LABEAR COLOUR BAR GENERATOR - KG1 6 patterns (P&P £4) only £25

LEVELL TM3B AC Microvoltmeter 1Hz-3MHz. 5uV-500V £80

LEVELL TM3C AC Microvoltmeter 1Hz-3MHz. 5uV-500V £40

LEVELL Oscillator TG152 3Hz-300KHz. Sine/SQ from £55

LEVELL Oscillator TG150M 1.5Hz-150KHz. Sine Wave £20

LEVELL Oscillator TG150DM 1.5Hz-150KHz. Sine/SQ Wave £25

LEVELL Decade Osc TG66A 0.2Hz-1.22MHz. Low Distortion from £35

AVO 8 MULTIMETERS

Good working order - physically not brilliant. Supplied with batteries & leads only £30

ALL OTHER MODELS AVAILABLE.

NEW EQUIPMENT

HAMEG OSCILLOSCOPE HM1005 Triple Trace 100MHz Delay Timebase £792

HAMEG OSCILLOSCOPE HM 604 Dual Trace 60MHz Delay Sweep £810

HAMEG OSCILLOSCOPE HM203.7 Dual Trace 20MHz Component Tester £338

HAMEG OSCILLOSCOPE HM205.3 Dual Trace 20MHz Digital Storage £810

All other models available - all oscilloscopes supplied with 2 probes

BLACK STAR EQUIPMENT (P&P all units £5)

APOLLO 10 - 100MHz Counter/Timer Ratio/Period/Time Interval etc £222

APOLLO 100 - 100MHz (As above with more functions) £285

METEOR 100 FREQUENCY COUNTER 100MHz £108

METEOR 800 FREQUENCY COUNTER 800MHz £135

METEOR 1000 FREQUENCY COUNTER 1GHz £178

JUPITER 500 FUNCTION GENERATOR 0.1Hz-500KHz Sine/SQ/Tri £110

ORION COLOUR BAR GENERATOR Pal/TV/Video £209

All other Black Star Equipment available

HUNG CHANG DMM 7030 3 1/2 digit. Hand held 28 ranges including 10mA/AC/DC 0.1% Acc (P&P £4) £39.50

As above DMM 6010 0.25% Acc £35.50

Carrying Case for above £3

OSCILLOSCOPE PROBES Switchable x1, x10 (P&P £5) £11

STEWARTS OF READING

110 WYKEHAM ROAD, READING, BERKS RG6 1PL
Tel: 0734 68041. Fax: 0734 351696. Callers welcome 9am-5.30pm Mon-Fri (until 8pm Thurs)

ACTIVE CONTACT PICKUP



Growing numbers of acoustic guitars these days are available with pickups — usually internally mounted — complete with volume and tone controls. The advantages of such pickups are pretty obvious, the main one being lifting the feedback ceiling which simple microphonic amplification of acoustic guitars suffers from.

Perhaps the most famous acoustic guitars to use internal pickups, and certainly those which give among the best sounds, are those made by Ovation. Ovation guitars have piezoelectric sensing transducers built into bridge saddles, coupled to an internal preamplifier which gives required amplification and equalization. These bridge sensing transducers are specially made by Ovation.

This Active Pickup follows the Ovation principle, using a straightforward, commonly available and cheap piezoelectric transducer (unlike the Ovation bridge), and coupling it with a purpose designed preamplifier which allows the same amplification and equalization controls. Also like the Ovation preamplifier, the project is designed to be mounted inside your guitar, with three holes (two for controls), one for jack socket) allowing volume and tone controls to be adjusted externally and your guitar lead to be unplugged when the guitar is not in use.

Although the Active Pickup is designed to be internally mounted in a guitar there is no reason why the preamplifier couldn't be mounted in a separate box, away from the guitar. This would be particularly suitable if you don't feel up to drilling a few holes into your guitar, and I certainly wouldn't advocate drilling any holes in any valuable instrument unless you really knew what you're doing. Mounted away from the guitar, however, you will find the pickup lead itself is susceptible to the usual knocks and vibrations which unpre-amplified contact pickups suffer from. If you're brave enough and up to doing it, best position is undoubtedly inside the guitar.

Guitars are not the only instrument with which the Active Pickup can be used — it will work with any instrument which has a soundboard (such as a mandolin, violin and so on) of any description. For test purposes, the prototype was used with a guiros (a South American scraper), a kazoo and a toy trumpet, working well each time.

Power is from a PP3-sized 9 volt battery. The life of this battery is quite exceptional as the Active Pickup has a minute current drain of around 2.5mA and will continue to operate with a voltage down to as low as 5 volts. A good quality alkaline battery will power the circuit for over 250 hours' use — long enough to see you through the world tour. Power is automatically disconnected from the circuit when your guitar lead is unplugged from the jack socket, so no on switch is needed.

This low power consumption is because the project uses a particular type of integrated circuit. The circuit of the Active Pickup is shown in Figure 1, where the single integrated circuit IC1 can be seen to form the heart of the project. This integrated circuit is an operational amplifier acting as an equalized pre-amplifier, buffering the output of a piezoelectric transducer which picks up the sounds made by the

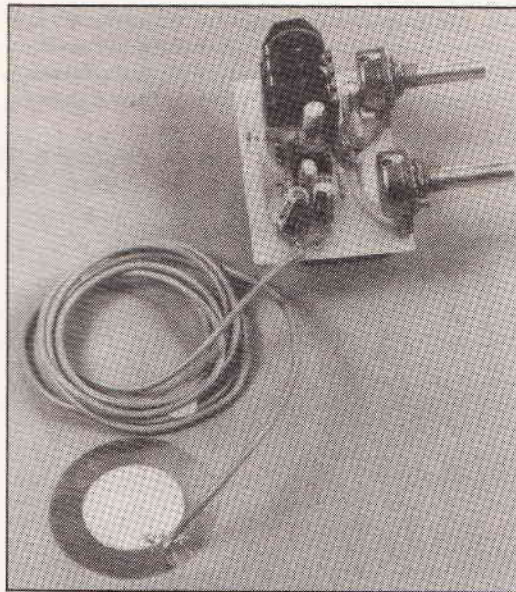

guitar strings. Output volume and tone are controlled by potentiometers RV1 and RV2.

Construction

Construction of this project is not too difficult, because the printed circuit board is designed to hold all controls, directly mounted. This greatly reduces the amount of wiring you have to undertake and, as it's often this wiring which causes problems in the first place, it increases your project's chance of first-time success.

Build yourself an active piezo transducer pickup for your acoustic guitar. Keith Brindley shows you how.

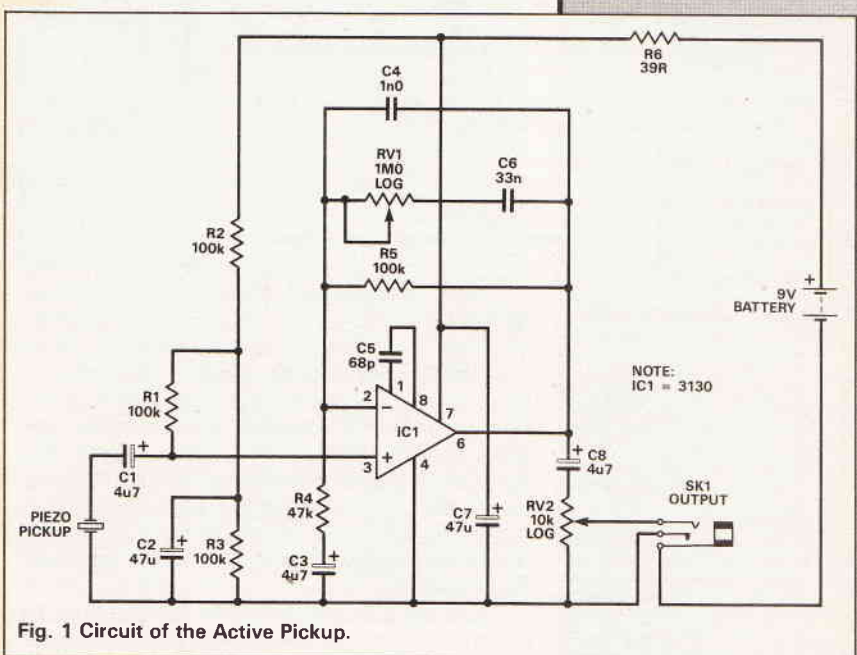

Fig. 1 Circuit of the Active Pickup.

A fairly logical order of assembly should be followed when making up a printed circuit board. First, get familiar with the layout of the board and where all the components are mounted or connected to. A component overlay, showing these and wiring details,



is given in Figure 2.

Make sure all holes in the blank circuit board are the right sizes. Component holes are usually 1mm in diameter. However, holes for connection pins of the stereo 1/4 inch jack socket and two potentiometer controls should be around 1.5mm in diameter.

Now you can start actual assembly. Push-fit the circuit board pins at all off-board connection points. There are two for the connections to the battery, and two allowing connection to the piezoelectric transducer. Although wired connections can be made directly to the circuit board, circuit board pins make a neater and more easily undertaken job of connecting to the board. Once push-fitted into the board, solder in the pins to the copper track.

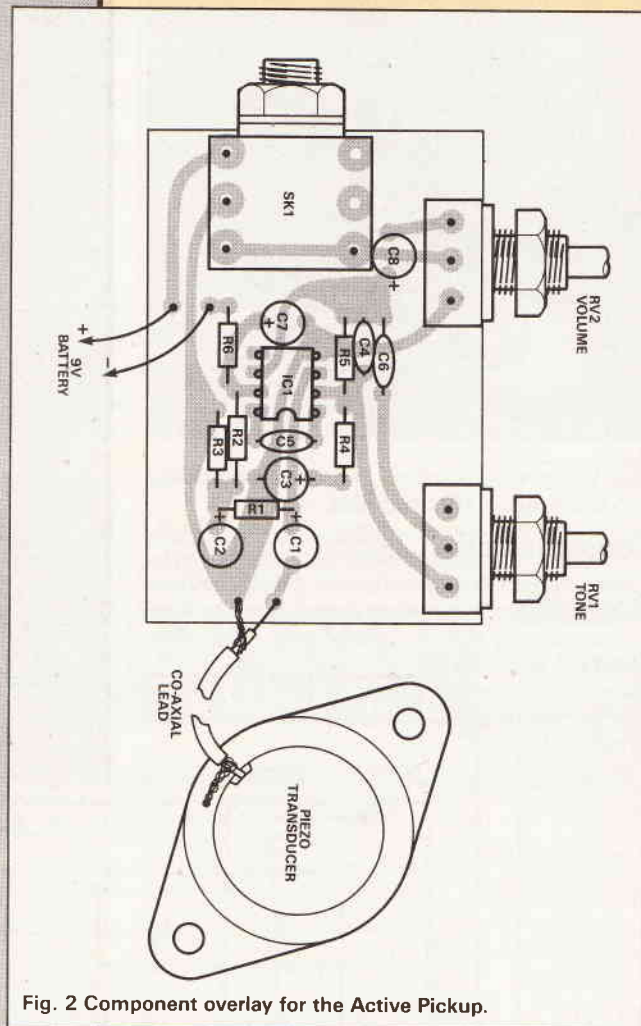

Fig. 2 Component overlay for the Active Pickup.

It is conventional (though by no means necessary) to insert and solder all resistors first, followed by capacitors, followed finally by semiconductors. This convention simply aids construction because the components less likely to be damaged by heat are soldered first. But as there is only one semiconductor (IC1) and we recommend use of an integrated circuit socket to mount it. It doesn't really matter what order components are soldered in.

Insert and solder jack socket SK1, the two potentiometers RV1 and RV2, and the integrated circuit socket.

Once you've completed main assembly of the circuit board, you can insert the integrated circuit itself into its socket. First, however, a word of warning. The integrated circuit used in the project incorporates CMOS transistors in its output circuit. CMOS devices are susceptible to damage by static discharge in careless handling, so take care when you insert the integrated circuit. There are a number of precautions

you can take, like using an earthed mat to assemble your project on; using a soldering iron with an earthed tip; wearing a bracelet on your wrist which is earthed and so on. However most devices won't be so easily damaged. Just make sure you don't touch the pins of the integrated circuit. Your integrated circuit should be supplied in either a small plastic holder or pushed into conductive foam. If it's in a holder, you can push it out onto your work surface with the tip of a pencil. Carefully pick it up between thumb and forefinger at each end, so you do not touch the pins. Now check which way round it should go and insert into its socket on the board.

Testing

Your project is now in a position to test, but to do this you need to connect the transducer and the battery, and have an amplifier to hear the results with.

The piezoelectric transducer used is in fact designed as a miniature loudspeaker-type of output device — the sort of thing which produces speech in toys and dolls. In your Active Pickup, on the other hand, it is used as an input device. It works perfectly well in either mode, in the same way that a real loudspeaker can also function as a sort of microphone.

Your transducer will probably be supplied with a couple of short leads attached. These are, of course, meant to be connections when in output mode. In input mode, a screened lead must be used to avoid picking up interference such as mains hum from amplifiers and so on. So, you must unsolder the short leads then solder on screened lead.

Be careful here! Piezo transducers of this sort are easily damaged by heat. Hold your hot soldering iron tip on the solder joint for only the minimum length of time necessary first to unsolder the leads, then resolder the screened lead. It's best to let the transducer cool down after each individual soldering operation. Connect about a metre of screened lead between transducer and circuit board initially — this is just for test purposes and you can reduce this length to suit your guitar later. Figure 2 shows the method of connecting screened and signal wires to the transducer and board.

Now connect a battery clip to the board as shown in the overlay, and connect a battery. Set both potentiometer controls to mid-position, and plug in a guitar lead between your project's jack socket and your amplifier. Adjust your amplifier's volume level to a suitable position.

Test your project simply by tapping the transducer gently. If the project works, you'll hear this directly through your amplifier. Now use masking tape, tape the transducer to an acoustic guitar (on the scratchplate is a good place to start). Play the guitar adjusting the controls to suit.

Once you've ascertained that your Active Pickup works you should play around with the transducer, moving it around the body of the guitar to find the best spot. As with all contact types of pickup, you'll find that sound varies greatly with position. My prototype was tested using a conventional jumbo-style guitar and a flat-necked 12-stringed Spanish guitar and on both, taping the transducer to the bridge proved a good position. For the jumbo, another good position was on the side of the body hips. For the 12-string, though, the best place was found to be around the scratchplate area.

Once you've found your optimum position, you need to remove the guitar strings to allow you access to the innards. This is where you need to drill your guitar body to mount the project. The best position is on the upper shoulder of the body, so the controls

PROJECT

are easy to adjust and the guitar lead plugs into the socket mounted on the guitar back. So you need to drill two holes for the potentiometers on the shoulder and one for the socket on the back — a fair bit of accurate measurement, estimation and good luck is probably called for here!

Before final mounting of the circuit board into your guitar, with two or three sticky pads mount the battery onto the back of the board. Also estimate the length of screened lead you'll need between board and transducer and cut and resolder to suit. (Resoldering the board end — not transducer end!) Mount the circuit board in the guitar and hold it in place with potentiometer and jack socket washers and nuts.

Next, fasten the transducer inside the guitar body in a place internally corresponding to optimum outside position. Instead of masking tape this time, though, use a sticky pad. Note that once you fix the transducer on with a sticky pad, you'll probably never get it off again in one piece, so make sure it's in the right position. If the screened lead between the circuit board and transducer is too long, you might find it clatters against the inside of the guitar body — in which case get a few self-adhesive cable ties to hold it down permanently.

Fasten on a couple of control knobs to the potentiometer spindles. Finally, restring your new electro-acoustic guitar.

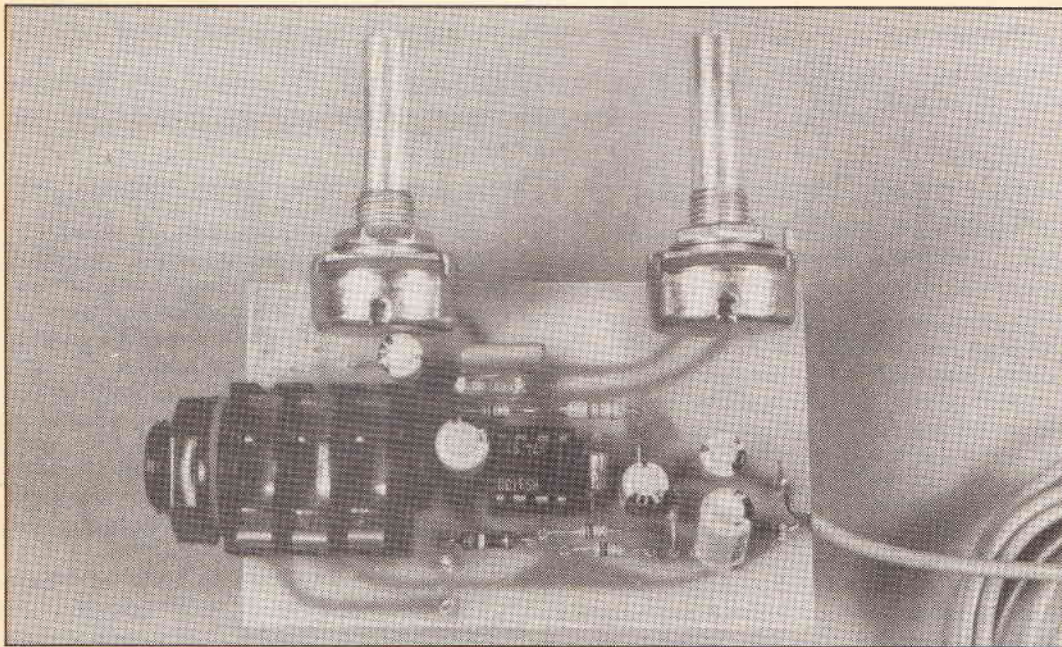

HOW IT WORKS

The piezoelectric pickup used in the project is actually an output transducer, used in toys to give speech or music effects. Used as an input device, however, it becomes a type of microphone with very high impedance and unequal frequency response. So it must be coupled to a standard guitar amplifier using a preamplifier, which has a correspondingly high input impedance and is capable of equalizing the signal to give a reasonably level frequency response.

Although we've specified a particular type of piezoelectric transducer, the Active Pickup will function with many types of similar device. The prototype was tested with two other commonly available types, although the specified type gave best overall frequency response.

The integrated circuit IC1 forms the active component in the preamplifier circuit, whose frequency response is shaped by the components around it. The preamplifier has an input impedance of 100k — high enough to match the high output impedance of the pickup, without being so high as to suffer from interference and noise problems. A small amount of gain is designed in to the preamplifier.

This integrated circuit has an extremely low current drain, around 2mA, and is thus ideally suited to battery-powered operation. It is also capable of running from a single supply (ie, only one battery is needed) down to less than 5V.

The potentiometer RV1 gives a measure of tone control, actively cutting or boosting frequencies above 750Hz. Potentiometer RV2 controls output volume level. On/off switching is undertaken as the output jack plug is inserted into jack socket SK1. The socket is a stereo version, on to one terminal of which the battery negative supply (or earth) is connected. The circuit's earth is connected to another terminal. Insertion of a mono jack plug connects these two earthed terminals and power is applied to the circuit.

PARTS LIST

RESISTORS (all ¼W 5%)

R1,2,3,5	100k
R4	47k
R6	39R
RV1	1M miniature logarithmic potentiometer
RV2	10k miniature logarithmic potentiometer

CAPACITORS

C1,3,8	4µ7 16V radial electrolytic
C2,7	47µ 16V radial electrolytic
C4	1n polyester
C5	68p polystyrene
C6	33n polyester

SEMICONDUCTORS

IC1	3130
-----	------

MISCELLANEOUS

SK1	stereo ¼ inch jack socket
Piezoelectric transducer — 41mm diameter, speech transducer.	
Printed circuit board, circuit board pins.	
8-pin dual-in-line integrated circuit socket.	
PP3-sized battery and clip.	
Screened lead.	
Sticky pads.	

BUYLINES

Most parts are easily obtainable from any component outlet. Piezoelectric transducer is available from Maplin (part number YU83E). The circuit board is available from the ETI PCB service.





Recent developments in CD hi-fi has seen the use of bitstream technology. Eric Kingdom shows how the latest chip from Sony works.



THE SONY HIGH DENSITY LINEAR CONVERTER

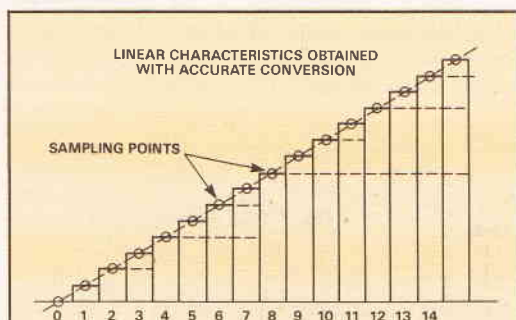

Fig. 1 Linear characteristics obtained with accurate conversion.

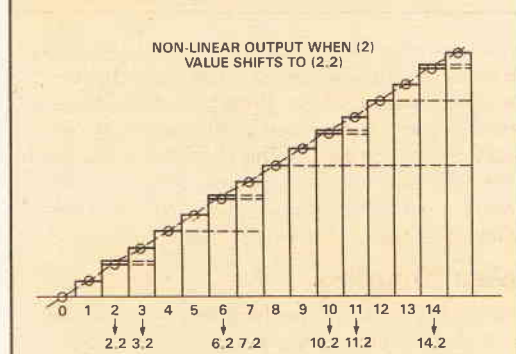

Fig. 2 Non-linear output when '2' value shifts to '2.2'

Recently the digital to analogue converter, a key component in digital audio equipment has been undergoing a series of remarkable technical improvements. Making maximum possible use of the 16 bit data within the compact disc system standard as originally formulated in conjunction with Sony, has always been a key aim of the system designer. A major step forward to this end has been achieved through Sony's new pulse D/A converter. Musical signals are represented by a changing density of pulses to achieve a new level of quality in high sound.

Conventional D/A Converters

Probably the most popular type of D/A converter is the step waveform type. Here the digital data input

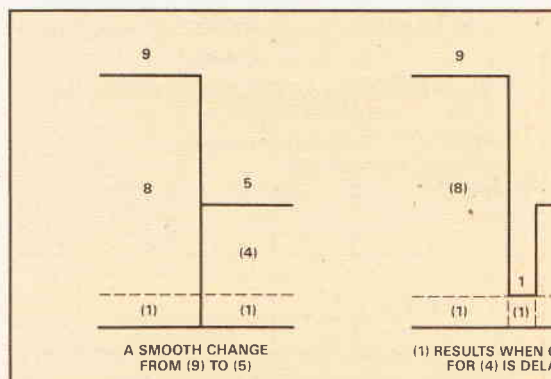

Fig. 3 A smooth change from '9' to '5'

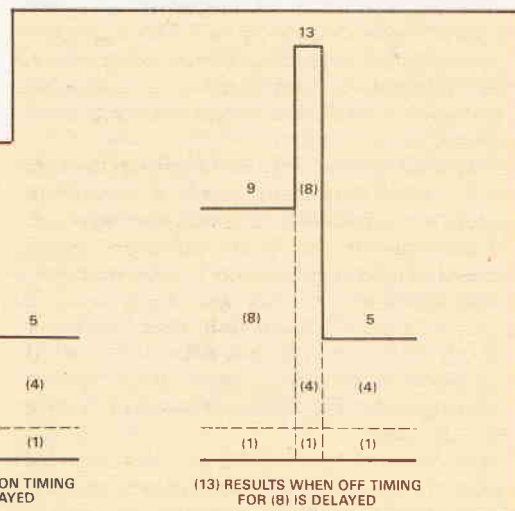

Fig. 4 Results when ON timing for '4' is delayed.

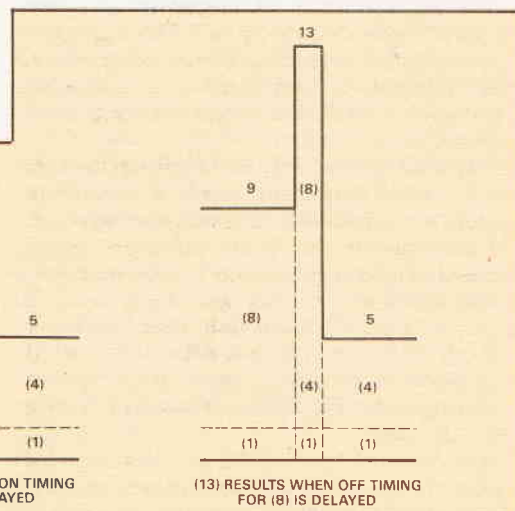

Fig. 5 '13' results when when OFF timing for '8' is delayed.

is converted into an analogue signal by switching a series of electronic switches. Each switch is connected to one of many current sources and the resulting currents combine to form the signal amplitude or volume. The quality of this type of D/A converter has been improved but there are some inherent drawbacks for example, differential non linear distortion, glitches and zero cross distortion. The types of distortion generated using a 16 bit DAC will now be explained.

Differential Non-Linear Distortion

In a 16 bit D/A converter there are 16 different current sources which can reproduce 2^{16} different signal levels or 65,536 output levels. Every slice or sample of the original signal is present in the form of a 16 bit wide input 'word' which can be one of a choice of 65,536 generating a corresponding output current level. Each current source must change in precise steps and is weighted in the order of 1, 2, 4, 8 32, 768. If we consider a 4 bit DAC which has 4 electrical sources with values 1, 2, 4 and 8. Putting these sources together in different combinational steps varying gives 16 possible levels. To express 7, levels 1, 2 and 4 are added; 15, will come from 1 + 2 + 4 + 8 and so on. If each current source is constant at all times the result is a linear conversion characteristic shown in Figure 1.

However, if the current source with value 2 fluctuates and becomes 2.2 then not only step 2 but all others using that source are effected; step 3 swells to 3.2, 6 to 6.2 and on up the scale. The linear characteristics are then lost, shown in Figure 2. This change distortion current is called differential non linear distortion.

Glitches

It is not possible to turn all sixteen electronic switches on and off at the same time due to minute differences in timing — for example, when the signal level changes from step 9 (9 = 1 + 8) to step 5 (5 = 1 + 4) in figure 3, the switching off of 8 must be

BITSTREAM

synchronized with the switching on of 4. If 4 is not turned on at the correct time, then only 1 is present momentarily (see figure 4). Similarly if 8 is not switched off in time, 13 would be momentarily represented (figure 5). The spike-like noise caused by such inaccuracies in switch timing is called a glitch and at low signal levels the glitch to signal value ratio is at its highest and is at its most severe. Some manufacturers have introduced deglitchers, but these create additional linearity problems in the total DAC circuit.

Zero-Cross Distortion

In a 16 bit system the moment the DAC output changes from 32767 to 32768 at the halfway point is called the zero cross point for audio signals. Consider a simple 4 bit system with 16 levels, the zero cross point is when 7 changes to 8. At this critical point electrical currents 1, 2 and 4 ($1 + 2 + 4 = 7$) are all turned off and 8 is turned on. This is the point when all switches operate and errors due to timing and level difference are not only more likely to occur but are more severe. A timing error in a 16 bit system could result in the momentary leap of many steps away from the original signal. This causes large fluctuations in current and switching speeds, considerable differential non linear distortion and glitches — collectively called zero cross distortion.

In some step waveform type DAC's these distortions are minimized and operating precision improved by 'laser trimming' during the manufacture of the IC's. For higher precision semi-fixed resistors are externally added to control more finely the current intensity of certain bits. However, none of this can take into account the effect of component ageing, temperature, component mounting on circuit boards and physical vibration. One may conclude that step waveform type D/A converters have already reached their full potential in terms of precision.

Principles of the 1 Bit D/A Converter

This new type of conversion is theoretically free of differential non linear distortion, glitches and zero cross distortion associated with step waveform type D/A converters. Also their conversion accuracy can be increased without trimming or regulation.

Output Section of 1 Bit Device

In the typical step waveform type DAC, digital data is converted into an analogue waveform varying in amplitude as in figure 6. If these are rotated 90° to the right, and laid on their side they are now constant in terms of amplitude as in figure 7. This represents output waveforms via the single bit method. Analogue signals can be obtained in the same way as the multibit or step waveform method after passing through a low pass filter.

Since the ideal single bit D/A converter has only a single current source and switch, it is free from variations in current intensity or switching speed. To compare between the 1 bit converters, some measured values are quoted later for reference only. Sensibly manufacturers have opted for a variety of different names to distinguish their particular approach, for they are certainly different in method and component, and do rely on the basic principle of handling a high speed data or bitstream on one form or another.

The Sony 1 bit pulse DAC uses one electrical source and one electronic switch to express only two values 1 and 0 switching them at ultra high speed. Musical signal levels are expressed by the changing densities of 1's and 0's. Imagine a tall tank, when a 1

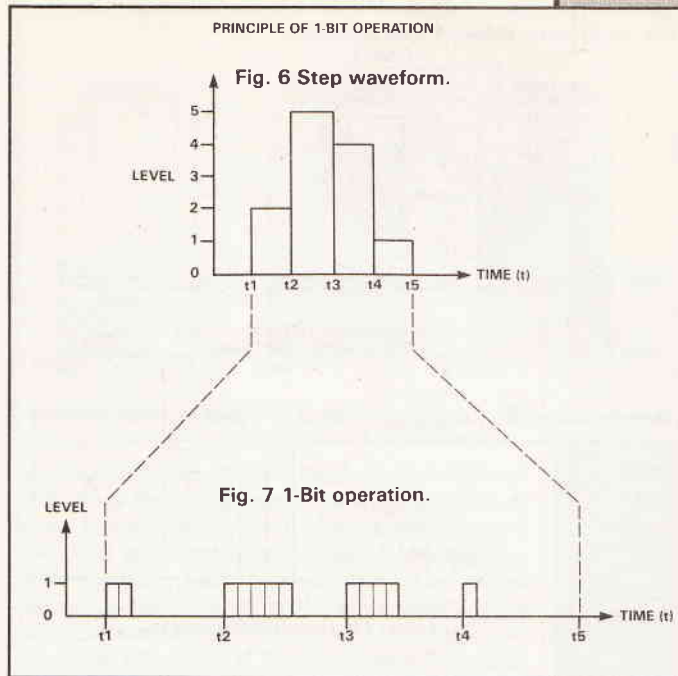

signal is sent from the digital processor the tap opens and water is added. When an 0 is received the drain opens and water is let out. When the music starts, a train of pulses is transmitted so the level of the tank water will vary constantly. This change in water level in the tank over a time corresponds to the musical signal. In effect, this type of analogy corresponds to the low-pass filter in the actual circuit.

Noise Shaping

To convert 16 bit data along the time axis directly using the single bit method, one would need a clock (the timer or governor for the electronic output switch) operating at approximately $44.1 \text{ kHz} \times (2^{16} - 3)$ Gigahertz !!!

This frequency cannot be produced practically with today's IC technology. However, if the 16 bit data is reduced into only a few bits, conversion can be performed using a clock with a frequency in the tens of megahertz.

However, bit reduction in dynamic range but this problem can be solved by noise shaping. Any error generated in the bit reduction process is returned to

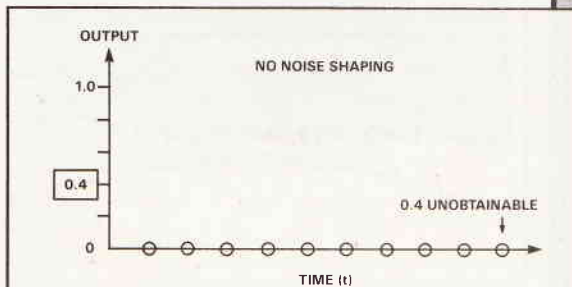

Fig. 8 No noise shaping with 0.4 input example.

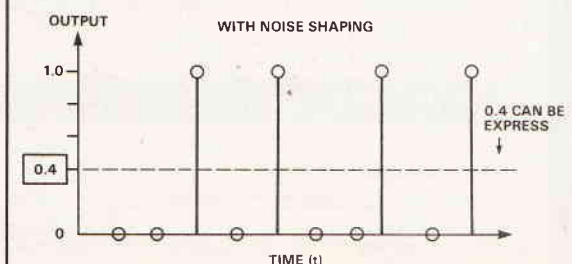
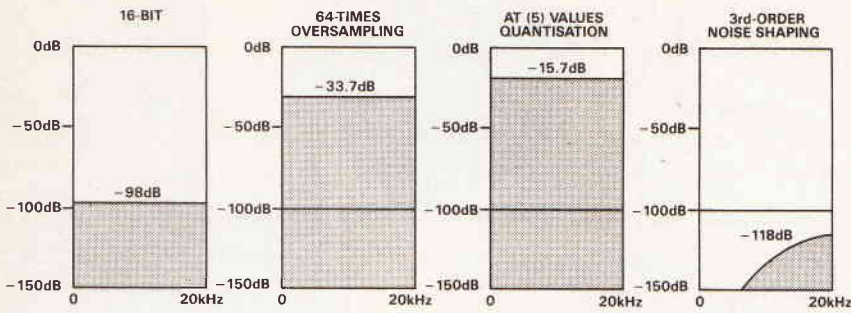

Fig. 9 Noise shaping with 0.4 as an input example.

Fig. 10 Spectral Noise of 1-Bit operation



a) 16-Bit b) At '5' values quantization c) 64 times oversampling d) 3rd-order noise shaping.

the input negative feedback to reduce noise in the audible spectrum, so improving dynamic range. If 16 bits are reduced to a single bit, only two output values are available 1 and 0, any other value cannot be expressed even if received. Output resulting from an input of 0.4 is given in Figure 8, with the help of noise shaping 2 out of 5 outputs will have the value 1 and three will have 0 so that a value of 0.4 can be expressed by averaging as in Figure 9. This feedback circuit also shifts requantisation noise from the audible frequencies to higher inaudible ones 'shaping' noise. (Figure 10).

D/A Converter Operation

Sony has developed a new single bit pulse D/A converter attaining a high level of conversion performance. As already discussed, a pulse DAC has a single current source, and a single electronic switch to rapidly switch between the two values of 1 and 0, the musical signals being expressed by the fluctuation in density of the values. Figure 11 shows that the black portion of the DACs output waveform corresponds to the ones and the white to the collection of zeros.

So, a higher signal level along the + axis corresponds to a thicker black or a greater density of the 1 value whilst a higher level along the - axis is represented by a more solid white or high density of 0 value. As this pulse D/A converter changes digital data into a train of pulses extremely similar to analogue values, the subsequent analogue low filter

can be of low order (with a gentle roll-off or slope) showing good group delay characteristics.

Different non-linear distortion and glitches are also absent from the pulse DAC. As there is only a single current source, a fluctuation will only change the pulse height and not the density, so differential non-linear distortion through variations in several current sources cannot exist. Similarly any change in switching speed of the pulse DAC only results in an overall delay of the whole pulse train. Glitches, from variations in switching speed cannot exist either.

The new pulse DAC consists of a PLM (pulse length modulation) convector, a newly developed Sony extended noise shaper and a direct digital sync as shown in Figure 12.

PLM Pulse Converter

The converter output is a train of pulses generated by a PLM type of pulse converter. In this way music signals can be expressed more accurately if the pulse density is made higher. A pulse generator operating at a maximum speed of 50MHz is integrated onto the CXD2552 Pulse D/A Converter IC. The operating speed is approximately twice as high as ordinary 'high speed' CMOS ICs. (20-30 MHz maximum). Thus a high speed pulse converter modulates pulse lengths in high density resolution.

Two arrangements are possible: the standard single mode using one pulse D/A converter, and the complimentary mode which uses two for higher performance.

The Single Mode

The PLM pulse converter in figure 11 will output 7 different pulse lengths each consisting of combinations of 1 and 0 values according to input data. So, the length between the 1 pulses is modulated according to input data and the change step is accurately controlled by a master clock operating at 45MHz (1,024 times the sampling frequency of CD). However, harmonic distortion is normally created by modulation of the pulse length, the main component being of a secondary type and irrespective of the parameters of the CMOS device. We think this distortion is caused by the asymmetrical modulation structures of 1 and 0 when modulation is applied to the length of the 1 pulses. Noise shaping data

BITSTREAM

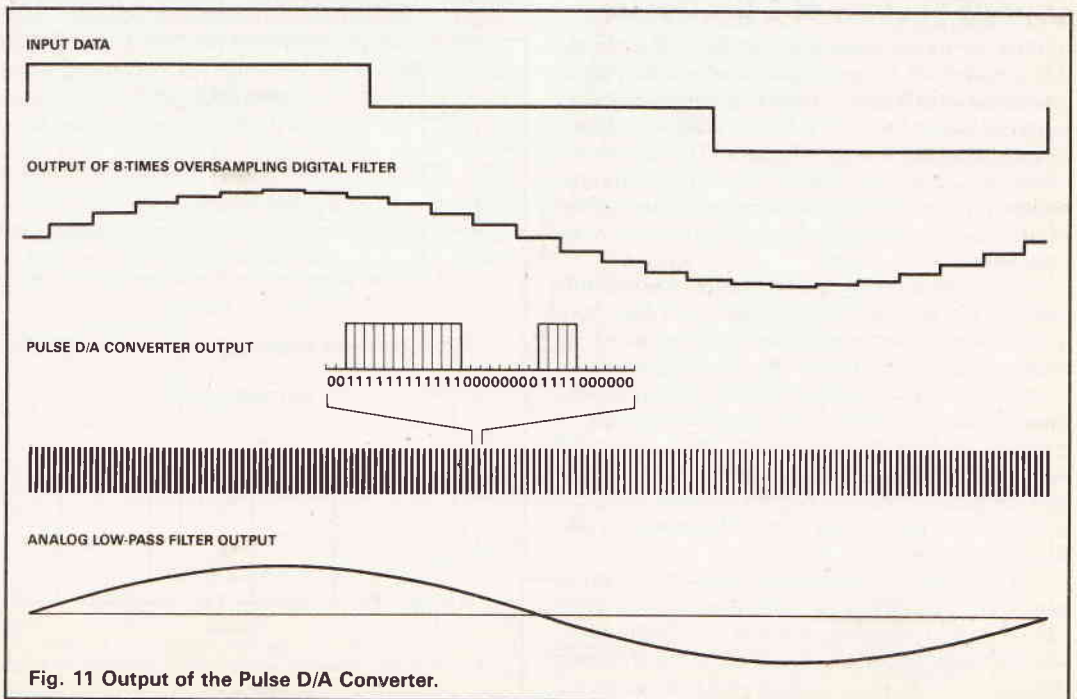

Fig. 11 Output of the Pulse D/A Converter.

modulates the 1 directly and the 0 is modulated by a complement of the maximum modulation value. The result is split into two halves, each one being added to the two adjacent data blocks equally.

Therefore asymmetry is generated by a type of 'aperture' effect caused by the ratio of signal cycle and pulse width. This type of asymmetry normally results in even number orders of harmonic distortion and is more obvious when the signal frequency is higher or the pulse rate is low. This is because of the relatively low number of pulses to each signal waveform. In fact it varies in proportion to the signal frequency squared and inversely to the operating rate squared. But, as the operating rate of this Sony system is above 45 MHz the secondary distortion component is kept quite low, around 100dB at 10KHz playback frequency.

The Complimentary Mode

Distortion arising in the single mode can be eliminated in a complimentary arrangement. The common method of pulse inversion and differential composition cannot cancel this type of distortion, for pulse inversion alone simply rearranges distortion and signals in the same orientation. The complimentary mode, in contrast, cancels distortion by modulating 1 pulses using data complimentary to each other and then composing the results differentially. This system uses two pulse D/A converters (figure 13) and can be found in the CDPX77ES.

Copies of actual waveform analysis, (figure 14) indicate that waveform C is free of distortion. Furthermore, when combined with the direct digital synchronisation (see later) the PLM pulse converter performs conversion without affecting the high precision of the quartz oscillator. The result is an extremely low distortion ratio of 0.001% (THD + N) or less.

Sony Extended Noise Shaper

The above noise shaper is a high dynamic range

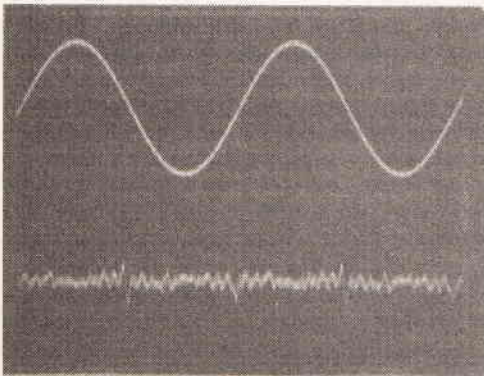

Conventional Sony D/A Converter

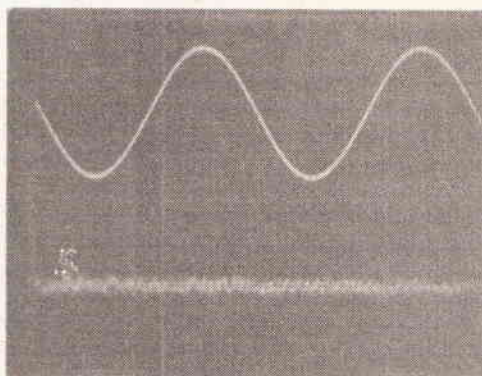

New Sony Pulse D/A Converter

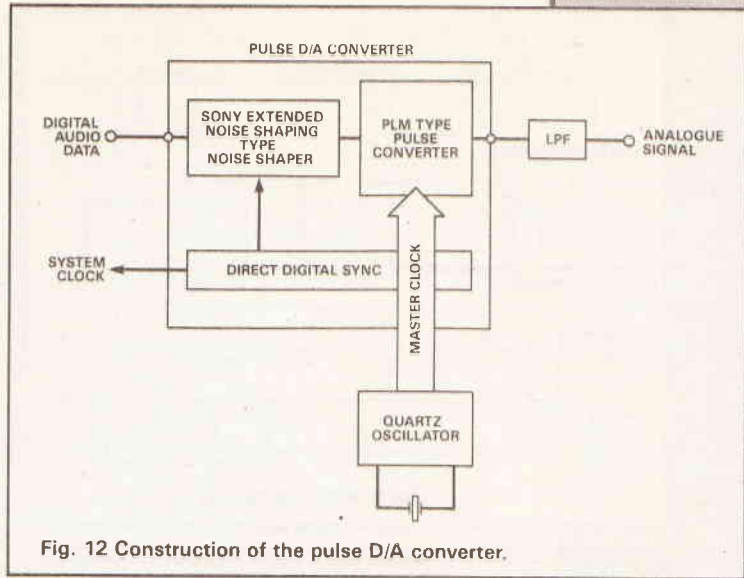

Fig. 12 Construction of the pulse D/A converter.

version of a third-order noise shaping operation using an EFB (Extended Feedback) pass. It generates the input data for the PLM pulse converter. Figure 15 shows the input/output characteristics of a basic noise shaper of the Nth order and is given by the equation:

$$Y = X + (1 - Z^{-1})^N Q$$

and changes when N, the number of orders, is varied in Figure 16.

The noise, from requantization in the audible range decreases as the value of N increases, but noise increases rapidly outside the audible range. This increase in noise will affect the burden on subsequent analogue low pass follow, so affecting sound quality.

A better solution to the problem is to increase the operation rate rather than the number of orders. This improves dynamic range in the audible sound spectrum. Sony's basic policy is to employ third-order

Table 1

		Typical PWM	Typical Higher Grade	Typical PDM	Sony Pulse CXD2552 & DF
Digital Filter	Oversampling Acc Bit Ripple	4x 18 ±0.0072dB	8x 24 ±0.0001dB	4x 28 ±0.02dB	8x 45 - CDP990 & UP (18) - CDP790 ±0.00001dB
D/A Converter	Order of N.S Oversampling Dynamic Range THD & N Master Clock	3rd 32x 106dB 0.003%* 768fs	3rd 32x 106dB 0.0025%* 768fs	2nd 256x 108dB ? 256fs	3rd 64x 118dB (single mode) 0.001% 1024fs

fs = frequency sample

* measurement method unknown

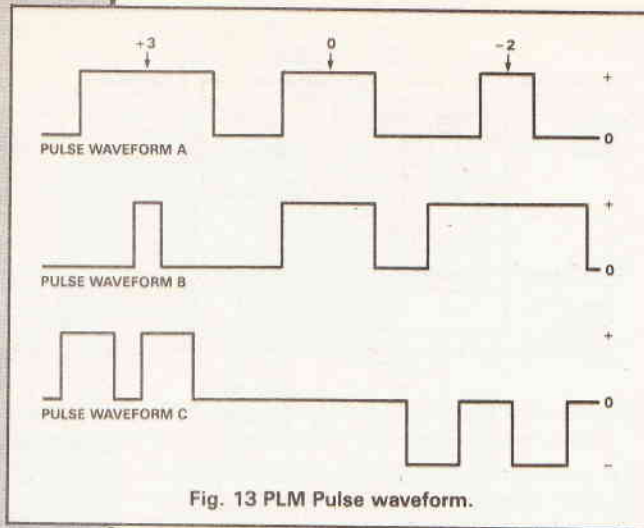

Fig. 13 PLM Pulse waveform.

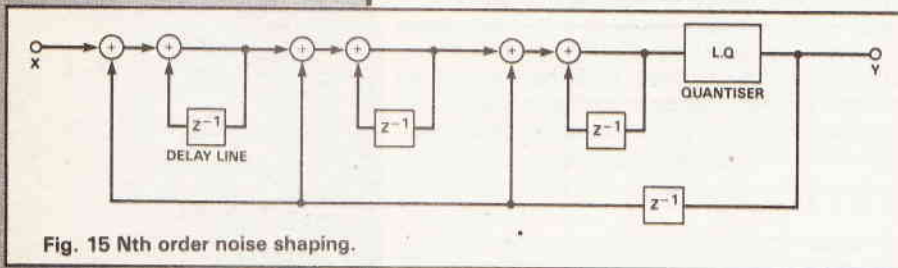

Fig. 15 Nth order noise shaping.

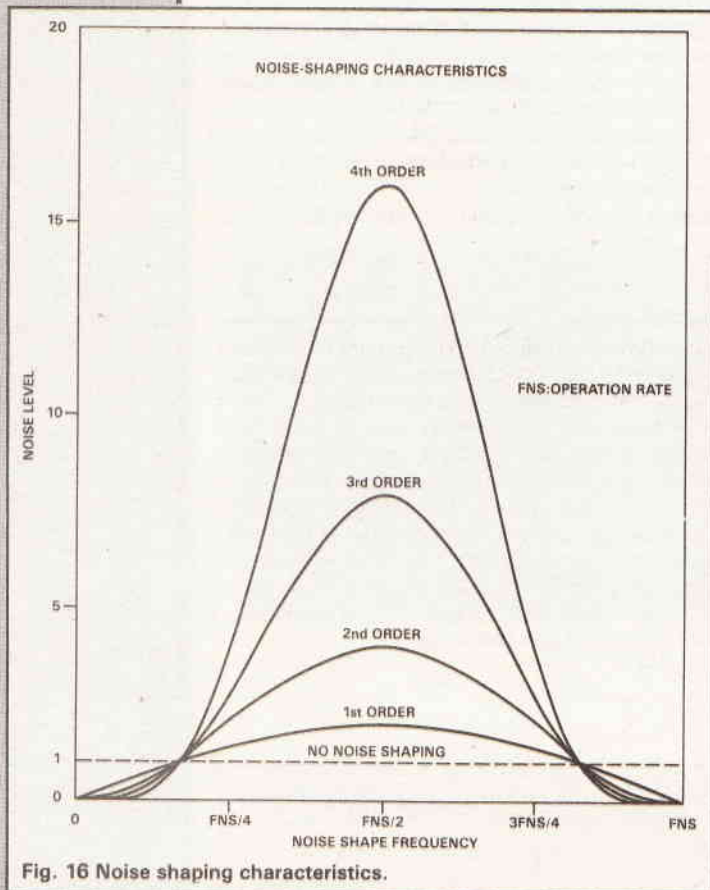

Fig. 16 Noise shaping characteristics.

noise shaping while using a high operation rate of 64 times oversampling to move the major noise component away from the audible range. Consequently, noise is kept below -100dB even by use of an analogue low pass filter of low order.

However, a problem exists with the arrangement shown in the last figure, if noise shaping is adopted at a third-order or higher. Without alteration operational stability would suffer due to overloading

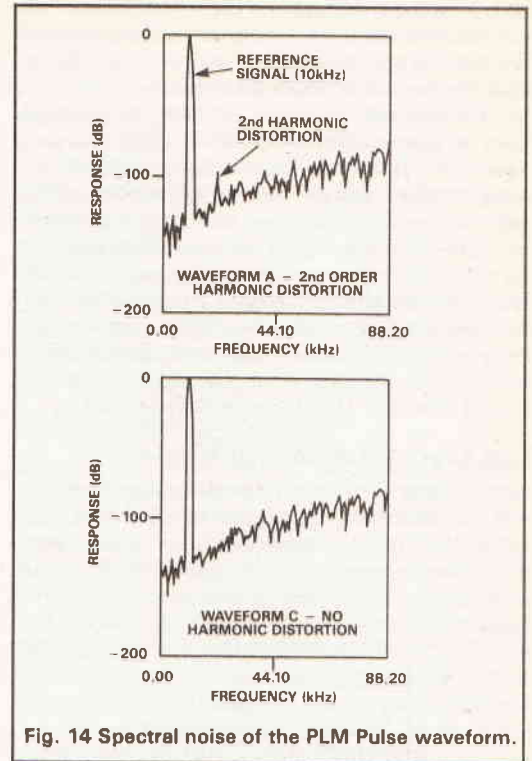

Fig. 14 Spectral noise of the PLM Pulse waveform.

of the integrator. In the pulse DAC stability is maintained by use of multistage noise shaping, (figure 17). Primary noise shaping operates on the signal in the first two stages. If the output of the second quantizer is three values or higher, the first stage may be overloaded.

This problem is solved by providing an EFB (extended feedback pass). Figure 17 shows that data is passed from A to B and figure 18 shows the circuit complete with EFB pass. The first integrator will receive ordinary feedback data along with data which passed the quantizer in the first stage, thus the EFB pass assists operational speed so preventing overload.

The output of the quantizer in the second stage can have two values giving an improved overall dynamic range of around 16dB.

Figure 19 shows a copy of the final noise spectrum which illustrates a noise distribution of 18dB per octave, a degree of third stage noise shaping and greater noise reduction in the lower ranges. Including such noise, the final dynamic range is an astonishing 118dB, quite sufficient as they say for the theoretical values of CD recording.

Sony Direct Digital Synchronisation

Last year Sony introduced an IC offering digital synchronisation, and was put immediately before the DAC jitter was eliminated. As the pulse D/A converter creates musical signals by altering pulse density it is vital that the pulses keep accurate time to give good conversion.

The digital synchronisation is now integrated into the IC, permitting direct connection of a highly accurate quartz oscillator master clock to the pulse converter which outputs the analogue signals. This contributes to the very low distortion ratio of the PLM pulse converter.

The Sony High Density Linear Converter System

The combination of the new CXD-2552 pulse D/A converter, a digital filter and an analogue low pass filter form the Sony High Density Linear Converter system shown in Figure 20.

Although the pulse D/A converter is very accurate, its performance will be limited if the digital filter preceding it in the data route is of inferior performance level. The HDLC system thus uses a noise shaping Sony digital filter (CXD 1244) which uses an internal 45 bit long accumulator performing highly accurate oversampling. The output data is then subjected to a first order noise shaping to produce high dynamic range.

The overall noise characteristics of the CXD 1244/CXD 2552 combination is illustrated in Figure 21. The right and left sections of the graph show differences in noise, reflecting a rational distribution of orders in noise shaping within the audio band.

Pulse Converter Characteristics

The greatest advantage of a pulse converter is low distortion. Figures 22 and 23 show distortion components from a conventional multibit DAC and the new pulse D/A converter. The upper section shows the output waveform and the lower section

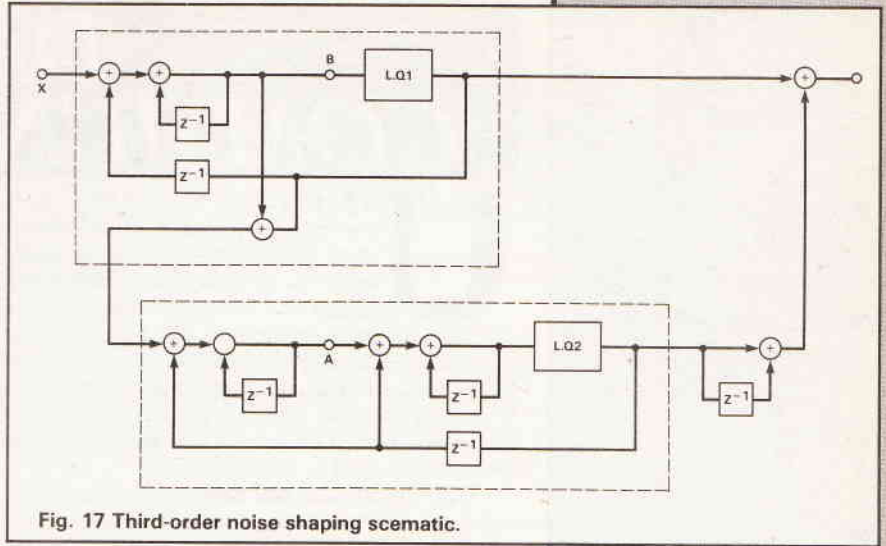

Fig. 17 Third-order noise shaping schematic.

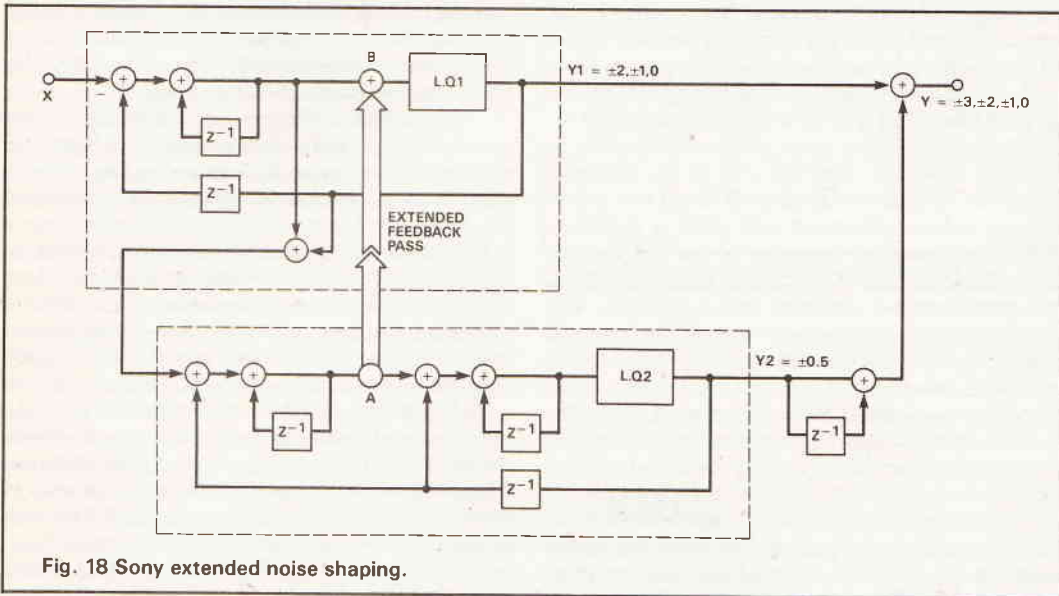

Fig. 18 Sony extended noise shaping.

distortion, both from playing sine waves through the components. As a conventional DAC produces differential non linear distortion and glitches, these copies show a larger version of zero cross distortion.

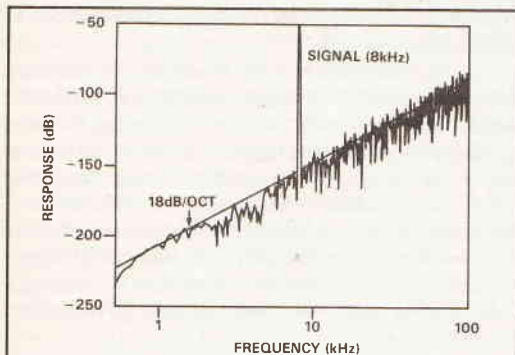

Fig. 19 Spectral noise of third-order noise shaping and EFB Pass.

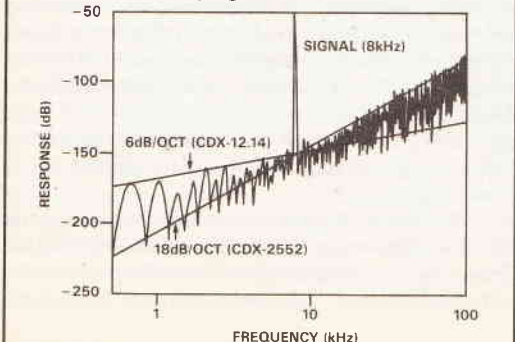

Fig. 20 Sony high density linear converter system.

Random noise is the main component in the pulse DAC and the output contains none of the described distortion so detrimental to sound quality.

I hope that this overview of the Sony High Density Linear Converter System and the rationale behind its development has been an interesting one. Time does not permit a more in depth view of what is a most fascinating example of applied research. Certainly, the new pulse D/A converter is an important part of Sony's CD player range, and it might be worthwhile to listen to any of these models and hear for yourself the musical appeal of this remarkable new conversion technology.

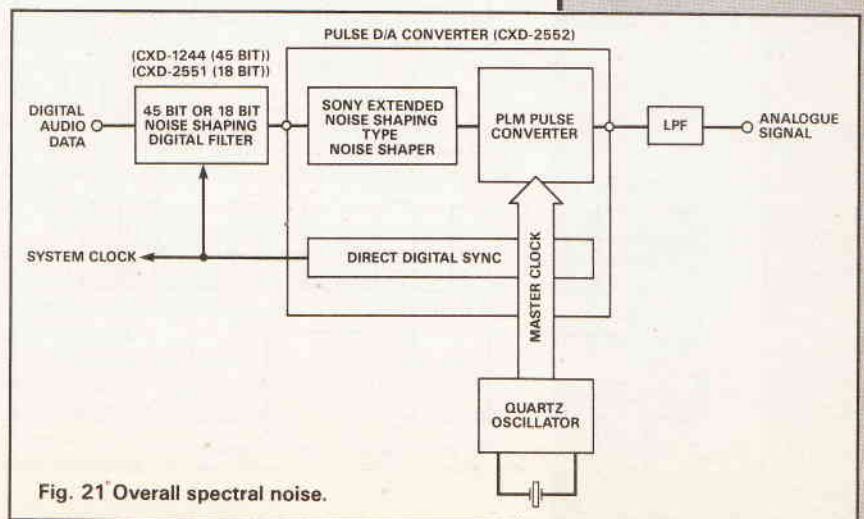

Fig. 21 Overall spectral noise.

In the second of two articles, Mike Bedford explains synchronous communications and networking.

DATA COMMUNICATIONS

Until recently, most home data communication used asynchronous serial links, the synchronous world being the domain of large IBM mainframes and suchlike. Whereas home users will still use asynchronous links for connecting a computer to say a printer, a plotter, a modem or an EPROM programmer, synchronous communications is starting to creep into the realm of radio data communications such as the AX25 packet switching systems now used by radio amateurs.

Asynchronous serial communications equipment uses a comparatively simple clocking technique which ensures that the transmitter and receiver stay in synchronisation for at least the length of one character, that is 8 or 9 bits (including parity). In order to achieve the necessary periodic re-synchronisation, each character is framed by a start bit and at least one stop bit, these being of different polarity so that re-synchronisation takes place on the first positive to negative transition after the end of the previous character. To refresh the memory about this and to provide some comparison with what is to follow, Figure 1a shows the waveform of the ASCII string ETI? (45H, 54H, 49H, 3FH) with an even parity bit transmitted asynchronously with 1 stop bit. The question mark is there because I needed an example with at least 5 consecutive binary 1s for reasons which will be revealed later!

In many applications, for example a link between a VDU terminal and a computer, where the user periodically types data at the keyboard and couldn't possibly keep up a 9600 baud rate, the interface is not 100% utilised and the additional start and stop bits added to each character do not decrease the overall data rate. Where data is continually being transmitted, however, the 25% decrease in throughput is significant. Furthermore, because of the comparatively simple clocking methods used in asynchronous communications, the maximum usable baud rate is limited to about 38,400. Synchronous communications overcomes these drawbacks.

Synchronous Communications

As its name suggests, in synchronous communication the transmitter and receiver stay in synchronisation

for the duration of large blocks of data, not just for a single character. This can only be achieved by sharing the same clock. The simplest means of achieving this is for, say, the transmitter to generate the clock and transmit this to the receiver over a conductor separate to the one on which the data is sent. RS232C does make provision for such a scheme but since in the general case of communications via telephone circuits this is clearly not possible, other means have to be found.

The next most obvious solution is illustrated as Figure 2a and is referred to as bipolar encoding. Here, a binary 1 is represented by a positive going pulse and a 0 by a negative one. There is a transition during every bit making it possible to extract the clock. In this scheme, three amplitude levels are required and this complicates modem requirements. This method is also known as RZ (for return to zero).

An alternative NRZ (non return to zero) encoding method overcomes this three amplitude level problem and is shown as Figure 2b. In this encoding method, which is known as phase or Manchester encoding, a 1 is represented by a positive going transition (not a pulse) and a zero by a negative going transition, in each case at the centre of the corresponding time interval. These two encoding methods both involve combining the data and the clock at the transmitter and then extracting the one from the other at the receiver. The alternative approach is analogous to asynchronous transmission in that the receiver has a stable clock which is periodically re-synchronised. However, since there are no start and stop bits, to use this method it is necessary to encode the data to ensure there are sufficient transitions in the data stream for this re-synchronisation to take place. Such an encoding method is called NRZI (non return to zero inverted) and is shown as Figure 2c. Here the signal level changes at the start of each zero bit but stays the same for a one. This means that so long as we don't try to transmit long strings of 1s (and for reasons we'll touch on later this won't happen) there are always enough transitions to allow a phase locked loop in the receiver to re-adjust.

Now that we've covered the means of ensuring that the transmitter and receiver remain in synchronisation, let's spend a bit of time considering the way in which data is bundled together in blocks, otherwise known as frames. There are two distinct methods, called *character orientated protocols* and *bit orientated protocols*. Since the character synchronous approach is somewhat long in the tooth and really only lingers on in the world of mainframe computers (for example IBM's BSC protocol) we shall only consider the newer bit orientated method.

HDLC (High-level Data Link Control), which is very important as it forms the basis for the X25 packet switching networks, uses such a bit orientated approach. Essentially, each frame is bracketed by an opening flag and a closing flag, both these being the bit pattern 01111110. Receipt of this pattern informs the receiver that a frame is about to start and then again that it has terminated. Between these flags is the frame content which may be any number of bits of binary data.

The astute will now be wondering what happens if the data happens to contain the sequence 01111110. This is where the technique of *bit stuffing* or zero bit insertion comes in. If the transmitting device detects

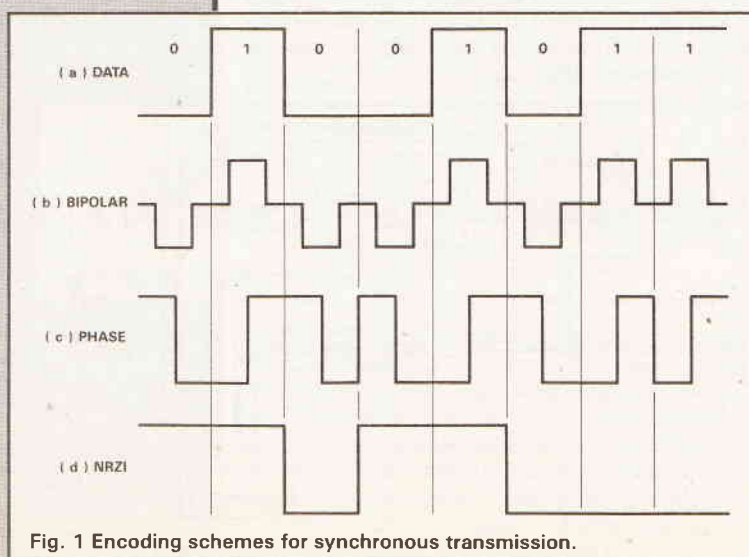

Fig. 1 Encoding schemes for synchronous transmission.

a string of five consecutive 1s then an extra 0 is automatically inserted so if the data actually was 01111110 then it would go out as 011111010. In order to compensate for this, the receiver, on receipt of a zero following five 1s, automatically deletes it. This explains how the dreaded continuous stream of 1s which would upset the NRZI encoding scheme is just not possible.

The data between the opening and closing flags of a frame is usually not all true data in the normal sense of the word. Of course true data is there, but each distinct protocol includes additional information which includes the destination of the frame (for use in networks), a code to indicate the type of frame (information frames or supervisory frames which are used for error and flow control) and error detection information. A proper discussion of all this takes us out of the realm of a hardware into the realm of software so we will call a halt at this point.

Let's now look at Figure 1 in its entirety. This figure illustrates the difference between asynchronous and synchronous transmission. Note 1b is atypical, as the waveform has been shown as low for 0 and high for 1, rather than an NRZI or phase encoded form which would normally be expected. This has been done to ease interpretation by the reader.

Let's briefly venture once more in to the realm of software, this time to consider error detection. Most readers will be aware of the concept of *parity* which is a simple form of error detection used with asynchronous communications. The addition of an extra parity bit to each character indicates any erroneous bits, so long as there is no more than one error in the character. In a block of many hundreds of bits, the addition of a single parity bit at the end is virtually useless. Since data is sent at a much higher rate in synchronous communications, a short burst of interference is much more likely to wipe out a number of consecutive bits so a parity bit every 8 bits wouldn't be very effective either. This is where the frame checksum (FCS) or cyclic redundancy check (CRC) comes in.

Frame Check Sums

Generated by use of polynomial codes, the FCS or CRC takes the form of a block of check bits appended to the end of the frame. The number of such bits is variable, but it's a case of the more the better) except of course that the longer the CRC, the more data there is to transmit and hence the overall speed decreases). Normally 16 or 32 bits are used. We won't go into a full mathematical proof of how polynomial codes work but in essence the following method is used to generate the checksum:

A number of zeros, equal to the number of check bits to be generated, is appended to the end of the data block. This is then divided (module 2) by a constant referred to as the polynomial generator, which is one bit longer than the length of the required checksum. The remainder of this division becomes the checksum.

The choice of polynomial generator is quite critical and affects both the efficiency of the error check and the types of error which will be detected. The generator recommended by the CCITT for use with telephone circuits is expressed as $x^{16} + x^{12} + x^5 + x^0$, which in binary terms means 10001000000100001.

So much for generation of the checksum but what happens at the other end? At the receiver the same process is carried out but the starting point is the received data, including the checksum rather than the data to be transmitted with a number of appended zeros. Assuming no errors, the remainder of such a

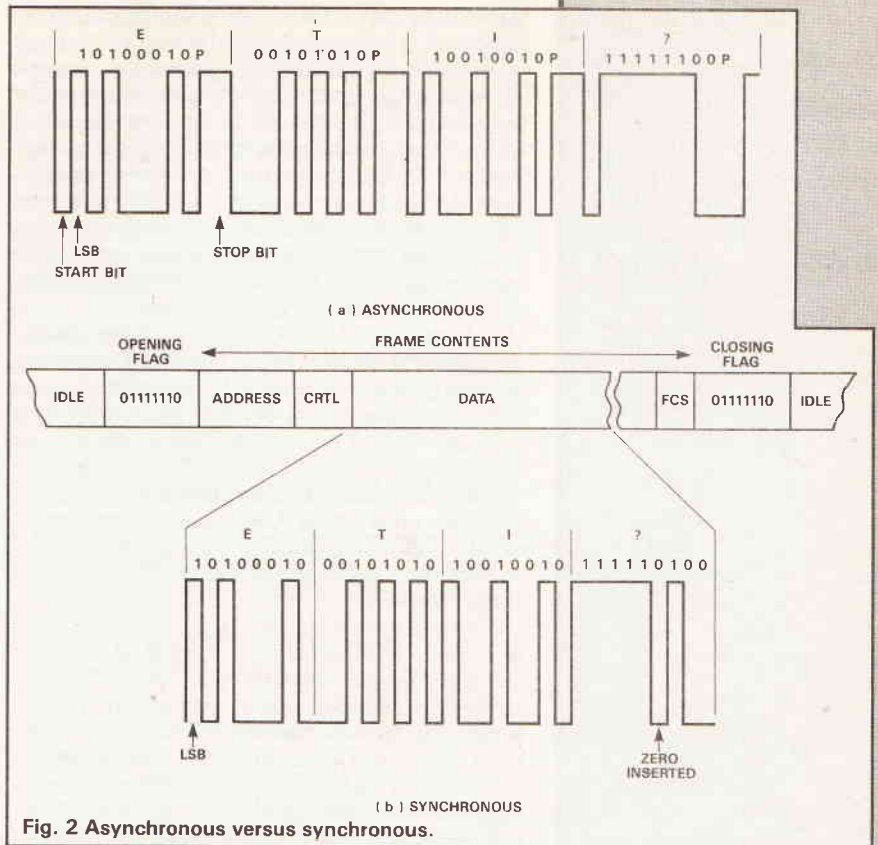

Fig. 2 Asynchronous versus synchronous.

division will be zero. A non-zero result is indicative of an error. At first sight the circuitry to do this computation seems quite involved but actually this isn't so. A combination of shift registers and exclusive OR gates is all that is needed to do the trick.

Networking

The past decade has seen a gradual increase in the proportion of personal computers compared to the more traditional mini-computer or mainframe. In the mini-computer environment a central computer with disc drives and line printer allowed simultaneous access to a number of users each operating a VDU terminal.

A typical scenario for the newer generation of PC users is a small company investing in a personal computer with off the shelf software. As requirements grow, further PCs are bought. Each user has a considerable amount of computing power at their disposal, probably more than that available to one of say 32 users on a mini. However, unlike the mini-computer situation, the individual PC users are not able to work on the same shared data files, an important consideration to the corporate user. Similarly, the shared use of expensive peripherals such as system line printers or plotters is not easily accomplished. This is where the network comes in. Although other classifications exist, we shall restrict our discussion to networks of physically close PCs, these being known as Local Area Networks (or LANs to their friends).

The first thing to consider about networks is their topology, in other words the way in which the individual PCs and other devices are interconnected. A *node* is the name given to such a constituent part of a network.

The simplest form of network to implement is a star, this being shown in Figure 3a. Although this is conceptually the easiest type of topology to create, there are a number of practical drawbacks. Firstly, since all the nodes (except one) connect to one central

machine (called the *file server*), a significant amount of cabling is required. Secondly, there is quite a workload on the file server, even for messages passed between two of the other nodes. In every case, the message has to be received by the central machine and re-transmitted to the destination. On the positive side, such an arrangement could be made to work with no special hardware. Although it would by no means give impressive performance, such a network could run over ordinary RS232C lines, so the only special requirement is for the file server to have sufficient ports to connect to each of the other nodes.

A quick word about file servers. Why was the central machine in the star network given this name? We have established that a need to share data was one of the main reasons for forming PCs together into networks. Now, if a number of PCs are to access a common set of data files, it makes sense for these to reside on the discs of a single machine which serves files to the other nodes. The other PCs can use their own hard or floppy discs for local files which are of no interest to other users, but common files are stored in the one place.

The requirements in terms of speed (both processor and disc access time) for this file server are a lot more stringent than those of a single PC if it is not to prove a bottle neck to the network. For this reason, the file server within a network of ordinary PCs is often based on an 80386 processor and could easily have a disc capacity of a hundred or more megabytes and a short access time. The file server can also be the machine to which expensive common hardware resources such as high speed printers are connected, in which case it also acts as a *printer server*. In the star network, the file server is topologically different to the other nodes, but this isn't the case in the other topologies we shall look at. However, the concept of a file server is common to all.

Bus Networks

Turning now to the bus structured network which is illustrated as Figure 3b, this topology is one of the two which make up the majority of LANs (the other is the ring, which we'll look at later).

Looking at the electrical interface requirement, we now need a multi-drop type so a RS232C, even if it gave an acceptable speed, could not be used. A multi-drop interface is one which allows a number of inputs and outputs to be connected to a single conductor. The interface used in Ethernet, one of the most common bus structured LANs, specifies a coaxial cable and operates at a speed of 10Mbits/sec. Typical LAN speeds look very high to those whose previous experience is limited to RS232C but remember that in a network it's not just a matter of transmitting user dialogue (VDU traffic) but often entire file contents.

How is line discipline ensured in a Bus Network. What prevents the chaos which would result from more than one workstation transmitting over the network at the same time? The method is known as

Carrier Sense Multiple Access/Collision Detection (CSMA/CD) and is an integral part of the Ethernet specification.

This is really a 'first come — first served' approach, so if a PC wishes to transmit it first listens on the network to see if it senses a carrier which would indicate that another station was transmitting. If other traffic is detected it waits, otherwise it starts to transmit a frame. Now it is quite possible that two nodes could be going through this process and both start transmitting at the same instant. Such an occurrence is called a collision. As a node starts to transmit, it listens to the signal on the network, comparing it with what is being sent. A mismatch indicates that the signal is being interfered with and in this instance the detecting node continues to transmit a jam sequence of random digits for a short while to ensure that the collision is recognised by the other node concerned. Eventually both these nodes will stop transmitting. At this point a random delay is executed before trying again. Hopefully this time one node will get in there first.

Ring Networks

In the ring topology (Figure 3c), each node is connected only to those on each side of it in the ring. So, for a message to be passed from one node to another at the opposite side of the ring it must be relayed by all the intermediate nodes. An implication of this is if one PC in the network were to be turned off, then the whole system would fall down. To overcome this, an arrangement of relays is used at each node so that when a unit is turned off, the relays revert to their closed position and effectively remove that node from the ring.

Here, discipline is maintained by giving each node in turn the opportunity to transmit. This method is called *Token Ring* as it involves passing a token around the ring. Only the holder of the token is authorised to originate a transmission. Of course those nodes not holding the token are still able to relay messages originated elsewhere around the ring. There is an interesting parallel here which was used in the early days of the railways to allow trains to pass in both directions over a stretch of single track. To ensure that a collision could not take place, a train could only enter the section of track if the driver was holding a token. This token would be carried along the track and passed to any train waiting at the other end to use the track.

Comms Software For The Home User

Well, so far you may be finding this article very interesting, but what use can you make of it? Very few people are going to decide to go out and 'do some synchronous communicating' but those who are starting to dabble in packet switching and the like will not get very far without this sort of grounding.

On the other hand, it is quite feasible that someone reading this may decide to start investigating the world of Prestel, bulletin boards, electronic mail,

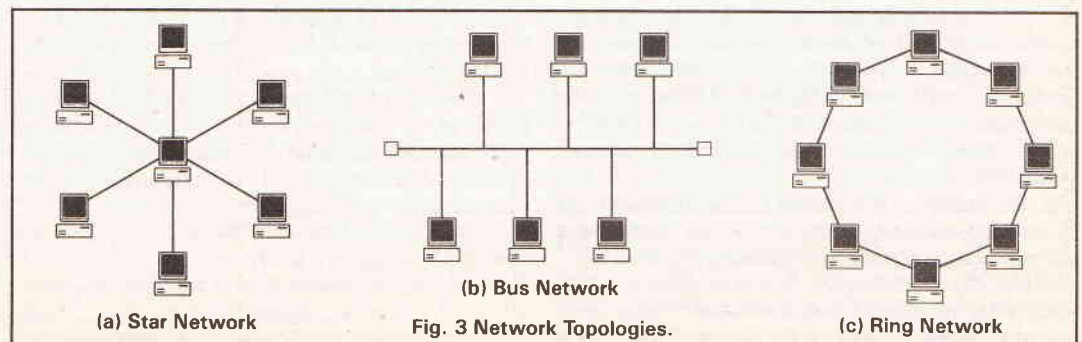

Fig. 3 Network Topologies.

tele-software and the like. We've said quite a bit about hardware selection but for those intending to use modems for the first time a mention of software requirements would prove useful.

Essentially something referred to as a communications package is required. I am not in a position to comment on other computers but quite a range is available for the IBM PC. Such packages sometimes come free with modems but if not, there are many available both commercially and as shareware. The package I have is called Procomm and is fairly typical. It includes modem support (auto-dial etc), VDU terminal emulations and protocols for software downloading.

As far as finding the various services is concerned, PCW lists UK bulletin boards each month. A word of warning — telephone charges really do mount up this way. It would be a shame to have to sell the modem to pay the first quarter's telephone bill! One final comment on modems, telephone links are not the only use of modems the home enthusiast could experiment with. Those with a communications receiver can explore the world of data on the airwaves both amateur and commercial. ASCII or Baudot data and even facsimile pictures are all there to be found.

And finally networking. Why, I hear you asking, would anyone want to implement a home network? Until recently there would have been no way a home user could justify the cost of doing so but the launch of a network for about £30 provides a convenient solution to file transfer problems. In today's confusing period of dual standard floppy disk drives on PCs (5.25" and 3.5"), users who want to exchange files have quite a headache.

So, what about this cheap network and how does it help? Well, it certainly doesn't match up to Ethernet in terms of speed, using RS232C ports as the

communications media, but it does manage 115,000 baud. RS232C isn't supposed to work at this speed but provided that the cables are short it should work. When the software is installed (and that is what you get for your money — there is no special interface and you make your own RS232C cable) it works like a real network. If PC1 has one floppy drive (A:) and one hard disk (C:) and PC2 has two floppies (A: and B:), then PC1 gains two extra virtual disks (D: and E:) which are really PC2's A: and B: PC2 gains D: and E: these being PC1's A: and C:. Each PC can therefore access the disks of the other machine as if they were its own. To copy a file from PC2 to PC1 would only require a command such as COPY D:FILE.EXE A: to be entered at PC1. This low cost network is available for £30.05 (including VAT and Carriage) from EQ Consultants on 0334 84248.

BAUD RATE and BITS per SECOND

Probably most people reading this article will be under the impression that the term *baud* is just another name for bits per second in much the same way that Hertz is synonymous with cycles per second. If experience has been limited to say connecting printers or VDUs to computers using an RS232C interface then this is understandable since in such an instance the baud rate truly is a measure of the data rate in bits/second. In the general case, however, the two terms cannot be interchanged.

The term baud is defined as the number of signal transitions per second. This gives a measure of data rate only if the number of states the signal can take is equal to two. If the signal can take 4 different levels then each time interval represents two bits (ie 00, 01, 10 or 11) and accordingly the data rate is double the baud rate. In general the following formula shows the relationship between baud rate and data rate:

$$\text{Data rate} = \text{Baud rate} \times \log_2 (\text{number of levels})$$

ETI



CRICKLEWOOD ELECTRONICS

BIGGER AND BETTER

1990

COMPONENT CATALOGUE



- ONE OF THE LARGEST RANGES OF COMPONENTS IN THE UK
- FAST AND EFFICIENT SAME DAY PERSONAL SERVICE
- VERY COMPETITIVE PRICES; QUANTITY DISCOUNTS AVAILABLE
- DISCOUNT VOUCHERS INCLUDED
- NO MINIMUM ORDER

FILL IN THE COUPON AND POST IT WITH YOUR CHEQUE, PO ETC FOR £1.50 TO RECEIVE YOUR 1990 CRICKLEWOOD ELECTRONICS CATALOGUE

CRICKLEWOOD ELECTRONICS 1990 COMPONENTS CATALOGUE

PLEASE SEND COPIES OF THE 1990 CRICKLEWOOD ELECTRONICS CATALOGUE AT £1.50 TO:

NAME

ADDRESS

.....

.....

.....

Remittance enclosed £.....

Cricklewood Electronics Ltd
40 CRICKLEWOOD BROADWAY, LONDON, NW2 3ET
Tel: 081-450 0995/452 0161
Fax: 081-208 1441 Telex: 914977

THE R4X LONG WAVE RECEIVER

A pocket fixed-frequency receiver for the BBC Radio 4 long wave transmission, using surface mount components by Bill Mooney.

A portable fixed frequency receiver was required which would pull in Radio 4 on earphones. This is mainly a talkie news station so the AM long wave transmission would have adequate quality and the receiver would not need re-tuning in different areas of the country. A small pocket receiver was the aim and this was a good reason to go for Surface Mount construction. All this leads to the latest generation of the famous ZN414 IC. The chip we are

with basic projects like this one the simplicity of this new technique is soon realised. At the same time the huge potential for complexity and miniaturisation become apparent. There's no return, you will soon want to make everything in SMD and will be ready for the increasing number of ICs and other components some of which are available only in SMD form. The excellent article on SMD by Keith Brindley in the February issue of ETI makes good background reading for this constructional project.

Construction And SMD Practice

Although we refer mainly to R4X here, the comments should be taken as general advice for hand working with SMDs.

The circuit of the R4X is shown in Figure 2. It is implemented using Surface Mount components which although designed and manufactured with automatic assembly in mind can easily be used for hand soldering. Several advantages over leaded devices will be noted. As can be seen from the track pattern in Figure 3, the PCB is very simple and the tedious process of hole drilling for component leads is eliminated. The use of a double sided PCB is highly recommended as single sided board tends to warp slightly and can put strain on the leadless chips. Provided there is no interaction, circuits could be implemented on both sides of the PCB. Double sided and hybrid construction is common practice on commercial boards.

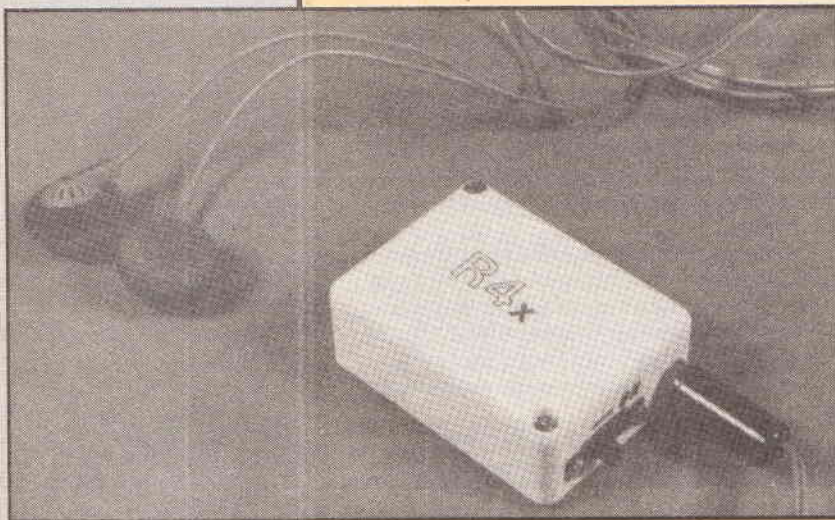

talking about is the ZN416 AM radio supplied in an SO8 Surface Mount package. This represents a considerable improvement over the 414 in that it has an added audio power amplifier output stage which will drive a pair of 64R headphones wild. The RF section of this IC is identical to the old ZN414 so most of the published information still applies. The internals of the IC are shown in Figure 1 and its main characteristics in Table 1. Turning this into a receiver is a simple matter.

The R4X receiver consists of a small Surface Mount PCB on which is mounted a ZN416 IC, a transistor audio preamp to liven things up a bit, and a handful of passive surface mount devices. Most of the space in the R4X is taken up by the battery and the ferrite rod aerial. The PCB is the smallest thing aboard and the whole thing fits into a 50mm x 37mm x 18mm plastic box. This is certainly the simplest receiver around if lack of knobs and switches is any guide. Not only do we leave out the tuning control but also the volume control. Volume level is affected by rotating the set to adjust the level of signal picked up by the ferrite rod. The ZN416 has a little AGC built in which also helps. Audio quality is excellent for speech and quite tolerable for music. The individual type earphones without a headband are the most appropriate as they are more efficient. Of course you don't have to fix tune it on R4 there are other forms of life on long wave.

The R4X is a desirable little radio as witnessed by the requests for copies from my teenage daughter and her friends who fix tune them on 252kHz. But more importantly, it is a simple way to get into Surface Mount construction. For many who take their first faltering steps into Surface Mount Devices (SMDs)

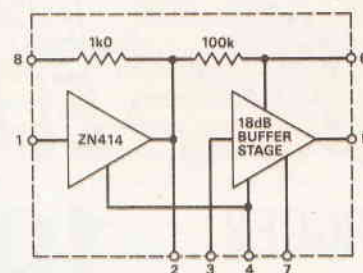

Fig. 1 The ZN414 IC internal structure

SMDs come in various sizes, the more popular '1206' size chip capacitors and resistors are used for the R4X as they are the easiest for hand soldering and still give an enormous size reduction. The '0805' chip devices are considerably smaller and becoming more popular but are not recommended for the beginner in the art of hand working SMDs. Incidentally, multi-layer ceramic chip capacitors are not marked with a value, although they may have a code letter on, so don't unpack them until you need them. Ceramic chips are used for values from a fraction of a pF up to 470n or even 1μ/16V. Higher capacities usually necessitate the use of SMD tantalum. 'Tants' are far more efficient than aluminium electrolytics of the same marked value and are the best choice for this type of work. ICs and transistors come in much smaller sizes also and all components produce circuits with wafer thin profiles. It can easily be seen how a super mini, slim version of the R4X would be possible when the very low profile of the finished surface mount PCB is considered.

PROJECT

Producing the PCB poses no problems. Just use the normal UV exposure and etch techniques. Dry transfers of SMD footprints are available and for single or small runs, 1:1 positives on drafting film are very satisfactory. The translucent type of drafting film will take drafting tapes but a 0.25mm or 0.18mm Rotring drawing pen will work on this media also and give excellent fine lines when needed. A 0.35mm pen can be used to fill in larger areas where copper is required. Leave as much copper on the PCB as possible, indeed if SOT89 power devices are used a small area of copper will act as an excellent heatsink.

Assuming you've got your etched PCB, make sure it's very clean and spray it with a thin coating of Electrolube solder-through lacquer. Allow it to dry fully on a radiator for an hour or two before populating it. The lacquer coat acts as a flux and also reduce the tendency for the chips to slide about on the copper.

In this circuit there is no preferred order of addition of the components but if you place the IC at an early stage it will make it easier to locate the position of the passives. The component positions are shown in Figure 4. SMDs must be held in place whilst soldering as they are very light and the surface tension of the solder will make them play tricks such as standing on end or going out of alignment resulting in an untidy PCB. It is important to ensure that components with tracks running underneath, such as R1, are aligned at right angles to the underun. Use a fine 26 swg (0.5mm) solder and an iron with a fine tip. Such devices and other SMD working instruments are readily available. Use the very minimum amount of solder otherwise the result will look messy and will be less reliable.

An SMD assembly jig is a real advantage as it holds the chips in place whilst soldering. This results in good alignment and a very neat finished PCB. However a much more important reason for using a jig is to allow a correct soldering procedure.

To solder a component in place it must be held down by pressing it to the copper footprints with a toothpick, for example. The soldering iron tip and the solder must be applied to the joint at exactly the same time. Carrying solder to the joint on the iron tip is just not on, because the flux evaporates in a fraction of a second and you end up applying a blob of very poorly 'wetted' solder to the joint. A dry, unreliable contact is will result. Three hands are therefore required to make a good SMD solder connection and most of us don't have three hands. The jig is therefore your third hand.

The operation is simple. With the PCB on the jig base, place the SMD on its footprints, slide the board gently into place and clamp the chip. It can now be soldered correctly. The operation of the jig is shown in Figure 5. It will take PCBs up to about 50mm and is ideal for most projects. A lot of electronics will fit on a 50mm SMD board.

Take note of the line indicating the positive side of the Tantalum capacitor and solder it in the right way around. Q1 is a tiny SOT23 device and like other SMDs is best handled with tweezers. If the tweezers are even slightly magnetised, they will make manipulation difficult due to the nickel content of the contacts. A residual magnetisation tends to build up on most tweezers after a time and is easily removed with a tape head demagnetiser. Note the use of a zero ohm jumper Rx, to bring the output connection to the edge of the PCB. This is not vital here but demonstrates their use. Zero ohm jumpers will get the designer out of many a tight spot by jumping one or two tracks and reducing the need for wire links. When all is complete give the PCB a second light spray with lacquer to protect everything from the environment.

The construction of L1 is worthy of comment.

Firstly the rod is easily cut to length by filing a groove right around its circumference after which it will easily snap if given a firm tap. Use 42 swg enamelled wire of the self tinning type. There may be some differences in ferrite materials and also the winding technique, so you may have to trim a few tens of turns to get the required station where you want it. Pile wind the coil as shown in Figure 6 using a portion of thin card or piece of plastic as a former to protect the wire from the rod. Make the coil moveable on the rod if you can. This will allow a coarse tuning control by moving the

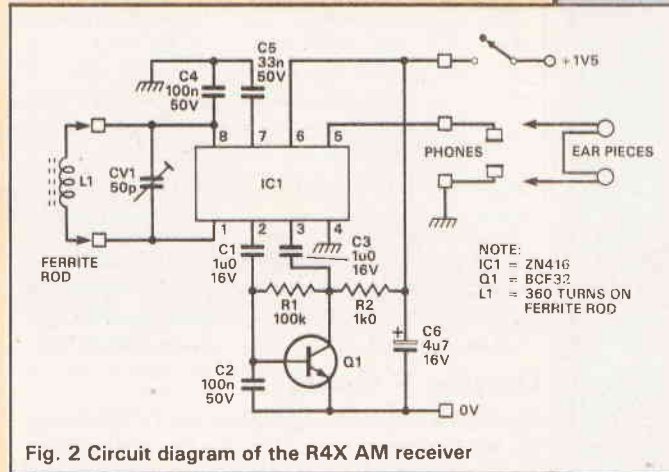

Fig. 2 Circuit diagram of the R4X AM receiver

rod in or out of the coil. The coil can be held in place with 'Blutac' whilst setting up and a more permanent adhesive can be substituted later.

When it comes to boxing it up, the simplest approach is to use a ready made plastic box. It must be plastic otherwise the ferrite rod won't work. A suitable type is the type 1521 from Maplin. This is too deep as supplied and can be trimmed by about 6mm. To do this mark a fine line all the way around. Cut off the excess using a junior hacksaw on the waste side. Then file to the line with a fine file. The pillars which

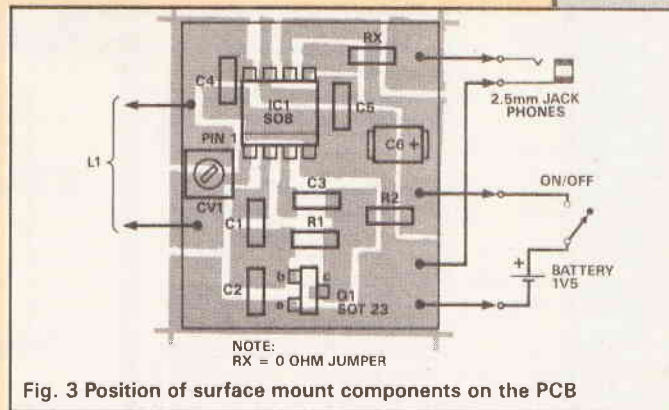

Fig. 3 Position of surface mount components on the PCB

take the self tapping screws for the lid are holed to the bottom of the box and can therefore still be used. Use countersunk M2 bolts to hold the N type battery holder, cutting off and filing smooth as required so as not to obstruct the cell. Use a miniature 2.5mm jack socket for the output. It will be necessary to reconnect the earphone leads in series to get the required 64R. The moulded jack plug supplied will therefore have to be replaced by a normal type. A miniature slide switch is used for the on/off function. The PCB is glued to the box lid. There is no need to bolt it down as it is very light.

Wire up the output jack, battery connections and on/off switch using 1/0.25mm kynar wire. This wire is excellent for miniature SMD work but it is solid core and won't take too much flexing. If you are a com-

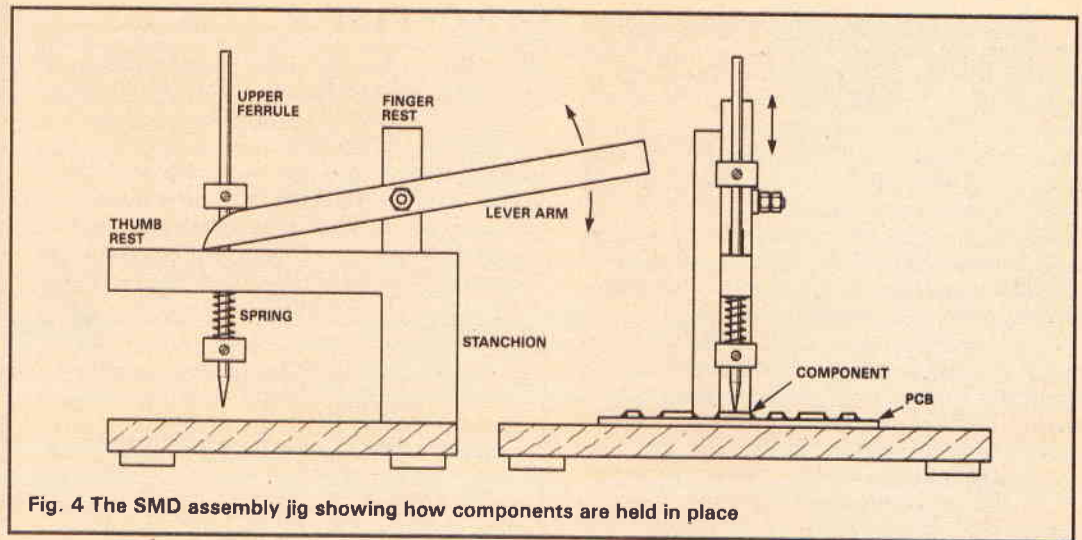

Fig. 4 The SMD assembly jig showing how components are held in place

pulsive twiddler, leave the connecting wires a bit longer than necessary so that reconnections can be made when breakages occur. Connect the coil to the PCB as indicated, taking care with the 42swg wire.

Getting It Going

Check all wiring and everything on the PCB. Wire up the headphones in series such that they are in phase (+ to - to +). Now plug in the headphones and switch on. At this stage you should hear some hiss at least. Bring in the required station using the trimmer. For setting up, an external variable capacitor of say 500p can be connected across CV1 and turns can be added or taken away until the signal is within the trimcap range with zero external capacitance in circuit.

With 1.5V applied, the current drain should be about 4mA. The voltage on Q1 collector should be 0.7V approx. If you get a lot of distortion and whistles, the thing may be 'taking off' due to feedback. This can usually be cured by moving the coil away from the PCB end. Strong signals may well cause clipping which can be reduced by rotating the ferrite rod to

reduce the signal level. The quality should be excellent when set up correctly.

Mods For Rockers

Certain pop stations appear on long wave from time to time and there is no reason why the R4X should not be used for their reception. A little more selectivity and a bigger rod would be required to pull in the French stations effectively on a UK wide basis but they are audible on the R4X. If a 10mm hole is drilled in the case to allow a little longer ferrite rod to protrude it makes an excellent tuning system. Removing a hundred or so turns will get you on the medium wave band.

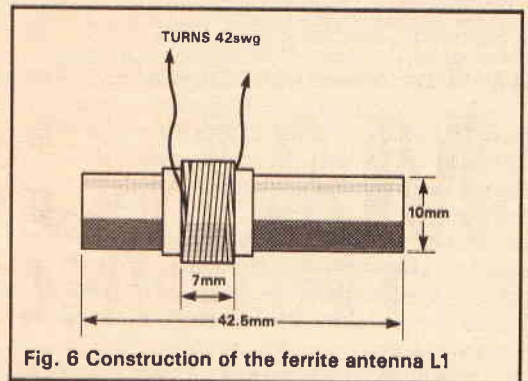

Fig. 6 Construction of the ferrite antenna L1

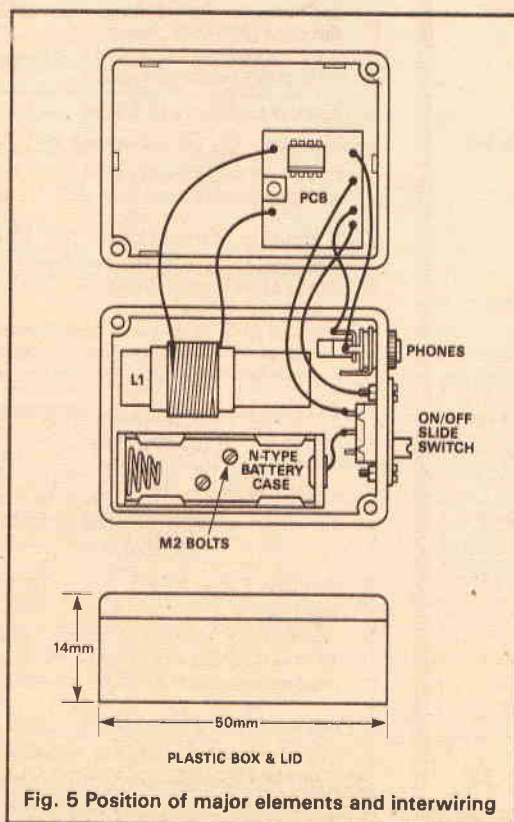

Fig. 5 Position of major elements and interwiring

HOW IT WORKS

The schematic of the R4X is shown in Figure 2. In summary there are four stages: signal selection, amplification, detection and audio power amplification.

This is a TRF (Tuned Radio Frequency) receiver which indicates that all signal amplification and detection takes place at the received frequency, there is no mixer stage, no intermediate frequency filtering and so on. The signal is selected by the tuned circuit centred on L1 which is also the ferrite rod aerial. This tuned circuit provides all the receiver's selectivity, anything getting past this stage will be detected and will appear in the audio output signal. The RF section of IC1 amplifies the selected signal by some 72dB and applies it to its internal transistor detector.

The required audio appears at pin 2 of the ZN416. Residual RF is removed by the low reactance of C2. Not all the RF goes down the drain. In some cases it gets to the output in an amplified form. So keeping output components away from the tuned circuit is good practice.

The upper audio frequency response is governed by C5 and is around 8kHz with 33n. The lower frequency cutoff is set by C1 and C3 to less than 50Hz.

Now the ZN416 has bags of gain for use as a normal medium

wave receiver but two factors necessitate the addition of a little extra audio amplification. First the gain of the RF section falls off at low frequency such as 198kHz and secondly we want to use a very short ferrite rod aerial which picks up a lot less signal. Q1 gives an extra few dBs of gain which makes all the difference to the R4X. It is very convenient to be able to slot in an extra function between pins 2 and 3 of the ZN414. A volume control for example (10k) could be put in here. Simplicity was the aim here and a volume control was not included because some rudimentary AGC operates in the RF section and rotation of the receiver provides a means of level control due to the directivity of the ferrite rod. The Radio 4 signal is very strong and can overload the RF stages so for this reason, the signal can be reduced by rotating the receiver so that the ferrite rod picks up a reduced amount of energy.

Looking now at the output section. This has a gain of some 18dB and has an open emitter output which should connect to a load impedance of 64R. Two 32R earpieces connected in series is ideal for the purpose. The circuit will come to no harm with lower loads such as 8R but the quality and loudness will be considerably reduced as will battery life. The whole ZN416 draws about 4mA quiescent current most of which is due to the output stage. The R4X will work from a 1.2V button cell but a 1.5V alkaline 'N' type cell is by far the best choice and will give much higher output for a longer time. The output is directly coupled so that the usual bulky output electrolytic capacitor is not needed and this saves lots of space.

PARTS LIST

RESISTORS

R1 100k 2% size 1206
R2 1k 2% size 1206
Rx Zero ohm jumper

CAPACITORS

C1,3 1µ/16V size 1206 Y5V dielectric. Ceramic chip
C2,4 100n/50V size 1206 Y5V dielectric. Ceramic chip
C5 33n/50V size 1206 Y5V dielectric. Ceramic chip
C6 4µ/16V Tantalum SMD cap
CV1 50p SMD Type 3204 trim cap

SEMICONDUCTORS

Q1 BCF32 in SMD type SOT23 package
IC1 ZN416 am radio IC

MISCELLANEOUS

L1 360 Turns 42 swg enam. wire on 3.5cm x 1cm diameter ferrite rod
2.5mm miniature jack plug
Miniature slide switch
N-type battery holder
M2 counter sunk and round head bolts and nuts
Connecting wire, Kynar 30 swg type
Plastic box type 1521 size 50x37x24mm

Table 1. Characteristics Of The ZN416 IC

Supply Voltage	1.1 to 1.6V
Quiescent Current	4mA
Frequency range	0.15kHz to 3.0MHz
Input Impedance	4M
Sensitivity	50µV
AGC range	20dB
Power gain - ZN414 RF section	72dB
Voltage gain - audio section	18dB
Output into 64 ohm	340mVpp

BUYLINES

All the Surface Mount components and the Kynar thin wire for interconnecting are available from: Blue Rose Electronics (Mail Order), 538, Liverpool Rd., Great Sankey, Warrington. WA5 3LU. (Tel: 0925 72 7848).

The Jack plug, on/off slide switch, battery holder, enamel wire and box are available from Maplin Electronic Supplies.

PROJECT

MARCO TRADING

ELECTRONIC COMPONENTS & EQUIPMENT

MAIL ORDER • WHOLESALE
RETAIL

**Latest 1991 Catalogue
Available now**

- * Free prepaid envelope
- * Many new lines
- * Pages of Special Offers
- * Free gifts

SEND £1.50 to:
MARCO TRADING
Dept ET 19
The Maltings
High Street
WEM, Shrewsbury
SY4 5EN
Tel: 0939-32763



JOIN UP WITH LITESOLD

Professional Soldering Equipment at Special Mail-Order Prices.

SK18 Soldering Kit. £19.75

Build or repair any electronic project. LC18 240v 18w iron with 3.2, 2.4, and 1.6mm bits. Pack of 18 swg flux-cored 60/40 solder. Tweezers. 3 soldering aids. Reel of De-Solder braid. In PVC presentation wallet.



ADAMIN Miniature Iron £8.60

Possibly smallest mains iron in the world. Ideal for fine work. Slim

nylon handle with finger grip. Interchangeable bits available 1.2, 1.6, 2.4, 3.4 and 4.7mm. Fitted with 2.4mm. 240v 12w (12v available). Presentation wallet.

'L' Series Lightweight Irons. 12w £9.20

High efficiency irons for all electronic hobby work. Non-roll handles with finger guards. Stainless steel element shafts. Screw-connected elements. Slip-on bits available from 1.6 to 4.7mm. LA12

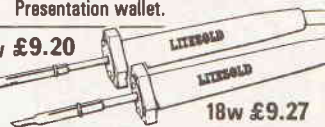

18w £9.27

model, 12w, 2.4mm bit. LC 18 Model, 18w, 3.2mm bit. 240v Std - 12v available. Presentation wallet.

Soldering Iron Stands 3&4 £7.33



Designed specially for LITESOLD irons. Heavy, solid-plastic base with non-slip pads. Won't tip over, holds iron safely. With wiping sponge and location for spare (hot) bits. No 5 stand for EC50 iron No 4 stand for ADAMIN miniature iron No 3 stand for LA12 and LC18 Irons.

De-Solder Pumps £8.65

High Quality version of increasingly popular type of tool. Precision made anodised aluminium body, plunger guard and high-seal piston. Easy



thumb operation. Automatic solder ejection. Conductive PTFE nozzle - no static problems.

Prices include p&p and VAT. Send order with Cheque/PO. Ring for Access/Visa sales



LIGHT SOLDERING DEVELOPMENTS LTD. DEPT. ET
97-99 GLOUCESTER ROAD, CROYDON CR0 2DN. 081 689 0574

PCB FOIL PATTERNS

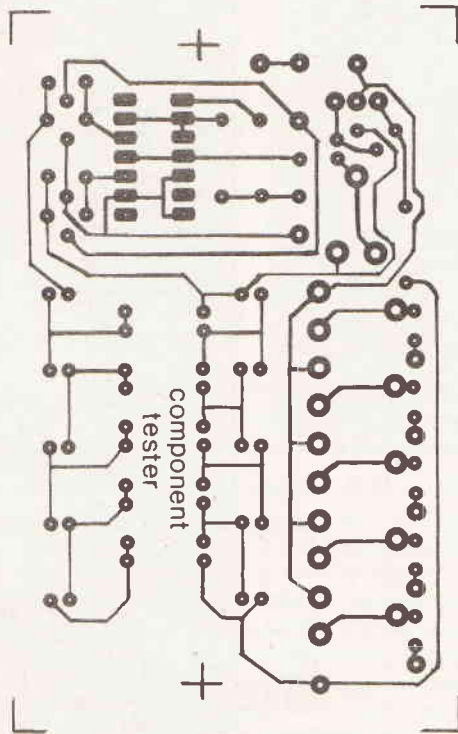

The Component Tester foil

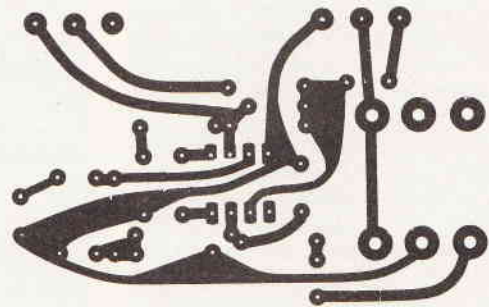

Active Contact Pickup

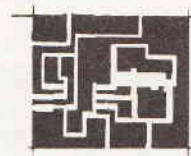

R4X Long Wave Receiver
(copper on component diode)

EASY-PC, SCHEMATIC and PCB CAD

NEW VERSION!
NOW DRAWS EVEN FASTER!

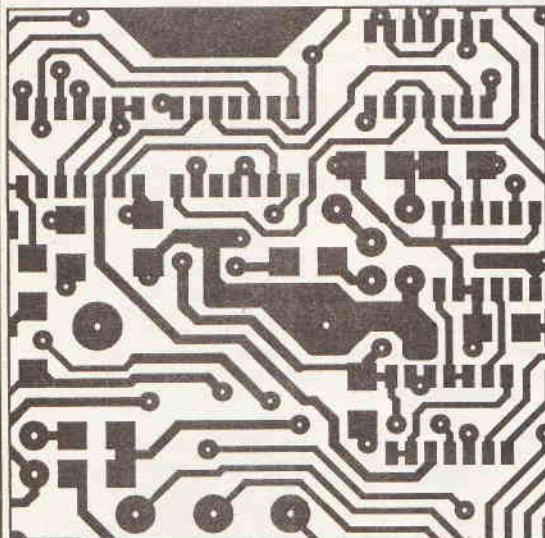

- Runs on:-
PC/XT/AT/386
CGA EGA VGA.
- Design:-
Single sided,
Double sided and
Multilayer boards.
- Provides Surface
Mount support.
- Standard output in-
cludes Dot Matrix
printer, Pen Plotter,
Photo-plotter and
N.C. Drill.

Still
Only
£98.00!

**BRITISH
DESIGN
AWARD
1989**

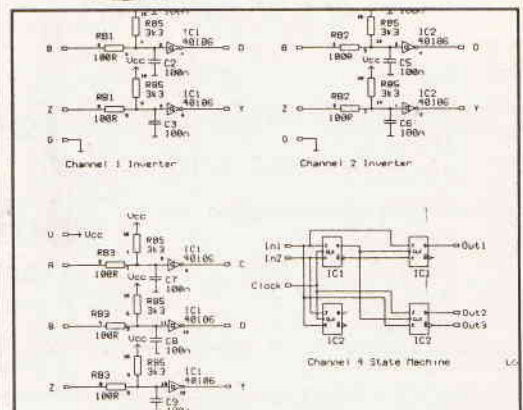

Fast Professional Quality Output at an Affordable Price

Write, Phone or Fax for full details:-

Number One Systems Ltd.



The CAD Specialists

REF: ETI, HARDING WAY, SOMERSHAM ROAD, ST. IVES, HUNTINGDON, CAMBS, PE17 4WR, ENGLAND.

Telephone: 0480 61778 (6 lines) Fax: 0480 494042

ACCESS, AMEX, MASTERCARD, VISA Welcome.



HART AUDIO KITS — YOUR VALUE FOR MONEY ROUTE TO ULTIMATE HI-FI

HART KITS gives you the opportunity to build the very best engineered hi-fi equipment there is, designed by the leaders in their field, using the best components that are available. With a **HART KIT** you have direct access to the friendly **HART** service, you are not dealing through, or paying for, any middlemen. Every **HART KIT** is not just a new equipment acquisition but a valuable investment in knowledge, giving you guided hands-on experience of modern electronic techniques. Telephone or write for your **FREE LISTS** giving full details of all our Kits, components and special offers. Here are a few selected items:-

AUDIO DESIGN 80 WATT POWER AMPLIFIER



This fantastic John Linsley Hood designed amplifier is the flagship of our range, and the ideal powerhouse for your ultimate hi-fi system. This kit is your way to get 80W performance for a few tenths of the cost!

Featured on the front cover of 'Electronics Today International' this complete stereo power amplifier offers World Class performance allied to the famous **HART** quality and ease of construction. John Linsley Hood's comments on seeing a complete unit were enthusiastic:- "The external view is that of a thoroughly professional piece of audio gear, neat elegant and functional. This impression is greatly reinforced by the internal appearance, which is redolent of quality, both in components and in layout."

The standard amplifier comes with the option of a stereo LED power meter and a versatile passive front end giving switched inputs, and ALPS precision, low-noise volume and balance controls. A new relay switched front end option also gives a tape input and output facility. This means that for use with tuners, tape and CD players, or indeed any other that inputs the power amplifier may be used on its own, without the need for any external signal handling stages. 'Slave' and 'monobloc' versions without the passive input stage and power meter are also available. All versions fit within our standard 420x260x75mm case to match our 400 Series Tuner range. ALL six power supply rails are fully stabilised, and the complete power supply, using a toroidal transformer, is contained within a heavy gauge aluminium chassis/heat sink fitted with IEC mains input and output sockets. All the circuitry is on a proper printed circuit with low-resistance blade connectors for the six stabilised DC outputs. **HART KITS** don't leave you to fiddle a few stabilised DC outputs on the main chassis and wire the power supply the hard way! **HART** wiring is even pre-terminated, ready for instant use! Remember with a **HART KIT** you get the performance you want at the price quoted through proper engineering design and the right components. We do not insult your intelligence by offering a kit at what seems a fair price and then tell you that you have to spend three times as much to get an upgraded model!

RLH10 Reprints of latest 'Audio Design Amplifier' articles £2.70
K1100CM **HART** Construction Manual with full parts lists £4.50

Why not buy the reprints and construction manual to see how easy it is to build your own equipment the **HART** way. The FULL cost can be credited against your subsequent kit purchase.

SPECIAL OFFERS FOR THE NEXT MONTH. All orders for complete kits will get the ALPS Precision Pots in the Passive Input Stage included FREE. We can also include the new Relay Switched Input Stage, normally £57.28, for only £30!

ALPS PRECISION LOW-NOISE STEREO POTS

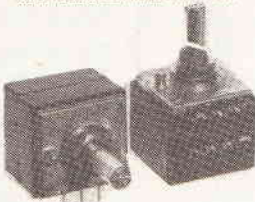

Now back in stock, the last batch sold out months ago! Exciting range of precision audio pots in values to cover most quality amplifier application. All are in 2-gang stereo format, with 20mm long 6mm dia. steel shafts, smooth rotation type with no indents. Now you can throw out those noisy ill-matched carbon pots and replace with the real hi-fi components only used selectively in the very top flight of World class amplifiers, and **HART KITS**! The improvement in track accuracy and matching really is incredible, giving better tonal balance between channels and rock solid image stability. Values available are 10K and 100K Log, 100K Lin and 10K Special Balance. (Zero loss in centre position). Our prices are incredibly low for pots of this quality due to large purchases for our quality kits.

2-Gang Lin £7.59
2-Gang Log £8.67
2-Gang Special Balance, zero crossstalk and zero centre loss £9.40

LINSLEY HOOD 400 SERIES SUPER HIGH QUALITY AM/FM TUNER SYSTEM

This ultra high quality analogue tuner system is the ideal companion to the 80W Audio Design Amplifier in any ultimate hi-fi setup, with case size, front plate layout and even control pitches unified for stacking. Like the 80W Audio Design Amplifier this is your route to ultimate performance at incredibly modest cost! Two designs by John Linsley Hood make up this combination of his ultra high quality FM tuner and stereo decoder and the Synchronyne AM receiver. Novel circuit features in the FM section include ready built pre-aligned front end, phase locked loop demodulator with a response down to DC and advanced sample and hold stereo decoder together making a tuner which sounds better than the best of the high-priced exotica but, thanks to **HART** engineering, remains very easy to build and set up. The Synchronyne AM Section with its selectable bandwidth provides the best possible results from Long and Medium wave channels, so necessary in these days of split programming. If you want the very best in real Hi-Fi listening then this is the tuner for you. Since all components are selected by the designer to give the very best sound this tuner is not cheap, but in terms of its sheer sound quality it is incredible value for money. To cater for all needs AM only and FM only versions are available as well as the full AM/FM model, with any unit being upgradable at any time. For further details see our fully illustrated lists.

RLH7 Reprints of articles describing the 'Synchronyne' Section £2.60
INS450 Construction Manual for 'Synchronyne' AM Section £2.90
RLH8 Reprints of 3 articles covering the FM Tuner Section £2.70
INS400 Construction Manual for FM Section £4.90

Don't forget you can buy the construction manual and reprints to see how easy it is and the cost will be credited IN FULL when you buy your kit.

HIGH QUALITY REPLACEMENT CASSETTE HEADS



Do your tapes lack treble? A worn head could be the problem. Fitting one of our replacement heads could restore performance to better than new! Standard inductions and mounting make fitting easy on nearly all machines and our TC1 Test Cassette helps you set the azimuth spot on. As we are the actual importers you get prime parts at lower prices, compare our prices with other suppliers and see! All our heads are suitable for use with any Dolby system and are normally available ex stock. We also stock a wide range of special heads for home construction and industrial users.

HS16 Sendust Alloy Stereo Head, High quality head with excellent frequency response and hyperbolic face for good tape to head contact £17.86
HC40 NEW RANGE High Beta Permalloy Stereo Head, Modern space save design for easy fitting and low cost. Suitable for chrome metal and ferric tapes, truly a universal replacement head for hi-fi decks to car players and at an incredible price too! £6.65
HX100 Special Offer Stereo Permalloy Head £2.85
HRP373 Downstream Monitor Stereo Combination Head £44.39
HQ551 4-Track Record & Play Permalloy Head for auto-reverse car players or quadrasonic recording £16.79
HSS24 Standard Erase Head £2.59
SM166 2/2 AC Erase Head, Standard Mount £12.60
HS9510 2/4 Stereo DC Erase Head £8.70
HQ751E 4/4 AC Erase Head, tracks compatible with HQ551 £57.06

REEL TO REEL HEADS

998R 2/4 Record/Play 110mH £13.34
298E 2/4 Erase Head 1mH £11.96

TAPE RECORDER CARE PRODUCTS

HART TC1 TEST CASSETTE. Our famous triple purpose test cassette. Sets tape azimuth, VU level and tap speed £5.36
DEM1 Reins Powered Tape Head Demagnetiser, prevents noise on playback due to residual head magnetiser £4.08
DEM115 Electronic, Cassette Type, demagnetiser £6.61

Our new SUMMER '90 list is FREE. Send for your copy now. Overseas customers welcome, please send 2 IRCs to cover surface post, or 5 for Airmail.

We now accept inland and overseas orders by post or telephone on all Access/Mastercharge and Visa credit cards.

Please add part cost of carriage and insurance as follows:

INLAND:
Orders up to £20 — £1; Orders over £20 — £2.50; Next day — £9

OVERSEAS:
Please see the ordering information with our lists.

QUALITY AUDIO KITS

24hr SALES LINE
(0691) 652894

ALL PRICES INCLUDE VAT



BINDERS

FOR YOUR VALUABLE
COLLECTION OF
**ELECTRONICS TODAY
INTERNATIONAL**
MAGAZINES

£6.80
inc
P&P

**B
I
N
D
E
R
S**

- ★ TOP QUALITY
- ★ SMART
- ★ EASY TO USE

ASP
READER SERVICES
ARGUS HOUSE
BOUNDARY WAY
HEMEL HEMPSTEAD
HERTS HP2 7ST
Telephone your order
(0442) 66551

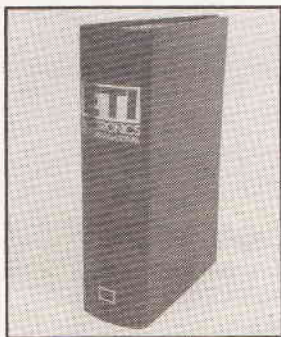

Please supply **ELECTRONICS TODAY INTERNATIONAL BINDERS**
@ £6.80 each inc. p&p.

Total £ (Please make cheques/postal orders payable to A.S.P)

NAME

ADDRESS

Or debit my
ACCESS/VISA Expiry.....

Please allow 28 days for delivery

OMNI ELECTRONICS

174 Dalkeith Road, Edinburgh EH16 5DX • 031 667 2611

**A COMPREHENSIVE RANGE WITH
SERVICE SECOND TO NONE**
OUR MUCH EXPANDED, BETTER ILLUSTRATED
CATALOGUE WILL COST £1.50 — TO INCLUDE
VOUCHERS TO USE AGAINST FUTURE
PURCHASES. TO RECEIVE A COPY, PLEASE
SEND YOUR REMITTANCE WITH YOUR NAME,
ADDRESS AND TELEPHONE NUMBER
REQUESTING A COPY OF THE 1990/91 OMNI
CATALOGUE.



Open: Monday-Friday 9.00-6.00
Saturday 9.00-5.00



19" RACK MOUNTING EQUIPMENT CASES

This range of 19" rack cases features satin black finished 16SWG (1.5mm) steel front panels (no fixing holes visible), with the rear box assembly constructed from 20SWG (0.9mm) steel. The standard units are 10" (254mm) deep. **NEW FOR 1990** 19" project cases only 4" (101mm) deep and are available in the following popular sizes:

PROJECT CASES		
Type	Height	Price
PU1	1 3/4" (44mm)	£16.50
PU2	3 1/2" (88mm)	£18.50
PU3	5 1/4" (133mm)	£20.50
PU4	7" (178mm)	£22.50
PU6	10 1/2" (266mm)	£26.50

EQUIPMENT CASES			
U1	U2	U3	U4
1 3/4" (44mm)	3 1/2" (88mm)	5 1/4" (133mm)	7" (178mm)
£20.70	£24.15	£27.60	£29.90

Delivery included (UK only).
All prices include VAT.
BLANKING PANELS, RACKING CONSOLES
and RACK CABINETS are also available.
Please send SAE for details.
Tel: 0275 823983 for Access/Visa Sales or cheque
with order to:



RACKZ PRODUCTS
PO Box 1402 Mangotsfield, Bristol, England, BS17 3RY

Courses



Start training now for the following courses. Send for our brochure — without obligation or Telephone us on **0626 779398** (Ref: ETI/10/90)

Name _____

Telecomms Tech C&G 271

Radio Amateur Licence C&G

Micro-processor

Introduction to Television

Radio & Telecommunications Correspondence School
12 Moor View Drive, Teignmouth, Devon TQ14 9UN

KITS

NEW VHF MICROTRANSMITTER KIT tuneable 80-135MHz, 500 metre range, sensitive electret microphone, high quality PCB, **SPECIAL OFFER** complete kit **ONLY £5.95**, assembled and ready to use £9.95 post free. Access/Visa order telephone 021-411 1821. Cheques/POs to: Quantek Electronics Ltd, Kits Dept (ETI), 45A Station Road, Northfield, Birmingham B31 3TE. S.A.E. for details of this and other kits.

KITS, PLANS, built units, micro-transmitters, telephone switches, beepers, personal protection (sonic and electric). SAE list: ACE(TI), 99 Greenheath, Hednesford, Staffs. 05438 71902.

FLATMATE SPEAKER enhanced electronics kit £49.50 pair. SAE details: Memex Electronics Ltd, 1 Icknield Close, Ickleford, Hitchin, Herts.

PCB'S

Sample Our Quality With
A FREE PRINTED CIRCUIT BOARD

Single/Double Sided Circuits
or Plated Through Hole

Write to:
PAYNE ELECTROPRINT LTD
Marcus Road, Dunkswell,
Nr Honiton, Devon EX14 0RA

CALL BEN ADEWOLE ON 0442 66551 TO ADVERTISE IN ETI



NATIONAL COLLEGE OF TECHNOLOGY

PACKAGED SHORT COURSES

The National College of Technology (NCT Ltd) offers a range of packaged short courses in analogue electronics, digital electronics and fibres and optoelectronics for study at home or at work. The advantages are that you may

— commence at any time— work at your own pace — have a tutor (optional) and there is no travelling involved. BTEC certificates are available subject to the conditions of the award. These highly popular packed courses contain workbooks, a cassette tape, circuit board and components necessary to provide both theoretical and practical training.

Whether you are a newcomer to electronics or have some experience and simply need updating, there is probably a packaged short course ready for you. Write or telephone for details, quoting ETI to:

NCT Ltd, Bicester Hall
5 London Road, Bicester, Oxon OX6 7BU
or telephone (0296) 613067 Ext. 202

ELECTRICAL COMPONENTS

ELECTRONIC COMPONENTS. Send for our 1991 catalogue contains 1000's of product lines including SMD components. Send cheque or P.O. for £1.80 to: Sarm Digital, 13 Pearle Street, Macclesfield, Cheshire SK10 2AL. Mail Order only. Prop: N. Farrar.

SWITCHES

VOICE/SOUND ACTIVATED SWITCHES easy to follow diagrams and uses only £1.00. Components and PCB's available. Herrington, 63 Home Farm Rd, Hanwell, London W7 1NL.

RETAIL OUTLETS

EDINBURGH

OMNI ELECTRONICS

stock a wide range of electronic components at

**174 Dalkeith Road,
Edinburgh EH16 5DX**

Tel: 031 667 2811

Open: Mon-Fri 9am-6pm, Sat 9am-5pm.
Send 2x18p stamps for latest catalogue.

LIVERPOOL

PROGRESSIVE RADIO

87/93 Dale Street Tel: 051 236 0154

47 Whitechapel Tel: 051 236 5489

Liverpool 2

'THE ELECTRONICS SPECIALISTS'

Open: Tues-Sat 9.30-5.30

LONDON

CRICKLEWOOD ELECTRONICS

One of the largest component retailers in the UK. Fast and efficient, same day personal service on 'IN STOCK ITEMS'. Very competitive prices. No minimum order. Call Cricklewood Electronics now.
40 CRICKLEWOOD BROADWAY, LONDON NW2 3ET
Tel: 081-450 0995/452 0161

SOUTH COAST

ELECTRONIC COMPONENTS
are best seen at

FRASER ELECTRONICS

42 ELM GROVE * SOUTHSEA * HANTS
Telephone (0705) 815584

Barclaycard

Access

COME AND BROWSE BEFORE YOU BUY

LIVERPOOL

ALLPARTS

TV & VIDEO SPARES EMPORIUM

NOW OPEN

Trade and Public Retail Outlet

FERG VIDEO HEADS FROM £10.95 • PANASONIC HEADS FROM £10.95

VIDEO COPY KIT £3.99 OR SCART KIT £3.99

FERG VIDEO LAMP WIRE ENDS 40p • FERG VIDEO LAMP WITH PLUG 60p

80MM A/B PUSHER £1 PER PACK OF TEN

ALL YOUR TV & VIDEO NEEDS HERE IN L'POOL

ALL PARTS - 101 ROCKY LANE TUEBROOK

LIVERPOOL 6 4BB - 051 2604825

Mon-Fri 10am-5.30 Sat 9am-5.30

LONDON

DIRECT ELECTRONICS

ELECTRONICS COMPONENT SPECIALISTS

627 ROMFORD RD,

MANOR PARK

LONDON E12 5AD

Tel: 081-553 1174

Mon-Sat 10-6 pm/Thurs 10-1pm

We stock a large range of TV & Video spares

ETI

Panel Engraving Service

Now you can give your projects a more professional finish by using the ETI Front panel service. If you have difficulty with drilling clean holes and producing good quality labels for your treasured projects then this service is a must for you. We will supply complete front panels for selected projects featured in ETI in a variety of base colours and coloured type according to your choice. The material used is a tough laminated plastic of extremely durable quality. It can be used as a glue on front-piece to a metal back plate or even as a front panel in its own right, the decision is yours. We believe the prices quoted are extremely good value for money and indeed hard to beat.

All you do is fill in the coupon stating clearly the code number, your name and address and your remittance made payable to: A.S.P. Reader Services.

For the choice of colour you must add two letters to the end of the code. They are these: BW — Black panel, white lettering, RW — Red panel, white lettering, WB — White panel, black lettering, WR — White panel, red lettering.

The ultimate in personal service must be to offer a front panel made to your design requirements and this does not have to be limited to electronic projects. It could be a design for a clockface, a door-panel insignia, even your own logo. Now we can offer that facility too. Send us by letter or Fax, a neat dimensioned millimetre drawing of your panel design and we will be happy to give you a quote for a coloured front panel. On acceptance of the quote just send in the artwork and we'll do the rest. There's a minimum charge of £10.00 + VAT for this custom service but we reckon it's worth it.

Here are some recent popular projects to start this brand new service on its way, the prices are inclusive of VAT and postage and packing:

P9005-1	The Business Bass Amp	£16.95
P9003-1	Superscope CRT Panel	£ 3.95
P9003-2	Superscope X shift Panel	£ 2.95
P9003-3	Superscope T/base	£ 4.95
P9003-4	Superscope Y1 Input	£ 4.00
P9003-5	Superscope Y2 Input	£ 4.00
P9003-6	Superscope All 5 boards	£17.95
P9001-1	Wavemaker FG	£ 5.00
P8910-1	Multimeter	£ 5.95
P9007-1	Decision Maker	£ 8.95

TELEPHONE ORDERS

0442 66551

ETI Reader Services, Argus House, Boundary Way, Hemel Hempstead, Herts, HP2 7ST

Please supply P9005-1	Colour	Qty	@ £16.95
Please supply P9003-1	Colour	Qty	@ £ 3.95
Please supply P9003-2	Colour	Qty	@ £ 2.95
Please supply P9003-3	Colour	Qty	@ £ 4.95
Please supply P9003-4	Colour	Qty	@ £ 4.00
Please supply P9003-5	Colour	Qty	@ £ 4.00
Please supply P9003-6	Colour	Qty	@ £17.95
Please supply P9001-1	Colour	Qty	@ £ 5.00
Please supply P8910-1	Colour	Qty	@ £ 5.95
Please supply P9007-1	Colour	Qty	@ £ 8.95

Cheques/P.O. payable to A.S.P. or debit my Access/Visa

Total £

Signature Expiry

Name

Address

ETI Reader Services, Argus House, Boundary Way,
Hemel Hempstead, Herts, HP2 7ST
Allow 28 days for delivery

NEXT MONTH

In the action packed November audio edition of ETI we have a comprehensive guide on how a recording studio is designed and put together in order to achieve the best results in sound recording, together with a whole host of musical tech tips for the constructor to experiment with ranging from a MIDI activated noise gate, to several other sound bending and modifying techniques.

There's a four channel cassette recorder/mixer for you to build which will take you into the winter months. We also present the second part on electrostatic loudspeaker design which highlights other methods of reproducing sound apart from using magnetic forces.

In the HDTV series, James Archer looks at existing Japanese technology for wide-screen high quality television together with its advantages and disadvantages.

So make sure of reserving a copy when ETI enters the market place on October 5th.

The above articles are in preparation but circumstances may prevent publication

LAST MONTH

On the list of items featured in the September Issue were articles covering Video cassette recorder timers and the new technology that could replace them, microwave applications from cooking to warheads, data communications and how computers talk to each other and cross-over networks, could they be a necessary evil? On the projects front, we presented a slide projector controller, a music relay system to send your hi-fi around the house and a diode tester. Some back copies are still available from Select Subscriptions.

ADVERTISERS' INDEX

ARA ELECTRONICS	44	MAPLIN ELECTRONICS.....	OBC
BK ELECTRONICS	IFC	MARCO TRADING	61
BLUE ROSE ELECTRONICS.....	8	NUMBER ONE SYSTEMS	62
CIRKIT HOLDINGS	7	OMNI ELECTRONICS	63
CRICKLEWOOD ELECTRONICS	17,67	RACKZ PRODUCTS	63
DISPLAY ELECTRONICS	IBC	REED ELECTRONICS.....	17
GREENBANK ELECTRONICS.....	44	STEWARTS OF READING	44
HART ELECTRONICS	63	SUMA DESIGNS.....	44
HENRYS AUDIO	41	TK ELECTRONICS.....	25
J & N BULL ELECTRICAL	42	WILMSLOW AUDIO.....	41
LIGHT SOLDERING.....	61		

THE ORIGINAL SURPLUS WONDERLAND!

MONITORS

MONOCHROME MONITORS

THIS MONTH'S SPECIAL!



There has never been a deal like this one! Brand spanking new & boxed monitors from NEC, normally selling at about £140! These are over-engineered for ultra reliability. 9" green screen composite input with etched non-glare screen plus switchable high/low impedance input and output for daisy-chaining. 3 front controls and 6 at rear. Standard BNC sockets. Beautiful high contrast screen and attractive case with carrying ledge. Perfect as a main or backup monitor and for quantity users! **£39.95 each (D) or 5 for £185 (G)**

CALL FOR DISCOUNTS ON HIGHER QUANTITIES!

Zenith ZVM12-00-0A brand new & boxed 12" amber flat screen with optional swivel and tilt base. Sunflex filter with dark tint. Standard TTL PC compatible. 18 mhz bandwidth. Very attractive "state of the art" tapered grey case. Standard 9 pin D plug (supplied) on 1 metre cord and mains cord terminated with IEC connector. 240 volts complete with operations manual. An absolute gem at **£59 (D) 10/£500 (G). Swivel/tilt base £4.95.**

Very high resolution, fully cased 14" green or amber screen monitor with non-glare screen and swivel/tilt base. The very latest technology at the very lowest price! Fully compatible and plug compatible with all IBM PCs and clones fitted with a high res Hercules or equivalent card! Enables superb graphics and resolution, all at a give away price. Has many extra features including aux +5 & 12v DC outputs to power at least 2 disk drives, if your PC power supply is getting hot! Supplied BRAND NEW and boxed. State whether amber or green screen required.

Amber screen£79 Green£69 (E)
Wang green screen 12" chassis monitor with composite video input. Adjustable for tilt. Requires 12 vdc. Brand new and boxed in perfect condition. Only **£39 each or 2 for £75 (F)**

Mitrolora M1000-100 5" black & white compad chassis measuring only 11.6H x 12W x 2.2D. Ideal for CCTV or computer applications. Accepts standard composite or individual H & V syncs. Needs 12vdc at only 0.8A. Some units may have minor screen blemishes. Fully tested with 30 day guarantee and full data. **£29.00 (C)**

Fully cased as above in attractive moulded desk standing swivel. Dim 12 x 14.5 x 26cm. **£39.00 (C)**

JVC 751 ultra compact chassis monitor for 12vdc 0.7A. Dim 11 x 14 x 18cm. Simple DIY data included to convert to composite video input. Full data. **BRAND NEW £65.00 (B)**

20" Black & white monitors by Aztek, Cotron & National. All solid state, fully cased monitors ideal for all types of AV or CCTV applications. Standard composite video inputs with integral audio amp and speaker. Sold in good used condition - fully tested with 90 day guarantee. **£85.00 (F)**

COLOUR MONITORS

Decca 16" 80 budget range colour monitor. Features a P1L tube, beautiful teak style case and guaranteed 80 column resolution, features usually seen only on colour monitors costing 3 times our price! Ready to connect to most computers or video outputs. 75Ω composite input with integral audio amp & speaker. Fully tested surplus, sold in little or hardly used condition with 90 day full RTB guarantee. Ideal for use with video recorder or our Telebox ST, and other audio visual uses. **£99 (E) 3/£275 (G)**

HI-DEFINITION COLOUR MONITORS

Brand new Centronic 14" monitor for IBM PC and compatibles at a lower than ever price! Completely CGA equivalent. Hi-res Mitsubishi 0.42 dot pitch giving 669 x 507 pixels. Big 28 Mhz bandwidth. A super monitor in attractive style moulded case. Full 90 day guarantee. Only **£149 (E)**

20", 22" and 26" AV SPECIALS

Superbly made UK manufacture. P1L all solid state colour monitors, complete with composite video & sound inputs. Attractive teak style case. Perfect for Schools, Shops, Disco, Clubs. In EXCELLENT little used condition with full 90 day guarantee.
20".....£155 22".....£170 26".....£185 (F)

COMPUTER SYSTEMS

TATUNG PC2000. Big brother of the famous Einstein. The TPC2000 Professional 3 piece system comprises: Quality high resolution Green 12" monitor. Sculptured 92 key keyboard and plinth unit containing Z80A CPU and all control circuits. PLUS 2 integral TEAC 5.25 80 track double sided disk drives. Generous other features include dual 8" IBM format disk drive support. Serial and parallel outputs, full expansion port, 64K ram and ready to run software. Supplied complete with CPM, Wordstar and Basic. Brand new and covered by our famous 90 day guarantee and backup. Normal price of this unit is over £1400! Our price only **£299 (E)**

V22 1200 BAUD MODEMS

We got a tremendous buy on further stocks of this popular Master Systems 2/12 microprocessor controlled V22 full duplex 1200 baud modem - we can now bring them to you at **half last advertised price!** Fully BT approved unit, provides standard V22 high speed data comm, which at 120 cps, can save your phone bill and connect time by a staggering 75%! Ultra slim 45 mm high. Full featured with LED status indicators and remote error diagnostics. Sync or Async use; speech or data switching; built in 240v mains supply and 2 wire connection to BT. Units are in used but good condition. Fully tested prior despatch, with data and a full 90 day guarantee. What more can you ask for - and at this price!
ONLY £69 (D)

IBM KEYBOARD DEALS

A replacement or backup keyboard, switchable for IBM PC, PC-XT or PC-AT. LED's for Caps, Scroll & Num Locks. Standard 84 keyboard layout. Made by NCR for the English & US markets. Absolutely standard. Brand new & boxed with manual and key template for user slogans on the function keys. Attractive beige, grey and cream finish, with the usual retractable legs underneath. A generous length of curly cord, terminating in the standard 5 pin DIN plug. A beautiful clean piece of manufacturers surplus. What a deal!
£39 (B) 5/£175 (D)

Brand new and boxed 84 key PC/XT type keyboards in standard IBM grey with very attractive mottled finish and "clicky" solid feel keys. 10 function keys on side. English layout and £ sign. Green LEDs for Caps, Scroll & Num locks.
£29.95 (B) 5/£135 (D)

CALL FOR DISCOUNTS ON HIGHER QUANTITIES!

FLOPPY DISK DRIVES BARGAINS GALORE!

NEW 5 1/4 Inch from £29.95!

Massive purchases of standard 5 1/4" drives enables us to present prime product at industry beating low prices! All units (unless stated) are removed from often brand new equipment and are fully tested, aligned and shipped to you with a 90 day guarantee and operate from +5 & +12vdc, are of standard size and accept the standard 34 way connector.

SHUGART SA405. BRAND NEW **£29.95 (C)**
TANDON TM100-2A IBM compatible DS **£39.95 (C)**
TANDON TM101-4 80 Track DS **£49.95 (C)**
CANON, TEC etc. DS half height. State 40 or 80T **£75.00 (C)**
TEAC FD-55-F. 40-80 DS half height. **BRAND NEW £99.00 (C)**

3 1/2 INCH BRAND NEW AT £19.95!!

Never before seen price for a 3 1/2" drive. Standard size believed to be by Canon. Brand new and packaged - mint condition! 40 track SS, run from +5 & +12vdc with standard power connector. Only **£19.95 or 2 for £34.50 (B)**

CHOOSE YOUR 8 INCH!

Shugart 800/801 SS refurbished & tested **£150.00 (E)**
Shugart 851 double sided refurbished & tested **£195.00 (E)**
Mitsubishi M2894-63 double sided switchable hard or soft sectors - BRAND NEW **£250.00 (E)**

SPECIAL OFFERS!!

Dual 8" drives with 2 megabyte capacity housed in a smart case with built in power supply! **Only £499.00 (F)**

Ideal as exterior drive!
End of line purchase scoop! Brand new NEC D2246 8" 85 megabyte of hard disk storage! Full CPU control and industry standard SMD interface. Ultra hi speed transfer and access time leaves the good old ST506 interface standing. In mint condition and comes complete with manual. Only **£399 (E)**

MAINS SUPPRESSORS & FILTERS

Roxburgh SDC 021 2 amp mains RFI filter. Has an extra wide frequency range of 150 khz to 30 mhz. Can type, solder lug connection. Quality manufactured to BS 613 standards. Dims 1-1/2"D x 1-3/4"H..... **£3.95 or 3 for £10 (A) 10 for £28 (B)**

Roxburgh SDA 013/25. Similar to above rated at 1-1/2 amps. Dims 1-1/2"D x 1-3/4"H..... **£3.25 or 3 for £8.50 (A) 10 for £25 (B)**

Suppression Devices S05 A10. Extra compact general purpose suppressor. Plastic moulded case with single bolt fixing and snap connectors. Rated at 230 vac 5 amps. Dims 1-3/4"L x 1-1/8"W x 5/8"H..... **£3.95 or 3 for £10 (A) 10 for £28 (B)**

Belling-Lee type L2127 3 amp mains RFI filters. Has a built in mains cable (English coding), and a three pin miniature non-reversible socket and a mating plug, to go to the equipment. Ideal for those who are bugged by RF interference. Very compact. Dims 3-1/8" x 2.5" x 1.5"..... **£3.95 each or 3 for £10 (A)**

RECHARGEABLE BATTERIES

LEAD ACID

Maintenance free sealed long life. Type A300.
12 volts 12 volts 3 amp/hours **£13.95 (A)**
6 volts 6 volts 3 amp/hours **£ 9.95 (A)**
12 volts Centre tapped 1.8 amp hours. RFE. **£ 5.95 (A)**
12 volts 12 volts 24 amp hours. A200. RFE. **£29.00 (B)**

NICKEL CADMIUM

Quality 12v 4ah cell pack. Originally made for the Technicolor video company. Contains 10 GE top quality D nicad cells in a smart robust case with a DC output connector. Ideal for portable equipment. Brand new. **£19.95 (B)**
Ex-equipment NICAD cells by GE. Removed from equipment and in good, used condition: D size 4ah **4 for £5 (B)**
F size 7ah **6 for £8 (B)**

SPECIAL INTEREST

Advance 6120 7 pin A3 plotter HPGL. New **£ 425**
Trio 0-18 vdc bench PSU. 30 amps. New **£ 470**
DEC VAX11/750 Inc. 2 Meg Ram DZ and full documentation, in brand new condition
DEC VAX Station 100
DEC LS/02 CPU board
Calcomp 1036 large drum 3 pen plotter
Thurby LA 160B logic analyser
1.5kw 115v 60hz power source
Tektronics R140 NTSC TV test signal standard.
Sony KTX 1000 Videotex system - brand new
Akkos 2020 VDU terminals - brand new
Sekonic SD 150H 18 channel Hybrid recorder
Trend 1-8-1 Data transmission test set **£ 225**
Kenwood DA-3501 laser pickup simulator **£ 350**

ANALOG to DIGITAL and DIGITAL to ANALOG CONVERTERS

Brand new and boxed Amdek ADA-200 analog to digital and digital to analog converter packed full of features: interfaces to most popular PC's; 2 channel input & output by software selection; integral input/output filters and address decoder; input pre-amp; over-level detector; trigger signal detector circuit; expansion availability and more. Input level 25mv to 50v p-p. Max. sampling frequency is 44khz and input gain variable to 200 times. Designed for use with almost any personal computer, allowing conversion of analog signals to digital data for processing by the computer plus conversion back to analog signals. The 26 page manual supplied includes data on the correct connection to various CPU's including the 8080, Z-80, 6800, 6502 and 6809 families plus data and schematics for user modification of I/O filter cut-off frequencies. Complete with 50 way ribbon cable and edge connector to go to the computer and power cable. All for a fraction of the regular price! **£49.95 (C)**



POWER SUPPLIES

All PSUs 220-240vac input and are BRAND NEW unless stated. Many types ranging from 3v to 10kv always in stock.

Fine OP-9619 20 watts switch mode. +5v @ 2a. +12v @ 0.1a. -12v @ 0.1a. 5" x 3" x 1-1/2". **£15.95 (B)**
Astec AC-8151 40 watts. Switch mode. +5v @ 2.5a. +12v @ 2a. -12v @ 0.1a. 6-1/4" x 4" x 1-3/4". **£19.95 (B)**
Greendale 19AB0E 60 watts switch mode. +5v @ 6a. +12v @ 1a. +15v @ 1a. RFE and fully tested. 11 x 20 x 5.5cms. **£24.95 (C)**
Conver AC130. 130 watt hi-grade VDE spec. Switch mode. +5v @ 15a. -5v @ 1a. +12v @ 6a. 27 x 12.5 x 6.5cms **£49.95 (C)**
Boshert 13090. Switch mode. Ideal for drives & system. +5v @ 6a. +12v @ 2.5a. -12v @ 0.5a. -5v @ 0.5a. **£29.95 (B)**
Farnell G6/A0A. Switch mode. 5v @ 40a. Encased **£95.00 (C)**
Farnell G24/5S. As above but 24v @ 5a. **£65.00 (C)**

COOLING FANS

Please specify 110 or 240 volts for AC fans.

3 inch AC 1 1/2" thick **£ 8.50 (B)**
3 1/2 inch AC ET81 slimline. Only 1" thick. **£ 9.95 (B)**
4 inch AC 110/240v 1 1/2" thick. **£ 10.95 (B)**
4 inch AC 1 1/2" thick **£ 9.95 (B)**
10 inch Round. 3 1/2" thick. Rotron 110v **£ 10.95 (B)**
62 mm DC 1" thick. No. 812 for 6/12v. 814 24v. **£ 15.95 (A)**
92 mm DC 12v. 18 mm thick. **£ 14.95 (A)**
4 inch DC 12v. 12w 1 1/2" thick. **£ 12.50 (B)**
4 inch DC 24v 8w. 1" thick. **£ 14.50 (B)**

THE AMAZING TELEBOX!

Converts your colour monitor into a QUALITY COLOUR TV!!



TV SOUND & VIDEO TUNER!

Brand new high quality, fully cased, 7 channel UHF PAL TV tuner system. Unit simply connects to your TV aerial socket and colour video monitor turning same into a fabulous colour TV. Don't worry if your monitor doesn't have sound, the TELEBOX even has an integral audio amp for driving a speaker plus an auxiliary output for headphones or Hi Fi system etc. Many other features: LED Status Indicator, Smart moulded case, Mains powered, Built to BS safety specs. Many other uses for TV sound or video etc. Supplied BRAND NEW with full 1 year guarantee.

Telebox ST for composite video input monitors..... **£29.95 (B)**
Telebox STL as ST but with integral speaker..... **£34.95 (B)**
Telebox RGB for analogue RGB monitors..... **£65.95 (B)**
NOT suitable for IBM or Clone type colour monitors.
PAL overseas version please call. SECAM not available.

BRAND NEW PRINTERS

TEC Starwriter Model FP1500-25 daisywheel printer renowned for its reliability. Diablo type print mechanism gives superb registration and quality. On board microprocessor gives full Diablo/Queme command capability. Serial RS-232C with full handshake. Bidirectional 25 cps, switchable 10 or 12 pitch, 136 cpl in Pica, 163 in Elite. Friction or tractor feed. Full ASCII including £ sign. Font and ribbon Diablo compatible..... **£199 (E)**
DED DPG21 miniature ball point pen printer plotter mechanism with full 40 characters per line. Complete with data sheet which includes circuit diagrams for simple driver electronics..... **£49 (B)**
Centronics 150 series. Always known for their reliability in continuous use - real workhorses in any environment. Fast 150 cps with 4 fonts and choice of interfaces at a fantastic price! **£ 295**
159-4 Serial up to 9.5" paper, fan fold tractor..... **£ 99.00 (E)**
150-4 Serial up to 9.5" paper, tractor, roll or s/sheet..... **£129.00 (E)**
£ 650
152-2 parallel up to 14.5" paper, tractor or s/sheet..... **£149.00 (E)**

CALL FOR THE MANY OTHERS IN STOCK.

Visit our Shop - Technical help always on hand plus many un-advertised specials. You can buy a colour television for as little as £29! Come and join the gang at 215 Whitehouse Lane!

LARGE QUANTITIES OF OSCILLOSCOPES AND TEST GEAR ALWAYS AVAILABLE - CALL NOW!

DISPLAY

MAIL ORDER & OFFICES
Open Mon-Fri 9.00-5.30
Dept ET, 32 Biggin Way,
Upper Norwood,
London SE19 3XF.

LONDON SHOP
100's of bargains!
Open Mon-Sat 9-5.30
215 Whitehouse Lane,
South Norwood,
London, SE25.

DISTEL © The Original
Free dial-up database!
1000's of Items-Info On Line
300 bd 081-679-1888,
1200/75 bd 081-679-6183,
1200/1200 bd 081-679-8769

ALL ENQUIRIES
081-679-4414
Fax: 081-679-1927
Telex: 894502



-Electronics-

All prices for UK Mainland. UK customers add 15% VAT to TOTAL order amount. Minimum order £10. PO orders from Government, Universities, Schools & Local Authorities welcome-minimum account order £25. Carriage charges (A)=£2.00, (B)=£4.50, (C)=£8.50, (D)=£10.00, (E)=£12.00, (F)=£17.00, (G)=Call. All goods supplied subject to our standard Conditions of Sale and unless otherwise stated guaranteed for 90 days. All guarantees on a return to base basis. We reserve the right to change prices & specifications without prior notice. Orders accepted subject to stock. Quotations willingly given for higher quantities than those stated. Bulk surplus always required for cash.

1991 BUYER'S GUIDE TO ELECTRONIC COMPONENTS

Maplin

FEATURING:
AN ELECTRONICS
CAST OF
THOUSANDS!

POWER-PACKED
WITH OVER
600 PAGES!!

STARRING
HUNDREDS OF
NEW PRODUCTS
AT SUPER
LOW PRICES!

SHOWING NOW!
at your local
WHSMITH

Order you copy of the New MAPLIN Catalogue on sale NOW
Pick up a copy from any WHSMITH for just £2.45 or post this coupon now to receive your copy for just £2.45 + 50p p&p. If you live outside the U.K. send £4.85 or £2.95 International Reply Coupons. I enclose £2.95.

Name _____
Address _____
Post Code _____
Send to Maplin Electronics,
P.O. Box 3, Rayleigh,
Essex SS6 8LR.

PERFORMANCES DAILY
At your local branch
of WHSMITH
ONLY £2.45

ROD BROWN '90