

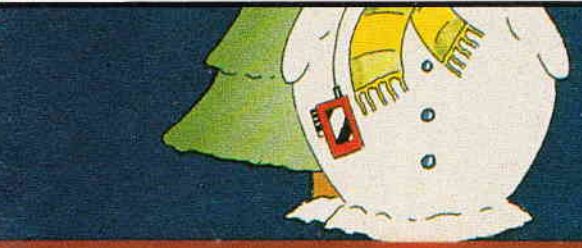

**ELECTRONICS**  
TODAY INTERNATIONAL



  
**R·D·S**  
**RADIO DATA SYSTEM**  
The Full Explanation

**1st CLASS**  
**Beginners**  
**In-car Power Supply**  
**Granny-Aid Hearing**  
**Booster**

**EPR0M Programmer**  
- The Latest Model  
**Rev-Rider**  
- Wake Up Your Wheels





# SOLDERLESS WIRING

## EASIWIRE

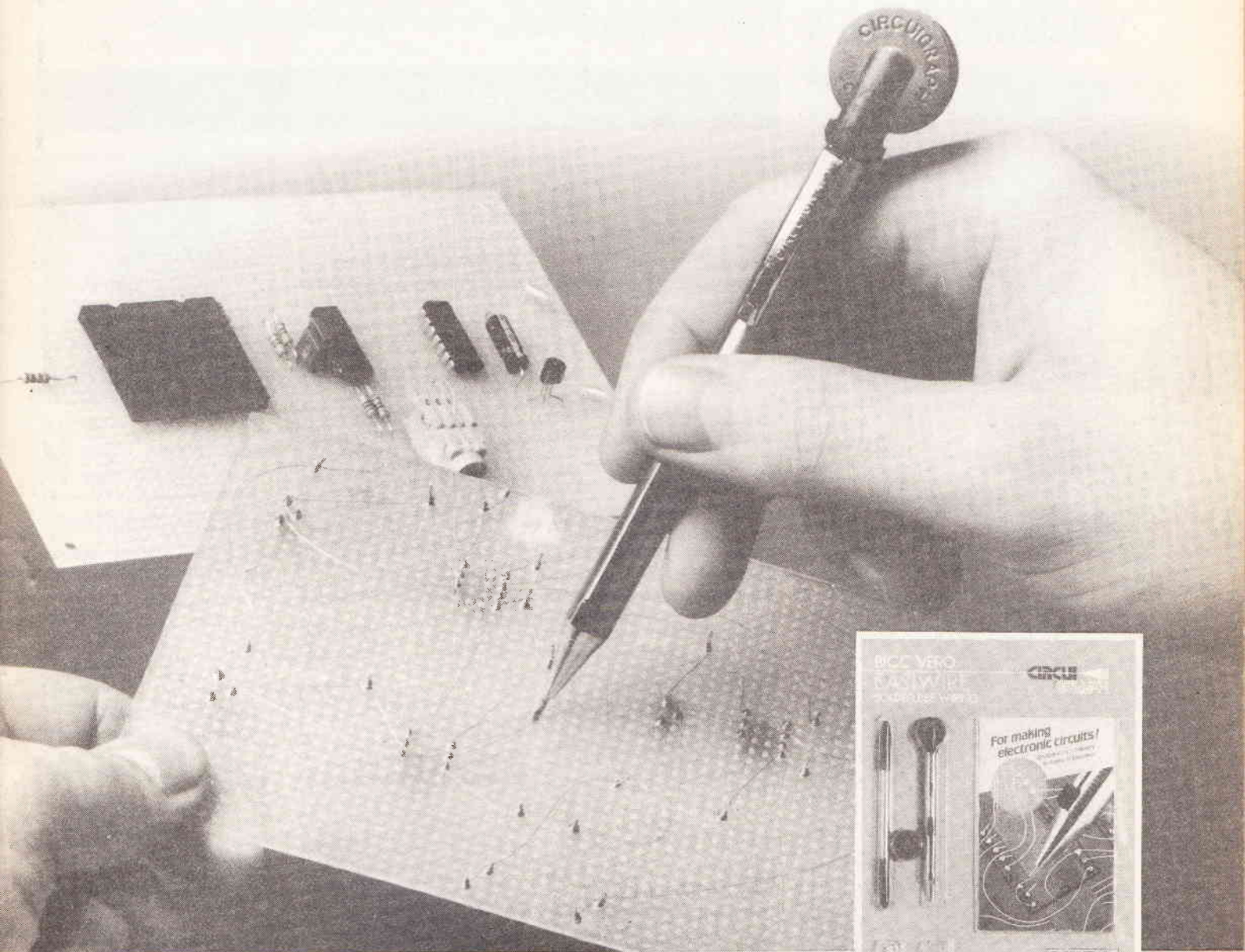

Construct your electronic circuits the new, quick and easy-to-learn way, **WITHOUT** solder: with Circuigraph Easiwire from BICC-VERO

With Easiwire all you do is wind the circuit wire tightly around the component pins. No soldering, no chemicals, no extras, simplicity itself. Circuits can be changed easily, and components re-used.

Easiwire comes in kit form. It contains all you need to construct circuits: a high-quality wiring pen with integral wire cutter, 2 reels of wire, a tool for component positioning and removal, a flexible injection moulded wiring board, double-sided adhesive sheets, spring-loaded terminals and jacks for power connections and an instruction book. Of course, all these components are available separately too.

To take advantage of the special introductory offer, complete the coupon on the right and send it to:

**BICC-VERO ELECTRONICS LIMITED,**  
Flanders Road,  
Hedge End,  
Southampton, SO3 3LG



Please rush me ..... Easiwire kits, retail price £18.-;  
**special introductory offer** £15.-. (includes p & p and VAT).

I enclose cheque/postal order for....., made payable to  
BICC-VERO Electronics Limited

Please debit my credit card as follows:



Card Number .....

Expiry Date .....

Name .....

Address .....

Signature .....

or phone 04892 88774 now with your credit card number  
(24-hour answering service).

January  
1989

VOLUME 18 No 1

Geoff Bains: Editor  
Jez Ford: Assistant Editor  
Paul Chappell: Projects Editor  
Jerry Fowler: Technical Illustrator  
Heather Hopkinson: Design

Mark Warford: Photography  
Selina Gayle: Ad Manager  
Heather Wust: Classified Sales  
Andrew Selwood: Copy Control  
Mark Webb: Group Editor

Page 42

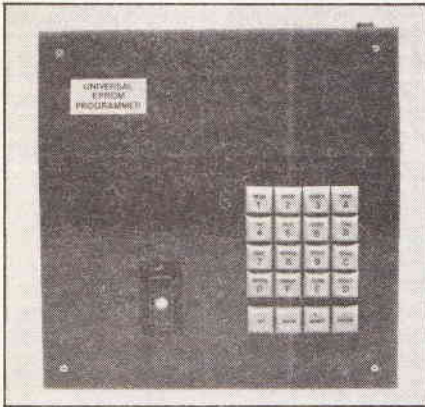

Page 33



ISSN  
0142-7229



Member of the  
Audit Bureau  
of Circulation

ETI is normally published on the first Friday in the month preceding the cover date. The contents of this publication including all articles, designs, plans, drawings and programs and all copyright and other intellectual property rights therein belong to Argus Specialist Publications Limited. All rights conferred by the Law of Copyright and other intellectual property rights and by virtue of international copyright conventions are specifically reserved to Argus Specialist Publications Limited and any reproduction requires the prior written consent of the Company. © 1988 Argus Specialist Publications Ltd. All reasonable care is taken in the preparation of the magazine contents but the publishers cannot be held legally responsible for errors. Where mistakes do occur, a correction will normally be published as soon as possible afterwards. All prices and data contained in advertisements are accepted by us in good faith as correct at time of going to press. Neither the advertisers nor the publishers can be held responsible however, for any variations affecting price or availability which may occur after the publication has closed for press.

• Subscription rates — UK: £18.00, Europe: £22.20, Middle East: £22.40, Far East: £24.00, Rest: £22.70 or US\$39.00.

**ARGUS  
PRESS  
GROUP**

1 Golden Square  
London W1R 3AB  
Tel: 01-437 0626  
Telex: 8811896

**REGULARS**

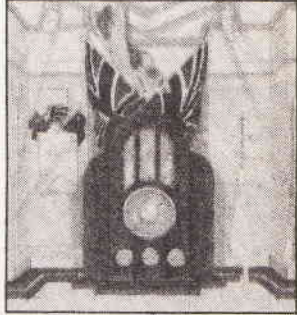
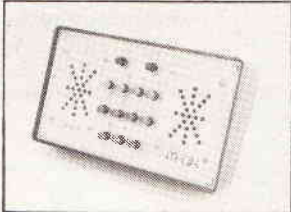
<b>News</b>	6	<b>Subscriptions</b>	26	
<b>Read/Write</b>	8	<b>Top Projects</b>	41	<b>BBC Radio Show Report</b>
<b>Insight</b>	9	<b>PCB Service</b>	50	<b>Open Channel</b>
<b>Diary</b>	9	<b>PCB Foil Patterns</b>	53	<b>Playback</b>
<b>Next Month</b>	11	<b>Oops!</b>	56	<b>Book Look</b>
<b>Special Offer</b>	11	<b>Classified Ads</b>	57	<b>Readers' Free Ads</b>
		<b>Keep Regular</b>	60	<b>Ad Index</b>
<b>Special Offer</b>	22	<b>Blueprint</b>	61	

Published by Argus Specialist Publications Ltd., 1 Golden Square, London W1R 3AB. Tel: 01-437 0626. UK newstrade distribution by SM Distribution Ltd., 6 Leigham Court Road, London SW16 2PG. Tel: 01-677 8111. Overseas and non-newstrade sales by Magazine Sales Department, 1 Golden Square, London W1R 3AB. Tel: 01-437 0626. Subscriptions by Infonet Ltd., 5 River Park Estate, Berkhamsted HP4 1HL. Tel: (0442) 876661. US subscriptions by Wise Owl Publications, 4314 West 238th Street, Torrance, CA90505 USA. Typesetting and origination by Project 3 Filmsetters, Whitstable. Printed and bound by The Chesham Press, Chesham. Covers printed by Loxley Brothers Ltd., Sheffield.

## FEATURES/PROJECTS



# 27

### ETI Cell Guide

Bill Higgins assaults the battery market with a survey of all you need to know about all battery types

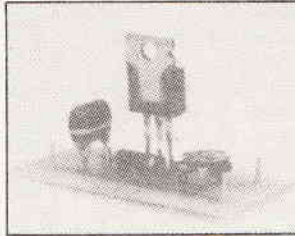

# 12

### RDS

The BBC's Mark Saunders reveals the codes and codicils of the Radio Data System, the BBC implementation and the future of Radio as we know it

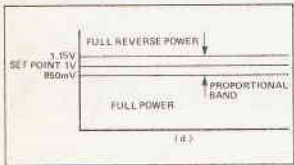

PROJECT

# 36

### In-Car Power Supply

Keith Brindley has a super-simple 1st Class project to let you run all your low voltage cassette players, radios, fly repellents or whatever inside the car or caravan

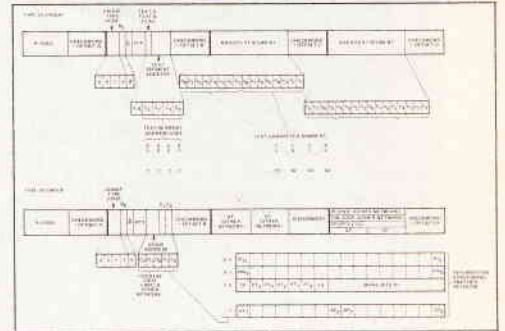

Page 12

# 20

### Op-Amps

Paul Chappell takes errors in his stride with a discussion of feedback for this month's *Circuit Theory*

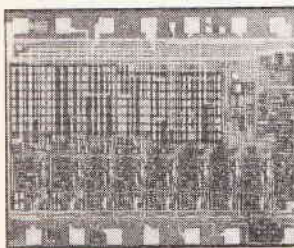

PROJECT

# 28

### Rev-Rider

If you get a bicycle for Christmas but really want a motor bike, Stuart Richards has the answer

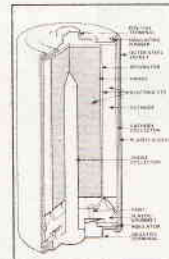
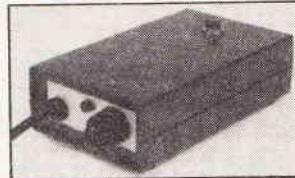

Page 27

# 24

### Language Lesson

Mike Barwise looks at high level languages and microprocessors for this month's *Chip In*

PROJECT

# 33

### A Christmas Present For Granny

John Linsley Hood moves away from his usual top-notch hi-fi designs to present a low voltage, automatic gain control hearing booster to help Granny listen to the Queen's speech

PROJECT

# 38

### Son Of Variat-Ion

Paul Chappell won't let a sleeping project lie and here presents a quick update to October 1988's Variat-Ion air ioniser

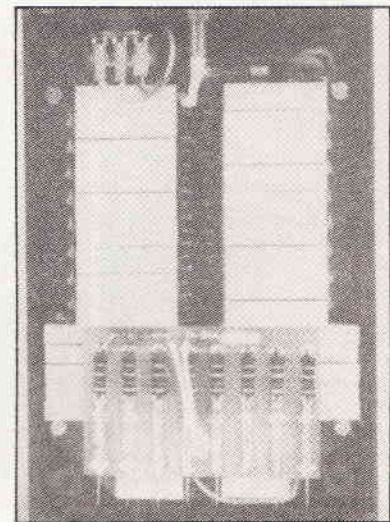

Page 38

PROJECT

# 42

### Stand-Alone EPROM Programmer

Mike Bedford and Gordon Bennett upgrade the Universal EPROM Programmer MkII of summer 1985 to work with any RS232 equipped computer

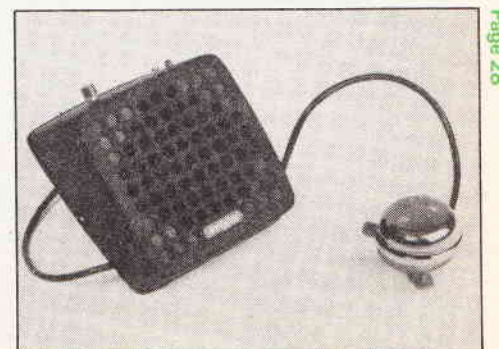

Page 28

# NEWS

## THE BIG SCREEN

The Japanese Ministry of Trade and Industry is developing a wall size liquid crystal television screen, as beloved by sci-fi writers for decades.

Twelve Japanese companies will be participating in the research which will initially be aimed at producing a 40in screen. The companies include Casio, Sharp, NEC, Hitachi and various printing and glass companies.

The aim is to get a screen no more than 10 centimeters thick so it can be easily wallmounted while still overcoming the problems of multiplexing the massive array of pixels. It is hoped that the first units will be on the market by 1995.

## ULTRASONIC TAPE



A pair of very reasonably priced ultrasonic measures are now available from Solex International.

The UR2000 and UR3000 measure distances in feet or metres simply by pointing the ultrasonic transmitter/detector at a surface up to 10m distant. Imperial units can either be feet and inches or feet to two decimal places. Accuracy for both units is 1%.

In addition the UR3000 has memories for three dimensions and can calculate cubic capacity and floor area.

The UR2000 costs just £29 + VAT, the UR3000 is £49 + VAT. Both units are available on 14 days approval.

Contact Solex International, 95 Main Street, Broughton Ashley, Leicester LE9 6RE. Tel: (0455) 283486.

## SCRAMBLE FOR STV CHANNELS

Rupert Murdoch has decided to scramble at least one of his four Astra STV channels in response to pressure from film distribution companies.

It was originally proposed that the Astra channels would be available without subscription, making the £199 price tag of the Amstrad/Murdoch STV receiver the only expense for new STV viewers.

The announcement that Sky Movies, probably to be the most popular of the four channels, is to be scrambled four months after its launch is a major departure from the single-payment concept originally planned.

Eurosport, another of Murdoch's Astra channels, may follow suit.

The pressure from the film distribution companies followed their realisation that the Sky channels were buying movie rights for the UK only, while the unencrypted Sky Movies would be available across much of Europe. The main advantage to viewers will be better films, financed by the (as yet unannounced) subscription charge.

Not that Mr Murdoch himself is able to watch anything at the moment. Westminster City Council recently rejected his application for a satellite dish on the roof of his St James's Place residence in London. Had he been content to use Amstrad's smaller dish, planning permission would not have been necessary!

## THE GENERATION GAME

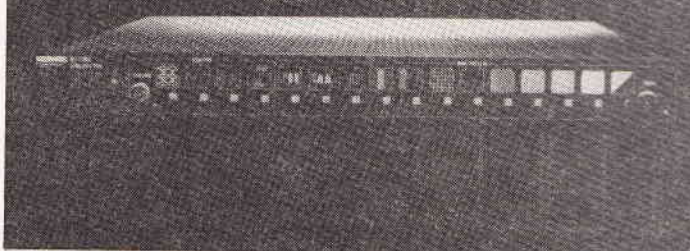

Two specialised signal generators have come on the market this month.

The first is the Kenwood DA3531, a reference generator to evaluate CD players. There are various test patterns covering frequencies from 20Hz-20kHz. Eight error patterns are available and sixteen subcodes. The DA3531 costs £1850 + VAT. The highly complicated DA3500A is also available, price £20250 + VAT.

The second unit, again for professional test work, is the 7765 Packet Test Signal Generator for D-MAC and D2-MAC signals. This replaces the

program for testing a transmission channel, receiver or code converter, generating all test signals digitally on 10-bits at the D2-MAC clock frequency.

The 7765 has a top price of £5850 + VAT.

Contact Schlumberger Instruments, Victoria Road, Farnborough, Hants GU14 7PW. Tel: (0252) 544433.

For details of the DA units contact Thurlby Electronics, New Road, St Ives, Cambs PE17 4BG. Tel: (0799) 26699.

## MULTI-MAGAZINE CD

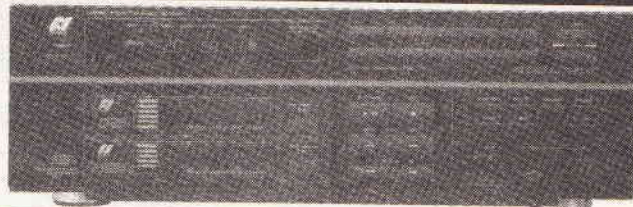

Sansui has taken the concept of multi-disc CD players one step further with the new CD-X510M, which can hold up to 12 discs in its pair of 6-disc magazines. This gives you over 12 hours of listening entertainment without leaving your seat — a questionably useful facility.

It does however allow you to keep your top 12 discs permanently in the player, removing all that tedious nail-breaking opening of boxes.

The CD-X510M also has a remote control with a numeric keypad so that

everything can be chosen from the comfy chair.

The normal range of CD functions is included — programming, repeat, skip, random play — plus a few more unusual facilities such as random intro play which plays through introductions randomly while you construct a program.

The CD-X510M retails at £299.95 and uses 16-bit twice oversampling.

Contact Sansui, Axis 4, Rhode Way, Watford WD2 4YW. Tel: (0923) 226499.

## BITS FOR KITS

I-TRON UK is a Berkhamsted company producing some clever little kits to fill those winter evenings.

Among them is the Theramin Music Generator (based on the legendary ancient mystical instrument . . .) at £12.75, and a low-price VHF-transmitting bug at £5.25.

For a full data sheet send an SAE, for orders enclose 95p postage.

Contact I-TRON UK, Castle Mill, Lower Kings Road, Berkhamsted, Hertfordshire HP4 2AD.

## BLOWING IT

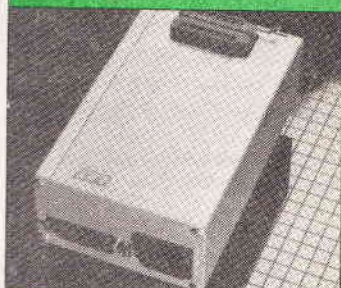

If the construction of the ETI Stand-Alone EPROM Programmer is too much for you and you want a programmer off the shelf, the ART EPP-1 from Brian Price Electronics is worth a good look.

The EPP-1 can program all 27x EPROMs from 2716s to 27513s as well as various 25x EPROMs and the X2564 EEPROM.

Control is from any computer via an RS232 link. Single character commands enable very simple operation and any instruction is halted by an ESC command.

The EPP-1 retails at £97 including VAT and postage. There is an operational program available for IBM compatibles, price £12.00. Brian Price also supplies the range of Bohm programmers.

Contact Brian Price Electronics, 389 Aspley Lane, Nottingham NG8 5RR. Tel: (0602) 296311.

Another unit which can program over 50 types of device is the Model 18 from MQP Electronics of Malmesbury. This can be controlled either by RS232 communication similar to that above or by MQP's Promdriver Advanced Features User Interface Package, which works with MS-DOS, PC-DOS and CP/M80 operating systems.

The Model 18 retails at £189.95 + VAT. Contact MQP, Unit 2, Park Road Centre, Malmesbury, Wilts SN16 0BX. Tel: (0666) 825146.

## ON GUARD

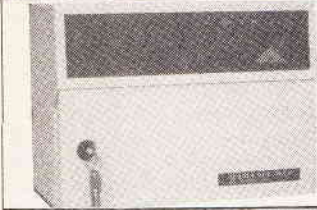

A new security system, the Audiogard 1000 from Abbey Security, not only informs the police of intruders on the premises but specifies the number of intruders, how they broke in, where they are now and quite possibly what their names are!

This seemingly impossible task of recognition and identification is performed by perhaps the most advanced listening device available — the human ear.

The concept is simple enough. When the on-site unit picks up any unusual noises from one or more high specification microphones it phones up Abbey Security's head office in Nottingham.

The 24hr monitor girls (girls can hear better than boys apparently) then listen in real time down the telephone link to check up on the details. The police are then alerted, and the possibility of a false alarm is eliminated.

The possibility of false alarms is an enormous problem in the security systems marketplace as 98% of all alarm triggering are false alerts — a situation that cost the police £28 million last year and has resulted in them threatening to charge for wasted police time or even withdraw support if false alerts continue.

Without police support, insurance companies will not cover premises and without insurance, most business are unable to operate. Clearly the situation must improve.

With Abbey's system the police are certain of their information and can respond in a far more positive manner than if they are 98% expecting nothing to be wrong.

The only hitch in the Audiogard's operation is the definition of an 'unusual' sound. If any sound detected were to trigger the alarm, the number of alerts reaching Abbey's HQ would be unmanageable.

So the Audiogard uses a noise recognition system based on EPROM recordings. This is claimed to distinguish between a cat knocking over a milkbottle and a thermic lance or between a thunderclap and the door crashing in. Only if an 'unfriendly' sound is identified will the alert be triggered.

A basic Audiogard 1000 system will cost around £1500 and although the first Abbey base is in Nottingham, any premises in Britain can be covered. Further bases in London and Manchester should follow.

Contact Abbey Security, Abbeyfield Road, Lenton Industrial Estate, West, Nottingham NG7 2SZ. Tel: (0602) 860164.

## IT'S ON THE CARDS

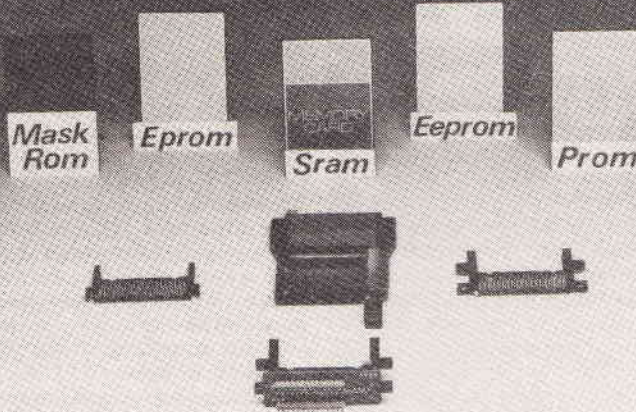

Credit card memories in various formats are now available from Hakuto in Waltham Cross.

The cards are available as SRAM, PROM, EPROM, masked ROM and now EEPROM memory, accessed through the edge connector at the top of the card.

Hakuto is also marketing a parallel read/write unit for the cards, fully MS-DOS controlled. The BB1R

connector is also available, a mechanically locking card holder which prevents the card being removed accidentally.

The various cards start at £22.89 + VAT (8K SRAM), the programming unit retails at £296.81 + VAT. Contact Hakuto UK, 33-35 Eleanor Cross Road, Waltham Cross, Herts EN8 7LF. Tel: (0992) 769090.

## THE WINTER COLLECTION

Last month saw the launch of most of the catalogues from the main component suppliers — Maplin (£1.95, Tel: (0702) 552911), Greenweld (£1.00, Tel: (0703) 772501 and

Electromail (£4.95, Tel: (0536) 204555). Cirkuit has two catalogues, one for the hobbyist (£1.30) and one for industrial users (free if you can get it), Tel: (0992) 441306.

## WHAT A WHOPPER!



Monitors are going up in the world with the Ranger 21 FST auto-synch 21in colour monitor, launched at the Computer Graphics 88 show in October.

Dynamic beam forming, automatic picture size compensation and automatic synchronisation combine to make the large screen 'possibly the best picture in the world'.

But then at £2100, you might expect that.

Contact Aydin Controls, 64 Wilbury Way, Hitchin, Herts SG4 0TP. Tel: (0462) 58804.

## £3 AMP

This month's special offer from KIA in Ilkley is a fully assembled 10W amplifier, at a bargain price of £3.00. Contact KIA-8, Cuncliffe Road, Ilkley LS29 9DZ or clip the coupon in the Classified section.

## POWER

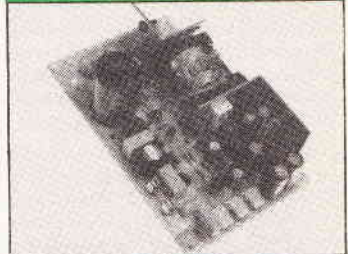

Switch mode power supplies have been reduced in price by Powersolve of Newbury. Two 40W units, SNP8171 and SNP8172 are available, measuring just 127 x 76 x 40mm with outputs at either +5V and ±12V or +5V and ±15V.

The 1-off price is £38 but in quantity this can come down to below £25.

The pictured 65W unit has +5V and ±12V outputs and an input that will take any signal from 90-260V AC. The 65W supply costs £59 — again much lower for quantity orders.

Contact Powersolve Electronics, 9 The Paddock, Hambridge Road, Newbury, Berks. Tel: (0635) 521858.

## ENTER THE SPICE AGE

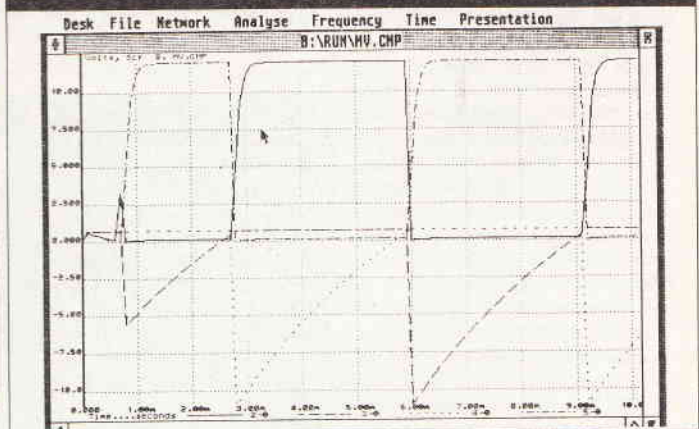

The latest product in the Spice range of circuit analysis software from Those Engineers is Spice\*Age, a high speed complex analysis program for PCs.

Spice\*Age can model simple components together with non-linear devices such as transistors, CMOS gates and saturating op-amps.

All devices may be amended so that different and modified devices can be produced.

The program can model frequency response, DC quiescent

voltages, transients and can analyse down to Fourier components.

Circuits are subjected to seven types of user-definable disturbances and both tabular and graphical results are produced.

A modular version of Spice\*Age is available from £70, a multi-user version from £500. Special prices are available for educational establishments.

Contact Those Engineers, 106a Fortune Green Road, London NW6 1DS. Tel: 01 435 2771.

# READ/WRITE

## RAT ZAP

The *Recurring Dream* article in the September 1988 issue had a concluding section on biofeedback. Neil Miller of Rockefeller University did indeed try to show that rats could be taught to control their heart rate. Unfortunately, the work that seemed to prove this hypothesis was never replicated by other groups either at Rockefeller or other universities.

David VanDercar MD, Ph D, who was one of my lecturers in the Department of Biomedical Engineering at the University of Miami, worked with Neil Miller's group and discovered an instrumentation fault that actually put several volts DC through the rats' hind brains, when the intent was to stimulate the pleasure center with a few minute pulses.

This simply burnt out the rats' brains and caused the heart rate to be controlled at the idiopathic rate determined by the ventricles which is usually much slower than the normal rate. Indeed, when David tried to replicate the experiments without curare, the rats performed backflips, much to everybody's amazement and consternation.

David is of the opinion that conscious control of heart rate is not possible because there is no evolutionary benefit. The autonomic rate and cardiac output are much too important for the body to allow conscious processes to interfere with them.

The idea of conscious control of heart rate is very attractive in number of ways. For example, being able to reduce high blood pressure using biofeedback techniques. In a study that VanDercar performed using women subjects there was only one person who showed any control.

When questioned about what she was thinking about to slow her heart down, she said that she imagined herself relaxing on a beach, and when she wanted to speed her heart rate up she envisioned herself the object of a violent sexual encounter with a gang. The bottom line is that this was not direct nervous control of heart rate, but that the changes were mediated via humoral mechanism.

Once again, I greatly enjoy your articles, which are always full very interesting ideas. Keep up the good work with ETI.

André Routh  
Miami Lakes, Florida

*One of the hazards of writing a never-ending stream of projects for ETI is that there's never enough time to check original sources so it's always good to hear from someone who's to the centre of things, as it were. Thank you for correcting us.*

## BAR-MY

As the writer of one of the 'profusion' of letters you received to inquire as to how to 'read a can of beans', I thank you for taking the trouble to put together the *Behind Bars* article in your November issue.

The subject of bar codes is indeed much more complicated than it first appears. Although I still can't march around the supermarket declaring where an item was grown or made, at least I now know why I can't!

George Hickman  
Ludlow, Salop.

*It certainly does liven up the Saturday shopping doesn't it. Another wizard wheeze is to use a black marker pen to turn your can of beans into a pot of shrimps or a bottle of brandy. You can sit back and chuckle as the manager calls the fraud squad.*

## D FOR DESTRUCTION



With reference to your NiCd Charger project in the ETI for November 1988, I feel you should have pointed out very clearly that some D size NiCds are not 4Ah but only 1.2Ah and if charged at the 340mA rate they will overcharge and could explode.

John Tyzzer

Guildford, Surrey

*Yes indeed. Most D-type NiCds are of the lower capacity and should not be charged at 340mA. Indeed, many C-type cells are only 1200mAh also. Both these types should be charged at 120mA using a 115R resistor. Coincidentally this is the same value as is used for charging a PP9 and so no modifications are required to the circuit.*

## SECURITY CONSCIOUS

Congratulations on the November issue and the free gift to build the *Burglar Buster* alarm. I look forward to next month's free PCB.

Perhaps you could embark on a course, covering say 12-18 months dealing completely with DIY projects to totally safeguard a house, including perhaps some manufacturers' equipment.

Might I also comment on the Nite Sentry reviewed in *Once Over*. I fitted two of these units a while ago. They are very good with a range of 8m or so but their limitation is that according to both the manufacturers and Maplin no sounding device can be attached.

Finally, I am currently fitting an alarm system to my bungalow using various commercial equipment. I need about 150 spade terminals to fit 2mm screws in the junction boxes. Can you tell me where I can purchase these.

F. G. Lawrence

Doddington Park, Lincoln

*Thanks for your comments on the November issue. We hope the December issue and even this one, go down as well. As to the series of home projection projects, we feel that would be turning ETI a little into a security-specific magazine. Nevertheless, we have in the past featured many security projects and will continue to do so in the future as particularly good ones come our way.*

*Any mains powered sounder can be simply connected to the Nite Sentry with the auxiliary lamp outputs. Alternatively, battery powered units could be connected with a mains activate relay. Spade connectors are available from most component stockists — Maplin stocks them — and from motorist accessory shops.*

## BONNIE BLUES

Further to your letter regarding the recent demise of Bonnie Langford in the new *Doctor Who* series, is there any truth in the rumour she is to be retrospectively substituted for Angela Cartwright as Penny in Channel 4's repeat showings of *Lost In Space*?

In trepidation  
Barry Peterson  
Matlock, Derbyshire  
PS Stair-climbing Daleks — wow!

*What is it with you guys? This is meant to be an electronics mag, if you have to go on about Doctor Who and*

The new series of *Doctor Who* may well lack the dear departed and much mourned Bonnie Langford (or is that much departed and dearly mourned?) but it does include stars from *Eastenders* and *Upstairs Downstairs*, not to mention the set from Ali's cafe.

Ian Gillman  
Woodeaton, Oxford

*Bonnie Langford, at least try and fit in a few references to electronics.*

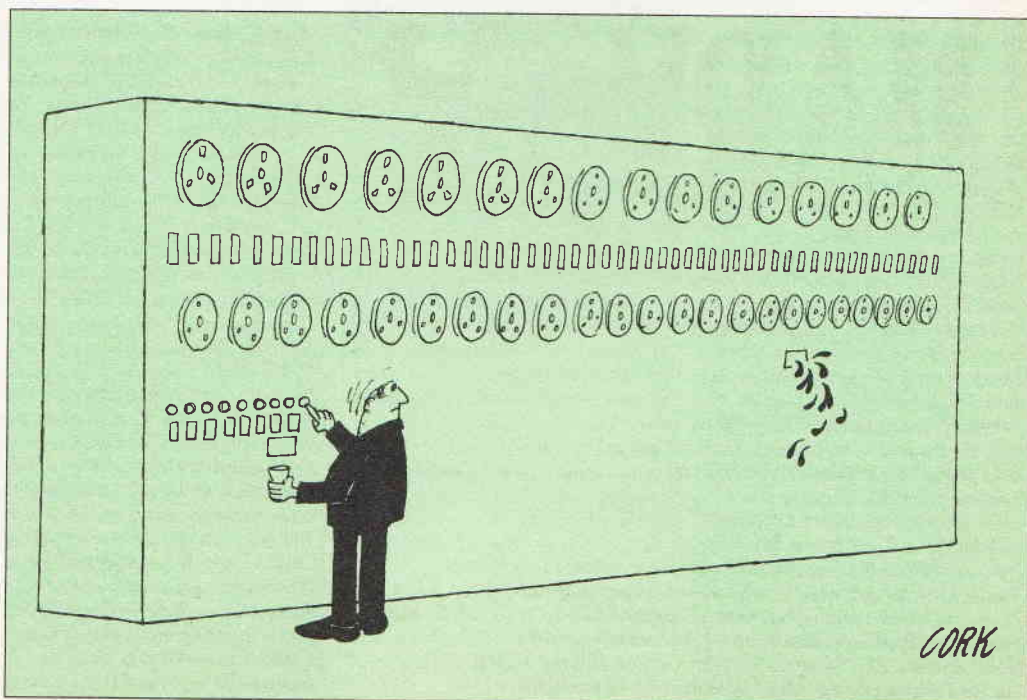



# INSIGHT

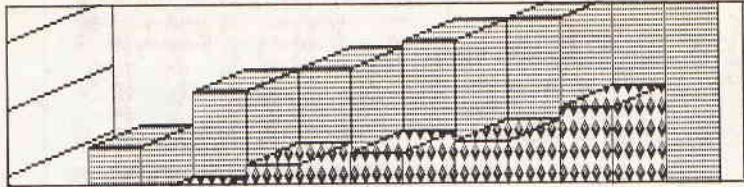

British electronic equipment manufacturers can be almost totally confident of renewed growth over the next few years, says a new and optimistic report published by ICC Business Ratios.

Short term growth should once again be strong after the virtual standstill between 1985/86 and 1986/87 sales — an unprecedented pause in the electronics market.

Despite the slack trade, many British companies managed rather impressively to raise profit margins and other indicators such that despite static sales overall profits rose slightly.

This optimism contrasts strongly with other recent reports such as the National Economic Development Office's work compiled by McKinsey which slated home-grown companies as having badly underperformed in recent years compared with UK subsidiaries of US and Japanese companies. That report was labelled by GEC ex-MD Lord Weinstock as 'not frightfully helpful'.

The ICC report shows indigenous UK firms leading the pack. Apart from IBM's UK holdings which are ahead on sales overall, the next six companies — English Electric, STC, Plessey, Racal, Marconi and GEC — are British through and through.

However, as many reports have stated in the past, much of the UK's electronics expertise lies not in the huge and wide-reaching but in the small and specialised. Niche products that defy mass production are the

mainstay of many of our smaller producers.

This situation looks unlikely to change drastically despite frequent calls for mergers to streamline the UK industry ready for a frontal assault on Europe come the revolution in 1992.

Plessey is often chosen as a shining example to us all in the art of streamlining, acquisition and co-operation, although it is often insufficiently stressed that 1992 is not simply a UK versus the rest of Europe situation.

Co-operation between our own companies and the best of Europe to create an international unit to rival the US and Japan is perhaps even more important in the long run. However, such unions are rare — one exception from the component industries being Plessey's work with Philips on the D-MAC and D2-MAC chipsets.

Our small companies, then, remain as much of the flesh of the industry, if not the skeleton. The ICC report shows that these companies are no less successful than the big boys (taking the ratio of return to employed capital as an indicator) with only two of the top ten performing companies having turnover above £10m.

Around the middle of this top ten comes Amstrad, worth singling out for some quite remarkable results in the last two years. Last year the ratio of Amstrad sales to fixed assets was 42:1, an outstanding ratio when the average for UK companies was less than 6:1.

This figure results from Amstrad

managing to turn over about £600,000 for each employee — the nearest rival to this was IBM, turning over about £150,000.

Meanwhile in the export market there are some examples of those niche markets mentioned earlier.

While IBM leads the field in terms of sheer volume, in terms of exports as a percentage of sales, the winner is Solid State Logic of Oxford, manufacturer of the legendary SSL studio mixing desks.

SSL is famous worldwide not only for the quality of its products but for the backup it provides at and following installation. A very specific market area is addressed but a reputation in that area has generated enormous success. Mass production would quite likely be counter-productive.

Overall the report is very optimistic, praising the small for being small and the big for being big. While it is recognised that the electronic equipment market can be heavily influenced by new developments and new markets (such as the recent takeoff of the Vodaphone network), it is confidently expected that next year's report will announce a further renewal of growth which will be maintained or exceeded in following years.

The report *Electronic Equipment Manufacturers, Business Ratio Report — An Industry Sector Analysis* is available for £185 from ICC Information Group, 28-42 Banner Street, London EC1Y 8QE. Tel: 01-253 3906.

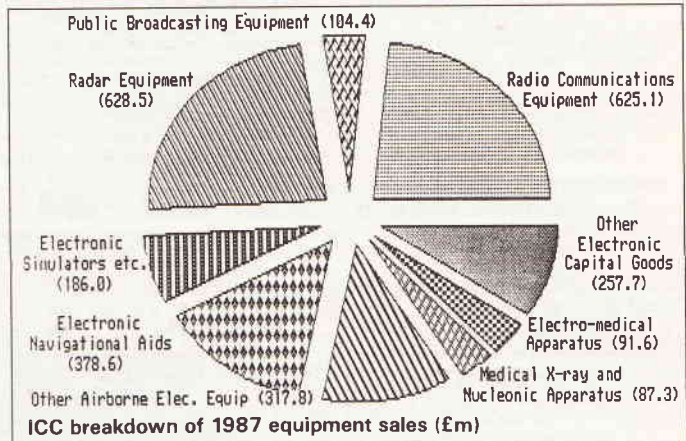

# DIARY

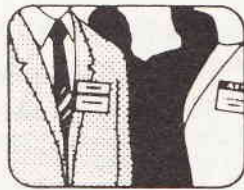

## Frequency Spectrum Management — December 5th

IEE, London. Lecture by IEEIE. Contact IEEIE on 01-836 3357

## Interactive 88 (Interactive Systems) — December 6-8th

Metropole Exhibition Centre, Brighton. Contact PLF Communications on (0733) 60535

## Electronic Messaging Systems — December 6-8th

Tara Hotel, London. Conference. Contact Blenheim Online on 01-868 4466

## Graphic Display Devices — December 8th

IEE, London. IEE Colloquium. Contact IEE on 01-240 1871

## Cassini — The Mission To Survey Saturn And Land On Titan — December 8th

IEE, London. IEE Lecture. Contact IEE on 01-240 1871

## CD-ROM — December 8th

IEE, London. IEE Colloquium. Contact IEE on 01-240 1871

## Computer & Technology Show — December 11th

Music Hall, University of Aberdeen. Contact SATRO on (0224) 273161

## Satellites And Broadcasting — December 13-14th

IEE, London. IEE Christmas Lecture. Contact IEE on 01-240 1871

## Radio Propagation In Bad Weather — January 5th

IEE, London. 24th Appleton lecture. Contact IEE on 01-240 1871

## Digital Audio Broadcast Systems — January 10th

IEE, London. IEE discussion meeting. Contact IEE on 01-240 1871

## Computer Vision For Robots — January 24th

IEE, London. IEE Colloquium. Contact IEE on 01-240 1871

## Super Conductors And Their Practical Uses — January 25th

RSA, London. Lecture by Royal Society for the Encouragement of Arts, Manufacture and Commerce. Free tickets from RSA on 01-930 5115

## The UK Direct Broadcast Satellite — January 26th

IEE, London. IEE Colloquium. Contact IEE on 01-240 1871

## Sound 89 — February 21-22nd

Heathrow Penta Hotel, London. Contact Sound and Communications Industries Federation on (06286) 67633

## Which Computer Show — February 21-24th

National Exhibition Centre, Birmingham. Contact Cahners Exhibitions on 01-891 5051

## Internepon Production — March 14-16th

NEC, Birmingham. Electronics manufacturers show. Contact Cahners Exhibitions on 01-891 5051

## Cable And Satellite 89 — March 16-19th

Olympia, London. Contact Montbuild on 01-486 1951

## Corporate Electronic Publishing Systems — March 21-23rd

Olympia, London. Contact Cahners Exhibitions on 01-891 5051

## Connectors 89 — March 23rd

Crest Hotel, Walsgrave, Coventry. Contact A F Hayes & Co. (0533) 881208

## Automan — May 9-12th

NEC, Birmingham. Automated manufacturing show. Contact Cahners Exhibitions on 01-891 5051

## Energy 89 — May 16-18

NEC, Birmingham. Contact Emap Maclaren on 01-660 8008

# PROFESSIONAL SURVEILLANCE EQUIPMENT KITS

- **MTX** Micro-miniature VHF transmitter. The smallest kit on the market measuring an incredible 17mm x 17mm including on-board mic. Super sensitive. Fully tuneable over FM band, 9V operation with range up to 1000m. **£10.95**
- **VT500** High power version of the MTX with on-board PA stage providing 250mW of RF. Measures just 20mm x 40mm, power requirements 9-15V. Excellent sensitivity and stability. Fully tuneable over FM band. Ranges over 3000m can be expected. **£12.95**
- **VOX75** Voice-activated transmitter. Variable sensitivity trigger level switches transmitter on when sounds are detected. Stays on for time delay variable between 1-20 sec. Fully tuneable output covers all FM band. Very sensitive and low standby current through CMOS circuitry. 9V operation, range up to 1000m. Measures 30mm x 40mm. **£15.95**
- **CTX900** Sub-carrier scrambled transmitter. Audio is double modulated providing very secure transmissions. Any unauthorised listener will not be able to demodulate signal without DSX900 Decoder unit. Variable modulation on-board. Fully tuneable output covering FM band. 9V operation, range up to 1000m. Measures 30mm x 40mm. **£18.95**
- **DSX900** Decoder unit for CTX900. Connects to earphone output of receiver to descramble signal from CTX900. Monitor using small speaker or headphones. Variable decode frequency on-board for best resolution. 9-12V operation. Measures 35mm x 50mm. **£17.95**
- **TLX700** Micro size telephone transmitter. Connects onto line at any point and requires no batteries. Clearly transmits both sides of conversations on both incoming and outgoing calls. Undetectable by phone users. Fully tuneable output covering FM band. Range up to 1000m. Measures just 20mm x 20mm. **£9.95**
- **ATR2** Micro size telephone recording unit. Connects onto line at any point and connects into ANY normal cassette recorder, standard or micro having MIC and REM sockets. Requires no batteries. Switches recorder on silently when phone is used for incoming or outgoing calls, switches off when phone replaced. Clearly records both sides of conversations. Undetectable by phone users. Measures 10mm x 35mm. **£10.95**
- **XML900** RF Bug Detector/Locator. Wide band input circuitry detects presence of RF field and triggers flashing LED and piezo bleeper. Variable sensitivity enables source of transmission to be pinpointed to within 6 inches. Max sensitivity will detect MTX or similar transmitter at around 15-20 feet. 9V operation. Measures 55mm x 55mm. **£21.95**

All kits come fully documented with concise assembly and setting-up instructions. High quality fibreglass PCB and all components necessary to complete the module. All prices are inclusive but please add £1.50 to cover P&P. Orders over £50.00 post free. Please state requirements clearly and enclose cheque or PO to cover.

Phone orders on ACCESS or AMEX accepted. Tel: 0827 714476  
 NOTE: It is illegal to operate a transmitter in the UK without a licence  
 Send 9x4 SAE for full catalogue of these and other surveillance kits

SUMA DESIGNS (Dept ETI), THE WORKSHOPS, 95 MAIN ROAD  
 BAXTERLEY, NR ATHERSTONE, WARCS CV9 2LE. TEL: 0827 714476

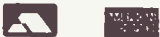

## FIELD ELECTRONICS

TV, VIDEO - ELECTRONIC SPARES - IMPORT & EXPORT  
 27 CUCKOO HILL ROAD  
 PINNER, MIDDLESEX HA5 1AS  
 Tel: 01-868 5650

Super Service  
 Competitive Prices  
 Speedy Delivery

Credit Card  
 Orders Welcome



Integrated circuits

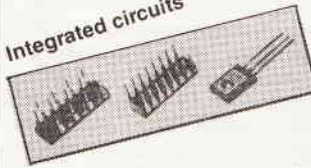

Transistors

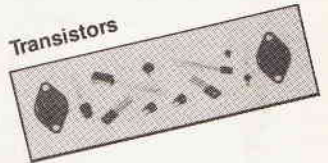

Crystals

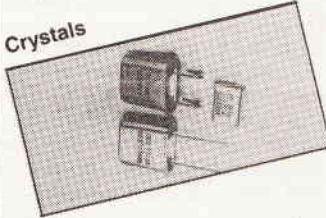

Valves

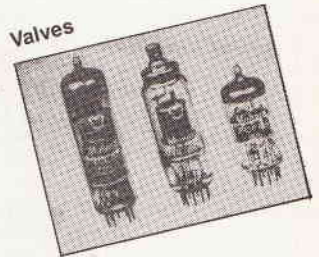

Varicap tuners

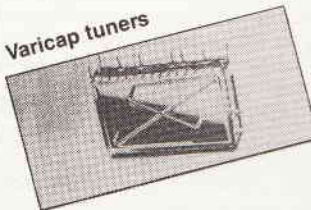

For  
 Quality Components  
 &  
 Fast Service

Please phone or write for catalogue. Mail order only.

## OMNI ELECTRONICS

174 Dalkeith Road, Edinburgh EH16 5DX • 031 667 2611

- ★ The supplier to use if you're looking for
- ★ A WIDE RANGE of components aimed at the hobbyist ★
- ★ competitive VAT inclusive prices ★
- ★ mail order - generally by return of post ★
- ★ fast, friendly service ★

- by mail order, telephone order or personal call  
 Current catalogue now available - Send 2x19p stamps  
 we do try to keep the goods we list in stock.  
 Whether you phone, write or call in  
 we'll do our best to help you.

Open: Monday-Friday 9.00-6.00  
 Saturday 9.00-5.00



## BRIAN PRICE ELECTRONICS

389 ASPLEY LANE  
 NOTTINGHAM NG8 5RR  
 Telephone: 0602 296311

Importers of BOHM Eaprom programmers:

**BOHM MicroProm** - The cheap programmer  
 Programms 2716 to 27256, 2532 etc, also via RS232  
 interface. High speed eg 2764 may be programmed  
 in 30 secs.

### BOHM Microprom 2000

Up to 1 Mbit programming. High speed RS232  
 interface, identify, blankcheck, adjustable  
 programming parameters.

Software for Commodore 64/128, Atari ST and IBM  
 computers available.

Also importers for the ART Programmer for use with  
 any computer with terminal emulation program -  
 only £100 plus software (IBM only).

Supplied in kit form or built by:  
**THE BOHM SPECIALISTS**

Please write or phone for full illustrated literature and price list

## BINDERS

FOR YOUR VALUABLE COLLECTION  
 OF ELECTRONICS TODAY  
 INTERNATIONAL MAGAZINES

• SMART • EASY TO USE • TOP QUALITY  
 To ASP Readers Services, PO Box 35,  
 Wolvey House, Wolvey Road, Hemel  
 Hempstead, Herts HP2 4SS (0442-41221)

£5.95  
 inc.  
 P&P

Please supply . . . Electronics Today International  
 Binders £5.95 inc. P&P

Total £ ..... (Please make cheques payable to ASP Ltd.)

Years Required - 198.....198.....198.....198.....

Name .....

Address .....

Please allow 21 days for delivery



Next Month  
in



**ELECTRONICS**  
TODAY INTERNATIONAL

The February ETI  
is out January 6th

Don't miss it!

Jackson slipped across the hallway and into the darkened library. The voices of Lady Grimshaw could be clearly heard above the rest of the company and Jackson smiled wryly to himself as he hid behind the library door. It had been her screams which had brought Sir William and the Colonel running to the scene of his last attempt to get into Wilkington Hall that morning but now her falsetto was working to his advantage.

Timing the creak of the French windows with her next outburst he slipped out onto the croquet lawn. The moon was nearly full and through the thin September mist he could clearly see the figure of the Colonel crouched over his workbench in the potting shed window.

'Now' thought Jackson 'Now we'll see what's the secret behind the blue pagoda'. He stole over to the shed darting between the lilac trees which fringed the lawn, conscious all the time that Sir William could at any moment tire of teasing his wife and burst out onto the lawn for his customary evening game.

As he reached the shed door he heard voices inside. The Colonel was not alone and Jackson quickly recognised the second voice as Inspector Claptrap's. Could the Inspector be caught up in this dastardly plot too? He inched open the door and drew his revolver from his pocket. 'Hands up Colonel, and you Inspector' he announced as the two conspirators looked up in surprise from the circuit board in front of them. 'The game's up and it's Parkhurst for the pair of you.'

'That's where you're wrong, Jackson' said a deep voice behind him. Jackson spun around — just in time to see the rolled-up copy of ETI as it hit him square between the eyes.

As he crashed to the ground he heard the stranger murmur '... handy thing, the February issue of ETI...'

Other uses for the February ETI include learning all about NICAM. John Linsley Hood reveals all about this stereo sound system for TV. We also start a major new project to build a complete stand-alone, intelligent plotter. First up is a versatile stepper motor drive board usable with most computers.

There's also the next part of the EPROM Programmer and the Quest-Ion ion counter to complement the Variat-Ion ioniser, not to mention a pet scarer *1st Class* project to humanely protect your flowerbeds.

Don't get caught in the potting shed, get the February ETI.

These articles are in an advanced state of preparation but the Colonel, Sir William or the Blue Pagoda may prevent publication and herald the end of freedom in the Western world.

**INTERBEEB**

**£49.95**

The Interbeeb unit connects to the BBC micro's 1MHz bus expansion connector and is supplied complete with its own power supply unit.

The interface unit is housed in a plastic case approx 4½x3x1in which contains the top quality double sided PCB and interface connectors.

- 8-bit input port
- 8-bit output port
- four switch sensor inputs
- four relay-switched 12V 1A outputs
- eight channel multiplexed analogue to digital converter
- precision 2.5V reference
- external power supply
- 15-way expansion bus

All sections of the interface are memory mapped in the 1MHz expansion map for maximum ease of use and compatibility with existing peripherals.

The expansion bus provides all the data and address/control signals for the addition of further DCP modules or home-built devices. All the information required for using additional devices is included.

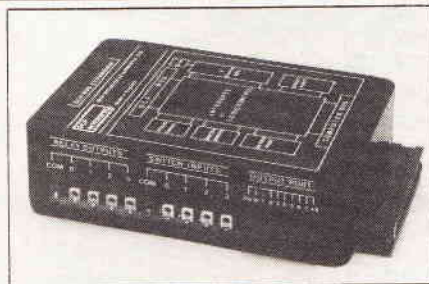

**INTERSPEC**

**£29.95**

The Interspec unit plugs directly onto the expansion edge connector of the Spectrum to provide a full range of interfacing facilities.

The unit is housed in a plastic case approximately 4½x3x1in which contains the top quality double sided PCB and interface connections.

- 8-bit input port
- 8-bit output port
- four switch sensor inputs
- four relay-switched 12V 1A outputs
- eight channel multiplexed analogue to digital converter
- 15-way expansion bus

All sections of the interface are I/O port mapped and designed for maximum compatibility with existing Spectrum peripherals. Power is supplied through the Spectrum edge connector.

The expansion bus provides all the data and address/control signals for the addition of further DCP modules or home-built devices. Connection is by multi-way PCB connector and all the information required for adding further devices is given.

**SPECIAL OFFER**  
FOR SPECTRUM AND BBC MICRO OWNERS

Now your computer can take control for an affordable price. These tried and trusted interfaces from DCP Microdevelopments are offered at **£20 off** the normal price.

Both units are extremely easy to use from both Basic and assembler/machine code and are supplied ready built and complete with all the documentation you need.

To order by post fill in the form below (or a copy) and send it with your remittance to  
**ASP READERS' SERVICES (RO ET5/6)**  
9 Hall Road, Maylands Wood Estate,  
Hemel Hempstead, HP2 7BH

Please make cheques payable to ASP Ltd. Overseas orders add £5 (Interspec) or £10 (Interbeeb) for airpost.

Access and Visa card holders can also place their order by phone on (0442) 41221 Allow 28 days for delivery.

Please supply ..... Interspecs (RO ET5) at £29.95 plus £1.95 p&p per order.  
Please supply ..... Interbeeb (RO ET6) at £49.95 plus £1.95 p&p per order.

Name .....  
Address .....  
.....  
.....

Please debit my ACCESS/VISA card  
No ..... to the sum of  
£ ..... Signed: .....

# RDS

Mark Saunders is the BBC's Development Manager for the Radio Data System and here explains the background to the system, the BBC implementation and possibilities for the future

In October the BBC launched a new radio service — the Radio Data System — or as it is more generally known RDS. RDS warrants an official launch as it marks the most significant development in radio technology and radio services since the introduction of the transistor thirty years ago which bred a new generation of portable radios.

Simply, RDS is a data signal added to the audio on VHF FM broadcasts carried by all major broadcasters throughout Europe. The data is used primarily for either display or control purposes at the listeners' radio sets (Fig.1).

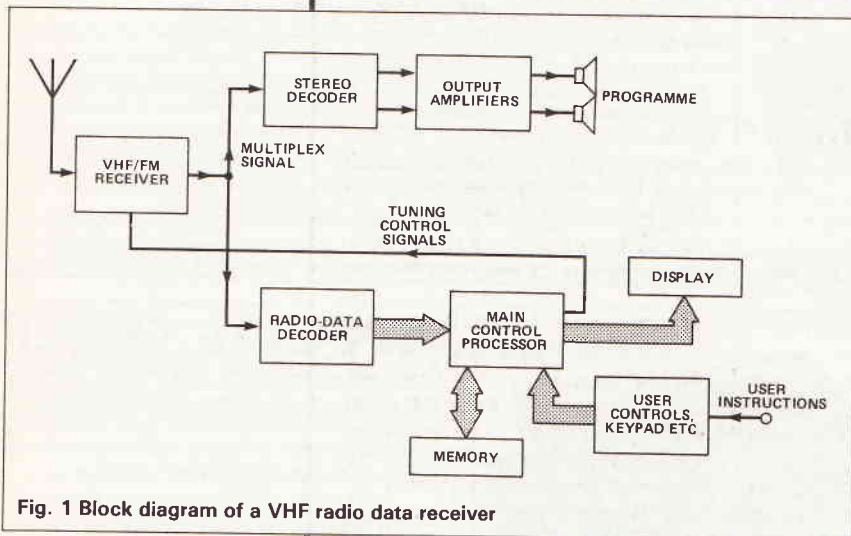
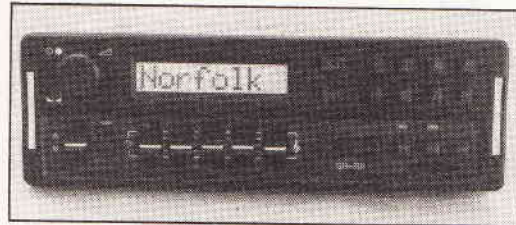

Fig. 1 Block diagram of a VHF radio data receiver

## Background

The Radio Data System has been the subject of development since the early 1970's when the European Broadcasting Union (EBU) charged a specialist technical committee to research and agree a common standard for subsidiary data broadcasting on FM band 2 for use throughout Europe. The three principal participants were the BBC Research Department, IRT (the German Broadcasters' Research Organisation) and the Research Group of Swedish Telecom Radio. The latter was chosen because of its considerable experience of adding data to FM broadcasts to run the MBS Paging service in Sweden.

The creation of a data format for use on conventional broadcasting creates unique problems. Most data transmission methods in non-broadcasting environments assume the terminal devices at each end of the data network are in fixed locations and under direct control of the data user, with a relatively predictable path. With data used to supplement a broadcasting service, the send equipment is under the control of the broadcaster but the receiver is controlled by the public who must be assumed to have no technical knowledge or ability.

As the data path is essentially one way only (from transmitter to receiver), there is no possibility of any handshaking between the receiver and transmitter to

verify correct reception of the data. In addition, whereas Teletext data is sent to TV receivers in fixed locations in the home which are usually fed with good fixed aerial systems, a large number of radio sets are used in cars where reception conditions will vary from minute to minute and will be entirely unpredictable. One moment the vehicle will be in a high signal strength area, the next it may be receiving in an area with severe multipath conditions.

The criteria for such a data system obviously creates problems not encountered in other areas and demands that the data format is very rugged.

The other problem to overcome is to ensure that any new service added to existing broadcasts does not in any way degrade reception of programmes on existing receivers, or at least not perceptively. There are about eighty million radio sets in the United Kingdom alone and billions worldwide. It is clearly unrealistic if the system chosen was to make these sets obsolete or in any way affect their performance.

The implication of this is that the data-stream needs to be sent at a considerably lower level than any audio signal, and must in some way be transmitted so as not to cause any undesirable audio effects. The need to send rugged data at a low level demands a very unusual data structure.

Extensive practical tests were carried out in varying terrains to evaluate which of several possible data structures carried on different sub-carriers at convenient gaps within the FM spectrum produced the desired combination of reliability of reception and lack of audio interference. The outcome was that the results favoured carrying the data on a 57kHz subcarrier (Fig.2).

This sub-carrier frequency is three times the 19kHz stereo pilot tone and is locked either in phase or quadrature to the third harmonic. A 57kHz sub-carrier is one that had been used successfully by the Swedish PTT for operating their paging system and also added to FM broadcasts in Germany for their traffic information system (ARI).

The normal deviation of the main FM carrier due to the unmodulated sub-carrier is  $\pm 2.0\text{kHz}$  which is a relatively insignificant proportion (approx 3%) of the entire transmitted signal. The sub-carrier is amplitude-modulated by the shaped and bi-phase-coded data signal, which results in the sub-carrier itself being suppressed. The basic data rate of the system is 1187.5 bits per second which can be obtained by dividing the transmitted sub-carrier frequency (57kHz) by 48.

## Base Band Coding

The largest element of the data structure is a 'group' of 104 bits which in turn comprises four blocks, each of 26 bits. Of these 26 bits, the first 16 (termed the information word) carry the data and the remaining 10 bits (checkword) provide both error protection and group and block synchronisation (Fig.4). This unusually high ratio of checkword bits: information bits to ensure a remarkably high degree of error detection and correction is possible. The error protection code will:

- detect all single and double bit errors in a block
- detect any single error burst spanning 10 bits or less
- detect about 99.8% of bursts spanning 11 bits and about 99.9% of all longer bursts.

In addition, the code is capable of correcting any single burst spanning five or less bits.

Several different types of group of 104 bits have been defined, each type carrying data for different

# RDS

applications according to the needs of the individual broadcasters.

The basic principles which underlie the message format and addressing structure are that:

- Messages which are most essential to the successful acquisition of data as a whole and which are required to be decoded regularly are repeated frequently and at a fixed position within every group. This ensures they can be decoded without reference to any block outside the one which contains the information.
- There is no fixed rhythm of repetition of the various type of groups allowing ample flexibility for broadcasters to interleave various features of RDS to suit their needs and also allowing for future developments and features to be added.
- Within any one group the mixture of different kinds of message is kept to a minimum. This is important because it allows broadcasters not broadcasting the Radio-Text facility, say, to omit the group types containing this information entirely. Capacity is not wasted by transmitting groups containing unused blocks, allowing groups containing the required features to be repeated more often.
- A number of group types remain undefined allowing for consequent future applications to be developed and awarded a group type of their own, for detection by later-generation receivers.

## Group Types And RDS Features

For ease of reference the individual blocks in each group are referred to as A, B, C and D. At present nine group types have been defined. Each group contains different combinations of the various RDS features. The features are:

- AF** Alternative Frequencies. The purpose of this data is to tell the radio receiver about other frequencies in the same and adjacent areas on which the same programme is also being broadcast.
- CT** Clock Time and Date.
- DI** The Decoder Information code informs a receiver of any audio processing being used by the broadcaster.
- IH** In-House. Used by the broadcaster for his own needs rather than for public reception.
- MS** This bit indicates simply whether the programme content is music or speech.
- ON** Other Networks Information. Enables a receiver tuned to one network to 'learn' what is happening on other stations in the area.
- PIN** Programme Item Number. This code uniquely identifies individual programmes on a station.
- PI** Programme Identification Code. This is a number comprising four hexadecimal digits which are allocated uniquely to each radio station. 'Programme' refers to what we in the UK would term a 'station'.
- PS** Programme Service Name. This feature provides an eight character alpha numeric display of the name of the station being received.
- PTY** Programme Type Code. Five bits used by broadcaster to label individual programmes (what we in the UK would call 'shows') according to their type or content.
- RT** Radio Text. Text messages of up to 64 characters can also be transmitted.
- TA** Travel Announcement. This bit is set only when a travel announcement is actually being spoken at that time. This bit is only used in conjunction with the TP bit.
- TP** Travel Programme. A single bit set on a station to indicate that this station carries travel messages for the local area.

The single most important feature of RDS is the PI code. This sixteen bit code is essential to ensure all other data is correctly referenced to the appropriate station. It is used by the microprocessor in the receiver and is never displayed to the listener. This code always appears as the 16-bit information word in Block A of each group type.

The 16 bits are represented as four hexadecimal digits, each having a special significance. The first indicates the country of origin of the transmission; in the UK this is a C. The second digit indicates the intended coverage area of the station — International, National, Regional or Local. The third and fourth digits are freely allocated by the broadcaster to ensure that no stations have identical PI codes.

Two other features of RDS require frequent repetition and hence occur in a fixed position in Block B of each group. These are the 5-bit PTY code and the single bit TP flag. These features, although less important than the PI code, are required to be received regularly as they are intended to cause rapid switching and returning within a receiver. A further 5 bits in Block B indicate the group type number and one of two possible variants. These bits allow the receiver microprocessor to identify which group type is currently being received and decode the data accordingly.

The remaining bits in Block B and Blocks C and D vary from group to group.

## Type 0 Group

One of the most attractive features of RDS is to inform a receiver of other frequencies for the currently received station within or adjacent to the transmitter service area. This information allows the receiver to compare the signal strength of the currently tuned frequency with those alternatives referenced in the RDS data. When an alternative provides an improved signal, the receiver will return to this alternative, whereupon it will begin to acquire a new list of alternatives from this transmitter.

Each alternative frequency referenced in this way requires eight bits, thus two alternatives are carried within Block C of this group as shown in Fig.5. Several repetitions of this group type are required for lists of several alternatives. The eight bits for each allow any of the 200 possible 100kHz spaced channels on FM band II to be referenced. The 56 remaining codes are

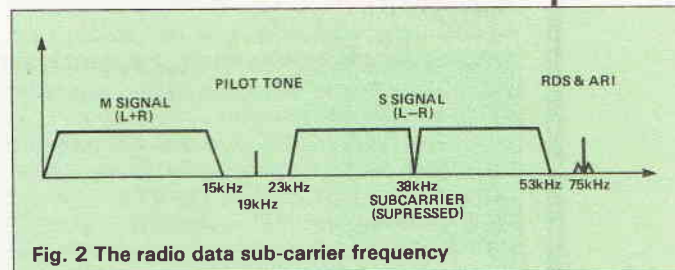

Fig. 2 The radio data sub-carrier frequency

Applications	Group types which contain this information	Recommended minimum repetition rate per second
Programme identification (PI) code	all	11
Programme service (PS) name	0A, 0B	1
Programme type (PTY) code	all	11
Traffic programme (TP) identification	all	11
Alternative frequency (AF) code	0A	4
Traffic announcement (TA) code	0A, 0B, 15B	4
Decoder identification (DI) code	0A, 0B, 15B	1
Music/speech (M/S) code	0A, 0B, 15B	4
Programme item number (PIN) code	1A, 1B	1
Radiotext (RT) message	2A, 2B	0.2

Table 1 Recommended transmission repetition rate for individual RDS features

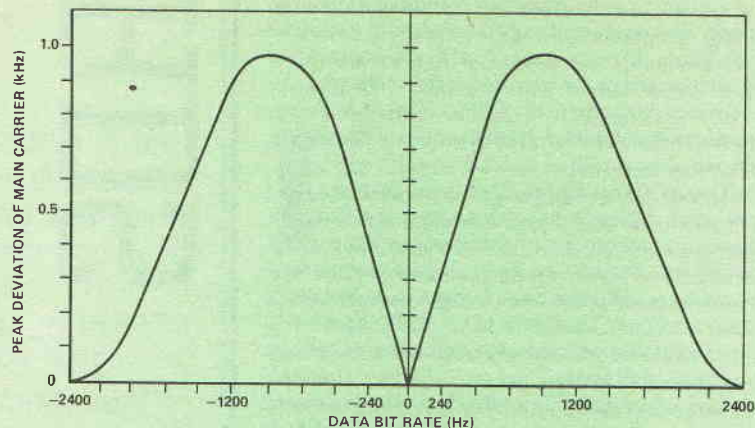

Fig. 3 The effect of the data bit rate on the carrier frequency deviation

used to indicate 25kHz offsets (although these are no longer used since the last Geneva band plan agreement) or to cross-refer to AM frequencies.

Block D of this Group Type provides for the receiver to display the name of the station. Two characters of the eight allowable for the Programme Service Name (PS) are sent at a time, completing the name in four successive transmissions of this block. Two bits in Block B indicate which pair of letters are currently being sent.

At the time of RDS development (which it must be remembered was in the mid 1970's) there was a degree of opposition to this feature because, although it was regarded as being an extremely useful feature, the display requirement was considered to be too expensive by the receiver manufacturers. Fortunately in the intervening years the costs of suitable displays has reduced significantly and although some receivers limit their display capability to numbers and upper-case characters only, others are capable of showing lower case and accented letters as well.

### Type 1 Group

The 16 bits comprising Block D in this group type are the PIN code or 'Programme Item Number' (Fig.6). This is a unique code number that identifies an individual programme on a radio station. The combination of the PIN and that station PI ensures a unique code for each specific programme, for at least a month. Five bits are used to indicate the day of the month, five bits indicate the hour (using the 24 hour system) and six bits give minute information.

This code reflects the scheduled starting time of the programme. The intention is that this code is sent at precisely the moment the programme to which it occurs begins transmission. This has obviously a considerable advantage over a simple time clock in the receiver which cannot take into account a programme starting either early or late, as many frustrated users of video recorders will have found to their cost.

### Type 2 Group

This group allows transmissions of text messages of up to 64 characters to accompany programmes (Fig.7). Typical applications of Radio Text would give extra detail about the currently transmitted programme, for example the programme title, the name and composer of the record currently being played or the telephone number to call to participate in a phone-in programme.

The text is free-format, so there is no limit to the text messages the broadcaster may choose to send (even adverts!). An impressive demonstration witnessed in Sweden was using Radio Text to sub-title a Mozart opera in English.

### Type 3 Group

These are intended for use for the Other Network (ON) information, potentially the most useful and exciting of RDS features as it allows receivers tuned to one station to learn what is happening on other stations. The group structure is shown in Fig.8.

As a national broadcaster with four national networks and a chain of local stations the BBC is amongst the first to recognise the importance and use of the ON features. This can best be demonstrated by illustrating a practical situation.

A motorist commences a journey from London to Manchester listening to Radio 2. His RDS car radio had identified that the best frequency for him while in the London area as 89.1MHz from the BBC Radio Two transmitter at Wrotham.

While the radio is tuned to Radio 2 and receiving a list of alternative frequencies via group 0 it is able to retune inaudibly to the best frequencies for Radio 2 on the journey to Manchester. Typically, the radio would retune six or seven times on the journey, finally settling on 89.3MHz, from the Holme Moss Transmitter.

Once in Manchester, the driver wishes to listen to Radio 4 to catch the latest happenings from Ambridge. The driver presses the button that he has previously allocated to Radio 4. Without Other Network information, the frequency stored behind this button was that of the London area transmitter (93.5MHz) as this was the last known frequency for Radio 4.

However, the required frequency in the Manchester area is 93.7MHz. In order to find Radio 4, the radio without ON will need to search the entire band looking for a PI code match corresponding to Radio 4, which would also have been stored along with the frequency, behind the Radio 4 button. This search could take several seconds.

However, a radio incorporating software to evaluate Other Networks information will be updated not only about the best frequency for the currently received station but all other stations referenced in the ON information carried within the type 3 group. Hence the driver arriving in Manchester and pressing the Radio 4 button will be instantly tuned to 93.7MHz. ON also provides the only way of achieving a realistic travel news service, capable of supplying local information to a motorist listening to a national radio broadcast and is the 'gateway' to other advanced features.

### Type 4 Group

Group 4 is used to transmit date and time information. The time information is expressed in terms of Co-ordinated Universal Time (UTC) using 11 bits, plus a further 5 for local offsets. The date information uses the modified Julian day system in which days are expressed as a single number in the range 0-99999, the receiver converting this to provide day, month and year information. This group is inserted in the data stream once per minute immediately preceding the minute edge (Fig.11).

It is expected that once this group has been received by the radio, the latter will be able to self-run and provide second information if required, and to maintain the clock within the receiver during periods when no RDS is being received (if the radio is returned to a station not carrying Time/Date information).

In the United Kingdom the reference for the RDS time information is from National Physical Laboratory 60kHz transmissions from Rugby received off-air at each transmitter site and then re-encoded into RDS format. In the event of a loss of Rugby transmissions (during maintenance periods for example) alternative sources are used automatically to maintain the service.

## Type 5 Groups

These groups are configured to carry a channel of what is termed 'transparent data'. As the name implies the channel is used purely as a data highway between the broadcaster and a receiver at a consumer's home or in the car. It may, therefore, be used for data at this relatively low data rate. The data itself is carried in blocks C and D of this Group Type, with five bits within block B being used to address the data to one of 32 possible peripheral devices (Fig. 10).

At the current stage of RDS implementation it is not believed that any broadcaster is using this feature as a service, but within the BBC there have been discussions about using this feature to send information sheets or teachers' notes to a computer-type printer to accompany schools broadcasts.

## Type 6 Groups

Group 6 information is not intended for reception by the general public and hence this group type should be ignored by domestic receivers. The unused bits in block B and all those in blocks C and D are free for unilateral assignment by an individual broadcaster for his own use. These so called In-House applications may be used for any purpose the broadcaster thinks necessary and could, for example, be used to control transmitter switching.

## Type 7 Groups

This group type was not defined in the original specification (published March 1984) and is an example of the expandability of the original format, in that this group type has only recently been standardised and added to the system. Group type 7 defines the way in which a paging service may be added within RDS.

Broadcasters in some countries have already adopted this feature with its attractive revenue-earning potential.

## Type 15 Groups

A final group type which was defined in the original specification is a type 15B group. It is intended that this group type is used to increase the repetition rate of the basic switching information contained in Blocks A and B of type 0 groups, without increasing the repetition

the service features he is offering. However, to ensure accurate reception of the features there is a recommended minimum repetition rate for transmission of each individual feature, which is shown in the Table 1.

Although the EBU specification was fully defined and published by 1984, as with any new broadcast development a willingness had to exist on the part of both the broadcaster and the receiver manufacturer to introduce the service. The problem is that no broadcaster feels justified in spending a large sum of money to develop and implement a service until there are receivers in the market to take advantage of the new service.

In a similar way no manufacturer is willing to spend money, time and effort in the research and development of receiver design until there are services available. This chicken and egg situation looked like occurring with RDS.

In 1985 the BBC and two or three other broadcasters resolved to solve this dilemma by guaranteeing a minimum public service of RDS using some of the basic features in an effort to stimulate the development of receivers.

RDS offers a wide range of features but realistically not all can be introduced from day one, across a country as complex and comprehensive in terms of broadcasting as the UK. The BBC carefully considered ways of introducing RDS as a phased programme. It made the general decision that initially the service offered should not rely upon heavy daily operational costs until the take-up of receivers had been established.

After careful examination of its own broadcasting structure it was also concluded that it was not possible to convert every single FM transmitter to carry RDS in a single phase, there being in excess of 300 transmitter installations required.

There appeared to be two possible routes. The first was to equip in its entirety across the UK one single network — for example Radio 2 — and then gradually add a second, third, fourth and then a Local Radio network to the system. This is the practice that has been adopted in other countries but it seemed to the BBC to lack a degree of logic for two reasons. Firstly, having spent money on a new radio, a listener would reasonably expect to find RDS on all services in their particular locality and secondly as the transmitters for the network services are co-sited, it makes sense to equip all services at a transmitter in a single visit, rather than make several visits to the same site to convert each service separately.

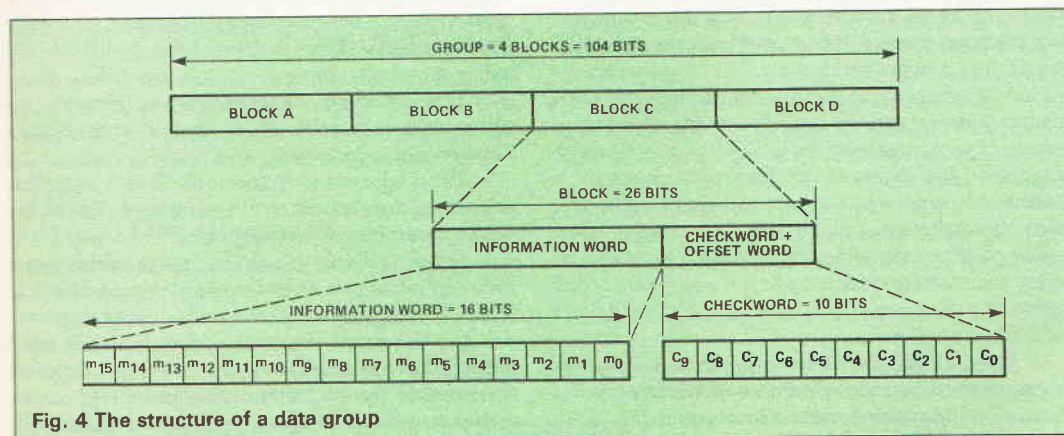

Fig. 4 The structure of a data group

rates of the other information within the type 0 group. Blocks C and D are simply repeats of Block A and B information.

## Data Stream Make-up

The entire data stream package comprises various groups according to the wishes of the broadcaster to suit

The conclusion of these deliberations was that the BBC planned to equip its RDS service on a geographical basis and to ensure that the maximum number of people could benefit as quickly as possible. About 75% of the United Kingdom population receive their radio services from transmitters in England which also has relatively few transmitters when compared to the number required for Scotland and Wales. England was

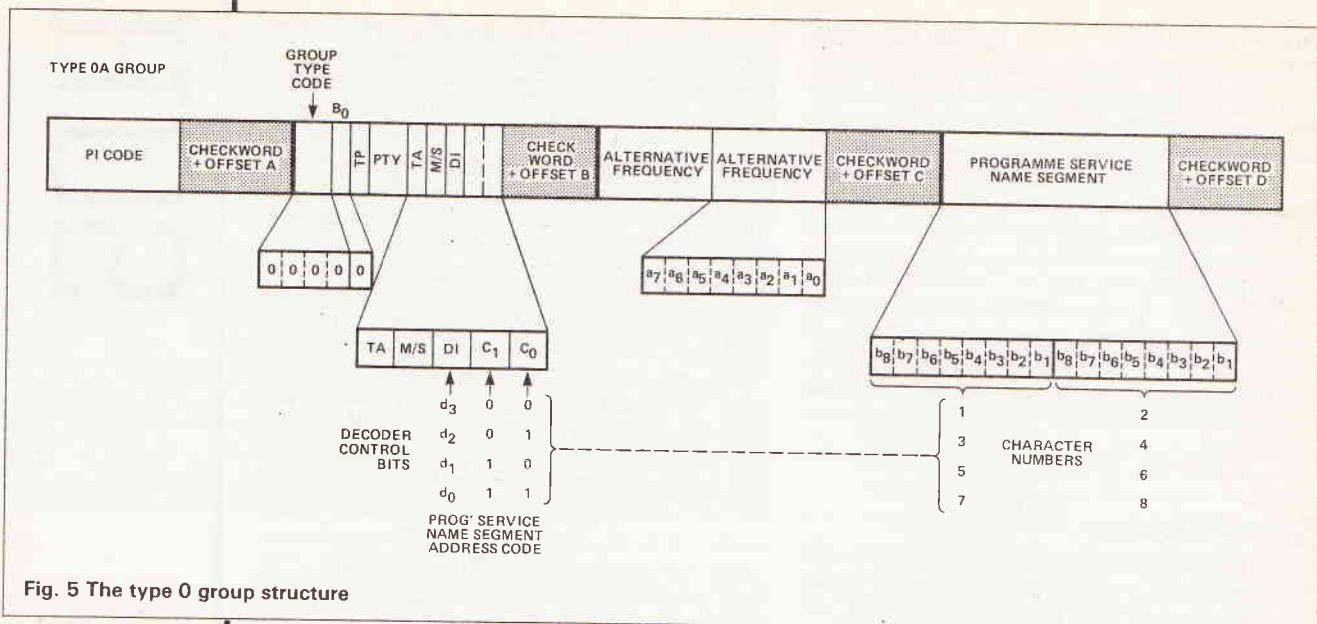

Fig. 5 The type 0 group structure

chosen therefore to form the first phase of installation with National services and Local Radio transmitters being equipped.

## Encoders

It is relatively easy to undertake an equipment installation programme if suitable equipment is available and its purpose well defined and predictable.

RDS was designed to be an expandable system allowing an initial simple implementation with a limited range of features and also for the possibility of adding others as the need arises. The BBC determined that its equipment and installation strategy should allow the transition to more complex applications without major re-engineering or equipment replacement. The requirements at each of the BBC's transmitter sites vary and there was an obvious advantage in keeping the number of encoder variations to the minimum.

When examining the market for suitable commercially-made encoder equipment the BBC found, perhaps not surprisingly, that no equipment meeting these parameters was already produced.

The BBC decided therefore that it would need to design and manufacture in-house. This proved to be a particularly farsighted decision as it gave the BBC the ability to react to the minor fine tuning of the specification that was discovered to be required after the design process had begun. The plan was for the BBC to equip all its English transmitter network by the beginning of September 1987. Due to the tremendous efforts of engineers from the BBC Design and Equipment and the efforts of the Transmitter installation teams, this target which earlier had looked optimistic was actually beaten. By July 1987, 98 separate transmitters were broadcasting five initial RDS features, a greater number than in the whole of the rest of Europe put together.

The encoders themselves are self-running and self supporting without any external input, the data coming from a PROM installed within each encoder unit. In this state they are capable of radiating the so called 'static' features of RDS. These are the PC code, the Programme Service name, the list of the Alternative Frequencies for that station and information about the frequencies for Other Networks.

The fifth feature, Clock Time and Date, although it is dynamically changing information, is static in the sense that it is derived at the transmitter site without the need for external data links.

These five features formed the basis of the first phase of RDS implementation and in themselves offer a considerable improvement for listeners, particularly those listening on FM in the car. The range of Band II FM VHF signals, unlike their AMMF and LF counterparts, is typically 40 miles radius as far as National Network transmitters are concerned. To cover the entire United Kingdom with just one service, over a 100 transmitters and 22 different frequencies are used.

The static RDS feature allows the automatic retuning of a car radio to the best available frequency for the required service, together with a confirmation of the service being received via the programme service name. The time feature, as well as ensuring that the clock in the car is always accurate, takes care of the biennial Winter/Summer time switch and also eliminates the need to have to reset the clock after the garage has obligingly disconnected the battery during car service. On a continental motoring holiday, this is the one clock that won't need adjusting as you cross time-zones.

Before more advanced service features of RDS can be introduced, there is a requirement to be able to change the radiated data to make it relate to transmitted programmes.

Programmes for the four National Networks are controlled from Broadcasting House, London, so RDS also needs to be controlled from this location and fed to the encoder units.

The audio for the programmes is distributed to the transmitters via the BBC NICAM system which also has the capacity to carry data.

To achieve dynamic control of RDS, a computer addressing the encoder units and taking an input from desk-top terminals was required.

Broadcasting is a somewhat specialised environment in that there is a need to maintain a service at all times. This is generally achieved by having duplicate sets of all essential equipment and duplicate feeds throughout. The failure of any one single item therefore doesn't affect the transmitted programme and a series of failures, provided they are within different parts of the system, similarly do not cause any problems.

RDS was seen as having no lesser priority than the audio and from the outset two sets of encoder equipment had been installed at network transmitters. At Broadcasting House there was a need for the central computer to be backed up by a second computer to maintain this duplication of essential equipment. At the time that decisions were being made concerning the choice of computer system for this task, DEC were

RDS



beginning to market a pair of PDP/11 computers arranged such that one computer was a hot standby for the other. This configuration ensured that if a on-line computer was to fail, an automatic changeover to the stand-by was achieved instantly.

## Travel News

With the computer installation decided, the BBC undertook market research to establish which of the more advanced 'dynamic' features now possible should be adopted first. It soon became apparent that the enhancement of the travel service provided by the BBC was seen by the listener and manufacturer as being a real added advantage and one that the listener would be prepared to pay a small price premium to receive.

Two features within RDS — TP and TA — emulate the German ARI system, allowing a quick method of searching for a local station by looking for a data stream with the TP bit set 'on'. Once having found an appropriate station, the switching on by the broadcaster of the TA bit will increase the radio volume or cause a switch over from in-car cassette or CD listening back to radio. This straightforward system, however, is not desirable for either the broadcaster or the listener. In order to hear Travel News, the listener is forced to listen to a particular station which may not be to their taste, and if this is the case, listeners will turn off the radio and listen instead to pre-recorded music.

The BBC recognised the considerable potential for improvement by combining the TP and TA feature with the 'Other Network' information carried by a National Network.

The data carried in the ON information already informs the radio of the frequency for the Local Radio station in the area but can also inform the receiver at the precise moment that a local radio station switches on the TA flag. This arrangement allows the listener to have his choice of BBC national or local radio station, with the radio retuning away from the national service to the local radio only for the period of a travel announcement. This is seen as having the potential to provide the most sophisticated travel service ever provided by a broadcaster as it effectively provides local travel news while listening to a national station (Fig. 11).

The practical implementation of this feature is not simple to achieve, as every local radio studio scattered around England needs to be connected back to the central RDS computer in London to change the ON data at the national network transmitters, and also to their own local transmitters to switch on the TA flag.

Although some saving in line installation has been achieved by some innovative techniques, it will still take two or more years before this service could become nationwide. The intention is to field-trial this feature on five stations as the first phase of this development.

## System Development

The original EBU specification outlines only the data

structure both broadcasters and receiver manufacturers must follow to take advantage of RDS. It does not attempt to influence the design of either the broadcasters' hardware or the receiver manufacturers' equipment.

With any new standard, it is inevitable that those who wish to exploit it first are required to learn and develop the best methods of meeting the standard. RDS proved to be no exception and a couple of examples illustrate this point.

The original EBU specification had allocated eight addresses for Other Networks information. It would not be illogical to imply from this that 8 other networks was considered to be the maximum that could need referencing. As the BBC soon discovered, in the case of, for example, services from the Holme Moss transmitter near Manchester, references need to be made to four national networks and five or six Local Radio services. The BBC took a lateral approach to the problem and reasoned that the same ON address need not always reference the same other network. It was quite in order to send information about one network and simply increment the ON address reference by one, before sending information about another network.

Using this philosophy there is no limitation to either the maximum or minimum number of other networks that could be referenced, and the receiver still had sufficient information to make intelligent use of the data.

A second example of decisions taken only when into the engineering test phase of RDS concerned the PI code itself. A problem can exist if the broadcaster does not clearly think how he is to allocate them to his services.

Take as an example the common practice throughout Europe of a service being available as a national service during parts of the day but at other times being split into several regional variations. While the transmitter chain is configured as a national network it is desirable that each individual transmitter should radiate the same PI code, allowing the automatic retuning between transmitters intended by the system.

On the other hand when the network splits into regional variations, they should not continue to radiate the same PI code, as a mobile receiver in a car between the service area of one region and the next would suddenly find the programme material changed as the radio discovered a stronger signal from a transmitter with the same PI code. In the overlap area where signal strengths from two adjacent regions are nearly equitable the receiver is likely to cycle several times between the two different programmes from adjacent regions.

This clearly is highly undesirable and the preferred solution would be to arrange that the PI code will change when a regional split occurs. As outlined above few countries in Europe have the necessary data infrastructure to effect dynamic changes of this sort. There was a need to solve this dilemma by allocating PI codes for all transmitters that could allow an appropriate

# RDS

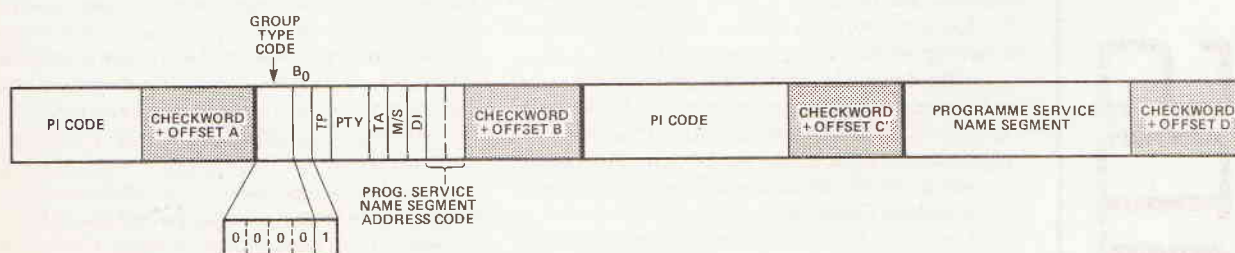
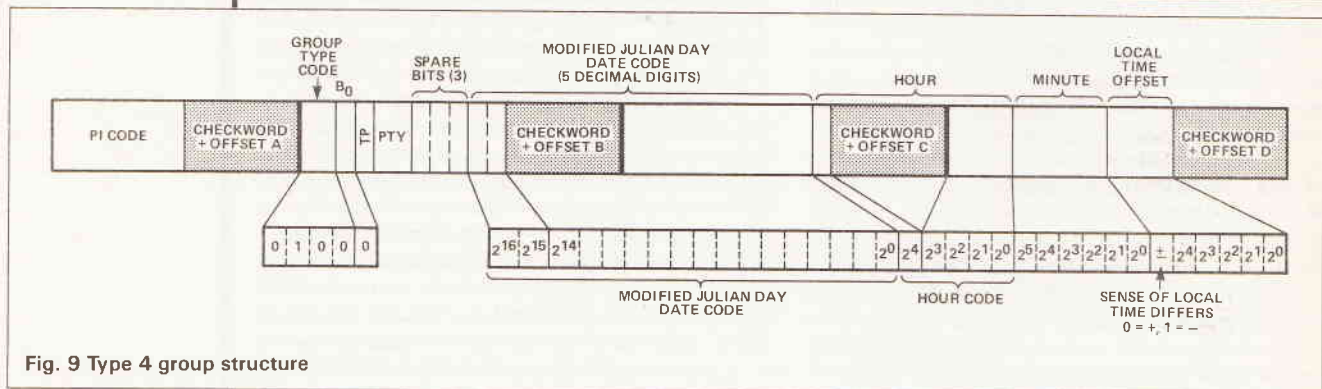
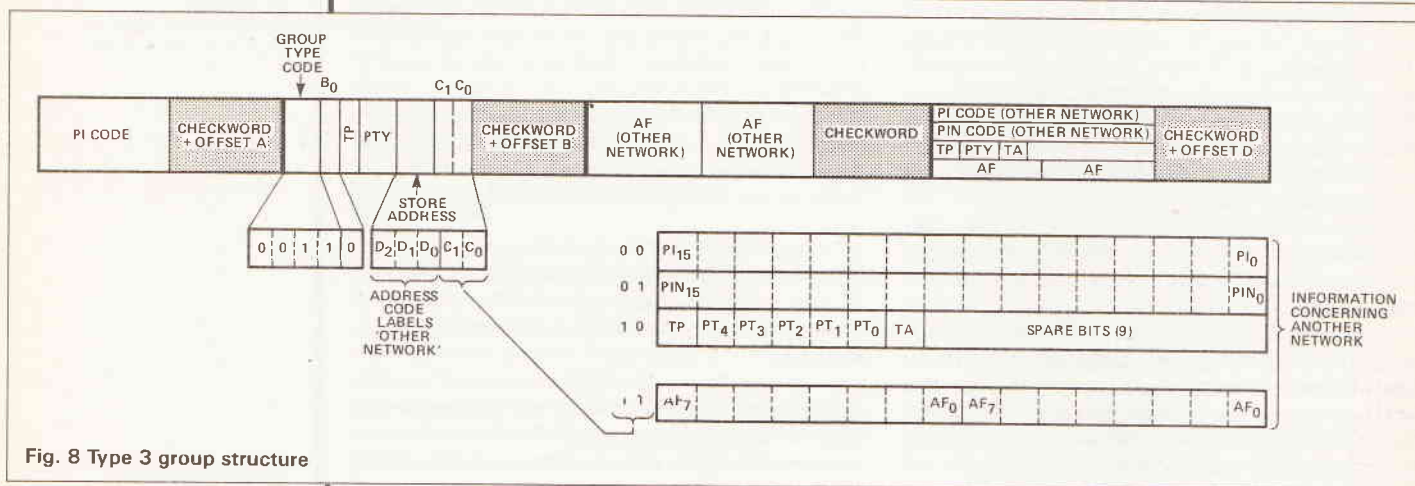
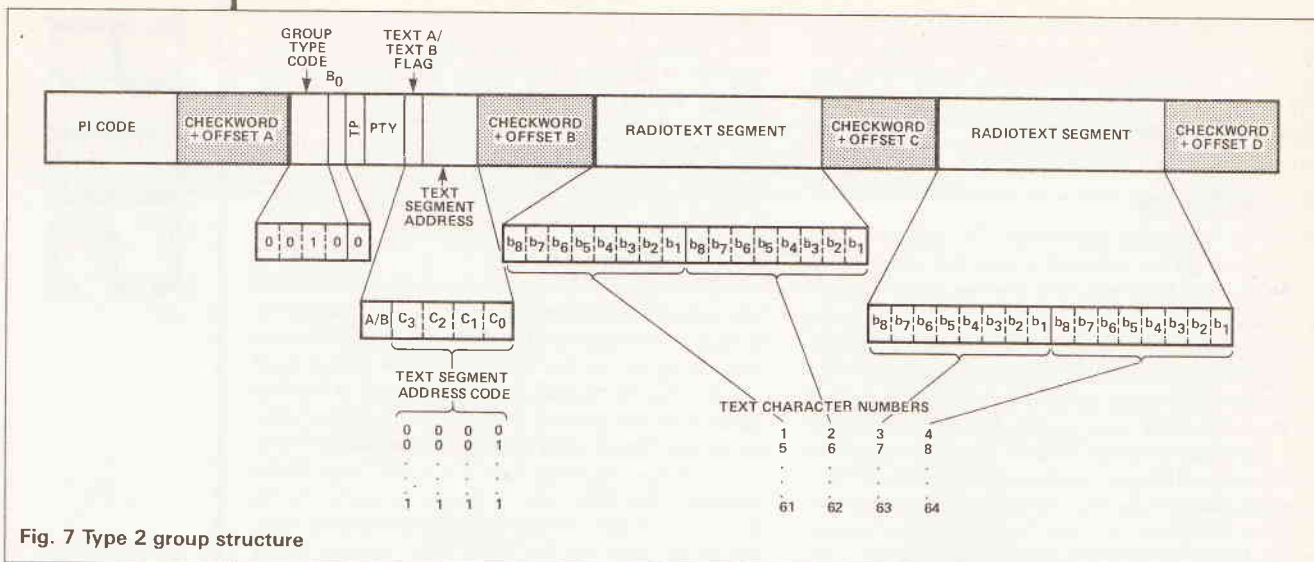

Fig. 6 Type 1 group structure



# RDS

solution at the receiver end.

Although this problem does not exist for the BBC, which does have the ability to change PI codes when regional splits occur, the solution has enabled a further attractive feature to be introduced for BBC Local Radio listeners.

In practice this means that the PI codes allocated to each of the BBC Local Radio stations are almost identical, varying only in the second of the four hexadecimal digits.

When a receiver is beginning to lose the signal strength from the currently received transmitter and can find no better signal within its AF list, the radio tries to find a better signal by doing an inaudible search for another occurrence of the same PI code. If this search fails, it then does a second level search this time looking for PI code that matches only in the 1st, 3rd and 4th digits, treating the second digit as a wild card.

If a match is made this time, the receiver knows this station is not identical in programme content to the

current one but is a similar station in style, content and presentation to the current. The frequency of this new station is loaded into the memory behind the original push button used to select the first BBC local station. When the listener decides that the audio quality has deteriorated sufficiently that he no longer wishes to listen to the station, a press of the same pre-set, will select the next local radio station geographically.

To extend initial RDS Features to the remainder of the UK is just a matter of time. To a large extent this process is inevitably slow, each new installation adds ever smaller audiences to RDS as the more remote areas are reached but if all goes well, this should be completed during 1990.

While this installation work is going on, the best ways of using the more advanced features of RDS will be determined. The BBC's installation has meant that the Radio Text, Programme Item Number and Programme Type code information can be transmitted on all of the BBC's national services. Tests using these

features are already occurring, ready for manufacturers to develop their sets to this level of technology.

## The Future

Development will continue for the foreseeable future. The system was designed to be 'future proof' allowing the addition of new features and new facilities by defining a new group type as the need was identified. On the horizon a particularly attractive further enhancement to information for motorists is likely to become part of the system within the next decade.

Several companies are already developing on-board navigation systems for cars. These in general rely upon an on-board computer which is loaded with a nation-wide map of the road network. Dead reckoning or other techniques pin point the precise location of the vehicle and it only remains for a driver to state his destination to allow the computer to quickly advise the best route for the journey. The short-coming of this system as it stands is that this does not take account of prevailing road conditions and hold-ups or temporary

the receiver is able to reconstruct the message which can then be output via a number of devices. A driver switching on his ignition in the morning may well be presented with a 'rip-and-read' printed summary of the travel problems still relevant to his area. On route this information is likely to be provided to him by a voice synthesiser.

The unique advantage to messages handled in this way is that the message does not have to interrupt existing programmes and because the language structure has been agreed throughout Europe, a motorist driving abroad will receive the message in his own native tongue.

Before this can become a reality there is clearly much to be done in finalising the vocabulary required and creating suitable code numbers to cover every possible location throughout Europe, as well as the not inconsiderable work to collect and then transmit the information. Although altogether an awesome task this is well within the capability of the Radio Data System and is just a foretaste of things to come.

# RDS

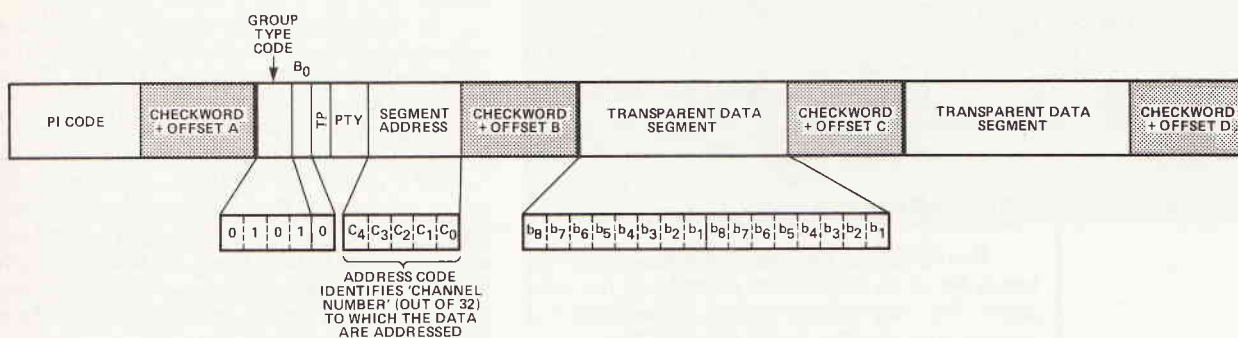

Fig. 10 Type 5 group structure

road closures.

RDS is likely to provide the means to update dynamically the on-board information to take account of the prevailing conditions.

A second future application of RDS will allow pre-coded traffic announcements to be carried to the motorist. A European-wide vocabulary of all likely road traffic messages is being compiled. Each individual phase relating to a traffic problem: cause, effect, location, direction of travel, advice, and expected duration of the problem is assigned a code number. By transmitting a sequence of code numbers an entire message may be quickly built up. In the motorist's car,

## Acknowledgements

The Author acknowledges the help of his BBC colleagues involved in RDS and in particular Managing Director Network Radio for his permission to publish this article.

## References

Specifications for the Radio Data System RDS for VHF/FM Sound Broadcasting, European Broadcasting Union, Tech 3244



- 1 Police learn about an accident in the Ashford area of Kent on the M20.
  - 2 They tell BBC Radio Kent of the incident using conventional means.
  - 3 Just prior to reading the travel announcement, BBC Radio Kent pressed a button which is communicated via a data link to Broadcasting House, London and the RDS Central Computer.
  - 4 The computer changes instructions to the network transmitter at Wrotham which serves the West Kent area. The RDS data from the network services (Radios 2, 3 and 4) is altered which in turn will inform an RDS radio that Radio Kent is to carry a travel announcement.
  - 5 The transmitter at Swinggate near Dover which serves East Kent relays the same RDS information received from Wrotham transmitter.
  - 6 A suitable RDS radio in a car will switch over to the Local Radio Service to receive news of the accident.
- A typical first generation RDS car radio (the Volvo SR-701). This particular model responds to PI, PS, AF, CT, TP and TA features of RDS.

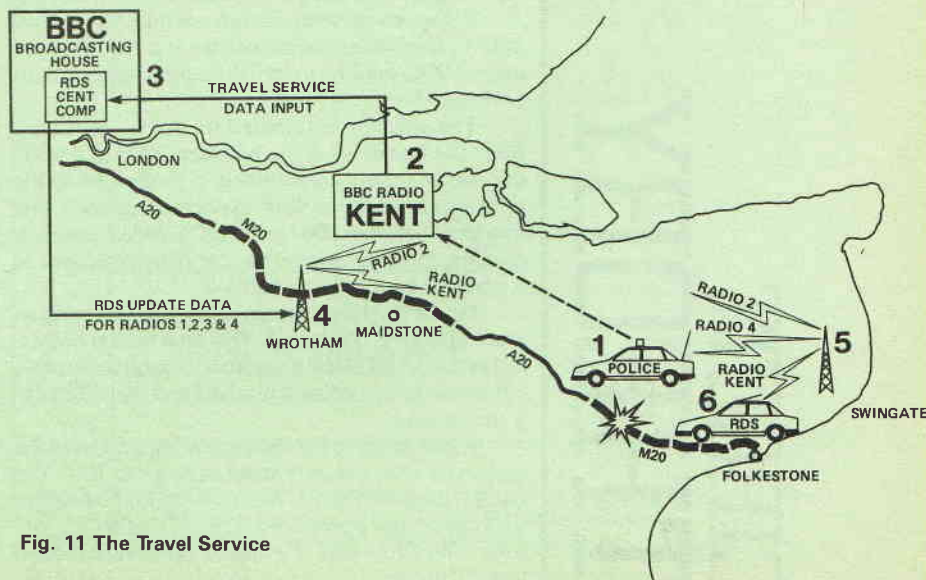

Fig. 11 The Travel Service

# OP-AMPS

Paul Chappell continues to cook up op-amp oven control circuits and finds there's much to be gained from errors

Continuing last month's investigation of temperature controllers, without further ado I'll give you an improved version. It's shown in Fig. 1. If you remember, we were trying to improve the performance of the controller by sensing how far it was from its target and using this error signal to increase or decrease the current to the heater, with the aim of making it respond more quickly to changes in the set temperature and sit more firmly at the proper temperature when outside influences tried to change it.

heater current will change very quickly indeed to restore it. It also means that if the set point is changed, the heater will spend more time with either zero or full power, so reaching the new temperature as quickly as possible.

Yet another advantage concerns a question I raised last month. Where will the temperature stabilise if the oven is placed in a draught (or moved to the land of the Eskimos or the Zulus?). Unless the heater is under-powered and couldn't sustain the proper temperature even with the full 20A or unless the temperature of the surrounding air is higher than the set-point, the temperature must stabilise somewhere in the proportional band, no matter where the oven is placed. With a  $\pm 100^\circ\text{C}$  proportional band as in Fig. 2b, the temperature could be anywhere within this region.

By narrowing the proportional band as in Fig. 2c, we've reduced the maximum error to  $\pm 10^\circ$  and if we increase the gain still further to 1000 (Fig. 2d), the maximum error is now only  $\pm 1^\circ$ .

There's just one last change I'd like to make to the control system. If you think about it, the controller covers the full range of heater currents within a  $2^\circ\text{C}$  band. This band has to be very close to the set point because otherwise the amplified error signal would be so large that it will swamp any other signal the controller can come up with. So what would happen if the 'sustaining current' output from the set-point box was removed? Not a lot!

The revised circuit is shown in Fig. 3a and the effect on the action of the controller in Fig. 3b. The proportional band has dropped so that it's entirely below the set-point (because if it ever reached the set point the error, and therefore the heater current, would be zero). We have to face the sad fact that this system can never hit the selected temperature spot-on but on the other hand we can still make the error as small as we please by increasing the error amplifier gain. It seems a small price to pay for getting rid of the awkward, non-linear output from the set-point box.

## A Postcard Home

We've come a fair distance now but where are we exactly (and what are we doing here)? Looking back over the journey, we started out with a control system which was working blind. It had no way to check on the results it was achieving and so couldn't correct for any errors or disturbances that upset its workings. This kind of affair is called an *open-loop* system (control theory is a very metaphysical discipline which sees every string of components as a potential loop, if only someone would join the end back to the beginning!)

Another open-loop system is shown in Fig. 4a. Here the thing that is being controlled is the op-amp's own output voltage and since it can't 'see' it, it doesn't make a very good job of it. Inside the IC, one transistor passes on the signal to the next and the slight drifts and errors introduced by each stage accumulate so that the output is a very poor attempt at an amplified version of the input.

To improve the temperature controller, our first step was to take a reading of the output (the oven temperature) and feed it back to compare with the input. The way we decided to use this *feedback* was to oppose any deviation of the output from the set point. If the temperature fell, the error signal would rise and vice versa. Feedback which opposes any

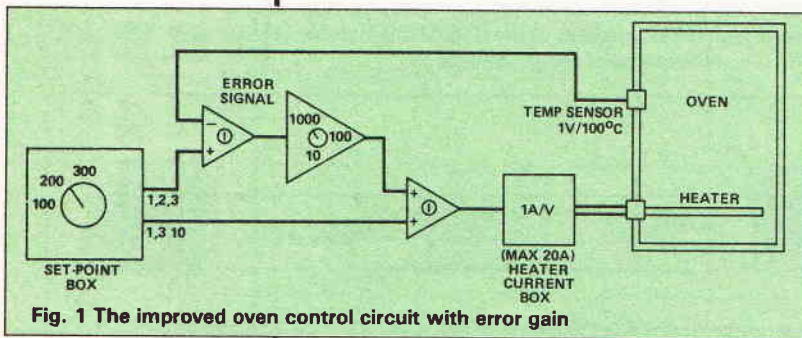

Fig. 1 The improved oven control circuit with error gain

The addition to the system, which we have high hopes for, is an amplifier to multiply up the error signal. The odd looking triangle with a knob is a variable gain amplifier which does just that.

Let's set the amplifier gain to 10, the temperature set-point control to  $300^\circ\text{C}$ , and turn the system on. The oven is initially at room temperature and the temperature sensor will be giving an output of about 200mV (assuming room temperature is about  $20^\circ\text{C}$ ) so the error signal will be about 2.8V. This is multiplied up to 28V by the amplifier and added to the 10V output from the set-point box which gives the heater the current it needs to sustain the set temperature once it reaches it, giving a total of 38V. This goes into the heater current box and since it gives a maximum of 20A, the heater will be full on.

The heater will remain full on until the oven temperature reaches  $200^\circ\text{C}$  at which time the amplified error signal will begin to fall below 10V and the current will decrease. At  $300^\circ\text{C}$  the heater will be receiving the 10A needed to sustain the temperature.

If the oven temperature should rise above  $300^\circ\text{C}$ , the heater current will fall at a rate of 1A for every  $10^\circ\text{C}$ , tending to let it drop more quickly to its set level.

The situation is summed up in Fig. 2a. Below  $200^\circ$  the heater is full on, between  $200^\circ$  and  $400^\circ$  the heater current correction is in proportion to the error signal and above  $400^\circ$  the heater current is zero. The band between  $200^\circ$  and  $400^\circ$  is called, naturally enough, the proportional band and the technique as a whole is 'proportional control'.

Figure 2b shows the situation where a temperature of  $200^\circ\text{C}$  is selected. This time the set point is not in the centre of the proportional band (why not?) but the set temperature is reached and maintained in a similar way.

A gain of ten to the error signal has improved the system no end, so how's about setting it to 100? The result is shown in Fig. 2c. We now have full power right up to  $290^\circ$  and a proportional band that is only  $20^\circ$  wide. The advantage of a narrow proportional band is that if the temperature strays from its set value, the

CIRCUIT THEORY

# CIRCUIT THEORY

straying of the output from the required value is called *negative feedback*.

Applying feedback results in a loop. In Fig. 3a it goes: subtractor — error amplifier — heater current supply — heater — oven — temperature sensor — and back to the subtractor again. The controller is now a *closed loop* system. We also discovered that the forward part of the loop (in Fig. 3a, the error amplifier, heater current supply and heater) can be activated by the error signal alone. The need for a certain steady heater current is accommodated by the loop with very little change in accuracy.

The benefits of negative feedback appear to be that you can make the temperature as accurate as you like by increasing the amount of feedback (that is, by increasing the loop gain), that outside influences have very little effect on the temperature and that the inherent non-linearity of the open-loop system (the 1-3-10 curve of heater current needed for linear temperature increases) is absorbed by the feedback loop, so it's no longer necessary to measure the exact characteristics of the actual heater and oven used.

So how does all this relate to op-amp circuits? Have a little more patience with me and you'll see! For a start, take a look at Fig. 4b. Let's suppose we're making a sample and hold circuit and that C1 is to be the capacitor that holds the sampled voltage. We'd like it to follow the input pretty smartly so that when the hold signal comes along it will have an accurate sample of the input voltage.

With the circuit as it stands, if the input voltage is moving slowly the capacitor will follow it quite well. If it moves quickly, the capacitor voltage will lag behind and for a very fast moving signal it would be just as good to guess at the voltage as to rely on what the capacitor says!

Let's see if we can put together a feedback loop to improve the performance of the circuit. Following exactly the same procedure as for the temperature controller I'll take a signal representing the output (the voltage across C1) and since it's already in the form of a voltage I'll just use the output itself. This voltage is subtracted from the input to form an error signal (which will be zero if the output and input are at the same voltage — the situation we're aiming for). The error signal is amplified and applied to R1 and C1 (Fig. 4c). Let's see if it works.

Suppose the input voltage and the voltage across the capacitor are both initially at 0V. The input then steps up to 1V and we'd like the voltage across the capacitor to do the same. The error signal will start off at 1V and the error amplifier will step this up to . . . 100V? Probably not! Let's suppose it has an output voltage swing of  $\pm 15V$ .

At first the output will be at +15V (full power if you like) and C1 will charge at the highest possible rate. When it gets to within 150mV of its target, the amplified error voltage will begin to fall at 1V for every 10mV rise in output. The circuit is in its proportional band.

The voltage across C1 will eventually settle a little less than 10mV below the 1V 'set point'. Can you see why it won't settle at exactly 1V?

The same kind of diagram can be drawn as for the temperature controller (Fig. 4d). The circuit has areas of operation analogous to the full power, proportional and minimum power bands of the control circuit. Can you see why the set-point is right in the middle of the proportional band for this circuit and above it for the temperature controller? (What if the amplifier could only give an output in the range 0 to  $\pm 15V$ ? Or if the oven heater was a Peltier device which could cool the oven down if the current was reversed?)

With the circuit of Fig. 4c, it appears once again

that increasing the loop gain will bring about all manner of good things. If the gain is increased to 1000, the capacitor will charge at its maximum rate all the way up to 985mV and the voltage will settle to within 1mV of the input. If you imagine that the circuit is following a changing voltage instead of aiming for a fixed one, this will work well too. The slightest difference between input and output will quickly supply a voltage to push charge in or out of the capacitor, and as the input gets further away from the output, the voltage increases to enable the capacitor to keep up. If the input gets as far as 15mV away from the output, the capacitor will be following as fast as it possibly can and only if the input moves faster still will the circuit run into difficulties.

In Fig. 4c, the error amplifier is an op-amp, and since it has a subtractor built in there's no need for a separate device to perform this function. In theory, if the op-amp has a voltage gain of  $10^5$ , the output

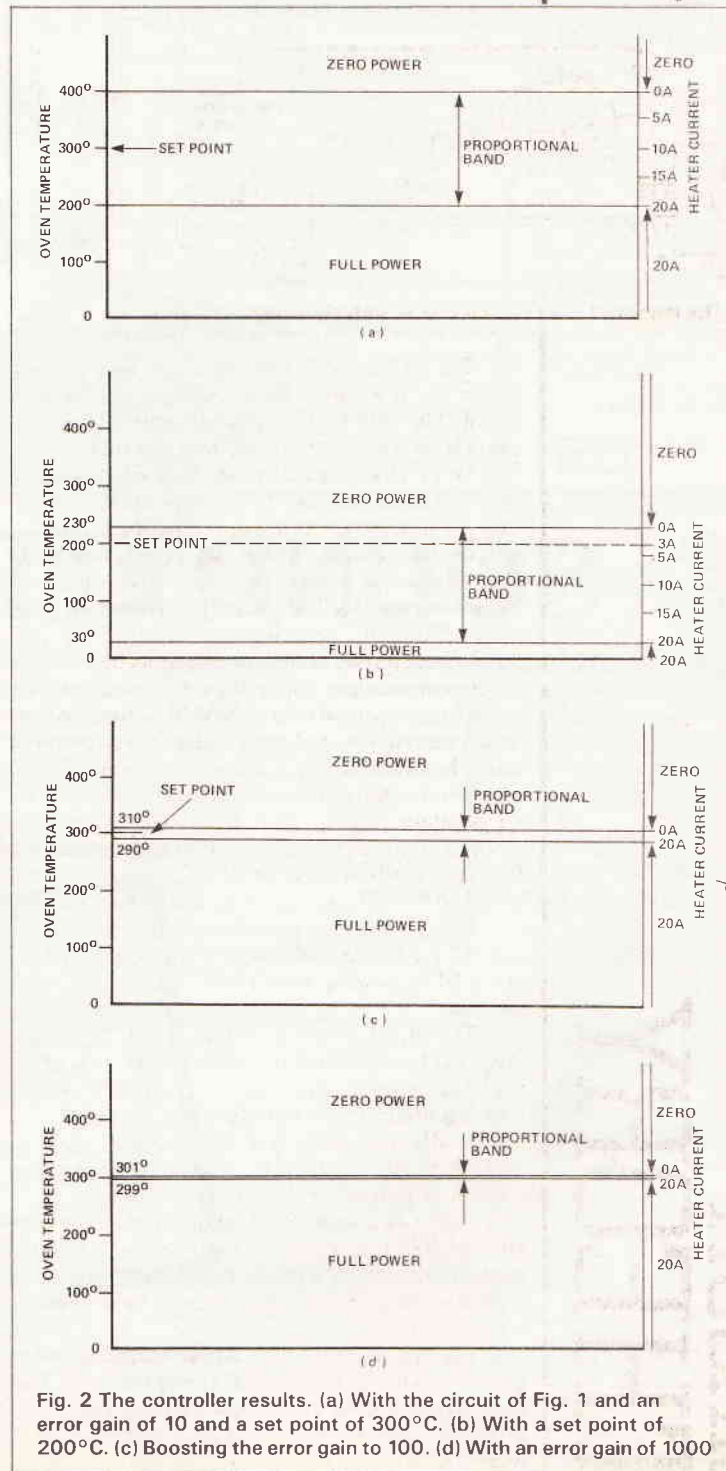

Fig. 2 The controller results. (a) With the circuit of Fig. 1 and an error gain of 10 and a set point of 300°C. (b) With a set point of 200°C. (c) Boosting the error gain to 100. (d) With an error gain of 1000

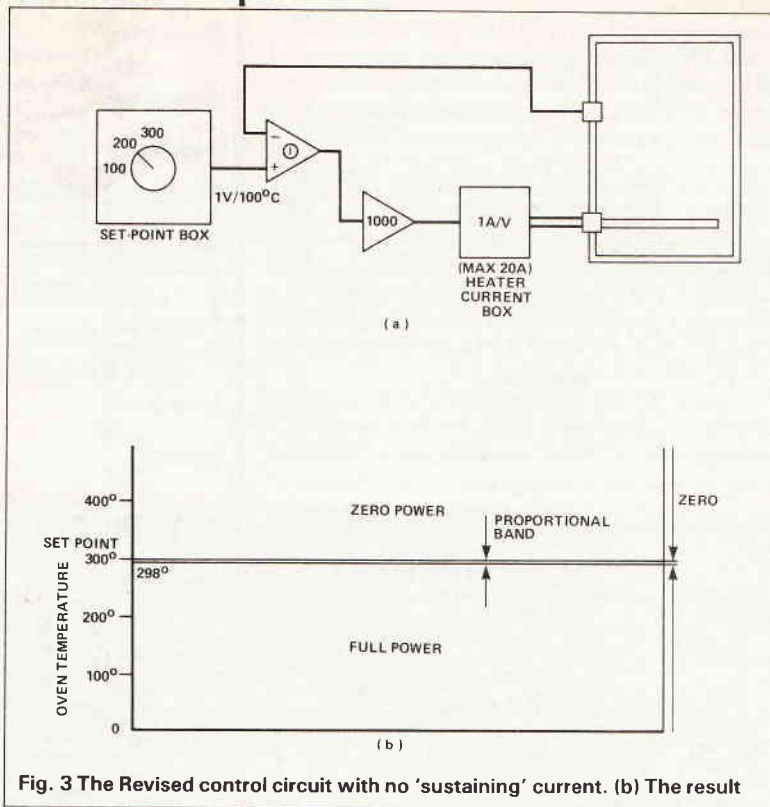

Fig. 3 The Revised control circuit with no 'sustaining' current. (b) The result

should settle within about  $10\mu\text{V}$  of the input but in practice the op-amp's subtractor isn't always up to scratch — remember input offset voltages? It should charge the capacitor pretty smartly, though.

So far we've only seen the good side of negative feedback but it has a dark side too. Next month we'll

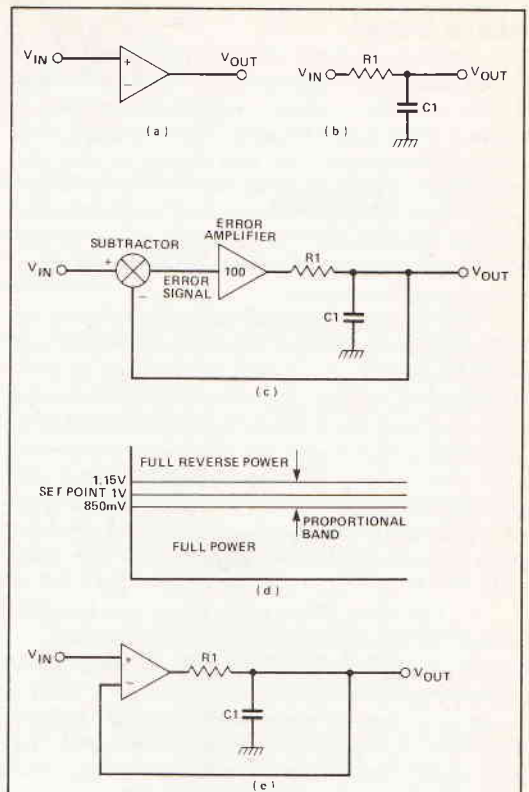

Fig. 4 (a) A simple open loop op-amp circuit. (b) An open loop sample-and-hold circuit. (c) Applying feedback. (d) The results. (e) The real circuit

see some of the problems it can cause and how to cope with them.



# SPECIAL OFFER SOUND EFFECTS SPECIAL OFFER

ETI has teamed up with ITRON UK to bring you this microprocessor-controlled programmable sound effects generator at a bargain price. The Sound-FX generates all manner of preset sound effects suitable for stage, toys, games or just for fun, plus it can be programmed to produce more musical sounds from the keyboard.

The Sound-FX comes ready to assemble with a sturdy console type case, two loudspeakers, pushbuttons for the keyboard and the all-important ready-made PCB containing the custom microprocessor and amplifier. The kit just needs soldering together and the addition of a PP3 battery to create a wide variety of sounds.

Please send me . . . . . Sound-FX complete kits at £11.99 each plus 95p postage.

I enclose a cheque for £ . . . . . made out to ITRON UK.

Name . . . . .

Address . . . . .

. . . . .

. . . . .

Postcode . . . . .

Send your order to:  
 ETI ITRON Offer  
 1 Golden Square  
 London W1R 3AB  
 Please allow 28 days for delivery

Normally costing nearly £14, the complete Sound-FX kit is available to ETI readers for just £11.99



Steam train & whistle  
 Helicopter  
 Electronic fly  
 Police Car  
 Foghorn

Trimphone  
 UFO  
 Rally car  
 Alien speech

and much more!

## POWER CONDITIONER

FEATURED IN ETI  
JANUARY 1988

The ultimate mains purifier. Intended mainly for lowering the noise floor and improving the analytical qualities of top-flight audio equipment.

The massive filter section contains thirteen capacitors and two current balanced inductors, together with a bank of six VDRs, to remove every last trace of impulsive and RF interference. A ten LED logarithmic display gives a second by second indication of the amount of interference removed. Our approved parts set consists of case, PCB, all components (including high permeability toroidal cores, ICs, transistors, class X and Y suppression capacitors, VDRs, etc.) and full instructions.

PARTS SET **£28.50** + VAT

Some parts are available separately. Please send SAE for lists or SAE + £1 for lists, circuit, construction details and further information (free with parts set).

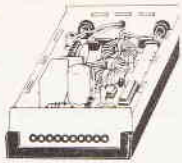

## KNIGHT RAIDER

FEATURED IN ETI JULY 1987

The ultimate in lighting effects for your Lamborghini, Maserati, BMW (or any other car, for that matter). Picture this: eight powerful lights in line along the front and eight along the rear. You flick a switch on the dashboard control box and a point of light moves lazily from left to right, leaving a comet's tail behind it. Flip the switch again and the point of light becomes a bar, bouncing backwards and forwards along the row. Press again and try one of the other six patterns. An LED display on the control box let's you see what the main lights are doing.

The Knight Raider can be fitted to any car (it makes an excellent fog light!) or with low powered bulbs it can turn any child's pedal car or bicycle into a spectacular TV age toy!

The parts set consists of box, PCB and components for control, PCB and components for sequencer board, and full instructions. Lamps not included.

PARTS SET **£19.90** + VAT

## RAINY DAY PROJECTS



All can be built in an afternoon!

**JUMPIN' JACK FLASH** (ETI March 1988) Spectacular rock, stage and disco lighting effect! **£6.90** + VAT

**CREDIT CARD CASINO** (ETI March 1987) The wicked pocket gambling machine. **£5.90** + VAT

**MAINS CONTROLLER** (ETI January 1987) Isolated logic to mains interface. **£6.20** + VAT

**MATCHBOX AMPLIFIERS** (ETI April 1986) Listen! 50W of Hi-Fi power from an amo small enough to fit in a matchbox!

Matchbox Amplifier (20W) **£6.50** + VAT

Matchbox Bridge Amplifier **£8.90** + VAT

L165V Power Amplifier IC with data and circuits **£3.90** + VAT

**TACHO/DWELL METER** (ETI January 1987) Turn your Metro into a Porsche! **£16.40** + VAT

**HI-FI POWER METER** (ETI May 1987) Measures Hi-Fi output power up to 100W. Includes PCB, components, meters.

Main power meter **£3.90** + VAT

Stranded power meter **£7.20** + VAT

## THE DREAM MACHINE

FEATURED IN ETI  
DECEMBER 1987

Adjust the controls to suit your mood and let the gentle relaxing sound drift over you. At first you might hear soft rain sea surf or the wind through distant trees. Almost hypnotic, the sound draws you irresistibly into a peaceful, refreshing sleep.

For many, the thought of waking refreshed and alert (or perhaps the first truly restful sleep in years) is exciting enough in itself. For more adventurous souls there are strange and mysterious dream experiences waiting. Take lucid dreams for instance. Imagine being in control of your dreams and able to change them at will to act out your wishes and fantasies. With the Dream Machine it's easy!

The approved parts set consists of PCB, all components, controls, loudspeaker, knobs, lamp, fuseholders, fuse, mains power supply, prestige case and full instructions.

PARTS SET **£16.50** + VAT

AVAILABLE WITHOUT CASE FOR ONLY **£11.90** + VAT



## THE MISTRAL AIR IONISER

The best ioniser design yet - this one has variable ion drive, built-in ion counter and enough power to drive five multi-point emitters. For the technically minded, it has nine main drive stages, five secondary drives, and a four section booster to give an output capability of almost fifteen billion ( $1.47 \times 10^{11}$ ) ions every minute, or  $2.45 \times 10^{11}$  ions per second. With extra emitters this can be increased still further!

**PARTS SET** **£24.80** + VAT

The parts set includes case, printed circuit boards, 126 top grade components, all controls, lamps, hardware, a multi-point phosphor-bronze emitter and full instructions.

Some parts are available separately - please send SAE for lists, or SAE + £1 for lists, circuit and construction details and further information (free with parts set).

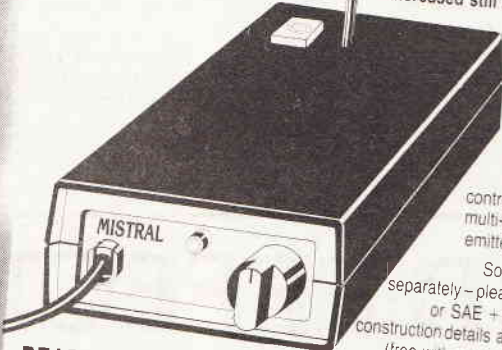

## READY-BUILT MISTRAL

The Mistral Ioniser (and most of our other projects) can now be supplied built, tested and ready to go. For details, please contact Peter Leah at P.L. Electronics, 8 Woburn Road, Eastville, Bristol BS5 6TT. Tel: 0272 522703.

## INTERNAL EMITTER **£2.69** + VAT

Can be used in place of the P-B external emitter, or both can be used together for the highest ion output. Parts set includes PCB, ion emitters, components and instructions.

## IPA BOARD CLEANER

**£0.98** - VAT

Essential for removing grease and flux residues from the Mistral PCB to achieve peak performance. Applicator brush supplied.

## ION DISPERSION METER

**£16.40** - VAT

A hand-held test meter to check ion levels in your room and output of any ioniser. Parts set available January 1989 onwards.

## MAINS CONDITIONER

FEATURED IN ETI  
SEPTEMBER 1986

Cleans up mains pollution easily and effectively. You'll hardly believe the difference in your Hi-Fi, TV, Video, and all other sensitive equipment.

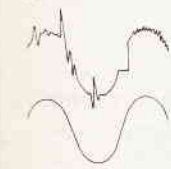

PARTS SET **£4.90** + VAT

RUGGED PLASTIC CASE **£1.65** + VAT

## POWERFUL AIR IONISER

FEATURED IN ETI  
JULY 1986

Ions have been described as vitamins of the air by the health magazines and have been credited with everything from curing hay fever and asthma to improving concentration and putting an end to insomnia. Although some of the claims may be exaggerated, there is no doubt that ionised air is much cleaner and purer and seems much more invigorating than dead air.

The DIRECT ION ioniser caused a great deal of excitement when it appeared as a constructional project in ETI. At last, an ioniser that was comparable with (better than?) commercial products was reliable, good to build, and fun! Apart from the serious applications, some of the suggested experiments were outrageous! We can supply a matched set of parts, fully approved by the designer, to build this unique project. The set includes a roller impedance printed circuit board, 66 components, case, mains lead and even the parts for the tester! According to one customer, the set costs about a third of the price of the individual components. What more can we say?

Instructions are included

PARTS SET WITH BLACK CASE **£11.50** + VAT

PARTS SET WITH WHITE CASE **£11.80** + VAT

## LM2917 EXPERIMENTER SET

Consists of LM2917 IC, special printed circuit board and detailed instructions with data and circuits for eight different projects to build. Can be used to experiment with the circuits in the Next Great Little IC feature (ETI, December 1986).

LM2917 EXPERIMENTER SET **£5.80** - VAT

## LEDs

Green rectangular LEDs for bar-graph displays  
50 for **£3.50** 500 for **£25**  
100 for **£6** 1000 for **£45**

DIGITAL AND AUDIO EQUIPMENT LEDs  
Assorted 3mm LEDs: red, green, yellow and orange  
25 of each (100 LEDs) for **£6.80**

U.K. orders: please add 80p post and packing and 15% VAT to total.  
Euro and overseas: no VAT. Carriage and insurance **£4.50**.  
Please allow up to 14 days for delivery.

*Specialist*  
**SEMICONDUCTORS**  
LIMITED

SALES DEPT., ROOM 107, FOUNDERS HOUSE, REDBROOK, MONMOUTH, GWENT.



FEATURED IN ETI  
AUGUST 1988

There's nothing quite so encouraging as having a quantifiable result to show for your training efforts. If you are not particularly fit, your resting heart rate will be around 80 beats per minute. As your jogging, aerobic or sport strengthens your heart, the rate will drop dramatically - possibly to 50bpm or less. With the S101, you can watch your progress day by day.

Breathing is important, too. How efficiently do you take up oxygen? How quickly do you recover from oxygen debt after strenuous activity? The S101 will let you know.

The approved parts set consists of: case, 3 printed circuit boards, all components (including 1T, 1C, quartz crystal, 75 transistors, resistors, diodes and capacitors), LCD switches, plugs, sockets, electrodes, and full instructions for construction and use.

PARTS SET **£33.80** - VAT

Some parts are available separately. Please send SAE for lists or SAE + £2 for lists, circuit, construction details and further information (free with parts set).



## ARMSTRONG 75W AMPLIFIER

FEATURED IN PE  
JULY 1988

A.J. Armstrong's exciting new audio amplifier module is here at last!

Delivering a cool 75W (conservatively rated - you'll get nearer 100W), this MOSFET design embodies the finest minimalist design techniques, resulting in a clean, uncluttered circuit in which every component makes a precisely defined contribution to the overall sound. You can read all about it in the July issue of PE, but why bother with words when your ears will tell you so much more?

Parts set includes top grade PCB and all components

SPECIAL INTRODUCTORY PRICE FOR FULLY UPGRADED MODULES.

SINGLE PARTS SET **£14.90** + VAT

STEREO PAIR **£25.90** + VAT  
Please send SAE + £1 for data and circuits (free with parts set), including diagrams for matching pre-amp and power supply. This amplifier will not be available from your usual audio supplier - we produce the only designer approved parts set.

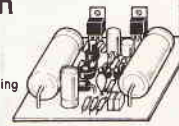

## BIO-FEEDBACK

FEATURED IN ETI  
DECEMBER 1986

Bio-feedback comes of age with this highly responsive, self-balancing skin response monitor! The powerful circuit has found application in clinical situations as well as on the bio-feedback scene. It will open your eyes to what GSR techniques are really all about.

The complete parts set includes case, PCB, all components, leads, electrodes, conductive gel, and full instructions.

PARTS SET **£13.95** + VAT

BIO-FEEDBACK BOOK **£3.95** (no VAT)

Please note the book, by Stern and Ray, is an authorised guide to the potential of bio-feedback techniques. It is not a hobby book, and will only be of interest to intelligent adults.



## BRAINWAVE MONITOR



FEATURED IN ETI  
AUGUST 1987

The most astonishing project ever to have appeared in an electronics magazine. Similar in principle to a medical EEG machine, this project allows you to hear the characteristic rhythms of your own mind! The alpha, beta and theta forms can be selected for study and the three articles give masses of information on their interpretation and powers.

In conjunction with Dr. Lewis's Alpha Plan, the monitor can be used to overcome shyness, to help you feel confident in stressful situations, and to train yourself to excel at things you're not good at.

Our approved parts set contains case, two PCBs, screening can for bio-amplifier, all components (including three PM precision amplifiers), leads, brass electrodes and full instructions.

PARTS SET **£36.90** + VAT ALPHA PLAN BOOK **£2.50**

SILVER SOLUTION (for pairing electrodes) **£3.60** + VAT  
Parts set available separately. We also have a range of accessories, professional electrodes, books, etc. Please send SAE for lists, or SAE + £2 for lists, construction details and further information (free with parts set).

# LANGUAGE LESSON

Mike Barwise takes a look at the range and types of programming languages available to designers of micro-processor based projects

**H**aving looked on various occasions at microprocessors, input and output devices and other microcomputer hardware, I think the time has come to examine software — the bit that makes all the hardware more useful than a hi-tech doorstep.

By software we mean the user program: a sequence of instructions which cause the microsystem to arrive at a given result. This instruction sequence always consists of machine op-codes. We will later examine high level languages but it is absolutely crucial to remember that regardless of the language you write

indirectly controls the internal data path and active elements of the microprocessor (CPU).

Although the codes are relatively unmemorable, they are far from arbitrary (though a lot of popular authors have suggested they are). If you knew which bit of the op-code controlled which internal element of the CPU, you would see a consistent pattern (similar functions use similar bit patterns). A simple illustration of the mechanism of control was given in my resumé of the discrete ALU using multipliers (ETI January 1988).

Each op-code is brought into the CPU in turn together with any parameters associated with it and the bit patterns are used to control multiplexers (an over-simplification of course) which pass data to various manipulating elements.

Having got this fundamental straight, let us look at methods of programming.

## Levels And Languages

The most commonly quoted terms are *high* and *low level*. Low level languages are those in which you need to know (and are kept aware of) the structure of the individual CPU hardware you are using. These really amount to machine code assemblers. In the old days (15 years ago!) you had to program CPUs by directly keying in the op-codes in sequence. This caused a significant evolutionary change in Homo Sapiens in California — creating a mutant breed of hairy human that could only communicate in hexadecimal number notation.

The world of computing has not yet recovered entirely from this ecological catastrophe but the invention of the assembler was a significant contribution to the cure. The assembler substitutes a relatively memorable alpha-numeric *mnemonic* for each op-code and latterly provides additional control features called directives, which facilitate the coding operation. The source code of an assembler is inevitably longer than the machine code it generates so your typing job is a big one!

The advantage of low level programming is the control which the programmer has over the end product. Critical timing constraints can be met and a high efficiency of execution attained. The trade-offs are increased programming time and comparatively heavy testing burdens, due to the difficulty of tracing

```
10 MODE3
20 VDU14
30 VDU2
40 VDU1,27,1,69,1,27,1,71
50 C=OPENIN("EPROM")
60 FOR A%=0TO&1FFF STEP 16
70   IFA%=&06C0 A%=&1F00:PTR#C=&1F00
80   IFA%=&1F90 A%=&1FF0:PTR#C=&1FF0
90   A$="000"
100  IFA%>&F A$="00"
110  IFA%>&FF A$="0"
120  IFA%>&FFF A$=""
130  PRINT;A$;~A$;" ";
140  FORI%=1TO16
150    D%=BGET#C:IFD%<&10PRINT;"0";
160    PRINT;~D%;" ";
170  NEXT
180  PRINT
190  NEXT
200 CLOSE#0
210 VDU3
220 END
```

Fig. 1 A BBC Basic program as seen on the screen — in full ASCII

a program in, the end product which the microsystem executes is a sequence of machining op-codes.

What is an op-code? That's very simple (although many people have been misled into thinking it's not). An op-code is a binary bit pattern which directly or

CHIP IN

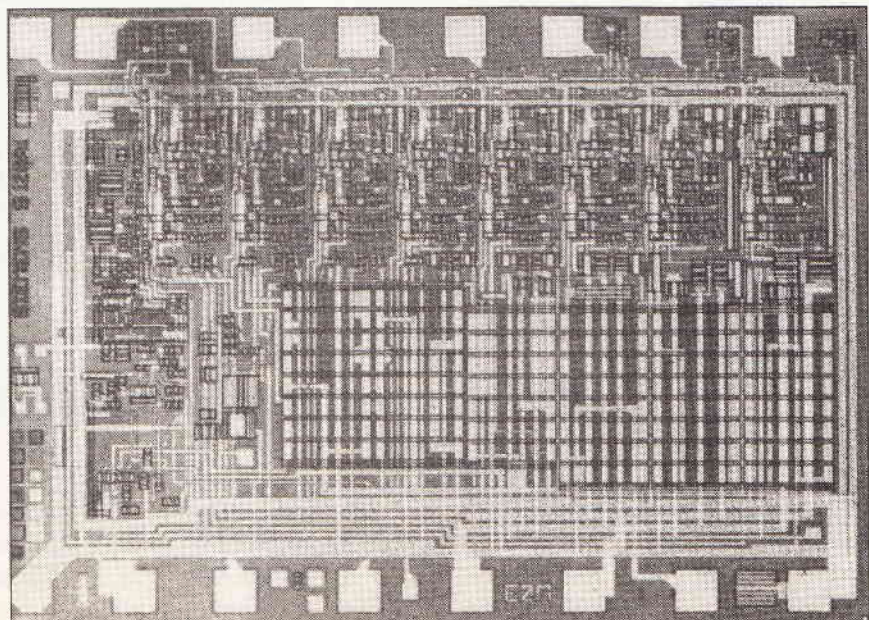



errors without a pre-defined check environment (more of this later).

High level languages are basically methods of programming where you need not be aware of (and have no control over) the exact sequence of op-codes at any given point in the program. You work instead in terms of larger entirely pre-coded routines. This means someone else has done most of the work for you. For example, instead of laboriously coding a 32-bit division each time you need it, you can call a routine known by a human readable name (which will vary according to the language you are using) which will eventually execute a division in machine op-codes.

Obviously, this is quicker and less error-prone when you are writing the program but it is frequently ignored that you are entirely at the mercy of the guy who wrote the machine code you are calling. This can be efficient or far from it, depending on the quality of the language package you are using.

The actual (quite small) amount of typing you have to do to create the source code (the human readable input to the programming system) usually bears very little relation to the size of the resultant executable program. An example of this is a Fast Fourier Transform written in C by a colleague of mine, which consisted of only about 35 lines of source code.

### Compile Or Not Compile?

Both compilers and interpreters are high level language conventions but they differ in their method of operation. The most familiar type of high level language is the *Interpreter*. This includes BASIC and FORTH. The main point about an interpreted language is that it is quick to write in and debug but executes relatively slowly.

Quite simply, an interpreter is a method of program execution which uses your source code as a run time list of routines for execution. A special piece of permanently resident machine code in the micro (called a command line interpreter in the case of BASIC) scans the program from start to finish and every time it succeeds in resolving a command which is acceptable, it looks up the entry address of the relevant machine code routine and goes to it.

This means between each command and its successor, some time out is taken to interpret the new command. This obviously slows things down (especially when a command may consist of three to eight characters) so various people have considered ways of speeding things up. The first major breakthrough was in FORTH, which was originally expected to control real world mechanical systems, albeit slow ones.

The problem facing FORTH was that although it came with a limited set of commands (the *primitives*) which were to execute fast, you can define new commands consisting of routines built out of the primitives, further commands built out of your first commands and so on.

The resulting nest would have executed excessively slowly if the ASCII commands were all interpreted at execution time, so instead of this an interpreted *Intermediate Code* is generated, which consists of a list of literal entry points of the routines to be executed. However, this left a problem to the designers of FORTH. Any parameters associated with routines are normally entered with the routine calls to allow the programmer to remain sane. A separate list of parameters would be impossible to cross reference reliably.

The address list has no provision for parameters, so something else has to be done. The answer is the *stack*. The stack is an area of memory set aside for parameters and has one major peculiarity. It is

addressed by a *pointer* rather than directly. This is a counter (stored in a special memory location) which points to the next sequential location at all times. Data can only be read from the stack in the reverse order to that in which it was written.

As you type in a FORTH program, user parameters are placed on the stack as they are encountered. They are ready for the relevant routines to access them when the program is running.

An alternative approach was used by the inventors of BBC BASIC. This followed from a previous Acorn BASIC which was a conventionally scanned ASCII source code. To speed up the execution phase, the BBC BASIC input control program substitutes a *token* (a single byte code) for each command word *as you type in the program*. Thus the record in memory or on disk consists of a sequence of tokens instead of a sequence of human readable command words.

This token list is interpreted at run time as before but each command is only one character (plus any parameters) in length which speeds up interpretation.

The next step is to look at compilers and I will discuss these next month, together with some more detail on internal mechanisms of code generation and testing.

# CHIP IN



1900	0D	00	0A	06	EB	33	0D	00	.....3..
1908	14	07	EF	31	34	0D	00	1E	...14...
1910	06	EF	32	0D	00	28	18	EF	..2..(..
1918	31	2C	32	37	2C	31	2C	36	1,27,1,6
1920	39	2C	31	2C	32	37	2C	31	9,1,27,1
1928	2C	37	31	0D	00	32	10	43	,71..2.C
1930	3D	8E	28	22	45	50	52	4F	=.( "EPRO
1938	4D	22	29	0D	00	3C	15	E3	M")..<..
1940	20	41	25	3D	30	B8	26	31	.A%=0.&1
1948	46	46	46	20	88	20	31	36	FFF...16
1950	0D	00	46	21	E7	41	25	3D	..F!A%=
1958	26	30	36	43	30	20	41	25	&06C0.A%
1960	3D	26	31	46	30	30	3A	CF	=&1F00:.
1968	23	43	3D	26	31	46	30	30	#C=&1F00
1970	20	0D	00	50	20	E7	41	25	...P..A%
1978	3D	26	31	46	39	30	20	41	=&1F90.A
1980	25	3D	26	31	46	46	30	3A	%=&1FF0:
1988	CF	23	43	3D	26	31	46	46	.#C=&1FF
1990	30	0D	00	5A	0C	41	24	3D	0..Z.A\$=
1998	22	30	30	30	22	0D	00	64	"000"..d
19A0	12	E7	41	25	3E	26	46	20	..A%>&F.
19A8	41	24	3D	22	30	30	22	0D	A\$="00".
19B0	00	6E	12	E7	41	25	3E	26	.n..A%>&
19B8	46	46	20	41	24	3D	22	30	FF.A\$="0
19C0	22	0D	00	78	12	E7	41	25	"..x..A%
19C8	3E	26	46	46	46	20	41	24	>&FFF.A\$
19D0	3D	22	22	0D	00	82	12	F1	=" ".....
19D8	3B	41	24	3B	7E	41	25	3B	;A\$;~A\$;
19E0	22	20	20	22	3B	0D	00	8C	"..";...
19E8	0C	E3	49	25	3D	31	B8	31	..I%=1.1
19F0	36	0D	00	96	18	44	25	3D	6....D%=<
19F8	9A	23	43	3A	E7	44	25	3C	.#C:.D%<
1A00	26	31	30	F1	3B	22	30	22	&10.;"0"
1A08	3B	0D	00	A0	0E	F1	3B	7E	;.....;~
1A10	44	25	3B	22	20	22	3B	0D	D%;".";.
1A18	00	AA	05	ED	0D	00	B4	05	.....
1A20	F1	0D	00	BE	05	ED	0D	00	.....
1A28	C8	07	D9	23	30	0D	00	D2	...#0...
1A30	06	EF	33	0D	FF	00	00	FE	..3.....

Fig. 2 The same BBC Basic program as held in memory — tokenised for compactness and speed

# FREE ISSUES

A subscription to your favourite magazine is the best way of making sure you never miss an issue.

And from now until 28th February 1989 you can get extra copies ABSOLUTELY FREE, by taking advantage of our special Christmas subscription offer. With a monthly title for example, this means you get 15 issues for the usual price of 12.

Order your subscription today using the coupon below and you will receive the best in reading entertainment right into the 1990's! This offer is also open to subscribers wishing to extend/renew their current subscriptions.

## Standard subscription rates ▶▶▶

### Monthly titles (15 for the price of 12)

	UK	Europe	Middle East	Far East	Rest of World
A & B Computing	£18.00	£27.30	£27.60	£31.10	£28.30
Aeromodeller	£23.40	£28.20	£28.40	£30.20	£28.70
Antique Clocks	£27.00	£32.40	£32.60	£34.70	£33.00
Citizens Band	£16.80	£20.70	£20.85	£22.35	£21.10
Electronics Today International	£18.00	£22.20	£22.40	£24.00	£22.70
Ham Radio Today	£16.80	£21.30	£21.50	£23.20	£21.80
Military Modelling	£16.80	£23.60	£23.85	£26.45	£24.30
Model Boats	£16.80	£21.20	£21.30	£23.00	£21.60
Model Railways	£15.00	£20.90	£21.10	£23.30	£21.50
Photography	£15.00	£22.00	£22.30	£25.00	£22.80
Photoplay	£13.20	£17.90	£18.10	£19.90	£18.40
Popular Crafts	£18.00	£23.30	£23.50	£25.40	£23.80
Radio Control Model Cars	£16.20	£21.10	£21.30	£23.10	£21.60
RCM&E	£15.60	£21.60	£21.80	£24.00	£22.20
Radio Modeller	£15.60	£21.20	£21.40	£23.60	£21.80
Scale Models International	£16.20	£20.80	£21.00	£22.70	£21.30
Video Today	£15.00	£20.20	£20.40	£22.30	£20.70
Which Video?	£15.00	£19.40	£19.50	£21.20	£19.80
Woodworker	£16.80	£24.00	£24.20	£26.90	£24.70
Your Commodore	£15.60	£23.25	£23.50	£26.40	£24.00

### Quarterly titles (5 for the price of 4)

Practical Wargamer	£ 7.80	£ 9.90	£10.00	£10.70	£10.10
Radio Control Scale Aircraft	£ 9.00	£11.10	£11.20	£12.00	£11.30

### Alternate monthly titles (8 for the price of 6)

Commodore Disk User	£15.00	£18.00	£18.20	£19.30	£18.40
Radio Control Boat Modeller	£ 8.10	£10.70	£10.80	£11.70	£10.90
Your Amiga	£ 9.00	£11.80	£11.90	£13.00	£12.10

### Fortnightly title (28 for the price of 24)

Model Engineer	£28.80	£37.80	£38.00	£41.50	£38.70
----------------	--------	--------	--------	--------	--------

Please commence my subscription to ..... with the ..... issue.

I enclose my cheque/money order for £..... made payable to ARGUS SPECIALIST PUBLICATIONS

or debit my Access/Barclaycard number  Card expiry date .....

Signature ..... Name .....

Address .....

..... Postcode .....

Please return this coupon with your remittance to:  
 Infonet Ltd. (ETFI/1) 5 River Park Estate, Billet Lane, BERKHAMSTED, Herts. HP4 1HL

# ETI

# CELL GUIDE

There are two basic types of cell: primary cells and secondary cells. Primary cells are non-rechargeable, they are thrown away when their duty cycle is finished. Secondary cells are rechargeable with multiple duty cycles.

This table lists the main battery of each type with detailed information for the engineer to consider when selecting a cell to specific requirements.

*Battery manufacture advances apace. Bill Higgins takes charge with his guide to the marketplace*



Type of Cell	ELECTRICAL					PHYSICAL					OTHER	
	Nominal Voltage	Max Over-charging Voltage	Operating Range	Ah Range		Size Range	Temperature Range		Shelf Life	Ah/Mass (gms)	General Remarks	Some Sources of Cells
				Smallest	Largest		Min	Max				
<b>PRIMARY</b>												
Alkaline manganese	1.5V	1.56V	1.3 to 0.8V	0.05Ah	15Ah	mainly cylindrical some disc	-30°C	70°C	3 years	0.111	High humidity may cause corrosion	Duracell, Crompton Vidor
Lithium manganese dioxide	3.3V	3V	3V to 1.4V	0.03Ah	1.25Ah	wide range, cylinder disc and rectangular	-40°C	70°C	6 years	0.078	Often used on rescue beacon equipment and life jackets	Dowty, Duracell
Lithium sulphur dioxide	3V	2.9V	2.9V to 2V	0.85Ah	8Ah	Cylindrical and disc	-55°C	70°C	10 years	0.0842	High external pressure can inhibit its functions	Dowty, Duracell, Crompton Vidor
Lithium thionyl chloride	3.6V	3.7V	—	—	18Ah	cylindrical and rectangular	-55°C	70°C	10 years	0.0758	—	Crompton Vidor, Dowty, RS
Mercury cadmium	0.9V	—	—	—	—	disc	-40°C	120°C	—	NRA	—	Dowty
Silver oxide	1.5V	1.6V	1.5V to 1.49V (rapid fall off)	0.075Ah	0.13Ah	disc and cylindrical	—	—	2 years	0.0118	Often used in digital watches and so on	Duracell
Zinc air	1.4V	1.45V	1.4V to 0.9V	0.07Ah	2.4Ah	disc, cylindrical and rectangular stacks	0°C	60°C	4 years	0.242	Relative humidity should be between 25 and 75	Duracell
Zinc carbon	1.5V	—	—	—	—	layered stacks and round cells	-10°C	50°C	1½ years	0.0513	Best blow 0°C	Crompton Vidor
Zinc mercury	1.35V	1.55V	1.3V to 0.9V	—	—	cylindrical	-30°C	70°C	2½ years	0.074	—	Crompton Vidor
<b>SECONDARY</b>												
Nickel cadmium	1.2V	1.8V	1.8V to 0.9V	0.01Ah	7Ah	cylindrical, disc and rectangular	-10°C	50°C	1 year	0.0295	Temperature variations can cause self discharge	Alcad, Ever Ready, Friwo, Sonnenschein, Tungstone, Varta
Lead acid	2V	2.3V	2V to 1.75V	1Ah	9.5Ah	large (multicell)	-50°C	50°C	6 months	0.0171	Temperature variations can cause loss of available capacity	GNB Absolyte, Sonnenschein, Yuasa

# REV-RIDER

Stuart Richards  
converts his Raleigh  
into a Kawasaki 1300  
with the help of this  
motorcycle simulator

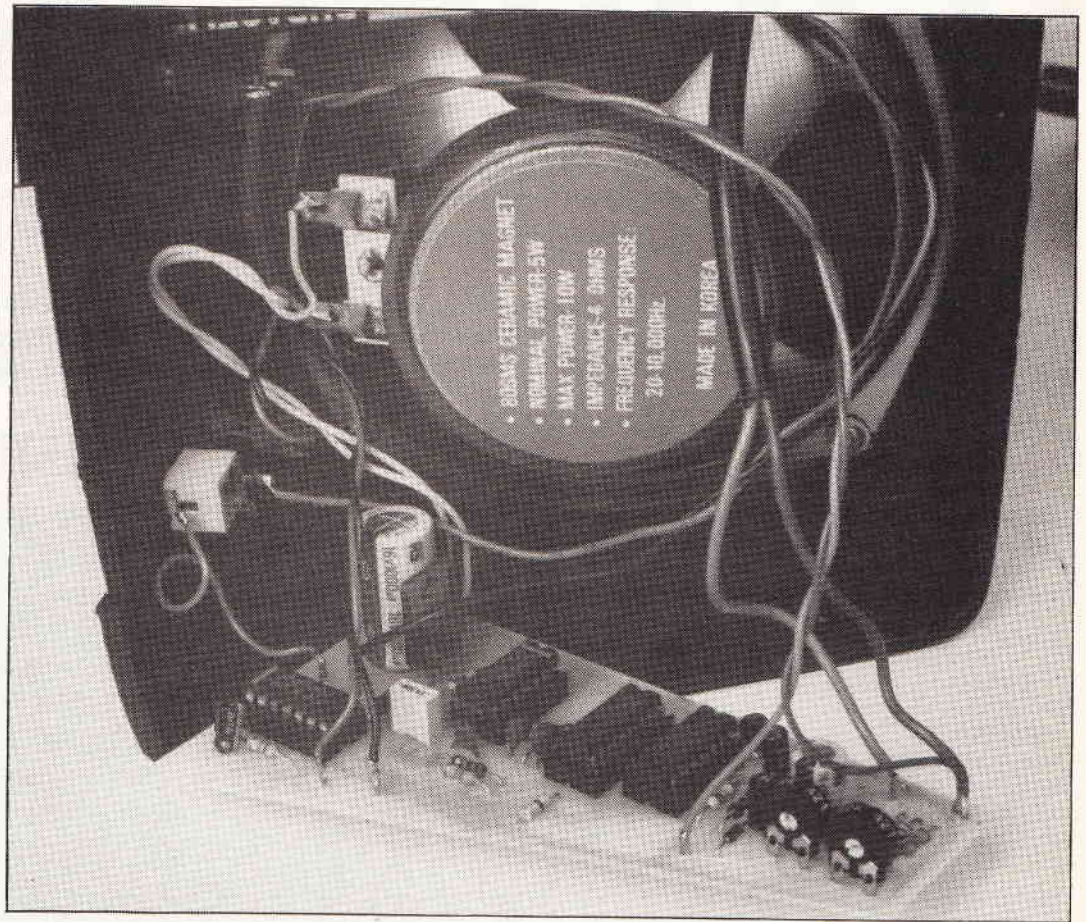

**T**his project was inspired by my childhood memories of making my bicycle sound like a motor bike by fixing a piece of cardboard near the rear wheel so that it flapped against the rotating spokes. The customary items to use were a piece of cigarette packet from the gutter and a wooden clothes peg stolen from Mum.

The Rev-Rider described here is a solid state version complete with ignition key, adjustable tickover, push-button revving control, flashing LED and last but not least a siren to annoy the neighbours.

The project is simple to construct, will give hours of pleasure from a small 9V battery and can be fitted to any vehicle (even an exercise bike!)

## Construction

The prototype was built in a surface mounting car speaker case with a piece of paxolin as the back baffle to the case (Fig. 2). The speaker was left in situ and the PCB designed to fit to one side of the case (which explains the lop sided shape of the board!).

Cheap car speaker units are easily obtainable for little more than the cost of a drive unit alone. A high quality drive unit is not required as the Rev-Rider is hardly hi-fi.

Before assembling the board, familiarise yourself with Fig. 3, checking orientation of all polarised components.

Start with smallest components first — resistors, diodes and links — then progress through to ICs and capacitors finishing with presets and the power Darlington, Q1.

I recommend fitting IC sockets. They prove invaluable if you need to change an IC.

Insert single sided pins at the off-board connections. This will allow wires to be connected and disconnected from the component side of the board. To fit these, push them through from the copper side as far as you are able then carefully push them the rest of the way with a hot iron, then solder to the track. This completes assembly of the board.

For convenience, the 'Ignition Switch' is simply a 3.5mm jack socket, with a short-circuited plug for the key. Drill a 2mm hole through the plastic plug cover to accept a key-ring and fob. This key will prove easy to replace if lost!

Drill holes in the case to accept jack socket, LED (5mm diameter) and push buttons if fitted. The LED will be a tight fit but should be secured with epoxy adhesive. Install the jack socket and push buttons, connect these together following the diagram leaving sufficient length of wire to enable the board to be released if necessary. Mount a 9V alkaline battery to the side of the case using a double sided adhesive pad. You shouldn't need to change this very often!

The two push buttons SW1,2 can either be fitted in the speaker case or mounted near the handlebar grip and connected to the board using thin 3-core mains cable taken through a hole on the case.

A simple way to mount the switches this way is by using a metal bicycle bell, first removing the striker and other internal bits. One or two holes are drilled in the side to accept SW1 and/or SW2 and the bell clamped to the handlebars so they can be operated by the thumb.

A back panel for the case can be cut from a sheet of plastic or hardboard using the speaker case as a template. Drill the two holes in the rear panel and

PROJECT

mount to the speaker case using M3 nuts and bolts.

Parts from two bells were again used to clamp the case to the handlebars of the bicycle but suitable clips can be obtained from any hardware/cycle shop.

Check again all wiring, battery polarity and correct insertion of all ICs. Insert ear plugs and switch on!

## Kick Start

You should hear an engine type noise somewhere between a slow tickover and a high-pitched scream. Adjust the tickover control RV2 to the desired tickover speed. If you get no sound at this stage, check first that 9V is getting to the board. The VCO input of IC3, Pin 9 should be at 1.9-2.6V according to the charge on C2. If this seems in order, look for a square wave output on Pin 4 of IC3.

If you have no scope, a multimeter connected from 0V to Pin 4 should read an average of half supply volts (4.5V). The voltage on the reservoir capacitor

C9 will be almost 9V at tickover and will decrease as the revs increase, as more energy is used by the speaker.

Press SW1, revs should increase slowly up to a maximum which can be set by adjusting RV1. Release SW1, revs should decrease again to the set tickover

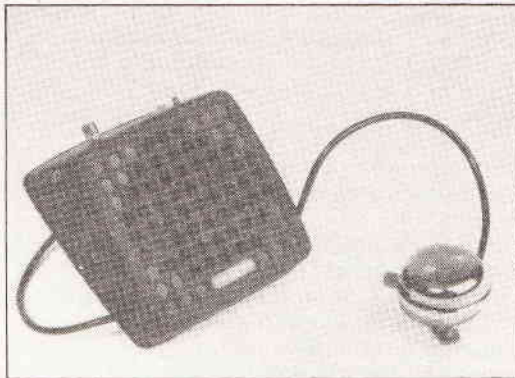

## HOW IT WORKS

The heart of this project is a voltage to frequency converter. This gives out a square wave pulse train, the frequency of which is proportional to a DC voltage that we apply to its input. For convenience, we use a 4046B phase lock loop IC which includes the voltage to frequency converter.

By applying an increasing voltage input to IC3, the 'revs' will increase and vice-versa. Capacitor C2 gives the circuit inertia, acting like a flywheel in an engine. Pressing the Rev button SW1, charges C2 via R1, R3 and D2, the maximum revs being set by RV1. Releasing SW1 allows C2 to discharge via RV1, R1, R2 and D1.

To achieve a steady tickover speed, independent of battery condition, the VCO input requires a positive offset of about 1.9V. To do this, a constant current of 0.56mA from regulator diode D3, passes through R4 and 'jacks up' the bottom end of C2. RV2 allows this voltage to be adjusted by shunting R4 and R5. D4 prevents C2 from being reversed biased. C3 ensures the circuit starts up slowly at switch on.

To give a high volume output with low battery consumption, the loudspeaker is fed with short duration pulses at 4-6V in amplitude. Q1 drives the speaker in emitter follower mode, drawing peak currents of over 1A from the reservoir capacitor C9. Resistor R15 limits the current drawn from the battery.

IC4 is used as two monostables triggering on alternate positive and negative edges of the VCO square wave output. To achieve a more realistic sound, these monostables are given different time constants, (typically 50 and 150 microseconds) resulting in alternate short and long pulses to the speaker.

Capacitor C8 slows the edges of the pulses making the noise more 'user-friendly'.

The resulting output provides ample volume while the drain on the battery is less than 5mA at tickover, rising to about 20mA at high revs.

The siren effect is obtained by utilising a 4066B quad analogue switch IC to change over the input of the VCO IC3, from the revving circuit previously described to triangular waveform generator IC2b.

The triangular signal from IC2 pins 1 and 2 passes through the switch IC1a and is AC coupled via R6 and C1 to the cathode of current regulator diode D3, modulating the VCO input signal to IC3 via R7 and closed switch IC1b.

Pressing the siren button SW2, brings this into action and also effectively shorts R15 allowing greater volume in the Siren mode.

Two paralleled spare gates, IC2c, drive the flashing LED directly from the square wave output of IC2b.

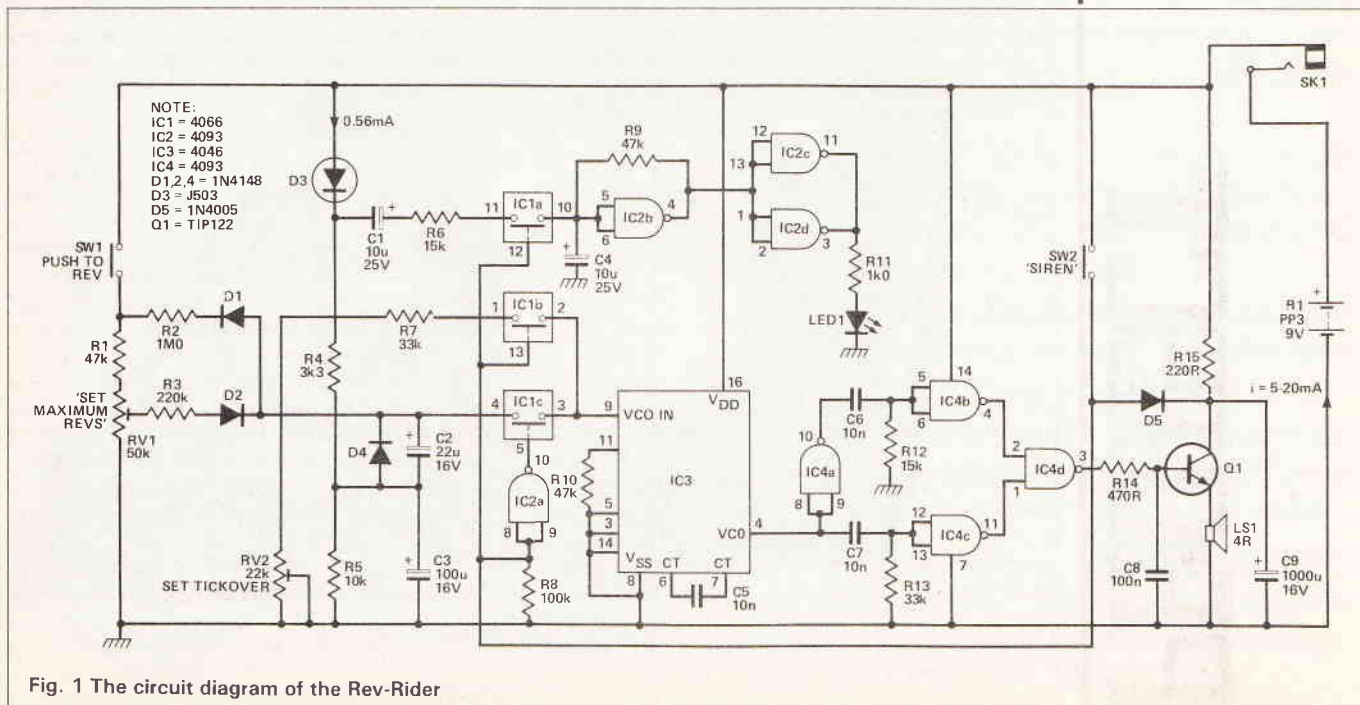

Fig. 1 The circuit diagram of the Rev-Rider

# PROJECT

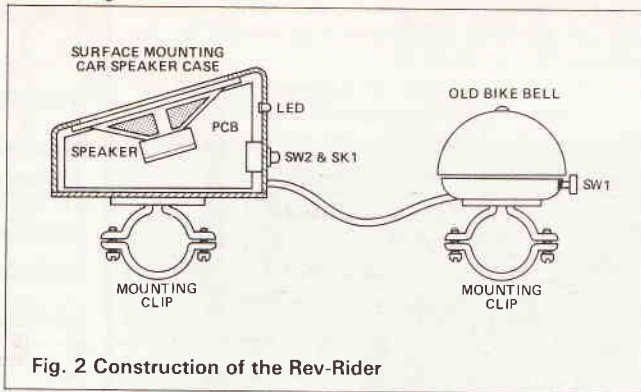

Fig. 2 Construction of the Rev-Rider

speed. Press Siren button SW2, the circuit should give loud wailing noise.

You can increase or decrease wailing speed by reducing or increasing the value of R9. For test purposes (or for indoor use) it may be desirable to insert a resistor (10-47R 1/4W) in series with the loudspeaker to reduce the volume to a tolerable level.

### Further Thoughts

The project outlined here suggests only one means of varying the speed of the output. Readers with mechanical flair might like to fit a proper throttle using a potentiometer connected either to a twist-grip or lever operated throttle.

'Gear changes' can be effectively achieved by switching in different values of charge resistor instead of R3 to give differing rates of charge/discharge of C2.

A slightly unstable tickover speed, as in many two-strokes can add further realism by slowly changing the voltage at the junction of R4/R5.

Types of speakers and enclosures will change the sound dramatically — a speaker mounted inside a cardboard tube for example will add resonance and give a nice popping sound like many 50-100cc machines.

With small changes the circuit could be adapted to other toys such as lawn mowers, pedal cars and so on. I wish you hours of fun.

## PARTS LIST

### RESISTORS (all 1/4W 5%)

R1,9,10	47k
R2	1M0
R3	220k
R4	3k3
R5	10k
R6,12	15k
R7,13	33k
R8	100k
R11	1k0
R14	470R
R15	220R
RV1	47k preset
RV2	33k preset

### CAPACITORS

C1,4	10μ 25V radial electrolytic
C2	22μ 16V radial electrolytic
C3	100μ 16V radial electrolytic
C5,6,7	10n ceramic
C8	100n polyester
C9	1000μ 16V radial electrolytic

### SEMICONDUCTORS

IC1	4066B
IC2,4	4093B
IC3	4046B
Q1	TIP122
D1,2,4	1N4148
D3	J503
D5	1N4004
LED1	5mm Red LED

### MISCELLANEOUS

B1	9V battery
LS1	4R 10W loudspeaker
SK1	3.5mm jack socket
PL1	3.5mm jack plug
SW1,2	SPST push switch
PCB, Case, Battery clips, Connecting wire, Mounting clips, Nuts and bolts.	



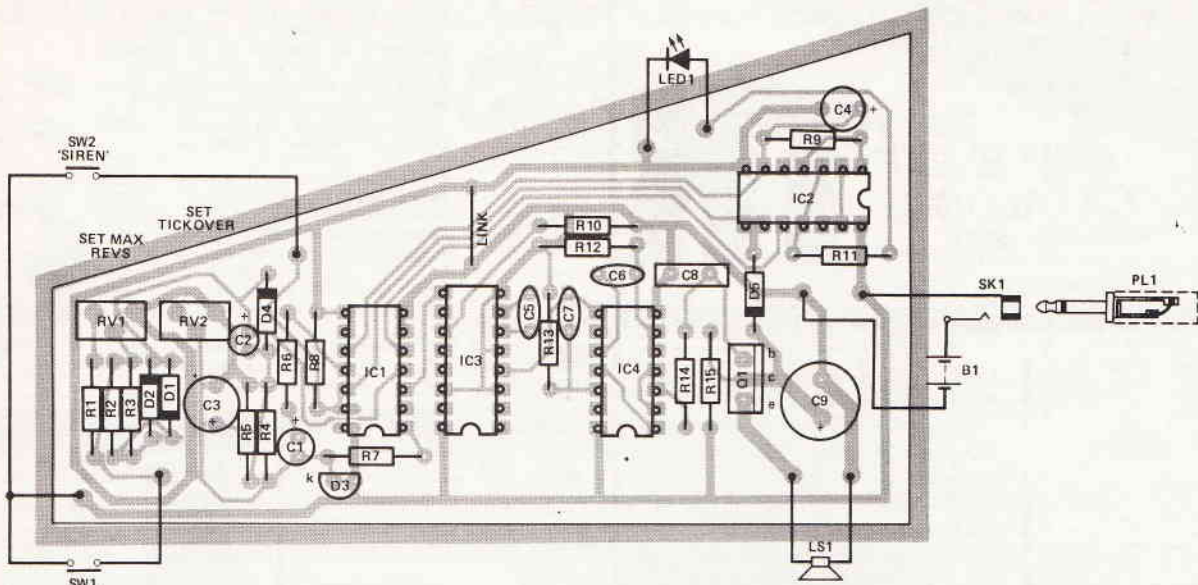

Fig. 3 The component overlay

## BUYLINES

Most of the parts for the Rev-Rider should pose no particular problems. A complete kit of parts for the Rev-Rider excluding a battery and the case back baffle is available from Technova Developments, Grange Walk, Wroxham, NR18 8RX (Tel: (06053) 2215) for £16.50 plus VAT plus £1.75 postage.

A suitable speaker and case can be purchased at a variety of

shops including Tandy, motorist accessory shops and your local component stockists. The case and speaker used in the prototype is available from Technova for £3.95+VAT+£1.75 postage. The J503 constant current diode (D3) is available from Electromail as part number 283-463 or from Technova for £1.20+VAT+75p postage. The PCB is available from Technova for £2.25+VAT+75p postage.



## NATIONAL COMPONENT CLUB

### SPECIAL OFFERS \* SPECIAL OFFERS

5	555 TIMER (IC's)	£1
5	741 OP-AMPS	£1
12	LED's (5mm red or green)	£1
25	GENERAL PURPOSE TRANSISTORS (BC548, BC182 etc)	£1
15	BATTERY CLIPS (PP3)	£1
25	ASSORTED POTS & PRESETS	£1
70	ASSORTED CAPACITORS (Picofarads-2200uf)	£1
25	ELECTROLYTIC CAPACITORS (1uf-2200uf)	£1
300	MIXED RESISTORS (6R2-9M1)	£1
?	MYSTERY PACK	£1
10	CROCODILE CLIPS (5 red and 5 black)	£1
1	90db PIEZO SOUNDER	£1

**ANY SIX PACKS FOR A FIVER!  
ALL TWELVE FOR A TENNER!**

P.O. or Cheque to: NATIONAL COMPONENT CLUB, DEPT ETI, HIGHER ANSFORD, CASTLE CARY, SOMERSET BA7 7JG.  
Please add £1 P & P but do not add VAT.

✪ **FREE CLUB MEMBERSHIP** ✪

Advertisement

## PCB Manufacturers — Which to choose?

With scores of PCB manufacturers falling over themselves to make your conventional boards, it can be very difficult to choose the right one.

You could however, choose a PCB manufacturer with more to offer. Such as, assembly, panel printing, final build and design.

Slee Electro Products can provide you with these services and will still offer you competitive prices on your PCB's.

"We're hot on quality and delivery too. And being a member of the Printed Circuit Association, means we have to try harder."

Slee Electro Products, Tel: 0226 200717,  
Fax: 0226 731817, Unit 4, Grange Lane  
Industrial Estate, Carrwood Road, Barnsley,  
South Yorkshire S71 5AS, England.

**For KITS & COMPONENTS -**  
**Choose the easy way - with**

**Send 50p\* & SAE**  
**for CATALOGUE**  
**(AUTUMN 1987)**

\*refundable with first order

**ORDERS: RING (01) 567 8910 - 24 HRS.**



**ELECTRONIC GUARD DOG KIT**



One of the best deterrents to a burglar is a guard dog and this new kit provides the barking without the bite! The kit when assembled can be connected to a doorbell, pressure mat or any other intruder detector and will produce a random series of threatening barks making the would be intruder think again and try his luck elsewhere. The kit is supplied complete with high quality PCB, transformer, all components and instructions. All you need is a mains supply, intruder detector and a little time. The kit even includes a horn speaker which is essential to produce the loud sound required. The "dog" can be adjusted to produce barks ranging from a Terrier to an Alsatian and contains circuitry to produce a random series of barks giving a more realistic effect.

**XK125 Complete kit of parts ..... £24.00**

**DISCO LIGHTING KITS**

**DL1000K** This value-for-money 4-way chaser features bi-directional sequence and dimming. 1kW per channel ..... **£19.25**  
**DLZ1000K** - A low coat uni-directional version of the above. Zero switching to reduce interference ..... **£10.80**  
**DLA/1** (for DL & DLZ1000K) Optional opto input allowing audio 'beat'/light response ..... **77p**  
**DL3000K** - 3-channel sound to light kit features zero voltage switching, automatic level control and built-in microphone. 1kW per channel **£15.60**

The **DL8000K** is an 8-way sequencer kit with built in opto-isolated sound to light input which comes complete with a pre-programmed EPROM containing EIGHTY - YES 80! different sequences including standard flashing and chaser routines. The KIT includes full instructions and all components (even the PCB - connectors) and requires only a box and a control knob to complete. Other features include manual sequence speed adjustment, zero voltage switching, LED mimic lamps and sound to light LED and a 300 W output per channel.

And the best thing about it is the price.

**ONLY £31.50**



**TEN EXCITING PROJECTS FOR BEGINNERS**

This Kit has been specially designed for the beginner and contains a **SOLDERLESS BREADBOARD, COMPONENTS, and a BOOKLET** with instructions to enable the absolute novice to build TEN fascinating projects including a light operated switch, intercom, burglar alarm, and electronic lock. Each project includes a circuit diagram, description of operation and an easy to follow layout diagram. A section on component identification and function is included, enabling the beginner to build the circuits with confidence.

**ORDER NO XK118 ..... £15.00**

**MICROPROCESSOR TIMER KIT**

Designed to control 4 outputs independently switching on and off at present times over a 7-day cycle. LED display of time and day. easily programmed via 20 way keyboard. Ideal for central heating control including different switching time for weekends. Battery back-up circuit includes box - 18 time settings.



**CT8000K ..... £47.20**  
**XK114 Relay kit for CT8000K** includes PCB, connectors and one relay. Will accept up to 4 relays. 3A/240V c/o contacts ..... **£4.30**  
**701 115 Additional relays ..... £1.80**

**THREE SIMPLE CONSTRUCTION KITS**

Especially aimed for the beginner. Have fun with your project even after you have built it and also learn a little from building it. These kits include high quality solder resist printed circuit boards, all electronic components (including speaker where used) and full construction instructions with circuit description.  
**SK1 DOOR CHIME** - plays a tune when activated by a pushbutton. **£3.90**  
**SK2 WHISTLE SWITCH** - switches a relay on and off in response to whistle command. **£3.90**  
**SK3 SOUND GENERATOR** - produces FOUR different sounds, including police/ambulance/fire-engine siren and machine gun. **£3.90**  
**SPECIAL OFFERS FOR SCHOOLS AND TRAINING CENTRES** - contact Sales Office for discounts and samples

**VERSATILE REMOTE CONTROL KIT**

This kit includes all components (+ transformer) to make a sensitive IR receiver with 16 logic outputs (0-15V) which with suitable interface circuitry (relays, triacs, etc - details supplied) can be used to switch up to 16 items of equipment on or off remotely. The outputs may be latched (to the last received code) or momentary (on during transmission) by specifying the decoder IC and a 15V stabilised supply is available to power external circuits. Supply: 240V AC or 15-24V DC at 10mA. Size (excluding transformer) 9 x 4 x 2 cms. The companion transmitter is the MK18 which operates from a 9V PP3 battery and gives a range of up to 60ft. Two keyboards are available—MK9 (4-way) and MK10 (16-way), depending on the number of outputs to be used.

- MK12 IR Receiver (incl. transformer) ..... £16.30**
- MK18 Transmitter ..... £7.50**
- MK9 4-Way Keyboard ..... £2.20**
- MK10 16-Way Keyboard ..... £6.55**
- 601 133 Box for Transmitter ..... £2.60**

**HOME LIGHTING KITS**

These kits contain all necessary components and full instructions and are designed to replace a standard wall switch and control up to 300W of lighting.

- TD300K Touchdimmer ..... £9.30**
- T8300K Touchswitch ..... £9.30**
- TDE/K Extension kit for 2-way switching for TD300K ..... £2.95**
- LD 300K Light Dimmer ..... £4.75**

**POWER STROBE KIT**

Designed to produce a high intensity light pulse at a variable frequency of 1 to 15Hz this kit also includes circuitry to trigger the light from an external voltage source (eg. a loudspeaker) via an opto isolator. Instructions are also supplied on modifying the unit for manual triggering, as a slave flash in photographic applications or as a warning beacon in security applications. The kit includes a high quality pcb, components, connectors, 5W strobe tube and full assembly instructions. Supply: 240V ac. Size: 80 x 50 x 45.  
**XK124 STROBOSCOPE KIT .... £13.75**

**XK113 MW RADIO KIT**

Based on ZN414 IC, kit includes PCB, wound aerial and crystal earpiece and all components to make a sensitive miniature radio. Size: 5.5 x 2.7 x 2cms. Requires PP3 9V battery.  
**IDEAL FOR BEGINNERS ..... £6.60**

**PROPORTIONAL TEMPERATURE CONTROLLER KIT**

Use "burst fire" technique to maintain temperature to within 0.5°C. Ideal for photography, incubators, wine-making, etc. Max. load 3kw (240V ac) Temp. range up to 90°C. Size: 7x4x2.5cms.  
**MK4 ..... £7.80**

**BARGAIN COMPONENT PACKS**

Refill those empty component drawers at a fraction of the normal price and don't be caught without that odd resistor or capacitor to complete your project. All components supplied are to full spec, and are not seconds or surplus stock.

- Pack A: 650 x .25 watt resistor 47R-10M ..... £4.25**
- Pack B: 60 x Radial electrolytes 1uf-1000uf ..... £3.25**
- Pack C: 30 x Polyester capacitors a or 0.01 uf-1uf ..... £4.50**
- Pack D: 35 x horizontal presets 1k-1M ..... £3.00**
- Pack E: 30 x IC sockets 8, 14, 16 pin ..... £2.00**
- Pack F: 25 x Red 5mm LEDs ..... £1.75**
- Pack G: 25 x Green LEDs ..... £2.00**
- Pack H: 30 x 5mm LEDs 10 Red, 10 Green, 10 Yellow ..... £2.50**
- Pack J: 50 x 1N4148 silicon diodes ..... £1.00**
- Pack K: 40 x npn/pnp transistors BC182/212 General Purpose ..... £2.25**

Solderless Breadboard (verobloc type). When you buy all ten packs, Prices exclude VAT (15%).

**GIANT SOLAR CELLS**

**NOW IN STOCK** these giant size solar panels 12 x 12ins will deliver over 12 volts 200mA in bright sunlight and 11.5 volts 60mA on a typical British summer day (dull and overcast). In bright sunshine we measured 17 volts (open circuit) and a short circuit current of over 480mA. **HUNDREDS OF USES IN THE CAR OR CARAVAN, E.G.**

Charging NiCads, powering low voltage circuits where mains or battery supplies are inconvenient or coupled to a lead acid battery and a simple inverter you could build yourself a self contained mains supply for low power appliances. **£14.50**  
 Stock No. 303 145 (+ £1.75 for p&p on total order)

**MK 14 AC POWER CONTROLLER KIT**

This kit uses phase control techniques to vary the power in a mains load by means of a d.c. control voltage. The control voltage (which may be derived from a potentiometer, thermistor, light dependent resistor or a digital to analogue converter) needs to be varied from 0 to 8 volts to vary the load power from zero to maximum and an amplifier is included for smaller voltages. The circuit is mains powered and can control up to 1kW if the triac is fitted with a heatsink. A d.c. supply is also available for powering external circuits. Applications include lighting controllers for stage and theatre, aquariums and aviaries, motor speed controls and fast response temperature controllers. The kit includes a printed circuit board, and components, together with a circuit diagram, instructions and applications circuits. **£5.70**

**SOLID STATE RELAY BARGAIN**

- \* ZERO VOLTAGE SWITCHING. No radio interference problems.
- \* 2.5 KV INPUT TO OUTPUT ISOLATION. No risk of damage to your computer or driver circuits.
- \* 4 KV TERMINALS TO HEATSINK ISOLATION. Simply bolt onto a heatsink.
- \* 0V to 32V INPUT VOLTAGE. easily interlaced to TTL or CMOS LOGIC.
- \* 24V to 240V rms LOAD VOLTAGE. Enabling switching of inductive loads
- \* BUILT IN SNUBBER NETWORK. Enabling switching of inductive loads
- \* 10A MAXIMUM CURRENT. 4A with no heatsink fitted at 40° C. **£2.25** **CO240/118**

**TOOLS ★ TOOLS ★ TOOLS**

- Good quality tools selected to offer outstanding value for money.
- 650 004** 6in mini. Snipe Nose Pliers. Serrated jaws and return spring. **£2.10**
- 650 005** 6in lap jointed side cutters. Insulated handles and return spring. **£2.10**
- 650 006** Light duty cutters. Cuttings capacity 0.22-1.2mm copper wire. **£1.50**
- TOOL KIT** Contains: side cutters, snipe nose pliers, wire strippers, flat blade screwdriver, Phillips screwdriver in black textured, reinforced and padded case which when opened out measures 240 x 205mm. **£5.80**
- 650 007** Self-adjustable automatic wire stripper with built-in cable cutter/1.5mm mini. **£3.95**
- 650 012** Watchmakers Screwdriver Set 1 001 402 012 403 013 8mm. **£1.75**
- 650 012** Set of 4 Stainless Steel Tweezers. Straight nosed, straight nosed-reverse angle, bent nosed, flat nosed 110mm long. **£3.65**
- 650 502** Retani 9 12V dc Drill. **£6.90**
- 650 500** Titan 12V ac Drill. **£10.25**
- 650 570** Saturn Mains Drill. **£15.50**

**WE ALSO STOCK ANTEX IRONS AND ACCESSORIES**

**AUTORANGING DIGITAL MULTIMETER**

High quality meter with features normally found in meters costing much more - e.g. DISPLAY HOLD, MEMORY, CONTINUITY BUZZER and 10A AC/DC current ranges. High accuracy and automatic operation - a must for the professional or serious hobbyist. Size: 127 x 69 x 25mm.

AC Volts: 0-2-20-200-500V  
 DC Volts: 0-200-2-20-200-1000V  
 AC Current: 0-20m-200mA (1.2%) 0-10A (2%)  
 DC Current: 0-20m-200mA (1.2%) 0-10A (1.5%)  
 Resistance: 0-200-2K-20K-200K-2M (1%)  
 Continuity Buzzer operates @ 20 ohm .. **£33.00**

**SUPER-SENSITIVE FM MICROBUG**

Highly sensitive FM transmitter measuring only 45 x 25 x 15mm including the built-in microphone. Frequency 88-108MHz enabling reception on a standard domestic FM radio. Range approximately 300m depending on terrain. Powered by 3V PP3 (7mA). Its small size and highly sensitive electret microphone makes it ideal for surveillance, baby alarm, etc. **£5.50**

**RECHARGEABLE SOLDERING IRON**

Powerful cordless iron complete with table-top/wall-mounting charging bracket. Reaches soldering temperature in 10 seconds. Includes lamp which lights when soldering. Comes with mains charging unit and 12V car battery adaptor. **Special Offer £15.95**

**ELECTRONIC WEIGHING SCALES**

This kit contains a Single Chip Microprocessor, PCB, displays and all electronics to produce a digital readout of weight in Kgs, or Sts, and Lbs. In normal use a toothed wheel (pattern provided) is made to rotate when a weight is placed onto the scales, interrupting two infra-red beams. The processor counts the number of teeth passing the sensor (up or down, depending on which beam is broken, first) and shows the reading on the LED display in Sts, & Lbs., or Kgs. A PCB link selects the scales for bathroom or two types of Kitchen Scales. A linear version of the toothed wheel could also be used. Other uses include up/down counters. A low cost digital ruler could be made by using a wheel with the correct tooth to diameter ratio. **£51**

**TR ELECTRONICS**  
**13 BOSTON RD**  
**LONDON W7 3SJ**  
**Tel: 01-567 8910**

**SEND 9"x6" S.A.E. & 50p FOR CATALOGUE OR CALL AT SHOP MON-FRI 9-5pm SATURDAY 10-4pm**

**ORDERING INFORMATION: ALL PRICES EXCLUDE VAT**

**FREE P&P on orders over £20 (UK only), otherwise add 75p + VAT. Overseas P&P: Europe £2.75. Elsewhere £6.50. Send cheque/PO/Barclaycard/Access No. with order. Giro No. 529314002.**

**LOCAL AUTHORITY AND EXPORT ORDERS WELCOME GOODS BY RETURN SUBJECT TO AVAILABILITY**



# CHRISTMAS PRESENT FOR GRANNY

# PROJECT

One of the most common problems that elderly people have to put up with is a gradual loss of hearing sensitivity. Unfortunately, this problem is made more irritating by the way that the rest of us tend to assume that they are daft as well — when they simply didn't hear what we said.

The NHS does its best to help but they have only a limited range of appliances which they can dispense. These are mainly small units which sit on top of the ear, with a microphone which points backwards — fine for hearing what people are saying behind one's back but not as useful for hearing what the person standing in front of one is saying.

The NHS units, being small, are also liable to get trodden on, mislaid or dropped into unlikely places, and are dear (hundreds of pounds-ish) to replace when lost.

However, from the point of view of the DIY electronics fraternity, the task of making a gadget which will amplify the output from a small microphone and will operate an earphone is neither difficult nor costly, provided that one doesn't aim to make it too miniaturised. This, in a sense, can be an advantage since if it isn't too small, it won't be so easily lost.

A word of warning is necessary at this point. The manufacture and supply of 'hearing aids' is a very profitable business — especially for the private enterprise side of the market. It is therefore, quite predictably, hedged around with official restrictions to prevent others from homing in on this market. So, no-one other than an officially approved manufacturer can market such devices as 'hearing aids', and no-one but a registered 'hearing aid' dispenser can sell them.

This does not restrict what one can do oneself if one has a mind to but it must be called something other than a 'hearing aid!' The few firms which exist in this country outside the patronage of the NHS refer to their products as 'binaural amplifiers' or 'microphone amplifiers'. Again, I suppose one can call it what one likes so long as it isn't sold.

## Design Considerations

There is quite a range of small 'electret' condenser-type microphones available, nearly all of which contain an integral FET buffer amplifier, of the general form sketched in Fig. 1. These require a small DC voltage in the range 2-15V to make them work.

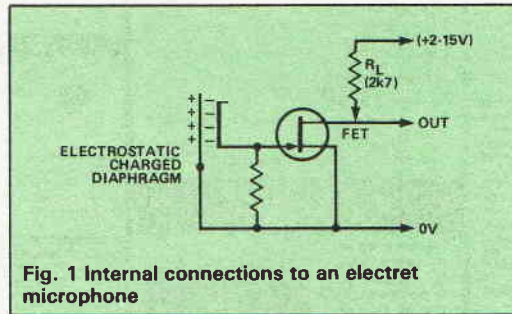

Fig. 1 Internal connections to an electret microphone

Some of these are '3-terminal' devices, with the FET load resistance inside the unit but most require the load resistor to be added externally, as shown in the diagram. Either of these types are usable.

There is also quite a range of small headphones on sale, for use with 'Walkman' type personal cassette players or personal radios. These are typically 30R impedance and require a few milliamps of drive. Check these before you buy, since some of the very cheap ones are too insensitive to be of much use.

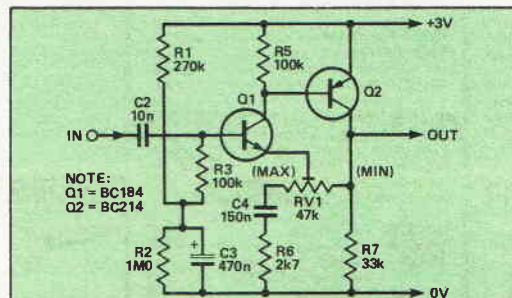

Fig. 2 The 2-transistor gain block with gain control



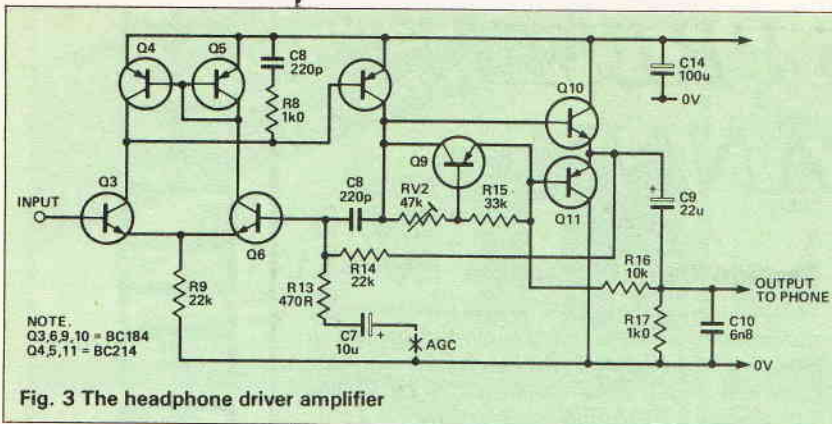

Fig. 3 The headphone driver amplifier

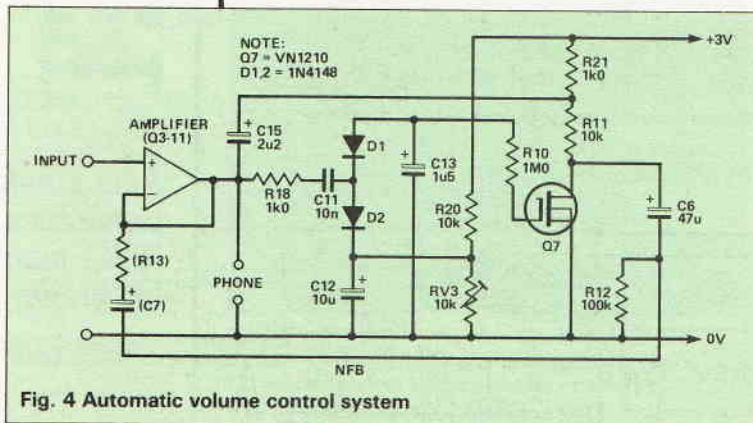
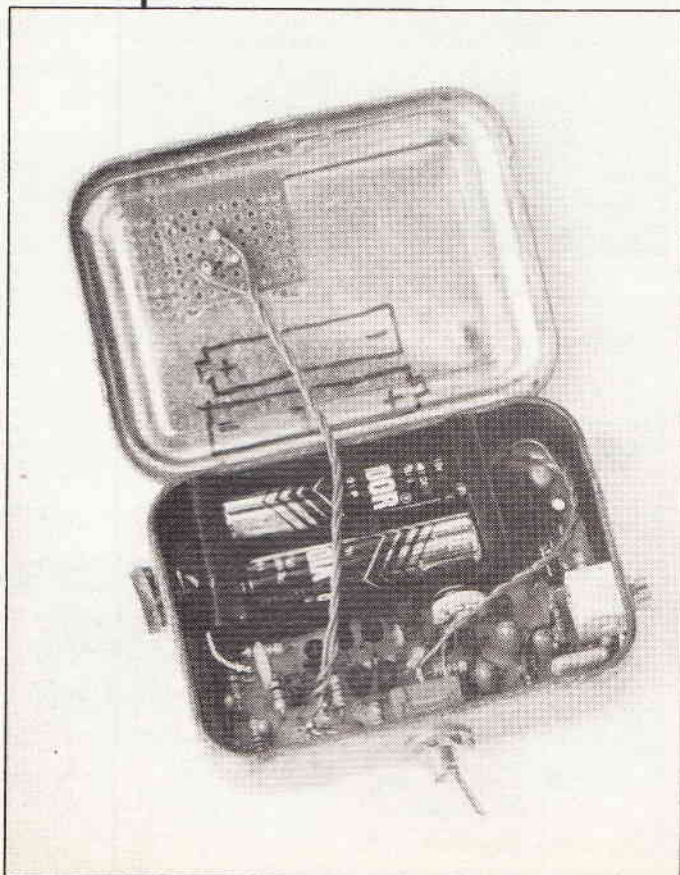

Fig. 4 Automatic volume control system

Between the microphone and the earpiece one must insert an amplifier giving an adjustable gain somewhere in the range 30-500 which will operate from 3V DC (the electret microphone requirements rule out 1.5V operation, as does the need to produce enough volume from a 30R earphone) and which won't take too much current.

Finally, it has to fit inside some fairly strong metal



container to give electrostatic screening and protection, such as the little hinged lid tins in which, in more expensive days, tobacco and cough sweets were sold and which are now largely to be found in the workshop or mending box, full of screws or safety pins.

## Circuit Design

The basic 2-transistor gain block of Fig. 2 will operate quite happily down to about 1.5V and will provide a peak-to-peak output voltage swing which is close to the limits set by the supply lines. It also provides a convenient means of adjusting the gain, by varying the amount of negative feedback. R1 and R2 are chosen to set the DC output level at about half the supply line voltage.

The following stages Q3-Q11, shown in Fig. 3, comprise a miniaturised hi-fi amplifier with a push-pull output operating on a 1mA quiescent current setting, giving a total quiescent battery demand of 2mA.

The 'bootstrapped' driver load (C9/R16), though now not used much in true hi-fi designs where a constant current source load for the driver stage is preferred, makes the best use of the limited supply voltage. Prior to clipping, with a 30R load and 3V supply, the overall THD is of the order of 0.02%.

## Automatic Gain

This is a facility which lifts this circuit out of the ordinary 'run of the mill' microphone amplifiers and greatly adds to its usefulness. Unfortunately, with the very limited available supply voltages and output swings, most of the normal AGC systems are inapplicable.

The circuit of this is shown in Fig. 4, and it operates by using the dynamic impedance of a small signal MOSFET device as part of the feedback loop of the amplifier to Fig. 3. When the MOSFET device (in this case a VN1210 but any similar enhancement-mode MOSFET will work as well) is conducting, it has a dynamic drain-source impedance of only a few ohms and the gain of the amplifier of Fig. 3 is  $22k/470 = 47$ .

In the normal quiescent state, the MOSFET is biased into conduction by the voltage developed across RV3, at a forward gate-source potential of about 1-1.5V. The AGV action arises because the output signal voltage from the amplifier is then rectified by the diode-pump circuit of D1, D2, C11 and C13, to provide a negative-going output voltage which progressively biases off the MOSFET and causes its dynamic impedance to rise.

As the MOSFET becomes an open-circuit, the gain of the output amplifier drops towards unity since the load resistor for the MOSFET is also bootstrapped by C15 and R21.

Sadly, this kind of AGC wouldn't be useful in true hi-fi applications since, when it is operating with the MOSFET somewhere between fully on and cut-off, it worsens the THD from about 0.02% to about 0.5%, mostly second harmonic. At small signal levels or large ones, when the MOSFET is either fully on or cut-off, the THD reverts to the lower figure.

This circuit will hold the output constant over at least a 100:1 input signal range and will do a lot to compensate for the wide range of ambient sound levels which exist in practice.

## Construction

The complete circuit of the unit is shown in Fig. 5. A suitable PCB layout is shown in Fig. 6. The mic should be mounted at one end of the case in a small rubber grommet to give some measure of sound isolation

# PARTS LIST

## RESISTORS (all 1/4W 5%)

R1	270k
R2,10	1M0
R3,5,12	100k
R4,6	2k7
R7,15	33k
R8,17,18,21	1k0
R9,14	22k
R11,16,20	10k
R13	470R
R19	470k
RV1,2	47k preset
RV3	10k preset

## CAPACITORS

C1,3	4μ7 tantalum
C2,11	10n ceramic
C4	150n ceramic

C5,8	220p polystyrene
C6	47μ tantalum
C7,12	10μ tantalum
C9	22μ tantalum
C10	68n ceramic
C13	1μ5 tantalum
C14	100μ tantalum

## SEMICONDUCTORS

Q1,3,6,9,10	BC184
Q2,4,5,8,11	BC214
Q7	VN1210
D1	1N4148

## MISCELLANEOUS

B1	2x AAA batteries
SW1	SPST toggle switch
PCB	Electret microphone. Case. Battery holders. Connecting wire.

# PROJECT

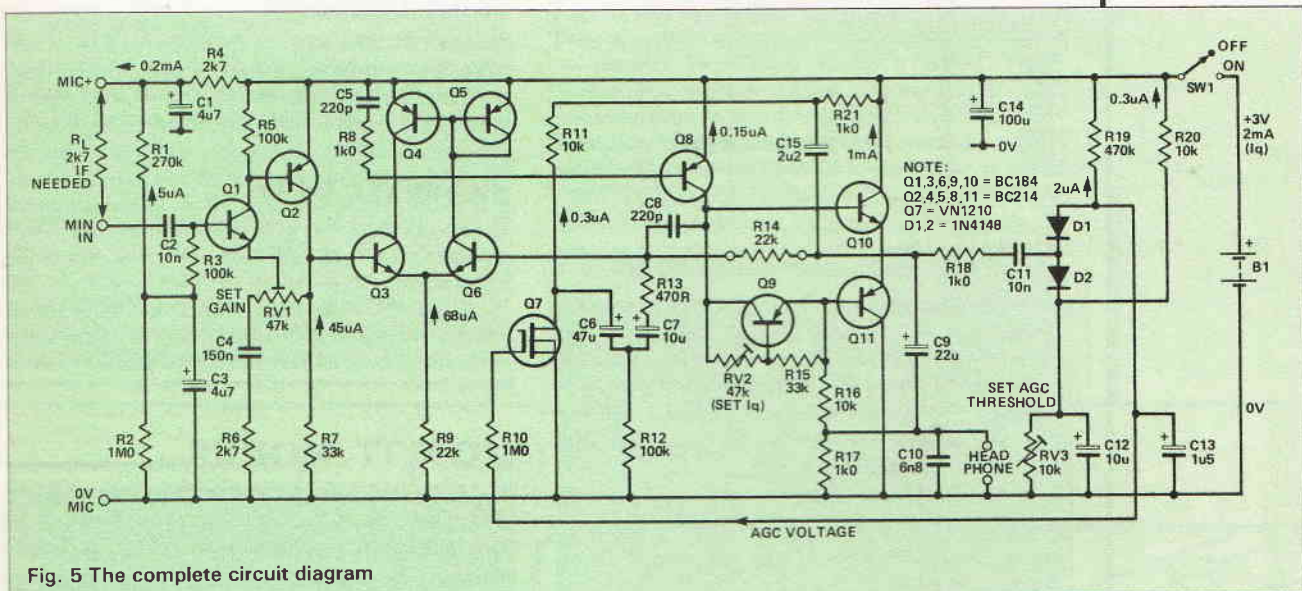

from the case. The 3mm phono jack for the headphone is mounted at the other end. A small preset pot is mounted on the hinged lid of the tin to allow an easily accessible adjustment to the sensitivity of the unit.

Power is provided by a pair of AAA sized batteries in small battery holders and should give a life of some hundreds of hours before battery replacement is needed. Ideally, the works would have been held in place by screws and stand-off spacers but on the prototypes the relative shallowness of the tin did not give adequate height, so the PCB was held in place by a couple of small strips of double-sided adhesive foam, after the copper side of the PCB was liberally covered with insulating tape to prevent any short-circuits from the protruding solder blobs to the tin can.

Setting up is simple. Set RV1 and RV3 to maximum and RV2 to minimum resistances and then adjust RV2 to give a total supply current of 2mA. Set the gain (RV1) to a level at which there is an adequate level of loudness on some sound (such as a radio) and gradually reduce RV3 from its maximum resistance value until the output sound level just begins to fall.

With devices of this type, it is undesirable that the LF response should be too good since most LF sounds are just noise or room resonances and add nothing to the information content. The LF gain can be reduced further, if needed, by reducing the values of C4, C7 or C9. In the prototypes, I mainly used

tantalum bead types for all the larger values in the interest of compactness but this is at the constructor's choice, depending on how much space there is available.

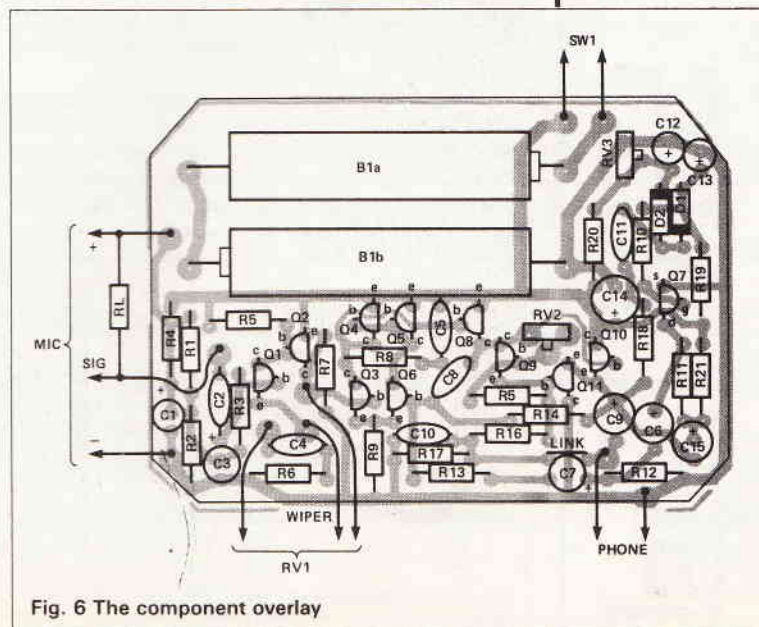

# IN-CAR POWER SUPPLY

For the mobile gadget user, Keith Brindley reveals a variable voltage battery eliminator which doesn't cost the earth and saves ££££s on gadget batteries

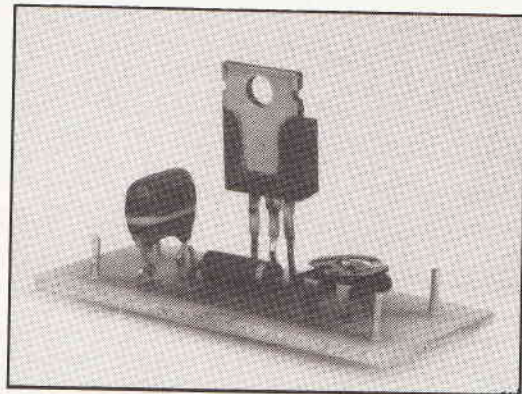

If you're a typical caravanner, camper or motoring tourer, you'll take at least one battery-powered appliance with you on your wayward trips. Even if you just take a simple tranny you'll be well aware of the need to make stops to buy new cells to listen to the weather forecast. If you carry a ghetto-blasters to annoy the people in the next van with them crazy jungle rhythms you'll know that these stops are often frequent and expensive!

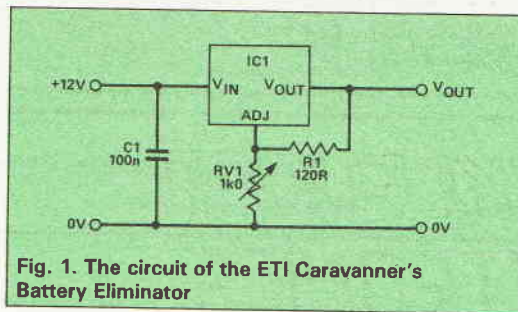

Fig. 1. The circuit of the ETI Caravanner's Battery Eliminator

Now wouldn't it be a good idea if someone would come up with a battery eliminator, just like a normal mains-powered one, except to run off your car or caravan's internal 12V battery? That is, of course, what this month's *1st Class* project is. Not content with giving you a design which eliminates the need for a battery in a single appliance, we've given you a completely variable voltage battery eliminator, for use with virtually any appliance.

This is all made possible by using an easy-to-obtain integrated circuit voltage regulator which allows use of a simple variable resistance to control output voltage. So the 12V battery voltage is regulated down to anything from about 1.2V up to 11V. Maximum output current of the device is some 1.5A sufficient

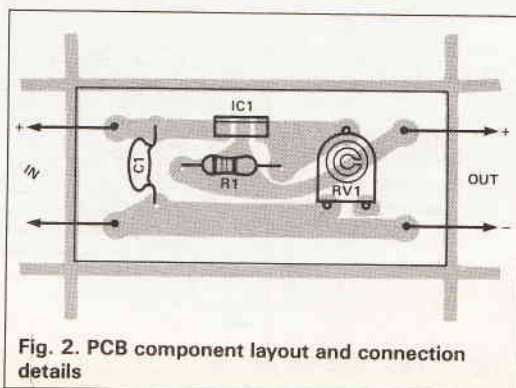

Fig. 2. PCB component layout and connection details

for all but the heaviest users of current.

Most battery-powered equipment should be accommodated by this project. Portable stereo cassette players generally need around 3V, tranny radios around 6V, ghetto-blasters around 9V. Consult your equipment manual to see what voltage is needed. Current consumption of your equipment isn't likely to be more than the project's capability — if it is, you must use up batteries at such a rate of knots you'd be well advised taking a portable mains generator with you instead of a battery eliminator!

## Construction

As usual, we offer you two methods of construction — PCB or stripboard. Details of construction don't vary much between them. Insert the passive components (that is, resistor R1, capacitor C1 and preset resistor RV1) first followed by integrated circuit IC1. The only component which you need to ensure goes in the right way round is IC1. Useful extras are circuit board pins, which allow you to make later wired connections to the board easily. However, these are not essential.

If you're using PCB, Fig. 2 gives details of component layout and connections. If you're using stripboard, layout and connection details are given in Fig. 3.

## HOW IT WORKS

The circuit of the project is given in Fig. 1. There's a lot to it, isn't there? Capacitor C1 filters the incoming voltage, to remove spikes or interference coming down the line. These could be present if the battery is under charge from the alternator in a moving car or from a mains-powered battery charger. Resistor R1 and preset RV1 form an adjustable potential divider network which allows variable control over output voltage.

Integrated circuit IC1 is a variable voltage regulator. It is a simple-to-use three-terminal linear device. Technical specifications are pretty good in voltage regulation terms. Some of the specs relevant to us in this project are: maximum output current is 1.5A, maximum input-output voltage differential is 40V and maximum power dissipation is 15W.

The output voltage of the circuit can be expressed simply as being equal to:

$$1.25 \left( 1 + \frac{RV1}{R1} \right)$$

So, with a preset resistance RV1 of 1kΩ and a fixed resistance R1 of 120Ω, the voltage is theoretically variable between 1.25 and 11.6 volts.

Housing is left to the reader. It is not particularly critical. The voltage regulator IC does, however, need to be mounted on an adequate heatsink to dissipate the heat generated. If you're mounting the whole project in a metal case, such as a diecast box, this solves the heatsink requirement quite neatly; simply bolt the IC to the case. This solution has the added benefit of allowing a suitable fixing method for the whole board. Alternative heatsinking can be effected using one of the many commercially available matt black finned heatsinks. These are rated in terms of their thermal resistance in °CW<sup>-1</sup>.

1st CLASS

Technically speaking, to give adequate heat dissipation from the voltage regulator, a heatsink with a thermal resistance of no greater than  $10^{\circ}\text{C/W}^{-1}$  should be used. Any greater than this and the device could be damaged by being driven past its maximum junction temperature. Saying that, this calculation for heatsink thermal resistance is made assuming maximum current flow of 1.5A at an output voltage of 9V. A lower current requirement (which will normally be the case) will allow use of a higher heatsink thermal resistance. For example, at a current consumption of 500mA at the same output voltage of 9V, the thermal resistance of the heatsink can be anything up to around  $60^{\circ}\text{C/W}^{-1}$ .

The project can be finished off by fitting a plug which matches the input power socket of the equipment, or an adaptor-plug with a variety of connector plugs in a star-arrangement can be fitted allowing the project to be used with equipment with different power sockets.

## PARTS LIST

### RESISTORS (all $\frac{1}{4}\text{W}$ 5%)

R1 120R  
RV1 1k $\Omega$

### CAPACITORS

C1 100n polyester

### SEMICONDUCTORS

IC1 317T voltage regulator

### MISCELLANEOUS

PCB or stripboard. Circuit board pins. Heatsink. Case. Connecting leads. Connecting plugs.

## Setting Up

Simplicity itself. Merely connect a voltmeter with at least a 10V range FSD to the project's output (noting and following correct polarity), connect the project to a 12V car battery (again noting and following correct polarity) and adjust preset resistor RV1 until the required voltage is obtained. Now disconnect the voltmeter and connect the project to your equipment.

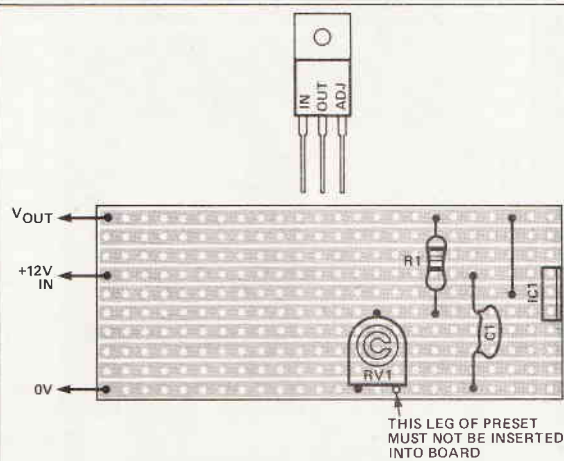

Fig. 3. Stripboard component layout and connection details (there are no track cuts necessary for this project)

## BUYLINES

Everything is easily obtainable. Integrated circuit IC1 is available from most mail order companies and your local stockist will have them off-the-shelf. The PCB is available from the PCB Service as detailed in the back of this issue.

**OUT  
NOW!**

**CRICKLEWOOD  
ELECTRONICS**

**1989 100 PAGE COMPONENT  
CATALOGUE PRICE £1**

SEND OFF FOR YOUR COPY TODAY...

- WE STOCK AN UNRIVALLED RANGE
- ALL OUR COMPONENTS ARE FIRST CLASS BRANDED ITEMS
- WE OFFER A SAME DAY SERVICE ON ALL STOCK ITEMS
- NO MINIMUM ORDER—IF YOU NEED ONE COMPONENT WE CAN SUPPLY ONE COMPONENT
- WE HAVE ADOPTED A NEW LOWER PRICING POLICY + QUANTITY DISCOUNTS
- FREE VOUCHERS WITH YOUR CATALOGUE—ORDER ONE NOW!...

JUST FILL IN THE COUPON OPPOSITE AND POST IT WITH YOUR £1 PAYMENT TO THE ADDRESS BELOW. YOU WILL RECEIVE NOT ONLY OUR SUPERB 100 PAGE CATALOGUE, BUT ALSO FREE VOUCHERS WHICH YOU CAN USE ON YOUR NEXT COMPONENTS ORDER.

CRICKLEWOOD ELECTRONICS LTD 40 CRICKLEWOOD BROADWAY LONDON  
NW2 3ET TEL: 01-450 0995/452 0161 FAX: 01-208 1441 TELEX: 914977

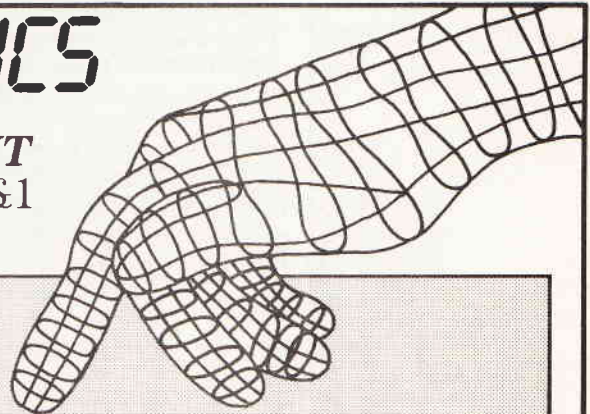

## FREE VOUCHERS!

SEND OFF FOR YOUR CATALOGUE  
AND VOUCHERS TODAY.

I WOULD LIKE TO RECEIVE.....  
COPY(COPIES) OF THE 1989  
CRICKLEWOOD ELECTRONICS  
COMPONENT CATALOGUE. I  
ENCLOSE £.....  
PLEASE ENCLOSE MY FREE  
VOUCHERS.

Tape your £1 coin  
here, or send a  
cheque or postal  
order for £1.00 for  
every catalogue you  
require.

NAME.....

ADDRESS.....



# SON OF VARIATION

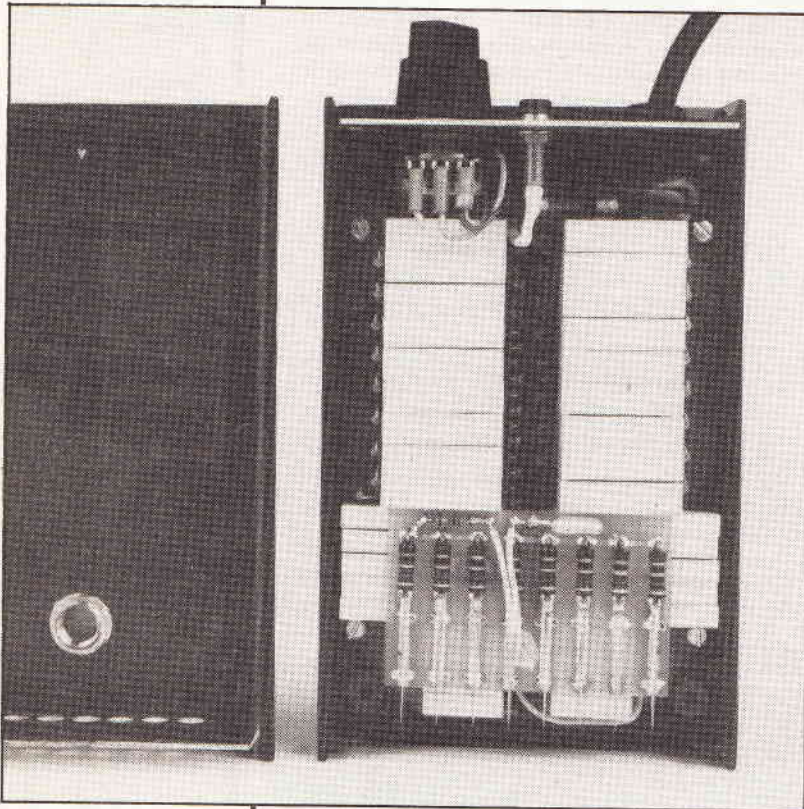

*Paul Chappell revisits the Variat-Ion ioniser of October 1988 for a few subtle but crucial changes to give even more charged bits for your money*

**N**o, it's not another ioniser design! No matter how popular ionisers may be with readers, three months from October's Variat-Ion is a little too soon to be contemplating another model. The thing is, no matter how good a project may be, there's always something that can be done to make it just that little bit better. Usually I resist the temptation to improve projects once they've been published, but for my favourite designs the urge to iron out every last wrinkle sometimes proves too strong for me.

This article describes the modifications and additions I've made to the Variat-Ion since last October. Don't worry if you missed the original circuit — the PCB layout is repeated here to show the alterations, so you could build the whole project from that.

## Air Ions

Having spoken at length about ions in the air in the first article I don't intend to repeat it all here. Suffice it to say that the purpose of an ioniser is to add negative charge to the molecules of the air, turning them into negative ions (neg-ions for short). The reason for wanting to do such a bizarre thing is that breathing ion-starved air makes you feel 'under the weather', while breathing ionised air makes you feel on top of the world. Or so people say.

Neg-ions are produced naturally and are around to a greater or lesser extent everywhere you go. After a storm the air is full of them. At the seaside or on a mountain top there are ions to spare. But in cities, inside modern houses and office blocks, there are hardly any.

The Variat-Ion not only re-charges the air with ions, it super-charges it. Every second it produces five times enough ions to make mountain-top levels. Give it an hour and you'll think your living room is a mountain by the seaside after a thunderstorm!

## Circuit Changes

The Variat-Ion is already about the ultimate as ionisers go, so no major changes have been made — it's mostly a matter of tidying up a few loose ends. The circuit diagram is shown in Fig. 1. The connections to the output level pot RV1 and to the neon are more sensible and there is no longer any need for a connection between the two — all wires now go to the PCB. The on-off switch pads have been removed since nobody wants to turn the ioniser off at all! If you are the exception to this, you can always wire a switch into the live wire of the mains input lead, so there's no loss in removing the connections from the board. The PCB layout and the new connections are shown in Fig. 2.

Something you'll also notice from Fig. 2 is that there are more resistors than before. Seventeen more to be exact. In the original project resistors of 1kV proof were specified but these are not too easy to obtain. The new resistors (R4a to R20a, all 10M) connect in series with the old resistors, reducing the stress on them so that ordinary carbon film types can be used. R3 has only half the voltage of the other so it doesn't need an extra one in series. The increase in total

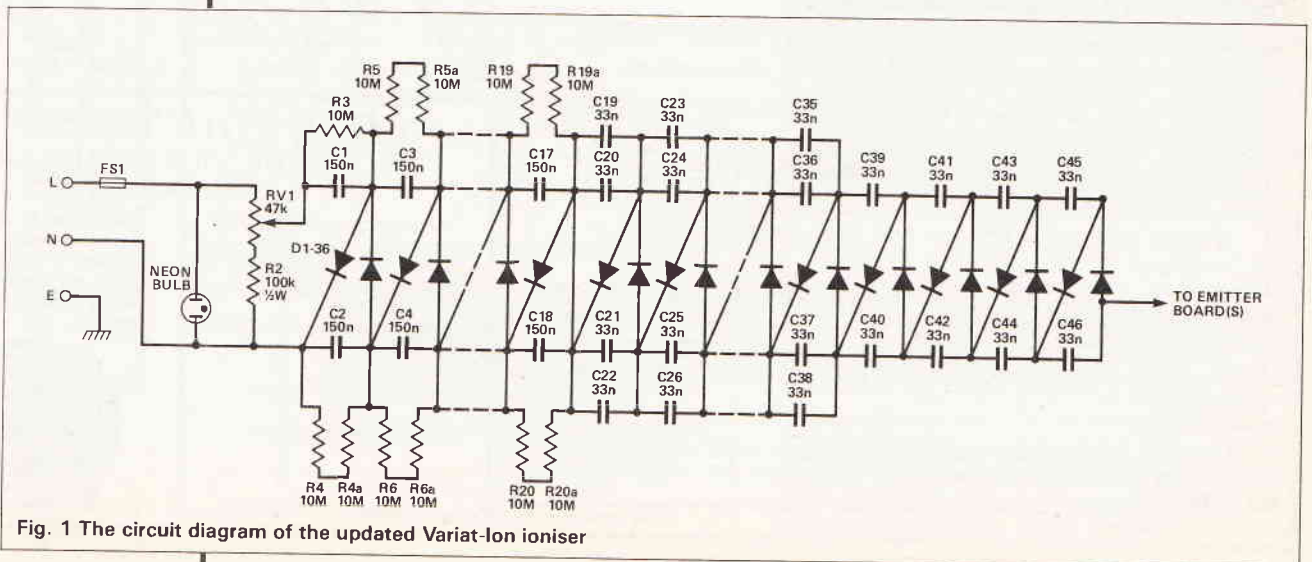

Fig. 1 The circuit diagram of the updated Variat-Ion ioniser

# PROJECT

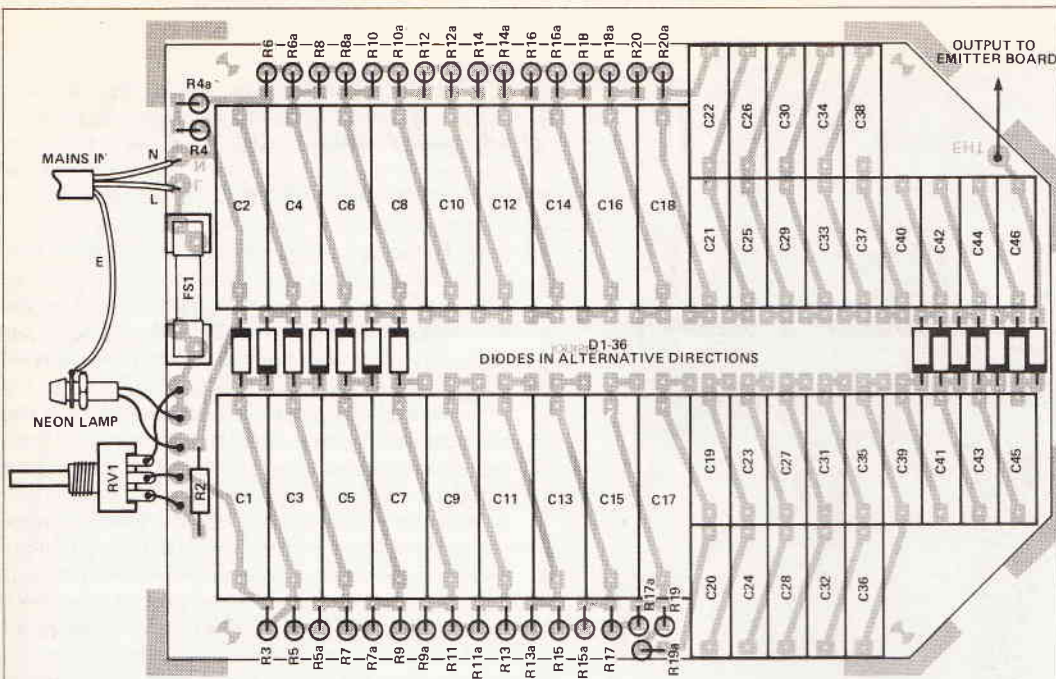

Fig. 2 Component layout and off-board connections for the modified main PCB. Note: if metal front panel is used, it must be earthed. The earth wire is connected to a OBA solder tag which is slipped over the body of the neon lamp and clamped to the front panel by its mounting nut

resistance across each section will also increase the efficiency of the ioniser a little, so the change is worth making.

That's all you need do to lift the main board from almost perfection to absolute perfection so it's on to the emitter section.

## Internal Emmitter

In the original article I suggested using a internal emmitter if the ioniser was to be used by youngsters, for safety reasons. My own reason for building one was slightly different: by using an internal *and* an external emmitter together, the Variat-Ion produces even more ions than before!

The circuit of the internal emmitter board is shown in Fig. 3 and the component layout in Fig. 4. Resistors R28-R35 are all 1/2W types to take advantage of their higher working voltage. They allow each emmitter point to establish its own working voltage (within reason) which makes for even greater efficiency. The board has its own ion counter and eight emmitter points.

The unusual thing about the PCB is that all components mount on the copper track side of the

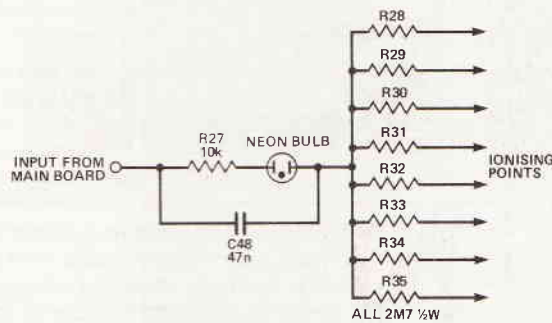

Fig. 3 The circuit of the internal emmitter section

## PARTS LIST

### RESISTORS (all 1/2W 5% unless specified)

R1	Not required
R2	100k 1/2W
R3-R20	10M
R4a-R20a	10M
R27	10k
R28-R35	2M7 1/2W
RV1	47k lin. pot.

### CAPACITORS

C1-C18	150n class X2
C19-C46	33n class X2
C48	47n 250V

### SEMICONDUCTORS

D1-D36	1N4007
--------	--------

### MISCELLANEOUS

PCB, Neon bulb, Needles.

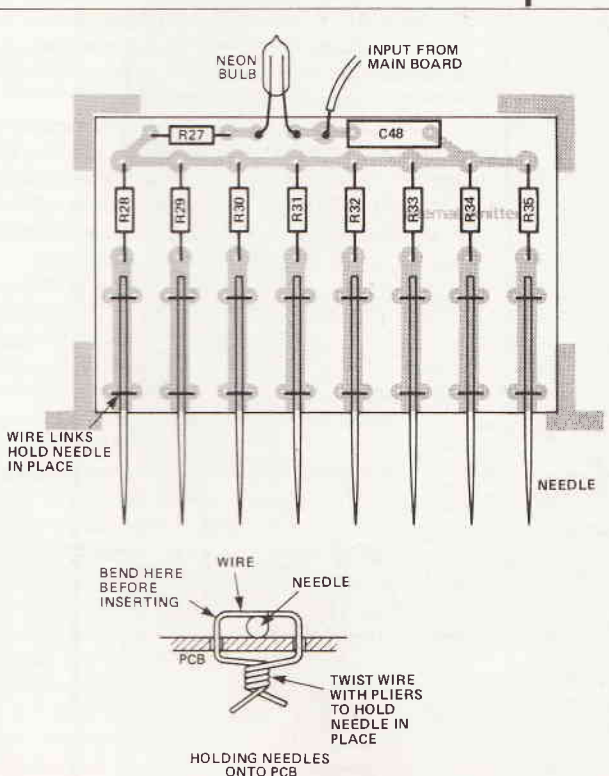

Fig. 4 Component layout for the internal emmitter board. Note that components are on the track side of the PCB

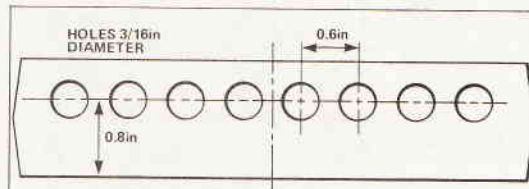
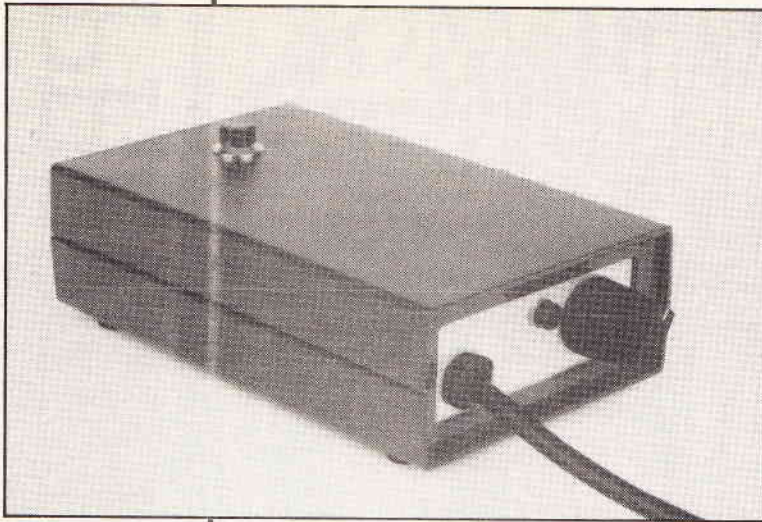

Fig. 5 Drilling diagram for the rear (plastic) panel

board. Bend the component leads and post them through the holes as usual, but solder at the top and cut the leads flush with the plain side of the board underneath. This is to leave a nice, flat surface so the PCB can rest on top of the 33n capacitors at the 'hot' end of the main board.

Insulate the neon leads and leave them fairly long, since it will have to reach at least to the top of the case, and further still if you decide you don't want the lamp to be immediately above the neon's board position.

The wire to join the emitter board to the main circuit is threaded through from the usual side — the plain side — and soldered on the copper side. When the board is in place it will run between the rows of capacitors on its way to the EHT output. Three inches of wire will be more than enough.

When you come to solder the needles, there are two ways to go about it. If you are supremely confident of your own manual dexterity you can do it like this. Wrap a rubber band around the needle end of the board at about the level of the first line of wire-line holes. Slip the eight needles under the band, one on each 'finger' and directly in the centre of it. Rest the PCB on top of the 33n capacitors on the main board and push it against the 150n capacitors so it's as far back as it will go. Slot in the rear panel of the case and adjust the needles so that the point of each is the same distance from the panel (about 1/16in). Now you can carefully remove the board from the case and solder the far end of each needle. Remove the rubber band, solder the front of each needle and you're done.

If you're a little less confident, the needles can be held more firmly in place with wire links through the holes provided. There's a trick to putting in the links — if you just loop them through the holes, no matter how hard you pull from the other side of the board they won't grip the needle. The wire will break first.

The trick is to bend the wire in two 'corners' before putting it through the holes so that it begins by lying flat on the top of the needle. Now when you tighten it (by twisting the ends at the back of the board) it will grip. The wires can be left in place and soldered along with the needles — cut off the twisted ends at the flat surface of the board afterwards.

When the components and needles have been mounted, clean off any dirt and flux residues with an IPA based board cleaner (isopropyl alcohol or isopropanol if you're a modern chemist, it's all the same). After cleaning the board thoroughly top and bottom, spray on a few coats of anti-corona compound, leaving it to dry between each coat. It's very tedious I know but a bit of patience will make all the difference when you turn the ioniser on. You'll be glad you took the trouble. If you place the board on top of the capacitors while the final anti-corona coat is not quite firm, it will glue it in place for you!

The final soldering job is to connect the input lead of the emitter board to the EHT output of the main board. When you glue (or stick with anti-corona spray) the emitter board to the capacitors, let the wire lie between the two rows. Once the glue is dry you can solder the free end of the lead to the main board and put a spot of Araldite over the joint to insulate it.

The drilling diagram for the plastic back panel is shown in Fig. 4. The holes should be 0.3in apart, since that's the spacing of the PCB 'fingers', and a little over 0.8in up from the bottom of the panel. On the prototype I made the holes just over 3/16in diameter — it doesn't allow prying fingers to get in but leaves the ions plenty of room to get out!

If you are making the enclosed version, the only thing left to do is to fix a lens for the neon bulb onto the lid of the box. The one in the photograph is from an incandescent lamp holder — I removed the bulb fitting and just used the lens and metal fixing parts. An alternative would be to cut off the lens of a spare panel neon, or to use the lamp as a whole if you can get at the series resistor to short it out or replace it with a 10k job. I fitted the lens about one inch away from the emitter end of the case but it's quite a stretch for the neon bulb so you might prefer to put yours a little further back.

That's about it for the internal version. You do have to put the case back together but I expect you guessed that yourself. For the two emitter version, all you need to do is to connect both emitter boards to the output of the main circuit — don't forget to insulate the joint with a dab of Araldite if you have to solder to an already sprayed board. You can use both ion counters if you put the two neons one on either side of the emitter brush (or whatever you're using).

That's about it for ionisers for the moment but don't think you've heard the last of it yet! Experimenting with different types of emitter has inspired me to make an ion meter which can check the output of any ioniser and also sniff out the ion levels around your house. It will be along very soon, so keep an eye on ETI (or an ion ETI if you like excruciating puns) for the project.



## BUYLINES

A complete parts set for the Variat-Ion (also known as the *Mistral*) is available from Specialist Semiconductors Ltd, Founders House, Redbrook, Monmouth, Gwent for £29.32, inclusive of postage and VAT. This set includes the original external emitter board and the modified main board.

There are no parts on the internal emitter board that should cause you the slightest difficulty. If you'd like to get them all in one place, a complete set including the PCB and even the needles is available from Specialist Semiconductors for £3.90 inclusive. Otherwise, the PCB is available from our PCB service and the components from your usual supplier.

A copy of the October 1988 article which described the construction of the project and a lot of info on air ionisation in general can be obtained from our photocopy service.



## Interak 1

### BUILD YOUR OWN COMPUTER

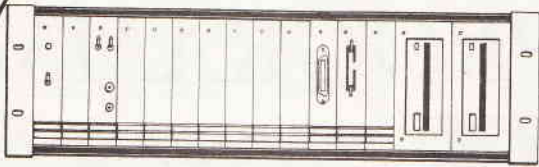

INTERAK can be commenced with the minimum of outlay. Bare boards from £10.95, beg borrow or steal the components, or buy from us - all parts available separately. No special or custom chips (ie PALS, ULAs, ASICs etc) used - no secrets.

Go as fast or as slowly as your funds and enthusiasm permit.

Made for those who must know what goes inside. Full circuit diagrams and descriptions are provided. And honestly, can you really use a computer effectively if you don't know what's inside and nobody will tell you?

Solid engineering construction - something to be proud of. 19" 3U rack mounting, plus in circuit boards and modular construction keeps obsolescence at bay.

Flourishing Independent Users Group, and newsletter. Hundreds of programs on disk at little or no cost from the Users Group. Program in machine code (Assembler), Basic, "C", Forth, etc. Database, Word Processing, Scientific applications.

Cassette tape operation or disk (up to 4 drives, 1 Megabyte 3.5" available from us, but you can add 3", 5.25", 8" if you want). Disk operating system CP/M Plus.

64K RAM, Z80 based at present with potential for expansion to a 16 Megabytes address space and Zilog's latest Z80280 in the future. Needs no specialised knowledge to construct, and we will happily get you out of a jam if you get into one.

Availability of personal and individual after sales service, impossible to obtain from large companies, who are only after your money. Security of supply - from Greenbank Electronics, established in 1970.

#### Greenbank

For more details write or phone us:

Greenbank Electronics, Dept. (T1E), 460 New Chester Road, Rock Ferry, Birkenhead, Merseyside L42 2AE. Tel: 051-645 3391.

### £150 + £125 = £1000?

Add our £125 sub-bass unit to your £150-per-pair "Best Buys" and your system will sound as if it has LARGE (and expensive!) speakers.

Although very compact, this ingenious Push-Pull design will fill-in that missing "Bottom Octave" and can be sited almost anywhere in the room - without affecting the stereo image. It can be connected directly into systems with medium sized speakers (87-90 dB sensitivity).

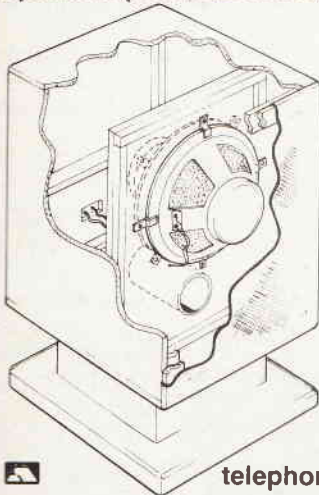

The Wilmslow Audio CPP sub-bass speaker kit contains 2 10" drive units, flatpack cabinet kit (inc. stand) machined from smooth MDF for easy assembly, low pass filters, grille fabric, reflex port etc.

Dims. (inc stand):

571x366x336mm

Amp. suitability:

20-120 watts

Impedance: 8 ohms

PRICE £125 inc. VAT plus carr/ins £11

telephone credit card orders

#### WILMSLOW AUDIO LTD.

35/39 Church Street, Wilmslow, Cheshire SK9 1AS Tel: 0625 529599

Call and see us for a great deal on HiFi (Closed all day Mondays)

DIY Speaker catalogue £1.50 post free (export \$6)

**ETI**  
ELECTRONICS  
TODAY INTERNATIONAL

# Top Projects

## 1988

ETI TOP PROJECTS 1988 presents a selection of the very best projects from a year of ETI crammed into one superb magazine.

Eighteen DIY delectables pack the 100 pages, covering the whole range from the essential to the esoteric, from the basic to the boggling!

Such great projects include Bicycle Speedometer, QWL Loudspeaker, Combination Lock, Passive Infra-Red Alarm and Metal Detector.

ETI TOP PROJECTS will provide plenty of reading throughout the festive season, and a multitude of marvellous morsels to keep your soldering iron smoking right through the winter!

The greatest hits from the finest electronics hobbyist magazine on the market - at just £2.50, is a treat not to be missed.

**ON SALE 16th DECEMBER.**

Alert your newsagent for a copy now or order direct (please add 50p p&p) from:

Infonet Ltd  
5 River Park Estate  
Billet Lane  
BERKHAMSTED  
Herts. HP4 1HL



# ETI STAND-ALONE EPROM PROGRAMMER

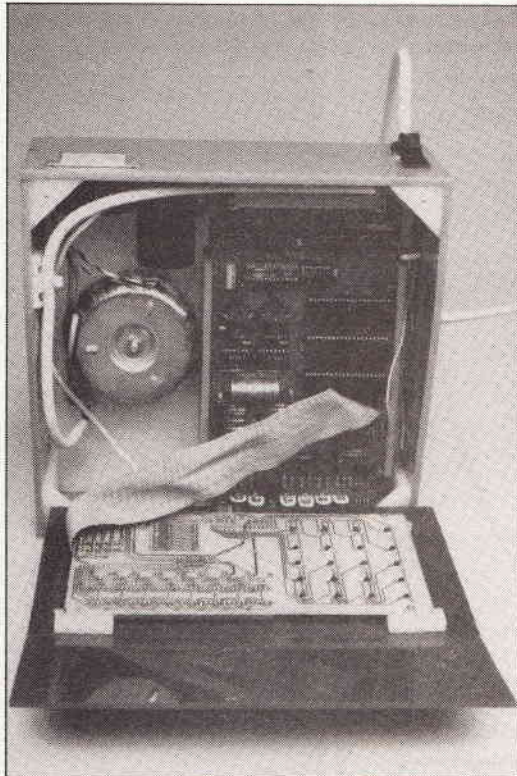

*Mike Bedford unveils the hardware of his new liberated programmer upgrade*

**T**his ETI Stand-alone EPROM Programmer has a long and proud ancestral history. The original design back in 1983 was able to program just about any EPROM around at the time but interfaced exclusively with the Tanbus system. This limited its appeal to Tangerine users (and some experimental users of other 6502

and 6809 based computers) but it was nevertheless an enormously popular project.

When technology progressed and memories enlarged, a MKII unit was produced to deal with EPROMs up to the 27512 and 27513. Although even larger EPROMs are available these days, their use is pretty unusual in a non-commercial situation (this means you) and we do not intend to put the price of this unit through the roof by catering for megamemories here.

Instead this new design upgrades the Universal EPROM Programmer to interface to virtually any computer system, using only an RS232 link. The project takes the MKII programmer as a starting point and adds local intelligence to implement programming, reading, verifying, editing, copying and data transfer. This also makes EPROM duplication or copying after minor changes to the data possible without any recourse to the host computer.

This stand-alone version can also include the EPROM emulator card from ETI July 1984 which can emulate EPROM sizes up to the 2764.

Table 1 shows the specifications available from the complete unit and Fig. 1 illustrates its operation in block diagram form. The programmer and emulator boards are all from the aforementioned projects as listed in the references at the end of the article. Any alterations are noted in the construction details later on.

Similarly the processor card requirements are easily fulfilled by the MCS Single Board Controller that was featured in ETI March 1985.

The main problem with the processor board is that it is no longer available from the original source. Any readers who have an unwanted board from previous projects or equipment might like to sell it

UPDATE

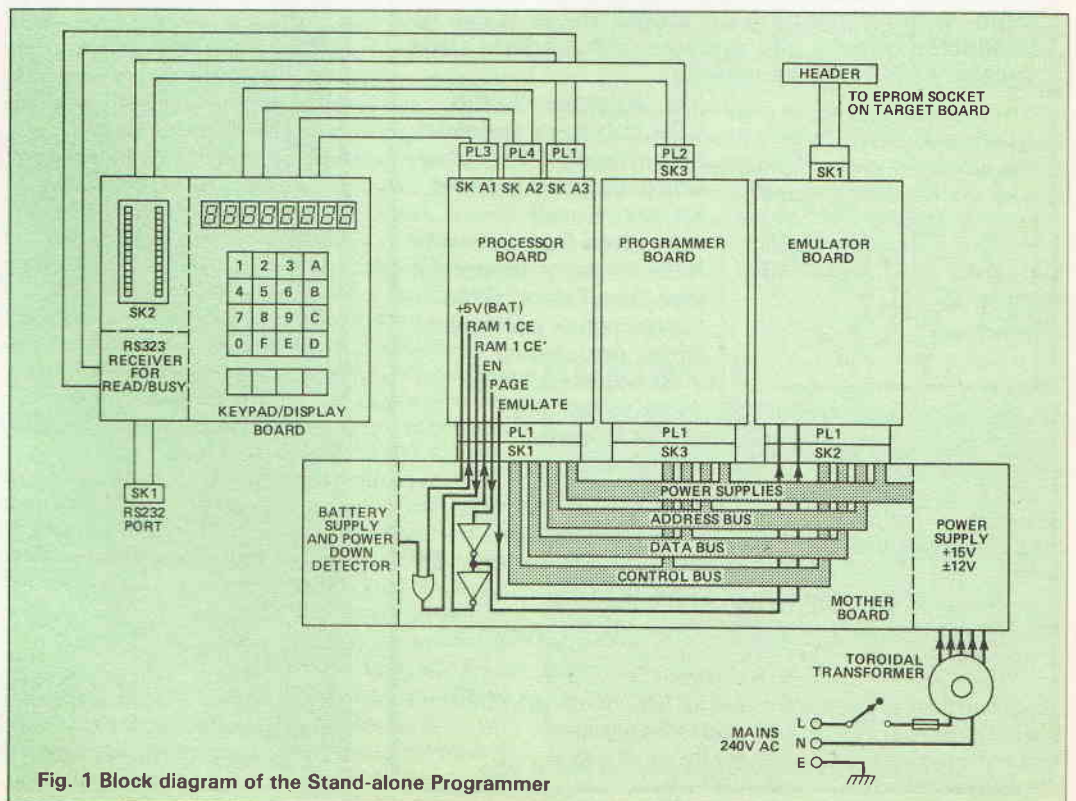

Fig. 1 Block diagram of the Stand-alone Programmer

through our Free Ads to eager constructors.

Readers in possession of MicroTan, Tanex and TanRAM units would be able to modify these with a small mother board to provide equivalent functions.

The last possible source of boards would be a future ETI article describing modifications to an existing 6809 processor board. If enough readers show interest in such a board this could be published in the near future.

Conforming to the Tanbus specification, the SBC processor board interfaces easily to the programmer and emulator cards. Up to 32k on-board RAM (after allowing for EPROM and scratchpad RAM) allows EPROMs up to 27256s to be fully programmed even without the emulator card in the system. Figure 2 shows the memory map of the processor card for this project.

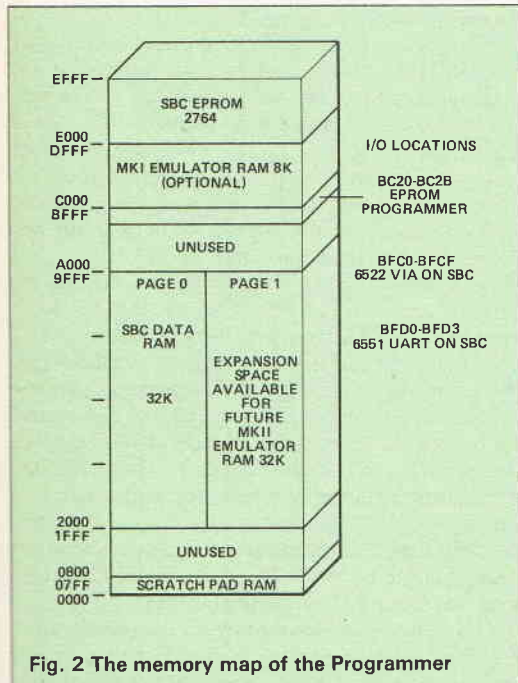

Fig. 2 The memory map of the Programmer

The user controls the programmer by means of a small keypad with dedicated keys, the feedback being through an 8-digit 7-segment LED display. A VDU, although more versatile, would be expensive and also inconvenient.

The mother board and power supply are only lumped together in Fig. 1 since it was convenient to fit both on the same PCB. The mother board provides little more than a bus network for the other cards.

## Keypad and Display

Firstly let's get the EPROM ZIF socket out of the way — it appears on this board only since it is handy to have it mounted near the keypad and display. It is connected by a ribbon cable to the programming board.

Similarly part of this board takes a ready/busy signal from the D-type RS232 connector and converts it to a TTL signal, passed as DSR to IC4 on the processor board (which alone provides a limited RS232 interface with only Rx/D and Tx/D at RS232 levels).

Neither of these sections of board affect the operations of the keypad and display in any way. These operations are fully described in *How It Works*.

The component overlay is shown in Fig. 3. It is suggested that sockets are not used for ICs since the board will be against the front panel of the enclosed unit and may prevent a flush fit. For the same reason the disc ceramic capacitors should lie flat.

The construction of the board should cause no problems. The ribbon cables take time but are difficult to connect incorrectly. Fitting SK2 after its associated ribbon cable makes the operations less fiddly.

The key caps recommended in *Buylines* are unlegended and can be labelled in transfer lettering followed by a coat of matt-finish varnish. The labels can be seen in Fig. 4.

## Mother Board

The mother board essentially consists of three DIN Euro-connectors wired in parallel to provide connection between the processor, emulator and programmer cards.

As always things are not quite that simple and a few extra signals are routed to the appropriate places on pins not used in the Tanbus specification. These signals are as follows:

- The page selection signal from the VIA on the processor via an inverter to the BE signal on the emulator and via a buffer back to BE on the processor.
- The emulation memory access signal from the VIA on the processor to the emulator.
- A chip enable signal for the non-volatile RAM, from the processor through a gate and back again.

This gating on the mother board prevents false writes at power up and down.

The power supply generates +5V at about 3A (for the three logic cards and the LED displays) and ±12V at low current for the RS232 drivers on the processor card.

The component overlay is shown in Fig. 5. Construction is extremely simple and should cause no problems. However, thorough testing of all outputs is recommended since the other boards will not react kindly to a fault here. Check soldering and tracks to ensure that nothing goes wrong at a later date either.

Although the board is simple, the transformer requires some work. The kit transformer (see *Buylines*) is supplied without secondary windings and with instructions generally in French or Flemish, which isn't very helpful (except for our French and Flemish readers).

The first secondary to be put on is the 8.5V which requires 90 turns of 18swg enamelled copper wire. The supplied bobbin is too large to pass through the transformer centre so wind an adequate length (10 metres) onto a narrow bobbin about 9in long constructed from very stiff cardboard or similar.

One end of the wire should be firmly taped onto the core with insulating tape, having first soldered a length of multi stranded insulated wire to it to act as the lead. Winding can now take place — straightforward but tedious. About 1½ complete layers of windings are required with a layer of the provided transparent tape tightly wound over the first layer.

The wire is then cut off, another length of wire for a lead is soldered to it and the end is firmly taped down. A further layer of the transparent tape should now be applied prior to starting the second secondary 240 turns of 24swg (about 25m).

The winding process is the same as before but a length of multi stranded wire needs soldering on as a lead after the first 120 turns. When both the windings are complete two layers of transparent tape should be used to finish off the transformer.

## Daughter Boards

The three daughter boards are all fully described in previous projects from ETI, available as photocopies (see *References*). To avoid repetition, nothing much will be said here about them at component level.

# UPDATE

### EPROMS SUPPORTED

2758	2564	27256*
2516/2716	2764	27512*
2532	2764A	27513
2732	27128*	
2732A	27128A*	

### FUNCTIONS PROVIDED

Read EPROM into memory  
Programme EPROM from memory  
Test EPROM for blank/checksum  
Verify EPROM against memory  
Input data from RS232 port  
Output data to RS232 port  
Copy data from memory to memory  
Search memory for string  
Fill memory with constant value  
Edit memory  
Split data into even/odd for 16bit

### PROGRAMMING ALGORITHMS

Standard 50mS pulse  
Fast 10mS pulse\*\*  
Intelligent algorithm\*\*

### RS232-C WORD FORMATS

7 Data, No parity, 1 Stop  
7 Data, No parity, 2 Stop  
7 Data, Even Parity, 1 Stop  
7 Data, Even Parity, 2 Stop  
7 Data, Odd Parity, 1 Stop  
7 Data, Odd Parity, 2 Stop  
7 Data, Mark Parity, 1 Stop  
7 Data, Mark Parity, 2 Stop  
7 Data, Space Parity, 1 Stop  
7 Data, Space Parity, 2 Stop  
8 Data, No Parity, 1 Stop  
8 Data, Even Parity, 1 Stop  
8 Data, Odd Parity, 1 Stop  
8 Data, Mark Parity, 1 Stop  
8 Data, Space Parity, 1 Stop

### RS232-C HANDSHAKING

Not required on input  
XON/XOFF or RDY/BSY on output

### DATA FORMATS SUPPORTED

Motorola S1 S9  
Intel loader  
\* Cannot be emulated  
\*\* Dependant on availability of algorithm on selected EPROM type

### Table 1 Universal Eprom Programmer/Emulator specification

**SBC - Construction**

LK1	A
LK2	B
LK3/4/5/6	only LK6 to be made
LK7	made
LK8	not made
LK9	made
LK10/11/12/13	only LK13 made
LK14	a-x
LK15	b-x
LK16	a-x
LK17	a-x
LK18	a-x
LK20	made
LK21	A
LK22	B
LK23	already made on PCB
LK24	A
LK25	not made

It is intended these links should be made by pin strips and link blocks, but if the SBC board is for no purpose other than as a component part of this project soldering short lengths of wire directly to the board is fine.

- A few more links are needed:
- Pin 27b on the edge connector to pin 12 on DIL socket A1
  - Pin 20b on the edge connector to pin 12 on DIL socket A2
  - Pin 25b on the edge connector to pin 24 of the RAM in F2 (this one pin of the RAM should be kept out of its socket and wired directly). Note that it is pin 24 of the 24-pin RAM not pin 24 of the 28-pin socket into which it plugs.

The track cut and wires run to edge connector pins 21b and 22b as shown in Figure 5.

**Table 2 Links on the processor board.**

# UPDATE

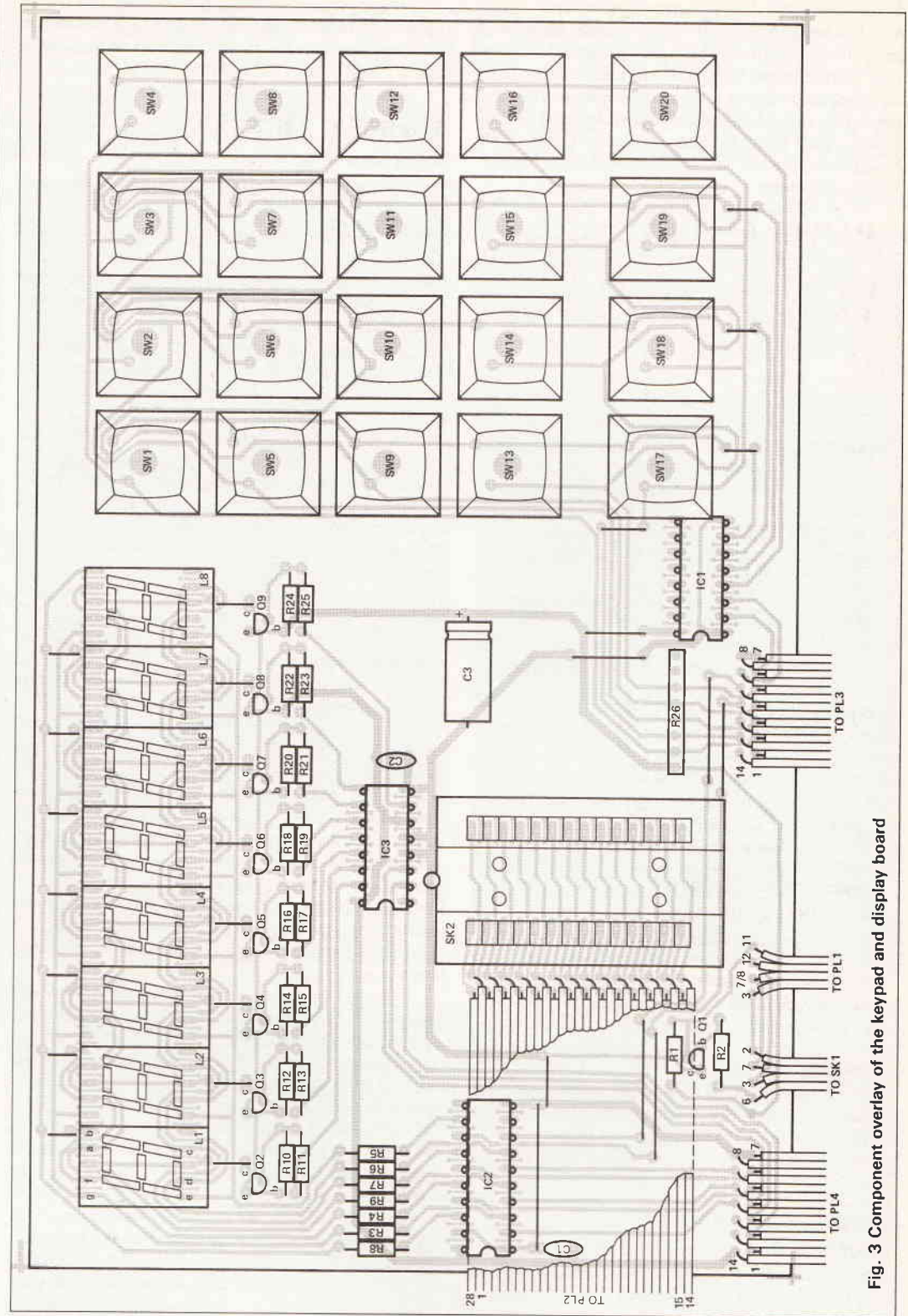

**Fig. 3 Component overlay of the keypad and display board**

The only aspect which requires consideration is the configuration of user selectable features and in particular the memory map. In order to allow a full 64K of user memory (required in addition to firmware, scratchpad RAM and I/O) a two page organisation is used, page switching being controlled by an output channel on the 6522 VIA.

Page 0 is resident on the main processor card whereas page 1 is available for further development (namely a MKII emulator card planned for the future). The firmware makes the pages appear as a single 64K area of RAM.

The processor card in its original form makes no provision for non-volatile (battery backed up) RAM memory. In this project, however, such a provision

would be very useful to avoid having to redefined the RS232 baud rates, RS232 data and parity bits of data format each time the unit is switched on. A slight modification to the processor board and a small amount of circuitry on the mother board to provide a battery supply to one chip and gating of its *chip enable* on power down to prevent false writes makes such a facility possible.

Construction of the processor cards is assisted by the manual, if you have one, and the original article (see *Buylines*). However, you should not use the manual's parts list as a number of features are not used. The parts list here shows all that is required, and the list of links in Table 2 should also be included.

The data for programming the memory mapping

PROM (numbered N3 in the manual) is shown in Listing 1. The final column is the actual data to be programmed to the locations in the second column.

Construction details of the optional emulator card are available in the original article (see *References*). To configure the emulator RAM at &C000 (see memory map in Fig. 2) wire the links on the DIL header as shown in Fig. 7a. Construction of the programmer board is again covered in its original article.

The only part specific to this project is selection of the correct address within the I/O area as &BC20. The links on the DIL header should be configured as shown in Fig. 7b.

## Putting It All Together

Now it is time to fit all the boards together. Don't forget to make sure the PSU is giving the right voltages in

## PARTS LIST

### Keypad and Display Board

#### RESISTORS (all 1/4W 5%)

R1,2	4k7
R3-9	150R
R10-25	1k0
R26	10k SIL 7 commoned resistor pack

#### CAPACITORS

C1,2	100n ceramic
C3	100µ 16V axial electrolytic

#### SEMICONDUCTORS

IC1	74LS139
IC2	74LS240
IC3	74LS138
Q1	BC184L
Q2-9	BC327
LED1-8	0.5in 7-segment red LEDs, common anode

#### MISCELLANEOUS

PL1,3,4	14-pin DIL header
PL2	28-pin DIL header
SK1	25-way D-type socket
SK2	28-pin DIL ZIF socket
SW1-20	switch modules plus blank keycaps (see Buylines)
PCB	14 and 28-way ribbon cable. Wire.

### Mother Board and Power Supply

#### RESISTORS (all 1/4W 5% except where stated)

R1	330R 2%
R2,5	10k
R3	68R 2%
R4,6	1k5
R7,8	4k7

#### CAPACITORS

C1	1500µ 15V electrolytic
C2,3	2200µ 25V radial electrolytic
C4	1µ0 35V tantalum
C5	100n ceramic
C6,8	220n ceramic
C7,9	470n ceramic

#### SEMICONDUCTORS

IC1	74LS04
IC2	4071
IC3	78H05
IC4	7812
IC5	7912
Q1	BC214L
Q2	BC184L
BR1	4A bridge rectifier
BR2	1A bridge rectifier
D1	1N4001

#### MISCELLANEOUS

FS1	20mm 1A mains fuse
SK1,2,3	DIN 41612 connectors, 64-way A+B sockets
SW1	panel mounting mains switch
T1	50VA toroidal transformer kit

PCB, 20mm fuse clip, 10m 18swg enamelled copper wire, 25m 24swg enamelled copper wire.

### Processor Board

#### RESISTORS (all 1/4W 5%)

R3,5,11,12,14	4k7
R4	1k0
R13	470R
RP1	4k7 SIL pack, 7 commoned
RP3	1k0 SIL pack, 4 separate resistors
RP4	1k0 SIL pack, 7 commoned

#### CAPACITORS

C1,7-14	100n ceramic
C2,15	10n ceramic
C3	100p ceramic
C5	100µradial electrolytic

#### SEMICONDUCTORS

B1	6522
C1	74LS393
C2	74LS04
D1	6551
D3	6502
D4	75150
E1	2764 programmed with firmware
E2	74LS244
E3	74LS244
F1,H1,K1,L1	2064 or 6264 8K x 8 static RAM
F2	6116P 2K x 8 CMOS static RAM
F3	74LS139
G3	74LS00
H3	74LS266
J3	74LS12
K3	74LS10
L3	74LS08
M3	74LS138 *NB This chip upside down
N2	74LS245
N3	74S288
Tr	BC184 (not BC184L used elsewhere)
D1-3	1N4001
XTAL 1	8MHz crystal
XTAL 2	1.8432MHz crystal

#### MISCELLANEOUS

DIN 41612 Connector, 64-way A+B plug, 3 x 14-way DIL sockets plus those required for ICs, 0.1in pin strips and jumpers for links if not hard wiring.

#### Overall Components

Mother board and power supply  
Keypad and display board  
MKII EPROM programmer board  
Processor board (Single Board Controller)  
MKI EPROM emulator board (optional)  
Case  
Fuse and fuseholder  
Mains switch  
3-way mains connector block  
Grommet  
Mains cable and plug

# UPDATE

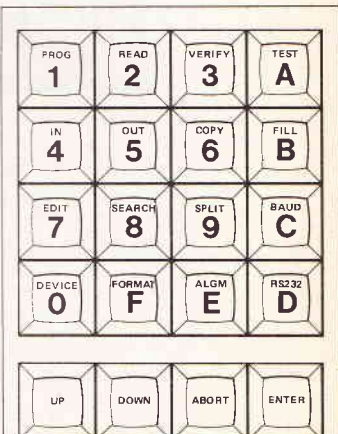

Fig. 4 Layout and legends for the keypad

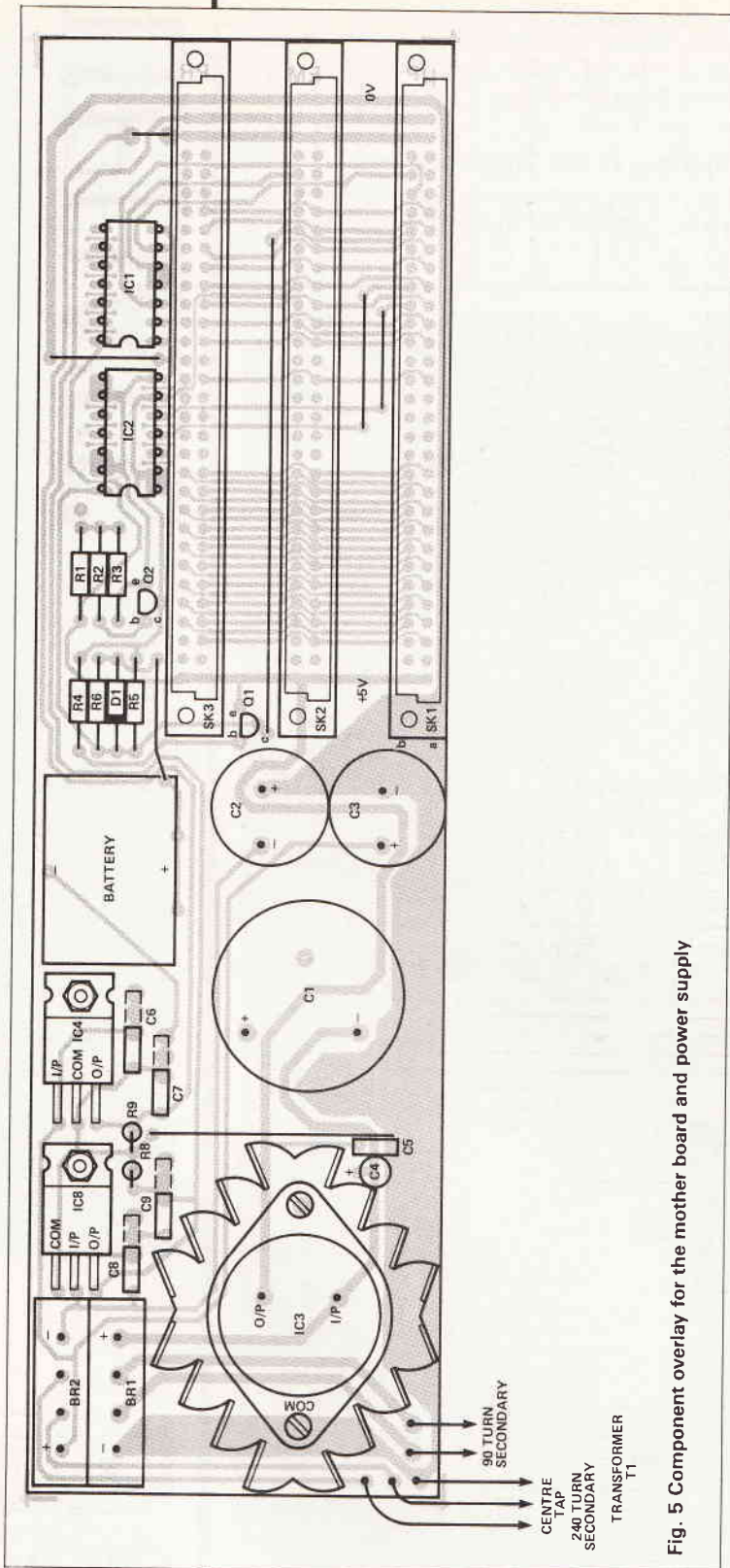

Fig. 5 Component overlay for the mother board and power supply

the right places before slotting the cards into the mother board.

- Plug the processor card into SK1 on the other board.
- Plug the programmer card into SK2 on the mother board.
- Plug the emulator into SK3 on the mother board.
- Plug PL1 from the keyboard/display board into socket A3 on the processor card.
- Plug PL2 from the keyboard/display board into socket SK3 on the programmer card.
- Plug PL3 from the keyboard/display board into socket A1 on the processor card.
- Plug PL4 from the keyboard/display board into

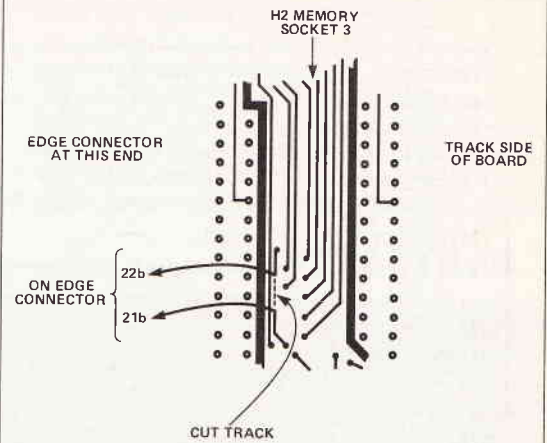

Fig. 6 Tracking modification for the processor board

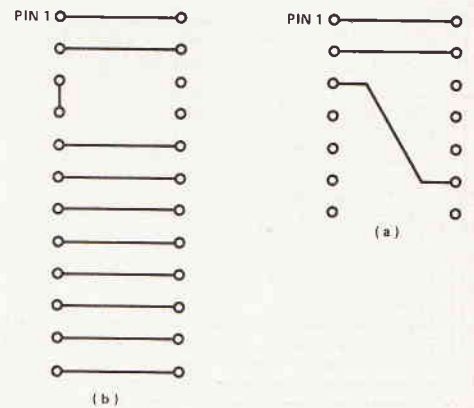

Fig. 7 (a) Links for emulator memory at &C000  
(b) Programmer board links for start address at &BC20

Processor Address Range (Hex)	Prom Address	Prom Data Bits	Hex Data
0000 - 07FF	00	0 0 0 0 1 0 1 0	0A
0800 - 0FFF	01	1 0 0 0 1 0 0 0	88
1000 - 17FF	02	1 0 0 0 1 0 0 0	88
1800 - 1FFF	03	1 0 0 0 1 0 0 0	88
2000 - 27FF	04	0 0 1 1 1 1 1 0	3C
2800 - 2FFF	05	0 0 1 1 1 1 1 0	3C
3000 - 37FF	06	0 0 1 1 1 1 1 0	3C
3800 - 3FFF	07	0 0 1 1 1 1 1 0	3C
4000 - 47FF	08	0 1 0 1 1 1 1 0	4C
4800 - 4FFF	09	0 1 0 1 1 1 1 0	4C
5000 - 57FF	0A	0 1 0 1 1 1 1 0	4C
5800 - 5FFF	0B	0 1 0 1 1 1 1 0	4C
6000 - 67FF	0C	0 1 0 1 1 1 1 0	5C
6800 - 6FFF	0D	0 1 0 1 1 1 1 0	5C
7000 - 77FF	0E	0 1 0 1 1 1 1 0	5C
8000 - 87FF	10	0 1 1 1 1 1 1 0	7C
8800 - 8FFF	11	0 1 1 1 1 1 1 0	7C
9000 - 97FF	12	0 1 1 1 1 1 1 0	7C
9800 - 9FFF	13	0 1 1 1 1 1 1 0	7C
A000 - A7FF	14	0 0 0 0 1 0 0 0	88
A800 - AFFF	15	0 0 0 0 1 0 0 0	88
B000 - BFFF	16	0 0 0 0 1 0 0 0	88
B800 - BFFF	17	0 0 0 0 1 0 0 1	89
C000 - CFFF	18	1 0 0 0 1 0 0 0	88
C800 - CFFF	19	1 0 0 0 1 0 0 0	88
D000 - D7FF	1A	1 0 0 0 1 0 0 0	88
D800 - DFFF	1B	1 0 0 0 1 0 0 0	88
E000 - E7FF	1C	1 0 0 0 0 0 1 0	82
E800 - EFFF	1D	1 0 0 0 0 0 1 0	82
F000 - F7FF	1E	1 0 0 0 0 0 1 0	82
F800 - FFFF	1F	1 0 0 0 0 0 1 0	82

Listing 1 SBC memory mapping Prom Data.

socket A2 on the processor card.

- Wire up the circuitry associated with the mains side of the toroidal transformer.

It should now work — assuming you've dealt

# UPDATE

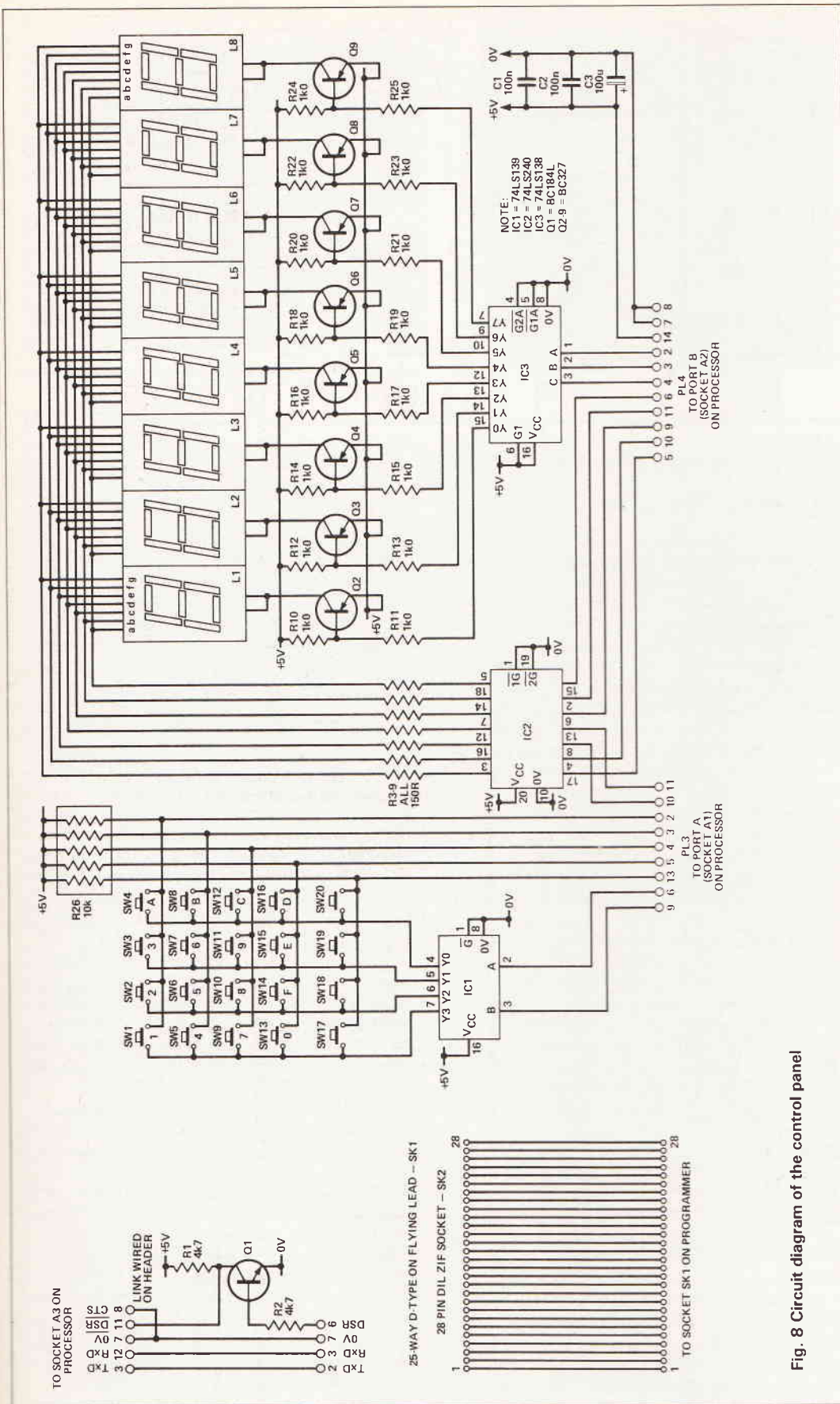

Fig. 8 Circuit diagram of the control panel

with the system ROM software to be described next month. However, building the unit up to be a robust and acceptable unit takes a little more time. The photographs show how the prototype was constructed and only a couple of handy hints are needed here.

Mount the keyboard/display board on pillars or long bolts from the base — that way the screws are kept off the top panel.

A couple of perspex pillars with notches across the three daughter cards will help to stop them shifting in the vertical plane and becoming loose.

It is worth slipping some thin sheets of insulating material between the cards to prevent any shorting. The clearances throughout this project are pretty small — this was to fit in a specific case which has since been rather inconveniently discontinued.

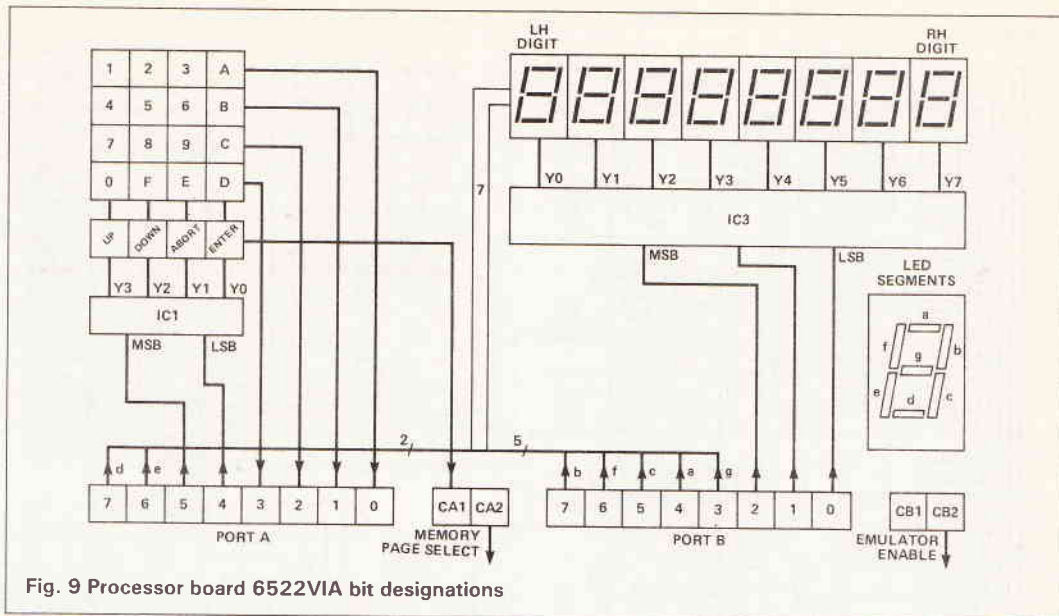

Fig. 9 Processor board 6522VIA bit designations

## HOW IT WORKS

Looking first at the keypad/display board (Fig. 8) the circuitry around Q1 is simple. An RS232 signal ( $\pm 12V$ ) is input on SK1/6 to the base of Q1. Clearly the +12V state will turn the transistor on giving a TTL low output whereas a -12V RS232 signal will turn the transistor off hence giving a TTL high output via R1. This signal is applied to the DSR input of the UART on the processor board.

The keypad is read by the 6522 VIA on the processor board through pins 13, 5, 4, 3 and 2 of PL3 each of which monitors one of the five rows of keys (Fig. 9). When all the keys are open the signals will all be held high by pull-up resistors (RP1). In order to detect depressions, the four columns of keys have a low level applied to them in turn. This is achieved by use of IC1 which gives a low at one of the four outputs depending on the binary value on the two inputs which are driven from the VIA. Once a low has been detected on one of the row inputs it is a simple task for the software to deduce which key was pressed from the column currently being driven.

The LED display is multiplexed so that only one of the eight is driven at any one time. The speed of multiplexing fools the eye into seeing all eight illuminated at the same time.

The LEDs used have a common anode - a device is selected by applying a positive supply to this common connection. The switching is achieved by PNP transistors Q2-9 driven by IC3. This chip gives a low level at one of its eight outputs depending on the binary value on its three inputs. The inputs are driven from the VIA via PL4.

Once the required LED has been selected, the appropriate segments are illuminated by applying a TTL low to their cathodes via current limiting resistors R3-9, again driven from the VIA via PL3 and PL4, through the buffer IC2 which provides the required current sinking capacity.

### Mother Board

Essentially the mother board (Fig. 10) consists of three 64-way sockets wired in parallel hence providing the address, data and control busses and power supplies for the three cards.

The processor card has been slightly modified to put two of its 6522 I/O channels onto its edge connector. These signals are *Emulate* and *Page*.

*Emulate* is connected on the mother board to the emulator board and controls whether the memory on this card is available to the processor on the processor card or as emulation memory to the processor on the target development board.

The *Page* signal is used to control which of the two 32K blocks of user memory is actually present in the memory map. When this signal is a logic zero it is fed back to the BE signal on the processor card via the two inverters in IC1 (giving a non-inverted signal) hence enabling the memory on this card. The signal routed to the BE pin on the emulator passes through one inverter and will therefore be a logic high under these conditions hence disabling the memory. Clearly output of a logic high as the *Page* signal will enable memory on the

emulator card only. The reason for using this two inverter configuration was to prevent the VIA output being loaded by more than the single TTL load which it is specified.

When the +5V supply is present at a proper level, the voltage at the junction of R1 and R3 will be sufficient to turn on Q2 which in turn switches on Q1 thereby allowing the +5V supply to be present on the +5V (BAT) line. Under these conditions the battery B1 will also trickle charge through current limiting resistor R6.

When the +5V supply is switched off, Q2 and hence Q1 will be switched off preventing the battery from discharging through the power supply. Instead, B1 now supplies the +5V (BAT) line through D1, this line being used to power the non-volatile CMOS RAM on the processor card during power down for data retention.

For such data retention it is also important to prevent glitches which occur on the bus during power up/down from corrupting the data in the RAM. A modification to the processor card brings out the CE signal for the RAM in question to the edge connector. This signal is gated by IC2a to prevent it going low except when the +5V supply is at its correct level. The gated CE signal is passed back to the RAM via the edge connector.

The chip which carries out this gating obviously has to be supplied by +5V (BAT) which limits it to a CMOS type. In adherence to usual CMOS practice the inputs to unused gates are held at a definite logic state to prevent them floating (and possibly switching on both output transistors simultaneously exceeding the power dissipation). The reason some are tied to 0V and the other to another output is purely to simplify the PCB artwork.

The remainder of the mother board is the power supply. The transformer provides secondaries of about 8V5 and 11V5-0-11V5 on load, the off load values being higher by about 13%, the regulation factor of this transformer.

The outputs of these two secondaries are full wave rectified by BR1 and BR2 respectively giving DC peak voltages of about 10.5V and 31V. The 10.5V supply is then smoothed by C1 and regulated to +5V by IC3. The level of the secondary voltage used was chosen to minimise the size of both the smoothing capacitor and the heat sink on IC3. The size of the heatsink depends on the current dissipated in the regulator and accordingly the voltage dropped across it. On the other hand, a high secondary voltage reduces the necessary value and thereby size of the smoothing capacitor. This compromise keeps both components to a reasonable size.

The requirements for the -12V supply were nowhere near as stringent as only a low current will be drawn from it. The smoothing capacitors are therefore quite small and the regulators dissipate very little power. This part of the circuit is very similar in principle to the +5V supply, the only difference being the way in which the supplies are referenced to the transformer secondary centre tap in order to provide a dual polarity supply.



## REFERENCES

The original EPROM Programmer appeared in ETI August and September 1983.

The MKII, from which the processor board of this project is taken, appeared in four parts from May to August 1985, but the July and August articles covered software only and are not relevant to this new design.

The EPROM emulator board is from the *Versatile EPROM Emulator*, in July and August 1984. The processor board is described in the article *Single Board Controller*, published March 1985.

To reduce the cost of ordering each article as a photocopy separately, ETI's Photocopy Service can supply copies of the MKII Programmer, the Emulator and the Single Board Controller as a single item, price £3. Contact ETI Photocopy Service, 9 Hall Road, Hemel Hempstead HP2 7BH. Ask for the Stand-Alone Programmer Pack.

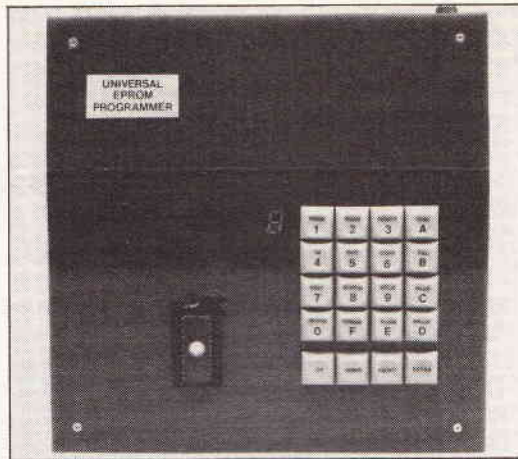

## BUYLINES

Most of the buying information for items in past projects is still valid.

However, as mentioned at the beginning of this article, the processor Single Board Controller is not available from either the original source or the ETI PCB Service.

The ROM labelled E3 on this board will be available from Gordon Bennett — details with the software next month. The other programmed part, the 27S288 memory mapping PROM N3, requires programming. If readers do not have the equipment — and if you're building a programmer this is quite likely — a blowing service is available from PLS, 16 Central Road, Worcester Park, Surrey KT4 8HZ. Tel: 01-330 6540.

The keyswitches and keycaps for the keypad board can be obtained from Verospeed (Tel: (0703) 644555) as parts 63-40781E

and 63-40791L respectively.

C1 on the mother board must be from Electromail (Tel: (0536)204555), part 164-348. The heatsink for IC3 is quite critical in terms of size. One suitable solution is available from Rapid Electronics (Tel: (0206) 272412).

The transformer is from Electronics and Computer Workshop (Tel: (0245) 262149) as part KT050. Most suppliers can only supply 18swg wire (for the secondary) in 2oz reels which isn't enough. Larger reels can be obtained from The Scientific Wire Company (Tel: 01-531 1568).

The battery B1 is 3V6, 0.1Ah. One suitable source is Farnell (Tel: (0532) 636311) if you have an account or Trilogic (Tel: (0274) 684289) if you don't. Part number 148-817.

# UPDATE



Next month we'll give the details of the system ROM and describe operation and programming functions.

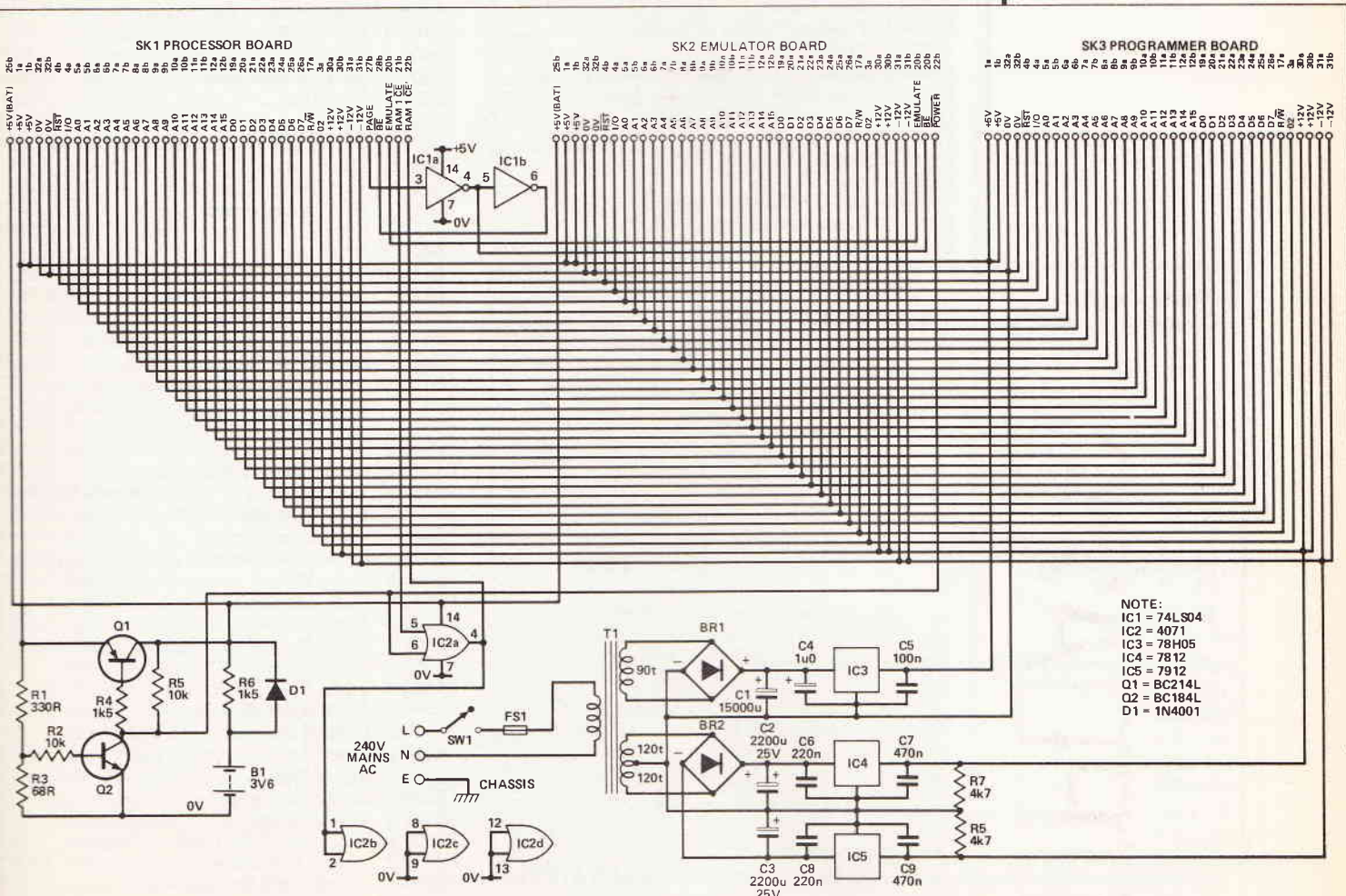

Fig. 10 Circuit diagram for the mother board and power supply

# ETI PCB SERVICE

Miss out the mess  
with ready-made  
pre-drilled PCBs for  
ETI projects

Use the form (or a photocopy) for your order. Please fill out all parts of the form.

Make sure you use the board reference number. This not only identifies the board concerned but also tells you when the project was published. The first two numbers are the year of publication and the next two the month. The number after the dash indicates the particular project in that issue.

Terms are strictly payment with order. We cannot accept official orders but we can supply a pro forma invoice if required. Such orders will not be processed until payment is received.

Please make cheques out to ASP Ltd. Payment can also be made through Access and Visa cards by telephone on (0442) 41221.

### Send your order to:

ETI PCB Service, ASP Readers Services, 9 Hall Road, Hemel Hempstead HP2 7BH

E8107-1	System A Disc Input board MC-MM	F
E8107-2	System A Pre-amplifier Main	K
E8108-1	System A Power Amp	L
E8109-2	System A PSU	F
E8201-2	Infant Guard	C
E8202-5	MM Stage Disc Pre-amp (Tilsbrook)	G
E8206-5	Logic Lock	F
E8208-1	Playmate Practice Amp (3bds)	K
E8212-1	ELCB	F
E8301-2	Analogue to digital conv ZX81/Spectrum	E
E8305-3	Dual Audio Power Supply, Linsley Hood	G
E8305-3	Balanced Input Preamplifier	F
E8307-2	Flash Trigger-sound or FR	F
E8308-1	Graphic Equaliser 1/3 Oct	M
E8308-2	Servo Fail-safe	C
E8309-1	NICAD Charger/Regenerator	F
E8310-3	Typewriter Interface — EX42	F
E8311-1	Mini Drum Synth	F

E8311-8	Moving Coil Pre-Pre-amp	F
E8312-3	Light Chaser EPROM Controlled (2 Bds)	K
E8402-1	Speech Board	M
E8402-2	Modular Pre-amp Disc Input Mono	F
E8402-3	Modular Pre-amp Stereo Output	F
E8402-4	Modular Pre-amp Relay, PSU	F
E8402-5	Modular Pre-amp Tone Main Mono	F
E8402-6	Modular Pre-amp Tone Filter, Stereo	F
E8402-7	Modular Pre-amp Balanced Output	F
E8402-8	Modular Pre-amp Headphone Amp	F
E8404-2	Mains Remote control Receiver	F
E8405-1	Auto Light Switch	F
E8405-2	ZX81 EPROM Programmer	N
E8405-3	Mains Remote Control Transmitter	H
E8405-4	Centronics Interface	F
E8405-6	Drum Synth	F
E8406-1	Oric EPROM Board	O
E8406-2	Spectrum Joystick	E
E8406-3	Audio Design RIAA Stage	G
E8406-4	AD Buffer/Filter/Tone	H
E8406-5	AD Headphone Amp	F
E8406-6	AD Preamp PSU	K
E8406-7	AD Power Amp	H
E8406-8	AD Power Amp PSU	J
E8406-9	AD Stereo Power Meter	F
E8406-10	AD Input Clamp	C
E8407-1	Warlock Alarm	M
E8408-2	EPROM Emulator	N
E8408-3	Infra-red Alarm Transmitter	E
E8408-4	Infra-red Alarm Receiver	F
E8409-1	EX42 Keyboard Interface	F
E8409-2	Banshee Siren Unit	F
E8410-1	Echo Unit	F
E8410-2	Digital Cassette Deck	N
E8410-3	Disco Party Strobe	H
E8411-5	Video Vandal (3 boards)	N
E8411-6	Temperature Controller	D
E8411-7	Mains Failure Alarm	D
E8411-8	Knite Light	D
E8411-9	Stage Lighting Interface	F
E8411-10	Perpetual Pendulum	E
E8412-1	Spectrum Centronics Interface	F
E8412-4	Active-8 Protection Unit	F
E8412-5	Active-8 Crossover	F
E8412-6	Active-8 LF EQ	F
E8412-7	Active-8 Equaliser	F
E8501-3	Digital Delay (2 bds)	T
E8502-1	Digital Delay Expander	N
E8502-2	Data Logger	J
E8503-1	Combo Preamplifier	F
E8503-2	THD Meter mV & oscillator boards (2 bds)	K
E8503-3	THD Meter Mains PSU	F
E8504-1	Framestore Memory	M
E8504-3	Framestore Control	N
E8504-4	Buzby Meter	E
E8504-5	CCD Delay	F
E8505-5	Stereo Simulator	F
E8506-1	Audio Mixer Main	J
E8506-2	Audio Mixer PSU	F
E8506-3	Audio Mixer RIAA	D
E8506-4	Audio Mixer Tone Control	D
E8506-5	EPROM Prog MKII	O
E8507-1	Noise Gate	H
E8508-1	RCL Bridge	N
E8508-2	EX42/BBC Interface	E
E8508-3	EPROM Emulator	L
E8509-1	Spectrum EPROM card	F
E8509-2	Direct Injection Box	E
E8510-9	Sunrise Light Brightener	K
E8511-1	MTE Waveform Generator	H
E8511-2	Millifaradometer	H

Please supply:

Quantity	Ref. no.	Price Code	Price	Total Price
Post and packing				£0.75
Total enclosed				£

Please send my PCBs to: (BLOCK CAPITALS PLEASE)

Name .....

Address .....

.....

..... Postcode .....

ACCESS and VISA credit card orders can be taken on (0442) 41221 during office hours.

# PCBS

E8511-3	Cymbal Synth	J	E8710-2	Concept Power board	K
E8511-5	Chorus Effect	H	E8710-3	Concept display board	G
E8511-7	Enlarger Exposure Meter	F	E8710-4	Hyper-Fuzz	F
E8511-8	Switching Regulator	E	E8710-5	Big Digits digit board	N
E8511-9	Second Line of Defence	M	E8710-6	Big Digits minute board	F
E8512-1	Specdrum Connector	F	E8710-7	Big Digits battery board	G
E8512-2	MTE Pulse Generator	H	E8711-1	Quiz Controller	E
E8512-3	Specdrum	L	E8711-2	256K Printer Buffer	N
E8601-2	Walkmate	L	E8712-1	Heating Management System	O
E8601-3	MTE Counter-timer	M	E8712-2	SWR Meter	H
E8602-1	Digibaro	O	E8712-3	Dream Machine (free PCB)	D
E8603-2	Programmable Logic Evaluation Board	H	E8801-2	Passive IR Alarm	H
E8603-3	Sound Sampler Analogue Board	R	E8801-3	Deluxe Mains Conditioner	G
E8604-1	JLLH PA PSU	H	E8801-4	RGB Dissolve	L
E8604-2	Matchbox Amplifier	C	E8802-1	Electric Fencer	E
E8604-3	Matchbox Amp Bridging Version	C	E8802-2	Telephone Intercom	L
E8604-4	MTE Analogue/Digital Probe	M	E8802-3	Transistor Tester (2 bds)	L
E8605-1	Microlight Intercom	E	E8802-4	Spectrum Co-processor CPU	N
E8605-2	Baud Rate Converter	M	E8803-1	Co-processor RAM board	N
E8605-3	Baud Rate Converter PSU Board	C	E8803-2	Beeb-Scope (3 bds)	O
E8605-4	Portable PA	H	E8803-3	Jumping Jack Flash	E
E8606-1	MIDI-CV Converter Board	H	E8804-1	Spectrum Co-processor Interface Board	N
E8606-2	MIDI-CV Converter PSU	D	E8804-2	Combo-lock	E
E8606-3	Troglograph	F	E8804-3	Kitchen Timer	E
E8606-4	80m Receiver	H	E8805-1	Virtuoso 2U PSU	M
E8606-5	Sound Sampler	R	E8805-2	Virtuoso 3U PSU	N
E8607-1	Direction	E	E8805-3	Bicycle Speedometer	F
E8607-2	Upgradeable Amp, MC stage (Stereo)	G	E8805-4	Dynamic Noise Reduction	E
E8607-3	BBC Motor Controller	F	E8806-1	Universal digital panel meter	L
E8608-1	Digital Panel Meter	G	E8806-2	Universal bar graph panel meter	K
E8608-2	Upgradeable Amp, MM stage (mono)	H	E8806-3	Virtuoso power amp board	N
E8609-1	Mains Conditioner	E	E8806-4	Virtuoso AOT board	G
E8609-2	Experimental pre-amp	F	E8806-5	Metal detector	E
E8609-3	Upgradeable amp, Tone board (mono)	H	E8806-6	Bicycle dynamo backup	D
E8609-4	Upgradeable amp, Output board (mono)	F	E8807-1	Bar Code Lock (2 bds)	N
E8610-1	Audio Analyser Filter Board	L	E8807-2	Analogue Computer Power Board	L
E8610-2	Audio Analyser Display Driver	K	E8807-3	Bell Boy	F
E8610-3	Audio Analyser Display	H	E8807-4	Logic Probe	J
E8610-4	Audio Analyser Power Supply	F	E8807-5	Updated FM stereo decoder	C
E8611-1	Audio Switcher (2 bds)	H	E8807-6	Breath Rate display board	F
E8611-2	PLL Frequency meter (4 bds)	Q	E8808-1	Breath rate main board	H
E8611-3	Upgradeable Amp PSU	J	E8808-2	Breath rate switch board	C
E8611-4	Call meter, main board	O	E8808-3	Telephone recorder	D
E8611-5	Call meter, interface board	N	E8808-4	Analogue computer main board (2 bds)	M
E8612-1	Bongo Box	J	E8809-1	Spectrum EPROM Emulator	M
E8612-2	Biofeedback monitor (Free PCB)	E	E8809-2	Frequency meter (2 bds)	P
E8701-1	RGB Converter	F	E8809-3	Travellers' Aerial Amp	E
E8701-2	Mains Controller	D	E8810-1	Gerrada Marweh Bikebell	E
E8701-3	Flanger	H	E8810-2	Peak Programme Meter (2bds)	N
E8701-4	Audio Selector main board	M	E8810-3	Variat-Ion ioniser	K
E8701-5	Audio Selector PSU	H	E8810-4	TV-to-RGB converter	E
E8701-6	Tacho-Dwell	F	E8810-5	Electron RGB buffer	C
E8702-1	Ratometer main board	K	E8811-1	NiCd Charger	E
E8702-2	Ratometer ranging board	F	E8811-2	Chronoscope (3 bds)	P
E8702-3	Photo Process Controller (3 bds)	O	E8811-3	Digital Transistor Tester	G
E8702-4	LEDline display board (2 off)	K	E8812-1	Doppler Speed Gun (2 bds)	K
E8702-5	LEDline PSU and controller (2 bds)	G	E8812-2	Small Fry Mini Amp	D
E8703-1	Capacitometer	F	E8812-3	Thermostat	E
E8703-2	Geiger Counter	L	E8812-4	Burglar Buster free PCB	D
E8703-3	Credit Card Casino	E	E8812-5	Burglar Buster power/relay board	E
E8704-1	BBC micro MIDI interface	L	E8812-6	Burglar Buster alarm board	C
E8704-2	ETIFaker patch box	H	E8812-7	Burglar Buster bleeper board	C
E8704-3	24Hr Sundial	E	E8901-1	EPROM Programmer mother board	M
E8705-3	MIDI Keyboard keyswitch boards (3 bds)	W	E8901-2	Variat-Ion updates main board	H
E8705-4	Batlite	C	E8901-3	Variat-Ion emitter board	E
E8705-5	Budget Power Meter	E	E8901-4	In-car power supply	C
E8706-1	Hi-fi Power Meter	N	E8901-5	Granny's hearing booster	E
E8706-2	MIDI Keyboard CPU	U			
E8706-3	MIDI Keyboard Front Panel	O			
E8706-4	Flame Simulator	G			
E8707-1	MIDI Keyboard PSU	H			
E8707-2	Telephone Alarm	J			
E8707-3	Nuclear Strategy Simulator	J			
E8708-1	Remindalite	F			
E8708-2	Rear Wiper Alarm	G			
E8708-3	Rev Counter	F			
E8708-4	Car Alarm	F			
E8708-5	Knight Raider	J			
E8709-1	Boiler Controller	G			
E8709-2	Amstrad Sampler (2 bds)	P			
E8709-3	Portable PA	G			
E8709-4	EEG Monitor (2 bds)	L			
E8710-1	Concept CPU board	N			

Price code	Price (inc. VAT)
C	£1.80
D	£2.50
E	£3.25
F	£4.00
G	£4.75
H	£5.50
J	£6.62
K	£7.20
L	£8.80
M	£10.60
N	£13.10
O	£15.80
P	£17.90
Q	£21.80
R	£23.90
S	£25.90
T	£29.00
U	£32.20
V	£35.80
W	£37.90
X	£40.70



**HART ELECTRONICS** are specialist producers of kits for designs by **JOHN LINSLEY-HOOD**. All kits are **APPROVED** by the designer.

**LINSLEY-HOOD CASSETTE RECORDER CIRCUITS**

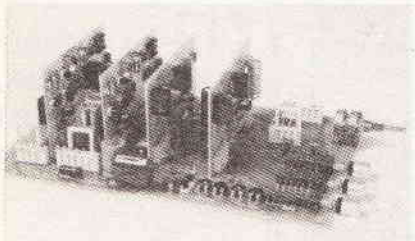

Complete record and replay circuits for very high quality low noise stereo cassette recorder. Circuits are optimised for our **HS16 Super Quality Sendust Alloy Head**. Switched bias and equalisation to cater for chrome and ferric tapes. Very easy to assemble on plug-in PCBs. Complete with full instructions.

- Complete Stereo Record/Play Kit ..... **£33.70**
- VU Meters to suit ..... **£2.30 each**
- Reprints of original Articles ..... **75p no VAT**
- 860X Stereo Mic Amplifier ..... **£8.70**

**LINSLEY HOOD 300 SERIES AMPLIFIER KITS**

Superb integrated amplifier kits derived from John Linsley-Hood's articles in 'HiFi News'. Ultra easy assembly and set-up with sound quality to please the most discerning listener. Ideal basis for any domestic sound system if quality matters to you. Buy the kit complete and save pounds off the individual component price.

- K300-35 35 Watt Discount price for Complete Kit ..... **£98.79**
- K300-45 45 Watt Discount price for Complete Kit ..... **£102.36**
- RLH485 Reprints of Original Articles from 'Hi-Fi News' ..... **£1.05 no VAT**

**LINSLEY-HOOD SUPER HIGH QUALITY AM/FM TUNER SYSTEM.**



Our very latest kit for the discerning enthusiast of quality sound and an exotic feast for lovers of designs by John Linsley-Hood. A combination of his ultra high quality FM tuner and stereo decoder described in "ELECTRONICS TODAY INTERNATIONAL" and the Synchronyne AM receiver described in "Wireless World". The complete unit is cased to match our 300 Series amplifiers. Novel circuit features in the FM section to include ready built pre-aligned front-end, phase locked loop demodulator with a response down to DC and advanced sample and hold stereo decoder together make a tuner which sounds better than the best of the high-priced exotica but thanks to HART engineering remains easy to build. The Synchronyne section with its selectable bandwidth provides the best possible results from Long and Medium wave channels, so necessary in these days of split programming. If you want the very best in real HiFi listening then this is the tuner for you. Since all components are selected by the designer to give the very best sound this tuner is not cheap, but in terms of its sound it is incredible value for money. To cater for all needs four versions are available with variations up to the top of the range full AM/FM model, with any unit being upgradeable at any time. Send for our fully illustrated details.

**STUART TAPE RECORDER CIRCUITS**

Complete stereo record, replay and bias system for reel-to-reel recorders. These circuits will give studio quality with a good tape deck. Separate sections for record and replay give optimum performance and allow a third head monitoring system to be used where the deck has this fitted. Standard 250mV input and output levels. These circuits are ideal for bringing that old valve tape recorder back to life. **K900W Stereo Kit with Wound Coils and Twin Meter Drive** ..... **£65.67**  
**RJS1 Reprints of Original Articles** ..... **£1.30 no VAT**

**HIGH QUALITY REPLACEMENT CASSETTE HEADS**



Do your tapes lack treble? A worn head could be the problem. Fitting one of our replacement heads could restore performance to better than new! Standard mountings make fitting easy and our TC1 Test Cassette helps you set the azimuth spot-on. We are the actual importers which means you get the benefit of lower prices for prime parts. Compare us with other suppliers and see! The following is a list of our most popular heads, all are suitable for use on Dolby machines and are in stock.

- HC20 Permalloy Stereo Head.** This is the standard head fitted as original equipment on most decks ..... **£7.66**
  - HS16 Sendust Alloy Super Head.** The best head we can find. Longer life than Permalloy, higher output than Ferrite, fantastic frequency response ..... **£14.86**
  - HQ551 4-Track Head** for auto-reverse or quadrophonic use. Full specification record and playback head ..... **£14.60**
  - HX100 Stereo Permalloy R/P Head.** Special Offer ..... **£2.49**
  - MA481 2/2 Language Lab R/P Head** ..... **£13.35**
  - SM166 2/2 Erase Head.** Standard mounting, AC type ..... **£8.85**
  - SM150 2/2 Erase Head.** DC Type ..... **£3.60**
  - HQ751E 4/4 Erase Head** for Portastudio etc. .... **£46.80**
- Full specifications of these and other special purpose heads in our lists.

**HART TRIPLE-PURPOSE TEST CASSETTE TC1**

One inexpensive test cassette enables you to set up VU level, head azimuth and tape speed. Invaluable when fitting new heads. Only **£4.66** plus VAT and 50p postage.

**Tape Head De-magnetiser.** Handy size mains operated unit prevents build up of residual head magnetisation causing noise on playback ..... **£4.54**  
**Curved Pole Type** for inaccessible heads ..... **£8.85**

Send for your free copy of our **LISTS**. Overseas please send 2 IRCs to cover surface Post or 5 IRCs for Airmail.

Please add part cost of post, packing and insurance as follows:

- INLAND**  
 Orders up to £10 - 50p  
 Orders £10 to £49 - £1  
 Orders over £50 - £1.50
- OVERSEAS**  
 Please send sufficient to cover Surface or Air Post as required.

Personal callers are always very welcome but please note that we are closed all day Saturday

**24hr SALES LINE (0691) 652894**

**ALL PRICES EXCLUDE VAT UNLESS STATED**



**SPECIAL OFFER — ALTAI DIGITAL MULTIMETER**

- ★ Full 3½ digit multimeter — 0.25% basic accuracy, 10A ac/dc
- ★ Temperature measurement
- ★ Capacitance measurement — up to 20µF
- ★ Transistor gain measurement
- ★ Full ac/dc capability
- ★ 10 functions
- ★ Complete with leads

**£49.95**  
 INC VAT & POSTAGE

DC VOLTAGE	RESOLUTION	ACCURACY
200mV	100µV	
2V	1mV	
20V	10mV	±(0.25% of reading + 1 digit)
200V	100mV	
1000V	1V	

Input Impedance: 10M on all ranges. Overload Protection: 1000V dc or peak on all ranges.

DC CURRENT	RESOLUTION	MAX FS ACCURACY	VOLTAGE DROP
200µA	100nA	±(0.5% rdg + 1d)	0.25V
2mA	1µA	±(0.5% rdg + 1d)	0.25V
20mA	10µA	±(0.5% rdg + 1d)	0.25V
200mA	100µA	±(0.75% rdg + 5d)	0.25V
2mA	1mA	±(2% rdg + 5d)	0.75V
10A	10mA	±(2% rdg + 5d)	0.30V

Overload Protection: mA Input 2A/250V fuse 10A Input: Utilised up to 15A for 15 seconds.

AC CURRENT	RESOLUTION	ACCURACY	FREQ RANGE
200mV	100µV		
2V	1mV		
20V	10mV	±(0.5% rdg + 5d)	45Hz-500Hz
200V	100mV	±(0.5% rdg + 5d)	on all ranges
750V	1V	±(1% rdg + 5d)	

Conversion: Calibrated for rms of sine wave. Input Impedance: 10M shunted by 100pF on all ranges except 200mV range. Overload Protection: 1000V dc or 750 rms ac continuous, except 15 sec max above 300V on 200M range.

AC CURRENT	RESOLUTION	MAX FS ACCURACY	VOLTAGE DROP
200µA	100nA	±(0.75% rdg + 5d)	0.25V rms
2mA	1µA	±(0.75% rdg + 5d)	0.25V rms
20mA	10µA	±(0.75% rdg + 5d)	0.25V rms
200mA	100µA	±(0.75% rdg + 5d)	0.25V rms
2000mA	1mA	±(2% rdg + 5d)	0.75V rms
10A	10mA	±(2% rdg + 5d)	0.30V rms

Overload Protection: mA Input 2A/250V fuse 10A Input: Utilised up to 15A for 15 seconds.

RESISTANCE	RESOLUTION	MAX OPEN ACCURACY	CIRCUIT V
200Ω	100mΩ	±(0.5% rdg + 3d)	2.8V
2kΩ	1Ω	±(0.3% rdg + 1d)	2.8V
20kΩ	10Ω	±(0.3% rdg + 1d)	500mV
200kΩ	100Ω	±(0.3% rdg + 3d)	500mV
2MΩ	1kΩ	±(0.75% rdg + 5d)	500mV
20MΩ	10kΩ	±(3% rdg + 5d)	500mV

Max allowable input: 500V dc or rms

**CONTINUITY TEST**

Resistance range: Buzzer sounds at approximately less than 200Ω

**DIODE TEST**

Test voltage: 2.8 Volts. Maximum test current: 3mA

TEMPERATURE	RESOLUTION	ACCURACY
-20°C to 1370°C	1°C	±(3% + 1d) up to 150°C ±3% of rdg over 150°C

Sensor: Type K (NiCr-NiAl)

CONDUCTANCE	RESOLUTION	ACCURACY
200nS	0.1nS	±(1.5% rdg + 10d)

CAPACITANCE	RESOLUTION	ACCURACY
2000pF	10pF	±(1.5% FS + 5d)
20nF	0.001µF	±(2% FS + 5d)
20µF	0.01µF	±(2% FS + 5d)

HFE TEST, Test condition: 10µA 2.8V. HFE gain 0-1000(npn pnp).

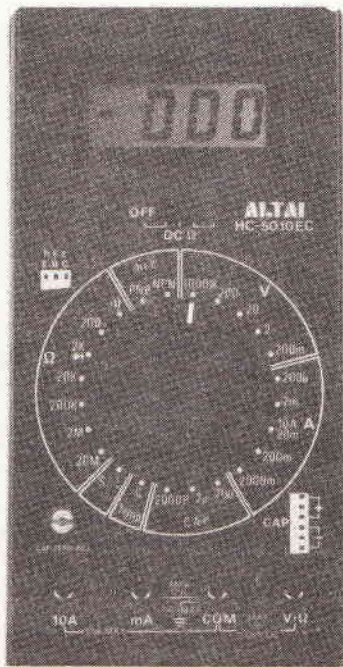

**THE** Altai HC-5010EC digital multimeter features a 0.5 inch 3½ digit lcd display with polarity, low battery and overrange indication. The meter gives 200 hours typical battery life with a 9V alkaline battery. The meter has a tilt stand built in, measures just 170x87x42mm and weighs 383gms. It is provided with an operator's manual, test leads, with extra screw-on insulated crock clip connectors, and a plug-in thermocouple for temperature measurement.

Post to: Meter Offer, BK Electronics, Unit 5, Comet Way, Southend-on-Sea, Essex SS2 6TR. Tel: 0702 527572

Please complete the coupon in BLOCK CAPITALS

Please supply		
Quantity	Item	Value
	Altai Digital Multimeters at £49.95 each (including VAT and postage)	£
<b>Total</b>		£

Visa/Access or Cheque No .....  
 Signature .....  
 Name .....  
 Address .....

**WE CAN ACCEPT VISA AND ACCESS ORDERS BY TELEPHONE**

# PCB FOIL PATTERNS

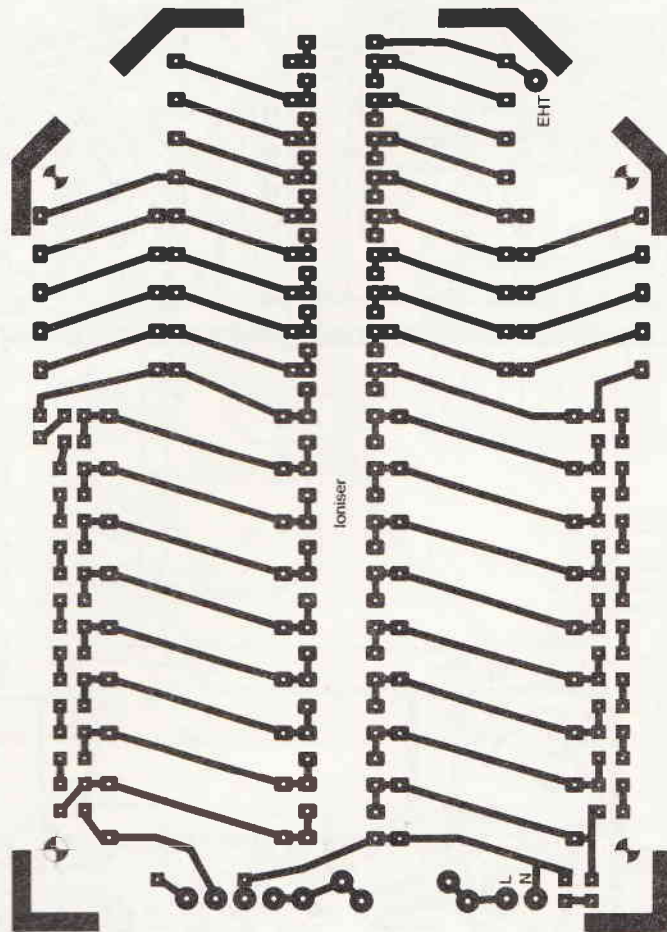

The updated Variat-ion ioniser main board

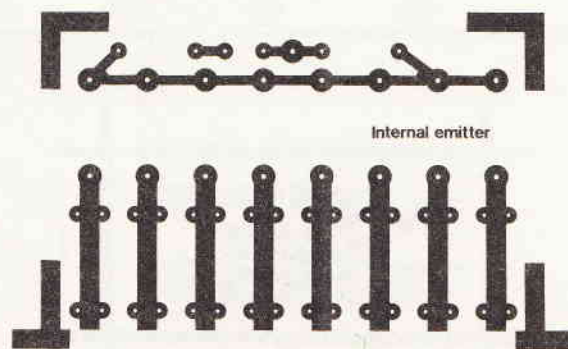

The updated Variat-ion ioniser emitter board

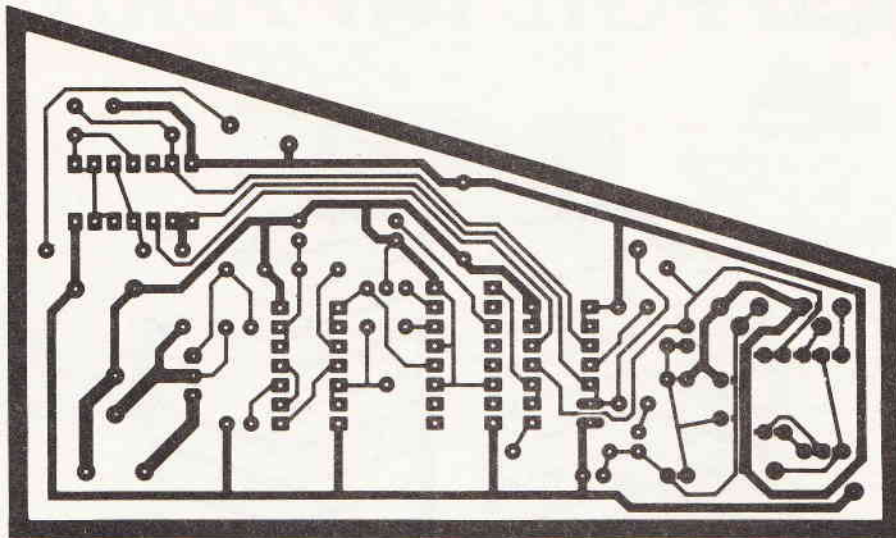

The Rev-rider foil pattern

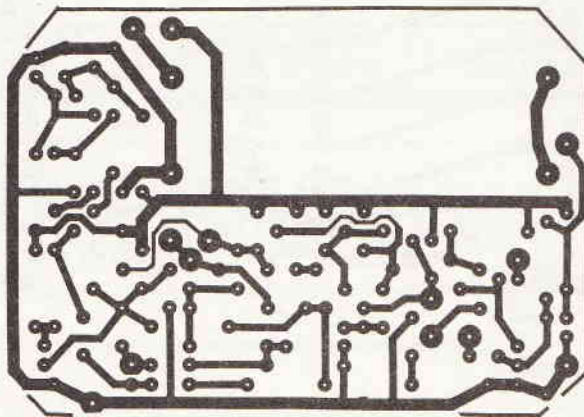

The hearing booster for Granny

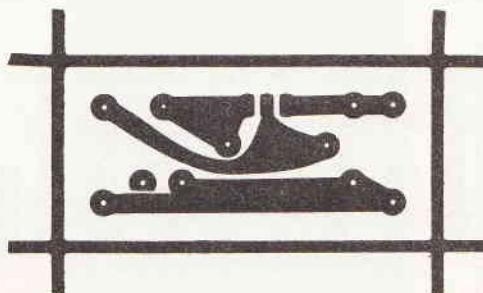

The In-Car power supply board

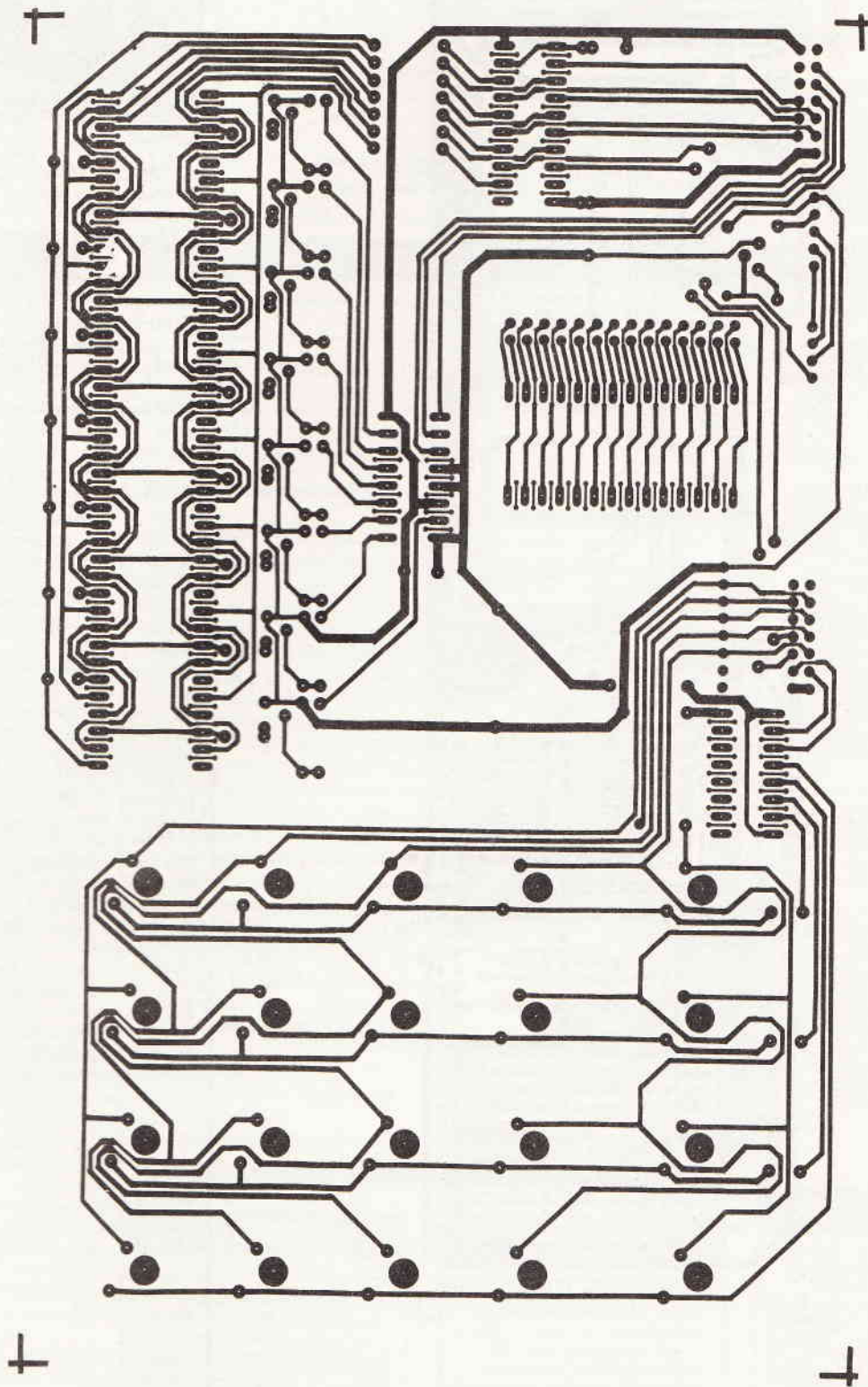

The EPROM Programmer key/display board

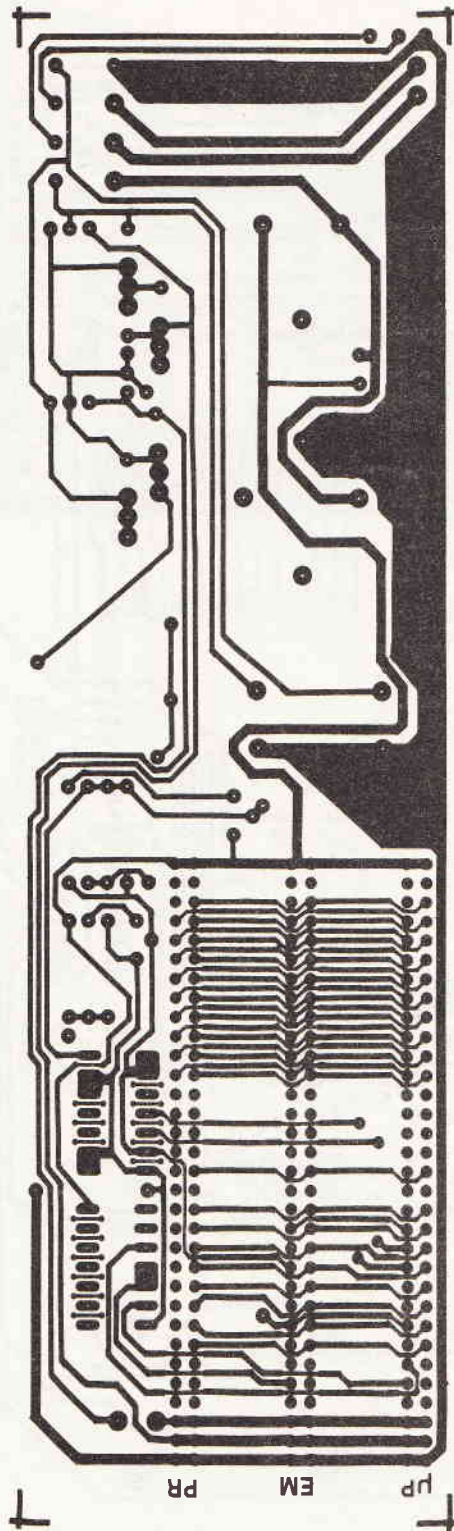

The EPROM Programmer mother board foil



### Heating Management System

(December 1987)

A 4116 is not a suitable alternative to the 6116 specified. A 4016 RAM chip will suffice. In Fig. 1 the junction of R1/D5 should connect to D1-4/C1 and not cross. The zener diodes above the temperature sensor ICs (IC16-19) should be deleted. C4 should be 220n and not 220 $\mu$ . C7-10 should be 10 $\mu$ . Q2-7 should be 2N3904 and not BC3904.

### RGB Auto-Dissolve

(January 1988)

In Fig. 5 there are marked two D6's. The right hand one should be D5 (they are both 1N4148's anyway). In the text the reference to zener diode D5 should read ZD1.

### Power Conditioner

(January 1988)

There is confusion between the values of R7 and R8 in the Parts List and Fig. 1. These should be: R7-27k, R8-10k and not as given in the Parts List. In addition, ZD1 is incorrectly orientated in Fig. 3. The positive terminal should be at the southern end.

### Passive Infra-Red Alarm

(January 1988)

Fig. 2(a) shows the base of Q1 connected to ground and to R14. It should be connected only to R14.

### Transistor Tester

(February 1988)

The foil pattern for the main board was printed reversed left-right on the foil pages. R14 is incorrectly given in Fig. 1 as 330k. It should be 330R as in the Parts List.

### Spectrum Co-processor

(March 1988)

Mogul Electronics, given in the Buylines as suppliers of the RAM chips, have moved to: Unit 11, Vestry Estate, Sevenoaks TN14 5EU. Tel: (0732) 741841.

### Dynamic Noise Reduction

(May 1988)

The LM1894 is no longer available from the sources listed but it can be obtained from the author. Please address orders to Manu Mehra, 88 Gleneagle Road, Streatham, London SW16 6AF.

### QL Output Port

(Tech Tips May 1988)

Several problems with the diagram for this one. A5 should read AS — that is, address strobe. Pins 22 and 24 should be connected to +5V and the junction of the (only) resistor and diode connected to VPA on the QL.

### QWL Loudspeakers

(August 1988)

Some dimensions were missing from Fig. 7. The bass driver port centre should be 3 $\frac{3}{4}$ in above the base of the baffle panel. The notches in the side of the tweeter cut-out are  $\frac{1}{2}$ in wide. The top plate is missing from the cutout diagram (Fig. 6). This is 7  $\times$  4 $\frac{5}{8}$ in.

### EEG Monitor

(September 1987)

The wiring for the switch SW1 in Fig. 5 shows all the wires for selecting Alpha and Beta waves swapped. A<sub>1</sub> should read B<sub>1</sub>, A<sub>2</sub> should read B<sub>2</sub> and so on. The easiest remedy is to swap the front panel labelling shown in Fig. 6 so that the switch labelling reads Theta, Beta, Alpha.

### Chronoscope

(November 1988)

In the overlay diagram for the counter PCB (Fig. 3) the polarity of C12 is shown the wrong way around. SW1a-d is shown as SW1-4. In Fig. 4 the cathodes of LED 8 and 9 are the righthand and lefthand pads respectively. The cathodes for LED 6,7 are marked as the wrong pin. In the text section on Battery Operation, Q1 should read T1. In Fig. 5 SW2 is incorrectly labelled SW5.



# ETI

## ELECTRONICS TODAY INTERNATIONAL



### CLASSIFIED

Heather Wust  
01-437 0699 Ext 292

Send your requirements to:  
Heather Wust, ETI Classified Department, ASP Ltd.,  
1 Golden Square, London W1.

Lineage: 54p per word VAT inclusive (minimum 15 words)  
Semi Display: (minimum 2 cms)  
£12.80 per single column centimetre + VAT

Ring for information on series bookings/discounts

All advertisements in this section must be prepaid.  
Advertisements are accepted subject to the terms and  
conditions printed on the advertisement rate card (available on request)



### COMPONENTS AND MATERIALS

- Series X Mixer Kits
- up to 1000 inputs
- on-board mic input
- 6 auxiliaries
- versions for recording  
FA, radio, disco
- From £9.92



Send 19p for catalogue to:

K. Tek, P.O. Box 172A, Surbiton,  
Surrey KT6 6HN. Tel: 01-399 3990

**PROMS - EPROMS - PALs**  
Any programmable IC supplied or blown  
Typical prices (excluding VAT) (Date Entry P&P extra)  
2716 £4.20 2732 £3.65 2764 £2.85 27128 £4.40  
BIPOLAR PROMs from £1.35 eg 82S123 16S030 74S235  
PALs, PLDs etc. from £3.26 eg 82S163 16L8 EP310  
Full design and prototyping service. Any quantity  
programmed - SAE or phone for details.  
P.L.S., The Central Road, Worcester Park,  
Surrey, KT4 8HZ. Phone: 01-330 6540

▶ **TOP QUALITY** ◀  
▶ **INEXPENSIVE** ◀  
▶ **ELECTRONIC** ◀  
▶ **COMPONENTS &** ◀  
▶ **TOOLS** ◀

To obtain our latest  
CATALOGUE

Send SAE and £2.50 to  
PO Box 10, St Annes-on-Sea  
Lancs FY8 1SA

**ELECTRONIC SUCCESS LIMITED**

Advertise  
your  
Components  
and  
Materials  
here

Tel: Heather Wust  
**01-437 0626**

#### LIGHTING EQUIPMENT FOR THEATRE, GIGS, DISCO

Professional dimmer modules from 1-5kw. Multiway channel desk  
modules: with master faders. A+B switching & flash; 4-10 way  
Sequencers — sound to light — rope lights — strobes; Parcans  
— clusters — floods; Cables — connectors — stands; All makes  
of lighting control equipment serviced & repaired. Write or phone  
for lists: 24hr Barclaycard phone orders. Fast return service  
CUSTOM CONTROLS, 144 Warwick Road,  
Upper Edmonton, London N16 1RT. 01-884 0881

### KITS

**EDU-SCOPE** Build your own solid  
state oscilloscope - complete kit of  
parts excluding case . . . . . £29.99  
**EDU-SCOPE CASE KIT** . . . £11.95  
**LOW COST LEAD/PROBE** . £3.95

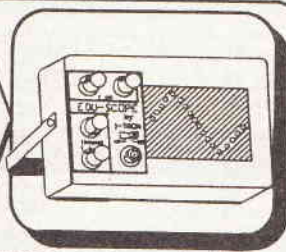

**BUG-89** Micro sized surveillance transmitter - can be received by any  
FM/VHS radio or our MICRO-FM - PCB size only 50x20mm . . . . £5.25  
**MICRO-FM** A micro miniature personal FM receiver - High quality IC  
design (no alignment problems) - Great for surveillance work or for just  
listening to your favourite radio shows! (cased) . . . . . £7.99  
**ROBO-VOX** Instantly transforms your voice into into Dalek/Robot type  
- also amazing feedback sound effects possible (cased) . . . . . £11.95  
**ROBOT CIRCULAR** Unique radio controlled robot - can also be  
converted to control via computer . . . . . £18.95  
**THERAMIN MUSIC GENERATOR** An electronic device based on an  
ancient legendary mystical instrument (cased) . . . . . £12.75  
**SOLARTRONICS-88** Enter the exciting world of Solar Electronics with  
our Solar Designer's experimenter kit . . . . . £7.75  
**SUPER SOUND-FX MICROCOMPUTER** An easy to use and  
program single chip sound effects Micro completely self contained -  
Incredible sound routines already masked programmed into the device -  
this is our most popular kit at present . . . . . £9.95  
**SOUND-FX PRO CONSOLE CASE KIT** . . . . . £3.99

Please add £0.95 per order for P&P.  
For FREE Datapack on all our Kits/  
Products send SAE. - Allow up to 14  
days for delivery - Make Cheques/Po's  
payable to :-  
ITRON U.K.

Castle Mill, Lower Kings Road  
BERKHAMSTED  
Hertfordshire HP4 2AD

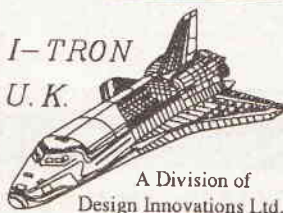

I-TRON  
U.K.

A Division of  
Design Innovations Ltd.

### BOOKS

#### FULL WORKSHOP SERVICE MANUALS

Any Video Recorder — £12.00 inc.  
Any Colour TV, Audio, Test, Vintage, etc.  
£6.00 inc. Please state Make/Model/Type  
with order. FREE Catalogue Unique Repair  
and Data Guides with all orders or LSAE for  
your copy.

**MAURITRON TECHNICAL SERVICES**  
(ETI), 8 Cherry Tree Road, Chinnor,  
Oxfordshire, OX9 4QY.  
Tel: (0844) 51694

### WANTED

Turn your surplus  
transistors, IC's etc., into  
cash. Immediate settlement.  
We also welcome the  
opportunity to quote for  
complete factory clearance.  
Contact:

**COLES HARDING & CO.**  
103 South Brink  
Wisbech, Cambs.  
**ESTABLISHED OVER 10 YEARS**  
Tel: 0945 584188  
Fax Number: 0945 588844

### TERMS & CONDITIONS

#### CLASSIFIED ADVERTISING TERMS & CONDITIONS

Our terms for new advertisers (semi-display  
and lineage) are strictly pro-forma payments  
until satisfactory reference can be taken up  
(excluding recognised advertising agencies  
Cheques and P.O.'s should be crossed and  
made payable to ARGUS SPECIALIST  
PUBLICATIONS LTD and sent together with the  
advertisements to:

The Classified Dept.,  
No. 1 Golden Square,  
London W1R 3AB.

There are no reimbursements for cancellations.  
Advertisements arriving too late for a particular  
issue will be inserted in the following issue  
unless accompanied by instructions to the  
contrary. It is the responsibility of the advertiser  
to ensure that the first insertion of every series  
is published correctly, and corrections must be  
notified in time for the second insertion,  
otherwise the publishers will not accept liability  
or offer any reduction in charges.

All advertising sales are subject to Government  
Regulations concerning VAT. Advertisers are  
responsible for complying with the various legal  
requirements in force eg. The Trade Description  
Act, sex discrimination act & the business  
advertisements (disclosure) order 1977.  
Full Terms & Conditions of Advertising  
available on request.

Copy deadline for March issue is  
**DECEMBER 15TH**

## COURSES

Start training now for the following courses. Send for our brochure — without obligation or Telephone us on

REF: ET1/6/88

06267 79398

NAME \_\_\_\_\_

- Telecomms Tech C&G 271
- Radio Amateur Licence C&G
- Micro-processor
- Introduction to Television

Radio & Telecommunications Correspondence School, 12, Moor View Drive, Teignmouth, Devon. TQ14 9UN.

## PCB'S

**PRINTED CIRCUIT BOARDS** At very competitive rates: 4 pence per square centimetre (less for orders of 10 plus) 1 off; 100 offs. Enquiries: Watling Wires, 52 Watling Street, Nuneaton, Warwickshire, CV11 6JL. Telephone (0203) 382296.

### QUALITY PRINTED CIRCUITS

- ★ Established 15 years ★
- ★ Single or double sided boards ★
- ★ Plated through hole boards ★
- ★ Personal service ★

**PAYNE ELECTROPRINT LTD**  
 Marcus Road, Dunkeswell  
 Nr Honiton, Devon EX14 0RA  
 Tel: Sales 040 489 646/664

**PCB Manufacturers**  
 Which to Choose  
 See Page 15

## SWITCHES

**VOICE/SOUND ACTIVATED SWITCHES** easy to follow diagrams and uses only £1.00. Components and P.C.B.'s available: **Herrington, 63 Home Farm Rd, Hanwell, London W7 1NL.**

## FOR SALE

Eproms ex equip all blank and tested: 2764, £1 each, £9 for 10; 2756, £2 each, £18 for 10; 200 step, stepper motors, 24/12 volts, £3 each. Add £1 p&p.

**EXTECH, THE COMPUTER CENTRE,**  
 53 Queens Street, Morley LS27 8DB  
 Tel: (0532) 537219

**TELESCOPIC AERIALS,** eight-section, 30 inches long, swivel base, £1 each inclusive. Quantek Electronics, 45a Station Road, Northfield, Birmingham B31 3TE.

### THE SCIENTIFIC WIRE COMPANY

811 Forest Road, London E17.

Telephone 01-531 1568

#### ENAMELLED COPPER WIRE

SWG	1lb	8 oz	4 oz	2 oz
8 to 34	3.63	2.09	1.10	0.88
35 to 39	3.82	2.31	1.27	0.93
40 to 43	6.00	3.20	2.25	1.61
44 to 47	8.67	5.80	3.49	2.75
48	15.96	9.58	6.38	3.69

#### SILVER PLATED COPPER WIRE

14 to 30	10.10	5.20	2.93	1.97
----------	-------	------	------	------

#### TINNED COPPER WIRE

14 to 30	3.97	2.41	1.39	0.94
----------	------	------	------	------

Post Free. Please add V.A.T. at 15%.

Orders under £3.00 add 50p.

SAE for list of copper and resistance wire.

Dealer enquiries welcome.

## PLANS AND DESIGNS

**ELECTRONIC PLANS,** laser designs, solar and wind generators, high voltage teslas, surveillance devices, pyrotechnics and computer graphics tablet. 150 projects. For catalogue. SAE to Plancentre Publications, Unit 7, Old Wharf Industrial Estate, Dymock Road, Ledbury, Herefordshire, HR8 2HS.

## SURVEILLANCE

### ESKAN ELECTRONICS

LEADING MANUFACTURERS AND SUPPLIERS OF SURVEILLANCE AND SECURITY EQUIPMENT.

MINIATURE TRANSMITTERS, TELEPHONE MONITORING EQUIPMENT, AND MANY OTHERS.

Send stamped addressed envelope for your free catalogue to:

172 Caledonian Road, London N1 0SG.

Telephone 01-278-1768

Trade Enquiries Welcome

### Omigron 2

The practical surveillance solution

£17.95 inc p&p

- Ideal eavesdropper or baby monitor
- Less than 1/2 matchbox size
- Absolutely shockproof housing
- Built-in sensitive microphone
- Battery life 72 hrs (Alkaline)
- Full 12 months warranty

Simply clip Omigron 2 to battery and hide — no adjustments, no fiddling, no fuss. Hear every sound perfectly on an ordinary FM radio up to 1/4 mile away. This must be the easiest to use, best value surveillance device available. No quibble 14 day money back guarantee.

TRADE: MILLEA ELECTRONICS  
 ENQUIRIES: 470-472 LEYMOOR ROAD,  
 WELCOME HUDDERSFIELD HD7 4QF.

Tel: (0484) 46003

Discuss your advertising details with Heather Wust  
**01-437 0626**

## PROJECTION

**AMAZING PROJECTOR** turns any size television into a 7ft TV screen! Easy to assemble! £15 — quantity rates available! Box 2296 ONO, Israel.

## COMPONENTS AND EQUIPMENT

**DRAMS:** 256k—12/15ns, £3.50/£4; 64k—15ns, £1; 16k, 50p; 4416, 16x4, £1.50. Tel: 021-355 3724.

## SPECIAL OFFERS

### J.P.G. ELECTRONICS

Resistors 1/4w 5% carbon E12 1P 1% metal fm E243P  
 Resistor Pack B5 different E12 values plus ohm link, total content of resistor 1,000 ..... £8.95  
 LED's Red/Green 3/5mm 6p each; Yellow 11p each  
 Cable Ties 75mm 1p ea. £5.95/1,000; £49.50/10,000  
 Power Transistors T/T 35C, TIP36C, 100V, 25A TIP3, Plastic case ..... £1.56 each  
 100db Piezo Buzzer ..... £1.50; Standard Buzzer ..... 80p  
 Solar Cells 0.45v 100mA ..... £1.48; 700mA ..... £3.50  
 Stepping motor 4 phase 12v 7.5 step 50ohms ..... £8.95  
 SAA 1027 Stepping motor drive chip ..... £3.95  
 Miniature FM transistor kits 100 108MHz high quality sound ideal for cordless microphones or guitars etc. £7.48  
 Metal Latching XLR line plug ..... £1.35  
 Line Socket ..... £1.48  
 Ferric Chloride pack for mixing with 1/2 litre water ..... £1.40  
 Flux cord solder 500g ..... reel £4.95  
 Automatic Squeeze action wire ..... stripper £3.45

#### SPECIAL OFFERS

Computer grade capacitors with screw terminals 58,000 uf 80v £4; 4,700 uf 63v £1.50; 38,000 uf 20v £1.95; 87,000 uf 10v £1.50.  
 Stereo LW/MW/FM tuner, pre-amp complete with volume/tone control and tuning scale. Brand new in makers box £5.95; Faulty £1.95.  
 Circuit diagram, description and setting up procedure for tuner assemble described above 50p  
 LCD display 16 digit 7x5 dots matrix ..... £2.50  
 Query keyboard 58 key unsealed good quality switches £5  
 CMOS TTL 74HC 74F linear transistor kits, capacitors, resistors, tools etc, always in stock.  
 Please add 75p +p per order VAT inc.  
**J.P.G. ELECTRONICS, 276 Chatsworth Road, Chesterfield S40 2BH. Callers welcome.**  
 Access orders (0246) 211202

## SCOPES

### MENDASCOPE LTD

REPAIR & RECALIBRATE OSCILLOSCOPES  
 ALL MAKES ALL MODELS NATIONWIDE COLLECTION & DELIVERY  
 FREE ESTIMATES  
 PHONE: 069 172 597

## COMPONENTS AND EQUIPMENT

**HUNDREDS OF** unusual items cheap! Send 80p for interesting samples and list. Grimsby Electronics, Lambert Road, Grimsby.

## FREE READERS OFFER

**THE CHRISTMAS GIVEAWAY** ... Fun-packed, 50-component gift pack!! Astd diodes, capacitors 8 wirepack — FREE + Projects & solder! SEND-US-THIS-AD + £1 coin (p&p) to KIA, 8 Cunliffe Rd, Ilkley, LS29. 60 WATT AMP-LIFIERS, £5.

## GOVERNMENT SURPLUS EQUIPMENT

### ANCHOR SURPLUS LTD.

The Cattlemarket, Nottingham NG2 3GY Tel 0602 864902  
 The UK's Largest Genuine Government Surplus Dealer

Always a large stock of Radio, Test, Service and General Equipment in stock. Pye, Racal, Marconi, Tek Redifon, Plessey, Mullard.



**Special:** Eddystone 730/4 1-30MHz RX £75 - £110. Pye PF2 LB FM from £25.  
**Phone Rob (G4ROB) For Details.**

Mail Order, Access/Visa Welcome

**ADVERTISERS**

Telephone  
**Heather Wust**  
 on 01-437 0626  
 or write to  
 her at  
**1 GOLDEN  
 SQUARE,  
 LONDON W1R 3AB**

**TERMS & CONDITIONS**

**CLASSIFIED ADVERTISING  
 TERMS & CONDITIONS**

Our terms for new advertisers (semi-display and lineage) are strictly pro-forma payments until satisfactory reference can be taken up (excluding recognised advertising agencies. Cheques and PO's should be crossed and made payable to ARGUS SPECIALIST PUBLICATIONS LTD and sent together with the advertisements to:

The Classified Dept.,  
 No. 1 Golden Square,  
 London W1R 3AB.

There are no reimbursements for cancellations. Advertisements arriving too late for a particular issue will be inserted in the following issue unless accompanied by instructions to the contrary. It is the responsibility of the advertiser to ensure that the first insertion of every series is published correctly, and corrections must be notified in time for the second insertion, otherwise the publishers will not accept liability or offer any reduction in charges.

All advertising sales are subject to Government Regulations concerning VAT. Advertisers are responsible for complying with the various legal requirements in force e.g. The Trade Description Act, sex discrimination act & the business advertisements (disclosure) order 1977. Full Terms & Conditions of Advertising available on request.

**RETAIL OUTLETS**

**E  
L  
E  
C  
T  
R  
O  
M  
A  
R  
T**

**E  
L  
E  
C  
T  
R  
O  
M  
A  
R  
T**

**BIRMINGHAM**  
**“SUPERTRONICS”**  
 Speakers, components and test equipment (new and used) at very competitive prices. Come and see us at  
**BIRMINGHAM**  
 65 HURST STREET,  
 BIRMINGHAM B5  
 TEL: 021-666 6504  
 9-6pm

**LONDON**  
**CRICKLEWOOD**  
 ELECTRONICS LTD  
 FOR COMPONENTS  
 LOTS OF NEW DEVICES  
 LOTS OF LOWER PRICES  
 Phone for our catalogue:  
 01 452 0161/450 0995 Telex: 914 977  
 40 Cricklewood Broadway,  
 London NW2 3ET.

**EDINBURGH**  
**OMNI ELECTRONICS**  
 stock a wide range of electronic components at  
**174 Dalkeith Road,**  
**Edinburgh EH16 5DX**  
**Tel: 031 667 2611**  
 Open: Mon-Fri 9am-6pm, Sat 9am-5pm.  
 Send 2x18p stamps for latest catalogue.

**SURREY**  
**PLS**  
 16 Central Road,  
 Worcester Park,  
 Surrey KT4 8HZ,  
 Tel: 01-330 6540.  
 Programmable device specialists.  
 (PALs, PROM's, PLD's etc). Many  
 other components in stock.

**LIVERPOOL**  
**PROGRESSIVE RADIO**  
 87/93 Dale Street Tel: 051 236 0154  
 47 Whitechapel. Tel: 051 236 5489  
 Liverpool 2  
**'THE ELECTRONICS SPECIALISTS'**  
 Open: Tues-Sat 9.30-5.30

**WOLVERHAMPTON**  
**WALTONS OF  
 WOLVERHAMPTON**  
 Established since 1947  
 Offering a complete range — ICs, transformers,  
 switches, pots, capacitors, resistors, kits, speakers,  
 test equipment, books and lots, lots more!  
 Come and see us at:  
**55A Worcester Street, Wolverhampton**  
 Mon-Sat: 9-6 pm Tel: 0902 22039

**CLASSIFIED COUPON**

ELECTRONICS TODAY INTERNATIONAL, CLASSIFIED ADVERTISEMENT DEPARTMENT, No. 1 GOLDEN SQUARE, LONDON W1R 3AB.

PLEASE DEBIT MY ACCESS/BARCLAYCARD No.   
 EXPIRY DATE

Rates: Lineage 54p per word (VAT inclusive) minimum 15 words. Semi-display £12.80 per single column cm plus VAT. No reimbursements for cancellations. All ads must be pre-paid.

Name .....  
 Address ..... Daytime Tel. No. ....  
 Signature ..... Date .....

FOR SALE     COMPONENTS     WANTED     KITS     PCB'S     OTHERWISE STATE

# HENRY'S

**ELECTRONICS FOR TRADE, INDUSTRY,  
EXPORT, EDUCATION AND RETAIL**

## \*INSTRUMENTS

■ SCOPES ■ COUNTERS  
■ DMMS ■ PSU'S  
■ GENERATORS ETC.

## \*PUBLIC ADDRESS

■ SPEAKERS ■ AMPLIFIERS  
■ MIXERS ■ MICS ETC.

## COMPONENTS

HUGE STOCKS ALSO  
■ TOOLS ■ CABLES ETC.

## \*ACCESSORIES

■ TV-VIDEO AMPLIFIERS  
■ AUDIO ■ TV/VIDEO  
■ SECURITY ■ CB RADIO  
ACCESSORIES

## COMMUNICATIONS

■ INTERCOMS ■ CB RADIO

## \*SECURITY

■ PANELS ■ PIRS ■ SIRENS  
■ DOORPHONES ■ STROBES

**FREE!**  
ILLUSTRATED  
CATALOGUES WITH  
RETAIL DISCOUNT  
VOUCHERS

■ Instruments/Security  
Computer  
■ General Catalogue

Please state Trade/Education  
or Retail/mail order Send 9" x 4"  
SAE £1.00 each or £1.50 for both

**HENRY'S**

404 Edgware Road, London W2 1ED

Tel: 01-724 0323

\*ALSO AT Audio Electronics 301 Edgware Road W2 01-724 3564

SALES OFFICE 01-258 1831 Telex 298102 Fax 01-724 0322

### OSCILLOSCOPES

TELEQUIPMENT D83 Dual Trace 50 MHz Delay Sweep. Large Tube with manual ..... £350  
COSSOR OSCILLOSCOPE CDU150. Dual Trace 35MHz Delay Sweep. Dual State. Portable 8x10cm display. With Manual ..... **NOW ONLY £180 each**  
Optional Front Protection Cover. Containing 2 Probes & Viewing Hood ..... £10  
S.E. LABS SM111 Dual Trace 10MHz Solid State. Portable AC or external DC operation 8x10cm display with Manual £150  
GOULD/ADVANCE OS255 Dual Trace 15MHz with Manual ..... £225  
TELEQUIPMENT D43 Dual Trace 15MHz. With Manual £100  
ADVANCE OS250TV. Dual Trace 10MHz. With Manual £150  
SCOPEX 4D10A Dual Trace 10MHz. With Manual ..... £150  
TELEQUIPMENT S54A Single Trace 10MHz. Solid State with Manual ..... £90

### MULTIMETERS

AVO 8 Complete with Batteries & Leads ..... from £50  
AVO 8 Mk V Complete with Batteries & Leads ..... £90  
AVO TEST SET No 1 (Military version of AVO 8. Complete with Batteries & Leads ..... £5  
TEST LEADS suitable for AVO METERS. Red & Black with two croc clips & prods (p&p £3) ..... £5  
BLACK EVER READY\* CASES for AVOS. Unused (p&p £4) ..... £20

MARCONI AF Power Meter TF893A 20Hz-35KHz. 20uW-10W. With Manual (p&p £7) ..... only £35  
MARCONI RF Power Meter TF1152A- DC-500MHz. 0.5 to 25 watts 50ohm. With Manual (p&p £7) ..... only £45  
MARCONI ATTENUATOR TF2162. DC-1MHz. 600ohm. 0-11dB on 0.1dB Steps (p&p £7) ..... £35  
HATFIELD ATTENUATOR DC-250MHz. 50ohm 0-100dB (p&p £4) ..... £60  
ADVANCE SG62B AM 150KHz-220MHz ..... £45  
LABGEAR Colour Bar Generator KG1. 8 Test Patterns (p&p £4) ..... only £40 each

### STEPPING MOTORS

Type 1 200 Steps per rev. 4 Phase (5 wire) 12/24V Torque 25oz inch will run on 5V with reduced torque £15.00  
Type 2 8/12 Steps per rev. 3 Phase. 12/24V (will work on 5V) £2 each 5 off ..... £7.50  
Type 3 NORTH AMERICAN PHILIPS 24 Steps per rev. 4 wire 5V 3.3Amps 0.250rpm 0.200 PPS ..... £6 each  
Type 4 200 Steps per rev. 120V (3 wire) Torque 25oz inch £4 each  
Type 7 WARNER 24 Steps per rev. 3 Phase (6 wire) 28V. Holding torque 45oz. inch ..... £5 each

Used equipment — with 30 days guarantee. Manuals supplied if possible.

This is a VERY SMALL SAMPLE OF STOCK. SAE or Telephone or Lists. Please check availability before ordering. CARRIAGE all units £16. VAT to be added to Total of Goods & Carriage.

### STEWART OF READING

110 WYKEHAM ROAD, READING, BERKS RG6 1PL

Tel: 0734 68041. Fax: 0734 351696. Callers welcome 9 am-5.30 pm. Mon-Fri (until 8 pm Thurs)

### SPECIAL OFFER at ONLY £300 each

TELEQUIPMENT D755 (NATO approved version of D75). Dual Trace. Delay Sweep. 50MHz.  
TRIO RF SIGNAL GENERATOR type SG402 100KHz-30MHz. Unused (p&p £7) ..... only £75  
COLOUR PAR GENERATOR type PAL MC-101. 8 patterns. Pocket Size. Rechargeable batteries. Complete with Battery Charger/Mains Adaptor. Unused (p&p £4) ..... only £90  
COLOUR PAR GENERATOR type PAL MC321. 8 patterns. Video/Sound Output. Unused (p&p £7) ..... only £175

AVO TRANSISTOR ANALYSER MK2 (CI 464) Suit-case style. Complete with batteries & operating instructions only £25 each (p&p £7)

AVO VALVE TESTER CT160 Suitcase style. 22 Bases only £25 each (p&p £7)

ISOLATING TRANSFORMERS 240V Input 240V Out 500VA ..... £15 (p&p £5) 100VA ..... £6 (p&p £3) 240V Out 200VA ..... £4 (p&p £4)

DISK DRIVE PSU 240V IN 5V 1.6V & 12V 1.5A out Size W125mm. H75mm. D190mm. Cased Unused only £10 (p&p £3)  
QWERTY KEYBOARD (as in LYNX MICRO) just to make Cased ..... £5 each (p&p £3)  
FARNELL SWITCHED MODE PSU 5V 40A +/-12V 5A £30 each (p&p £4)  
OTHER SWITCHED MODE PSU available. Please enquire.  
DISK DRIVES 5 1/4" Double Sided. Double Density. 80 track Tester & 2 Probes ..... From £50

### NEW EQUIPMENT

HAMEG OSCILLOSCOPE 604. Dual Trace 60MHz. Delay Sweep. Component Tester + 2 Probes ..... £575  
HAMEG OSCILLOSCOPE 20336. Dual Trace 20MHz. Component Tester & 2 Probes ..... £314

All Other Models Available

BLACK STAR FREQUENCY COUNTERS P&P £4  
Meleor 100-100MHz ..... £99  
Meleor 600-600MHz ..... £126  
Meleor 1000-1GHz ..... £175  
BLACK STAR JUPITOR 500 FUNCTION GENERATOR Sine/Square/Triangle 0.1Hz-500KHz p&p £4 ..... £110  
BLACK STAR ORION. PAL TV/VIDEO COLOUR PATTERN GENERATOR ..... £199  
HUNG CHANG DMM 7030. 3 1/2 digit. Hand held 28 ranges including 10 Amp AC/DC 0.1%. Complete with batteries & leads. p&p £4 ..... £39.50  
As above DMM 6010. 0.25% ..... £33.50  
Carrying Case for above ..... £3  
OSCILLOSCOPES PROBES Switched x1: x10 p&p £3c11

# KEEP REGULAR

Don't miss out on your favourite electronics mag. Why search high and low for a copy? Let your newsagent take the strain and reserve you a copy each month.

Fill in your name and address on the form below and hand it to your local newsagent. It will keep you as regular as All-bran. Alternatively, you can eat the coupon. They you'll need the All-bran.



Dear Mr Newsagent  
Please order me a copy of ETI  
and reserve/deliver me a copy  
every month.



Note this magazine is available to your wholesaler through:  
SM Distribution, 6 Leigham Court Road, Streatham, London SW16 2PG. Tel: 01-677 8111.

Name \_\_\_\_\_

Address \_\_\_\_\_

## PCB DESIGNER FOR THE 48K ZX SPECTRUM

Now you can produce high quality printed circuit boards / circuit diagrams / component layouts on your 48k zx spectrum. If you don't own one it's worth getting one just for this suite of programs! comprehensive manual included with getting started tutorial

FULL SUITE FOR ONLY £30.00 INC

### PCB LAYOUT :

Produce quality printed circuits directly from your EPSON RX/FX or compatible dot matrix printer using a dense t1 printout on positive photoresist coated board. Or super quality using x2 printout and photoreduction. Many features such as 15 track widths; 15 pad sizes; 16 transistor/ic/corners; 20 connectors; large multi screen WYSIWYG display gives a clear uncluttered view of pads tracks and drill holes; 0.1" grid on/off; Block move; copy; mirror; rotate; erase; area fill (ideal for earth plane); preview; undo; dimensionally accurate printer routine with quick print; t1 or 2:1 dumps; Custom pad design and library: AVAILABLE SEPARATELY FOR £20.00 INC.

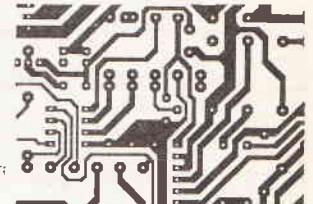

### COMPONENT LAYOUT :

Draw component layouts directly or from existing pcb layouts using a unique track reducing facility: The following components are provided: resistors; capacitors; ic's; diodes; transistors; Line drawing; printout and block commands as above: NOT AVAILABLE SEPARATELY.

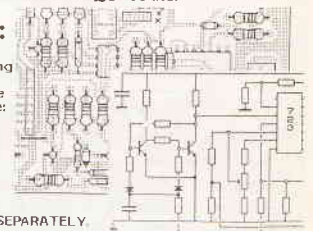

### CIRCUIT DIAGRAMS :

Features similar to the above programs with a library of electronic symbols including resistors; capacitors; diodes; transistors; fets; op amp; switches; inductors; logic gates: NOT AVAILABLE SEPARATELY.

State version required from: DISCIPLE / D; DISCOVERY; +3; MICRODRIVE & TAPE. IMPORTANT! TAPE AND MICRODRIVE USERS PLEASE STATE CENTRONICS INTERFACE IN USE OR SEND £1.00 FOR DETAILS.

KEMSOFT THE WOODLANDS, KEMPSEY, WORCESTER, WR5 3NB

tel 0905 821088 after 6pm : or see us on A.I.X. - 386 BULLETIN BOARD 0905 52536/754127 on any computer with modem

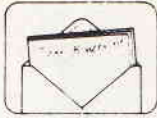
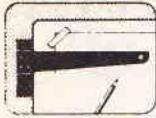

This column is a service to readers to provide electronic designs to order. Many a project never gets further than the drawing board because of difficulties with one small part. If you are stuck for a circuit or a technique, let the ETI expert help you out. Send your requirements, with as much detail as possible, to ETI Blueprint, 1 Golden Square, W1R 3AB.

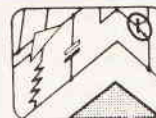

This month's querant, N. Allen of Leamington Spa, wants to make a high speed NiCd charger with automatic shutoff. The interesting point about this is that he wants to detect the end of charge by measuring the battery voltage rather than by timing it. The apparent purpose of this is to fast charge batteries used to race radio controlled model cars. In this situation the batteries may not be completely discharged before charging commences so a timed fast charge would have to be set to put in a lot less than a full charge to avoid the risk of the batteries making a loud noise!

However, it is important to charge the batteries as much as is safe, to prevent them from giving out partway through a race. Consequently some means of detecting end of charge is required.

### Constant Current

The useful characteristic of NiCd batteries for this purpose is that the voltage falls slightly when the maximum permissible fast charge point has been reached. The voltage follows the law shown in Fig. 1 (supplied by Mr Allen). The peak voltage of the batteries in use is between 9.3V and 10.5V and the source of charge current is a car battery whose voltage may be between 11.5V and 14V.

Mr Allen says the charger provides a constant current by passing the charge current through a power transistor which is switched on and off at 50Hz by a 555 astable circuit. The mark/space ratio is adjusted to control the current. The purpose of this method is to minimise heat dissipation.

With a peak NiCd battery voltage of approximately 10V and a nominal car battery voltage of 12V, there would appear to be limited heat dissipation in a constant current charger. If, for example, the charging current is 4A, then the dissipation would be 8W typically, 18.8W worst case. Even 18.8W is within the capabilities of a 2N2955 (I am assuming a re-entrant regulator configuration) mounted on a 2.2°C/W heatsink in free air.

### Dissipation

However, the method described has a worse drawback than of simply being overcomplex for the requirement. It won't save on dissipation. Assuming that the on state current of the power transistor is limited by a resistor then the total dissipation will be the same for the same average charging current. After all, if the charge current is 8A for half the time or 4A for the whole time, the energy dissipated (current voltage time) is the same.

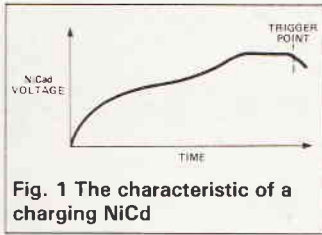

Fig. 1 The characteristic of a charging NiCd

If the dissipation must be reduced then the energy should be stored in an inductor and transferred from inductor to NiCd. This sort of system is one example of a switched mode power supply. Alternatively a linear constant current source could be used. In either case there are design problems associated with providing a high regulated current when the car battery is at 11.5V and the NiCd is at 10.5V.

If a linear constant current source is used, it would be good practice to drop a significant part of the voltage across a resistor. Otherwise, a fault which switched the transistor fully on for only a few milliseconds could destroy it, as many tens of amps would flow.

Omission of any resistor would of course cause hundreds of amps to flow in such a fault, until the fuse flew or the wires melted or the NiCds exploded.

The one fairly sure way to defeat this problem would be to use a flyback converter to increase and invert the car battery voltage. Another less complicated way would be to run the car engine when charging the NiCd.

### Endpoint Detection

Now to the actual question asked — how to detect a 20mV fall in battery voltage. From the graph of battery voltage supplied (Fig. 1) I would assume that the 20mV fall in battery voltage occurs over a period of approximately one minute.

The first idea of how to detect the battery voltage change is shown in

Fig. 2. This is a differentiator circuit and it gives an output voltage proportional to the rate of change of input voltage. The only time the battery voltage should fall and give a positive output from this circuit is when it has reached its end of charge point.

### Interference

Unfortunately this circuit suffers from sensitivity to interference, as illustrated by the end part of the input and output waveforms. It also suffers from a more serious problem in this application. Because the rate of change of battery voltage is very slow (I have assumed 0.33mV/s) a very long time constant is needed. For example, a low leakage capacitor of 2.2μF and a resistor of 1000M would be suitable.

The second idea, shown in Fig. 3, is to use a peak hold circuit followed

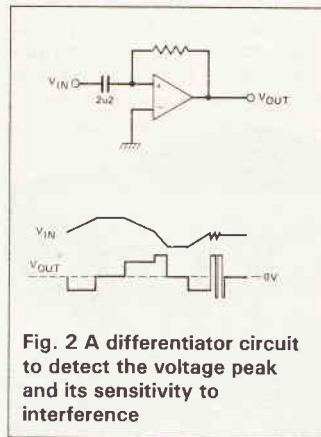

Fig. 2 A differentiator circuit to detect the voltage peak and its sensitivity to interference

by a comparator and compare the battery voltage with its peak value to date. The crucial factor here is the rate of drift of the peak hold circuit. For reliable functioning it should not drift at more than half the rate of change of voltage of the battery.

Most of the drift on the peak hold will be caused by the bias current of the op-amps. The chosen op-amp, the LF353, has a maximum input bias

current of 200pA. Two op-amp inputs are connected to the hold capacitor, so the total maximum bias current is 400pA. The voltage change on a 2.2μF capacitor over one minute with this current is 10.9mV, which would seem just acceptable.

However, the flat part of the charging curve shows a lower rate of change of voltage than the detection area. It is important that the capacitor should not charge by more than approximately 10mV during this period or the switch off may occur earlier than it should. Of course, if the capacitor is discharging during this period, then it will be kept up to the correct voltage by the action of the peak detector circuit but the bias current may flow in either direction.

To take account of this, an optional extra resistor, R2, is added in parallel with D1. This should only be added if tests show that the charging switches off without it. The purpose of the resistor is to balance the effect of the bias current when there is a voltage of 10mV across it, thus ensuring that a maximum error of 10mV exists.

### Finally

Several other points should be noted in passing. First of all, the peak hold circuit will hold the peak voltage for a very long time so it must be manually reset with the reset switch provided each time a new battery is charged. An adjustable offset voltage is provided via RV1 to bias the comparator into the correct state (output low) while the battery voltage is increasing. It will switch high when the voltage starts to decrease.

C2 has been added to the comparator because it has little DC positive feedback at the start of switching and extra AC positive feedback guarantees that once it starts to switch it will complete the process.

The circuit shown here is based on a genuine constant current charge regime. If a pulsed system is used then the input to this circuit must be preceded by an RC filter which reduces the ripple due to the pulsed charging to less than 5mV.

In the unlikely event that leakage through D1 proves to be a problem, the junction of a 2N3819 junction FET typically has lower leakage than a 1N4148. However, with 20mV across it at the crucial period, the leakage of the 1N4148 is unlikely to be a problem.

I think this wraps it up for the end of charge detection circuit, though perhaps the charger itself would benefit from reconsideration.

Andrew Armstrong

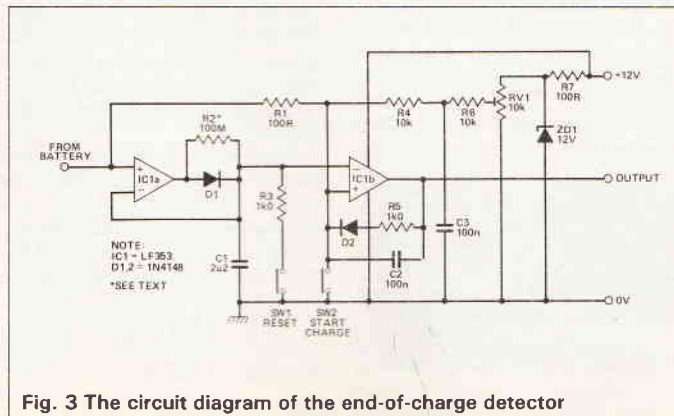
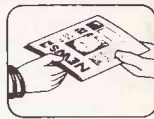
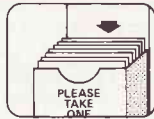
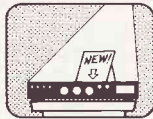

Fig. 3 The circuit diagram of the end-of-charge detector

# BBC RADIO SHOW REPORT



**G**ood idea, the Radio Show. An enormously wide consumer appeal — everyone listens to the radio. Get a lot of easy publicity (on the BBC as well!) so the punters can be charged £5 a ticket and the exhibitors £125 a square metre. Watch the sterling flood in. Well done the BBC, another winner.

Pity then that the hall had to be so small. Pity that there were just 71 listed exhibitors — 28 of whom would have a hard time explaining their connection with radio. Pity that many of the BBC programmes being recorded had a strictly limited audience and were ticketed such that anyone arriving later in the day didn't stand a chance of getting in. All a bit of a letdown really.

The BBC Radio Show ran for nine days at the beginning of October. The whole kaboodle was put together by the ever-inventive BBC Enterprises, taking as its excuse the 21st anniversary of Radios 1,2,3,4 and the local radio network. A giant birthday party, a two million pound extravaganza, a radio listener's paradise.

The pre-publicity was substantial and imaginations were fired throughout the industry. A huge sound-and-light 'Story of Radio' was promised. On a Sunday morning two weeks before the show, I was surprised to encounter a nine foot high chipboard radio on the pavement outside Broadcasting House. 'Radio Show?' I asked a porter struggling with a lifting trolley. 'Radio Show', he confirmed with resignation.

So arriving at Earls Court for the preview day I was disappointed to be led away from the large ground floor exhibition hall (taken up by the National Concrete Convention) to the much smaller upper hall.

It took all of two hours to see everything and that included 20 minutes being given a demonstration of Grundig's Fine Arts hi-fi system with DAT and RDS tuner (both of which even they admitted were severely limited in use at present).

To be fair to Grundig, some other products are well worth a look, particularly the new car audio range. Apart from a well publicised RDS radio-cassette, most models have the sensible addition of an automatic

switch to mono if the signal strength is too low for clear stereo sound.

Also new is the concept of SCV — 'Speed Controlled Volume'. Does your car get louder the faster you go? Do you fret and curse as the engine drowns out your favourite drive-time hit? No, nor do I but obviously the designers at Grundig do, and a jolly innovative feature it is too. One day all in-car audio will be made this way.

Pioneer built itself an impressive black monolithic palace of a stand — spacious, airy and impeccably staffed. The leading product was the CLD-1200, a combined laser disc, CD and CD-video player.

The CDVs creeping onto the market can handle about six minutes of audio-visual plus about twenty more minutes of normal CD audio. This duration limit on CDV is severely limiting and will almost certainly stop any mass take-off of CDV machines, particularly since Hi-Fi sound on VHS video is now commonplace and quite comparable to CD quality at £10 for 90 mins thank you very much.



Sensibly, the Pioneer machine can take 20cm and 30cm Laser Discs as well. A 30cm disc can give 60 minutes of sound and vision — this might survive if (and only if) mass production can bring the disc prices low enough. Something of a chicken and egg problem but then so was compact disc not so long ago.

One area well covered at the Radio Show was hi-fi loudspeakers. Wharfedale, Goodmans (read Mordaunt-Short and Tannoy), Celestion, BOSE and Acoustic Research all took

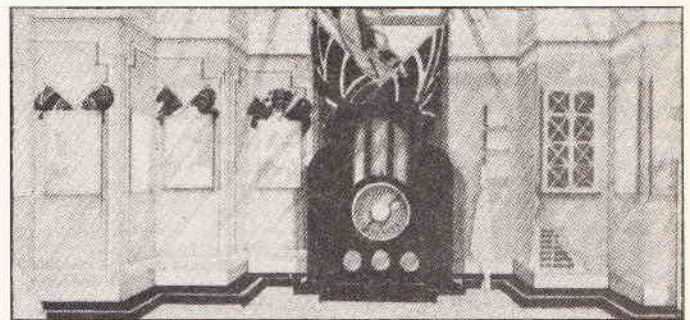

stands. Of course a barn like Earls Court is hardly the place to judge sound reproduction but there was much to see and more to read.

Linn premiered its Helix LS150 speaker as well as its award-winning Nexus LS250, a ported two-way design (as is the Helix) with polypropylene baffle. Separate wiring of bass and treble sections is possible.

KEF was also present and correct with its coincident-source C series of speakers (see September *Playback*). These have the Uni-Q Driver with a soft-dome HF unit actually inside the LF driver. Such a system should be able to avoid many problems in predicting response.

JVC had a proud demonstration of S-VHS, the late arrival about to set the home video industry alight. The line resolution is vastly improved and the results are clearly visible. With the VHS symbol behind it, the new standard has an assured future in the UK — unlike the developing Super Beta although this is likely to be even better (when it gets here).

It is reasonably safe to assume the exhibition organisers had little communication with programme makers when allocating the stands. The main Radio Show stage was surrounded by hi-fi and loudspeaker companies — the resulting ambient noise for the stage was appalling. During actual broadcasts demonstrations were halted but rehearsals were badly handicapped.

All the broadcasts were great fun, as broadcasts generally are. The live concert by TPau on Thursday night was accompanied by brilliant visual mixing on the 49-screen displays at either side of the stage. Sound was well mixed at both orchestral and rock events.

But the shows were too few and far between to represent value for money, particularly when you remember that you can go to all these events free simply by writing to the BBC Ticket Unit or calling in at the Paris Studios.

And the Story of Radio sound-and-light exhibit? Eleven rooms with loop tapes of a few minutes in length, almost loud enough for you to hear properly if there are other people in

the room and certainly loud enough to spill into the other rooms.

The first few rooms represented a decade each, starting in 1930 (the emotional part of the war), through the 40s (the happy part of the war) and the 50s (most of the chipboard radios were here) to the 1960s (although this room was ambiguous in being Radio 1's Roadshow room as well). The entire local radio network was dismissed in a single corridor, followed by the room for Radio 2 — apparently presented as a network purely for drivers.

Radio 3 came out with the most tasteful display which consisted of a flag-decked piano and pseudo promenade concert stage. Radio 4 chose Desert Island Discs as its sole representative (did you know that Morgot Fonteyn's island luxury was a skin diver's mask?). That's about it for the Story of Radio.

Oh — apart from the final room entitled 'Whatever Next?' In here was the grand public launch of the Radio Data System. Most people didn't seem very interested. The whole room was centred on a glass cabinet housed in the tip of an inverted pyramid hanging from the ceiling. In the cabinet was an impressive sparking plasma globe... which had unfortunately packed up by the fifth day leaving an almost-as-impressive empty case.

A few other exhibits relieved the monotony — regular news broadcasts from the BBC newsroom, PPLs competition to win a radio hat, Ensoniq's keyboard stand, Schweppes giving free orange away throughout the show. The best thing of all was the exhibition guide, which included a well-written and lavishly illustrated feature on the history of radio.

The stand that best captured the mood of the whole event, the stand that probably shifted the most merchandise, the stand that took prime position right by the Story of Radio exit — was the BBC Enterprises Shop.

Such was the BBC Enterprises Show. There was talk of making this an annual event. That remains to be decided. I don't think I'll be too much bothered either way.

**Jez Ford**



## OPEN CHANNEL



The recent successful launch and landing of the US Space Shuttle starts my monthly wanderings. Regular and long-term readers will remember (hands up who doesn't) my last comment on space launches, regarding the problems which could mount up in world communications systems if the shuttle (and in fact the European launch rocket Ariane as well) were to be grounded for any great length of time.

Both vehicles are used to take communications satellites up to the geostationary orbit height. At the time neither of the systems were operational and so no European or North American satellites were getting off the ground, except carried piggy-back by rockets of a deeply hued red colour. Ariane's problems were surmounted a little while back and now the shuttle is all systems go again, so it seems we're back in action. A fact we should all be most pleased about.

One of Ariane's launches which is most interesting to us is the one which was scheduled for November 8. Ariane Flight 27 took up perhaps the most famous satellite of all time — Astra. By the time this issue of ETI hits the streets, Astra will be transmitting live and will be operating to a full service by February. Astra is, of course, the first European satellite launched specifically for the purpose of transmitting broadcast television signals for public reception — known as direct-to-home reception. Direct-to-home reception requires that medium-to-high-powered satellites (with a power of 45-100W per transponder) be used, simply to allow small dish aerials of around 60 centimetres or so to pick up the signals back on earth. Astra's 16 operational transponders are each of 45 watts.

Meanwhile, a satellite provider which already has a number of satellites in orbit transmitting television signals (specifically, low-powered — only 20W — non-public and requiring large dish aerials of around a metre or so in diameter), Eutelsat, seems to have realised the need for direct-to-home reception, and is forging ahead with plans to launch a number (at least four, maybe more) of medium-powered satellites of 50W transponder power. The race heats up.

### CT2

The second generation of cordless telephones, called CT2, can be used as much more than the mere cordless telephones which many of us use and love in our homes. Some readers may have heard of the Telepoint wide-area system, whereby users with a CT2 phone are able to make telephone calls from anywhere within the country, provided they are within sight of a Telepoint base station terminal.

The Telepoint base stations are to be quickly brought into operation in most city centres and areas of public gathering, such as shopping arcades, public transport stations and so on. Ferranti's Zonephone forms the basis of the Telepoint standard which looks as though it is about to be adopted as the European standard this year (1989, that is).

The reason behind this strong British influence on a pan-European standard is that all the UK manufacturers have got their act together regarding CT2 equipment, with the result that a common air interface standard has been agreed. This means that equipment from all UK manufacturers is compatible, being able to make calls to a single standard range of base stations.

Telepoint could be an important new communications medium, if pricing strategies are carefully worked out. For instance, if the phones are around the £150 range depending on facilities, they provide a very cheap mobile communications method. Far cheaper than a cellular radio telephone.

Devotees of cellular telephones would, no doubt, point out two disadvantages. First, a CT2 phone cannot receive a telephone call. That is true, but to many people that is no real disadvantage. Besides, the situation can be sidestepped marginally, by the user carrying a pager, too. Once a message has been received via the pager (say, a telephone number to call) the user contacts whoever is paging him.

Word has it that some species of CT2 phones will feature an in-built pager, for this very purpose.

The second CT2 disadvantage is that the phone cannot make a call unless in the vicinity of a base station. Nobody can argue against that but as long as base stations are provided in sufficient quantities throughout the country and are always in similar spots (say, always in the High Street of each city or always in Motorway service areas) users can rely on being able to make a call when they get to such a specified place.

However, if the price of a CT2 phone is twice this then the situation changes as users see the benefits of cellular telephones. More than twice, and potential users will think again.

Currently, the Department of Trade and Industry is considering applications from a number of potential Telepoint service providers. Up to four operators are to be licensed to manufacture base stations for use on the system. I hope to report on the outcome of the DTI's consideration next month.

Keith Brindley

## PLAYBACK

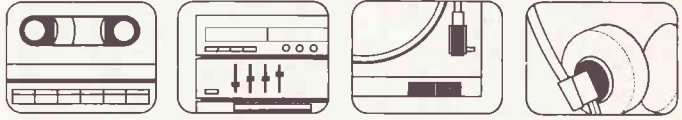

Specmanship has ceased to be an important arbiter of sound quality as far as the specialist audio market is concerned.

It is quite common for our home-grown amplifiers, for example, to suffer relatively high levels (0.1-0.5%) total harmonic and intermodulation distortion while the Far Eastern competition still seems hell-bent on pursuing THD down to infinitesimal levels.

Furthermore these specialist amplifiers are generally thought to sound better than much of the mass market competition, despite their being inferior in the technical arena.

### Xenophobia

Now, this is simply an observation based on experience — it is not intended as an exercise in xenophobia. However, it does begin to hint that the Far Eastern manufacturers are caught between two stools as other markets, such as Continental Europe, seem to place greater store in the traditional *measured* performance of such products.

All this may seem to add further evidence to the suggestion that objective/subjective correlation is something of a misnomer. In fact quite the reverse is true but it requires the acceptance that distortion *per se* is not necessarily a bad thing.

Designers in this country (who may be building for a very restricted marketplace) generally accept that it is nigh-on impossible to construct a perfectly linear amplifier for £200 or £300. As such many of them succeed in *manipulating* those distortion mechanisms that are present to their advantage. The attitude is: if you can't beat it then use it!

### Enhancement

Most of us are familiar with the sonorous presentation of many valve amplifiers despite the fact that they should sound like a bag of nails — THD often approaching 5% or 10% at the frequency extremes. The fact that certain forms of distortion are subjectively more acceptable than others is nothing new but the concept of deliberately introducing such aberrations so as to *enhance* the perceived sound quality is altogether more recent.

Naturally, those designers who have a feel for such electronic trickery are not exactly shouting about their methods but distinct trends do seem to be emerging. I was fortunate enough to be able to gauge public opinion on this matter at the recent Penta Hi-fi Show where three nominally identical power amplifiers were put up for audition.

Each amplifier was subject to subtle, detail modifications that altered the distortion complement rather than the distortion level to any great degree. In fact THD and IMD were kept below 1% across the 20Hz-20kHz bandwidth, amplifier 1 having the least distortion while amp 3 incurred the most.

Noise, power output, channel separation and output impedance were identical across the trio of amplifiers.

Around 150 people took part over two days and the results were wholly consistent — amplifier 2 coming out on top. Interestingly this amplifier did not enjoy the lowest distortion of the trio but the mechanisms were contrived to produce entirely even-order harmonic and IM residues. A broad carpet of harmonic (2nd to 10th) and IMD summation products (2nd to 8th order) persisted, lending the amplifier a smooth and relaxing sound even though it was clearly less *accurate* than amplifier 1.

Amplifier 3 was universally rejected, its harmonic and IM compliment being entirely odd-order. Interestingly, amp 1 produced a low and consistent level of 2nd and 3rd harmonic distortions with principally 2nd order sum and difference IMD — the kind of result usually obtained with the reliable and competent mass market amps that abound in great quantity.

Other alterations were made to the regulation and capacity of the power supply feeding amplifier 1, resulting in a linear relationship between the input/output signal and any harmonic/IM artifacts identified in a Ramped Supply Modulation test (a 40Hz driving signal is used, raising the amp from -96dB to full output while observing the relative level of 40Hz harmonics and 50Hz or 100Hz supply modulation components).

Amplifier 2 and 3 demonstrated a non-linear relationship between signal level and IMD when subject to this test and though the artifacts were typically less than -90dB there was a clear loss in subjective detail resolution at low frequencies.

### Anomalies

In the event, this proved fascinating for it showed that anomalies at extremely low levels could still influence sound quality, anomalies that are laid bare in the traditional low distortion amps but are masked by the preferable colourations imposed by many specialist designs.

Nevertheless, I feel it will be some time yet before the mass market brigade adopts the principle of contrived distortion.

Paul Miller

## BOOK LOOK

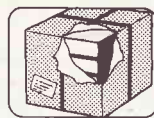
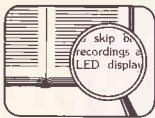

**B**enchmark Books is a new company on the electronics scene and this month's *Book Look* review deals with the company's first two offerings.

**Key Techniques for Circuit Design. Designing DC Power Supplies. Both by G. C. Loveday. £6.95 each from Benchmark Book Company, 59 Waylands, Swanley, Kent BR8 8TN.**

The author of these works, G. C. Loveday, is in fact one half of Benchmark Books. There are already four books promised for this initial series entitled 'The successful design of electronic hardware' and these first two provide a tempting taste of what is to come.

The two works are both a touch short and a little amateurish in presentation, reflecting the new (and no doubt impoverished) state of the publishers. However, although all the diagrams and (by the look of it) the text are hot off a computer printer, the end result is quite good enough to make reading easy.

These are almost text books. Indeed, they are aimed at BTEC National and Higher National students but they are also essentially non-mathematical (or as non as you can be) and firmly in the practical, real life camp — suitably for home hobbyists as much as schoolroom pupils.

### Number One

*Key Techniques* is a generalised primer for anyone contemplating moving up from the jigsaw assembly of magazine electronics projects to actually creating their own electronic designs.

It follows a near classic formula with five chapters on 'The Design Problem', 'Using Passive Components', 'Using Active Devices', 'Equivalent Circuits' and 'Design Examples'. There is also a handful of questions at the end of each chapter with (grovelling thanks from a thousand teachers) answers at the back.

Everything is explained from basic principles with a methodical stepwise approach which is both clear to understand and easy to emulate when it comes round to designing your own circuits.

This is a basic starter book which will not take you very far down the road to being a fully fledged electronics designer. However, it lays good groundwork which will certainly stand you in good stead.

The style is not too heavy (unlike most text books) but neither is it padded out with useless (if 'friendly') waffle so it does serve both as a course

in itself and as a useful back reference for when you get stuck with your own problems.

The book omits the poignant question of conceptual design — how to go from the real life problem to an electronic idea and specification — and concentrates on the move from specification to circuit. However, this is a nearly universal failing of all tutorial books, understandable as it must be the most difficult skill to teach and is usually put down to native talent.

Ideally I should like to see this series greatly expanded with further books following on where this one leaves off. It could just be that Loveday would then have created an electronics course which *genuinely* teaches from beginner to reasonably expert.

However, for the moment *Key Techniques* serves well.

### Second Half

*Designing DC Power Supplies* is a little different in its approach. Here Loveday concentrates on a relatively narrow subject with far more detail.

A wide range of different power supply types are dealt with (with the notable exception of switch mode types — understandable as they provide enough material for several books on their own).

Transformers, rectifiers, regulators, reference supplies and protection circuits are all covered along with sensible design methods and testing procedures.

Although the style is similar to *Key Techniques*, with concise and clear explanations and short problems at the end of each chapter (again, answered at the back), the overall impression is that this book is less of a course book and more of a reference work for looking up a particular type of supply when it is required. Again, there is little on the basic problem analysis side to help you determine which type of power supply is required for any particular project.

Nevertheless, it provides a useful addition to any hobbyist's library at a reasonable price and a good basis on a much underated subject which forms an important part of nearly every design.

With the other two titles already promised for the series (*Designing With Linear ICs* and *Designing Interface Circuits*) and hopefully with yet further titles added in the future, these two works provide an excellent starting point for any enthusiast beginning to produce their own circuits and Benchmark Books promises to be a company to watch.

**Martin Tame**

# THE CIRKIT WINTER '88-89 CATALOGUE IS OUT NOW!



and features many new products:

- Books - 12 Latest Titles
- Navico 2m Transceiver
- Miniature Mains Rocker Switches
- 8 Channel Logic Analyser
- Collet Knobs and Caps
- 2.4GHz Frequency Meter
- 10.7MHz Ceramic Filters
- Broadcast Band FM Tunersets
- RF Dip Meter
- IEC Mains Connectors
- Scanning Receivers - New Models
- 100MHz 3 Ch Oscilloscope
- RF and AF Signal Generators
- Pyropen - Cordless Gas Iron
- High Temp Elec Capacitors
- Miniature Analogue Multimeter

Plus discount vouchers, easy to enter competition and feature project. Available from your newsagent or directly from Cirkit.



PRICE **£1.30**

**Cirkit Distribution Ltd.**

Park Lane, Broxbourne, Herts EN10 7NQ  
Telephone (0992) 444111 Telex: 22478



# FREE READERS' ADS

Buy, sell or exchange through our free service to readers

**WANTED** circuit of SCC63484, external circuitry. Also info on AM2901, GI8438SGA, 8437CFA, 8435CHA. Tel: Andrew Peacock (0256) 472208 (evenings).

**WOW AND FLUTTER METER WANTED** by OAP interested in recording. 5 Southcourt Avenue, Bexhill. (0424) 221636.

**WANTED** printed circuit foils or boards for ETI project, March 1979, "Stage Lighting Controller". Postage paid. Tel: (07683) 61577 (evenings).

**EXPERIMENTERS** several top quality chart recorders synchronous motor, 2-speed drive guaranteed full working order. Many uses. Details: phone (0288) 2652 evenings.

**SCOPEX 4D.10A** dual trace 10MHz oscilloscope. Never used, as new complete with manual. Phone (0359) 50634 (evenings). £100 ono.

**SHUGART 8in FLOPPY DRIVE**, case, FD1771 controller chip, Nasbus wire wrapped card, misc. components, circuit diagrams. £125. Tel: (0242) 603938.

**FUJITSU 8in 70mB WINCHESTER** disk and manuals for sale. £150. Bob 031-333-4291 evenings.

**AMSTRAD ROMBOARD WITH** Protex Prospell Utopia £50 or will split. Phone Dublin 0001 947552. Ask for Anthony.

**WANTED CIRCUIT.** Tape deck. Philips N2501. Also wanted mains transformer for same (or similar). Please phone John (0454) 416635 evenings.

**ULTRAVIOLET LIGHT BOX** for developing PCB's etc. Nearly new £40. Mr G. Hope, 72 Picket Close, Fordingbridge, Hants. Will post.

**WANTED** any project kits or circuit diagrams for good quality audio tone generators for use in music. Phone (0296) 24280.

**WANTED:** Volume 1 of Harmworth's Wireless Encyclopaedia A to D: ppl to 736. P. C. Jones. Phone (0432) 77428.

**ATARI 800XL** computer with Atari 1010 recorder (program) software and books. Price £80.00. Phone Chard (04606) 61955.

**FOR SALE** 50 only solderable heat sinks R.S. No. 403-184 25p each. Mr Poole, 12, Penk Rise, Tettenhall Wood, Wolverhampton, WV10 6TN. Tel: (0902) 741374.

**WANTED MODEM** VTX-2000 S in working order. Max £40.00. Phone (0294) 602126 after 6pm.

**KEYBOARDS** Ex-working equipment. Oric, Atom, VIC20, TRS80, Dragon. Only one of each, so phone first. Pay postage. Crawley 513354.

**TEKTRONIX 551** dual beam 40MHz scope, various plug, instruction manual. Good working order. £80. St. Albans 25427.

**WANTED CIRCUIT DIAGRAMS** for large mainframe computer Triumph Adler TA1000. H. Culpeck, 39 Carlton Way, Cambridge CB4 2BY

**SPECTRUM** hardware, etc for sale very reasonable prices. Send SAE for list to J. Norman, 25 Milton Road, Corby, Northants.

**WANTED** memory map and/or schematic diagram for Acorn 6809 CPU. Phone Eden 01-286 8124.

**PHILIPS RF GENERATOR** PM5321, 150kHz to 108MHz, FM/AM, int/ext. modulation 0-50mV variable output, good condition. £60. (0543) 491867 (Lichfield area).

**S100 COMPUTER** Transam Tuscan with twin 5.25in drives, sound effects board and some software/manuals £120 or exchange, WHY? 01-462 2178.

**SINCLAIR QL** £110. boxed. ZX80 £40. boxed. Olivetti MS-DOS software, IBM compatible, various £50 each. Quantity video TV/HI-FI service manuals. For details 01-897 9603.

**VARIOUS EPROMS** 2716, 2732/A, 2764 gift from ex-employer £1 each inc p&p, untested. M.O. York, 24 Ebrington Rd, St Thomas, Exeter, Devon EX2 8JQ.

**WANTED** absolutely anything to do with laser graphics systems. Phone Dave (04545) 3845.

**SPECTRUM+** datacorder Wafadrive, thermal printer, joystick with £400 software and £150 mags. Sell for £299. Tel: (05912) 341. Ask for Nick.

**MSX DISC DRIVE** SV1.707 circuit diagram wanted. Alan Charles: (09278) 3579 or 01-794 0500 X3198 (Royal Free Hospital Hampstead NW3 2QG).

**BBC B OS 1-2** two 100K DS DD disks, Acorn DFS. As new boxed, service manual, Watford EPROM board. £210. Tel: 021-308 1959.

**CLEARING STUDIO.** 3 portable Sony B+W VCRs. 2 cameras zoom lenses, monitor. Manuals. £200 or exchange for test equipment (0252) 621505.

**WANTED SOLATRON CX 1571** X+Y plotter for CD1400 scope. Phone (0536) 743524 anytime.

**AUDIO AMPLIFIERS.** Laser tubes with power supplies. Light controllers. Spectrum RGB interface. Circuits. Plus much more. (0283) 223332 after 6pm and weekends.

**MEMOTECH** computer and hardware wanted. Anything considered regardless of condition. Also software wanted. Phone Adrian Cooper on Worcester (0905) 22591.

**CBM 64C** 1 yr old with all extras. Mint condition. Details write: Lynn 2 Ashby Rd. Melbourne, Derbyshire DE7 1ES. £120 ONO.

**SOLARTRON 7040** precision DMN, DCV, ACV, DCA, ohms. Accuracy 0.02% DCV. Resolution 10µV. Input resistance 1 Gohm. Measures 138 x 57 x 177. £75 (0628) 663669.

**WANTED** any information for the Act series 800 computer. O/S manuals, software, etc. Contact Mr A. Bridgewater after 6pm. Tel: (0934) 415718.

**BBC B 64K,** monitor, dual DS-40/80T, ATPL-board, ZIF, plinth, Olivetti JP-101, 14 ROMs, Pineapple AR-PCB, Meta assemblers, cables disks, books, mags, etc £700. Tel: 01-969 3622.

**COMPRESSED AIR REFRIGERATION** -30°C to +90°C Hot air. Redpoint vortex tubes model 106 for sale £10 (trade £100+VAT) Tel: (0274) 593382.

**FLUKE 8020B** hand held multimeter including case and leads as new £60. Phone Yateley (0252) 870628.

## CONDITIONS

- These ads are only for ETI readers not engaged in buying or selling the same items or services on a commercial basis.
- Ads will be inserted as and when space permits. Insertion in a specific issue cannot be guaranteed.
- ETI reserves the right to alter or refuse ads whenever this is judged necessary.
- All ads are accepted in good faith. Neither the magazine nor its publishers can be held responsible for any errors in the reproduction of ads, nor for untruths or misrepresentations, nor for the activities of advertisers or respondents.
- Advertisers submitting ads for this section shall be deemed to have accepted these conditions.

Ads should be 20 words or less including the address and/or telephone number. Please write in black block capitals or type in the grid provided on this form or a photocopy.

Send the form to:  
**FREE READERS' ADS**  
**Electronics Today International**  
**1 Golden Square**  
**London W1R 3AB**

Enter your advertisement below



**ADVERTISERS INDEX**

BICC VERO	3
BINDERS	10
BK ELECTRONICS	IFC, 52
CIRKIT DISTRIBUTION	64
CRICKLEWOOD ELECTRONICS	37
DISPLAY ELECTRONICS	IBC
FIELD ELECTRONICS	10
GREENBANK ELECTRONICS	41
HAAT ELECTRONICS	52
HENRY'S AUDIO ELECTRONICS	60, 66
KEMSOFT	60
MAPLIN ELECTRONICS	OBC
NATIONAL COMPONENT CLUB	31
OMNI ELECTRONICS	10
BRIAN PRICE	10
RISCOMP	66
SAGE AUDIO	66
SLEE ELECTRONICS	31
SPECIALIST SEMICON DEVICES	23
STEWARTS OF READING	60
SUMA DESIGNS	10
TJ DEVELOPMENT	66
TK ELECTRONICS	32
WILMSLOW AUDIO ELECTRONICS	41

**19" RACK CASES**

\* Suitable for instruments, high quality amplifiers and many other applications that demand strength and professional finish \* New improved construction and finish \* Black anodised aluminium front panels \* Separate front mounting plate, no fixing screws visible on the front and the side of the enclosure \* Heavy gauge front panel is of brushed aluminium finish enhanced with two professional handles \* With ventilation slits and plastic feet \* Rear box manufactured from 1.1mm steel finished in black. Rack mounting or free standing. Comes in quick assembly flat package spare front panels available

Order Code	Panel Size WH (inch)	Rear Box W H D	Weight	Price £
1U-10	19 x 1.75	17 x 1.5 x 10	2.4kg	23.50
2U-10	19 x 3.5	17 x 3.0 x 10	2.9kg	24.50
3U-10	19 x 5.25	17 x 5.0 x 10	3.5kg	26.50



1U-12	19 x 1.75	17 x 1.5 x 12	2.8kg	£24.50
2U-12	19 x 3.5	17 x 3.0 x 12	3.3kg	£25.50
3U-12	19 x 5.25	17 x 5.0 x 12	4.0kg	£27.50
4U-12	19 x 7.0	17 x 6.5 x 12	4.6kg	£29.95

Please add £3.00 P&P for the first item and £1.50 for each additional item. No VAT to be added to the price.

A range of low cost, high quality test equipments available, s.a.e. for details. To order send cheque/postal order. Quantity discount available. Customers who require further information please send S.A.E. Trade and overseas orders welcome. Mail order only.

**T.J.A. DEVELOPMENTS**  
Dept. ETI, 19 Welbeck Road,  
Harrow, Middlesex HA2 0RN.

QUALITY...

**SECURITY SUPPLIES**

FOR  
DIY &  
TRADE

...AT LOWEST PRICES

**CONTROL UNITS**

- Automatic
- Modular
- Lighting
- Timer

**SENSORS**

- Passive Infra-Red
- Ultrasonic
- Infra-Red Beam

**ACCESSORIES**

- Contacts
- Pressure Pads

**CARS & VANS**

- Security Lighting
- Cable Etc. Etc.

**HOMES & FACTORIES**

**PRODUCT OF THE MONTH**



**MINIATURE PASSIVE INFRA-RED SENSOR RP33**

Detects intruders up to 12 metres away.

- Size only 80x60x40mm.
- Switchable detection indicator.
- Wide 85° coverage.

■ Suitable for use with most security systems. **ONLY £23.95 +VAT**  
Quantity discounts start at 3 units.

**The Security Specialist**

**RISCOMP LIMITED**

Dept. 51 Poppy Road  
Princes Risborough, Bucks.  
HP17 9DB

Callers by Appointment  
Office hours Mon-Fri  
9am-5pm

(084 44) 6326



TELEPHONE  
OR SEND FOR  
FREE  
LITERATURE  
TODAY

TOP QUALITY  
AUDIOPHILE  
COMPONENTS

NEW FROM SAGE AUDIO

HIGHEST POSSIBLE  
TECHNICAL  
PERFORMANCE

**SUPERMOS 2** (100W to 500W) ±50V to ±75V

THE MOST ADVANCED HI-FI AMP IN THE WORLD

Following the success of the original SUPERMOS we now launch a higher powered version with many new exclusive sound improvements not available on any other amplifier, kit, board, module, or ready made.

**FEATURES:-**

- Highly efficient distortionless PURE CLASS A throughout (low heat generation)
- Top audiophile components inc. best SMD's
- Exclusively made matched custom semiconductors.
- Minimal capacitor design (without DC servos)
- PSU sound colouration eliminated.
- Advanced PSU feedforward ripple elimination including internally separately regulated voltage AND current to ALL stages using SAGE Super-Supply circuitry.
- Total reactance (difficult speaker) drive capable.



SIZE 240 x 100 x 100mm

THD 0.0001%, Slewrate 685V/us, f-3dB 0.5Hz-350kHz, O/P Current 80amps, Damping factor 940, transient power (2ohms) up to 1800W max.

**PLUS** By innovative technical design we have eliminated 5 individual sound colouration components found in all other conventional amplifiers.

**ELIMINATED** - 1) Emitter resistors 2) Zobel networks 3) HF pole compensation 4) Fixed bias Vbe multiplier and temp gen distortions 5) Capacitor sound.

**AND THERE'S MORE** ... Sage exclusive CLEAN CLIPPING (not to be confused with soft clipping) eliminates PSU ripple from reaching the output even when severely clipped, this together with individual regulated supplies to all stages (Super-supplies) TOTALLY eliminates PSU component sound colourations. (A World first!)

**Supermos £65, Supermos1 £78, Supermos2 £140 each**

**AND THERE'S MORE** ... We can't possibly describe this amp fully in this ad. To receive an 8 page glossy brochure describing these modules inc description of our Class A operation and all our products send **£1.50 cheque, PO, coins plus a 9" x 12" 26p SAE** (note we no longer send information without the above money and SAE or IRC's overseas) to:



Sue Wilson, Sales Dept., SAGE AUDIO, Construction House,  
Whitley Street, Bingley, Yorks BD16 4JH, England  
Tel: (0274) 568647 Tlx: 517783 Fax: (0274) 551065

**METEX PROFESSIONAL DMM'S**

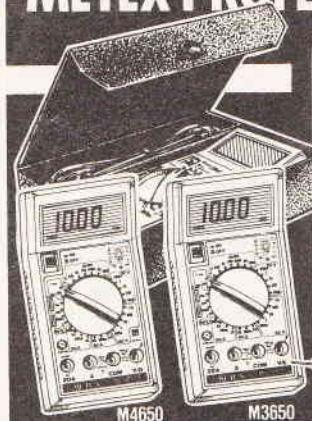

**EDUCATION AND QUANTITY PRICES ON REQUEST**

3½ and 4½ 12mm LCD Digital multi-meters. 5 ranges AC and DC volts; 6 Resistance Ranges to 20M ohm; AC/DC to 20 Amps; Hfe Transistor test; Diode Test; Continuity; Auto polarity and zero; Plus extra features as below. Size 176 x 90 x 36 mm (3800 172 x 88 x 36); All with Test Leads; Fused; Hard carry case and instructions.

**ALL MODELS WITH FREE HARD CARRY CASE**

MODEL	DIGITS	RANGES	EXTRA FEATURES	BASIC	PRICE
3800	3½	32	Low AC/DC 0/20 micro amp ranges	0.5%	£35.00
3610	3½	30	LED continuity indicator	0.3%	£39.09
3630	3½	30	5-Range Capacitance Test	0.3%	£45.17
3650	3½	30	2-Range frequency counter 5-Capacitance	0.3%	£52.13
4630	4½	30	Data Hold 5-Range Capacitance	0.05%	£60.83
4650	4½	30	Data Hold, 2-Range Freq. 5-Capacitance	0.05%	£69.52

Add 15% VAT UK only - UK POST/INS etc. FREE (EXPORT EXTRA)

OPEN 6 DAYS A WEEK — CALLERS WELCOME

**AUDIO ELECTRONICS**

TELEPHONE 01-724 3564  
301 EDGWARE ROAD, LONDON W2 1BN  
ORDER BY POST OR TELEPHONE

**INSTRUMENT CATALOGUE**  
Ref TG  
UK Send  
SAE A4  
£1.00



# THE NEW MAPPLIN CATALOGUE IT'S OUT OF THIS WORLD SEND FOR YOUR COPY TODAY

**ORDER YOUR COPY OF THE NEW MAPPLIN CATALOGUE ON SALE NOW**

Pick up a copy from any W.H. Smith for just £1.95 or post this coupon now to receive your copy by post for just £1.95 + 50p p & p. If you live outside the U.K. send £3.40 or 15 International Reply Coupons. I enclose £2.45.

Name \_\_\_\_\_  
Address \_\_\_\_\_  
Send to Maplin Electronics, P.O. Box 3, Rayleigh, Essex SS6 8LR. Post Code \_\_\_\_\_

**AVAILABLE FROM 11th NOVEMBER 1988 IN ALL W.H. SMITH STORES**

ET1 899

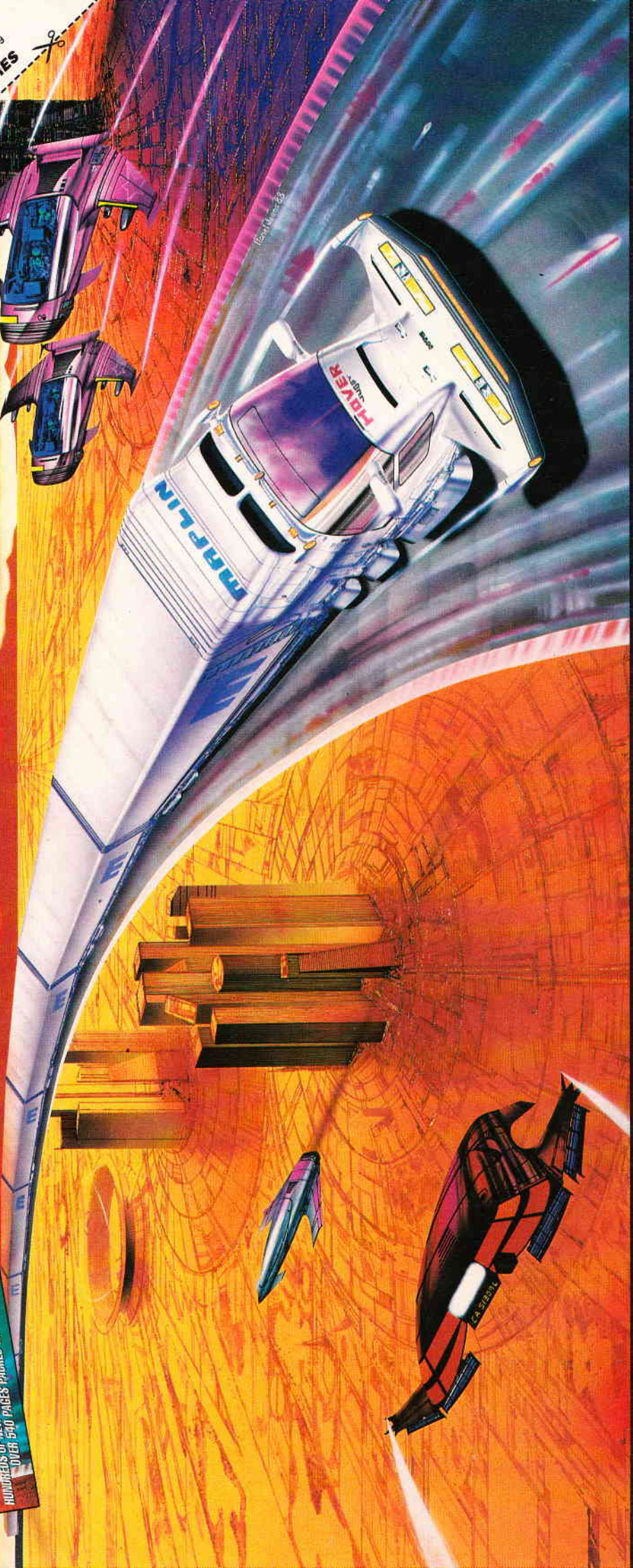

Evening on the planet Oldana, as the Maplin Juggernaut thunders along the highway, captured on canvas by galaxy famous artist Lionel Jeans and featured on the cover of the new Maplin Catalogue.