

AN ARGUS SPECIALIST PUBLICATION

# electronics today

INTERNATIONAL

MAY 1987

£1.30

## MIDI MASTER KEYBOARD



### MUSIC MAKERS' SPECIAL

MIDI KEYBOARD

REVIEW: SAGE AMP MODULES

NEW MUSIC COLUMN STARTS THIS MONTH

BUMPER BUNCH OF MUSIC TECH TIPS

AUDIO... COMPUTING... MUSIC... RADIO... ROBOTICS...

# OMP POWER AMPLIFIER MODULES

PRICES INCLUDE V.A.T. \* PROMPT DELIVERIES \* FRIENDLY SERVICE \* LARGE S.A.E. 28p STAMP FOR CURRENT LIST

## OMP POWER AMPLIFIER MODULES

Now enjoy a world-wide reputation for quality, reliability and performance at a realistic price. Four models available to suit the needs of the professional and hobby market - i.e. Industry, Leisure, Instrumental and Hi-Fi etc. When comparing prices, NOTE all models include Toroidal power supply, Integral heat sink, Glass fibre P.C.B., and Drive circuits to power compatible Vu meter. Open and short circuit proof.

Supplied ready built and tested.



**OMP100 Mk II Bi-Polar** Output power 110 watts R.M.S. into 4 ohms. Frequency Response 15Hz - 30KHz -3dB. T.H.D. 0.01%. S.N.R. -118dB. Sens. for Max. output 500mV at 10K. Size 355 X 115 X 65mm. PRICE £33.99 + £3.00 P&P.

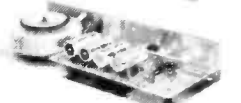

**OMP/MF100 Mos-Fet** Output power 110 watts R.M.S. into 4 ohms. Frequency Response 1Hz - 100KHz -3dB. Damping Factor 80. Slew Rate 45V/uS. T.H.D. Typical 0.002%. Input Sensitivity 500mV. S.N.R. -125dB. Size 300 X 123 X 60mm. PRICE £39.99 + £3.00 P&P.



**OMP/MF200 Mos-Fet** Output power 200 watts R.M.S. into 4 ohms. Frequency Response 1Hz - 100KHz -3dB. Damping Factor 250. Slew Rate 50V/uS. T.H.D. Typical 0.001%. Input Sensitivity 500mV. S.N.R. -130dB. Size 300 X 150 X 100mm. PRICE £62.99 + £3.50 P&P.



**OMP/MF300 Mos-Fet** Output power 300 watts R.M.S. into 4 ohms. Frequency Response 1Hz - 100KHz -3dB. Damping Factor 350. Slew Rate 60V/uS. T.H.D. Typical 0.0008%. Input Sensitivity 500mV. S.N.R. -130dB. Size 330 X 147 X 102mm. PRICE £79.99 + £4.50 P&P.

NOTE: Mos Fets are supplied as standard (100KHz bandwidth & Input Sensitivity 500mV). If required, P.A. version (50KHz bandwidth & Input Sensitivity 775mV). Order - Standard or P.A.

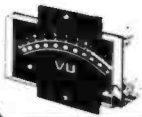

**Vu METER** Compatible with our four amplifiers detailed above. A very accurate visual display employing 11 L.F.D. diodes (7 green, 4 red) plus an additional on/off indicator. Sophisticated logic control circuits for very fast rise and decay times. Tough moulded plastic case with tinted acrylic front. Size 84 X 27 X 45mm. PRICE £8.50 - 50p P&P.

**LOUDSPEAKERS 5" to 15" up to 400 WATTS R.M.S.** Cabinet Fixing in stock. Huge selection of McKenzie Loudspeakers available including Cabinet Plans. Large S.A.E. (28p) for free details.



**POWER RANGE**  
 8" 50 WATT R.M.S. Hi-Fi/Disco.  
 20 oz magnet 1" ally voice coil. Ground ally fixing escutcheon. Res. Freq. 40Hz. Freq. Resp. to 6KHz. Sens. 92dB. PRICE £10.99. Available with black grille £11.99. P&P £1.50 ea.  
 12" 100 WATT R.M.S. Hi-Fi/Disco.  
 50 oz magnet 2" ally voice coil. Ground ally fixing escutcheon. Die cast chassis. White cone. Res. Freq. 25Hz. Freq. Resp. to 4KHz. Sens. 95dB. PRICE £28.60 - £3.00 P&P ea.

**McKENZIE**  
 12" 85 WATT R.M.S. C1285GP Lead guitar/keyboard/Disco.  
 2" ally voice coil. Ally centre dome. Res. Freq. 45Hz. Freq. Resp. to 6.5KHz. Sens. 98dB. PRICE £29.99 + £3.00 P&P ea.  
 12" 85 WATT R.M.S. C1285TC P.A./Disco 2" ally voice coil. Twin cone.  
 Res. Freq. 45Hz. Freq. Resp. to 14KHz. PRICE £31.49 + £3.00 P&P ea.  
 15" 150 WATT R.M.S. C15 Bass Guitar/Disco.  
 3" ally voice coil. Die-cast chassis. Res. Freq. 40Hz. Freq. Resp. to 4KHz. PRICE £57.87 + £4.00 P&P ea.  
 10" 60 WATT R.M.S. 1060GP Gen. Purpose/Lead Guitar/Keyboard/Mid. P.A.  
 2" voice coil. Res. Freq. 75Hz. Freq. Resp. to 7.5KHz. Sens. 99dB. PRICE £19.99 + £2.00 P&P  
 10" 200 WATT R.M.S. C1020GP Guitar, Keyboard, Disco.  
 2" voice coil. Res. Freq. 45Hz. Freq. Resp. to 7KHz. Sens. 101dB. PRICE £44.76 + £3.00 P&P  
 15" 200 WATT R.M.S. C15200 High Power Bass.  
 Res. Freq. 40Hz. Freq. Resp. to 5KHz. Sens. 101dB. PRICE £62.41 + £4.00 P&P  
 15" 400 WATT R.M.S. C15400 High Power Bass.  
 Res. Freq. 40Hz. Freq. Resp. to 4KHz. Sens. 102dB. PRICE £89.52 + £4.00 P&P.

**WEM**  
 5" 70 WATT R.M.S. Multiple Array Disco etc.  
 1" voice coil. Res. Freq. 52Hz. Freq. Resp. to 5KHz. Sens. 89dB. PRICE £22.00 + £1.50 P&P ea.  
 8" 150 WATT R.M.S. Multiple Array Disco etc.  
 1" voice coil. Res. Freq. 48Hz. Freq. Resp. to 5KHz. Sens. 92dB. PRICE £32.00 + £1.50 P&P ea.  
 10" 300 WATT R.M.S. Disco/Sound re-enforcement etc.  
 1" voice coil. Res. Freq. 35Hz. Freq. Resp. to 4KHz. Sens. 92dB. PRICE £36.00 + £2.00 P&P ea.  
 12" 300 WATT R.M.S. Disco/Sound re-enforcement etc.  
 1" voice coil. Res. Freq. 35Hz. Freq. Resp. to 4KHz. Sens. 94dB. PRICE £47.00 + £3.00 P&P ea.

**SOUNDLAB (Full Range Twin Cone)**  
 5" 60 WATT R.M.S. Hi-Fi/Multiple Array Disco etc.  
 1" voice coil. Res. Freq. 63Hz. Freq. Resp. to 20KHz. Sens. 86dB. PRICE £9.99 - £1.00 P&P ea.  
 6 1/2" 60 WATT R.M.S. Hi-Fi/Multiple Array Disco etc.  
 1" voice coil. Res. Freq. 56Hz. Freq. Resp. to 20KHz. Sens. 89dB. PRICE £10.99 - £1.50 P&P ea.  
 8" 60 WATT R.M.S. Hi-Fi/Multiple Array Disco etc.  
 1" voice coil. Res. Freq. 38Hz. Freq. Resp. to 20KHz. Sens. 89dB. PRICE £12.99 - £1.50 P&P ea.  
 10" 60 WATT R.M.S. Hi-Fi/Disco etc.  
 1 1/2" voice coil. Res. Freq. 35Hz. Freq. Resp. to 15KHz. Sens. 89dB. PRICE £16.49 + £2.00 P&P.

**PANTEC HOBBY KITS.** Proven designs including glass fibre printed circuit board and high quality components complete with instructions.

**FM MICROTRANSMITTER (BUG)** 90/105MHz with very sensitive microphone. Range 100/300 metres. 57 x 46 x 14mm (9 volt) Price: £8.62 + 75p P&P.  
**3 WATT FM TRANSMITTER** 3 WATT 85/115MHz varicap controlled professional performance. Range up to 3 miles 35 x 84 x 12mm (12 volt) Price: £14.49 + 75p P&P.  
**SINGLE CHANNEL RADIO CONTROLLED TRANSMITTER/RECEIVER** 27MHz. Range up to 500 metres. Double coded modulation. Receiver output operates relay with 2amp/240 volt contacts. Ideal for many applications. Receiver 90 x 70 x 22mm (9/12 volt). Price: £17.82. Transmitter 80 x 50 x 15mm (9/12 volt). Price: £11.29 P&P + 75p each. S.A.E. for complete list.



3 watt FM Transmitter

POSTAL CHARGES PER ORDER £1.00 minimum. OFFICIAL ORDERS WELCOME, SCHOOLS, COLLEGES, GOVERNMENT BODIES, ETC. PRICES INCLUSIVE OF V.A.T. SALES COUNTER VISA/ACCESS/C.O.D. ACCEPTED.

## BURGLAR ALARM

Better to be 'Alarmed' than terrified. **Thandar's famous Minder Burglar Alarm System.** Superior microwave principle. Supplied as three units complete with interconnection cable. FULLY GUARANTEED.

**Control Unit** - Houses microwave radar unit, range up to 15 metres adjustable by sensitivity control. Three position, key operated fascia switch - off - test - armed 30 second exit and entry delay.

**Indoor Alarm** - Electronic swept freq. siren 104dB output.

**Outdoor Alarm** - Electronic swept freq. siren 98dB output. Housed in a tamper-proof heavy duty metal case.

Both the control unit and outdoor alarm contain rechargeable batteries which provide full protection during mains failure. Power requirement 200/260 Volt AC 50/60Hz. Expandable with door sensors, panic buttons etc. Complete with instructions.

SAVE £138.00 Usual Price £228.85

**BKE's PRICE £89.99 + £4.00 P&P**

Why buy a collection of sell assembly boards!

IDEAL for Workshops, Factories, Offices, Home, etc. Supplied ready built.



## OMP LINNET LOUDSPEAKERS

The very best in quality and value. Made specially to suit today's need for compactness with high sound output levels. Finished in hard wearing black vinyl with protective corners, grille and carry handle. All models 8 ohms. Full range 45Hz - 20KHz. Size 20" x 15" x 12". Watts R.M.S. per cabinet. Sensitivity 1W 1mtr dB.

**OMP 12-100 Watts 100dB. Price £149.99**

per pair.

**OMP 12-200 Watts 102dB. Price £199.99**

per pair.

Delivery Securicor £8.00 per pair



## OMP 19" STEREO RACK AMPS



Professional 19" cased Mos-Fet stereo amps. Used the World over in clubs, pubs, discos etc. With twin Vu meters, twin toroidal power supplies. XLR connections. MF600 Fan cooled. Three models (Ratings R.M.S. into 4 ohms). Input Sensitivity 775mV.

**MF200 (100 + 100)W. £169.00 Securicor**

**MF400 (200 + 200)W. £228.85 Delivery**

**MF600 (300 + 300)W. £322.00 £10.00**

## 1 K-WATT SLIDE DIMMER

- Control loads up to 1Kw
- Compact Size 4 1/2" x 1" x 2 1/2"
- Easy snap in fixing through panel cabinet cut out
- Insulated plastic case
- Full wave control using 8 amp triac
- Conforms to BS800

Suitable for both resistive and inductive loads. Innumerable applications in industry, the home, and disco's, theatres etc.

PRICE £13.99 - 75p P&P

## BSR P295 ELECTRONIC TURNTABLE

- Electronic speed control 45 & 33 1/3 rpm
- Plus Minus variable pitch control
- Belt driven
- Alu. minimum platter with strobed rim
- Cue lever
- Anti-skate (bias device)
- Adjustable counter balance
- Manual arm
- Standard cartridge fixings
- Supplied complete with cut out template
- D.C. Operation 9.14V D.C. 65mA

Price £36.99 - £3.00 P&P.

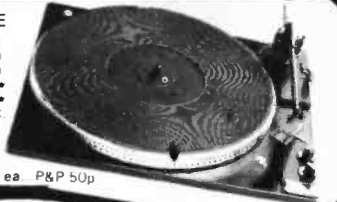

ADC Q4 mag. cartridge for above. Price £4.99 ea. P&P 50p

## PIEZO ELECTRIC TWEETERS - MOTOROLA

Join the Piezo revolution. The low dynamic mass (no voice coil) of a Piezo tweeter produces an improved transient response with a lower distortion level than ordinary dynamic tweeters. As a crossover is not required these units can be added to existing speaker systems of up to 100 Watts (more if 2 put in series). FREE EXPLANATORY LEAFLETS SUPPLIED WITH EACH TWEETER.

**TYPE 'A' (KSN2036A)** 3" round with protective wire mesh. Ideal for bookshelf and medium sized Hi-Fi speakers. Price £4.90 each - 40p P&P  
**TYPE 'B' (KSN1005A)** 3 1/2" super horn. For general purpose speakers, disco and P.A. systems etc. Price £5.99 each - 40p P&P  
**TYPE 'C' (KSN6016A)** 2" x 5" wide dispersion horn. For quality Hi-Fi systems and quality discos etc. Price £6.99 each - 40p P&P  
**TYPE 'D' (KSN1025A)** 2" x 6" wide dispersion horn. Upper frequency response retained extending down to mid range (2KHz). Suitable for high quality Hi-Fi systems and quality discos. Price £9.99 each - 40p P&P  
**TYPE 'E' (KSN1038A)** 3 1/2" horn tweeter with attractive silver finish trim. Suitable for Hi-Fi monitor systems etc. Price £5.99 each - 40p P&P  
**LEVEL CONTROL** Combines on a recessed mounting plate. level control and cabinet input jack socket. 85 x 85 mm. Price £3.99 - 40p P&P

## STEREO DISCO MIXER

**STEREO DISCO MIXER** with 2 x 5 band L & R graphic equalisers and twin 10 segment L.E.D. Vu Meters. Many outstanding features. 5 inputs with individual faders providing a useful combination of the following -  
 3 Turntables (Mag), 3 Mics, 4 Line plus Mic with talk over switch, Headphone Monitor, Pan Pot, L & R Master Output controls. Output 775mV. Size 360 x 280 x 90mm. Price £134.99 - £3.00 P&P

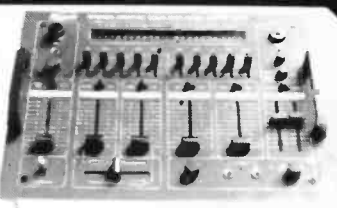

# B. K. ELECTRONICS DEPT ETI

UNIT 5, COMET WAY, SOUTHEND-ON-SEA, ESSEX. SS2 6TR TEL: 0702-527572

# electronics today

INTERNATIONAL **MAY 1987** VOL 16 No.5



**Geoff Bains:** Editor  
**Ian Pitt:** Deputy Editor  
**Paul Chappell:** Project Editor  
**Jerry Fowler:** Technical Illustrator  
**Alisdair Chisholm:** Ad. Manager  
**Nicola Baty:**  
 Classified Sales Executive  
**Andrew Selwood:** Copy Control  
**Dave Bradshaw:** Group Editor  
 - Electronics

**PUBLISHED BY:**  
 Argus Specialist Publications Ltd.,  
 1 Golden Square, London W1R 3AB.  
**DISTRIBUTED BY:**  
 Argus Press Sales & Distribution Ltd.,  
 12-18 Paul Street, London EC2A 4JS.  
 (British Isles).  
**TYPESET BY:**  
 Project Three.  
**PRINTED BY:**  
 Adlard & Son Ltd, The Garden City Press.  
**COVERS PRINTED BY:**  
 Loxley Brothers Ltd.

ISSN  
 0142-7229



Member of the  
 Audit Bureau  
 of Circulation

Electronics Today is normally published on the first Friday in the month preceding cover date. □ The contents of this publication including all articles, designs, plans, drawings and programs and all copyright and other intellectual property rights therein belong to Argus Specialist Publications Limited. All rights conferred by the Law of Copyright and other intellectual property rights and by virtue of international copyright conventions are specifically reserved to Argus Specialist Publications Limited and any reproduction requires the prior written consent of the Company. © 1987 Argus Specialist Publications Ltd □ All reasonable care is taken in the preparation of the magazine contents, but the publishers cannot be held legally responsible for errors. Where mistakes do occur, a correction will normally be published as soon as possible afterwards. All prices and data contained in advertisements are accepted by us in good faith as correct at time of going to press. Neither the advertisers nor the publishers can be held responsible, however, for any variations affecting price or availability which may occur after the publication has closed for press.

■ Subscription Rates. UK: £18.10. Overseas: £22.50. USA: \$29.50. Airmail: £49.50.

## EDITORIAL AND ADVERTISEMENT OFFICE

1 Golden Square, London W1R 3AB. Telephone 01-437 0626.  
 Telex 8811896.

## FEATURES

- HARDWARE DESIGN CONCEPTS 12**  
 Mike Barwise continues his design of a pulse generator for all to see. This month he concentrates on the main pulse board.
- CIRCUIT THEORY .....16**  
 Paul Chappell looks at the wondrous sine wave and how it helps the electronics designer in all manner of ways.
- THE TRUTH ABOUT HI-FI .....19**  
 A lot has been written about hi-fi

(quite a bit in the hallowed pages of ETI) and a little of it is true. Andrew Armstrong sorts out sheeps from goats.

**SAGE AUDIO MODULES .....47**  
 Ian Pitt has been trying out a couple of amplifier modules from Sage Audio and has found them to be stars of the stage and home.

**PROJECT INDEX**  
**1972-1987.....Centre Pages**  
 The second part of the pull-out guide to 15 years of ETI projects.

## PROJECTS

- BATLITE .....24**  
 Holy broken bones, Batman, it's that ingenious Andy Armstrong again. This time he's taking over the world with a fiendish battery voltage indicator.
- MIDI MASTER KEYBOARD ....27**  
 John Yau can produce an orchestra of sounds with only one set of ivories thanks to his top-notch MIDI controller keyboard.
- HI-FI POWER METER .....33**  
 Paul Chappell looks into the whole business of measuring audio power and produces a budget power meter

before next month's all-singing, all-dancing model.

**TELFAX .....38**  
 Ever been stuck for a jingle, at a loss for a sales pitch, or just can't get your dog to bark? Geoff Phillips' Telfax machine can solve all your problems.

**MUSIC CIRCUITS .....44**  
 A bunch of musical Tech Tips to keep the muse busy.  
 Electronic Tuning Fork  
 Guitar Lead Checker  
 Metronome  
 Electric Guitar De-fleaing  
 Valve Distortion Fuzz Box

## REGULARS

- NEWS DIGEST .....6**
- NEXT MONTH'S ETI .....8**
- DIARY .....9**
- READERS' OFFER .....10**
- SPECIAL OFFER .....23**
- READ/WRITE .....26**
- KEYNOTES .....50**
- BOOK LOOK .....51**
- PLAYBACK .....51**
- OPEN CHANNEL .....52**
- PCB FOILS .....53**
- PCB SERVICE .....56**
- SUBSCRIPTIONS .....58**
- READERS' FREE ADS .....59**
- CLASSIFIED ADS .....60**
- AD INDEX .....62**

### BBC Micro Computer System

**BBC Master Series**

AMB15 BBC MASTER includes one free ROM cartridge ..... **£385 (a)**

AMB12 BBC MASTER Econet computer ..... **£315 (a)**

AMC06 Turbo (65C102) Expansion Module ..... **£99 (b)**

ADF14 Rom Cartridge ..... **£13 (d)**

ADF10 Econet Module ..... **£41 (b)**

ADJ22 Ref. Manual Part I ..... **£14 (c)**

ADJ23 Ref. Manual Part II ..... **£14 (c)**

ADJ24 Advanced Ref Manual ..... **£19.50 (c)**

ACORN ADD-ON PRODUCTS

Universal 2nd Processor ..... **£75 (b)**

TORCH ZEP 100 ..... **£229 (a)**

Muliform Z80 2nd Processor ..... **£289 (b)**

Acorn Teletext Adaptor ..... **£95 (b)**

Acorn IEEE Interface ..... **£265 (a)**

**BBC Master Compact SYSTEM 1**

128K, Single 640K Drive & bundled software ..... **£385 (a)**

**SYSTEM 2**

System 1 with a 12" Med Res RGB Monitor ..... **£469 (a)**

**SYSTEM 3**

System 1 with a 14" Med Res RGB Monitor ..... **£599 (a)**

Second Drive Kit ..... **£99 (c)**

**UPGRADE KITS**

1770 DFS Upgrade for Model B ..... **£43.50 (d)**

Basic II ROM ..... **£22.50 (d)**

1.2 OS ROM ..... **£15 (d)**

DNFS ROM ..... **£17.50 (d)**

ADFS Rom (for B with 1770 DFS & B Plus) ..... **£26 (d)**

**ECONET ACCESSORIES**

Econet Starter kit ..... **£85 (d)**

Econet Socket Set ..... **£29 (c)**

Econet Bridge ..... **£174 (b)**

File Server Level II ..... **£75 (d)**

Printer Server Rom ..... **£41 (d)**

10 Station Lead set ..... **£26 (c)**

Adv. Econet User Guide ..... **£10 (d)**

**COMMUNICATIONS ROMS**

Terminator ..... **£25 (d)**

Communicator ..... **£49 (d)**

Commstar ..... **£28 (d)**

**DATABEEB** ..... **£24 (d)**

**BBC FIRMWARE & SOFTWARE**

Database Management Systems, Word Processors, Languages, Spreadsheets, Utilities

For full details on the wide range of above packages please write to us.

### DISC DRIVES

These are fully cased and wired drives with slim line high quality mechanisms. Drives supplied with cables manuals and formatting disc suitable for the BBC computer. All 80 track drives are supplied with 40/80 track switching as standard. All drives can operate in single or dual density format.

PD800P (2 × 400K/2 × 640K 40/80 DS) with built in monitor stand ..... <b>£249 (a)</b>	PS400 with psu 1 × 400K/1 × 640K 40/80T DS ..... <b>£129 (b)</b>
PD800 (2 × 400K/2 × 640K 40/80T DS) ..... <b>£229 (a)</b>	<b>3.5" DRIVES</b>
TD800 (as PD800 but without psu) ..... <b>£199 (a)</b>	1 × 400K/1 × 640K 80T DS ..... <b>£75 (b)</b>
TS400 1 × 400K/1 × 640K 40/80T DS ..... <b>£114 (b)</b>	PS35 1 with psu ..... <b>£119 (b)</b>
	2 × 400K/1 × 640K 80T DS ..... <b>£135 (b)</b>
	PD35 2 with psu ..... <b>£187 (b)</b>

### 3M FLOPPY DISCS

High quality discs that offer a reliable error free performance for life. Each disc is individually tested and guaranteed for life. Ten discs are supplied in a sturdy cardboard box.

<b>5¼" DISCS</b>	<b>3½" DISCS</b>
40T SS DD <b>£10.00 (d)</b>	40T DS DD <b>£12.00 (d)</b>
80T SS DD <b>£14.50 (d)</b>	80T DS DD <b>£15.50 (d)</b>
	80T DS DD <b>£25.00 (d)</b>

### DISC ACCESSORIES

FLOPPICLENE Disc Head Cleaning Kit with 20 disposable cleaning discs ensures continued optimum performance of the drives... 3½" **£16 (d)**, 5¼" **£14.50 (d)**

Single Disc Cable ..... <b>£8 (d)</b>	Dual Disc Cable ..... <b>£8.50 (d)</b>
10 Disc Library Case ..... <b>£1.80 (c)</b>	30 Disc Case ..... <b>£8 (c)</b>
40 Disc Lockable Box ..... <b>£8.50 (c)</b>	100 Disc Lockable Box ..... <b>£13 (c)</b>

### MONITORS

All 14" monitors now available in plastic or metal cases, please specify.

<b>MICROVITEC: 14" RGB</b>	<b>14" RGB with PAL &amp; Audio</b>
1431 Std Res ..... <b>£179 (a)</b>	1431 AP Std Res ..... <b>£199 (a)</b>
1451 med Res ..... <b>£225 (a)</b>	1451 AP Med Res ..... <b>£259 (a)</b>
1441 Hi Res ..... <b>£365 (a)</b>	
Swivel Base for Plastic 14" Microvitecs ..... <b>£20 (c)</b>	
<b>20" RGB with PAL &amp; Audio</b>	
2030CS Std Res ..... <b>£380 (a)</b>	2040CS Hi Res ..... <b>£685 (a)</b>
TAXAN SUPERVISION 620 12" High Resolution ..... <b>£279 (a)</b>	TAXAN SUPERVISION III with amber/green option, BBC & IBM .. <b>£319 (a)</b>
MITSUBISHI XC1404 14" RGB Med Res IBM & BBC Compatible .. <b>£219 (a)</b>	PHILIPS 8501 RGB Std Res ..... <b>£139 (a)</b>

TAXAN KX 1201G Hi Res 12" Etched Green Screen ..... <b>£85 (a)</b>
TAXAN KX1202G Hi Res 12" Long Persistence (P39) ..... <b>£95 (a)</b>
TAXAN KX 1203A Hi Res 12" Etched Amber Screen ..... <b>£95 (a)</b>
PHILIPS BM7502 12" Hi Res Green Screen ..... <b>£75 (a)</b>
PHILIPS BM7522 12" Hi Res Amber Screen ..... <b>£75 (a)</b>

Swivel Base for Taxan Monochrome fitted with Digital Clock ..... **£21 (c)**

### SPECIAL OFFER

2764-25 ..... <b>£2.50</b>
27128-25 ..... <b>£2.75</b>
6264LP-15 ..... <b>£2.80</b>

**ATTENTION**

All prices in this double page advertisement are subject to change without notice.

**ALL PRICES EXCLUDE VAT**

Please add carriage 50p unless indicated as follows:

(a) £8 (b) £2.50 (c) £1.50 (d) £1.00

### Serial Test Cable

Serial Cable switchable at both ends allowing pin options to be re-routed or linked either end using a 10 way switch making it possible to produce almost any cable configuration on site.

Available as M/M or M/F ..... **£24.75 (d)**

### Serial Mini Patch Box

Allows an easy method to reconfigure pin functions without rewiring the cable assy.

Jumpers can be used and reused. **£22 (d)**

### Serial Mini Test

Monitors RS232C and CCITT V24 Transmissions, Indicating status with dual colour LEDs on 7 most significant lines.

Connects in Line. **£22.50 (d)**

**EPSON**

LX86NLQ (80 col) ..... **£199 (a)**

EX800 ..... **£409 (a)**

EX1000 ..... **£579 (a)**

EX1000 ..... **£579 (a)**

LQ800 (80 col) ..... **£439 (a)**

LQ1000 (136 col) ..... **£589 (a)**

JX80 4 colour ..... **£229 (a)**

FX800 ..... **£329 (a)**

FX100 ..... **£499 (a)**

TAXAN KP815 (80 col) NLQ ..... **£269 (a)**

TAXAN KP915 (156 col) ..... **£369 (a)**

**NATIONAL PANASONIC KXP 1080** (80 col) ..... **£159 (a)**

STAR NL10 (IBM interface) ..... **£209 (a)**

STAR Power Type (Daisy) ..... **£229 (a)**

JUKI 6100 Daisy Wheel ..... **£259 (a)**

BROTHER HR20 ..... **£329 (a)**

INTEGREX Multicolour ..... **£525 (a)**

HITACHI 672 A3 Plotter ..... **£459 (a)**

### ACCESSORIES

**EPSON**

FX plus sheet feeder ..... **£129.00 (b)**

LX80 Sheet feeder ..... **£48.00 (b)**

Paper Roll Holder ..... **£17.00 (d)**

Interfaces: 8143 RS232 ..... **£28.00 (c)**

8132 Apple II ..... **£80.00 (c)**

8165 IEEE + cable ..... **£85.00 (c)**

8177P NLQ (FX80/FX100+) ..... **£99 (d)**

Serial & Parallel Interfaces with larger buffers available.

Ribbons: RX/FX 100/100+ ..... **£0 (d)**

RX/FX 80/80+ ..... **£4.00 (d)**

LX80 ..... **£4.50 (d)**

Spare pens for H180 ..... **£7.80/set (d)**

FX80 Tractor Attachment! (c)

**TAXAN CANON**

RS232 Interface + 2K Buffer ..... **£63 (c)**

Ribbon KP810/910/815/915 ..... **£6.00 (d)**

**JUKI:**

RS232 Interface ..... **£65 (c)**

Spare Daisy Wheel ..... **£14.00 (d)**

Ribbon ..... **£12.00 (d)**

Sheet Feeder ..... **£182 (a)**

Tractor Feed Attachment ..... **£149 (a)**

**Sheet Feeder** ..... **£239 (a)**

Tractor Feeder ..... **£118 (a)**

Ribbons Carbon or Nylon ..... **£3.00 (d)**

Red Correction Ribbon ..... **£2.00 (d)**

**BBC Printer Lead:**

Parallel (1.2m) ..... **£6.00 (d)**

Serial (1.2m) ..... **£7.00 (d)**

Printer Leads can be supplied to any length.

**Paper:**

2000 Sheets Fanfold:

9.5" x 11" ..... **£13 (b)**

14.5" x 11" ..... **£18.50 (b)**

Labels: (per 1000)

3.5" x 17/16" Single row ..... **£5.25 (d)**

27/16" x 17/16" Triple row ..... **£5.00 (d)**

### MODEMS

All modems listed below are BT approved

#### MIRACLE 3000:

MIRACLE WS2000 V21/23 Manual ... **£95 (b)**

MIRACLE WS4000 V21/23. (Hayes Compatible, Intelligent, Auto Dial/Auto Answer) ... **£149 (b)**

MIRACLE WS3000 V21/V23 As SW4000 and with BELL standards and battery pack up for memory ... **£295 (b)**

MIRACLE WS3000 V22 As WS3000 V21/V23 but with 1200 baud full duplex ..... **£495 (b)**

MIRACLE WS3000 V22 bis As V22 and 2400 baud full duplex ..... **£650 (b)**

MIRACLE WS3022 As WS3000 but with only 1200/1200 ..... **£395 (b)**

MIRACLE WS3024 As WS3000 but with only 2400/2400 ..... **£570 (b)**

DATA Cable from Ws series/PC or XT ..... **£7 (d)**

**'DATATALK Comms Package'** if purchased with any of the above modems' ..... **£79 (c)**

**PACEL Nightingale Modem V21/V23 Manual** ..... **£75 (b)**

### GANG OF EIGHT INTELLIGENT F. ST EPROM COPIER

Copies up to eight eproms at a time and accepts all single rail eproms up to 27256. Can reduce programming time by 60% by using manufacturer's suggested algorithms. Fixed Vpp of 21 & 25 volts and variable Vpp factory set at 12.5 volts. LCD display with alpha moving message. **£395 (b)**.

### SOFTY II

This low cost intelligent eprom programmer can program 2716, 2516, 2532, 2732, and with an adaptor, 2564 and 2764. Displays 512 byte page on TV - has a serial and parallel I/O routines. Can be used as an emulator, cassette interface. Softy II ..... **£195 (b)**

Adaptor for 2764/2564 **£25.00 (c)**

### UV ERASERS

All erasers with built in safety switch and main indicator.

UVI B erases up to 6 eproms at a time. .... **£47 (c)**

UVI T as above but with a timer ..... **£59 (c)**

UVI40 erases up to 14 eproms at a time. **£88 (b)**

UVI41 as above but with a timer. .... **£88 (b)**

### I.D. CONNECTORS

(Speedlock Type)		Header	Recept	Edge Conn.
No of ways	Plug	tacle	85p	120p
10	90p	85p	120p	120p
20	145p	125p	195p	195p
26	175p	150p	240p	240p
34	200p	160p	320p	320p
40	220p	190p	340p	340p
50	235p	200p	390p	390p

### D CONNECTORS

No of Ways		9	15	25	37
<b>MALE:</b>	Ang.Pins	120	180	230	350
	Solder	60	85	125	170
	IDC	175	275	325	-
<b>FEMALE:</b>	St Pin	100	140	210	380
	Ang.pins	160	210	275	440
	Solder	90	130	195	290
	IDC	195	325	375	-
	St Hood	90	95	100	120
	Screw	130	150	175	-
	Lock	-	-	-	-

**TEXT TOOL ZIF**

SOCKETS	24 pin <b>£7.50</b>
28-pin	£9.00
	40 pin <b>£12</b>

### EDGE CONNECTORS

	0.1"	0.156"
2 × 6-way (commodore)	150p	300p
2 × 10-way	150p	300p
2 × 12-way (vic 20)	150p	300p
2 × 18-way	175p	350p
2 × 23-way (ZX81)	220p	440p
2 × 25-way	225p	450p
2 × 28-way (Spectrum)	200p	400p
2 × 36-way	250p	500p
1 × 43-way	260p	520p
2 × 22-way	190p	380p
2 × 43-way	395p	790p
1 × 77-way	400p	800p
2 × 50-way (S100conn)	600p	1200p

### EURO CONNECTORS

	Plug	Socket
DIN 41612	230p	275p
2 × 32 way St Pin	230p	275p
2 × 32 way Ang Pin	275p	320p
3 × 32 way St Pin	260p	300p
3 × 32 way Ang Pin	375p	400p
IDC Skt A + B	400p	400p
IDC Skt A + C	400p	400p

For 2 × 32 way please specify spacing (A + B, A + C).

### AMPHENOL CONNECTORS

Solder	ZDC
36 way plug	500p 475p
36 way skt	550p 500p
24 way plug	-
IEEE	475p 475p
24 way skt	-
IEEE	500p 500p
PCB Mtg Skt Ang Pin	24 way 700p 36 way 750p

### GENDER CHANGERS

25 way D type	Male to Male	Female to Female
Male to Male	£10	£10
Female to Female	£10	£10
Male to Female	£10	£10

### RS 232 JUMPERS

(25 way D)	Solder	IDC
24" Single end Male	£5.00	£5.25
24" Single end Female	£5.25	£10.00
24" Female Female	£10.00	£9.50
24" Male Male	£9.50	£9.50
24" Male Female	£9.50	£9.50

### RIBBON

	40p	34-way	160p
10-way	40p	34-way	160p
16-way	60p	40-way	180p
20-way	85p	50-way	200p
26-way	120p	64-way	280p

### DIL HEADERS

	Solder	IDC
14 pin	40p	100p
16 pin	50p	110p
18 pin	80p	-
20 pin	75p	-
24 pin	100p	150p
28 pin	160p	200p
40 pin	200p	225p

### TECHNOLINE VIEWDATA SYSTEM

Using 'Prestel' type protocols for information and orders phone 01-450 9764. 24 hour service, 7 days a week.

74 SERIES		74181	340p	74LS162A	75p	74S08	50p	4063	85p
7400	30p	74182	140p	74LS163A	75p	74S10	50p	4066	40p
7401	30p	74183	180p	74LS164	75p	74S11	75p	4067	230p
7402	30p	74184	180p	74LS165	110p	74S12	50p	4068	25p
7403	30p	74185	130p	74LS166A	150p	74S13	50p	4069	24p
7404	30p	74186	130p	74LS167	130p	74S14	50p	4070	24p
7405	30p	74187	115p	74LS168	100p	74S15	50p	4071	24p
7406	40p	74188	110p	74LS169	100p	74S16	50p	4072	24p
7407	40p	74189	110p	74LS170	140p	74S17	50p	4073	24p
7408	40p	74190	110p	74LS171	140p	74S18	50p	4074	24p
7409	40p	74191	110p	74LS172	140p	74S19	50p	4075	24p
7410	30p	74192	110p	74LS173	140p	74S20	50p	4076	25p
7411	30p	74193	220p	74LS174	200p	74S21	50p	4077	25p
7412	30p	74194	220p	74LS175	200p	74S22	50p	4078	25p
7413	50p	74195	190p	74LS176	190p	74S23	50p	4079	25p
7414	70p	74196	150p	74LS177	150p	74S24	50p	4080	25p
7415	36p	74197	300p	74LS178	275p	74S25	50p	4081	24p
7416	36p	74198	300p	74LS179	275p	74S26	50p	4082	24p
7417	40p	74199	300p	74LS180	275p	74S27	50p	4083	24p
7418	40p	74200	300p	74LS181	275p	74S28	50p	4084	24p
7419	40p	74201	300p	74LS182	275p	74S29	50p	4085	24p
7420	40p	74202	300p	74LS183	275p	74S30	50p	4086	24p
7421	60p	74203	170p	74LS184	275p	74S31	50p	4087	24p
7422	36p	74204	105p	74LS185	275p	74S32	50p	4088	24p
7423	36p	74205	105p	74LS186	275p	74S33	50p	4089	24p
7424	36p	74206	105p	74LS187	275p	74S34	50p	4090	24p
7425	36p	74207	105p	74LS188	275p	74S35	50p	4091	24p
7426	40p	74208	300p	74LS189	275p	74S36	50p	4092	24p
7427	40p	74209	300p	74LS190	275p	74S37	50p	4093	24p
7428	43p	74210	180p	74LS191	75p	74S38	50p	4094	90p
7429	40p	74211	180p	74LS192	75p	74S39	50p	4095	90p
7430	30p	74212	200p	74LS193	80p	74S40	50p	4096	90p
7431	36p	74213	200p	74LS194	80p	74S41	50p	4097	90p
7432	36p	74214	200p	74LS195	80p	74S42	50p	4098	90p
7433	36p	74215	200p	74LS196	80p	74S43	50p	4099	90p
7434	36p	74216	200p	74LS197	80p	74S44	50p	4100	90p
7435	36p	74217	200p	74LS198	80p	74S45	50p	4101	90p
7436	36p	74218	200p	74LS199	80p	74S46	50p	4102	90p
7437	36p	74219	200p	74LS200	80p	74S47	50p	4103	90p
7438	36p	74220	200p	74LS201	80p	74S48	50p	4104	90p
7439	36p	74221	200p	74LS202	80p	74S49	50p	4105	90p
7440	36p	74222	200p	74LS203	80p	74S50	50p	4106	90p
7441	36p	74223	200p	74LS204	80p	74S51	50p	4107	90p
7442	36p	74224	200p	74LS205	80p	74S52	50p	4108	90p
7443	36p	74225	200p	74LS206	80p	74S53	50p	4109	90p
7444	36p	74226	200p	74LS207	80p	74S54	50p	4110	90p
7445	36p	74227	200p	74LS208	80p	74S55	50p	4111	90p
7446	36p	74228	200p	74LS209	80p	74S56	50p	4112	90p
7447	36p	74229	200p	74LS210	80p	74S57	50p	4113	90p
7448	36p	74230	200p	74LS211	80p	74S58	50p	4114	90p
7449	36p	74231	200p	74LS212	80p	74S59	50p	4115	90p
7450	36p	74232	200p	74LS213	80p	74S60	50p	4116	90p
7451	36p	74233	200p	74LS214	80p	74S61	50p	4117	90p
7452	36p	74234	200p	74LS215	80p	74S62	50p	4118	90p
7453	36p	74235	200p	74LS216	80p	74S63	50p	4119	90p
7454	36p	74236	200p	74LS217	80p	74S64	50p	4120	90p
7455	36p	74237	200p	74LS218	80p	74S65	50p	4121	90p
7456	36p	74238	200p	74LS219	80p	74S66	50p	4122	90p
7457	36p	74239	200p	74LS220	80p	74S67	50p	4123	90p
7458	36p	74240	200p	74LS221	80p	74S68	50p	4124	90p
7459	36p	74241	200p	74LS222	80p	74S69	50p	4125	90p
7460	36p	74242	200p	74LS223	80p	74S70	50p	4126	90p
7461	36p	74243	200p	74LS224	80p	74S71	50p	4127	90p
7462	36p	74244	200p	74LS225	80p	74S72	50p	4128	90p
7463	36p	74245	200p	74LS226	80p	74S73	50p	4129	90p
7464	36p	74246	200p	74LS227	80p	74S74	50p	4130	90p
7465	36p	74247	200p	74LS228	80p	74S75	50p	4131	90p
7466	36p	74248	200p	74LS229	80p	74S76	50p	4132	90p
7467	36p	74249	200p	74LS230	80p	74S77	50p	4133	90p
7468	36p	74250	200p	74LS231	80p	74S78	50p	4134	90p
7469	36p	74251	200p	74LS232	80p	74S79	50p	4135	90p
7470	36p	74252	200p	74LS233	80p	74S80	50p	4136	90p
7471	36p	74253	200p	74LS234	80p	74S81	50p	4137	90p
7472	36p	74254	200p	74LS235	80p	74S82	50p	4138	90p
7473	36p	74255	200p	74LS236	80p	74S83	50p	4139	90p
7474	36p	74256	200p	74LS237	80p	74S84	50p	4140	90p
7475	36p	74257	200p	74LS238	80p	74S85	50p	4141	90p
7476	36p	74258	200p	74LS239	80p	74S86	50p	4142	90p
7477	36p	74259	200p	74LS240	80p	74S87	50p	4143	90p
7478	36p	74260	200p	74LS241	80p	74S88	50p	4144	90p
7479	36p	74261	200p	74LS242	80p	74S89	50p	4145	90p
7480	36p	74262	200p	74LS243	80p	74S90	50p	4146	90p
7481	36p	74263	200p	74LS244	80p	74S91	50p	4147	90p
7482	36p	74264	200p	74LS245	80p	74S92	50p	4148	90p
7483	36p	74265	200p	74LS246	80p	74S93	50p	4149	90p
7484	36p	74266	200p	74LS247	80p	74S94	50p	4150	90p
7485	36p	74267	200p	74LS248	80p	74S95	50p	4151	90p
7486	36p	74268	200p	74LS249	80p	74S96	50p	4152	90p
7487	36p	74269	200p	74LS250	80p	74S97	50p	4153	90p
7488	36p	74270	200p	74LS251	80p	74S98	50p	4154	90p
7489	36p	74271	200p	74LS252	80p	74S99	50p	4155	90p
7490	36p	74272	200p	74LS253	80p	74S00	50p	4156	90p
7491	36p	74273	200p	74LS254	80p	74S01	50p	4157	90p
7492	36p	74274	200p	74LS255	80p	74S02	50p	4158	90p
7493	36p	74275	200p	74LS256	80p	74S03	50p	4159	90p
7494	36p	74276	200p	74LS257	80p	74S04	50p	4160	90p
7495	36p	74277	200p	74LS258	80p	74S05	50p	4161	90p
7496	36p	74278	200p	74LS259	80p	74S06	50p	4162	90p
7497	36p	74279	200p	74LS260	80p	74S07	50p	4163	90p
7498	36p	74280	200p	74LS261	80p	74S08	50p	4164	90p
7499	36p	74281	200p	74LS262	80p	74S09	50p	4165	90p
7500	36p	74282	200p	74LS263	80p	74S10	50p	4166	90p

### LINEAR ICs

AD7581	€18	LM710	40p	TBA820M	75p
ADC0808	110p	LM711	100p	TBA920	200p
AM7910DC	€28	LM723	80p	TBA950	200p
AN103	200p	LM725CN	400p	TC9106	80p
AY-15000	100p	LM733	90p	TC9440	175p
AY-3-1360	450p	LM741	22p	TD10110	220p
AY-3-8910	450p	LM747	75p	TD1022	400p
CA018A	180p	LM748	80p	TD1024	300p
CA3028A	110p	LM1014	180p	TD11705	300p
CA3045	70p	LM1801	30p	TD2002	300p
CA3059	320p	LM1830	280p	TD2004	180p
CA3090E	70p	LM1871	30p	TD2006	330p
CA3098	80p	LM1872	30p	TD2008	330p
CA3099	80p	LM1959	480p	TD2030	280p
CA3090AQ	370p	LM2917	70p	TD20310	700p
CA3130E	80p	LM3002	80p	TD21000	300p
CA3130T	130p	LM3003	80p	TD21002	300p
CA3140E	40p	LM3009	100p	TD21003	40p
CA3140T	100p	LM3011	180p	TL081CP	40p
CA3190E	30p	LM3014	320p	TL084	80p
CA3191E	340p	LM3015	340p	TL071	40p
CA3192E	80p	LM3016	340p	TL072	70p
CA3199E	270p	LM13600	180p	TL074	110p
CA3240E	180p	MS1813L	230p	TL081	35p
CA3290G	270p	MS1816L	480p	TL082	85p
DA3140B-8	300p	MB3172	90p	TL083	75p
DAC0800	230p	MC1413	75p	TL084	100p
DAC0808	300p	MC1415	75p	TL085	200p
DAC0808Q	300p	MC1455	75p	TL086	300p
DG308	300p	MC1465L	70p	UA229	80p
HA1386	180p	MC1486	300p	UA229A	150p
ICL7108	875p	MC330AP	200p	ULN2801A	600p
ICL7161	110p	MC3401	75p	ULN2804A	75p
ICL7660	40p	MC3403	80p	ULN2808	200p
ICL7660D	290p	MC3404	100p	ULN2809	180p
ICL8008	40p	MC3409	400p	ULN2809A	180p
ICM7555	80p	ML920	500p	ULN2804	180p
ICM7556	140p	ML922	400p	UPC475	375p
LC7120	300p	MM221A	300p	UPC592H	200p
LF1737	300p	NE544	180p	UPC1158H	300p
LF361	180p	NE555	400p	XR2201	400p
LF363	80p	NE564</			



## Micro Power Beats Power Cuts

Engineers at Bath University are developing a model of the national electricity grid on one of the most powerful microcomputer systems ever built.

Rod Dunn and Richard Daniels of the University's School of Electrical Engineering have been working for some years on the model using relatively slow 16-bit processors.

Now, with the aid of grants from the CEGB and the Science and Engineering Research Council, they are developing a faster model using 12 microcomputers in parallel, each with a 32-bit processor. The resulting system will be at least seven times more powerful than the original design.

When complete, the model will be used by CEGB engineers both as a training aid and to help in the prediction of faults on the national grid. The university hopes that suitably modified versions can be sold to other countries.

## New Centre to Help Industry

The increasing reliance of British Industry on computer automation has led to the setting up of a national communications standards centre.

Known as ComCentre, it will work closely with the major national and international bodies responsible for communications standard setting and maintain a database of standards and information. Companies will be asked to pay a membership fee in return for which they will receive on-line access to the database and immediate telephone advice when required.

The centre will be operated by the Production Engineering Research Association (PERA).

Initial funding has come from the Department of Trade and Industry which provided £1 million to cover the first three years of operation. At the end of that time it is hoped the centre will be self-financing.

Speaking at the launch of ComCentre, Industry Under-Secretary John Butcher argued that Britain must use the latest manufacturing technology in order to remain competitive. ComCentre would help make companies aware of the technology available and its capabilities.

ComCentre, PERA, Melton Mowbray, Leicestershire LE13 0PB. Tel. (0664) 501 501.



## A New Twist To Screwdriving

Dura-Drive is a four-in-one screwdriver with a unique lever action to shift stubborn screws.

It provides two slot-head and two cross-head blades which cover most DIY and maintenance requirements and is made from tough Dupont plastic.

The Dura-Drive differs from most multi-blade screwdrivers in that the various blades are permanently attached and simply fold out of the handle when required. This removes the risk of

losing blades and cuts down the time and effort required to change from one to another.

The lever action is achieved by folding one of the unused blades out to 90° from the handle (see picture). Difficult screws can then be tightened or removed with very little effort.

The Dura-Drive is available by mail-order at an all-inclusive price of £8.57 from Electronic and Computer Workshop Ltd, 171 Broomfield Road, Chelmsford, Essex CM1 1RY. Tel. (0245) 262 149.



## BK Imports Vari-Speed Turntable

Audio equipment specialist BK Electronics has added a high-quality variable speed turntable to its range following an exclusive agreement with an overseas manufacturer.

The turntable will be sold in the UK under the OMP brand name and will be known simply as the Vari-Speed.

It uses a high-torque DC motor with electronic servo control and offers standard speeds of 33½ and 45 RPM as well as the separate variable speed function. The die-cast platter is belt driven and the rim is illuminated with a strobe prism to enable the speed to be checked.

Other features include a precision balanced S-shaped tone arm, a universal cartridge headshell and a viscose damped cueing lever.

BK says the turntable offers an unsurpassable price/performance ratio and expects it to prove popular in disco and studio applications. The unit should also be of interest to those building domestic hi-fi systems.

The OMP Vari-Speed turntable costs £53.99 including postage and VAT and can be obtained from BK Electronics, Unit 5, Comet Way, Southend-on-Sea, Essex SS2 6TR, Tel. (0702) 527 572.

● The IBA has recently completed six weeks of test transmissions in preparation for the UK's first radio teletext service. The system will be used to transmit up-to-date financial information using techniques already well-established in the USA but not previously employed over here. The initial period of testing has been carried out in the London area on 97.3MHz VHF/FM and a further series of tests will begin shortly on 95.8MHz using the IBA's other VHF/FM transmitter in London.

● Kit News is a small leaflet which describes the range of products available from Cambridge Kits. Many of the items have a strong amateur radio bias but there are also kits for a sound meter, a rugby clock and various items of test gear plus some useful hints and tips on construction and fault-finding. Cambridge Kits, 45 Old School Lane, Milton, Cambridge CB4 4BS, Tel. (0223) 860 150.

● A wide range of reed and mercury-wetted relays is described in a 20-page, two-colour catalogue from Hamlin. Among the types listed are miniature and subminiature relays in DIL and single-in-line packages plus multi-pole devices and various high voltage and other special types. Contact Hamlin Electronics Europe Ltd, Park Road, Diss, Norfolk IP22 3AY, Tel. (0379) 4411.

● A new era in board games is about to begin, according to certain national newspapers and magazines. One of the star exhibits at the recent Toy Fair in London was a revolutionary microchip device which is all set to replace a traditional element of many games — the dice. The idea is apparently regarded as rather novel and games firm Waddingtons is amongst those taking a close interest. Odd, really, when you bear in mind that ETI published an electronic dice circuit as long ago as 1976 and has published several more since. Then again, perhaps they don't appreciate the benefits of electronics: as the Daily Mail sees it, the principal benefit of the new dice is that it is unlikely to roll under furniture and get lost!

● At just under 400 pages the 1987/88 Philips Test And Measurement catalogue is definitely the thickest ETI has received this month. It includes all the usual types of test equipment plus microcomputer development systems, microwave test equipment and specialised items for television and video testing. Copies are free from Eleanor Bullett, Pye Unicam Ltd, York Street, Cambridge CB1 2PX, Tel. (0223) 358 866.

NEXT MONTH

AN ARGUS SPECIALIST PUBLICATION

# electronics today

INTERNATIONAL

## THE TELEPHONE SYSTEM

Ever wondered what happens at the other end of the telephone line? Is there any truth in the rumour that the only reason the system suffered no major breakdowns during the recent engineers' strike is because it's all run on carrier pigeons anyway? ETI reveals all.

## FLAT ALARM

Not a warning for punctured tyres but a simple, low cost, but remarkably effective alarm system for a flat, maisonnette or small house.

## RIAA EQUALISATION

All amp designs equalise but some are more equalised than others. RIAA equalisation is required for all record preamplifiers (remember records? They're those large, black things that work a bit like CDs only not so well). It's not as simple as it's often assumed to be so we take a lingering look at designing amp stages that accurately follow the RIAA curve.

## NOT ONLY BUT ALSO

Plus there's the next part of the MIDI Master Keyboard to build, the hi-fi version of the audio power meter and all your usual favourites — news, diary, Tech Tips, letters, readers' ads, and so on.

## THE JUNE ISSUE OF ETI

### — SNAP IT UP ON 1st MAY

All the articles listed are in an advanced state of preparation but circumstances beyond our control may prevent publication.

**ETI NEEDS YOU!**

This copy of ETI is your magazine — in more ways than one. You bought it (and thank you for that!) but it is ETI readers like you who provide most of the contents.

Staff and regular contributors fill some ETI pages but we still have a constant need for good features, projects and circuits. We'll even pay you for them!

If, like most ETI readers, you build electronic devices of your own design we want to hear from you. You may have just finished the hi-fi controlled Seltotape dispenser, or just a great gadget to impress your friends.

Whatever your project, if it will appeal to other readers it can earn you fame and fortune in ETI into

If you don't want to take your idea to a working prototype, novel circuits and improvements to existing ETI projects are always welcome for the ever-popular Tech Tips pages.

From experts in their fields we want features. ETI has a reputation for presenting interesting, informative and wide-ranging features. If you know something the rest of us don't, tell us all through the pages of ETI.

Whatever you can contribute to ETI we want to hear from you soon. Write in with a brief description of your idea. Include a circuit diagram for projects and a brief synopsis of features.

Write to:  
The Editor  
Electronics Today International,  
1 Golden Square,  
W1R 3AB.



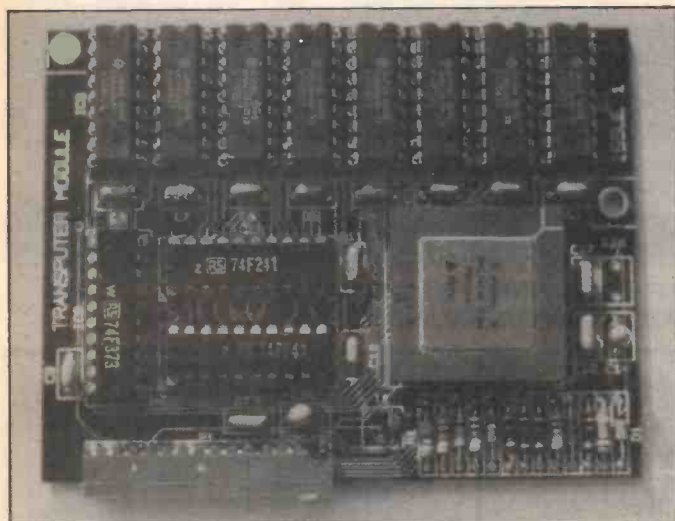

## Low-Cost Parallel Processing

The TMI Transputer module offers educational establishments and other users an opportunity to evaluate the Inmos Transputer chip at relatively low cost.

The module consists of a small, four-layer PCB which carries a T414-15 transputer and 256K of high speed DRAM. The T414-15 is capable of 75 MIPS (millions of instructions per second) but for more demanding applications the module can be supplied with a T414-20 capable of 10 MIPS.

The module can be used on its own or with an existing system by means of a suitable interface. All connections are made via one 15-way connector and an interface

board for use with IBM PC-compatible systems will be available soon.

A compact, powerful parallel-processing system can be built by using several TMIs together. Up to eight can be accommodated on a single Eurocard, giving anything up to 60 MIPS from a system small enough to be held in one hand.

The basic TM1 module fitted with a T414-15 Transputer costs £600 for a single board and £457 when six or more are purchased. Details of other quantity discounts can be obtained from the manufacturers.

Concurrent Technology, 30 Baldslow Road, Hastings, East Sussex TN34 2EY, Tel. (0424) 714 790.

## News On The Cortex Newsletter

We got it wrong last month when we said the Cortex newsletter had ceased publication.

As countless readers have since pointed out, the newsletter is still available. It comes out six times a year and the annual subscription is £5. For details contact the editor, Tim Grey, at 1 Larkspur Drive, Featherston, Wolverhampton, West Midlands WV10 7TN.

We have also received a call from Anthony Rowell who wrote the Basic programme for the Cortex and was involved in the design of the hardware. Anthony says he will be happy to give advice to anyone who is having problems with a Cortex and he is also willing to blow ROMs for the machine. His address is 11 Manor Close, Irchester, Northamptonshire NN9 7ED.

• Need an unusual character on your printer? Butler & Tanner will take daisy wheels, golf-balls and other impact type-heads and replace redundant characters with new signs and symbols. Astronomical, mathematical, biological and meteorological signs are among those available plus musical notation, fractions, foreign alphabets and any other type face or alphabet not usually available on a print-head. The company will also produce print characters from original drawings. Butler &

Tanner Ltd, The Selwood Printing Works, Frome, Somerset BA11 1NF, Tel. (0373) 449 967.

• Rohde & Schwarz are celebrating over 50 years of precision voltage measurement with the publication of a 20-page, full-colour catalogue. It lists the characteristics, capabilities and main technical features of a wide range of voltmeters and accessories. Rohde & Schwarz UK Ltd, Roebuck Road, Chessington, Surrey KT9 1LP, Tel. 01-397 8771.

## DIARY: DIARY: DIARY: DIARY: DIARY: DIARY: DIARY: DIARY:

### Digitally implemented Radios — April 1st

The IEE, London. Colloquium. Contact The IEE at the address below.

### Fibre Optics in Communications — April 2nd

University of Cambridge, 7.00pm. Lecture organised by the IEEIE. For details 'phone 019-863 3357.

### The Role of Alternatives in The World Energy Scene — April 7-9th

University of Reading. See March '87 ETI or contact the IEE at the address below.

### Frequency Control and Synthesis — April 8-10th

University of Sussex. Conference. Contact the IERE on 01-388 3071.

### Reliability '87 — April 14-16th

Birmingham. See April '87 ETI or contact the Institute of Quality Assurance on 01-584 9026.

### Electricity And The Body — Friend Or Foe? — April 23rd

The IEE, London. See April '87 ETI or contact the IEE at the address below.

### The Audio/Visual Show — April 27-30th

Wembley Exhibition Centre, London. Exhibition aimed principally at trade users but open to anyone. Contact Emap-McLaren Exhibitions on 01-686 9200.

### The Electronic Data Interchange Conference — April 28-29th

The Barbican Centre, London. See February '87 ETI or contact Online at the address below.

### British Electronics Week — April 28-30th

Olympia Exhibition Centre, London. See February '87 ETI or contact the Evan Steadman Communications Group on (0799) 26699.

### Digital Audio Tape Recording — April 30th

The IEE, London. See March '87 ETI or contact the IEE at the address below.

### Tool Kits And Sneaky Tricks — May 15th

The IEE, London, 2.00pm. Discussion meeting. Contact the IEE at the address below.

### TV Displays: The Next Ten Years — May 20th

The IEE, London, 2.00pm. Discussion meeting. Contact the IEE at the address below.

### Computer North — May 27-29th

G-Mex Complex, Manchester. Business computer show. Contact Cahners on 01-891 5051.

### UK Telecommunications Networks: Present & Future — June 2-3rd

IEE, London. Conference. Contact the IEE at the address below.

### CableSat '87 — June 2-4th

Metropole Hotel, Brighton. Exhibition and conference. Contact Online at the address below.

### International ISDN Conference — June 15-18th

London. Conference on the Integrated Services Digital Network. Contact Online at the address below.

### Networks '87 — June 16-18th

London. For details contact Online at the address below.

### Condition Monitoring For Safety — June 25th

Regent Crest Hotel, London. Seminar and Exhibition. Contact ERA Technology on (0372) 374 151.

### Satellite Communication Systems — July 26-31st

University of Surrey. Vacation school organised by the IEE. Contact them at the address below.

### Designing For Electromagnetic Compatibility — September 13-18th

University of Sussex. Vacation school organised by the IEE. See address below.

### Design Engineering Show — September 15-18th

NEC, Birmingham. Exhibition and conference covering all areas of engineering including electronics and CAD/CAM. Contact Cahners on 01-891 5051.

### IDEX '87 — September 21-23rd

Metropole Exhibition Halls, Brighton. See April '87 ETI or contact Nutwood Exhibitions on (04848) 25891.

### Addresses:

Institution of Electrical Engineers, Savoy Place, London WC2 0BL. Tel 01-240 1871.

Online Conferences Ltd, Pinner Green House, Ash Hill Drive, Pinner, Middlesex HA5 2AE. Tel 01-868 4466.



NOW AVAILABLE FROM ETI READERS SERVICES, 9 HALL ROAD  
MAYLANDS WOOD ESTATE, HEMEL HEMPSTEAD. HP2 7BH.

### POWER CRAZY

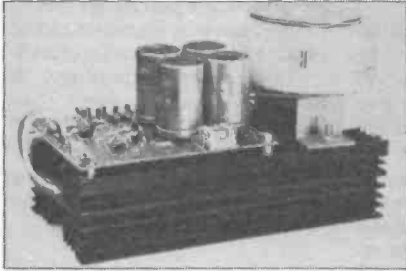

#### 240W HIFI AUDIO POWER AMPLIFIER KIT NR. K2587

The introduction of MOSFET transistors in power amplifiers opened a new area in this field. Wide power bandwidth, low driving power, high output power and an almost ideal transient response are only a few of the advantages. This kit is based on this technology. Apart from the power amplifier, it also includes the powersupply, heatsink and transformer. Once assembled, its ready for use and can easily be housed. Only 2 final adjustments are required and only needs a multimeter.

Some applications: Discobars and discotheques - Orchestra or theatre - DC coupled powercontrols.  
- Power supply (including transformer): 2x45VDC/5A.  
- 240W musicpower at 4 Ohm.  
- Distortion (1kHz): 0.0%  
- Intermodulation distortion: 0.0%  
- Input impedance: 33K.

Price £184.80 + p&p

## AUDIO LABORATORY DIY TEST GEAR COMPUTERS TOP QUALITY KITS FOR HOME CONSTRUCTION



velleman-kit

### YOU CAN'T MISS IT

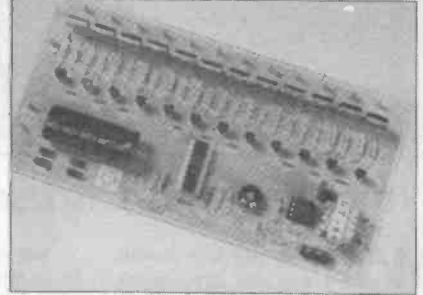

#### GIANT VU METER KIT NR. K2620

Several circuits providing different light effects, from the simple lightorgan to real 'lightcomputers', have already appeared on the market.

This kit is something new... a giant VU meter with 240V bulbs. The 12 bulbs are mounted as a lightcolumn which varies according to the sound level.

The input is galvanically separated and the sensitivity is adjustable, so there is no danger when connected to a pre-amplifier or to a power amplifier.

- 12 triac outputs: 400W each (non-cooled).  
- Input impedance: ca. 20 Kohm.  
- Input sensitivity: adjustable from ca. 100mV to 3V at full scale.  
- Power supply: 9 VAC/0.5A.

Price £36.85 + p&p

K610	VU-LED MONO (UAA 180) USING LED'S	13.74
K611	7W LF AMPLIFIER	7.13
K612	DIMMER 1000 WATTS	7.93
K613	DIMMER DEPARASITE 9 (NOISE SUPPRESSED)	12.60
K1771	FM OSCILLATOR	7.48
K1803	PRE-AMPLIFIER UNIVERSAL MONO	5.22
K1804	60 WATT LF AMPLIFIER	23.84
K1823	1 AMP POWER SUPPLY WITH LM317 IC	9.18
K1861	POWER SUPPLY FOR 60 WATT STEREO (K1804)	24.67
K1874	RUNNING LIGHT (4 CHANNEL)	23.70
K2032	LOW COST DIGITAL PANEL METER	26.82
K2532	ADAPTOR SOCKET FOR TMS2532 TO	
K2578		39.45
K2543	ELECTRONIC TRANSISTOR IGNITION	13.13
K2545	UNIVERSAL CRYSTAL 50HZ TIMEBASE	18.65

K2557	DIGITAL PRECISION THERMOMETER	37.68
K2568	20 CM DISPLAY (CATHODE)	31.93
K2569	3 TONE CHIME (DOOR CHIME)	11.23
K2570	POWER SUPPLY 5-14 DC 1AMP	9.18
K2572	STEREO PRE-AMPLIFIER	9.13
K2573	STEREO RIAA CORRECTION AMPLIFIER	10.33
K2574	UNIVERSAL 4 DIGIT UP&DOWN COUNTER WITH COMPARATOR	65.50
K2575	MICRO PROCESSOR DOORBELL (25 TUNES PLUS 1 CHIME)	23.12
K2576	40WATT AUDIO AMPLIFIER	17.10
K2578	MICRO PROCESSOR CONTROLLED EPROM PROGRAMMER	316.81
K2579	UNIVERSAL START&STOP TIMER	10.93
K2580	POWER SWITCH&DIMMER (600 WATT UNCOOLED)	13.69
K2581	DC CONTROLLED STEREO TONE CONTROL	21.00
K2582	STEREO AUDIO INPUT SELECTOR	16.50
K2588	3 CHANNEL SOUND TO LIGHT WITH PRE-AMPLIFIER	29.70
K2590	LIGHTCOMPUTER WITH EPROM	31.30
K2592	20 WATT LF AMPLIFIER KIT	13.45
K2594	ZERO CROSS PROGRAMMABLE TIMER	15.25
K2598	CAR BOOSTER 15-30 WATT	18.15
K2578M	EPROM PROGRAMMER (BUILT AND TESTED)	374.23
K2600	2A DIMMER	10.12
K2601	STROBOSCOPE	14.78
K2602	4 CHANNEL RUNNING LIGHT WITH MODULATOR	32.25
K2603	MICROPROCESSOR YEAR TIMER	152.15
K2604	KOJAK POLICE SIREN	9.90
K2606	LED AUDIO POWER METER	16.75
K2607	THERMOMETER ADAPTOR	16.00
K2622	AMSFM AERIAL AMPLIFIER	10.40
K2623	LAB POWER SUPPLY 0-24V 3 AMP	38.41
K2625	DIGITAL RPM METER	31.00
K2626	27640/27128 ADAPTOR KIT FOR K 2578	38.30
K2632	HARDWARE EXTENSION KIT FOR K 2603	22.08
K2636	AC MOTOR CONTROL	20.30
K2637	2.5 WATT AUDIO AMPLIFIER	8.23
K2638	CAR ALARM	19.32
K2639	LIQUID LEVEL CONTROL	21.50
K2644	FROST INDICATOR	11.15
K2646	MEDICAL-PILL TIMER	18.86
K2645	GEIGER MUELLER COUNTER	71.53

### LED LEVEL

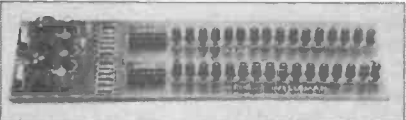

#### STEREO LED VU-METER KIT NR. 1798

Two rows of 16 Leds each and a 'spot' indication instead of a 'Baragraph' makes up for the difference between this kit and the mono VU-meter. Thanks to an adjustable input amplifier matching to almost any kind of pre- or power amplifier can easily be made.

- 2x16 Leds.  
- Supply: 12VDC.  
- Input impedance: 10kOhm.  
- Input sensitivity: adjustable between 100mV to 10V full scale.  
- Power consumption: 50mA.

Price £25.02 + p&p.

K2549	INFRA-RED DETECTOR TRANSMITTER (ALARM)	17.88
K2550	INFRA-RED DETECTOR RECEIVER (ALARM)	21.37
K2551	CENTRAL ALARM UNIT	25.26
K2553	STEREO DECODER WITH 19KC FILTER	16.26
K2554	HIGH QUALITY FM TUNER	30.30

### LIGHT UP THE SKY

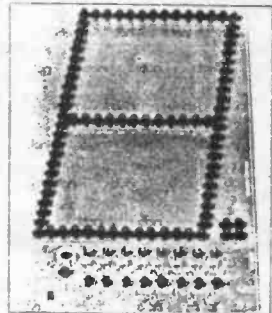

#### 20CM DISPLAY 'COMMON ANODE' KIT NR. K2567

This kit contains a 7-segment display consisting of 12 leds per segment and 4 leds for the decimal point. With the aid of a supplementary power supply, it is possible to connect this kit to any existing circuit equipped with common anode displays of any brand and any dimension.

If the digit and segment drivers of the circuit can supply sufficient current, it will be possible to connect in parallel two or more displays, or even, leave the small display of the circuit in place and connect the 20cm display in parallel. This latter will not effect the brightness of the 20cm display due to the special concept of the driver circuit.

- Common anode.  
- Power supply: 22 to 26VDC non-stabilized.  
- Minimum anode input voltage (on): 2V.  
- Maximum anode input voltage (off): 1.2V.  
- Segments input impedance: 10K.  
- Segment current: static (R6=00): 40mA multiplex (R6=220hm): 75mA.  
- Total current consumption in static mode: maximum 400mA.  
- Maximum power (U=22V): 8.8Watt.

Price £30.26 + p&p

#### 20CM DISPLAY 'COMMON CATHODE' KIT NR. K2568

This kit is in terms of appearance and application identical to K2567 'COMMON ANODE'. As far as specifications are concerned, read cathode for anode.

Price £31.93 + p&p

A FULLY ILLUSTRATED  
CATALOGUE IS AVAILABLE  
WHICH GIVES COMPLETE  
DETAILS OF KITS.

## MICROPROCESSOR UNIVERSAL TIMER KIT NR. K1682



This unique timer is in principle a 24-hour clock provided with 4 relay-switched outputs and a programming period of 1 week. 20 switching programs can be memorized and via the membrane keyboard be programmed. Outputs or timing periods can be selected at random. All program steps are indicated by LEDs. A printed alu frontplate is included in the kit, making building-in of this timer a simple affair. This microprocessor timer was primarily designed for industrial and labo purposes, but the amateur can use it in dozens of applications as well.

- 20 daily- or weekly programmable timerfunctions.
- Memory display of programmed timer functions per output or per day.
- 4 independent relay outputs (1 relay included).
- Display of: day of week - AM/PM - output - clock.
- ON/OFF - sleep.
- The timer is based on the TMS 1122 microprocessor.
- Transformer 12VAC/1A (not included).

Price £75.85 + p&p

## TAPE/SLIDE SYNCHRONIZER KIT NR. K2565

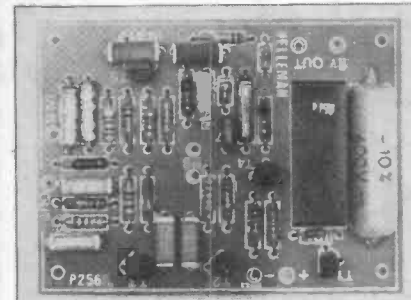

Actually, alot of tape/slide synchronizers are available on the market. The price of these devices varies from expensive to very expensive. Those owning a tape- or cassette recorder can with this simple and inexpensive device, record synchronizing pulses and use these pulses to control automatic slide projectors. The circuit is small in sized and can easily be housed.

- Power supply: 9 to 13VDC.
- Current consumption: 40mA.
- Output frequency (tone): +1.5KHz.
- Output amplitude: +250mV.
- Input sensitivity A: minimum 1.5V peak to peak.
- Input sensitivity B: minimum 100mV.
- Oscillator: AMV type.
- Input Impedance (I<sub>B</sub>): 1 KOhm.
- Output impedance: 15 KOhm.

Price £12.75 + p&p

## SCREEN WIPER ROBOT KIT NR. 2599

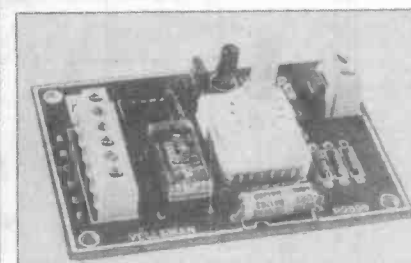

Three different time intervals may be selected by using a multipole rotary switch. With small component changes, the intervals may be varied. Some applications: windscreen wiper delay - diaprojector control - hazard warning via the brakelights of the car. In the manual you will find a complete description how to build this kit in a car, with wiring instructions to connect it to the existing wiper installation.

- Power supply: 12-15V DC.
- Intervals: 5-10-15-seconds.
- Relay output: 240V/2x3A.
- Relay output with two change-over contacts.
- Current consumption:
- Output 'OFF': 25mA.
- Output 'ON': 100mA.
- Dimensions: 82x56x41mm.

Price £14.84 + p&p

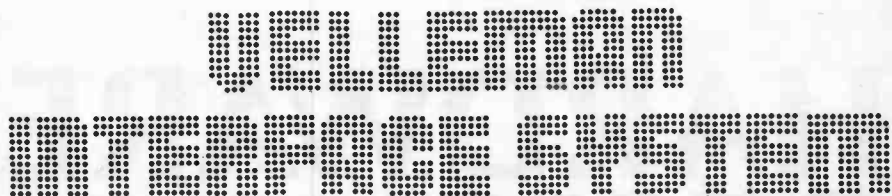

## NEW DIMENSIONS IN COMPUTER INTERFACES

The Velleman Interface System starts your computer to measure, convert and control signals. This universal interface links your computer with everyday devices such as light and heat sources, audio amps, pumps, waterheaters, etc...

## AUTOMATION, CONTROLLING, MASTERING, ROBOTICS

Even the smallest computer can afford powerful applications you wouldn't dare to imagine. Today we have 10 function cards in our system but tomorrow there might be more. And sure: while using this system you keep all communication means originally provided on your computer.

### VELLEMAN INTERFACE SYSTEM - KITS

K2609 OC OUTPUT BOARD INTERFACE FOR HOME COMPUTER	22.60	K2631 EXTENSION BOARD FOR K2640 OR K2641	21.22
K2610 A/D CONVERTER INTERFACE FOR HOME COMPUTER	35.55	K2633 RELAY CARD	15.25
K2611 OPTO INPUT BOARD INTERFACE FOR HOME COMPUTER	26.30	K2634 QUAD TRIAC SWITCH CARD	16.33
K2613 BREADBOARD INTERFACE	32.43	K2635 8 TO 1 ANALOG MULTIPLEXER INTERFACE	27.60
K2614 ZX 81 SPECTRUM CENTRONICS INTERFACE	39.56	K2640 INTERFACE MOTHERBOARD FOR AMSTRAD	48.70
K2615 INTERFACE MOTHERBOARD (SPECTRUM)	40.02	K2641 INTERFACE MOTHER-BOARD KIT FOR MSX STANDARD	48.70
K2618 D/A CONVERTER INTERFACE FOR HOME COMPUTER	32.80	K2642 MOTHERBOARD KIT FOR B.B.C. AND MASTER COMPUTERS	53.13
K2628 INTERFACE MOTHERBOARD (COMMODORE)	51.65	K2643 MOTHERBOARD KIT FOR AMSTRAD CPC6128 COMPUTERS	55.32
K2629 REAL TIME CLOCK INTERFACE FOR HOME COMPUTER	41.35	K2612 RS232 MOTHERBOARD (I.B.M. COMPATIBLE)	123.34

### VELLEMAN INTERFACE SYSTEM - BUILT AND TESTED

M2615 INTERFACE MOTHERBOARD SOECTRUM	63.85	M2618 D/A CONVERTER INTERFACE FOR HOME COMPUTER	36.86
M2616 INTERFACE MOTHERBOARD ZX 81	63.60	M2629S REAL TIME CLOCK INTERFACE (SPECTRUM)	58.60
M2628 INTERFACE MOTHERBOARD COMMODORE 64	80.40	M2629U REAL TIME CLOCK INTERFACE (UNIVERSAL)	58.48
M2609 OC OUTPUT BOARD FOR HOME COMPUTERS	29.96	M2633 RELAY CARD	22.31
M2610 A/D CONVERTER INTERFACE FOR HOME COMPUTER	41.92	M2634 QUAD TRIAC SWITCH CARD	22.21
M2611 OPTO INPUT INTERFACE FOR HOME COMPUTER	40.13	M2635 8 TO 1 ANALOG MULTIPLEXER INTERFACE	38.64
M2614 ZX 81 SPECTRUM CENTRONICS INTERFACE	45.60		

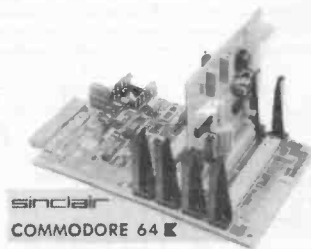
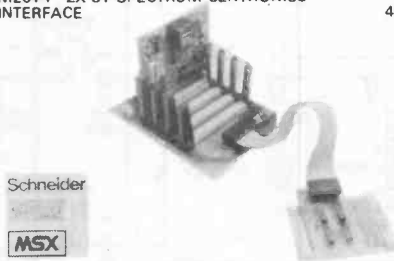

## EURO CARDS

ECL 160x100 MM	4.07	ECS3 160x100 MM	4.07
ECS 160x100 MM	4.07	ECL 1/2 80x100 MM	2.24
ECI 160x100 MM	4.07	ECS 1/2 80x100 MM	2.24

ECI, ECS3 AND ECC CARDS ARE COMPATIBLE WITH EURO DIN CONNECTORS DIN 41617 AND DIN 41612  
ALL CARDS ARE MADE OF BLUE (TINNED) MULTILAYER EPOXY PRE-DRILLED.

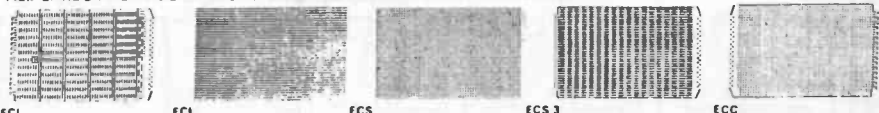

## TOROIDAL TRANSFORMER - KITS

TR2623 TOROIDAL TRANSFORMER KIT (2x16V/2x7.5V-130VA) FOR K2623	44.39	TR2603 TRANSFORMER FOR K2603	9.66
--	-------	------------------------------	------

## MEMBRANE KEYBOARDS

KN12 MEMBRANE KEYBOARD 12 KEYS WITHOUT SYMBOLS	11.48	KB16S MEMBRANE KEYBOARD 16 KEYS WITH SYMBOLS	11.48
KB12S MEMBRANE KEYBOARD 12 KEYS WITH SYMBOLS	11.48	DF1R DISPLAYFILTER	1.61
KB16 MEMBRANE KEYBOARD 16 KEYS WITHOUT SYMBOLS	11.48		

Kit number	QTY	DESCRIPTION	Unit Price	TOTAL

Postage & packing: UK - 75p per kit

Overseas - £1.50 per kit, surface mail (Airmail charged at cost)

Please send me (tick as required):  
 VELLEMAN KITS CATALOGUE  
 INTERFACE SYSTEM CATALOGUE  
 Cost per catalogue (inc. P&P): UK - 75p, Overseas - £1.50 (NO VAT)

Please make cheques/postal orders payable to ARGUS SPECIALIST PUBLICATIONS  
 Payment by ACCESS - see below

IF INVOICE IS REQUIRED PLEASE TICK HERE

NAME .....  
 ADDRESS .....

Please debit my ACCESS account with the amount of ..... (ACCESS orders must go to cardholder's address)  
 Signed .....  
 ACCESS account no. ....

# HARDWARE DESIGN CONCEPTS

Mike Barwise looks at the design of the main board of his pulse generator.

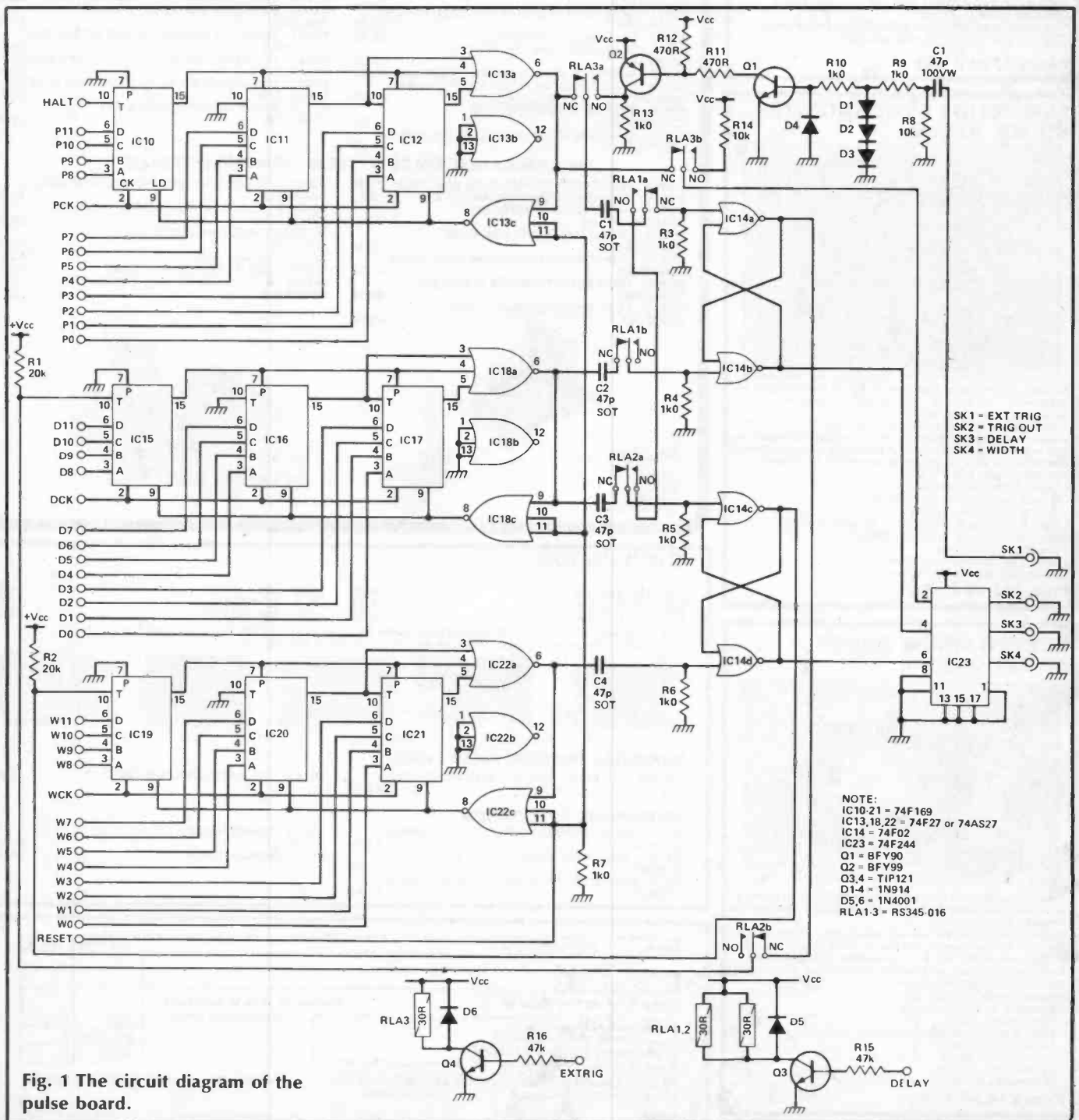

Fig. 1 The circuit diagram of the pulse board.

This month we look at the pulse generator proper from a purely practical standpoint. The final theoretical schematic (ETI March 1987) leaves out one or two minor but desirable features. These are:

- The ability to generate pulses using period and width only, ie no delay.
- The option of triggering the pulse generator from an external source rather than driving the experiment from the pulse generator trigger output.

There is also a minor functional enhancement which is worth describing — the conversion of the control flip-flops to edge triggered operation.

All these details appear in the full circuit diagram (Fig. 1), so let's look at them in order.

## Without Delay

To generate a 'no-delay' pulse, we simply have to eliminate the delay stage from the system so that the period stage directly unlocks the width stage. To do this with extra gating would slow the system down, so we use relays.

The total requirement is for four pole, two way switching, but for cheapness we are using two pole, two way telecomms relays together (RLA1/RLA2). Contacts RLA1a and RLA2a perform the switching out of the delay stage and, just as a precaution, RLA1b and RLA2b together with pull down resistors R3 and R4 and pull up resistor R1 disable the isolated delay stage to stop it free running.

The external triggering option is again switched by a relay (RLA3). This simply disconnects the period (free running) stage from the delay and/or width stages and connects a front panel socket instead.

Again as a precaution, the TRIGGER OUT front panel socket is taken permanently high while using external trigger. This is because we cannot easily stop the disconnected period stage without complicating the programming job at the microprocessor control section.

Optionally, if you want an additional rate controlled pulse source in external trigger mode, you can omit R14 and jump across RLA3b but this will require a software modification to allow independent trigger rate programming and external trigger selection.

## Protection

The really crafty part of the external trigger system is the input protection circuit, for which I am indebted to Richard Cripps, a technician in the Department of Metallurgy at Oxford.

The need for some kind of protection is self-evident. A 12V trigger would completely zap the whole generator. This solution is more than average elegant, and it's very safe. It was designed for a rig I installed at Oxford, to be completely student proof. OK, so how does it work?

The input capacitor, C1 (which *must* be a high voltage type) passes only fast edges and its small size limits the amount of power that can be passed across it to the transistors and diodes. Q1 is normally off (as the capacitor is discharged by R8) but turns on when the voltage at its base is about 0.6V.

As soon as the voltage on the capacitor rises to about 1.8V, the forward biased diode chain D1-D3 turns on and clamps the voltage to very near ground. This both limits the output pulse and protects Q1 against over voltage.

Q1 is only on (conducting) during rising inputs between 0.6V and 1.8V. The output of Q1 is a short negative going pulse starting at the 0.6V threshold of the positive going input edge, and ending at the 1.8V threshold.

Any negative going input is clamped at -0.6V to D4 to avoid destruction of Q1. The second transistor is a re-inverter stage so that positive inputs yield positive outputs. With the specified components the circuit is

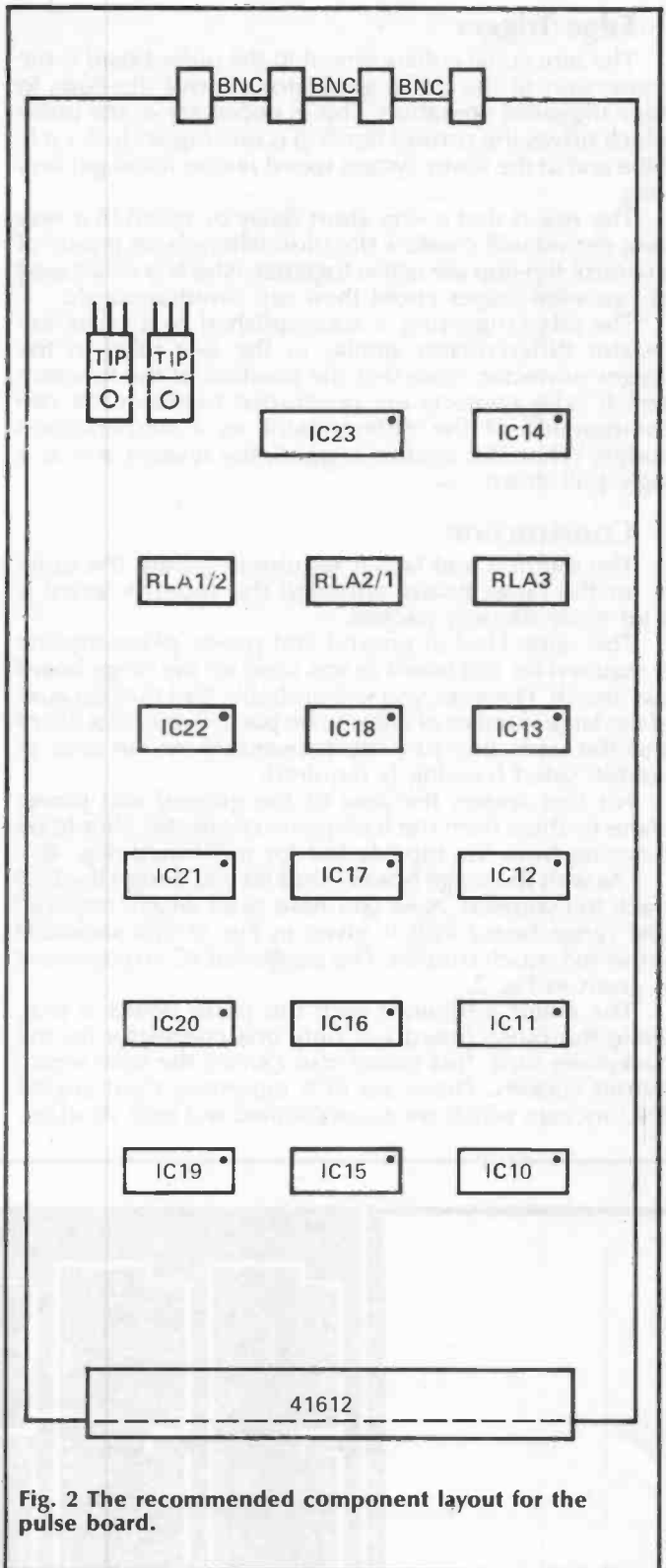

Fig. 2 The recommended component layout for the pulse board.

extremely fast (we measured about 7 to 10 nanoseconds propagation delay) and will respond to any signal with a positive going rise time of 1V/microsecond or faster.

The output pulse width is, of course, input risetime dependent. Any logic-adequate square wave (CMOS or TTL) will trigger the circuit. We tested the circuit on 50Hz 240V mains and, although it did not trigger (too slow a risetime), it survived. However, note that this is not a recommended user test!

What this does mean, though, is that you can trigger one-shot pulses from, say, an RS232 channel under test or most other available system signals.

## Edge Trigger

The functional enhancement to the pulse board is the conversion of the pulse generator control flip-flops to edge triggered operation. This is necessary as the pulse which drives the control flip-flop is one input clock cycle wide and at the lower system speed ranges it can get very long.

The risk is that a very short delay or width in a very long period will create a situation where both inputs of a control flip-flop are active together, which is disallowed as cascaded stages could then run simultaneously.

The edge triggering is accomplished by a capacitor/resistor differentiator similar to the one used in the trigger protector. Note that the position of the function switch relay contacts are positioned between the two components of the differentiator as a simplification dodge. When the contact is open, the resistor acts as a logic pull down.

## Construction

The method and layout requirements are the same as for the range board, although this month's board is a lot more densely packed.

The same kind of ground and power plane topside is required for this board as was used for the range board last month. However, you will probably find that because of the large number of chips to be packed onto this board and the wide bus running between them, an area of double sided tracking is required.

For this reason the area of the ground and power plane furthest from the backplane connector should be removed from the topside foil for this board (Fig. 4).

As with the range board I shall let you design the PCB track foil yourself. Now you have seen what's required (the range board PCB is given in Fig. 5) this shouldn't prove too much trouble. The suggested IC arrangement is given in Fig. 2.

The major difference with the pulse board is that, while the range board has only one connector (to the backplane bus), this board also carries the user input/output sockets. These are PCB mounting right angled BNC sockets, which are an established test gear standard.

Pin	A	B	C
1	+5V	+5V	+5V
2	KEYCK	PROCK	—
3	WCK	—	—
4	DCK	—	—
5	PCK	—	—
6	—	—	—
7	—	—	—
8	W10	W11	—
9	W8	W9	—
10	W6	W7	—
11	W4	W5	—
12	W2	W3	—
13	W0	W1	—
14	D10	D11	—
15	D8	D9	—
16	D6	D7	—
17	D4	D5	—
18	D2	D3	—
19	D0	D1	—
20	P10	P11	—
21	P8	P9	—
22	P6	P7	—
23	P4	P5	—
24	P2	P3	—
25	P0	P1	—
26	EXTRIG	—	—
27	HALT	DELAY	—
28	RSYNC	RESET	—
29	WR0	WR1	—
30	DR0	DR1	—
31	PR0	PR1	—
32	GND	GND	GND

— not used by the range board or the pulse board.

Fig. 3 The backplane connector pinout used by the range and pulse boards.

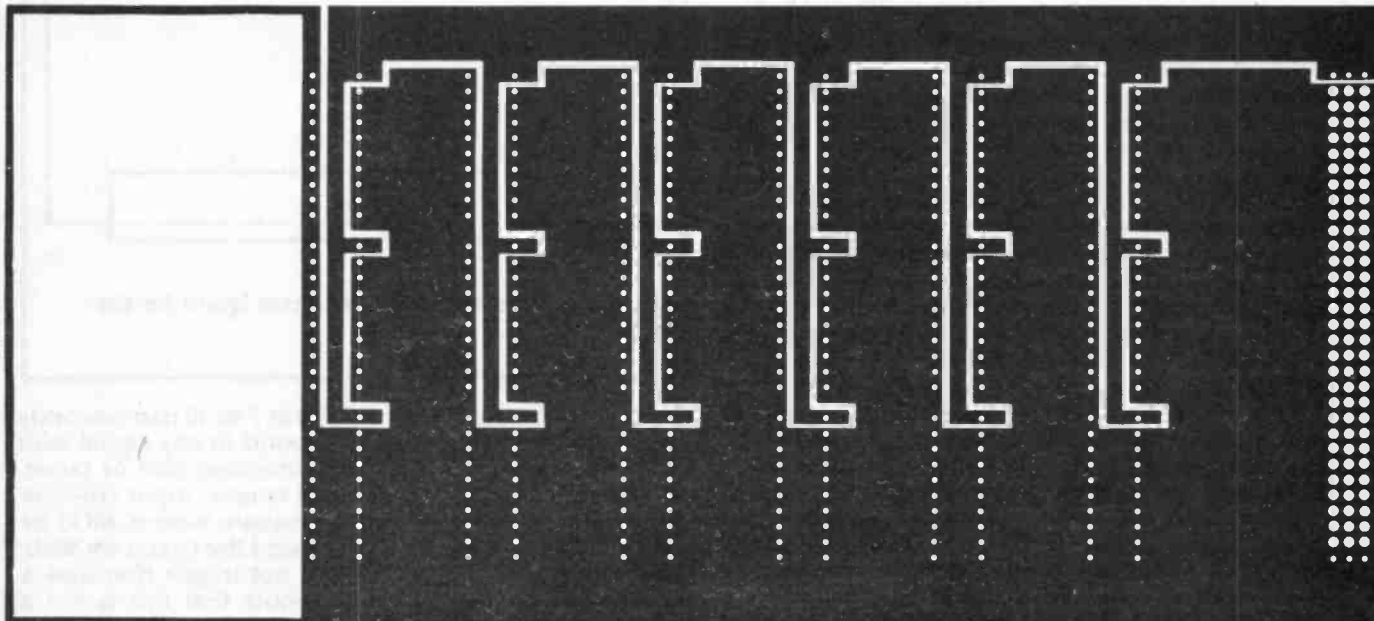

Fig. 4 The topside foil used for the pulse board.

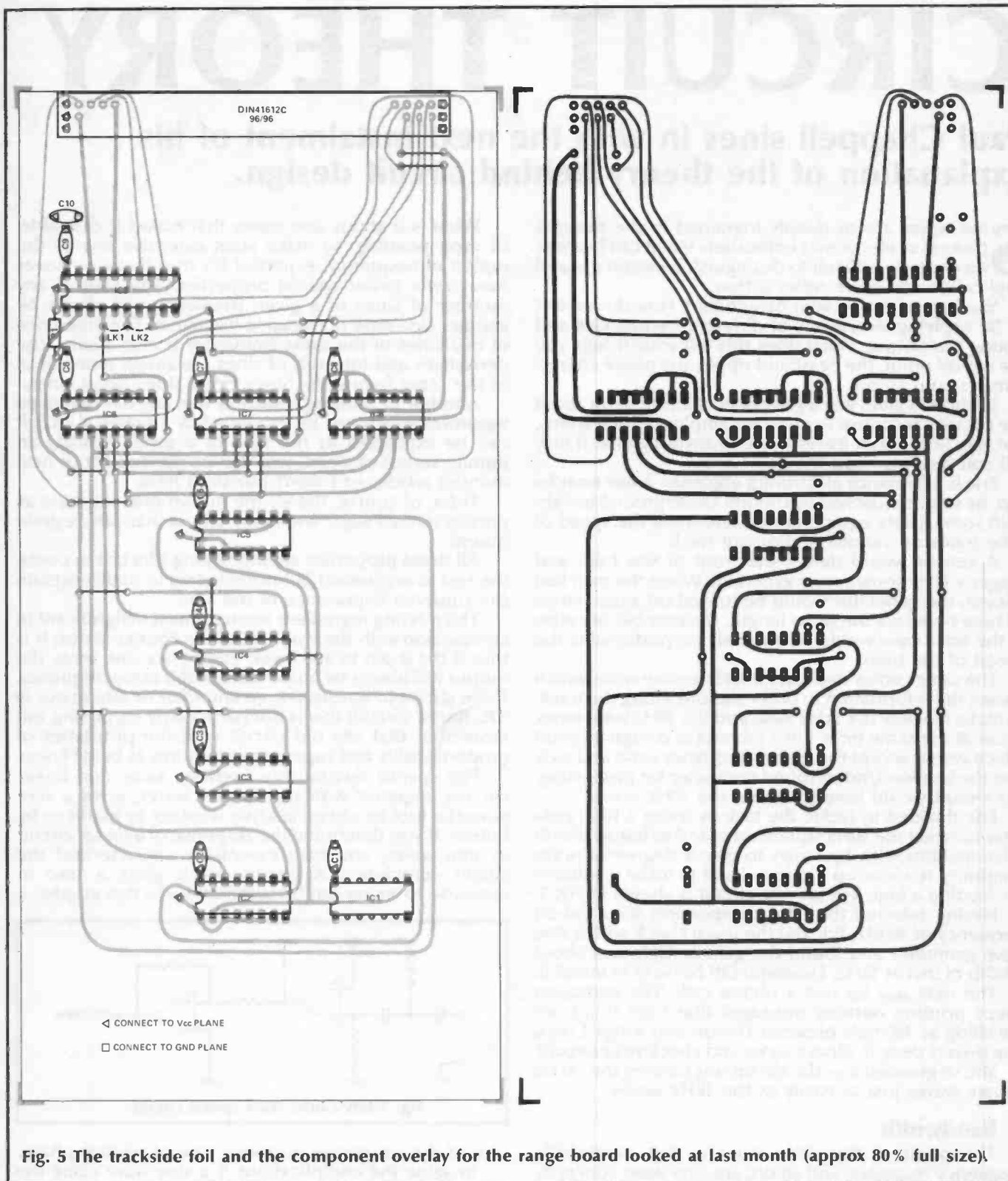

Fig. 5 The trackside foil and the component overlay for the range board looked at last month (approx 80% full size)

You will find that this board *needs* a front panel, whereas it is optional for the range board. The reason is that constant twisting and pulling at the BNC connectors will eventually cause board failure. The front panel screws to the subrack metalwork as well as to the board, so it prevents a lot of wobble.

The front panel holes do not have to fit the BNC sockets closely: in fact they may have to be considerably oversized to accommodate the BNC plug nose, depending on how near the edge of the board the sockets are mounted. This does not matter, as the rigidity is imparted

by the brackets coupling the board corners to the panel.

These are the sort of details you have to think of as you go along in systems design, otherwise bits start falling off in service. Figure 2 shows the bus pinout extended to include all the new signals we have added this month.

That's about all for now (and certainly enough to be going on with). Next month we will discuss how to control and program the whole pulse generator, at which point we should be able to define a formal performance specification.

ETI

# CIRCUIT THEORY

Paul Chappell sines in with the next instalment of his explanation of the theory behind circuit design.

Sine waves are so deeply ingrained in the thought process of electronics enthusiasts that it can become exceedingly difficult to distinguish between a useful application and mere reflex action.

You have a filter on your breadboard. How do you test it? By applying sine waves of different frequencies and noting the output. What does this tell you? It tells you the cut-off point, the passband ripple, the phase characteristics, and so on.

In short, it gives you a great deal of information about the circuit's response to constant amplitude sine waves, but very little about its response to anything else. It may tell you less than you think.

Eric is a freelance electronics engineer. A few months ago, he was approached by London Underground to help with some safety equipment to determine the speed of tube trains on various sections of track.

A sensor would detect the front of the train and trigger a 1kHz square wave generator. When the train had passed, the generator would be turned off again. Since all tube trains are the same length, the number of cycles of the 1kHz wave would be inversely proportional to the speed of the train.

The same cables also carry a 10Hz square wave, which passes the information to other stations along the track. To make life easy the 1kHz wave and the 10Hz wave never occur at the same time. Eric's job was to design a circuit which would accept the higher frequency wave and pass it to the London Underground computer for processing. His circuit would have to ignore the 10Hz wave.

Eric decided to tackle the task by using a high pass filter to reject the 10Hz square wave and to follow it with a comparator with hysteresis to give a degree of noise immunity, to clean up the signal and to make it suitable for feeding a logic circuit. His circuit is shown in Fig. 1.

Having selected the filter components for a cut-off frequency of 100Hz, Eric did the usual check with a sine wave generator and found the gain at 10Hz was about 1/100th of that at 1kHz. Excellent! Off he went to install it.

The next day he had a phone call: 'The computer keeps printing warning messages that tube trains are travelling at 180mph between Euston and Kings Cross. The drivers deny it. Please come and check your circuit!'

You've guessed it — the circuit was passing the 10 Hz square waves just as easily as the 1kHz waves.

## Bandwidth

The point of this little story is that bandwidth, frequency response, and so on, are *sine wave* concepts. How much they tell you about anything else depends on your skill at relating sine waves to other waveforms. Any naive attempt to transfer sine wave concepts directly to other waveforms will lead to 180mph tube trains!

What could square wave bandwidth possibly mean? A square wave will be distorted to a greater or lesser extent by any practical circuit. A high-pass filter will distort it in both the sine wave pass-band and the sine wave stop-band, but the sine wave stop-band certainly won't stop it!

Perhaps we could say that a square wave pass-band is where the distortion is not too bad and the stop-band is where it's awful?

What is it about sine waves that makes it desirable, or even possible, to make such extensive use of the notion of frequency response? It's true that sine waves have some rather special properties. The sum of any number of sines of a given frequency will always be another sine wave of the same frequency. The difference of two sines of the same frequency is also a sine. The derivatives and integrals of sines are always more sines of the same frequency. Sines beget sines beget sines.

Another interesting feature is that any old repetitive waveform which can be produced by a practical circuit can be expressed as the sum of a series (usually an infinite series) of sines. This will be the subject of next month's article, so I won't pursue it here.

Then, of course, there's the notion that sines are as pure as refined sugar and more natural than whole-grain muesli.

All these properties are interesting (the last to poets, the rest to engineers) but none seems to totally explain the supreme importance of the sine.

The missing ingredient seems almost insignificant in comparison with the wonders of the Fourier series. It is this: if the input to any linear circuit is a sine wave, the output will always be a sine wave of the same frequency. If the circuit in question is an amplifier or attenuator (a 'DC linear' circuit) this is not particularly surprising but remember that any old circuit with the properties of proportionality and superposition counts as being linear.

The special relationship between sines and linear circuits, together with the Fourier series, gives a very powerful tool for circuit analysis whether by maths or by tuition. If you determine the response of a linear circuit to sine waves, you have essentially characterised the circuit completely. A circuit which gives a sine in response to a sine can be summed up in two graphs —

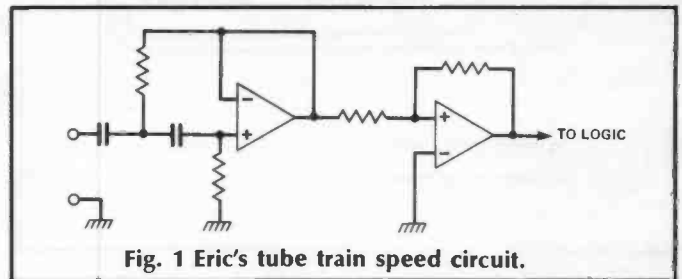

Fig. 1 Eric's tube train speed circuit.

one of the amplitude response, one of relative phase.

Imagine the complications if a sine wave came out distorted in a way dependent on frequency, just as a square wave would. How would you then describe the frequency response of the circuit? You'd have to draw the output waveform at each frequency as well as determining its amplitude and phase, or devise some horrendous mathematical expression to sum it all up — it just wouldn't be worth the effort.

If sines didn't give rise to sines in linear circuits, Fourier would be nothing more than a mathematical curiosity.

Notionally, one way to analyse the response of a linear circuit to a given waveform is to split the waveform into its sine wave components, determine the response to



each component individually by means of the amplitude and phase response curves and then add up the individual responses for each sine wave to determine the response to the composite wave.

This is rarely carried out in practise, but an understanding of the relationship of a waveform to its sine components can give rise to some very useful general principles and insights.

## Superposition

The last step in the notional analysis process is justified by superposition and is the universal and 'unquestionable' application of the principle that I referred to last month. You may not recognise it from my description, but any statement such as 'the capacitor removes the high frequency components of the signal' is actually an assertion of faith in superposition — that the individual components of a waveform can be dealt with individually and independently.

It's important to remember that all this applies only to *linear* circuits. Try adding up the individual responses from (say) a log law circuit and you'll end up with rubbish. Superposition doesn't work.

To show how general reasoning based on sines and superposition might work in practise, I'll take a simple example.

## Amplitude Modulation

Since ETI has not published any AM radio circuits for as long as I can remember, I'll skim through the basics of AM transmission for anyone who may have missed it. The radio transmitter produces a high frequency sine wave known as the 'carrier' — this is the signal you tune your radio set to. The sound signal to be transmitted varies the amplitude of the carrier. At the receiver the sound can be recovered by rectifying the amplitude modulated signal and filtering out the remains of the carrier. This, in a nutshell, is AM radio transmission. Figure 2 shows the various stages involved.

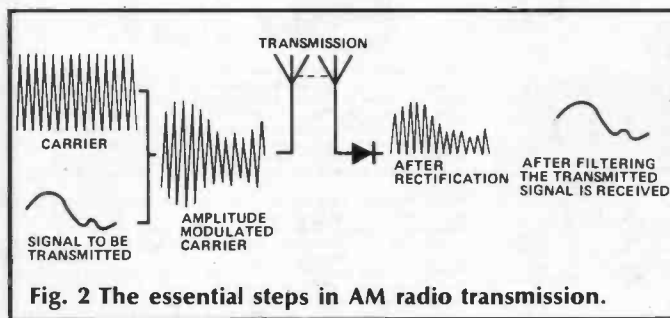

Fig. 2 The essential steps in AM radio transmission.

The receiver selects the radio station by means of a tuned circuit. Commercial radio receivers will usually have several tuned stages, but for our purposes we'll make do with one.

By suitable choice of coil and capacitor, the tuned circuit can have various degrees of 'sharpness' of tuning. Naturally, we would like the tuning to be selective enough to reject other radio stations broadcasting on adjacent frequencies but is there a limit to how sharp the tuning should be made? As any text book will tell you, the answer is 'yes', and it depends on some mysterious entities called sidebands.

If you wanted to transmit a 1kHz sine wave on a 1MHz carrier, there are several ways you could go about it. The most direct method would be to alter the gain of some amplifying stage in the path of the carrier in proportion to the 1kHz wave.

Another possibility would be to generate three sine waves — one at 1.001MHz, one at 1MHz, the third at 0.999MHz. By adding these together in suitable propor-

tions (equal amounts of each will do) you'll get a 1MHz signal amplitude modulated at 1kHz (Fig. 3). Exactly the same signal as by the gain control method.

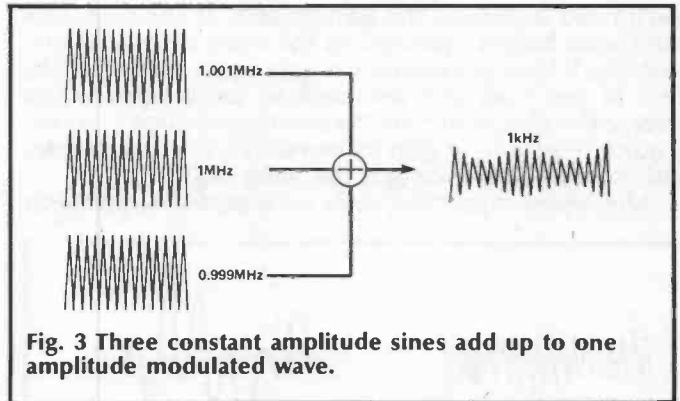

Fig. 3 Three constant amplitude sines add up to one amplitude modulated wave.

I'm not suggesting either of these as practical methods to produce an AM wave. The point to fasten on to is that the AM wave is equivalent to the sum of three constant amplitude sine waves. The 1MHz wave is called the carrier, the 1.001MHz wave the upper sideband and the 0.999MHz the lower sideband.

Look at the radio's tuned circuit again. The principle of superposition tells us that if we determine its response to the carrier, the upper sideband and the lower sideband individually and then add together the results, we will have found its response to the amplitude modulated wave.

It follows that if the tuning is so sharp that the sidebands are lost, all we are left with is the constant amplitude 1MHz carrier. The 1kHz wave (which is what we were trying to transmit) has gone for good and cannot be recovered.

## Sine On The Line

I wouldn't blame you if you are not particularly happy with that argument. It seems to be in direct conflict with common sense. The frequency of the AM wave is always 1MHz, the tuned circuit is tuned to 1MHz, surely it should pass with no trouble? Common sense says 'yes', sidebands and superposition say 'no'. Which is right?

The special relationship between sine waves and linear circuits requires that the sine waves should be of constant amplitude. The frequency response curve for the tuned circuit would be drawn up for a practical circuit by applying constant amplitude sine waves at various frequencies and plotting the outputs. We now know the response of the tuned circuit to sine waves but this tells us *nothing* about how the circuit will respond to any *other* waveform, no matter how much like a sine wave it appears to be.

Does the amplitude modulated sine wave have very much in common with a steady sine wave anyway? If you have a signal generator you could set it to produce a 1MHz sine wave and then, just by varying the output level control, make your own amplitude modulated wave (Fig. 4a). You haven't set the waveform control to anything different, you haven't altered the frequency setting so the output must still be a 1MHz sine wave — right?

Let's see how far your credulity will stretch. I think you'll agree that on a fairly low frequency setting you could, just by jiggling the output level control, produce something similar to Fig. 4b. You haven't altered the frequency or waveform setting, you've just altered the output level, so this too is a sine wave — right? Or not?

If you are prepared to believe that Fig. 4b is a sine wave, how about Fig. 4c? To produce this amplitude modulated sine wave is a highly skilled job and takes years of practice. This is how you start. Set your signal

generator to produce a 0.1Hz sine wave, connect the output to a 'scope', then adjust the gain control constantly so that the trace moves upwards at 45°. Where the sine wave crosses the axis you'll need unity gain; beyond that you'll need to reduce the gain steadily as the unmodulated wave bulges upwards. As the wave approaches its peak you'll have to increase the gain again, fairly quickly, until at the peak you are back to unity again. Then reverse the procedure for the downward slope — a fairly quick reduction in gain followed by a slower increase, and so on. You'll soon get the hang of it.

After years of practice, daily wrist exercises, and with

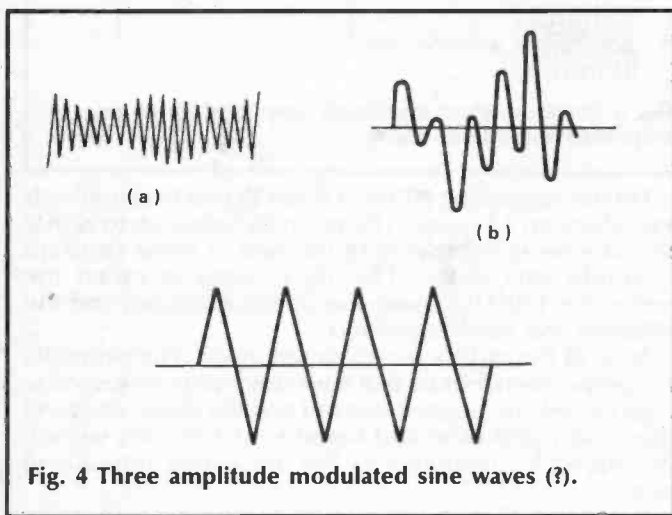

Fig. 4 Three amplitude modulated sine waves (?).

a low inertia output level control you may eventually manage it at 1MHz! So — a triangular wave is nothing more nor less than an amplitude modulated sine wave, if you choose to look at it that way.

Since the tuned circuit's response to sine waves, which we know about in great detail, tells us nothing about the response to anything else (and I hope you'll now agree that the AM wave is in the 'anything else' category) where do we go from here? The answer is that we regard the AM wave as being the sum of three sine waves. It is three sine waves in the sense explained earlier — if you add the three waves together, you get the AM wave.

Now we can determine the response of the circuit to each of the three sine waves — we know all about that. It's what we draw in the frequency response curve. The final stage is to apply the principle of superposition. If the three sine waves are applied all at once (in the form of the AM wave) then the output will be the sum of the responses to the individual sine waves. And there we have it. All we need now is the maths!

To analyse linear circuits, then, we need three things — a way of splitting up arbitrary waveforms into sine waves, a way of determining the response of the circuit to sine waves, and a way of adding the sine waves back together afterwards.

This process is rarely carried out in total — it's more important to have a clear understanding of the principles. However, the methods of determining a circuit's response to sine waves can come in very handy at times and Fourier analysis is very useful for passing exams so next month I'll begin on the maths behind it all. **ETI**

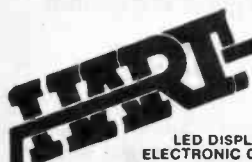

### LED DISPLAY DIGITAL ELECTRONIC CLOCK MODULE

Electronic clock module with MOS LSI circuit, 4-digit 0.5" LED display, power supply and other components on a single PCB. Only needs a transformer and switches to construct a complete pretested digital clock/timer for many applications. Suitable for 50 or 60 Hz mains supplies. Direct (non-multiplexed) LED drive eliminates RF interference. Supplied complete with 240v mains transformer and wiring diagram/data. Order as SOL 144 Alarm Clock Module £6.85

### LIQUID CRYSTAL DISPLAY WATCH MODULE

With LCD display, 2 pieces of Polarising material, backlight diffuser, micro lamp, precision crystal, trimmer, battery contacts and open microcircuit. Untested ..... 5 for £1

### PLESSEY MAINS INTERFERENCE SUPPRESSORS

Filter unit for mains borne interference. Max current 1.5A. Our Price, brand new ..... only £2.27  
Same item, store soiled ..... only £1.51  
Similar Unit but 10A. Brand new ..... £3.49

### 10W POWER AMPLIFIER MODULE

Mullard LP1173 Amplifier module. Needs 24v DC Supply to give 10 watts into 4 ohm speaker. Size 112x70x29mm. Complete with heat sink ..... Only £2.40 complete with Data

### ALPS FF317U FM FRONT END

Beautiful precision made High Quality variable capacitor tuned FM Front End with Dual-gate MosFet. Covers full FM range of 87 to 109MHz. 12v supply ..... ONLY £8.90  
Circuit if required 35p

### CAR RADIO FM IF AND STEREO DECODER

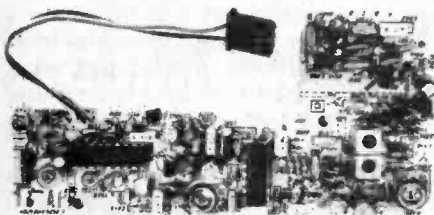

Miniature PCB with 10.7MHz ceramic filters, 2-transformer ratio detector, AX10 noise suppression IC, and TCA4500A advanced stereo decoder IC. Only needs front end to make FM tuner or car radio. Complete with circuit. Incredible value at ..... Only £1.99

HART ELECTRONICS are specialist producers of kits for designs by JOHN LINSLEY-HOOD. All kits are APPROVED by the designer.

### LINSLEY-HOOD CASSETTE RECORDER CIRCUITS

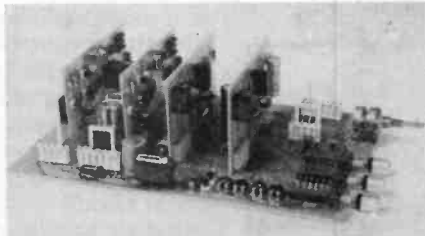

Complete record and replay circuits for very high quality low noise stereo cassette recorder. Circuits are optimised for our HS16 Super Quality Sendust Alloy Head. Switched bias and equalisation to cater for chrome and ferric tapes. Very easy to assemble on plug-in PCBs. Complete with full instructions.

Complete Stereo Record/Play Kit ..... £33.70  
VU Meters to suit ..... £2.30 each  
Reprints of original Articles ..... 75p no VAT  
860X Stereo Mic Amplifier ..... £8.70

### LINSLEY HOOD 300 SERIES AMPLIFIER KITS

Superb integrated amplifier kits derived from John Linsley-Hoods articles in 'HiFi News'. Ultra easy assembly and set-up with sound quality to please the most discerning listener. Ideal basis for any domestic sound system if quality matters to you. Buy the kit complete and save pounds off the individual component price.

K300-35 35 Watt. Discount price for Complete Kit ..... £98.79  
K300-45 45 Watt. Discount price for Complete Kit ..... £102.36  
RLH4&5. Reprints of Original Articles from 'Hi-Fi News' ..... £1.05 no VAT

### LINSLEY-HOOD SYNCHRODYNE AM RECEIVER

Very high quality kit for this recent design featured in 'Wireless World'. This unit represents the first attempt to make a much needed HIGH QUALITY AM Tuner since pre-FM days. This will give you Radio 4, or even 1 in better quality than your Eastern 'Tranny'. Advanced construction system, approved by the Author, uses 3 double sided PCBs in a stacked layout for total stability, ease of construction and minimal wiring. This module will form the AM section of an ultra high quality AM/FM switched bandwidth tuner to match our 300 series amplifiers. Power supply and tuning gang will be included with the FM section.  
K450 JH Synchrodyne Kit Special Price ..... £59.95

## HIGH QUALITY REPLACEMENT CASSETTE HEADS



Do your tapes lack treble? A worn head could be the problem. Fitting one of our replacement heads could restore performance to better than new! Standard mountings make fitting easy and our TC1 Test Cassette helps you set the azimuth spot-on. We are the actual importers which means you get the benefit of lower prices for prime parts. Compare us with other suppliers and see! The following is a list of our most popular heads, all are suitable for use on Dolby machines and are ex-stock.

HC20 Permalloy Stereo Head. This is the standard head fitted as original equipment on most decks ..... £7.66  
HS16 Sendust Alloy Super Head. The best head we can find. Longer life than Permalloy, higher output than Ferrite, fantastic frequency response ..... £14.85  
HQ551 4-Track Head for auto-reverse or quadrophonic use. Full specification record and playback head ..... £14.60  
Please consult our list for technical data on these and other Special Purpose Heads. MA481 Latest version Double Mono (2/2) Record/Play head ..... £13.35  
Replaces R484 ..... £13.35  
SM166 Standard Mounting 2/2 Erase head. Compatible with above or HQ551 4-Track Head ..... £8.85  
H524 Standard Erase Head. Semi double gap, high efficiency ..... £2.25  
H561 Metal Tape Erase Head. Full double gap ..... £7.35

## HART TRIPLE-PURPOSE TEST CASSETTE TC1

One inexpensive test cassette enables you to set up VU level, head azimuth and tape speed. Invaluable when fitting new heads. Only £4.66 plus VAT and 50p postage.

Tape Head De-magnetiser. Handy size mains operated unit prevents build up of residual head magnetisation causing noise on playback ..... £4.54  
Curved Pole Type for inaccessible heads ..... £4.85

Send for your free copy of our LISTS. Overseas please send 2 IRCs to cover surface Post or 5 IRCs for Airmail.

Please add part cost of post, packing and Insurance as follows:

INLAND Orders up to £10 - 50p  
Orders £10 to £49 - £1  
Orders over £50 - £1.50  
OVERSEAS Please send sufficient to cover Surface or Air Post as required.

Personal callers are always very welcome but please note that we are closed all day Saturday

24hr SALES LINE  
(0691) 652894

ALL PRICES EXCLUDE VAT UNLESS STATED



# THE TRUTH ABOUT HI-FI

**Andrew Armstrong separates fact from fiction in this, the real life guide to designing and choosing audio equipment.**

**T**he subject of hi-fi is one which engenders more confusion in normally commonsensical people and has more infernal twaddle written about it than most others. Hi-fi is an area in which art meets science. Perhaps this is why commentators endeavour to screw up the inscrutable while providing a superficially acceptable definition of the whichness of what.

I shall try to demystify the subject and stimulate a critical appreciation of bunkum (including any which I may inadvertently perpetrate).

## Distortion

The ideal of hi-fi is to provide the closest possible approach to the original recorded sound. The first requirement of any amplifier or preamp is that its transfer characteristic is linear over the audio range and that its frequency response is flat (or very nearly so) over the dynamic range of any likely programme material. Noise, (hiss, hum and so forth) should be low enough to be inaudible at normal volume settings. An amplifier which simply meets this specification is likely to give good sound quality, but will have some second order defects which slightly undermine the effect.

An amplifier which falls down seriously on any of the above would be barely usable. And yet I remember reading recently that harmonic distortion was not as significant as — what was it? — distortion caused by the crystalline structure of the wire ...

Frequency response figures extending well into the RF region are also not helpful. In fact too wide a response can be a disadvantage. That should stir things up a bit! According to research carried out at Aston University, significant ultrasonic components in the final output can cause headaches, so if such signals are present in the signal source it is preferable to attenuate them.

Transient intermodulation distortion (TID) on the other hand is a genuine distortion from which simple amplifiers may suffer. An amplifier may respond perfectly to any sinewave signal in the audio range but not to complex waveforms. Some of these may have slew rates (rate of change of voltage) significantly greater than the greatest slew rate of the highest frequency sinewave in the audio band. In amplifiers which use a lot of overall feedback across several stages, the feedback may not keep up with a really fast edge, even though it is adequate to cope with a full amplitude sinewave at the top of the audio range.

If TID occurs the amplifier may produce a high distortion for a short period. This effect can be missed in a short listening test but over a long period there is a sense that the sound is not completely clear.

So there is virtue in the amplifier responding without distortion to frequencies significantly above the audio range. This also prevents unwanted frequencies driving the amplifier into non-linear regions and affecting audio frequencies. However, while it is an advantage for the active circuitry to respond accurately to high frequencies, it is even better to exclude them with a gentle rolloff filter that does not cause response ripples inside the audio range. If a passive filter is used on the input of a preamp it should also virtually eliminate RF pickup on the inputs. This will be a step towards immunity to CB radios, fridge thermostats, etc.

When TID was first discovered there was some scepticism but the effect can be shown both in prolonged listening tests and by measurement. Different circuit design techniques used in valve amplifiers make them less prone to TID than transistor amplifiers.

Most current commercial designs avoid TID so it is no longer a red hot issue but it still appears as a bug in less rigorous designs.

## Coloured Wire

Don't laugh! I have encountered, in otherwise



Certainly not hi-fi, but what's the difference?

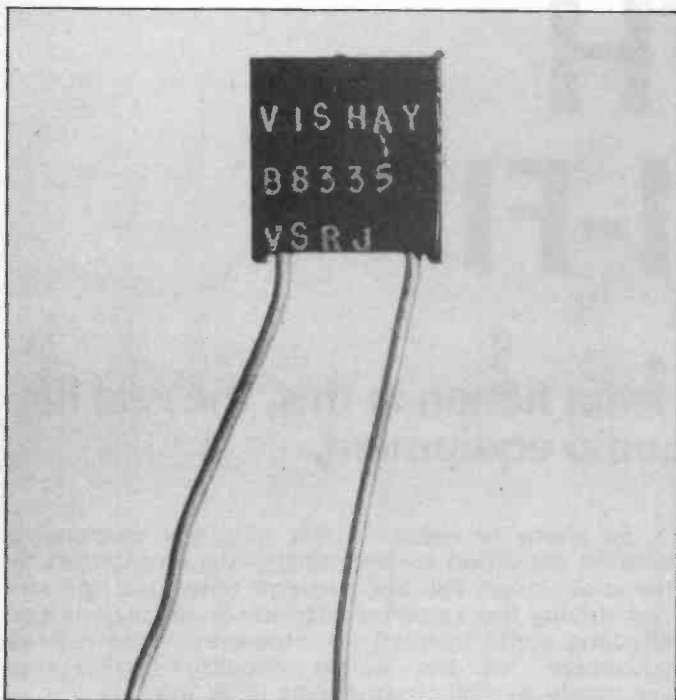

The ubiquitous bulk foil metal resistor. High temperature stability certainly but are they worth several pounds a time?

reputable places, the theory that the colour of the plastic insulation of internal wiring affects sound quality. If I remember correctly the message was to always use grey loudspeaker wire, because coloured dye will migrate into the copper and make the current flow non-linear. The writer did seem to be serious.

There is a current theory that the crystalline structure of any wire used in hi-fi equipment affects the sound quality, and that only linear crystal wire should be used. Linear crystal wire probably does carry current in a slightly different way on a microscopic level and this may lead to tiny variations in the graph of current against voltage for the particular wire. Such a variation might make a difference in the quantity and type of noise generated by the resistance of the wire. Accepting this for the sake of argument, the noise contribution of the wire could be about, oh, -100dB relative to the other noise ...

I have also seen criticism of the use of screened lead on the grounds that the dielectric loss in the capacitance between inner and outer could cause attenuation of high frequencies. This is true for RF but for audio it is far fetched. In any case, a well designed system will not use high impedances on long cable runs such that the self capacitance of the cable is significant.

I would criticise screened lead on another count. The screening is not always adequate. I noticed this effect recently on an electric guitar lead, where a standard coiled lead picked up buzzing from a fluorescent light while a top quality non-coiled lead picked up no untoward noise, even though it was longer.

In the few instances where ordinary screened lead is insufficient, I recommend the use of the thin PTFE insulated RF co-ax. This is expensive and rarely necessary. The screened lead used to connect the recent audio switcher project to its input sockets was quite ordinary, but there is no interference because the whole project is in a metal case. The only result of using ordinary screened lead is that if an unconnected input is selected and the volume turned to maximum there is just-audible crosstalk from an adjacent input.

If something is plugged into the selected input (even a tuner which is switched off) no crosstalk is detectable. To put this further into context, the cables are tied tightly together and the crosstalk is audible at a volume control setting above the pain level for an active input.

## Resistors

The types of resistor used in audio circuits, particularly in preamp circuitry, can be significant. Carbon resistors generate a lot of noise and it is better to use metal film in almost all cases. In general, if ordinary 1% metal film resistors are used, the semiconductors in the circuit will dominate the total noise and the contribution made by the resistors will be insignificant.

In cases where the ultimate performance is needed (for instance with a very low output cartridge) there may be some advantage in using high precision metal film resistors or even wirewound types. These should give a noise level not too much above the theoretical thermal noise.

However, in no case is the voltage coefficient of the resistor significant. Any non-linearity introduced by this effect will be negligible when compared with other circuit non-linearities, and indeed with the quality of any available signal source.

## Capacitors

In a well designed circuit the capacitors will be deployed in such a way that minor deviations from the theoretical capacitor do not matter. Electrolytic capacitors should always be polarised in the correct direction and should not be asked to do anything except couple or decouple. If an electrolytic couples a signal from one stage to the next, its value should be high enough that the alternating voltage across the capacitor at the lowest frequency is negligible. For example, the impedance of a 100 $\mu$  capacitor at 20Hz is 85 ohms, so if a capacitor of this value is used to couple into a stage having 100k input resistance only a small proportion of the signal will appear across it. Indeed, less than you think because the capacitive impedance is 90° out of phase with resistance. The change in overall impedance due to the addition of the capacitor is the square root of the sum of the squares — good old Pythagoras.

If the capacitance is slightly dependent on the voltage across the capacitor, the effect of this is minute. The same applies to any unwanted inductance or resistance in a supposedly pure capacitance and, for that matter, to any question of dielectric loss and non-linearity in different types of electrolytics. If the circuit is designed sensibly and a suitable value of capacitor is chosen, any effect on frequency response or linearity will be too tiny to measure. When I say such an effect can be neglected, I mean it is smaller than other unavoidable system defects.

There are times when the quality of capacitor is important. For example, in a tone control or filter there is inevitably a significant proportion of signal across the capacitors. In particular, some types of capacitor have a significant voltage coefficient — the capacitance depends on the voltage across the capacitor. Ceramics have been the worst offenders. On the other hand some polyesters and all polypropylene and polystyrene types are very good. The least consistent polyester capacitor I have measured had around 0.1%/V change in capacitance, while I have found ceramic types which show over 1%. As a general rule, it is safe to use polyester capacitors in filters or tone controls so long as a good brand is used and not one out of the junkbox.

Quality is also significant in decoupling. There the capacitor should not have a significantly higher impedance at higher frequencies, or high frequencies impressed onto the power supply may cause slight cross coupling between stages. High value electrolytics are often offenders due in part to self inductance. There is an argument for using local low value electrolytics or, if appropriate, tantalum bead capacitors to decouple sensitive stages. Tantalum beads have an excellent high frequency performance as decouplers although they also have a significant voltage coefficient. Some pundits suggest the use of film capacitors in parallel with the main power supply reservoir capacitors. This is not always a good move because the inductance of the electrolytic can resonate with the capacitance of the film capacitor and worsen the effect.

## Power Supply

With an oscilloscope it is easy to check whether power supply lines have any stray signal on them, by using AC coupling and a sensitive range. If little or nothing shows up when a full amplitude signal at say 15kHz is fed in then the decoupling is sound. A small amount of stray signal may not cause any problem.

Practical circuitry will of course be slightly sensitive to power supply ripple or noise, but this effect should be minimised. A good way to do this is to use wide bandwidth low noise op-amps in preference to transistors in low level signal processing. If devices with good power supply rejection ratio (PSRR) and common mode rejection ratio (CMRR) are used, only a low level of hum will result with even a volt of ripple on the power supply. The use of voltage regulators should make hum inaudible at maximum volume setting with all signal sources switched off. To exceed this performance is clearly not necessary.

However, it is still necessary to use local decoupling capacitors on the power supply because the CMRR and PSRR are reduced at higher frequencies, as is the ability of the regulator to maintain a steady power supply voltage in the presence of a fluctuating load.

A good choice of voltage regulator for use in a pre-amplifier is the LM317 (and its negative counterpart the LM337). If the adjust terminals and the outputs are decoupled with 10 $\mu$  electrolytic capacitors, the power supply noise is significantly less than with 7800 and 7900 series regulators.

In a power supply for a preamplifier, the transformer should keep the voltage on the reservoir capacitors high enough to operate the regulators even if the mains is 15% below nominal. Then the sound will remain good even if the mains is a bit low. The regulators will then have perhaps six volts across them, in a circuit designed to supply  $\pm 12V$ .

In this case, the regulators will need small heatsinks and the power drawn from the transformer is significantly greater than that drawn by the preamp circuitry. Because the wattage rating of a transformer with a rectifier/capacitor load is about  $\frac{2}{3}$  of its VA rating, a transformer with a VA rating of at least double and preferable triple the preamplifier wattage should be used. More than this is unlikely to be beneficial, and can cause hum by its greater stray magnetic field.

To give an example, a 15V 6VA transformer would be suitable to operate a small preamplifier running on regulated supplies of  $\pm 12V$ .

## Semiconductor Choice

There is a myth that only discrete transistors are suitable for quality audio, and that op-amps are inferior. This idea had some truth when the 741 was young, but nowadays it is outdated. The right choice of op-amps

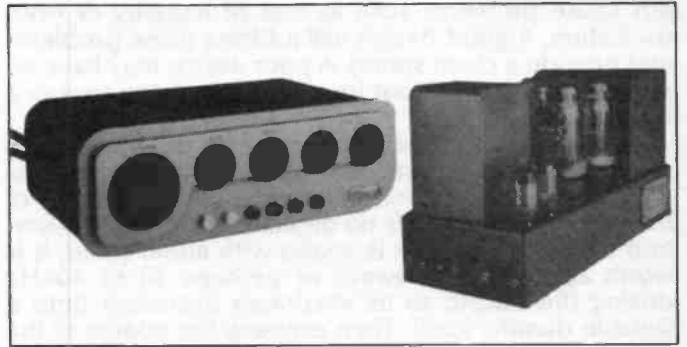

The famous Quad II valve amplifier. The valve amps of old had specifications far from the standards of modern transistor amps and yet many are still held in awe today.

can outperform any discrete design. Unless, of course, you use a very complicated circuit of transistors lovingly matched by hand on a curve tracer. This would be a discrete op-amp!

One reason why op-amps work so well in audio circuits is that the very high gain gives negative feedback effects which all but eliminate harmonic distortion. However, high levels of overall negative feedback mean the possibility of TID, so it is important to consider an op amp's ability to handle the highest slew rate which it will encounter.

It also helps if the internal design of the op-amp does not have any serious non-linearity. The 741 design used to have an unbiased class B output stage, and the feedback was therefore called on to correct for severe crossover distortion which it could not handle at the high end of the audio range. A load resistor connected to one of the power supply rails on the output of the op-amp was an effective way to improve its performance by preventing the output from crossing over at all. More modern designs do not suffer from this problem.

Some modern op-amps have a noise figure lower than ordinary discrete transistor circuits. The 5532 dual or 5534 single op-amps, which have been around for some time, give sufficiently low noise for most audio applications. There are newer and better designs worth consideration for very low signal levels. The OP37 is one but its price rules it out for applications in which its improved performance is no real advantage.

The choice of circuit techniques for power amplifier stages is rather different. Where the signal input level is much higher than that of a preamplifier, noise is no longer a problem. The voltage level of the output signal precludes the use of op-amps directly, though an op-amp could be used in an early stage. However, there is little to be gained because most op-amps do not perform well in larger systems with overall feedback round the whole circuit.

Power amplifiers often use long tailed pairs in the early stages with various output configurations. In general it is better if each stage of an amplifier has enough local negative feedback to make it fairly linear, so that the overall feedback is not called on to correct for too much. This reduces the likelihood of significant TID. It is also important that the output stage should have adequate gain. A well designed complementary output stage may have three transistors in each half because the gain of power transistors normally drops considerably at high currents. Excessive amounts of gain must be provided at low power levels to avoid unreasonable demands on the driver stage at high output power levels.

It is difficult to ensure that the gain change of the output stage over the cycle of the output signal does

not cause problems such as loss of linearity or even oscillation. A good design will address these problems and provide a clean sound. A poor design may have no simple faults but will not be pleasant to listen to over a long period.

Some significant faults are not easy to identify with simple tests using a sinewave generator and an oscilloscope but the use of extreme tests can dig up some of the problems. If there is no detectable crossover distortion when an amplifier is tested with audio tones, it is worth applying a sinewave of perhaps 30 or 40kHz driving the output to its maximum excursion (into a suitable dummy load). Then examine the middle of the waveform on an oscilloscope with the input sensitivity set to show a range of a few volts. Amplifiers designed a little close to the limit may exhibit just detectable crossover distortion under these circumstances, which would suggest the possibility of TID on some signals.

## MOSFETS

There is a real argument in favour of using class A to minimise the problems of designing a completely clean output stage. If crossover does not occur, a possible source of distortion is removed. Also, the effects of gain change are much reduced when neither transistor reaches zero current.

Another fashionable technique is to use power MOSFETS in the output stage. The gain change due to current change is lower and the crossover region is spread over a greater voltage range so the feedback which linearises it does not have to work so fast.

The disadvantage of power MOSFETs is that they often have a very high gate capacitance and can be difficult to drive without sacrificing speed, limiting the overall bandwidth or reducing the phase stability margin of the amplifier. It is easier to design a clean power amplifier using power MOSFETs, but a design using ordinary transistors need not be worse. If the circuit is properly designed to give clean performance it does not matter what devices are used in the output stage.

To sum up my thoughts on hi-fi circuit design, some factors affecting sound quality are surprising but everything significant is amenable to measurement. Not everything that matters is currently measured. Consider TID. This rather obscure effect was not discovered for a long time partly because measurements on hi-fi amplifiers were not designed to detect it. Once the theory arrived, the effect was detected. Anything which is literally incapable of being measured is most unlikely to produce an effect detectable by the human ear.

## Damping factors

An amplifier's damping factor measures how well the amplifier damps out spurious loudspeaker cone vibrations. As the cone vibrates, the movement of the coil in the magnetic field generates a voltage. If the coil is deliberately shortcircuited and the cone vibrated, the response will be very soggy and any cone resonance will be damped. Ideally the amplifier output should look like a short circuit to any currents arising from spurious vibrations. A low output impedance gives a high damping factor.

It is not worth chasing extremely high damping factors in selecting a commercial amplifier because its effects will be reduced by other factors such as the resistance of the loudspeaker cables (even where good quality thick cables are used). The crossover unit in the loudspeakers will also reduce the level of damping seen by the loudspeakers.

As consideration of the damping factor has as much to do with choosing as with designing a hi-fi system, this

is a good place to move onto other 'choice factors'.

## General Criteria

Before worrying too much about the technical specifications, you should work out how and where your hi-fi will be used. If you have a special listening room, soundproofed and lined with acoustic tiles then it is worth aiming for a very high specification with the lowest possible noise level and distortion.

Unless you use headphones, the ultimate hi-fi will sound no better than average equipment in most living rooms. Traffic noise and so forth will prevent you from hearing the difference between 80dB and 90dB signal to noise ratio. Room colouration will alter the frequency response enough to render a totally flat response pointless.

## Loudspeakers

The loudspeaker is probably the major factor in sound quality. Loudspeakers are often the weakest link in the chain and a good place to invest real money. When looking at loudspeakers, reject immediately those which do not have a solid, non-resonant cabinet. If it sounds like a box when you tap it with your finger, it will sound like a box when you play music through it. The duller the tap, the better. Concrete cabinets are probably the best but impractical for most people!

Generally, the more drive units a loudspeaker has the more carefully it must be designed to benefit. A really cheap three unit design should be viewed with suspicion. When you have rejected unsuitable speakers, listen to the serious contenders critically. Choose music you are familiar with and which is demanding of loudspeaker performance. Also, listen to speech through the speaker before you buy it. Close your eyes and see if you could imagine a person speaking, rather than a wooden box. Because the human voice is so familiar it can betray defects which are not otherwise obvious.

When a possible loudspeaker has been chosen, a suitable amplifier is the next requirement. This must have sufficient power output to produce an adequate sound level from the chosen speakers, but (ideally) not enough to blow them up. Most well designed power amplifiers will perform so the human ear can detect no flaw but choosing a reputable make is an added insurance.

A preamplifier should be chosen to provide low noise and all the inputs you need. Nothing is worse for the equipment or the user than to be constantly plugging and unplugging connectors at the back. There is a fashion to eschew tone controls on expensive preamps, but I think they are to be preferred. However, it is important there is a clearly marked neutral position which you can trust or, even better, a tone defeat switch. This will allow you to listen to your best recordings without unwanted modification.

If you intend to play records a scratch filter is a good idea. A choice of frequencies is also an advantage, to clean up the sound while losing as little music as possible.

When you listen to the system so far, set the volume as loud as you ever expect to want it and then turn off the signal source. Can you hear any hiss? If you can hear much then reconsider your choice of preamp.

## Sources

Choosing signal sources is complicated. Perhaps the easiest one to deal with is CD. The majority of CD players nowadays are so good that most people cannot hear any deficiency. The facilities offered by each one are different, as is the standard of assembly. Some of

the newest machines offer better error correction than earlier designs, but only in more expensive models. This can be useful as worse scratches can be tolerated without losing sound quality.

Reject any machine which seems mechanically flimsy then choose one which you feel happy with. The chances are you will be happy with it. Don't worry about the last ounces of performance. If the noise and distortion are below the level you can hear in your living room, halving them won't produce a dramatic improvement.

Although vinyl discs will decline in popularity as CD takes over they will probably be around for decades. If you want to play records then buy a good deck. To put it simply, the turntable should be heavy and solid and the arm should be light, free moving and capable of precise adjustment. Evidence of mechanical precision in all parts is a good sign.

Cartridges are often priced from tens of pounds to around a thousand. There are good, inexpensive ones, but they do give slightly different tonal balances so listen for one which sounds right to you. Spending £500 on a cartridge is barmy because the quality of the best pressings is nowhere near the quality available from a CD player.

Tuners are a big subject in themselves, so I will just say that the performance varies significantly between models. Among other things is the ability to reject strong out of band signals while receiving a weak station in stereo. Listen critically to a number of different stations.

## Dolby

In cassette players there is enormous variation in the quality of reputable brand machines. Both the

mechanics and the electronics have to be well designed and assembled to provide reasonable performance.

Before switching on, look at the facilities. If the machine sports Dolby C, check that fine adjustments can be made for individual tapes. If the flat frequency response cannot be tweaked to the correct level when recording, Dolby C will multiply up response errors much more than Dolby B. Dolby C gives a dramatic reduction in noise but it cannot do its job well unless the machine is first class.

The mechanics should be solid. Tape heads on a slide made of a thin piece of bent metal are useless. Even if the line up is accurate when the machine is new, this will not last. Small head alignment errors of only a few minutes of arc can have a seriously deleterious effect. A good test for head stability is to make a mono recording of the interstation hiss from an FM tuner and then play it back in mono. If the head alignment shifts at all, the left and right channels will have a time difference and weird phasing effects will result.

Access to the heads and the capstan pinchwheels for cleaning is vital. If the machine is impractical to clean don't buy it. Sooner or later you will play a tape with a dirty pinchwheel and it will stick to the wheel and be mangled.

In conclusion, when you have put together a good hi-fi system, keep it clean. I cannot say this too strongly. There is little point in cleaning the pickup after it has damaged your favourite LP or cleaning the pinchwheel after it has ruined a tape. Nothing distorts quite so thoroughly as a recording with a hole in it.

Happy listening.

ETI

## SPECIAL OFFER ... SPECTRUM AND BBC OWNERS! Computers In Control At An Affordable Price

DGP Interspec: only £29.95 for ZX Spectrum owners (normally £49.95)  
DGP Interbeeb: only £49.95 for BBC Micro users (normally £69.95)



The DGP interfaces are tried and trusted add-ons which will bring your computer the full benefits of interfacing.

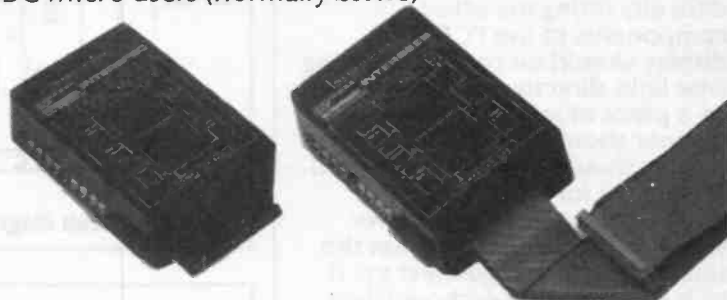

To order by post please send the order form (or copy) with your remittance to:  
ASP READERS' SERVICES (RO ET5/6), 9 Hall Road, Maylands Wood Estate, Hemel Hempstead, Herts.  
Please make cheques payable to ASP Ltd.  
Phone ACCESS or VISA only: (0442) 211882  
Overseas airmail: add £5 (Interspec) £10 (Interbeeb).

Order Code RO ET5. Please supply ..... Interspecs at £29.95 plus £1.95 p&p. per order.

Order Code RO ET6. Please supply ..... Interbeebes at £49.95 plus £1.95 p&p. per order.

NAME .....

ADDRESS .....

.....

.....

Or, I authorise you to debit my  
ACCESS/BARCLAYCARD No. ....  
to the sum of £ ..... Signed .....

Please allow up to 28 days for delivery.

The Interspec and Interbeeb both include the following features:

- \* 8-bit input port
- \* 8-bit output port
- \* four switch sensor inputs
- \* four relays switching 12V 1A outputs
- \* 8-channel multiplexed analogue-to-digital converter
- \* 15-way expansion bus

All parts are I/O-mapped (including the expansion bus) and have been designed for maximum compatibility with existing peripherals. In addition to the above facilities, the Interbeeb includes a separate power supply (the Interspec takes its power from the Spectrum edge-connector) and a precision 2.5V voltage reference in the ADC (the Interspec uses a simple zener diode reference). The ADC is based on the 0809 device and has a stated conversion time of 1ms and an accuracy of 1LSB.

These units are extremely easy to use and are supplied, built and tested, with all the documentation necessary to get you up and interfacing.

# THE BATLITE

Andy Armstrong's Batlite checks batteries, alternators and wiring thus preventing darkness in the Batcave.

This is a simple project which can give advance warning of a number of possible problems with a car's battery, alternator or wiring. The Batlite could also be used to indicate voltage changes in other situations.

The battery voltage is shown with a simple colour display made from an array of bi-colour LEDs. This alters colour from red, through orange, and green according to the voltage present on the supply line. Keeping an eye on the Batlite mounted on a car's dashboard can give early warning of several potentially disastrous problems.

## Construction And Testing

All the components except the LED display are mounted on the PCB. R4, for which no value is given, should be omitted at this stage. There should be no difficulty fitting the other components to the PCB. The display should be connected using wire links directly on the pins, or on a piece of stripboard, in the manner shown in Fig. 1. The display should then be connected to the PCB for testing.

At this stage a bench power supply is highly desirable. Set the supply to 11V and connect up. If all is well the display should light up red. If any segments are not red, then reverse the connections to them. If it's all green then reverse the whole display.

## BUYLINES

The LED array is, to our knowledge, only available from Farnell. Non-account holders should contact Trilogic, 29 Holm Lane, Bradford who will supply Farnell products at a cost. Alternatively, there is nothing wrong with making your own array using four bi-colour LEDs — Maplin UF96E or QY83E types, for example. The LM358 is available from Electromail (stock no. 632-871) and the PCB will be available from our PCB Service.

## HOW IT WORKS

IC1a forms an oscillator in which C1 is alternately charged and discharged via R6. The charge and discharge times of C1 are modified by the contribution from the potential divider comprising R3, R4, and R5. This effect is dependent on the battery voltage and so the mark to space ratio depends on the battery voltage.

The square wave output from IC1a is inverted by IC1b and the signal and its

inverse are fed to opposite sides of the display with a current limiting resistor in series. The apparent colour of the display depends on the relative length of time for which the red and green LEDs are on, and hence on the mark to space ratio of the oscillator (Fig. 2).

The extra voltage drive afforded by the second op-amp is necessary because of the high voltage drop of four LEDs in series.

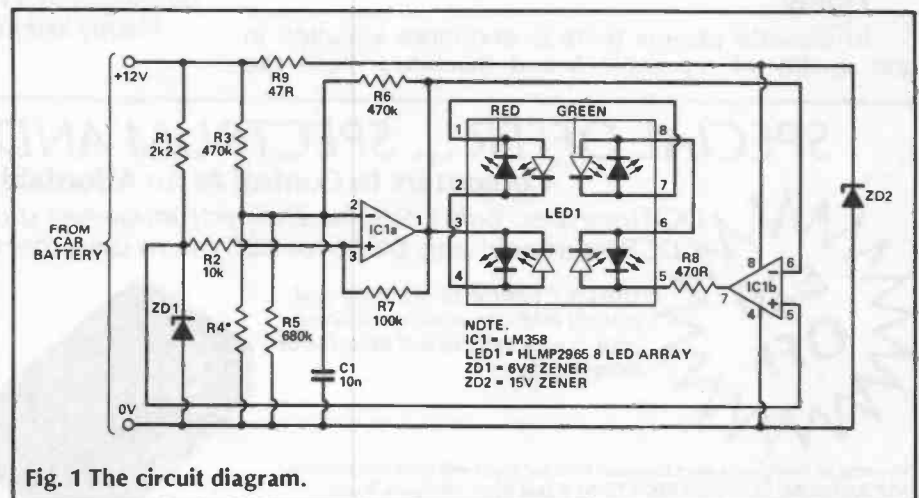

Fig. 1 The circuit diagram.

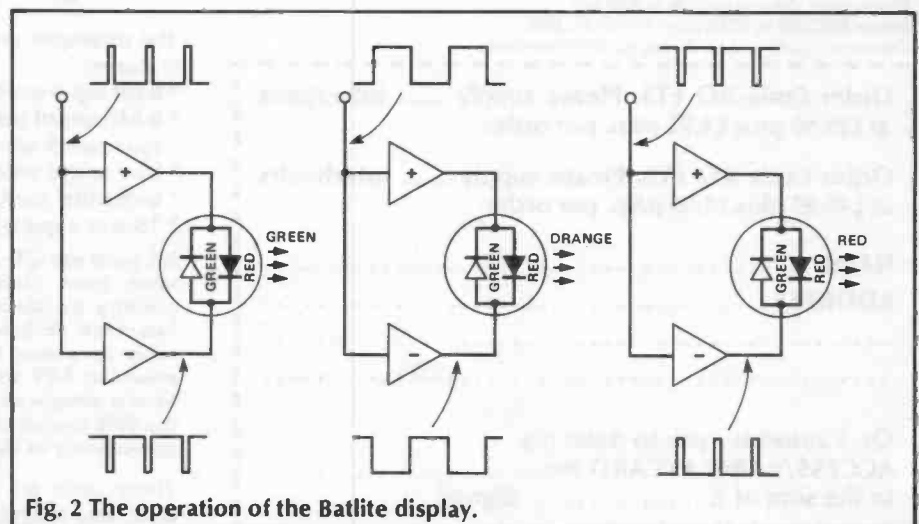

Fig. 2 The operation of the Batlite display.



Increase the voltage until the display shows all green and no red. If this happens at about 14V then R4 is not needed. If, on the other hand it happens at a lower voltage, the addition of a high value resistor for R4 should correct the situation. A good value to start with is 3M3, and then test again to find out if a higher or lower value is needed.

If you are using the Batlite for purposes other than car battery monitoring, you will have to establish for yourself a suitable value for R4 and R5.

## Operation

The gadget should be connected to a point in the car's

wiring which maintains the same voltage as the battery. That is to say, not at the end of a long thin wire with a variable load on it. A thick wire on the ignition switch is a good bet.

If you should connect it the wrong way round, then ZD2, whose normal function is to absorb spikes, will conduct in a forward direction, and protect the op-amp. Under these circumstances R9 will smoke mightily.

Once you are used to how the Batlite responds to normal conditions, the alteration of response due to a fault should be very obvious. If the display remains orange even when the

engine is running fast, then the alternator has probably failed.

If it only turns orange when the headlight or rear heater are on, then the fan-belt may be slipping. A battery in bad condition will cause the colour to change to red rapidly when the engine slows to idle, at red traffic lights.

Keep an eye on it. A prototype of the same device warned me that the brushes in my alternator had failed when there was no other symptom — nor would there have been until the lights dimmed and the engine stopped.

## PARTS LIST

### RESISTORS 1/4W 5%.

R1	2k2
R2	10k
R3, 6	470k
R4	* See text
R5	680k
R7	47R
R8	470R

### CAPACITORS

C1	10n polyester
----	---------------

### SEMICONDUCTORS

IC1	LM358
ZD1	6V8 400mW zener
ZD2	15V 400mW zener
LED1	HLMP2965 (Hewlett Packard LED, available from Farnell)

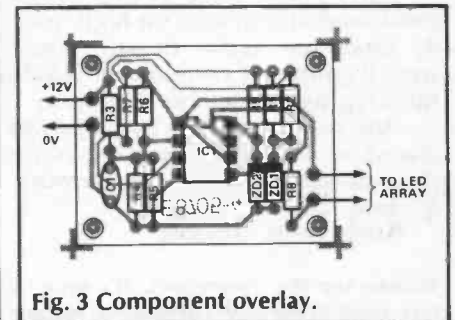

Fig. 3 Component overlay.

ETI

# AUDIOKITS Precision Components

Specialists in Audio Amplifier Construction and Design

## COMPLETE KITS

incl. Casse, Transformer, Pcts.  
**ETI VIRTUOSO PREAMP**  
**PE 30+30 INTEGRATED AMP**  
**EE APEX PREAMP**  
**EE APEX POWER AMP**

These are the highest quality audio amplifier kits. The 'standard' version use high quality components and compare favourably with the best ready built amplifiers at 2 to 3 times the price.

The 'Upgraded' version use the very best audiophile parts to enable you to build an amplifier so good that it would be impossible to buy.

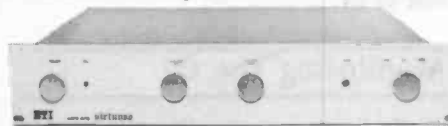

**BUILD THESE SUPERB ETI PROJECTS WITH AUDIOKITS COMPONENTS**  
**AUDIO DESIGN PREAMP**  
**AUDIO DESIGN POWER AMP**  
**SYSTEM A PREAMP**  
**SYSTEM A POWER AMP**  
**VALVE PREAMP**  
**ELEKTOR PREAMP (Nov 86) ALSO**  
**TAA 20 WATT CLASS A**  
**TAA DANIEL VALVE PREAMP**

Our component application notes gives our prices of parts to build the projects plus details of higher grade parts which will enable you to enjoy better sound quality than the original.

Cases for your audio amplifier built to order including:

**SYSTEM A POWER AMP**  
**AUDIO DESIGN POWER AMP**  
**PASSIVE PREAMPS**

## COMPONENTS

IAR WONDERCAPS  
 CLOSE TOLERANCE POLYSTYRENE CAPACITORS  
 BULK FOIL RESISTORS  
 WONDER WIRE  
 KIMBER CABLE  
 GOLD PLATED SWITCHES  
 CONTACT CURRENT DIODES  
 GOLD PLATED PHONO PLUGS AND SOCKETS  
 LONG LIFE ELECTROLYTIC  
 HIGH CURRENT BRIDGE RECTIFIERS

## SEMI CONDUCTORS

BC184C	2N3716	MPSA06	25D786
BC214C	2N3792	MPSA56	
BC307C	2N4401	MAT01GH	2N5457
BC547C	2N4403	MAT02FH	2N5459
BD243C	2N5401		2N5460
BD244C	2N5551	OP27GZ	VN1210M
MJ11015			
MJ11016	2SB737	J112	

SAE for details of components and kits to:

**AUDIOKITS PRECISION COMPONENTS**  
**6 MILL CLOSE, BORROWASK, DERBY, ENGLAND**  
**TEL: 0332 674929**

# READ/WRITE

## Reviews Review

I feel I should compliment you on a couple of recent articles — Gareth Connor's CAD review (March 87) and Barry Porter's article on balanced lines (February 87). I found Gareth's comments refreshingly unbiased. I use the Analyser II package on my IBM PC clone along with the EC-ACE package from the US. Both are excellent.

Barry Porter rates as one of the most readable writers on high quality analogue audio design. Apart from a couple of component values missing his article was excellent.

Any further articles by Barry will always be welcome as will any more reviews along the lines of Gareth's.

Tony Crane

Kings Lynn, Norfolk.

Thanks for the comments. It's nice to feel wanted! We shall continue to feature Barry porter's articles and to review relevant micro packages when we can.

## Bird Brained

Your new column 'Bird's Eye View' looks like it's going to be great! You ought to double its size immediately.

Do tell us. Who is this fella John Bird who stands in judgement of all other contributors?

S.R. Thackery

Ripley, Derbyshire.

I was sitting by the glowing log fire reading my action-packed March copy of ETI (back to front as I usually do) when I spotted a new name — John Bird's eagle-eyed views on a parcel of back issues of ETI.

I am delighted Mr. Bird agrees the standard of features and circuits is very high with few exceptions. However, Mr. Bird does feel most ETI projects have no engineering content. He finally gets round to this conclusion in column two. Why he bothers heaven knows — is the Editor short of projects I ask myself. I do hope he will enlighten us how many ETI projects he has built since 1972. I have successfully built 27 but back to the facts...

I can find no fault with the presentation of projects in ETI. Generally the engineering content is sufficient for the construction and build-up and in some three part series the engineering content is remarkable.

I have also compared ETI with other electronics magazines which arrive on my desk daily. ETI always wins. The features are more balanced and interesting and the projects have that little extra thought which lets you know the circuit is well tested, proven and can be easily built with good results.

Perhaps ETI readers would prefer a project rather than another chunk from Mr. Bird!

Keith Lawrence

Ilkley, West Yorkshire

John Bird has been a mainstay member of the British electronics industry for many years. More than that he is (understandably, perhaps) reluctant to reveal.

However, he has constructed many of the projects in ETI and even contributed a few (under suitable pseudonyms of course). Yes, some of his own projects he holds to be lacking in engineering content! It is *electronic* engineering which John Bird feels is lacking and not mechanical details. He thinks too many projects are jigsaw compendiums of standard building blocks.

We are delighted that Keith Lawrence disagrees with this and yes, we do need more projects! Anyone with experience of 27 successful ETI projects can surely come up with a few novel ones for the rest of us...

## Monitoring The QL

My main interest is computing for a hobby and for word processing. Your magazine is of great interest to people like myself who need to interface odd pieces of equipment.

The 'Foreign Ports' article in the March ETI was excellent and I am now looking forward to the follow-up ETIFaker.

I have a QL which requires a 'special' monitor. At present I use a Philips black and white TV set. Can you advise what is necessary to convert the TV set for use as a monitor? There must be many people in this position who would welcome such a project.

L.E.G. Lettice

Alresford, Hampshire.

It is not possible for us to specify the modifications required for every TV set around. Moreover, the gain in quality with a monochrome set is very small anyway. The QL can be used with many 'normal' RGB monitors and we would

advise you try some of these first. We are planning a generalised TV-to-RGB monitor conversion project but this will only cover colour TVs.

## Air Conditioner

My immediate neighbour recently bought a Sony TV and, although their two previous sets required no filtering of any kind against my transmissions (I am a radio amateur), the new unit did. The antenna down lead was filtered with four ferrite rings in an effort to remove the interference but a complete cure was not effected until I fitted an ETI mains conditioner (September 1986 issue).

From observations I have gained the impression that Sony sets are very prone to interference and suffer from a general lack of gain. Do you have any comments?

R.C. Parnaby (G2DPA)

Beverley, East Yorkshire.

As far as we are aware, Sony sets are no better or worse than any others with regard to interference.

At the risk of teaching Granny to suck eggs, there are a few comments to make on the subject of dealing with interference. If the set is fitted with a pre-amplifier, any filtering must come before the amplifier.

It can be a damn nuisance to place the filters correctly if a mast-head pre-amp is fitted, but it's got to be done.

After following your natural instinct to filter the aerial lead, it's as well to look around for any other source of pickup. Any old length of wire can inject unwanted signals into the set. The mains lead is no exception. If TVs have much resistance to interference entering via the power supply it's as often as not by accident rather than by design.

Fitting a mains filter is always a sensible precaution and we are pleased to hear that the ETI design proved effective.

*ETI welcomes letters from readers on any topic. If you want to put us to rights, air your views or just want to see your name in print, put pen to paper (or finger to keyboard) immediately and let us all share your ideas.*

Write to:

Electronics Today International,  
1 Golden Square,  
London, W1R 3AB.

ETI

# MIDI MASTER KEYBOARD

John Yau shows how all manner of MIDI instruments can be controlled from the ETI master keyboard.

The Musical Instrument Digital Interface (MIDI) is now the universally accepted standard for communication between synthesisers, drum machines, music computers and other musical peripherals. Probably the most common MIDI application is to link synthesisers together in a way that permits a single keyboard to play all the other units attached to it via MIDI, as shown in Fig. 1.

This project is a six octave velocity sensitive keyboard designed to be a central controller for any number of connected MIDI synthesisers.

MIDI information transmitted by the keyboard controller includes note on/off events, program changes, pedal hold on/off and also pitch bend and modulation information, more details of which will be given later.

A full description of the MIDI standard was given in the January and February 1987 issues of ETI but before embarking on a description of the ETI MIDI Master Keyboard's specifications it is worthwhile giving a brief description of the concept of MIDI channels.

When the controller keyboard is played, the corresponding note information is passed through to all the other synthesisers via the MIDI serial link in a 'daisy chain' fashion. Each synthesiser can usually be programmed to act upon MIDI information transmitted on any one of the 16 possible channels.

These channels do not exist physically (remember the MIDI link is a serial one). As we shall see, the intended channel destination for a MIDI message is conveyed in the form of a number embedded within the message itself. MIDI synthesiser units with programmable channel number reception (virtually all commercial units) combined with a keyboard controller that transmits on a programmable MIDI channel, can

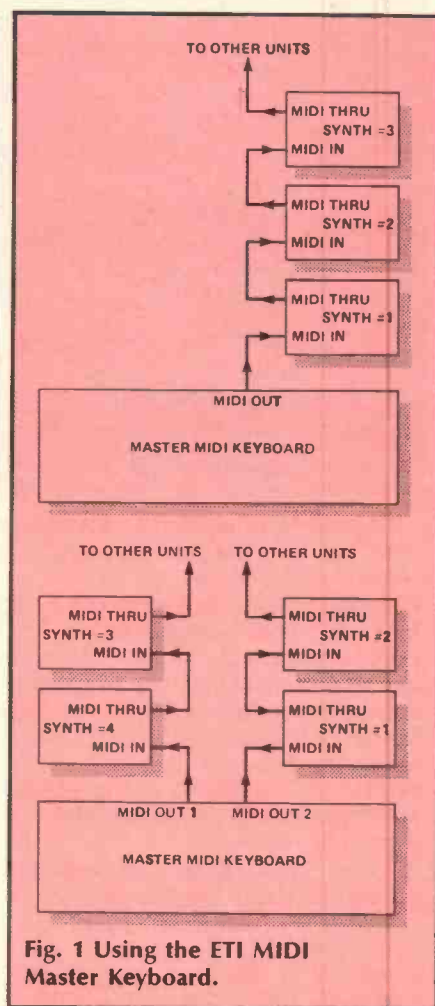

Fig. 1 Using the ETI MIDI Master Keyboard.

provide a very useful and powerful configuration as far as the musician is concerned.

From the transmitting keyboard it is possible to select and play any synthesiser in the connected MIDI 'daisy chain'. Alternatively two or more synthesisers can be played in unison if they are selected to receive on the same MIDI channel.

This 'doubling up' of synthesiser voices by playing different modules in unison is a common trick used by keyboard musicians to achieve a richer or 'fatter' sound. Since the average player has only one pair of hands the unison playing implementa-

tion offered by using MIDI is more than welcome!

Using MIDI, a single synthesiser keyboard can independently select up to 16 separate slave instruments. In such a system in which the master mother keyboard controls other instruments, the slave instruments may be just MIDI equipped sound modules and need not have keyboards at all. Moreover the mother keyboard itself does not need to have the capability of generating sound of its own accord.

More and more synthesisers are being made available in the form of a black box equipped with a MIDI interface without a keyboard for incorporation into a master mother keyboard system. Examples of such products are Yamaha's TX7 (a DX7 without the keyboard), the rack-mounting keyboardless versions of the Ensoniq Mirage and the Prophet 2000 sampling synthesisers.

The project presented here is a MIDI master keyboard that is suitable for controlling slave instruments in this way. The actual keyboard unit itself does not have its own sound generation hardware but is capable of full MIDI control of any externally connected device.

## Specifications

For maximum flexibility the 72-note keyboard is fully touch sensitive. This means that if the slave synthesiser module can respond to key velocity information, the harder you strike a note the louder it will be. For some synthesisers such as the Yamaha DX7, the key velocity information is also used to alter the tonality of the sound as well as the amplitude.

A unique feature of the system is that the touch sensitivity of the keyboard can be varied over a range of 16 different preset settings. This means you have complete control of the dynamic

range of the synthesiser module direct from the mother keyboard. For synthesisers that do not feature touch sensitivity, the velocity information transmitted by the mother keyboard is simply ignored.

Most MIDI synthesisers have performance controls which are accessible via MIDI. To accommodate this the mother keyboard system has two joystick controls and three footswitch inputs. The joysticks enable the system to transmit MIDI information relating to pitch bend and modulation. The footswitches enable sustain pedal hold, portamento switch and program advance information to be sent.

MIDI information is transmitted in two output streams, called channel A and channel B. The default setting is that channel A transmits on MIDI channel number one and channel B transmits on channel number two. However, the output streams can be independently assigned to any of the possible 16 MIDI channels.

The main purpose of having two MIDI output streams is to facilitate a split point on the keyboard. A split point can be programmed to be anywhere on the keyboard. Any notes played to the left of (and including) the split point key are sent to the MIDI channel assigned to the channel A output stream while notes to the right of the split point are assigned to channel B.

Using this facility two separate synthesiser modules can both be played from the mother keyboard with each synthesiser assigned to either side of the split point.

For the average piano player, transposing a written piece of music whilst playing can be a bit of a nightmare, especially when a lot of flats and sharps are involved in the key signatures. When playing synthesisers with the MIDI Master Keyboard an easy way out is offered to the musician fed up with mentally juggling semitones whilst playing.

The transpose feature in the master keyboard allows note information to be transposed before it is transmitted. So it is possible to play in a fixed key in relation to the physical keyboard while the actual notes played and transmitted through MIDI can be of any key signature.

This facility is especially useful when playing keyboards to accompany singers. The music can be instantly transposed at a touch of a button to suit the singer's range.



An additional feature incorporated into the mother keyboard system is the ability to independently transpose the keyboard at either side of a programmed split point. The main use of this feature is to transpose voices independently over octave ranges. Although one does not relish the thought of two synthesiser modules being played at different key signatures the possibility is there!

The ETI MIDI Master Keyboard project enables the music enthusiast to acquire a high specification MIDI mother keyboard at low cost. Some time and patience is required for the construction, especially within the mechanical construction side. However, the level of finish is up to the individual. You may be content with the keyboard nailed onto a wooden base (the prototype remained in that state for quite a spell!). Alternatively, a professional style cabinet finish may be easily achieved.

### Hardware Overview

There are a total of six printed circuit boards making up the guts of the hardware for the ETI MIDI Master Keyboard. This may seem a lot but some consolation can be drawn from the fact that three of them (the keyswitch PCBs) are



identical. These three boards are mounted along the length of the keyboard and serve the dual purpose of holding the CMOS multiplexer circuitry and providing the mounting base for the keyswitch springs.

Of all the PCBs the only double sided one is the main CPU board. This board holds the 6502A processor circuitry and all its associated peripheral devices as well as the analogue parts of the pitch bend and modulation joystick circuitry. The fifth board (the front panel board) holds all

# PROJECT: MIDI Keyboard

LED display circuitry and also serves as a mounting base for the push button switches that form the data entry keypad. Last but not least is the power supply PCB, which provides the necessary power rails for all the boards.

The heart of the system lies within the CPU board as shown in Fig. 2. All the necessary functions for the operation of the MIDI keyboard are directed by the on-board 6502A processor running at 2MHz. Physical tasks to be performed by the processor include scanning the keyboard,

## HOW IT WORKS

Figure 3 shows the circuit of the three keyswitch PCBs mounted along the length of the keyboard chassis.

Both the upper and lower bus bars are tied to +5V via pull up resistors R65 and R66. IC27-35 are 4051 CMOS 8 channel multiplexer devices.

Each device has its data input tied to 0V. The three bit address input presented at pins 9, 10, 11 routes the data input (0V) to one of the eight outputs. However, at any time only one of the CMOS multiplexer devices is selected to be active by IC26, a 4-to-16 decoder (of which only nine data outputs are actually used).

With a 7 bit address (four bits for the 4-to-16 decoder, IC26, and three bits for the CMOS multiplexers, IC27-35) a 0V signal can be routed to any one of the 72 keyswitch contact springs that are electrically connected to the CMOS multiplexer outputs.

To examine the state of a key, all that has to be done is to supply the 7 bit address of the key and then read the state of the upper and lower bus bars. If the key were idle the contact spring would be touching the upper bus bar, thereby pulling its potential to 0V (actually not quite 0V due to the resistance of the CMOS switch). Similarly, a key depression would ground the lower bus bar. In the transition state both bus bars would remain at 5V potential.

scanning the data entry keypad and footswitches, reading the joystick positions, setting the current LED display and finally transmission of MIDI data. All these tasks require a substantial number of peripheral devices to be placed within the address space of the 6502A processor.

## Scanning The Keyboard

Perhaps the most critical task performed by the 6502 is the

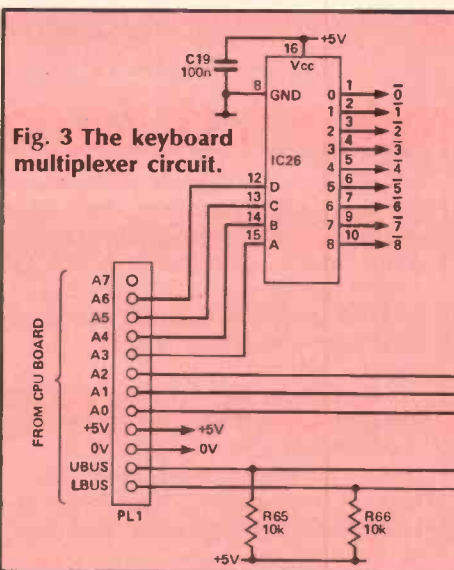

scanning of the keyboard. Each note on the keyboard can be in any one of three possible states — pressed, not pressed and in transition.

Detection of the transition state is required for velocity sensing and necessitates a two bus bar system as shown in the diagram of the keyboard mechanics in Fig. 4.

When a note is in neutral or unpressed state its contact spring touches the upper bar. Pressing a note causes the plunger to force the contact spring against the

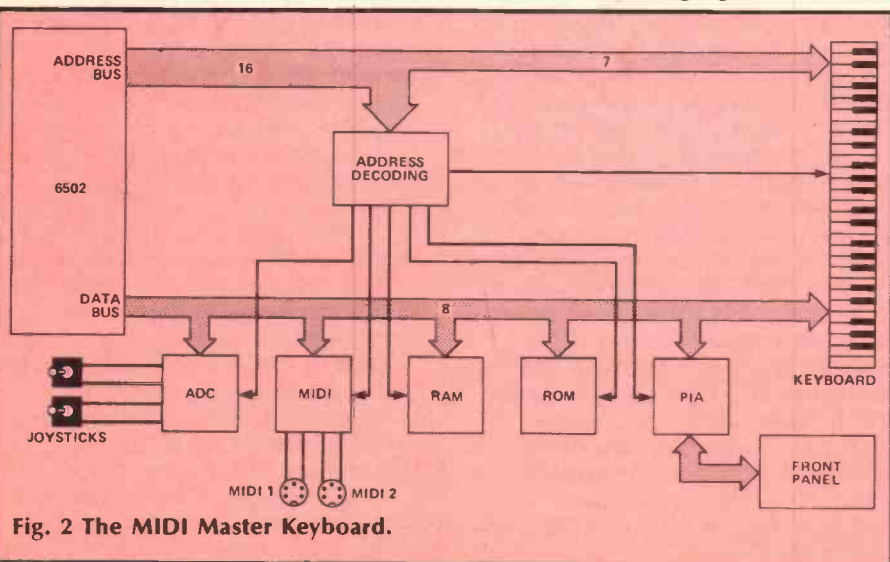
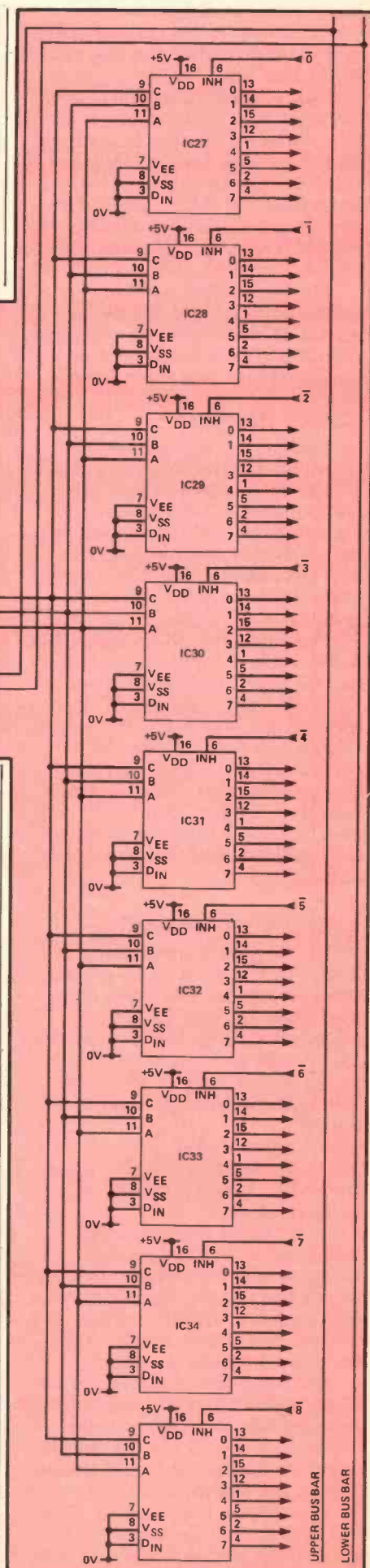

Fig. 2 The MIDI Master Keyboard.

lower bus bar. When in the transition state the contact spring is touching neither the upper nor lower bus bar.

The software examines each key at precise time intervals of 2ms. Velocity sensing is achieved by timing how long a key takes to transverse from the upper to lower bus bar when pressed by counting the number of discrete time intervals that the key spends in the transition state.

For the moment we will concentrate on the hardware aspect of the keyboard scanning with the construction of the keyboard and keyswitch PCBs.

### Construction

Some time and patience is required in assembling the MIDI Master Keyboard as there are a fair number of printed circuit boards to be tackled as well as the keyboard mechanical assembly (and cabinet construction, for those who want a professional finish).

The keyswitch PCBs should be made up and incorporated into the keyboard mechanics first. Thereafter the CPU board, the front panel board and the power supply can be assembled separately and wired into the keyboard unit to make up the complete system. The construction of the latter boards will be described in subsequent issues.

### Keyswitch Mounting

The keyboard mechanics comes in the form of 72 plastic notes which are mounted on a steel plate chassis. Each note pivots on a flange protrusion from the chassis and has a return spring at the back of the note, pulling it towards the chassis (Fig. 4).

A keyboard with square fronted notes may also be used, the choice being a matter of personal taste.

Attached to the underside of each note is a nylon plunger tab which, when the note is pressed causes the contact spring for that note to move from the upper bus bar and come into contact with the lower bus bar, as shown.

Start with the assembly of the three keyswitch PCBs. Although all three boards are identical the component layout for the middle board (called board B and shown in Fig. 5) is slightly different because of the inclusion of IC26 (the 74LS42 decoder) and the bus bar pull up resistors R65 and R66.

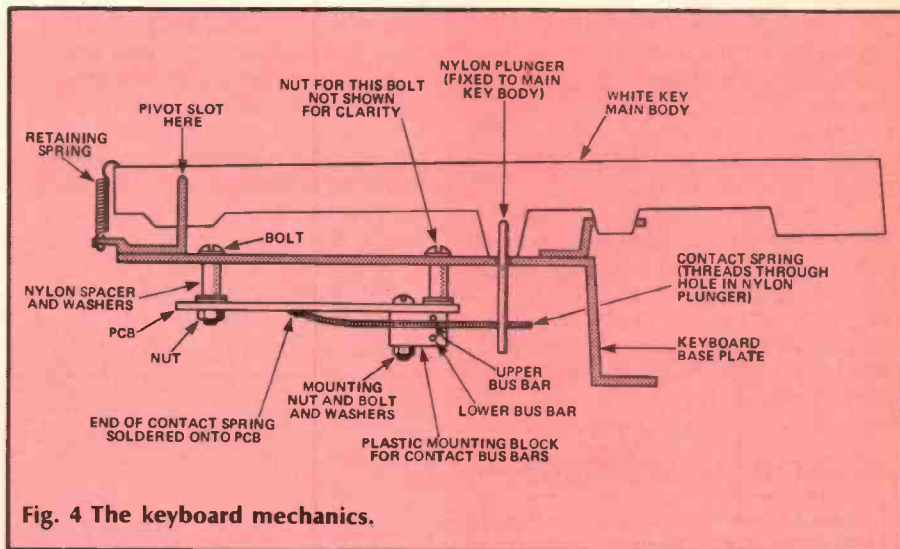

Fig. 4 The keyboard mechanics.

All the jump links should be kept identical on all boards (in fact some links on boards A and C are redundant because of the absence of IC26 and R65, R66, so the keep-them-the-same rule is for simplicity's sake).

It is important to note that the contact springs are *not* to be soldered in at this point. It is better to mount them after the boards have been bolted onto the chassis of the keyboard, in order to ensure best alignment.

A 12-way cable should be fitted to board B around IC26 and terminated with a female PCB multi-way connector. Cable length should be about 50 cm — long enough to reach the CPU board. The 12 way cable should be soldered directly to board B since there is no room for a multi-way connector when the board is mounted on the keyboard chassis (boards are mounted with component side facing the chassis with only about 8mm clearance).

After all the components and links have been mounted, the next task is to mount the upper and lower bus bars. These are gold plated contact rods which run parallel to each other along the whole length of the keyboard. Ready drilled plastic mounting blocks were used. These have two holes spaced a short distance apart in which the contact rods are mounted and a larger single hole for mounting onto the PCB.

Use eight mounting blocks and insert the rods through all of them and space them roughly equally apart. On board A drill holes marked by the letter A, use the B holes on board B and C on board C. Adjust the mounting blocks so they are positioned above these holes and use suitably sized bolts to fasten them to the boards.

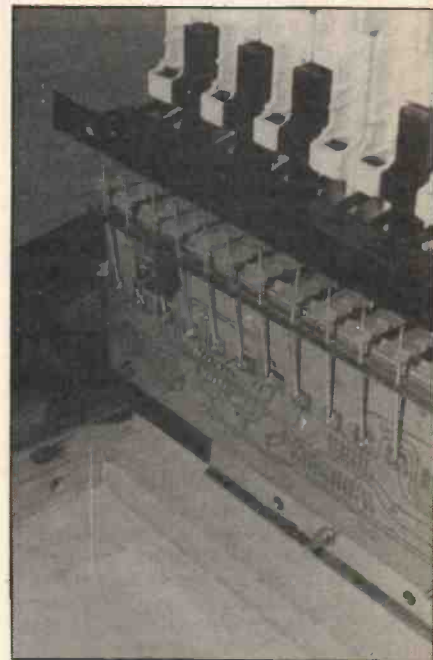

The prototype keyboard fully assembled and hinged up in its cabinet to reveal the PCB, contact springs and bus bars.

The three boards are now held together by the parallel bus bar assembly. At this stage, link the three PCB tracks which run parallel along the edge of the boards so that they continue throughout the span of the three boards. Also link the power rail terminations so that they span all three boards.

Wire the bus bars by soldering two wires from appropriate points on the bus bars to the take-off points on board B (lightly tin a small area on each bus bar before soldering the wires). Finally, wire the nine decoder outputs from IC26 to the appropriate terminals on the three PCBs as shown in the component overlay diagram.

Some keyboards are supplied already assembled and mounted on a steel chassis. Buyers of such

keyboards should skip the next section.

To mount the keyswitch PCB assembly, drill holes in the keyboard chassis and use a combination of nuts, bolts, washers and nylon spacers to firmly fix the three PCBs in place. The stand-off height of the PCBs is important since it effects the keyswitch action. In the prototype, the stand-off height was about 8mm (see Fig. 4 for details of assembly), but a different height may be required depending on the dimensions of the keyboard mechanics.

It is essential that the stand-off height should be such that when a contact spring is soldered onto the PCB pad and threaded through the lower hole in the nylon plunger (having passed between the bus bars) it is in contact with the upper bus bar with slight tension when the key is neutral and in contact with the lower bus bar when pressed. In order to achieve the optimum position, it may be necessary to fine adjust the height by adding or removing washers.

When mounting the boards onto the chassis some notes on the keyboard will have to be

## PARTS LIST KEYBOARD

### RESISTORS

R65,66                    10k

### CAPACITOR

C19                        100n

### SEMICONDUCTORS

IC26                        74LS42

IC27-35                    4051

### MISCELLANEOUS

PL1                        12 way female  
multiway PCB  
connector

PCBs (3 off); 72 note plastic keyboard;  
72 spring contacts; bus bars (2 off);  
12-way ribbon cable and female multiway  
connector; plastic mounting blocks for  
bus bars; metal keyboard base plates;  
spacers, nuts and bolts.

## BUYLINES

The keyboard mechanics are available from Clef Products, 44a Bramhall Lane South, Bramhall, Stockport, Cheshire, SK7 1AH. The prototype used a 73 note keyboard with the rightmost note as a dummy key.

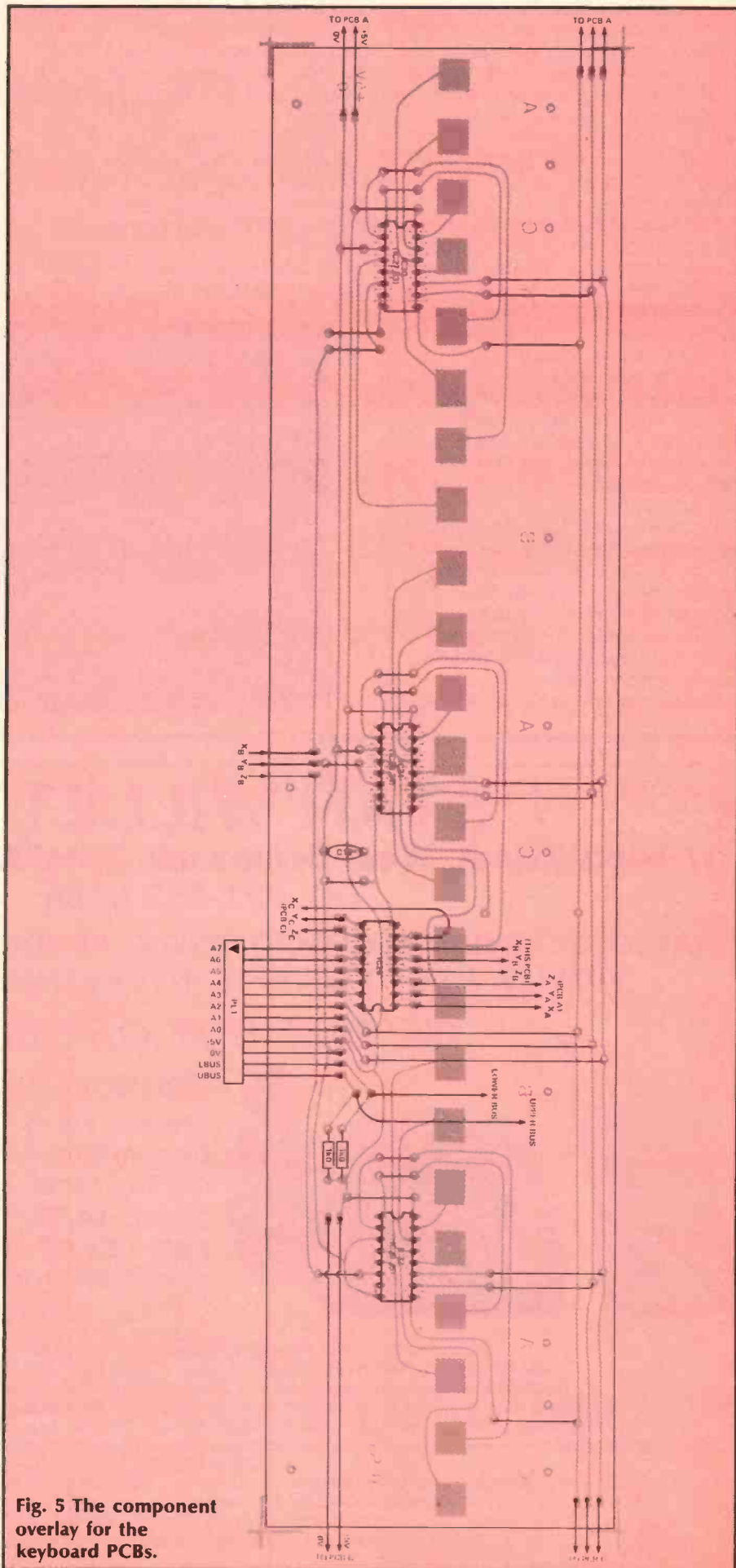

Fig. 5 The component overlay for the keyboard PCBs.

Project	Mth	Yr	Pg	Project	Mth	Yr	Pg		
<b>COMPUTING</b>									
16 channel A to D board	Dec	1983	19	EPROM emulator	part 1	Jul 1984	22		
64K DRAM board	Sep	1983	64	part 2	Aug	1984	50		
64K DRAM board, improved	Errata	Jan	1985	28	EPROM emulator for the 6802 evaluation board	Aug	1985	46	
6502 real-time clock/calendar	Dec	1984	31	EPROM eraser	May	1984	17		
6502 sound/DAC card	Apr	1983	31	EPROM board for the Oric/Atmos	Jun	1984	36		
6802/6809 single board controller	Errata	Aug	1983	70	Errata	May	1985	62	
6802 evaluation board	Mar	1983	48	EPROM board for the Spectrum (ETI SpectROM)	Sep	1985	40		
6802 evaluation board EPROM emulator	Mar	1985	35	EPROM programmer for the Triton	Jan	1980	42		
6809 single board computer	Errata	Mar	1986	60	EPROM programmer for the ZX81	May	1984	26	
	May	1985	27	Errata	Sep	1984	68		
	Aug	1985	46	part 1	Aug	1983	45		
	Dec	1985	27	part 2	Sep	1983	37		
	Jan	1986	36	Errata	Jan	1984	61		
	Feb	1986	31	Errata	Apr	1984	33		
	Mar	1986	47	EPROM programmer, universal, MKII	part 1	May	1985	35	
	Apr	1986	49	part 2	Jun	1985	43		
	Apr	1984	41	part 3	Jul	1985	48		
Ace colour board	Errata	May	1984	69	part 4	Aug	1985	51	
Ace keyboard/joystick interface	Nov	1983	20	ETIfaker (RS232 patch box)	Apr	1987	38		
ADC, ZX81/Spectrum, 8 ch, 8 bit	Jan	1983	61	EX42 keyboard interface	Sep	1984	23		
ASCII keyboard, System 68	Errata	Aug	1983	70	EX42 typewriter interface for the BBC	Aug	1985	41	
A to D board, 16 channel	Apr	1977	25	Experimenters' DRAM card, 64K	Dec	1984	31		
Atom keypad	Dec	1983	19	Fast light pen	Nov	1983	81		
Baud rate converter	Jun	1983	78	Filter amplifier, DAC/ADC	Nov	1983	59		
	May	1986	33	Joystick controller for 6502 micro-computers (Reader's Design)	Jun	1981	36		
	Errata	Mar	1987	63	Joystick interface for the Jupiter Ace	Nov	1983	20	
BBC Midi interface, two channel	Apr	1987	42	Joystick interface for the Sharp	Aug	1984	42		
BBC motor interface	Jul	1986	34	Errata	Sep	1984	68		
BBC typewriter interface	Aug	1985	41	Joystick interface for the Spectrum	Jun	1984	49		
Bongo box for the Commodore 64	Dec	1986	43	Errata	Aug	1984	66		
Cassette deck, digital	part 1	Sep	1984	27	Keyboard interface, EX42	Sep	1984	23	
	part 2	Oct	1984	28	Keyboard interface for the Jupiter Ace	Nov	1983	20	
Cassette interface	Oct	1980	63	Light pen, fast	Nov	1983	81		
	Errata	Dec	1980	13	Low-cost VDU, ETI 560	part 1	Aug	1976	56
Centronics interface for the Cortex	part 1	Jun	1984	65	part 2	Sep	1976	10	
	part 2	Aug	1984	23	part 3	Oct	1976	30	
Centronics interface for the Sharp MZ80K	May	1984	47	Errata	Nov	1976	8		
Centronics interface for the Spectrum	Dec	1984	57	Marvin (Z80 control computer)	part 1	Aug	1983	65	
	Errata	Oct	1985	58	part 2	Sep	1983	59	
Colour board for the Jupiter Ace	Apr	1984	41	part 3	Oct	1983	56		
	Errata	May	1984	69	Errata	Nov	1983	96	
Computer output driver	Jul	1983	28	Message panel	Oct	1982	53		
Control port for the Spectrum	part 1	Oct	1984	44	Message panel interface	Nov	1982	68	
	part 2	Nov	1984	29	Microbox II single-board computer	part 1	Dec	1985	27
	Errata	Jul	1985	27	part 2	Jan	1986	36	
Cortex 16-bit computer	part 1	Nov	1982	24	part 3	Feb	1986	31	
	part 2	Dec	1982	55	part 4	Mar	1986	47	
	part 3	Jan	1983	42	part 5	Apr	1986	49	
	Errata	Dec	1982	83	Microcomputer expansion system	part 1	Dec	1981	22
Cortex Centronics interface	part 1	Jun	1984	65	part 2	Jan	1982	58	
	part 2	Aug	1984	23	part 3	Feb	1982	76	
Cortex parallel I/O	Sep	1985	53	part 4	Apr	1982	26		
	Errata	Jun	1986	55	Microtan single board controller, 6802/6809	Mar	1985	35	
DAC/ADC filter amplifier	Nov	1983	59	Microtutor — machine code tutor	part 1	Aug	1982	50	
DEPROM (EPROM eraser)	May	1984	17	part 2	Sep	1982	72		
Digital cassette deck	part 1	Sep	1984	27	part 3	Oct	1982	46	
	part 2	Oct	1984	28	Errata	Apr	1983	11	
Digital control port for the Spectrum	part 1	Oct	1984	44	MIDI interface for the BBC, two channel	Apr	1987	42	
	part 2	Nov	1984	29	Mini-Mynah speech synthesiser board	Feb	1984	20	
	Errata	Jul	1985	27	Errata	May	1984	69	
DRAM board, 64K	Sep	1983	64	Motor interface for the BBC	Jul	1986	34		
	Errata	Jan	1985	28	Multiple output port	Nov	1983	52	
DRAM board, 64K, improved	Dec	1984	31	Music board, ZX81	part 1	Apr	1983	16	
DRAM board, Z80	Mar	1984	45	part 2	May	1983	54		
DRAM board Z80 upgrade	Feb	1984	29	Errata	Jun	1983	15		
Drum synthesiser for the Commodore 64 (Bongo Box)	Dec	1986	43	Numeric keypad for the Atom	Jun	1983	78		
Drum synthesiser for the Spectrum (SpecDrum)	Dec	1985	41	Oric/Atmos EPROM card	Jun	1984	36		
Electron second processor	part 1	Jun	1985	32	Errata	May	1985	62	
	part 2	Jul	1985	43	Output driver for computers	Jul	1983	28	
Electron speech board	Nov	1984	57	Output port, multiple	Nov	1983	52		
	Errata	Jul	1985	27	Parallel I/O for the Cortex	Sep	1985	53	
					Errata	Jun	1986	55	





Project	Mth	Yr	Pg	Project	Mth	Yr	Pg		
Spirit Level (reaction timer) (Short Circuit)		Oct	1977	28	Bike speedometer	Jun	1975	23	
Stars and Dots game		Jun	1978	17	Buzby Meter (telephone call meter)	Apr	1985	34	
	Errata	Jul	1978	7	Coin Collector (metal locator)	Jul	1973	20	
Superdice		Jul	1981	71	Compass, automatic	Jun	1983	20	
Survival game		Sep	1980	87	Data logger	Feb	1985	45	
Tank Battle TV game		May	1978	50	DC-DC Converter, 12V-55V, 2A	Apr	1986	19	
	Errata	Jun	1978	13	Desoldering made simple	Aug	1972	61	
Touch buzzer (Free PCB project)		Nov	1980	48	Digital barometer (ETI Digibaro)	part 1	Feb	1986	26
TV Chess Game	part 1	Oct	1978	48		part 2	Mar	1986	50
	part 2	Nov	1978	44		Errata	Oct	1986	63
TV games unit		May	1977	12	Digital display	Errata	Oct	1975	15
Wheel Of Fortune		Sep	1978	61		Errata	Nov	1975	77
					Digital display module		Jan	1979	35
					Digital panel meter		Aug	1986	41
					Doorbell, electronic (Free PCB project)		Oct	1982	29
					Doorbell, musical		Dec	1980	60
					Doorbell, two-tone (Short Circuit)		Feb	1977	50
					Drill speed controller		Feb	1975	46
					Drill speed controller		Mar	1977	56
					Drill speed controller		Sep	1980	69
					Dry cell charger		Sep	1984	53
					Earth leakage circuit breaker		Dec	1982	25
					Earth resistivity meter		Jul	1973	30
					Easy way to make PC boards		Oct	1973	66
					Electronic doorbell (free PCB project)		Oct	1982	29
	Errata	Aug	1980	11	ETIwet plant waterer		Aug	1978	61
Dimmer, push-button		Feb	1975	30	FM mains remote control		Oct	1981	56
Dimmer, stage		Mar	1979	50	Garden watering systems		Jun	1976	26
	Errata	Apr	1979	13	Gas monitor		Apr	1978	33
Dimmer, touch		May	1981	79	Geiger ratemeter and counter	part 1	Feb	1987	35
Disco lightshow controller		Dec	1978	44		part 2	Mar	1987	39
	Errata	Apr	1979	13			Oct	1974	24
Disco/party strobe (Finesse)		Oct	1984	52	Hear-and-tell unit				
Ecolight		Jul	1984	55	Helping hand (RNID competition winner)		May	1978	16
Emergency lighting unit		Oct	1972	41	Homes for ohms (resistor storage system)		Jan	1973	47
Finesse disco/party strobe		Oct	1984	52	Induction balance metal locator		Feb	1977	33
Finesse light chaser		Dec	1983	44	Induction balance metal locator		Feb	1978	32
Fluorescent light dimmer		Nov	1972	42	Induction loop, portable		Jul	1983	52
Fluorescent light inverter		Mar	1973	58	Infra-red remote control		May	1981	51
High power beacon		Aug	1976	30	Infra-red remote control, ETI IR60	part 1	May	1980	33
Hi-power strobe		Jun	1972	62		part 2	Jun	1980	73
Inverter for fluorescent lighting		Mar	1973	58	Intelligent call meter (telephone)	part 1	Aug	1986	36
Lampsaver		Dec	1983	69		part 2	Oct	1986	53
Light chaser (Finesse)		Dec	1983	44		part 3	Nov	1986	53
Light/heat controller (Free PCB project)		Oct	1982	25		part 4	Dec	1986	54
Light Wand		Mar	1982	73		Errata	Mar	1987	63
Multiswitch — multi-point light switching		Nov	1983	47	Intercom for noisy environments (Microlight Intercom)	Errata	May	1986	28
Porch light		Feb	1978	28			Mar	1987	63
Push button dimmer		Feb	1975	30	Intercom (Using the LM380)	Errata	Dec	1974	32
Sound/light unit (ETI Colour Organ)		Feb	1975	11			Jan	1975	70
Sound-to-light unit (Free PCB project)		Oct	1982	31	Kitchen scales, digital	part 1	Jul	1982	30
Spectracolumn		Dec	1982	65		part 2	Aug	1982	39
Stage dimmer		Mar	1979	50		Errata	Sep	1982	9
	Errata	Apr	1979	13	Knife Light		Nov	1984	69
Stage lighting unit	part 1	Jan	1983	22	Large-digit scoreboard		May	1985	43
	part 2	Feb	1983	34	Laser, low-cost		Mar	1974	34
	part 3	Apr	1983	42	LCD panel meter		Mar	1978	26
	part 4	May	1983	79	LED jewellery		Jun	1981	45
	Errata	Aug	1983	70	LED pendant		Nov	1977	41
Stage lighting interface for the Spectrum		Nov	1984	72	Light activated switch		Nov	1980	81
Strobe, high power		Jun	1972	62	Light activated switch module		Mar	1981	52
Sunrise light brightener		Oct	1985	48	Light operated switch (Autolum)		Nov	1974	28
Visual complex sound analyser		Apr	1981	21	Low battery warning		May	1975	48
					Mains-borne remote control	part 1	Apr	1984	53
						part 2	May	1984	37
							Sep	1986	42
					Mains conditioner				
					Mains failure alarm (ETI Vogonoff)		Nov	1984	66
					Mains seeker		Jun	1979	46
					Memo minder — slotted opto-switch (Free PCB project)		Mar	1986	33
					Message panel		Oct	1982	53
					Message panel interface		Nov	1982	68
					Metal locator		Jul	1973	20
					Metal locator		Mar	1980	78
						Errata	Apr	1980	9
						Errata	Jun	1980	11

## LIGHTING

## MISCELLANEOUS

# FROM JAYTEE

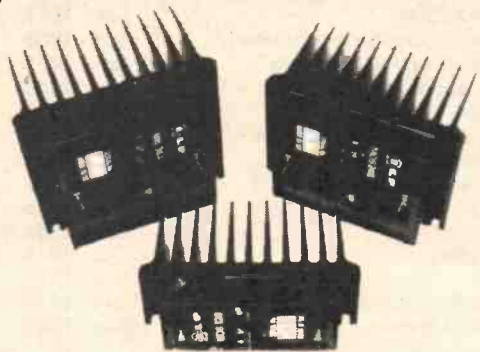

## THE SPECIAL DISTRIBUTOR FOR SPECIAL AMPLIFIERS

ILP have long been recognised as manufacturers of top quality amplifiers.

All ILP products are built to extremely high specification for the ultimate in hi-fi performance. They're unique in being completely encapsulated with integral heatsinks, and can bolt straight onto the chassis. They're also extremely robust, ensuring high levels of reliability as well as performance.

ILP Amplifiers are now available through Jaytee. The UK Distributor with the availability and service to match the quality of the amplifiers.

### POWER BOOSTER AMPLIFIERS

The C15 and C1515 are power booster amplifiers designed to increase the output of your existing car radio or cassette player to 15 watt rms.

C15.....	15 watts	£10.65
C1515.....	15 + 15 watts	£19.78

### ILP LOUDSPEAKER

power.....	350 watt rms
size.....	12 inches
impedance.....	8 ohms
range.....	20 Hz to 5 KHz

**NEW £78.61**

FOR FREE DATA PACK PLEASE  
WRITE TO OUR SALES DEPT.

## PREAMPLIFIER MODULES

All modules are supplied with in line connectors but require potentiometers, switches, etc. If used with our power amps they are powered from the appropriate Power Supply.

Type	Application	Functions	Price
HY6.....	Mono Pre-Amp	Full Hi Fi facilities.....	£8.95
HY66.....	Stereo Pre-Amp	Full Hi Fi facilities.....	£14.55
HY73.....	Guitar Pre-Amp	Two Guitars plus Microphone.....	£14.95
HY78.....	Stereo Pre-Amp	As HY66 less tone controls.....	£14.25

NEW! HY83 Guitar and Special Effects Pre-Amp as HY 73 Plus Overdrive and Reverb £18.95

MOUNTING BOARDS: For ease of construction we recommend the B6 for HY6 £0.95. B66 for HY66-83 £1.45.

## MOSFET MODULES

Type	Output Power Watts (rms)	Load Impedance $\Omega$	Price
MOS128	60	4.8	£35.95
MOS248	120	4.8	£42.25
MOS364	180	4	£67.45

## BIPOLAR MODULES

Ideal for Hi Fi. Full load protection integral Heatsink, slew rate 15v/ $\mu$ s

Type	Output Power Watts (rms)	Load Impedance $\Omega$	Price
HY30.....	15	4.8	£10.95
HY60.....	30	4.8	£10.95
HY6060.....	30 + 30	4.8	£22.95
HY124.....	60	4	£17.95
HY128.....	60	8	£17.95
HY244.....	120	4	£23.45
HY248.....	120	8	£23.45
HY364.....	180	4	£34.95
HY368.....	180	8	£36.45

Distortion less than 0.01%

## POWER SUPPLY UNIT

Type	For Use With	Price
PSU30.....	PRE AMP	£9.45
PSU412.....	1 or 2 HY30	£17.20
PSU412.....	1 or 2 HY60, 1 HY6060, 1 HY124	£19.35
PSU422.....	1 HY128	£21.35
PSU432.....	1 MOS128	£22.35
PSU512.....	2 HY128, 1 HY244	£23.70
PSU522.....	2 HY124	£23.70
PSU532.....	2 MOS128	£24.65
PSU542.....	1 HY248	£24.65
PSU552.....	1 MOS248	£26.65
PSU712.....	2 HY244	£26.35
PSU722.....	2 HY248	£29.30
PSU732.....	1 HY364	£29.30
PSU742.....	1 HY368	£31.25
PSU752.....	2 MOS248, MOS364	£31.25

All the above are for 240v operation



Jaytee Electronic Services, 143 Reculver Road, Beltinge, Herne Bay, Kent CT6 6PL Telephone: (0227) 375254

All Prices include VAT, Post & Packing

## LIGHTING!

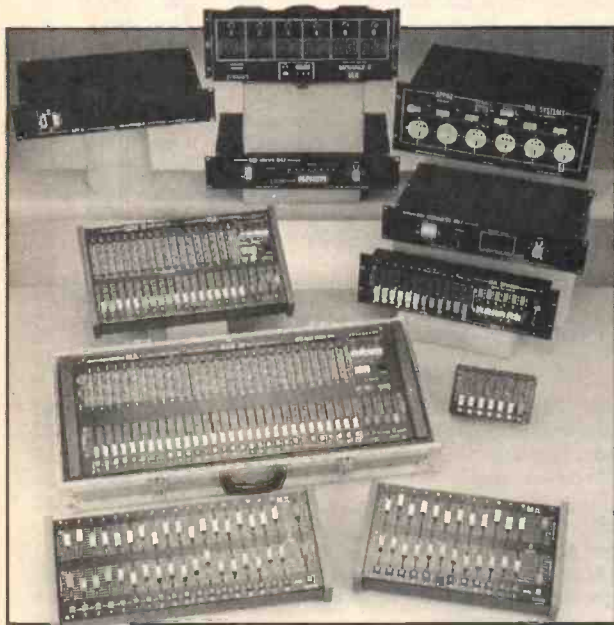

ITS GREAT NEWS AT MJL. WE CAN NOW SELL DIRECT TO THE PUBLIC IN THE UK AT TRADE PRICE — SO MR. TRADE CUSTOMER WHAT ARE YOU READING THIS FOR. ASK FOR YOUR FREE COLOUR BROCHURE AND SAVE YOURSELF A FORTUNE!

**MJL (INTERNATIONAL) LTD**  
**01/689/4138**

45 WORTLEY RD. W. CROYDON. SURREY CR0 3EB, UK

Design your own

**PCB**  
with the

## BBC COMPUTER

Lay out double sided PCB on the screen, separating the layers by colour. Store design on disc, recall for editing or plot it on an Epson HI-80. A-4 plotter ready for 2:1 photo reduction. 40 or 80 Trac disc based software £20.

**VINDEREN ASSOCIATES, PO BOX 130,  
BELFAST BT9 6NB. TEL: 0232 667885**

AA117

## BINDERS

FOR YOUR VALUABLE COLLECTION  
OF ELECTRONICS TODAY

INTERNATIONAL MAGAZINES

• SMART • EASY TO USE • TOP QUALITY

To ASP Readers Services, PO Box 35,  
Wolsey House, Wolsey Road, Hemel  
Hempstead, Herts HP2 4SS (0442-41221)

**£5.20**  
inc  
P&P

Please supply.....Electronics Today International  
Binders @ £5.20 inc. P&P

Total £ ..... (Please make cheques payable to ASP Ltd.)

Years Required — 198.....198.....198.....198.....

Name .....

Address .....

Please allow 21 days for delivery



# PROJECT: MIDI Keyboard

temporarily removed in order to access the other side of the steel chassis to tighten up the bolts.

Before finally tightening up the bolts make sure that the boards are positioned squarely so that the bus bar edge lies perfectly parallel to the row of nylon plungers in the keyboard mechanics.

The final stage in the keyswitch assembly is to mount the contact springs themselves. When handling the contact springs only pick them up by the bulbous end, otherwise sweat or dirt from your hands can easily impair the spring's conductivity.

Take each spring and tin the bulbous end very lightly with solder. Act very quickly when doing this to avoid flux creeping along the length of the spring and making it stiff.

Tin the copper pad on the PCB and position the spring, by passing it between the bus bars and threading it through the nylon plunger. Find the best position to solder the spring within the copper pad by testing the key action. When the optimum position is found a mere

touch with the soldering iron will be all that is necessary to fix the contact spring into place. Check that the spring is squarely in position and that the key action is correct.

Repeat the procedure for the rest of the springs until all 72 notes are completed. When complete, check the overall keyboard action for correct operation.

It may be necessary to lightly clamp each nylon plunger so that

the contact springs cannot slip out via the side slot as a result of frantic keyboard playing. If this is to be done, use a light set of pliers and be careful not to let the tool slip and damage the springs.

That completes the construction of the keyboard itself. Next month we shall look at the construction of the main PCB which holds the CPU and the other major sections of the MIDI Master Keyboard. **ETI**



## STAN WILLETTS

37 High Street, West Bromwich, West Midlands B70 6PB  
Tel: 021-553 0186

RADIO, TELEVISION COMPONENTS, AERIALS, TVs, AMPLIFIERS,  
VIDEOS, MULTITESTERS, INTERCOMS, FM WIRELESS

*WE WILL BUY OR SELL*

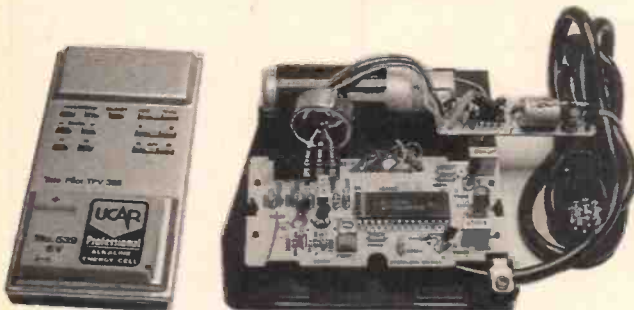

GRUNDIG infra-red remote control system VIF-K1, consist remote control transmitter TPV 355 and the remote control receiver VIF-E1 brand new and boxed **£4.99** P&P £2. VIF-E1 receiver only **£2.00** P&P £1.50. TPV 355 transmitter only **£3.00** P&P £1. VIF-E1 10 for **£10** P&P £4.

**GRUNDIG 2x4 Super Stereo Video Recorder** working **£79** (callers only)

**GRUNDIG** cable Remote Control 440 8 meter 10 core cable new boxed **£3.75** P&P £2.

**GRUNDIG** monitor video camera lead (7 metre) 8 pi plug & socket new boxed **£3** P&P £1.

**GRUNDIG** Television lead 4½ meter with cigar lighter plug brand new 8000 for sale offers sample **£2**.

**PYE 21VR20** (V2000) video tuner timer & charger 15 + ext (SCART) brand new boxed **£29.95** P&P £4.

**DATA RECORDERA** for use with Commodore Computers Vic 20 & VIC 64 manufacturers returns perfect working order guaranteed **£12.95** P&P £2.

**GRUNDIG CFB 1900** camera remote control 7 meters brand new boxed **£3** P&P £1.

**V2000 VIDEO FILMS** (pre-recorded) ex rental **£3** each P&P £1.

**V2000 VIDEO TAPES** (blank) VCC240 **£5.95**.

VCC360 **£6.95**, VCC480 **£7.95** all brand new Memorex, Post £1.

# HI-FI POWER METER

Paul Chappell develops a power meter that not only serves your hi-fi but is in itself hi-fi as well.

When faced with the task of designing a power meter for audio amplifiers, the variety of different approaches that can be taken is almost overwhelming.

If the load to the amplifier is known, the power can be derived from the voltage alone. The very simplest method is to assume that the load is a pure resistance, to rectify the output voltage and apply it to a single quadrant

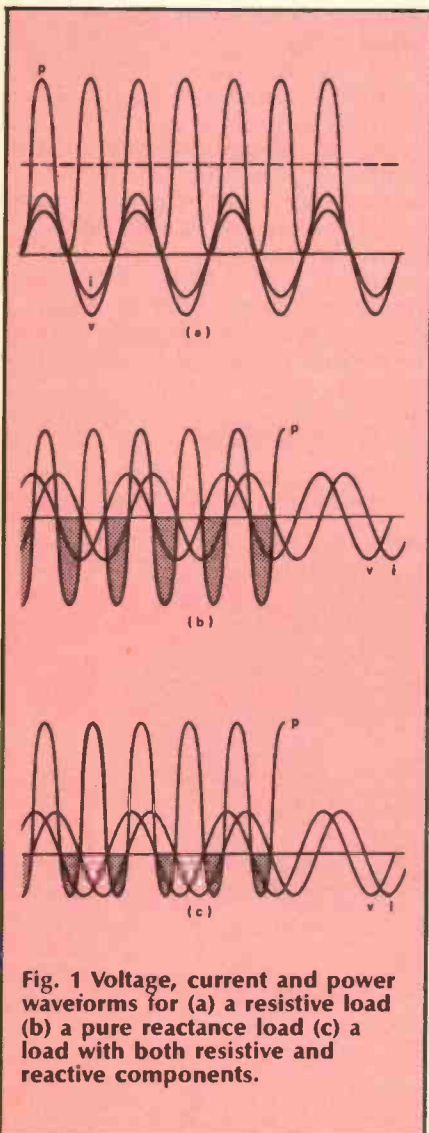

Fig. 1 Voltage, current and power waveforms for (a) a resistive load (b) a pure reactance load (c) a load with both resistive and reactive components.

square-law circuit, (since power is proportional to the square of the voltage for a given resistive load) and then to smooth the output and use it to drive a meter.

If the meter movement is sensitive enough, the entire circuit can be made from passive components and will divert very little power from the loudspeakers.

This approach relies for its accuracy on two factors. First of all it assumes the loudspeaker impedance is close enough to a pure, fixed resistance for the assumption to be valid. The second assumption is that a reasonably accurate square-law circuit can be made. In practise, reasonable results can be achieved, and this type of design has the advantages of being simple, cheap and reliable. A practical circuit along these lines will be given later on.

This is all very well for PAs, music centres and the like but for top flight hi-fi or for accurate power monitoring, something considerably better is called for. If the current is measured as well as the voltage, there is no need to make any assumptions about the loudspeakers. The circuit can take into account the characteristics of the load. But how?

What do we do with the current and voltage signals when we've got them? Multiply them? Find the RMS values and multiply? Find the average and multiply? It depends on exactly what we're trying to measure — which is not as silly a question as it sounds.

## Power To The People

For a resistive load there's no doubt about what we want to measure. However, for a load with a reactive component the case is not so clear cut. Figure 1a shows the voltage, current and instantaneous power waveforms for a resistive load with a sinusoidal voltage applied. The

power ( $p$ ) varies from a peak when  $v$  and  $i$  are both at peak positive or negative values, down to zero when  $v$  and  $i$  are both zero. However, it is always positive.

The average power delivered to the load is shown by the dotted line. This is the mean value of the instantaneous power curve. It can be calculated by taking the product of the instantaneous current and voltage over a whole number of half cycles and averaging the result, or by multiplying together the RMS voltage and current, or from the mean squared value of the voltage divided by the load resistance, and so on. All these methods give exactly the same result.

Figure 1b shows the situation where the load is a pure reactance — it can be a capacitor or inductor depending on which of the waveforms you take to represent  $v$  and which to be  $i$ .

In either case the instantaneous power varies symmetrically about zero. On the positive parts of the curve, energy is being stored by the load. On the negative parts it's being returned to the source. The load does not dissipate any energy and the mean value of the power curve is zero.

However, if we multiply the RMS voltage and current in this case we get exactly the same result as for the resistive load. One way of calculating power gives the answer zero, another gives a positive value. Which is correct?

The answer is that it depends on exactly what you are trying to measure. If you want to know the average power delivered to the load (the 'real' power, measured in watts) the answer is zero.

On the other hand, suppose you were to connect a capacitor directly across a mains transformer. The current flow in the windings would have just the same heating effect as for a

resistive load. There is a limit to the size of capacitor you can connect directly across a transformer before it burns out! Clearly the 'real' power is not the whole story.

The effect on the transformer is measured by the product of RMS voltage and current. It is called the 'apparent' power and is measured in volt-amperes (VA) — a unit you'll no doubt have come across in transformer specifications.

Figure 1c shows the more general situation where the load has resistive *and* reactive components, as in the case of a hi-fi loudspeaker. Here, the power situation is even worse — we can distinguish three different kinds!

The product of RMS voltage and current still gives the apparent power (VA), the mean of the power waveform will give the real power (watts). Now, the difference between the two gives yet another power reading — the 'reactive' power, measured in 'volt-amperes reactive' (VAR).

The apparent power, then, is made up of two components: the real power delivered to the load and the reactive power which shunts backwards and forwards between load and source. So — what should a power meter measure?

### The Old Bill

If we asked the electricity board, we'd get an answer without hesitation — apparent power is

### HOW IT WORKS

D1 to D4 form a bridge rectifier which provides drive of a suitable polarity for the meter. The presence of the diodes gives a degree of non-linearity to the current to voltage relationship and with a little imagination we can pretend it's something like a square law relationship.

To make the best of the diode characteristics, the more sensitive the meter movement the better. If you choose a more sensitive type, you should reduce the value of R4 and leave all other component values the same.

The network of resistors around SW1 and SW2 simply pad the voltage divided to cope with different input ranges. The arrangement looks unnecessarily complicated but was devised to avoid the need for a double gang switch in each channel. With the arrangement shown, two DPDT switches can be used for the stereo version. Since the pot settings are not entirely independent, it's important to calibrate the meter in the order described in the text — RV1 first, RV2 next, and so on.

D5 gives protection to the meter movement against the overload.

the one to go for! It's bigger than either of the other two and the choice can be justified by saying that even if the energy transferred from the generators to the customer's load is less than the meter reading, the 'extra' power shunted back and forth means that heavier gauge wires and bulkier transformers are needed.

The electricity board does indeed charge for apparent power!

As a slight digression, factories are perfectly well aware that they can be charged for energy they haven't used and go to great lengths to apply power factor correction to their supplies.

The most common cause of trouble is large electric motors which have a high inductive component and the solution is to connect a whopping great capacitor across the mains — just like an amplifier's Zobel network but on a much, much larger scale.



As the budget power meter requires no external power supply it can be fitted directly into a loudspeaker cabinet for that 'hi-tech hi-fi' look.

The result is that the factory appears more like a pure resistance to the power supply and the reactive power circulates between the capacitor and the motors.

Unlikely as it sounds, this measure will often give a considerable reduction in the electricity bills!

I should point out that the capacitors used are not the type you buy from your corner shop. They have to withstand continuous mains voltage and huge currents and are therefore very costly and bulky. For household supplies it just isn't worth the time and effort. Also, since different gadgets are being turned on and off at various times, there's no sensible way to compensate for them, so please don't try it.

To return to the hi-fi power meter, the most sensible thing to measure seems to be the power that is actually used by your

loudspeakers — the real power. It may not be quite so flattering to your amplifier as apparent power but it's a realistic indication of the power used by the loudspeakers. How much of this actually gets converted to sound rather than heat is a matter between you and your hi-fi supplier!

If you've already read this month's Circuit Theory article then alarm bells should have been sounding for quite a while now. I've slipped into the usual habit of illustrating the principles of power by means of sine waves and there is no reason to suppose that all this applies to any other waveform.

As it happens, some of the discussion applies (in the form I've presented it) only to sine waves. However, the method for calculating real power applies to any old waveform, and this is:

The voltage and current signals are continuously multiplied to give the instantaneous power, then the resulting power waveform is average over a number of cycles to give the mean power.

A four quadrant multiplier is needed because the areas below zero on the power waveform represent energy returned to the amplifier to be dissipated in the output transistors. This must be subtracted from the area above zero which represents the total energy supplied (some of which is returned). This will all be taken care of by a four quadrant multiplier and suitable averaging circuit.

### Acceptability

Having decided what we want to measure and how to go about

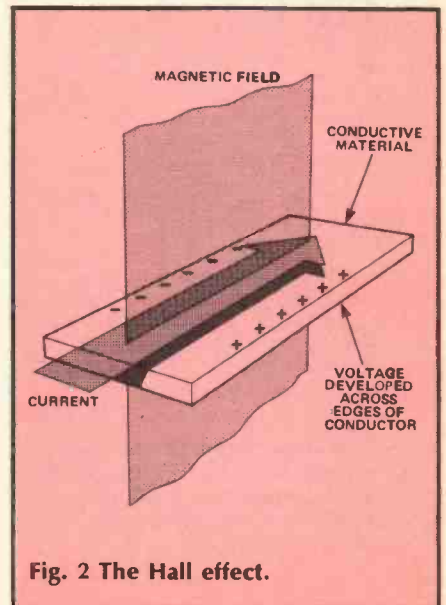

Fig. 2 The Hall effect.

it, the next question is acceptability. What will hi-fi enthusiasts feel happy to connect to their amplifiers? Not being hi-fi manufacturers, ETI can't be black-mailed into catering for the whims of the more over-enthusiastic of hi-fi buffs. I have made no attempt to align the grain of the wire with the Glastonbury lay-line or whatever is the current 'essential'. My modest aim has been to produce a circuit which will introduce no distortion whatsoever into top-flight hi-fi equipment. Anybody who will be happy with this approach should be more than satisfied with the circuit.

Tapping a voltage reading from the amplifier output presents no particular problem. The main question is how to derive a suitable current signal. Introducing a resistor into one of the speaker leads is the usual solution (see the power meter in ETI, March 1984 for example). However, although the disturbance caused by a 0.1 ohm resistor would be negligible in all but the very finest equipment, a better approach should be sought if possible.

My first thought on the subject was to use a Hall effect device to measure the current. If you are not familiar with the Hall effect, Fig 2 shows the general idea. The rectangle is a strip of some kind of conductive material. A magnetic field at right angles to the strip will produce a voltage at the edges, the polarity of which can be determined by somebody or other's left boot rule!

The effect is exhibited by any conductor whatsoever, even the tracks on a PCB but is generally so small as to be unmeasurable. (Nevertheless, hi-fi over-enthusiasts can hear it and will always align their amplifiers parallel to the earth's magnetic field).

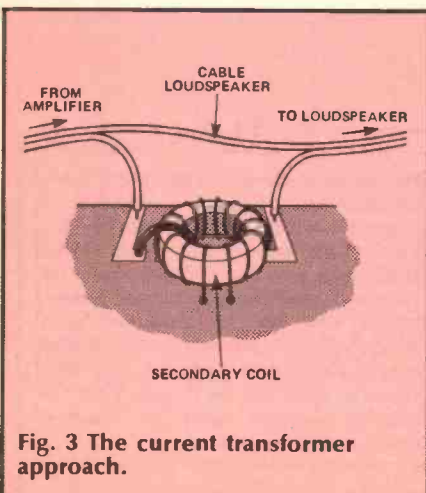

Some semiconductor materials produce relatively high voltages for fairly modest flux densities and can be obtained in IC form, often with internal amplifiers (for example: stock number 304-267 from Electromail).

One of the loudspeaker leads running alongside such an IC would have been the ideal way to derive a current signal without disturbing the audio signal. Unfortunately, the devices I tried were all far too noisy and insensitive to obtain a clean signal, so it was back to the drawing board.

## The Long And Winding Road

The solution that eventually produced excellent results was a current transformer (Fig. 3). One of the speaker leads is broken and forms a half turn around a suitable toroid via a single hoop of wire. The secondary coil is wound around the toroid giving a step-down in current of about 200:1.

For best performance (and to avoid reflecting the slightest suspicion of anything unwanted back into the primary circuit) the transformer must be terminated

with a very small resistance — a fraction of an ohm if possible. Since high performance current buffers don't exist in IC form, this approach leads to some interesting problems, about which there will be more next month. For this month, I'll finish with the circuit for the simple, low-cost power meter.

## Budget Power Meter

The circuit of the budget power meter is shown in Fig. 4. It depends entirely on the voltage for the readings, and draws a small current from the amplifier output to drive the meter. The rectifiers are used to produce an approximation to a square law, and also to rectify the signal for the meter. Two different speaker impedances can be selected by SW1 and two different power ranges (0-10W and 0-100W) by SW2.

The component overlay for the project is shown in Fig. 5. There is so little on the PCB that it should be almost impossible to make a mistake! If you use the specified meters, the PCBs can be mounted on the back. Otherwise, they can be fixed to the case by means of the screw holes.

The meters we used can be

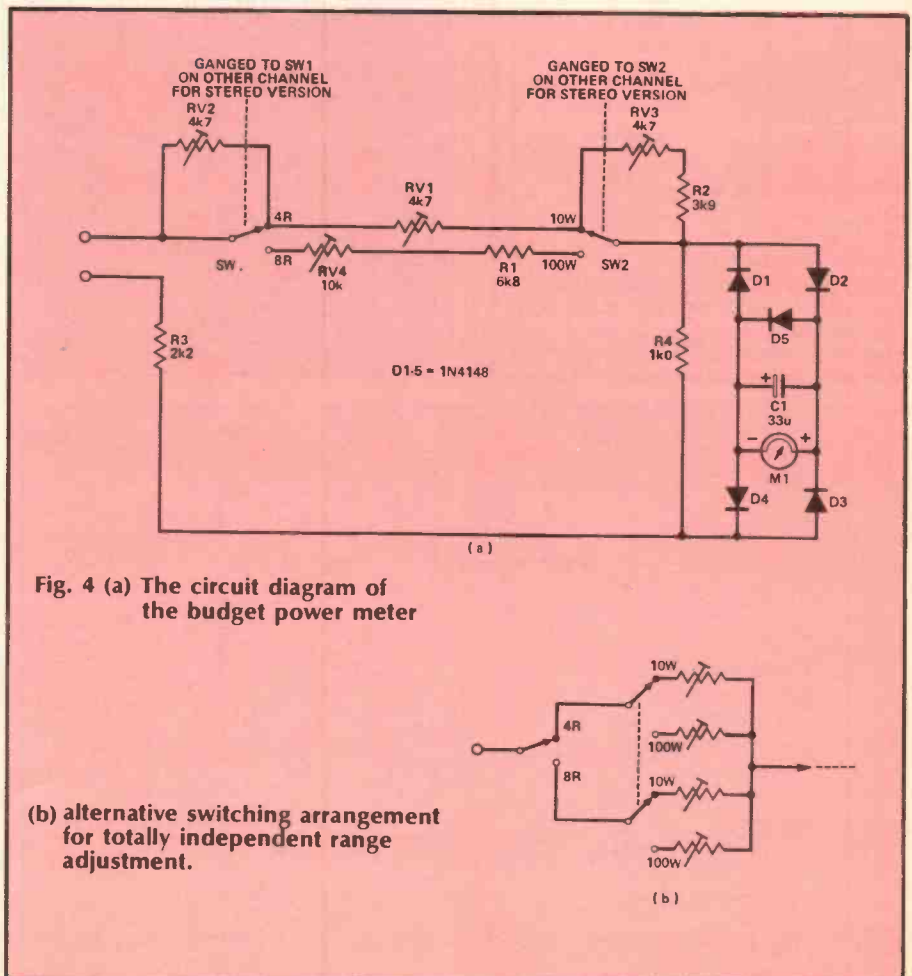
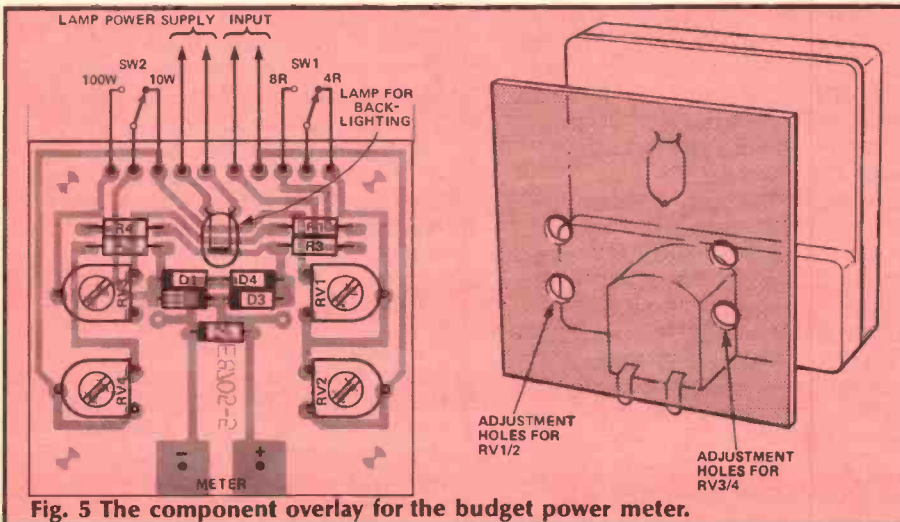

Fig. 4 (a) The circuit diagram of the budget power meter

(b) alternative switching arrangement for totally independent range adjustment.

# PROJECT: Power Meter



## Calibration

You will need a sine wave generator and a multimeter. If you haven't got a signal generator, the circuit of Fig. 6 will do the trick. If you haven't got a multimeter, go out and buy one! (How on earth do you manage to test your circuits without it?).

Disconnect the speakers from your amplifier and connect a 1k0 resistor across the output of one channel instead. Feed the sine wave into a suitable input on your amplifier (the AUX input will probably be best) and connect the power meter across the 1k0 resistor. Connect your multimeter on AC volts range across the resistor too.

Set the power meter switches to 4 ohms, 10 Watts and then adjust the volume control of your amplifier until the meter reads 6.3V. Adjust RV1 until the power meter reads 10W exactly.

Set the power meter to 8 ohms, and adjust the amplifier volume control until the meter reads 8.9V. Adjust RV2 until the meter reads 10W.

For 4 ohms, 100W, set the multimeter to 20V and the power meter to a scale reading of 10 (which represents 100W on this range).

For 8 ohms, 100W, set the multimeter to 28.3V and the power meter to a reading of 10 (which once again represents 100W).

This completes the calibration. There is, of course, no reason why you shouldn't expand the number of ranges and speaker impedances to suit your own purpose, although the PCB only allows for two of each.

Next month I shall investigate the really *hi-fi* power meter which operates without disturbing the audio signal and gives true and accurate power readings.

ETI

back-lit, but this means giving the meter a power supply it would not otherwise need, so it's up to you whether or not you think it worthwhile. Incandescent bulbs will give better results than LEDs. You can probably get away with using a small transformer driving a few bulbs in series.

## PARTS LIST

### RESISTORS

R1	6k8
R2	3k9
R3	2k2
R4	1k0
RV1,2,3	4k7
RV4	10k

### CAPACITORS

C1	33uF 16V elect.
----	-----------------

### SEMICONDUCTORS

D1-5	1N4148
------	--------

### MISCELLANEOUS

PCB; meter movement; optional components for back lighting: bulbs and suitable mains transformer; Case.

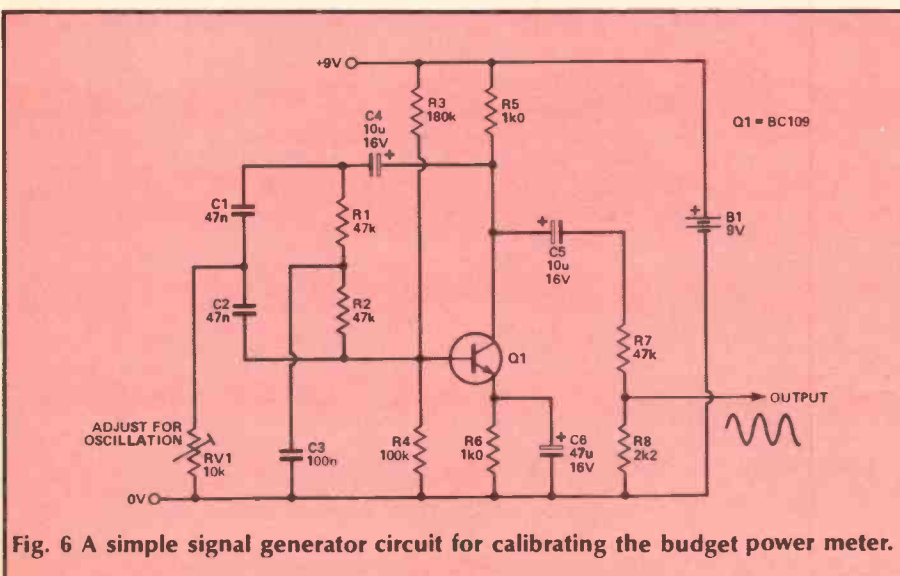

## BUYLINES

The meter movement can be any fairly sensitive current meter, scaled 0-10. A range of low cost meters is stocked by: Cirkit, Park Lane, Broxbourne, Herts. Their stock number 37-00520 would be suitable. A meter with the legend 'power' scaled 0-10 can be obtained from Specialist Semiconductors, who will also supply a complete parts set. See their advert in this issue for details. The PCB will be available from our Readers Services in due course.



# Complete Parts Sets for ETI Projects

## MAINS CONDITIONER

FEATURED IN ETI, SEPTEMBER 1986

It is astonishing how many people buy or build top-flight hi-fi equipment, and then connect it to a noisy, spiky mains supply. Rather like buying a Ferrari and trying to run it on paraffin, you might think, Expecting crystal clear sound, the poor music enthusiast ends up with a muddy, confused mush, and feels that he has somehow been cheated. Is this hi-fi? My music centre sounded just as good!

The domestic mains supply is riddled with RF interference, noise, transient spikes, and goodness knows what else. Computers crash, radios pop and crackle, tape recordings are spoiled and hi-fi sounds 'not quite right'. Why put up with it when the solution is so simple? The ETI mains conditioner is the lowest cost upgrade you will ever buy, and probably the most effective!

Our approved parts set consists of PCB, all components, toroid, enamelled wire, fixing ties, fast response VDR's, and full instructions.

ETI MAINS CONDITIONER/PARTS SET ONLY £4.60!

\*Note: the toroid and VDR supplied are superior to the types specified in the article

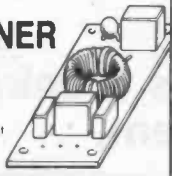

## CREDIT CARD CASINO

FEATURED IN ETI, MARCH 1987

This wicked little pocket gambling machine measures only 3" x 2" x 1/2". It will play all kinds of casino games, including:

- Roulette
- Craps
- Pontoon

Our approved parts set comes complete with case; self-adhesive fascia; tinned and drilled printed circuit board; all components; hardware; full instructions and three different games to play!

CASINO PARTS SET ONLY £5.90!

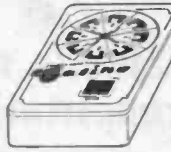

## MAINS CONTROLLER

FEATURED IN ETI, JANUARY 1987

Have you ever wondered what people do with all those computer interfaces? Put your computer in control, say the ads. The Spectra-bee has eight TTL outputs. What on earth can you control with a TTL output? A torch bulb?

The ETI Mains Controller is a logic to mains interface which allows you to control loads of up to 500W from your computer or logic circuits. An opto-coupler gives isolation of at least 2,500V, so the controller can be connected to experimental circuits, computers and control projects in complete safety. Follow your computer interface with a mains controller and you're really in business with automatic control!

The mains controller connects directly to most TTL families without external components, and can be driven by CMOS with the addition of a transistor and two resistors (supplied). Your mains controller parts set contains: high quality roller tinned PCB; MOC3021 opto-coupler; power triac with heatsink; mounting hardware and heatsink compound; all components, including snubber components for switching inductive loads; transistor and resistors for CMOS interface; full instructions.

MAINS CONTROLLER PARTS SET £6.20

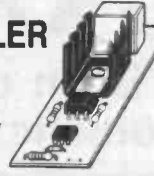

## POWERFUL AIR IONISER

FEATURED IN ETI, JULY 1986

Ions have been described as vitamins of the air by the health magazines, and have been credited with everything from curing hay fever and asthma to improving concentration and putting an end to insomnia. Although some of the claims may be exaggerated, there is no doubt that ionised air is much cleaner and purer, and seems much more invigorating than 'dead air'.

The DIRECT ION ioniser caused a great deal of excitement when it appeared as a constructional project in ETI. At last, an ioniser that was comparable with (better than?) commercial products, was reliable, good to build... and fun! Apart from the serious applications, some of the suggested experiments were outrageous!

We can supply a matched set of parts, fully approved by the designer, to build this unique project. The set includes a roller tinned printed circuit board, 66 components, case, mains lead, and even the parts for the tester. According to one customer, the set costs about a third of the price of the individual components. What more can we say?

Instructions are Included DIRECT ION PARTS SET £9.50



## MATCH BOX AMPLIFIERS

20W Single IC parts set £6.50

50W Bridge Amplifier parts set £8.90

L165V Power Amplifier IC, with data, £3.90

## LM2917 EXPERIMENTER SET

Consists of LM2917 IC, special printed circuit board and detailed instructions with data and circuits for eight different projects to build. Can be used to experiment with the circuits in the 'Next Great Little IC' feature (ETI, December 1986).

LM2917 Experimenter Set £5.80

## RUGGED PLASTIC CASE,

suitable for mains conditioner and mains controller. ONLY £1.65



## SPECIAL OFFER

Our best selling ioniser kit is now available with an elegant white case.

WHITE IONISER PARTS SET ONLY £9.80!

Orders should be sent to Specialist Semiconductors at the address below including 60p towards postage and packing. Please allow up to 14 days for delivery. There is no telephone service at the moment, but all letters or requests for lists will be answered (at top speed if you send SAE!)

# Specialist SEMICONDUCTORS

FOUNDERS HOUSE REDBROOK MONMOUTH GWENT



## CCTV CAMERAS FROM ONLY £69.50 EACH! PLUS CARRIAGE & VAT

We are now able to offer CCTV cameras, from as little as £69.50 + VAT and carriage.

These cameras have been refurbished to a high standard in our own workshop and come with a standard lens and a 3 month guarantee.

They produce a standard composite output of 1volt pp and will work with any video recorder having the video input sockets, digitiser, monitor or with a domestic TV with the addition of a modulator which is available separately. These cameras are powered from the standard 240v AC mains supply. This model employs a vidicon rack and will allow focusing from infinity down to an inch or two.

The standard lens supplied is a 1:1.6f = 16mm non iris TV lens. The lens boss is the standard c mount (1" diameter by 32 thread per inch) and will thus allow a very wide range of camera lenses to be accommodated.

The sensitivity of the cameras is in the order of 110 lx which allows their use in the domestic environment. Pictures can be produced with as little light as 2.5lux but with a lower signal to noise ratio. Low light versions of this camera are available giving sensitivities of 0.1lux which is equivalent to half moonlight. Typical cost is approx. £350. + VAT and carriage.

Many alternative lenses are available from stock please ask for details. Mounting of these cameras is by standard tripod bush, (1/4" Whitworth Thread). Many of these cameras are available from stock but reconditioned and new, i.e. Brand new mini 12 volt camera at only £80. + (VAT & carriage) lens etc.

We are also able to offer servicing facilities for any make of camera/monitor. We also supply camera and monitor tubes for a wide range of models, as well as scanning yokes for a wide range of cameras.

Currently on offer is a professional drive board and tube to make a superb 12" professional green panelled tube monitor at £34.50. This would normally cost well over £200. Buy 10 of them and they will only cost you £24.50 each incl. Be sure to ask us to quote for any of your camera/monitor requirements, we will never be beaten on price.

MOST MAJOR CREDIT CARDS ACCEPTED

**CROFTON ELECTRONICS** ☎ 05448 557  
'KINGSHILL', NEXTEND, LYONSHALL, HEREFORDSHIRE HR5 3HZ

### OSCILLOSCOPES

TELEQUIPMENT D75 Dual Trace 50MHz Delay Sweep	£325
CDSSOR CDU150, Dual Trace 35MHz Solid State Portable 8x10cm display, With Manual	£200
S.E. LABS SM111, Dual Trace 18MHz Solid State Portable AC or External DC operation 8x10cm display, With Manual	£165
TELEQUIPMENT D61 Dual Trace 10MHz, With Manual	£150
TELEQUIPMENT D43, Dual Trace 15MHz, With Manual	£100
SOLARTRON CD1400 Dual Trace 15MHz, With Manual	£100
TELEQUIPMENT SS4A, Single Trace 10MHz, Solid State, With Manual	£110
PHILLIPS PM3200 Single Trace 10MHz	£80

### MULTIMETERS

AVO 9 Mk 4 (Identical to AVO 8 Mk 4 but scaled differently) Complete with Batteries & Leads	£55
AVO 8 Mk 2 Complete with Batteries & Leads	£45
Above items in GOOD WORKING ORDER - appearance not A1 hence the price	
AVO TEST SET No 1 (Military version of AVO 8) Complete with batteries, leads & Carrying Case	£65
AVO Model 7x, Complete with batteries, leads & carrying case	£40
AVO Model 72 Pocket Multimeter (Analogue) 30 ranges, With Batteries & Leads	£10
ANALOGUE POCKET MULTIMETERS, Phillips/Taylor etc. With Batteries & Leads	from £10

### ADVANCE/GOULD DVMS

Auto ranging; max reading 20,000 AC/DC volts - resistance only £50 p&p £5

### AVO TRANSISTOR TESTER TT169

Handled, GO/NO GO for in-situ Testing, With batteries, leads & instructions (p&p £3) NOW ONLY £12

### ISOLATING TRANSFORMERS

240V INPUT - 240V OUTPUT	
500 VA £15ea P&P £5	100 VA £6ea P&P £2
240V Input 24V500VA output £6 p&p £5	
240V Input 24V200VA output £4 p&p £4	

DISK DRIVE PSU, 240V IN, 5V 1.6A & 12V 1.5A out. Size: W125mm, H75mm, D180mm. Casd. Un-used. Only £10.00 each (P&P £2)

Qwerty keyboard (as in Lynx Micro). Push to make. Casd. £5 each (P&P £2)

Various 5 1/4" Floppy Disk Drives and Stepping Motors Available.

Used equipment - with 30 days guarantee. Manuals supplied if possible.

This is a VERY SMALL SAMPLE OF STOCK. SAE or Telephone for Lists. Please check availability before ordering. CARRIAGE all units £16. VAT to be added to Total of Goods & Carriage.

**STEWART OF READING**  
110 WYKEHAM ROAD, READING, BERKS RG6 1PL  
Telephone: 0734 68041 Callers welcome 9 am - 5.30 pm Mon.-Fri. (until 8 pm Thurs.)

### COMMUNICATION RECEIVERS

Racal RA17L 500kHz-30MHz	ONLY £140 each with manual
Eddystone 730/4 480kHz-30MHz	only £110 each with manual

### SPECIAL OFFERS

B + K Precision CRT Restorer/Analyser Model 467 - Supplied with 2 bases and Manual. (P&P £7) ONLY	£125 each
LABGEAR Colour Bar Generator KG1, 8 Test Patterns. (P&P £4)	ONLY £40 each

### STEPPING MOTORS

Type 1	200 Steps per rev. 4 Phase (5 wire) 12 24V Torque 25oz Inch will run on 5V with reduced torque	£15.00
Type 2	6/12 Steps per rev. 3 Phase. 12/24V (will work on 5V)	£2 as 5 off £7.50
Type 3	NORTH AMERICAN PHILIPS 24 Steps per rev. 4 wire 5V 3.3Amps @ 250rpm	£6.00
Type 4	200 steps per rev. 120V (3 wire) Torque 25oz inch	£4.00
Type 7	WARNER 24 Steps per rev. 3 Phase (6 wire)	£5.00

ADVANCE AM SIGNAL GENERATOR Type 62, 150KHz-220MHz	£30
RACAL 32MHz UNIVERSAL COUNTER TIMER Type 836	£50
MARCONI TF2604 (Later version of TF 1041 VTM) 20Hz-1500MHz, AC/DC/Ohms AC 300mV-300V FSD	£60
PHILIPS COLOURBAR GENERATOR 1ypr 5508. Video out. Many Functions	£125

### NEW EQUIPMENT

HAMEG OSCILLOSCOPE 605, Dual Trace 60MHz, Delay Sweep, Component Tester	£583
HAMEG OSCILLOSCOPE 203, 6 Dual Trace 20MHz, Component Tester with 2 Probes	£314

BLACK STAR FREQUENCY COUNTERS P&P £4	
Meteor 100 - 100MHz	£99
Meteor 600 - 600MHz	£126
Meteor 100 - 1GHz	£175
BLACK STAR JUPITOR 500 FUNCTION GENERATOR, Sine/Square/Triangle, 0.1Hz - 500KHz, P&P £4 £110	

HUNG CHANG OMM 7030, 3 1/2 digit, Hand held 28 ranges including 10 Amp AC/DC 0.1%. Complete with Battery and Leads P&P £4

As above DMM6010 0.25% £33.50

OSCILLOSCOPES PROBES, Switched x1: x10, P&P £2

# TELFAX

Geoff Phillips is on cue with all his messages thanks to this ingenious automatic audio presentation system.

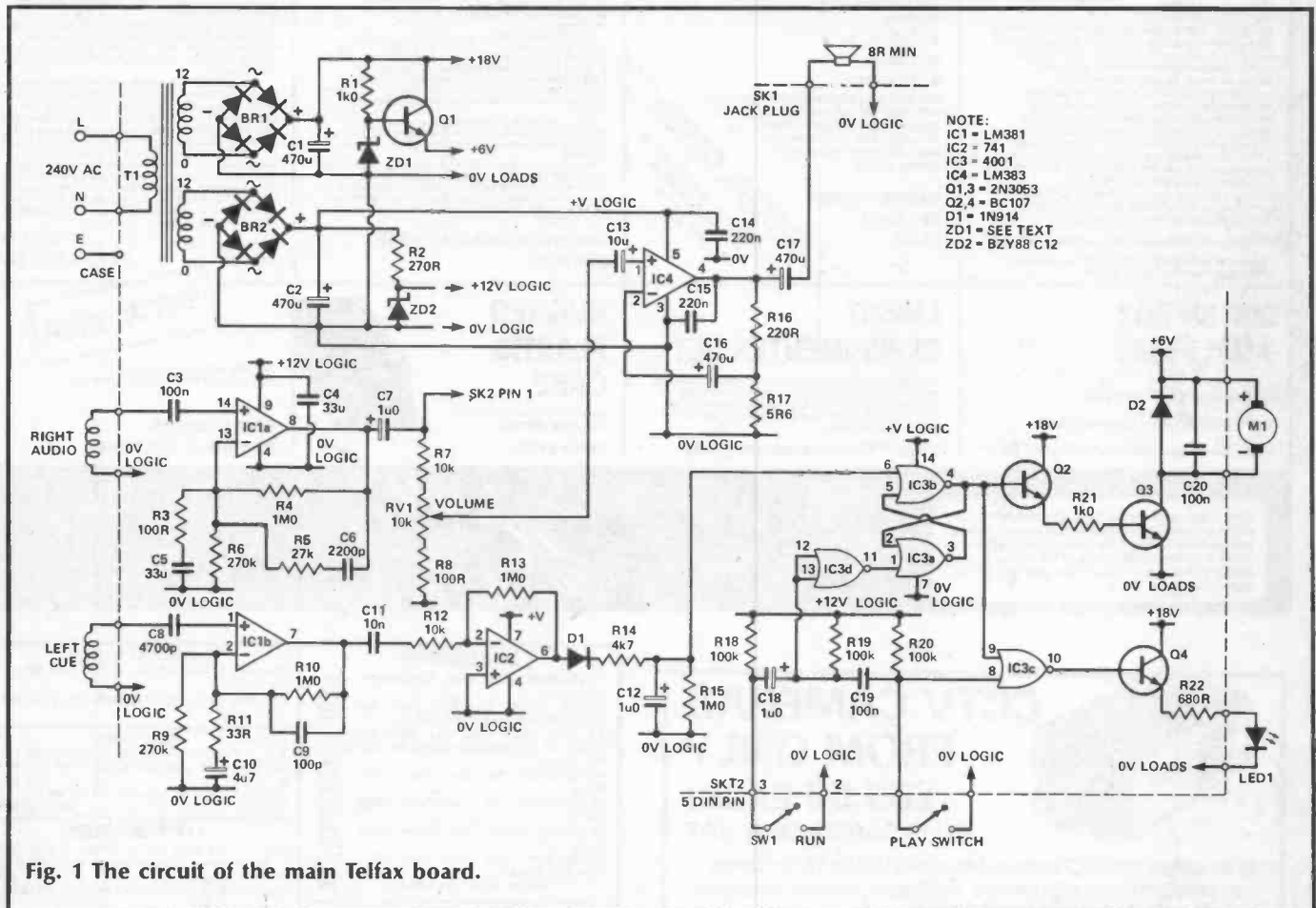

Fig. 1 The circuit of the main Telfax board.

**T**elfax is a complete system for presenting any kind of recorded message or sound effect at the exact time it is wanted.

After delivering the recording, Telfax automatically re-cues ready for the next.

Telfax uses messages recorded on a normal cassette and has outputs for both an external loud-speaker and an amplifier. The messages can be triggered either with a push button switch built into the unit or by any external contacts such as a door switch or a pressure mat.

Telfax can be used for the quick and accurate cueing of jingles for a disco or hospital radio. It can provide sales information in a shop when triggered by a customer approaching the display. Telfax could provide a calming and instructive message when triggered by a fire alarm, instead

## HOW IT WORKS — TELFAX

IC1 is a dual low noise pre-amp IC which is used to amplify the signals from the tape head. IC1a is used to amplify the audio information on the right stereo track. The feedback components are calculated to give the necessary NAB tape head equalisation curve for 1½ in per second tape speed. The gain of this stage is 56dB at 1kHz.

IC1b amplifies the 1kHz cue tone which is recorded on the left stereo track. This stage has a narrow bandwidth centred on 1kHz and a gain of approx 90dB. The 1kHz cue tone is further amplified by IC2 before being rectified by D3 and integrated by C12.

Operation of the cassette motor is controlled by the condition of the bistable IC3a and b. When the Run contacts are closed, the differentiated pulse produced at R18/C18 sets the bistable to the motor run position. The

motor is energised via Q2 and Q3 and the Telfax message is then played.

When the 1kHz cue tone is received via IC1b and IC2, the bistable is reset to the motor stopped condition. D4 and C20 are included to suppress switch-off transients generated by the motor. The Cued LED is then lit via IC3 and Q4.

The output of the audio pre-amp IC1a is fed to the volume control chain R7, RV1 and R8. R8 has been included to give a minimum volume level and may be replaced with a shorting link if the volume is required to be reduced to zero.

R7 is included to give a maximum volume level and was chosen to set the max level just below the point at which self oscillation of the audio chain occurs. IC4 is a power amplifier which can supply up to 4W into a 4 ohm speaker.

of the usual panic-inducing alarm bell. Telfax could even be used to provide a barking dog sound triggered by an approaching intruder as part of a domestic security system.

The possibilities are (almost) endless.

## Basic Concept

The audio message is recorded onto the right stereo track of an endless compact cassette and a 1kHz cue tone is recorded onto the left stereo track at the end of the message. The Telfax machine is a compact cassette player with its cassette drive motor controlled by a bistable latch.

The latch is set by a pair of contacts closing. The cassette motor then starts and plays the message. At the end of the message the 1kHz cue tone on the left track of the tape causes the bistable to be reset and the cassette motor is stopped.

If the stop or cue tone is placed near to the start of the message, the Telfax machine automatically cues the tape ready for almost instant play of the message when the start contacts are closed again.

The Telfax machine has its own built-in power amplifier which can supply 4W of audio power to an external loudspeaker. It is also fitted with a line output level DIN socket for connection to a PA amplifier.

## Cassette Mechanism

There are a number of suppliers of low cost cassette mechanisms most of which will function satisfactorily with the Telfax circuit. Ideally the motor should be 12V DC although there is provision on the PCB to fit a zener regulator for lower voltage motors. A stereo head is required but no erase head is needed.

It should be pointed out that Telfax calls for the cassette mechanism's pinch wheel to be engaged with the capstan when the motor is stationary. Some manufacturers suggest this can wear flat sections onto the pinch wheel. A cassette mechanism is available from Symot which has a specially formulated pinch wheel for continued engagement with the capstan. The mechanism is ideal for Telfax as it has been designed for use with endless cassette tapes.

However, it should be mentioned that the original Telfax prototype did not use a special pinch wheel and is still functioning well after four years' service.

## Construction

Circuit layout is critical, especially the 0V connections and the high gain pre-amp stage. Construction using the printed circuit board layout shown on the foil pages of this magazine is highly recommended as this layout has been thoroughly proven. PCB mounted sockets and transformer are used which considerably simplify construction. The component overlay is shown in Fig.2.

It is better to solder IC1 in place rather than use a socket as the low level signals may be troubled by socket oxidation after a year or two.

Layout of the circuitry around IC1 should be made compact, keeping the leads as short as possible. C3 and C8 should be bent flat against the PCB so as to minimise hum pick-up. IC1 and associated circuitry should be screened by constructing an

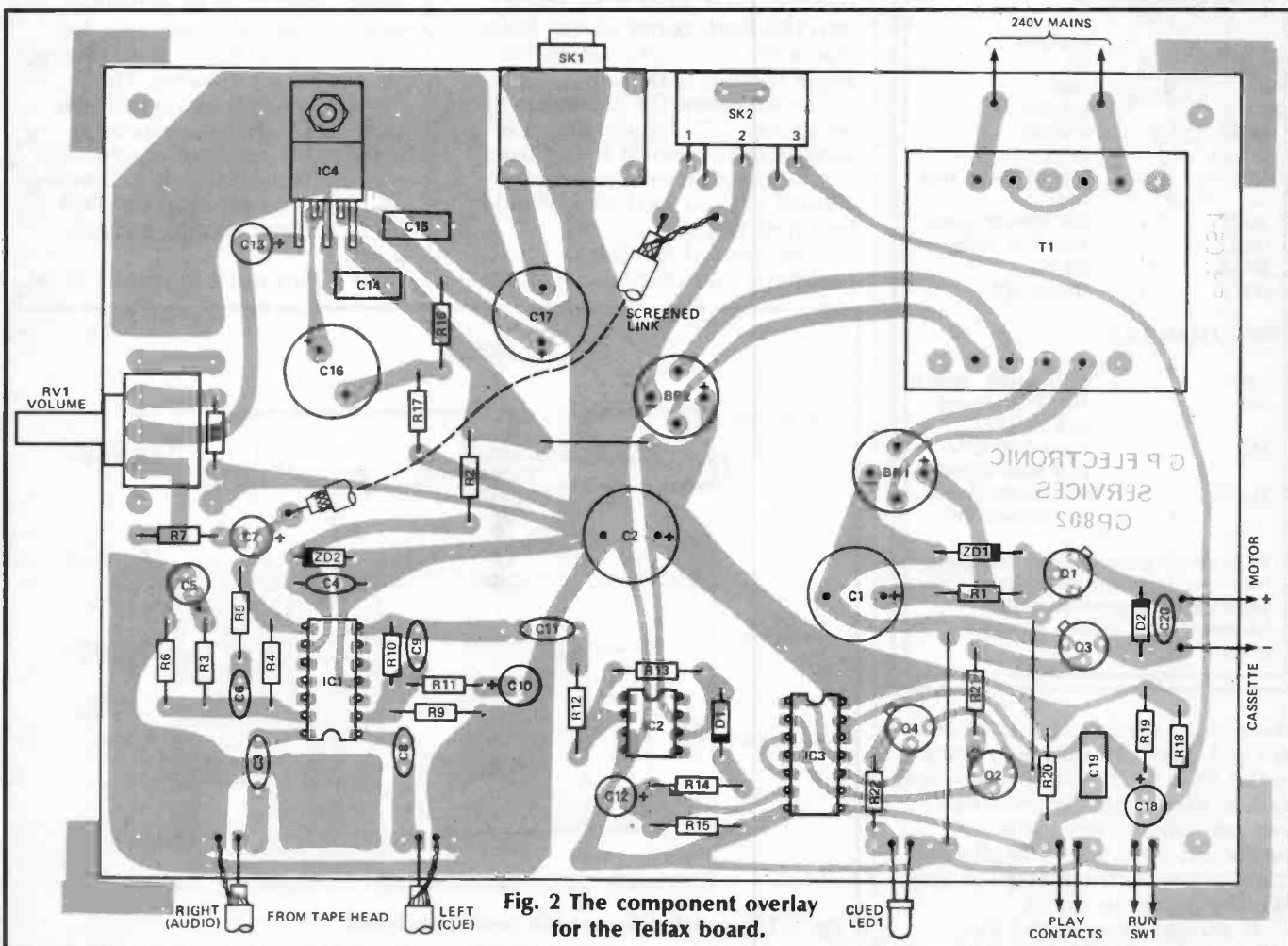

Fig. 2 The component overlay for the Telfax board.

## PARTS LIST TELFAX

**RESISTORS** all ¼W 5% unless specified

R1,21	1k0
R2	270R
R3,8	100R
R4,10,13,15	1M0
R5	27k
R6,9	270k
R7,12	10k
R11	33k
R14	4k7
R16	220R
R17	5R6
R18,19,20	100k
R22	680R ½W
RV1	10k log PCB mount pot

**CAPACITORS**

C1,2,16,17	470µ 25V electrolytic
C2,19,20	100n ceramic
C4,5	33µ 25V
C6	2200p ceramic
C7,12,18	1µ0 24V electrolytic
C8	4700p ceramic
C9	100p ceramic
C10	4µ7 25V electrolytic
C11	10n polyester
C13	10µ 25V electrolytic
C14,15	220n polyester

**SEMICONDUCTORS**

IC1	LM381N
IC2	741
IC3	4001
IC4	LM383T
Q1,3	2N3053
Q2,4	BC107
ZD1	400mW zener (see text)
ZD2	12V 400mW zener
D1,2	1N914 or similar
BR1,2	WO1
LED1	Green LED

**MISCELLANEOUS**

SW1	SPST push switch
SK1	¼in PCB mount jack socket
SK2	5 pin 180° DIN PCB mount socket
T1	0-12+0-12V mains transformer 6VA

PCB; cassette mechanism; fine gauge twin core screened cable; aluminium angle; 1/16in aluminium sheet; hardwood side cheeks; nuts and bolts.

aluminium shield plate as shown in Fig 3. This can be easily bolted to the PCB by its fixing screw next to IC1. Alternatively the screen may be constructed from cardboard onto which is glued some aluminium kitchen foil (just like the Japanese do it).

It should be ensured the screen is in electrical contact with

**Fig. 3** The screen for the preamp stage.

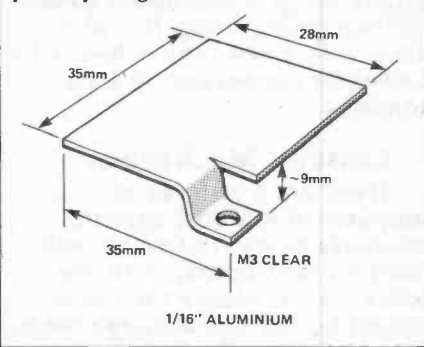

the 0V plane of the PCB. This is easy to achieve as the fixing hole in the PCB penetrates the 0V plane. The screen must not touch any of the component leads of course.

RV1 is a PCB-mounted volume control which has an integral mounting bracket. However, these are not too easy to find. The same type of pot without the bracket is easier to find (see Buylines). This will suffice but will be less rigid when soldered in place.

The power amp, IC4, is bolted to the PCB through a piece of 20mm aluminium angle section approx 35mm long. This is used to conduct heat away from the IC into the back panel of the Telfax machine's case onto which the angle section is bolted.

Zener diode D1 is chosen to be approx 0.7V higher than the voltage of the motor being used. If a 6V cassette motor is employed a small clip-on heat sink should be fitted to Q1.

The case of the Telfax prototype was constructed from

1/16th inch aluminium as shown in Fig 4. Hardwood side cheeks give the finished case a very professional appearance. The PCB is clamped to the rear of the case via the PCB-mounted jack socket and a 4mm screw through the power amp angle section. 0V connection from the PCB to the case is made via this angle section.

The PCB is also supported on 13mm stand-offs mounted on the base plate of the case. The cassette deck is also supported on stand-offs of a suitable length for the mechanism used.

Very fine gauge twin core screened cable should be used to connect the tape head to the PCB. The left stereo track is the track at the lowest edge of the tape. This track is the cue tone channel and should be connected to the input coupled by C8. The right track is the audio channel and is connected to the C3 input.

Once the connections are made to the tape head, the cable should be anchored to the head supporting assembly so the connections cannot be fractured during movement of the assembly.

If the cassette mechanism being used is fitted with Play switch contacts, these may be connected to the PCB as shown on the layout drawing. These contacts merely extinguish the Cued LED when a cassette is withdrawn from the mechanism and are not essential. A shorting link must be fitted at the PCB input if Play contacts are not used.

If a Run push button is to be

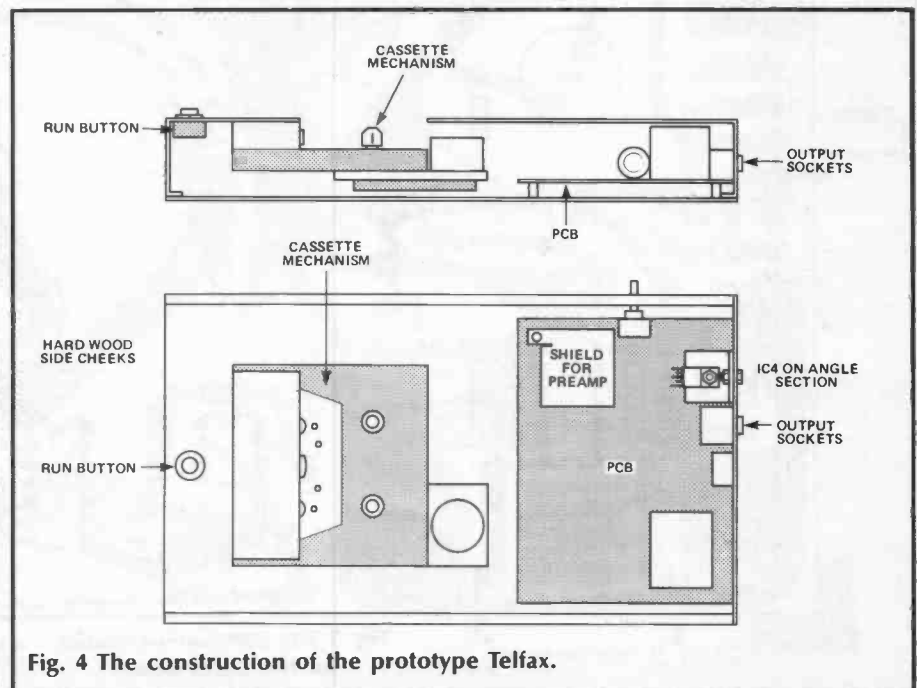

**Fig. 4** The construction of the prototype Telfax.

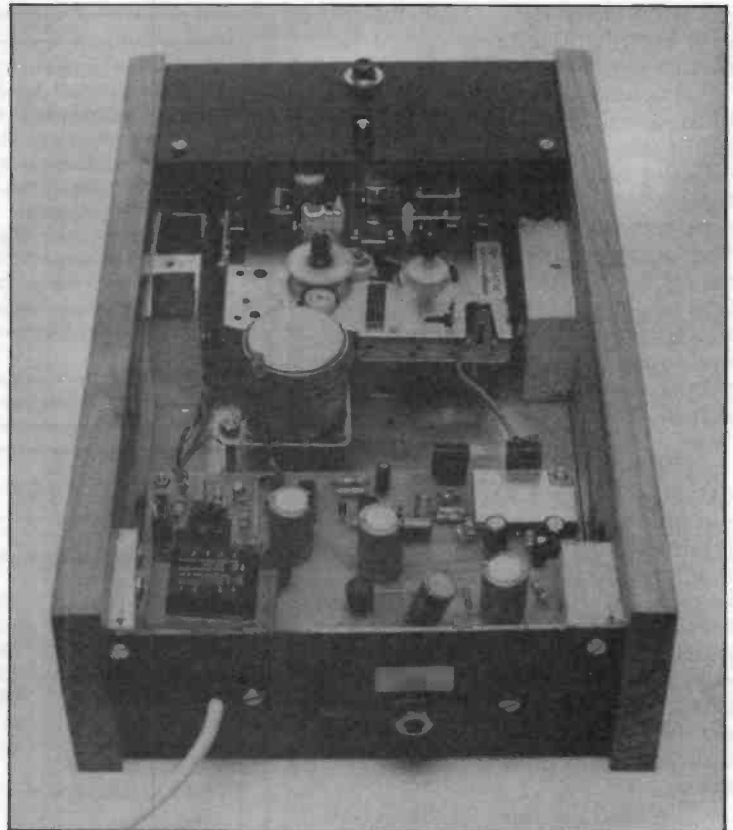
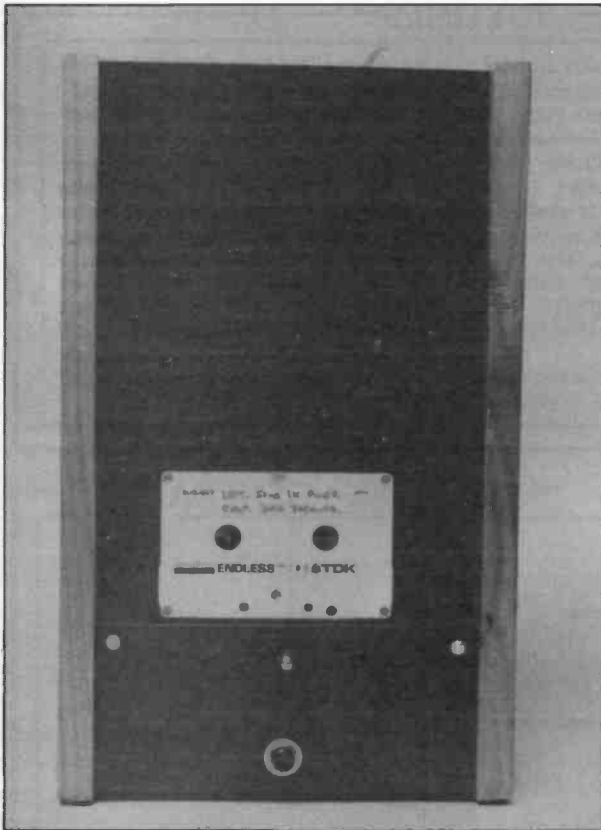

fitted to the machine, this is wired up to the appropriate input on the PCB. Otherwise (or additionally), external Run contacts may be brought into the Telfax machine via pins two and three of the five pin DIN socket.

### Message Tapes

No specialised equipment is required to prepare message tapes for Telfax. A good quality stereo

cassette recorder is all that is required. Endless cassettes are available from TDK and are ideal for Telfax as the message need only be recorded once. The tape will then automatically re-cue to the beginning of the message. Tapes are available in various lengths ranging from twenty seconds to three minutes.

Conventional cassettes can also be used but the message must be

recorded again and again as many times as required.

During early development of Telfax it was found that a reasonably satisfactory cue tone could be generated by simply vocalising the sound DUH into a microphone plugged into the left channel of the recording machine.

A more professional method is to construct a 1kHz tone generator which outputs a set

## HOW IT WORKS — 1kHz TONE GENERATOR

Figure 5 shows the circuit diagram of the tone generator. The duration of the tone is adjustable by means of a selector switch so the best duration may be found by experiment. The selector switch could be replaced by a link selection arrangement so that, when the best tone length is found, the unit can be permanently wired for that condition.

IC1 and 2 are connected as a 20ms period square wave oscillator which is controlled by the bistable IC1/3 and 4.

The 1kHz tone is generated by IC3 and is fed via an analogue switch IC4 to the jack socket output. When SW1 is pressed, the bistable is set causing pin 11 of IC1 to go high. This enables the analogue switch IC4 allowing the 1kHz tone to pass to the output.

The square wave oscillator is energised at the same time and the decade counter, IC2, counts up the negative edges from IC1/2. Depending upon the setting of SW2 the bistable is reset after a delay of 40,60,80,100,120,140 or 160 ms. The analogue switch is then disabled and the cue tone ceases.

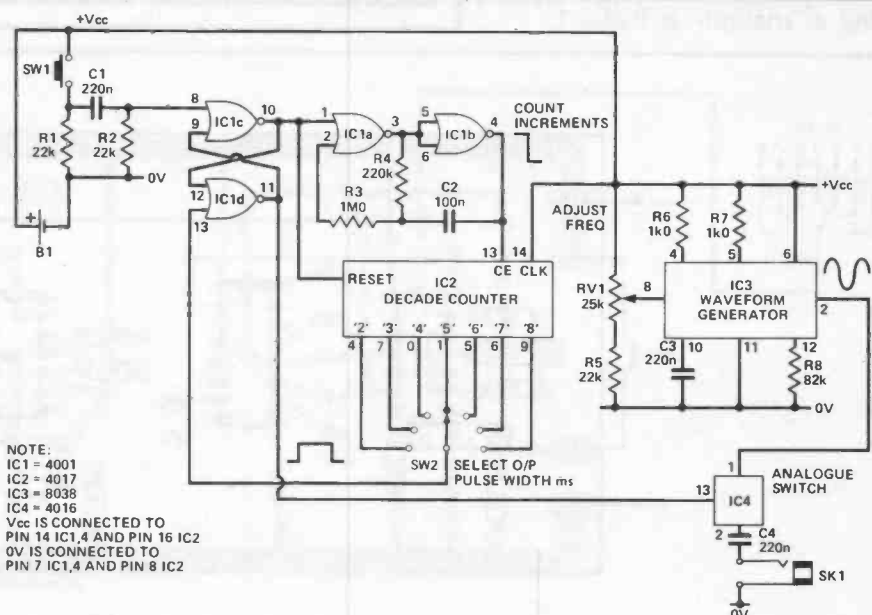

Fig. 5 The circuit of the 1kHz tone generator.

## BUYLINES

duration 1kHz tone at the touch of a button. A suitable circuit for this is given in Fig 5.

The best duration of tone can be determined by experimentation but it was found that about 60ms was the best compromise between reliability and noticeable crosstalk into the audio channel. The best volume level can also be found by experiment and -3 to 0dB is a good starting point. If you are recording spoken messages it's a good idea to prepare a script and rehearse several times before going for a 'take'.

If you are using endless cassettes, ensure the tape is long enough for your message or jingle. Start the recording machine, press the cue tone button and immediately start your message. If you are recording music, practice your skill at cueing the record for the piece of music required (ask any DJ how to do this), press the cue tone button and immediately start the music.

Transfer the tape to the Telfax machine and test the results. If you have started the message too close to the cue tone you will hear the message 'whine' as the motor is still accelerating up to speed.

If you've placed the cue tone too far away from the beginning of the message there will be an awkward silence after you've pressed the Telfax button. This will not matter too much for sales messages but it spoils continuity in discos and amateur radio stations. With practice you will find that you can have jingle tapes starting as snappily as Radio 1.

Most of the components should present no problems. Suitable cassette mechanisms are available from Maplins, Henry's, and many other suppliers. The endless cassette mechanism is available from Symot Ltd. (Tel: (0491) 572663).

The PCB mounting pot is available from Electrovalue. The PCB mounting DIN socket (type 473-278), the PCB mounting jack socket (type 477-573) and the transformer (type 207-756) are available from Electromail (Tel: (0536) 204555).

The PCBs for this project are available from GP Electronic Services, 87 Willow-

tree Avenue, Durham, DH1 1DZ. Prices are £6.99 for the Telfax board and £4.99 for the 1KHz tone generator board. Both prices include VAT and postage.

Separate power supplies are used for the motor circuitry and the audio circuitry. D1 and Q1 regulate the motor supply voltage and the zener is chosen to be approx 0.7V higher than the voltage of the motor used. If a 6V motor is used, Q1 will require a small clip-on heat sink as it would have to dissipate approx 1W during play of the machine. The supply for the dual pre-amp IC is derived by the 12V zener D2.

## PARTS LIST — 1kHz TONE GENERATOR

### RESISTORS all ¼W 5%

R1,2,5	22k
R3	220k
R4	39k
R6,7	1k0
R8	82k
VR1	22k skeleton pre-set pot

### CAPACITORS

C1, C3, C4	220n polyester
C2	1µ0 polyester

### SEMICONDUCTORS

IC1	4001
IC2	4017
IC3	8038
IC4	4016

### MISCELLANEOUS

SK1	¼in jack socket
SW1	push button switch

PCB; PP3 battery and holder; case.

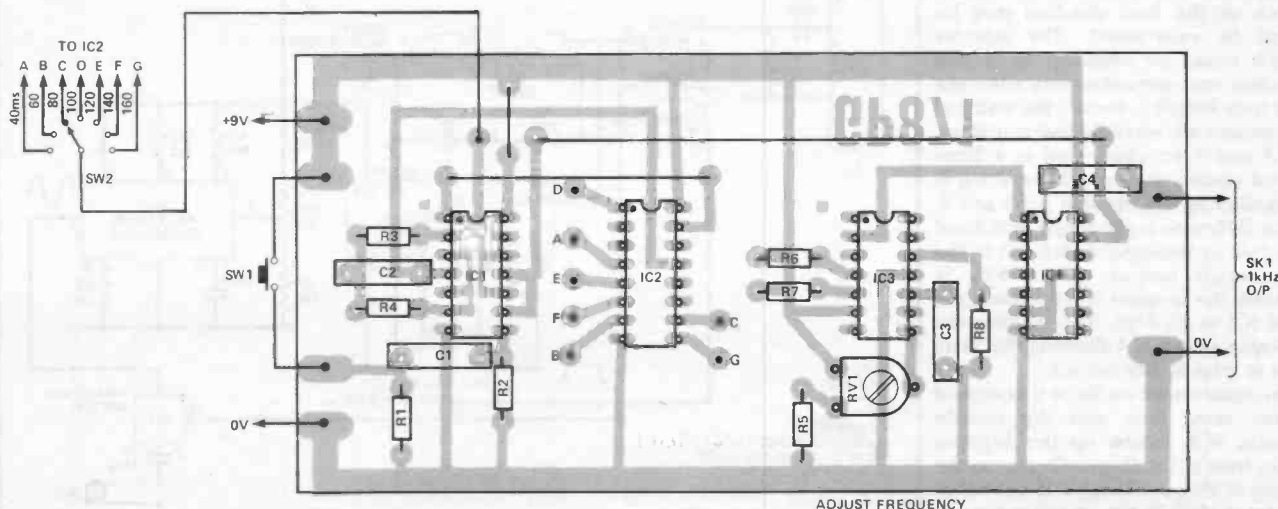
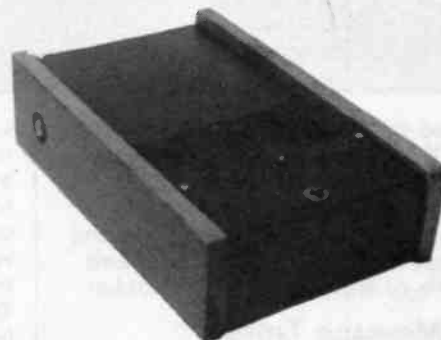
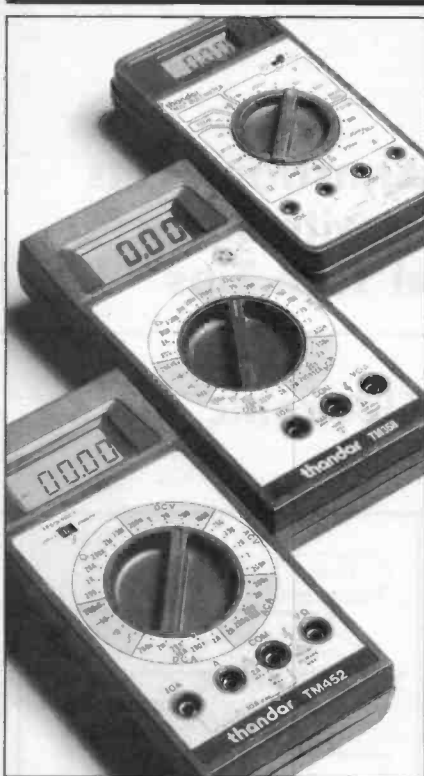

Fig. 6 The component overlay for the 1kHz tone generator.

ETI



# MULTIMETERS

**TM357** £39 + VAT

3.5 digit 0.4" LCD hand-held. 0.5% basic accuracy; 30 ranges.

**TM358** £65 + VAT

3.5 digit 0.5" LCD hand-held. 0.5% basic accuracy; 31 ranges. Conductance and  $h_{FE}$  measurement.

**TM452** £138.50 + VAT

4.5 digit 0.4" LCD hand-held. 0.05% basic accuracy; 31 ranges. Conductance and frequency measurement.

**TM355** £85 + VAT

3.5 digit 0.5" LED bench/portable. 0.25% basic accuracy; 29 ranges.

**TM356** £95 + VAT

3.5 digit 0.5" LCD bench/portable. 0.25% basic accuracy; 29 ranges.

**TM351** £115 + VAT

3.5 digit 0.5" LCD bench/portable. 0.1% basic accuracy; 29 ranges.

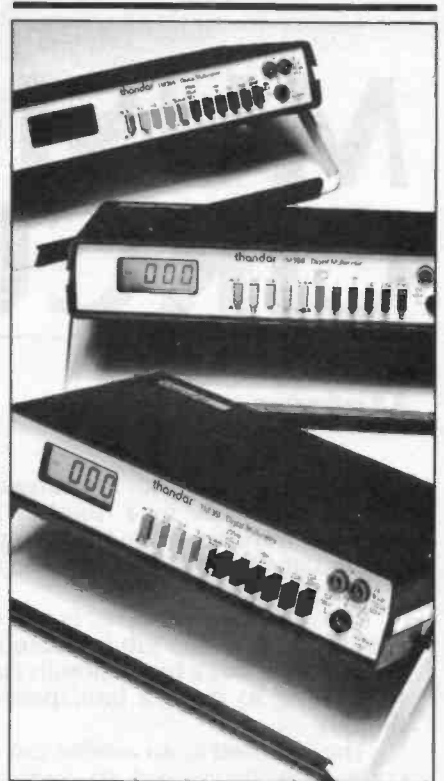

# thandar

ELECTRONICS LIMITED

Thandar Electronics Limited,  
London Road, St. Ives, Huntingdon,  
Cambridgeshire PE17 4HJ, England.  
Telephone (0480) 64646 Telex 32250 Test.

THE LOGICAL CHOICE

# CRICKLEWOOD

ELECTRONICS LTD



## It's no secret...

... that there is a *real* difference at *Cricklewood Electronics*. That's why you should never be without the *FREE CRICKLEWOOD ELECTRONICS COMPONENTS CATALOGUE*, for sheer variety, *competitive prices* and *service* from the U.K.'s number one 100% component shop. No gimmicks, no gadgets or computers, just components, millions of them, all easily available by mail order, calling or credit card telephone orders. Just pick up the phone (or a pen) to get your *FREE* copy now (no SAE required). You have nothing to lose.

**CRICKLEWOOD ELECTRONICS LIMITED**

40 Cricklewood Broadway, London NW2 3ET

Tel: 01-450 0995/01-452 0161

Telex: 91 4977



ETI

## FREE 100 PAGE CATALOGUE

1000's Major & Minor Electronic components

Audio, Hifi, Car Radios, Amps, Kits, Computer Bits, Meters scopes, Test Gear, Transistors, Disco, Hardware Tools.

write or phone:

**SMITH ELECTRONICS**

157 CHAPEL STREET, LEIGH,  
LANCS WN7 2AL Tel:(0942) 606674

## If an advertisement is wrong we're here to put it right.

If you see an advertisement in the press, in print, on posters or in the cinema which you find unacceptable, write to us at the address below.

The Advertising Standards Authority. ✓

ASA Ltd, Dept 3 Brook House, Torrington Place, London WC1E 7HN

# MUSIC CIRCUITS

Andy Armstrong gets creative with some musical Tech Tips

## Metronome

A simple electronic metronome can be made in a number of different ways. For example, a single op-amp or CMOS IC can be used as the oscillator.

The 555 timer, however, is one of the best ICs for the job because its output stage has a high enough current rating to drive a loudspeaker directly.

The 555 used as an astable can of course be connected to give an almost even mark:space ratio. However, this design uses an extremely uneven mark:space ratio to good effect.

This means that the tick rate is absolutely even, rather than having a slight difference between alternate time periods. Also, the sound output

level of the tick is greater than with the nearly even mark:space ratio configuration, because the loudspeaker is fed with a pulse rather than with a single edge.

A frequency range of about 30 to 300 beats per minute should cover most requirements and the component values are chosen to allow this. A log pot is specified, connected so that the tick rate increases with anticlockwise rotation. This is the reverse of what you would expect but it does even out the scale usefully.

Calibration at 30, 60, and 120 beats per minute is possible with the use of the seconds count on a digital watch (or even an analogue watch's second hand). Other calibration points can be marked by interpolation or by using an oscilloscope to measure the time period of each tick.

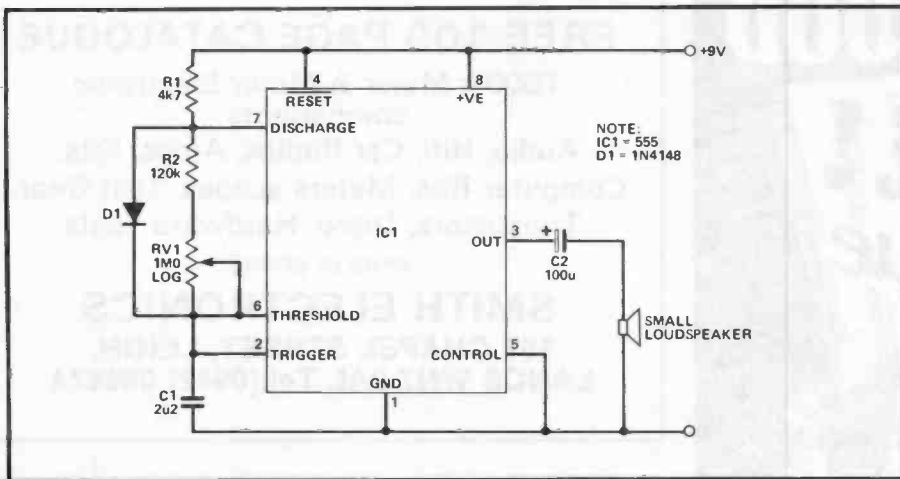

## Guitar Lead Checker

It is sometimes difficult, when under pressure to set up the equipment quickly, to buzz out an apparently faulty lead with a meter or audible continuity checker.

This simple gadget will show open or short circuit leads much more easily. Just plug the two ends of the lead into the two sockets and press each button in turn. The corresponding LED should light when the button is pressed. If it does not the connection is broken. Crossed or shorted connections are indicated

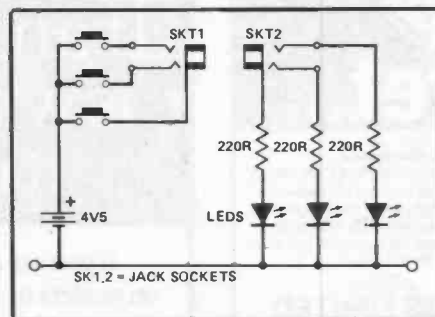

by the wrong LED or two LEDs respectively.

If several different types of lead are to be tested, it is convenient to wire the different sockets in parallel.

## Electronic Tuning Fork

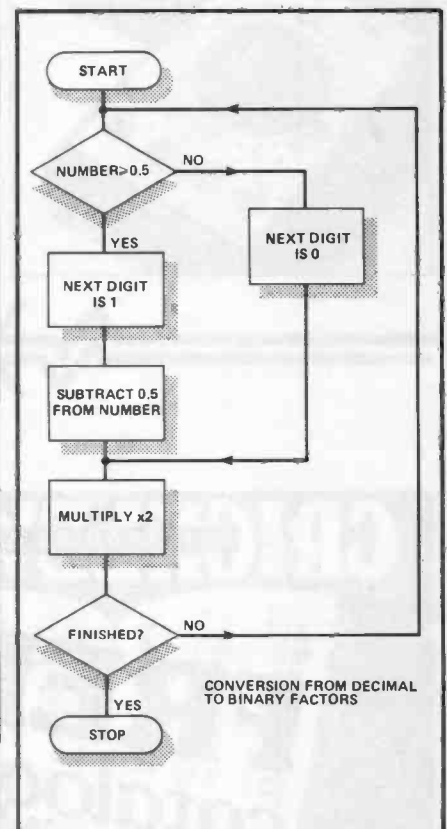

Most musical instrument tuning is done using the A below middle C. Here is a design to produce this note very accurately, under crystal control.

Some instruments are more difficult to tune than others and it may sometimes be necessary for everyone else to tune a little off. This need may arise, for example, if you are using a piano, which cannot be retuned on the spot. If they all tune to the same standard, this causes no problem. This tuner has a switch to offset its standard a little high or low to match the requirement.

A 1MHz crystal is used as the frequency standard because this frequency is readily available. Unfortunately, there is no convenient whole number division ratio to produce the required frequency — 440 Hz.

The nearest frequency above is



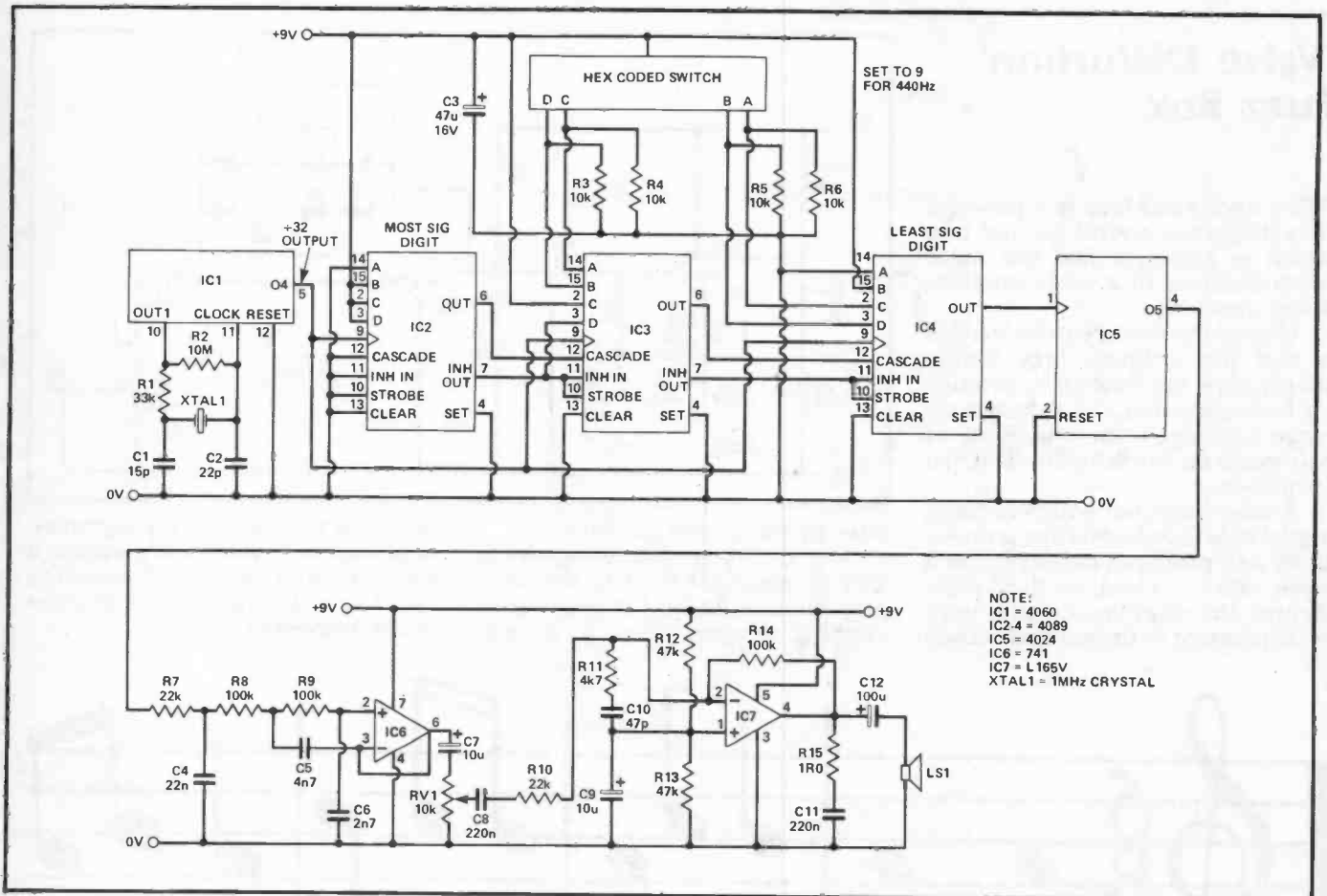

488.28 Hz, provided by dividing 1MHz by  $2^{11}$ . The required frequency is 0.90112 times this, which is not normally easy to provide. However, a binary rate multiplier is just the IC for the job. It multiplies an input frequency by a binary fraction.

"Binary fraction, What's that?" I hear you say. Well it's the same idea as a decimal fraction, except it uses powers of two instead of ten. The first digit after the binary point is half, the next a quarter, and so on. Thus, .1001 would be  $9/16$ .

Binary rate multipliers (BRMs) can be cascaded to provide as many places after the binary point as you want, so long as you don't clock them so fast that the carry speed can't cope.

For this application we need ten bits to reach an accuracy of 1 part in  $1024 \times 90112$ , which is a reasonable accuracy to aim for. This requires three 4-bit BRMs, but the last two bits are not very significant.

The only question now is how to convert a decimal fraction to a binary one. Easy peasy, if a bit tedious. Draw the point (the binary one, not a picture of the Milton Keynes cinema) then follow the flow chart until you have enough digits. The answer (to twelve places) is .111001101010

Inevitably, the output from the BRMs is not of an even frequency. There are missing pulses here and there. The BRMs are designed to provide as even an output as possible but jitter is inherent in the concept.

To give a clean output, the output frequency is divided down so that the jitter is also divided. Thus the total division by powers of 2 is shared before and after the BRMs to avoid clocking them too fast on the one hand and to provide a useable output on the other.

The result is a squarewave with slight timing jitter. This is filtered by an RC network (which also reduces

the amplitude to below the clipping level of IC6) and then by an active second order filter.

The signal at the volume control is quite a good sinewave and this is fed to a simple audio output stage using the L165V power op-amp, which should be familiar to ETI readers by now.

The binary bits can simply be hard wired to logic levels all through the circuit but if the switched offset facility is required a hexadecimal coded switch, or four individual switches, are required to program four of the bits. With the four bits chosen, each step on the switch will be approximately  $1/2$  Hz. This should be close enough for the pickiest guitar player.

The power supply is not very critical but below about 7 or 8 volts the 1MHz oscillator might not start. Anything from about 7.5 to 15V will do, but it should be properly decoupled on the board.

## 'Valve Distortion' Fuzz Box

The traditional fuzz box provides a distinctive sound but not one which is remotely like the more musical sound of a valve amplifier being overdriven.

One of the main reasons for this is that the ordinary fuzz design simply clips the waveform, producing harmonics over a wide frequency range with significant amplitude of harmonics far from the fundamental frequency.

A valve amplifier which is being moderately overdriven clips progressively and produces harmonics of a lower order — closer to the fundamental. The resulting sound is both more pleasant to the ear and sought

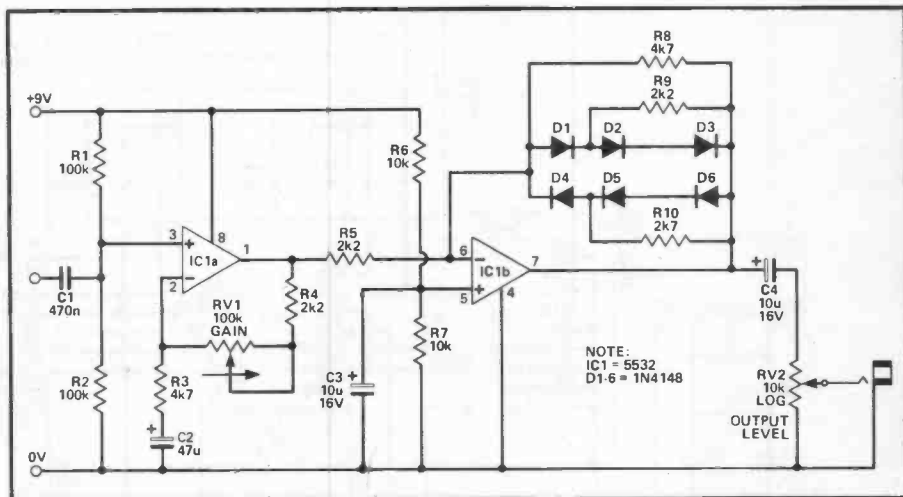

after by many rock guitarists.

The circuit here is designed to give an approximation to the valve amplifier sound by introducing its clipping progressively. It is also

designed to give a slightly asymmetrical response which will generate a small amount of even harmonics. This too is an effect noted in valve guitar amplifiers.

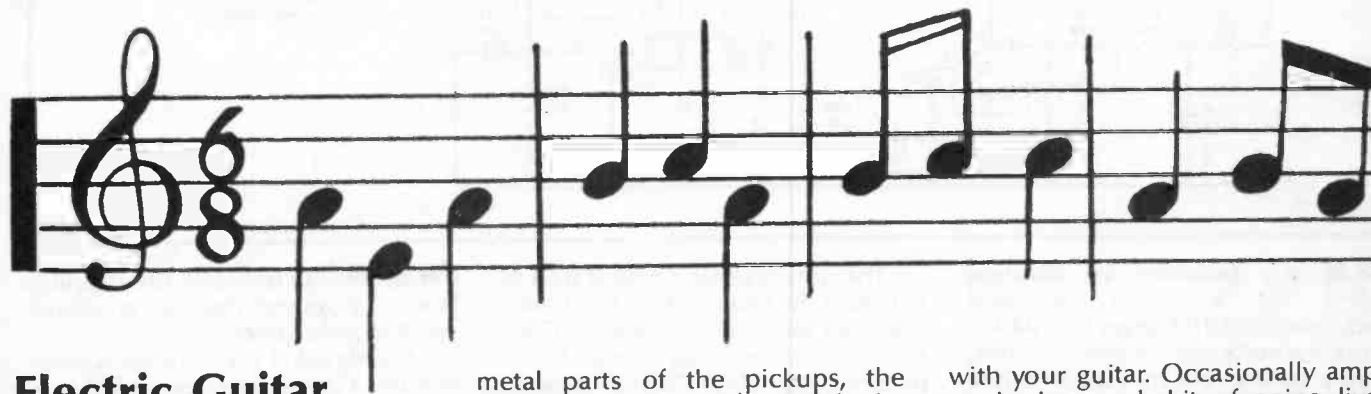

## Electric Guitar De-Fleaing

Most electric guitars have an annoying tendency to pick up hum and other noises, due mainly to the non-existent screening with which they are provided. A recent job of cutting the noise on a friend's Squire Telecaster proved educational.

Those who built the recent preamp project will realise how much hum twisted wire picks up. The guitar I was working on didn't even have properly twisted wire from the pickups to the controls — which is even worse. The first job was to replace this with proper co-ax.

At the same time I grounded the

metal parts of the pickups, the controls, and the bridge. While the controls and pickups were out of the body, I fixed aluminium foil round the inside of the cutouts in such a way as to contact the grounded metalwork when it was re-assembled. Any flexible glue should do for the foil but do make sure that the foil is electrically continuous, not just held together with glue.

It wasn't easy to remove the output jack to fit co-ax, so I simply disconnected the wire at the control end, twisted it, and reconnected it. This wire is only a couple of inches long anyway so it will not pick up much interference.

It would be a good idea to fit a 60mA fuse (or lower, if you can find them) into both the signal and earth lines in the guitar lead if you try this

with your guitar. Occasionally amp stacks have a habit of going live (when the beer you've been standing on the top of your backline finally spills all over it). The fuses prevent the strings and other guitar parts you come into contact with from following suit.

Tests showed the de-fleaed guitar to be much less noisy but there was still some hum. This proved to come from the lead which was a cheap spiral type.

It seems that the screening on some of these leads is little better than with twisted wire so a better quality lead was substituted. The only remaining noise came from a fluorescent light, when the guitar was directly underneath.

The verdict — not perfect, but a great improvement.

**ETI**

# SAGE AUDIO MODULES

Les Sage has been making some very immodest claims about his new 100W amplifier modules. Ian Pitt connects a couple of them up to see if the claims are justified.

**Y**ou may not have heard of Sage Audio but the man behind the company should be familiar to all regular readers of ETI. Les Sage was the author of the series *Designing Transistor Stages* which appeared in the November and December 1985 issues and in February 1986.

Since writing that series Les has set up in business and brought out his first two products, a pair of 100W amplifier modules called the Superamp and the SuperMOS. The Superamp is an all-bipolar design while the SuperMOS is similar but has a MOSFET output stage. Both are said to offer very high levels of performance combined with ease of use and high efficiency.

Les Sage claims the modules will out-perform any other amplifier modules on the market and says the SuperMOS is particularly good. He believes it offers at least a ten-fold improvement over its competitors.

The internal circuit of the modules has not been disclosed but the data sheet includes a block diagram and the operating principles are described in general terms. The most notable features are a Class A output stage and the use of very low levels of feedback derived from nested loops. The output stage is fully-complementary and uses four bipolar or MOSFET transistors with very high transition frequencies. This arrangement is said to contribute greatly to the performance, combining high current capability, very high slew rate and an efficiency of around 70%, far higher than is normal for Class A amplifiers.

According to Sage's product literature, the modules have been designed so that high-quality audio systems can be constructed as simply as possible. To this end they contain all the circuitry of an audio power amplifier and the only additional items required are a dual-rail supply, a case and a signal feed from a suitable preamplifier.

Internal overload and short-circuit protection is provided and the heatsinking fins can comfortably dissipate the heat developed during domestic operation. Additional heatsinking may be required when the modules are to be used for sustained periods at high powers, as might be the case in a club or a disco.

## Gathering No MOSFETs

Both modules have already been launched onto the market but the SuperMOS has been suspended temporarily. Les Sage told us he is having difficulty obtaining MOSFET output transistors which are up to standard and consistent from sample to sample. For this reason the modules reviewed here are the bipolar version, the Superamp.

The modules consist of a black-anodised aluminium heatsink with a central well containing the circuitry. Black encapsulating resin covers the well, hiding the Superamp's circuitry from prying eyes, and a piece of paper stuck over the resin carries information on the pin connections, maximum voltage ratings, etc. The lead-outs protrude from the back of the module and the positive

supply lead is coloured red to reduce the risk of confusion. Four nuts and bolts are provided to secure the module in place.

A considerable amount of information is provided, including a suggested layout, advice on wiring and earthing, some simple circuits to test various aspects of the amplifier's performance and a list of specifications. A suitable power supply circuit is given and the accompanying text suggests sources for some of the components and even lists the supplier's order codes. There is a paper template to help you drill the right pattern of holes for the module's lead-outs.

The recommended power supply circuit is a simple dual-rail unregulated design using two capacitors and a

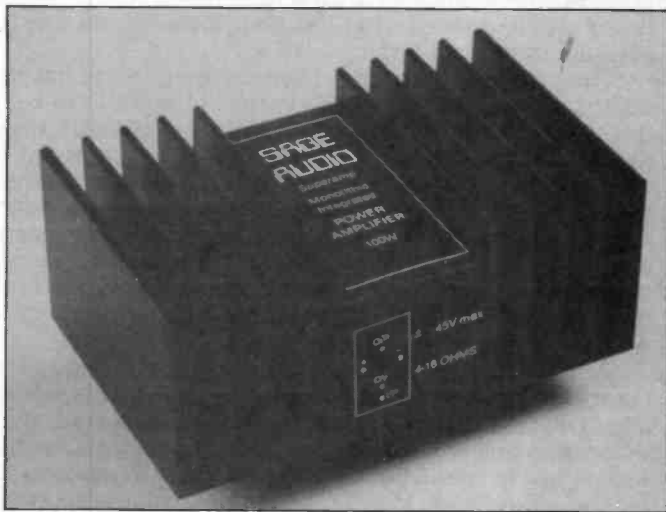

bridge rectifier for each channel. Sage claims the modules have a differential input stage with balanced impedances and says this gives a very high power supply ripple-rejection ratio. However, the best results will only be obtained when the modules are fed from a source impedance which balances out the internal feedback loop impedance, in this case a figure somewhere below 1k $\Omega$ . Sage recommends using a preamplifier with an output impedance of 600 $\Omega$ , and suggests that the power supply should be stabilised if significantly higher source impedances are to be used.

## Transforming The Sound

Certain decisions have to be made before ancillary components can be purchased. The main one concerns the choice of mains transformer. Since this is likely to be the largest item in the amplifier it will also play a part in determining the size of case needed.

If the full output power of the modules is not needed, a low voltage, low VA rating transformer can be used instead of the specified type. The notes supplied with the modules list suitable DC supply voltages and the AC transformer output voltages which will provide them,

taking into account such factors as regulation.

On the other hand, if you want both full output power and the highest possible quality, Sage recommends you buy a transformer which is considerably larger than would be needed to supply a module operating at full output. There is a strong feeling among certain groups of audio designers that sound quality can be improved by the use of over-size mains transformers, and regular readers may recall Graham Nalty's comments on the subject in his Upgradeable Amplifier series (ETI June, July, August, September and November 1986). Since the Sage modules are designed for use in very demanding applications, it seemed a good idea to put this proposition to the test.

Accordingly, it was decided that two different sizes of transformer would be used. The minimum VA rating needed to drive the modules to full output is 225VA so toroidal transformers of this size were used for the bulk of the review.

For the larger size the choice was limited by the range of voltages provided on commercial toroids. Transformers of up to 1000VA are readily available but sizes above 600VA rarely offer voltages as low as the 25-0-25 required by the Sage modules. Because of this, the transformer eventually chosen for the second part of the test was a standard 500VA toroid.

The choice of case also needs to be thought about carefully. The layout given in the instructions is very specific and the accompanying notes suggest there is good reason to stick to it. One false move, it seems, and those much-vaunted ultra-low distortion figures will be severely compromised.

The problem is that the recommended layout has the reservoir capacitors mounted vertically in order to keep the supply leads as short as possible. Any other arrangement seems to fall foul of one or other requirement of the layout, such as not placing the capacitors anywhere near the input wiring. This imposes something of a height restriction on the chosen case and rules out many modern slimline designs for audio use. It seems a pity since the other components and the modules themselves will all fit comfortably into any one of a number of attractive cases.

Being a sucker for good-looking gear, I decided to compromise slightly and mount the capacitors horizontally. This allowed me to fit both modules and their associated power supplies in a 2U high 19in racking case with space to spare. Were it not necessary to make room for the large 500VA toroids, an even smaller case could have been used.

### Loudspeaker Choice

The notes supplied with the modules include a loudspeaker crossover and driver circuit which is recommended for use during testing. Presumably it shows the arrangement used during initial testing and on which the published specification is based. The diagram specifies Peerless drive units, and although not stated it appears to be the circuit of the Peerless 825/2R kit loudspeaker available from Wilmslow Audio.

I am not familiar with the 825/2R but I do have a pair of Peerless CD825/2Rs, a very similar design which uses a 100W paper-coned bass driver instead of the 90W polypropylene-coned unit on the 825/2R. A review of the CD825/2Rs appeared in the June 1984 issue of ETI. All listening tests on the Sage amplifiers were made using these loudspeakers.

Rather than get caught up in convoluted arguments regarding the suitability of this or that preamplifier, I auditioned the modules using a direct feed from a Philips CD104 compact disc player via a pair of 10k volume control potentiometers. For comparison I used the power

amplifier stages of a NAD 3130 and my own home-grown 30W Class B power amplifiers.

Listening first of all to a selection of rock albums, the most noticeable difference between the Sage modules and the other amps was the quality and stability of the stereo image. The digitally-mastered album *Brothers In Arms* by Dire Straits showed this up particularly well. Vocal solos were firmly positioned in relation to the backing tracks and the sound effects on *Across The River* detached themselves from the music and became a living backdrop.

The difference was even more noticeable on *Don't Worry*, a track I had hardly noticed on previous playings. The descending chime passages took on a life of their own and seemed to hang in the air long after they had sounded.

Moving on to classical music only confirmed the first impression. Solo instruments were spaced well away from the orchestra and there seemed to be much more room between different groups of instruments. By comparison, the other amplifiers produced nice, well behaved sounds which remain rooted in the speaker boxes and were content to be heard and not seen.

### Doubling Up

I assume the difference lay in the use of separate power supplies for the two channels on the Sage amplifier, a feature not shared by the other two amps. Temporarily I connected up the 500VA toroidal transformer in place of the separate 225VA toroids and doubled-up the reservoir capacitors. The Sage modules didn't quite admit defeat in the face of this emasculation but they did start to behave a lot more like the other two amps.

The differences between the Sage modules and the other two amplifiers were less marked in other respects.

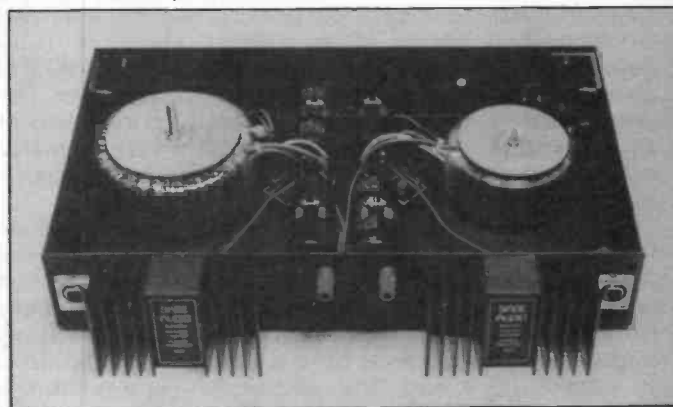

The Superamp modules assembled into a case with power supplies. Note the two different sizes of toroidal transformer referred to in the review.

I liked the tightness and bass extension they provided and fancied I could hear a little more detail at lower frequencies than with either of the other amps. The NAD by comparison seemed almost to emphasise the lower register with some coincident muddling of the sound.

The mid-range seemed very slightly veiled but that might have been because the treble was particularly clear. Higher pitched voices and instruments seemed to start up with a little more assurance than on either of the other amps but I could not hear any ringing or other indication of poorly controlled treble.

### A Definite Possibility

Having got the 500VA toroid into circulation it seemed a good idea to press on with the transformer comparison. I reconnected one of the channels to its 225VA toroid,

separated out the capacitors again and left the second channel running from the 500VA toroid. With the two loudspeakers side by side I soldered a couple of mixing resistors across the volume pots to give a mono signal and then faded up and down rapidly between the two channels.

<b>Power output</b>	50-150W RMS depending on supply voltage, load impedance, etc.
<b>Load impedance</b>	4-16R
<b>Supply voltage</b>	± 30V to ± 45V
<b>Input sensitivity (for 100W into 8R)</b>	0.775V RMS
<b>Distortion (THD)</b>	0.0009%
<b>Frequency response</b>	5Hz-125kHz
<b>Signal-to-noise ratio (CCIR/ARM)</b>	120dB
<b>Slew rate</b>	125V/us
<b>Transient output current</b>	45A peak-to-peak
<b>Damping factor (typical at 100Hz)</b>	800

**Table 1 Manufacturers' specification for the Superamp module.**

And? Well yes, there was a difference, but I'm not sure what it was or which of the two sounds I preferred. With a little bit of imagination I could convince myself that the channel with the 500VA toroid sounded better at low frequencies, a little more open, perhaps, a little less mud and confusion. Then I'd play another disc and everything would change.

Perhaps a transformer rating of twice the minimum wasn't enough. Maybe I should have stuck out for a 1000VA model and hung the expense. Then again, it's possible that any differences were being masked by the use of a mono signal and that a full stereo audition would reveal them more clearly. Personally I doubt it, but it would be interesting to be proved wrong on this point.

## In Conclusion

The Sage bipolar Superamp modules are clearly worthy of consideration by anyone building a high power, high-quality audio system. In spite of the stern warnings in the instructions the modules seem reasonably tolerant on the layout front and this coupled with their simple power supply requirements must make them a good choice where ease of construction is a major consideration.

I'm not keen on the sort of lash-ups which are all too often found on stage and disco equipment, but if any module is going to survive and sound good in that sort of application I suspect these will. They should also be of interest in domestic audio systems since they offer good quality sound at a not unreasonable price. The set-up used here cost around £170 in total and I suspect you would have to pay a lot more for anything substantially better.

The Superamp bipolar power amplifier module is available from Sage Audio, Construction House, Whitley Street, Bingley, West Yorkshire BD16 4JH, Tel (0274) 568 647. They cost £47.50 each inclusive of VAT and postage. The MOSFET-output SuperMOS modules are currently unavailable but should be on sale again soon. Contact Sage Audio directly for details.

ETI

## RACK STYLE CABINET

\* Suitable for instruments, high quality amplifiers and many other purposes \* Black anodised aluminium front panel enhanced with two handles \* Aluminium version, wholly made of black anodised aluminium sheets \* Metal version, rear box is manufactured from steel painted in black with aluminium front panel \* Rack mount or free standing. Customer who requires further details, please send S.A.E.

Panel Size W x H (Inch)	Rear Box W x H (Inch)	Price Steel	AL
19x2.5	17x2x10	22.50	27.50
19x3.5	17x3x10	24.50	29.50
19x5.25	17x5x10	26.50	—
19x3.5	17x3x12	25.50	30.50
19x5.25	17x5x12	27.50	32.50
19x5.75	17x5.5x12	29.95	33.50
19x7.0	17x6.5x12	29.95	—

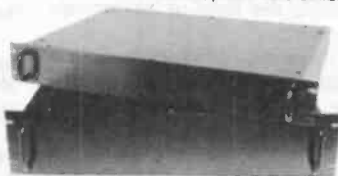

Please add £3.00 P/P for the first item and £1.50 for each additional item. Quantity discount available. A limited quantity of electronic kits at give away prices. SAE for details. Overseas orders welcome. Mail order only. To order send cheque/postal order, please allow up to 7 days despatch for cheque clearance.

## T J A DEVELOPMENTS

53 Hartington Road, London E17 8AS.

## MAKE YOUR INTERESTS PAY!

More than 8 million students throughout the world have found it worth their while! An ICS home-study course can help you get a better job, make more money and have more fun out of life! ICS has over 90 years experience in home-study courses and is the largest correspondence school in the world. You learn at your own pace, when and where you want under the guidance of expert 'personal' tutors. Find out how we can help YOU. Post or phone today for your FREE INFORMATION PACK on the course of your choice. (Tick one box only!)

Electronics	<input type="checkbox"/>	Radio, Audio and TV Servicing	<input type="checkbox"/>
Basic Electronic Engineering (City & Guilds)	<input type="checkbox"/>	Radio Amateur Licence Exam (City & Guilds)	<input type="checkbox"/>
Electrical Engineering	<input type="checkbox"/>	Car Mechanics	<input type="checkbox"/>
Electrical Contracting/Installation	<input type="checkbox"/>	Computer Programming	<input type="checkbox"/>
GCE over 40 'O' and 'A' level subjects <input type="checkbox"/>			



Name \_\_\_\_\_ P. Code \_\_\_\_\_  
Address \_\_\_\_\_  
International Correspondence Schools, 312/314 High St., Sutton,  
Surrey SM1 1PR. Tel: 01-643 9568 or 041-221 2926 (24 hrs) Dept EB557

## INSTRUMENTS FROM STOCK

UK's LARGEST IN-STOCK RANGE

WITH FREE CASE*	DIGITAL MULTIMETERS	Price
★ 105 14 Range 2A DC, 2 Mohm		£24.75
★ 528 14 Range D.2A DC, 2 Mohm Hfe test		£29.95
★ 615 19 Range 10A DC, 20 Mohm Hfe test		£34.95
★ 6010 28 Range 10A AC/DC 20 Mohm (0.2MA AC/DC)		£38.53
★ 578 20 Range 10A AC/DC 2M. Buzzer Display Hold		£39.68
★ 5010 28 Range 10A AC/DC 20 Mohm (20µA AC/DC)		£41.98
★ 5010EC 34 Range 10A AC/DC 20 Mohm Hfe test		£59.95
★ ME540 Auto/manual 10A AC/DC 20M		£48.30
★ 6013 Digital Capacitance meter 8 ranges 200pf-2000 MFD		£63.25



WITH FREE CASE*	ANALOGUE MULTIMETERS	Price
★ 1015 15 Range Pocket 10K/V		£8.63
★ 1035 19 Range Pocket 20K/V 10A DC 10 Mohm		£11.95
★ 102BZ 19 Range 20K/V 10A DC		£14.50
Hfe Buzz 10 Mohm		£17.95
★ 201 19 Range 20K/V 12A AC/DC 10 Mohm		£21.95
★ 2010 20 Range 30K/V 10A DC 20 Mohm		£23.95
★ 3010BZ 24 Range 30K/V 10A DC Buz 10 Mohm		£28.95
★ 830A 26 Range 30K/V 10A AC/DC 10 Mohm		£32.95
★ 5050E 41 Range 20MEG FET 12A AC/DC 1000 MEG		£32.95



POWER SUPPLIES	Price
001c 13.8v 3A DC	£14.95
154 5/15v	£38.25
243 0/24v 0/3A DC	£49.75
0/4A DC	£38.25
0.30v 1.5A DC	£34.44

OSCILLOSCOPES WITH FREE PROBES	Price
UK FREE DELIVERY	
HAMEG Dual trace with component testers 8 x 10cm screen:	
203/6 Dual 20MHz	£342.70
204 with a sweep delay	£462.30
CROTECH with component tester single trace:	
3031 5 1/2 x 6 1/2cm Display	£224.25
3036 8 x 10cm Display	£239.20
HUNG CHANG	
620 Dual 20MHz + component test	£339.25
635 Dual 30MHz Sweep delay	£458.85
615 Dual 15MHz bat/Mains	£458.85

LOGIC PROBE	Price
07 20MHz Logic Probe	£10.95
TTL CMOS etc	



**STOCKISTS FOR**  
Frequency Counters • Generators • Power Supplies •  
Tools • Computer Equipment • TV/Video Accessories •  
Nicads • Communications and Security Equipment •  
Public Address & Audio • (See catalogue)

ALL PRICES INCLUDE VAT

ORDER BY POST OR PHONE. OPEN 6 DAYS A WEEK FOR CALLERS

VISA  
**HENRY'S ELECTRONICS**  
301 Edgware Road, London W2 1BN. 01-724 3564  
404 Edgware Road, London W2 1EQ. 01-724 0323  
EDUCATION/TRAINING & EXPORT SUPPLIED

FREE CATALOGUE  
Ref TG/E  
Send s.a.e.  
(min 12" x 9")  
with £1 stamp UK  
Callers/export £1.00

# KEYNOTES

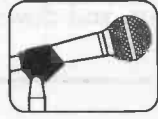
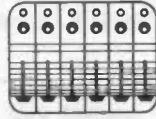
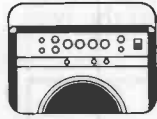
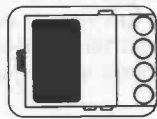
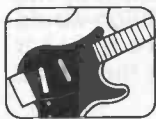

During the last five years digital technology has ravaged the world of music synthesis and audio in general. Polyphonic capability, velocity and/or pressure sensitive keyboards, battery-backed patch and sequence storage, multistage envelope generation and MIDI are now accepted norms, while still more impressive features such as additive synthesis and 16 bit quality are unlikely to raise many eyebrows. All this at prices that made traditional analogue synthesis wish in vain that the micro would go away and die quietly.

Gone forever is that golden era when you could impress your friends with a simple monophonic synth housed in a biscuit tin.

## The Micro

In its earliest days the micro-processor offered the promise of reduced cost, increased performance and reduced design time. Synth manufacturers of American and Japanese origin (Australian too, I should add) were quick to adopt this new technology. Those that did not died overnight. EMS and ARP (once famous names) are no longer with us.

The classical Von Neumann architecture (bus-orientation) of microprocessors imposes serious limitations on their ability to directly process or generate waveforms in real time, even at audio frequencies, since most machine cycles are wasted on calculations of address values and transfer of data.

NED's Synclavier and the Fairlight circumvented the proverbial Von Neumann bottleneck by entirely different design philosophies. NED used a wider bottle. Fairlight used more of them. However, both machines were of necessity hardware-intensive and you were getting what you paid for.

The current Fairlight employs a 6809 and 68000 in each of its sixteen voice channels. The Synclavier, on the other hand, is based on bipolar bit-slice technology (probably AMD's 4 bit 2901s but don't quote me on that) with 25ns static RAM memory. Easier said than done, as witnessed by the fact that NED commenced work on the project in 1973.

With the dawn of the '80s the pace quickened as Japanese firms unfettered themselves from what was at one time a deserved reputation for poor quality. Even Moog was having to run to stand still in spite of the demise of arch-rival ARP.

However, more surprises were to come and few people knew of the activities proceeding in the development laboratories of Yamaha.

## DX7

These few were affiliated to Stanford University and included Dr John Chowning who had almost accidentally pioneered the application of FM to audio signals back in 1967. There was nothing new about FM itself. The theoretical and mathematical aspects had all been laid down before the advent of the triode valve. Furthermore, the modulation of one VCO by another in analogue synthesis had already been investigated and found to produce interesting results.

Chowning nevertheless had the foresight to realise the FM synthesis technique constituted an exceptionally efficient means for digitally generating complex yet controllable audio spectra and consequently registered a patent under the auspices of Stanford University. Stanford contacted a number of major US manufacturers (such as Hammond and Lowrey) none of whom understood what all the fuss was about. A licensing agreement was finally signed with Japanese Yamaha.

The DX7 bombshell finally dropped in 1983 and caused devastation in the wake of its sales (about 200,000 to date).

Here was a machine that offered sixteen-voice polyphony, multistage envelopes, an implementation of the then new MIDI standard, a velocity and after-touch sensitive keyboard, 32 patch memories, provision for external ROM/RAM cartridges, plus all the usual performance controls.

Each voice sported no less than 145 controllable parameters and comprised six stages of FM modulation (dubbed 'operators') which could be configured in any of 32 different series/parallel combinations. The price tag was a miraculous £1,600 and the

miracle was implemented entirely digitally (albeit only eight bit, but that was eight more than might have been expected at the time).

The protracted development of the DX7 had been undertaken in absolute secrecy and the competition and market alike were taken by genuine surprise.

## LSI

Yamaha had been able to reduce the size and complexity (and cost) of their original lab prototypes only by the design of custom LSI devices.

To digress for a moment, custom chips (usually called ASIC — 'application-specific' IC) fall into two categories: semicustom and full custom. In semicustom, a chip pattern is built in modular fashion from a library of smaller standard patterns (macrocells or megacells, depending on size) each representing ready-made logic functions such as shift registers, latches or RAM.

Development cost for a semicustom is commonly under £40,000 — surprisingly low considering the level of technology involved.

However, production costs make semicustom LSI expensive and the only solution is to reduce the required silicon area by going the whole hog with full custom — laying out a chip transistor by transistor — typically tens of thousands of them, often more. Needless to say, this is exorbitantly expensive.

Yamaha had to adopt the full custom approach to keep the retail price of the DX7 low enough to make it a winner. Yamaha is no longer the only synth manufacturer to have developed its own LSI but they were certainly the first. Their marketing department knew what it was doing (an unusual phenomenon in the music business) and the gamble paid off as the machine soared into the commercial sky, followed by the DX1, DX5, DX9, DX21, DX27, DX100, TX7, TX216 and TX816, all based on proprietary chips.

Moog and other firms that had been letting the grass grow retired from the race before it was too late, moving into other areas such as MIDI software and sound sampling (the latter

becoming a temporary haven for Western manufacturers).

Synthesiser circuitry slowly disappeared from electronics magazines as designers and readers realised that competition on the same price/performance level as the industrialists was no longer viable or worth the effort.

I paint a gloomy picture, but it is necessary to be realistic. Although it is possible to put together a synth that is in some aspects superior to commercially available equipment, this is a challenging task and is exceedingly unlikely to work out cheaper. Having said that, a wealth of interesting opportunities to break new ground exist for anyone prepared to accept these terms.

## Books

Some new ground worth breaking will be covered in this magazine over forthcoming months but in the unlikely event of uncontrollable enthusiasm you could certainly do worse than to visit the local university or polytechnic library in search of the *Computer Music Journal* and *Journal of the Audio Engineering Society*.

Not all libraries have these, but you will almost certainly be able to find *Signal Processing Aspects of Computer Music: A Survey* by J.A. Moorer (IEEE Proceedings, Vol. 65, No. 8, August 1977). This concise and well-referenced overview neatly illustrates the width of the gulf that exists between the know-it-alls and the real know-it-mores.

Are there any good books on music synthesis? Yes, but only one. Hal Chamberlin's *Musical Applications of Microprocessors* (Hayden, NJ) is now in its 700 page second edition. Chamberlin's book covers many more general issues than its title implies, including signal analysis techniques and analogue synthesis.

Particularly clear and readable accounts are given of difficult issues such as digital filtering and the fast Fourier transform. The only major gripes are the lack of adequate referencing for further reading and perhaps the very-American price. Even the softback leaves scant change from £20 but take heart that there are simply no comparable books available to choose from.

Bruno Hewitt

## BOOKS

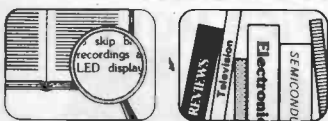

**Sinclair and the 'Sunrise' Technology.** Ian Adamson and Richard Kennedy (Penguin Books) £3.95

This Penguin paperback takes a long hard look at the Sinclair myth. It is basically a biography covering Sinclair's achievements from his early efforts in the world of audio kits up to the recent Amstrad buyout and the formation of Anamartic to produce the waferscale memory.

However, unlike most biographies (and certainly most about Sir Clive) this one is far from reverent.

Adamson and Kennedy aim to show that Sinclair, far from being the avuncular figure and darling of Thatcher's hopes for the future of British industry, is actually the epitome of the British failings.

Documented like this, Sinclair's repeated floundering despite the obvious success of (most of) his products shows him to be nothing short of a poor and narrow minded businessman.

To put forward such a controversial re-assessment of the man who could do no wrong as far as the press were (and still are?) concerned, you have to have your facts right. Unfortunately this work is plagued by many minor (and some less than minor) errors. The launch of the QL is portrayed as a total con with nothing working at the launch and no-one allowed near the 'mock-ups' displayed.

That must have been a different launch to the one I attended. I will grant that the QL when launched was not in production and still largely unfinished, but there were certainly working machines available for (rather limited and undirected) tinkering.

Worse than the odd inaccuracy is that this book suffers from tedium. It is difficult to present a detailed story of anyone's life in a truly interesting manner. After a few chapters all we are hearing is the same story, the same tales of commercial disaster and the same home-grown philosophies.

Nevertheless, this book makes a refreshing change. The angelic image of Sinclair in the press is not a true one. Like all people he has made many mistakes. Many of these mistakes, if we are to believe this book, are down to business incompetence and obsessions with the irrelevant.

It is good to feel a breath of fresh air but also a little sad to see the idol come crashing down.

**Malcolm Brown**

## PLAYBACK

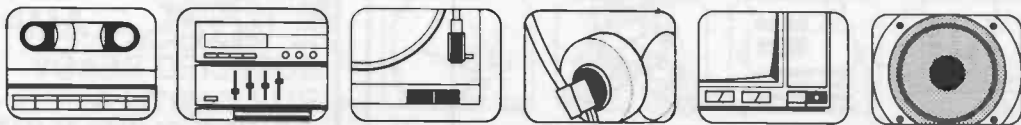

Recently I had the chance to play with a review copy of Sony's top of the range recording Walkman — with Dolby C and a crystal locked capstan. The advance of this interesting beastie over early models led me to reflect on the development of the ubiquitous personal stereo.

### The Original

The first personal stereo to hit the market was the original and now legendary Sony Walkman about six years ago. This was a smart all-metal cased unit 140x85x30mm. It looked well made to me and, although large by modern standards, it seemed tiny at the time.

It had two headphone outlets and a press to talk internal microphone, presumably to allow the two people to converse while wearing the headphones. A silly habit at the best of times.

It boasted separate left and right channel volume controls and a treble cut switch labelled 'metal'. The sound was pretty good but the treble cut was not enough to avoid a sensation of cheesewire between the ears when playing a Dolby encoded metal tape.

This old faithful has been thrashed continuously and it's still working perfectly with just one change of drive belt.

### And The Next

Its successor, a Sanyo M-G18D, proved lighter, more beautiful, and less durable. It's a whole heap smaller, 110x80x30mm, with Dolby B, separate left and right volume controls, and continuously variable treble cut. Judicious use of the tone control rendered Dolby C recordings listenable. This tiny miracle also had an internal mono loudspeaker and auto-reverse.

One other thing Sanyo got right — the player comes equipped with a clip to hang it over the waistband of the jeans. All the others I have seen offer the choice of wearing a belt (which I don't) or swinging the player around on a shoulder strap.

After about two years of heavy use the Sanyo declined to remain at the speed normally associated with cassette players.

I took the machine to bits to

try to find the reason for the speed variation. A few electrical measurements pinpointed the fault to the motor but given the size of it a repair looked chancy. It still works, but after a brief period the speed variation tends to bring on seasickness.

### Sony DC6

It was about this time I got a chance to play with the do-everything recording Walkman, the Sony DC6. The words *Quartz Locked Capstan* attracted my eye, after my problems with the Sanyo variable speed motor.

In fact, this particular Walkman has an intentionally variable speed function whereby the tape speed can be adjusted about 10% either side of nominal or run at the right speed when you tell it.

The facilities on this recorder include Dolby C and an LED peak reading record level meter. In addition to the stereo microphone input and the headphone output, it has line input and output sockets. The record and replay level controls have no separate adjustment for left and right channels.

This (fairly substantial) object seems to be intended to double as a component in a larger stereo system, so I tested it accordingly. It did stand up well. I carried out my tests using TDK SA tape and Dolby C. If there are any errors in the frequency response then Dolby C accentuates them greatly.

The results from the left and right channels were very similar. I measured the frequency response at two different levels, with the -5dB LED just on, and then with the -10dB LED just off. This corresponds to about -3dB and -12dB respectively. In both cases the response was ruler flat up to 15kHz, and about -3dB by 16kHz. After this the roll off is like the side of a cliff. Without getting too tied up with measurements, this is quite impressive. The important question is whether the sound is as good as the measurements.

A recording made with a microphone was indistinguishable on playback from the original on the headphone monitoring. The perceived noise level was low and the main limitation on

quality was the microphone itself. Recordings of music made on my Nakamichi recorder in Dolby C also sounded good, but there was a detectable flaw.

On some rapid changes of sound level there was a slight hesitation, as if the replay Dolby system was responding at a slightly different rate from the one which made the recording.

### Dolby C

The Dolby C system compresses certain frequency ranges very heavily on record and expands them again on replay. If there is any error in the tracking of the replay system with the record system then the very high degree of compression will make this more obvious than with Dolby B. Taking an extreme example, if you play a Dolby B recording with Dolby C switched on, the result is almost unlistenable.

Bearing all this in mind, it is not surprising that mismatches between different machines are evident. What is more surprising is that any Dolby C machine without adjustments to compensate for differences between tapes of nominally the same grade should work well. Some of them do though, as witness the Sony DC6.

To cut a long tale short, I found the effect of the Dolby C mismatch much less irritating than the pit-of-adders tape hiss which is the alternative. On the strength of the tests on the DC6, I bought its smaller brother (the DC2) which does not record. It's about a millimetre smaller in all dimensions than the Sanyo machine and makes most other walkmen sound like tin boxes. It is too soon to comment on its reliability but it has survived a crash which snapped my ski pole. The speed remains absolutely constant as I lurch unevenly around the ski slopes and the headphones are comfortable. Even under a ski hat.

Of all the walkmen I have looked at (including many others in various hi-fi shops) this one seems the clear winner in the choice between size, price, and performance.

The DC6 costs about £250, the DC2 about £150.

**Andy Armstrong**

# OPEN CHANNEL



I have reported in the past regarding my concern for the work involved in gaining requisite approvals to market products in Britain. At the time I was concerned that too many approvals bodies existed.

My suggestion was simple: combine all approvals bodies into one so that manufacturers had only one office to deal with.

However, if streamlining means a lowering of standards then this is not the way forward. Any easing of approvals procedures must not allow the equipment to be of inferior quality.

A recent report suggesting simplification of approvals procedures for telecommunications equipment went decidedly close to doing just this by recommending that transmission and signalling performances need not be tested. Instead, one presumes, market forces will decide whether the equipment sells — users will not buy the product if it doesn't work sufficiently well!

This is a dangerous and slippery path to take. Unfortunately, there will always be a market for cheap products, even if they don't work as well as they should. Take a look in any 'backstreet' electronics equipment shop window and you'll see many unapproved telephones which sell for much less than approved counterparts. True, some of them may be perfectly adequate as far as the user is concerned (in that they are cheap) but are they up to the mark regarding telecoms quality? At present if the product is unapproved, we can only assume it is not.

If the suggestions of the report are followed, it may be difficult to ensure that even approved equipment is of a high enough quality to maintain good telecommunications services.

Streamline approvals by all means. But don't interfere with quality!

## Second Generation Cells

Narrowband time division multiple access is probably to be the standard for the second generation of cellular telephones, planned for the early 1990s. This standard was agreed by all but France and Germany in late February and work has already been commenced to define the system in detail.

Agreement has been reached more by necessity than by mutual

consent. All involved parties have realised the importance of the tight timescale and scheduling which must be met if the system is to start early enough.

The overriding concern has been that existing systems will be totally overloaded by about 1991 at current rates of expansion. Overloading will occur even before that in dense urban areas. Development work must start now.

## Need For Speed

Hopefully, the Department of Trade and Industry will take note of the need for speed as it has yet to decide on the British operator. A lot of design, development, manufacturing and marketing jobs depend on an early decision.

To delay will almost certainly mean that operators from other countries could steal some, if not all, of the British potential.

If a DTI decision comes rapidly, on the other hand, British operators could perhaps steal some of the other European countries' potentials. The second generation cellular system is to be a pan-European system (nick-named PEDS 92 — pan-European digital system 1992) which means users will be able to roam — use an individual cellular telephone anywhere in Europe.

Because of this manufacturers and operators will theoretically also be able to 'roam' with their products — selling equipment and services throughout Europe. However, this will only be so for those with products and services to sell.

Incidentally, any reader who currently has a first generation cellular telephone and feels a little put out by all this talk of a new system within just a few years — take heart. The development of second generation services will not kill existing services. Far from it!

First generation services will continue to operate until well into the next century. All the second generation system will do is ease the pressure on the current deadlines for the overloading of the existing services.

Second generation cellular telephones will also (I predict) be far more expensive than present cellular telephones. So, if you're considering a cellphone at present but are put off by talk of a new system, don't be. Go ahead and get your phone!

Keith Brindley



## EVEN MORE MAD MARCH OFFERS

From **RTVC**

### 125 WATT POWER AMPLIFIER MODULE

SUPPLIED READY BUILT WITH A POWER SUPPLY KIT

**£19.90** + £3 pp

THIS QUALITY POWER AMP MODULE IS SUITABLE FOR HI FI DISCO UNITS. PA AND PROFESSIONAL USE IT IS OPEN AND SHORT CIRCUIT PROOF AND CAN BE USED WITH 4-16Ω SPEAKERS OUTPUT INTO 4Ω 125 WATTS RESPONSE 25Hz-20KHz T.H.D. 0.1% INPUT SEN 500 mV

### PHILIPS BURGLAR ALARM

IDEAL FOR FLATS MAISONNETTES AND SMALLER OFFICES OR HOUSES SUPPLIED WITH PRESSURE MAT MAG REED SWITCHES CABLE SOUNDER AND CONTROL BOX WITH TIME DELAY ENTRANCE AND EXIT

**£29.99** + £2.80 pp

MADE TO SELL FOR £59

### VHF STEREO TUNER KIT — £8.95

+ £2.50 p+p.

Easy to build 3-band stereo AM/FM tuner kit designed in conjunction with P.E. For ease of construction and alignment it incorporates 3 Mullard modules and an I.C. IF. System. **FEATURES:** VHF, MW, LW Bands, Interstation muting and AFC on VHF. Tuning Meter. Two back printed PCBs. Ready made chassis and scale. Aerial: AM — ferrite rod, FM — 75 or 300 ohms. Stabilised power supply with 'C' core mains transformer. All components supplied are to strict P.E. specification. Front scale size: 10½ x 2½" approx. Complete with diagram and instructions.

### PRACTICAL ELECTRONICS STEREO CASSETTE RECORDER KIT **£19.95**

+ £2.75 p+p.

★ Noise Reduction System ★ Auto Stop ★ Tape Counter ★ Switchable Eq ★ Independent Level Controls ★ Twin VU Meter ★ Wow & Flutter 0.1% ★ Record/Playback I.C. with Electronic Switching ★ Fully variable recording bias for accurate matching of all tapes, Metal, Chrome, etc. Kit includes transport mechanism, ready punched and back printed quality circuit board and all electronic parts. I.e. semiconductors, resistors, capacitors, hardware, top cover, printed scale and mains transformer. You only supply the solder and hook-up wire. As featured in P.E.

Complete with case.

### ENHANCE YOUR TV SOUND

WITH AN ACCESSORY BY POST FROM RTVC

**£29.50**

+ £2 pp



In the cut-throat world of consumer electronics the sound quality of the domestic TV set is one of the first casualties. Small speakers and no tone controls are common and this is really quite sad as the TV companies do the best to transmit the highest quality sound. Given this background a compact, independent TV SOUND TUNER that connects direct to your HiFi is a must for quality reproduction. The unit is mains operated. The unit offers full UHF coverage with 5 pre-selected tuning controls. It can be used in conjunction with your video recorder. Dimensions: 10½" x 2½" x 7½".

### SOLAR AA BATTERY CHARGER

4-6 hours recharge time. You can use the Solar 'AA' Battery Charger anywhere you go.

All you need is strong sunlight

**Mall: 21 HIGH ST, ACTION W3 6NG**

Callers to Acton or 323 EDGWARE ROAD, LONDON W2. (Open 6 days a week). Please allow 14 days delivery. Payments to RTVC Ltd. Order by ACCESS Tel:01-992 8430

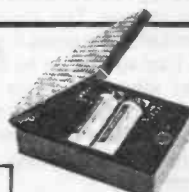

**ONLY £9.95**

+ 55p p&p

FOR USE WITH NI-CAD BATTERIES



---

---

# PCB FOIL PATTERNS

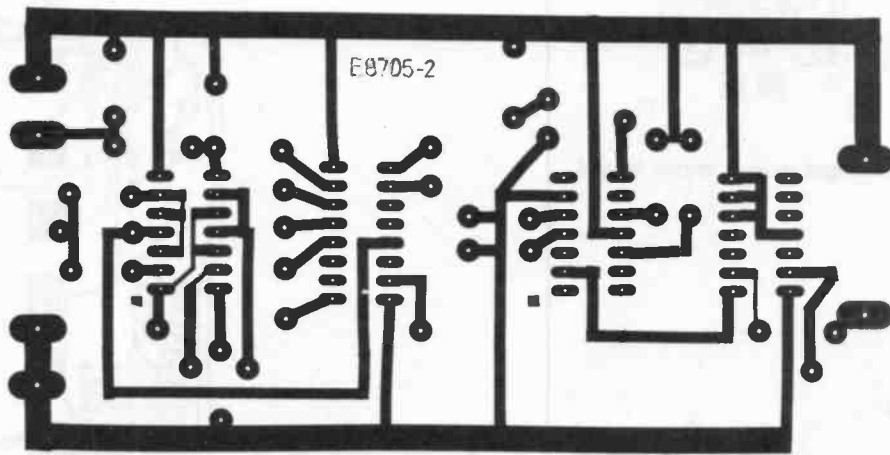

The Telfax 1kHz cue tone generator board.



The main Telfax board foil pattern.

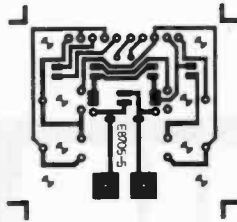

The budget power meter board.

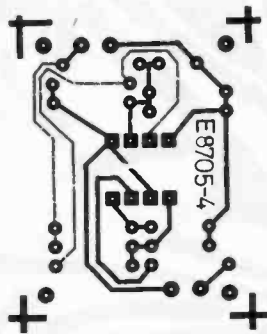

The foil pattern for the Batlite voltage indicator.

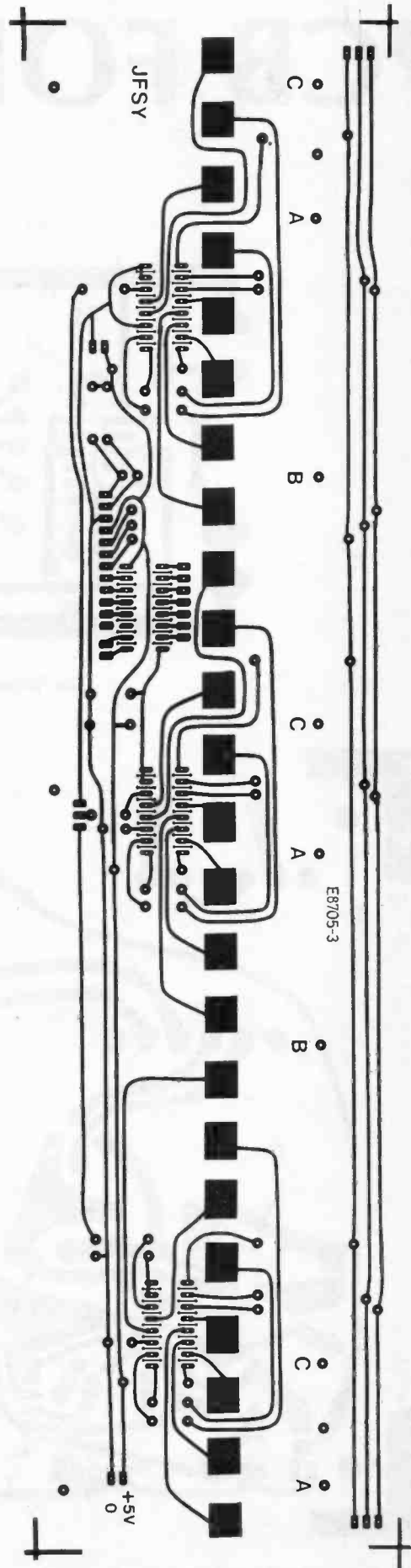

The entire MIDI keyboard keyswitch PCB approx 75% full size.

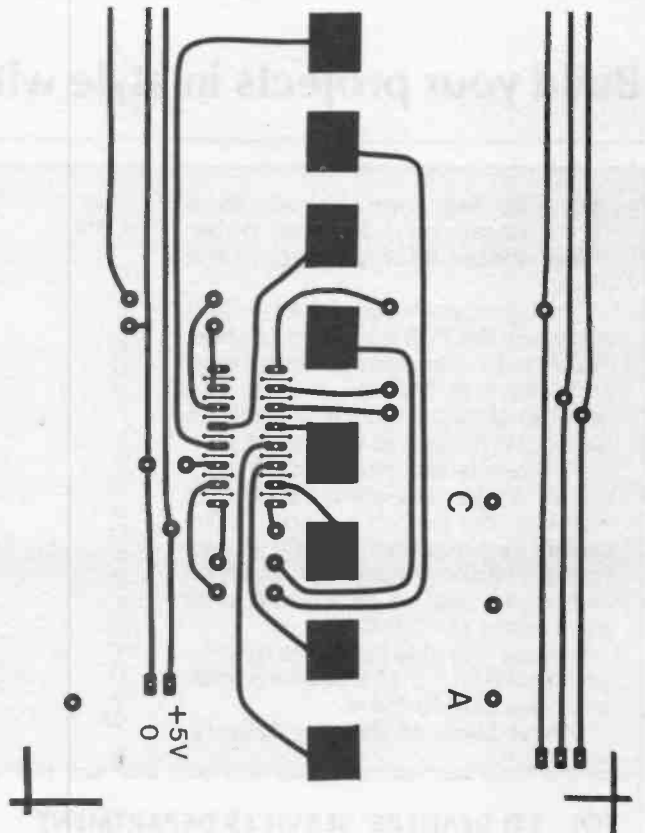
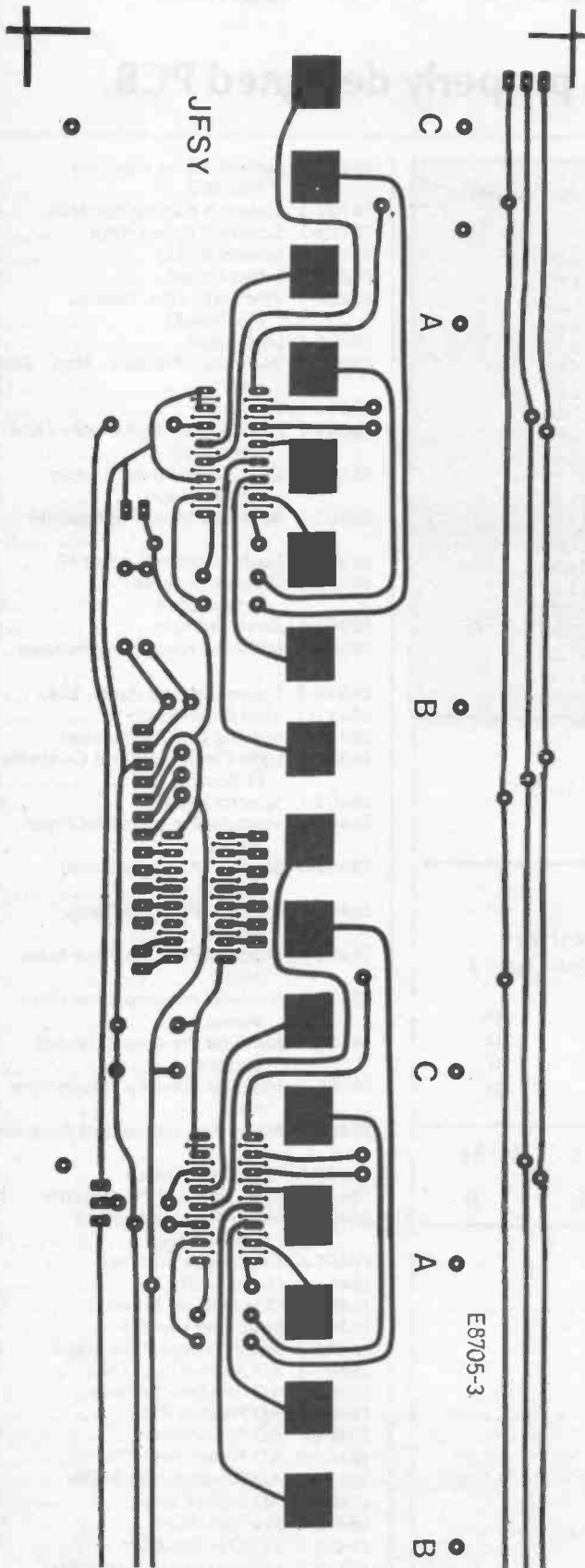

Sections of the MIDI keyboard keyswitch PCB full size.

# ETI PCB SERVICE

Build your projects in style with a properly designed PCB.

Use the form below (or a photocopy) for your order. Please fill in all parts of the form.

The board reference number tells you when the PCB foil was published. The first two numbers are the year and the next two the month. The number after the dash indicates the particular project in that issue.

The terms are strictly cash with order. Make cheques payable to ASP Ltd. We cannot accept official orders but we can supply a pro-forma invoice if required. Such an order will not be processed until payment is received.

Orders can also be made by telephone on (0442) 211 882 for Access and Visa card holders.

Please allow 28 days for delivery.

Price Code	Price (inc VAT) £
C	1.80
D	2.50
E	3.23
F	4.00
G	4.75
H	5.50
J	6.62
K	7.20
L	8.80
M	10.60
N	13.10
O	15.80
P	17.90
Q	21.80
R	23.90
S	25.90
T	29.00
U	32.20
V	35.80
W	37.90
X	40.70

**TO: ETI READERS' SERVICES DEPARTMENT**  
**Argus Specialist Publications Ltd,**  
**9 Hall Road, Hemel Hempstead,**  
**Herts HP2 7BH**

Please supply:

No. required per type	Board reference number	Price letter	Price each £	Total for board type £
	E	-	£ . p	£ . p
	E	-	£ . p	£ . p
	E	-	£ . p	£ . p
	E	-	£ . p	£ . p

POSTAGE & PACKING £ 0.75p

TOTAL ENCLOSED £ . p

**ORDER TO BE SENT TO: (BLOCK CAPS PLEASE)**

Name .....

Address .....

Postcode .....

(Make cheques payable to ASP Ltd)

**ACCESS and VISA credit card orders can be taken on (0442) 211 882 (office hours only).**

- E8107-1 System A Disc Input bd MC-MM. .... F
- E8107-2 System A Preamp Main ... K
- E8108-1 System A Power Amp ..... L
- E8109-2 System A PSU ..... F
- E8201-2 Infant Guard ..... C
- E8202-5 MM Stage Disc Preamp (Tilsbrook) ..... G
- E8206-5 Logic Lock ..... F
- E8208-1 Playmate Practice Amp 3bds SA1 ..... K
- E8212-1 ELCB ..... F
- E8301-2 Analogue to digital conv (ZX81/Spectrum) ..... E
- E8305-3 Dual Audio Power Supply, Linsley Hood ..... G
- E8305-5 Balanced Input Preamplifier ..... F
- E8307-2 Flash Trigger-sound or FR ..... F
- E8308-1 Graphic Equaliser 1/3 Oct/Chnl ..... M
- E8308-2 Servo Fail-safe ..... C
- E8309-1 NICAD Charger/Regenerator ..... F
- E8310-3 Typewriter Interface- EX42 ... F
- E8311-1 Mini Drum Synth ..... F
- E8311-8 Moving Coil Pre-Preamp ..... F
- E8312-3 Light Chaser EPROM Controlled (2 Boards) ..... K
- E8402-1 Speech Board ..... M
- E8402-2 Modular Pre-amp Disc Input Mono ..... F
- E8402-3 Modular Pre-amp Stereo Output ..... F
- E8402-4 Modular Pre-amp Relay, PSU ..... F
- E8402-5 Modular Pre-amp Tone Main Mono ..... F
- E8402-6 Modular Pre-amp Tone Filter, Stereo ..... F
- E8402-7 Modular Pre-amp Balanced Output ..... F
- E8402-8 Modular Pre-amp Headphone Amp ..... F
- E8404-2 Mains Remote control Receiver ..... F
- E8405-1 Auto Light Switch ..... F
- E8405-2 ZX81 EPROM Programmer ... N
- E8405-3 Mains Remote Control Transmitter ..... H
- E8405-4 Centronics Interface ..... F
- E8405-6 Drum Synth ..... F
- E8406-1 Oric EPROM Board ..... O
- E8406-2 Spectrum Joystick ..... E
- E8406-3 Audio Design RIAA Stage ... G
- E8406-4 AD Buffer/Filter/Tone ..... H
- E8406-5 AD Headphone Amp ..... F
- E8406-6 AD Preamp PSU ..... K
- E8406-7 AD Power Amp ..... H
- E8406-8 AD Power Amp PSU ..... J
- E8406-9 AD Stereo Power Meter ..... F
- E8406-10 AD Input Clamp ..... C
- E8407-1 Warlock Alarm ..... M
- E8408-2 EPROM Emulator ..... N
- E8408-3 Infrared Alarm Transmitter ... E
- E8408-4 Infrared Alarm Receiver ..... F
- E8409-1 EX42 Keyboard Interface ..... F
- E8409-2 Banshee Siren Unit ..... F
- E8410-1 Echo Unit ..... F



E8410-2	Digital Cassette Deck	N
E8410-3	Disco Party Strobe	H
E8411-5	Video Vandal (3boards)	N
E8411-6	Temperature Controller	D
E8411-7	Mains Failure Alarm	D
E8411-8	Knite Light	D
E8411-9	Stage Lighting Interface	F
E8411-10	Perpetual Pendulum	E
E8412-1	Spectrum Centronics Interface	F
E8412-4	Active - 8 Protection Unit	F
E8412-5	Active - 8 Crossover	F
E8412-6	Active - 8 LF EQ	F
E8412-7	Active - 8 Equaliser	F
E8501-3	Digital Delay (2 boards)	T
E8502-1	Digital Delay Expander	N
E8502-2	Data Logger	J
E8503-1	Combo Preamplifier	F
E8503-2	THD Meter mV & oscillator bds (2 boards)	K
E8503-3	THD Meter Mains PSU	F
E8504-1	Framestore Memory	M
E8504-3	Framestore Control	N
E8504-4	Buzby Meter	E
E8504-5	CCD Delay	F
E8505-5	Stereo Simulator	F
E8506-1	Audio Mixer Main	J
E8506-2	Audio Mixer PSU	F
E8506-3	Audio Mixer RIAA	D
E8506-4	Audio Mixer Tone Control	D
E8506-5	EPROM Prog MKII	O
E8508-1	RCL Bridge	N
E8508-2	EX42/BBC Interface	E
E8508-3	EPROM Emulator	L
E8509-1	Spectrum	F
E8509-2	Direct Injection Box	E
E8510-9	Sunrise Light Brightener	K
E8511-1	MTE Waveform Generator	H
E8511-2	Millifaradometer	H
E8511-3	Cymbal Synth	J
E8511-5	Chorus Effect	H
E8511-7	Enlarger Exposure Meter	F
E8511-8	Switching Regulator	E
E8511-9	Second Line of Defence	M
E8512-1	Spectrum connector	F
E8512-2	MTE Pulse Generator	H
E8511-3	Spectrum	L
E8601-2	Walkmate	L
E8601-3	MTE Counter-timer	M
E8602-1	Digibaro	O
E8603-2	Programmable Logic Evaluation Board	H
E8603-3	Sound Sampler Analogue Board	R
E8604-1	JLLH PA PSU	H
E8604-2	Matchbox Amplifier	C
E8604-3	Matchbox Amp Bridging Version	C
E8604-4	MTE Analogue/Digital Probe	M
E8605-1	Microlight Intercom	E
E8605-2	Baud Rate Converter	M
E8605-3	Baud Rate Converter PSU Board	C
E8605-4	Portable PA	H
E8606-1	Midi-CV Converter Board	H
E8606-2	Midi-CV Converter PSU	D
E8606-3	Troglograph	F
E8606-4	80m Receiver	H

E8606-5	Sound Sampler	R
E8607-1	Direction	E
E8607-2	Upgradeable Amp, MC stage (Stereo)	G
E8607-3	BBC Motor Controller	F
E8608-1	Digital Panel Meter	G
E8608-2	Upgradeable Amp, MM stage (mono)	H
E8609-1	Mains Conditioner	E
E8609-2	Experimental preamp	F
E8609-3	Upgradeable amp, Tone board (mono)	H
E8609-4	Upgradeable amp, Output board (mono)	F
E8610-1	Audio Analyser Filter Board	L
E8610-2	Audio Analyser Display Driver	K
E8610-3	Audio Analyser Display	H
E8610-4	Audio Analyser Power Supply	F
E8611-1	Audio Switcher (2 bds)	H
E8611-2	PLL Frequency meter (4 bds)	Q
E8611-3	Upgradeable Amp PSU	J
E8611-4	Call meter, main bd.	O
E8611-5	Call meter, interface bd	N
E8612-1	Bongo Box	J
E8612-2	Biofeedback monitor (Free PCB)	E
E8701-1	RGB Converter	F
E8701-2	Mains Controller	D
E8701-3	Flanger	H
E8701-4	Audio Selector main board	M
E8701-5	Audio Selector PSU	H
E8701-6	Tacho-Dwell	F
E8702-1	Ratometer main board	K
E8702-2	Ratometer ranging board	F
E8702-3	Photo Process Controller (3bds)	O
E8702-4	LEDline display board (2 off)	K
E8702-5	LEDline PSU and controller (2 bds)	G
E8703-1	Capacitometer	F
E8703-2	Geiger Counter	L
E8703-3	Credit Card Casino	E
E8704-1	BBC micro MIDI interface	L
E8704-2	ETIFaker patch box	H
E8704-3	24Hr. Sundial	E
E8705-3	MIDI Keyboard keyswitch bds (3 bds)	W
E8705-4	Batlite	C
E8705-5	Budget Power Meter	E

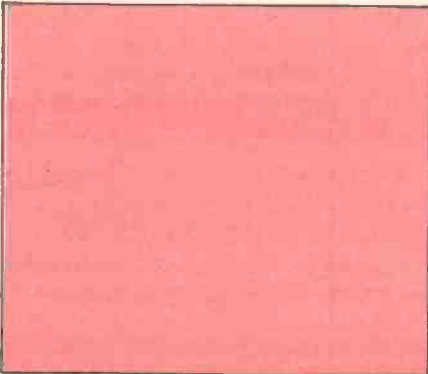

#### Audio Analyser (October 1986)

The PCB foil for this project was printed incorrectly. Referring to the overlay diagram (Fig. 3), a short vertical length of track should be inserted between the elbow to the right of R35(4) lower connection and the elbow to the right of R33(4) right hand connection so as to connect pin 11 of IC9(3,4) to 0V. A similar length of track connecting the elbows to the right of Ra(6) should be removed so that pin 3 of IC8(5,6) is *not* connected to pin 4. In the parts list C2 should be 100n and ICI should read LM3915N.

#### Digital Audio Selector (November/December 1986 and January 1987)

In Fig. 5 (December 1986) the resistors shown as R14 and R114 should be R19 and R119. This error is continued in the discussion of gain setting in the January 1987 issue.

The DG507A IC used in the prototype came from Farnell Electronic Components of Leeds, Tel: (0532) 636 311. Farnell normally deals only with trade customers but private orders are sometimes handled at the company's discretion. Trilogic of 29 Holm Lane, Bradford BD4 0QA, Tel: (0274) 684 289 will obtain any Farnell component to order on payment of a 25% handling charge. The Farnell order code is simply the full device number — DG507ACJ.

#### Biofeedback Monitor (December 1986)

The capacitor C4 is shown the wrong way around in the component overlay diagram (Fig. 4).

#### The Intelligent Call Meter (December 1986)

The hex dump listing of the ROM for this project (Table 3) was badly printed. The byte at location BF should read 7F.

#### The Better Flanger (January 1 1987)

In the circuit diagram (Fig. 2) D1 is not labelled. This is connected to Q1. In the component overlay (Fig. 5) several components are missing. A link should connect the two pads to the left of C1. Q1 is situated next to D1 and connection point P4 is situated between R16 and R33. In addition, the positions of R16 and C11 should be swapped.

#### Aerial Without Holes (In-Car Tech Tips, January 1987)

Using enamelled wire of only 0.5mm diameter for the bifilar coils could cause over-heating problems and even a fire risk with some cars. A much thicker wire (1.5mm should be sufficient) should be used.

#### Credit Card Casino (March 1987)

The circuit diagram (Fig. 1) incorrectly showed a connection between C2 (negative lead) and the positive rail. The PCB foil is correct.

#### Capacitometer (March 1987)

The circuit diagram (Fig. 1) should show pin 1 of IC1 connected to 0V. The zener diode (ZD1) should be connected between the junction of R10/R11 and 0V. The PCB foil is correct.

# BIG

## SUBSCRIPTION SAVINGS FOR YOU!

Take advantage of these fantastic money saving subscription offers to these magazines. Hurry, this amazing offer is for a limited period only.

### UNITED KINGDOM

### OVERSEAS

(Accelerated surface post)

	Normal Price	Sale Price	Please Tick	Normal Price	Sale Price	Please Tick
A&B Computing	<del>£21.00</del>	£18.00	<input type="checkbox"/>	<del>£26.00</del>	£20.80	<input type="checkbox"/>
Computer Gamer	<del>£16.00</del>	£13.00	<input type="checkbox"/>	<del>£21.50</del>	£17.20	<input type="checkbox"/>
Your Commodore	<del>£16.00</del>	£13.00	<input type="checkbox"/>	<del>£21.50</del>	£17.20	<input type="checkbox"/>
ZX Computing Monthly	<del>£15.00</del>	£12.00	<input type="checkbox"/>	<del>£18.00</del>	£14.40	<input type="checkbox"/>
Citizens' Band	<del>£16.90</del>	£13.52	<input type="checkbox"/>	<del>£22.00</del>	£17.60	<input type="checkbox"/>
Ham Radio Today	<del>£17.30</del>	£14.40	<input type="checkbox"/>	<del>£21.00</del>	£16.80	<input type="checkbox"/>
Electronics Digest	<del>£11.30</del>	£ 8.30	<input type="checkbox"/>	<del>£14.00</del>	£11.20	<input type="checkbox"/>
Electronics Today International	<del>£18.10</del>	£14.40	<input type="checkbox"/>	<del>£22.50</del>	£18.00	<input type="checkbox"/>
Video Today	<del>£16.90</del>	£13.52	<input type="checkbox"/>	<del>£21.00</del>	£16.80	<input type="checkbox"/>
Which Video?	<del>£16.90</del>	£13.52	<input type="checkbox"/>	<del>£21.00</del>	£16.80	<input type="checkbox"/>
Photography	<del>£16.00</del>	£12.00	<input type="checkbox"/>	<del>£21.50</del>	£16.00	<input type="checkbox"/>
Photoplay	<del>£17.90</del>	£14.32	<input type="checkbox"/>	<del>£21.50</del>	£17.20	<input type="checkbox"/>
Clocks	<del>£30.80</del>	£24.64	<input type="checkbox"/>	<del>£35.00</del>	£28.00	<input type="checkbox"/>
Woodworker	<del>£16.90</del>	£13.52	<input type="checkbox"/>	<del>£21.00</del>	£16.80	<input type="checkbox"/>
Popular Crafts	<del>£17.90</del>	£14.32	<input type="checkbox"/>	<del>£21.50</del>	£17.20	<input type="checkbox"/>
Winemaker & Brewer	<del>£13.70</del>	£10.96	<input type="checkbox"/>	<del>£17.00</del>	£13.60	<input type="checkbox"/>
Aeromodeller	<del>£25.10</del>	£20.08	<input type="checkbox"/>	<del>£29.00</del>	£23.20	<input type="checkbox"/>
Military Modelling	<del>£16.90</del>	£13.00	<input type="checkbox"/>	<del>£21.00</del>	£16.80	<input type="checkbox"/>
Model Boats	<del>£16.10</del>	£13.00	<input type="checkbox"/>	<del>£20.00</del>	£16.00	<input type="checkbox"/>
Radio Control Model Cars	<del>£19.10</del>	£14.00	<input type="checkbox"/>	<del>£21.50</del>	£17.20	<input type="checkbox"/>
Model Engineer	<del>£27.40</del>	£22.00	<input type="checkbox"/>	<del>£32.50</del>	£26.00	<input type="checkbox"/>
Radio Control Boat Modeller	<del>£ 8.50</del>	£ 7.50	<input type="checkbox"/>	<del>£11.50</del>	£ 9.20	<input type="checkbox"/>
R C M & E	<del>£15.00</del>	£12.00	<input type="checkbox"/>	<del>£20.00</del>	£16.00	<input type="checkbox"/>
Radio Control Scale Aircraft						
Quarterly	<del>£ 9.70</del>	£ 8.00	<input type="checkbox"/>	<del>£11.50</del>	£ 9.20	<input type="checkbox"/>
Radio Modeller	<del>£16.10</del>	£13.00	<input type="checkbox"/>	<del>£20.00</del>	£16.00	<input type="checkbox"/>
Sea Classic International	<del>£10.30</del>	£ 9.00	<input type="checkbox"/>	<del>£12.50</del>	£10.00	<input type="checkbox"/>
Scale Models International	<del>£18.00</del>	£13.00	<input type="checkbox"/>	<del>£20.00</del>	£16.00	<input type="checkbox"/>
Your Model Railway	<del>£16.00</del>	£12.00	<input type="checkbox"/>	<del>£25.00</del>	£20.00	<input type="checkbox"/>

**(Offer ends 30th April 1987)**

Please commence my subscription(s) with the ..... issue.

I enclose my cheque/postal order for £..... made payable to Argus Specialist Publications Ltd.

or debit £..... from my Access/Barclaycard No.

valid from ..... to ..... Signature .....

Name .....

Address .....

Send this form with your remittance to: **Subscriptions Savings Offer (S.O87)**  
**INFONET LTD., Times House, 179 The Marlowes, Hemel Hempstead, Herts. HP1 1BB.**

# FREE READERS' ADS

Buy, sell or exchange through our free service to readers

**BROADCASTTAPE RECORDER.** Scopetronics 1150. Valve electronics and all manual transport. £200 ONO. Pete: 01-737 2260.

**CORTEX** 16 bit micro, as featured in ETI. Many extras. Any reasonable offer. Tel: High Wycombe (0494) 35659.

**WANTED POWERTRAN** 1024 sequencer. Working or not working. Send details: R. Ford, 48 Hambleside, Bicester, OX6 8GB.

**EPSON P40 PRINTER**, box of paper. unused. £30. (0980) 33371 ext. 5237, ask for Mr. Holman. 8.30 am to 4.30 pm.

**HI-FI CASSETTE DECK** NAD 6050C with Dolby B and C. £100 ONO. 01-856 3851 at weekends.

**WANTED/BORROW:** Books on ZX81 ROM dis-assembly Part 'A' or Your ZX81 ROM by Dr. Ian Logan. Offers. Tel: (94) 760244.

**WANTED** Plus 1 for Acorn Electron. Preferably work- ing. Ed Turnbull. Tel: (0434) 607264. Evenings.

**WANTED** EPROM eraser reasonably priced, or swap. Also **FOR SALE:** ZX Spectrum. £60. Brand new. Tel: Worthing 200111. 24-hr Ansphone.

**FOR SALE** VIC 20 personal computer with manuals and data recorder. £35. Mr D. Egerton, 42 Beech Ave., Greenacres, Oldham, Lancs, OL4 2EE.

**TEXAS T156** programmable scientific calculator. £15. Mr. Richardson, 20 Callerton Close, Ashington, Northumberland, NE639QT.

**TWO 2x12 SPEAKER CABINETS**, empty. £40. **CASIO PT1**, new. £20. **SOLID STATE REVERB.** £35. St. Albans (0727) 55005.

**OLIVETTI M20** 16 bit computer. Complete with WP, Multiplan, MS-Basic, manuals. £300. Tel: (0395) 265301.

**TELETYPE** Data Dynamics 390. Printer, keyboard,

paper tape punch/reader, pedestal. £20. Tel: (0705) 592036.

**JUPITER ACE** computer, FORTH language. Unused since new. Includes manual, PSU. £25 ONO. F.D. Woodsford, 16 Braefoot, Carnoustie.

**NASCOM 2** complete. Extra power supply. Extra main board. EPROM programmer, eraser. Offers: Mr. Bisher, 37 Merchiston Avenue, Edinburgh, EH10 4PD.

**SOUND SAMPLER** for C64 and 128. £42. **MIDI INTER- FACE** £42. Timor Ozergin, Slingerstigen 14, 6670, Forshaga, Sweden.

**WANTED:** Hewlet Packard 9100 series desktop calculators or similar 1960s models. Please phone James on 01-727 5956.

**RS232** serial port for **SANYO MBC555** computers. Plug in accessory. New, unused. £20. Tel: 031-449 6104.

**For sale:** ETI flanger. **TIME MACHINE** aural exciter, compressor-noise gate. **ACCESSIT** compressor. Offers. (0704) 41148 (evenings).

**WANTED: AY-1-0212 OR MO87** IC to complete elec- tronic piano project. Cash paid. Mr. Runacre, 21 Dundonald Road, Ramsgate, Kent. Tel: Thanet 586371.

**SPECTRUM PLUS**, joyball, interface, games, ZX printer, six rolls paper. Hardly used. £70. Tel: Tony (0438) 351657.

**MAPLIN MATINEE ORGAN.** Two keyboards, pedals, service manual. £160. Part ex. synthesizer/expander. Cardiff (0222) 628473.

**SIRIUS** micro. Fully expanded, 640K RAM, clock card, software, etc. £600. Simon, Brighton (0273) 736880.

**20 INCH RGB MONITOR.** Converted television. Excellent resolution. £70 ono. Details Tel: Dave, Southampton (0703) 433871.

**WANTED: BEEPER UNIT** for page alert 4444T. Please Tel: 021-328 3994 (Birmingham) evenings.

**CONDITIONS**

- These ads are only for readers not engaged in buying or selling the same equipment or services on a commercial basis.
- Ads will be inserted as and when space is available. Insertion in a particular issue cannot be guaranteed.
- Ads should be of 20 words or less and in block capitals or typed. Words to appear in bold should be underlined.
- Advertisers should fill in their name, address, and telephone number and sign the form to indicate acceptance of these conditions. Adverts can be on the printed form or a photo- copy of it but they must be accompanied by the token at the top of this page.
- ETI reserves the right to refuse or to alter submitted ads wherever this is judged necessary.
- Ads are accepted in good faith. Neither the magazine nor its publishers can be held responsible for any errors in the reproduction of an ad, nor for untruths or misrepresenta- tions, nor for the activities of advertisers or respondents. By acceptance of these condi- tions the advertisers undertake to indemnify the publisher against any legal action arising from publication of their advertisement.

Enter your advertisement below

Name .....

Address .....

Telephone .....

I accept the conditions set out here.

Signed .....

Send this form to:

**Free Readers' Ads  
Electronics Today International  
1 Golden Square  
London W1R 3AB.**

## SUPPLIES

**QUALITY WALKIE TALKIES 49** MHz, long range satisfaction or refund. £24.99/pair (normally £31.49), 48 hrs delivery, Xenon (dept ET 19) 24 Wharnclyffe Street, Barnsley, Yorkshire.

## TERMS

### CLASSIFIED ADVERTISING TERMS & CONDITIONS

Our terms for new advertisers (semi-display and lineage) are strictly pro-forma payments until satisfactory reference can be taken up (excluding recognised advertising agencies). Cheques and P.O.'s should be crossed and made payable to ARGUS SPECIALIST PUBLICATIONS LTD, and sent together with the advertisement to:

"The Classified Dept.,  
No. 1 Golden Square,  
London W1R 3AB.

There are no reimbursements for cancellations. Advertisements arriving too late for a particular issue will be inserted in the following issue unless accompanied by instructions to the contrary. It is the responsibility of the advertiser to ensure that the first insertion of every series is published correctly, and corrections must be notified in time for the second insertion, otherwise the publishers will not accept any liability or offer any reduction in charges.

All advertising sales are subject to Government Regulations concerning VAT. Advertisers are responsible for complying with the various legal requirements in force eg: The Trade Description Act, sex discrimination act & the business advertisements (disclosure) order 1977.

Full Terms & Conditions of Advertising available on request.

## PLANS & DESIGNS



Design and build your own electronic dashboard. Plans, instructions, circuits, parts lists £4.95 inc p&p

**BURLINGTON MOTOR CO. LTD.,**  
(G4) ARCH 39M, BATH PLACE,  
LEAMINGTON SPA. CY3 3AQ.

**ELECTRONIC PLANS,** laser designs, solar and wind generators, high voltage teslas, surveillance devices, pyrotechnics and computer graphics tablet. 150 projects. For catalogue, SAE to Plancentre Publications, String Works, Bye St., Ledbury HR8 2AA.

**PORTABLE WORK Station** - easily constructed from plywood. Plans £3.50 only. BOLDELEC, 5 Denise Avenue, Penketh, Warrington WA5 2RE.

## SERVICES

**DESIGN SERVICES,** microprocessor, special interfaces, analogue, digital, signalling, alarm systems, PCB design and artwork. Prototype and small batch production. **ALAB ELECTRONICS.** Grantham (0476) 860089.

## COMPONENTS

### PROMs - EPROMs - PALS

ANY PROGRAMMABLE IC SUPPLIED OR BLOWN

PRICES (Including Programming)

2716 £3.45 2732 £3.60  
2764 £2.85 27128 £3.20 etc.

**BIPOLAR PROMs from £1.35**  
e.g. 82S123, 18S030, 74S288  
**PALS, PLDs etc. from £3.26**  
e.g. 82S153, 16L8, EP300

Full design and prototyping service  
Any quantity programmed - SAE or phone for details

**P.L.S., 16 Wordsworth Drive,**  
Cheam, Surrey, SM3 8HF  
Phone 01-644 8095

### I.G.S. COMPONENTS, NO 18 QUEENSWAY, SHELLEY, ONGAR, ESSEX. CM5 0BN.

Resistors 1/4W 5% carbon film E12 1+2p. 25+1.5p. 100+1p 4R7 to 10M anymix. 10off each above=770 resistors £4.40. 5mm LEDs red 1+8p. 25+6p. 100+5p. green or yellow 1+11p. 25+9p. 100+8p. IDC Ribbon Cable Grey 0.05in pitch. 10way 12p/ft. 16way 18p/ft. 20way 23p/ft. 26way 30p/ft. 34way 34p/ft. 40way 46p/ft. IDC connectors also available full list free on request. All prices inc VAT. Orders under £10.00 50p extra.

## EQUIPMENT

### 100 WATT MOSFET AMPLIFIER

Including Toroidal Power  
Supply £37.95.

Details from:

**DATABITS, 65 Latimer Road,**  
Cropton, Leicester LE7 7GP.

**COMPLETE GEIGER counter** (with Tube) for radiation measurement - Under £50. Send for details: Radiation Detectors 46/47 Pall Mall, London SW1Y 5JG. Tel (01) 839 3143.

## MISCELLANEOUS

**HEATHKIT U.K.** Spares and service centre. Cedar Electronics, Unit 12, Station Drive, Bredon, Tewkesbury, Glos. Tel. 0684 73127.

5.25" disks, bulk RPS, DS 96tpi £0.46  
Resistors .25W 5% E12 values £0.01  
Caps. .01, .015, .022, .033, .047, £0.06  
.1 £0.06  
Elec. Caps. 1/83, 10/16, 100/16 £0.06  
Eprom 27256-2, 12.5 Vprog £3.95  
25 way D plug, socket or shell £0.74  
DIN plugs & skt's 5, 6, 7 pin £0.20  
LED's 5mm red, grn, amber £0.10  
All prices inc. P&P, please add  
VAT 15%

**T-systems Ltd** Tel. 0689 22196

**The Signal Cabin,**  
61 High Street,  
Orpington, Kent, BR6 0JF

**RING NICOLA BATY**  
**ON 01-437 0699 FOR**  
**ADVERTISING DETAILS**

**E  
L  
E  
C  
T  
R  
O  
M  
A  
R  
T**

## LANCASHIRE

### ELECTRO SUPPLIES NORTHERN COMPONENT SPECIALISTS

 Test equipment, Computers, Peripherals

SEND FOR CATALOGUE

also at  
45 Lower Hillgate, Shawclough Road,  
Stockport, Cheshire Waterfoot, Rossendale  
061 477 9272 884 9JZ. 0706 - 215556

## LIVERPOOL

### PROGRESSIVE RADIO

87/93 Dale Street Tel: 051 236 0154

47 Whitechapel. Tel: 051 236 5489

Liverpool 2

'THE ELECTRONICS SPECIALISTS'

Open: Tues-Sat 9.30-5.30

## YORKSHIRE

### COMPUTERCARE Electronic Components \* Computer Supplies \*

Repairs

12 COMMERCIAL ROAD,  
LEEDS, LS5 3AQ.

(Across from Kirkstall leisure centre)

Open: Monday-Friday 9-5.30

(Saturday please phone first)

Phone LEEDS 743356 for stock list

## TYNE AND WEAR

### ELECTRONIC COMPONENTS AND KITS



STATION ROAD, CULLERGOATS,  
NORTH SHIELDS, TYNE & WEAR NE30  
4PQ. 091 251 4363.

MON-SAT 9.30 to 5.30  
CLOSED THURS.



**E  
L  
E  
C  
T  
R  
O  
M  
A  
R  
T**

**electronics today**  
INTERNATIONAL

### CLASSIFIED ADVERTISING COUPON

Post to: ETI, 1 Golden Square, London W1A 3RB

Rates: 48p per word, £7.20 (VAT incl). There are no reimbursements for cancellations. All ads must be prepaid. Semi display (min. 2cm) £11.60 per single column centimetre + VAT.

Please debit my Access/Barclaycard No.  

Expiry date.....

£.....for.....insertions.

Or I enclose my cheque/PO for £.....for.....insertions.

Please use BLOCK CAPITALS and include post codes.

Classification.....

Name (Mr/Mrs/Miss/Ms).....  
(delete accordingly)

Address.....

Signature.....Date.....

Daytime Tel. No. ....



# ELECTRONICS TODAY INTERNATIONAL CLASSIFIED

**Lineage:**  
**48p (VAT incl) per word (minimum 15 words)**  
**Semi Display: (minimum 2 cms)**  
**£11.60 per single column centimetre**  
 Ring for information on series bookings/discounts  
 All advertisements in this section must be prepaid.  
 Advertisements are accepted subject to the terms and conditions printed on the advertisement rate card (available on request)



01-437 0699 Ext 292

Send your requirements to:  
**Nicola Baty**  
**ETI Class. Dept.,**  
**ASP Ltd.,**  
**1 Golden Square,**  
**London W1.**

## COURSES

Start training now for the following courses. Send for our brochure — without obligation or Telephone us on **06267 79398**

REF: ETI/5

**NAME** \_\_\_\_\_

City & Guilds Exam

Radio Amateur Licence

Micro-processor

Introduction to Television

Radio & Telecommunications Correspondence School,  
 12, Moor View Drive, Telnmouth, Devon. TQ14 9UN.

## ALARMS

# ALARMS

**FREE BOOKLET** on **BURGLAR ALARMS** with **LOWEST U.K. DIY PUBLISHED PRICES**

PHONE OR WRITE FOR YOUR COPY  
**051-523 8440**  
**AD ELECTRONICS**  
 217 WARBRECK MOOR  
 AINTREE, LIVERPOOL L9 0HU

## ELECTRONICS TECHNICIANS

Updating Courses  
 London Electronics College,  
 (Dept ETI), 20 Penywem Road,  
 London SW5 9SU. 01-373 8721.

## SPECIAL OFFERS

FREE MEMBERSHIP to a new NATIONAL ELECTRONICS CLUB.

For details and a free gift of components worth over £10 send only £1.00 p&p to Woodside, Dowsett Lane, Ramsden Heath, Essex CM11 1JL.

**AMAZING EASTER GIVE-AWAY!**... poweramps... 60 watt/£5----100 watt/£8...power supplies...40V/STAB/£5---- KIA-8 Cunliffe Road, Ilkley, LS29 9DZ.../100 free resistors — return ad + 50p (p&p)!!

## POWER SUPPLIES

**220/240v AC** Electricity from 12v batteries. Encapsulated modules with screw terminals. Microchip design. Just connect transformer and 8 heat sinked transistors to terminals. 400W/12v £28; 600W/24v £30 p&p £0.75. Detailed assembly instructions provided, Chataigne Products, Green Lane, Great Horkesley, Colchester, Essex, CO6 4HD. (Prop. J.A. Richmond).

## WANTED

We purchase for cash or immediate settlement surplus stocks of I.C's, Memories, Transistors, etc. Please contact by: **Telephone or Telex No: 825616 or 0767 317388.**

Turn your surplus transistors, IC's etc., into cash. Immediate settlement. We also welcome the opportunity to quote for complete factory clearance. Contact:

**Coles Harding & Co.**  
 103 South Brink  
 Wisbech, Cambs.

ESTABLISHED OVER 10 YRS  
 Tel: 0945 584188

**01-437 0699 = RESULTS**

## REPAIRS

**INSTRUMENT REPAIRS** oscilloscopes, generators, multimeters and more. Viking Electronics, Potkins Lane, Orford, Suffolk IP12 2SS (0394) 450006.

## SCOPES

### MENDASCOPE LTD.

REPAIR & RECALIBRATE  
 OSCILLOSCOPES.  
 ALL MAKES ALL MODELS.  
 NATIONWIDE COLLECTION & DELIVERY  
 FREE ESTIMATES  
 Phone 069-172-597

**TEKTRONIX OSCILLOSCOPES** dual-trace, Calibrated. 585A 85 MHz delay sweep from £325, 547 50 MHz delay sweep from £185, 561B 875 MHz sampling £195, eight-tracers from £185, Hameg 70 MHz delay sweep £415. Fine condition. Tel: (01) 868 4221.

## SWITCHES

**VOICE/SOUND ACTIVATED SWITCHES** easy to follow diagrams and uses only £1.00. Components and P.C.B's available: **Herrington, 63 Home Farm Rd, Hanwell, London W7 1NL.**

## BOOKS

**PARAPHYSICS** Journal (Russian Translation); Psychotronics; Kirlianography, Heliphonic Music, Telekinetics. Computer Software. S.A.E. 4 x 9", Paralab, Downton, Wiltshire.

## KITS AND READY BUILT

**FM TRANSMITTERS** Same day despatch **MINIATURE MODEL** frequency 60-145 Mhz, range 1 mile. Glass fibre P.C.B. All components. Full instructions 9-12V operation, broadcast reception. Super sensitive microphone. Pick up on **FM/VHF** radio. £6.95 inc or ready built £8.95. Size 57 x 19 x 12mm. **HIGH POWER MODEL.** 3 watts 80-108 MHz. Professional broadcast performance. Low drift varicap controlled. Range up to 7 miles. 12V operation. Any input audio/microphone. All components P.C.B. diagrams and instructions. Size 103 x 39 x 29mm. Kit 13.99 inc or ready built £18.99 inc. Send S.A.E. for our DataPack on other products. **ZENITH ELECTRONICS.** 14 Cortlandt Business Centre, Hailsham, East Sussex BN27 1AE. Tel: 0323 847973.

**ETI KITS** assembled and tested\* by electronic trainees under supervision within a purpose built electronic workshop for as little as £10\* (\* depending on type of kit and complexity). Contact:- A.J. Smith, Dept K.A. Electronics Workshop, Lincoln I.T.E.C. Dean Road, Lincoln LN2 4JZ. Tel. 0522 43532.

**LINSLEY HOOD** Designs. Send S.A.E. for details to Teleradio Electronics, 325 Fore Street, London N9 OPE.

★ BRAND NEW CATALOGUE ★  
**OMNI ELECTRONICS**

We stock a wide range of components:  
transformers, switches, pots, ICs, capacitors, resistors, diodes, boxes,  
triacs, LEDs, cable, connectors, PCBs—  
in fact, all you need for your projects.

Send for our new catalogue - 20p + 18p postage or call at our  
shop Mon-Fri 9am - 6pm, Sat 9am - 5pm.

**174 Dalkeith Road  
EDINBURGH EH16 5DX  
031-667-2611**

**Interak 1**

**AN EXPANDABLE DISK-BASED  
Z80A DEVELOPMENT SYSTEM  
YOU CAN BUILD YOURSELF!**

Universities, Colleges, Industry, Enthusiasts:

Unlike home computers, development systems have entirely  
"open" architectures, use standard TTL etc. chips (ie no  
ULA's!), and are built in a proper engineering fashion. Usua-  
lly these superior products carry a correspondingly  
superior price tag, but you can build Interak yourself board  
by board and thus afford a system which would normally be  
out of your reach and/or understanding.

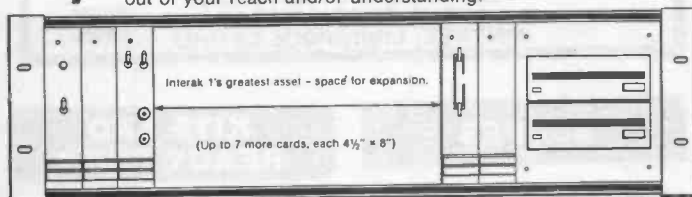

Interak 1's greatest asset - space for expansion.

(Up to 7 more cards, each 4 1/2" x 8")

YOUR OWN EXPANSION  
(EG. SPEECH SOUND EPROM PRINTER MODEM TAPE,  
RELAY CONTROL INTERFACING ETC. ETC.)

The initial development system has 64K of RAM, a 4 MHz  
Z80A CPU, parallel ASCII keyboard interface, VDU interface  
(TV set or monitor), and a floppy disk drive interface for up to  
4 drives. Any size (including 8" double density) can be used,  
but our 1 Megabyte 3.5" drives are proving very popular  
because they can fit into the system rack, (and they only  
cost £94.00 each + VAT). CP/M Plus is available, giving  
access to thousands of "public domain" programs.

The system can be described as "future proof" because it  
uses plug in 4.5" x 8" cards in an industrial quality 19" 3U  
rack. We have been established since 1970, and this system  
was first made in 1977 so (unlike almost all other computers)  
it has stood the test of time.

Send two second class stamps, or telephone for a  
detailed descriptive leaflet, specification, prices, etc.

**Greenbank**

Greenbank Electronics (Dept T5E), 460 New Chester Road,  
Rock Ferry, Birkenhead, Merseyside L42 2AE. Tel: 051-645 3391

**TRANSFORMERS EX-STOCK**

MAINS ISOLATORS				30/15V or 15.0-15V				24/12V or 12-0-12V				AUTOS																																			
Pw/Sec 120V/2 OR				2+15V TAP SECS				2+12V Secs. Pri. 240V				105, 115, 220, 230, 240V																																			
240 to 415/440V				30V 15V £ P&P				12V 24V £ P&P				For step-up or down																																			
(50-1000VA Tap Secs)				0.5 1 2 3 4 5 6 8 10 12 15 16 20 24 28 32 36 40 43.75 48 56 60 600				0.5 0.5 0.25 1 2 4 6 8 10 12 15 16 20 24 28 32 36 40 43.75 48 56 60 83 41				VA £ P&P																																			
20	7.60	2.18	2	1	2	5.24	1.70	0.3	0.15	2.92	1.10	80	5.86	1.70	150	8.49	1.85	250	10.34	1.98	500	16.12	2.68	1000	28.79	3.25	1500	34.17	3.68	2000	51.09	4.62	3000	86.88	5.72	4000	112.78	O/A	5000	131.33	O/A	7500	202.71	O/A	10KVA	239.53	O/A
250	23.01	3.24	6 P	12	18.40	2.55	8 M	4	10.85	2.10	20	10	21.17	3.04	CASED AUTOS																																
500	35.45	3.66	8 S	16	21.95	2.95	12 P	6	13.20	2.25	30	15	26.31	3.10	240V Cable input																																
1000	64.28	4.62	10 S	20	25.32	2.84	16 S	8	15.73	2.60	40	20	37.56	3.75	115V USA socket outlets																																
1500	82.92	5.85	12	24	28.07	2.95	20	10	21.17	3.04	VA £ P&P																																				
2000	98.76	6.36	15	20	31.65	3.51	83 41 62.09 5.65				20 8.34 1.76																																				
3000	139.89	O/A	20	40	43.22	5.95	INVERTERS				80 11.33 1.87																																				
6000	298.89	O/A	2+30V TAP SECS				12/24V DC to 240V AC				150 14.87 2.20																																				
			0.5 1 2 3 4 5 6 8 10 12 15 16 20 24 28 32 36 40 43.75 48 56 60 600				100W to 4kW				250 17.87 3.02																																				
			2+25V TAP SECS				WINDING SERVICES				500 29.32 3.19																																				
			50V 25V £ P&P				3VA TO 15KVA				1000 40.29 4.34																																				
			0.5 1 2 3 4 5 6 8 10 12 15 16 20 24 28 32 36 40 43.75 48 56 60 600				Single or 3-phase				2000 73.33 5.28																																				
			1 2 8.09 1.90				Plus Toroids				3000 105.26 O/A																																				
			2 A 4 10.84 2.20				Stack-Items by return				Full range AVO's, Meggers																																				
			3M 6 12.54 2.25				CONSTANT VOLTAGE				Fluke, Edgcombe																																				
			4 P 8 17.16 2.58				TRANSFORMERS FOR				ALSO VALVE MAINS																																				
			6 S 12 21.84 2.79				Spike-free stable mains				OUTPUT & MATCHING																																				
			8 16 30.89 3.15								TRANSFORMERS																																				
			10 20 36.66 3.60																																												
			12 24 43.87 3.80																																												

Unit 211, Stratford Workshops, Burford Road, London E15 2SP  
**BARRIE ELECTRONICS LTD**  
Tel: 01-555 0228 (3 lines)

**Zenith Electronics**  
**Kits - Modules - Hardware**

**YOU KNOW US FOR OUR TRANSMITTER KITS - NOW**  
**TAKE A LOOK AT OUR GROWING RANGE OF**  
**QUALITY KITS AND READY-BUILT PROJECTS:**  
**MODULES AND ELECTRONIC HARDWARE**

- The following are examples of our proven product designs in kit form:
- ★ Miniature FM Transmitter; 60-145MHz. Kit £6.95; R/Built £8.95.
  - ★ 3 Watt FM Transmitter, 80-108MHz. Kit £13.99; R/Built £18.99.
  - ★ 10 Channel Variable Speed Running Light; Drives LEDs or mains lamps. Kit £14.97.
  - ★ 3 Note Electronic Door Chime unit; 9 volt operation, 3 melodious tones; variable frequency. Kit £9.83.
  - ★ 300 Watt Light Dimmer unit for 240 volt mains lights. Kit £6.95
  - ★ 5 Code Digital Code unit plus Key Pad—select own code; 9 volt. Kit £14.21.
  - ★ 5-100 Watt Electronic Loudspeaker Overload Protector, adjustable. Kit £11.11.
  - ★ VU Meter 10 LED indicator; -5 to +12dB range. Kit £12.59.
  - ★ Automatic light controller; automatically turns on and off lights at pre-set times and triggered by darkness. Kit £25.08.
  - ★ Mains Wiring and Metal Detector; complete with case. £11.00
  - ★ Digital Clock module; 12-24 hour timing; LED type—£17.49, or LCD type—£22.80.
  - ★ Amplifier Power Meter; 10 LED indicator from 0-25-100 Watt Input—9 volt operation. Kit £9.52.
  - ★ Light sensitive relay unit; variable sensitivity trigger control; senses light or dark—selectable. Kit £8.45.
- ALL KITS CONTAIN FULL INSTRUCTIONS: P.C.B.s AND COMPONENTS.  
ALL PRICES INCLUDE VAT AND POSTAGE & PACKING.  
OVERSEAS ORDERS—ADD 10% TO ABOVE PRICES.  
PLEASE SEND CHEQUE OR POSTAL ORDERS WITH ORDER.

**S.A.E. For** ★  
**FREE** —  
**Data Pack** ★

Zenith Electronics, 14 Cortlandt Business Centre,  
Hailsham, E. Sussex, U.K. BN27 1AE.  
Tel: 0323 847973 Dept 2.

**ADVERTISERS INDEX**

Audiokits	25
Barrie Electronics	62
BK Electronics	IFC
Cricklewood Electronics	43
Crofton Electronics	37
Display	IBC
Greenbank	62
Hart Electronics	18
Henrys Audio Electronics	49
ICS	49
Jaytee Electronics	32
Maplin Elec. Supplies	OBC
MJL	32
Omni	62
Readers Services	10&11
RTVC	52
Stewarts of Reading	37
Technomatic	4&5
TJA Development	49
Thandor Electronics	43
Vinderen Associates	32
VW & E Smith	43
Stan Willets	32
Zenith Electronics	62

# COMPUTER WAREHOUSE

1000's OF BARGAINS FOR CALLERS

## THE "ALLADINS' CAVE OF COMPUTER AND ELECTRONIC EQUIPMENT

### HOT LINE DATA BASE

## DISTEL

The ORIGINAL FREE OF CHARGE dial up data base. Buy, browse or place YOUR OWN AD for goods or services to sell. 1000's of stock items, spares and one off bargains. Updated daily. ON LINE NOW. CCITT, 8 bit word, no parity. For 300 baud modems call 01-679 1888 For 1200-75 baud modems call 01-679 6183

## FREE

Your monitor from its computer!! For only £24.95 it becomes a SUPERB HIGH QUALITY \* COLOUR \* TV SET

The fabulous TELEBOX, an INVALUABLE MUST for the owner of ANY video monitor with a composite input, colour or monochrome. Made by a major UK Co. as a TOP QUALITY, stand alone UHF tuner and costing OVER £75 to manufacture. This opportunity to give your monitor a DUAL FUNCTION must not be missed!! The TELEBOX consists of a compact, stylish two tone charcoal moulded case, containing ALL electronics tuner, power supply etc to simply plug in and convert your previously dedicated computer monitor into a HIGH QUALITY COLOUR\* TV SET, giving a real benefit to ALL the family!! Don't worry if your monitor doesn't have sound - THE TELEBOX even has an integral 4 watt audio amplifier for driving an external speaker, PLUS an auxiliary output for superb quality television sound via your headphones or HI FI system etc. Other features include: Compact dimensions of only 15.75" w x 7.5" d x 3.5" h, latest technology, BRITISH manufacture, fully tuneable 7 channel push button tuner, Auto AGC circuit, SAW filter, LED status indicator, fully isolated 240v AC power supply for total safety, Mains ON-OFF switch etc. Many other uses.

LIMITED QUANTITY - DON'T MISS THIS OFFER!!!

ONLY £24.95 OR £19.95 if purchased with ANY of our video monitors. Supplied BRAND NEW with full instructions and 2 YEAR warranty. Post and packing £3.50 \*When used with colour crt

## COLOUR & MONOCHROME MONITOR SPECIALS

### 'SYSTEM ALPHA' 14" COLOUR MULTI INPUT MONITOR

Made by the famous REDIFFUSION Co. for their own professional computer system this monitor has all the features to suit your immediate and future requirements. Two video inputs: RGB and PAL Composite Video, allow direct connection to BBC/IBM and most other makes of micro computers or VCR's including our very own TELEBOX. An internal speaker and audio amp may be connected to computer or VCR for superior sound quality. Many other features: PIL tube, Matching BBC case colour, Major controls on front panel. Separate Contrast and Brightness - even in RGB mode. Separate Colour and audio controls for Composite Video input, BNC plug for composite input, 15 watt 'D' plug for RGB input, modular construction etc.

This Must Be ONE OF THE YEAR'S BEST BUYS. PC USER Supplied BRAND NEW and BOXED, complete with DATA and 90 day guarantee. ONLY £149.00 as above OR IBM PC Version £185.00 15 Day 'D' skt £1.00. BNC skt 75p BBC interface cable £5.50

### DECCA 80 18" COLOUR monitor. RGB Input.

Little or hardly used manufacturer's surplus enables us to offer this special converted DECCA RGB Colour Video TV Monitor at a super low price of only £99.00, a price for a colour monitor as yet unheard of!! Our own interface, safety modification and special 15" high definition PIL tube coupled with the DECCA 80 series TV chassis give 80 column definition and quality found only on monitors costing 3 TIMES OUR PRICE. The quality for the price has to be seen to be believed!! Supplied complete and ready to plug direct to a BBC MICRO computer or any other system with a TTL RGB output. Other features are: internal speaker, modular construction, auto degaussing circuit, attractive TEAK CASE, compact dimensions only 52cm W x 34 H x 24 D, 90 day guarantee. Although used, units are supplied in EXCELLENT condition. ONLY £99.00 + Carriage.

DECCA 80 16" COLOUR monitor. Composite video input. Same as above model but fitted with Composite Video input and audio amp for COMPUTER, VCR or AUDIO VISUAL use. ONLY £99.00 + Carr.

REDIFFUSION MARK 3, 20" COLOUR monitor. Fitted with standard 75 ohm composite video input and sound amp. This large screen colour display is ideal for SCHOOLS, SHOPS, DISCOS, CLUBS and other AUDIO VISUAL applications. Supplied in AS NEW or little used condition ONLY £145.00 + Carr.

BUDGET RANGE EX EQUIPMENT MONOCHROME video monitors. All units are fully cased and set for 240v standard working with composite video inputs. Units are pre tested and set up for up to 80 column use. Even when MINOR screen burns exist - normal data displays are unaffected 30 day guarantee.

12" KGM 320-1 B/W bandwidth input will display up to 132 x 25 lines £32.95  
12" GREEN SCREEN version of KGM 320-1. Only £39.95  
9" KGM 324 GREEN SCREEN fully cased very compact unit. Only £49.00

Carriage and insurance on all monitors £10.00

## DC POWER SUPPLY SPECIALS

GOULD OF443 enclosed compact switch mode supply with DC regulated outputs of +5v @ 5.5a, +12v @ 0.5a, -12v @ 0.1a and -23v @ 0.02a. Dim 18 x 11 x 6 cm. 110 or 240v input. BRAND NEW only £18.95  
GOULD G8-40A 5v 40 amp switch mode supply NEW £130.00  
AC-DC Linear PSU for DISK drive and SYSTEM applications. Constructed on a rugged ALLOY chassis to continuously supply fully regulated DC outputs of +5v @ 3 amps, -5v @ 0.6 amps and +24v @ 5 amps. Short circuit and overvoltage protected. 100 or 240v AC input. Dim 28 x 12.5 x 7 cm NEW £49.94

Carriage on all PSU's £3.00

## KEYBOARDS

Manufacturer's BRAND NEW surplus

DEC LA34 Uncoded keyboard with 67 quality gold plated switches on X-Y matrix - ideal micro conversions etc £24.95  
AMKEY MPNK-114 Superb word processor chassis keyboard on single PCB with 116 keys. Many features such as On board Micro, Single 5v rail, full ASCII coded character set with 31 function keys, numeric keypad, cursor pad and 9600 baud SERIAL TTL ASCII OUTPUT. Less than half price. ONLY £89.00 with data. Carriage on Keyboards £3.50



## DON'T MISS THE CPM Deal OF THE CENTURY

### The FABULOUS CPM TATUNG PC2000 Professional Business System

A cancelled export order and months of negotiation enables us to offer this professional PC, CPM system, recently on sale at OVER £1400, at a SCOOP price just over the cost of the two internal disk drives!! Or less than the price of a dumb terminal!!

Not a toy, the BIG BROTHER of the EINSTIEN computer, the DUAL PROCESSOR PC2000 comprises a modern stylish three piece system with ALL the necessities for the SMALL BUSINESS, INDUSTRIAL, EDUCATIONAL or HOBBYIST USER. Used with the THOUSANDS of proven, tested and available CPM software packages such as WORDSTAR, FAST, DBASE2 etc. the PC2000 specification, at our prices, CANNOT BE BEATEN!!

The central processor plinth contains the 84K, Z80A processor, DUAL TEAC 55F 5 1/4" CENTRONICS and system expansion ports, and if that's not enough a ready to plug in STANDARD 8" DRIVE port for up to FOUR 8" disk drives, either in double density or IBM format. The ultra slim 92 key, detachable keyboard features 32 user definable keys, numeric keypad and text editing keys, even its own integral microprocessor which allows the main Z80A to devote ALL its time to USER programs, eliminating "lost character" problems found on other machines. The attractive, detachable 12" monitor combines a green, anti-glare etched screen, with full swivel and tilt movement for maximum user comfort. Supplied BRAND NEW with CPM 2.2, user manuals and full 90 day guarantee. Full data sheet and info on request.

PC2000 System with CPM Etc. COST OVER £1400

PC2000 Business System with CPM and Ready to Run FAST Sales and Purchase ledger, supports up to 9000 Accounts, VAT etc. COST OVER £1700

PC2000 Wordprocessor System with CPM and TEC FP25 daisywheel printer

NOW only £399

NOW only £499 Carriage & Insurance £12.00

NOW only £799

## MODEMS

Join the communications revolution with our super range of DATA MODEMS, prices and specifications to suit all applications and budgets.....

BRAND NEW State of the art products.  
DACOM DS2123 Multi standard 300-300, 1200-75 Auto answer etc. £288.00  
DACOM DS2123AQ Auto dial, smart modem with multi standard AUTO SPEED detect and data buffer with flow control etc. £385.00  
DACOM DS2123GT THE CREAM of the intelligent modems auto dial, auto call, index, buffer etc etc. £498.00  
Steebeck SB1212 V22 1200 baud FULL DUPLEX, sync or async, optional auto dial £485.00  
TRANSDATA 307A Acoustic coupler 300 baud full duplex, originate only, RS232 interface. £49.00

Ex BRITISH TELECOM full spec, CCITT, ruggedised, bargain offers. Sold TESTED with data. Will work on any MICRO or system with RS232 interface.  
MODEM 13A 300 baud unit, only 2" high fits under phone, CALL mode only £45.00  
MODEM 20-1, 75-1200 baud. Compact unit for use as subscriber end to PRESTEL, TELECOM GOLD, MICROWET etc. £39.95 +pp £6.50  
MODEM 20-2 1200-75 baud. Same as 20-1 but for computer end. £65.00 +pp £6.50  
DATEL 2412. Made by SE Labs for BT this two part unit is for synchronous data links at 1200 or 2400 baud using 2780/3780 protocol etc. Many features include 2 or 4 wire working, self test, auto answer etc. COST OVER £800. Our price ONLY £199 +pp £8.00  
DATEL 4800, RACAL MPS4800 baud modem, EX BT good working order. ONLY £295.00 +pp £8.00

### SPECIAL OFFER

MODEM TG2393. Ex BT, up to 1200 baud, full duplex 4 wire or half duplex over 2 wire line. ONLY £85.00 PER PAIR +pp £10.00

For more information contact our Sales Office.

## MATRIX PRINTERS

SPECIAL BULK PURCHASE of these compact, high speed matrix printers. Built in Japan for the Hazeltine Corporation this unit features quality construction giving 100cps bidirectional, full pin addressable graphics, 6 type fonts, up to 9.5 single sheet or tractor paper handling, RS232 and CENTRONICS parallel interface. Many other features. BRAND NEW and BOXED. COST £420. Our price ONLY £199.00

## RECHARGEABLE BATTERIES

Dry Fit MAINTENANCE FREE by Sonnenschein & Yuasa.  
A300 07191315 12v 3Ah NEW £13.95  
A300 07191312 6v 3Ah NEW £9.95  
A300 07191202 6-0.6v 1.8Ah TESTED Ex Equip £5.99

## VDU TERMINALS

Standard VDU data entry terminals at give away prices!!

QUME QVT108. Current product, state of the art terminal with detachable keyboard, 12" Green screen, 2 page RAM, TVI 925, Hazeltine, ADMSA emulations software setup, 25 x 80. Clock, Swivel and tilt base. Printer port, Function keys etc. BRAND NEW and BOXED AT ALMOST HALF PRICE ONLY £425.00  
AJ510 - EX RENTAL, Z80 controlled, 15" green screen 24 x 80 display, graphics, cursor addressing, printer port etc. Very good condition TESTED complete with manual only £225.00  
ADDS 520 - Dumb terminal, used 12" b/w screen RS232 interface and printer port TESTED. ONLY £125.00. Carriage on terminals £10.00. 100's of other terminals in stock, CALL for more details.

## SURPLUS SPECIALS ON PRESTEL - VIEWDATA - TELEX

PLESSEY VUTEL, ultra compact unit, slightly larger than a telephone features A STANDARD DTMF TELEPHONE (tone dial) with 5" CRT monitor and integral modem etc. for direct connection to PRESTEL, VIEWDATA etc. Designed to sell to the EXECUTIVE at over £800!! Our price BRAND NEW AND BOXED at only £99.00  
DECCAFAX VP1 complete Professional PRESTEL system in slimline desk top unit containing Modem, Numeric keypad, CPU, PSU etc. Connects direct to standard RGB colour monitor. Many other features include: Printer output, Full keyboard input, Cassette port etc. BRAND NEW with DATA A FRACTION OF COST only £55.00  
ALPHATANTEL. Very compact unit with integral FULL ALPHA NUMERIC keyboard. Just add a domestic TV receiver and you have a superb PRESTEL system and via PRESTEL the cheapest TELEX service to be found!! Many features: CENTRONICS Printer output, Memory dialling etc. Supplied complete with data and DIY mod for RGB or Composite video outputs AS NEW only £125.00  
Post and packing on all PRESTEL units £8.50

## EX-STOCK INTEGRATED CIRCUITS

4164 200 ns D RAMS 9 for £11 4116 ns 1.50 2112 £10.00 2114 £2.50 2102 £2.00 6116 £2.50 EPROMS 2716 £4.50 2732 £3.00 2764 £4.95 27128 £5.50 6800 £2.50 6821 £1 68A09 £8 68B09 £10 8085A £5.50 8086 £15 8088 £8 NEC765 £8 WD2793 £28 8202A £22 8251 £7 8748 £15 Z80A DART £6.50 Z80A CPU £2.00. Thousands of IC's EX STOCK send SAE for list.

## DISK DRIVES

Japanese 5 1/4" half height, 80 track double sided disk drives by TEAC, CANON, TOSHIBA etc.  
Sold as NEW with 90 day guarantee ONLY £85.00  
TEC FB-503 Double sided HH 40 TRK NEW £75.00  
SUGART SA400 SS FH 35 TRK £55.00  
SIEMENS FDD100 SS FH 40 TRK £65.00  
Carriage on 5 1/4" drives £5.50  
Brand NEW metal 5 1/4" DISK CASES with internal PSU.  
DSKC1 for 2 HH or 1 FH drive £29.95 +pp £4.00  
DSKC2 for 1 HH drive £22.95 +pp £3.50  
DKSC 3 As DSK1 LESS PSU £12.95 +pp £2.50  
DSKC 4 As DSK1 LESS PSU £10.95 +pp £2.00  
8" IBM format TESTED EX EQUIPMENT.  
SHUGART 800/801 SS £175.00 +pp £8.50  
SHUGART 851 DS £250.00 +pp £8.50  
TWIN SHUGART 851's 2 Mb total capacity in smart case, complete with PSU etc. £595.00  
MITSUBISHI M2894-63 B: DS1 Mb equiv. to SHUGART SA850R. BRAND NEW at £275.00. +pp £8.50  
DYSAN B: Alignment disk £29.00 +pp £1.00  
Various disk drive PSU's Ex Stock SEE PSU section.  
HARD DISK DRIVES  
DRE/DIABLO Series 30 25 Mb total load £525.00  
Exchangeable version £295.00, ME3029 PSU £95.00  
DIABLO 44/DRE4000A, 8.5 +5 Mb from £750.00  
CDC HAWK 5 +5 Mb £795.00. CDC 9782 80 MbrM03 etc. £2500.00.  
PERTEC D3422 5+5 Mb £495.00  
RODIME 5 1/4" Winchester ex-stock from £150 CALL Clearance Items - Sold as seen - No guarantee.  
ICL 2314 BRAND NEW 14" Mb Removable pack hard disk drive, cost over £2000 with data ONLY £99.00  
BASF 8172 B: 23Mb Winchester £199.00  
Unless stated all drives are refurbished with 90 day guarantee. Many other drives and spares in stock - call sales office for details.

All prices quoted are for U.K. Mainland, paid cash with order in Pounds Sterling PLUS VAT. Minimum order value £2.00. Minimum Credit Card order £10.00. Minimum BONA FIDE account orders from Government Depts., Schools, Universities and established companies £20.00. Where post and packing not indicated please ADD £1.00 + VAT. Warehouse open Mon-Fri 9.30-5.30. Sat 10.30-5.30. We reserve the right to change prices and specifications without notice. Trade, Bulk and Export

32 Biggin Way, Upper Norwood, London SE19 3XF  
Telephone 01-679 4414 Telex 894502 Data 01-679 1888



Applying

# OUR DIGITAL THERMOMETERS ARE GUARANTEED ALCOHOL FREE!

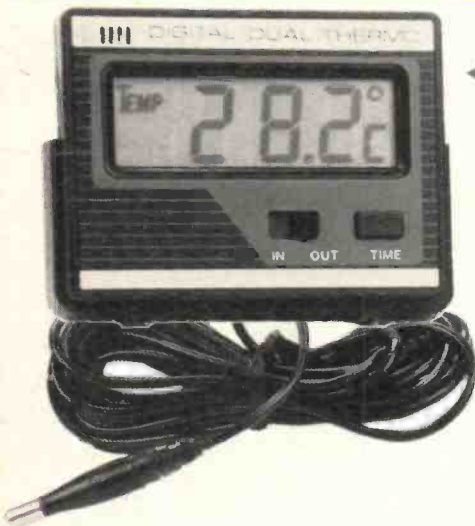

### Dual Scale Thermometer

A neat digital thermometer with internal and external sensors displaying °C or °F. The external sensor is a waterproof probe (max. length 3m). Temperature range -5°C to 50°C (internal), -20°C to 70°C (external). Includes a 12 hour clock. Order Code FD25C Price £9.95



### Pocket Thermometer

A well made temperature meter displaying °C or °F and a 12 hour clock. Temperature range -5°C to 50°C (internal), -20°C to 70°C using external probe (max. length 900mm). High and low temperatures can be set and an alarm sounds when these are reached. A set/lock switch prevents accidental resetting. Order Code FD26D Price £14.95

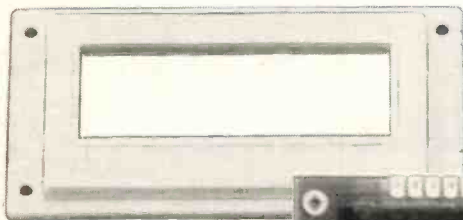

### Temperature Module

Versatile thermometer module displays in °C or °F, includes a 12 hour clock and serial data output. Temperature range -5°C to 50°C (internal), -20°C to 70°C with external probe. Overall size 68 x 35 x 23mm deep. Probe (max. length 3m) and bezel also available.

Module Order Code FE33L Price £6.95

Probe Order Code FE34M Price £2.50

Bezel Order Code FE35Q Price 15p

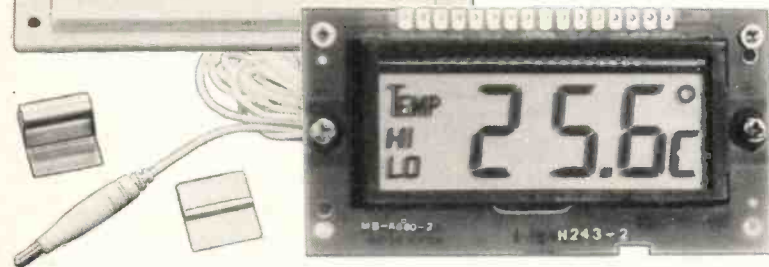

All prices include VAT. Please add 50p towards postage. Prices firm until 15th August 1987. Subject to availability.

## Maplin ELECTRONIC SUPPLIES LTD.

Mall Order: P.O. Box 3, Rayleigh, Essex SS6 8LR. Tel: Southend (0702) Sales: 554161, Enquiries: 552911; Trade sales: 554171, Trade enquiries: 552961.

### Shops

Birmingham: Lynton Square, Perry Barr. Telephone: 021 356 7292.

London: 159-161 King Street, Hammersmith W6. Telephone: 01 748 0926.

Manchester: 8 Oxford Road. Telephone: 061 236 0281.

Southampton: 46-48 Bevois Valley Road. Telephone: 0703 225831.

Southend-on-Sea: 282-284 London Road, Westcliff-on-Sea, Essex. Tel: 0702 554000.

All shops except Manchester closed all day Monday.



Pick up a copy of our 1987 catalogue from any branch of W.H. Smith for just £1.50. Or to receive your copy by post just send £1.50 + 40p p & p to Mail Order address. If you live outside the U.K. please send £2.50 or 11 International Reply Coupons.