



ELECTRONICS
TODAY INTERNATIONAL

RELATIVITY

Shedding Light On The Universe

COMPUTER CONTROL

RS232 Relay

Interface Project

CASE STUDY

Reflex Loudspeaker Design

BEGINNERS'

Infra-red Camera Trigger Project

ISSN 0142-7229



07

9 770142 722009

RELATIVITY

The fact that light travels at a finite (if very high) speed was first discovered by a Danish astronomer Ole Christensen Roemer in 1676. He was watching the moons of Jupiter (as one does) and noticed that the times at which they passed behind their parent planet varied with the distance between earth and Jupiter. Reasoning that this was because the light took longer to arrive when the distance was greater, he went on to produce an estimate of 140000 miles per second. A little out perhaps, but then the distance between Earth and Jupiter wasn't exactly common knowledge back in 1676 — 11 years before the publication of Newton's Principia Mathematica.

It was nearly 200 years later that James Clerk Maxwell came up with his theory of electromagnetic wave propagation and predicted that the waves should travel at a precise fixed speed, the speed of light, 186000 miles per second. But through what, wondered the eminent physicists of the age, did it actually travel?

The Ether

'Light is waves travelling through space,' says one eminent physicist.

'Yes, but waves can't travel through *nothing* can they — I mean all wave propagation needs a medium, stands to reason!' counters another.

'Fair enough' says the first. 'So theres this luminiferous ether which permeates all space and the light moves through that.'

Nods of agreement all round. Solved at a stroke. But not a good move. Let us pause to consider . . .

Sound waves. Here we have a nice sensible wave propagation through a medium not conspicuously tangible most of the time, but there nevertheless. The existence of such a material medium does strange things to the way we observe waves once things start moving relative to each other and to the medium. 'The Doppler Effect!' I hear you cry and you're not far wrong. In fact there are two quite distinct effects to be observed here.

Take a look at Fig. 1. You are standing in still air and a bee buzzing at 100Hz is moving towards you at a third of the speed of sound. Ignoring your instinct to dive for cover, you notice the sound waves that reach your ear are still travelling at the speed of sound, regardless of the bee's motion. The velocity of sound is after all merely a function of the density of the medium — how long it takes for a disturbed air molecule to pass on the vibration. Since you are stationary with respect to the air, that velocity cannot change.

Your ear does however hear that the buzz is doppler shifted to 150Hz. This is because the length of each buzz (or wavelength if you prefer) is being shortened by the distance the bee flies while buzzing it.

However, if you were to travel at a third of the speed of sound towards a stationary bee (your can of Vapona in hand) the situation would be different. The frequency is now shifted from 100Hz to 133Hz. The buzz wavelengths are not being shortened but you are

hearing more of them than you would if you remained stationary.

More importantly, although the velocity of the buzz in air is still 330m/s, as far as your moving ear is concerned the velocity of the sound is 440m/s, since you are moving relative to the stationary medium.

It was this change in apparent velocity that a duo called Michelson and Morley looked for in light with their famous interferometer experiments of the 1880s. They presumed that the movement of the Earth through the ether would result in light apparently travelling different speeds in different directions. It didn't.

Albert Takes A Bow

Well how far into a relativity article could we get without him? It's time for the main attraction. A big hand please for Mr Albert Einstein.

Physicists had been tying themselves in knots over the ether. If our motion through space didn't seem to affect the velocity of light, then maybe the Earth dragged the ether along with it. Or perhaps things shrank when moving through the ether so that measurement found nothing. Or maybe (but whisper it quietly), maybe the Earth was stationary relative to the ether. This of course would make us the centre of the universe, a delightful position with a nice view, not to mention being something of a coup de grâce for the Pope and one in the eye for Copernicus.

Einstein's simple and elegant solution to this jumble was to declare that there was no ether. (Note: A lot of books will have it that Einstein did not reject the *existence* of an ether but merely stated that it could never be detected. Such books fail to explain the philosophical difference between something that doesn't exist and something that cannot be detected in any way either directly or through its effects within the bounds of the universe.) So if there's no ether, where does that leave us?

For a start this is where the principle of relativity comes in. If there's no absolutely stationary medium though which light travels and against which we can base all our measurements then we can only ever determine relative velocities. You can be travelling at 500 miles per second relative to the Earth or the Moon or Mars, but if you're out in empty space with no immediate reference points you cannot tell if you are moving at all. There is no experiment you can perform within your rocket of Fig. 2 that will distinguish whether you

Stephen Malone examines the space-time continuum and its effects on light as we know it

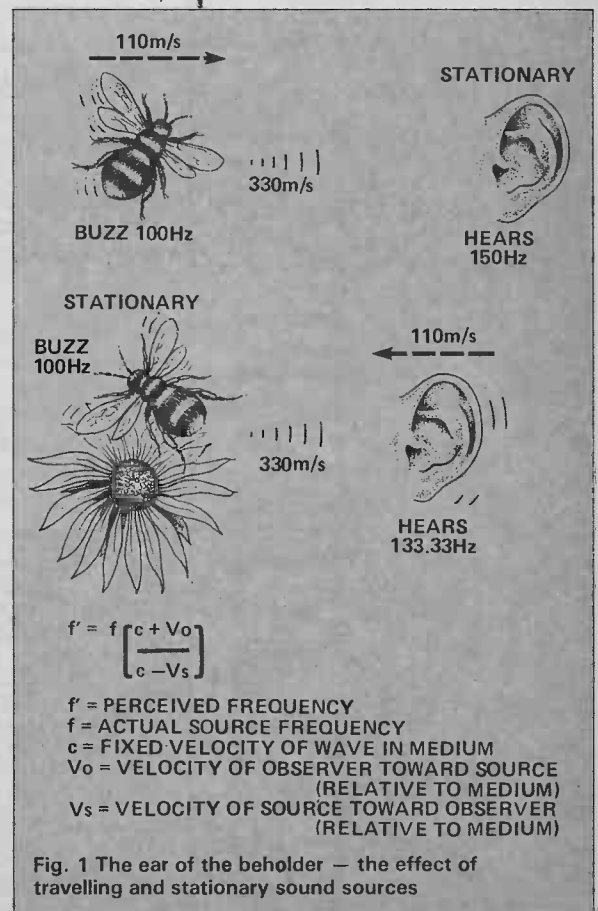

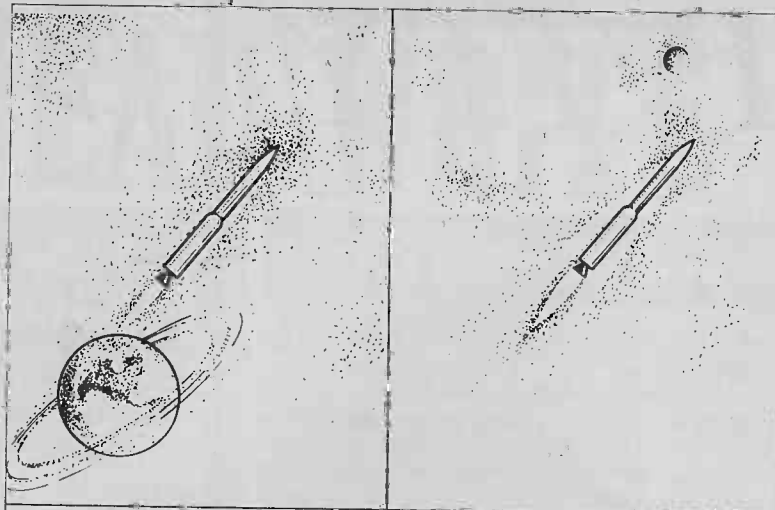

5000 miles/sec

HOW FAST?

Fig. 2 Relative velocities require reference points

are moving or not. Or to put it another way, all physical laws are the same in any unaccelerated frame of reference (they're the same in accelerated frames as well but for the moment let's stick to Special Relativity).

Now, bearing in mind that the speed of light (the speed of transmission of electromagnetic waves) can be derived directly from Maxwell's equations, this means that the speed of light as measured by any observer is always constant — Einstein's second basic postulate. Mind you it really just follows on from the first and things are much neater that way. One basic statement about the nature of the universe — *There Is No Absolute* — and everything else follows, no special pleading. ('There is no Absolute,' commandeth the Lord, rather paradoxically. 'Thanks,' says man, 'but you're forgetting my latest theories about the constant speed of light. Fit those into your commandments and we'll take ten.)

Take Nobody's Word For It

Of course, this doesn't constitute *proof* that there is no absolute. That remains a postulate. And beware of the circular argument — at least one standard exposition of the theory states first that without an absolute you can only measure relative velocity and then goes on to 'prove' that since we can only measure relative motion, the ether (which would possess absolute motion) cannot exist.

So, how can we make up our minds about the ether? Well, we can set out to look for the effects it would have if it was there. Michelson and Morley's experiment would work for a start, but more particularly the light coming from the sun would travel at different speeds at different times of the year (Fig. 3). Indeed all the light we receive from distant

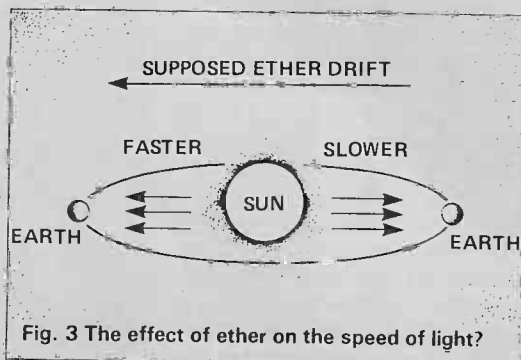

Fig. 3 The effect of ether on the speed of light?

stars and galaxies would be coming at us at different speeds from different directions and would vary with the time of year. This would all be most odd but happily it doesn't happen.

Nor does the motion of the source affect the velocity of light. As we saw with the bee, it doesn't do so for ordinary wave motion but since we've just abolished the ether we can't really take this for granted. We have an easy test in the form of X-ray pulsars. These consist of a binary system of a neutron star orbiting closely around an ordinary star. Gas from the latter falls down onto the neutron star and X-rays are given out. A pulsar with its orbit facing edge on to us would appear most peculiar if its rotation affected the speed of the X-rays given out. Quite apart from its regrettable tendency to disappear from time to time we would also be rewarded with the bizarre sight of a star coming and going at the same time. Happily the universe is more orderly than that. Light always travels at the same speed in empty space (just as Maxwell's equations predict) and there's no overtaking allowed.

A happy thought for solipsists. The centre of the universe is wherever the observer happens to be at the time. Whatever speed you go and wherever in the universe you are, the light from the stars around you is coming towards you passing you and beaming on its way again at a nice uniform 186,000 miles per second.

The idea that the speed of light is the same for all observers, whilst being necessary for the orderly running of the universe, doesn't accord very well with our commonsense distance-over-time ideas of velocity. But remember, we have evolved this common sense while sitting at the bottom of a gravity well surrounded by large quantities of gaseous nitrogen, oxygen and carbon dioxide. While this does provide a modicum of home comfort, it is hardly the most common situation in the universe. There are stranger things to come and for all the affront they offer to our 'common sense' they do provide a self-consistent framework which has so far stood up to all our testing.

The Lorentz Transformation

This is where things start getting mathematical. If you're up to it then follow me to the box of mathematics opposite. Those of you of a more trusting nature can skip to conclusions coming up, the rest of you follow me.

OK, the conclusions of the maths are the Lorentz transformations linking relative times and distances, shown in the last set of equations of the mathematics box.

Of particular import is the omnipresent k-factor, the constant that varies with velocity. It should be noted here that this is where travelling faster than light goes out the window. It is not a direct prohibition put into the theory, it merely follows as a logical consequence of the assumption that the speed of light is the same for all observers. A quick look at the Lorentz Transformation equations will show you that v can never surpass (or for that matter equal) c . These equations are merely relating the measurements of two observers, do them in spherical or cylindrical coordinates or however, this will always be the case. The k-factor (often written as the γ -factor) tends to infinity as v gets very close to c and this cannot be avoided.

That's all well and good, but now we've got our transformation equations what do we do with them? Stick around, you'll find out.

String's The Thing

How long is a piece of string? That rather depends on how fast you are travelling with respect to it.

Consider a piece of string stationary in reference frame O (Fig. 5). Its ends are at coordinates x_1 and x_2 and its length is thus $L_0 = x_2 - x_1$ (this is a nice happy, well adjusted and conveniently straight piece of string). If I coast by at a speed of v the ends of string in my frame of reference will be x'_1 and x'_2 . The relation between these sets or coordinates (more maths, sorry) will then be $x_2 = k(x'_2 + vt')$ and $x_1 = k(x'_1 + vt')$ — using the transformation to relate x_1, x_2 to what I measure x'_1, x'_2, t' .

The lengths are thus related by

$$L_0 = x_2 - x_1 = k(x'_2 - x'_1) = kL$$
 So that the length that I measure

$$L = \frac{L_0}{k} = L_0 \sqrt{1 - \frac{v^2}{c^2}}$$

The piece of string is shorter the greater our relative velocities. And in fact all moving observers will measure things differently. This may seem a strange way to run a universe but all your own measurements will be self-consistent and will always agree with anyone who is stationary relative to you. After all, motion is relative — why should you believe his measurements when you're the one who's standing still (whatever he thinks). But where does this leave our piece of string (now undergoing a serious identity crisis)? Is there no objective reality? Well, there isn't time to go into that now, but being at rest with respect to the string is about as absolute as we can get and that measurement (the one the string itself would measure) can be considered the 'real' length of the string. This is unhelpful of no particular use to us —

just try matching velocities before you make any astronomical observations and see how far you get!

Times They Are A Changing

The Lorentz Transformation equations also show that observers can disagree on the timing of an event. More particularly they will have differing views of each other's time.

As we have seen,

$$t' = k(t - \frac{vx}{c^2})$$

and for the position of O' viewed from O , $x = vt$. So the time at O' as seen by O is given by

$$t' = k(t - \frac{v^2t}{c^2}) = \frac{1}{c^2} \frac{1}{\sqrt{1 - \frac{v^2}{c^2}}} t(1 - \frac{v^2}{c^2}) = t \frac{\sqrt{1 - \frac{v^2}{c^2}}}{c^2}$$

If O sees one hour pass on his own clock, he will see a shorter time pass on the clock at O' . Time has slowed down in the moving frame.

So where does this leave interstellar travel? Well, consider an astronaut setting off on a trip to Alpha Centauri and back, a round trip of about eight light years. If he travels at an average velocity of $\frac{1}{3}c$ then we have $t' = \frac{1}{3}t$. Whereas the journey will have taken 10 years from the Earth point of view, only 6 years will have elapsed for the astronaut.

This is the stage where the words 'twin paradox' start getting bandied about. Actually there's no paradox at all. The viewpoint 'rocket accelerates away from the earth, turns round and comes back' is not interchangeable with 'earth accelerates away from the rocket, turns round and comes back'. All uniform motion is relative, but by his acceleration and

THE MATHEMATICS

Assume that observers O and O' , with frames of reference XYZ and $X'Y'Z'$ respectively, are moving with relative velocity v . The X and X' axes pointing in the direction of their relative motion (Fig. 4). Both observers set their clocks so that $t = t' = 0$ when the two frames coincide. (What? I've lost you already! Perhaps you'd better join the others at the bottom of the page.)

At time $t = 0$ a flash of light is emitted from their common position. After a time t , observer O will note that the light has reached point A at a distance r . The light travels with a velocity c , so we may write $r = ct$ and since $r^2 = x^2 + y^2 + z^2$ this gives us $x^2 + y^2 + z^2 = c^2t^2$. Similarly, observer O' notes the arrival of the light at point A in a time t' but with the same velocity c , and from this we get $r' = ct'$ or $x'^2 + y'^2 + z'^2 = c^2t'^2$.

Since in this case $y' = y$ and $z' = z$ we may reduce this to the two equations $x^2 - c^2t^2 = 0$ and $x'^2 - c^2t'^2 = 0$ (call these equations 1 and 2) or combining these $x^2 - c^2t^2 = x'^2 - c^2t'^2$.

Note that we can't get away with keeping the time interval the same for both observers, if $t = t'$ then $x = x'$ and our two observers are still at the same point. Measurement of distance and time must be different to different observers if c is to remain the same — and if you're still unsure of that go back, start again and consider what a universe with differing speeds of light looks like.

Next we need a transformation between the two sets of coordinates, and that goes like this.

Since the distance $OO' = vt$ for observer O we must have $x = vt$ when $x' = 0$ (point O'). So we need an equation of the form $x' = k(x - vt)$ where k is a constant to be determined. As we have seen above t' also depends on x and t and so for this we write $t' = a(t - bx)$.

Substituting these into equation (2) we have,

$$k^2(x^2 - 2vxt + v^2t^2) - c^2a^2(t^2 - 2bxt + b^2x^2) = 0$$

or,

$$(k^2 - b^2a^2c^2)x^2 - 2(k^2v - ba^2c^2)xt - (a^2 - k^2\frac{v^2}{c^2})c^2t^2 = 0$$

This must be equivalent to equation (1), which gives us

$$k^2 - b^2a^2c^2 = 1,$$

$$k^2v - ba^2c^2 = 0,$$

$$a^2 - k^2\frac{v^2}{c^2} = 1$$

And solving this set of equations we find

$$k = a = \frac{1}{\sqrt{1 - \frac{v^2}{c^2}}} \quad \text{and} \quad b = \frac{v}{c^2}$$

which gives us our transformation linking the two sets of coordinates:

$$x' = k(x - vt) = \frac{x - vt}{\sqrt{1 - \frac{v^2}{c^2}}}$$

$$y' = y$$

$$z' = z$$

$$t' = k(t - bx) = \frac{t - \frac{vx}{c^2}}{\sqrt{1 - \frac{v^2}{c^2}}}$$

These are the Lorentz Transformation Equations. If you want to try inverting them to get x, t in terms of x', t' you'll find you get exactly the same equations but with v replaced by $-v$ as you'd expect.

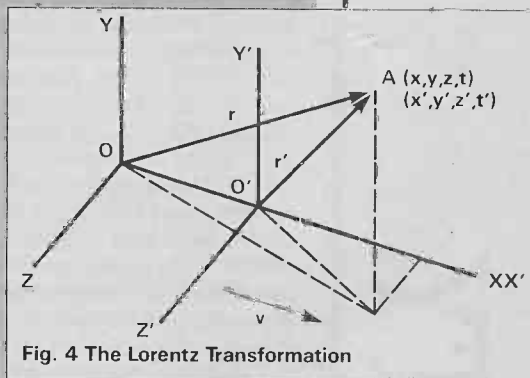

Fig. 4 The Lorentz Transformation

deceleration the astronaut has undergone a completely different experience to those left on the earth. On a more mundane level, throwing a cricket ball to the wicket keeper is not the same as throwing the entire universe in the opposite direction — now there would be a paradox!

A question may occur to some of you at this point. If the astronaut has travelled eight light years in only six years, isn't that travelling faster than light?

It may appear so at first, but if you want to send a message to Alpha Centauri and get a reply there is no way this can be done in less than 8 years. The messenger may feel he's put in good time doing it in 6 years but if he measures the distance himself he'll find that he's travelled $L = 8 \sqrt{1 - v^2/c^2} = 4.8$ light years at an

average speed of $\frac{4.8c}{6} = \frac{4c}{5}$. Measurements of distance,

as we have seen, are private. The faster the messenger travels, the shorter distances will seem and he will never be able to measure his own velocity as greater than that of light. Nor will he ever be able to travel from the earth and back in a time that contravenes this limit. He will however be travelling very large distances (as measured by us) in a reasonably short subjective time.

Energy Matters

For our third relativistic effect let us return for a moment to the Doppler Effect.

Consider the two most extreme cases. If a star were travelling away from us at the speed of light, its light would be red-shifted completely. The waves would be stretched out flat with a frequency and energy of zero. If, on the other hand, the star was travelling towards you at light speed its light would be completely blue-shifted, the incoming waves of light would all be piled up on top of each other, the frequency and energy would be infinite and you would be vaporised. (Those of you still hoping to accelerate your spaceships up to light speed should take careful note. All other considerations aside, any light source ahead of you would be infinitely blue-shifted and there wouldn't be much of you left to arrive.)

This is obviously none too symmetrical. A star travelling away from you at light speed would just be one less speck in the night sky, one coming towards you infinitely bright. Energy gained in the blue shift is greater than energy lost in the red shift (this example is of course impossible but the imbalance remains at more realistic speeds).

First take your spaceship (a new one if you just tried the above experiment) and fly past the sun at high speed. On approach the sunlight will appear 'blue' and when flying away it will appear 'red'. If you now estimate the average energy of the blue-shifted and red-shifted light it will be greater than if you were stationary near the sun.

So where does this energy come from? The sun may seem to be shedding more energy from your point of view but you can't change the intensity of sunlight received on the earth merely by flying a rocket past the sun. The effect must be wholly due to the relative velocities of your spaceship and the sun.

OK, so the sun has a higher velocity relative to the ship which gives it increased energy of motion. Some of this energy is being shed as extra light. Got you so far.

The usual way to shed energy of motion is to slow down. The sun hasn't really got this option (that would be even more severe, merely flying a rocket past the sun would knock it out of position — you could move the stars around just by looking at them). So the sun must be losing mass in order to give out extra light.

In other words, mass and energy are equivalent

and interchangeable. Or, as we've all come to know it, $E = mc^2$. Don't let the c^2 worry you, the velocity of light only comes in because of the units used to measure energy and mass. We could equally well write $E = m$ and adjust our units but $E = mc^2$ is a useful convention as it emphasises that even a very small mass represents a very large amount of energy.

What does this do to our high speed astronaut? Well, suppose his motor is accelerating him at one g, increasing his speed by 9.8ms^{-1} in every second. From an onlooker's point of view the astronaut's seconds are protracted and despite his expenditure of energy he is not gathering speed as rapidly as he supposes. This is the reverse of the above effect. From the observer's point of view the astronaut's energy of motion increases faster than his increasing velocity would allow, so he seems to be getting heavier. Indeed all objects at high speed seem heavier, the relationship here being $M = \gamma m_0$ (how did you guess).

2+2=3

The Lorentz Transformation equations say we can't go faster than light, mass tends to infinity, length tends to zero and time slows to a stop. But surely if I'm going at over half light speed in one direction and you're going as fast in the other . . . ? Let's take a look at this thorny problem of the addition of velocities (Fig. 5).

If two rockets set off from the earth in opposite directions at $0.75c$ you might be inclined to think their relative velocities would be $1.5c$. Yet it is still possible for either rocket to send radio messages to the earth and receive a reply. So if one rocket were to send a message back to the earth this could be relayed on the other. The two rockets can still contact each other with messages travelling at the speed of light. Indeed the earth need not be there at all and the message would

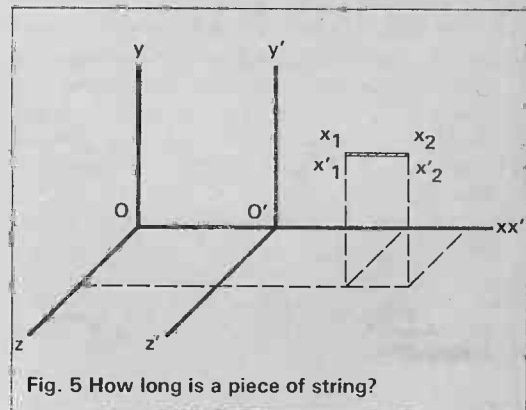

Fig. 5 How long is a piece of string?

whizz right on by from one to the other. Obviously they can't be travelling apart with a velocity greater than that of light.

The point here is that the observer on earth is in no absolute position to determine the relative velocities of two other objects. You can only determine the velocity of each relative to yourself, a bit of simple addition won't do to determine what they see.

In order to determine that you have to go into some hairy mathematics involving three moving frames. Frame O' moves at speed v with respect to O and O'' at a speed v' with respect to O' — the Lorentz transformation between O and O'' is what we need but if you try it, keep an eye on those superfixes, the new transformation needs to contain the new velocity v'' , which is what we're after.

A couple of pages of algebra later we have our result $v'' = \frac{v+v'}{1 + \frac{vv'}{c^2}}$

In the case of our two rockets above, we find that they actually measure each other's velocities as $0.96c$. Even if they could travel in opposite directions at the speed of light (as measured by us) they would measure their relative velocity as c .

That about wraps it up for Special Relativity. The above are the most important effects and strange as they may seem, they all follow directly from the statement that the speed of light is the same for all observers. Mind you, you don't have to take this purely on faith. If you want proof you need go no further than your friendly neighbourhood particle accelerator. There you can watch as particles accelerated to high speeds increase in mass (exactly in line with the theory) and see normally short-lived particles lasting for much longer periods (exactly in line with the theory).

This latter you can even verify in your own back garden. First build a detector capable of catching mu-mesons. Then sit in your garden and wait for one to arrive from the stratosphere. Got one? Good, that proves it then.

A mu-meson in the laboratory has a lifetime of about 2 microseconds. A lot of these mu-mesons are formed by cosmic ray interactions high in the atmosphere. In 2 microseconds they shouldn't be able to reach the ground but plenty of them do. This corresponds to a mean lifetime of about 30 microseconds. Time dilation strikes again — the high altitude mesons have an initial velocity of around $0.998c$ which is why they last over 15 times as long. Of course from the meson's point of view the distance to the ground has shrunk by the same factor and the meson is merely living out its allotted span of 2 microseconds.

Can You Feel The Force?

Special Relativity, as its name implies, deals with a rather special set of circumstances — nice uniform velocities, no messy accelerations of gravity. This is where General Relativity comes in, extending the theory to cover these less pleasantly uniform situations. Of course, unless we want the whole universe to start coming part at the seams the laws of physics must still remain the same despite the effects of motion or gravity and so the speed of light will still be the same for all observers.

This leads, via the introduction of Reimann's Tensor Calculus, to the concept of warped space-time and another set of bewildering relativistic effects. Before we get to that let us pause to consider the way we feel accelerations and gravity.

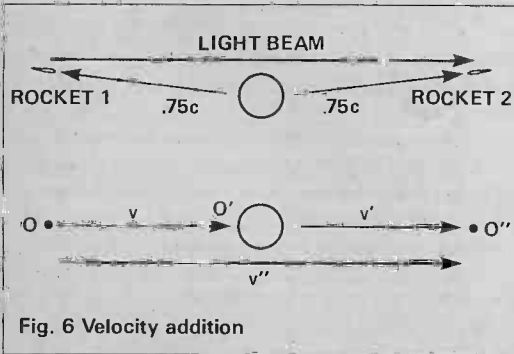

Fig. 6 Velocity addition

First off we have the *principle of equivalence*: the effect of gravity and acceleration are indistinguishable. This, of course, nearly halves the amount of work we have to do and is therefore a *Good Thing* — it also happens to be right. The easiest example is the classic one of the lift (Fig. 6). As a lift accelerates upwards we feel heavier. If the entire lift were now instantaneously

transported to a planet whose gravity matched this acceleration we would be unable to tell the difference. If we felt twice as heavy in the lift then on a $2g$ planet we would feel twice as heavy — not a conspicuously different sensation.

This may seem paradoxical because surely on the planet's surface we are being accelerated *downward*. But that is to misunderstand that what we actually feel are *forces*. The floor of the lift acts on us to hold us up against a $2g$ acceleration and the planet surface does exactly the same thing. You don't think the ground is holding you up? Imagine the ground beneath your feet were to suddenly disappear — which direction would you move in? It's the gravitational effect of the earth as a whole that pulls you down, the bit you're standing on does the opposite.

As I say, it's forces that make the difference. The freest states are those in which no force acts upon us. The obvious one is when moving at a uniform velocity in empty space, but *free fall* in a gravitational field is also just such a state. You only feel a force when something gets in your way and stops you falling (it's the old joke — it's not the fall that kills you, it's hitting the ground at the bottom).

Consider again our rocket with its uniform velocity in 'empty' space. If there's a star or planet nearby the rocket will be falling very slowly towards it as it passes. There's no force involved unless you try to resist this motion, you are merely moving in a straight line in warped space-time.

So what is this space-time stuff we hear so much about? Essentially it is a mathematical construct, a way of dealing with the three space (x, y, z if we're being cartesian) and one time (t) coordinates needed to specify an event. By lumping them together into a neat 4-vector (x, y, z, t) we can use Tensor calculus to describe the effects of gravity in terms of this space-time. And it does the job. Uniform motion with no forces acting is always in a straight line (and so we would hope) but

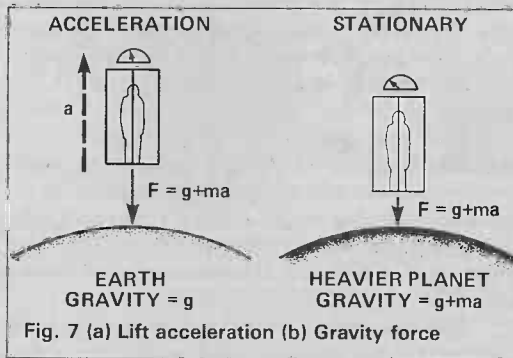

Fig. 7 (a) Lift acceleration (b) Gravity force

space can become curved by a gravitational mass which is how such motion can appear to be deflected without a force acting. (Tensors? Well, vectors are just a special case of the more general class of tensors, the properties of which are admirably suited to the invariance between frames of reference required by relativity.)

OK so far, a mathematical construct which explains what we observe. But a good theory needs to make predictions which can easily be tested.

Starting with his theory of gravity, Einstein worked out new equations for the orbits of the planets and these do turn out to be slightly different. The elliptical orbits are not stationary but slowly rotate about the sun (Fig. 7). This correction to Newton is not very large — Newton's law of gravity would become

$$F = \frac{Gm_1m_2}{d^{2.00000016}}$$

For Mercury, where it shows up the most, this procession would amount to all of 43 seconds of arc per

ETI RELATIVITY

century. When other effects are eliminated a previously unexplained 43 seconds of arc is precisely what is observed.

The general theory also implies that light will be deflected by a gravitational field, after all if space is curved light must follow this curved route. Apparent deflections in the positions of stars close to the sun's disc observed during an eclipse confirm this (Fig. 8).

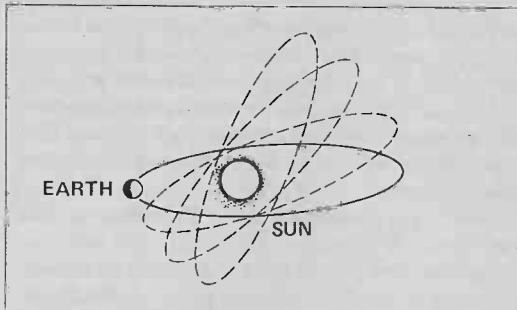

Fig. 8 Orbital precession

From here it is but a small step to the existence of black holes. If light is affected by gravity then if a star were dense enough none of its light would be able to escape and nor would anything falling into the star unless it could travel faster than light (and I think we've covered that).

Gravity would also have to affect time under the general theory. In fact time would be slowed down by a gravitational field. Once again an extreme prediction perhaps but experiments involving atomic clocks have shown this to be the case. Clocks at ground level run slower than those at high altitude where the gravitational field is weaker.

At this point some of you may be saying, 'OK the

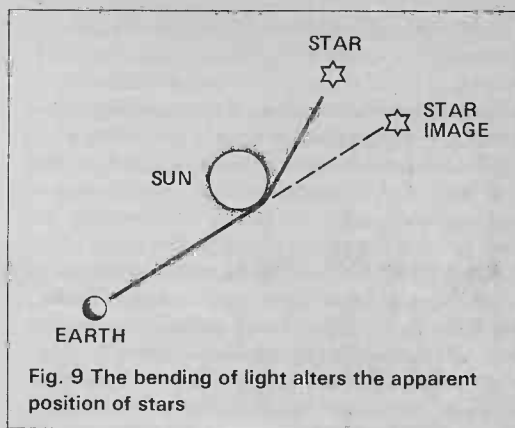

Fig. 9 The bending of light alters the apparent position of stars

clocks run faster at high altitude but is time really faster, I mean time is this big abstract thing isn't it?' The answer of course is no. Take the current scientific definition of a second: 9,192,631,770 vibrations of the microwave radiation emitted by caesium-133 atoms during a specific atomic transition. Pretty exact really. If seconds start getting shorter it's because all atomic processes have speeded up. That includes the ones that drive the chemistry of your body, all your thoughts and reactions will be speeded up too, everything is in step.

Indeed there is no experiment you could do that would show any difference in the length of your second, only in comparison with the clock on the ground would you notice any change. Time for you has speeded up, by the only measure you can use, that of atomic processes all of which are governed by interactions communicated at the speed of light, the very basis of our universe. The speed of light is more fundamental than space or time. Space is what light moved through, time is how long it takes to move.

HART

HART AUDIO KITS — YOUR VALUE FOR MONEY ROUTE TO ULTIMATE HI-FI



Yes, you too can afford the very best in real hi-fi equipment by building a HART kit. With a HART kit you can avoid the hilarious prices and magical claims of the 'oxygen free grain oriented copper' brigade and the flashy exterior and mundane interior of the mass market products. With every HART kit you get the benefit of circuit design by world leaders in their field, men of the calibre of John Linsley Hood for instance who has been in the forefront of audio design for many years. This circuit expertise is harnessed to realise its full potential by HART engineering standards which have been famous in the kit field since 1961. The HART approach is simply to give you the best value in hi-fi by combining the best circuit concepts with the latest and best components within a unit carefully designed to bring out your hidden skills as an equipment builder.

Units in the HART audio range are carefully designed to form matched stacks of identically sized cases, in many cases even the control pitches are also lined up from unit to unit for a cohesive look to your customised ensemble.

Flagship of our range, and the ideal powerhouse for your ultimate system is the new AUDIO DESIGN 80 WATT POWER AMPLIFIER, described in the May issue of 'Electronics Today International'. This complete stereo power amplifier has so many features that your really need our list to browse through them all. Glossing over its technical merits, which its pedigree guarantees anyway, it is a power amp with the extra versatility of a built-in passive input stage giving three switched inputs, volume and balance controls. Tape or CD players may therefore be directly connected along with a standard pre-amp output, indeed your system may not need a pre-amp at all with the well balanced output of competent CD players.

Send for our new FREE Spring '89 List. It has full information on this new amplifier as well as details of improvements to other kits in our range.

Our 300 SERIES amplifiers for instance now feature optional phono input sockets and double size LCR power supply capacitors.

The 400 SERIES John Linsley Hood Audiophile Tuner range now incorporates the very latest updated stereo decoder circuit which can also be retro-fitted to existing tuners with our 'Tuner Enhancement Package'.

Also listed are many exciting new products for the serious audiophile such as our Gold plated phono and XLR plugs and sockets and ultimate quality connection leads for CD audio or digital signals.

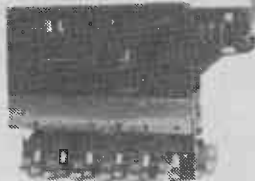

High quality, reasonably priced front loading cassette deck, fitted with good quality stereo R/P and erase heads. The mechanism has a 3-digit counter, chrome operating keys, mechanical auto stop and a removable decorative cassette door with central window and key functions marked below. Cassette door carrier has hydraulically damped 'soft eject' feature. Motor is internally governed and only needs a 12v DC supply with an average current of 80mA. A change-over switch is fitted to energise the motor when required and provide a make contact in the stop position for replay mute. Overall size is 160mm wide including counter, 100mm high and 85mm deep including motor and keys. A robust and thoroughly useful deck for many purposes.

VFL600 Vertical Front Loading Cassette Deck
SPECIAL GUMMER SALE PRICE ONLY £15

SOLENOID CONTROLLED FRONT LOAD CASSETTE DECK TN3600

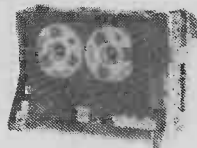

High quality (0.08%W&F) successor to our very popular SF925F. A very useful high quality cassette mechanism for domestic or industrial use. Offers all standard facilities plus cue and revue modes all under remote, logic or software control. The power and control requirements are very simple with 12v solenoids and 12v Motor with built in speed control. Deck is supplied as standard fitted with a very nice 10KHz R/P head and a 1.5mH erase head.

TN3600 Deck with stereo head £48.53
INF340 Full manufacturers data £2.90

HIGH QUALITY REPLACEMENT CASSETTE HEADS



Do your tapes lack treble? A worn head could be the problem. Fitting one of our replacement heads could restore performance to better than new! Standard inductances and mounting make fitting easy on nearly all machines and our TC1 Test Cassette helps you set the azimuth spot on. As we are the actual importers you get prime parts at lower prices, compare our prices with other suppliers and see! All our heads are suitable for use with any Dolby system and are normally available ex stock. We also stock a wide range of special heads for home construction and industrial users.

HS16 Sendust Alloy Stereo Head. High quality head with excellent frequency response and hyperbolic face for good tape to head contact £17.86

HC40 NEW RANGE High Beta Permalloy Stereo head. Modern space save design for easy fitting and low cost. Suitable for chrome metal and ferric tapes. Truly a universal replacement head for hi-fi decks to car players and at an incredible price too! £6.65

HX100 Special Offer Stereo Permalloy Head £2.86

HRP373 Downstream Monitor Stereo Combination Head £44.39

HQ551 4-Track Record & Play Permalloy Head for auto-reverse car players or quadraphonic recording £16.79

H524 Standard Erase Head £2.59

SM166 2/2 AC Erase Head, Standard Mount £12.60

HS9510 2/4 Stereo DC Erase Head £8.70

HQ751E 4/4 AC Erase Head, tracks compatible with HQ551 £57.06

We can supply card reader heads for OEMs at very keen prices.

REEL TO REEL HEADS

999R 2/4 Record/Play 110mH. Suits Stuart Tape Circuits £13.34

996E 2/4 Erase Head 1mH. Universal Mount. Suits Stuart £11.96

TAPE RECORDER CARE PRODUCTS

HART TC1 TEST CASSETTE Our famous triple purpose test cassette. Sets tape azimuth, VU level and tape speed £5.36

DEM1 Mains Powered Tape Head Demagnetiser, prevents noise on playback due to residual head magnetisation £4.08

DEM115 Electronic, Cassette Type, demagnetiser £8.61

Our new SPRING '89 List is FREE. Send for your copy now. Overseas customers welcome, please send 2 IRCs to cover surface post, or 5 for Airmail.

Please add part cost of carriage and insurance as follows:
INLAND: Orders up to £10 — £1; Orders £10 to £49 — £1.50; Orders over £50 — £2.50; Express Courier — £9.

OVERSEAS: Please see the ordering information with our lists.

QUALITY AUDIO KITS

24hr SALES LINE
(0691) 652894

ALL PRICES EXCLUDE VAT
UNLESS STATED

HART
HART ELECTRONIC KITS LTD
4 PENYLAN MILL
OSWESTRY, SHROPSHIRE
SY10 9AF

CRYSTAL CLEAR

The crystal oscillator is a common enough component, ticking away on most logic and microprocessor circuits — anywhere that a reliable frequency source is needed. Yet often, particularly with digital designers, the analogue workings of the oscillator are not really understood. Here we explain how the principles of phase delay in reactive networks are used to produce an oscillator.

Squash Quartz

A quartz crystal is a lump of silicon dioxide sandwiched between two electrodes. Quartz exhibits the piezo-electric effect — if a voltage is applied to the electrodes (across the quartz) it changes dimensions. Conversely, if it is stressed it generates a voltage.

Another physical property is that as with all materials it has a mechanical resonance at a specific frequency. This frequency is dependant upon the dimensions of the crystal.

The equivalent electrical circuit of the crystal is shown in Fig. 1. The inductor, resistor, and C_s are

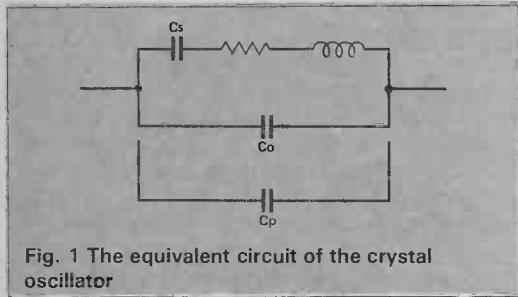

inherent in the quartz and together they are known as the *motional arm* of the crystal. C_o is a small capacitance resulting from the crystal case and electrodes.

Fig. 1 also shows C_p . This is not part of the crystal but is all the parallel capacitance external to the crystal. In a Pierce oscillator circuit such as that in Fig. 2 (the most common in digital electronics) this is made up of the two circuit capacitors in series plus any stray capacitance. (Note that to the crystal $C1$ and $C2$ appear in series by virtue of their common connection to V_{SS}).

Table 1 shows some typical component values for R, L, C_s and C_o .

At most frequencies the crystal itself looks like the capacitor C_o but at resonance the motional arm values come into play. Fig 3 shows the reactance plot. This basic shape is the same whether or not C_p is included with C_o .

It may not be obvious how the crystal's equivalent circuit produces this plot. A series capacitor and inductor (Fig. 4a) will give negative reactance at low frequencies (capacitor dominating the load) and positive reactance at high frequencies (inductor dominating the load).

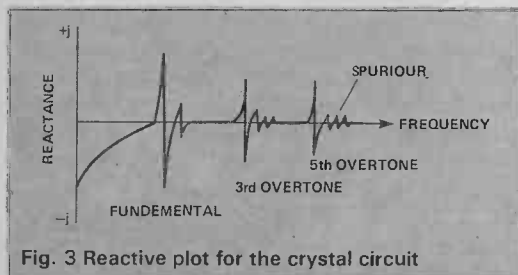

Fig. 3 Reactive plot for the crystal circuit

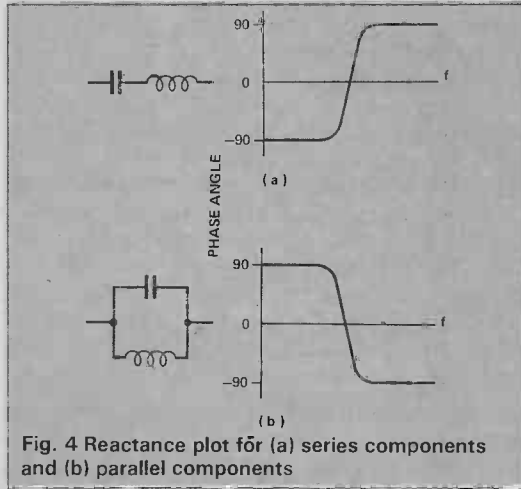

Fig. 4 Reactance plot for (a) series components and (b) parallel components

With a parallel capacitor and inductor (Fig. 4b) the equations work the other way around — reactance is positive at low frequencies and negative at high frequencies.

Combining the two gives the plot of Fig. 3, with inductive reactance over a very small resonant frequency range. This explains why crystal oscillators are so accurate since it is only when the crystal is an inductor that the conditions for oscillation are present.

Colpitts Lookalike

The Pierce circuit of Fig. 2 can be redrawn as Fig. 5a. Bearing in mind the resonant inductive reactance of the crystal, this bears a striking resemblance to the classic Colpitts oscillator circuit of Fig. 5b. The crystal replaces the inductor in the phase-shift network.

Also, instead of the op-amp or transistor amplifier to provide gain, there is a logic inverter with a high value feedback resistor. This resistor biases the inverter in the 'linear' region, turning it into an inverting amplifier.

Figure 6a shows the circuit of a simple logic inverter — basically a class B amplifier with no feedback. Figure 6b shows the simplified transfer function (how the output signal varies with the input).

The transfer function is explained as follows. The lower transistor is an n-channel MOSFET (analogous to a npn bi-polar transistor) such that when the input voltage is low, the MOSFET is off.

When the input voltage rises to a couple of volts or so above V_{SS} (0V) it switches on, conducting current. In fact, up to a point, the higher the input voltage the more current it will conduct. This is rather like saying the higher the input voltage to the MOSFET the lower its *on* resistance becomes.

The same is true of the upper transistor, except in reverse. This is a p-channel MOSFET (analogous to a pnp transistor). When the input voltage is high

CRYSTALS

Alistair Dixon resolves the resonant world of the crystal oscillator

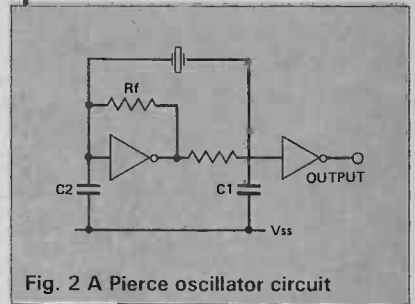
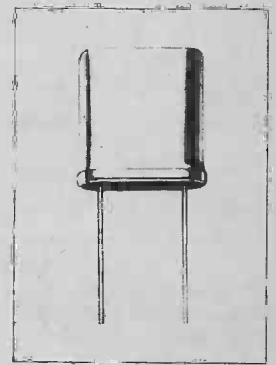

Fig. 2 A Pierce oscillator circuit

Frequency	R	L	C_s	C_o
32 kHz	40k	4800H	0.00491p	2.85p
260 kHz	1820R	25.9H	0.0125p	5.62p
525 kHz	1400R	12.7H	0.00724p	3.44p
2 MHz	100R	520mH	0.0122p	4.27p
4.608 MHz	36RA	117mH	0.01p	2.9p
11.25 MHz	19R	8.38mH	0.024p	5.4p

Table 1 Typical component values for different crystal frequencies

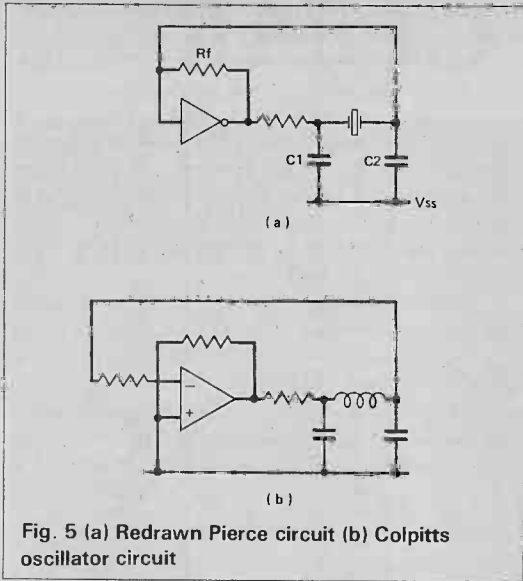
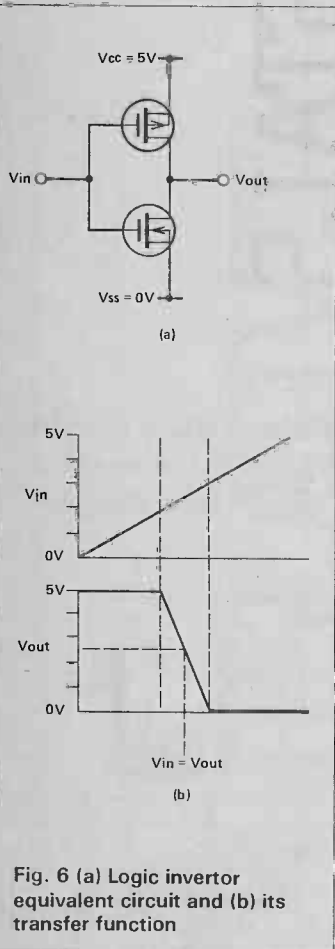

Fig. 5 (a) Redrawn Pierce circuit (b) Colpitts oscillator circuit

the MOSFET is off. When the input voltage falls to a couple of volts or so below V_{cc} (usually 5V) it switches on.

It can be seen that when the input voltage is somewhere in the middle, say 2.5V, both transistors are on. This means that the output voltage is somewhere in the middle as well. The purpose of the feedback resistor, R_f , is to stabilise the output voltage. If the output begins to go up then, via the resistor, so does the input. Since it is an inverting amplifier this pulls the output back down. The same happens in reverse if the output tries to fall. R_f can be a high value because the input resistance of the MOSFETs is even higher — in the region of hundreds of megaohms.

The linear region of a logic inverter is defined as the region when both transistors are on such that a small change in the input voltage results in an opposite change in the output voltage.

The Barkhausen Criterion

The Barkhausen criterion for oscillation is the correct name for the two conditions needed to make a circuit start oscillating. It states:

The total loop phase shift must equal 0 degrees, 360 degrees or any multiple thereof, and the total loop gain must be greater than unity.

The amplifier inherently produces 180° phase shift because it is an inverting amplifier. Providing the network produces a further 180° phase shift at the frequency we want, the requirements will be met.

Note that the loop gain must be greater than unity so that the oscillations can build up from nothing (actually from circuit noise) to their full value. Once they reach their final value the loop gain needs to be exactly unity. It is most unlikely that the loop gain would become unity at just the right oscillation amplitude, so what can happen is that the amplifier 'clips' the oscillations on the power rails.

Phase Shift

There is a natural phase shift in capacitors and inductors, and these can be used to make the Colpitts oscillator.

Figure 7a shows a voltage source connected to a capacitor. It is a property of capacitors that the current flowing through them *leads* the voltage across them by 90 degrees. The current waveform is always a quarter of a cycle *in front* of the voltage waveform.

Figure 7b shows the same voltage source

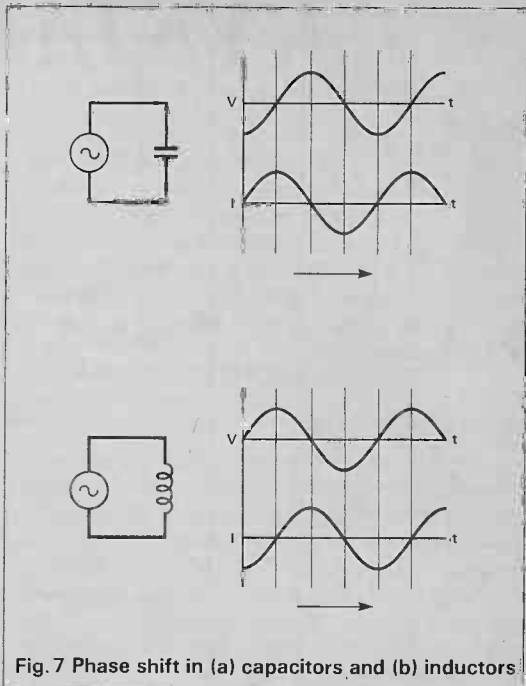

Fig. 7 Phase shift in (a) capacitors and (b) inductors

connected to an inductor. Here the current *lags* the voltage by 90 degrees. The current waveform is always a quarter of a cycle *behind* the voltage waveform.

How the current can be out of phase with the voltage in capacitors and inductors is an extremely difficult concept bringing in imaginary mathematics and many other worrying principles. If you can accept it as true, all well and good. If your healthy enquiring mind wants to know *why*, refer back to our *Circuit Theory* series on complex theory (October 1987 to April 1988).

If the circuits are changed to include a resistor as in Fig. 8, then the current and voltage relationships are changed and they become frequency dependent.

The first point is that the voltage at the capacitor is no longer the same as at the voltage source. At low frequencies it is as if the capacitor wasn't there because its impedance is so high. This means very little current flows in the circuit, very little voltage is dropped across the resistor and so the capacitor voltage is more or less the same as at the voltage source. The two voltages, input and output, are in phase.

When the frequency is high the capacitor looks almost like a short circuit to 0V. Therefore the voltage across it is very small and the effective load to the voltage source is just the resistor. Because the load is resistive, the current out of the voltage source is in phase with the voltage. But we know that the voltage across the capacitor lags the current by 90 degrees.

In fact the phase doesn't actually reach -90° degrees until the frequency is infinite. Likewise the phase is only zero when the frequency is zero. So in practise the phase is only ever *between* 0 and -90° . The frequency at which the middle phase value, 45 degrees, occurs is always

$$f = \frac{1}{R} \times \frac{1}{2\pi C}$$

The voltage, current and phase argument used above to describe the capacitor network can be applied in exactly the same way to the inductor network, remembering that the current lags in an inductor. The intermediate frequency at which the phase lag is at its middle value (-45°) is always

$$f = \frac{R}{2\pi L}$$

To get our desired -180° phase shift we could

use two resistor and capacitor networks cascaded as in Fig 9a, or two cascaded inductor networks as in Fig 9b.

However there is a better solution than either of these. We can use superposition and combine the two

capacitor in place of the resistor. At first sight this would seem to be worse than having no source resistor! The problem is that at higher frequencies the propagation delay of the inverter becomes significant.

Consider a 74HC04 inverter. When it is switching logic levels, the maximum propagation delay is 25ns. This means that the output changes 25ns later than the input. At low frequencies this is hardly noticeable but at 40MHz it is significant (a full half cycle at 40MHz) so the propagation delay actually adds a 180° phase shift.

At frequencies less than 40MHz the phase shift caused by the propagation delay is less than 180° but it can still be significant. At 16MHz for instance, it would be 72° and at 4MHz it would be 18°.

It might be thought that the propagation delay could be used to advantage, allowing the designer to remove the source resistor and the first capacitor, but this is not possible because the inherent output

CRYSTALS

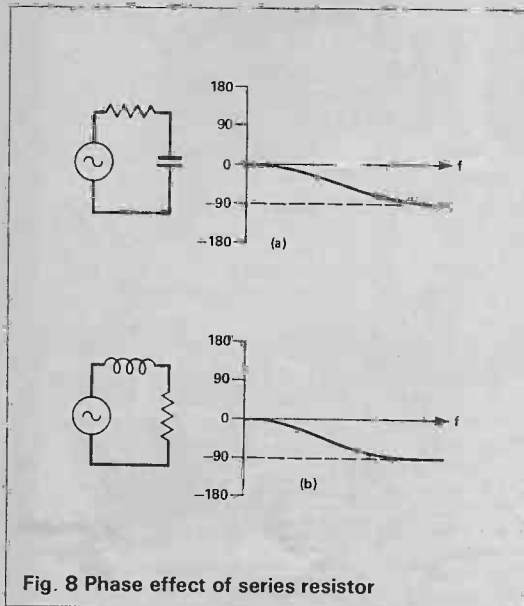

Fig. 8 Phase effect of series resistor

circuits resulting in the network in Fig. 9c. Now we have an inductor and a capacitor, so the phase shift will go up to nearly -180°. The problem here is of course that it will only produce the required -180° phase shift at infinite frequency. We need a three pole network that could go up to nearly -270° so that -180° is easily attainable at a middle value. This gives us the circuit in Fig 10. (Note that the resistor is still present to get the -90° from the first capacitor).

Relating this to the Pierce and Colpitts circuits (Fig. 5) we again see that the crystal is performing the function of an inductor.

Design Points -- Source Resistance

We have shown that the phase shift network must have a phase shift of more than -180° for oscillation, and that with the three pole network used in the Pierce and Colpitts oscillators this is only possible with the resistor between the amplifier and the first capacitor. Some crystal oscillator designs do not include a resistor in this position. Instead the design relies on the output resistance of the inverter (or the propagation delay of the inverter — see below). This is of course poor design practice because the output resistance of logic gates is not a specified parameter. Also, if the logic gate has a buffered output the output resistance is too low to have much effect.

Parallel Crystal Capacitance

When a crystal is manufactured, it is trimmed so that the mechanical resonance occurs at exactly the required frequency. In order to do this the manufacturer needs to know what the total value of C_p is (in Fig 1). The manufacturer chooses a value, say 20pF, and specifies this on the data sheet. It is then up to the circuit designer to ensure that the design values combine to meet the specified value. If the specified value is not met the circuit will still work, but at a slightly different frequency from that specified.

Source Capacitor

High frequency crystal oscillators often have a

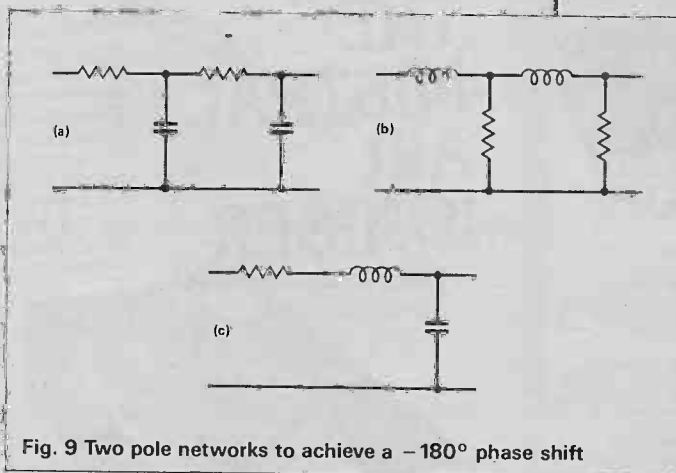

Fig. 9 Two pole networks to achieve a -180° phase shift

resistance of the inverter would still be present, and the crystal depends upon both capacitors being present in order to work properly. The solution is to add an additional series capacitor to produce a positive phase shift. This is usually to be found in oscillators of higher than 4MHz.

Overtones

The diagram in Fig 3 shows that the crystal is inductive at other frequencies than the fundamental. These frequencies are called overtones. It is important that the crystal does not start oscillating at one of the overtones rather than at the desired frequency.

In most designs it could never happen because the bandwidth of the amplifier and the propagation delay mean that the conditions for oscillation are not met at the higher frequencies. However this should always be checked in every new design.

Sometimes very high frequency oscillators are specifically designed to oscillate at one of the overtones. This is more tricky because the design must ensure that the conditions for oscillation are not met at the fundamental frequency. A possible circuit is shown in Fig. 11. Here C_s and the inductor are tuned so that they resonate at approximately the overtone frequency. Therefore all other frequencies are attenuated, including the fundamental and the other overtones.

Power

Often crystals are specified to operate at a maximum power level. Exceeding this level could damage the crystal or change its frequency of oscillation. In a 5V system the power is likely to be about a milliwatt, and so almost any crystal can be safely used.

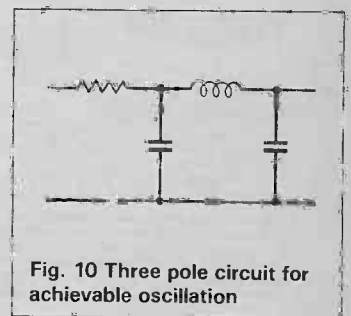

Fig. 10 Three pole circuit for achievable oscillation

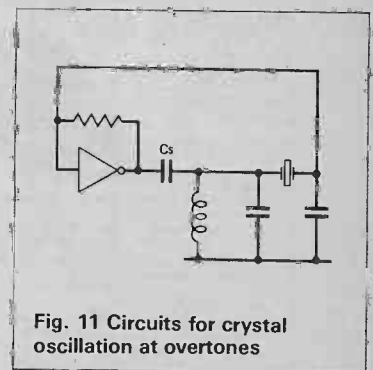

Fig. 11 Circuits for crystal oscillation at overtones



NOISE

ANNOYS

CIRCUIT THEORY

I began the investigation of noise in electronic circuits last month and gave a formula for the RMS thermal noise voltage produced by a resistor: $v = \sqrt{4kTBR}$. For some resistors, notably wire wound and bulk foil types, this is a good indication of how much noise they will contribute to a circuit. For the more common carbon or metal film varieties, it gives an optimistic estimate. With no external applied voltage the figure you get will be spot on but as soon as a voltage appears across the resistor, up goes the noise.

Calculating the additional noise is not easy since it will vary with the type of resistor and the way it's manufactured. Meaningful figures are hard to come by, particularly if you are not buying from professional suppliers. As a rough and ready guide, the thermal noise figure calculated from the formula above can be raised about 100nV per volt for a good quality metal film resistor and about five times as much for a carbon film type. So for a metal film resistor with 2V across it you'd add 200nV, for 5V you'd add 500nV and so on. The extra noise tends to be concentrated at low frequencies, so unless you're using a very narrow frequency response or a high pass filter, the bandwidth doesn't make much of a difference.

It's a bit early to look for too many design rules but an obvious conclusion to be drawn is that if the budget won't stretch to bulk foil resistors, it's a good idea to keep the voltages as low as possible across

resistors in sensitive circuits. For instance, you could have a bias circuit like that of Fig.1a (although I wouldn't recommend it at all, since every bit of hum and goo on the supply rails will find its way to the input of the amp — but it can sometimes be used to avoid a separate 0V rail). Far better is Fig.1b, it produces exactly the same DC operating conditions (remember Thevenin's theorem?) but without the extra noise introduced by the 15V across each resistor of the other circuit. This is rather an extreme example but shows the kind of thing to watch for.

Adding Noise Voltages

The noise in any practical circuit is unlikely to come from a single source. Usually there will be several resistors making their contributions and the op-amp

Paul Chappell sums up the vexing voltages produced by noise

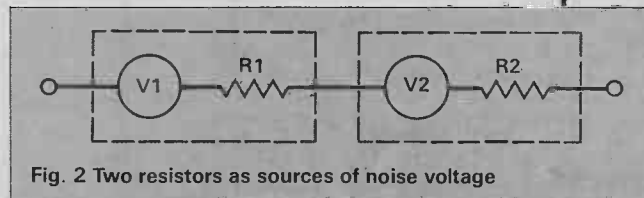

Fig. 2 Two resistors as sources of noise voltage

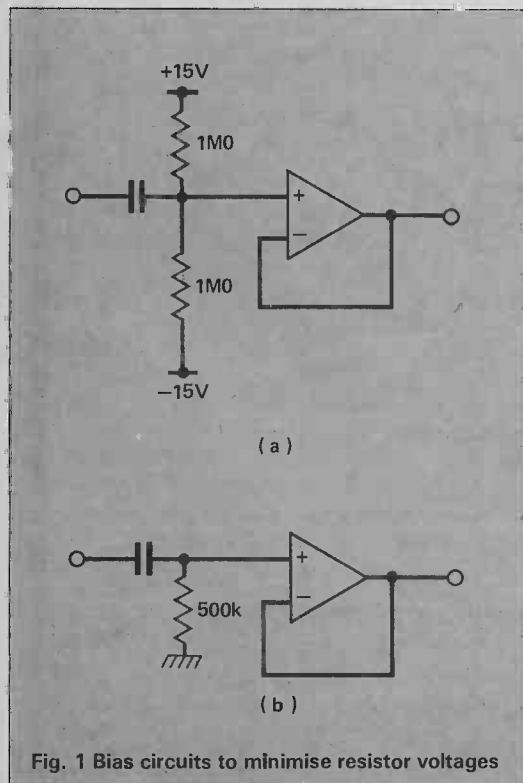

Fig. 1 Bias circuits to minimise resistor voltages

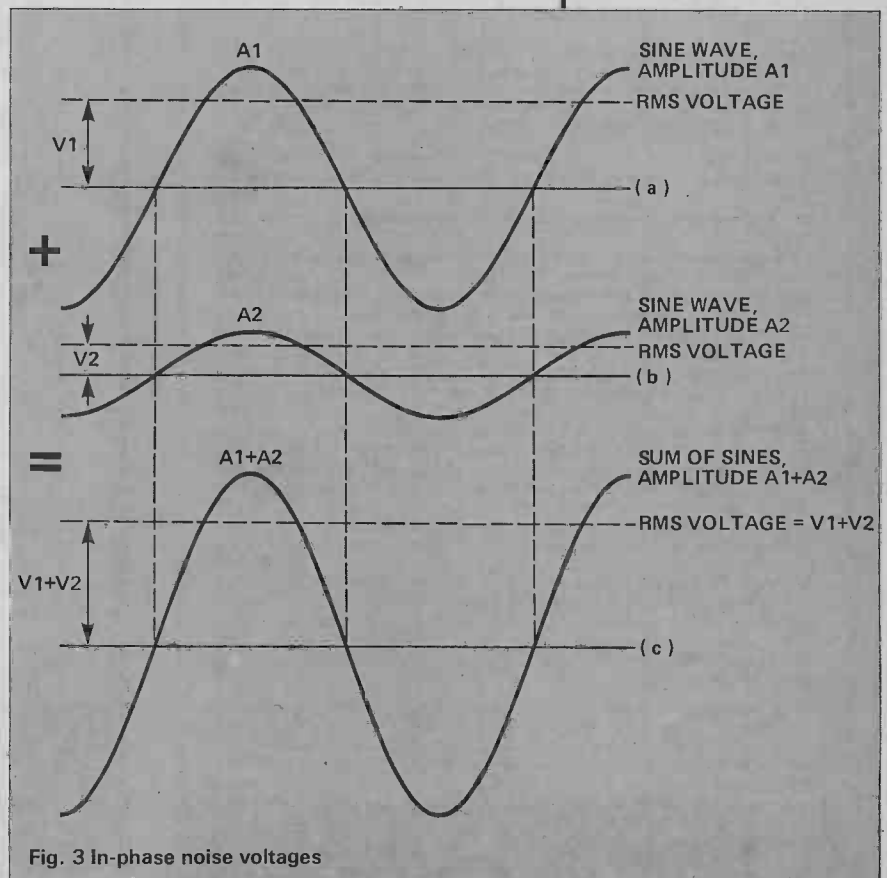

Fig. 3 In-phase noise voltages

July

1989

VOLUME 18 No 7

Einstein Cover photograph
courtesy Hulton Picture
Library/Bettman Archive

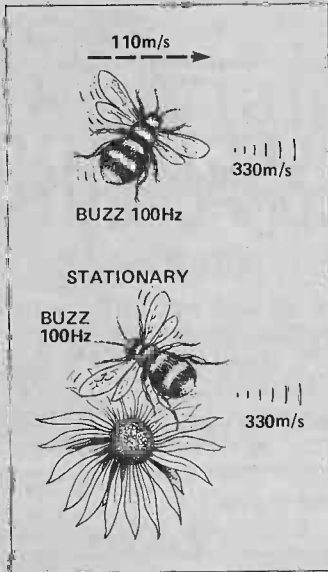

Page 33

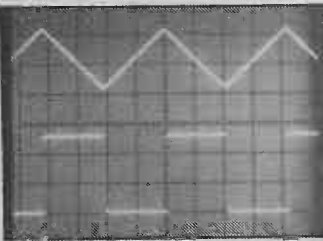

ISSN
0142-7229

ABC

Member of the
Audit Bureau
of Circulation

ETI is normally published on the first Friday in the month preceding the cover date. The contents of this publication including all articles, designs, plans, drawings and programs and all copyright and other intellectual property rights therein belong to Argus Specialist Publications Limited. All rights conferred by the Law of Copyright and other intellectual property rights and by virtue of international copyright conventions are specifically reserved to Argus Specialist Publications Limited and any reproduction requires the prior written consent of the Company © 1989 Argus Specialist Publications Ltd. All reasonable care is taken in the preparation of the magazine contents, but the publishers cannot be held legally responsible for errors. Where mistakes do occur, a correction will normally be published as soon as possible afterwards. All prices and data contained in advertisements are accepted by us in good faith as correct at the time of going to press. Neither the advertisers nor the publishers can be held responsible, however, for any variations affecting price or availability which may occur after the publication has closed for press.

• Subscription rates — UK: £18.00. Europe: £22.20. Middle East: £22.40. Far East: £24.00. Rest: £22.70 or US\$ 39.00.

**ARGUS
PRESS
GROUP**

Argus House
Boundary Way,
Hemel Hempstead
HP2 7ST
Tel: (0442) 66551
Telex: 827797

Jez Ford: Editor
Paul Chappell: Projects Editor
Mark Webb: Group Editor
Julie Horstead: Production

Cass Gilroy: Ad Manager
Nick Peters: Classified Sales
Jerry Fowler: Technical Illustration
Mark Warford: Photography

REGULARS

News	6	PCB Foil Patterns	59
Open Channel	9	Free Ads Coupon	60
Playback	10	Oops!	61
CADCAM Show Report	10	PCB Service	34
Blueprint	11	Keep Regular	39
Read/Write	12	Photocopies	52
Subscriptions	32	Backnumbers	52
		Special Offer	58
		Classified Ads	62
		Fame & Fortune	64
		Next Month	66
		Ad Index	66

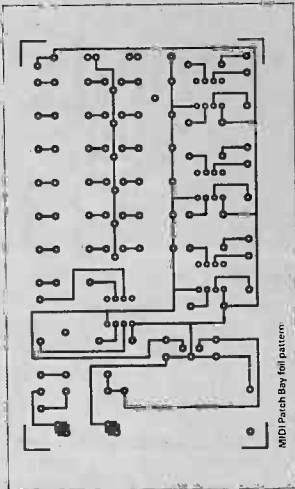

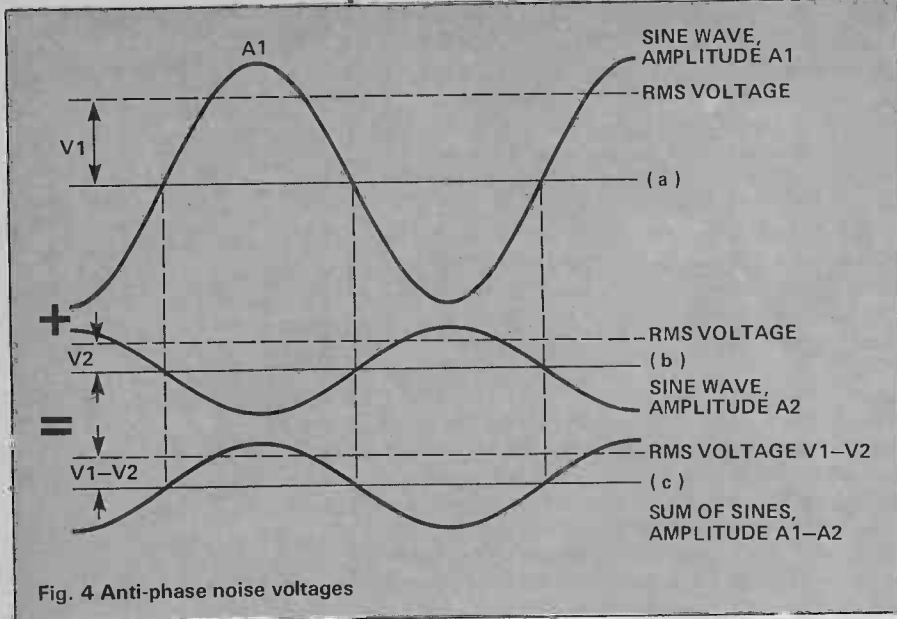

Fig. 4 Anti-phase noise voltages

throwing in some noise of its own, so how do we reckon up the total? Just add together each individual contribution?

Figure 2 shows two resistors in series, a situation where you might very well expect the noise voltages to add. The noise is shown as a 'let's pretend' voltage source inside each resistor: the idea is that if you make believe that each resistor package contains an entirely noiseless resistor and a voltage generator which produces the noise, it makes absolutely no difference to any practical measurements you might make and it helps make the situation easier to visualise. It's a common trick in electronics.

So having measured noise voltages v_1 and v_2 for the individual resistors, do we find a voltage of $v_1 + v_2$

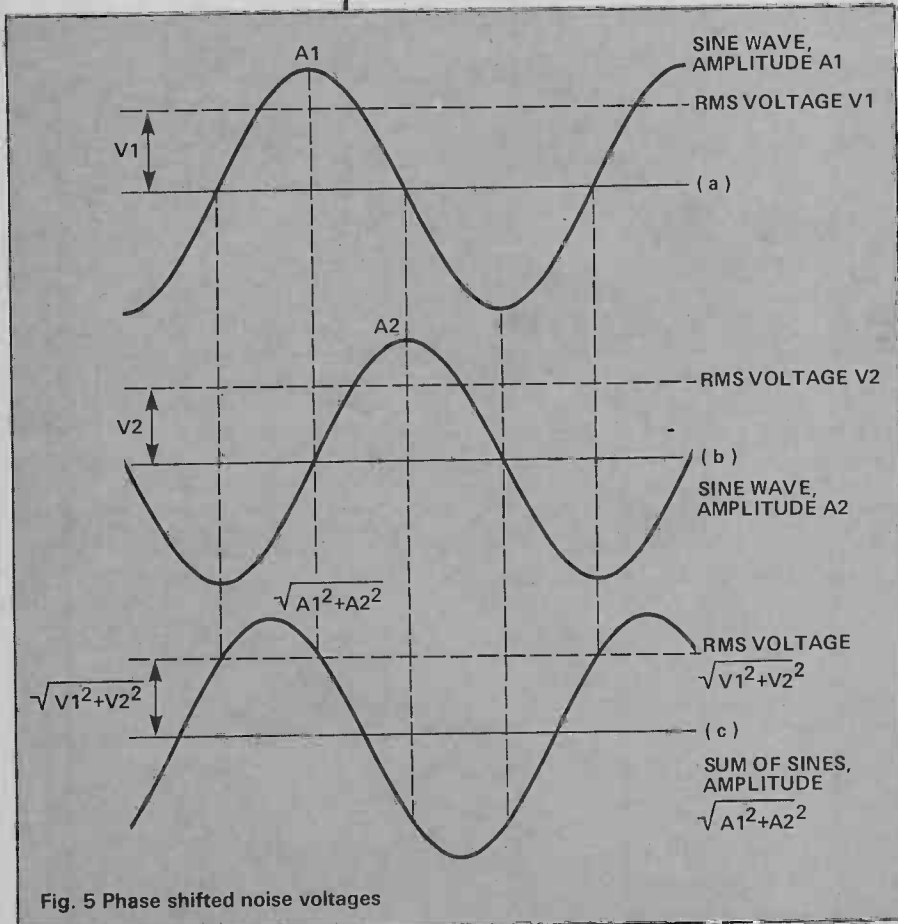

Fig. 5 Phase shifted noise voltages

across the two? Sad to say, it's not quite that easy. The trouble is that v_1 and v_2 are totally unrelated to each other: at some moments the two instantaneous voltages might add, at others they may partially or completely cancel, so the resulting RMS voltage will be something less than the sum of the two. To be exact, it will be $\sqrt{v_1^2 + v_2^2}$. For several resistors in series it will be $\sqrt{v_1^2 + v_2^2 + \dots + v_n^2}$.

The same applies to adding other noise voltages, whether they come from resistors or from some other source. You square each RMS noise voltage, add up, then take the square root of the result. The only exception to this rule occurs when the two voltages are related in some way.

Figure 3a and 3b shows a pair of sine waves of different amplitudes but of the same frequency and in phase. To find the RMS voltage of the sum of the two (Fig. 3c) you just add the individual RMS values for the two waves. If the two waves were 180° out of phase, as in Figs. 4a and 4b, the RMS voltage of the sum of the two waves would be calculated by taking the difference of the individual RMS values.

Figures 5a, b and c show the addition of two sine waves 90° out of phase. In this case they add in exactly the same way that noise voltages do: you square the two RMS values, add, then take the square root. Figure 6 shows a phasor diagram of the addition, which demonstrates how the 'root of the sum of the squares' comes about, at least for the amplitudes. Since the RMS value is proportional to the amplitude, it's no surprise that the same formula applies there too.

Now, sine waves ain't noise voltages but what I'm trying to demonstrate is that if the RMS voltages you're trying to add come from waves that are related, the result can be anything from the arithmetic sum to the difference. The 'relatedness' doesn't depend on the waves being the same shape but on them spending more of their fair share of the time being positive together and negative together, or alternatively being of opposite polarities for more than half the time. Oh dear, this is getting complicated. So much easier just to write down a formula!

Let's go back to the noise voltages. Suppose that you were to rig up a gambling device which goes like this: as soon as one noise voltage from a resistor (say) hits 100nV, a red light comes on. At the same instant the noise voltage from an op-amp (say) is sampled and a green light comes on if the voltage is positive and a yellow one if it's negative. The yellow and green lights are hidden behind a flap: you have to make your bet before you can take a peek.

This is how you play. As soon as the red light comes on, you take a bet on which of the other two lights will be lit, the yellow or the green. If you guess wrong, you lose your money. If you guess right, you get back twice your stake. When you've settled up, you press a button to reset the circuit and try again. Ready to play?

If the noise sources are unrelated, you'd expect the green light to come on as often as the yellow light over a long series of plays. On average you would end up with more or less the same money as you started with — it would be much the same as betting on the toss of a coin. But if one light came on more than the other, you'd start to have your suspicions about the independence of the noise sources.

Oddly enough, you'd be in the same position if you played the gambling game with the sine waves of Figs 5a and 5b. The machine as I've described it wouldn't be entirely fair (can you see why?) but the fact remains that if you know only that A1 is at say 2V, there's no way of knowing whether A2 will be positive or negative. If you guessed, you'd have an exact fifty-fifty chance of being right.

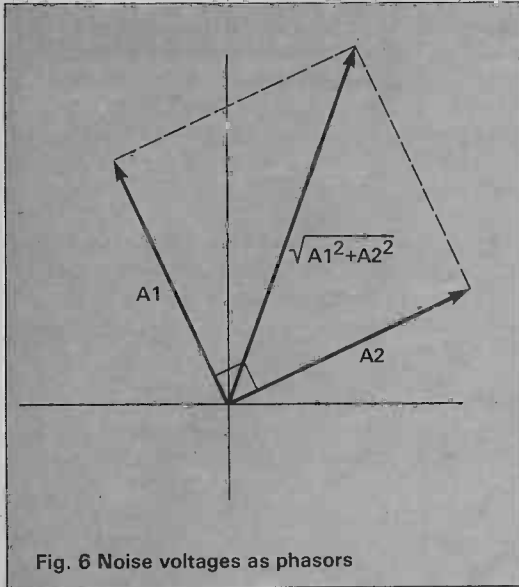

Fig. 6 Noise voltages as phasors

of minus one: they always 'do the opposite thing'. The waves of Fig. 5 are uncorrelated: they don't do anything alike and the RMS values add up in just the same way as noise voltages.

Getting back to op-amp circuits after our two month digression, what are the consequences of all this. Well, most of the time you can assume that any noise voltages that occur are uncorrelated. There's no reason to suppose that the thermal noise produced by one resistor, for instance, will have any relationship whatever to the noise produced by another. To add up the noise voltages, you do the root of sum of squares calculation.

On the other hand, you might find yourself adding the input noise voltage of an op-amp to the voltage developed across a resistor by the op-amp's noise current, and in this case there's no guarantee that the two will be totally independent. The chances are they won't be. In this case, the usual calculation won't be entirely accurate: how far off the mark it is will depend on the degree of correlation and whether it is too large or too small will depend on whether the correlation is positive or negative.

Now you're going to ask me what can be done about the situation and I'm going to have to reply: not a sausage. It's not that the sums are difficult, it's just that you can't get hold of the figures to plonk into them. The sad lesson to be learned is that your noise calculations will never be entirely accurate, so don't use them as more than a guide. You can get a 'worst case' figure by simply adding the RMS voltages whenever you're in doubt about their independence. If you do this you'll find that the circuit will almost always perform better than you expect, which seems like a cheerful note to end on!

The intuitive notion of 'not being able to tell what one wave is doing by knowing the value of the other' is made precise by the mathematical notion of *correlation*. If the gambling machine is fair and the noise voltages unrelated, they have a correlation coefficient of zero. If the machine has a bias towards the green light, the signals have positive correlation and if the yellow light is on for more than its fair share of the time they have negative correlation. The sine waves of Fig. 3 have a correlation of one: they always 'do the same thing'. Those of Fig. 4 have a correlation



OUT NOW!

CRICKLEWOOD ELECTRONICS

1989 100 PAGE COMPONENT CATALOGUE PRICE £1

SEND OFF FOR YOUR COPY TODAY...

- WE STOCK AN UNRIVALLED RANGE
- ALL OUR COMPONENTS ARE FIRST CLASS BRANDED ITEMS
- WE OFFER A SAME DAY SERVICE ON ALL STOCK ITEMS
- NO MINIMUM ORDER—IF YOU NEED ONE COMPONENT WE CAN SUPPLY ONE COMPONENT
- WE HAVE ADOPTED A NEW LOWER PRICING POLICY + QUANTITY DISCOUNTS
- FREE VOUCHERS WITH YOUR CATALOGUE—ORDER ONE NOW!

JUST FILL IN THE COUPON OPPOSITE AND POST IT WITH YOUR £1 PAYMENT TO THE ADDRESS BELOW. YOU WILL RECEIVE NOT ONLY OUR SUPERB 100 PAGE CATALOGUE, BUT ALSO FREE VOUCHERS WHICH YOU CAN USE ON YOUR NEXT COMPONENTS ORDER.

CRICKLEWOOD ELECTRONICS LTD 40 CRICKLEWOOD BROADWAY LONDON NW2 3ET TEL. 01-450 0995/452 0161 FAX. 01-208 1441 TELEX 914977

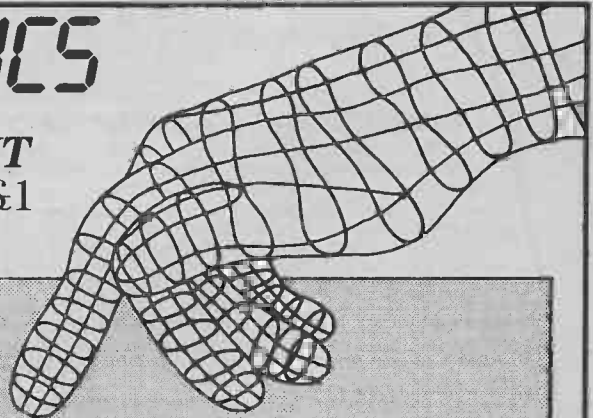

FREE VOUCHERS!

SEND OFF FOR YOUR CATALOGUE AND VOUCHERS TODAY.

I WOULD LIKE TO RECEIVE..... COPY(COPIES) OF THE 1989 CRICKLEWOOD ELECTRONICS COMPONENT CATALOGUE. I ENCLOSE £..... PLEASE ENCLOSE MY FREE VOUCHERS.

Tape your £1 coin here, or send a cheque or postal order for £1.00 for every catalogue you require.

NAME.....
 ADDRESS.....



REFLEX ACTION

AUDIO

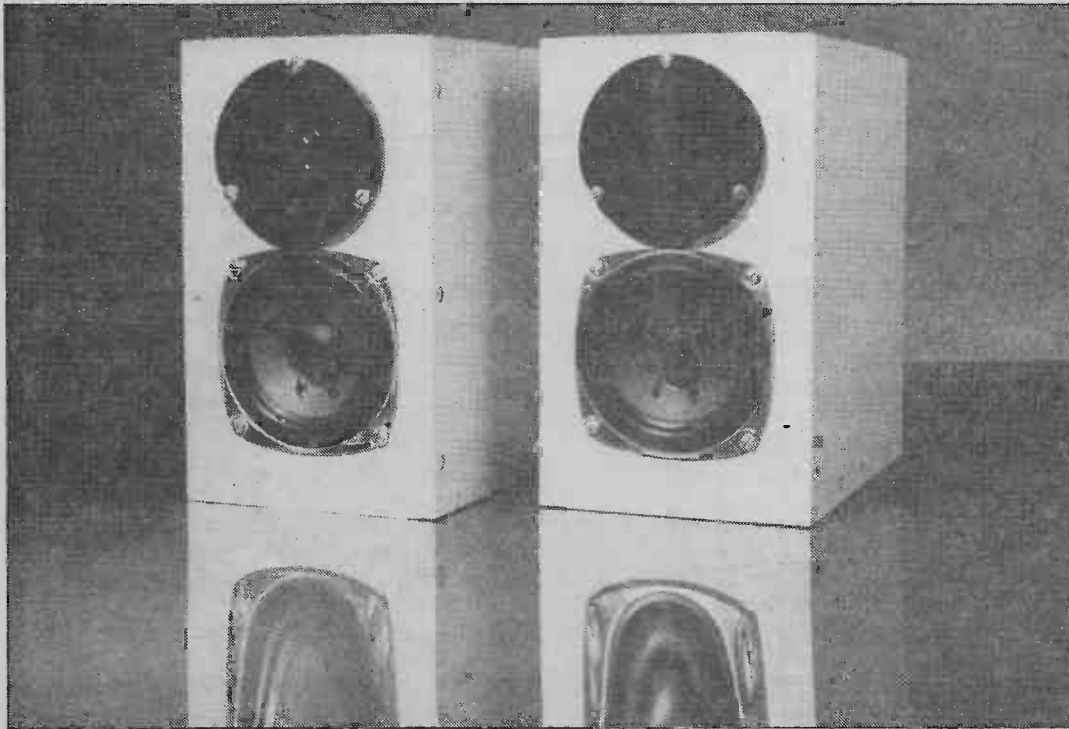

The moving coil loudspeaker has been with us for over fifty years. During this period a multitude of cabinet designs have been tried and tested with the intention of squeezing out the last vestige of bass response. Many designs go in and out of fashion — such as the bass reflex.

The basic problem with all speaker units is that they radiate sound from the rear as well as the front of the cone. Sound travels at a relatively constant rate and because the drivers are small relative to the bass wavelengths, low frequency signals are radiated from either side in antiphase and thus cancel.

The only sensible way of getting bass from a speaker is either to contain the back waves in a cabinet or to lose them in a transmission line. Transmission lines are good performers but are typically seven feet long (and that's just the quarter wavelength!), a little incongruous for the average living room.

Most domestic speaker arrangements are either plain sealed boxes, the infinite baffle arrangement or bass reflexes. Superficially the bass reflex resembles

the infinite baffle but a close look reveals a duct or port inserted into the cabinet, usually taking the form of a short tube.

The port tunes the enclosure to a known low frequency so that the box itself becomes resonant. Enclosure and speaker work as a kind of acoustic transformer, with the speaker as the primary and the air in the duct as a secondary. When this technique is correctly employed, the system can operate down to much lower frequencies. Therein lies the rub — the technique must be correctly applied. If not then the nasty response curves shown in Fig. 1 can be produced.

So how can a well-damped system be designed given simply the driver parameters as a starting point?

Filter Solution

Before answering we should take a brief look at filter theory. A speaker unit mounted in a cabinet exhibits the same behaviour as classic hi-pass electronic filters.

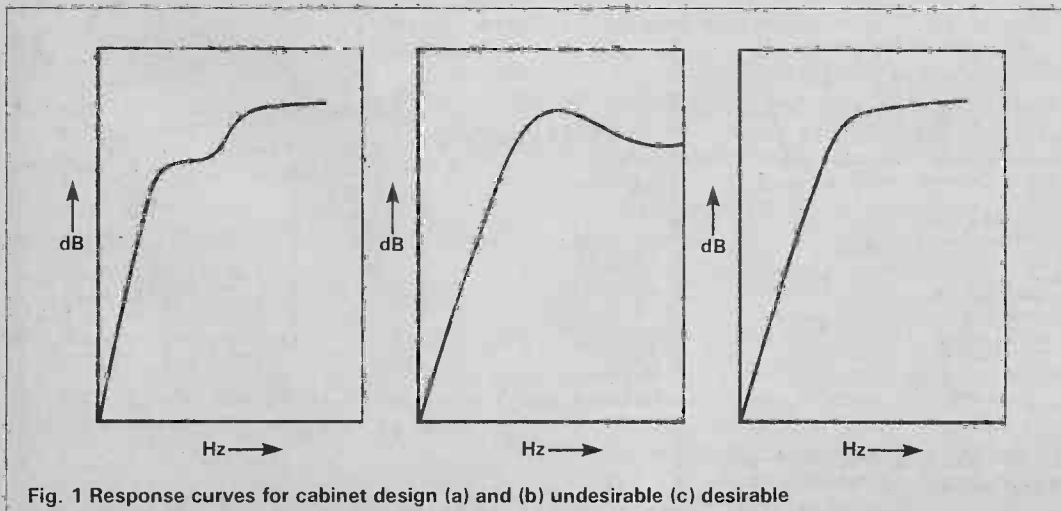

Fig. 1 Response curves for cabinet design (a) and (b) undesirable (c) desirable

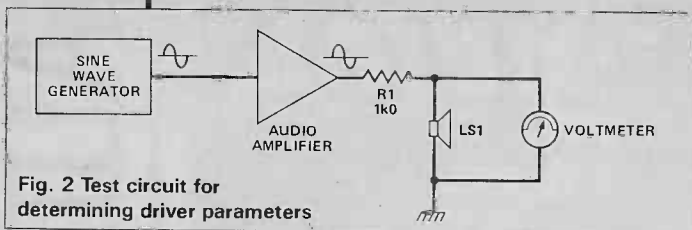

Fig. 2 Test circuit for determining driver parameters

DRIVE PARAMETERS

Many constructors will have a pair of suitable speakers gathering dust somewhere for which they have no data. These can be determined quite simply with a little ingenuity and some extra maths.

Some equipment is necessary. An accurate audio signal generator and multimeter with a low voltage range is essential. If available an oscilloscope is very useful too. The parameters we wish to determine (f_0 , Q_{ts} and V_{as}) can be determined with the test set up shown in Fig. 2.

To begin the testing place the driver face upwards on your workbench and connect the audio generator through a suitable amplifier and R1 to the speaker. Connect the multimeter (on a suitably low voltage range) across the speaker. Switch the signal generator to its lowest range and slowly sweep up the frequency from 20Hz. A point will be found of maximum deflection on the voltmeter. This frequency is f_0 .

Determining Q_{ts} requires a little more work. Disconnect the driver and measure its voice coil resistance, R_v . Next substitute a 10R resistor for the speaker. Measure the voltage across the resistor when being fed from the signal generator. Adjust the signal generator for a suitable level say 100mV across the 10R, equivalent to a 10Vrms signal from the amp. Now when you substitute the speaker for the 10R you will be able to measure its impedance in ohms at various frequencies.

Once again repeat the test and adjust the signal generator for f_0 . Note the voltage reading (V_0) at this point. Now comes the difficult part. The resistance at resonance is

$$R_m = \frac{V_0}{10mV}$$

It is now necessary to find two frequencies either side of the resonance where the voltage reading is $r_q = \sqrt{R_m} \times R_v$. Having found the value of r_q both frequencies (f_1 and f_2) can be found. Q_{ts} can now be determined from

$$Q_{ts} = \frac{f_0}{f_2 - f_1} \sqrt{\frac{R_v}{R_m}} \quad (8)$$

Lastly V_{as} needs to be determined. There are two ways of finding this. Probably the easiest way is to build a test box, mount the speaker in it and measure the resonant frequency f_0 with the test set up described above. Make your box volume at least 0.5cuft, airtight and with no absorbant of any kind.

Using this method,

$$V_{as} = V_0 \left(\left(\frac{f_0}{f_c} \right)^2 - 1 \right)$$

If you don't have a test box but still want to find V_{as} the following method produces fairly accurate results to within 10%, close enough to allow the enclosure design methods outlined above.

The method involves adding a known amount of mass to the speaker cone and measuring the frequency of the new (lower) resonance frequency. Three old pennies, for those whose memories stretch back that far, used to weigh an ounce! Interestingly new ten pence pieces weigh 10g. Take two ten pences and add a blob of that tacky blue stuff to each. Weigh the coins with the blue tack adjusting them until both have identical mass. Take these and press them gently onto the cone either side of the dust cap.

With the speaker still face up on the bench measure the new resonant frequency, f_{om} . Use the same method you used to determine f_0 . From this the surround compliance can be calculated:

$$C_m = \frac{1}{39.47m} \times \frac{(f_0 + f_{om})(f_0 - f_{om})}{(f_0 \cdot f_{om})^2}$$

where m is the added mass in kg, and C_m is in meters/newton.

Now you need to find the area of the speaker cone. C_a in square meters then

$$V_{as} = 4.94 \times 10^6 \times C_a^2 \times C_m$$

The answer is in cubic feet.

AUDIO

```

10 REM *** OPTIBOX ****
20 home$=CHR$(27)+"E"+CHR$(27)+"H"
30 PRINT home$
40 PRINT "This program designs reflex speakers given driver parameters "
50 PRINT:PRINT "press any key to continue "
60 WHILE INKEY$="": WEND
70 PRINT home$
80 INPUT "Speaker resonant freq;fs";fs
90 INPUT "Speaker total Q; Qts ";qts
100 INPUT "Air compliance volume; Vas ";vas
110 INPUT "To design optimum reflex enclosure enter e";e$
120 IF e$="e" THEN 230
130 PRINT home$:INPUT "required cutoff frequency ";f3
140 IF f3=0 THEN PRINT "To start again enter e";e$
150 vb= vas/((f3/fs)^2)
160 fb = fs*((vas/vb)^0.32)
170 r = 20*LOG10(2.6*qts*((vas/vb)^0.35))
180 PRINT "Enclosure volume = ";vb:PRINT "tuned to ";fb;"Hz":PRINT " -3db at ";
PRINT " Ripple = ";r;"db"
190 INPUT "Design port? 1=yes 0=no";b
200 IF b=1 THEN 270
210 INPUT "New f3? 1=yes:0=no";a
220 IF a=1 THEN 130 ELSE STOP
230 vb=15*vas*(qts^2.87)
240 f3 = 0.26*fs/(qts^1.4)
250 fb =0.42*fs/(qts^0.9)
260 GOTO 180
270 INPUT "Port Area in sq inches";a
280 l=(2700*a/(vb*(fb^2)))-0.96*a
290 IF l>3360/(7*fb) THEN PRINT "Port Area to large; try again":GOTO 320
300 IF l<=1 THEN PRINT "Port area to small; try again": GOTO 320
310 PRINT "Port length =";l;" inches"
320 INPUT "Another port area; 1=yes 0=no";c
330 IF c=1 THEN 270
340 GOTO 210

```

of stiffness) of the cone surround and the moving mass of the cone. Compare it to a mass on a string. If the mass is pulled down and released then the system oscillates at a fixed frequency. Increase the mass or use a more compliant spring and the frequency will be reduced. Decrease the mass or increase the compliance and the frequency will increase.

When the speaker is fitted into a cabinet the stiffness of the enclosed air reduces the compliance of the air and raises the resonant frequency. This is why drivers that in free air will respond right down to say 25Hz will only respond to about 50Hz in any case of a size that does not give your housemates heart failure. When mounted in this way the response looks like a classic 2nd order filter rolling off a 12dB/octave at low frequencies. To complicate matters however the 'Q' of the response curve will rarely be optimum, which results in a peak in the response.

A bass reflex enclosure also operates like a high pass filter, this time with a much steeper roll off of 24dB/octave (a 4th order response).

Finding The Optimum

This similarity between active filters and speaker systems allows analysis. Knowing three pieces of information about your proposed drive unit you can accurately predict its performance in any given enclosure without having to build it first! For this particular revolution we can thank Messrs Theile and Small whose pioneering work in this field has made this happy state of affairs possible.

The bad news is that for each driver there is one, and one only, ideal enclosure size. However if 1 or 2dB of ripple in the pass band can be tolerated then the rules can be bent somewhat to produce a number of acceptable compromises. Better still the majority of these are possible in reasonable sized cabinets.

The Maths

Here goes. To design an optimum size enclosure you need to know three driver parameters. The first is f_o , the resonant frequency of the driver in free air. Next Q_{ts} . This is the total Q of the driver. Lastly you need V_{as} . This is the volume of air which has the same compliance as the driver's surround.

All these parameters should be available with the driver. Design proceeds as follows.

- First find the optimum enclosure volume:

$$V_b = 15V_{as}(Q_{ts})^{2.87} \quad (1)$$

- Then the bass -3db cut off frequency:

$$f_3 = \frac{0.26f_o}{(Q_{ts})^{1.4}} \quad (2)$$

- The frequency to tune the box to:

$$f_b = \frac{0.42f_o}{(Q_{ts})^{0.9}} \quad (3)$$

- Passband ripple:

$$R = 20 \log \left(2.6 \times Q_{ts} \left(\frac{V_{as}}{V_b} \right)^{0.35} \right) \quad (4)$$

To illustrate let's take KEF's B110 where $V_{as} = 0.83 \text{cuft}$, $Q_{ts} = 0.33$ and $f_o = 37 \text{Hz}$. For the B110:

$$V_b = 15 \times 0.83 \times 0.33^{2.87} = 0.516 \text{cuft}$$

$$f_3 = \frac{0.26 \times 37}{0.33^{1.4}} = 45.4 \text{Hz}$$

$$f_b = \frac{0.42 \times 37}{0.33^{0.9}} = 42.1 \text{Hz}$$

$$R = 20 \log \left(2.6 \times 0.33 \times \left(\frac{0.83}{0.516} \right)^{0.35} \right) = +0.114 \text{dB}$$

Note that the sign of the ripple is important, +ve indicates a peak, -ve a dip.

Having obtained our alignment information we are left with a problem. Designing the vent. Once again we have to get our calculators out. To determine the length of the duct we have first to decide on its diameter (assuming of course that a tube is to be used. This is not essential — a duct can be of any given shape as long as its area is maintained).

First let us assume a 2in drainpipe for our duct. The area A will be πr^2 in square inches (where r is of course the radius) or 3.14sqin. The required length is then found from the expression

$$L = \frac{2700A}{V_b f_b^2} - 0.96\sqrt{A} = 7.9 \text{in} \quad (5)$$

That's essentially all there is to it. However a few words on vents wouldn't come amiss since there are a few peculiarities. Firstly the larger the vent the longer it will be. The advantage of a larger vent is that the air velocity in it will be low. If you try too small a vent with the above equation you will get a negative length. The solution here is obvious!

Secondly the pipe length must be less than $3360 \div 7f_b$ else you might get organ type resonances in it. This deals with the ideal case and it's recommended that this be calculated first.

If you want to try a different enclosure volume because say the enclosure is too big or you want to extend the bass response proceed as follows.

Firstly choose your new low frequency cutoff, f_3 , then

$$V_b = \frac{V_{as}}{\left(\frac{f_3}{f_o} \right)^2} \quad (6)$$

$$f_b = f_o \left(\frac{V_{as}}{V_b} \right)^{0.32} \quad (7)$$

Determine the ripple from equation 4. This is the test of whether your proposed system will be worth building. Good transient response implies low ripple. In practise you should aim for as little as possible. By the time the figure reaches 3dB the transient response will be compromised. So this represents the maximum allowable for hi-fi performance.

Having determined these parameters use equation 5 to determine the duct and you're in business.

To illustrate these equations again let's design a system with the B110 and a f_3 of 35Hz.

$$V_b = \frac{0.83}{\left(\frac{35}{37} \right)^2} = 0.927 \text{cuft} \quad (6)$$

$$f_b = 35 \times \left(\frac{0.83}{0.927} \right)^{0.32} = 36.3 \text{Hz} \quad (7)$$

$$R = 20 \log \left(2.6 \times 0.33 \times \left(\frac{0.83}{0.927} \right)^{0.35} \right) = -1.66 \text{dB} \quad (4)$$

The ripple has naturally increased from the optimum case (pun) but is still acceptable.

Finally for those amongst you who like doing things the easy way here is a computer program that does all the hard work for you. Although written for an Amstrad 8256 it will work on any IBM compatible machine that runs Basic and shouldn't be too difficult to convert to other machines. Most of the program is self explanatory. Line 90 sets the clear screen on the Amstrad. If you can use CLS or HOME to do the same job substitute this for line 90 and subsequent PRINT CL\$ instructions. Similarly the WHILE INKEY\$="" :WEND instruction simply pauses the machine until a key is pressed. Different dialects of Basic will have equivalent instructions.

Hopefully all this has helped dispel some of the mysteries from the 'black art' of successful bass reflex design. Next month we present a complete design for a pair of reflex speakers, the Micro Monitors.

The author would like to thank Mr Hugh Haines for his invaluable assistance with this article.

RS232 RELAY BOARD

Neville Croucher takes control with his micro using this general purpose relay interface

PROJECT

Microcomputers can make versatile and powerful tools for controlling electrical equipment. The usual method of control is through the computer's expansion port — but these ports are invariably specific to model or manufacturer. Equipment connected to the expansion ports will be specific to the particular computer for which it was designed.

The RS232 interface, on the other hand, is an almost universal interface, standard on the vast majority of micro and home computers. The project presented here allows any computer equipped with this interface to control six relays each of which can switch up to 10A at mains voltages. There is also an 8-bit input port which can be fed with external signals or simply set using switches.

In order to be as universal as possible, the serial data parameters such as baud rate and parity are set up on PCB-mounted switches.

The circuit is based around the AY-3-1015D UART (Universal Asynchronous Receiver/Transmitter). This device handles all the serial data transmission and reception as well as generating all the timing signals. The device is designed to be pin programmable so does not require a microprocessor to set up any control parameters. The only external signal required is a clock to set the baud rate.

Construction

Construction is straightforward if the ready-made circuit board is used. The capacitors, resistors, connectors, crystal, DIL switch and diodes should be fitted first. IC sockets do not have to be used, although one is recommended for the UART. Care is needed when soldering some of the IC pins to avoid solder bridges on some of the between-pin tracks.

The +12V supply can now be connected and the supply pins of the ICs checked. ICs 2 and 3 should have 10V, ICs 1, 5 and 7 should have 5V, and ICs 4 and 6 should have 12V.

If all is well the clock ICs 2 and 3 should be fitted. If a frequency meter or oscilloscope is available the frequencies in Table 1 should appear on pin 40 of the UART for the different settings of SW1 to SW3.

The darlington driver IC4 should be fitted next. With the +12V supply on, C2 should have between

HOW IT WORKS

The complete circuit diagram is shown in Fig. 1. The +12V input is supplied directly to the relays, IC4 and IC6. Zener regulators are used to supply 10V for the oscillator circuitry and 5V for the UART and the monostable.

As has already been mentioned, most of the work is done by the UART, IC1. The second IC, a CMOS 4060, contains an oscillator and a divider chain. The oscillator is driven by crystal XTAL1. R6 provides the bias and C4 and C5 are the load capacitors. The frequency used is 2.4576MHz. This value is used because it easily divides (by powers of two) down to the standard baud rate frequencies.

The UART actually requires a clock frequency of sixteen times the required baud rate. Therefore to run at 1200 baud would require 19.2kHz. This is the clock frequency exactly divided by 128, an integer power of two.

The outputs from IC2 are connected to IC3. This is a CMOS 4051, the equivalent of a one pole eight way switch. The actual connection being made is determined by the state of the three binary inputs. This is used because it only requires three of the switches from the DIL switch and is cheaper than using a PCB multiway switch. The clock output is 10V point to point and this is divided by R1 and R2 to half this level before going into the UART transmitter and receiver clock inputs.

The other five switches in the DIL switch are connected to the EPS, NB1, NB2, TSB, and NP inputs of the UART. These are used to set the parity, the number of data bits, and the number of stop bits.

Six pins of the output port from the UART are connected to IC4, a ULN2003 darlington driver. (This IC actually contains seven buffers but one is used elsewhere in the circuit). The six outputs are connected to the six relays. IC4 has built in back emf protection diodes so these do not have to be added externally.

The 8-bit input port of the UART is connected to a screw terminal block. The inputs have built-in pull up resistors so they may be connected directly via switches to ground.

Following reception of a valid signal the receive buffer is full and the data available flag is set. This in turn sets the DAV pin of the UART high and triggers the monostable built around IC5. The monostable has two functions. Firstly it clears the data available flag via the RDAV pin which resets the DAV pin. Secondly it pulses the DS pin of the UART which initiates transmission of the data present on the input port. In this manner a transmission of output data to the board automatically initiates a return of the input port value.

Received data from the RS232 line comes through IC7 which is a 1489 line receiver. This inverts the signal and handles the level conversion. Transmitted data is sent by the 1488 line driver IC6. This requires a negative supply rail (this is generated locally to eliminate the need for an external negative power supply).

The negative supply is generated using a diode capacitor pump. The drive for this is taken from the remaining buffer in IC4. The input is driven at 9.6kHz from IC2. The output is connected by RS to the +12V supply. This signal is then level shifted by C1 and smoothed by C2. In fact the use of a resistor as a pull up device is very inefficient but for the amount of power required it is simple and cost effective. The additional electrical load is about 60mA — relatively low compared with the 260mA consumed when all six relays are on.

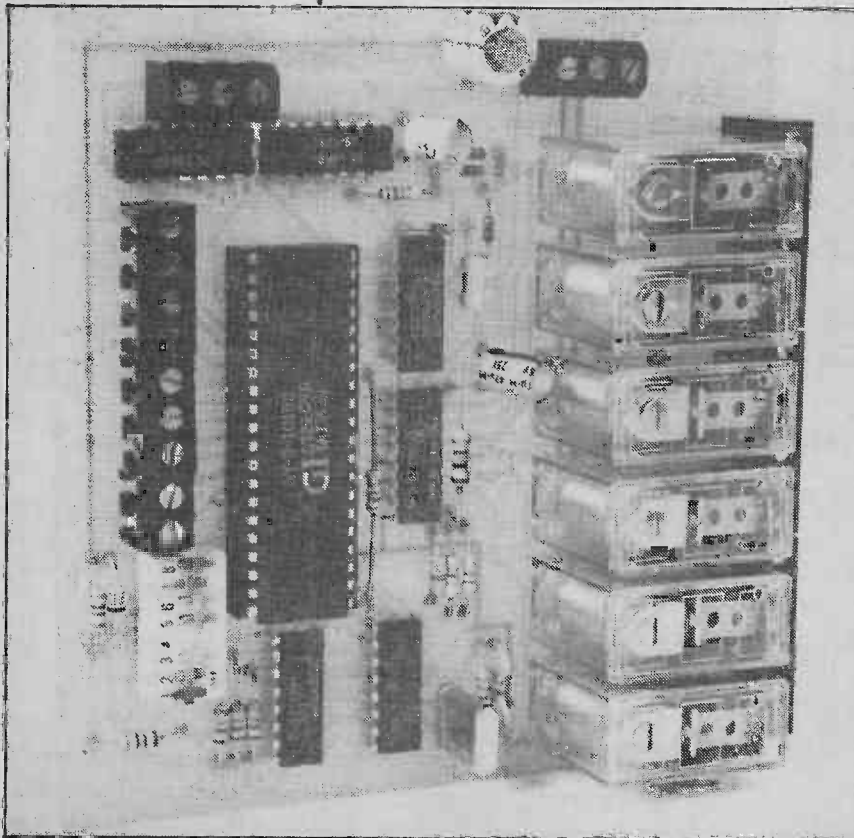

PROJECT

NOTE:
 IC1 = AY-3-1015D
 IC2 = CD4060
 IC3 = CD4051
 IC4 = ULN2003
 IC5 = CD4001
 IC6 = DS1488
 IC7 = DS1489
 D1-4 = 1N4148
 ZD1 5V1 ZENER (BZY88C5V1)
 ZD2 = 10V ZENER (BZY88C10V)

RELAY
 OUTPUTS

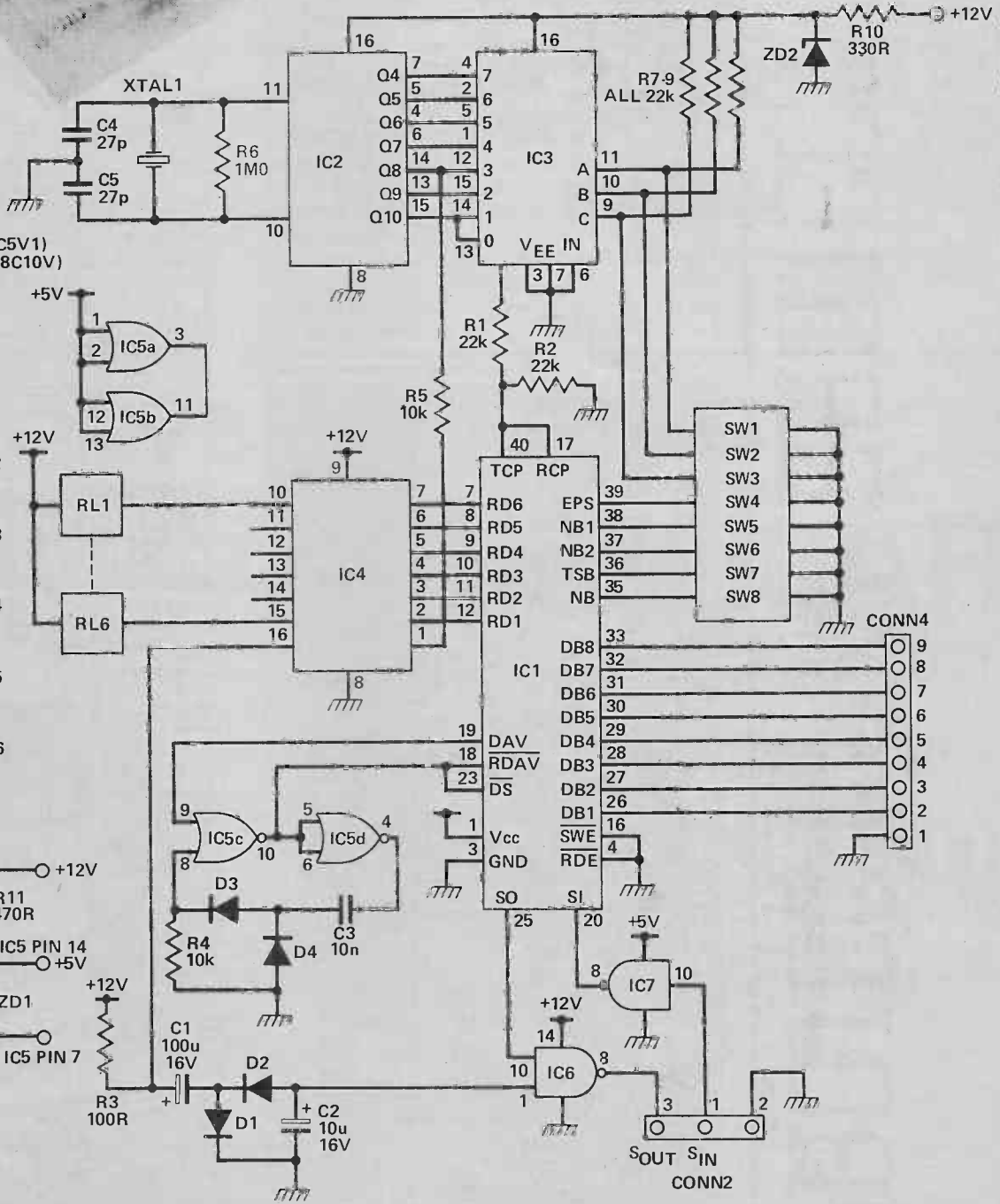
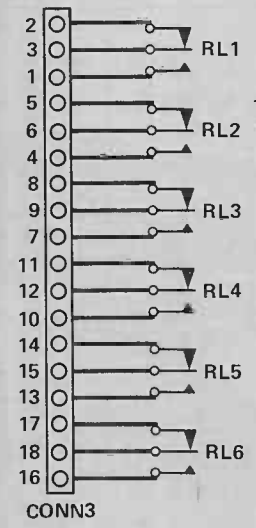

Fig. 1 Circuit diagram of the RS232 relay board

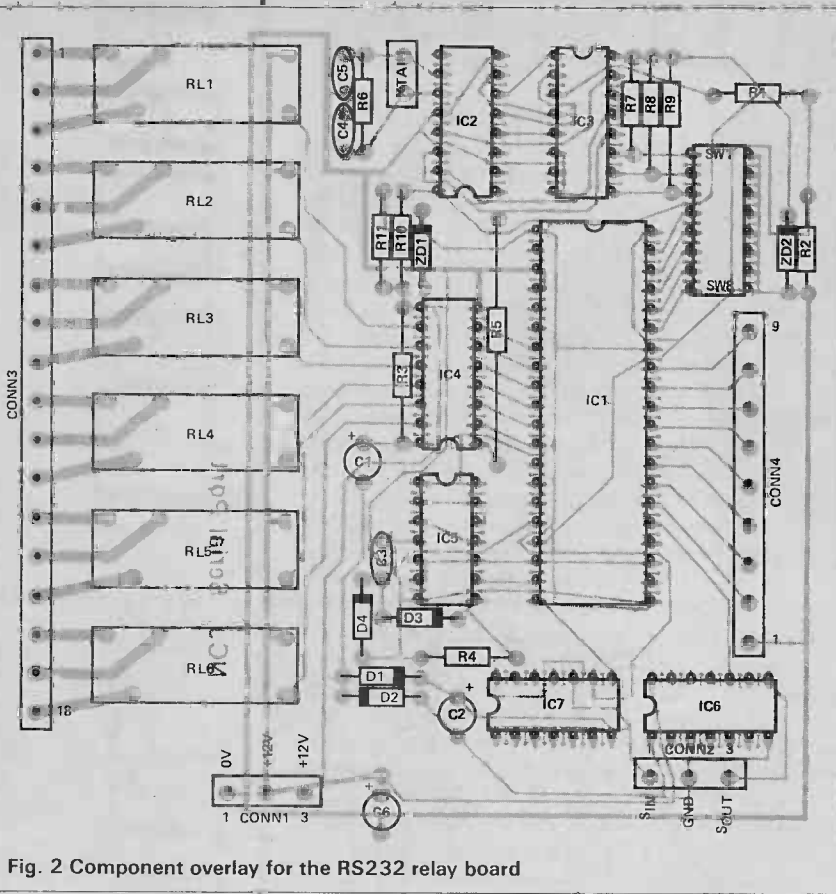

Fig. 2 Component overlay for the RS232 relay board

PARTS LIST

RESISTORS (all 1/4W 5% unless specified)

R1,2	5k6
R3	100R 1W
R4,5	10k
R6	1M0
R7-9	22k
R10	330R
R11	470R

CAPACITORS

C1	100µ 16V
C2	10µ 16V
C3	10n 100V
C4,5	27p
C6	220µ 16V

SEMICONDUCTORS

IC1	AY-3-1015D
IC2	CD4060
IC3	CD4051
IC4	ULN2003
IC5	CD4001
IC6	DS1488
IC7	DS1489
D1-4	1N4148
ZD1	5V1 zener (BZY88C5V1)
ZD2	10V zener (BZY88C10V)

MISCELLANEOUS

CONN1,2	3-way 0.2in PCB screw terminal
CONN3	18-way 0.2in PCB screw terminal
CONN4	9-way 0.2in PCB screw terminal
RL1-6	Omron G2R117PV or equivalent
SW1-8	DIL subminiature switches
XTAL1	2.4576MHz crystal (HC18U)
PCB. 12V 300mA power supply.	

SW1	SW2	SW3	Frequency
OFF	OFF	OFF	153.6kHz
ON	OFF	OFF	76.8kHz
OFF	ON	OFF	38.4kHz
ON	ON	OFF	19.2kHz
OFF	OFF	ON	9.6kHz
ON	OFF	ON	4.8kHz
OFF	ON	ON	2.4kHz
ON	ON	ON	2.4kHz

Table 1 Setting the clock frequency

SW1	SW2	SW3	Baud rate
OFF	OFF	OFF	9600
ON	OFF	OFF	4800
OFF	ON	OFF	2400
ON	ON	OFF	1200
OFF	OFF	ON	600
ON	OFF	ON	300
OFF	ON	ON	150
ON	ON	ON	150

SW4	Parity
OFF	even parity
ON	odd parity

SW8	Parity
OFF	no parity
ON	parity

SW5	SW6	SW7	Bits/Character	Stop bits
OFF	OFF	OFF	8	2
ON	OFF	OFF	7	2
OFF	ON	OFF	6	2
ON	ON	OFF	5	1.5
OFF	OFF	ON	8	1
ON	OFF	ON	7	1
OFF	ON	ON	6	1
ON	ON	ON	5	1

Table 2 Setting the baud rate and protocol

Connection	Relay	Value to add
INPUT 1	RL1	1
INPUT 2	RL2	2
INPUT 3	RL3	4
INPUT 4	RL4	8
INPUT 5	RL5	16
INPUT 6	RL6	32
INPUT 7		64
INPUT 8		128

Table 3 Port values for switching the relays

BUYLINES

All components in this project may be obtained from:

NCJ Electronics,
38 Murrayfield Road,
Chanterlands Avenue,
Hull HU5 4DW.

The price for the PCB is £10.35 inclusive of VAT and postage. A complete kit with PCB costs £40.25. A full list of available parts may be obtained by sending an SAE.

PROJECT

PROJECT



-7V and -12V on its negative terminal. R3 dissipates about 600mW and will therefore be quite warm.

The remainder of the components may now be fitted.

Testing

One way of testing the board is with a serial terminal. Some of the home computers (such as the Amstrad PC and the Atari 520) have a terminal emulation program supplied. The difficulty with this is that specific bit patterns are required rather than ASCII characters. The most effective thing to do is write a program which will accept a value from the keyboard and display the value of any received characters on the screen.

It is important that the correct parameters are set up to establish the correct communications protocol. Table 2 shows the effect of the different switch settings. Note that if the data length is less than eight bits only some of the input pins will be read and sent up the RS232 line. Likewise if the data length is less than six bits only some of the relays will be operated.

One of the more common settings for serial communications is eight bits, no parity, one stop bit.

When the parameters are set up correctly and a suitable test program is loaded the values in Table 3 should be used to test the board.

To calculate the value of the data to turn on a particular relay Table 3 should be used. All relays that are to be turned on should simply have their appropriate values added together. For example if RL1, RL3, and RL5 are to be turned on the value will be $1+4+16=21$.

The value of the input port is calculated in an identical manner. If the data is to be handled by a computer then a logical AND can be used to separate the different signals.

If a computer is not available a partial test can be done in the following way. Connect six switches between the low order six input pins and ground. Connect SOUT to SIN on CONN1. Using a 1kΩ resistor connected to +5V, momentarily touch the IC5 end of R4. The setting of the input port should now be duplicated by the relays.

If an oscilloscope is available the serial line can be seen to be active. As the switches are changed the relays should change accordingly. The disadvantage of this test is that the baud rates and other parameters cannot be checked properly.

The board may be built into a case but for experimental purposes it may be used standing alone. It is important that the input pins are not subjected to any voltage above +5V and it is therefore recommended that simple switches are used. A suitable power source could be one of the cheap and readily available plug-top power supplies. It is however important that the voltage with no relays turned on does not exceed 15V. A simple solution is to use a 7812 voltage regulator which should be mounted on a small heatsink.

When using the board it is essential that mains voltages are only connected to the relay contacts and under no circumstances should they be connected to any other part of the circuitry. If mains is to be applied to the relay contacts it is recommended that the board is thoroughly cleaned with a solvent and that the bottom of the board around the relay pins and CN3 is sprayed with an appropriate lacquer. If this is done it is important to wait until the lacquer is thoroughly dry before connecting any high voltages to the board.

HENRY'S

ELECTRONICS FOR TRADE, INDUSTRY, EXPORT, EDUCATION AND RETAIL

*INSTRUMENTS

- SCOPES ■ COUNTERS
- DMMS ■ PSU'S
- GENERATORS ETC.

*PUBLIC ADDRESS

- SPEAKERS ■ AMPLIFIERS
- MIXERS ■ MICS ETC.

COMPONENTS

- HUGE STOCKS ALSO
- TOOLS ■ CABLES ETC.

*ACCESSORIES

- TV-VIDEO AMPLIFIERS
- AUDIO ■ TV/VIDEO
- SECURITY ■ CB RADIO
- ACCESSORIES

COMMUNICATIONS

- INTERCOMS ■ CB RADIO

*SECURITY

- PANELS ■ PIRS ■ SIRENS
- DOORPHONES ■ STROBES

FREE!
ILLUSTRATED
CATALOGUES WITH
RETAIL DISCOUNT
VOUCHERS

- Instruments/Security
- Computer
- General Catalogue

Please state Trade/Education or Retail/mail order Send 12¾" x 9" (A4) SAE £1.50 each or £3.00 for both

HENRY'S

404 Edgware Road, London W2 1ED
Tel: 01-724 0323

*ALSO AT Audio Electronics 301 Edgware Road W2 01-724 3564
SALES OFFICE 01-258 1831 Telex 298102 Fax 01-724 0322

KEEP REGULAR

Don't miss out on your favourite electronics mag. Why search high and low for a copy? Let your newsagent take the strain and reserve you a copy each month.

Fill in your name and address on the form below and hand it to your local newsagent.



Dear Mr Newsagent
Please order me a copy of ETI
and reserve/deliver me a copy
every month.



Note this magazine is available to your wholesaler through:
SM Distribution, 6 Leigham Court Road, Streatham, London SW16 2PG. Tel: 01-677 8111.

Name _____

Address _____

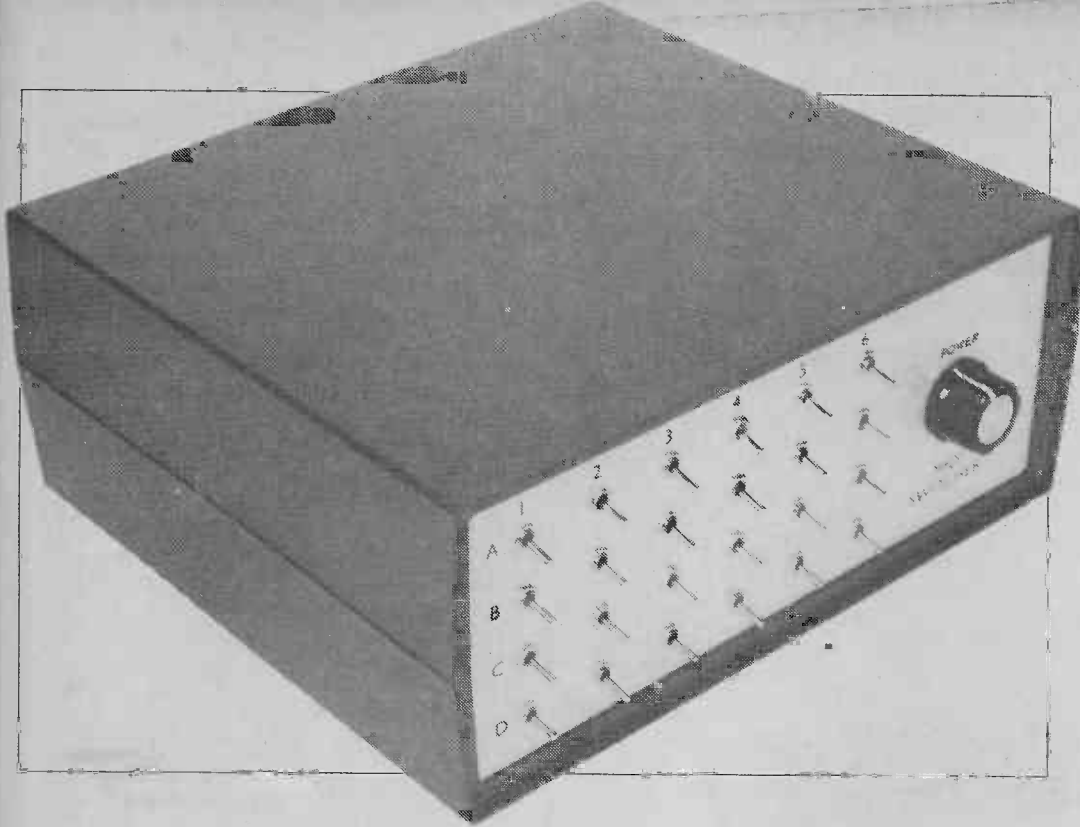

PATCH WORK

Robert Penfold presents a four into six MIDI patch bay to solve your routing problems

The days when you had to be a millionaire in order to afford a complex electronic music system are now long gone. While a good MIDI setup costs something more than peanuts, powerful multi-timbral MIDI keyboard instruments and expander units are available at prices that have enabled many electronic music enthusiasts to equip themselves with multi-instrument MIDI setups, usually with the aid of some sophisticated computer control.

One slight problem with a complex MIDI system is connecting everything together properly. There is not usually any difficulty in getting everything wired up in the classic manner shown in the example configuration of Fig. 1. Here a computer at the heart of the system is in two way communication with a keyboard instrument — sequences can be played into the computer from the keyboard and then played back into the instrument's sound generation circuits. The two expanders can also be sequenced from the computer via the THRU sockets and the so-called *chain* method of connection. At one time THRU sockets were something of a rarity but they are present on most new MIDI equipment. However, if you have equipment that lacks this facility, the chain method of connection is not possible.

This type of chain setup looks fine in theory but in practice there can be problems. You may find that system messages sent to one instrument (but received by all three) have an unwanted effect on other instruments. You might want to send patch data (or something of this nature) via MIDI from one instrument to another and this method of linking the instruments is unlikely to provide the desired data route. The expanders do not have their OUT sockets utilised, and will certainly not be sending their data dumps anywhere.

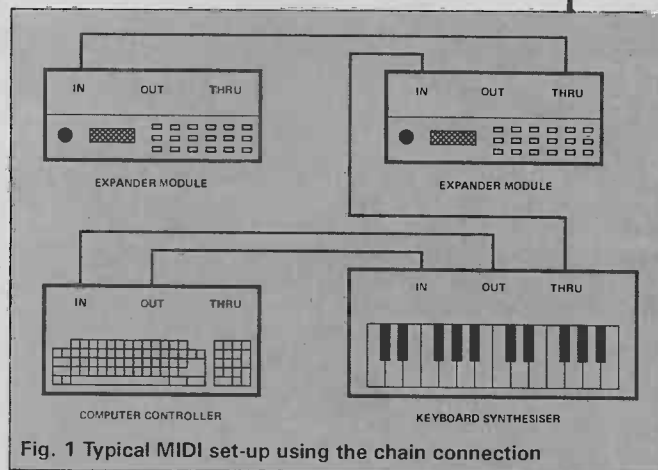

Fig. 1 Typical MIDI set-up using the chain connection

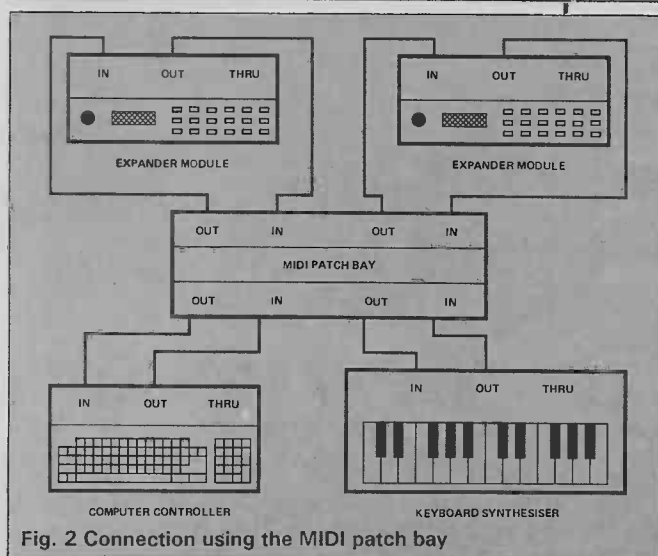

Fig. 2 Connection using the MIDI patch bay

FEATURES/PROJECTS

13

Relativity

Steve Malone makes light work of the complicated concepts surrounding Einstein's universe

19

Crystal Clear

Alistair Dixon watches the clock and finds out exactly what makes the time-honoured crystal oscillator tick

19

Noise Annoys

Paul Chappell continues his attack on cacophonous currents and vociferous voltages

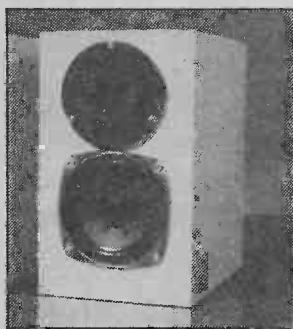

29

Reflex Action

Jeff Macauley moulds his ports with care and precision. Here he explains the details of optimising the design of bass reflex loudspeaker enclosures



33

Competition

Your chance to win Maplin's triple trace professional oscilloscope in our free-to-enter competition

36

RS232 Relay Board

Taking its instructions from any computer with an RS232 port, this interface controls up to six relay switches at the touch of a bit. Design by Neville Croucher

41

MIDI Patch Work

Four into six will go! Robert Penfold presents a MIDI patchbay to maximise versatility and minimise all that tedious replugging



PROJECT

46

Infra-red Camera Trigger

Keith Brindley introduces a remote IR sensor to trigger the ETI Camera Trigger circuit

50

PROJECT

Priority Quiz Switch

Ken Blackwell presents his simple *1st Class* circuit that challenges contestants to beat the buzzer

54

PROJECT

Aerial Amplifier

Paul Chappell presents a high class aerial amplifier to give you Wogan without the wobbles and Lost In Space without loss of picture

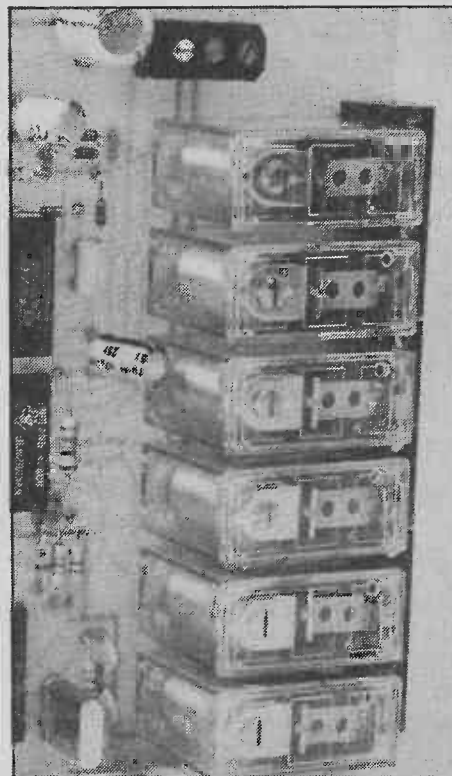

Page 36

Page 50

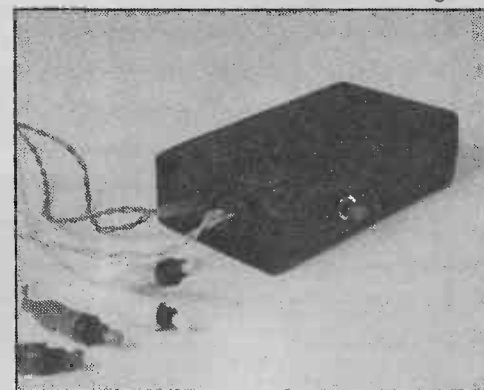

Page 41

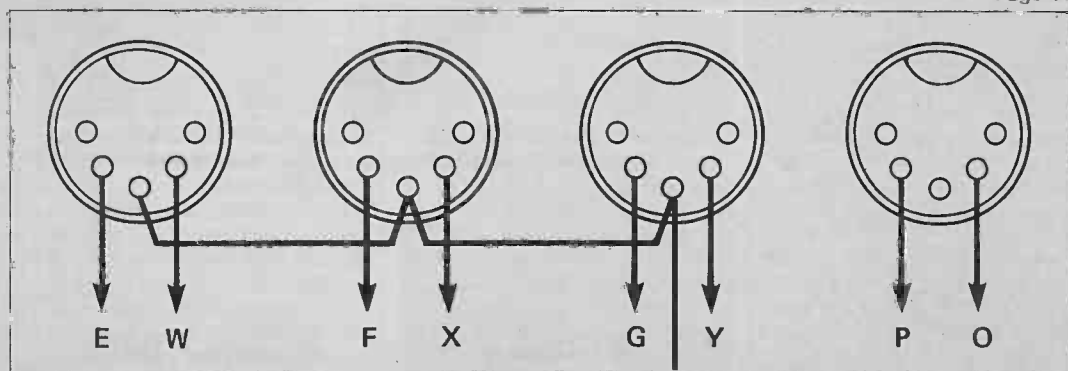

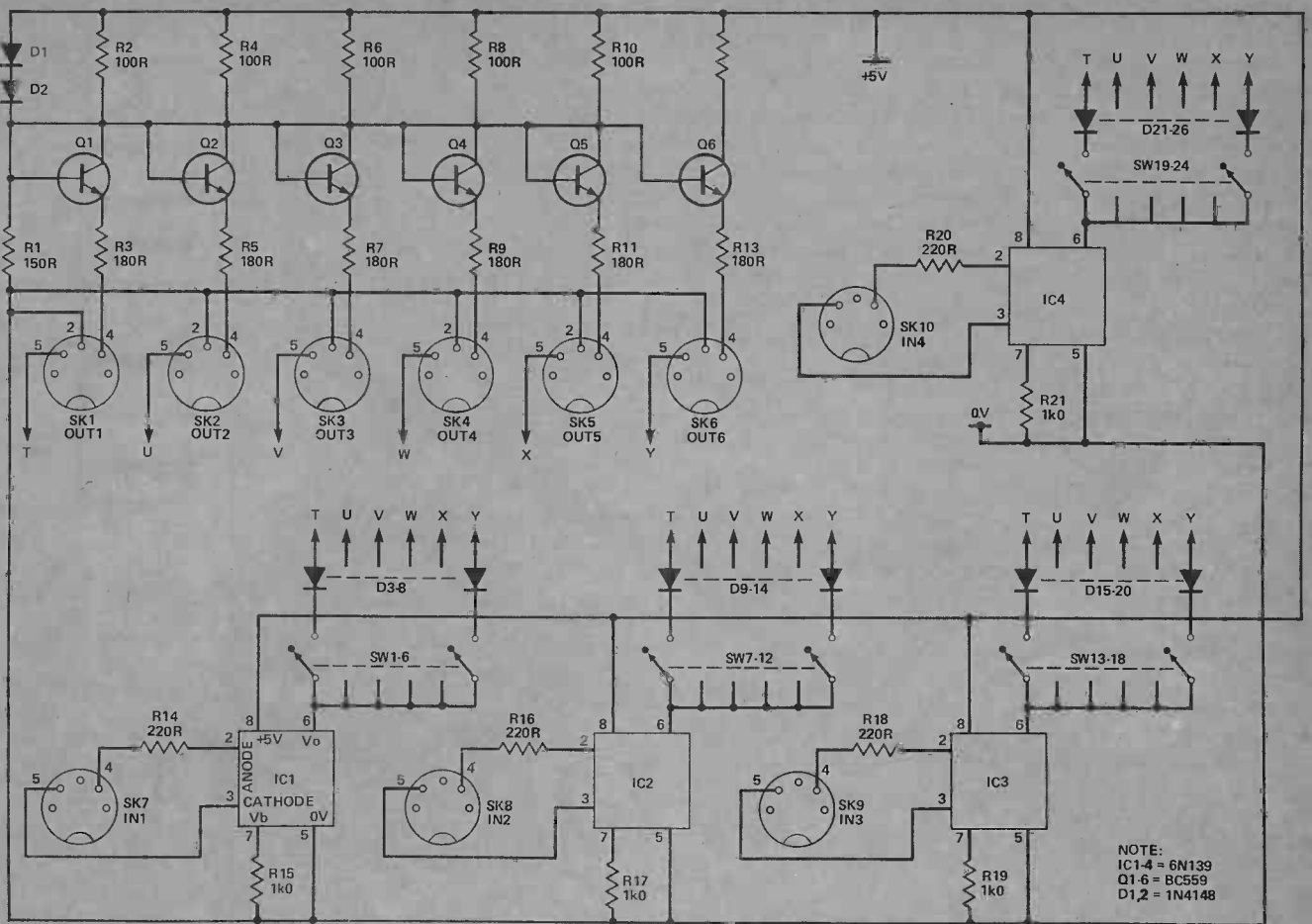

Fig. 3 Circuit diagram of the MIDI patch bay

Patching Things Up

Obviously you can keep rewiring the system to meet your particular requirements at the time but MIDI sockets are usually tucked away on the rear panels of instruments where they are not easy to get at. Also, repeatedly plugging in and unplugging leads could eventually damage the equipment.

The usual solution to the problem is a MIDI patch bay. These vary considerably in complexity from simple switcher units with no active circuits, through to expensive microprocessor controlled units which have memories that can store your favourite patches for instant recall. The unit featured in this article falls somewhere between these two extremes. It has four MIDI inputs and six outputs. Each input has six switches, used to select which output (or outputs) each input is connected to. Thus you can connect any input to any output, or combination of outputs.

The equipment from Fig. 1 can now be rewired as shown in Fig. 2. The IN and OUT sockets of each unit in the system are coupled to the OUT and IN sockets (respectively) of the patch bay. The THRU sockets are no longer needed as the patch bay effectively acts as a THRU box. Such an arrangement is called the *star* method of connection. A lack of THRU sockets on any items of equipment is of no consequence when this method of interfacing is used.

To give the 'star' equivalent of Fig. 1 the patch bay would be set so that the input of the computer is connected to the output of the keyboard instrument. The three instruments would then all have their inputs connected to the output of the computer. Obviously it would only take a few seconds to reset the switches to (say) connect the output of the keyboard instrument

through to the input of an expander for sound data dumping.

The patch bay might seem a bit lop-sided with six outputs but only four inputs. This is however realistic since nearly all MIDI devices have an IN socket but not all units have OUTs. (In fact most units these days do have an OUT socket but in many cases it is for little more than decorative purposes and a fair proportion of MIDI units have nothing worthwhile to say.) However, the circuit is easily expanded if desired and it could easily be provided with six or more inputs.

Normally it is not acceptable to have two MIDI outputs connected to a single input. A lot of MIDI outputs are of the open collector variety and while this might give satisfactory results it could easily produce a situation where neither output drives the input correctly. With this MIDI patch bay it is quite in order to connect several of its inputs through to one or more of the outputs. It will provide a simple mixing action so that any input signal will be properly fed through to the output socket or sockets. Note though that only one input should receive data at any one time. Feeding two or more sets of input data to a common output simply results in the sets of input data being combined into one garbled and unusable output signal. You also need to take reasonable care to avoid something silly, such as linking that results in data being looped around the system indefinitely.

Construction

With its large number of switches and sockets this project is inevitably a bit awkward from the construction point of view. I opted for printed circuit board construction plus a fair amount of hard wiring. Details

of the PCB are provided in Fig. 5, with the front and rear panel wiring being shown in Figs. 6 and 7 respectively.

When choosing a case for this project bear in mind that although the circuit board will fit into quite a small enclosure, the switches and sockets require a fair amount of panel space. A fairly large case with a reasonable height dimension is therefore needed.

The switches are mounted on the front panel. It is essential to use a logical layout as wiring up the unit will otherwise be quite difficult. Also, it will be confusing in use if the switches are not laid out sensibly. I used four rows of six switches. From top to bottom the rows represent inputs 1 to 4. From left to right they represent outputs 1 to 6. With this method it is easy to find the right switch to connect any input to any output. Leave plenty of space for on/off switch SW25 on the right hand portion of the panel.

The sockets are mounted on the rear panel of the case. Fig. 7 shows the layout used on the prototype. The sockets should be mounted well towards the left hand side of the unit, leaving a space for the mains lead entrance hole at the other end of the panel. This hole should be fitted with a grommet to protect the cable.

There is little out of the ordinary about construction of the printed circuit board. The fuse is mounted on-board by way of a pair of 20 millimetre fuse-clips. Use plenty of solder when fitting these clips so that they are securely held in place. Although the four opto-isolators are not static sensitive devices, they are fairly expensive and I would consequently recommend the use of holders for them anyway. Fit pins to the board at the points where connections to off-board components will be made in the fullness of time.

Mount the PCB on the base of the case, leaving space for the mains transformer. The chassis of the transformer must be earthed to the mains earth lead via a soldertag fitted on one of its mounting screws. If the case is of all metal construction this will also earth the case. However, if the enclosure is a type of mainly plastic construction with metal front and rear panels, for safety reasons these panels must also be connected to the mains earth lead.

Although there is a substantial amount of point-to-point style wiring, it is quite simple and straightforward. The main difficulty is in fitting and wiring in the twenty four diodes. Wiring the diodes to the switches should not present any great difficulties but the junctions of the sets of four diodes are more demanding. I originally used tag-strips at these junctions but eventually settled for simply soldering the four leadouts together. This is not difficult provided the leads are preformed into the correct positions. The leads from the sockets can then be easily connected to the diodes without any risk of the existing joints falling apart as the new connections are made.

The other wiring is simple. Note that only the output sockets have pin 2 (the middle one) earthed to the appropriate pin on the circuit board. This pin must be left unconnected on each of the input sockets or it will circumvent the opto-isolation provided at each point.

In Use

Provided the specified type of socket is used and all the sockets are connected as shown in the wiring diagrams, the units will function properly with standard MIDI leads. If you wish to make up your own connecting leads, it is just a matter of using twin screened cable with the inner conductors connecting pins 4 and 5 on one plug to the same pins on the second plug (do not use cross-coupling as you do in audio DIN leads). The two pin 2s are connected by

way of the screening. In my experience it is not necessary to use expensive cable for MIDI leads except perhaps for long leads (more than a few metres or so). The basic method of using a unit of this type is to have the MIDI IN and OUT sockets of each piece of equipment wired to OUT and IN sockets of the patch bay (any THRU sockets are superfluous and are ignored). Then close the appropriate switches to give the required method of interconnection.

Suppose that there are two keyboard instruments in the system. It only takes the flick of two switches to change from one to the other, or to have both keyboards simultaneously connected to the input of the computer controller (the two keyboards must not be played simultaneously).

It is very easy to change a few switches to (say) direct the MIDI output of one synthesiser to the inputs of different expanders. Although it might not be necessary to switch out any other sources from the synthesiser that is to receive the MIDI data, malfunctions are more likely to occur if there interconnections all over the system. It is probably best

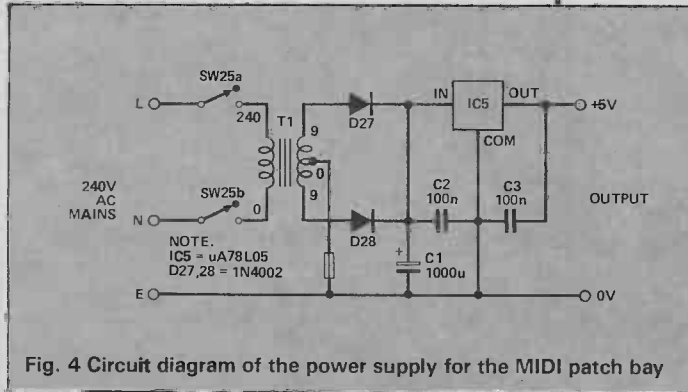
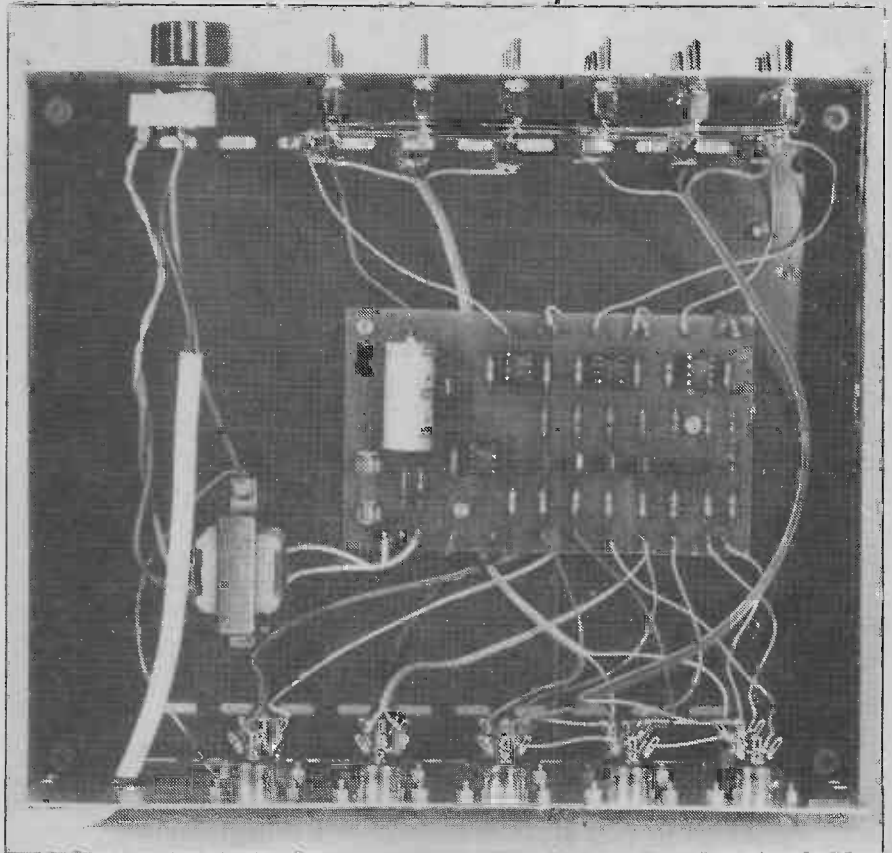

Fig. 4 Circuit diagram of the power supply for the MIDI patch bay

to always have the smallest number of interconnections that will provide the desired result. Once you have had the unit connected into your MIDI system for a while you will wonder how you ever managed without it.



PROJECT

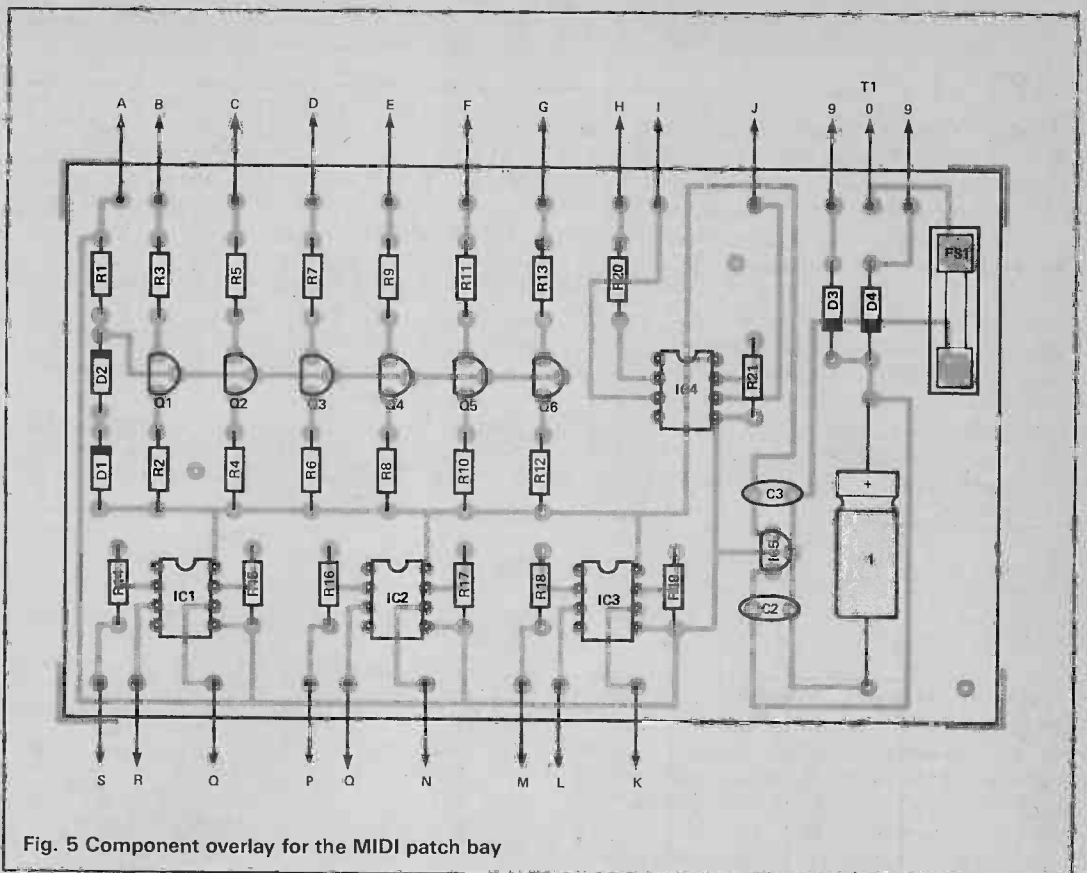

Fig. 5 Component overlay for the MIDI patch bay

HOW IT WORKS

The main circuit diagram for the MIDI Patch Bay appears in Fig. 3. The circuit for the mains power supply unit is shown separately in Fig. 4.

It is a requirement of the MIDI standard that all MIDI inputs have opto-isolation. This brings several benefits, the main ones being a reduced risk of 'hum' loops, avoidance of large voltage differences between the earth rails of equipment in the system resulting in costly damage, and greatly reduced risk of digital noise from a controller being coupled into the audio circuits of instruments.

The relatively high MIDI baud rate of 31250 baud plus the use of a loop current of just 5mA rules out the use of bog standard opto-isolators, which lack the necessary speed and efficiency. The 6N139s used in this design (IC1 to IC4) have a photo-diode feeding an emitter follower buffer amplifier and a common emitter output stage. This combination gives excellent efficiency together with high speed operation. In both respects the 6N139 is more than adequate for the current application.

R15, R17 etc are load resistors for the emitter follower stages. These resistors ensure that these stages operate at a reasonably high

current, essential to high speed operation. Note that Darlington devices are unsuitable for this application as they are far too slow in operation. In fact I would not recommend the use of any substitutes for the 6N139s.

The open collector outputs of the common emitter output stages drive the MIDI output sockets. However, each socket is driven via a switch which can be used to cut off any output signal to that socket if desired. A diode is included in series with each switch and this avoids any unwanted signal paths through the switches. Without these diodes it would be possible to direct a signal to one of the output sockets by closing the switches for two other sockets!

The method of operation used in this circuit means that each output socket can be driven from more than one input. The open collector outputs of the opto-isolators means that there is no risk in having two or more outputs wired together, as there is no way in which one output can drive a current through another one. Any output that is activated will feed its signal to the selected sockets. (Only one output at a time should drive an output socket, otherwise the two sets of data will be scrambled together and a malfunction of the system will result).

If more than one output should be activated simultaneously there is a risk that excessive output currents will flow. In order to avoid this possibility each output socket includes a 5mA current-limiting circuit instead of the usual series resistors. These are conventional current limiters based on Q1 to Q6.

There should be no difficulty in expanding the system if required. More outputs can be obtained by adding extra switches, diodes, current limiting circuits and output sockets. Obviously there is a limit to the number of outputs that each opto-isolator can drive, but there should be no difficulty in driving at least ten of them. With a lot of extra current limiting circuits R1 would have to be made a little lower in value.

In theory you can have as many inputs as you like. It is just a matter of adding opto-isolator stages, complete with full sets of switches and diodes. The practical limitation is the number of input stages that you are prepared to wire up!

The power supply circuit is a conventional 5V regulated type. Note that fuse FS1 should be an anti-surge type and not one of the common quick-blow variety. The latter would be likely to blow at switch-on due to the high surge current as smoothing capacitor C1 charges up.

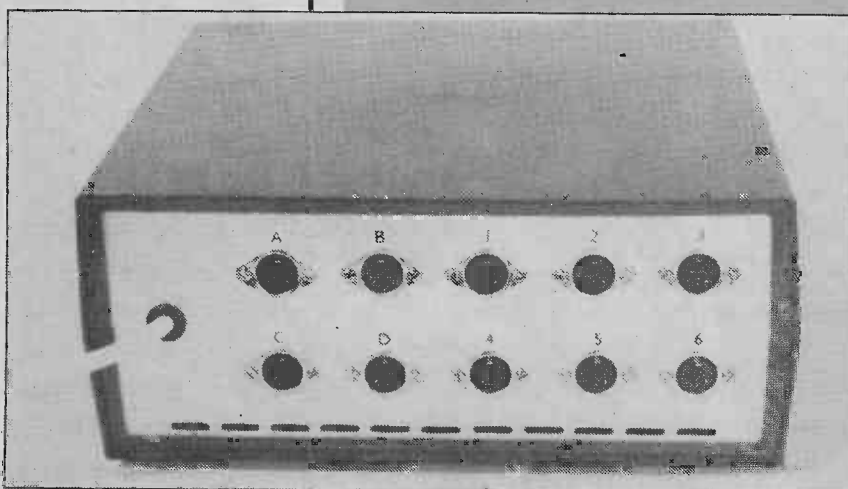

PARTS LIST

RESISTORS (all 1/4W 5% carbon film)

R1	150R
R2,4,6,8,10,12	100R
R3,5,7,9,11,13	180R
R14,16,18,20	220R
R15,17,19,21	1k0

CAPACITORS

C1	1000 μ 16V axial elect
C2,3	100n disc ceramic

SEMICONDUCTORS

IC1-4	6N139 opto-isolator
IC5	μ A78L05 (5V 0.1A reg)

Q1-6	BC559
D1-26	1N4148
D27,28	1N4002

MISCELLANEOUS

FS1	200mm 100mA anti-surge
SKI-10	5-way (180 degree) DIN panel mounting
SW1-24	SPST miniature toggle
SW25	rotary mains switch
T1	Mains primary, 9-0-9V 100mA sec

PCB. Case (240x220x100mm). Fuse clips. IC holders. Main lead.
Wire. PCB pins.

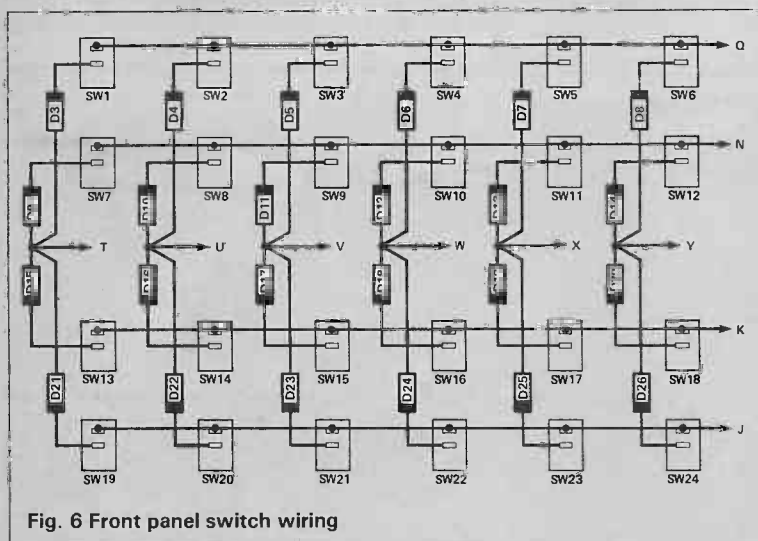

Fig. 6 Front panel switch wiring

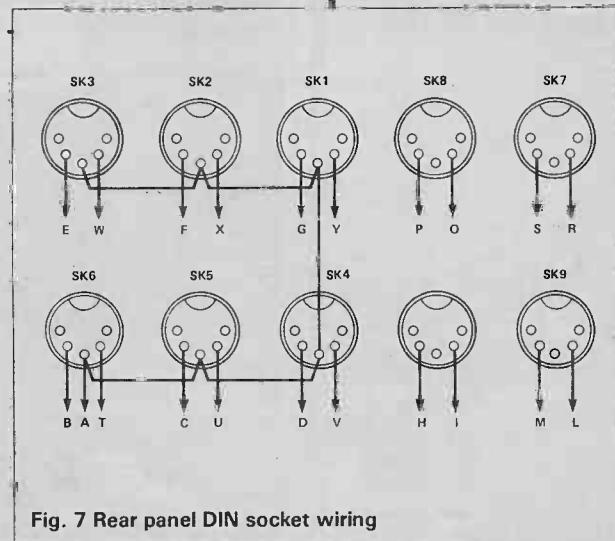

Fig. 7 Rear panel DIN socket wiring



take out a subscription

Make sure of your regular copy of Micro Music, with all the news, views and reviews from the computer music scene, delivered to your door at no extra cost in the UK. Just fill in the form, enclose your remittance and you're in touch.

6 issues	UK	£10.50
6 issues	Europe	£14.00
6 issues	Middle East	£14.15
6 issues	Far East	£15.50
6 issues	Rest of the World	£14.40
6 issues	USA	\$25.00

Air Mail rates given on request. Overseas subscriptions include postage.



Please begin my subscription(s) to Micro Music with the £
I enclose my cheque/postal order for £
or debit £ valid from
NAME (Mr/Mrs/Miss)
ADDRESS
made payable to Argus Specialist Publications
to
Signature
Send your remittance to:
INFONET, 5 River Park Estate,
Berkhamsted,
Herts. HP4 1HL.

INFRA-RED REMOTE CAMERA TRIGGER

Third in Keith Brindley's series of camera trigger projects, this one generates and senses a beam of infra-red light, invisible to the eye

This project is one of a series of projects designed to connect to the ETI Camera Controller of the April issue of ETI, such that the camera being controlled can be electronically, rather than mechanically, triggered in a number of ways. The ETI Camera Controller, if you remember, was designed so that a simple negative-going electronic pulse would fire the camera. A similar pulse then resets the circuit, ready for the next firing.

the transmitter and receiver are positioned in close proximity, say across the entrance to a birdhouse or mouse-hole, you'll get fairly candid shots of wildlife as birds or mice cut the beam. On the other hand, if the transmitter and receiver are separated across a house doorway, you'll get even more candid shots of people, authorized or unauthorized, as they traverse the entrance. What's good about the project is the fact that an infra-red beam of light is used, invisible to the eye and which works equally well in day or night

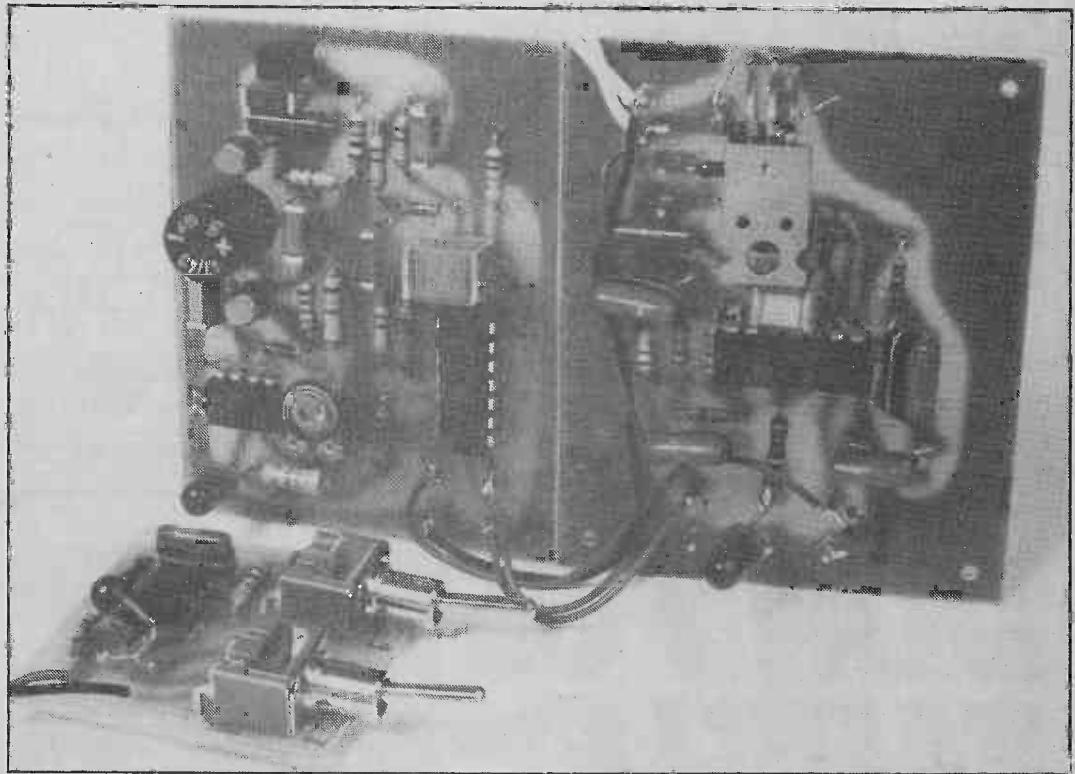

Like the previous remote camera trigger project — an ultrasonic transmitter and receiver featured in ETI's May issue — the ETI Infra-red Remote Camera Trigger project comprises two distinctly separate parts (an infra-red transmitter and an infra-red receiver with control circuit). Each part is built on its own PCB or stripboard, such that distances from a few centimetres to around two or three metres can be traversed by the infra-red beam. More than acceptable, we feel, for its purpose. This quite wide range is made possible by using a high output power infra-red LED as the transmitting device, with a sensitive photodiode as the infra-red receiving device. Surprisingly simple (yet cunningly clever) transmitting and receiving circuits complement these.

Also like the ultrasonic transmitter and receiver of the May issue, the infra-red transmitter and receiver featured here are more-or-less self-sufficient so, although designed specifically to trigger the camera controller, may be used to remotely trigger other devices too — your ingenuity alone limits use.

So what are the project's designed uses? Where

situations. Your candid shots will be *really* candid! Burglars beware; wildlife watch out.

Like the two preceding projects the trigger is designed essentially for battery-powered operation — if you're going to use a remote camera trigger, it's hardly likely you'll have a mains power point at the camera's position. Power supply for the receiver is taken from the power supply of the Camera Controller, simply because the two boards of the projects will be located close together. Power supply for the transmitter is a simple PP3-sized battery.

However, maximum current drain, around 15mA at 9V, means that a PP3-sized battery won't last too long (about 30 hours for an alkaline battery), so if the project is to be used as a burglar-detector (for continuous operational use) a separate mains power supply is advised.

To allow the transmitter to be used in close proximity to the receiver, switch SW2 of the transmitter allows you to choose between high-power and low-power infra-red transmissions. Thus, close to the receiver (from a couple of centimetres to around 50

PROJECT

PROJECT

cm) low-power would be chosen, while further away high-power is used. Low-power transmission also cuts battery current drain, allowing corresponding longer battery life.

Construction

A choice of constructional techniques is offered: printed circuit board or stripboard. Construction is, as you might expect, divided into two parts: transmitter and receiver.

The transmitter circuit is shown in Fig. 1, its PCB layout and wiring is shown in Fig. 2, while stripboard layout and wiring is shown in Fig. 3. As you'll see from the circuit, the transmitter is not particularly complex and, correspondingly, neither is construction. On PCB, construction doesn't need to follow any particular order, although it's probably best to leave semi-conductors (integrated circuit IC1 and light emitting diode LED1) until last — that only leaves four passive components to solder in first — as we said it's not particularly complex! If you prefer, use an integrated

circuit socket for IC1 — although 555s aren't that expensive anyway. The two switches SW1 and SW2 are PCB-mounted switches, although any old types can be used, hard-wired. The use of PCB-mounted types gives a really small and neat project.

On stripboard, the usual rules apply. First make all track breaks where shown, then insert and solder all components. Suggestion for an integrated circuit socket applies here too. Once built, leave the transmitter aside.

Circuit for the receiver is shown in Fig. 6, while PCB layout and wiring is shown in Fig. 5, stripboard layout and wiring is shown in Fig. 4. All the earlier rules regarding order of component assembly apply here, whether PCB or stripboard is your choice. It's also useful to use PCB pins for power supply, shoot and reset connections, though not by any means essential.

Photodiode D1 requires careful insertion. As shown in the PCB and stripboard layouts, the chamfered edge of the photodiode corresponds with the

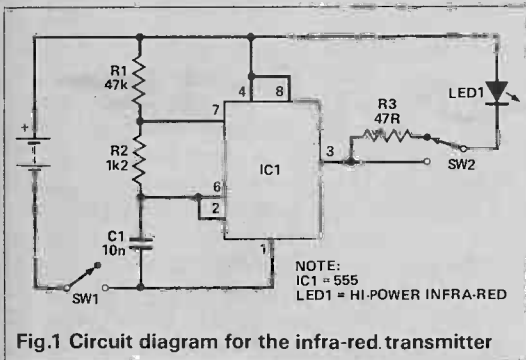

Fig.1 Circuit diagram for the infra-red transmitter

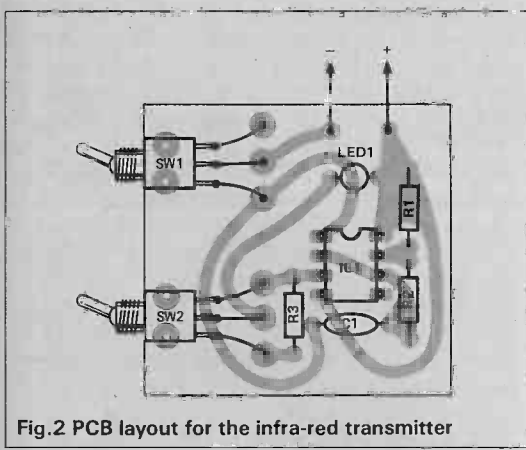

Fig.2 PCB layout for the infra-red transmitter

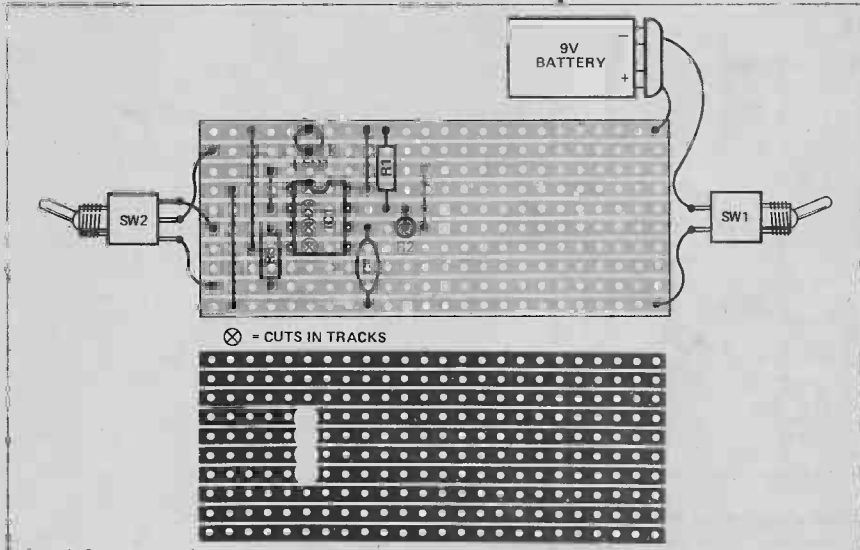

Fig.3 Stripboard layout for the infra-red transmitter

PARTS LIST

TRANSMITTER

RESISTORS (all 1/4W 5%)

- R1 47k
- R2 1k2
- R3 47R

CAPACITORS

- C1 10n polyester

SEMICONDUCTORS

- IC1 555
- LED1 high powered infra-red LED

MISCELLANEOUS

- SW1,2 SPDT PCB-mounting toggle switch, left/right action
- Battery clip, PP3 9V battery, PCB or stripboard.

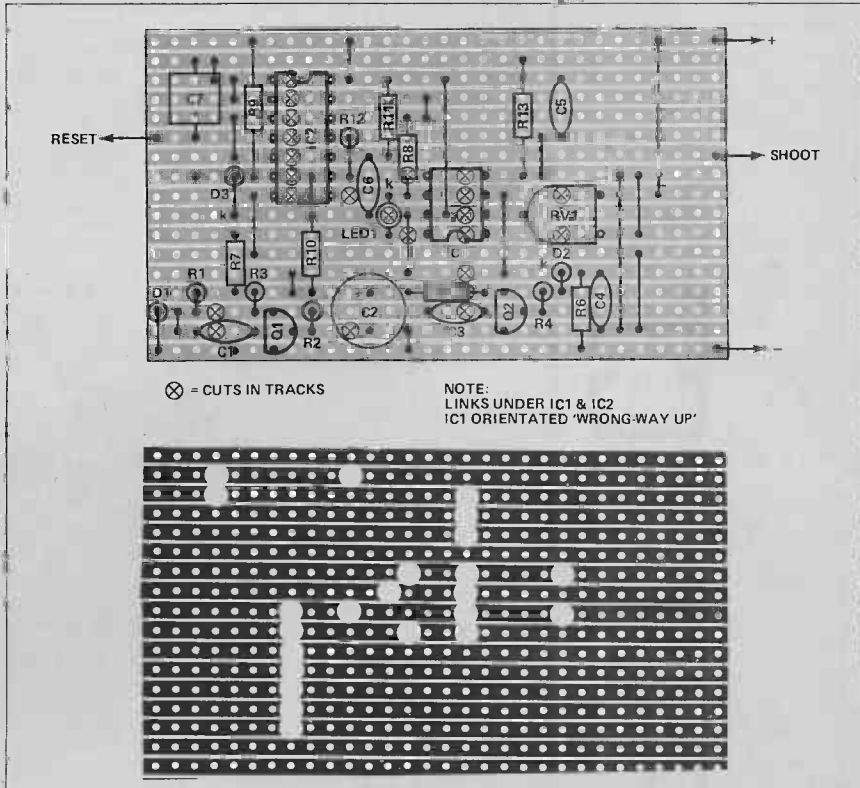

Fig.4 Stripboard layout for infra-red receiver

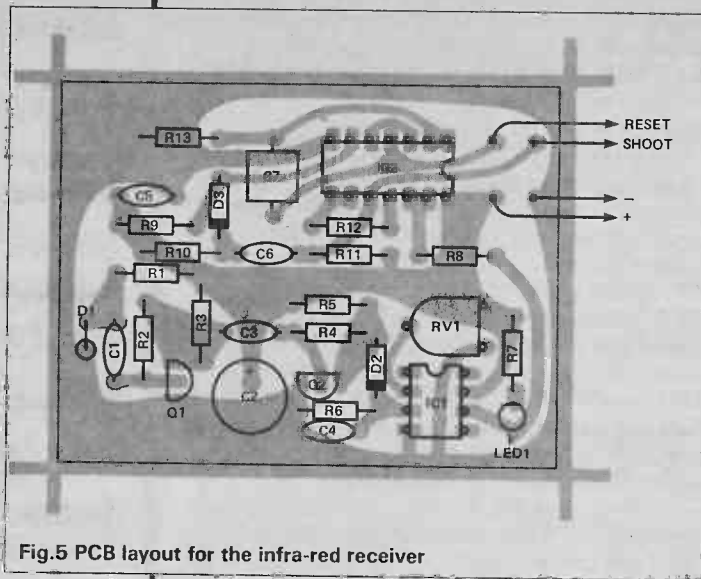

Fig.5 PCB layout for the infra-red receiver

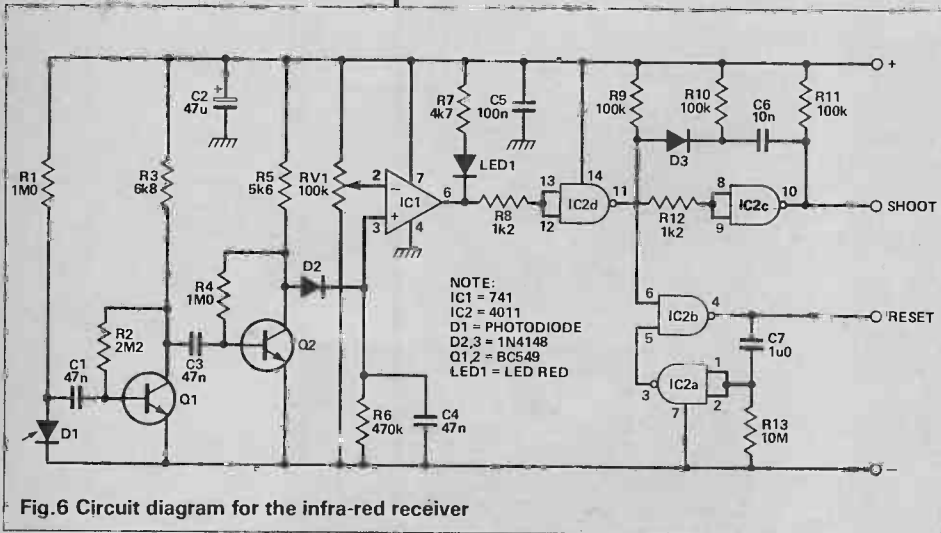

Fig.6 Circuit diagram for the infra-red receiver

cathode strips of the layouts. With the photodiode that way round the infra-red-sensitive surface faces outwards.

Housing of the two parts of the project is left entirely up to the reader. The receiver should be mounted close to the Camera Controller PCB, as the two are to be connected as shown in the wiring details of Figs. 5 & 6. The transmitter, on the other hand, is small enough to fit into most available potting boxes. Indeed, you may decide not the house the project parts at all.

Setting Up

Setting up your project is not difficult, there being only one adjustment to make — preset RV1 of the receiver. First connect the receiver to the Camera Controller. There are four connections: power supply (+ and -), shoot, and reset. Apply power and turn the preset RV1 fully anti-clockwise. Light emitting diodes LED1 of the receiver and LED1 of the Camera Controller should extinguish; if not immediately, within a few seconds. Now turn preset RV1 slowly clockwise, until LED1 of the receiver just lights (LED1 of the Camera Controller will light too for about 5 seconds then automatically extinguish). The receiver is now more-or-less set up — final 'tweaks' may be made later.

Now position the transmitter and receiver about 30cm apart, making sure the transmitter infra-red LED points directly at the receiver photodiode. Infra-red light is emitted directly from the top of the LED, while the sensitive surface of the photodiode is the larger surface pointing away from the circuit board or strip-board. Connect a battery to the transmitter, and switch on. Switch SW2 of the transmitter should be in low-power mode position. LED1 of the receiver should go out, showing presence of an infra-red beam on the photodiode D1.

In the process of siting the transmitter, LED1 of the Camera Controller may light up. If it does, simply wait for a few seconds till it goes out again. Now put your hand between the transmitter and the receiver. Both LEDs should light. Take your hand away and LED1 of the receiver should go out and a few seconds later so should LED1 of the Camera Controller. If that does happen, your project is working, and can be used to trigger a camera whenever the beam is cut.

To tweak the system, change switch SW2 position to high-power mode and slowly separate the transmitter from the receiver until the receiver LED lights up. Tweak preset RV1 until the LED goes out again and move the transmitter further away, repeating the process until further tweaks cannot improve distance apart.

BUYLINES

Most parts for this project will be easily obtained from all component stockists. The high-powered infra-red LED and infra-red photodiode could be a little difficult to locate, however.

Maplin (tel: (0702) 554161) stocks a suitable LED, while Electromail (tel: (0536) 204555) stocks LED and photodiode. Both stock suitable transmitter switches SW1 and SW2.

The PCBs are available as a pair from the ETI PCB Service.

PROJECT

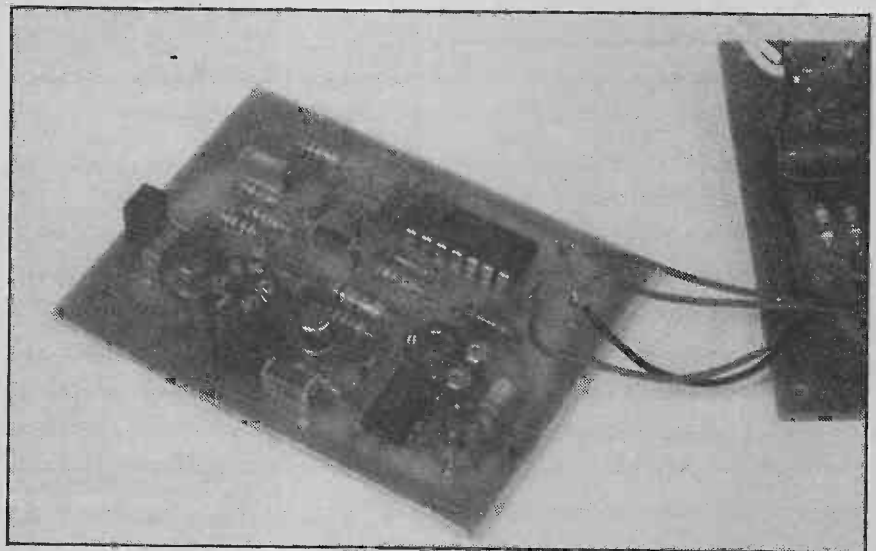

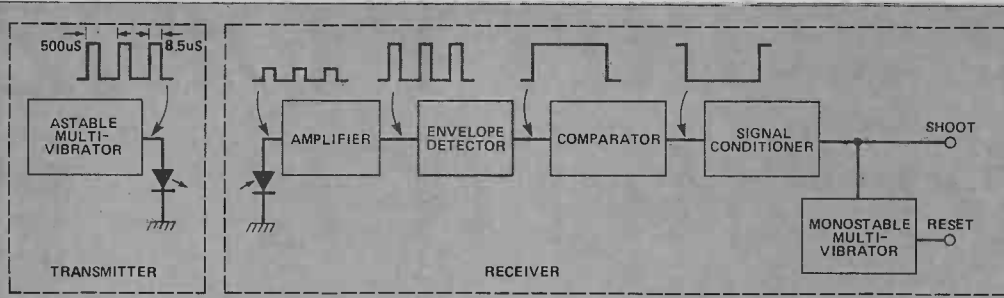

Fig.7 Block diagram of the system

HOW IT WORKS

A block diagram of the Infra-red Camera Trigger is shown in Fig. 7. The transmitter comprises a fairly straightforward astable multivibrator using a 555 in a fairly conventional circuit, though output waveform is of the form shown in Fig. 7, rather than the pure square-wave usually associated with astables.

Frequency of the waveform is approximated by the formula:

$$f = \frac{1.44}{C1(R1 + 2R2)} = 2000\text{Hz}$$

This frequency corresponds to a total waveform period of $1/2000 = 500\mu\text{s}$.

The LED is connected to the positive supply rail, so it emits infra-red light only when the output of the 555 is low and the time this occurs is approximated by the formula:

$$t = 0.7C1(R2) = 8.5\mu\text{s}$$

So, the LED is energised for only about $8.5\mu\text{s}$, every $500\mu\text{s}$. Pulsing power to a LED in this manner ensures that a high-powered beam of infra-red light may be generated, while keeping overall (average) power to the LED within LED power characteristics. It also helps to reduce average battery current drain.

In switch SW2's high-power position, all the current available from the 555 is available to the LED but when in SW2 low-power position series resistor R3 reduces the current.

In the receiver, things are a little more complicated. Photodiode D1 detects the received infra-red pulses, converting them into a minute 2kHz electrical signal. Transistors Q1 and Q2 together with

associated components form a two-stage amplifier to amplify the signal.

Rectification of the amplified 2kHz signal is undertaken by diode D2, with capacitor C4 and resistor R6 completing an envelope detection stage, giving a positive-going DC voltage, each time the receiver picks up an infra-red beam from the transmitter.

An op-amp comparator IC1 compares the DC envelope voltage with an adjustable set-point voltage, such that whenever the envelope voltage is greater than the set-point voltage the comparator output is high. This gives a negative-going switched output voltage, each time an infra-red beam is detected. Preset RV1 adjusts the set-point voltage to the comparator, so allows a measure of sensitivity adjustment to be made.

Gates IC2,c,d condition the negative-going pulse, which then forms the *shoot* output of the receiver.

The *shoot* output also forms the input to a monostable multivibrator formed by IC2,a,b and associated components. Timing period of this monostable multivibrator is set by the components resistor R13 and capacitor C7 according to the approximate relationship:

$$\text{on period} = 0.8 \times R13 \times C7 = 0.8 \times 1,000,000 \times 10 \times 10^{-9}$$

that is, around eight seconds. The output of the monostable multivibrator is a negative-going pulse at the end of the period, which is used to reset the Camera Controller.



PARTS LIST

RECEIVER

RESISTORS (all 1/4W 5%)

R1,4	1M0
R2	2M2
R3	6k8
R5	5k6
R6	470k
R7	4k7
R8,12	1k2
R9-11	100k
R13	10m
RV1	100k miniature horizontal preset

CAPACITORS (all polyester layer unless otherwise specified)

C1,3,4	47n
C2	47μ 40V radial electrolytic
C5	100n
C6	10n
C7	1μ0

SEMICONDUCTORS

IC1	741
IC2	4011
Q1,2	BC549
D1	PIN infra-red photodiode
D2,3	1N4148
LED1	red LED
PCB or stripboard. PCB pins.	

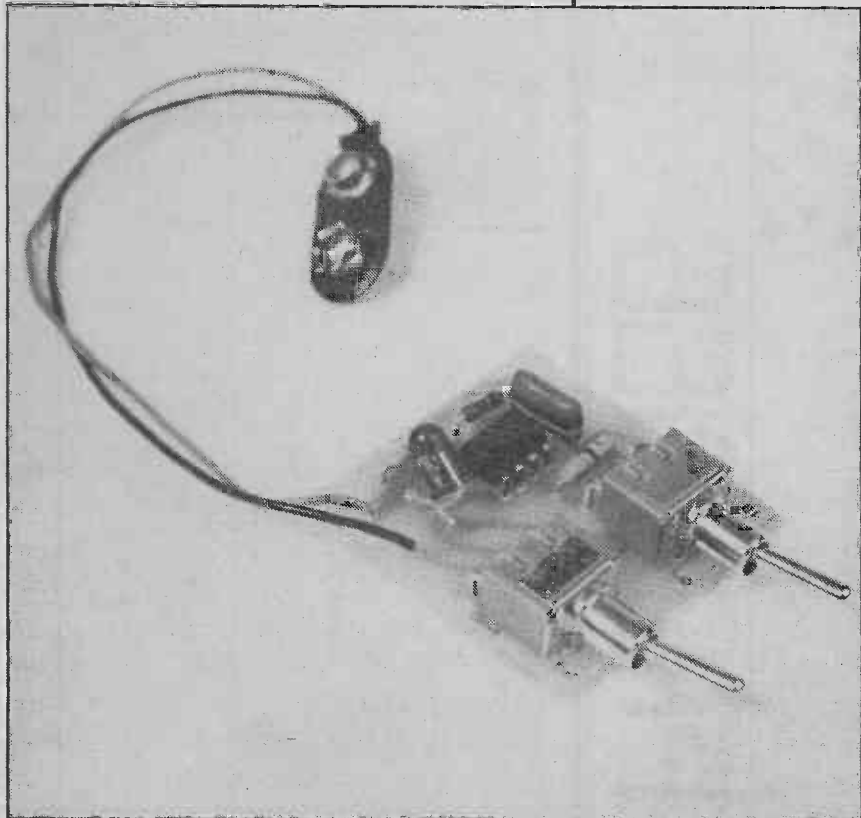

PRIORITY QUIZ SWITCH

Ken Blackwell presents his fair fare to adjudicate over the most cantankerous contestants

This simple priority switch was designed for use as a quiz controller, with four contestants answering questions on a first-press first-served basis.

Such a situation provides obvious design criteria for consideration. The push switches should be remotely positioned from the main unit and clear indication of the winning switch should be available for all to see. There should also be a simple and instantaneous reset facility and of course the circuit has to be scrupulously fair, otherwise you'll have a panel of contentious contestants before the game is out!

So this unit switches the first received signal from any number of inputs (four in this particular case but it is trivial to expand the unit), latching this signal and

illuminating the relevant LED. If it were desired the LED could be replaced by a relay or opto-isolator to trigger a much bigger light design — or even to light contestants' names in front of them. Bob Holness eat your heart out!

Construction

The circuit with four switches has been designed to fit into small handheld case from the company listed in *Buylines*. To give the clearest indication of the 'winner', different colour LEDs are used for each contestant and the switches and the wires to them are of the same colour as these LEDs. The coloured wires in the prototype were removed from a multi-strand cable after stripping the screen and outer cover.

The PCB layout is very straightforward and is shown in Fig. 2. The switches SW1-4 are obviously outside the case. Stripboard could be used as an alternative to the PCB.

The LEDs are positioned so that they are already in alignment to poke through holes in the box lid. The leads of the LEDs should be left long enough for the board to sit in the bottom of the case with the tops of the LEDs just above the height of the case.

Note that LED4 is a tricoloured LED. The centre leg is the cathode (negative bias) and goes to the common rail. Join the two outside legs of LED4 together to the positive position.

The four LEDs will mount through the top of the

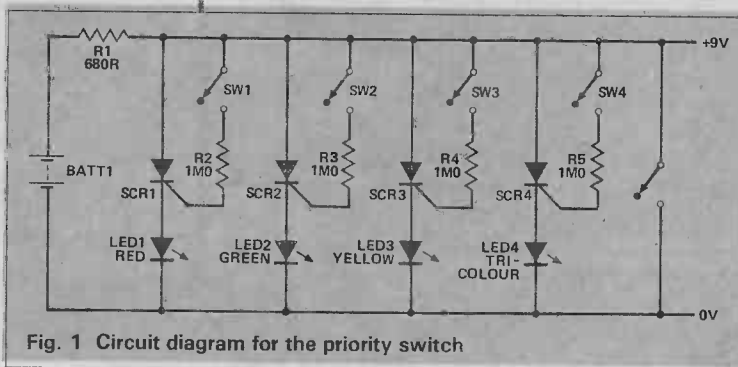
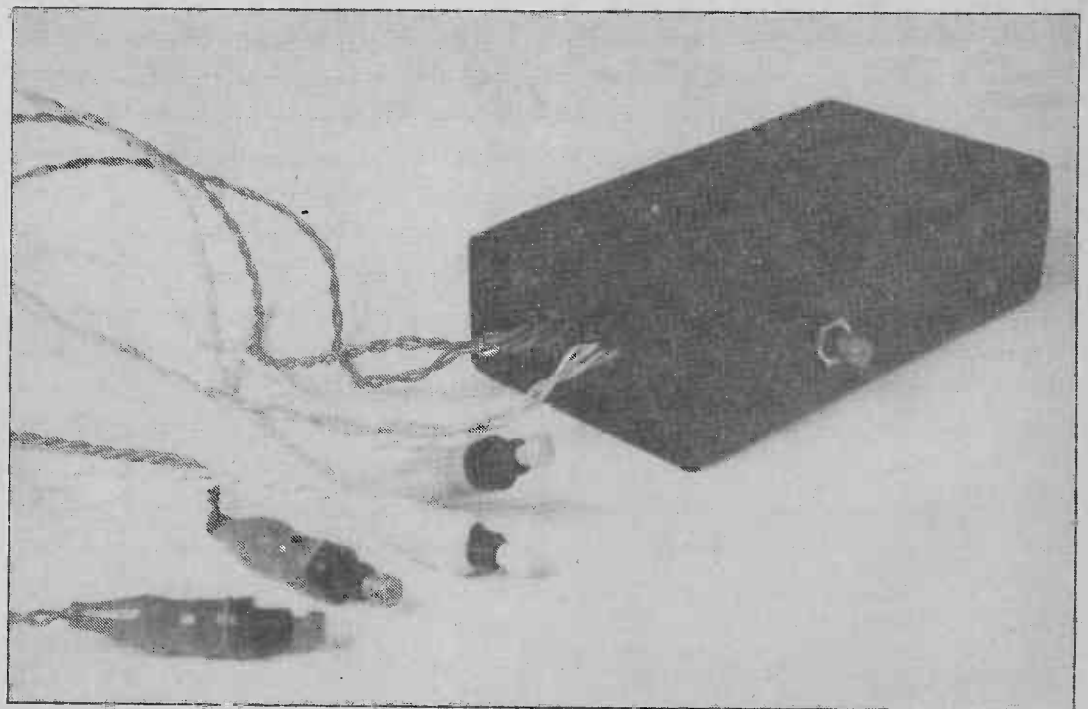
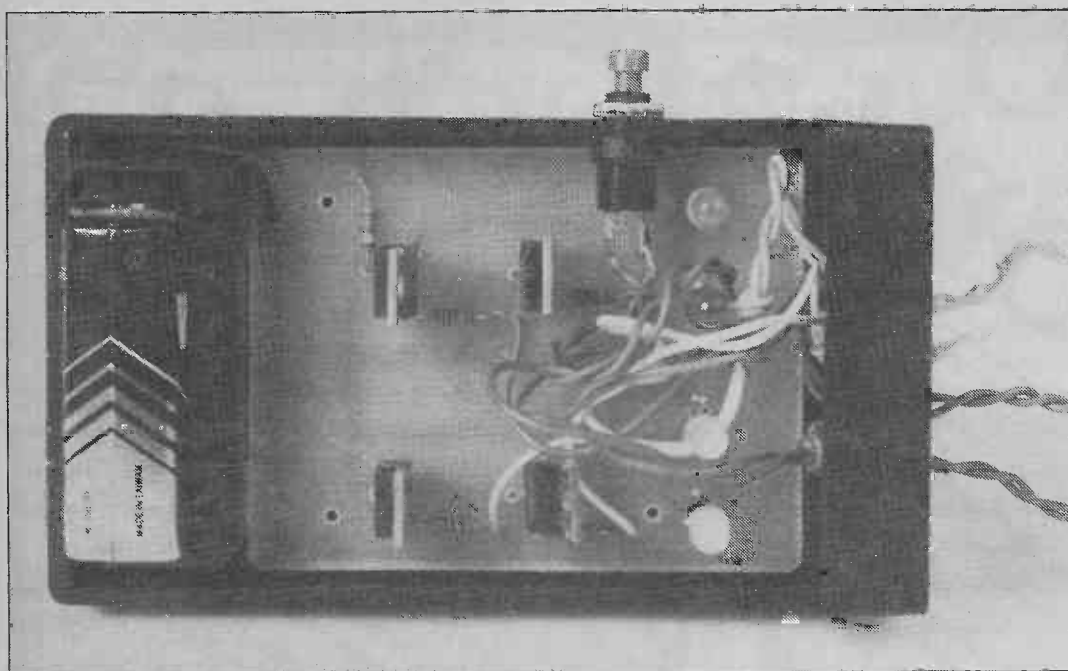

Fig. 1 Circuit diagram for the priority switch

1st CLASS





box, so use the PCB or stripboard as a template to mark the positions for four 6.35mm holes into which you can insert 5mm plastic clips and bezels for a tidy finish.

The wires to the trigger switches leave through the front template. Drill four evenly spaced 5mm exit holes across the centre width of the blank and fit 3mm plastic bezels. Through each hole pass one of the pairs of coloured wires. It might be a good idea to ensure that the wire lengths are the same for each switch — although this will make about as much difference to the fairness of the circuit's action as the different lengths of PCB track or the different actions of almost identical switches, it is the first thing a punter will identify as the cause of his slow reactions!

The reset switch can be mounted anywhere you like, remotely or on the case itself. A 7mm hole is required to mount the recommended switch on the case.

With all the switches and LEDs wired up it remains only to connect the battery and to practice your catchphrase as quiz show host!

HOW IT WORKS

The circuit consists of thyristor switches each comprising a normally open push button switch, a thyristor with a high resistance gate resistor and an LED.

Any number of these can be placed parallel to each other — the circuit illustrated in Fig. 1 uses four.

The circuit is restricted to supply only enough current for one module to operate, about 13mA for an LED supply. To restrict power resistor R1 is placed in the positive supply and all connections are made below this.

When one switch is closed, power is passed through that gate resistor, activating that module. As soon as it is conducting the remaining modules experience a voltage drop down to about 3V. Although other switches are pressed there is insufficient power to switch a second module.

To reset the circuit, switch SW5 shorts the 13mA to ground, unlatching the thyristor.

Different values of R1 would allow more or all modules to be lit simultaneously. This could be used for, say, four different teams to hit their button on completion of a task, in the style of the Krypton Factor or It's a Knockout.

Note that if different thyristors are used, the values of the gate resistors R2-5 may need to be lowered (between 470k and 1M Ω) to counter a higher base resistance in the thyristors.

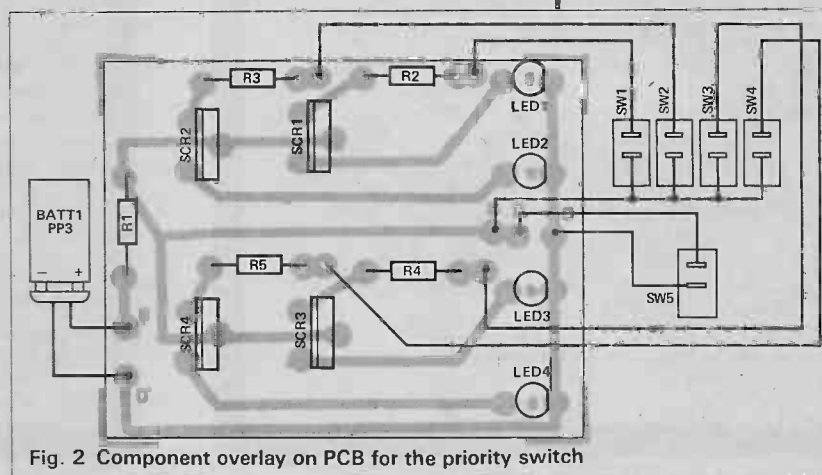

Fig. 2 Component overlay on PCB for the priority switch

PARTS LIST

RESISTORS (all 1/4W 5%)

R1	680R
R2-5	1M Ω

SEMICONDUCTORS

SCR1-4	TIC106D
LED1	5mm red LED
LED2	5mm green LED
LED3	5mm yellow LED
LED4	5mm tri-colour LED

MISCELLANEOUS

BATT1	9V PP3 battery
SW1	push-to-make switch red
SW2	push-to-make switch green
SW3	push-to-make switch yellow
SW4	push-to-make switch white
SW5	push-to-make switch black
PCB or stripboard. LED bezels and clips. Wire and boots coloured to match SW1-4. Case.	

BUYLINES

All the components in the prototype were obtained from Rapid Electronics, Hill Farm Industrial Estate, Boxted, Colchester, Essex CO4 5RD. Tel: (0206) 272730.

The PCB is available from the ETI PCB Service.



NEWS

UNDERGROUND POWER MOVEMENT

LICENCE FEE

The DTI has announced that low power radio devices no longer require licensing. The corollary for ETI readers is that unlicensed low power radio devices are no longer illegal.

The deregulation has been made to reduce the amount of generally unnecessary licensing — an estimated 25000 annual licenses will no longer be required. The many forms of exempted devices include remote operators (garage doors, car locks etc), children's walky-talkies, certain radio-operated burglar alarms, radio microphones and low power microwave devices. The low power upper limit for excused telemetry is 1mW.

However the amnesty is not absolute. Devices still require technical type approval to a DTI specification. Full details are available in the DTI publication 'The Wireless Telegraphy Apparatus (Low Power Devices) (Exemption) Regulations 1989', available from HMSO offices, price £1.35.

LIGHT SWITCHES

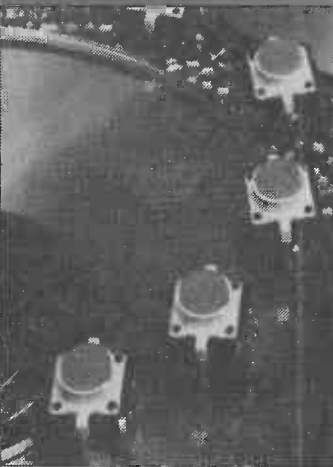

A new range of illuminated switches is available from IMO Electronics.

The B3F 9000 switches are miniature PCB-mounting momentary action switches with a 7.3mm height and switching capacity of 50mA at 24V DC.

The operating force is 130g and tactile feedback is good. The switches are available in three colours: red (99p), green or yellow (£1.11).

Contact IMO Ltd., 1000 North Circular Road, Staples Corner, London NW2 7JP. Tel: 01-452 6444.

A new problem for the privatised electricity industry has emerged as another of the industry's major customers has announced its intentions to cross the supply line and become a generator.

The London Underground at present generates about 75% of its power requirements in Chelsea and Greenwich, purchasing the rest of its considerable needs from the London Electricity Board. Recently it was proposed that the company should cut its generation and rely more heavily upon the LEB. However, that was before the Government plans for privatisation and the possibilities for private companies to supply power to the National Grid.

London Underground Ltd is now considering a new proposal to raise its generating capacity in Chelsea to around 130% of its own needs, and reap additional profits by selling the surplus power. This would certainly seem a sensible proposal for the company, providing council permission is forthcoming. But for the electricity supply industry it poses a problem.

LUL will not be the last major customer to consider producing its own power, and if too many large and predictable customers are lost (even replaced by additional power production), over-capacity may force down prices as well as making more difficult the prediction of demand and the organisation of supply. This in turn will throw out the careful calculations that are being made at present regarding the viability of privatisation.

LUL's proposals introduce a new variable that should be carefully considered.

BT THREAT

British Telecom has warned that it may be forced to discontinue successful research and development programmes in broadcasting technology if the Government does not alter proposals that ban it from extending its operations into this area.

The restrictive legislation was part of the Government's recent white paper on broadcasting, not yet law but likely to become so in the next session. The proposals prevent BT using its telephone network to distribute TV signals, or from bidding for ITV companies, whether alone or as part of a consortium.

BT's threats may have been encouraged by last month's agreement to allow tests of TV over fibre optics (see ETI News June). Many fear that if BT abandons its research then the UK's strong position in broadcast technologies will be threatened.

WATCH WHILE YOU WALK



Sony's much heralded Video Walkman is now on the market, priced at around £800.

It measures 8½ x 5 x 3ins, which would be an acceptable size for a portable TV, let alone a combined TV and video. The picture screen is LCD with a 3in diagonal, with colour resolution to 92160 pixels.

The video uses Sony's Video 8

standard with long and standard play and a single-event timer.

In operation the unit suffers from a rather weedy loudspeaker output. Picture quality is better than many portable TVs, particularly when backlit with the screen unit lifted.

For further information contact Sony on (0784) 67000.

MICRO CD

Yet another new format of compact disc is about to be unleashed on the world, courtesy of French manufacturers VMG.

The format is to be entitled CD6.35 or more descriptively the Micro CD. It measures just 6.35cm across and

has a playing time of approximately eight minutes.

Micro CD would compare favourably with the current 8cm CD-single format — although the playing time is limited it is expected to retail at the same price as vinyl singles.

JUST THE FAX MAM



Telephones, fax machines and other datacoms equipment can all be operated from a single phone line using the new Phaxswitch from Switch Electronics.

The unit distinguishes between an incoming automatic fax signal or personal caller and routes the call appropriately.

Fax machines that are not automatic are also catered for using a voice message requesting the caller to

say the word 'fax' if they wish to send a fax. Otherwise the call is routed to the telephone.

Although the unit costs £175 + VAT, savings are made in the cost of installing and renting an additional fax line.

For further details contact Switch Electronics, 241 Desborough Road, High Wycombe, Bucks HP11 2QW. Tel: (0494) 463532.

AERIAL AMPLIFIER

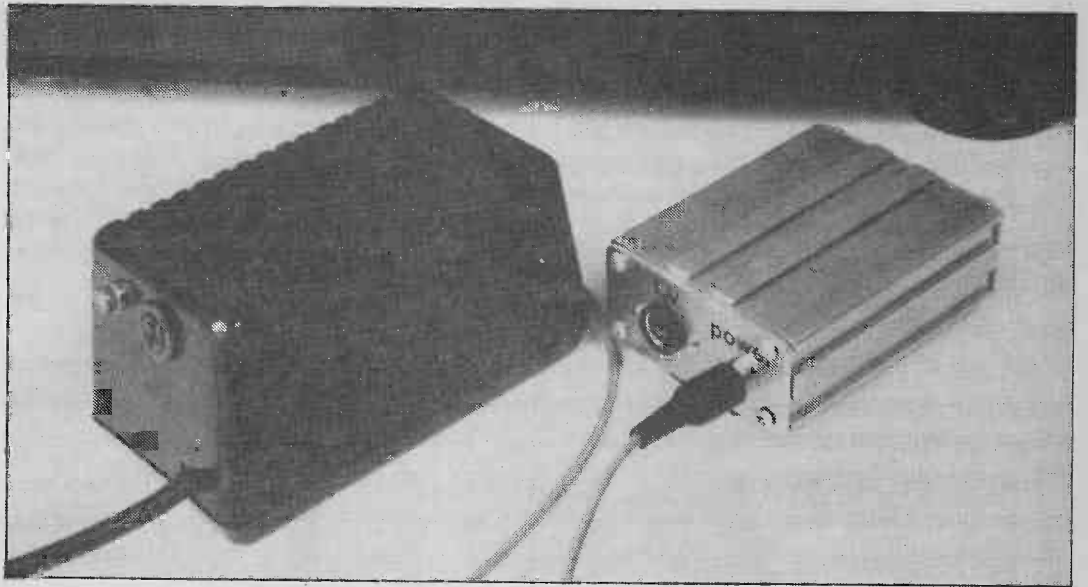

Paul Chappell, ETI's illustrious Projects Editor, adds even more class to a former First Class project

What do project editors do in their spare time? Build other peoples' projects, of course! The last one I had a go at was Keith Brindley's *Traveller's Aerial Amp* from the September 1988 issue of ETI. Although Keith designed it for mobile TV addicts — caravanners and the like — my reason for building it was to get decent pictures from the portable TV and indoor aerial in my London flat. I felt that a smarter looking box was called for, and a mains power supply of course, but first I took a good look at the PCB layout.

Laying out PCBs for UHF circuits can be a very tricky business. A few millimetres of component lead or PCB track can look like a whopping great inductor at TV frequencies (not great in value, which will be the same at any old frequency, but great in its effects!). Two conductors side by side will make a pretty good capacitor.

When you think that 10pF at 500MHz (the kind of frequency we're dealing with) has the same effect as 1 μ F at 5kHz or 100 μ F at 50Hz (and bearing in mind that you'll be hard pressed to lay out a PCB without introducing capacitances of this kind of size), it's amazing that any UHF circuit ever works. Imagine trying to make an op-amp circuit work with 1 μ F capacitors connected here and there between adjacent pins and 10mH inductors in series with all the leads. Rather you than me!

For audio frequency circuits, we're used to thinking in terms of lumped components. Two pieces of wire running side by side will have a certain capacitance, bring them closer together and the capacitance will increase, put certain materials between them and the capacitance will be increased still further. But a home-made two-wire capacitor will never have anything like the capacitance needed for an audio coupling capacitor, let alone a power supply smoothing cap. So we buy specially made parts where the two wires have been spread out into a huge area placed very close together and interleaved with a suitable dielectric material to intensify the effects. Since the capacitance effect that goes on inside the capacitor is perhaps a million times larger than the effect that occurs between two adjacent tracks on the PCB, we think of the capacitance as being concentrated in the

component and for the most part ignore any that goes on elsewhere.

For UHF circuits, the capacitance and inductance effects that turn up whether you want them or not are comparable in size to the components you're using and certainly can't be ignored. Every single PCB track, piece of wire and component lead has to be regarded as an extra component in the circuit. The capacitance and inductance of these new components is not concentrated at a certain point but is distributed along their length, so two adjacent PCB tracks will look to the circuit like the combined inductor and capacitor of Fig. 1.

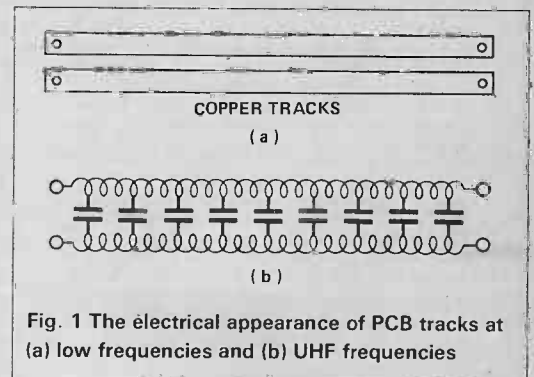

Fig. 1 The electrical appearance of PCB tracks at (a) low frequencies and (b) UHF frequencies

A first guess at what this circuit does would probably be that it acts as a low-pass filter. However it has one very interesting characteristic: if you balance up the ratio of inductance to capacitance just so and terminate the circuit with a certain resistance, you can fool the drive circuit into thinking it's driving a resistance and the receiving circuit into thinking that the signal comes from a resistive source.

On a PCB, you trim the inductance to capacitance ratio by adjusting the width of the track. This leads to the track dimensions chosen by Keith in his design. An extension of the idea can lead to all kinds of reactive components being made just by the size and shape of the PCB tracks: inductors, capacitors, tuned circuits and so on.

This sorts out the main signal connections. The next consideration is to prevent signals being fed back from output to input, which could very easily cause

PROJECT

the circuit to oscillate. The first line of defence here is to use a ground plane (a large area of copper connected to ground) on the component side of the PCB and even better to have the same on the track side too. You can think of this as making the capacitance to ground at any point of the circuit large in comparison with any other stray capacitances, taking away energy which might otherwise end up in the wrong place.

Ground planes were included in the original design but being a cautious old projects editor I decided to take the technique one stage further. At low frequencies, if two areas of copper are connected together, they'll be at the same voltage and that's all there is to say about the matter. With UHF signals, the changes are going on so fast that on a TV downlead (for instance) there will be several complete cycles of the signal along its length. If you could freeze the wire at one moment in time and then measure the voltage along the wire, you'd find a peak positive voltage at one point, zero at perhaps 150cm further along, peak negative voltage after another 150cm and so on. If you imagine connecting a 500MHz signal generator to a length of cable which is shorted at the other end, the generator would go through several cycles before

bottom edge of the screening piece is soldered all the way along to the top ground foil of the main PCB.

Construction

The circuit hasn't been changed at all — it's shown in Fig. 2. If it is to be permanently connected to its power supply, you can miss out D1 altogether — just connect

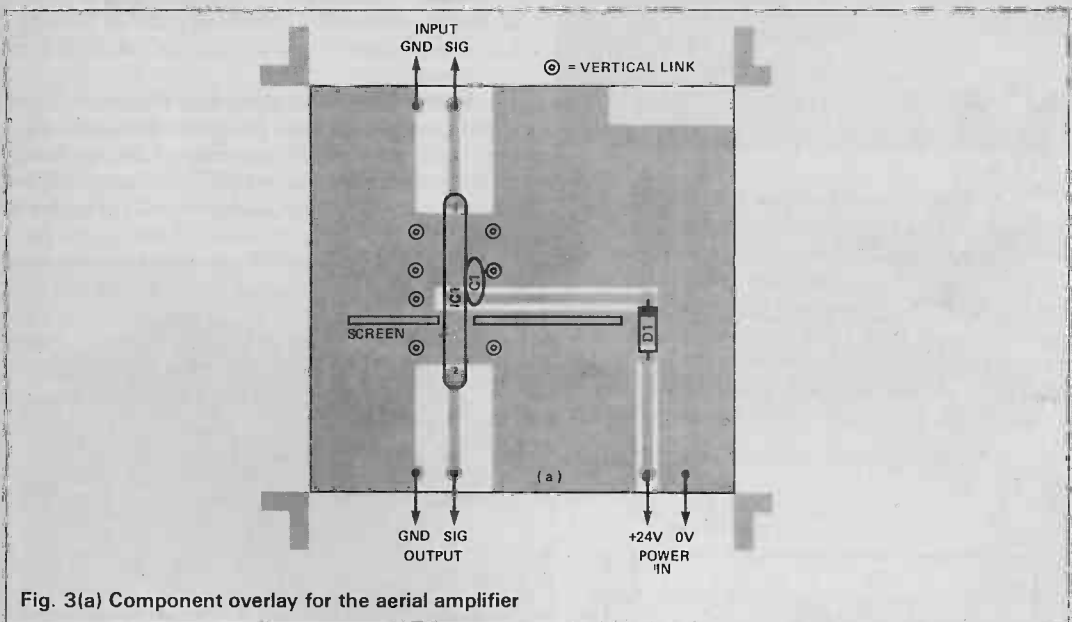
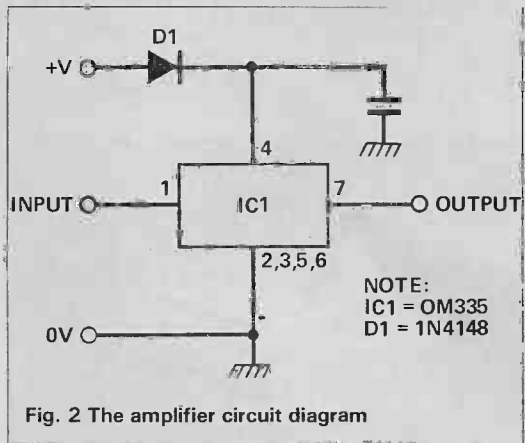

the energy even reached the other end of the wire, so a short circuit at UHF doesn't mean quite the same thing as it does at low frequencies. Eventually you'd get standing waves set up along the length of the cable — not at all what you'd expect if you fed the output of your audio amp into the same shorted length of cable. You might find the idea hard to swallow but if you're having any truck with UHF circuits, you better believe it!

The very same thing applies to the PCB — if you have a ground plane, you can't just think of it as an area of copper at 0V. The voltage will actually vary at different parts of it and a voltage difference can exist between the top and bottom ground foils of the board. One thing that helps to keep the circuit in order is to connect the top and bottom foils of the PCB together in several places, particularly around the IC where the signals originate. If you've already built Keith's circuit, it's an easy enough matter to drill a few extra holes in the PCB and put in through links, just to be on the safe side!

One more thing I did was to include a screening piece made from an offcut of PCB material to further isolate the input of the circuit from the output. This straddles the IC like a cowboy on his horse. The

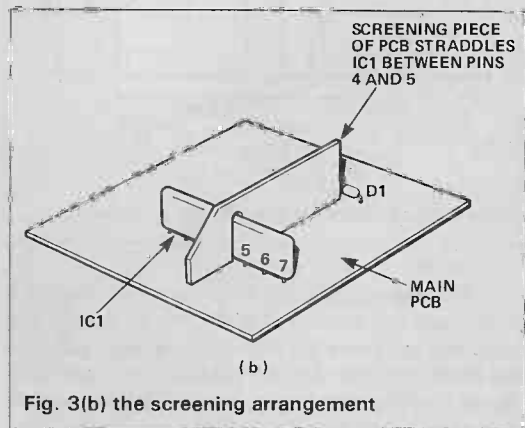

a piece of wire across its position on the PCB.

The component overlay is shown in Fig. 3. In mounting the OM335 there are two conflicting requirements: one is that the IC should be as close as possible to the PCB, the other that pins 2,3,5 and 6 should be soldered to the top foil of the PCB. The trick is to leave a gap just wide enough for the solder to be applied, without having the IC standing on long

PROJECT

stalks (each one of which will become an unwelcome inductor). If the IC stands with 1mm of the leads showing above the board, this will be about right.

The capacitor should be mounted with the lead which connects to pin 4 of the IC as short as possible, and the other lead soldered on both sides of the board. The diode you just put in as usual. All the other holes, apart from the ones at the edges of the board (which will later connect to the sockets) should be used for through-links: use offcuts from the diode and capacitor leads, post them through the holes and solder to the top and bottom foils of the PCB.

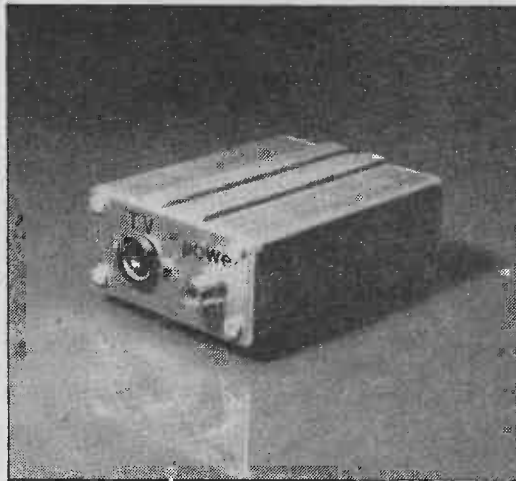

The dimensions of the screening piece are shown in Fig. 4. If you intend to use the specified case, it would be just as well to follow them exactly. If not, just cut a rectangle of PCB material and make a slot in one edge to fit the IC. The screen slips over the body of the IC between pins 4 and 5 and is soldered to the top foil of the PCB all along the edge. The best method is to solder at one or two points to hold the screen in place, then to run solder all the way along the join.

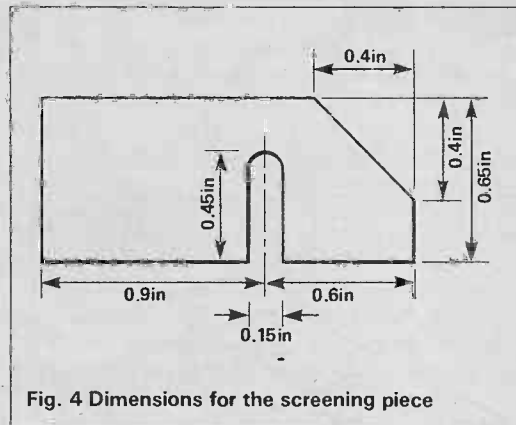

Fig. 4 Dimensions for the screening piece

The drilling positions for the front and rear panels of the case are shown in Fig. 5. The TV sockets are mounted just above the top surface of the top side of the PCB using the shortest possible lengths of wire. To see how much you need, screw one of the sockets to a panel, slide the PCB into the lowest slot in the box, fix the panel to the box, then sight along the top of the board to gauge the distance from board to socket terminals.

Attach both TV sockets and the phono (power inlet) socket to the PCB, soldering all earth wires to both foils of the board. Then fix the output and power sockets to the front panel, with the TV socket mounted behind the panel. To the rear of the input socket, glue a 4BA nut behind each flange.

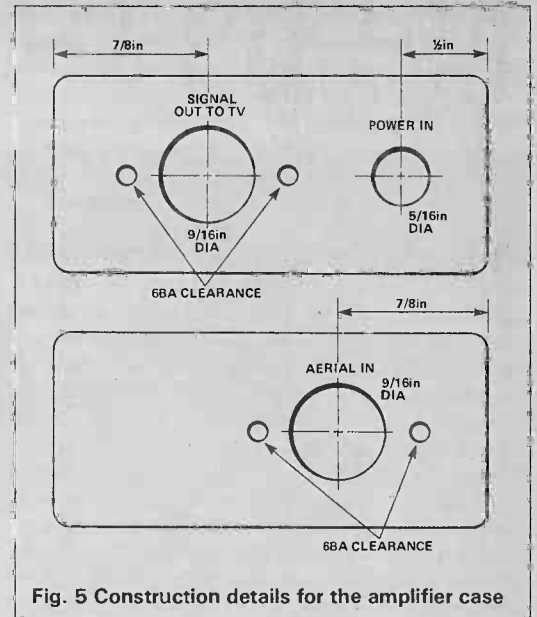
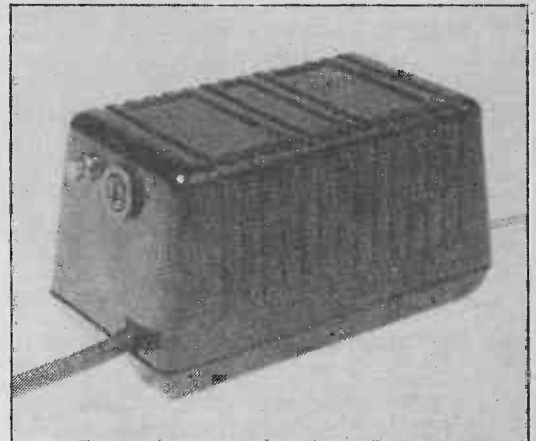

Fig. 5 Construction details for the amplifier case

Slide the PCB into the lowest slot in the case until the front panel meets the body of the case, then screw the panel in place. Screw the rear panel to the input socket, then screw that to the box too. The aerial amp is now complete!

If you're using the rubber feet, they come in the form of a strip which should be cut into two lengths, each the length of the body of the case. Before putting on the rear panel, you simply slide them into the grooves on the underside of the case. The panel holds them in place.



PARTS LIST

CAPACITORS

C1	100n ceramic
C2	1000µF 35V electrolytic
C3	10µF 35V tant

SEMICONDUCTORS

IC1	OM335
IC2	7824
D1	1N4148
D2-5	1N4001

MISCELLANEOUS

FS1	500mA anti-surge fuse
T1	PCB mounting mains transformer, 0-12, 0-12 secondary

For power supply — Neon lamp. Fuse holder. PCB supports. Case. PCB. Phono plug. Length of mains wire. Bell wire or screened wire (for a neater appearance). For amplifier — TV sockets. Phono socket. Case. PCB.

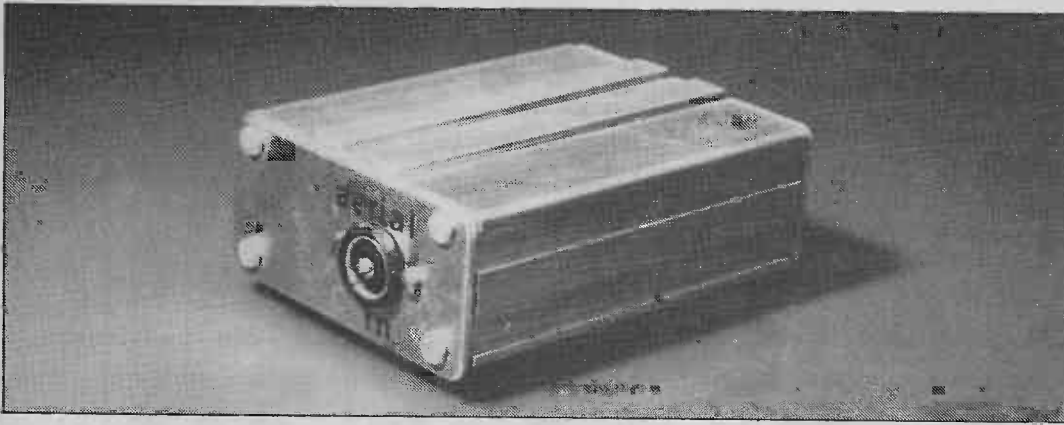

Power Supply

For caravan and camping use the amp can be run from a car battery or dry batteries but for my purposes I wanted a mains power supply. The circuit is shown in Fig. 6 and the component overlay in Fig. 7. There's nothing complicated about the construction.

I used a 24V regulator, since this is the voltage at which the IC gives its maximum gain but if you can't get hold of one a 12V or 15V regulator will do. I used the 1A version since the 'L' version doesn't seem to be available at 24V. There's no need for a heat sink — the amp takes very little current.

The PCB is attached to the bottom of the case by means of self-adhesive supports, avoiding any drilling. The fuseholder and 'on' indicator go right at the very top of the case — be careful to put them high enough so they don't foul the transformer. To take the power to the amp, a length of bell wire with a phono plug at the end is fine. Make sure to connect the plug so that the positive side of the supply goes to the inner

pin (perhaps that diode is a good idea after all!). The wire should be knotted just behind the exit hole in the case to prevent any strain on the PCB connections, as should the mains wire for the same reason.

After checking with a multi-meter to make sure that the power supply is indeed giving 24V, it's time to plug everything together. The aerial plugs into the input socket of the amp and a length of TV co-ax connects the output to your receiver. The power supply plugs into the power inlet on the amp and that's about it.

Oh yes, you have to turn the TV on too! Happy viewing.



BUYLINES

Various parts sets for this project are available from Specialist Semiconductors Ltd. See their ad. for details.

The OM335 on its own can be had from Electromail (tel: (0536) 204555) or from Highgrade Components, 8 Woburn Road, Eastville, Bristol BS5 6TT.

PCBs are available from our PCB service — details on the centre pages. For DIY PCB etchers, the patterns are printed on page 61.

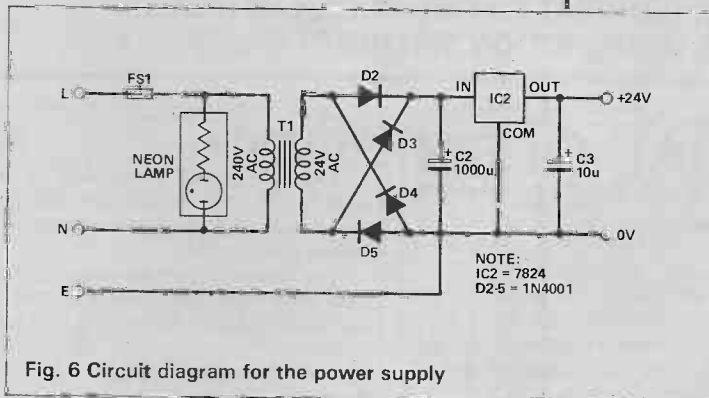

Fig. 6 Circuit diagram for the power supply

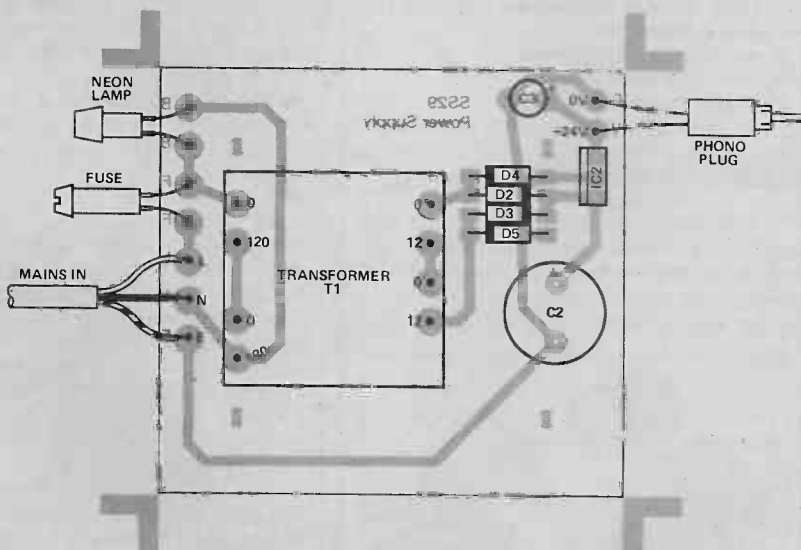

Fig. 7 Component overlay for the power supply

NUCLEAR COST

The incompatibility of nuclear power with a privatised electricity industry has yet to be resolved. Proposals for a 'nuclear levy' or for an enforced minimum nuclear power production are in direct conflict with the Government's principles of non-intervention, yet without such measures the capital outlay and risks involved in the nuclear industry will almost certainly stop any private enterprise commissioning a new station.

John Banham, director general of the Confederation of British Industry, has called for the separation of nuclear power from the rest of the industry. It should not be sold, he says, at least until the rest of the industry has settled down and until there is more certainty of nuclear costs. He claims this would also benefit the rest of the industry, freeing it from many restraints and allowing more immediate competition.

Meanwhile Friends of the Earth has disputed the plans to provide sufficient funds to decommission existing nuclear plants when their lifespan is complete. The CEBG calculations are based around costs of decommissioning running around 2% above inflation. Final stages of decommissioning would not take place for about 100 years after shut-down. Friends of the Earth feels that costs, particularly the price of labour, will rise significantly faster than this, and that public opinion would be likely to force final procedures earlier than the 100 year period, making the work more hazardous and so more expensive.

DC/DC ISOLATORS

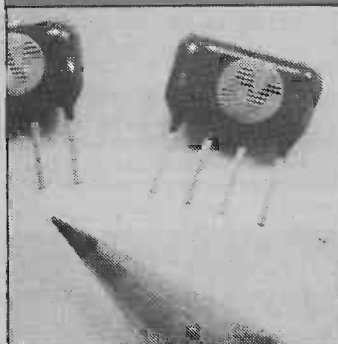

Miniature DC-DC converters in a 4-pin SIP version are now available from Newport Components of Milton Keynes.

The converters are available with inputs of 5V or 12V and with outputs of 5, 12 or 15V, fully isolated with an efficiency of up to 80%.

For further details contact Newport Components, Tanners Drive, Milton Keynes MK14 5NA. Tel: (0908) 615232.

NEW ENGINE FOR HOTOL

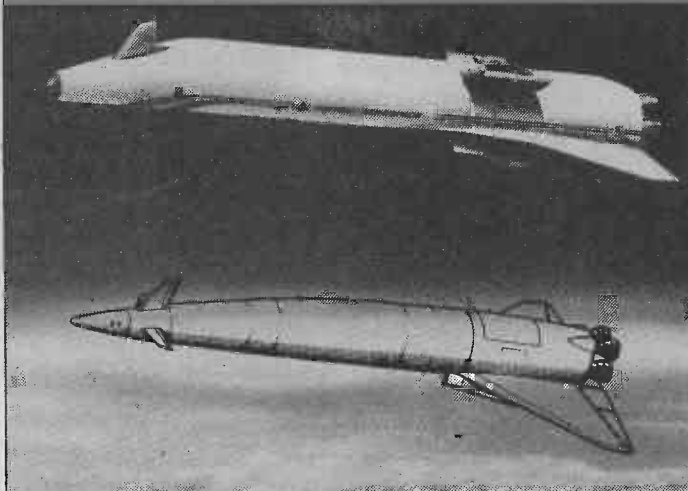

HOTOL, the Horizontal Take-Off and Landing craft designed by Alan Bond, is far from dead. Despite the British Government's refusal to fund it or allow him to obtain funding from abroad, HOTOL remains under development at British Aerospace. Now Alan Bond has designed a new engine that will increase the efficiency of fuel consumption, which should help silence claims that HOTOL would not be efficient enough to carry any commercially viable size of payload.

The new engine is called SATAN, a disturbing acronym which Bond refuses to explain for fear of giving away its secrets. He is also not registering the design for a patent, since this would risk

the design being classified. Although this leaves Bond open to accusations that his new engine does not actually exist, his past achievements and performance makes such a fraud most unlikely.

British Aerospace has recently redesigned its proposed shell for the HOTOL craft, replacing the 'finger-mouse' nose styling with a horizontal rocket, shown below the original in the above illustration. Although British Aerospace has yet to receive details of the SATAN engine, its incorporation should prove no problem as the new design is similar in shape to the old engine. The original engine patent is owned by Rolls Royce.

SCOPES FOR IMPROVEMENT

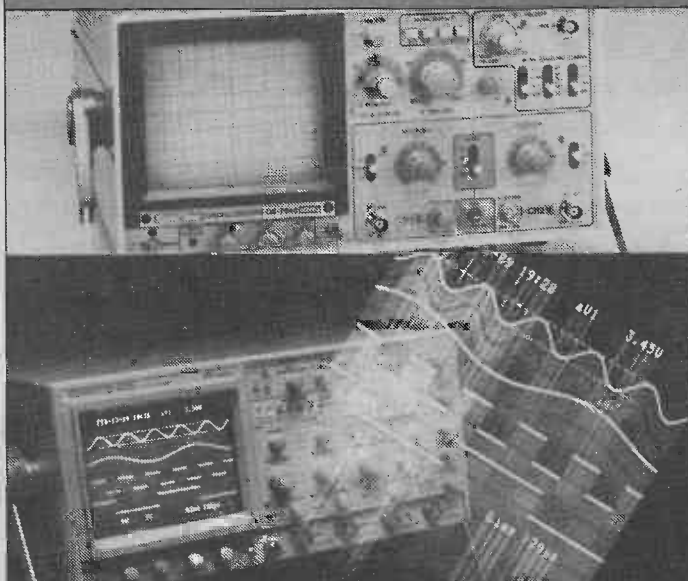

A pair of new oscilloscopes are available this month, one from Alpha in Manchester, one from Thurlby in Huntingdon.

The Thurlby scope is the Kenwood CS6020, a 10-trace, four channel, 140MHz unit, with on-screen readouts and full delayed timebase, retailing at a whacking £1995 + VAT.

Contact Thurlby Electronics, Burrel

Road, St Ives, Huntingdon PE17 4LE. Tel: (0480) 63570.

The more affordable scope is the Gold Star OS7040, a dual trace 40MHz model with sensitivity down to 1mV/cm. This retails at £499 + VAT.

Contact Alpha, Unit 5, Linstock Trading Estate, Wigan Road, Atherton, Manchester M29 0QA. Tel: (0942) 873434.

MINIATURE MOTOROLA

Motorola has launched its major cellular telephone product for the 1990s, the 9800X personal cellphone.

The 9800X represents a real advance in portability over existing competitors and Motorola's previous units. The mouthpiece folds over the keypad so that the 9800X can be carried at a size of just 6½ x 2½ x 1½ ins. It weighs either 305 or 350g depending on the battery size chosen. This makes it a comfortable size for the pocket — 'body-friendly' as Motorola insists on calling it, 'rather than merely briefcase friendly'.

Technically the unit is excellent with no performance compromises through the size reduction. This is mainly possible thanks to surface mount technology and in-house custom chip design — 90% of the components are sourced within Motorola.

Power consumption has been reduced so that the larger of the two battery sizes will power 20 hours of standby time or 75 minutes of continuous talk time. The full ETACS capability gives 1320 channels with 25kHz spacing.

Motorola is confident that the cellular marketplace worldwide is going to skyrocket to over ten times its present size in the next decade, to handle over 50 million subscribers. And this, it reckons, is a conservative estimate.

Interestingly it regards the development of CT2 — the telepoint system — as of little relevance to the cellular network, claiming it will if anything stimulate the market and act as an additional spur for development.

This would seem an optimistic view considering the enormous price differentials involved. The personal cellphone retails at £2295, CT2 units should be available under £200.

There are also doubts that cellphone networks will be able to expand capacity to meet the scale of increase predicted by Motorola. Cellnet found it necessary to undertake a huge overhaul of its network this Easter to solve problems of oversubscription.

Motorola's estimate of 2 million subscribers in a single city combine a strong profit motive with a whacking technical and administrative challenge.



DISCORD FROM MUSIC IMPORTERS

The musical instrument industry in the UK is suffering from the effects of unofficial importers offering equipment at undercut prices.

Eight major distributors have issued a joint statement to warn dealers and punters of the dangers of these 'grey' imports. The main problem is the invalidation of any US warranty without the substitution of a UK replacement.

However it may prove difficult for the official distributors to do more than warn people against the importers. Many dealers who fail to get a franchise with the official distributors are left with unofficial sources as their only supply. Some claim they might even take such deals out of spite.

In any case the 'grey' imports are not illegal providing customs duties are observed. Any attempt to cut out purchasing at the US end is likely to fall foul of stateside restrictive practises legislation.

Since the situation seems likely to continue, the official distributors might do better to examine why unofficial importers are able to get second-sourced units to the UK in small quantities at cheaper prices than the manufacturers' own agents.

DISH AERIAL



A neat new indoor TV antenna should solve many cases of plummeting aerials by housing the reflectors in a unit the manufacturers call 'the world's nicest design'.

The antenna is called the Planar and has been produced by Cobra, an Italian company based in Milan. The base section remains stationary while the top section revolves to find signal direction, a marked improvement on re-balancing your conventional antenna on that pile of video cassettes!

The unit should soon be available through high street video shops. It is being distributed in the UK by Bandbridge, 1 York Road, London SW19 8TP. Tel: 01-543 3633.

CONTROLLER BOARD

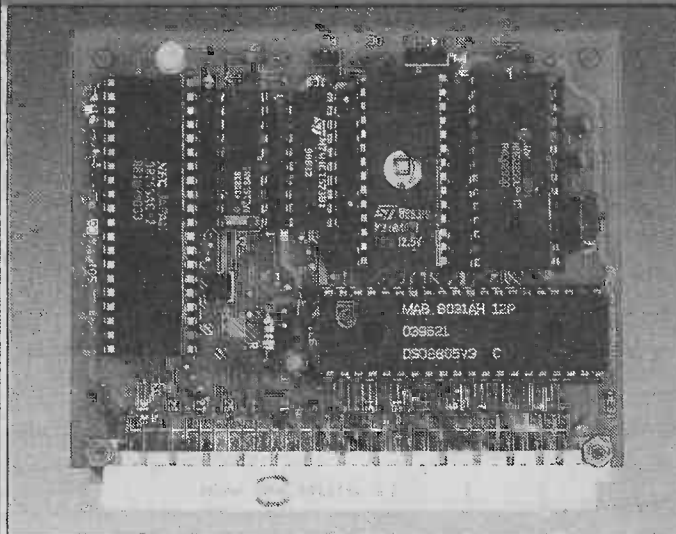

A versatile single board controller at a reasonable price is on the market from GNC Electronics in Norfolk.

The uE31 microcontroller is based around the 8031 microprocessor, with the 15 I/O lines being augmented by a further 24 on an 8255 programmable I/O chip. All 40 lines, including the 8031's timers and interrupts, are available on a standard DIN41612 connector.

For on-board memory the unit uses 32K RAM and 32K EPROM (this is link selectable to be seen as 8K, 16K or

32K) and can be programmed from an RS232 port of a PC or compatible. Programs are downloaded into RAM and executed, a bi-colour LED displaying status.

The uE31 is crammed onto a card 8 x 10cm. A manual comes with the unit giving full circuit diagram, source listings and the downloading software supplied on the EPROM.

It costs just £49.95 + VAT. Contact GNC Electronics, Unit 2b Gilray Road, Vines Industrial Estate, Diss, Norfolk IP22 3EU. Tel: (0379) 644285.

MONEY TALKS

Canada's blind population will soon benefit from a device that can identify the value of Canadian banknotes and tell the value through an integral speech synthesiser.

Bank of Canada currency has identification marks that the unit can identify with a light sensor, passing the value of the note (\$2, \$5 or \$10) to a speech unit that can be switched to announce the verdict in French or English.

The unit is being produced as a joint venture between the Bank of Canada, Brytech and Carleton University.

VEROETCH PROTOTYPING

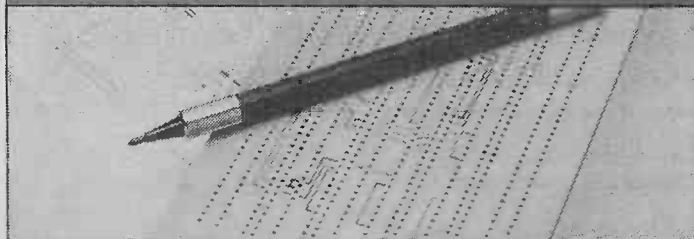

Bicc-Vero has introduced a new system of prototyping double-sided PCBs — VeroEtch.

VeroEtch comes as a kit with predrilled double-sided PCBs with a gold-plated high density pad pattern that remains after etching.

The thin gold tracks between pads

can be joined at each end to provide tracks by use of the supplied etch-resist pen.

Full details of VeroEtch are available from Bicc-Vero Electronics Circuit Board Division, Flanders Road, Hedge End, Southampton SO3 3LG. Tel: (0703) 266300.

A TOOL FOR ALL TRADES

Ceka Tools were at British Electronics Week displaying the increasingly expansive range of CK specialised tools for electronics.

A complete range of tweezers and pliers for manipulating those fiddly surface-mount chips and components were on show together with ranges of more conventional screwdrivers, strippers and cutters.

For full details of Ceka's tool range contact Ceka at Pwllheli, Gwynedd, North Wales LL53 5LH. Tel: (0758) 701070.

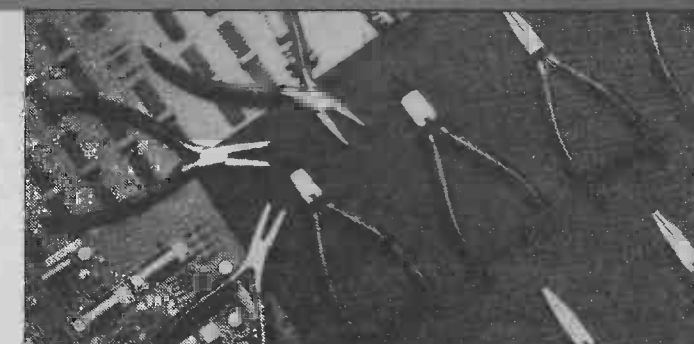

FIBRE-OPTICS



New fibre-optic products were on show at the British Electronics Week from Lambda Electronics.

The fibroclip is designed to make optical fibre splicing as simple as audio tape editing. Two fibre ends are butted together in the fibroclip's V-connector, clamping them into position. A drop of adaptor fluid at the junction cements the joint.

The joints are only supposed to be temporary solutions but performance at splices shows a loss of only 0.2dB.

There is also a simple mechanical splicer kit available for 125µm fibres.

Lambda has a new laser extender that matches a laser output and transmits the original signal through single mode fibre to a new output up to 10m distant.

An optical power meter is also available that can measure down to 0.0001W (or 0.1dBm if you prefer). The unit can handle any of the common wavelength and connector types.

Contact Lambda Photometrics, Lambda House, Batford Mill, Harpenden, Herts AL5 5BZ. (05827) 64334.

OPEN CHANNEL

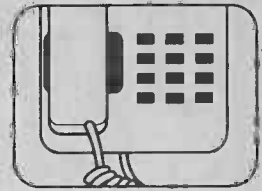

Back in the April issue I let it slip that TAT-8 (that is, *transatlantic telephone cable number 8*) was about to go operational. Well, that much of the story was true. But what couldn't possibly be known at the time of writing was that at the very time readers would be perusing my words, the cable was about to break down. On 21 March, to be precise, the French leg of the cable ceased to work. Ah well not to worry, thought the cable engineers, we'll just re-route the French traffic over the British leg of the cable, through England and across the Channel to la belle France, while we get the French leg up-and-running again.

Fine — until on 27 March (yes, you've guessed it) the British leg gave up the ghost, too. Embarrassing, to say the least.

Intelsat (the cable operators' rival), keeping a moderately straight face with only a smug smile no doubt, stepped in to route all traffic via satellite across the Atlantic.

The All-American Kid

While we're on the subject of transatlantic communications, American dreams of becoming market leaders in consumer electronic equipment manufacture once again — in the form of high-definition television (HDTV) receivers — are currently undergoing a change into mild nightmares.

A couple of months ago, I reported that the newly named ATV (advanced television) project in the States was having problems. Until recently, they'd all assumed they were going the route of the Japanese HDTV system and had wasted a great deal of time planning along those lines — all 1125 of them! However, somebody (the Federal Communications Commission to

be precise) sat down and thought of the consequences of HDTV (much increased transmission bandwidth, incompatibility with existing television receivers and so on) and realised that it's just not on. The FCC ruled that no extra transmission frequencies would be allocated for HDTV purposes — basically because there *are* no new frequencies. In a single move, therefore, the Japanese HDTV system becomes a white elephant.

So ATV was born, along with a commitment to lead the market. However, to lead the market you've got to have a product to sell. The debate now seems to centre around where the money is going to come from to pay for the development of ATV. The American electronics industry is reluctant to reach into its pocket but the American government is, as you'd expect, equally reluctant to fund what it sees as a private concern. It sounds more like a British scenario, don't you think?

Many over the water see ATV as America's last chance in the electronics manufacturing market. A document recently prepared by the American Electronics Association (AEA) has shown that America stands to lose out not only on television sales but on sales of semiconductors and computers too, if the American electronics industry doesn't get its finger out. Figures of losses amounting to hundreds of billions of dollars and job losses of around two million have been bandied about in the ensuing arguments.

Without doubt, ATV is an emotive issue in the States — indeed, many feel it's make-or-break point. Yet one thing appears to have slipped by unnoticed in the brouhaha: *an adequate and acceptable standard for ATV has not been devised*. Talk about putting the cart before the horse!

When Irish Eyes . . .

British Telecom's dreams for an *integrated services digital network* (ISDN) are coming one step closer to reality, as it unveils plans to lay over 1000km of optical fibre cable in Northern Ireland. BT is expected to invest over £100m in the network, which will link 44 digital exchanges in 36 Ulster towns to the British mainland.

See Tea, Too

It looks as though the German national telephone organisation, Deutsches Bundespost, is about to join the international consortium headed by BT to operate the second generation cordless telephone system CT2 (cryptic subtitles forever I say). BT, along with France Telecom, STC, Nynex, and now Deutsches Bundespost if they decide to participate, call their system *Phonepoint*, and it should be operating throughout Britain shortly. I won't go into user-operation again (read last month's column for a description), suffice to say that a consortium headed by three of Europe's biggest telecommunications operators can hardly be ignored by the standards powers that be — in this case ETSI (the European Telecommunications Standards Institute).

Get Smart

This not-so-cryptic sub-head brings us to the subject of smart-cards, which by now some readers will have already gained experience of. Smart-cards are typically thought of as 'clever' bank-cards or pay-phone telephone cards — nothing great in that I suppose. Unlike their 'dumb' equivalents however, which use a magnetically-coded stripe to store details of bank account number and bank branch or number of telephone units remaining, smart-cards feature on-board (or should I say *on-card*?) semiconductor devices for memory and, more important, pro-

cessing capabilities.

Smart-cards rely initially on the ability to mount the required semiconductor devices onto the thin plastic base, and then to allow electrical connections between the devices and the card-reading machines. Coupled with these restrictions, the card then has to be fairly robust to withstand everyday handling: storage in wallets, sitting on them when they're in your back trouser pocket, flushing down the loo, chewage of my 18-month-old son and so on — not an easy task overall. Once this is cracked, which it now successfully appears to be, the potential for smart-cards is laid wide open. They are not restricted to simple memory applications in hole-in-the-wall banking machines or pay-phones. They can process information for use in academic records, access control, medical records and so on. Development work in these areas is already underway.

Smart-cards are to be used also in Sky Television's *subscription management system* (Sky's words, not mine) — that is, Sky's pay TV system. Sky is expecting to encrypt its *Sky Movies* and *The Disney Channel* channels by the end of the year, so anyone wishing to receive the channels will then require a Sky smart-card. And Sky is currently boasting some 700,000 homes capable of receiving its service, whether by satellite or cable means, so a lot of us look as though we're going to become familiar with smart-cards. Incidentally, by the time you read this, Sky estimates that 100,000 dishes and receivers, capable of receiving transmissions from the Astra satellite which Sky transmits from, will be reaching the market. Many more smart-card applications are expected too: the potential applications are supposedly limited only by imagination.

Keith Brindley

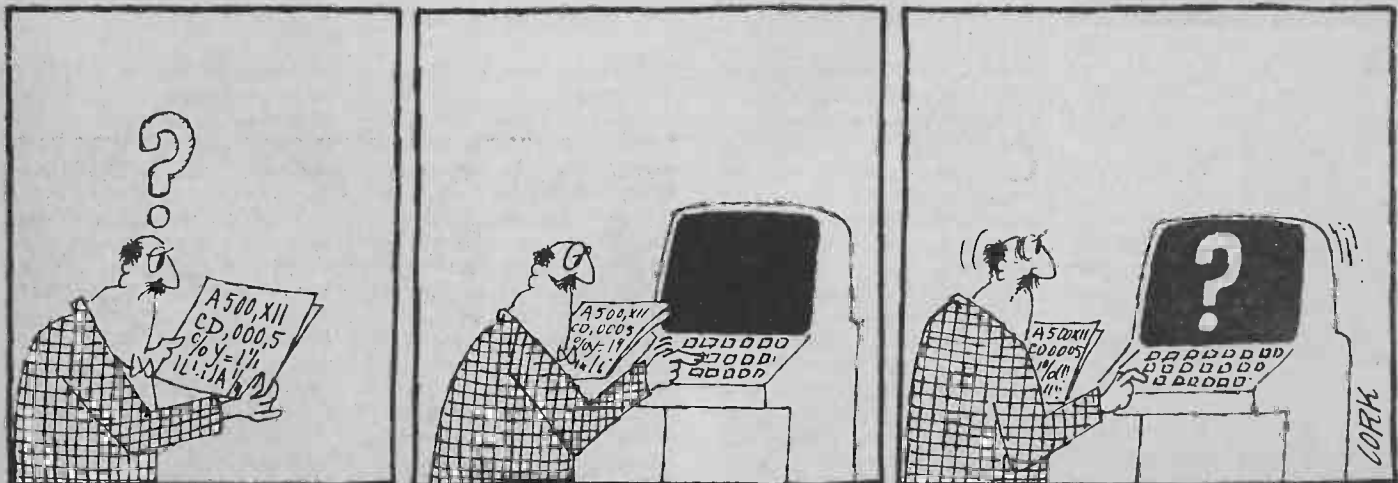

PLAYBACK

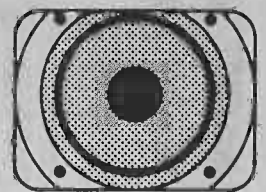
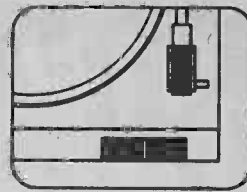

In previous Playback columns I have dispaired at the 'numbers war' currently being waged by the manufacturers of CD players. What started with 16-bit linear D/A conversion has now reached new heights of technical one-upmanship with the emergence of 20-bit convertors and multiple oversampling filters offering a coefficient rounding accuracy of up to 45 bits! Nevertheless with an average lifetime of 9-12 months many of these CD players appear to be launched ahead of their time.

Marketing dictates that each successive model has to be one step ahead of the last, but the question must be whether R&D departments can really keep pace with these demands? I think not.

Just look at the so-called 20-bit convertors that are currently in use. These are either paralleled 18-bit DACs subject to bit-shifting and attenuation in the analogue domain or simply 18-bit DACs with an extra 2 bits tacked on with discrete circuitry.

Try matching the reference current levels between a discrete 2-bit convertor and a Burr Brown PCM64P! So low-level quantisation errors may be reduced but in practical terms the amplitude linearity of these '20-bit' machines is no better than a standard 16-bit 4x chipset. As usual, the basic idea is a good one but the technology should not be implemented until it has sufficiently matured.

Enter PDM

However, in the summer/autumn of this year the numbers war should be thwarted as Philips and Sony introduce a new concept in D/A conversion — Pulse Density Modulation (PDM). Referred to by Philips under the proprietary name of 'Bit Stream Conversion' the PDM process is entirely compatible with current CD software but adopts a different method for digital to analogue conversion.

The system relies on several stages of oversampling to increase the 44.1kHz sampling frequency to 11.2896MHz while also truncating the 16-bit data into a 1-bit digital word. The 1-bit code is then converted into a stream of fixed-height fixed-width pulses (+1 and -1) using a switched-capacitor PDM DAC, prior to removing the residual quantisation noise (up to 11.2896MHz) via a 3rd order LPF. This positive and negative-going pulse train should be treated as a continuous variation in signal density rather than a succession of +1 and -1 spikes: the closer in density and +1 and -1 outputs, the lower is the amplitude of the final analogue waveform and vice-versa.

A conventional 16-bit DAC operates over a predetermined series of discrete current (amplitude) levels, but the linearity of each 'step' is influenced by ageing and thermal variations that lead to both non-monotonicity, zero-cross distortion

and glitches. By contrast the accuracy of the PDM DAC is almost singularity determined by the accuracy of the incoming 11.2896MHz clock — in essence the PDM DAC is a digital rather than analogue device.

Both the oversampling, DAC and low-pass filter stages are contained within a single monolithic IC, a quad-flat package known as DAC-3 or SAA7320. The standard 16-bit/44.1kHz (I^2S) serial input is first subject to a 4x oversampling (FIR) transversal filter that generates three new samples between each pair of original samples. The sampling frequency is then raised to the required 11.2896MHz (256x 44.1kHz) through a 32x linear interpolator and 2x sample and hold circuit, with the addition of 1MSB to accommodate a high level (-20dB) 352kHz dither signal.

Noise Ploys

Oversampling can be implemented to spread any residual quantisation noise over a wider bandwidth and therefore improve the s/n ratio of the passband signal. However in the case of the SAA7320 (which uses a quantiser to truncate the final 17-bit code into a 1-bit code) the optimum s/n ratio obtained with 256x oversampling is still limited to 31.9dB — equivalent to a perfectly dithered 5-bit system.

In practice the s/n ratio actually approaches that of an 18-bit system, or

108dB, and is achieved with recourse to noise shaping.

Noise shaping is rather like digital feedback, each successive error caused by truncation of the digital word being added to the next. With time-averaging the accumulated error is reduced to zero within the sampled passband, just as the resulting quantisation noise is pushed to the upper end of the stopband. Close to 11.2896MHz the quantisation noise approaches a peak output of 0dB (2V) but is dealt with by the integrating reconstruction filter employed after the PDM DAC.

Pulse Density Modulation is not an entirely new concept but its fulfilment is very recent, if only because appropriately fast, powerful and cost-effective CMOS devices have only just become available.

Nevertheless, fascinating as the technology is we shall have to wait for production samples of this system before the subjective verdict can be cast. After all, if PDM does not sound very good then we might as well return to the drawing board!

Paul Miller

SHOW REPORT



The National Exhibition Centre in Birmingham was a veritable hive of electronics industry from 14th to 16th March this year. It played host to no less than three separate electronics exhibitions and conferences — CADCAM89, Semiconductor International and Internecon.

CADCAM89 exceeded all expectations last year with a record breaking 21,000 visitors, but this year it looked set to cater for even more. It is the largest computer aided design and manufacture exhibition in Europe, having doubled in size over the last two years and now taking up three halls of the NEC. The halls, incidentally, for those readers who have been to the NEC, were the newly-completed (well, nearly-completed anyway — workmen were still going hammer and tongs at the

entrance walkway) halls 6, 7 and 8.

Semiconductor International is the specialist exhibition for, surprise surprise, the semiconductor industry. It's been uprooted from its traditional Autumn venue to run alongside CADCAM and Internecon and, as such, is bound to get a wider and bigger audience. It was actually in the same hall as Internecon, and featured some 80 or so stands, all jam-packed with advanced chips and advanced chip manufacturing equipment.

Internecon itself, celebrating its 22nd birthday, was the biggest of all three exhibitions, with over 350 exhibitors from the electronics production and manufacturing industry. All aspects of the business were on show, with the highlight of the exhibition being a complete functional circuit production line.

Highlighted on *The Line* were the three alternative methods of assembling a circuit: conventional PCB, hybrid assemblies and surface mounted boards. All aspects of the three methods were working, from computer aided design of the circuit and board layout, component insertion and mounting, soldering, cleaning, diagnostic, reworking to stress testing. Without doubt, this was an extremely impressive display.

Some forty suppliers of production equipment made up *The Line*, and worked consistently to prove that powerful production methods are within fairly easy grasp — even for the small electronics assembly company.

Elsewhere in the exhibition, manufacturers who specialise in production products were showing their products. Some surface mount components specialists were giving

away completed surface mounted assemblies, as they rolled out of the reflow soldering machines, still warm to touch — hot from the proverbial press, no less.

Alongside the exhibition a conference ran for the whole three days, covering important aspects of industrial electronics production. Packaging and interconnection, surface mounting, electromagnetic interference, inspection and reliability were all topics under the gaze.

All-in-all, Internecon was well worth a visit. Coupled with CADCAM89 and Semiconductor International, there's so much to see that a day doesn't really do justice. If you didn't catch it this year — stick it in your Forward Planner for next year! Everyone who is anyone was there. Why weren't you?

Keith Brindley

BLUEPRINT

This column is a service to readers to provide electronic designs. Send your requirements, with as much detail as possible, to ETI Blueprint, Argus House, Boundary Way, Hemel Hempstead HP2 7ST.

This month the question is from a Mr T. Y. Cooper of Banbury, who would like the circuit of a null detector for a DC bridge. The design is to replace an old mirror galvanometer system.

I do not know how sensitive such a galvanometer system is, however it should be possible to better it using modern electronic circuitry. The requirement boils down to a high gain DC amplifier with minimal DC offset or drift. There are almost as many cunning ways of tackling the problem as there are analogue designers, but here we will just consider two main classes of solution.

The first and most obvious solution is to use an op-amp of such a low offset that this is not a problem, and to incorporate a fine offset adjuster which may be zeroed whenever the instrument is used. This may not be the most innovative solution but it works reliably. The circuit can be designed around a suitable op-amp and the performance will be predictable.

An alternative technique is to convert either the bridge excitation or the bridge output to AC and then to amplify this signal. The disadvantage of such a technique is that in simple implementations of this solution there is no indication as to the direction of imbalance.

In addition, though the performance may be better than that of the straight DC amplifier, the operation of switching components must be taken into account. This makes it much more difficult to determine what the limits of the instrument actually are, and whether the design is working as intended.

Offset

Some very good op-amps are available at reasonable prices nowadays. The OP07 made by PMI is one good example. Its salient characteristics are: input bias current = $\pm 6\text{nA}$ max, input offset current = 5.6nA max, input offset voltage = $200\mu\text{V}$ max. The circuit of Fig. 1 shows a suitable application circuit for this device. At the gain stated, the output offset of the op-amp before nulling should not exceed about 210mV before offset null adjustment is carried out, while a 1mV signal will indicate about 60% full scale on the meter. If this sensitivity is excessive, the value of R2 may be reduced.

The very low offset of the op-amp is allied with low offset drift. This means that, when the offset null has been adjusted, it will not drift significantly during a series of measurements, or indeed probably over a month.

Several points about the circuit deserve a mention. First of all, if the

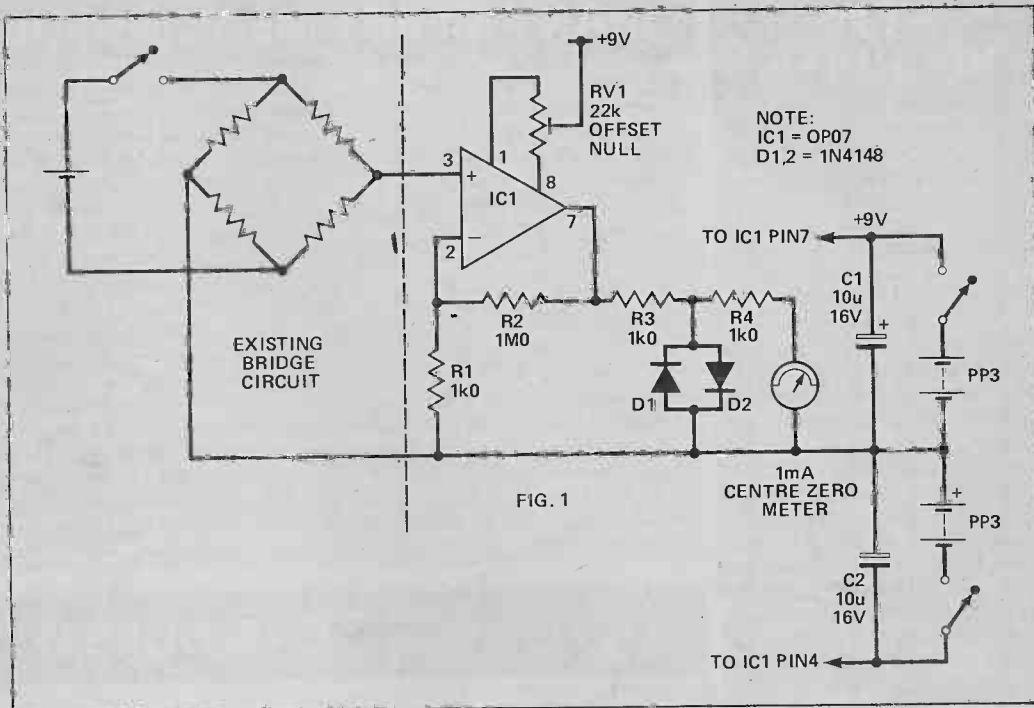

output resistance of the bridge circuit is significant then the values of R1 and R2 should be chosen so that their parallel combination is approximately equal to the bridge output resistance. This will minimise the contribution of the op-amps bias current to its total output offset.

The circuit is powered from a totally separate power supply. This is important because if it were powered from the same supply as the bridge excitation, then a much more complicated differential amplifier circuit would be needed. The necessarily limited common mode rejection of

differential amplifiers would add to the errors in the system.

A very sensitive indication is needed but it is important not to damage the meter. D1 and D2 limit the sensitivity of the meter at near full scale deflection and severely compress the ends of the scale. Thus an indication of severe imbalance is given without damaging the meter, while high sensitivity is provided for small imbalances. To make the meter indications fit the scale to best effect, the value of R4 may be chosen by experiment. The value shown on the circuit is a reasonable starting point.

Operation

The electronic null indicator should be offset nulled when the instrument is first used and the offset should be checked at the beginning of each session of use. To do this, switch on the null indicator but not the bridge excitation. This will give zero input to the amplifier. Adjust the offset null potentiometer to obtain zero output as indicated on the centre zero meter. The equipment is now ready for use.

A Big Chopper

For the sake of comparison, Fig. 2 shows the circuit of a system which converts the DC signal from the bridge to AC and amplifies it in this form. This means that a low offset op-amp is not needed and drift in the amplifier has negligible effect on the output.

The circuit shown does take account of the polarity of the signal from the bridge, by synchronously detecting the output from the AC amplifier. If this facility is not needed, then this part of the circuit may be omitted and a full wave precision rectifier circuit used instead. Such a circuit is shown in Fig. 3.

Because CMOS analogue switches are used in this circuit, the maximum voltage between positive and negative should not exceed 18V under any circumstances. Therefore, a suitable source of power would be a pair of 6V batteries — two battery holders each containing four AA cells, for example.

Minor details are omitted as the chopper circuit is included for information only.

The OP07 op-amp is available from Maplin Electronic Supplies.

Andrew Armstrong

