

MARCH 1974

electronics

today

INTERNATIONAL

20p

eti

READER OFFER:
610 RESISTORS
FOR
£2.65

BUILD A
LOW-POWER
LASER

PLUS

ELECTRONICS
AT SEA
ETI MUSIC
SYNTHESIZER

HI-FI... CONSTRUCTION ... COMMUNICATIONS... DEVELOPMENTS

There is a variety of **AMTRON Electronic Test Equipment**

Included in the vast range of over 200 AMTRON ELECTRONIC KITS are a number of various TEST EQUIPMENT units. In common with all AMTRON Kits they come complete with comprehensive assembly instructions and even the solder required inside an attractive blister pack. Shown here are a few examples:

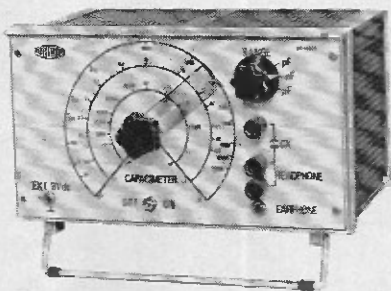

BRIDGE CAPACITANCE METER

Portable, can be driven from internal battery, or from mains source via the UK.407 Power Supply (available in kit form from AMTRON).
Rec. Retail Price £17.35.



T.V. SWEEP GENERATOR

For the aligning of tuned circuits of T.V. receivers to the resonance values prescribed by manufacturers. Frequency ranges: 28-36 Mhz; 36-49 Mhz.
Rec. Retail Price £21.68.



POWER INVERTER

Specifications to be announced.
Rec. Retail Price To be announced.

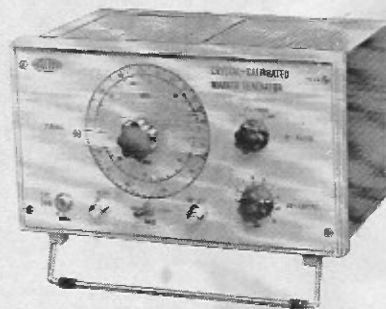

CRYSTAL-CALIBRATED MARKER GENERATOR

Output frequencies 27.5-47 Mhz fundamental.
Rec. Retail Price £19.32.

THE BIG NAME IN ELECTRONIC KITS



AMTRON U.K. 4 & 7 CASTLE STREET, HASTINGS, SUSSEX. TELEPHONE HASTINGS 2875.

electronics today

INTERNATIONAL

MARCH 1974

Vol.3 No.3.

main features

ALL AT SEA	14
<i>Electronics facilitates ocean exploration-on and beneath the surface</i>	
LM322N & CO	20
<i>A versatile timer I.C. discussed</i>	
ARC WELDING TODAY	24
<i>Arc welding now uses increasingly sophisticated electronic techniques</i>	
EXPERIMENTS WITH LASERS	37
<i>How to use ETI's low cost laser project</i>	
ELECTRONICS—IT'S EASY	46
<i>A new approach to basic electronics</i>	
CREATIVE AUDIO	52
<i>A practical guide to creating and using your own sound</i>	

projects

HAMGEAR PMIX CALIBRATOR	28
<i>A unit which ensures spot-on calibration</i>	

product tests

LOW COST LASER	34
<i>Build your own low power laser</i>	
INTERNATIONAL MUSIC SYNTHESISER—PART THREE	40
<i>Constructing the power supply, mixer and noise generator/controller</i>	

news & information

EDITORIAL	5
NEWS DIGEST	6,60
INPUT GATE	30
PREVIEW OF NEXT MONTH'S ETI	32
BOOK REVIEWS	33
ELECTRONICS TOMORROW	58
TECH—TIPS	63
DX MONITOR	57

SPECIAL OFFER	31
-------------------------	----

Cover: Gas-assisted laser cutting stainless steel. Our laser project is very low power by comparison but still enables a lot of experiments to be conducted. Photo courtesy of BOC Laser Systems.

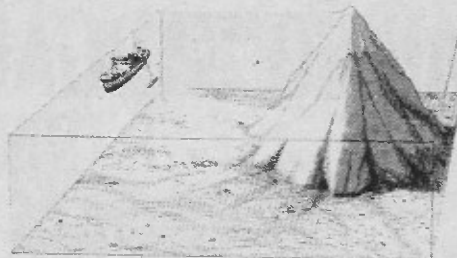

Page 14

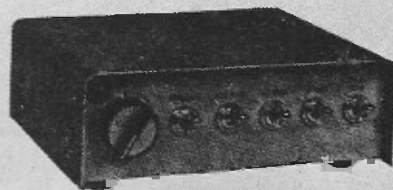

Page 28



Page 31

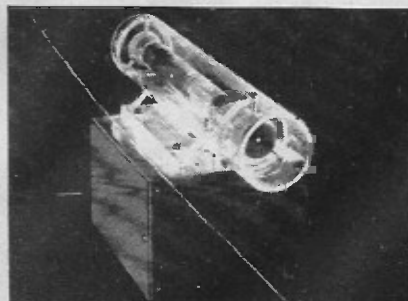

Page 34

EDITORIAL & ADVERTISEMENT OFFICES
36 Ebury Street, London SW1W 0LW

Phone: 01-730 2139

Published by: MODERN MAGAZINES
(HOLDINGS) LTD

Distributed by: Argus Press Ltd
INTERNATIONAL ASSOCIATES: Modern
Magazines (Holdings) Ltd, Ryrie House,
15 Boundary Street, Rushcutters Bay 2011,
Sydney, Australia. ACP, Room 401, 1501
Broadway, New York, USA, Bancho
Media Service, 15 Sanveicho, Shinjuku-Ku
Tokyo, Japan.

Printed in England by: Alabaster Passmore
& Sons Ltd, London & Maidstone
© Copyright Worldwide
Subscription rates per year: Home—£3.60
Overseas—£4.00

BI-PRE-PAK AUDIO BARGAINS

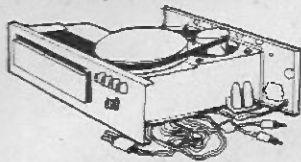

**8 TRACK
ONLY £11**

Incl. P. & P. and V.A.T.

The latest B.S.R. 8 Track cartridge Replay Deck.
Ready to install in your Hi-Fi Stereo System.
This unit comes complete with Hi Gain Stereo Pre-Amplifier,
4-Programme Indicator Lamps, Track Selector Switch, all
leads and plugs, etc. for 230 volt A. C. mains operation.

3 W.R.M.S. I.C. AMP
only **£1.65**

Incl. P. & P. and V.A.T.
Order Code I.C.A.1

on P.C. Board with all components or
2 on one board for **£2.86**.
Order Code I.C.A.1/S.

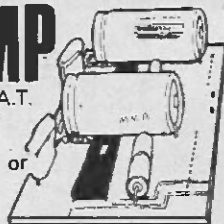

These amps. are supplied with a free booklet on connecting
up, specifications and easy to build projects using the I.C.A. 1.

5W & 10W AMPS

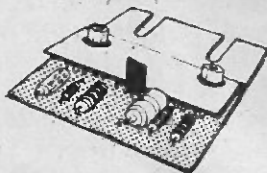

5W ONLY £1.98
10W ONLY £2.49
incl. P. & P. and V.A.T.

These matchbox size amplifiers have an exceptionally good
tone and quality for the price. They are only 2 1/4" x 1 3/4".
The 5W amp will run from a 12V car battery making it very
suitable for portable voice reinforcement such as public
functions.

Two amplifiers are ideal for stereo. Complete connection
details and treble, bass, volume and balance control circuit
diagrams are supplied with each unit. Discounts are avail-
able for quantity orders. More details on request. Cheapest
in the U.K. Built and tested.

Now available for 5 & 10W AMPS

Pre-assembled printed circuit boards 2" x 3" available in
stereo only, will fit .15 edge connector.

Stereo Pre-Amp 1 (Pre. 1). This unit is for use with low
gain crystal or ceramic pick-up cartridges **£1.21**.

Stereo Pre-Amp 2 (Pre. 2). This unit is for use with mag-
netic pick-up cartridges **£1.69**.

Stereo Tone Control (STC). This unit is an active tone
control board and when used with the right potentiometers
will give bass and treble boost and cut. **£1.21**.

Instruction leaflet supplied with all units. Post and packing
and V.A.T. included in prices.

I enclose £..... for
..... 8 Tracks/..... 3W Amps/..... 5W Amps
..... 10W Amps/..... Stereo Pre-Amps 1
..... Stereo Pre-Amps 2..... Stereo Tone Controls
(Please insert quantities and delete those not applicable.)

NAME.....
ADDRESS.....

BI-PRE-PAK
Co. Regn. No. 820919

Dept. H, 222/224 West Road,
Westcliff-on-Sea,
Essex SS0 9DF.
Tel: Southend (0702) 46344.

P.C. BORED?

— not with the

DECON- DALO 33PC

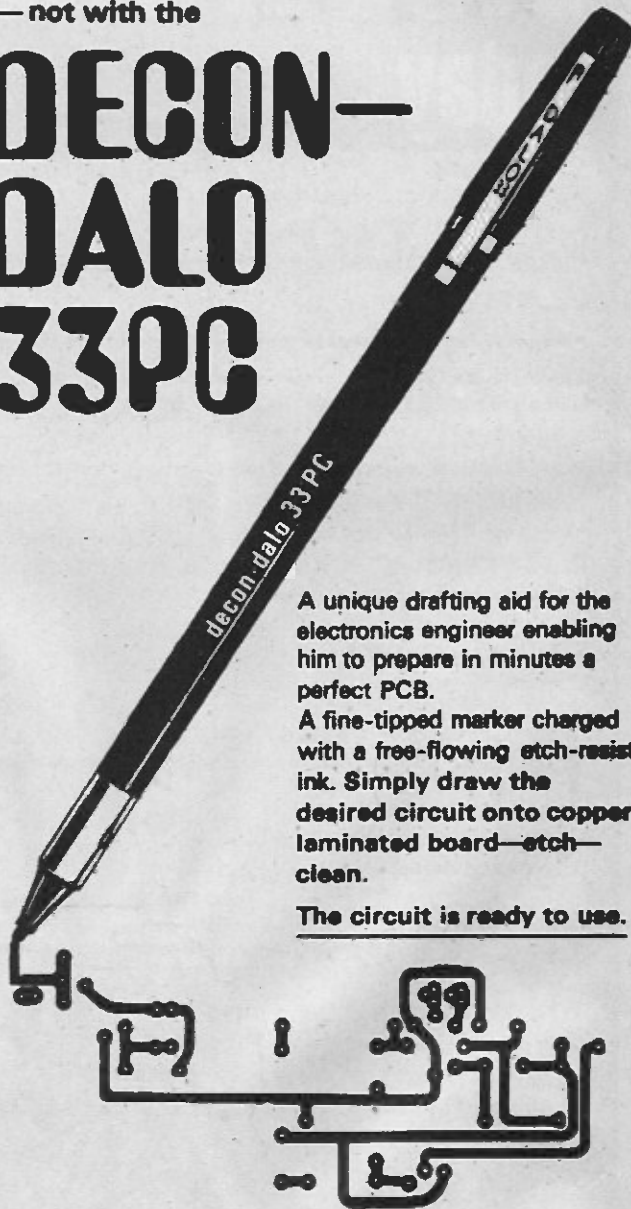

A unique drafting aid for the
electronics engineer enabling
him to prepare in minutes a
perfect PCB.

A fine-tipped marker charged
with a free-flowing etch-resist
ink. Simply draw the
desired circuit onto copper
laminated board—etch—
clean.

The circuit is ready to use.

NO MESS — NO MASKING A perfect circuit every time!

The Decon-Dalo 33 PC marker is now available in France, Ger-
many, Italy, Switzerland, Austria and all Scandinavian countries.
Send for details of local supplier.

Please send me further details on the 33PC:

Name

Address

Post to: **DECON LABORATORIES LTD.**
FREEPOST
PORTSLADE, BRIGHTON, ENGLAND!
(No Stamp Needed) Phone 0273 414371

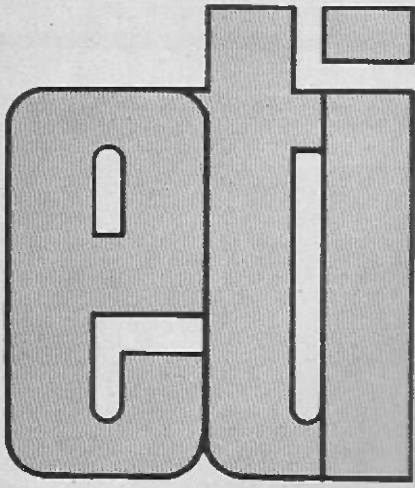

HALVOR MOORSHEAD

Editor

ROBERT EVANS

Advertisement Manager

HELEN GIMPLE

Editorial Assistant

JEAN BELL

Production Assistant

Electronics Today International
36 Ebury Street
London SW1W 0LW
01-730 2139

International Editions

COLLYN RIVERS

Editorial Director

Australia

BRIAN CHAPMAN

Technical Editor

WENDY ROY

Assistant Editor (Hi-Fi)

BARRY WILKINSON

Engineering Manager

Electronics Today International
Ryrie House, 15 Boundary Street
Rushcutters Bay 2011
Sydney, Australia

France

DENIS JACOB

Editor-in-chief

CHRISTIAN DARTEVELLE

Editor

Electronique Pour Vous
International
17 Rue de Buci
Paris, France

POWER SAVING INGENUITY

IN THE LAST FEW WEEKS we have been receiving large numbers of letters and phone calls from those looking into solutions for the energy crisis. They either want basic advice on electronics (can it do this and that?) or they want to be put in touch with experts or other interested parties. We can't always help but it does show what an interest there is.

We do not apologise for returning once again to the energy crisis for it is not yet the boring subject that it will no doubt become.

Take space heating for instance. Early heating systems (coal or log fires) were - even are - highly inefficient, putting most of the heat up the chimney. Early central heating systems were much better but hard to control. Modern systems are more efficient, maintaining even temperatures with less waste but there is a long way to go. It should be fairly simple to devise an electronic control system which could cut down waste even further. Bathrooms only require heating two or three times a day at reasonably fixed periods. Similarly bedrooms need heat for considerably less than a full day. Certainly, sophisticated control systems are possible and are used but they have cost more than the fuel they save. Space heating is only one example but there are lots more. Light dimmers if they ever become popular, could save a few per cent; microwave ovens, described in a recent ETI, could add their share of savings; ten per cent on the cost of a car could result in appreciable cost savings on predicted petrol costs.

We are moving from a time when 'brute force' methods will be replaced by sophistication in the use of power. The terrifying shock that we have received may prove beneficial in the long run: a gradual awareness of the problem would never have had the same effect.

The curiosity of companies and individuals is very healthy and we will always consider articles dealing with possible solutions for inclusion in ETI.

Some of the ideas that we have heard sound impractical (but so did flying at one time!) but even if only one in a thousand ideas pays off, the interest shown is so tremendous that we are going to see some ingenious energy saving ideas in use very soon. —H.W.M.

news digest

12-FUNCTION SCIENTIFIC POCKET CALCULATOR FROM SINCLAIR

Sinclair are planning to launch a 12-function, scientific pocket calculator for £53.90 (inc. VAT). The 'Sinclair Scientific', as it is known will be available in the UK, USA and Germany during March.

Identical in size to the 'Cambridge' - measuring $4\frac{1}{2}$ in x 2in x $\frac{3}{4}$ in deep and weighing just $3\frac{1}{2}$ ozs - this is the first calculator from Sinclair to incorporate an integrated circuit which is exclusive to the company and they're keeping quiet as to who makes it for them. The 'Sinclair Scientific' features an 'upper' and 'lower' case operation which allows all 12 functions to be obtained using only four function keys and so provides convenient and rapid operation. All key buttons have positive, 'click-action'.

Apart from the basic four (+ - X \div) operator keys the 'Scientific' incorporates: logarithms to base 10, antilogarithms, sine, cosine, tangent, arcSine, arcCosine and arcTangent. These enable rapid squaring, doubling and xy including square and other roots.

Entry and result are in scientific notation with a signed 5 digit mantissa and a signed 2 digit exponent giving the 'Scientific' a capacity for very large or very small numbers from 10^{-99} to 10^{99} . The calculator is powered by four standard Mallory batteries giving around 20 hours of continuous use.

Sales of Sinclair's first pocket calculator, the 'Executive' introduced in June 1972 are now in excess of £2.5m. Recent development of this model is the 'Executive Memory' retailing in the UK at £49 plus VAT. Production of the 'Cambridge' model, price £29.95 plus VAT is running at 1200 units per day with the majority being exported, particularly to the USA and Germany.

SPAIN TO USE PAL SYSTEM?

Spain is to introduce colour TV in 1975. Currently the state-owned TV network is conducting test transmissions using the PAL system using experimental PAL colour programmes and equipment purchased from West Germany.

Informed sources say that the Spanish government has already decided to use the PAL system.

TOSHIBA PLAN U.K. LAUNCH FOR NEW COLOUR TV TUBES

Two new ranges of colour tubes developed by Toshiba - which offer reduced accessory costs and greater efficiency in receiver production - are



The Sinclair Scientific

to be introduced to British television manufacturers in the near future featuring vertical stripe screens, they are the SSI 90° tubes and the RIS wide angle 110°.

Toshiba - the major overseas supplier of colour tubes to British TV manufacturers - plan to launch the new generation of colour tubes at a series of presentations to manufacturers in early March.

The SSI 90° tubes, designed for use in smaller screen and portable TV sets, offer simplified dynamic convergence, a slotted mask and an in-line gun. Features include: better focus with less spherical aberration; better convergence quality with adjustment requiring only two controls; lower deflection power (70% of that conventional 90° tubes); shorter tube length; constant white balance independent of brightness changes; and high brightness and better contrast.

The 110° RIS colour tubes, with rectangular cone, in-line gun and slotted mask, offer highly improved convergence and electron beam landing - designed for the new generation of wide-angle colour TV receivers.

Features of the RIS tubes include: lower deflection power by the rectangular cone with semi-toroidal deflection yoke; excellent convergence and beam landing with simplified adjustment by the vertical stripe screen; better focus and high voltage stability provided by the large diameter electron gun; short tube length; and high brightness and better contrast.

Toshiba plan to produce 14in and 16in models of the SSI tube, and 16in, 18in, 20in, and 22in versions of the RIS 110° tubes.

Toshiba (UK) Ltd, Feltham, Middx.

FOG WARNING SYSTEM FOR TRAFFIC SAFETY

An automatic fog warning system for road safety is being introduced to Britain by Harrison Instruments Ltd. Units may be set up at susceptible sites such as in valleys, wooded areas and river bridges. Alternatively the system may be used for fog warning at airports and harbours.

The principle of operation is that a beam of modulated infra-red light is sent out, and then the proportion transmitted back into a detector after

reflecting off fog particles is monitored. Thus no reflector, as such, is needed. On actuation the unit controls warning signals to be displayed on indicator signs seen by drivers one or two kilometers along the road or motorway.

Two adjustable ranges are available so that a pre-warning can be given when visibility is down, perhaps to 150 metres and another, the major warning, at, perhaps, 100 metres.

The use of frequency modulated light, made invisible through the use of red filters, is a major advantage because it prevents interference from extraneous light. Another feature is a switch-on/off delay of about 50 seconds, to ensure that false alarm signals are not given as a result of temporary smoke or vapour clouds. In addition, the equipment includes a built-in paper tape printer to register the date and time of the start and end of fog.

Power requirements are 220V/50Hz and normal consumption is 60VA.

Harrison Instruments Ltd, 209 Lynchford Road, Farnborough, Hants.

SINGLE CHIP AM-FM RADIO

Lester Hogan, president of Fairchild Camera and Instrument Corporation recently told a US marketing seminar of Fairchild's plans to produce a one chip high fidelity AM-FM radio.

Hogan did not disclose technical details of the chip - which is presumably a linear MSI device - but indicated that the device could well take the AM-FM radio market back from the Japanese.

VERSATILE DIL REED RELAYS

Dual-in-line reed relays which interface directly with DTL, TTL and HTL logic without additional buffering are now available from Amphenol Limited.

The 14-pin (GB820) and 8-pin (GB830) versions are offered with coil voltages of 5V, 12V and 24V d.c. Configurations available include 1 Form A (normally open) and 2 Form A (two normally open), Form B (magnetically biased: Normally closed) and Form C (changeover).

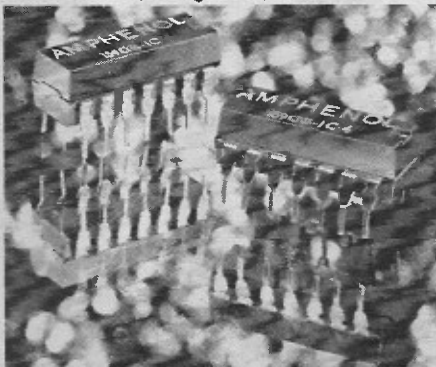

FREQUENCY SHIFTER FOR HOWL-ROUND REDUCTION

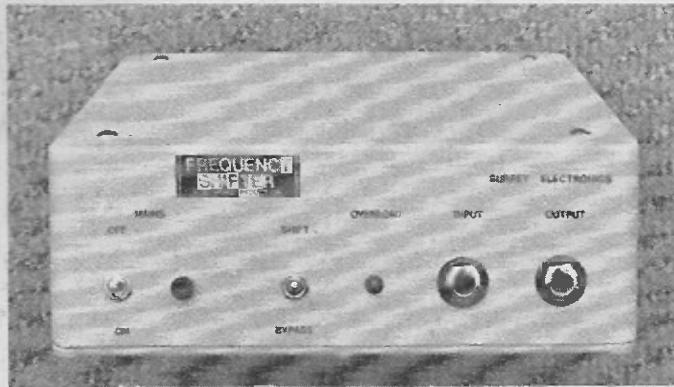

In any public address system where the microphones and loudspeakers are in the same vicinity acoustic feedback (howl-round) occurs if the amplification exceeds a critical value. By shifting the audio spectrum fed to the speakers by a few Hertz the tendency to howling at room resonance frequencies is destroyed and an increase in gain of 6-8dB is possible before the onset of feedback. The 5Hz shift used is imperceptible on both speech and music.

Shifter units are being made by *Surrey Electronics, 24 The High Street,*

Merstham, Redhill, Surrey, for both balanced and unbalanced systems and have a signal overload LED, a shift-bypass switch, jack or cannon XLR audio connectors and are housed in weatherproof diecast boxes.

A royalty is paid to the University of Manchester Institute of Science and Technology where the original development work was done. Also available are mains-powered fibreglass shifter circuit boards at £29 for building into public address and discotheque equipment.

Contact resistance typically does not exceed 0.2Ω and contact ratings extend up to 10W (Forms A and B) or 5W (Form C). Internal diodes on all models ensure driver protection. Magnetic shielding derived from the lead frame design minimises magnetic coupling of adjacent relays and electrostatic shielding is an available option.

Pin spacing conforms to standard DIL lead spacing and the design admits to direct PCB mounting (GB830). Standard height of these components is 7mm. Low profile types 4.7mm in height are available on request. Life expectancy is typically of the order of 10 million to 100 million operations depending upon load.

Amphenol Ltd, Thanet Way, Whitstable, Kent.

COMPLETE DATA TRANSMITTER AND RECEIVER ON A SINGLE CHIP

The purposes of any data transmission system is to transmit information represented by a pattern of electrical pulses and to receive the pulse pattern at some remote point without modifying or destroying the intelligence contained within the pattern. Normally the information is represented by a word and that word is transmitted bit-by-bit in a serial number.

A complex MOS microcircuit manufactured by General Instrument

Microelectronics - and available for immediate delivery from SDS Components Ltd of Portsmouth - contains both a complete data transmitter and receiver on a single chip. Two of the devices used together form a complete duplex digital communications system. However, more important, the exact way in which the devices operate can be determined by external connections or signals so that they can be made to match, and work with, many of the extremely varied data transmission systems in use today.

The data word length can be anything between 5 and 8 bits; and the devices can be made to operate with odd or even parity conventions or without parity checks at all. One or two stop bits can be employed.

The microcircuit - type AY-5-1012 - examines the received word for parity (if required) for framing errors and for overrun. A word can be loaded into the transmitter's input buffer register while a second word is actually being transmitted and, if desired, transmission and reception can take place simultaneously.

Employing tri-state outputs and fully compatible with MOS and MTNS as well as TTL and DTL, the AY-5-1012 will operate at speeds of up to 20k bauds and is a truly universal data transmission system.

SDS Components Ltd, Hilsa Trading Estate, Portsmouth, Hants.

Henry's

U.K.'s LARGEST RANGE OF BRANDED AND GUARANTEED DEVICES. (Quantity Discounts 10% 12+, 15% 25+, 20% 100+) (Any one type except where quantity discounts show) Min. Order £1.00 please. Post 10p.

INTEGRATED CIRCUITS

VERY IMPORTANT. ONLY branded I.C.'s are to the FULL manufacturers specifications. ALL others are not. Henry's sell only branded Integrated Circuits. From TEXAS ... I.T.T. ... FAIRCHILD ... SIGNETICS. So why buy alternatives or under spec. devices when you can purchase the genuine article from us—ex stock—need we say more!



Type	1/11	12/29	30/99	Type	1/11	12/29	30/99	Type	1/11	12/29	30/99
£p	£p	£p	£p	£p	£p	£p	£p	£p	£p	£p	£p
SN7400N	0.20	0.18	0.16	SN7448N	1.50	1.27	1.13	SN74141N	1.00	0.90	0.80
SN7401N	0.20	0.18	0.16	SN7450N	0.20	0.18	0.16	SN74142N	2.88	2.38	2.52
SN7401AN	0.38	0.38	0.33	SN7451N	0.20	0.18	0.16	SN74145N	1.44	1.44	1.26
SN7402N	0.20	0.18	0.16	SN7452N	0.20	0.18	0.16	SN74147N	2.30	2.30	1.83
SN7403N	0.20	0.18	0.16	SN7454N	0.20	0.18	0.16	SN74148N	2.01	2.01	1.63
SN7403AN	0.38	0.38	0.33	SN7460N	0.20	0.18	0.16	SN74150N	2.01	2.01	2.01
SN7404AN	0.24	0.21	0.18	SN7470N	0.33	0.30	0.27	SN74151N	1.15	1.15	1.00
SN7405N	0.20	0.18	0.16	SN7472N	0.38	0.38	0.34	SN74152N	1.09	0.90	0.95
SN7405AN	0.44	0.44	0.38	SN7473N	0.44	0.41	0.37	SN74154N	2.20	2.30	0.91
SN7406N	0.40	0.38	0.35	SN7474N	0.48	0.48	0.42	SN74155N	1.15	1.15	1.00
SN7407N	0.48	0.38	0.35	SN7475N	0.59	0.55	0.51	SN74156N	1.09	1.09	1.00
SN7408N	0.25	0.22	0.19	SN7476N	0.45	0.36	0.32	SN74157N	1.09	1.09	0.95
SN7409N	0.33	0.33	0.28	SN7478N	0.80	0.70	0.50	SN74159N	2.44	2.44	2.14
SN7409AN	0.44	0.44	0.38	SN7481N	1.25	1.10	0.95	SN74160N	1.58	1.58	1.36
SN7410N	0.20	0.18	0.16	SN7482N	0.87	0.80	0.72	SN74161N	1.58	1.58	1.38
SN7411N	0.28	0.28	0.25	SN7483N	1.20	1.10	1.00	SN74162N	1.58	1.58	1.38
SN7412N	0.28	0.28	0.25	SN7485N	1.87	1.87	1.63	SN74163N	1.58	1.58	1.38
SN7412AN	0.38	0.38	0.33	SN7486N	0.50	0.50	0.44	SN74164N	2.01	2.01	1.76
SN7413N	0.30	0.27	0.25	SN7489N	1.42	1.32	1.18	SN74165N	2.01	2.01	1.76
SN7414AN	0.72	0.72	0.63	SN7490N	0.75	0.75	0.63	SN74166N	2.16	2.16	1.89
SN74161N	0.30	0.27	0.25	SN7491AN	1.10	1.00	0.95	SN74167N	4.10	4.10	3.59
SN7417N	0.30	0.27	0.25	SN7492N	0.75	0.75	0.63	SN74170N	2.88	2.88	2.52
SN7420N	0.20	0.18	0.16	SN7493N	0.75	0.75	0.63	SN74172N	5.76	5.76	5.04
SN7422N	0.28	0.28	0.25	SN7494AN	0.85	0.80	0.75	SN74173N	1.66	1.66	1.45
SN7422AN	0.38	0.38	0.33	SN7495N	0.85	0.80	0.75	SN74174N	1.80	1.80	1.57
SN7423N	0.37	0.34	0.32	SN7496N	1.25	1.25	1.13	SN74175N	1.29	1.29	1.13
SN7425N	0.37	0.37	0.32	SN7498N	2.60	2.60	1.89	SN74176N	2.16	2.16	1.89
SN7427N	0.37	0.37	0.32	SN7499N	0.68	0.53	0.45	SN74177N	1.44	1.44	1.26
SN7428N	0.43	0.43	0.37	SN7499AN	0.69	0.53	0.45	SN74180N	1.44	1.44	1.26
SN7430N	0.20	0.18	0.16	SN7400N	0.91	0.91	0.81	SN74181N	5.18	5.18	4.53
SN7432N	0.37	0.37	0.32	SN7401N	0.95	0.95	0.85	SN74182N	1.44	1.44	1.26
SN7433AN	0.43	0.43	0.38	SN7402N	1.16	1.16	1.03	SN74184N	2.16	2.16	1.89
SN7437N	0.43	0.43	0.37	SN7403N	0.96	0.90	0.83	SN74185AN	6.48	6.48	5.67
SN7438N	0.43	0.43	0.37	SN7404N	0.96	0.90	0.83	SN74190N	2.30	2.30	2.01
SN7442N	0.57	0.57	0.50	SN7405N	1.05	1.05	0.92	SN74191N	2.30	2.30	2.01
SN7443AN	0.43	0.43	0.37	SN7406N	1.05	1.05	0.92	SN74192N	2.30	2.30	2.01
SN7444N	0.20	0.18	0.16	SN7407N	0.80	0.80	0.70	SN74193N	2.30	2.30	2.01
SN7445AN	0.85	0.75	0.73	SN7408N	1.44	1.44	1.26	SN74194AN	1.72	1.72	1.51
SN7446AN	0.85	0.75	0.73	SN7409N	1.44	1.44	1.26	SN74195AN	1.44	1.44	1.26
SN7447AN	1.50	1.27	1.13	SN7410N	0.69	0.69	0.60	SN74198N	1.58	1.58	1.38
SN7448AN	1.50	1.27	1.13	SN7411N	0.69	0.69	0.60	SN74197N	1.58	1.58	1.38
SN7449AN	2.16	1.16	1.03	SN7412N	0.72	0.72	0.63	SN74198N	3.16	3.16	2.77
SN7449AN	2.16	1.16	1.03	SN7413N	0.63	0.63	0.55	SN74199N	2.88	2.88	2.52
SN7449AN	2.16	1.16	1.03	SN7414N	0.63	0.63	0.55				

LARGER QUANTITY AND C.E.M. PRICES PHONE (01) 723 3646. PRICING OF SN7400 SERIES IS CALCULATED ON THE TOTAL NUMBER ORDERED REGARDLESS OF MIX. SN74... HIGH POWER... SN74... LOW POWER SERIES IN STOCK. SEND FOR LIST 36, FREE ON REQUEST. LOW PROFILE SOCKETS 14 PIN... 15p. 8 PIN... 17p. 8 PIN... 14p.

TRANSISTORS

A SELECTION FOR FULL LIST SEND FOR BOOKLET 36 TODAY.

AAZ13	10p	BC182	12p	BZ133	33p	OC44	85p	ZTX108	10p	ZN3714	1.60
AC107	35p	BCY32	85p	OC050	55p	OC45	18p	ZTX300	14p	ZN3771	1.75
AC128	20p	BCY39	4.00	GET11	55p	OC46	18p	ZTX302	18p	ZN3773	2.25
AC187	20p	BCY55	2.50	GET15	75p	OC47	15p	ZTX500	15p	ZN3790	2.25
ACY17	35p	BCY70	15p	GET33	55p	OC72	25p	2G301	40p	ZN3919	35p
ACY39	65p	BCV71	20p	LM309K	1.87	OC77	55p	2N697	15p	ZN3956	75p
AD149	50p	BCV72	20p	MAT121	1.87	OC83	25p	2N930	20p	2N4002	14p
AD167	30p	BCV73	20p	MUE340	50p	OC90	65p	2N987	35p	2N4126	15p
AD192	30p	BD131	45p	MJES20	65p	OC170	35p	2N132	25p	2N4871	35p
AF117	50p	BF115	22p	MJES20	65p	OC200	55p	2N1304	22p	2N6457	35p
AF115	50p	BF180	33p	MJES305S	75p	OC201	25p	2N706	10p	2N3903	15p
AF139	33p	BF194	13p	MPF105	46p	OC232	90p	2N1671	1.00	25Q26	8.90
AF188	40p	BF193	25p	NKT217	45p	OC237	25p	2N1671	1.00	25Q26	8.90
AF239	44p	BFY34	65p	NKT217	45p	OC238	25p	2N1671	1.00	25Q26	8.90
AS272	30p	BFY88	22p	NKT404	60p	ORP12	55p	2N1671	1.00	25Q26	8.90
BA115	10p	BFY50	20p	OA200	8p	ORP50	45p	2N1671	1.00	25Q26	8.90
BAX13	5p	BFY51	20p	OA81	10p	P3A6A	20p	2N1671	1.00	25Q26	8.90
BC107	15p	BFY84	45p	OC18	85p	TIP31A	61p	2N3440	50p	40A25	75p
BC108	15p	BFY90	75p	OC20	1.25	TIP41A	74p	2N3440	50p	40A25	75p
BC109	15p	BLV66	6.25p	OC28	65p	TI2A2A	20p	2N3814	59p	40A25	75p
BC192C	14p	BSS20	15p	OC35	55p	V405A	25p	2N3814	59p	40A25	75p
BC113	16p	BU105	2.20								
BC147	12p	BY100	15p								
BC169C	14p	BY127	15p								

TRIACS

Std. mounting with accessories

3 AMP RANGE	Price
SC45B 200v £1.15	1-11
SC45D 400v £1.45	1-11
SC45E 500v £1.85	1-11
SC35A 100v 80p	
SC35B 200v 85p	
SC35D 400v 90p	
SC35E 500v £1.20	
SC40A 100v 90p	
SC40B 200v 95p	
SC40D 400v £1.20	
SC40E 500v £1.50	

SILICON CONTROLLED RECTIFIERS

Type	1-11
ONE AMP (T05) P.I.V.	
CRS 105AF	50v 30p
CRS 110AF	100v 30p
CRS 120AF	200v 35p
CRS 140AF	400v 45p
CRS 160AF	600v 55p
THREE AMP (T048)	
CRS 310AF	50v 40p
CRS 320AF	100v 45p
CRS 340AF	200v 55p
CRS 360AF	400v 65p
FIVE AMP	
CRS 510AF	400v 60p
SEVEN AMP (T048)	
CRS 7100	100v 80p
CRS 7200	200v 87p
CRS 7400	400v 95p
CRS 7600	600v 95p
SIXTEEN AMP (T043)	
CRS 16100	100v 70p
CRS 16200	200v 75p
CRS 16400	400v 85p
CRS 16500	600v £1.10

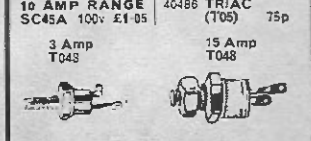

EASY TO BUILD KITS BY AMTRON

— Everything supplied

Model No.	2.98
310 Radio control receiver	5.98
300 4-channel R/C transmitter	5.98
345 Superhet R/C receiver	12.33
455 AM signal generator	1.40
65 Simple transistor tester	3.90
115 8 watt Amplifier	4.70
120 12 watt amplifier	5.70
125 Stereo control unit	3.80
130 Mono control unit	4.85
605 Power supply for 115	4.55
610 Power supply for 120	5.73
615 Power supply for 2 & 120	2.93
230 AM/FM aerial amplifier	5.90
240 Auto packing light	6.08
275 Mic. preamplifier	16.90
570 LF generator 10Hz-1mHz	14.80
575 Sw. wave generator 20Hz-20KHz	12.85
590 SWR meter	8.00
620 Ni-CAD Charger 1-2-12v	8.16
630 STAB Power supply 6-12v 0.25-0.1A	2.87
690 DC motor speed Gov.	7.00
700 Electronic Chaffinch	6.80
705 Windscreen wiper timer	10.75
760 Acoustic switch	9.65
780 Metal Detector (electronics only)	6.85
790 Capacitive Burglar alarm	4.28
835 Guitar preamp.	6.19
840 Delay car alarm	
875 CAP. Discharge ignition for car engine (1-Car)	
-80 Scope Calibrator	13.16
255 Level indicator	2.28
525 120-160mHz VHF timer	11.30
715 Photo cell switch	7.70
795 Electronic continuity tester	4.30
890 Photo timer	13.20
371 Slide projector auto. feed control	7.18
235 Acoustic Alarm for driver	7.90
465 Quartz XTAL checker	8.75

ALL KITS OFFERED SUBJECT TO STOCK AVAILABILITY

Prices correct at time of preparation. Subject to change without notice

EXCLUSIVE SPECIAL OFFERS

NW/LW CAR RADIO	£6-50 camo pack 30p
8 TRACK CAR STEREO	£12-50 camo pack 40p
PORTABLE BATTERY CASSETTE TAPE PLAYER	£7-25
CAR LIGHTER PLUG AND ADAPTOR	£1-95 each
Full size cassette and mixer (7.5v output (state width))	
HOTEL RA310	£34-52
15 - 15 watt Stereo Amplifier (List £52.00)	
AKAI GX40	£89-95 camo pack 50p
Stereo cassette recorder	£8-95 camo pack 20p
Pack-Age 2-DM microphones	
WEIN W600	£12-76
Stereo Cassette Recorder	
PORTABLE CASSETTE TAPE	£7-25 camo pack 20p
Player—for car or carry around.	
HANIMAX BC808 POCKET CALCULATOR WITH KEY	£27-85
HANIMAX BC811M	£37-60
Memory Version	£2-86
Mains Unit for BC808, BC811M (state model)	
HANIMAX H101 STEREO CAMP RECORD PLAYER	£39-95
2x7 watts. Complete with speakers. List £54.50! Price £39-95	
Plus free set of stereo phones.	

BRIDGE RECTIFIERS

FEATURES SMALL SIZE AND LOW COST. Sizes are approximate.

250M/A QUARTER AMP	
BOZ05/50 50 PIV 16p	
BOZ10/100 100 PIV 18p	
BOZ20/200 200 PIV 23p	
BOZ40/400 400v 25p	
BOZ60/600 600v 27p	
3 x 1/2 x 1/2" dia.	
1 AMP P.I.V.	
B1105 50v 25p	
B1110 100v 25p	
B1120 200v 28p	
B1160 600v 30p	
3	

Henry's

U.K.'s LARGEST RANGE OF ELECTRONIC COMPONENTS AND EQUIPMENT AT BARGAIN PRICES
 Latest Catalogue price 55p post paid. Complete with Discount Vouchers



Now built and used by thousands of satisfied customers. Features slim design overall size in cabinet 15 1/2" x 22 1/2" x 6 1/2" IC's, 10 transistors, stabilisers, Gardners low field transformer, Fibre Glass PC Panel, complete chassis work. Now available built and tested as well as in kit form. HIGH QUALITY AND STABILITY ARE PRE-DOMINANT FEATURES DEVELOPED BY TEXAS ENGINEERS FOR PERFORMANCE, RELIABILITY AND EASE OF CONSTRUCTION. FACILITIES.

On/off switch indicator, headphones socket, separate treble, bass, volume and balance controls, scratch and rumble filters, mono/stereo switch, input selector, Mag. P.U. Radio Tuner. Aux. Can be altered for Mic., Tape, Tape-head, etc. Constructional details Ref. No. 21 30p. Distributed by Henry's throughout UK.

FREE—Teak cabinet with complete kit.

KIT PRICE £28.50

(+VAT+50p carr/packing) or built and tested £35.00 (+VAT+50p carr/packing) as illustrated.

BUILD THE TEXAN

20 + 20 WATT IC STEREO AMPLIFIER

As featured by Practical Wireless 1972

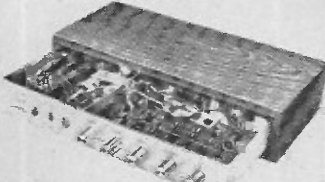

BUILD THE NEW HENELEC STEREO FM TUNER



You pay less VAT with Henry's Low Prices

A completely new high stability stereo FM tuner. Features variable capacity diode tuning, stabiliser power supply, IC Decoder, high gain low noise. IF stages, LED indicators, Tuning meter, AFC, easy to construct and use. Mains operated. Slim modern design with fibre glass PC, teak cabinet etc. Available as a kit to build or ready built. Overall size 8" x 2 1/2" x 6 1/2". Produced to give high performance with a realistic price. (Parts list and constructional details Ref. No. 5 30p). Henry's are sole distributors UK and Europe.

Kit price £21.00 (+ VAT)

OR BUILT AND TESTED £24.95 (+ VAT)

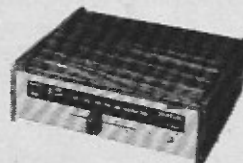

EARN YOURSELF EASY MONEY, WITH PORTABLE DISCO EQUIPMENT

- DISCO MINI A complete portable disco, fitted mixer/preamp. 2 decks all facilities **£98.50**
- As above but with Slider Controls **£118.50**
- 100 watt amplifier for above **£42.50**
- SDS1 100 100 watt mixer/amplifier with slider controls **£69.00**
- R50 50 watt mixer/amplifier **£49.50**
- R100 100 watt mixer/amplifier **£67.60**
- DISCO AMP 100 watt mixer/amplifier chassis **£73.00**
- DISCO MIXER/PREAMPLIFIERS (17 for up to 6-100 watt amplifiers)
- SDJ rotary controls **£49.50**
- SDJL slider controls **£58.50**
- DISCO VOX (slider controls) the complete disco package **£72.00**
- DJ100 100 watt power amplifier for above **£48.50**
- D300 3 channel 3kw sound to light **£39.00**
- DJ400 400 plus built in microphone **£47.50**
- DESLAMATIC 1 kW adjustable speed auto turner **£25.00**
- Cassette reproduction unit **£44.00**
- SCENE STROBE **£19.00**
- ROAD STROBE **£25.00**
- SUPER **£55**
- Disc and feedback microphone **£11.95**
- Col 150 watt liquid wheel projector **£22.50**
- 150 watt liquid wheel projector **£50.00**
- 150 watt oil cassette wheel projector **£50.00**
- Scene Effects and liquid cassettes large range of options **£6.00**

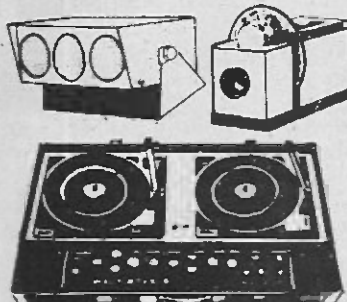

- 6 1/2" Liquid wheels **£5.50**
- Mini spot bank fitted 3 lamps **£12.95**
- Auto Trilite (mini with flashers) **£17.00**
- Bubblemaster with 1 gull. Liquid **£41.15**
- Misc/Misc/Speakers/Lighting UK's largest range. FREE stock list ref. No. 18 on request. AKC/Reelo/DJ/Carsbro/Eagle Mics, Stands, Mixers, Cabinets Chassis & Complete speaker systems, megaphones, turntables, Public Address Components.

EXCLUSIVE DECCA KELLY SPEAKERS

12 watt speaker Tweeter systems. 8" Bass/Midrobe and Melinex Domed HF radiator plus crossover **£12.50** per pair of systems (carr/pack 40p) or built into veneered cabinets, size 18x12x6 1/2" **£19.50** pair (carr £1).



HI-FI TAPE EQUIPMENT

UK's largest range with discounts and demonstrations for callers. Latest stock lists on request (Ref No. 17). Phone 01-402 4736 for Barclay/Access Card. Direct orders and latest prices.

ELECTRONIC SUPPLIES

UK's largest range for every application. Small quantity discounts. Also Trade, Export and Industrial enquiries invited. Latest stock list (ref No. 36). Including valves on request.

TRANSISTORS/ SEMICONDUCTORS

Specialists in electronics for more than 30 years. Trade and industry supplies — every type of component and equipment.

MINIATURE AMPLIFIERS

- AMPLIFIERS (carr. etc. 30p)
- 4-300, 0.3 watt 5 volt **£1.75**
- 104, 1 watt 5 volt **£2.95**
- 104, 4 watt 5 volt **£2.95**
- 555, 3 watt 12 volt **£3.10**
- E1204, 5 watt 12 volt **£3.10**
- 608, 10 watt 24 volt **£4.18**
- 410, 10 watt 28 volt **£4.95**
- E1206, 30 watt 45 volt **£9.95**
- E1210, 24 + 24 watts 12 volt **£9.95**
- RE500, 5 watt IC mains operated Amplifier with controls **£6.30**
- SAC14, 7 + 7 watt Stereo with controls **£8.70**
- SAC19, 15 + 15 watt Stereo with controls **£11.75**
- SINCLAIR UNITS (carr. 20p) **230 £3.57, Z50 £4.37**
- Stereo 60 Pre-amplifier **£7.87**
- PZ5 £3.97, PZ6 £6.37, PZ8 (for Z50) **£4.77** (TRANS £2.95)
- ARU £4.45, PROJECT 605 KIT £19.95 PROJECT 805 £28.95

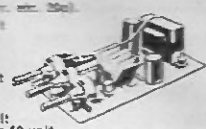

POWER SUPPLIES FOR EVERY PURPOSE

- (All cased unless stated chassis)
- 470C 67 1/2 volt 300 MA (includes Multi-Adaptor for Tape Recorders, etc.) **£2.15** post 20p
 - Car Lighter Voltage Adaptors 300mA (State voltage 6v, 7.5v, 9v) **£1.95** ea. post 25p
 - SC202 3/57 1/2 volt 400 mA **£3.35** carr. 30p
 - HC244R Stabilised version **£4.35** carr. 30p
 - P500 9 volt 500mA **£2.90** post 20p
 - P11 24 volt 500mA (chassis) **£2.90** post 20p
 - P15 26/28 volt 1 amp (chassis) **£2.90** post 20p
 - P1080 12v 1 amp (chassis) **£4.25** post 20p
 - P1081 45v 0.9 amp (chassis) **£7.50** post 20p
 - P12 4 1/2-12 volt 0.4-1 amp **£7.15** post 30p
 - SE101A 3/6/9/12 volt 1 amp (Stab.) **£10.30** post 25p
 - RP164 6/7 1/2/9/12 1 amp (Stab.) **£10.20** post 30p



LOW COST HI-FI SPEAKERS

- SPECIAL OFFER**
 EMI 13" x 8" — full range speakers (post 20p each or 30p pair)
 *150TC — 8 ohms Twin Cone 10 watt **£2.20** each or **£4.40** pair.
 *450 10 watt C/o Twin Tweeters 3, 8 or 15 ohms **£3.50** each or **£5.90** pair.
 EW 15 watt 8 ohms C/o Tweeter **£4.30** each or **£7.90** pair.
 350 20 watt C/o Tweeters 8 or 15 ohms **£7.50** each or **£14.20** pair.
 * Polished wood cabinet **£4.60** post 35p.



- SPEAKER KITS (carr. etc. 35p)**
- 20-2 20-2 8" 30 watt **£19.00** each
 - 20-3 20-3 8" 40 watt **£19.95** each
 - LINTON 2 30 watt **£28.85** pair
 - GLENDALE 3 30 watt **£42.00** pair
 - DOVEDALE 3 50 watt **£20.40** each
 - KEF KK2 **£32.00** each
 - KEF KK3

TEST EQUIPMENT MULTIMETERS (carr. etc. 30p)

- M210 20k/Volt Slimline **£6.75**
- TL433D 2k/Volt Robust **£7.50**
- U437 10k/Volt Steel case. AC up to 40KHz **£4.95**
- U4324 20K/Volt with AC current ranges **£8.00**
- AF105 50K/Volt **£11.95**
- U4313 20K/Volt AC current, Steel case **£10.50**
- U4341 Plus Built in transistor tester **£10.50**
- Model 500 30K/Volt **£9.95**



OTHER EQUIPMENT

- SE250B Pocket Signal Injector **£10.00** each
- SE500 Pocket Signal Tracer **£15.00** each
- TE15 Grid Dip meter **£40.00**
- TE20D 280mHz **15.00** carr. 30p
- TE40 AC Millivoltmeter 1.2mHz **18.95**
- Car. 35p. TE65 28 Range valve voltmeter **19.95** carr. 40p
- TE20D 120kHz-500mHz RF Generator **17.95** carr. 40p
- TE22D 20Hz-200kHz Audio Generator **18.95** carr. 40p
- SE350A Deluxe Signal Tracer **12.50** carr. 20p
- SE400 Volts/ohms/R-C sub/RF field/RF gen. **14.75** carr. 20p

NEW SINCLAIR PROJECT 80

- Stereo Pre-Amplifier **£11.95**
- Audio Filter Unit **£6.95**
- Z40 15 Watt amplifier **£5.45**
- Z60 Watt Amplifier **£6.95**
- PZ5 Mod. for 1 or 2 Z40 **£4.98**
- PZ6 Mod. (S Tab) 1 or 2 Z40 **£7.98**
- PZ8 Mod. (S Tab) 1 or 2 Z60 **£7.98**
- TRANSFORMER FOR PZ8 **£3.95**
- NEW FM TUNER **£11.95**
- STEREO DECODER **£7.45**

All items post paid.

SPECIAL PURCHASES

- AVOMETER MOVEMENTS AVO 8 or 9 50uA MOVEMENTS Ex Brand New AVO's **£3.50** Post 20p
- UHF TV TUNERS CHANNELS 21 TO 64 Brand new transistorised geared tuners for 625 Line Receiver 1F output. **£2.50** Post 20p

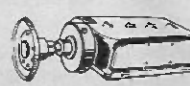

All types offered subject to availability. Prices correct at time of proof. Subject to change without notice. E. & O. E. 10% VAT to be added to all orders. Export supplied.

GARRARD BATTERY TAPE DECK

GARRARD 2 speed 9 volt tape decks. Filled record/play and oscillator/Eraser heads. Wind and rewind controls. Takes up to 4" spools. Brand new complete with head circuits. **£9.50** carr. 30p.



FIBRE OPTICS

- O-D1 Diam. Mono Filament **£1.50** per 25 metre reel
- O-13 Diam. 84 Fibres Sheathed **£1.00** per metre
- SPRAYS 15mm Diam. Mares Tails **£9.50**

TOP QUALITY SLIDER CONTROLS

60mm stroke high quality controls complete with knobs (post. etc. 15p any quantity).
 Single Log and Lin 5K, 10K, 22K, 50K, 100K, 250K, 500K, 1 Meg. 45p each.
 Ganged Log and Lin 10K, 22K, 50K, 100K, 250K, 500p each (Quantity discounts available.) Complete with knobs.

MARRIOT TAPE HEADS

- 4 TRACK MONO or 2 TRACK STEREO 17 High Impedance **£2.00**
- 16 Medium Impedance **£2.00**
- 4000 R/S30E73 2 track mono Record/Eraser low imp. 70p pair.
- Eraser Heads for 17" and 18 7/8" **£3.2** track mono hi. imp. **£1.75**
- 43 Erase head for 63 7/8" (Post. etc. 15p any quantity.)

SUPER TESTER 680R — The complete testing system

- Volts AC — 11 ranges from 2V to 2500V
- Volts DC — 13 ranges from 100mV to 2KV
- Amp DC — 12 ranges from 500uA to 10A
- Amp AC — 10 ranges from 200uA to 5A
- Ohms — 6 ranges from 0 to infinity of Ohm to 100MOhm
- Resistance — 1 range from 0 to 10MOhm
- Capacity — 6 ranges from 0 to 500pF and from 0 to 50,000pF
- Frequency — 2 ranges from 0 to 500Hz and from 0 to 500KHz
- Output Voltage — 9 ranges 10u to 2500V (40uamps)
- 10 ranges from —24 to +700V



price **£18.50**

- Accessories**
- Transistor tester **£11.00**
 - Electronic voltmeter **£18.00**
 - Amplifiers **£11.95**
 - Temperature probe **£11.95**
 - Gas meter **£11.95**
 - Signal Injector **£5.95**
 - Phase Sequence **£5.95**
 - EHT Probe **£5.95**
 - Shunt **£4.00**
 - 25/50/100A **£4.00** each

Henry's RADIO LIMITED

EDGWARE ROAD, LONDON W2

404-406 Electronic Components and Equipment 01-402 8371
 309 PA — Disco — Lighting High Power Sound 01-723 6963
 303 Bargains Store (Callers only)
 Home and Car Entertainment Centres London and branches now open
 120 Shaftesbury Avenue, London W1 01-437 9692
 104 Burt Oak Broadway, Burnt Oak, Edgware 01-952 7402
 190-194 Station Road, Harrow, Middlesex 01-663 7788/9
 354-356 Edgware Road, London W2 01-402 5854/4736

All mail to 303 Edgware Road, London W2 18W
 All stores open 9 am to 6 pm six days a week
 Hi-Fi — Tape Equipment Discount Stock List Free at all stores

HIGH FLUX SOLAR CELL

At the present time, the high cost of photovoltaic solar cells prohibits their use in the large scale generation of electricity from sunlight. However, Plessey have now shown that suitably designed gallium arsenide/gallium aluminium arsenide heterostructure junction semiconductor solar cells can be operated at light intensities of 2,000 times full sunlight, to produce specific outputs between 20 and 40W per square centimetre, whereas with silicon cells the maximum usable sunlight concentration is about 10 times.

This high concentration is possible because the (Ga,Al)As material is relatively transparent to sunlight so that the surface layer over the junction can be much thicker than is the case with silicon, giving a lower electrical resistance and allowing much higher power to be generated.

Cheap concentrators such as curved mirrors or Fresnel lenses can thus be used to focus the sun's rays onto small area solar cells, thereby greatly reducing the unit cost of the electricity produced. The optimum working voltage and efficiency of gallium arsenide solar cells increases with light intensity, and at 2,000 times full sunlight an efficiency of 24 per cent is forecast. Efficiencies approaching this value have already been achieved with non-bloomed and non-optimised cells of this type.

Plessey scientists are at present working with small cells, but it is envisaged that in practical applications cells of normal size - about 1 inch square - would be employed.

BRITISH AERIAL STANDARDS COUNCIL

Early this year the British Aerial Standards Council started an extensive advertising campaign in the Trade Press, with publicity and point-of-sale material to promote B.A.S.C.

The secretary said that one of the objectives of the campaign is to emphasize to the Trade that B.A.S.C. is in business to promote acceptable standards of design and manufacture in domestic TV and vhf-radio aerials. This point is already appreciated by those large retail groups which now specify 'B.A.S.C.-approved' aerials when they put sets into customers' homes.

The Council is keen to encompass all the established TV aerial makers of the U.K. Applications to join B.A.S.C. as Associates are also welcomed from Companies, Authorities and Trade Associations



One of the team, Mick Coffey of London, gets used to changing cassettes half-way up a mountain. Next time it will be the treacherous Torre Egger with perhaps a mile's drop beneath him.

TAPING THE CLIMB

An eight-man British climbing team is to attempt the first successful ascent of the 8000ft. Torre Egger in South America. With them they will take several cassette tape recorders and a supply of C60 and C90 cassettes.

The recorders will be used during the actual climb to capture the 'life and death' mood of the ascent. Remote

control neck microphones and recording heads modified to allow sound synchronisation to film cameras will make possible the recording of the reality of such a dangerous climb.

At the end of each day's climb, the team will camp and record their progress on a reel to reel recorder using the 5 inch BASF LH tape. The smaller reels will be used as letter tapes to send reports to the world's media.



whose representation and participation at future B.A.S.C. Council and Technical Meetings could be mutual benefit.

Contact Jack Hum, B.A.S.C. Secretary, Houghton-on-the-Hill, Leicester LE7 9JJ.

SOLID STATE TRANSDUCERS

Now available off the shelf from National Semiconductor are IC

transducers of every type - absolute, gage and differential.

The calibration error band is $\pm 1.5\%$ of one span (max). Arithmetic functions, digital format and multiplexing are easily attainable because of single ended op amp configuration. The units have low mass, no moving parts and good frequency response. Input overvoltage and input short circuit protection is provided.

Temperature measurement capability is provided at the point of pressure sensing. National transducers contain in a single small package all four of the basic transducer elements: diaphragm and vacuum reference; piezoresistive sensor or signal discriminator and conditioner; and signal amplifier and processor. The first three are contained on a single die, the fourth provided by standard IC operational amplifier.

By automatic laser trimming techniques, the output of each transducer is factory-adjusted so that it meets the nominal values within the specified tolerances.

The price for all products designated LX16 is £17.50 each and for LX17 the price is £19.00 each.

National Semiconductor (UK) Ltd.
The Precinct, Broxbourne, Hertfordshire.

OPTOELECTRONIC MEASUREMENT

There are many occasions when it is necessary to measure the dimensions of an object automatically. One could think of countless applications in industry, such as ensuring that manufactured parts are within required tolerances as they pass automatic measuring equipment on a conveyer belt; sparking plug gaps; the length, width or diameter of objects; the widths of slots; the size of holes; the level of liquids in bottles, and the like.

The heart of the system is a linear monolithic array of photo-diodes manufactured by Reticon in America. The photo-diodes are formed in a single chip of silicon and are arranged in a line. The distance between diodes is accurately determined during manufacture. A shift register made on the same chip enables each diode in turn to be 'addressed' and a signal proportional to the light falling on the addressed diode appears at the output.

The speed at which the diodes are addressed is determined by the rate at which clock pulses are fed to the photo-diode array. Each clock pulse causes the next diode in the line to be addressed. The sequence is started by a start pulse which is followed by a number of clock pulses. The next scan is then commenced by applying a new start pulse.

In measuring the dimensions of an object the object's silhouette is arranged to fall on the array of diodes. The number of diodes in the array 'blackened out' by the shadow is proportional to the size of the device. As the speed at which the diodes are scanned is accurately known (clock pulse rate), the length of time a black signal level occurs is also proportional to the size of the object.

Although the arrays are capable of sensing all levels of grey between black and white, in measuring applications of the sort being discussed it is usually only necessary to differentiate between black and white.

The accuracy of measurements taken in this manner is determined by a number of factors. The clock speed can be accurately set by employing a crystal oscillator. The object is normally focused on the array using lenses. The accuracy achieved will therefore depend on the precision of the optics and the field of view which, in turn, is determined by the focal length of the lens and the distance from the object.

In general terms, if a 64-diode array is used and the field of view is 64mm, the resolution will be one millimetre.

A very simple circuit for driving a

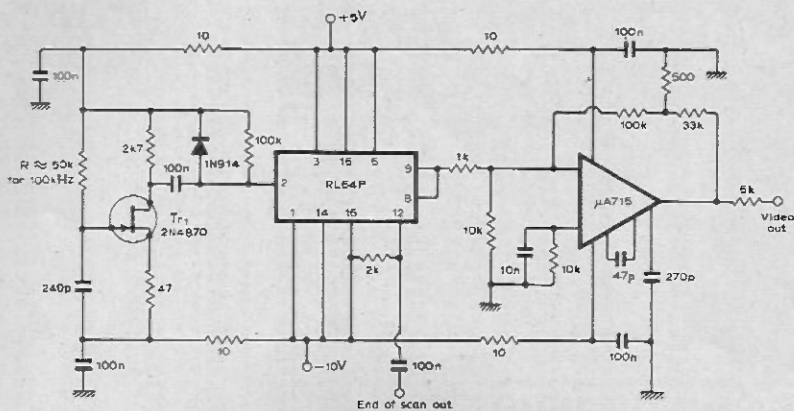

SIMPLE CIRCUIT FOR MEASURING SIZE WITH RETICON ARRAYS

64-bit Reticon photo-diode array is shown in the accompanying diagram.

A standard unijunction oscillator (Tr_1) produces the necessary clock pulses for the RL-64P photo-diode array. Each clock pulse causes a signal proportional to the light falling on one photo-diode to appear at the output. In addition, the clock pulses cause each of the diodes to be addressed in turn. A μA 715 op. amp as a straightforward amplifier to produce an output signal of about 6V from diodes saturated with light.

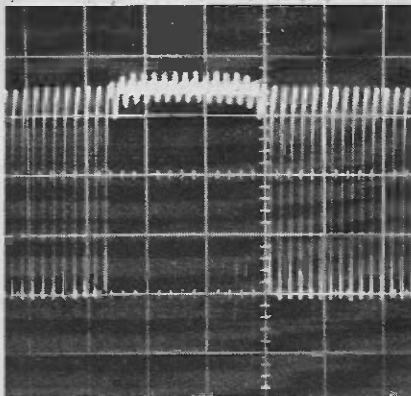

The accompanying photograph shows the output waveform which occurred when the shadow from a piece of wire 30 mils in diameter was allowed to fall on the array. The diameter of the wire can be measured by counting the pulses.

The circuit demonstrates a very simple application of Reticon arrays; more sophisticated circuitry can be employed in more complex applications. For instance, if the output amplifier is allowed to trigger a monostable with a time constant slightly greater than the clock pulse width, a single output pulse is obtained with a width proportional to the size of the object being measured. Pin 15 can be used to control the start of the scan by external circuitry in synchronised applications.

Walmore Electronics Ltd, 11-15
Betterton Street, Drury Lane, London
WC2H 9BS.

ULTRASONIC PROTECTOR

This is a complete Intruder Alarm Unit and has been designed for use in Building Site Huts.

It consists of a robust pressed steel housing (for wall mounting) containing an Ultrasonic unit whose radiations fill the area being protected. When an intruder enters the premises the pattern of sound waves is disturbed. This is detected by the control circuit which then operates an alarm siren. The siren will sound for 5 seconds and the unit will then automatically re-set. If the intruder is still present however the siren will operate again and will continue until 5 seconds after the intruder has left.

The Ultrasonic Unit has a variable sensitivity control to provide an effective range up to a distance of 10 metres. The area of protection is a solid cone 130° wide in the horizontal plane and 70° high in the vertical plane, and the cone can be adjusted through a range of 90° between the vertical and horizontal planes thus enabling coverage for any type or shape of building from the fixed position of the unit.

The unit has connections for the mains supply and also for wiring to a remote Tamperproof Self Activating Bell Unit which can be fitted on the outside of the premises. Tampering with either unit or the cables between them will set off the alarm.

To help eliminate false alarms switchable counting/memory circuit is incorporated. The false impulse received sets the memory and if a second impulse is received within a few seconds then the Alarm Relay operates. If the second pulse is not received then the memory re-sets.

The price for the Space Protector Unit (Type PU74) is £100.00 plus VAT. and for the Tamperproof Self Activating Bell Unit (with cable and plugs) the price is £24.00 plus VAT.

Photain Controls Ltd, Randalls
Road, Leatherhead, Surrey.

Continued on page 60

The largest selection

BRAND NEW FULLY GUARANTEED DEVICES

AC107 0-22	ADT140 0-55	RC153 0-31	BD136 0-44	BK188 0-44	MPE105 0-41	2G371B 0-13	2N1222 0-22	2N1392 0-16	2N4061 0-13
AC113 0-22	AF114 0-27	RC154 0-31	BD137 0-50	BF194 0-13	OC109 0-39	2G373 0-19	2N1238 0-16	2N1393 0-16	2N4062 0-13
AC115 0-22	AF115 0-27	RC157 0-20	BD138 0-55	BF195 0-13	OC209 0-30	2G374 0-19	2N1239 0-16	2N1394 0-16	2N4063 0-13
AC117K 0-22	AF116 0-27	RC158 0-13	BD139 0-61	BF196 0-16	OC212 0-52	2G377 0-19	2N1236A 0-16	2N1395 0-16	2N4064 0-13
AC121 0-13	AF117 0-27	RC159 0-31	BD140 0-66	BF197 0-16	OC233 0-54	2G378 0-19	2N1241 0-16	2N1396 0-16	2N4065 0-13
AC125 0-19	AF118 0-39	RC160 0-50	BD155 0-88	BF200 0-50	OC24 0-62	2G381 0-18	2N1242 0-17	2N13403 0-23	2N4287 0-19
AC126 0-19	AF124 0-33	RC161 0-55	BD175 0-66	BF222 1-40	OC25 0-42	2G382 0-18	2N1246 0-32	2N1404 0-31	2N4288 0-19
AC127 0-20	AF125 0-33	RC167 0-13	BD176 0-66	BF257 0-50	OC26 0-32	2G391 0-33	2N1271 0-23	2N1405 0-46	2N4289 0-19
AC128 0-20	AF126 0-31	RC168 0-13	BD177 0-72	BF258 0-50	OC28 0-55	2G414 0-33	2N1272 0-23	2N1414 0-17	2N4290 0-19
AC132 0-16	AF127 0-31	RC169 0-13	BD178 0-72	BF259 0-54	OC29 0-55	2G417 0-33	2N1273 0-23	2N1415 0-17	2N4291 0-19
AC134 0-16	AF139 0-33	RC170 0-13	BD179 0-77	BF262 0-51	OC35 0-46	2N388 0-39	2N1274 0-23	2N1416 0-17	2N4292 0-19
AC137 0-16	AF178 0-55	RC171 0-16	BD180 0-77	BF263 0-51	OC56 0-55	2N388A 0-61	2N1275 0-23	2N1417 0-31	2N4293 0-19
AC141 0-20	AF179 0-55	RC172 0-16	BD 85 0-72	BF260 0-39	OC41 0-22	2N404 0-22	2N1276 0-23	2N1422 0-31	2N4294 0-19
AC141K 0-33	AF180 0-55	RC173 0-16	BD186 0-72	BK271 0-33	OC42 0-27	2N404A 0-22	2N1277 0-23	2N1423 0-31	2N4295 0-19
AC142 0-20	AF181 0-55	RC174 0-16	BD187 0-77	BF272 0-33	OC44 0-17	2N404B 0-22	2N1278 0-23	2N1424 0-31	2N4296 0-19
AC142K 0-28	AF186 0-55	RC175 0-24	BD188 0-77	BF273 0-39	OC45 0-14	2N405 0-22	2N1279 0-23	2N1425 0-31	2N4297 0-19
AC151 0-17	AF239 0-41	RC177 0-21	BD189 0-83	BF274 0-39	OC70 0-11	2N405A 0-22	2N1280 0-23	2N1426 0-31	2N4298 0-19
AC154 0-22	AL102 0-72	RC178 0-21	BD190 0-83	BF275 0-43	OC91 0-11	2N406 0-14	2N1281 0-23	2N1427 0-31	2N4299 0-19
AC155 0-22	AL103 0-72	RC179 0-21	BD195 0-94	BF276 0-43	OC72 0-16	2N406A 0-14	2N1282 0-23	2N1428 0-31	2N4300 0-19
AC156 0-22	ANV26 0-28	RC180 0-27	BD196 0-94	BF277 0-43	OC74 0-16	2N407 0-15	2N1283 0-23	2N1429 0-31	2N4301 0-19
AC157 0-27	ASV27 0-33	RC181 0-27	BD197 0-94	BF278 0-43	OC75 0-17	2N407A 0-15	2N1284 0-23	2N1430 0-31	2N4302 0-19
AC165 0-22	ASV28 0-28	RC182 0-11	BD198 0-94	BF279 0-43	OC76 0-17	2N408 0-15	2N1285 0-23	2N1431 0-31	2N4303 0-19
AC166 0-22	ASV29 0-28	RC183 0-11	BD200 1-45	BF280 0-27	OC77 0-17	2N409 0-15	2N1286 0-23	2N1432 0-31	2N4304 0-19
AC167 0-22	ASV30 0-28	RC184 0-13	BD201 0-88	BF281 0-27	OC78 0-17	2N410 0-14	2N1287 0-23	2N1433 0-31	2N4305 0-19
AC168 0-27	ASV31 0-28	RC185 0-13	BD202 0-88	BF282 0-27	OC81 0-17	2N411 0-14	2N1288 0-23	2N1434 0-31	2N4306 0-19
AC169 0-16	ASV32 0-28	RC186 0-13	BD206 0-88	BF283 0-22	OC82 0-17	2N412 0-14	2N1289 0-23	2N1435 0-31	2N4307 0-19
AC176 0-22	ASV34 0-28	RC187 0-13	BD207 1-45	BF284 0-22	OC83 0-22	2N413 0-14	2N1290 0-23	2N1436 0-31	2N4308 0-19
AC177 0-27	ASV35 0-28	RC188 0-13	BD208 1-45	BF285 0-22	OC89 0-17	2N414 0-14	2N1291 0-23	2N1437 0-31	2N4309 0-19
AC178 0-31	ASV36 0-28	RC189 0-13	BD209 1-45	BF286 0-22	OC139 0-22	2N415 0-14	2N1292 0-23	2N1438 0-31	2N4310 0-19
AC179 0-31	ASV37 0-28	RC190 0-12	BD210 0-77	BF287 0-22	OC140 0-22	2N416 0-14	2N1293 0-23	2N1439 0-31	2N4311 0-19
AC180 0-22	ASV38 0-28	RC208 0-12	BD211 0-77	BF288 0-22	OC169 0-28	2N417 0-14	2N1294 0-23	2N1440 0-31	2N4312 0-19
AC180K 0-31	ASV39 0-28	RC209 0-12	BD212 0-77	BF289 0-22	OC170 0-28	2N418 0-14	2N1295 0-23	2N1441 0-31	2N4313 0-19
AC181 0-22	ASV40 0-28	RC210 0-12	BD213 0-77	BF290 0-22	OC171 0-28	2N419 0-14	2N1296 0-23	2N1442 0-31	2N4314 0-19
AC181K 0-22	ASV41 0-28	RC211 0-12	BD214 0-77	BF291 0-22	OC172 0-28	2N420 0-14	2N1297 0-23	2N1443 0-31	2N4315 0-19
AC187 0-24	BC108 0-13	RC212 0-14	BD215 0-77	BF292 0-22	OC173 0-28	2N421 0-14	2N1298 0-23	2N1444 0-31	2N4316 0-19
AC187K 0-25	BC109 0-13	RC213 0-14	BD216 0-77	BF293 0-22	OC174 0-28	2N422 0-14	2N1299 0-23	2N1445 0-31	2N4317 0-19
AC188 0-24	BC111 0-11	RC214 0-16	BD217 0-77	BF294 0-22	OC175 0-28	2N423 0-14	2N1300 0-23	2N1446 0-31	2N4318 0-19
AC188K 0-25	BC114 0-17	RC215 0-16	BD218 0-77	BF295 0-22	OC176 0-28	2N424 0-14	2N1301 0-23	2N1447 0-31	2N4319 0-19
AC197 0-17	BC115 0-17	RC216 0-12	BD219 0-77	BF296 0-22	OC177 0-28	2N425 0-14	2N1302 0-23	2N1448 0-31	2N4320 0-19
AC198 0-22	BC116 0-17	RC217 0-12	BD220 0-77	BF297 0-22	OC178 0-28	2N426 0-14	2N1303 0-23	2N1449 0-31	2N4321 0-19
AC199 0-22	BC117 0-20	RC218 0-12	BD221 0-77	BF298 0-22	OC179 0-28	2N427 0-14	2N1304 0-23	2N1450 0-31	2N4322 0-19
AC200 0-22	BC118 0-11	RC219 0-12	BD222 0-77	BF299 0-22	OC180 0-28	2N428 0-14	2N1305 0-23	2N1451 0-31	2N4323 0-19
AC201 0-22	BC119 0-13	RC220 0-12	BD223 0-77	BF300 0-22	OC181 0-28	2N429 0-14	2N1306 0-23	2N1452 0-31	2N4324 0-19
AC202 0-22	BC120 0-11	RC221 0-12	BD224 0-77	BF301 0-22	OC182 0-28	2N430 0-14	2N1307 0-23	2N1453 0-31	2N4325 0-19
AC203 0-22	BC121 0-11	RC222 0-12	BD225 0-77	BF302 0-22	OC183 0-28	2N431 0-14	2N1308 0-23	2N1454 0-31	2N4326 0-19
AC204 0-22	BC122 0-11	RC223 0-12	BD226 0-77	BF303 0-22	OC184 0-28	2N432 0-14	2N1309 0-23	2N1455 0-31	2N4327 0-19
AC205 0-22	BC123 0-11	RC224 0-12	BD227 0-77	BF304 0-22	OC185 0-28	2N433 0-14	2N1310 0-23	2N1456 0-31	2N4328 0-19
AC206 0-22	BC124 0-11	RC225 0-12	BD228 0-77	BF305 0-22	OC186 0-28	2N434 0-14	2N1311 0-23	2N1457 0-31	2N4329 0-19
AC207 0-22	BC125 0-11	RC226 0-12	BD229 0-77	BF306 0-22	OC187 0-28	2N435 0-14	2N1312 0-23	2N1458 0-31	2N4330 0-19
AC208 0-22	BC126 0-11	RC227 0-12	BD230 0-77	BF307 0-22	OC188 0-28	2N436 0-14	2N1313 0-23	2N1459 0-31	2N4331 0-19
AC209 0-22	BC127 0-11	RC228 0-12	BD231 0-77	BF308 0-22	OC189 0-28	2N437 0-14	2N1314 0-23	2N1460 0-31	2N4332 0-19
AC210 0-22	BC128 0-11	RC229 0-12	BD232 0-77	BF309 0-22	OC190 0-28	2N438 0-14	2N1315 0-23	2N1461 0-31	2N4333 0-19
AC211 0-22	BC129 0-11	RC230 0-12	BD233 0-77	BF310 0-22	OC191 0-28	2N439 0-14	2N1316 0-23	2N1462 0-31	2N4334 0-19
AC212 0-22	BC130 0-11	RC231 0-12	BD234 0-77	BF311 0-22	OC192 0-28	2N440 0-14	2N1317 0-23	2N1463 0-31	2N4335 0-19
AC213 0-22	BC131 0-11	RC232 0-12	BD235 0-77	BF312 0-22	OC193 0-28	2N441 0-14	2N1318 0-23	2N1464 0-31	2N4336 0-19
AC214 0-22	BC132 0-11	RC233 0-12	BD236 0-77	BF313 0-22	OC194 0-28	2N442 0-14	2N1319 0-23	2N1465 0-31	2N4337 0-19
AC215 0-22	BC133 0-11	RC234 0-12	BD237 0-77	BF314 0-22	OC195 0-28	2N443 0-14	2N1320 0-23	2N1466 0-31	2N4338 0-19
AC216 0-22	BC134 0-11	RC235 0-12	BD238 0-77	BF315 0-22	OC196 0-28	2N444 0-14	2N1321 0-23	2N1467 0-31	2N4339 0-19
AC217 0-22	BC135 0-11	RC236 0-12	BD239 0-77	BF316 0-22	OC197 0-28	2N445 0-14	2N1322 0-23	2N1468 0-31	2N4340 0-19
AC218 0-22	BC136 0-11	RC237 0-12	BD240 0-77	BF317 0-22	OC198 0-28	2N446 0-14	2N1323 0-23	2N1469 0-31	2N4341 0-19
AC219 0-22	BC137 0-11	RC238 0-12	BD241 0-77	BF318 0-22	OC199 0-28	2N447 0-14	2N1324 0-23	2N1470 0-31	2N4342 0-19
AC220 0-22	BC138 0-11	RC239 0-12	BD242 0-77	BF319 0-22	OC200 0-28	2N448 0-14	2N1325 0-23	2N1471 0-31	2N4343 0-19
AC221 0-22	BC139 0-11	RC240 0-12	BD243 0-77	BF320 0-22	OC201 0-28	2N449 0-14	2N1326 0-23	2N1472 0-31	2N4344 0-19
AC222 0-22	BC140 0-11	RC241 0-12	BD244 0-77	BF321 0-22	OC202 0-28	2N450 0-14	2N1327 0-23	2N1473 0-31	2N4345 0-19
AC223 0-22	BC141 0-11	RC242 0-12	BD245 0-77	BF322 0-22	OC203 0-28	2N451 0-14	2N1328 0-23	2N1474 0-31	2N4346 0-19
AC224 0-22	BC142 0-11	RC243 0-12	BD246 0-77	BF323 0-22	OC204 0-28	2N452 0-14	2N1329 0-23	2N1475 0-31	2N4347 0-19
AC225 0-22	BC143 0-11	RC244 0-12	BD247 0-77	BF324 0-22	OC205 0-28	2N453 0-14	2N1330 0-23	2N1476 0-31	2N4348 0-19
AC226 0-22	BC144 0-11	RC245 0-12	BD248 0-77	BF325 0-22	OC206 0-28	2N454 0-14	2N1331 0-23	2N1477 0-31	2N4349 0-19
AC227 0-22	BC145 0-11	RC246 0-12	BD249 0-77	BF326 0-22	OC207 0-28	2N455 0-14	2N1332 0-23	2N1478 0-31	2N4350 0-19
AC228 0-22	BC146 0-11	RC247 0-12	BD250 0-77	BF327 0-22	OC208 0-28	2N456 0-14	2N1333 0-23	2N1479 0-31	2N4351 0-19
AC229 0-22	BC147 0-11	RC248 0-12	BD251 0-77	BF328 0-22	OC209 0-28	2N457 0-14	2N1334 0-23	2N1480 0-31	2N4352 0-19
AC230 0-22	BC148 0-11	RC249 0-12	BD252 0-77	BF329 0-22	OC210 0-28	2N458 0-14	2N1335 0-23	2N1481 0-31	2N4353 0-19
AC231 0-22	BC149 0-11	RC250 0-12	BD253 0-77	BF330 0-22	OC211 0-28	2N459 0-14	2N1336 0-23	2N1482 0-31	2N4354 0-19
AC232 0-22	BC150 0-11	RC251 0-12	BD254 0-77	BF331 0-22	OC212 0-28	2N460 0-14	2N1337 0-23	2N1483 0-31	2N4355 0-19
AC233 0-22	BC151 0-11	RC252 0-12	BD255 0-77	BF332 0-22	OC213 0-28	2N461 0-14	2N1338 0-23	2N1484	

-the lowest prices!

74 Series T.T.L. I.C.'s

BI-PAK STILL LOWEST IN PRICE FULL SPECIFICATION
GUARANTEED, ALL FAMOUS MANUFACTURERS



7400	1	25	100+	7448	1	25	100+	74122	1	25	100+
7401	0-18	0-17	0-16	7450	0-18	0-17	0-16	74123	£3.00	£2.90	£2.80
7402	0-18	0-17	0-16	7451	0-18	0-17	0-16	74145	£1.85	£1.80	£1.75
7403	0-18	0-17	0-16	7453	0-18	0-17	0-16	74145	£1.65	£1.65	£1.45
7404	0-18	0-17	0-16	7454	0-18	0-17	0-16	74150	£2.90	£2.80	£2.70
7405	0-18	0-17	0-16	7456	0-18	0-17	0-16	74151	£1.10	£1.05	£1.00
7406	0-39	0-34	0-31	7470	0-32	0-29	0-27	74153	£1.30	£1.20	£1.10
7407	0-39	0-34	0-31	7472	0-32	0-29	0-27	74154	£1.98	£1.90	£1.75
7408	0-20	0-19	0-18	7473	0-41	0-39	0-35	74155	£1.50	£1.45	£1.35
7409	0-20	0-19	0-18	7474	0-41	0-39	0-35	74156	£1.50	£1.45	£1.35
7410	0-18	0-17	0-16	7475	0-50	0-48	0-46	74157	£2.00	£1.90	£1.80
7411	0-28	0-27	0-26	7476	0-44	0-43	0-42	74160	£2.10	£2.00	£1.90
7412	0-39	0-34	0-31	7480	0-74	0-71	0-64	74161	£2.10	£2.00	£1.90
7413	0-52	0-51	0-50	7481	£1.25	£1.20	£1.20	74162	£4.40	£4.15	£3.85
7416	0-48	0-44	0-42	7482	0-96	0-95	0-84	74163	£4.40	£4.15	£3.85
7417	0-48	0-44	0-42	7483	£1.20	£1.15	£1.05	74164	£2.20	£2.10	£2.00
7420	0-18	0-17	0-16	7484	£1.10	£1.05	£1.00	74165	£2.20	£2.10	£2.00
7422	0-55	0-53	0-50	7485	£3.80	£3.40	£3.30	74166	£3.20	£3.10	£3.00
7423	0-55	0-53	0-50	7486	0-35	0-34	0-33	74174	£2.50	£2.40	£2.30
7425	0-65	0-63	0-60	7489	£4.00	£3.75	£3.50	74175	£1.75	£1.65	£1.55
7426	0-50	0-46	0-44	7490	0-74	0-71	0-64	74176	£1.85	£1.75	£1.65
7427	0-50	0-46	0-44	7491	£1.10	£1.05	£1.00	74177	£1.85	£1.75	£1.65
7428	0-55	0-53	0-50	7492	0-74	0-71	0-64	74180	£1.50	£1.40	£1.30
7430	0-18	0-17	0-16	7495	0-74	0-71	0-64	74181	£5.00	£4.80	£4.60
7432	0-50	0-46	0-44	7496	0-85	0-82	0-75	74182	£2.00	£1.90	£1.75
7433	0-75	0-73	0-70	7495	0-85	0-82	0-75	74184	£3.20	£3.10	£3.00
7437	0-70	0-68	0-65	7496	0-96	0-93	0-86	74190	£2.15	£2.10	£2.00
7438	0-70	0-68	0-65	74100	£1.50	£1.45	£1.40	74191	£2.15	£2.10	£2.00
7440	0-18	0-17	0-16	74104	£1.07	£1.04	£1.00	74192	£2.15	£2.10	£2.00
7441	0-74	0-71	0-64	74105	£1.07	£1.04	£1.00	74193	£2.15	£2.10	£2.00
7442	0-74	0-71	0-64	74107	0-44	0-42	0-40	74194	£2.98	£2.86	£2.75
7443	£1.20	£1.15	£1.10	74110	0-60	0-55	0-50	74195	£2.00	£1.95	£1.90
7444	£1.20	£1.15	£1.10	74111	£1.38	£1.27	£1.21	74196	£1.95	£1.90	£1.85
7445	£1.98	£1.95	£1.90	74118	£1.10	£1.05	£1.00	74197	£1.95	£1.90	£1.85
7446	£1.20	£1.15	£1.10	74119	£1.50	£1.40	£1.30	74198	£5.00	£4.75	£4.50
7447	£1.10	£1.07	£1.05	74121	0-50	0-48	0-45	74199	£5.00	£4.75	£4.50

DEVICES MAY BE MIXED TO QUALIFY FOR QUANTITY PRICES (TTL 74 SERIES ONLY) DATA IS AVAILABLE FOR THE ABOVE SERIES OF I.C.'s IN BOOK FORM. PRICE 35p.

The AL50 HI-FI AUDIO AMPL

50W pk 25w (RMS)

0-1% DISTORTION! HI-FI AUDIO AMPLIFIER

- Frequency Response 15Hz to 100,000—1dB.
 - Load—8, 4, 8 or 16 ohms. Supply voltage 10-35 Volts.
 - Distortion—better than 0-1% at 1kHz.
 - Signal to noise ratio 90dB.
 - Overall size 63 mm x 103 mm x 13 mm.
- Tailor made to the most stringent specifications using top quality components and incorporating the latest solid state circuitry conceived to fill the need for all your A.F. amplification needs.
- FULLY BUILT—TESTED—GUARANTEED.



BRITISH MADE. only £3.58 each

STABILISED POWER

MODULE SPM80 £3.25



AP80 is especially designed to power 2 of the AL50 Amplifiers, up to 15 watt (r.m.s.) per channel simultaneously. This module embodies the latest components and circuit techniques incorporating complete short circuit protection. With the addition of the Main Transformer MT80, the unit will provide outputs of up to 1.5 amps at 35 volts. Size: 63 mm x 103 mm x 20 mm. These units enable you to build Audio Systems of the highest quality at a hitherto unobtainable price. Also ideal for many other applications including: Disco Systems, Public Address, Intercom Units, etc. Handbook available, 10p.

TRANSFORMER BMT80 £2.15 p. & p. 25p

INTEGRATED CIRCUIT PAKS

Manufacturers "Fall Out" which include Functional and Part-Functional Units. These are classed as "out-of-spec" from the maker's very rigid specifications, but are ideal for learning about I.C.'s and experimental work.

Pak No.	Contents	Price	Pak No.	Contents	Price	Pak No.	Contents	Price
UI000	—12 x 7400	0.55	UI048	—5 x 7448	0.55	UI090	—5 x 7490	0.55
UI001	—12 x 7401	0.55	UI049	—5 x 7449	0.55	UI091	—5 x 7491	0.55
UI002	—12 x 7402	0.55	UI050	—12 x 7450	0.55	UI092	—5 x 7492	0.55
UI003	—12 x 7403	0.55	UI051	—12 x 7451	0.55	UI093	—5 x 7493	0.55
UI004	—12 x 7404	0.55	UI052	—12 x 7452	0.55	UI094	—5 x 7494	0.55
UI005	—12 x 7405	0.55	UI053	—12 x 7453	0.55	UI095	—5 x 7495	0.55
UI006	—8 x 7406	0.55	UI054	—12 x 7454	0.55	UI096	—5 x 7496	0.55
UI007	—8 x 7407	0.55	UI055	—12 x 7455	0.55	UI097	—5 x 7497	0.55
UI008	—12 x 7410	0.55	UI056	—12 x 7456	0.55	UI098	—5 x 7498	0.55
UI009	—12 x 7420	0.55	UI057	—8 x 7470	0.55	UI099	—5 x 7499	0.55
UI010	—12 x 7430	0.55	UI058	—8 x 7471	0.55	UI100	—5 x 74100	0.55
UI011	—12 x 7440	0.55	UI059	—8 x 7472	0.55	UI101	—5 x 74101	0.55
UI012	—12 x 7440	0.55	UI060	—8 x 7473	0.55	UI102	—5 x 74102	0.55
UI013	—12 x 7440	0.55	UI061	—8 x 7474	0.55	UI103	—5 x 74103	0.55
UI014	—12 x 7440	0.55	UI062	—8 x 7475	0.55	UI104	—5 x 74104	0.55
UI015	—5 x 7441	0.55	UI063	—8 x 7476	0.55	UI105	—5 x 74105	0.55
UI016	—5 x 7442	0.55	UI064	—5 x 7481	0.55	UI106	—5 x 74106	0.55
UI017	—5 x 7443	0.55	UI065	—5 x 7482	0.55	UI107	—5 x 74107	0.55
UI018	—5 x 7444	0.55	UI066	—5 x 7483	0.55	UI108	—5 x 74108	0.55
UI019	—5 x 7445	0.55	UI067	—5 x 7484	0.55	UI109	—5 x 74109	0.55
UI020	—5 x 7446	0.55	UI068	—5 x 7485	0.55	UI110	—25 Assorted 74's	1.55

Packs cannot be split, but 25 assorted pieces (our mix) is available as PAK UI0 XI.

LINEAR I.C.'s—FULL SPEC.

Type No.	I.C.	1	25	100+		
22202	DEL	14	0.50	0.48	0.45	
22700	DEL	14	0.25	0.22	0.20	
22710	DEL	14	0.45	0.43	0.40	
22741	DEL	14	0.40	0.38	0.35	
22741C	DEL	8	0.45	0.43	0.40	
22741D	DEL	8	0.38	0.36	0.34	
22784P	DEL	8	0.28	0.26	0.24	
2L201C	DEL	8	0.50	0.45	0.40	
SL701C	DEL	8	0.50	0.45	0.40	
SL702C	DEL	8	0.50	0.45	0.40	
1A1203	TA	72	1	0.50	0.50	
1A1203P	TA	74	10	1.00	0.85	0.50
1A1203A	TA	3	10	1.85	1.50	1.70
1A1203B	TA	3	10	0.28	0.26	0.24
1A1203C	TA	3	10	0.25	0.23	0.20
1A171	TA	15	10	0.45	0.43	0.40
ZN114	EQ	18	4	1.20		

DTL 930 SERIES LOGIC I.C.'s

Type	1	25	100+
HD200	0.15	0.14	0.13
HD201	0.16	0.15	0.14
HD202	0.16	0.15	0.14
HD203	0.16	0.15	0.14
HD204	0.16	0.15	0.14
HD205	0.16	0.15	0.14
HD206	0.16	0.15	0.14
HD207	0.16	0.15	0.14
HD208	0.16	0.15	0.14
HD209	0.16	0.15	0.14
HD210	0.16	0.15	0.14
HD211	0.16	0.15	0.14
HD212	0.16	0.15	0.14
HD213	0.16	0.15	0.14
HD214	0.16	0.15	0.14
HD215	0.16	0.15	0.14
HD216	0.16	0.15	0.14
HD217	0.16	0.15	0.14
HD218	0.16	0.15	0.14
HD219	0.16	0.15	0.14
HD220	0.16	0.15	0.14

DUAL-IN-LINE SOCKETS

Type	1	25	100+
MAN 3M	1.80	1.70	1.60
CD 60	1.80	1.70	1.60
GR 110	1.80	1.70	1.60

STEREO PRE-AMPLIFIER TYPE PA100

Built to a specification and NOT a price, and yet still the greatest value on the market, the PA100 stereo pre-amplifier has been conceived from the latest circuit techniques. Designed for use with the AL50 power amplifier system, this quality made unit incorporates no less than eight silicon planar transistors, two of these are specially selected low noise MPN devices for use in the input stages.

Three switched stereo inputs, and rumble and scratch filters are features of the PA100, which also has a STEREO/MONO switch, volume, balance and continuously variable bass and treble controls.

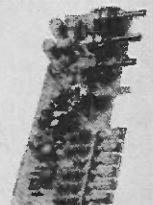

SPECIFICATION:

Frequency response	20Hz—20kHz ±1dB	Bass control	±15dB at 20Hz
Harmonic distortion	better than 0-1%	Treble control	±15dB at 20kHz
Inputs: 1. Tape head	1.25mV into 50kΩ	Filters: Rumble (high pass)	100 Hz
2. Radio, Tuner	30mV into 50kΩ	Scratch (low pass)	8kHz
3. Magnetic P.U.	1.5mV into 50kΩ	Signal/noise ratio	better than +65dB
All input voltages are for an output of 250mV.		Input overload	+26dB
Tape and P.U. inputs equalised to RIAA curve		Supply	+35 volts at 20mA
within ±1dB from 20Hz to 20kHz.		Dimensions	292 x 52 x 35 mm

SPECIAL COMPLETE KIT MK50 COMPRISING 2 AL50's, 1 SPM80, 1 BMT80 & 1 PA100 ONLY £25.30 FREE p.&p. only £13.15

TERMINAL POSITIVE VOLTAGE REGULATORS

7805	3A (Regulator) (P.P. 1.5 Amps)	£1.74
7809	3A (Regulator) (P.P. 1.5 Amps)	£1.74
7812	12V (Regulator) (P.P. 1.5 Amps)	£1.74

BI-PAK CATALOGUE AND LISTS

Send S.A.E. and 18p.

TEAK VENEERED CABINETS for:

- STEREO 20
- TC 20. £3.95 p&p 30p.
- MK 50 KIT
- TC 100. £6.50 p&p 40p.
- E.M.I. LER 350 Loudspeaker System Enclosure kit in Teak Veneer, including speakers.
- Rec. Retail Price £45.50 per pr.
- OUR SPECIAL PRICE £35.50 per pair p&p £1. ONLY WHILE STOCKS LAST!

The STEREO 20

The 'Stereo 20' amplifier is mounted, ready wired and tested on a one-piece chassis measuring 20 cm x 14 cm x 5.5 cm. This compact unit comes complete with on/off switch, volume control, balance, bass and treble controls, Transformer, Power supply and Power amps. Attractively printed front panel and matching control knobs. The 'Stereo 20' has been designed to fit into most variable plinths without interfering with the mechanism or, alternatively, into a separate cabinet. Output power 20 peak. Input 1 (Cer.) 300mV into 1M. Freq. res. 25Hz-25kHz. Input 2 (Aux.) 4mV into 30k. Harmonic distortion. Base control ±12dB at 60Hz typically 0-25% at 1 watt. Treble con. ±14dB at 1kHz.

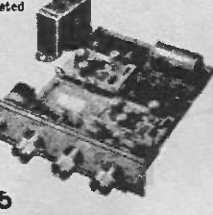

£14.45

FRONT PANEL, 4 knobs, Headphone Socket, on/off switch and neon for PA 100/MK 50. FPK 100 £2.95.

TRANSFORMERS

T401 (Use with AL10)	£1.25 P & P 16p
T638 (Use with AL20)	£1.95 P & P 15p
BMT80 (Use with AL30 & AL50)	£2.15 P & P 25p

POWER SUPPLIES

WE'RE ALL AT SEA...

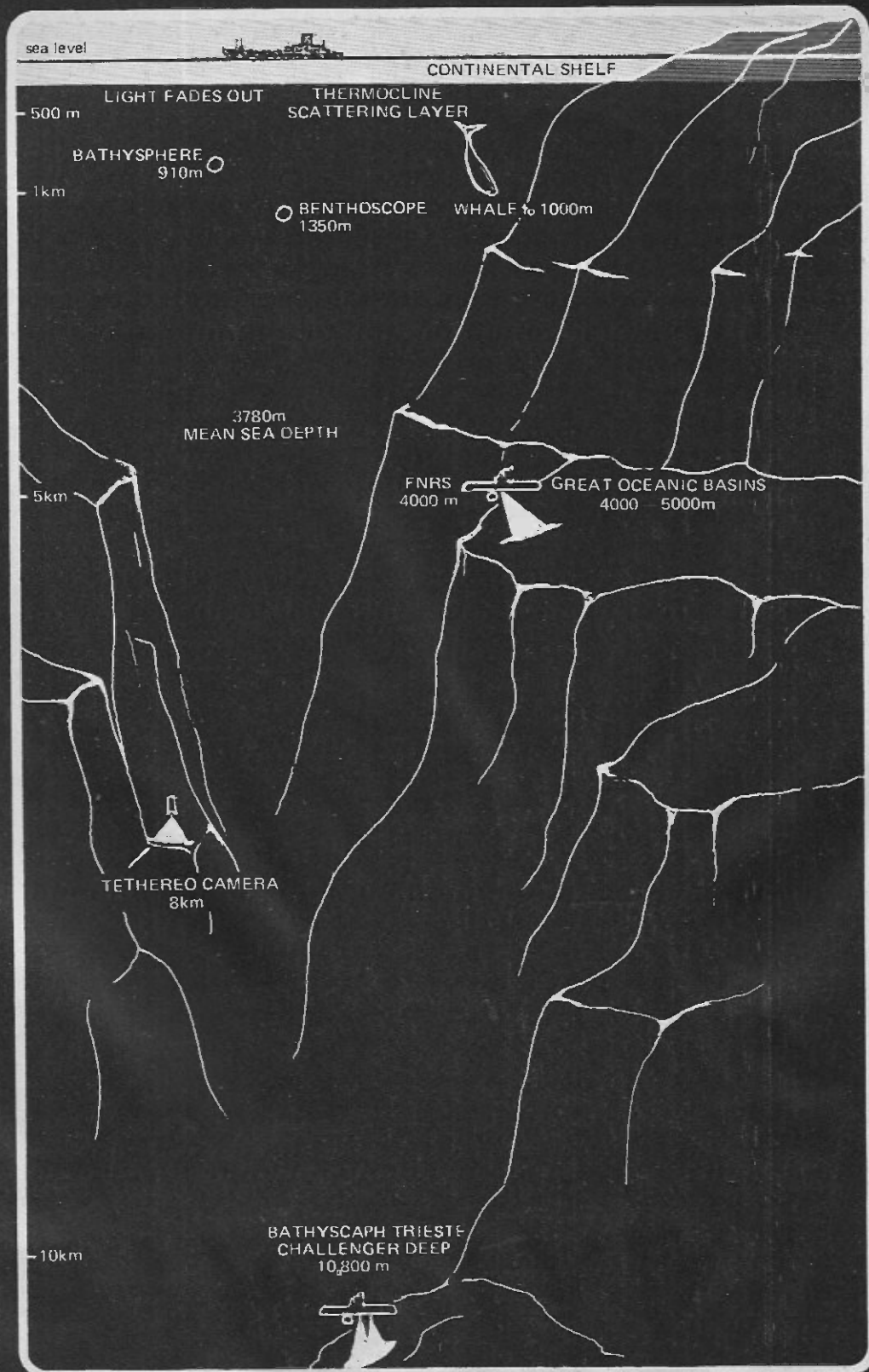

Fig. 1. The oceans are deep, as this diagrammatic cross-section shows.

But where are we?

In recent years man has taken to the seas as never before. In this article Dr Sydenham discusses position-location on the sea surface. A following article will deal with sub-surface measurements.

THERE is hardly a square metre of land surface that has not been seen by man — even parts of the distant Moon have been visited. Yet, compared with our knowledge of the land, the seas remain virtually unknown to us: oceanography is a relatively new science. Starting around 1850, scientific enquiry into the oceans soon gained ground and today exploitation of the seas is a multimillion dollar industry. The first study of note was the voyage of the Challenger (1873-1876) in which 150 000 km of ocean was charted and sampled. This wealth of fact finally dispelled the popular notion that the oceans were all of immense depth and lifeless.

Movement into the depths, however, was inhibited because of the existence of several significant barriers. Firstly, it was possible to estimate their position in those days, with precision, only if close to land — there are no distinguishable marks on the surface of the sea as there are along a coastline.

Under the surface of the sea the problems multiply rapidly — see Fig. 1.

The pressure increase demands that the unprotected diver be given time for his physiological functions to adjust; natural light fades rapidly; hostile sea creatures may be present: disturbed mud and silt masks the artificial light. In all, it is only certain kinds of people who dare venture there without the comfort of a submersible chamber.

THE NEED TO EXPLORE THE UNDER SEA

About 70% of the Earth's surface is covered by seas — a mere $700 \cdot 10^6$ km². To many it is an ocean of salt water, but it is becoming increasingly obvious that it abounds with food, minerals and energy. Oceanographers suggest the fish catch could be as high as 10^{14} tonnes a year. We do not, as yet, come anywhere close to this size of yield: fishermen need to know where the fish are in order to catch them.

As the known deposits of economic minerals on land are worked out, the price rises. It has now reached a point where it is economical instead to look for, and win, minerals from the sea-floor. For example, diamonds are

now literally sucked from the sea bottom.

Getting away to a slow start off the coast of South Africa in the 1930's, diamond dredging was eventually shown to be an economic operation. One dredge extracted a one carat diamond per 250 kg of spoil moved — by comparison, on land the ratio is around $50 \cdot 10^6$ kg per carat. However, when operating dredges it is vital to know their position accurately in order to dredge the floor in a systematic manner.

Diamonds are not the only sea-floor wealth; tin, gold, sulphur, iron, organite sands and phosphorites are also available. Manganese nodules, growing by chemical action at a millimetre per thousand years, exist as dark lumps lying on the sand surface with densities reaching as high as 30 kg per square metre.

There can hardly be a person who has not heard of the seabed oil and gas wells. Offshore drilling, a practice developed extensively in the last decade had its start back in the 1930's.

Today huge platforms, supported on legs that go to the floor, or float at depth, are now in place in many oceans and seas. This is big business; financial returns being such that incredibly expensive and sophisticated procedures have been justified to aid the drilling and control of wells. Accurate position control is essential for the rig, for it must not drift away when the drilling-string is drilling a well.

Whenever man seeks wealth it is necessary for him to lay claim to his patch of territory — the problems of undersea claimstaking and the definition and policing of international water boundaries are still not adequately solved — there are no distinguishable surface marks and no easy way to provide a fence that is stable in location.

Budgets of the wealthier countries, earmarked for oceanographic research, have been on the increase this decade. Private industry spends as much as governments in the race to exploit the cream of the ocean resources. In the U.S.A. for instance, research funds run to $\$5 \cdot 10^8$ p.a.

A large part of these monies goes to fundamental research. Programmes such as the deep dry-dive experiments

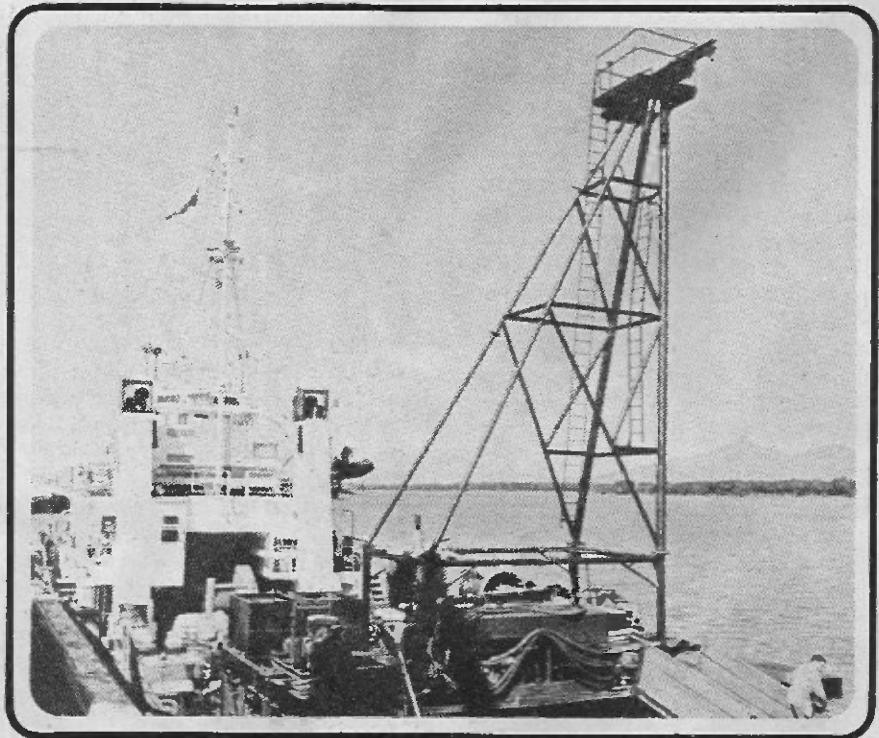

Fig. 2. Survey vessel equipped for marine site investigation.

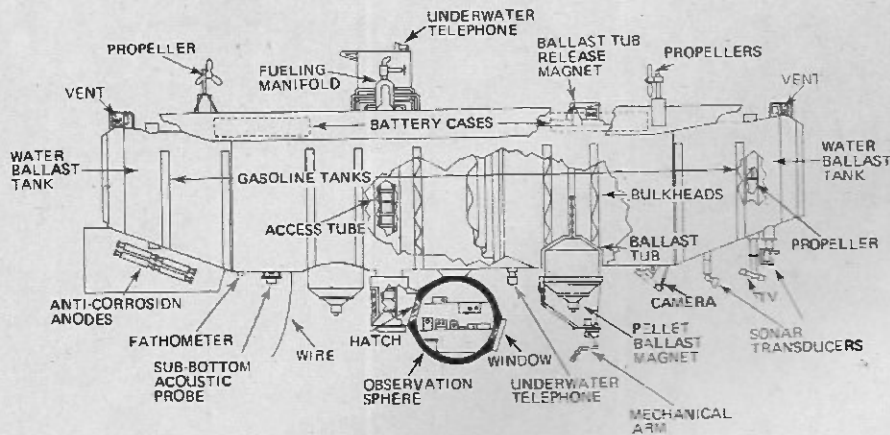

Fig. 3. Trieste — a submersible that has taken man to the deepest depths — bristles with underwater sensing devices.

(the diver undergoes the test in a compression chamber in the laboratory — an equivalent depth of some 500 m has been reached in this way by an unprotected man) and the testing of the now numerous unmanned and manned submersibles — the Trieste (a cross section shown in Fig. 3.) is the best known example — holding the deepest dive record of more than 10 km in the Challenger Deep (at that depth the pressure rises to around 12 kg per mm².) Not everyone wishes to go that deep — there is more urgent work in more moderate depths. In all such studies depth and position information is a vital part of the programme.

It goes without saying that the military also need to know the location of submarines, both of their country and of others.

Many submersibles are operated by remote control from a surface mother ship — sea floor crawlers seeking minerals, fish nets that automatically close when a shoal passes into the net, exploration devices, and deep-sea rescue modules come to mind. In order to manipulate these devices it is necessary to build in sensors that will monitor depth and relative position so that control can be effected.

We start this survey with a look at the means available for position fixing at a point on the surface of the sea.

MEASUREMENTS ON THE SEA SURFACE

The long-standing position-location problem is that of continuously monitoring the position of a ship in order that it can make way in safety on an efficient course. Another important need is that of avoiding collisions between vessels navigating the recognized shipping lanes. In relatively recent times another class of need has arisen — that of holding a constant position over the sea bed, for example, whilst drilling the sea bed with a floating drill-rig.

USING THE STARS AND SUN

Before the advent of radio-location methods the only means of accurately establishing position away from land was to sight the stars at night, or the sun by day, using a sextant and an accurate clock. Between these checks navigation is achieved by using the magnetic compass bearing and ship's speed to establish up-dated data. The obvious problem is how to overcome the effects of cloud that often cover the stars or sun when a sight is needed.

Total automation of this procedure became a reality in the 1960's when the U.S. space programme developed guidance systems for spacecraft based on electro-optical star trackers. There is, however, little real need for this degree of sophistication in sea navigation as other methods exist that are more reliable and not prone to problems of cloud masking. The use of low-light-level optical sensors does, in fact now permit celestial tracking systems to be used through clouds, but the cost is unwarranted in normal sea navigation.

RADIO-LOCATION

Radio transmission of signals was first demonstrated in 1864 using a pair of kites separated by 30 km. By the 1920's, radio was an established routine feature of everyday life in its communications role, but its value as a direction finder was only just being explored. In 1930 Meint Harms, a German, filed a little known patent describing a method now commonly known as hyperbolic navigation. The patent wording suggests that it was already common knowledge at that time that position could be crudely estimated from a knowledge of the directional signal strengths from transmitters. These methods used amplitude measurements and were, therefore, not very accurate because of the varying transmission attenuations. The patent preamble hints at the hyperbolic method, in so much as it

recognises that sectional areas exist in space wherein the received signals from two distant transmitters would pass through minimum and maximum signal strengths. Harms' contribution was to suggest that the two distant transmitters should be locked in phase so that phase differences at a receiver could be used to obtain precision position-location.

It is now agreed that this patent foreshadowed the now commonly used Decca system. Harms, like many an inventor beyond his time, tried to interest many notable companies in the idea — Lorenz, Telefunken and others rejected his idea as unworkable. Today the credit for the first routinely-working hyperbolic location system goes to Dippy for the development of a pulsed system and to O'Brien and Schwartz for the CW method.

For a constant frequency transmission the distance travelled for a given number of cycles is fixed — if these were known, distance would be known (in fact, some methods of surveying do use this procedure). When a second beam is also received from another direction the phase difference between them defines position along an hyperbolic curve — not a point in space. With two fixed base stations one can plot a family of hyperbolic curves that represent phase differences ranging from zero to many cycles. If the sum of the phases is plotted in a similar way another set of curves is created — these are ellipses and they run at right angles to the phase-difference curves. If, therefore, both difference and sum are known, position can be defined with respect to the base line. It is, however, not as simple a matter to measure phase-sum as it is to obtain differences, so another procedure is used that avoids the need to take the sum. It makes use of a third base station taking two phase-difference measurements — one hyperbolic net is superimposed over another but at a different angle. This concept is shown in Fig. 4. With this it is possible to locate which small region, or which curve intersection, the receiver is at.

The British designed Decca Sea-Fix system, shown in Fig. 4 uses transmission of 1W operating at 2000 kHz: position can be located to within 2 m in 37 km distances. It is a coastal system providing little aid for out at sea. Its North American equivalent is Shoran, in the main.

The current controversial Omega system also uses this hyperbolic principle — its salient features are that the transmission is in the 10 kHz region providing a signal over distances spanning the Earth, and that it can also penetrate down into the seas and oceans enabling a submerged vessel to

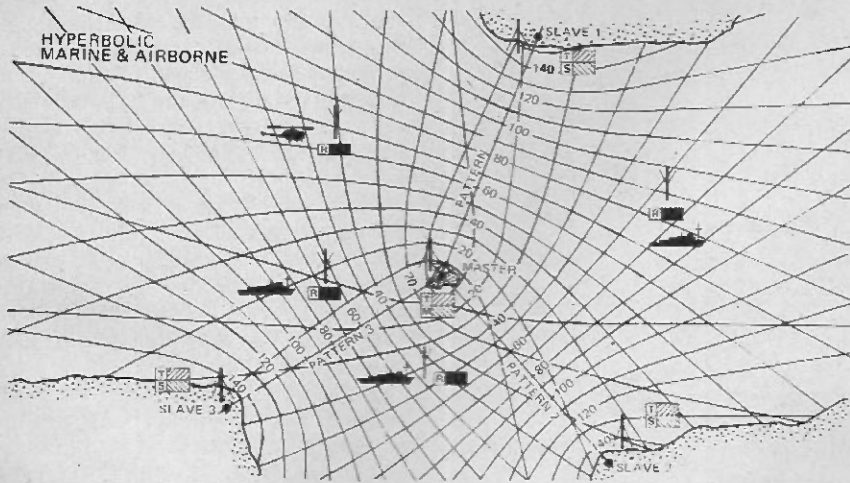

Fig. 4. Ships can locate position by comparing the phase — differences of phase-locked transmissions received from different locations, hyperbolic radio location.

navigate without surfacing. Only eight stations are needed to give global coverage.

A little later than the Harms' patent, in the 1940's, radar became reality making use of the timed flight of a pulse of radio carrier (radio waves travel a metre in three nanoseconds) to give a measure of distance using a single point transmitter/receiver to send and receive the reflected echo. This meant that a more direct method could be used to locate position, as range, distance and bearing suffice to define location. An alternative and more commonly adopted method uses trilateration — two radar stations, placed a known distance apart, each measure range (only) to the target. As the three side lengths of the triangle formed are known, position is known. An extra station, as shown in Fig. 5, overcomes fading and other communication loss defects.

When positioned away from the base

stations the system can be used in reverse measuring distance to known bases from a common point. In the HIRAN equipment a pulse of radar energy is sent out from the vessel to base units called transponders; these only transmit a return pulse when a signal is received. An interrogator unit calculates distances and, as we shall see later, can provide control signals for steering. Automatic allowance is made for the fact that the transponders may not be at the same elevation as the vessel.

A more advanced system SHIRAN (S-Band HIRAN) operates over 450 nautical miles using 20 W transmission to plot position to within 13 m. The French Trident II method operates on 270 MHz achieving similar precision.

The advantage of trilateration is that it gives greater precision, but is said to be less flexible than the hyperbolic method. It is, however, ultimately limited in precision by the finite pulse

Fig. 5. Ships may also locate position using time of flight radar to obtain two or more distances to known position transmitters, trilateral or ranging radio location.

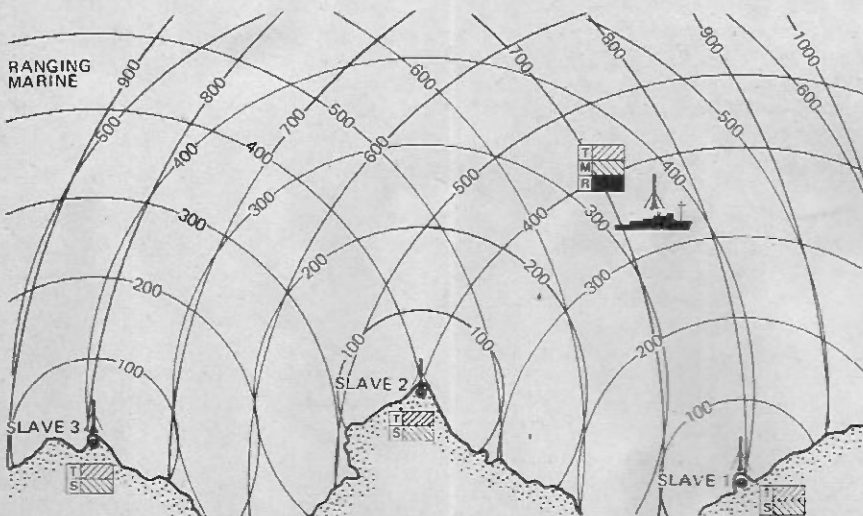

rise-times. Yet another system is the Cubic Corporation Autotape for short ranges — it can resolve to 0.01 m, even when travelling at 200 knots in an aircraft.

If the energy is transmitted into a very narrow beam — as in laser radiation — it would be feasible to measure position using one distance and an angle. Laser light-houses have recently been invented to aid navigation, operating in the normal way as a rotating and flashing light source. Perhaps we may see them developed to yield position information at the receiving end. For example, the laser beam can be modulated and detected to give distance between the vessel and the light-house. Angle is then needed. This could be achieved by superimposing another modulation frequency onto the beam that varies with respect to the azimuth bearing of the rotating output beam — giving angle as the instantaneous frequency measured at the receiver.

The latest addition to the numerous variations of the above concepts makes use of satellites to act as precisely placed radio beacons in the sky. Whereas these satellites have enabled geodetic surveyors to improve our knowledge of the Earth's shape and the accuracy of the world mapping grids, there has been justifiable comment that ocean liners do not need such accuracy. (The QE2 has satellite navigation fitted). There is, however, a definite case for its use in marine hydrographic surveys where utmost precision is valuable.

INERTIAL NAVIGATION

A mass suspended in space resists forces attempting to move it; continuous double integration of the accelerations experienced by the mass gives a measure of distance travelled. It is also necessary to use a second device that keeps the mass orientated the same way in space so that the distances obtained are meaningful — this is usually achieved with a gyroscope. For fast-moving vehicles, such as aircraft, this method can provide reasonable position accuracy, for inaccuracy is a function of the time interval between readings. Generally, therefore, in sea application its use is restricted to fine manoeuvring such as in turning. It also plays an important part in the automation of roll stabilisation of ships, gyro's providing the control signals that operate the angle of attack of the correcting fins. The distinct advantage of inertial methods is that a remote station is not needed.

DOPPLER NAVIGATION

If the velocity of the vessel is integrated with respect to time,

WE'RE ALL AT SEA...

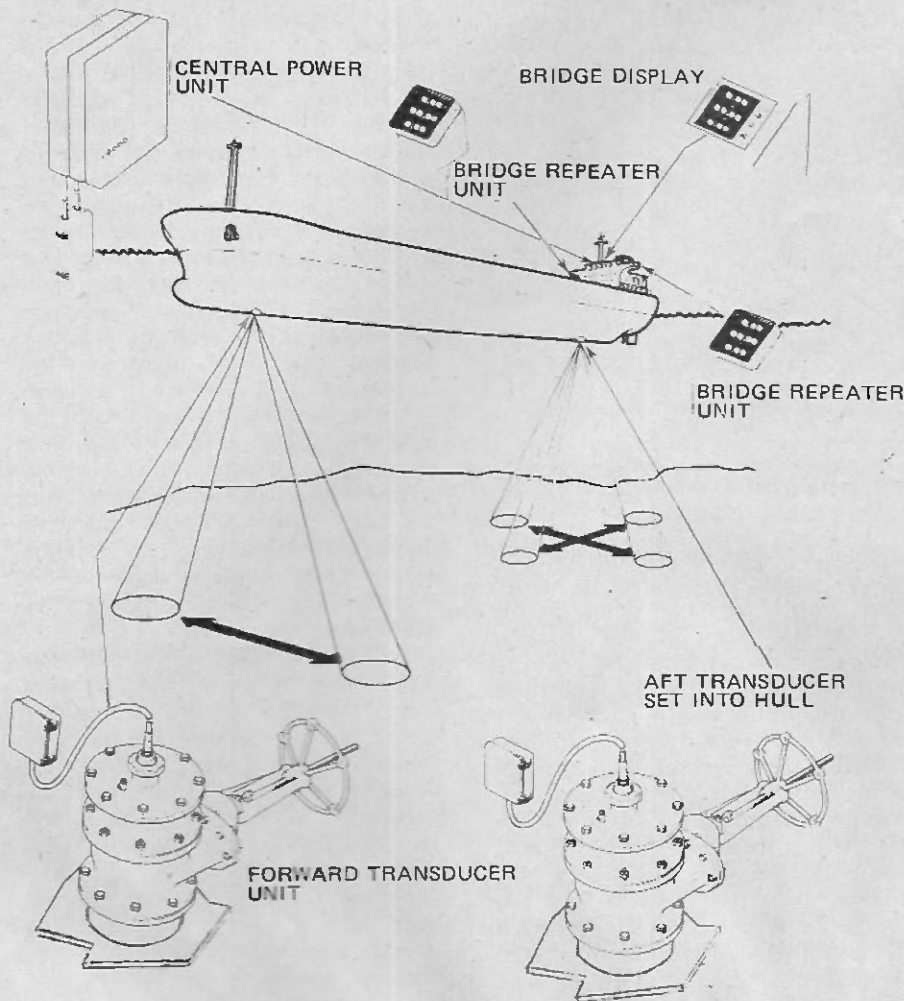

Fig. 6. Diagrammatic explanation of doppler sonar used to give true speeds of ships, and the units needed in a Thompson-CSF installation.

distance is obtained. Performed in two directions, position on a plane surface can be defined. The doppler method makes use of the phenomenon in which a reflected, alternating-intensity energy wave has its frequency shifted by an amount proportional to the relative velocity between the vessel and the fixed surface.

No complicated base station is needed, any reflecting surface sufficing to return some of the transmitted radiation. Sea water surface, land or sea-bed are sufficiently good reflectors for this purpose. Doppler radar has been in use for many years but like inertial methods lacks the large scale precision afforded by radio-location methods. It does, however, give high definition over comparatively short distances.

As seems to be the case in this field of position measurement at sea, we can look to the airborne situation to see how things will develop in at-sea measurements. For example, in 1964 the moon-shot programme started design of doppler-radar landing control for the touch-down on the Moon. By

about 1970 the same idea had been applied to the berthing of ships. In the Marinex 1973 exhibition, held in London, Marconi Marine exhibited a speed of approach system developed to assist the docking of ships, especially super-tankers. The all-up weight of some loaded tankers is now

greater than 500 000 tonnes — even a slight bump into the wharf could be disastrous. There is usually no suitable reflective surface ahead of the ship so docking sonars use the doppler effect of acoustic waves reflected from the dock bottom as shown in Fig. 6. There are transducers at both ends of the ship to enable its orientation to be monitored as well as its velocity. With units like this the ship's speed can be measured to as low as 5 mm per second. The term fine-grained navigation has been coined for such applications.

Another doppler system of interest because of its implications on the future trends of marine instrumentation is the Raytheon airborne doppler using a 5W, frequency stabilised, CO₂ laser. The laser beam, modulated at 100 kHz is sent to the ground and a reflection received back at the moving aircraft. The resulting doppler difference, as a frequency, gives a measure of actual ground speed.

A recent report reveals that a powerful laser has been used to obtain airspeed of an aircraft using the doppler method facing forward instead of downwind. The aerosols in the air backscatter the forward-projected laser beam providing a return signal that is frequency shifted with respect to the transmitted beam.

REMOTE SENSING

Whilst on the subject of position location of objects on the sea and aircraft, it is appropriate to include the use of the air-borne thermal scanners. These can detect (using the heat radiation emitted) the presence of surface ships at night and in fog, not only where they are at the time of detection but also where they were for periods up to hours beforehand. The heated water-wake of a ship remains after it has passed. Deeply deployed atomic submarines are not immune to

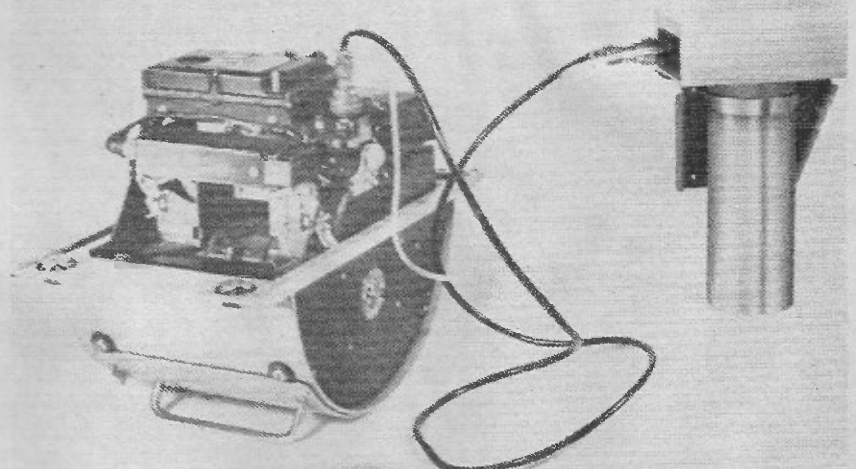

Fig. 7. Airborne thermal scanners such as this can be used to locate relative positions of objects at sea even when not visible to the eye.

this form of detection — their power-sources must be cooled and this produces a heat patch on the surface.

The thermal scanner, as the name implies, scans a high-sensitivity infrared detector across the surface of the sea. The signal strength (related to thermal emission of the sea surface) is used to control the intensity of a visual glow producing a graded black and white trace that portrays the thermal amplitude as a visual equivalent. As the plane flies forward the lines add parallel to each other, in sequence, to form a frame in the reconstructed output display. Commercial scanners, such as the Hawker Siddeley unit shown in Fig. 7, have sensitivities of about 0.1 K. This is adequate to see effects such as the flow-streams of fresh water entering sea water and the position of ships at night. Military scanners probably have a temperature resolution of 1 mK, and no doubt, there are satellites orbiting above us that are taking high sensitivity pictures of the oceans in an attempt to plot the deployment of submarines.

LASER DEFINED LANES

Ships approaching a harbour, dredges working along a channel, laying of submarine cables and similar tasks need straight line guidance. Laser beams can fill this need at low cost. The marine channel light shown in Fig. 8 (designed originally in Australia and marketed by Decca) consists of a laser head that has two output beams emerging nearly parallel to each other. The two beams are shaped in cross section in order that the two overlap in between their axes. One beam is mechanically switched with 0.5 s on and 1.5 s off, the other has 1.5 s on and 0.5 s off. When navigating up this dual beam, toward the laser unit, it appears to the eye as a steady central spot if right on line, or as 0.5 s or 1.5 s flashing signal depending on which way the path has erred. Another method using a laser beam rocks the beam from side to side with a nodding mirror to achieve the same purpose but without the use of two emergent beams. These laser lanes exist out to 20 km at night and 10 km by day. With the currently guaranteed laser life of 18 months this is a cheap and effective form of guidance.

To complete this survey of surface measurements we must include collision avoidance devices.

COLLISION AVOIDANCE

Another measurement need coming

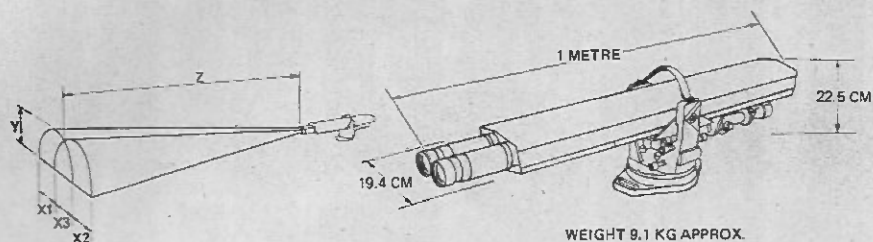

Fig. 8. The marine channel light uses two overlapping laser beams that flash alternately to define shipping guidance along a defined line.

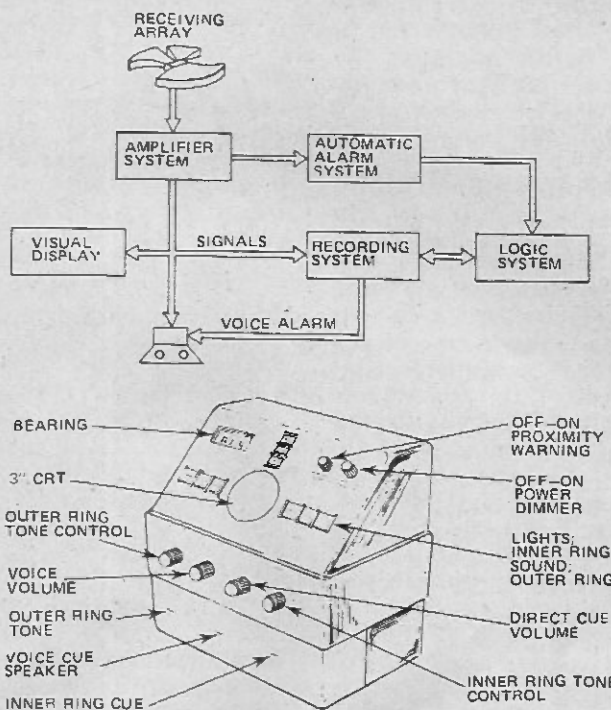

Fig. 9. Schematic of the prototype LAD collision warning system.

to prominence is that of providing ships with a highly reliable estimate of the position of other vessels in close proximity. The man on watch is fast proving to be unreliable, as the sea-lanes fill with traffic. Collisions are ever on the increase. Figures from the U.S. Coastguard suggest that about 200 collisions each year occur because of inadequate collision warnings.

LAD (Lookout Assessment Device) was proposed by Sperry Marine 1970 — it makes use of either a radar or acoustic ranging methods. Details of LAD are given in Fig. 9. Of the many alternatives available, Sperry designers felt that radar was the only truly useful method on all counts. Collision warning radars need to be different from normal marine radars inasmuch as they must be ultra-reliable in a continuous operation mode and the false alarm rate must not be too high — one per watch is felt to be the design criteria sought.

Again we can look to the air to see what might happen at sea. Collision of aircraft is a far more serious problem because of the usually disastrous

consequences. Aviation law already insists on the use of powerful red or white Xenon strobed lights on aircraft. Vigilaire (by Lora Aircraft Systems) uses silicon photo-conductive sensors to detect infrared radiation from these lamps. It provides a display in the aircraft cockpit that shows which sector the other aircraft is in. Advanced systems incorporate altitude measurements to ascertain if the other aircraft is at the same height and, therefore, a potential threat.

Infrared sensing of ships, from ships, is a developing military skill — the thermal signature of ships enables them to be identified in the dark. It would seem reasonable to expect infrared proximity detectors to be applied to marine collision detection in the near future.

Later we will look at the ways and means by which many of these position location methods are applied to control the course and position of vessels.

We will also consider the devices that have been invented accurately to locate a position beneath the waves. ●

LM322N & CO

The 555 timer has rightly become an extremely popular device and is now well known. The LM322N and its brothers have certain advantages over the 555 but are relatively unknown. This article should put the record straight.

BY J. BRIAN DANCE, M.Sc.

NATIONAL SEMICONDUCTOR have recently added a new type of timer to their range of integrated circuits. It can provide time delays from a microsecond to an hour or more.

The circuit of this device incorporates a 3.15 V internal regulator which feeds the timing circuit itself. The time delays are therefore independent of the power supply voltage (which may have any value in the range of 4.5 V to 40 V) and the operation of the circuit is unaffected by ripple or noise on the power supply line.

The device will operate a relay or provide an output pulse to another circuit.

TYPES

This integrated circuit containing some 35 transistors is available in a variety of encapsulations. The LM322N is the cheapest of the range at a recommended price of £2.25 in small quantities. It employs a 14 pin dual-in-line encapsulation with the connections shown in Fig. 1.

The LM322H is an equivalent device in a circular can with ten leads; both the LM322H and the LM322N can operate over the temperature range 0°C to 70°C. The circular LM222H can be used over the range -25°C to +85°C, whilst the circular LM122H and the flat LM122F can be used from -55°C to +125°C. However, it is assumed that most readers will find the LM322N suitable for their requirements.

CIRCUIT OPERATION

The operation of a typical LM322N is shown in Fig. 2. This provides an output pulse one second after a trigger pulse is applied.

Initially capacitor C1 is held in the discharged state by the circuit. The timing operation is started by the

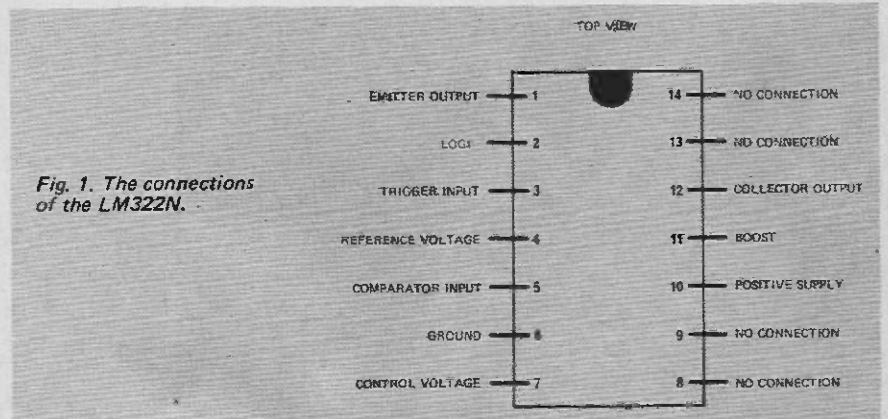

Fig. 1. The connections of the LM322N.

application of a positive going trigger pulse to pin 3. This triggering pulse should have an amplitude of at least 2 V and a duration of not less than one microsecond, but the device will not be damaged by the application of pulses of up to ± 40 V to pin 3.

The current taken by the trigger input is typically 25 μ A. The author has found that the circuit can easily be triggered if pin 3 is touched by a wire held in the hand (provided that one is not holding a wire connected to pin 6). It is more reliable momentarily to connect pin 3 to pin 4.

The triggering process causes the output stage to be switched and also allows C1 to commence charging through R1 from the 3.15 V reference

potential at pin 4. When the voltage across C1 reaches about 2 V, the output circuit is switched back to its original state and this capacitor is discharged. The internal circuit of the device is designed so that this occurs at a time equal to R1C1 seconds after the triggering pulse when pin 7 is not connected.

In the circuit shown in Fig. 2, R1 = 10⁶ ohm and C1 = 10⁻⁶ F, so the time delay is equal to one second. The difference between the product R1C1 and the actual time delay is likely to be around 1 per cent, but the component tolerances must also be added to this to estimate the total timing error.

OUTPUT

The output of the timer is a 'floating' transistor. In other words, it consists of a transistor which is not connected to either of the power supply lines, but which has its collector and emitter circuits brought out to separate pins. This output transistor is switched between its conducting and non-conducting states.

In the circuit of Fig. 2, the emitter of the output transistor is earthed and the load is placed in the collector circuit of pin 12. When the transistor is in the non-conducting state, very

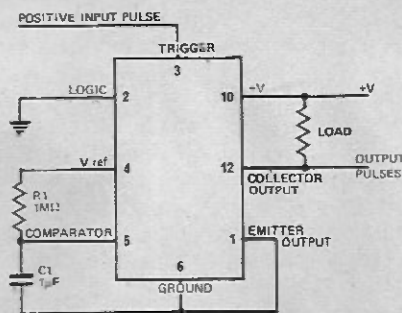

Fig. 2. The use of the LM322N in a one second timer.

little current (less than $1 \mu\text{A}$) passes through the load. When the transistor is switched to conduction, however, the current passing through the load is only a little less than the current which would pass if the load were connected directly between the power supply lines (subject to a maximum current of about 50 mA).

Thus when the transistor is non-conducting, the output potential approximates to that of the positive supply line. When the transistor conducts, however, the output is only slightly above ground potential.

The load can also be placed in the emitter circuit, as shown in Fig. 3. In this case, the collector of the output transistor (pin 12) may be connected directly to the positive supply line. This type of circuit is useful when one side of the load must be earthed. The output potential increases from zero to near the positive supply line potential when the output transistor conducts.

In the circuits of Figs. 2 and 3, the logic circuit (pin 2) is earthed. In this case, the output transistor is switched to conduction when the circuit is triggered and remains conducting until the end of the timed period.

If, however, the logic pin 2 is connected to the reference voltage of pin 4 instead of to ground, the output transistor will normally be held in the conducting state, but will be switched to the non-conducting state when triggering occurs.

The logic circuit connected to pin 2 can therefore be used to provide outputs of either polarity.

Once the LM322N has been triggered, it will remain unaffected by any subsequent pulses to pin 3 until the delay time has elapsed. The circuit is triggered only by the rising edge of the pulse applied to pin 3; if pin 3 is connected to the positive supply line voltage or to pin 4, the circuit will be triggered once only even though pin 3 remains positive with respect to ground.

The load must not be shorted continuously, but at ambient temperatures of up to 40°C , the output may be shorted for a time $t = 120/V_{ce}$ seconds where V_{ce} is the collector to emitter voltage across the output transistor during the short.

RELAY DRIVE

The load resistors in the circuits of Figs. 2 and 3 may be replaced by small lamps which are illuminated when the output transistor conducts.

The circuit of Fig. 4 can be used to close the relay when a trigger pulse is applied; the relay remains closed for a period of 100 seconds before it reopens when the values shown are employed.

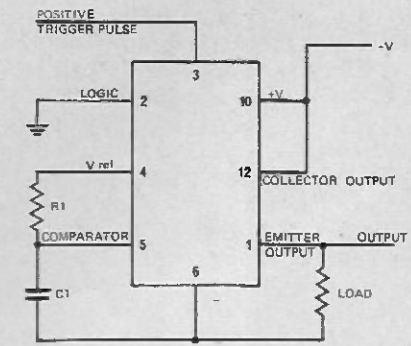

Fig. 3. A circuit in which one side of the load is earthed.

When the output transistor of the LM322N is switched off, the current passing through the relay falls rapidly and a large 'back e.m.f.' is generated across the relay coil. This back e.m.f. can damage the integrated circuit and a protective diode, D1, is therefore incorporated in the circuit to prevent this possibility.

D1 is reversed biased during the time a current is passing through the relay and does not affect the normal operation of the circuit. When the current to the relay is switched off, however, the back e.m.f. biases the diode in the forward direction and the unwanted pulse is shorted to ground.

The relay used with the LM322N must operate with a current not exceeding 50 mA and from a voltage supply not exceeding about 38 V. The value of the supply voltage may be made equal to the recommended relay operating voltage.

If the logic circuit (pin 2) is connected to pin 4, the relay will open when the circuit is triggered and will close at the end of the delay period. The author found that this circuit would trigger only when an OA47 or a similar type of germanium diode (preferably gold bonded) was employed across the relay coil. When the OA47 was replaced by a IN914 silicon diode, the circuit could not be triggered, although the output current did commence to fall each time a trigger pulse was applied. It appeared that this effect was caused by

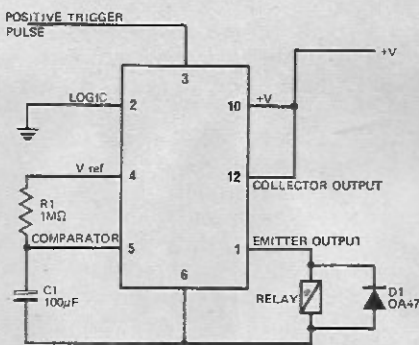

Fig. 4. A circuit which closes a relay for 100 seconds when a trigger pulse is received.

feedback between pins 1 and 2 and that one could adequately suppress the pulse at pin 1 with an OA47 diode but not with a IN914.

POWER SUPPLY

The current taken from the power supply by an LM322N (excluding any current passed by the output transistor) is typically 2.5 mA with a maximum of 4 mA. The current increases to this value at about 4 V, but little further increase occurs as the supply voltage rises to 40 V.

The maximum permissible power dissipation in the device is 500 mW; in practice, however, one should not reach this value if the device is operated correctly. The maximum voltage drop across the output transistor is 3 V and 50 mA when the load is in the emitter circuit, so the power dissipated in this stage should not exceed 150 mW. If the device passes the maximum current of 4 mA from a 40 V supply, an extra 160 mW is dissipated in the remainder of the circuit.

COMPARATOR CURRENT

If the comparator input (pin 5) of the device requires a current, it should be clear that the capacitor will take longer to charge to the voltage at which switching occurs. The delay period will thus be extended.

The maximum value of the pin 5 current in the LM322N is 1 nA (typically 0.3 nA) when pin 11 is not connected. Thus if a resistor of 100 megohms is employed for R1 in Figs. 2 and 3, the maximum current of 1 nA flowing through it to pin 5 will produce a voltage drop of only 0.1 V and a timing error of a few per cent. Thus the small comparator current enables one to use a large resistor and hence to obtain long time delays.

If one uses an electrolytic capacitor, one must take the leakage current taken by the capacitor into account when determining the maximum possible value of the timing resistor for a long delay. The voltage across the capacitor is always small (normally less than 2 V) and this minimises the leakage current.

CURRENT BOOST

The current taken by the voltage comparator circuit connected to pin 5 is too low to enable the circuit to operate in the microsecond region if pin 11 is not connected. If, however, pin 11 is connected to the positive supply line, the current to pin 5 is 'boosted' to a maximum value of 100 nA (30 nA in a typical device) and the circuit will then operate with delays as low as one microsecond.

Pin 11 should be connected to the positive supply line for any timing

intervals of less than 1 ms. For times between 1 ms and 100 ms it does not matter whether pin 11 is left unconnected or whether it is connected to the positive line.

Although the comparator current to pin 5 is increased by the use of the boost connection, this is no disadvantage when the delay is short, since the timing resistor can be relatively small for short delays. The increased current flowing through such a resistor will not produce an appreciable voltage drop. However, the boost should not be used for long delays.

COMPONENT VALUES

Typical values of the timing resistor and capacitor suitable for various delay times are shown within the shaded areas of Fig. 5. The times where the current boost should be used and where its use is optional are also marked.

One may, for example, use a 3.3k ohm resistor and a 300 pF capacitor to produce a delay of 1 μ s, 100 k ohm and 0.01 μ F to produce a delay of 1 ms, 1 M ohm and 0.1 μ F to produce a delay of 0.1 s and 100 M ohm and 10 μ F to produce a delay of 1000 seconds.

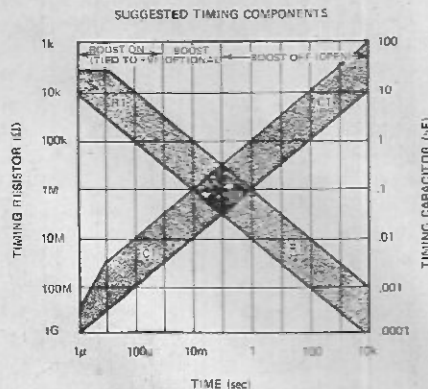

Fig. 5. A chart showing how typical component values may be selected for various delay times.

CONTROL OF DELAY TIME

The time delay provided by the circuits discussed previously is equal to the product of the value of R1 and C1 of Figs. 2 to 4. However, it is sometimes useful to be able to make variations in this time. This can be done by altering the voltage at pin 7.

Part of the internal circuit of the LM322N associated with pin 7 is shown in Fig. 6. The delay period is terminated when the voltage at pin 5 reaches a value equal to that at the base of Q1 in Fig. 6, since Q1 forms one input to a differential amplifier the other input being connected to pin 5.

R1 and R2 of Fig. 6 have been chosen so that the delay period is

equal to the product of the values of the timing resistor and capacitor when pin 7 is not connected. The potential at the base of Q1 is 0.633 times that at pin 4 and the delay period is therefore terminated when the potential across the timing capacitor reaches 0.633 times the pin 4 potential. Any variation of the pin 4 reference potential does not therefore affect the timing period.

If the voltage at the base of Q1 of Fig. 6 is altered by a feeding control voltage to pin 7, the delay period will

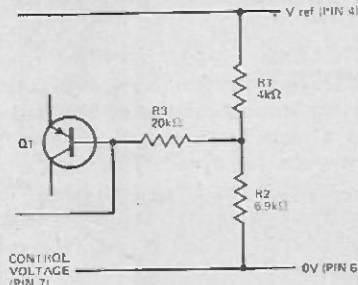

Fig. 6. Part of the internal circuit of the LM322N which is used for controlling the time delays by the use of pin 7.

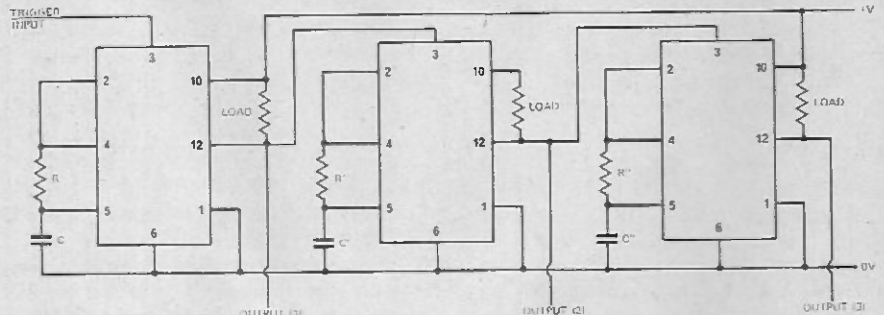

Fig. 7. A sequential timer.

be terminated when the voltage across the timing capacitor reaches some other fraction of the reference voltage. The delay period can be reduced by making the potential at the base of Q1 less than 0.633 times the reference potential and can be increased by making the base potential greater than this value.

The delay time may be reduced by connecting a resistor of some thousands of ohms between pin 7 and ground, since this will reduce the potential of the base of Q1. Similarly, a resistor connected between pins 4 and 7 will increase the time delay. If a potentiometer is connected between pin 4 and ground with its slider connected to pin 7, it may be adjusted to give either an increased or a decreased delay time.

When such circuits are used, the resistor values must be chosen so that the current taken from pin 4 does not exceed 5 mA. The potential at pin 7 must never exceed 5 V.

The application of control voltages to pin 7 enables a variation of the delay time over a range of at least 50:1 to be obtained.

RESET TIME

At the end of the delay period, the capacitor C1 of Figs. 2 to 4 is discharged into pin 5. The time taken for this to occur is approximately $750C1$ seconds where C1 is the capacitor value in farads. The voltage remaining on the capacitor is about 2.5 mV when R1 exceeds 1 megohm and about 25 mV when R1 is 10 k ohm.

SOME APPLICATIONS

The LM322N can be used in various applications other than those which merely provide an output pulse at a definite time after an input trigger pulse. For example, we have seen how it can be employed to close a relay for a definite time after it has been triggered by a pulse which may be only a microsecond in duration and 2 V in amplitude.

Although the input responds only to positive triggering pulses, a negative pulse may be differentiated and the positive going trailing edge used for triggering the LM322N.

The device also makes an excellent pulse shaper. Output pulses of any amplitude up to about 40 V and of any duration up to an hour or so can be obtained from short, low amplitude input pulses. The logic facility can be used to produce phase inversion if this is required.

A positive going output pulse from one LM322N timer can be used to trigger a second LM322N device which can produce another value of delay. A sequential timer consisting of a number of such circuits can be made which will produce output pulses which follow one another at any desired intervals (Fig. 7). Such sequential timers have industrial applications where operations must be performed at times related to one another.

COMPARISON WITH OTHER DEVICES

When compared with the 555 device, the LM322N has the advantage that the comparator input current taken from the junction of the timing

Continued on page 29

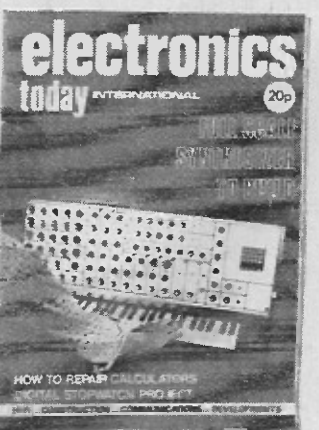
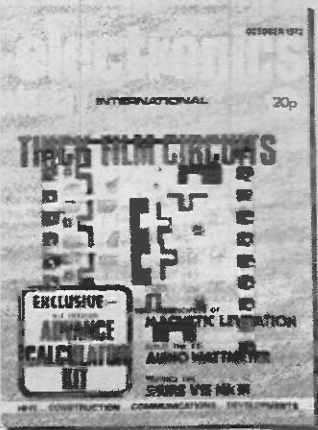
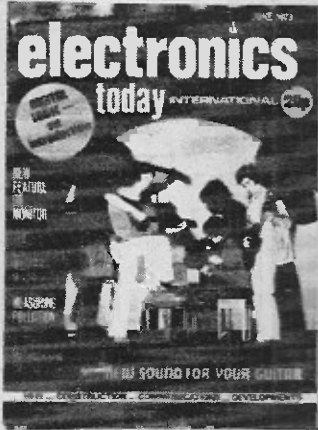
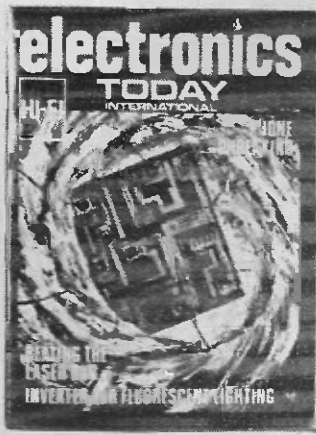

The Editor of ETI is losing his hair rapidly. Part of the problem can be put down to natural causes but his growing baldness is also due to his frequently pulling out his own hair.

Why?

Well, ETI has been printing more copies each month for some time to meet demand but at the same time more and more people complain that they can't get hold of a copy - it's frustrating isn't it.

There are two ways to guarantee a copy. Ask your friendly newsagent to reserve a copy for you: he'll be glad to help. The other course is to take out an annual subscription. It costs a bit more due to postage but we guarantee you a nice, crisp, fresh copy of ETI within days of printing.

So help the Editor keep his hair a little longer reserve your copy at the newsagents or fill in the form on the right.

Cut

To: SUBSCRIPTION DEPARTMENT
ELECTRONICS TODAY INTERNATIONAL
36 EBURY STREET,
LONDON SW1W 0LW.

Please find enclosed £3.60 which includes postage (£4.00 overseas) for my annual subscription to ETI starting with the next available issue.

Name

Address

March 1974

ARC WELDING TODAY

Once a basic electrical power engineering application, arc welding now uses increasingly sophisticated electronic techniques. This article, by ETI correspondent Dr. Peter Sydenham, and Don Northcote of the Welding Services Division of Commonwealth Industrial Gases, explains.

DURING a demonstration lecture of sparks and discharges in 1876, Elihu Thomson realised that powerful electric arcs could be used to join metals by fusing them together, history records that two wires in his experiment unexpectedly welded. No doubt other people of that time had already had a similar experience, but it was Thomson who nurtured the idea in the years that followed. Progress was slow, however, for at that time only comparatively weak dc currents could be sustained.

In 1880, Thomson retired from teaching to form a company, (that eventually became the Thomson-Houston Electric Company) whose market aim was to promote the industrial and domestic use of electricity. In 1884 circumstances enabled him to begin the serious development of welding, for by then high-current ac generators had been developed enabling transformers to be employed to raise the available current to the tens or hundreds of amperes needed. Typical light construction welding requires from 70 amperes

upward, to heavy work consuming 650 amperes. The arc voltage ranges from 20 to 30 volts. (Few people are aware of the enormous energy needed to make an arc weld. The average weld requires some 5 kW liberated in a volume of 50 mm³. The arc temperature may rise to 6000°C.)

Electric arc welding soon became a practical reality, being used to join metals of all kinds in a number of diverse situations. It was not long before suitable dc generators were also designed and from then on, until the development of electronics, there was little change in the basic methods of arc welding.

In essence, arc welding uses a low-voltage, high-current source that provides an initially high striking voltage that drops once the arc is struck — to a limit that provides the desired current for the welding rod in use.

Initial development was slow, for the first electrodes were bare and did not produce as good a weld as did oxyacetylene flame welding. By the

1930s, however, coated electrodes were available and arc welding became the predominant method of joining metals. The coating includes substances that reduce oxidation, resulting from the burning action of the arc, and also forms a shield of slag that retains ionised gas which would otherwise escape, with resultant loss of the flame, at each zero-crossing of an ac power source. The simplest electrodes are single piece coated rods that are used one by one in the common process known as stick welding.

POWER SUPPLIES

Schematic diagrams of the two main types of ac welding plant are shown in Fig. 1. To strike an arc, it is first necessary to break down the air path, forming a conducting gas. The supply is designed to generate a reasonably high open-circuit voltage — 40 to 80 V is typical but is sometimes higher. This voltage drops as the current increases in the arc.

In one method of achieving this characteristic, the primary and secondary windings of the transformer are arranged on the laminated iron core such that the flux from the primary is only loosely coupled to the secondary. At no-load, full secondary voltage is induced. As the secondary current rises, flux is lost and the voltage falls. Fig. 1a shows a scheme by which this is done. Control of the short-circuit current is by movement of the shunt core.

An alternative method is to have the two windings more tightly coupled, using a separate inductor to control the current — see Fig. 1b. This gives better control by limiting the rate of rise of current as well as its final value.

Direct-current welding generators have field windings that are designed to give the same 'sloping' characteristics. In some generators a separate reactor is used to control the field winding currents.

The slope (of voltage drop) usually lies between 1.5 to 3.5 volts per 100 amperes of output current, having been established from experience as the characteristic that provides the

Fig. 1 Alternating current welding supplies. (a) Leakage-transformer design with shunt. (b) Improved characteristics can be obtained with a separate inductor.

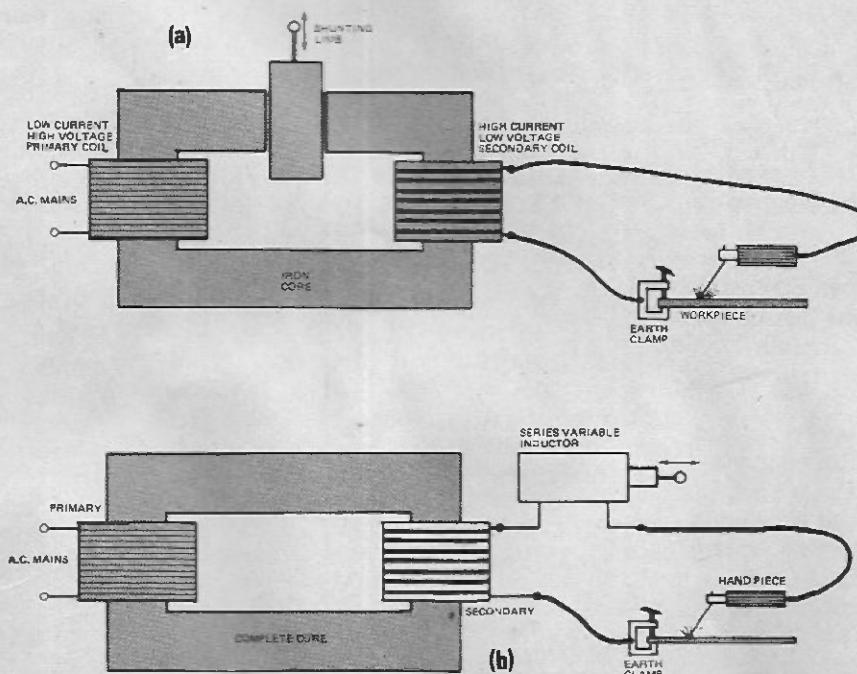



Fig. 2. The amount of in-line inductance alters the harshness of the weld attack.

kind of start that satisfies most welding operators. The effect of varying the inductance used is shown schematically in Fig. 2.

PILOT ARC WELDERS

If a means of maintaining the ionisation is provided, bare rods may be used with ac systems. The so-called pilot-arc welder incorporates extra components to do just this: it also provides better control of currents, especially for light sheet welding.

A resonant L-C system provides a superimposed 100 kHz current across the arc gap. This is achieved without the use of an active electronic oscillator, using the circuit shown in Fig. 3. Transformer T_1 provides several thousand volts to the capacitor C_1 , and when charged, the voltage breaks down the air-gap across the gap G. This momentarily short-circuits the output of T_1 and C_1 via T_2 , inducing a transient voltage in T_2 that recharges C_1 in the opposite sense. The sequence repeats until all energy is wasted in resistive losses — it provides a decaying oscillation that appears across the electrode-to-workpiece gap, ionising the air whenever the arc extinguishes.

Although the pilot-arc will provide a nasty shock, it is not lethal, for the high frequency signal travels only in

the skin. An automatic switch shuts down the pilot arc when there is no demand for an arc.

WIRE WELDING

It is somewhat tedious to be continually changing rods on a long weld run, and the break possibly introduces a faulty area of weld. A more recent development feeds a continuous wire — called wire welding — through a coaxial shield of gas (in the main CO_2 is employed for ferrous metals, argon for non-ferrous, but other gasses are also used) that serves the same purpose as electrode coatings. Many names are used to describe wire welders, for instance, it may be called MIG (metal inert gas), wicky wire, shielded wire or short arc, to name a few in common useage.

Flux-cored wire has also been marketed in which the metal forms a sheath that contains deoxidants and alloying elements needed to provide a satisfactorily strong and ductile weld.

The layout of a typical semi-automatic wire welding plant is given in Fig. 4. When the operator presses the trigger, wire is automatically fed through the handpiece making a sliding contact with an inbuilt electrode. The gas flow is also started, to shield the arc. No

slag is left on the weld with this method. Note that the ac supply is rectified to dc to obtain optimum welding performance.

ENTER ELECTRONICS

For many years arc welding equipment used little, if any, electronic circuitry. Today, however, we are seeing increasing use of it for control and rectification. This trend has been brought about by the need for increased sophistication, and by the rapidly reducing cost and increased reliability of electronic systems. Selenium rectifiers are, however, still used in many plants because of their high overload capacity under short-circuit conditions.

Many plants now incorporate a feedback servo that maintains the arc voltage at a preset value by continuously monitoring the voltage and comparing it with the reference. Any difference is used accordingly to reset the voltage to the correct value. This helps the operator to produce a consistent weld with less skill.

AUTOMATION IN PIPE-LINE WELDING

Circumstances where the welding task is repetitive and has a well-defined geometry set the scene for the serious consideration of fully automatic systems. Pipe-lines are such a case for there complete automation of the pipe-joining process can render great savings.

Lengths of individual lines run to hundreds of kilometres and there are literally tens of thousands of kilometres of large diameter (0.3m — 1m) pipe-lines in daily use at this time. Current projects in planning or execution include a 3000km line, of 0.3m diameter, running from Canada to Northern USA; a 1700km line from central Australia to Sydney using pipe nearly 1m in diameter to convey natural gas; a 611km line of over a metre in diameter to carry ores in a slurry mix in the Gulf of Carpentaria area of Australia. The Lone-Star pipe-line system of the American continent has 20,000km of pipe in operation. This year alone they are adding 880km more.

Pipes usually arrive on site in (nominally) 12m lengths, so there are numerous joins to be made in the field to obtain a one piece pipe-line. These joints must be executed rapidly as fine-laying can only progress as fast as the individual welds are made.

Traditional methods of jointing use stick-welding by highly skilled welders. This may suffice in some contracts but the growing demand for trained men has become impossible to meet and fully-automatic methods are being

Fig. 3. Circuit for providing the pilot arc, high-frequency signal.

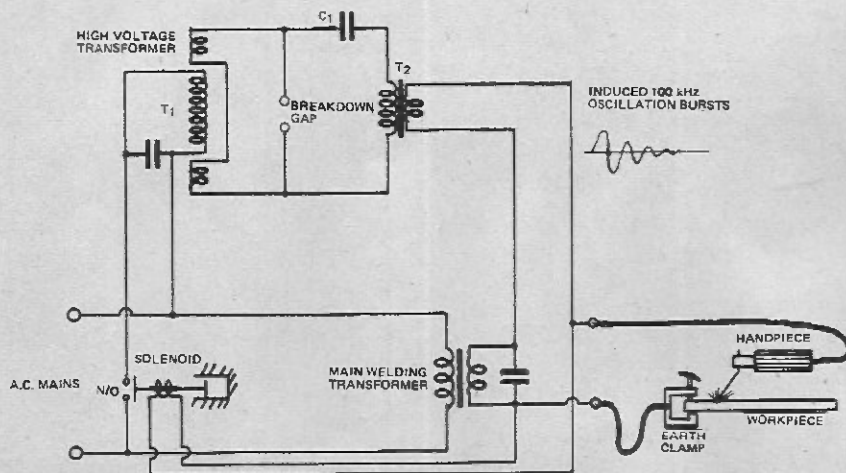

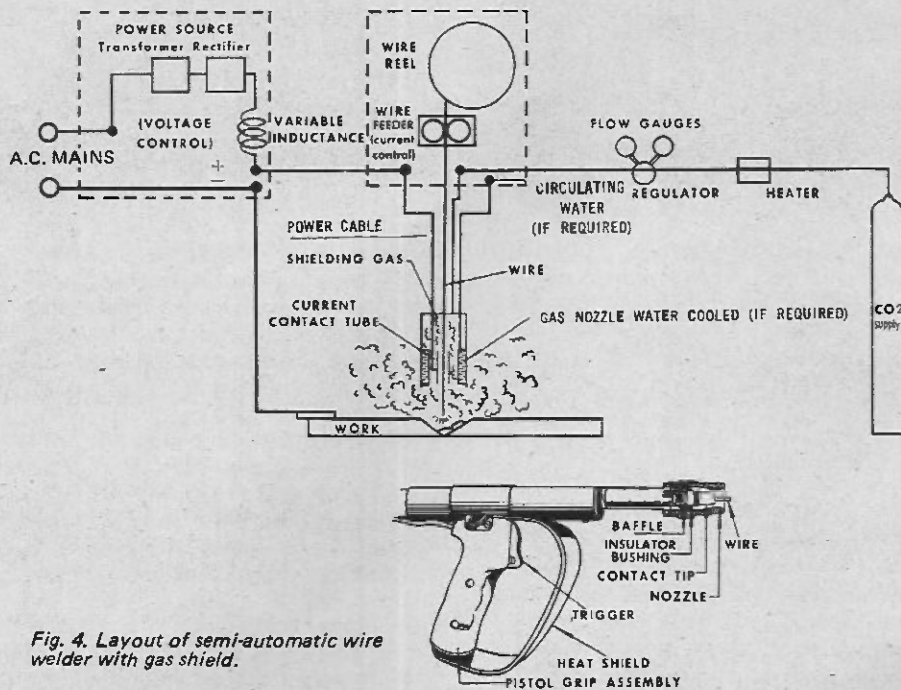

Fig. 4. Layout of semi-automatic wire welder with gas shield.

introduced to meet this need and to further increase the laying rate.

One automatic system that is gaining wide acceptance is the CRC-Croze internal and external welding machines. The degree of automation used in their design has been made possible by the use of electronic control systems. The main stages of pipe-laying with this system are as follows.

After the ends of the pipes have been bevelled to an accuracy of 0.2 mm with a special, portable, on-site, end-milling machine, they are brought into line along the string with the ends butted. The positioning and holding operation for the first weld is critical: for this the internal machine is used. This self-contained 500kg device, (Fig. 5) moves up the free end of the pipe (which is usually two or even four 12m lengths prejoined elsewhere on site) under its own battery power. Pneumatically-operated shoes expand outward on each side of the joint, forcing the two ends into circular

Fig. 5. Internal line-up clamp for joining pipe sections.

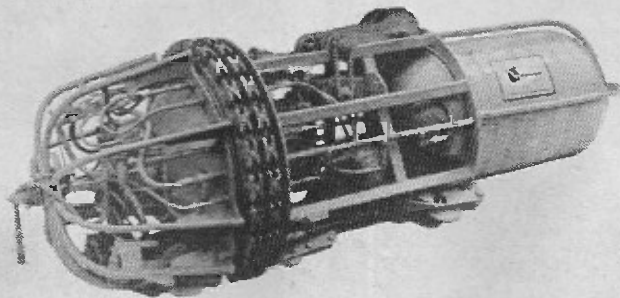

shape and holding them in alignment. Internal clamps such as that shown are now quite common, but the CRC-Cross method goes one step further, for their advanced system carries four MIG welding heads that weld the initial (or stringer) pass from the outside. Two heads, operating together, weld half the pipe joint, the other two then complete it. Whilst this operation is in progress the operators are attaching a band to the outside, on which the external welding machines run. The stringer pass takes just three

Fig. 6. Two welding bugs set up to demonstrate their use to weld automatically around the outside of a pipe.

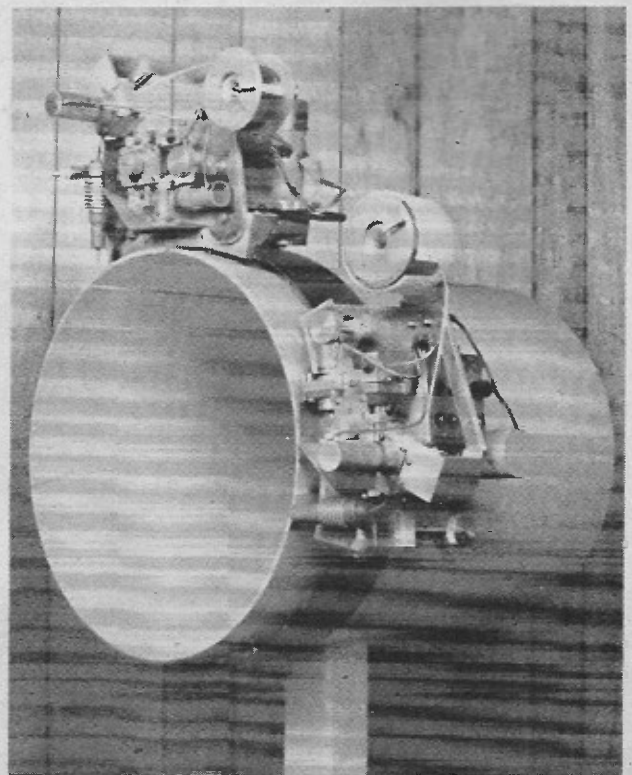

minutes to complete, after which the internal machine is remotely released and driven out ready for the next joint, for this can proceed now that the joint has sufficient strength.

To fill the vee to full strength and seal, external machines (called bugs) are used. Two are shown in Fig. 6. They have velocity servo-control on the drive motor to ensure that the weld speed is constant regardless of position around the band. A second motor gently oscillates the welding head across the vee to produce a wider weld. The third motor feeds the wire. Electronic circuits monitor the arc voltage, controlling against the desired set value. Control is obtained by varying the alternator field using silicon controlled rectifier SCR techniques. The circuits have been designed to produce a power supply characteristic that has the desired amount of slope and effective inductance. This method eliminates the need for heavy and expensive control inductors. Conventional-style plug-in printed circuit cards are used on the controls; in the event of a fault the unskilled operators can easily effect a repair by exchange. It is vital in applications such as this, where a skilled electronic technician is not available, that the system does not lose favour due to inability to keep it running.

This equipment has been used in Italy, America, Britain and is currently in use on the 240 km line from the Forties Field to Peterhead in Scotland.

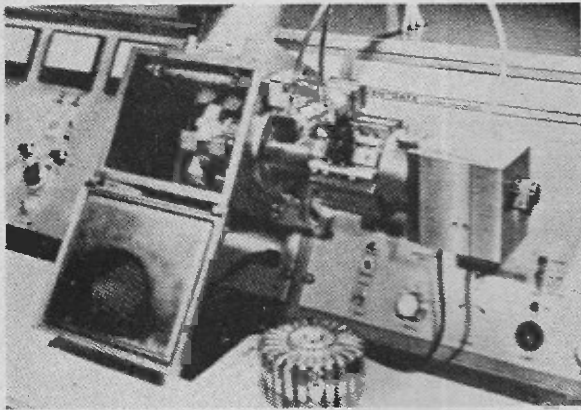

Fig. 7. A low-power workshop electron-beam welding plant.

A recent record for the laying team was to make 138 joints in an 8.5 hour day. Other companies — Midwestern Specialties Company, H.C. Price, Thomas Contracting and Columbia Gas Corporation — have also developed pipe joining systems that feature some of the CRC-Crose facilities.

We have seen how electronics has gradually been accepted as a means of improving arc-welding. Current research developments go even further.

ELECTRON BEAM WELDING

If a work piece is bombarded with a dense stream of high-energy electrons, it will be heated by virtue of the impact energy exchange. This is the principle of electron-beam welding. To date, welding with electron beams has been limited to comparatively small tasks, but now work is in hand to adapt the technique to pipe-line joining.

The electron-beam, produced in an electron gun, is focussed and accelerated toward the work-piece, the whole operation taking place in high-vacuum conditions. A production electron-beam welding unit, designed to accommodate metals ranging in thickness from 0.05 to 5mm, is shown in Fig. 7.

Obviously many design problems are involved to use electron-beam welding when the workpiece cannot be placed in a vacuum chamber and when the plant must be rugged for use in extreme cold or hot areas in the field. The first difference is the need to provide an annular doughnut-shaped shroud, encircling the join, to provide a vacuum. Internal and external expanding rubber tubes are incorporated to seal off the area for pumping down to at least 10^{-4} torr — better than the ultimate vacuum of a two-stage mechanical vacuum pump.

In one proposed design, the beam is

made to track the pipe seam using magnetic deflection coils. It is generally agreed that a right angle gun deflection system is also needed to prevent back-sputtering from contaminating the triode electron gun. This may seem a lot of trouble to go to, but there are important gains to be obtained. Firstly, electron-beam welding has greater depth of penetration than conventional methods, and this means a smaller vee can be tolerated. In fact a straight cut pipe can be joined successfully, saving both time and labour.

Secondly, only one pass is needed to join a thick pipe. Again, this provides savings in the whole pipe-laying operation.

PLASMA ARC WELDING

Yet another "arc" process gaining acceptance is the plasma-jet torch used to weld, cut or trim metals. An arc, maintained between positive and negative electrodes, has gas passing through it to become ionised into both positive and negative ions, the whole retaining charge neutrality. Heat from this torch is transferred to the workpiece by virtue of the ion impacts — it is an efficient process. Plasma-arc welding holds attractions that the joints need not be premachined to close tolerances, the edges can be cut straight (which is easier to do) and that the method appears to be more reliable. Already plasma torches are in use to "turn-off" stock in a lathe, to clean away the greasy surface of railway lines and for cutting.

No longer is arc welding a power electrical engineering discipline — electronic methods are obviously paving the way to new possibilities. Who would have thought back in the 1930's that a modified cathode ray tube device would be used to weld metre-diameter pipe-lines!

BUILD THE TREASURE TRACER MK III

METAL
LOCATOR



- Incorporates varicap tuning for extra stability
- Weighs only 22oz and has perfect balance
- Loudspeaker or earphone operation (both included)
- Handle knocks down to only 16in for transport
- Ministry approved design
- Excellent sensitivity and stability
- Kit can be built using only soldering iron, screwdriver, pliers and wire snips
- Drilled, tinned, fibreglass p.c. board with component siting printed on
- Incorporates Faraday screen

Send s.a.e. for leaflet

Complete kit
with pre-built
search coil

£9.80
Plus 35p Post
(inc. VAT)

Built, tested
and
Guaranteed

£13.75
Plus 35p Post
(inc. VAT)

MINIKITS ELECTRONICS,
35d Langley Drive, Wanstead,
LONDON E11 2LN
(Mail order only)

HAMGEAR PMIX CALIBRATOR

electronics
TODAY
INTERNATIONAL
product test

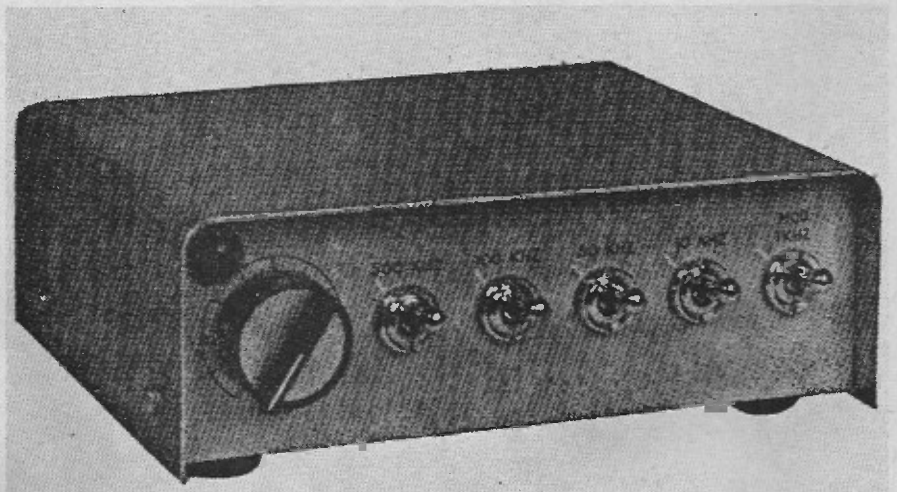

A long, long time ago, I discovered (at not inconsiderable expense, frustration and annoyance!) that not all manufacturers' swans possessed the stately grace and effortless efficiency of that beautiful bird: too many turned out to be rather nasty specimens of the goose family -- a fact to which a well-stocked attic of junk is crystal-clear testimony. For the last 18 months or so, I have been a very satisfied user of "Hamgear's" very attractive PM IIBX solid state, mains-

operated, pre-selector which has served to convince me that the old adage that "a good Communication receiver doesn't need a pre-selector" is just that -- an old adage that has been handed down from generation to generation of DXers. I was, therefore, delighted when Hamgear Electronics (address at the end of this Report) offered to make their PMIX Calibrator available for inspection, evaluation and testing: if you don't wish to read any further than this paragraph, the summing-up is "here we have another swan to join the PM IIBX".

My interest in frequency measurement as an adjunct to DXing started, as I recall, in the early 1960s as the number of stations on the SW spectrum proliferated just about the time that I came into possession of a really good Communication receiver for the first time. Like so many DXers, I had graduated through a variety of domest-

ic receivers, multi-band portables (which in those days seemed to share a common propensity to transfer the stronger signals in the 49 metre band, the band they describe as "marine") and early examples of World War II "surplus" receivers which were neither correctly aligned (as I now know!) nor calibrated with any accuracy. A stange assortment of frequency measuring gear has graced my shack over the years - strange indeed! The first, I think, was a calibrator "strip" disinterred from the innards of one of the old 52 sets and using a multi-vibrator which, at the drop of a hat, used to give 9 or 11 "divisions" per 100kHz (or even 8 or 12!) making frequency measurement more amusing than accurate. The successor was a straight 100kHz calibrator which was certainly an improvement but involved tedious graphing of logging scales since dial calibration is seldom linear over

even just 100kHz. Next in line, as I recall, was the Wavemeter Class "D" Mark 1 which covered just 2 to 8MHz on fundamentals and was not all that accurate once one started to use its harmonics to extend the range into the 20MHz-plus range. This soon gave way to the Wavemeter Class "D" Mark 11 - an infinitely more accurate frequency measuring device BUT which necessitated a major shack refit to accommodate the monster and required the patience of Job and the judgement of Solomon to decide whether the heterodyne was a spurious response or the real thing! Last in my line of gadgetry designed to ascertain a frequency with tolerable accuracy came another "surplus" item - this time a BC221 Frequency Meter. I am prepared to concede that a new BC221 was probably of laboratory-standard and laboratory-accuracy BUT mine (and from fellow-DXers reports, theirs too!) had a built-in ability to produce misleading answers which defied all efforts to track down the fault and restore it to its original pristine electronic efficiency. We shall pass over without comment various early IC devices which came and went unsung and unhonoured!

What makes the PM 1X different from the devices that have preceded it? Firstly, its aesthetic appeal - a neat silver hammer finish case with a grey panel, measuring only 7 x 5½ x 2¼in high, with a pleasant-to-handle convenient size on-off switch cum gain control and 5 neat toggle switches in a row across the front. Secondly, a thoughtful design with a mains neon (of just the right brightness) on the front, the mains input at the rear and the output leads at the rear, too, avoiding those trailing leads which always seem to get caught up with one's feet. Thirdly, and most important of all, a unit that does the job it is meant to do without any fuss, bother or snag.

"Hamgear" describe the PM 1X as "a sophisticated calibrator giving outputs at 1MHz, 500kHz, 100kHz, 50kHz, 10kHz, with modulation at 1kHz being available at all outputs excepting 50 and 10kHz". Lifting the "bonnet" one finds a conventional mains transformer, fused, supply, giving a 10V supply for the 2N3710 and two SN7490's which divide the 1MHz crystal output. The harmonics of the 1MHz crystal are available up to at least 144MHz and the zero-beat adjuster allows "the crystal to be adjusted ... to set (it) to within 2 cycles of absolute at 1MHz as shown by MSF Rugby on 5MHz". My own tests indicated that I could achieve slightly better accuracy than this using the standard frequency transmissions on 15MHz and, I found the

manufacturers' claim that "stability is reasonable" was something of an under-statement. In a constant ambient temperature stability was, for all practical purposes, absolute over a period of several hours.

Detailed instructions for use are supplied with the calibrator and it is pointless to repeat them here. For ordinary use (up to 30MHz) all that is needed is to plug the mains lead into a suitable mains outlet and to connect a twin lead to earth and to the aerial input of the receiver. A separate coaxial outlet is provided, to replace the twin leads, when one is dealing with higher frequencies and the marker points were easy to establish with this in use up to, at least, 102MHz which was the maximum point tested by me.

The unit was tested in conjunction with two Communication receivers - a "Racal" RA17K, which has built-in marker points every 100kHz, and an "Eddystone" 730/4, which has a 500kHz crystal calibrator. There was complete convergence between the built-in frequency markers and those provided by the PM 1X and it was of the greatest use to be able to check intermediate points simply by use of the sequential switches on the PM 1X front panel. Slight non-linearity in the tuning dials of the two receivers was immediately quantified and frequencies could be read to a much higher standard of accuracy than was previously the case without the trouble of preparing frequency graphs against dial readings. As a further test, the PM 1X was used to check the dial alignment of a standard FM receiver over the 88 to 102MHz range and also to realign the frequency ranges of a SW convertor installed in the car and covering the bands between 90 and 13 metres (using a long extension mains cable). Results were more than satisfactory and the unit performed without a hitch.

All-in-all, this is a really excellent frequency measuring unit which will be a worthwhile addition to any DXers shack. The price is £19.75, including postage and packing, and it is produced by Messrs Hamgear Electronics, 2 Cromwell Road, Sprowston, Norwich NOR 65R from whom full details of this and a range of other calibrators and preselectors may be obtained on request (please enclose a stamped self-addressed envelope). Like all equipment which does its job it is difficult to review at length - it is far easier to review items which fall down in one respect or another. I can only say that I part with it, after evaluation, with the intention of acquiring one at a very early date! Yes - this one is a "swan"!

LM322N & CO

Continued from page 22.

resistor and capacitor is about one thousand times less than that of the 555. This enables long, accurately repeatable time delays to be obtained without the use of large value electrolytic capacitors. The leakage current of the latter varies with age, temperature and use and affects the repeatability of the delay times.

The time delay of the LM322N is accurately equal to the product of the resistor and capacitor values used in the circuit, whereas in the case of the 555 device it is equal to 1.1 times this product.

The 555 can control a larger output current (200 mA), but the LM322N can control a larger output voltage and has a more versatile output circuit.

The LM322N incorporates its own internal voltage regulator. This enables the time delays produced by this device to be less dependent on the supply voltage than in the case of 555 circuits.

The 555 has the advantage that it can be operated as a free running or astable oscillator much more easily than the LM322N. This opens the field of applications for the 555 considerably.

The EXAR type XR-220/230 devices are somewhat similar integrated circuit timers. They can provide output currents of up to 100 mA from a power supply of up to 20 V. Although they can be used in the astable mode, they are more expensive than the LM322N or the 555. The XR-2556 contains two 555 timers in a single encapsulation.

Long, accurate time delays can be obtained by using the LR171E. Elremco digital timer without the use of large value capacitors. Unfortunately this device currently is priced at £12 each for small quantities, although it is much cheaper in large quantities.

Another I.C. for long delays is the XR-2240 which employs programmable digital techniques. Such devices can, for example, be used to cause a meter to be read once per month or to control the irrigation cycle on a farm.

New timer integrated circuits are under development. It is expected that a new version of the LM322N will become available in an 8 pin dual-in-line encapsulation, but will not have all the LM322N facilities. A 557 device is expected to be available soon which will incorporate a constant current source and will provide delays of up to a few hours without the use of large capacitors. ●

NICE ONE, ETI

Whilst writing for back numbers, I feel I must tell you how much I enjoy your magazine. It is the only one of its kind on the market, two months ahead of all the others and is read cover-to-cover by myself and 20 boys on an electronics course I run.

J.A.S. Southampton.

Thanks for the compliment. We don't publish too many of these letters though we do receive quite a few. We will also publish nasty ones, assuming they are constructive as well as being insulting so, if you don't like what we do, tell us.

PRINTED CIRCUIT BOARDS

The references given to your p.c. boards (such as ETI 417) imply that you make them so can we have more information on the supply please?

P.J.L. Birch Vale, Derbyshire.

We do not make or market p.c. boards ourselves. The numbers we use are for a convenient reference when ordering a particular board. A number of companies sell p.c. boards which have appeared in ETI including Ramar Constructor Services, 29 Shelbourne Road, Stratford-on-Avon, Warwicks who make up a master of every p.c.b. published in ETI, whether it is called for or not, and are ready if there is a demand.

ETI ELECTRONIC TRANSISTORISED IGNITION

We would like to apologise to all our customers who are still waiting delivery of the ETI Transistor Ignition Kit and would like to thank all those people who are bearing with us and not threatening us with all kinds of action.

We would like to put our customers in the picture:

Firstly, we provisioned for One thousand Kits, which proved no easy task for our buyer. When the number of orders rose to a figure of well over three thousand, we found that we were dealing with delivery dates of up

to thirty weeks with certain suppliers. Then, on top of all this, we are now having further excuses thrown at us by manufacturers, these being the three-day week and the acute shortage of steel, which is used for the transformer. However, despite all these setbacks, our buyer has really worked miracles and with the promised delivery of Tag-strips by the end of January we will be able to send out kits just as quickly as the Transformers are delivered. This should be in the region of one hundred to two hundred each week.

The reason we are continuing to advertise the ETI is due to the fact that advertising copy has to be with the magazine at least three months in advance and, obviously, when we first experienced difficulty in obtaining materials, which was after the first thousand units, we had no idea of the length of time the matter would hang fire.

Bi-Pre-Pak Limited are gravely concerned about the poor delivery of this kit as in the past we have had such a good reputation for service; same day turnaround. We are more used to receiving letters of delight at our service rather than letters of complaint.

Bi-Pre-Pak,

The Editor of ETI would like to endorse the above letter and confirm that the company involved have been caught in an unusual position. Both Bi-Pre-Pak and your Editor have had experience of similar editorial offers in the past but there is no doubt that the ETI kit has been the most popular offer of its type ever arranged in the U.K. This also coincided with the worst shortage of components that there has ever been.

SOCIAL CONSCIENCE OF ENGINEERS

In your December issue you refer to a Hippocratic oath for Engineers.

I would like to point out that in my book 'Man, Machines and Tomorrow' in the last chapter there is given a Hippocratic oath which I have been advocating for nearly ten years. I am enclosing a copy of the printed version

of this oath, of which I have distributed some 9,000 copies at my own expense. I think it would be worth pointing out that we are not behind the Americans in this respect.

Professor M. W. Tring, Head of Mechanical Engineering Department, Queen Mary College, University of London.

The copy which Professor Tring enclosed reads as follows:

AN OATH FOR APPLIED SCIENTISTS AND ENGINEERS.

I vow to strive to apply my professional skills only to projects which, after conscientious examination, I believe to contribute to the goal of co-existence of all human beings in peace, human dignity and self fulfilment.

I believe that this goal requires the provision of an adequate supply of the necessities of life (good food, air, water, clothing and housing, access to natural and man made beauty), education and opportunities to enable each person to work out for himself his life objectives and to develop creativeness and skill in the use of the hands as well as the head.

I vow to struggle through my work to minimize danger, noise, strain or invasion of privacy of the individual: pollution of earth, air and water, destruction of natural beauty, mineral resources and wild life.

BRITISH AMATEUR ELECTRONICS CLUB

Since 'discovering' your magazine about six months ago, I have become extremely interested in electronics and although I take several of the magazines and have been reading a lot of books, I feel somewhat in isolation as none of my friends share my interest.

Is there any club which I could join where I could be in touch with others who are equally interested.

J.K.W. Ilford, Essex.

We suggest that you get in touch with the British Amateur Electronics Club, 26 Forrest Road, Penarth, Glamorgan.

eti

reader offer

610 RESISTORS: £2.65
(inc. VAT and Postage)

Please note: The resistors, when delivered are not loose packed as shown but are on bandoliers in groups of ten.

Electronics Today International and B.H. Component Factors have co-operated to bring ETI readers a real bargain: a development pack of 610 top grade resistors covering the E12 range from 22Ω to $2.2M\Omega$ for only £2.65. At less than 0.45p each these resistors cost about one third of the

current price yet they are high quality carbon film (not composition) resistors with a 5% tolerance. There are ten of each value, supplied on bandoliers. Generally the resistors are $\frac{1}{4}W$ but due to the current shortages one or two values may be $\frac{1}{8}W$ or $\frac{1}{2}W$ rating.

Offer comprises 10 of each of the following values

	100	1k	10k	100k	1M
	120	1.2k	12k	120k	1.2M
	150	1.5k	15k	150k	1.5M
	180	1.8k	18k	180k	1.8M
22	220	2.2k	22k	220k	2.2M
27	270	2.7k	27k	270k	
33	330	3.3k	33k	330k	
39	390	3.9k	39k	390k	
47	470	4.7k	47k	470k	
56	560	5.6k	56k	560k	
68	680	6.8k	68k	680k	
82	820	8.2k	82k	820k	

Resistors are carbon film, $\frac{1}{4}W$, 5% types (one or two values may have a different wattage rating.)

Cut
TO: ETI/BH Component Factors
Resistor Offer
61 Cheddington Road,
Pitstone,
Nr. Leighton Buzzard,
Beds. LU7 9AQ.

Please find enclosed a cheque/P.O. for £2.65 for the resistor pack.

Name

Address

Offer closes 30th April, 1974.

What to look for in April's ETI

FREE COMPETITION

WIN A HEWLETT-PACKARD HP970A DIGITAL MULTIMETER

Every once in a while an item of electronic equipment is introduced which everyone wants. The HP970A comes into this category: it measures a.c. and d.c. volts (up to 500V) and resistance ($1k\Omega$ to $10M\Omega$) quickly and accurately selecting the range automatically. A $3\frac{1}{2}$ digit LED display features fully automatic decimal placement and polarity indication. It uses rechargeable nickel-cadmium batteries which allow for more than 2000 measurements on each charge. There are so many features in fact that it is impossible to list them all here. The VAT inclusive price is over £150 but next month you have a chance to win one in ETI's special competition.



ENTRY COUPON IN NEXT
MONTHS ETI

4 HI-FI TESTS

DYNACO A-25 SPEAKER
SONY ECM22P MICROPHONE
SHURE M75-EO CARTRIDGE
PHILIPS RH521 AMPLIFIER

Tech-Tips, although only a small item in ETI, is one of the most popular features. From next month we are expanding this feature considerably because of reader's requests and we shall be including general tips as well as circuits.

PLUS

THE CONTINUING STORY OF
ETI SYNTHESISER
CREATIVE AUDIO
ELECTRONICS—ITS EASY
LASER EXPERIMENTS

INTERNATIONAL 4-CHANNEL AMPLIFIER

This major project has been designed and proved in our own laboratories and has all the qualities you expect of ETI projects: clarity, quality and good design. The amplifier is designed for SQ matrix - used by 85% of the makers of 4-channel matrix equipment.

Although highly sophisticated in its operation, construction has been kept simple by the use of amplifier modules and an i.c. decoder.

Each channel gives over 12W at low distortion. Complete Circuit details etc. are given in the March issue.

ON SALE MARCH 15TH—20p

ETI TAKES A PRIDE IN BEING REALLY UP TO DATE, SO WE OURSELVES DO NOT ALWAYS KNOW WHAT WILL BE IN THE NEXT ISSUE SO THE FEATURES MENTIONED ON THIS PAGE ARE ONLY SOME OF THOSE THAT WILL BE INCLUDED.

electronics
today INTERNATIONAL

BOOK REVIEWS

REVIEWER: Brian Chapman



UNDERSTANDING SOLID-STATE ELECTRONICS. Available from Data Sales, Texas Instruments Ltd, Manton Lane, Bedford. Soft covers 242 pages 215 x 130mm. Price £1.20 including postage. (cheques payable to Texas Instruments Ltd.)

There must be many thousands of people who wish they had an understanding of electronics but are scared off by the complicated appearance of the subject as presented by many books supposedly written for beginners.

Here is a book which is suitable for anyone who wants to understand how semi-conductors work and how they are used in basic electronic systems.

The book is constructed as a 12 lesson self teaching course in the basic theory of diodes, transistors, thyristers, optoelectronic devices; and bipolar, MOS and linear integrated circuits. Each lesson is prefaced by a glossary of the terms which will be introduced, and is followed by a self-test questionnaire.

The course is written in layman's language, is well illustrated, and almost completely free of any but the most elementary mathematics. It may truly be said that no previous technical background is required at all.

Although the treatment is simple and lucid, it does not skimp on depth of treatment. Hence, having completed this course, the student would not feel that he has gained merely a superficial knowledge of the subject.

No doubt this book is one of the best basic electronic-theory texts available. — B.C.

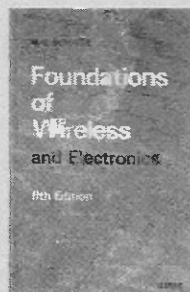

FOUNDATIONS OF WIRELESS AND ELECTRONICS by M.G. Scroggie
8th Edition. Published by the Butterworth Group 1971. 521 pages 215 x 135mm.
Soft cover edition £1.80, hard cover £3.00.

This book is one of the traditional basic texts making its first appearance as long ago as 1936. This eighth edition bears little resemblance to the first and is completely up-to-date, in that it contains transistor and integrated circuit techniques as well as some traditional valve theory. The valve theory may well be considered redundant, but there are still a lot of valves in use, and it serves as a useful comparison for the FET theory given in parallel with that for valves.

The real value of the book lies in the soundness of the basic theory. The coverage is thorough and to a reasonable depth without sacrificing clarity. This particular feature of a clear, conversational and easy to understand text, is what made Mr. Scroggie one of the best technical authors in the field of electronics for almost half a century.

Apart from its value as a standard electronics text, the book could well serve as an example of how a text should be written.

This book, and in fact all Mr. Scroggie's books, are thoroughly recommended to any budding technician. — B.C.



DIGITAL ELECTRONICS by Doktor and Steinhauer.
Published by Macmillan 1973.
Hard covers, 270 pages 235 x 155mm. Price £5.95.

This book is part of the Philip's technical library series, and with its recent publishing date, is right up to the minute in its treatment of digital technology.

The text commences with a discussion of analog and digital techniques, as applied to electronic measurement and data handling, and then covers coding and switching algebra in considerable detail before passing on to a treatment of the realization of basic logical functions by electronic means.

This is followed by the design of the basic logic circuits and then by the various manufacturing methods used to realize these designs. An extensive bibliography at the end of the book provides references for those who wish to pursue individual topics further.

Naturally, the book concentrates on devices of Philips manufacture but this does not affect the validity of the treatment in any way.

The book is suitable for engineers or students requiring a general survey of digital techniques with particular emphasis on logic and coding. — B.C.

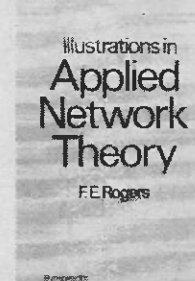

ILLUSTRATIONS IN APPLIED NETWORK THEORY by F.E. Rogers.
Published by Butterworths 1973. 228 pages 215 x 135mm. Price £5.00 hard cover, £2.50 soft cover.

A thorough understanding of network theory is vital to any practicing design engineer, yet it can be one of the most uninteresting of subjects, causing many undergraduates to develop a distinct dislike for that section of their course.

The main reason for this is perhaps the lack of relation between the theory, as taught, and the solution of real engineering problems.

This book attempts to overcome the problem by firstly providing a well written, fresh approach to basic network theory, and secondly by providing numerous worked illustrations of typical problems. These illustrations are presented in the form of a question, an interpretation of the problem and a comment on the technique employed. Any limitations of the system used, and points worthy of note in the solution, are discussed in this comment.

Written by a man who specializes in the teaching of network theory, this book should help remove the traditional distaste for the subject. — B.C.

eti LOW COST LAS

Inexpensive helium-neon laser can be used for communications, and innumerable applications in every area of science.

IN the past ten years, lasers have enabled scientists to know more about physics than the combined efforts of all previous scientific endeavour.

From demonstrations of basic principles, to, 'sawing' up unwanted buildings, providing sight lines for surveyors, to shooting down enemy missiles, applications for lasers are virtually unlimited.

Until recently, lasers have been totally out of the realm of all but the wealthiest amateur experimenter.

But now, simple helium-neon laser tubes are available at surprisingly low cost. It is absolutely practicable for the amateur to build a working laser for under £100

The helium-neon laser is simply a 'cold-cathode' type of gas tube with mirrors mounted internally to 'generate' the lasing action, (a full description of the operating principles of this, and other, lasers was published in our August 1973 issue).

To energize the laser, a suitable high voltage power supply must be used. This supply is in fact the major part of this constructional project.

The characteristics required are shown graphically in Fig. 1(a).

Over the range OA, very little current

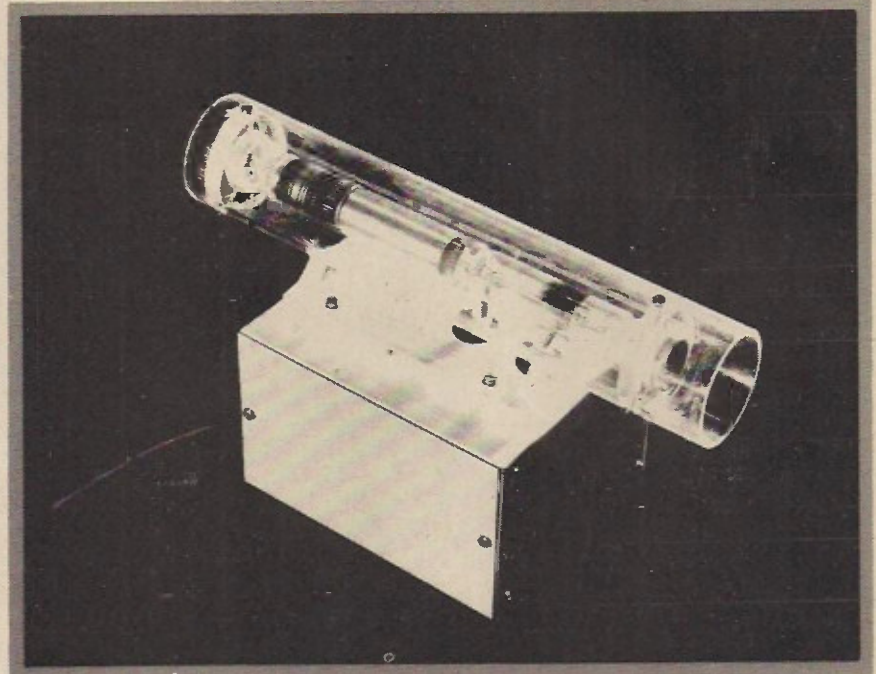

The ETI laser — note the 9.5 mm thick perspex rings mounted within the tube to take the support screws. These rings and the tube mounting base were made from small off-cut of the material which can be obtained from any acrylic supply house.

is drawn and no light is given off — this is known as the 'dark discharge' or 'Townsend' discharge region. At point 'A' (about 6kV for the suggested tube) a breakdown occurs and the dark discharge changes to the characteristic orange-coloured, neon-glow discharge i.e. the tube is 'fired'. Region A to B is the region in which this glow discharge continues. However at C, a further breakdown occurs and the glow discharge becomes an arc discharge.

The glow discharge and arc discharge regions are characterised by successively lower voltages and higher

currents, i.e. there is a 'negative resistance' characteristic.

The laser tube must be operated at an optimum point that is determined by tube parameters such as gas pressure, discharge length and optical volume in the arc discharge region. For the tube the specified operating point is 900V at 5mA. The laser power supply must hence perform the dual role of:—

1. Supplying at least 6 kV at low current to fire the tube, and
2. Supplying 900V at 5mA to 'maintain' the tube.

A suitable circuit, that does just this, is a modified form of the Cockcroft

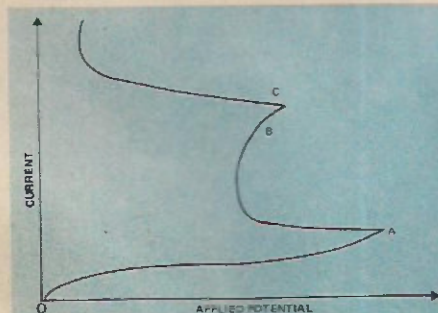

Fig. 1(a). Characteristic V-I curve for a low pressure gas discharge tube.

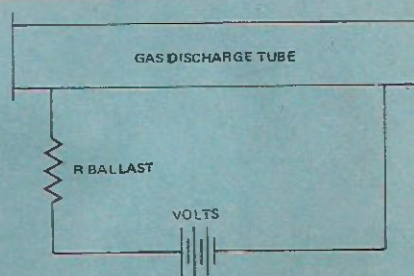

Fig. 1(b). A ballast resistor is required to counteract the 'negative resistance' characteristic of the tube.

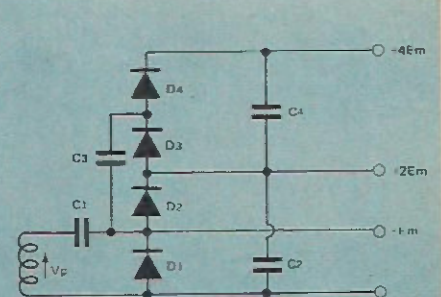

Fig. 2. The basic Cockcroft-Walton voltage quadrupler circuit.

LASER TUBE DATA

Model	LGR7620 (Siemens)
Beam divergence (milli-radians)	3.0
Beam diameter (for one tenth intensity)	1.3mm
Trigger volts	6kV
Operating volts	900V
Tube length	220mm
Tube diameter	29mm
Ballast resistor	100k
Maximum current	5.5mA
Light output power	1mW at 6328A (Mode TEM _{mnq})

PARTS LIST

R1,2,3,4,	Resistor	22 k	1 Watt	5%
R5,5	"	27 k	1 Watt	5%
R7	"	12 k	1 Watt	5%
R8	"	5.8 k	1 Watt	5%
R9	"	3.3 k	1 Watt	5%
R10,11,12,13	"	1 M	½ Watt	5%
R14	"	33 k	"	"
R15	"	2.2 k	"	"
VDR1	Voltage Dependent Resistor	220V, 1mA, 800mW		
(Home Radio, 240 London Road, Mitcham, Surrey CR4 3HD)				
C1	Capacitor	50pF	6.5kV min	disc ceramic
C2	"	0.01µF	3kV	"
C3	"	1000pF	4kV	"
C4,5,5,7	"	8µF	500V	electrolytic
C8	"	10µF	25V	"
D1-D16	Diode	1N4007		
Q1	Transistor	MJE340 (Henry's Radio)		
Laser Tube		LGR7620	see box	
T1	Transformer	240V to 1325V, 13mA	see box	
SW1	Switch	Double pole on-off		
See text and photograph for mechanical components such as box and tube.				

The Laser tube LGR7620 is made by Siemens and can be ordered from one of their distributors:

JVN Components Limited
204-206 High Street,
Bromley, Kent,
01-464 1245

Douglas Electronic Industries Ltd are preparing transformers for this project. Their address is Thames Street, Louth, Lincs.

Walton, voltage-multiplier circuit. The basic configuration of this is shown in Fig. 2.

The 'modification' is simply the choice of capacitor values. C₁ is chosen to be quite large (by a factor of 100) with respect to C₂, C₃, and C₄; and C₂, C₃, and C₄ are chosen such that under light loading, as is present before the tube actually 'fires', (i.e. in the 'dark discharge' region,) the circuit does in fact operate as a voltage multiplier but, under the heavier loading of the glow discharge, these capacitors cannot hold the necessary charge for the circuit to continue operating as a voltage multiplier. Since C₁ is larger than these capacitors, and can maintain sufficient charge, the circuit now acts as a simple half wave rectifier with D₁ and C₁.

To overcome the negative resistance characteristic of the laser, a ballast resistor is inserted in series with the anode (or cathode) lead to the tube. There is usually an optimum value specified for this resistor, but it is not critical and can be varied to obtain correct tube operating voltage.

ETI have made arrangements with

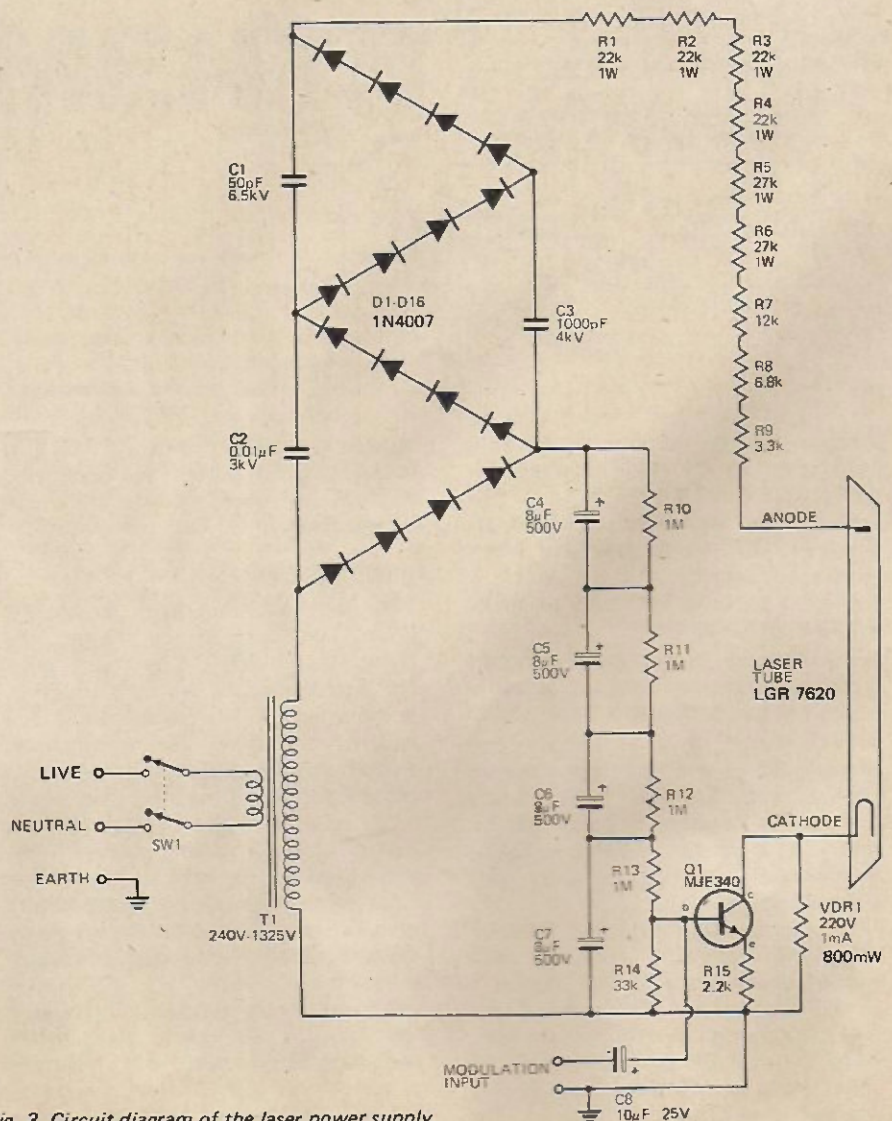

Fig. 3. Circuit diagram of the laser power supply.

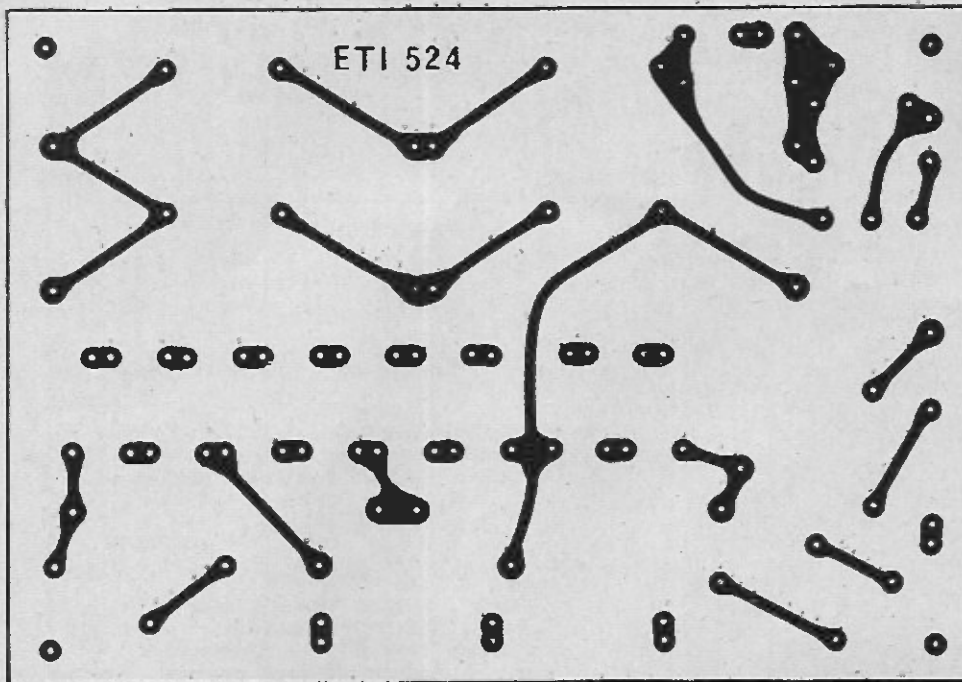

Fig. 4. Printed circuit board layout for the laser power supply.

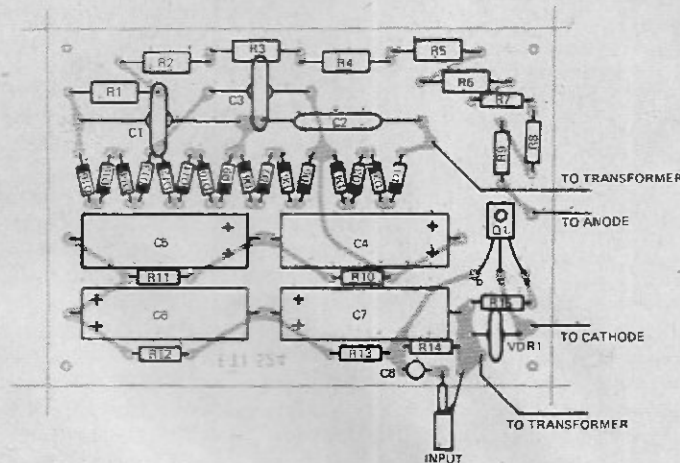

Fig. 5. Component overlay.

Douglas for the supply of suitable transformer for T1. This has a secondary of 1325V at 13mA.

This, after half-wave rectification, becomes 1870 volts peak and when multiplied provides 7.5 kV which is sufficient to cause the tube to strike (more than 5 kV).

This simple power supply circuit would operate the tube satisfactorily but it can be considerably improved to provide better output stability and reduced ripple and quantum noise on the output. This is achieved by maintaining constant tube current by means of a constant current regulator incorporated in the cathode lead. (Transistor Q1).

Varying the current through the laser tube will vary the coherent light output proportionally, and hence, a signal applied to the base of the regulator transistor will cause the laser output to be modulated. The modulation source should not exceed one volt peak (to avoid clipping). The

voltage dependent resistor, VDR1, is incorporated to prevent the laser being cut off by over modulation which would result in Q1 being destroyed.

CONSTRUCTION

Mount the components to the PC board in accordance with the component overlay. The board, after the interconnecting wiring is attached, is mounted on 12 mm spacers in one end of the box. The transformer, switch, input jack and mains input cable are fitted to the other end.

The tube itself may be mounted in a variety of ways, as long as there is not a heat source, or heat sink, near the body of the tube. Uneven temperature gradients along or across the tube may cause buckling and consequent minor mirror misalignment.

A good simple method of mounting the tube is to use a three point mounting for the tube at both ends of a piece of aluminium or perspex tubing. The tubing will need to be

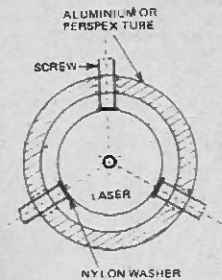

Fig. 6. Proposed method of mounting the laser tube. If perspex tubing is used a reinforcing piece may be required (see photo of laser).

about 50 mm inside diameter and about 305 mm (12 inches) long. Distance between the mounting points will depend on the type of tube used.

The perspex has the advantages of insulation and transparency so that the tube may be seen (for school demonstrations etc). However the orange glow from the gas discharge may be a nuisance in some experiments. We cemented our perspex mounting tube to a 3/8 perspex base, and drilled holes through the combined base and tube to accommodate the anode and cathode leads.

The lead from the ballast resistance to the pin connection of the tube should be as short as possible. Connection to the pins must be made with small clips. DO NOT FORCE the clips onto the pins, but use a gentle twisting movement. DO NOT attempt to solder to the pins. The pin-to-glass seals are extremely fragile.

Remember also that the voltage on the tube is high — THIS IS LETHAL if due care with insulation and layout is not taken.

ADJUSTMENT

When the laser is switched on it will be necessary to adjust the ballast resistance such that 100 volts is obtained across the collector to emitter of Q1. This will also ensure that the tube operates in the correct current range.

THE LASER TUBE

The LGR7620 has a multimode output that is several spatial modes propagating in the cavity resulting in a multi-spot output.

The LGR7620 has prealigned mirrors and so no adjustment is necessary. A data sheet will be sent out with each tube which gives details of connections.

JVN Components are able to supply a limited number of the LGR7620, the price being £72. However this is being replaced by the LGR7621 which costs rather more, about £115. The cheaper LGR7620 will be supplied to the first applicants.

This interesting pattern was produced by intercepting the beam with bubble glass.

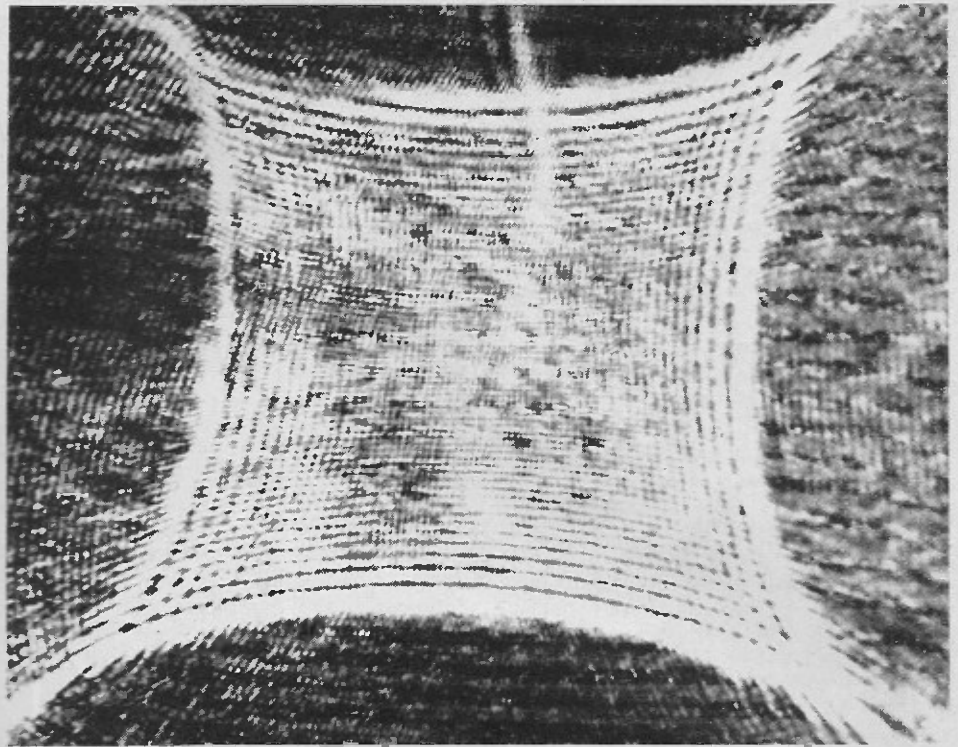

LASER EXPERIMENTS

Simple observations and experiments using the ETI 524 laser.

THE helium-neon laser generates an intense, coherent beam of red light at a wavelength of 6328 \AA . The laser beam, having little divergence, lends itself to the performance of many experiments which were previously only possible by the use of elaborate and expensive equipment set-ups. In fact, it is said that research using lasers has helped develop, in the past ten years, more physical theory than all previous, combined endeavour.

In this article we examine, firstly, some of the peculiarities of the laser beam and then, some simple experiments which may be performed with a minimum of ancillary equipment.

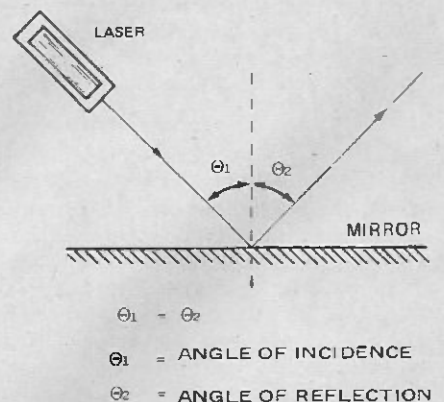

Fig. 1. Technique for measuring the angles of incidence and reflection for a plane mirror.

CHARACTERISTICS OF THE LASER BEAM

Scattering

When we first switch on the laser we find that the beam itself cannot be seen, only a spot of intense red light wherever the beam strikes something. The beam may be made visible by blowing smoke or chalk dust into the beam path. The laser beam then becomes visible because of the light being scattered by the tiny smoke or chalk particles.

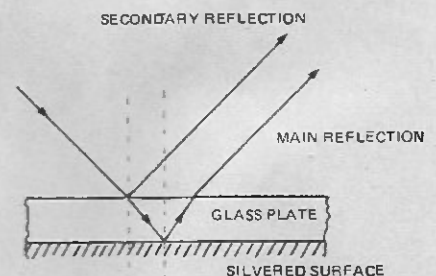

Fig. 2. A secondary reflection from the front of the glass will occur with a back silvered mirror.

SAFETY

Although the 0.5 W to 1 mW output of this laser is not particularly hazardous it is still advisable to take precautions.

Do not look directly into the beam; nor into any specular reflections.

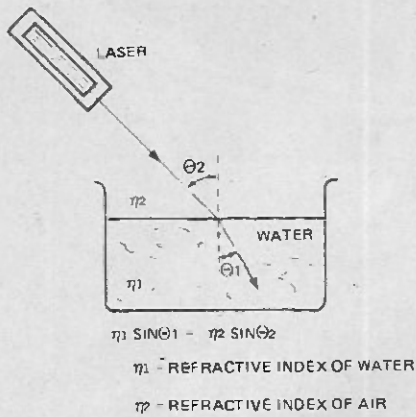

Fig. 3. Procedure for measuring the refractive index of water.

Granulated appearance

If the laser beam is expanded by inserting a lens in the beam path, we find that the enlarged spot has a granular or speckled appearance when it falls onto a diffuse-reflecting surface

such as a piece of white paper. That is, the expanded spot seems to be made up of a large number of tiny spots.

The explanation for this is that, although the amplitude of the reflected light is constant over the surface, the phase of the reflected wave, or its polarization (or both), varies randomly from one elemental area to the next over the illuminated screen; hence the radiation from all these elemental areas adds and cancels (depending on phase), in space, to produce a very complex interference pattern.

This granular appearance can be put to very good use in diagnosing nearsighted vision (myopia). With the laser beam held steady, move your head slowly from side to side and then observe whether the spots appear to move in the same direction. If they move *with* the motion of your head (same direction) you have either normal vision or you are farsighted; if

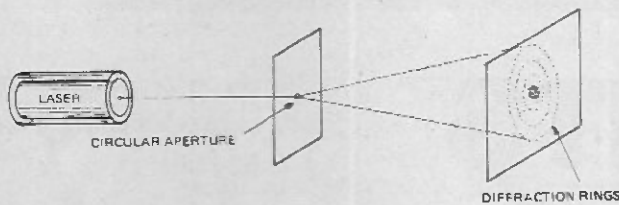

Fig. 4. A tiny hole punched through aluminium foil with the point of a needle will produce a circular diffraction pattern similar to that shown on the right.



Complex pattern of dots produced by passing laser beam through frosted glass.

they move in the opposite direction, you are nearsighted. For those who wear glasses, try it both with and without your glasses.

If the laser beam is directed onto milk, no specular pattern is observed because milk is a colloidal suspension, and the Brownian motion of the suspended particles causes very rapid variations of the interference pattern similar to that produced by incoherent light.

Colour of the beam

We are struck, at first, by the intense red colour of the beam, but although as said before, this red colour is a single 6328 Å wavelength, *there are other colours present*.

These may be observed by darkening the room and placing colour filters in front of the beam. It will be found that the laser also has fairly strong outputs of *incoherent* light in the blue and green wavelengths. These are due to the non-lasing atomic transitions in the helium and neon gases. We will leave it to you to try various coloured filters and determine which is needed to *transmit* individual colour components of the beam and absorb those not wanted.

Polarization

The laser beam is polarized and the plane of polarization may be determined by passing the beam through a piece of polaroid film (or

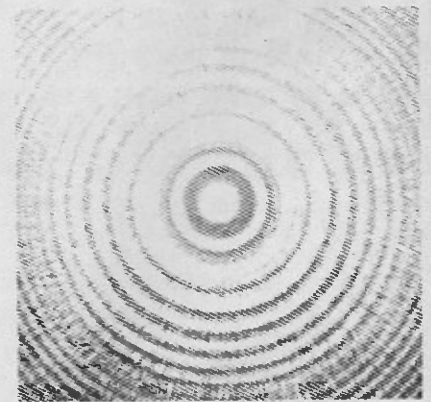

polaroid sunglasses). By rotating the polaroid, the plane of polarization of your laser will be found.

Further it will be found that this plane of polarization rotates with time. This effect varies from laser to laser due to small differences in manufacture.

LAWS OF GEOMETRICAL OPTICS

The laser may quite readily be used to verify laws of geometric optics. In

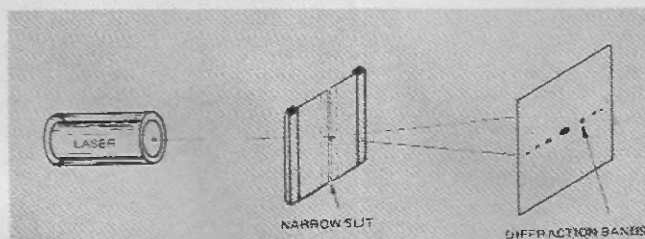
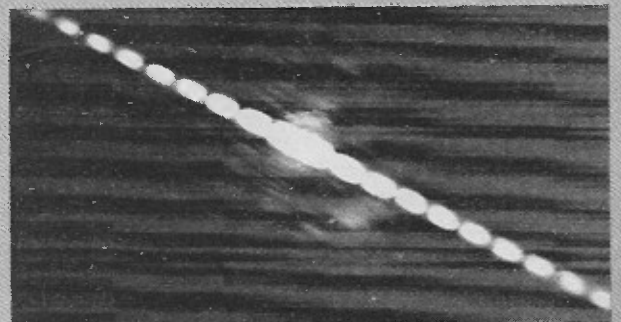

Fig. 5. Two razor blades can be used to make a narrow slit for the production of horizontal diffraction bands (shown right).



LASER EXPERIMENTS

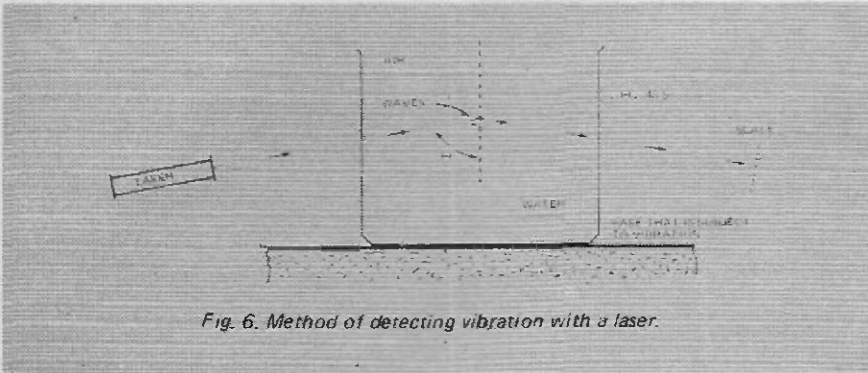

Fig. 6. Method of detecting vibration with a laser.

all these experiments take care that reflected or diffracted laser beams do not enter the eye.

Reflection

One of the first laws of optics is that the angle of incidence is equal to the angle of reflection. This may be verified as follows: reflect the beam off the surface of a mirror as shown in the diagram, make the beam visible with smoke and measure the angles Θ_1 and Θ_2 to the normal (line perpendicular to mirror). It will be observed that Θ_1 equals Θ_2 . Additionally it will be seen that the incident ray, the reflected ray, and the normal all lie in the one plane.

If an ordinary plate glass mirror is used in this experiment a second reflected beam may be observed. This is because the mirror is silvered on the back of the plate glass and consequently, you will not only observe the main reflected beam from the silvered surface, but also a secondary, less bright, reflection from the front of the glass.

Refraction

When a ray of light passes obliquely from air to water, air to glass etc., the ray changes direction at the interface, that is, the ray is bent or refracted. This refraction depends on the relative densities of the two media. In glass or water, for example, the velocity of light waves is decreased and the beam is deflected towards the normal. This effect may easily be illustrated by passing the laser beam through a glass of water. If the water is made steaming hot, and a tiny amount of milk or liquid detergent is added to it, both the incident and refracted beams will be visible. (Steam makes the incident beam visible).

LAWS OF PHYSICAL OPTICS

Physical optics is concerned with

those phenomena which are characteristic of light itself. The following experiments verify the classical wave theory of light. We cannot treat this subject to any depth but full theory can be found in any standard physics text.

Diffraction

When light waves pass through an aperture, or past the edge of an obstacle, they always spread to some extent into the region which is not directly exposed to the oncoming waves. This phenomenon is called 'diffraction'. To explain this bending of light, Huygens (nearly three centuries ago) proposed the rule that each point on a wave front may be regarded as a new source of waves. This is a very important principle and is basic to the explanation of the diffraction phenomena.

To observe diffraction, simply pass the laser beam through a small circular aperture or a very narrow slit. A small aperture is easily made with a needle point in aluminium foil. A slit may be constructed by bringing two sharp, clean edges, such as those of razor blades, together to form a slit approximately 0.3 mm wide.

An endless variety of diffraction patterns can be formed by passing the laser beam through pieces of broken glass or patterned drinking glasses or hair. These diffraction patterns are formed by imperfections in the glass and sharp edges. Refraction effects are also present and hence the patterns are quite intricate.

OTHER EXPERIMENTS

Vibration detector

By directing the beam into a container of water at an angle greater than the critical angle (the angle for which there is reflection off the water-air interface and no refraction through the interface), you can construct a vibration monitor.

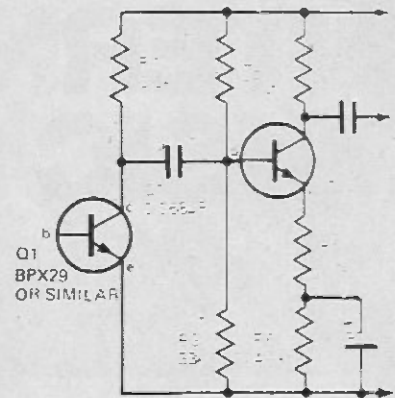

Fig. 7. A suitable detector circuit for optical communications experiments.

Any vibration of the base (such as the floor boards of a house when someone is walking) will be transmitted to the surface of the water as waves which are easily detected by observing movement of the reflected beam. Further, if the container of water and laser are placed on a solid base in the ground (e.g. a heavy concrete block), you now have a sensitive 'earthquake' detector capable of monitoring slight earth tremors.

Observing heat waves

Since temperature has an effect on the density of air, it is possible to observe the shadows of heat waves with a laser. You can readily observe this by holding a burning match or cigarette lighter in the path of the beam after expanding it with a lens.

Optical communications

A simple communications link over distances of up to 1/2 km (depending on atmospheric conditions) can be established by modulation of the output of the laser and by detecting this modulation with a photo-transistor, or PIN diode, coupled to a suitable amplifier. The circuit of a suitable detector, preamplifier is given in Fig. 7.

An input jack is provided on the laser for a modulation input which should be a maximum of one volt peak. Signal levels greater than this will result in signal clipping.

Much more elaborate systems can of course, be built with extended bandwidth and sensitivity. For transmission over long distances, say up to 1 km, beam collimation and collecting optics are usually necessary.

However, because of the inductive effects of the tube itself, it is difficult to current modulate this type of laser tube much above 500 kHz, and maintain a reasonable power output.

Further experiments using this laser will be described next month.

INTERNATIONAL MUSIC SYNTHESIZERS

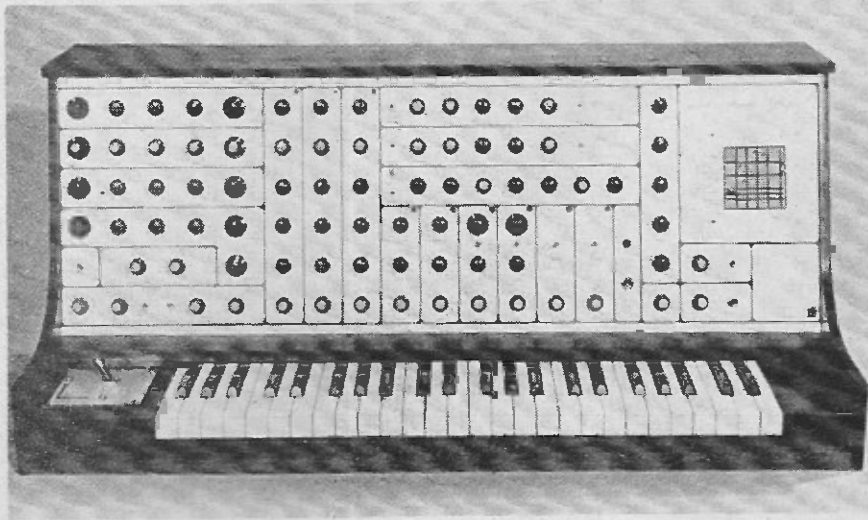

 **3600/4600**

Constructional details of the mixer, noise generator/controller and power supply are provided in this, the third article in the series.

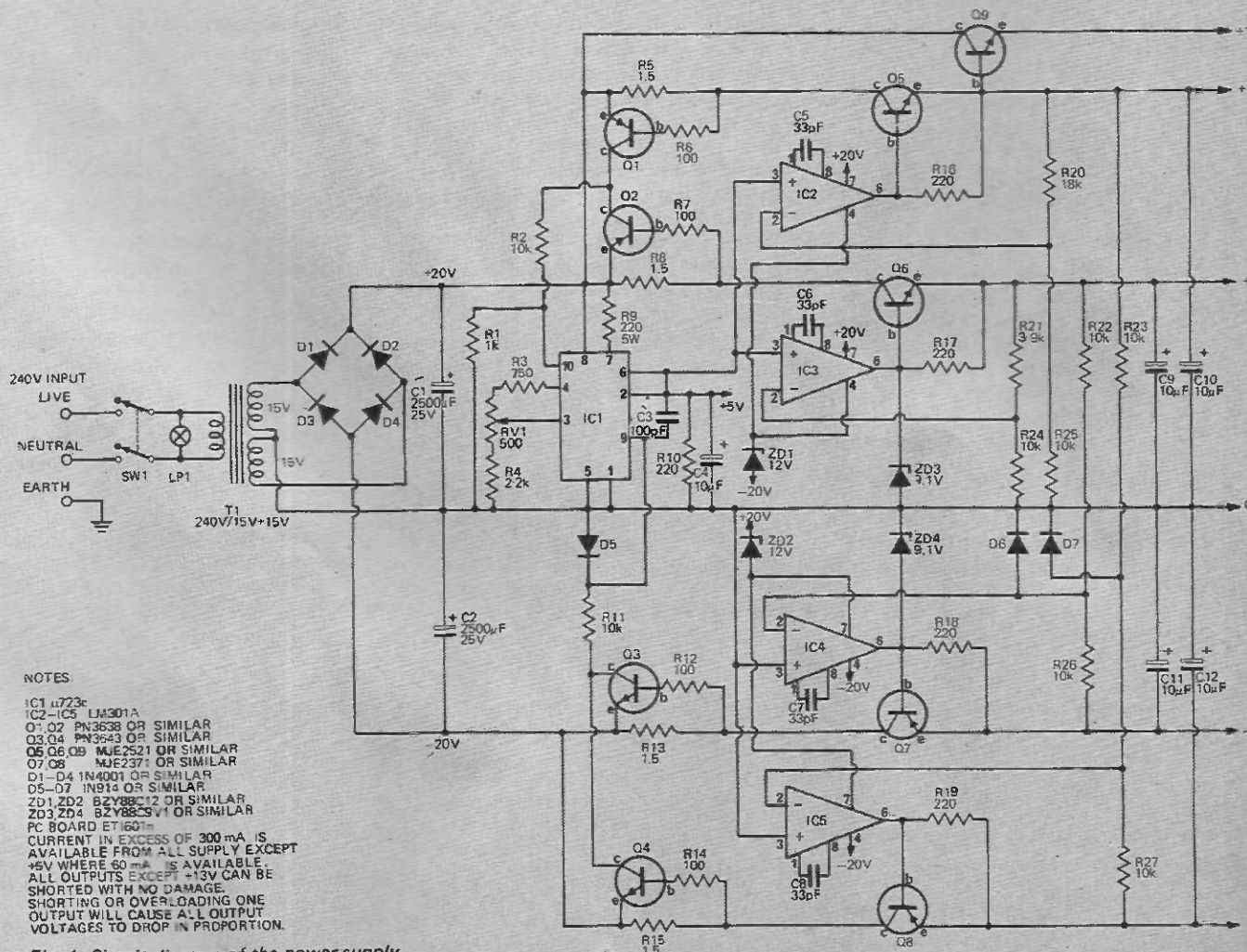

Fig. 1. Circuit diagram of the power supply.

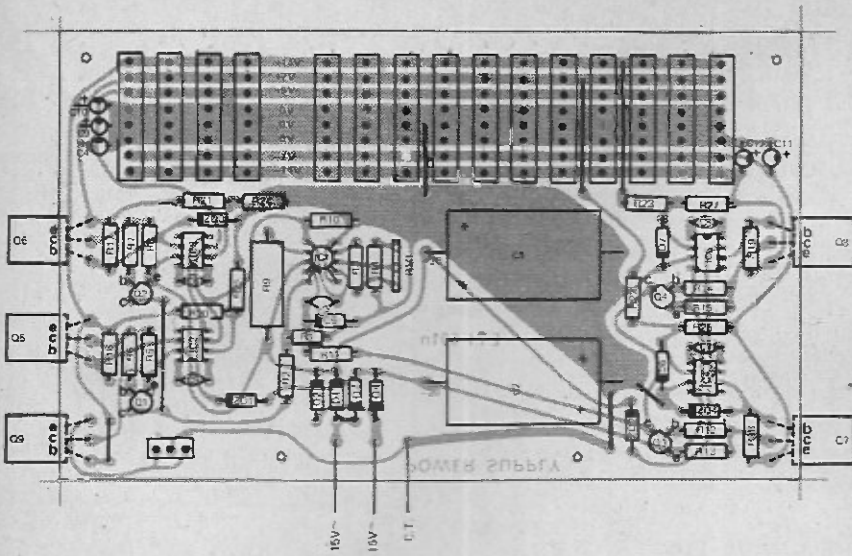

Fig. 2. Component overlay for power supply.

MODULES to be described this month are, the mixer, noise generator and controller, and the main power supply.

These three modules, together with those described last month enable the partly completed unit to be used to generate quite complex waveforms — and hence, sounds.

CONSTRUCTION Power Supply

Assemble the PC board with the aid of the component overlay Fig. 2. The power transistors should not be mounted at this time. Check the orientation of all the components especially checking the 723 regulator, the tag on the IC being next to pin 10.

The PC board is mounted by ¼ inch

spacers onto an aluminium panel, Fig. 9, which is also the heatsink for the power transistors. The power transistor leads must be bent apart and up at right angles to pass through the PC board from the underside.

The heatsink should be used as a guide to determine the bending points. Since the transistors are on the under side of the PC board there must be no strain on the joints, otherwise the PC board track may be broken. Mount the transistors, using mica insulators, in position on the heatsink. The transistors may then be soldered to the PC board through the access holes provided. If required the heatsink may then be removed for other work to be carried out.

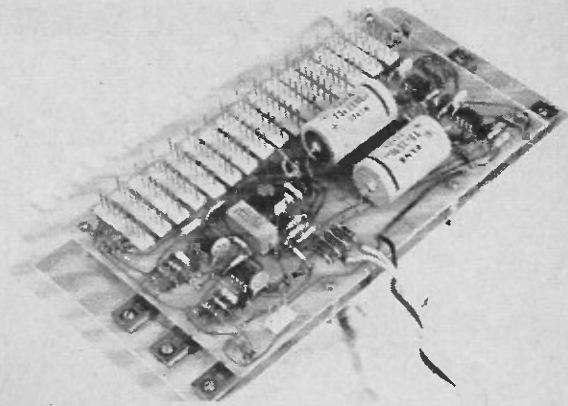

The method of construction of the power supply. Note particularly the mounting of the power transistors.

All assemblies and modules described in this, and last month's, article are used in the larger (4600) model synthesizer.

Some of the components are used also in our smaller (3600) unit, but interconnections etc, are changed. Full details of this will be provided later.

Mixer

Assemble the PC board with the aid of the component overlay Fig. 4. Check the orientation of ICs and transistors. With the BC548-558 transistors there are two different pin connections used, depending on the manufacturer. National and Fairchild versions are the same and as shown on the overlay, whereas the Philips type is the reverse. The Philips type can be identified by the base (centre) lead, which is bent off centre, away from the flat. To use the National type bend the centre lead towards the flat.

The mechanical assembly is slightly different for this module than that for the oscillators. A metal plate is used to hold all the potentiometers (24) and three small brackets hold the PC board. The LED indicators are mounted on the front panel itself and are connected to the PC board either by soldering, or as recommended, by a plug and socket.

Each oscillator output is fed to three potentiometers on the mixer board. Five pads are provided on the PC board for connecting the common connection of each set of three potentiometers. A pin may also be fitted to each pad so that the oscillator connection may be disconnected if required.

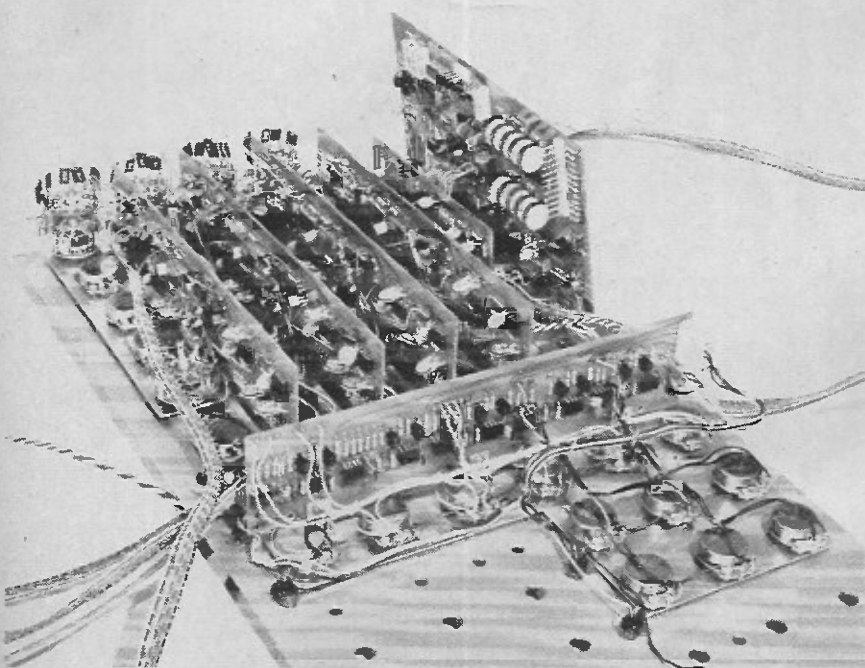

The mixer and noise generator modules shown mounted in position.

INTERNATIONAL MUSIC SYNTHESIZERS

Fig. 3. Circuit diagram of a mixer stage.

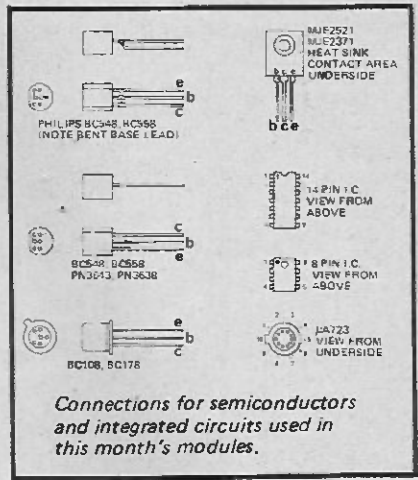
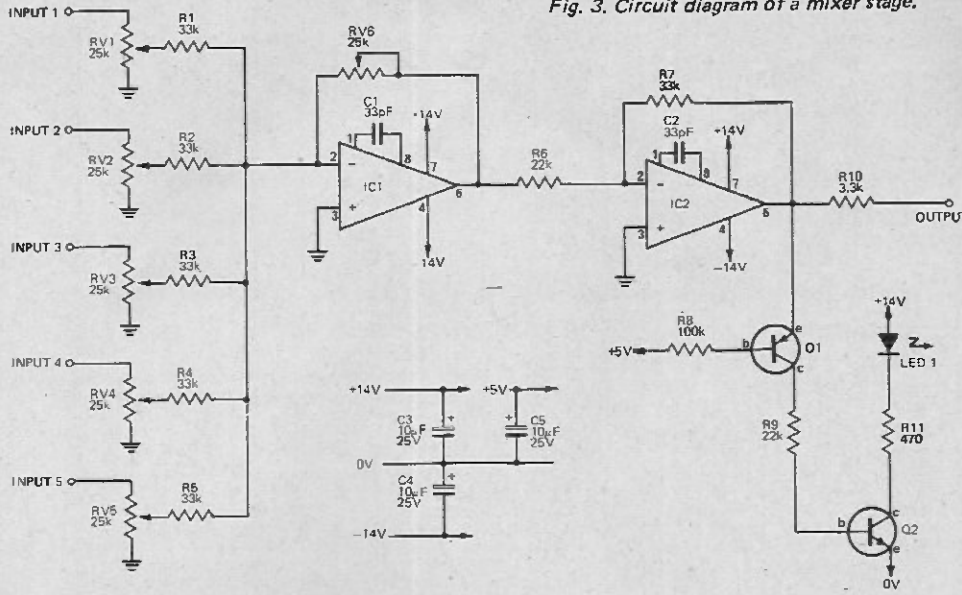

Connections for semiconductors and integrated circuits used in this month's modules.

NOTES:

- MIXER 1 ONLY SHOWN, MIXERS 2-5 ARE SIMILAR EXCEPT MIXERS 4 AND 5 HAVE ONLY 2 INPUTS
- IC1 AND IC2 LM307A OR SIMILAR
- O1 BC548 OR SIMILAR
- LED1 NSL 5023 OR SIMILAR
- COMPONENT NUMBERS FOR MIXERS 2-5 ARE AS FOLLOWS:
- MIXER 2: ADD 20 TO ALL NUMBERS I.E. R5 BECOMES R25
- MIXER 3: ADD 40 TO ALL NUMBERS I.E. R5 BECOMES R45
- MIXER 4: ADD 60 TO ALL NUMBERS I.E. R5 BECOMES R65
- MIXER 5: ADD 80 TO ALL NUMBERS I.E. R5 BECOMES R85

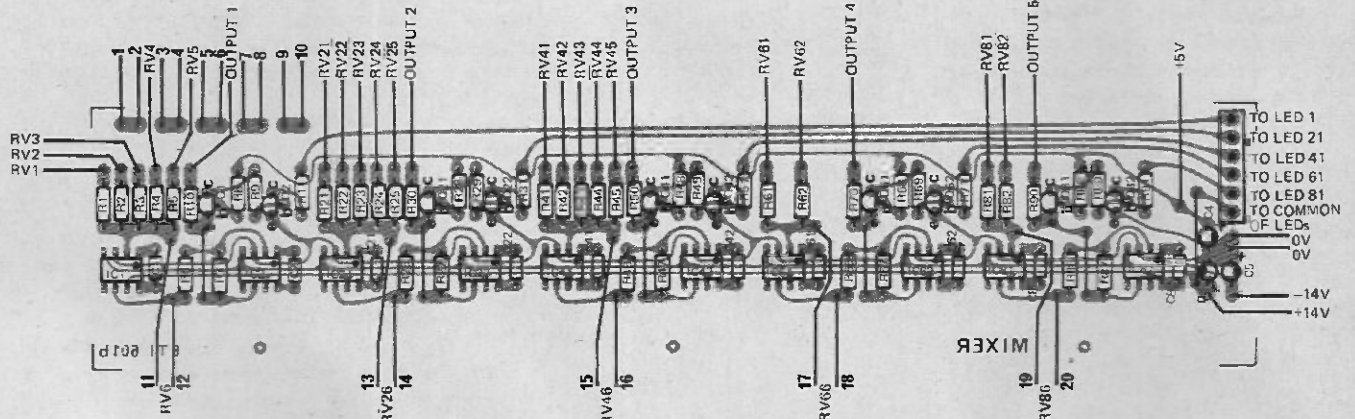

Fig. 4. Component overlay for mixer board.

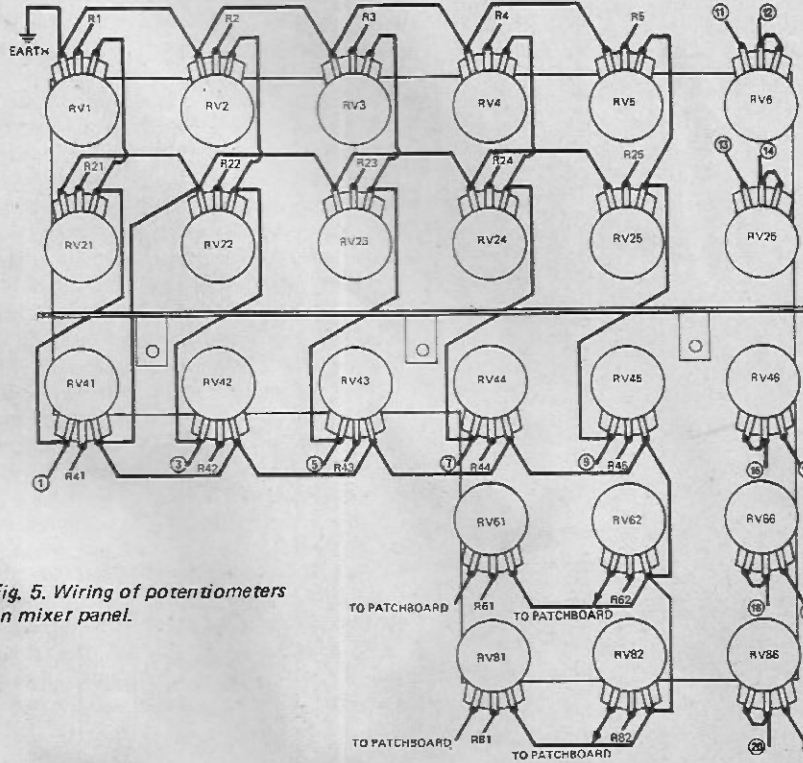

Fig. 5. Wiring of potentiometers on mixer panel.

Noise generator and controller

The construction of the module is very similar to that of the oscillator described last month.

Assemble the PC board with the aid of the component overlay, Fig. 7. It is recommended, that IC sockets are used for the CMOS. Make sure the integrated circuits and electrolytic capacitors are orientated correctly before soldering in place.

The PC board is then mounted on the metal bracket shown in Fig. 12. The bracket goes on the component side of the PC board to prevent any possibility of shorting the copper tracks. The two potentiometers and the switch may now be mounted and wired up. This bracket also holds the additional switch related to oscillator 4 which is wired up as shown in Fig. 8. The interconnection between this switch and that in oscillator 4 can be either by soldered leads or, a plug and socket can be used.

Soldering with power connected should be avoided along with accidental shorting of the outputs. The output can be shorted for a brief

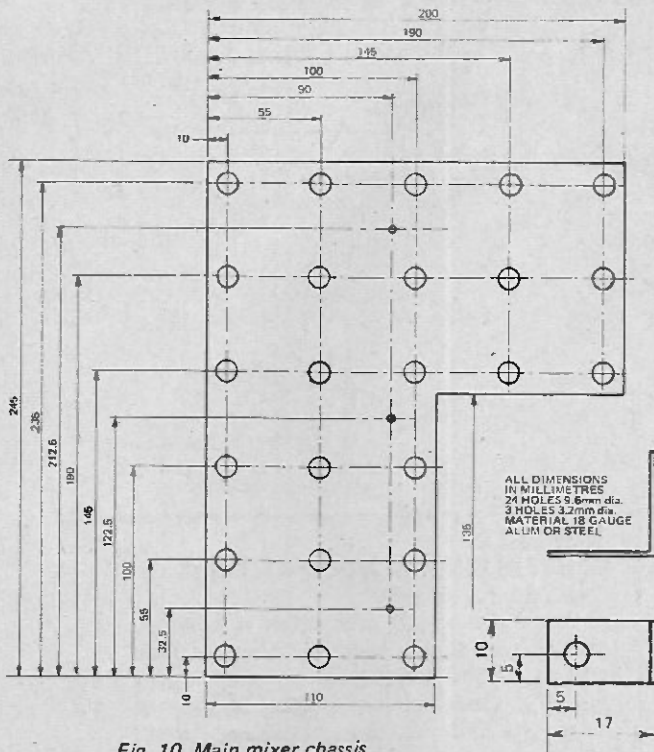
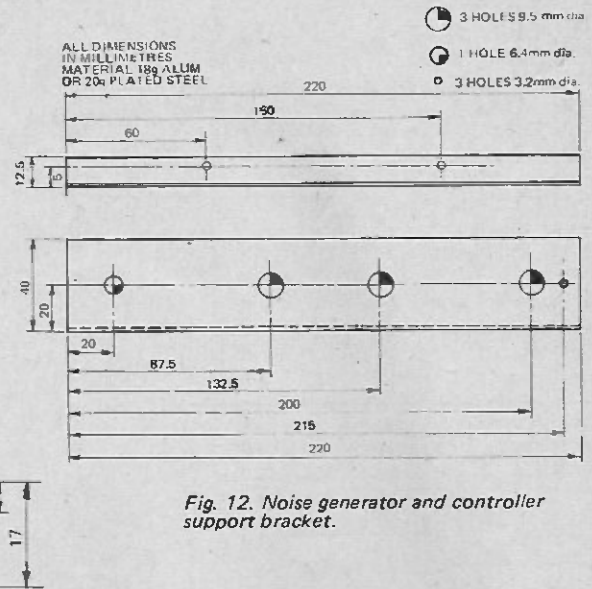

Fig. 10. Main mixer chassis.



ALL DIMENSIONS IN MILLIMETRES. 2 HOLES 3.2 mm dia. MATERIAL 18 GAUGE STEEL OR ALUM

Fig. 11. Mixer board support bracket (three required).

Fig. 12. Noise generator and controller support bracket.

PARTS LIST POWER SUPPLY

R1	Resistor	1k	1/4 W	5%
R2,11,22,23,24,25,26,27	"	10k	"	"
R3	"	750Ω	"	"
R4	"	2.2k	"	"
R5,8,13,15	"	1.5Ω	1/2 W	"
R6,7,12,14	"	100Ω	1/4 W	"
R9	"	220Ω	5 W	"
R10,16,17,18,19	"	220Ω	1/4 W	"
R20	"	18k	"	"
R21	"	3.9k	"	"
RV1	Potentiometer	500Ω large trim type		
C1,2	Capacitor	2500μF 25 V electrolytic		
C3	"	100pF ceramic		
C4,9,10,11,12	"	10μF 20V electrolytic		
C5,6,7,8	"	33pF ceramic		
IC1	Integrated Circuit	μA723C metal can type		
IC2,3,4,5	"	LM301A minidip		
Q1,Q2	Transistor	PN3638 or similar		
Q3,4	"	PN3643 "		
Q5,6,9	"	MJE2521 "		
Q7,8	"	MJE2371 "		
D1-D4	Diode	1N4001 or similar		
D5,6,7	"	1N914 "		
ZD1,2	Zener Diode	BZY88C12 "		
ZD3,4	"	BZY88C9V1 "		
T1	Transformer	240V primary 15 V-0-15 V sec @ .75A or more.		
SW1	Toggle Switch	DPDT 240 V rated		
LP1	240V Neon Indicator			
	PC board ETI 601 n			
	Heatsink as per Fig. 9.			
	T05 heatsink for IC1			
	4 1/4" spacers			
	Recommended extras			
16	8 pin Molex plugs type	A2402-8		
1	3 pin Molex plug type	A2402-3		

PARTS LIST MIXER

R1,2,3,4,5,7	Resistor	33k	1/4 W	5%
R21,22,23,24,25,27	"	33k	"	"
R41,42,43,44,45,47	"	33k	"	"
R61,62,67	"	33k	"	"
R81,82,87	"	33k	"	"
R6,9,26,29,46	"	22k	"	"
R49,66,69,86,89	"	22k	"	"
R8,28,48,68,88	"	100k	"	"
R10,30,50,70,90	"	3.3 k	"	"
R11,31,51,71,91	"	470	"	"
RV1-6	Potentiometer	25k lin rotary		
RV21-26	"	25k "		
RV41-46	"	25k "		
RV61,62,66	"	25k "		
RV81,82,86	"	25k "		
C1,2,21,22,41	Capacitor	33pF ceramic		
C42,61,62,81,82	"	33pF "		
C3,4,5	"	10μF 20 V elect. PC mounting		
IC1, 2,21,22,41	Integrated Circuit	LM301A minidip		
IC42,61,62,81,82	"	"		
Q1,21,41,61,81	Transistor	BC548, BC108 or similar		
Q2,22,42,62,82	"	BC558, BC178 or similar		
LED 1,21,41,61,81	light emitting diode	NSL5023 or similar		
	PC board ETI 601 b			
	Metal chassis as per Fig. 10			
	3 brackets as per Fig. 11			
	Recommended extras			
1	6 pin plug Molex type	A2402-6		
1	6 pin socket Molex type	M2139-6		
14	8 pin socket Molex type	M2139-8 pins Molex type		

PARTS LIST NOISE CONTROLLER

R1	Resistor	1M	1/4 W	5%
R2	"	150k	"	"
R3	"	33k	"	"
R4	"	18k	"	"
R5,6,7	"	10k	"	"
R8,14	"	3.3 k	"	"
R9,10,11,12,13	"	100k	"	"
RV1,2	Potentiometer	25k lin rotary		
C1	Capacitor	0.47μF 25V elect. PC mounting		
C2	"	100pF ceramic		
C3	"	0.0022 polyester		
C4	"	0.001 "		
C5	"	0.015 "		
C6,7,8	"	33pF ceramic		
C9,10	"	10μF 20 V elect. PC mounting		
IC1	Integrated Circuit	SCL4006AE*CMOS		
IC2	"	SCL4030AE*CMOS		
IC3	"	SCL4001AE*CMOS		
IC4,5,6	"	LM301A minidip		
	*The prefix and suffix of CMOS varies from manufacturer to manufacturer.			
SW1	Toggle switch	DPDT		
	PC board ETI 601 f			
	Metal bracket as per Fig. 12.			
	Recommended extras			
3	14 pin IC sockets	Molex type M1938-4 or similar		
1	8 pin Molex socket type	M2139-8		
8	pins for above socket type	M2138		

ETI have made arrangements with Maplin Electronic Suppliers, P.O. Box 3, Rayleigh, Essex for the supply of the components for the ETI Synthesiser. Maplin are producing a price list for each part of the series and this will be sent on receipt of a stamped, self addressed envelope.

POWER SUPPLY — How it works

The power supply provides regulated outputs of +14V, +7V, +5V, -7V and -14V. The 5V supply can deliver 60 mA and all other outputs 300 mA. An additional output of +13.4V is provided to supply the high current requirement of the headphone output amplifier.

The rectifier and filter is a conventional system supplying $\pm 20V$. The 5V output is derived from a $\mu A723C$, voltage regulator (IC1) which has very good temperature and load regulation. The +5 volts is used as the main reference for the other supplies. Current limitation is provided for by R9 which limits the current to about 85 mA. The output is adjustable by RV1 such that exactly 5V can be obtained.

The output of IC1 can be shut down in either of two modes. A positive current into pin 10 or a negative current out of pin 9 will cause the output voltage to drop to zero. Use of this is made in the overload network of the other supply outputs.

The +7V output is via a series pass transistor, Q6, which is controlled by IC3, a high gain differential amplifier which is used as a comparator. The non-inverting input (positive) of IC3 is connected to the +5V output where, in addition, the inverting (negative) input, is connected via a 5/7 divider R21/24. The result of this connection is that the output will stabilize at +7V. The high gain of IC3 will keep this voltage constant with nominal load and supply voltage changes.

A current sensing resistor, R8, is in series with the collector of Q6. If the voltage across this resistor exceeds 0.6V, the base emitter of Q2 will become forward biased, turning it on. This causes a positive current to flow into pin 10 of IC1 shutting it down. Since the output of the +7V regulator is referred to the +5V output, the +7V supply will also shut down and the output current will be limited to about 400 mA. To prevent over voltage from the +7V supply on

switch on, the output is limited by ZD3 to about 8.5 volts.

The -7V supply is similar to the +7V supply, except that the reference voltage is now zero volts, (pin 3) and this is compared to a voltage at the junction of R26 and R22. The voltage will be zero when the output of the -7V is identical to the +7V but of opposite polarity. Diode D6 is used to protect the input of IC4. Overload on this output turns on Q3 which removes current from pin 9 of IC1 shutting it down. This shuts down the +7V supply and since the -7V "tracks" the +7V output, it also will shut down.

The $\pm 14V$ supplies are identical to the $\pm 7V$ supplies except for the sensing resistors R20/25 on the +14V supply.

The +13.4V output is simply an emitter follower on the +14V rail. This supply should not however be shorted since no protection is provided.

MIXER — How it works

The mixer used is quite conventional, using an IC (IC1) to sum the input currents. Individual gain control is provided by RV1-5 and overall gain by RV6. Since the output of this type of mixer is inverted an additional IC is used to reinvert the signal.

Overload indication is provided by Q1, Q2 and LED1. If the output voltage exceeds 5.6V, Q1 becomes forward biased and Q1 and Q2 turn on, illuminating the LED indicator. The base resistor R8 prevents damage to Q1 should the output swing negative. The overload point as indicated by the LED is chosen to protect the inputs of following stages from being overloaded. The mixer itself has an overload point of about 12V.

Mixers 1,2, and 3 are identical whereas mixers 4 and 5, although otherwise identical, have only 2 inputs. The inputs of mixers 1,2, and 3 are wired directly to the outputs of the individual oscillators.

NOISE GENERATOR AND CONTROLLER — How it works

White noise is generated digitally by an 18 bit shift register which is clocked at about 35 kHz. Several feed-back loops around the shift register cause it to generate a pseudo-random bit pattern which closely approximates white noise.

The oscillator uses a quad, dual-input NOR CMOS gate (IC3), and although a NAND or inverter could be used in the circuit, it would not necessarily be a pin for pin replacement. Feedback is taken from the 5th, 9th and 18th stage in the shift register and these outputs are "mixed" by IC2 which is an exclusive OR gate, (see table) the output of which controls the 'D' input of the shift register. Resistor R1 and capacitor C1 are used to ensure that the system will start.

INPUTS		OUTPUTS
A	B	
0	0	0
0	1	1
1	0	1
1	1	0

1 = HIGH LEVEL

0 = LOW LEVEL

The output of IC2/1, as well as being the control for the shift register, is the white noise we require. However, due to some unwanted components above 15 kHz, a low pass filter is used with a 15 kHz cutoff. To give an alternate "PINK" noise output, the filter is changed to cut frequencies above 500Hz with a 6 dB/octave slope. Since the output voltage will fall if some of the spectrum is removed, additional gain is also provided when 'PINK' noise is selected.

The controller is a completely separate function which is used to add a dc component to another signal or control voltage. This is done by mixing, in IC5, a percentage of the input signal and a percentage of a dc voltage. The output of IC5 is negative however, and must be inverted by IC6.

GIRO NO. 331 7056
C.W.O. only. P & P 10p on orders below £5
Discount: £10 10%, £20-15% (except net items)
Export Order enquiries welcome (VAT free)

Official Orders accepted from
Educational & Government Departments
ALL PRICES INCLUDE VAT

SPECIAL RESISTOR KITS
10E12 1W KIT: 10 of each E12 value, 10 ohms—1M, a total of 610 (CARBON FILM 5%), £1-10 net
10E12 1W KIT: 10 of each E12 value, 10 ohms—1M, a total of 610 (CARBON FILM 5%), £3-20 net
25E12 1W KIT: 25 of each E12 value, 10 ohms—1M, a total of 1525 (CARBON FILM 5%), £7-20 net
25E12 1W KIT: 25 of each E12 value, 10 ohms—1M, a total of 1525 (CARBON FILM 5%), £7-35 net
20E12 1W KIT: 20 of each E12 value, 10 ohms—1M, a total of 1220 (METAL FILM 5%), £7-50 net
15E12 1W KIT: 15 of each E12 value, 10 ohms—1M, a total of 915 (METAL FILM 5%), £8-15 net
10E12 2W KIT: 10 of each E12 value, 10 ohms—1M, a total of 610 (METAL FILM 5%), £12-65 net

PLUGS
DIN 2 Pin 12p
3 Pin 13p
5 Pin 180° 13p
Sd. Jack 14p
2.5mm Jack 11p
Phone 51p

SOCKETS
DIN 2 Pin 10p
3 Pin 10p
5 Pin 180° 12p
Sd. Jack 14p
2.5mm Jack 11p
Phone 51p

B. H. COMPONENT FACTORS LTD.

61 CHEDDINGTON ROAD, PITSTONE,
MR. LEIGHTON BUZZARD, BEDS, LU7 9AQ
Tel.: Cheddington 668446 (Std. Code 0296)
PLEASE WRITE FOR FREE CATALOGUE

VEROBOARD 0-1 0-15
24 x 5" 28p 28p
24 x 3" 28p 18p
33 x 5" 32p 33p
34 x 3" 28p 28p
24 x 1" 7p 7p
24 x 5" (Plain) 14p
24 x 3" (Plain) 12p
5 x 3" (Plain) 22p
Insertion tool 59p 59p
Track Cutter 44p 44p
Pins, Pkt. 25 10p 10p

CARBON FILM RESISTORS 1W 5% 10 ohms—2M, 1W 5% 10 ohms—1M, 1p each or 100 for 62p, 130p for 44.50
METAL FILM RESISTORS 1W 5% 10 ohms—10M, 1p each or 100 for £1-10.

POLYESTER CAPACITORS MULLARD C290 250V
µF: 0-01, 0-015, 0-022, 0-033, 0-047, 33p each; 0-068, 0-1, 0-15, 47p each; 0-22, 53p; 0-33, 8p; 0-47, 9p; 0-68, 11p; 1-0, 15p; 1-5, 22p; 2-2, 25p.

MINIATURE CERAMIC PLATE CAPACITORS
50V: (pF) 22, 27, 33, 39, 47, 56, 68, 82, 100, 120, 150, 180, 220, 270, 330, 390, 470, 560, 680, 820, 1K, 1K5, 2K2, 3K3, 4K7, 6K8, (µF) 0-01, 0-015, 0-022, 0-033, 0-047, 24p; 0-1, 30V, 44p; 0-1, 100V, 53p.

MULTI-PART BISTABLE CAPACITORS C295 SERIES
160V: (µF) 0-01, 0-015, 0-022, 24p; 0-047, 0-068, 33p; 0-1, 0-15, 44p; 0-22, 53p; 0-33, 6p; 0-47, 7p; 0-68, 11p; 1-0, 12p.

MINIATURE MULLARD ELECTRONICS 015 016 017 SERIES
(µF/V): 163, 1-5/63; 2-2/63, 3-3/63, 4-7/63, 8-40, 10-16, 10-63, 15/16, 15/16, 16/40, 22/25, 22/63, 32/10, 33/16, 33/40, 32/63, 47/10, 100/10, 100/25, 150/16, 220/10 All Above 6p, 47-33p; 68/63, 12p; 100/63, 14p; 220/16, 8p; 220/63, 21p; 330/16, 12p; 470/6-4, 9p; 470/40, 20p; 1000/16, 20p; 1500/15, 25p; 2200/10, 25p.

ELECTROLYTIC CAPACITORS, Tubular and large can
(µF/V): 2-2/25, 2-2/63, 4-7/10, 4-7/25, 4-7/63, 22/10, 22/25, 22/63, 50p; 2/10, (10/10) 50/10, 100/10, 10/25, 50/25, 100/50, 200/10, 100/25, 50/50, 6p; 500/10, 200/25, 100/50, 9p; 1000/10, 500/25, 200/50, 11p; 2000/10, 1000/25, 500/50, 16p; 1000/50, 25p; 1000/100, 66p; 2000/25, 27p; 2500/12, 17p; 2500/25, 33p; 2500/50, 62p; 3000/50, 72p; 5000/25, 66p; 5000/50, 94p.

TRANSISTORS
BC212L 12p OC81 16p
AC127 16p BC109 13p BC213L 12p OC170 23p
AC128 22p BC148 12p BC214L 17p TIS43 33p
BC107 11p BC149 12p OC44 18p 2N2926 11p
BC108 12p BC162L 12p OC71 13p 2N3702 11p

ELECTRONICS

PART 2

-it's easy!

This course, written in down-to-earth language, takes the mystery out of electronics — explaining it as the logical, fundamentally simple, yet far ranging subject it really is.

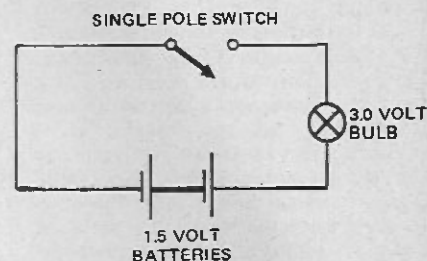

Fig. 1(a) Exploded view of the common hand torch.

Fig. 1(b). The same torch in its schematic symbol form.

TO UNDERSTAND the operation of the basic components used to build system blocks, and to see how they work together to produce many different functions, we must look at electricity at its most basic level. This lays the foundation for understanding how things operate — and for the design of simple devices.

We are going to start by considering a simple torch — basically a light bulb energised by power supplied from a couple of batteries.

Figure 1a shows how the torch is constructed.

It is obviously not very convenient to use actual photographs or detailed drawings of all electronic components — hence a system of representative symbols is used instead. Each symbol represents a component or 'black box'.

Figure 1b shows how the torch would be drawn using these symbols. This method of representation is called a circuit drawing and is almost invariably used to depict electronic circuits.

Looking at the torch as a 'system', the batteries supply electrical energy to the torch bulb where it is converted to visible light energy. The purpose of the connecting wires and switch is to control *when* and *where* this energy conversion process takes place.

The paragraph above explains the purpose and operational requirements of the torch, but does not explain why and how it operates. To understand this we must look at the internal action of the components themselves — getting right at the structure of matter.

THE STRUCTURE OF MATERIAL

Our physical world is made entirely of chemical elements. There are over a hundred different kinds, but each has a basic similarity.

Each element — no matter what it is — is composed of tiny entities called atoms. These in turn consist of even smaller particles called protons and electrons. It is the number of such protons and electrons, and their orientation with respect to each other, that varies from element to element. (There are also a number of other sub-atomic particles making up the structure of the atom. These include neutrons, mesons, etc. These particles play no part in electronic theory and for this reason will not be discussed).

Each atom has a central, very dense part (called the nucleus) that is made up of one or more protons held together as a single unit. Around this, at great speed, whirl one or more electrons, at a radius considerably larger than that of the nucleus. The mass of the electrons is negligible compared to that of the nucleus. Thus our concept of an atom is one of shells of electrons surrounding a tiny nucleus. Normally there are as many protons as there are electrons — but not always, as we shall see later.

As the electrons whirl — at enormous speed — around the central protons, outward forces are generated that, unless balanced in some way, must inevitably cause the electrons to be hurled from their orbits.

A fundamental property of protons and electrons is that each is physically attracted to the other (whilst electrons and protons each repel their own kind). It is this attractive force between the protons and the whirling electrons that (normally) balances the outward force — thus maintaining a stable situation.

This attractive or repulsive effect is known as 'charge'. By convention, the charge on an electron is called 'negative', and that on a proton is called 'positive'.

The simplest of the elements is hydrogen. This has just one proton in

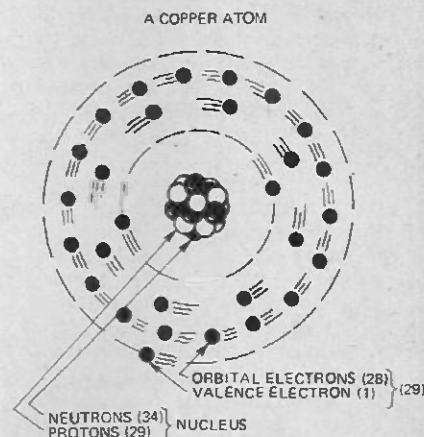

Fig. 2. Representation of a copper atom. Electrons in orbital shells surround a tightly packed central nucleus of neutrons and protons. Neutrons are neutral particles which really are a combination of proton and electron. Together they exhibit neutral charge. The valence electron in the outer shell is the electron which forms molecular bonds and is also the one which may easily be stripped off and become part of an electrical current flow.

its nucleus, and one electron in orbit. But just where the electron *is* at any time, is impossible to define, for the orbit changes direction continually.

Moving up the periodic table (the classification chart listing the chemical elements in order of number of protons) the combinations become increasingly more complex as the number of protons and electrons increase.

Electrons also exist in more than one shell — following certain basic physical laws. An element having many shells is shown in Fig. 2. Normally the charges balance, giving neutral overall charge, but if as can be done, an electron is *removed*, the atom then has a surplus of positive charge and is called a *positive ion*. If an electron is *gained* it is known as a *negative ion*.

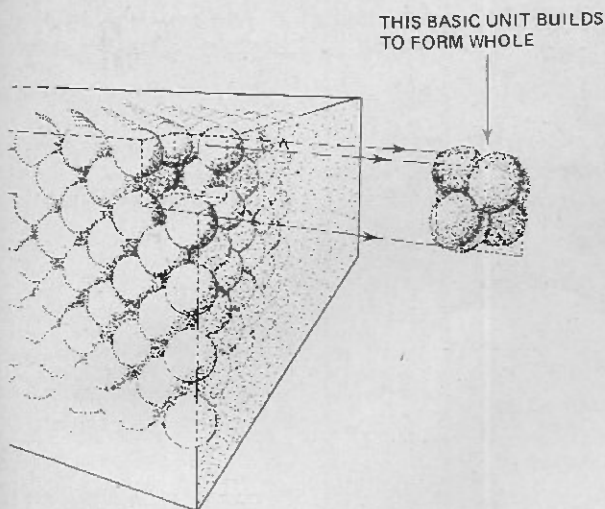

Fig. 3. How atoms join together to form matter.

Like people, atoms rarely exist solely by themselves. They like to form associations with others of the same kind (or other kinds). These combinations of atoms are called molecules and it is large assemblies of molecules, held together by molecular forces, that form the physical matter of the universe. Water, for example, is formed of molecules each consisting of two hydrogen atoms and one oxygen atom.

CONDUCTORS, RESISTORS AND SEMICONDUCTORS

All matter then is made of atoms arranged in a more or less uniform matrix — as shown in Fig. 3. In some materials a few of the electrons, in the outer shells, are not rigidly attached to any particular nucleus. They make what is called a "sea" of electrons, formed by the free electrons, as depicted in Fig. 4.

Materials in which this occurs to a marked extent are called *conductors* of electricity — for the free electrons can be made to flow around a loop of material if a charge unbalance is produced in some way. The wires in the torch, the filament in the bulb and the switch connections are *conductors*. In these, electrons flow easily, although, as we see later, less easily in the filament.

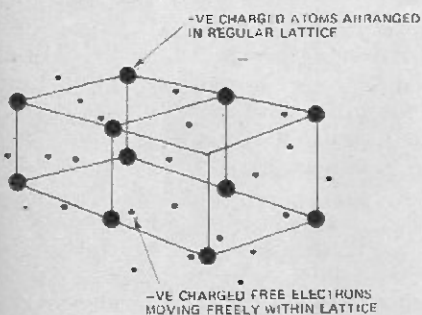

Fig. 4. In a conducting material, numerous electrons are free to move around as portrayed in this simplified picture of a piece of conductor.

In other materials the electrons are tightly bound to the nucleus and there are no free electrons to form the "sea". It is not possible to produce a flow of electrons. These materials are called *insulators*.

Insulators enable us to isolate electron flow, thus allowing it to occur only when we wish. The coating on the wires and the case of the torch are both insulators. The insulating coating ensures that battery power does not leak away — but is only used to energize the lamp when we want it to.

Air is an excellent insulator, when our torch is switched off, for example, the action of the switch is to separate a pair of contacts. The air gap thus introduced effectively blocks electron flow.

There are no sharp dividing lines between conductors and insulators. At one extreme there are exceptionally good conductors such as silver, copper, and gold. Then there are reasonably good conductors such as steel and brass. At the opposite extreme there are very poor conductors such as rubber, dry wood, plastics, phenolic boards and ceramics. Poor conductors such as these are generally known as *insulators*.

The filament in the torch bulb is a poor conductor of electrons by comparison with the connecting wires and switch contacts. It resists the flow of electrical energy. In so doing, heat is generated — to the extent that if the battery can supply the necessary energy the filament will glow white hot, thus providing light.

There are, as said before, a range of materials whose properties lie somewhere between that of conductors and that of insulators. Some of these materials have other specialised properties — these will be described later in this series.

CURRENT

If two pieces of material, one with an excess of electrons, and one with a

deficiency of electrons, are joined by a conductor, electrons will flow from the material with an excess of electrons to the material with a deficiency of electrons until the charge on the two pieces of material has been equalised (Fig. 5).

Material with an excess of electrons is known as 'negatively charged' and conversely, material with a deficiency of electrons is known as 'positively charged'. Thus electron flow is from negative to positive.

Early experimenters in electricity knew nothing of atomic theory and, unfortunately for us, arbitrarily agreed to accept a direction of current flow that is in fact precisely opposite to that which takes place. This concept is called conventional flow, whilst the later (and correct) concept is called electron flow.

The flow of electrons along a conductor is called an electric current. It is measured in units called amperes, (amps for short), rather than in actual quantities of electrons, because the number of electrons flowing is enormous — even our humble torch would have well over 10^{18} electrons flowing through its components each second! (One ampere = 6.24×10^{18} electrons/second).

Currents in electronic circuits are usually much smaller than in power equipment. For example the current flowing in a pocket transistor radio is only a few hundredths of an amp. In an electric heating radiator it is several amps. The current picked up by the aerial of a radio receiver is only a few millionths of an amp.

So that they may be expressed more easily, electrical units are, where necessary, prefixed to indicate a larger or smaller value of the base unit. These standard prefixes are shown in Fig. 6.

VOLTAGE

Current flow is caused by an imbalance of positive and negative charges. This imbalance may be called 'electron pressure'. The greater the difference between the positive and negative charge the greater this electron pressure will be.

The amount of imbalance is called the 'voltage' — the unit of electron pressure being the 'volt'.

Voltage, being akin to pressure, determines the amount of current flow.

Like the unit for current, the volt is also given suitable prefixes to cover the wide variations in magnitude that can occur in electrical phenomena. The voltage level in a radio receiving aerial will be a few microvolts. Lightning strikes may be in megavolts.

In our torch, each battery provides 1.5 volts. When the two batteries are connected together their voltages add

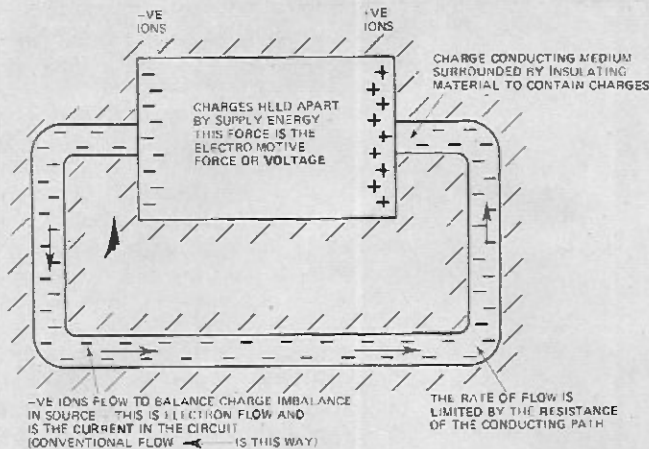

Fig. 5. Current is a flow of charges.

to provide 3.0 volts.

An older term — electro-motive force — is still sometimes used for voltage. Yet another term is voltage potential — or just potential.

RESISTANCE

Electrons inevitably collide with atoms as current flows through any material capable of electrical conduction. These collisions impede the flow of current and cause the material to heat up.

Current flow is also affected by the cross-sectional area of the material, for just like water, more current can flow through a large conductor than a small one.

The combination of these effects — which cause a material to impede the flow of current — is known as resistance. Resistance is measured in ohms, a unit often represented by the Greek letter Omega (Ω).

In many instances resistance is an undesired effect, for by impeding the flow of current, and thus causing heat to be generated, energy is wasted. The leads connecting a car battery to the starter motor are, for example, made of large sectional area and kept as short as possible in order to reduce this wastage of energy.

But in other applications — especially in the field of electronics — resistance is deliberately used to control current, voltage — or both.

Resistors, manufactured for use in electronic circuits, have either a fixed or an adjustable value. Their values of resistance may vary from fractions of an ohm to billions of ohms. A number of typical resistors are illustrated in Fig. 7. (The ohmic value of resistors is usually shown in the form of concentric bands of colour — the relevant code is shown in Fig. 8).

OHMS LAW

We have seen that an increase in voltage will cause an increase in current flow, and that increased resistance will cause a decrease in current flow. Ohm, in the 19th

century discovered that there is an exact relationship between voltage, current and resistance.

This relationship, which has become

Fig. 6. Prefixes of units used to denote small and large numbers.

tera	T	10^{12}	1,000,000,000,000.0
giga	G	10^9	1,000,000,000.0
mega	M	10^6	1,000,000.0
kilo	k	10^3	1,000.0
milli	m	10^{-3}	0.001
micro	μ	10^{-6}	0.000,001
nano	n	10^{-9}	0.000,000,001
pico	p	10^{-12}	0.000,000,000,001
femto	f	10^{-15}	0.000,000,000,000,001
atto	a	10^{-18}	0.000,000,000,000,000,001

Still used but should be avoided:

hecto	h	10^2	100.0
deca	da	10^1	10.0
deci	d	10^{-1}	0.01

For example, $1.85 \text{ M}\Omega = 1.85 \times 10^6 \Omega = 1,850,000 \Omega$

FIG. 8. KNOWING RESISTOR VALUES

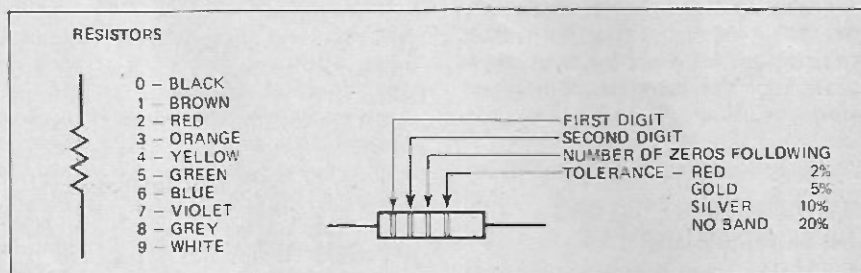

READING THE RESISTOR CODE

Resistors are coded with coloured bands to ease the problem of marking such small components.

The numbers corresponding to the ten colours used and the values per position are:

For example, 180 000 ohms is coded with the first digit brown, then grey and finally yellow. The fourth band indicates the tolerance that the value has with respect to the stated value. For example, silver indicates 10% tolerance meaning the 180 000 ohms could vary between $180\,000 \pm 18\,000$ i.e. 162 000 to 198 000.

These tolerance may seem to reflect poor manufacture but in most circuits they are, in fact, quite satisfactory. Relaxing the tolerance enables the maker to sell them more cheaply.

PREFERRED VALUES

If the maker tried to produce and sell every value of resistance that exists there would be chaos and the costs would be greatly increased. The actual values made, therefore, are limited to a range called the preferred values. These are listed below

The values may seem illogical at first sight, but this is not so. They stem from the fact that the tolerance extremes of a value reach the extremes of adjacent values, thereby covering the whole range without overlap. Values normally available stop in the megohm decade.

Tolerance

	$\pm 5\%$	$\pm 10\%$	$\pm 20\%$
1.0		1.0	1.0
1.1			
1.2		1.2	
1.5		1.5	1.5
1.6			
1.8		1.8	
2.0			
2.2		2.2	2.2
2.4			
2.7		2.7	
3.0			
3.3		3.3	3.3
3.6			
3.9		3.9	
4.3			
4.7		4.7	4.7
5.1			
5.6		5.6	
6.2			
6.8		6.8	6.8
7.5			
8.2			
9.1			

known as Ohms law is perhaps the most basic and certainly one of the most used laws in the whole of electronics and electrical engineering.

From it the designer can determine just how much resistance is needed to limit current to desired values at various voltages, to establish what voltage is needed to perform certain functions, even in the case of our torch, to calculate how much resistance the bulb filament must have to be able to produce the desired light.

Ohms law may be expressed as

$$I = \frac{V}{R}$$

where I = current in amps
V = voltage in volts
R = resistance in ohms

That is, the current flowing in a circuit is linearly related to voltage, and also linearly related to the inverse of the resistance.

Thus if we know any two quantities we may calculate the third, eg, we may find the voltage if current and resistance are known by using simple algebra on the formula. This then becomes:—

$$V = IR$$

Similarly, resistance may be found by using the form:—

$$R = \frac{V}{I}$$

For example, the total resistance of a circuit, in which one volt causes one amp to flow, is one ohm. Or if 10 volts is applied across a resistor of 10 ohms — then a current of one amp will flow.

Conductors and insulators are really so-called because of their largely different values of resistance (for materials of the same size and cross-sectional area). There are also certain materials called semiconductors that do not conform to Ohms law — more about these later.

COMBINATIONS OF RESISTORS

We have seen that if we know the total resistance in a circuit, together with the applied voltage — then we can calculate the current flowing. Often however we will find that there are a number of resistances connected end-to-end (series), or across each other (parallel) — or even mixtures of the two. In such cases it is necessary to work out the 'effective' resistance of the whole circuit.

Resistors in series have a total resistance equal to the sum of each. For example, in Fig. 9 the total resistance is 2050 ohms. Obviously the total must exceed the value of the largest of the resistors — a good check that a decimal place has not been lost.

In our torch, the total resistance is

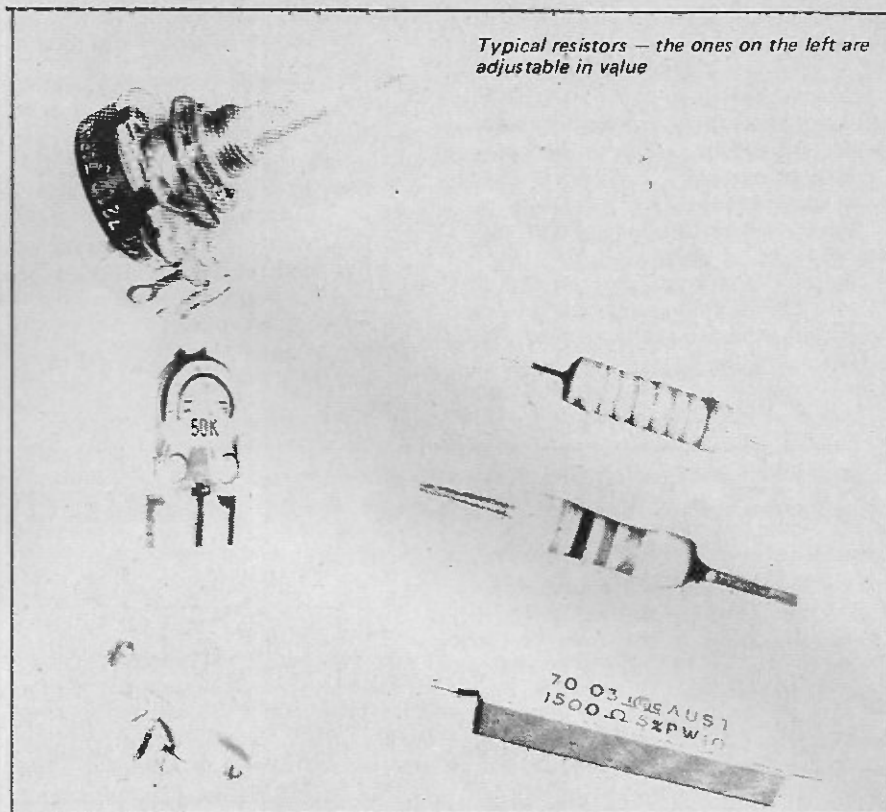

Typical resistors — the ones on the left are adjustable in value

that of the bulb plus interconnecting wires and switch contacts. But here the resistance of the wires and contacts is so small (tiny fractions of an ohm) that they do not significantly affect the total and therefore may be ignored.

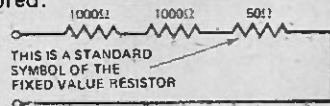

Fig. 9. Resistors connected in series, total resistance is 2050 ohms.

Resistors in parallel are rather more tricky. The rule here is

$$\frac{1}{R_{\text{total}}} = \frac{1}{R_1} + \frac{1}{R_2} + \frac{1}{R_3}$$

where R total = total resistance where R₁, R₂ etc = individual resistors.

Thus the circuit shown in Fig. 10 has a total resistance of 45.45 ohms. (Note that with resistors in parallel the total must always be smaller than the value of the smallest resistor.)

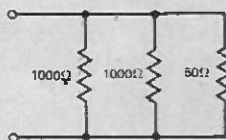

Fig. 10. Resistors connected in parallel. Total resistance is 45.45 ohms.

When a circuit has a combination of series and parallel resistors (Fig. 11 for example), the total resistance can be determined by reducing individual sets in turn. The two parallel 10 ohm

resistors reduce to an effective value of 5 ohms. Thus we now have two five ohm resistors in series — equivalent to 10 ohms. Finally we have this effective 10 ohms in parallel with the remaining single five ohms resulting in a final effective value of 3.33 ohms.

POWER RATING OF RESISTORS

When discussing the energy

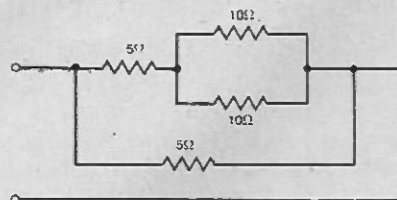
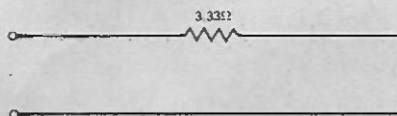

Fig. 11. Combination of series and parallel resistors — their effective resistance is 3.33 ohms — as shown in Fig. 11b.



relationships of black boxes we said that some dissipate power — a resistor does this of course, producing heat energy that is lost. It is essential to know just how much heat is dissipated, for overheating could lead to incorrect operation — or even failure if that resistor was not designed to withstand the heat generated.

Power is measured in units called watts. The method of calculating power dissipated in a resistor is

$W = VI$ where W equals power in watts
 I equals current in amps
 V equals voltage in volts

By substituting the appropriate Ohms Law equation for V or I we obtain two other equations. Thus substituting $V = IR$ we get:—

$$W = (IR) I = I^2 R.$$

Similarly substituting $I = \frac{V}{R}$ we get:—
 $W = V \cdot \frac{V}{R} = \frac{V^2}{R}.$

Hence if we know any two of the three Ohms Law quantities we can calculate the power dissipated in a resistor as well.

For example, a resistor of 1000 ohms connected to a supply voltage of 10

volts has

$$W = 10^2/1000 = 0.1W \text{ (or 100 mW).}$$

Resistors come in various wattage ratings, either as fixed values or variable for use where the value needs to be adjusted. Ratings range from 1/8 W to 25 W and more. The majority of circuitry uses 1/4 and 1/2 W resistors. A point worth remembering is that the rating quoted is the maximum that the manufacturer recommends. A resistor run at that rating gets quite hot. It is good design to use them to only half the rated value. ●

PARTS LIST

- 1 — 12 V battery or supply and connector.
- 1 — 12 V lamp (100 mA to 320 mA) and holder.
- 1 — Miniature relay, 185Ω, two change-over contacts.
- 1 — Relay holder socket.
- 1 — Single pole switch.
- 10 — 1/4W, resistors, assorted say, 47, 100, 470, 1.0k, 1.5k, 4.7k, 10k, 100k, 1M.
- 1 — ORP 12 light dependent resistor (LDR). Hookup wire of assorted colours.
- 1 — Mounting board 24 holes by 3 inch.

ELECTRONICS -in practice

THE best way to learn practical skills is to be actually involved with the hardware. Now is the time to start building circuits in order to learn how to solder properly and to become familiar with components.

If you do not already have them you should purchase a small set of the essential handtools. You will need a lightweight soldering iron, a pair of side cutters, long nose pliers, screwdrivers and preferably an electric or hand drill complete with drill bits.

In this first exercise we will use resistors in conjunction with a device called a relay. The complete circuit is given in Fig. 12 and a list of parts needed for the exercises is given to assist you in purchasing the necessary components.

As this is the first encounter with practice the procedure will be carefully detailed.

The 12 V supply can be obtained by using eight 1½ volt torch-cells placed positive to negative to obtain 12 V. Alternatively, a 12V car or motorcycle battery, or a model train supply, will do in this instance.

The relay is a switching device in which the current flowing in the coil magnetizes a soft iron core which pulls down an armature. The armature in turn mechanically actuates a set of contacts. In the relay specified, the operation of the armature and contacts can be seen through the plastic cover. The relay has two sets of contacts. We will use this component to build many simple and interesting devices.

A switch between the circuit and the battery supply is desirable but not essential for operation.

The coil of the relay specified has a resistance of 185Ω so, if you calculate the current flowing when operated from 12 V, you should get 65 mA. Wire the circuit without the resistor R , and check that the lamp lights when

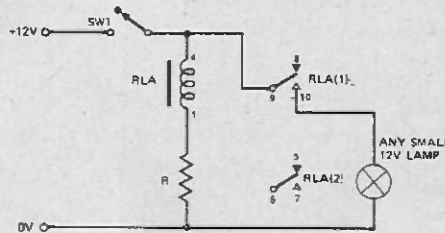
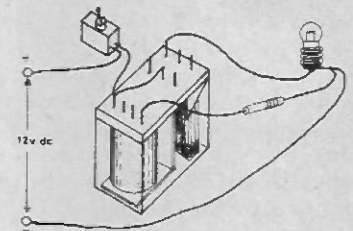

Fig. 12. Basic relay circuit



This sketch shows the actual component connection for the circuit shown in Fig. 12.

the switch SW1 is closed.

Next, place the resistors, one by one,

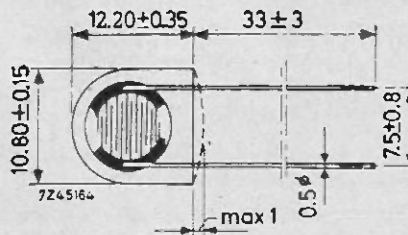

Fig. 13(a). Light dependent resistor (type ORP 12)

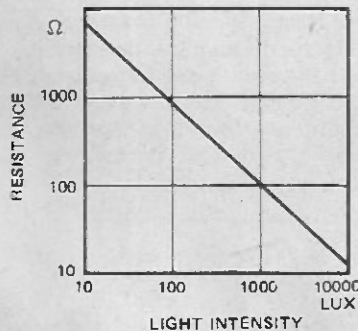

Fig. 13b. Characteristic curve of ORP-12 light dependent resistor.

in series with the relay coil and find the value that just enables the coil to pull in contacts, turning on the lamp. In each case calculate the current

flowing through the relay, and the power-rating needed of the resistor. You should be able to do this by referring to the theory given. Having found the value of R , calculate the voltage that just operates the relay (having found the current flowing and knowing the coil resistance, it is a case of applying Ohms Law). Knowing the voltage required, and the current, calculate the power required to operate the relay. Confirm your results by then using the coil resistance rather than the current.

Understanding Ohms law is absolutely essential and tests such as the above will help provide this understanding.

Having now determined the characteristics of our relay we can use another interesting device, the light dependent resistor (LDR), to turn the relay on whenever light falling on the LDR exceeds a certain level.

This device may be wired in place of 'R' in Fig. 12.

Unlike a normal resistor the LDR changes its resistance in accordance with the light intensity falling on its grid-like structure (see Fig. 13a). The relationship between light level and resistance is non-linear and is best expressed by means of a graph, as in Fig. 13b. Such a graph, as it tells us the characteristics of a particular device, is called a *Characteristic Curve*.

We previously determined the

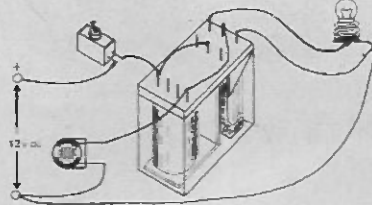
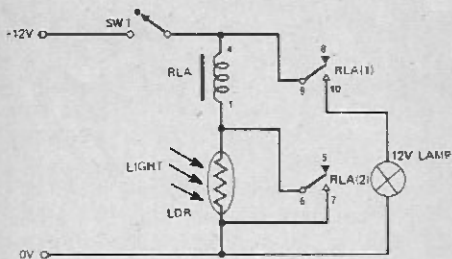

Fig. 14. Replacing resistor *R* with an LDR (see text), will allow the relay to be operated by a light beam. Relay contacts 6 and 7 are used to hold the relay in once it is operated. Omit connections to these contacts if hold operation is not required.

resistance necessary to just operate the relay from a 12 volt supply. By finding this value of resistance on the graph we can look across and down, to find the corresponding light intensity necessary to the relay when using an LDR type ORP 12.

A well lit room is generally around 100 lux and bright sunlight up to 8000 lux or more. The intensity must be higher than the amount determined from the graph for reliable operation of the relay.

Just as for an ordinary resistor, the power dissipated in the LDR may be

calculated. Note however that this must be done for each light level, and that the power dissipation in the LDR rises rapidly as the light intensity increases.

CIRCUIT MOUNTS

There are many ways to construct circuits. The simplest is to use brass or copper plated nails placed in a piece of dry wood. Although this will suffice, it is better in the long run to use a board made specially for the purpose. As the course proceeds we will discuss various

other means.

A good start is to use ready drilled matrix board with hole spacings at 0.25 inches. There are other boards with holes at 0.1 inch centres, but the extra space afforded by 0.25 inch centres makes it easier for beginners. Pins are sold that push into the holes ready to take the components.

The spare contacts on the relay can be used to hold the relay on once it has been operated, even though the light has been removed. This method of operation is called latching. The circuit for this is given in Fig. 14. The normally-opened contacts close when the relay operates, shorting out the LDR. To release the relay operate SW1.

Do not cut the leads of components unless the circuit is to be permanent. Also, do not solder too close to the component body as the heat can damage it.

No doubt you can think of many uses for this light sensitive relay. The contacts can switch currents up to 1 ampere at a voltage up to 100 V. *Do not use it to switch circuits connected to the 240 V mains: it would be lethal.*

SOLDERING

Good soldering is most important — many of the problems that beginners have with their first projects are due to poor joints. The following hints will aid you to become adept at soldering.

1. Purchase a good quality iron with a wattage rating between 15 and 25 watts.

2. Use only resin-cored solder (60/40 tin-lead content). Do not use acid flux.

3. A new, or worn, iron will need tinning. To do this let the iron get quite hot and file the tip smooth to expose fresh clean copper. Quickly, before the copper has time to discolour, apply resin — cored solder — it should flow all over the tip forming a shiny coating.

4. Keep your soldering iron clean. Wipe it frequently with a damp cloth or sponge.

5. Make sure the connection to be soldered is clean. Wax, frayed insulation, and other foreign substances will result in inferior joints.

6. With older components, or copper wire, it will be necessary to clean and tin the individual components before soldering

them together (see 3 above).

7. Attach the wires to be soldered. Do not make more than a half turn in a lead to be soldered — twisting makes subsequent removal difficult.

8. Heat the connection with the iron and apply the solder to the connection. Do not melt solder on the iron and carry it to the joint.

9. Keep the iron on the joint until the solder just commences to flow on the connection. Too little heat results in a high-resistance joint (known as a dry joint) too much causes component damage and evaporates the tin component again causing a poor joint. This step requires practice.

10. Let the solder harden before moving the connection. Then check for a smooth bright joint. A joint that has been moved will have a crystalline appearance, may have a high resistance and will fracture easily.

Good soldering is a matter of practice. If you follow the above hints, it will be only a matter of time till you are making professional joints.



Poor connections look crystalline and grainy, or the solder tends to blob.

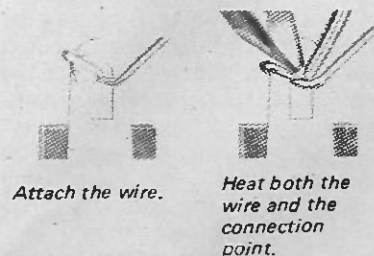

Attach the wire.

Heat both the wire and the connection point.

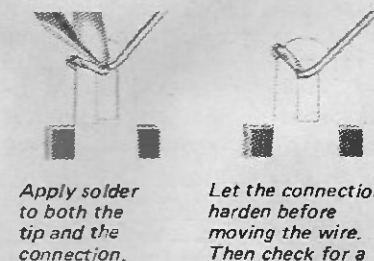

Apply solder to both the tip and the connection.

Let the connection harden before moving the wire. Then check for a smooth, bright joint.

A practical guide to creating and producing your own sound
by Terry Mendoza B. Sc. (Hons).

Fig. 1 Hum Filter (see text)

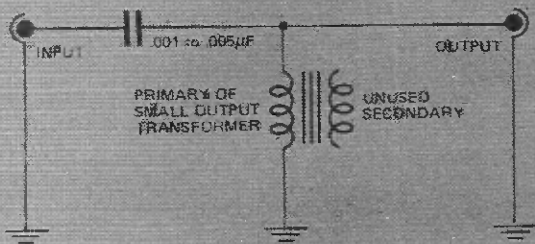
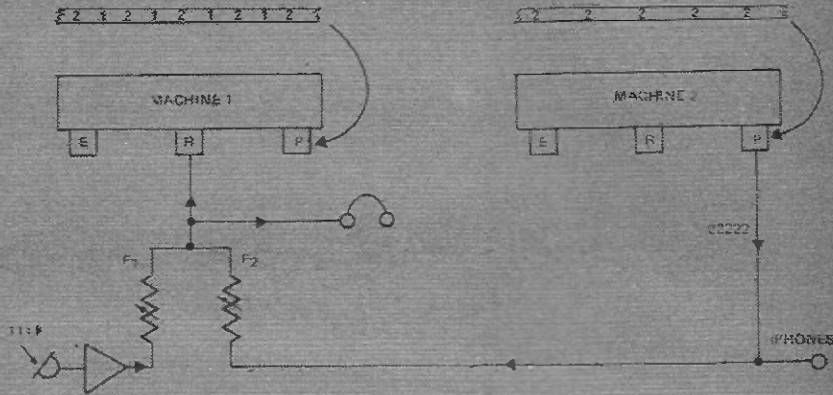

Fig. 2 Simple multi-track set up. Machine 2 plays backing which is combined with new material (via mic) on machine 1.



AS the name implies, multi-track is the technique of combining multiple separate recordings into one composite master.

Its most critical application is in the production of multi-instrumental music, but it may also be applied to documentary creation or drama presentation.

At its simplest, multi-track recording may be utilised purely on grounds of economy — if the recordist is a musician results can be obtained by combining both roles, if the recordist is *not* musically blessed, then at least one musician will be required. It is a great deal easier to find one violinist and re-record him six times than it is to find a willing six-piece violin section.

But having said that, it should be stressed that multi-track music should aim to do *more* than just produce the impression of a number of musicians, where only one had played in reality.

The first problem encountered in multi-track work is maintaining adequate quality. The process involves the copying of signals from one tape track to another in combination with further signals. Immaculate planning is essential, maximising the signal qualities by minimising the number of layers. Another major difficulty is the achievement of the optimal instrumental balance; perfection here

depends on careful listening and plenty of practice.

Let us consider the stages in making a piece of multi-track music before going on to consider the many additional techniques that can be used to add sparkle to the finished product.

THE SCORE

The arrangement and instrumentation are the first things to consider once a tune has been selected. The instruments and any incidental sounds should be in keeping with the mood of the piece; for example, a highly reverberated bass saxophone for a sinister piece and a jangle piano for a comedy one. Most people will initially find it easier to work to a full score; once written it is subdivided, say into bass line, rhythm, melody, counter-melody and 'twiddly bits'. Always bear in mind that *change sustains interest*. combinations of instruments, lead 'voices', musical key and tempo.

RECORDING QUALITY

Clean, demagnetised heads are, as always, essential. The earliest recorded tracks undergo most quality loss, hence one should always work from the least important (or least quality-conscious) instrument, usually rhythm or drums. The last track normally carries the lead. Melody lines

offer the advantage of immunity to extraneous noise, but may be just as susceptible to hiss or mains hum. Where the lowest fundamental pitch of an instrument is above 100 Hz, a simple inductive high-pass filter may be inserted between the instrument and the recorder. Mains hum is most obtrusive when 'double speed' technique is used (replaying a track at twice the speed it was originally recorded), as this raises the pitch an octave, taking the hum well into the audible spectrum. If a filter, such as the one illustrated, (see Fig. 1) is used, it should be noted that the waveform will be affected.

MULTI-TRACK PROCEDURE

A simple set-up is illustrated in Fig. 2. The first track is laid down on machine 1, in the example being considered, this will be a drum track, made by playing different-sized cardboard boxes. It must be recorded at the maximum possible gain just below distortion level and, most important, the timing must be *very* exact. Any timing error on the original recording will throw the rest of the instrument timings out and synchronized playing will be difficult or impossible. Let us suppose we only record six bars of straight 'box rhythm', without any linking 'middle-8' or introductory drumming. A manageable number of bars are accurately cut from the tape and joined to make a continuous rhythm loop, as detailed in the first part of this series.

The existence of very small speed differences between recorders must be acknowledged and, generally, tracks recorded on a particular machine must be replayed on that same one to avoid

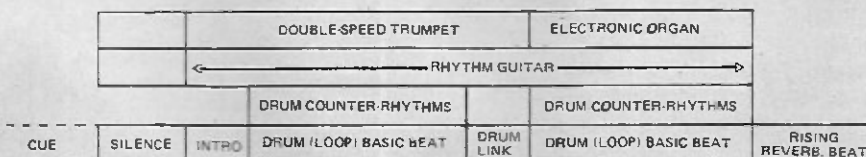

Fig. 3 Graphical representation of final composite master as discussed in the text.

the slight but unwanted pitch change that would otherwise occur. Luckily though, the 'box rhythm' does not have pitch values of any consequence, so the loop can be transferred to machine 2. Monitoring the loop over headphones, *without* feeding it onto the first recorder, a synchronized one beat to the bar is recorded via microphone, leading to a linking passage, still keeping in strict time with the loop. The same goes for an introductory drum passage. Using the same techniques, two bars of cue drumming followed by one bar silence are recorded prior to the true introductory drum passage. Eventually this dummy cue passage will be cut off once the tape is complete, but it serves to enable all the instruments to be fully synchronized from the first bar of the introduction.

The rhythm loop is then fed onto machine 1, via fader 2, ensuring that maximum gain is being utilised. If desired, a more complex rhythm can be recorded simultaneously on machine 1 by opening fader 1 and, using headphones, playing along with the loop replay from machine 2, and balancing the recording levels F1 and F2 against each other. The tape on machine 1 can now be edited to give, in the correct order: cue drumming, one silence, introductory drumming, 'x' bars of composite drumming, linking drumming and 'y' bars of composite drumming.

The chord accompaniment can now be recorded. The introduction of pitch gives the added difficulty that all instruments must be tuned to the same

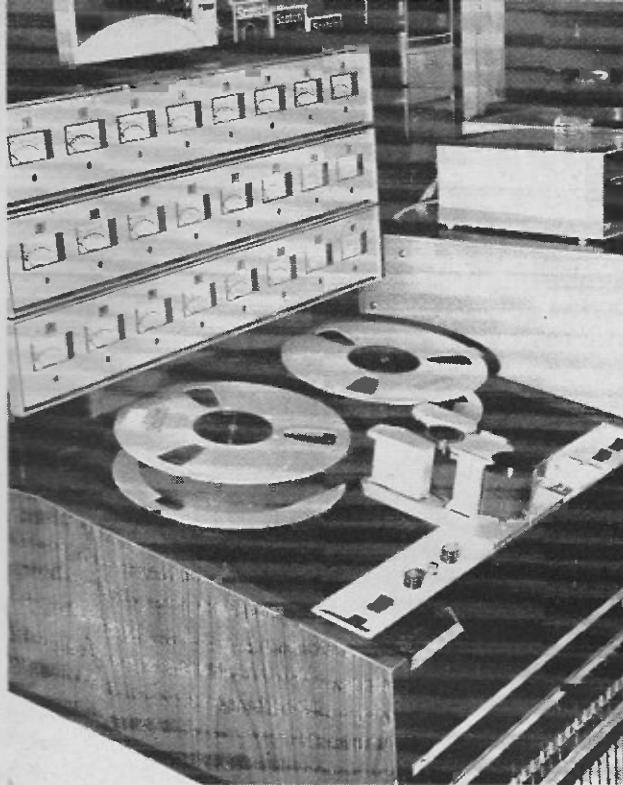

Fig. 4, 24 channel multitrack recorder utilising two-inch wide tape (manufactured by 3M)

scale. When using a 'fixed tuned' instrument (a vibraphone is one example), the rest of the instruments should be tuned to the fixed one, using it as a reference. Let us assume that an electric guitar is to provide the chord rhythm. A fresh tape is laced up on machine 2 and the set-up patched so that machine 1 plays back the completed percussion track and this is mixed with the electric guitar signal, possibly through the hum-filter. The electric guitar is set to give maximum

gain compatible with least aberration of quality and, monitoring the recording inputs of machine 2, the percussion/guitar levels adjusted to give the best balance at the highest undistorted modulation possible.

Monitoring can be carried out over loudspeakers as microphones are not being used; it is recommended that the loudest possible monitor signal levels are used to permit the detection of any less obtrusive flaws in the signal. Once the guitar has been tuned, 30 seconds or more of chromatic 'A' are recorded on the fresh tape — to be used as a tuning reference on later occasions. A few rehearsals at playing along with the taped percussion will be necessary before laying down the next copy on machine 2. Thus the new tape will consist of a tuning period followed by cue drumming and finally the percussion/rhythm track proper. We shall confine ourselves to two lead instruments in this initial experiment, one playing up to the drum link and the other playing the remainder.

At the moment the composite tape is on machine 2, and must be left there due to the pitch considerations already discussed, so the set-up must be juggled around to replay on machine 1 and record on machine 2. Although two lead instruments are to be featured, intelligent planning can permit the exercise to be conducted as only one overall copy.

The overdub of the first lead instrument is carried out normally up to just past the drum link. Machine 1 is then stopped as the first instrument will not be playing in the latter half of the tune. The composite tape on

Fig. 5 Self sync circuit (only one channel illustrated)

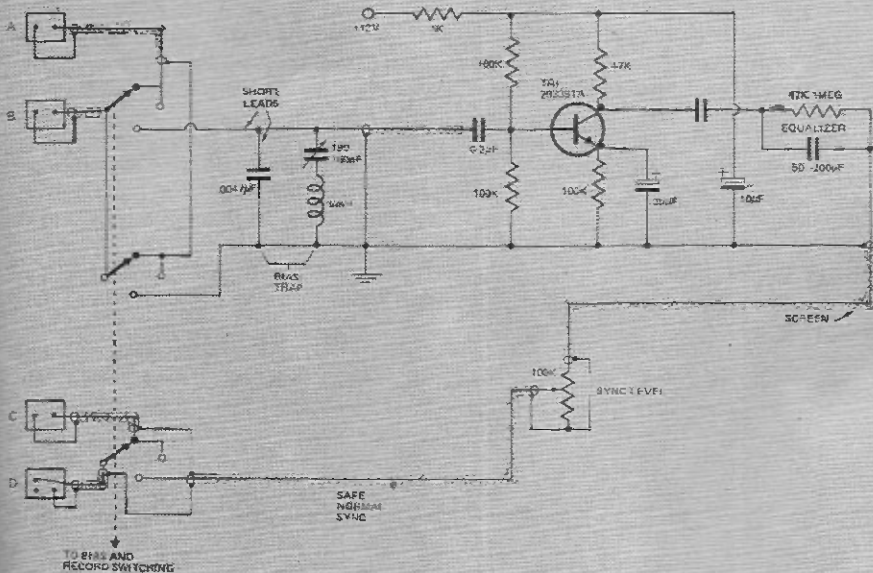

Fig. 6 Economic pan-pot arrangement

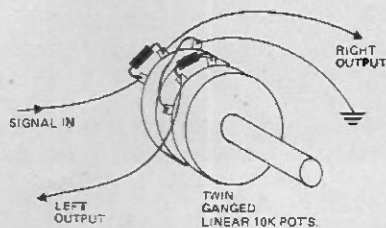
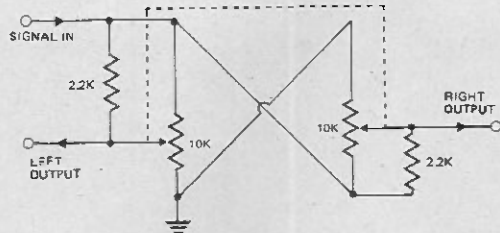
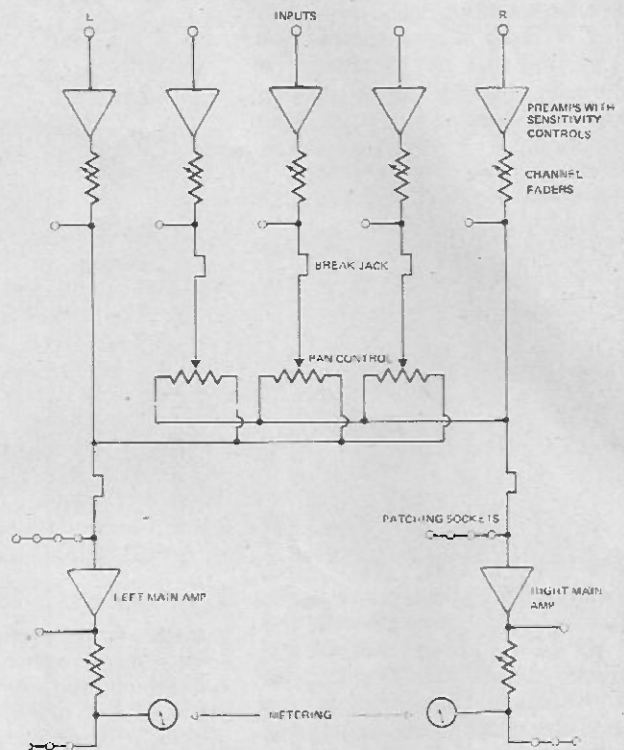

Fig. 7 Simple multi-track mixer design — great flexibility is due to the use of break-jacks and patching sockets.



machine 2 is run back to a short way before the drum link and the second lead instrument rigged up and balanced. Setting machine 1 to record again the second lead instrument is playing along with the backing to the end of the tune. The tape on machine 1 now has two completed halves of a tune. It is now quite simple to splice them together using the drum link from the first half of the recording to allow the ambience of the initial lead instrument to die away.

TRICK EFFECTS

Trick effects are a prerequisite for success in the multi-track process. Let us assume one of the lead instruments is a trumpet. The trumpet can monitor his backing track via headphones or alternatively, a soft talk-back loudspeaker. If the replay and recording machine speeds are both dropped one speed during this overdub, reversion to the original speed will raise the trumpet pitch one octave and halve its characteristic attack and decay times giving an ethereal reedy effect. It also can enable the trumpeter to provide an extremely rapid counter-melody if required, due to the doubling of the replay speed.

We now wish to put a memorable

ending to our tune which at present just tails off after the second lead passage. Returning to the original rhythm loop, the first beat of a bar is cut off and spliced into the middle of a long length of leader tape. This single sound is replayed on machine 2 and recorded on machine 1 whilst simultaneously feeding the signal from the replay head of machine 1 back into the recording channel. This results in the well-known tape-echo effect. The signal will build up to instability if the feedback level is too high, instead of dying away after half a dozen or so repetitions. Trial and error will eventually give the new recording of the single beat a long echo-decay time (to save time it may be an idea to loop the leader and keep re-recording the effect until satisfied).

The newly-recorded effect is now copied yet again, this time removing the power from the capstan motor on the recording machine the instant before dubbing so that although the dubbing still takes place the recording machine tape-drive will be continuously slowing down. This latest copy will consist of a reverberated beat, the pitch and rapidity of which will rapidly rise until it disappears from the audible spectrum. This effect can now be spliced onto the composite

master at the end of the tune and at the position where the first beat of a new bar would have occurred.

It is evident that quality may be maintained over periods where less instrumentation is needed, by splicing in passages from earlier takes; during passages where 'everything is playing' background hiss will not be noticeable anyway.

When all else fails, one neat trick is to cover the hiss by overdubbing a final track of rolling cymbal and snare-brush.

To avoid bringing up hiss, any fades or quieter passages should be made so on the last practicable dub.

Although double-speed has been mentioned earlier, half-speed is just as valid a technique, i.e. doubling record and replay speeds whilst adding an extra voice. It is a difficult proposition however, as one has to synchronise with the extremely rapid (double-speed) tempo and the result, though it is one octave lower, tends not to be very accurate. The principal use of half-speed is with the acoustic electronic dubbing link for 'cavern' reverberation, as detailed in Part 1 (see p.39).

EQUIPMENT POSSIBILITIES

The foregoing description has

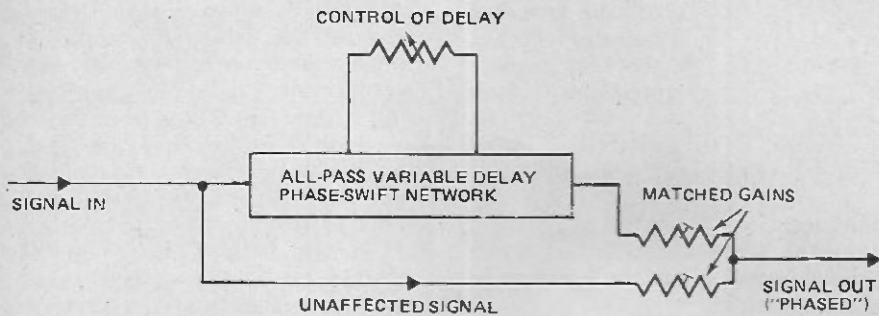

Fig. 8 Block diagram of electronic phasing system

assumed the use of two mono recorders, so it should be stated that virtually the same capabilities may exist on a versatile 3-head stereo recorder.

All professional multi-channel tape recorders are equipped with self-sync. facility, that is to say previously recorded material may be monitored through the recording head so new tracks being laid down are in synchronisation with the existing ones. Hence only after sixteen or even twenty four tracks have been laid down, will one copy be necessary — to provide the final stereo master — and quality will naturally be at a premium. Fig 4 illustrates a recorder of this type.

Figure 5 illustrates a circuit suitable for use with one channel of a stereo recorder (the preamplifier was designed with an input impedance characteristic matching a nominal 3000 ohms at 1000 Hz. The record function is disabled in the 'safe' mode and the other two modes are self-explanatory. The equalizer introduces a complementary high frequency boost to compensate for the high frequency roll-off due to the relatively large record head-gap, in comparison with the much finer replay head-gap. Self-sync'ing on a stereo machine gives the undoubted advantage that two independant tracks can be laid down before the first dub becomes necessary, i.e. when transferring this recoding to a second recorder in combination with a new instrument.

A second stereo deck will allow stereophonic multi-track music to be accomplished, but to achieve a true stereo effect, as opposed to a left/right ping-pong situation, some form of stereo routing is necessary — a 'pan-pot' or panning-potentiometer. The sensation of linear 'aural movement', in common with all our senses, is dependent on the existence of a logarithmic/antilogarithmic relationship between the sound levels reaching our two ears. The pan-pot must mimic this gain relationship; one way is to use a pair of ganged back-to-back log/antilog potentiometers. These tend to be prohibitively expensive as it is very

difficult to make such potentiometers track accurately and match well. A far more economical solution is illustrated in Fig. 6; ganged linear potentiometers are utilized with the linear law distorted to a log law (approximately) by a pair of low value load resistors.

MIXING

The simple mixing circuit illustrated in Fig. 2 will be found in all reasonably equipped recorders, mono or stereo. Active mixing is always to be preferred to purely resistive mixing in all types of audio work. An ideal specification of a multi-tracking mixer might run as follows:

Five channels, three with pan-pots to two output groups. two direct channels, one feeding only the right hand side and a similar one for the left; variable equalisation, sensitivity, and feedback for monitoring can be useful on each channel, and break-jacks at each stage of the mixer channels so that limiters/compressors, reverb. units etc. can be patched in at will. (See Fig. 7.)

The mixer designs previously published in ETI offer a useful guide to possible circuitry.

HALF TRACK EFFECTS

A whole range of unusual effects are possible when a half-track stereo

recorder is used. When there is a narrow spacing between record and replay heads and a high tape speed is chosen, a "parallel wall" single echo can be achieved by simply dubbing from one track to another, then playing the original and the copy (i.e. both tracks) simultaneously. More startling results are obtained by pan-potting the two tracks around the stereo field whilst they are being copied onto a second stereo recorder.

If the spools are swapped over after making a recording 'reverse play' will be obtained — an interesting effect as the attack and decay are transposed. A reversed drum rhythm loses its percussiveness and is transformed into a rhythmic pattern of whooshes; a piano track similarly treated assumes an organ-like attack characteristic.

If a reversed passage is tape echoed and the echoed piece then restored to its rightful direction, the outcome will be the conventional original track with each note *preceded* by a swelling 'echo' of the note — its pre-echo. Softly strummed guitar gives an effect not unlike the flamenco style of playing.

TAPE SPEED

When carrying out a recording with conventional tape-echo, if the tape speed is adjusted by gently pinching the tape as it enters the sound channel, an eerily different sound is obtained due to the varying discord set-up between the music entering the recorder and the pitch of the tape-echo.

An eccentric capstan, produced by building up a layered lump of splicing tape on one side of it, will impart a warble to any tape played or recorded on it — indeed some of the cheapest tape machines seem to have this facility already built-in!

The relationship between replay (or recording) tape speed and pitch has

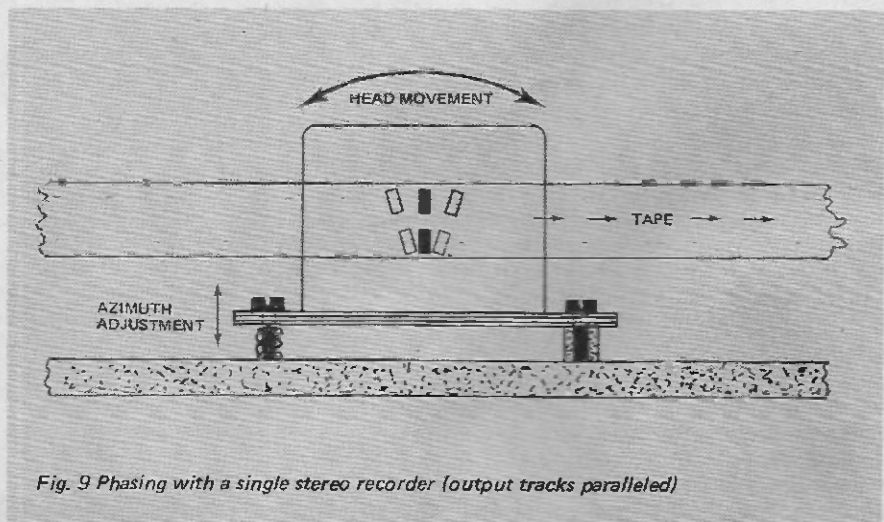

CREATIVE AUDIO

long been one of the most important tools for music concrete. A single note, or noise replayed at different speeds, will provide a chromatic scale of notes which can be edited to perform any desired melody. The origin of the effect may have been anything from a bedspring to a pneumatic drill! It is usually edited into a loop which can then be played on the variable speed machine.

Tape machines may be modified in one of two ways to suit them to this type of work:

1. Mains synchronous capstan motors may be amenable to powering by an auxiliary unit which is essentially a variable frequency sine wave source (with suitable amplification).

2. Different radii capstan sleeves may be bolted to the main capstan — finely engineered sleeves offer the less drastic alternative but have the drawback that glissando effects are impossible.

EXTENDED LOOP FEEDBACK

Where musicians prefer to ad-lib, instead of working to a full score, this process is most effective. It is based loosely on conventional tape echo which, to recap, is the feeding back of a replay of a newly recorded signal to the record head at a slightly lower level, so that although perpetuated, each repetition is at a lesser magnitude. If the small gap between the record and replay head is now expanded to around five seconds worth of tape, a newly-recorded musical statement will take five seconds to get to its first repetition and re-recording. This gives the musician adequate time to accompany himself on the re-recording and continue the process ad infinitum or until he makes a mistake — when this happens the error crops up every five seconds as well!

The procedure is easier to carry out with two recorders, the first one recording and the second replaying, although it should be feasible on a single 3-head machine if a lengthy loop is taken out between the record and replay heads. In the former case the recorders are spaced the required distance apart, using chair-legs as necessary as additional tape guides. The tape is taken through the first sound channel, thence across the room and through the second sound channel, with the take-up spool placed on the second machine. Head cleanliness is essential and so is very careful setting of the replay and record controls of both machines. If the replay setting is too high the composite tape will get continuously louder until it enters distortion, and if too soft the initial passages will

quickly get lost under tape hiss. The fine balance point between the live music being fed to the first machine and the taped accompaniment from the second machine can only be determined by experiment. A useful dodge is to repeat earlier musical statements occasionally as this reinforcement will prevent them becoming fuzzy and indistinct which otherwise results as the number of copies increased.

PHASING

Phasing or skying gained popularity in the 'psychedelic' era and is still with us; it consists of combining a signal with itself, delaying one part by a short variable amount. The frequencies within the signal which have been delayed by $\frac{1}{2}$ wavelength will cancel, and the others will be subject to varying degrees of cancellation or reinforcement, depending on their phase relationships.

Altering the delay between the signal and its time-shifted counterpart affects the phase relationships and alters the "phasing" sound.

There are legion methods of producing phase, and a few of the commoner ways are outlined below:

(a) Electronically (Fig. 8), a signal is fed to an all pass phase-shift network, the shift being governed by a single potentiometer. The output of the network is suitably attenuated to be combined at equal gain with the untreated signal.

(b) Using a single stereo recorder (Fig. 9) the signal is recorded simultaneously on both tracks. On replay the head is moved in a direction parallel with that of the tape movement, using the azimuth adjustment screw, and the two output channels are combined.

(c) Using a 2-head mono machine (Fig. 10), an additional head is wired in parallel to operate on the unused track, the lower one if it is a half track recorder. The recording is made on a clean tape. During recording or, if

preferred, on replay, a loop is induced between the two replay heads using some kind of swinging guide arrangement.

(d) Using one stereo recorder and one other recorder; this method is very effective and requires no special construction, but total success is rarely achieved, and an edited combination of various takes is often the best solution.

The material to be phased, preferably with some sort of cue for signal synchronising is placed on the second recorder and carefully copied onto the lower track of the stereo (first) machine. Both tapes are rewound and the lower track copy routed so that it can be copied onto the upper track in combination with replay of the tape still on the second machine. The levels of both tapes are balanced and the second recorder paused at the cue signal. The stereo recorder is started (lower track playing, and upper track recording) and as the cue from the lower track is heard the second recorder is released. The two tracks will probably be well out of synchronisation (giving a parallel wall echo type effect) and, by slowing down or speeding up the tape on the second machine with a hand respectively placed on feed or take-up spools, synchronisation is gradually achieved. The material goes through its most intense phasing just prior to sync. and jockeying the spools will cause the pitch of the effect to rise and fall.

Whichever technique is adopted, the phasing will be *least* effective with simple, pure tones, and *most* effective with complex harmonic signals i.e. fuzz guitar, cymbal and drum percussion.

To conclude, multi-track is a highly creative art which relies on imaginative scoring, playing and engineering, well maintained equipment and plenty of patient practice.

Next month we shall be looking at documentary compilation. ●

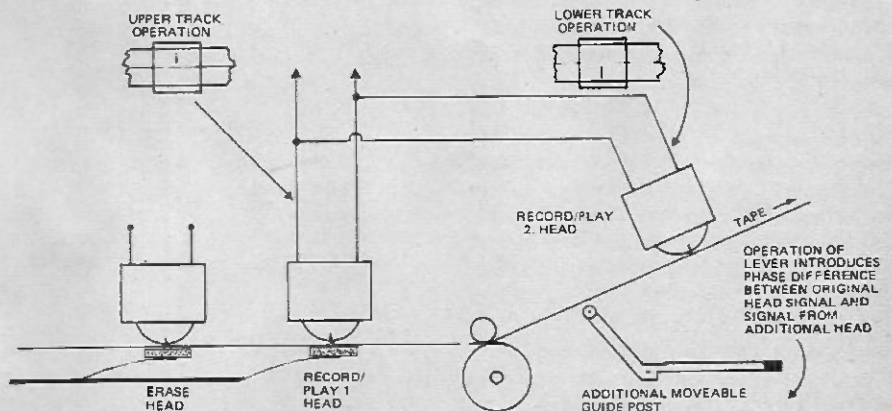

Fig. 10 Phasing system for use with 2 head mono machine

DX MONITOR

Compiled by Alan Thompson

It is pleasant to note that the first day of March is, so far as meteorologists are concerned, the first day of Spring as well as being the day on which Welshmen throughout the world celebrate the birthdate of their patron Saint David. Perhaps this year, more than usual, the end of winter will only be moaned by the small boys who see in its passing the start of an endless (to them) wait until the return of Guy Fawkes day and the chance of days of ice and snow are here again. Older folk will be less sad to see the days lengthen and the sun regain some of its warmth.

In some ways, Spring marks the passing of the DX season for another year because the high days of Summer are, in general, not the time for really superb DX catches. However, the period around the Spring equinox often provides some really good DX conditions in the early evening hours, especially towards Africa on which continent our spotlight is beamed this month.

Throughout the year there is no real difficulty in hearing African radio stations on the international shortwave bands and there is little point in giving frequency and time details owing to the time passing between this piece being written and its appearing in print. Suffice it to say that the 19, 25, 31, 41 and 49 metre bands all carry their quota of African stations and in reasonable reception conditions it is possible to log some 10 or 15 countries in that continent in the course of just one evening's listening. Major "African" broadcasters to be heard in the international bands, with broadcasts in English, include Ascension Island - where B.B.C. has its "Atlantic Relay Station" - the Arab Republic of Egypt; Ethiopia - from where the Radio Voice of the Gospel, ETLF, operates - Ghana; Liberia - two distinct English language broadcasters in this small West African republic use the international bands. Firstly, the Voice of America has a relay base at Monrovia, and, secondly, Radio Station ELWA may be heard airing missionary programmes from the same city - Morocco (with a Voice of America relay base at Tangier); Nigeria: Rwanda (where the West German overseas broadcasting organisation, Deutsche-Welle, has a relay base at Kigali) and the Republic of South Africa.

Those are the easy-to-hear stations and countries but there are something like 60 separate radio countries in the African continent and some of them, e.g. Tristan da Cunha and St. Helena, are, for all practical purposes, incapable of being heard in the British Isles. However, with a fair amount of effort and a good measure of luck it is possible to log a very high proportion of those 60 so let's have a look at the when and where of DXing some of the less common ones.

Z stands for Zambia and whilst you may be fortunate enough to hear its External Service after 1600 GMT (usually on 17895kHz in the 16 metre band), you are more likely to log this country by means of its Home Services. The best frequencies to try are 3346 and 4911kHz and the ideal time is about an hour each side of dusk in the Spring period. Next door to Zambia stands Rhodesia, which is often audible at the same time (and on the same days of good propagation) as Zambia. This one, too, is usually captured on the 90 or 60 metre bands, and frequencies worth a try are 3396 or 3306 in the 90 m.b., and 4828 or 5012kHz in the 60 m.b. Staying in the same part of Africa, if you manage to hear either Zambia and/or Rhodesia then its time to try for Malawi - the best frequency for this is 3380kHz and Radio Blantyre is often heard somewhat later in the evening often coming to a peak around 2000 to 2100 GMT.

Moving across to the west side of the continent we find a mass of countries in the bulge inwards of the land-mass around the Gulf of Guinea. A nice little group of domestic services can be found in a space of just under 20kHz on the 60 metre band - at the lower end, Radio Yaoundé operates on 4972.5kHz, with one of the two Radio Ghana home services on 4980kHz and Radio Nigeria's Lagos Home Service transmitter using 4990kHz. Sandwiched amongst that group you may be lucky enough to locate Radio Uganda on 4976kHz, or, more difficult, Radio Tananarive in the Malagasy Republic (the current name of Madagascar) on 4985kHz. Lastly, should you hear a station in Arabic on 4994kHz it is probable that



it will be Radio Omdurman in the Sudan which used this channel for years before moving to 5038kHz: stations have a habit of returning to old channels and 5038kHz is not the best of channels so Omdurman could well make another frequency move.

One of the easiest West African stations to log in late evening is Radio Abidjan in the Ivory Coast. Whereas, the previous group are normally at their best from about 1800 to 2100 (indeed, some of them close at around 2100), Abidjan comes into its own after Radio Kiev vacates 4940kHz at 2200 GMT and then has programmes of lively national music to round off its day. The I.F.R.B.'s "Tentative H.F. Broadcasting Schedule" for the period starting in March is not published as these notes are being written (hence the absence of international band frequencies throughout this article!) but Abidjan has been using 11920kHz for a number of years and its 100kW transmitter puts in excellent signals on most evenings.

From the fairly easy to two of the more difficult! Sierra Leone, the Land of the Lion, is one of the REAL DX catches for African DX fans, as the only frequency used which will propagate to the U.K. is now 3316kHz, a channel occupied by a utility station (which works long, hard and strong!). Try (and that's the operative word!) around about 2100 to 2300 GMT - it took me 3 years of listening just about every night until suddenly there it was and at good strength, too! Gambia is a little less difficult and this one, too, has only one frequency that offers a logging. 4820kHz carries its Home Service over a transmitter of just 3.1kW and to make things worse most of the programming is in local languages. The English identification is "This is Radio Gambia broadcasting from Banjul", the name of the capital having been changed about a year ago.

Last of all in this round-up of African DX, Spanish Sahara is one of the real so-and-so's to hear on shortwave. It can sometimes be heard throughout the evening on 7230kHz in periods when that channel is not being used by one or other of the European broadcasters, but it is seldom better than fair - the language used is Hassania, a derivative of Arabic with many Spanish importations, and there are news relays (one at 2100 GMT) from the studios of RNE in Madrid. Another place to try for this one is 4627kHz where a point-to-point link between El Aaiun and Villa Cisneros operates (sometimes in AM and sometimes in SSB) using a 5kW transmitter. The PTP link is in operation irregularly so don't be surprised if you don't log it at first try.

Good luck with your African Safari! DXing Africa is fun and the Spring evenings are ideal for it so why not have a go and let me know how you get on. My address is 16 Ena Avenue, Neath, Glamorgan SA11 3AD, and if you'd like to see your best African (or any other for that matter) QSL in print, send along a good black-and-white photo and ETI will pay £1 for every one we use. Photos can not be returned and colour pics are not suitable for reproduction. Send your photos to me together with a few words about this station and your logging: leave the rest to us and you could be a £1 better off! Need I say that the rarer the QSL the better the chance of its being used, so now's your chance to get into print with that QSL that came from a lucky fluke or from real, concentrated, hard graft. Until next month, then, over to you, and from me, 73.

Electronics by John Miller-Hickpatrick Tomorrow

NOW IS THE TIME to think about Christmas presents; at this time last year pocket calculators were at about the £80 mark but a lot of £20-£40 calculators were given as Christmas presents last December. Next Christmas you will have the choice of two digital presents, a pocket calculator at £16-£20 or a digital watch at less than £100.

Although calculator prices have tumbled in the past year, the basic price of a calculator is not the complexity of the chip but the cost of the case, keyboard and display. Until someone comes up with new techniques of cheaper production of these items, the basic cost of a calculator is going to be about £10. It will be interesting to see if the basic four function machine will disappear completely as the price of machines like the new Sinclair Executive or the Sinclair Scientific slowly drops to the area of £20 by this time next year.

In August 1972 the Hamilton Watch Corporation produced 500 digital watches called the *pulsar*. Some of you may have noticed Roger Moore

wearing one in 'Live and Let Die', it was a typical James Bond watch at a price of £1000. At last year's RECMF show in London, Solidev launched their digital watch at a price of about £200, very similar to the pulsar. The watch used LED readouts and to conserve battery power a button had to be pushed in order to read the time. The logical readout to use is liquid-crystal which consumes power in microwatts but these devices require 50V peak-to-peak a.c. in order to operate efficiently. However, a new type of liquid-crystal has now been produced and tested to an extent to satisfy watch manufacturers. This is the Twisted Nematic crystal which relies on a polarising system and requires only a few volts to operate.

The availability of such a display has persuaded Cal-Tex of California to produce a chip to provide digital clock/watch functions and drive low voltage liquid-crystal devices. The chip, designated the CT6002, is available in five different packages - the die, a 34-pin Flattie, 40-pin DIL, a module ready for casing and the com-

plete watch with strap, etc. The completed watch will be available in a few weeks at about £150-£200 but the author has already built a clock using the Flattie package and it runs from nine hearing aid batteries and should continue to do so for several months.

The CT6002 is a single chip complementary MOS circuit that contains all of the logic necessary for a digital readout wristwatch using a field effect liquid-crystal display. Designed to operate directly from a single 1.5V silver oxide battery, the chip contains an inverter for the quartz crystal oscillator, countdown chain, minutes and hours counters, seven segment decoders, level translators/drivers for the display and active components that can be used to form a regulated power converter. The chip applies a.c. drive to the individual segments of a 3½ digit display, giving a presentation of minutes and hours based on a 12 hour cycle. In addition a signal is provided to turn the colon or decimal on and off at 1Hz.

The timekeeping abilities of the

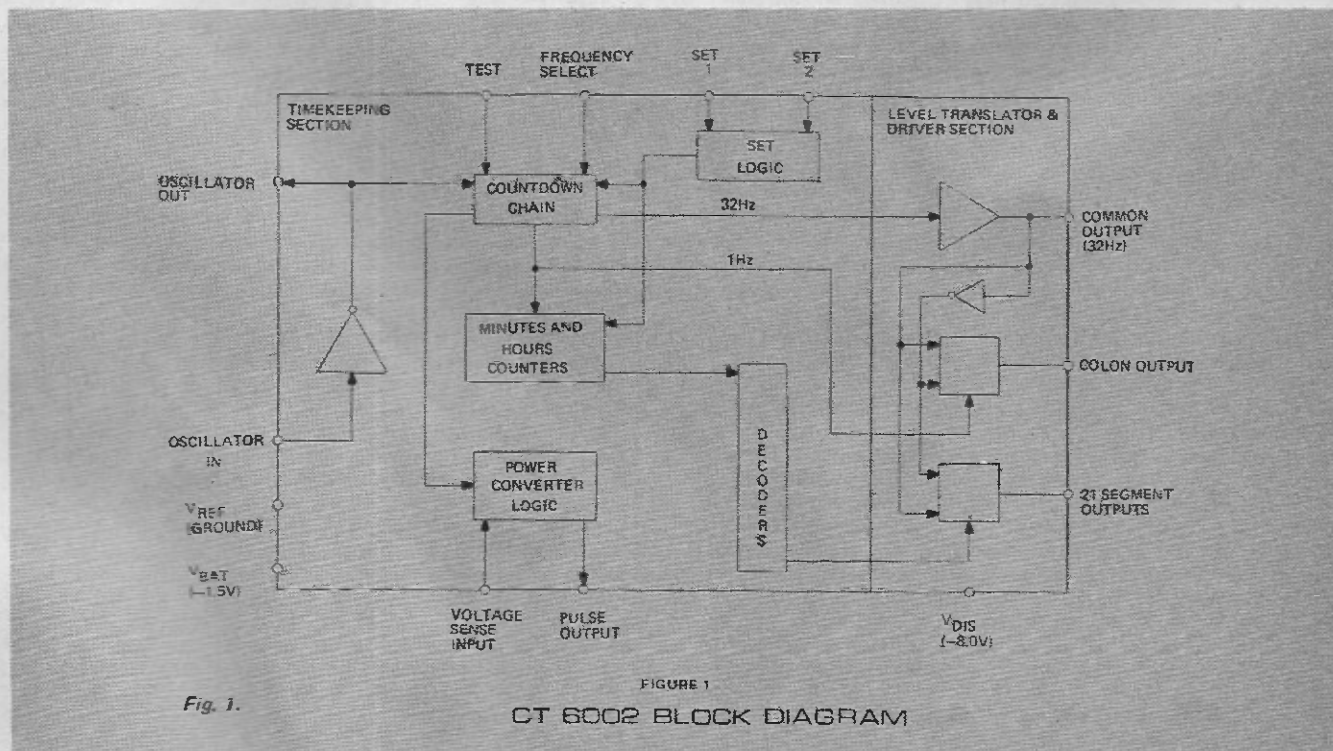

Fig. 1.

FIGURE 1

CT 6002 BLOCK DIAGRAM

ANOTHER 555 SOURCE

Although industrial supplies of the 555 timer are a little easier than they have been recently, it seems that yet another company has decided to second source this little device. The 555 was first introduced by Signetics and second sourced by National, Motorola and now by Raytheon. Jermyn have stocks of the Raytheon 555 timers in mini-dip (8-pin) packages. The 555 can be used as a conventional timer with a period from microseconds to hours, as an astable or monostable multi-vibrator, as a missing pulse detector, as a pulse width modulator and in many other circuits and system configurations.

Raytheon 555s from Jermyn, Vestry Estate, Sevenoaks, Kent.

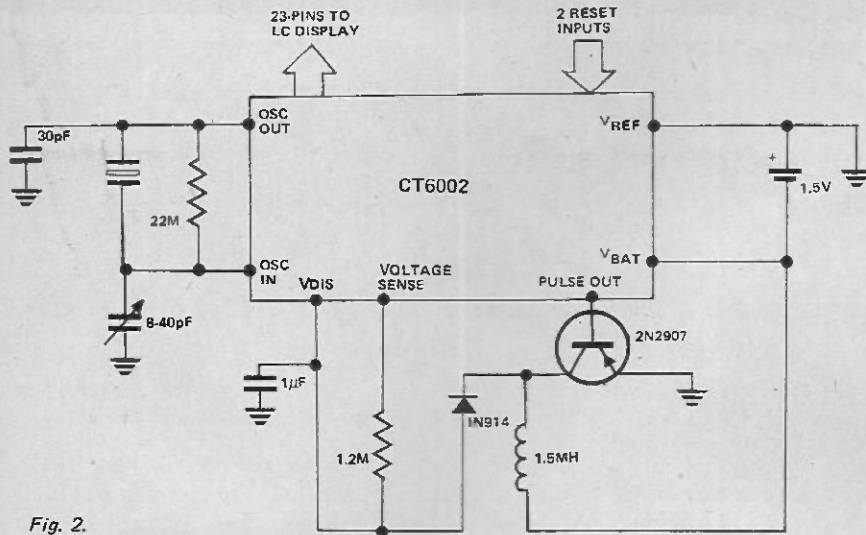

Fig. 2.

CT6002 begin with a quartz crystal oscillator; a complementary inverter is provided with accessible input and output. The frequency of the crystal can be either 32,768Hz or 65,536Hz because the length of the countdown chain can be altered by the frequency select input to give either a division by 216 or 215.

Two switch inputs allow setting of the watch in three modes:-

1. Advance hours at 1Hz rate, minutes counters continue counting.
2. Advance minutes at 1Hz rate, hours counters held.
3. Hold existing display and reset seconds counter to zero.

The a.c. drive for the liquid-crystal display is generated from the 32Hz square wave in the countdown chain. The 32Hz waveform, like all logic levels on the chip, has an amplitude of 1.5V. In order to drive a liquid-crystal display the amplitude must be changed to about 8.0V, therefore the 32Hz square wave is passed to a level translator and driver circuit. This new 32Hz signal is passed to the common output terminal to be passed on to the backplane of the display. At the same time the signal is inverted and passed to the 22 segment output drivers. In response to low-level logic signals from the timekeeping section of the chip, the output drivers apply either the true or the complement of the common output voltage to the segments of the display. If the true waveform is applied then the voltage differential between the common backplane and the segment is always zero and thus the segment is 'off'. If the complement of the waveform is applied then the backplane will vary between -8V to +8V, whilst the segment voltage goes from +8V to -8V and thus the segment will be 'on'.

The 8V required can be provided from separate batteries or from a power converter which requires only a few external components to generate the higher voltage. This works by using a voltage sense input which gates a pulse output. The pulse output is amplified by a transistor and passed to a transformer or other inverter and to a small reservoir capacitor.

The voltage on this capacitor is sensed by the voltage sense input which in turn can gate the pulse output to increase or decrease the capacitor voltage.

The CT6002 can be obtained through Bywood Electronics, 181 Ebbens Road, Hemel Hempstead, Herts. Prices of the chip, the liquid-crystal and the quartz crystal makes this as expensive as a clock at present but perhaps someone will do a constructional article when prices drop a little.

THIS MONTHS SPECIAL OFFER

Hands up all of those that can think of a novel use for the 741 Op Amp that has not previously been published. The author searched and asked all over the place for examples to publish with this article to show the uses of the devices offered this month but found that this and other magazines had covered most of the applications as level detectors, audio amps, MOS-TTL-MOS interfaces etc. All we can say is that our benefactors this month are B. H. Component Factors and that they are offering three brand new 741s for the princely sum of £1 including VAT and P&P. The offer is limited to 1000 devices or 333 packs and as the 741 normally retails for 40p this is likely to be a well subscribed offer. As usual, please enclose an s.a.e. for return of your money if the offer runs out before your order arrives.

SPECIAL OFFER

To B. H. COMPONENT FACTORS
61 Cheddington Road,
Pitstone,
Nr. Leighton Buzzard,
Beds. LU7 9AQ.

Please supply three 741 Op Amps as mentioned in Electronics Today International, March 1974.

I enclose cheque/M.O./P.O. for £1 to cover the cost of the components, VAT and Post & Packing.

Name

Address

Offer closes 30th April 1974 or when 1000 Devices have been sold.

NOISE-CANCELLING MICROPHONES

AB Pearl Mikronlaboratorium, a Swedish company, have announced noise-discriminating microphones, available in two versions in the UK. The military version (Model M68) features a noise-discriminating ceramic capsule, which reduces background noise by 80 to 95%.

This lightweight robust hand microphone is suitable for use in situations where high ambient noise, or feedback, or a combination of these, prevents the use of normal microphone techniques. An internal amplifier provides a high output line level (4.5V).

The frequency response of the M68 is restricted to the range 500 to 5000Hz. An alternative version (ND68) is available with an extended low-frequency response. An additional feature of this model is the thumb-operated volume control mounted on the microphone body.

Allotrope Ltd, 90 Wardour Street, London W1V 3LE.

SINGLE AXIS LOW POWER MAGNETOMETER

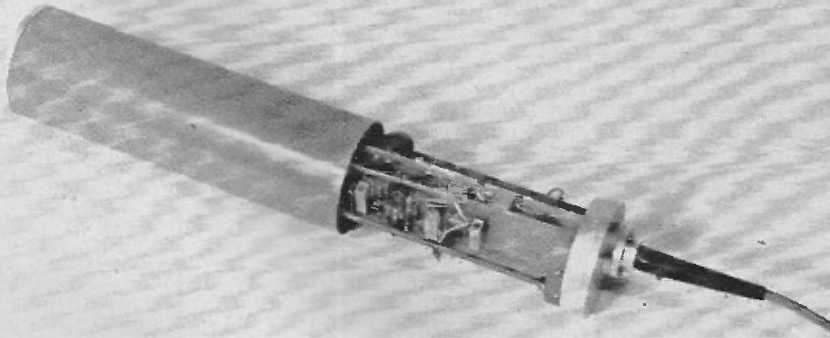

Thorn Automation has recently introduced a single axis, low power, low cost magnetometer. The unit - the S.A.L.P. magnetometer - has been designed as a compact, low power consumption, sensitive magnetometer. The unit requires 6V d.c. and consumes approximately 100mW.

The S.A.L.P. magnetometer can be used for a variety of applications. For example, general use as a moving anomaly detector; industrial applications, including detection of small steel components, steel bolts in rubber belts, ferrous materials in brass, magnetic inclusion, testing for magnetically clean areas for tooling control, quality control exercises, medical applications including respiratory monitoring especially for premature

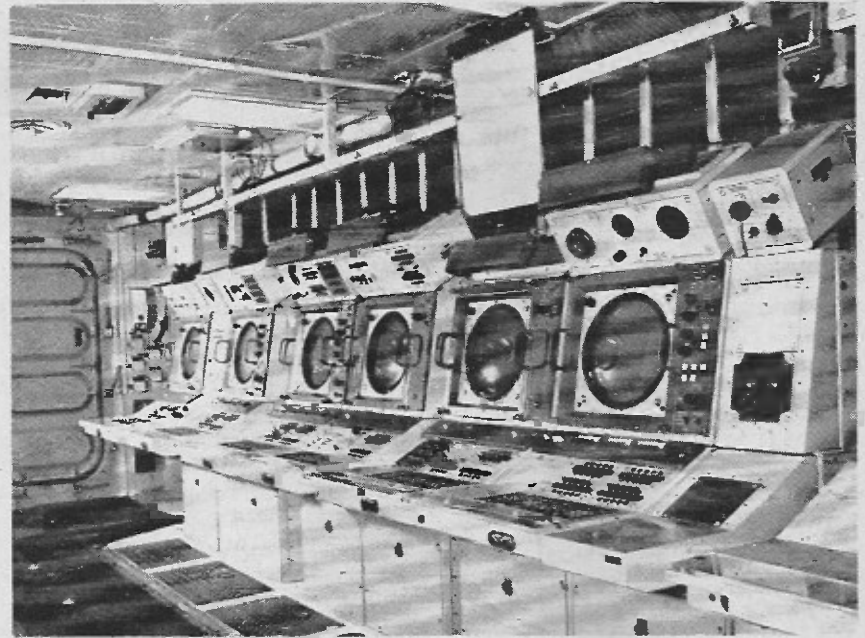

Pictured above is the Plessey Radar digital display equipment which forms part of the Action data Automation (ADA) Weapon System aboard HMS Bristol, Britain's latest guided weapon destroyer, HMS Bristol is the Royal Navy's first operational vessel to be so fitted. Her action information organisation is designed around the Plessey display system which incorporates a comprehensive fit of display consoles for detection, tracking and engagement of targets.

NEW FIRE ALARM SYSTEM

Any Fire Alarm System is only as good as the sensors which it employs and the cables which transmit the information from the sensor back to the control unit. Whilst the sensors are covered by a variety of minimum operating standards the cables are normally left to the installation or at best are recommended to be "protected".

The new Fire Alarm System announced by Photain Controls Ltd. of Randalls Road, Leatherhead provides for complete protection of the external sensor cables as a standard feature and any "break" or "short" in the cables results in the alarm operating immediately. This is achieved by fitting a "Loop Sensor" at the end of the cable run which balances the circuit. A "break" or "short" in the cable puts the circuit out of balance and operates the alarm.

The Control Unit is solid state and is contained in a pressed steel housing 9in. x 6in. x 4in. and is complete with a "mains on" indicator light and key on/off switch. It contains fully floated Nickel Cadmium batteries providing 24V at 0.5A and a battery charging circuit.

The standard batteries will maintain the operation of the system in the event of a mains supply failure for over 72 hours and will operate 3 alarm bells or electronic sirens for over 30

babies and other applications including vehicle compass development.

The major feature of this magnetometer is the automatic balance system. The auto-balance allows the magnetometer to detect variations of magnetic field in three range ± 1000 gamma, ± 100 gamma, ± 10 gamma, in a static field of up to 60,000 gamma. The selected range, selected by a link in the unit gives an output of $\pm 1V$ for each range, between 100V/Oe and 10,000V/Oe.

The S.A.L.P. unit is completely self-contained and includes two printed circuit cards, between which is housed the fluxgate. Size is 7in. long x 2in. diameter.

Thorn Automation Ltd, P.O. Box 4, Rugeley, Staffs.

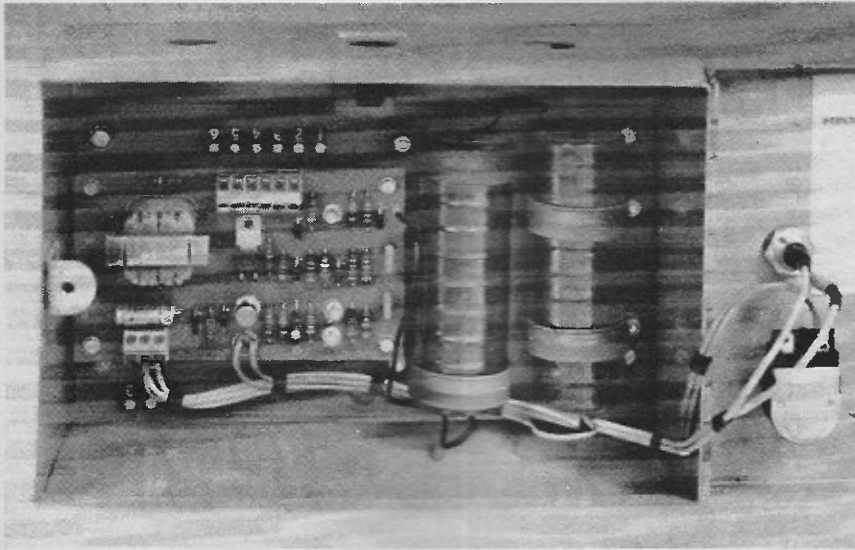

ELECTRONICALLY CONTROLLED TRANSMISSION FOR CARS

A new electronically controlled automatic transmission system for cars has been developed by Associated Engineering Developments (Cawston House, Cawston, Rugby, Warwickshire.

The company has granted an option to Volkswagen to licence the system for use in cars.

Under a specific test programme the suitability of the electronic control equipment for use in Volkswagen vehicles will be examined. BMW are also evaluating one of their 3.0S saloons that has been modified at AED's R & D Centre, to accept this new form of transmission control.

The AED system in effect replaces the conventional automatic transmission's familiar but complex hydraulic labyrinth of oilways and valves with an electronic governor or throttle linkage inputs as these are derived electronically to save space and weight. It is extremely flexible in terms of the gear change programmes available to the user and the quality of the change is optimised at all times by precise control of the main hydraulic feed pressure within the gearbox. This technique eliminates 'hard' gear shifts and engine speed run-up during shifts, so prolonging the normal life of gearbox components. Mechanical coupling of the transmission selector lever to the gearbox is no longer necessary, since transmission mode selection is initiated entirely by electrical switching. This feature alone makes the new system very attractive to the car interior designer, insofar as transmission selection can be of conventional 'T' bar form or more conveniently consist of a row of illuminated push-buttons, TV 'touch-plates' or even a single rotary switch.

Several failsafe facilities are incorporated including electronic interlocks to prevent forced changes at excessive speed, and 'fail to top gear' in the event of electrical faults. This means in practice, in the unlikely event of the electronic package malfunctioning, it can simply be un-plugged thus permitting the vehicle to be safely driven home in top gear, whereas a major fault condition on a 'conventional automatic' normally immobilises the vehicle until it has been rectified by a specialist service engineer.

SOLAR-POWERED WATCH

A solar-powered watch is now on sale in the USA. Described by its manufacturers (Ness Time, Palo Alto, California USA) as the 'most significant development in watches since the quartz watch', the device sells for around \$500.

minutes. The batteries will re-charge to full capacity within 24 hours.

Any number or type of Fire Alarm Sensor can be connected to the two wire "monitored" loop circuit - normally closed sensors being wired in series and normally open sensors wired in parallel. In addition solid state ionisation smoke detectors can be connected in parallel on the same two wire circuit.

Using this unique control system, installation can be carried out by unskilled personnel which will considerably reduce the cost of providing an effective fire alarm system for all types of buildings and in particular for Hotels, Boarding Houses, Nursing Homes and similar premises, which are now subject to stringent fire regulations. Recommended retail price is £48.00.



Typical applications of Honeywell's new photoelectric controls include any kind of counting activity - here, a unit eyes vehicles passing into a car park; the obvious control function is to activate 'Car Park Full' signs and lock inward gates to the park when a certain number of cars have entered. A similar unit located on the park's outward gates monitors vehicles leaving, so that an exact count of the number of cars in the park is always available.

Apart from a wide range of counting applications in industry, photoelectric controls can act as positioning devices, speed controllers, process controllers, quality controllers and safety devices. In all these areas, the photoelectric control responds to the interruption - or the restoration - or a light beam by throwing a switch to bring about some control activity.

OP AMP SELECTION GUIDES

A complete new, up to date set of operation amplifier selection guides is now available from National Semiconductor. The guides contain complete information on all of National's hybrid and monolithic op amps, including the new quad op amps, the LM124 and the LM3900.

The complete set of operational amplifier guides consists of two military guides, one for hybrid integrated circuits and one for monolithic IC's; two industrial guides, one for hybrids and one for monolithic IC's; and a commercial monolithic guide.

To make device selection simple, the guides provide information on input characteristics including input offset voltage, offset voltage drift, offset current and bias current. Also included are specs for voltage gain, bandwidth, slew rate, output current, common mode range, differential input voltage, and supply voltage and current. The number of external compensation components required and the package types the devices are available in are also indicated.

*National Semiconductor (UK) Ltd,
The Precinct, Broxbourne, Herts.*

EUROPE'S FIRST COMMUNICATION SATELLITE FAILS TO ACHIEVE ORBIT

Britain's Skynet II, the first operational communications satellite designed and built outside the USA or Russia, was launched from Cape Kennedy on January 18th by Thor-Delta rocket but due to second stage failure, it did not achieve orbit. The 960lb satellite was designed and built for the Ministry of Defence by Marconi Space and Defence Systems Limited.

However, its sister spacecraft, which is due to be launched later this year, has sufficient capacity to overcome this set back. Skynet II will form the space segment of the most comprehensive military satellite communication system in the world, carrying British defence communications over an area from the UK to the Far East. These spacecraft will replace the smaller, US designed and built, Skynet I satellites already in orbit.

The prime contractor, Marconi Space and Defence Systems Ltd., has built equipment for every British satellite to date and is now the first UK electronics company to take the prime responsibility. The Philco-Ford Corporation, is Marconi's major subcontractor on the Skynet II project, providing important sub systems and components.

The complete Skynet system comprises, in addition to the satellites, a network of ground terminals including the 42 foot master communication station at Oakhanger, 40 foot semi-static terminals, 21 foot air transportable terminals and the new 3½ foot shipborne terminals for the Royal Navy.

The Skynet II satellite is built in the form of a cylindrical drum with solar cells covering the entire curved surface. It will measure approximately 78" long overall with a diameter of 75". The second satellite will be launched into a highly elliptical orbit by a Thor-Delta rocket. Transfer into synchronous orbit will be achieved by firing a solid fuel apogee motor contained in the satellite itself and mounted along the major axis of the cylinder. The complete satellite will be spin stabilised at about 90 revolutions per minute from the time second stage burning

ceases. However, once in synchronous orbit the communications antenna will be de-spun and controlled to point constantly at the earth.

BRAIN TRANSPLANT

Dissatisfied with his brain power, the Man enquired the cost of suitable transplants.

"Artist's brains" said the Surgeon, "are £25 a pound lawyer's brains about £50 a pound; doctor's brains are £200 a pound and at the top of the line we have some politician's brains at £2500 a pound.

"My Goodness," said the Man, "Why are Politician's brains so expensive?"

"Do you have any idea" replied the Surgeon, "just how many politician's brains it needs to make up a pound?"

WIDE RANGE OF DIGITAL PANEL METERS

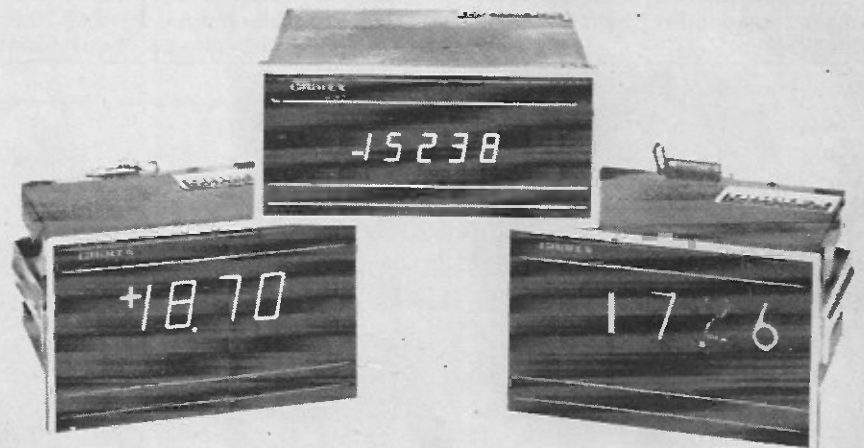

Signatrol Ltd, of Cheltenham, Glos., has completed arrangements to market in the U.K. digital panel meters from two leading U.S.A. manufacturers.

With Signatrol's own range of digital panel meters, the three ranges combine to provide what the company claims is the most comprehensive choice of such meters from a single U.K. source.

The U.S. companies are: Gralex Industries (part of the General Microwave Corporation) and Faratron Inc. (a principal supplier of military components in the U.S.A.).

In broad terms the complete range will embrace 2½, 2%, 3, 3½, 3¾ and 4½ digit meters, some being seven-segment display, others Nixie tube. There are single polarity and bi-polar types as well as mains operated and 5V logic power supply models. Not every permutation of those variables is available but some of the features

common throughout are: binary coded decimal outputs, display blanking, programmable decimal points, adjustable conversion rates, hold-read and external trigger capability.

Mains operated meters of 2½ and 2¾ digit types are single-polarity and have d.c. voltage and current input ranges. Operating on the step-ramp converter principle, they offer 30 options on the full-scale range. Mains operated 3, 3½ and 3¾ digit are bi-polar of the floating differential input type, with voltage input ranges, and an accuracy of the order of 0.05 per cent. The 4½ digit bi-polar version has both voltage and current inputs and offers higher accuracy (0.01 per cent) and ultra-high impedance facilities.

Meters suitable for 5V logic power supplies are also bi-polar, with transformer isolated inputs and accuracies of 0.05 per cent.

NEWSAGENT: _____

Please deliver **ELECTRONICS TODAY INTERNATIONAL** for 12 months, starting with the _____ issue:

NAME _____

ADDRESS _____

GIVE THIS COUPON TO YOUR LOCAL NEWSAGENT

USE
THIS COUPON



costs
no
more
delivered
to your
door ...

...by your local newsagent

For only £2.40 a year (12 issues at 20p each) you ensure that every copy of **ELECTRONICS TODAY INTERNATIONAL** will arrive on your doorstep as soon as it is published — and that you'll never miss out on it if an issue happens to sell out.

electronics
TODAY
INTERNATIONAL



SIMPLE COMPRESSOR

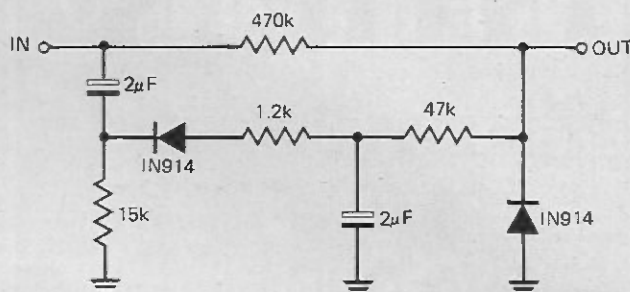

THIS simple compressor is very effective when tape recording from the speaker terminals of a receiver.

Input can vary anywhere from 200 mV to six volts and the output will remain very close to five millivolts.

Attack time is approximately three milliseconds and release time is approximately one hundred milliseconds. The diodes should be high back resistance types; 1N914's should be suitable.

THE GOOD MIXER

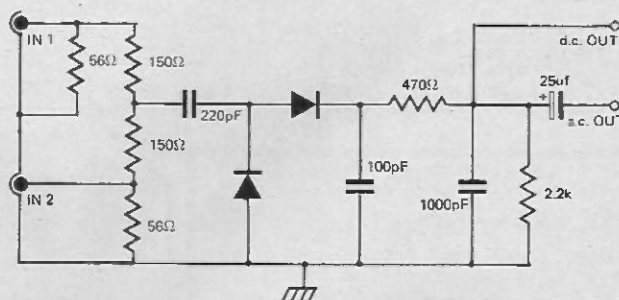

A mixer is a very useful device in any workshop.

It may be used as a frequency meter (signal generator in one input, unknown signal in the other, listen for beat note at ac output), to find parasitics in transmitters, as an untuned detector-monitor etc.

For best wideband performance, all leads should be kept as short as possible. Input impedance is close to 50 ohms, and shorting one input has little or no effect at the other input.

Germanium diodes are the best types to use for good sensitivity. Hot carrier diodes are even better.

TECH-TIPS CIRCUITS

In the next month or two we aim to increase appreciably the space devoted to Tech-Tips. In order to have a good choice, we are prepared to consider any submitted by companies or readers. All items used will be paid for.

Drawings should be as clear as possible and the text should preferably be typed. Circuits for consideration should be sent to The Editor, Electronics Today International, 36 Ebury Street, London SW1W 0LW.

MINI-ADS

FOR FURTHER INFORMATION
PHONE: BOB EVANS
01-730-2139

TRAMPUS

MONEY BACK IF NOT SATISFIED

all brand new, full spec. Top grade.

Free fabulous NEW catalogue. Send SAE.

red+ 1-8 pin data source **LED's 17p!** **Til209** & clip 25p
BIG panel clip & RED LED 28p. GREEN & clip 59p
INFRA RED LED EL. IC photo amp 44p. & amp/switch 85p

Digital Display LED 1/3 0-9DP.DIL £1.69

Minitron type 0-9DP.DIL £1.19. SOCKETS 13p.

IC DIGITAL CLOCK CHIPS. ANTEX £7.50

Texas etc with 4 displays £12. 6 displays & chip £14.

Mostek date & alarm chips with 6 displays £19. pcb £1.49

hit! All parts & case. National chip. 4 digit £20. 6x £23.

with data **integrated circuits**

741: 8pin 29p, to99 & 14pin 27p. 748 33p 709 21p

710 35p 723 59p. 555 timer 79p. ZN414 rx. £1.10

703 if of 28p mc1310 & led £2.76 mc1339 £1.20 TAD100 & if £2

1AMP+ REGULATOR 7805,5 (&7-20)V. also 12 & 15V £1.49

AUDIO AMPS: mfc4000 50p; 1 & 2W £1.19; 3W £1.29; 6W...

gates 7400 etc 16P 7413 32P 7447 £1.25

7470/72 32P 7474/76 39P 7490 63P

7492 69P 74121 49P & all others in cat. low prices.

NEW 16pin counter/divider 90/47 £2.25

DIL SOCKETS: Professional/gold P. Pins hi or lo Profile 8, 14, 16 Pin 13p

2N3055 33p. four £1. BC107, BC108, BC109 all 7p ea

1N914 3p. ZENERS BZY88 8p. 1A RECTS 50v 34p. 400v 5p. BRIDGE 20p. FETS:

2N3819 19p. 2N3823E 20p. 4416E 25p. BC182/3/4 10p. BC212/3/4 11p. BCY70

13p. BD131/2 35p ea. BFY5 1/2/3 15p. TIS43 25p. 2N2926 Oy 7p. 2N3053 15p.

2N3702/3/4/5/6/7/8/9/10/11 all 9p ea. 2N3904/6 14p. HEATSINKS 56/T05

185/T018 5p. TO3: 4YL 29p. TV3 14p. CAPACITORS 25v 10, 50, 100uf 5p. DISCS

4p. PRESETS 5p. CARBON-POTS 11p each. Dual 53p. ULTRASONIC

TRANSDUCERS £2 ea. FLUORESCENT LIGHTS. 8W 13" 12 volt £2.59.

Trampus ADD 10% VAT TO PRICES. P&P 10P CWO.
electronics P.O. BOX 29, BRACKNELL, BERKS.

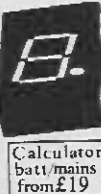

Calculator
batt./mains
from £1.9



GAS sensor
TGS 308 £2
KIT £4.69
fully
built £8

M.Sc. Course in Electrical Engineering

with specialisation in any one of the following:

Electrical Machines,

Power Systems,

Communication Systems,

Electronic Instrumentation Systems,

Control Engineering and Digital

Electronic Systems,

Design of Pulse and Digital Circuits
and Systems,

The Course, which commences in October 1974, may be taken on a Full Time, Part Time, sandwich, or Block Release basis, and is open to applicants who will have graduated in Engineering or Science, or who will hold equivalent qualifications, by that date. The Science Research Council has accepted the Course as suitable for the tenure of its Advanced Course Studentships.

Research in Electrical Engineering

Applications are also invited from similarly qualified persons who wish to pursue a course of research leading to the Degree of M.Phil. or Ph.D. in any of the above subjects.

Application forms and further particulars from the Head of the Department of Electrical Engineering (Ref. M.Sc. 8), The University of Aston in Birmingham, BIRMINGHAM B4 7PB.



THE UNIVERSITY
OF ASTON
IN BIRMINGHAM

DRAUGHTING AIDS

Give your P.C. Boards that professional look. Tapes, pads and I.C. groups for 1:1 masters. S.A.E. for price list.
ADELTA, 54 DICKENS AVENUE, HILLINGDON, MIDDLESEX.

LABORATORY CLEARANCE

Oscilloscopes, AF/RF Oscillators, Audio and General Test Equipment, Tape Heads, Decks, Millivoltmeters, Bridges, Sweep Generators, Etc. Etc. Tel: Lower Beeding 236

SERVICE SHEETS · MANUALS · BOOKS

SERVICE SHEETS 40p plus S.A.E. * SERVICE SHEET CATALOGUE 25p

OVER 12,000 SERVICE SHEETS & MANUALS IN STOCK ON COLOUR/MONO TELEVISIONS
RADIOS, RADIOGRAMS, T/RECORDERS, R/PLAYERS, ETC. S.A.E. WITH ENQUIRIES

NEW BOOKS & PUBLICATIONS

- | | |
|--|-------|
| ELECTRONICS IN MUSIC by F. C. Judd. 169 pp. Circuit designs and operation..... | £3.15 |
| RADIO SERVICING OF TRANSISTOR EQUIPMENT 2nd Edition by G. J. King. 184 pp .. | £1.90 |
| THE HI-FI & TAPE RECORDER HANDBOOK by G. J. King. 304 pp .. | £2.00 |
| HOW TO READ SCHEMATIC DIAGRAMS by D. E. Herrington. 160 pp .. | £1.20 |
| MAKING & REPAIRING TRANSISTOR RADIOS by W. Oliver. 126 pp .. | £1.20 |
| 20 Solid State Projects For The Car and Garage by R. M. Marston. 124 pp .. | £1.80 |
| 20 Solid State Projects For The Home by R. M. Marston. 114 pp .. | £1.60 |
| 50 PHOTOELECTRIC CIRCUITS & SYSTEMS by P. S. Smith. 88 pp .. | £2.30 |
| 110 Semiconductor Projects For The Home Constructor by R. M. Marston. 134 pp .. | £1.80 |
| 110 Integrated Circuit Projects For The Home Constructor by R. M. Marston. 138 pp .. | £1.80 |
| HOW TO GET THE BEST OUT OF YOUR TAPE RECORDER by P. J. Guy. 142 pp .. | £1.50 |
| CREATIVE TAPE RECORDING by Vivian Capel. 183 pp. Shows advanced techniques. | £3.50 |
| TAPE RECORDERS by H. W. Hellyer. 239 pp. A must for the enthusiast .. | £2.25 |
| UNDERSTANDING ELECTRONIC CIRCUITS by Ian R. Sinclair. 204 pp. 127 illus .. | £3.50 |
| UNDERSTANDING ELECTRONIC COMPONENTS by Ian R. Sinclair. 218 pp. 130 illus .. | £3.50 |
| FAULT LOCATION EXERCISES in Radio & TV Servicing by K. J. Bohman. Vol. 1 .. | £0.80 |
| FAULT LOCATION EXERCISES in Radio & TV Servicing by K. J. Bohman. Vol. 2 .. | £1.35 |
| WORLD RADIO TV HANDBOOK 1972. 26th Edition. 384 pp. Special reduced offer .. | £1.00 |
| WORLD RADIO TV HANDBOOK 1973. 27th Edition. 400 pp .. | £5.00 |
| COMPUTER SCIENCE by P. Harvey. A general introduction and principles .. | £2.00 |
| RADIO TECHNICIANS BENCH MANUAL by H. W. Hellyer. 215 pp. 131 illustrations .. | £3.00 |
| AUDIO TECHNICIANS BENCH MANUAL by John Earl. 182 pp. 114 illustrations .. | £3.00 |
| HANDBOOK OF TRANSISTOR EQUIVALENTS & SUBSTITUTES by B. B. Babani .. | £0.40 |
| SERVICING WITH THE OSCILLOSCOPE by G. J. King. 176 pp. Illustrated .. | £1.80 |
| BEGINNERS GUIDE TO RADIO by G. J. King. 7th Edition. 204 pp. Illustrated .. | £1.00 |

NEWNES RADIO & TELEVISION SERVICING books bought & sold (all years) Good prices paid...
Please add 10% for Postage and Packing on all books. Send large S.A.E. for FREE book lists.

BELL'S TELEVISION SERVICES
190 KING'S ROAD, HARROGATE, YORKSHIRE. Telephone 0423-55885

HARDWARE

Screws, nuts washers etc.
Sheet aluminium cut to size or in standard packs, plain or punched/drilled to spec.
Printed circuit boards for published designs or individual requirements, one-off or small runs.
Fascia panels, dials, nameplates etc in etched aluminium. 6p for details.

Ramar Constructor Services,
29 Shelbourne Road,
Stratford on Avon, Warwicks.

ESSENTIAL BOOKS

HOW TO MAKE WALKIE-TALKIES FOR LICENSED OPERATION. Only 40p., p.p. 10p. 2 Copies sent for 80p. post free.

MOBILE RADIOTELEPHONE EQUIPMENT HANDBOOK. Gives circuits, data and illustrations plus some valuable modification details for commercial radio telephone equipment including Pye and other popular manufacturers. Price £4 including postage.

HOW TO MAKE 2 & 4 METRE CONVERTORS FOR AMATEUR USE. 60p. p.p. 10p. **ADVANCED BOOK OF CRYSTAL SET DESIGNS.** 40p. p.p. 10p.

THE GOVERNMENT SURPLUS WIRELESS EQUIPMENT HANDBOOK. Gives circuits data and illustrations plus valuable information for British/USA receivers, transmitters, transmitters, receivers. With modifications to sets and test equipment. Latest impression £3.25 including postage.

DIRECTORY OF GOVERNMENT SURPLUS WIRELESS EQUIPMENT DEALERS. Gives details of surplus wireless equipment stores and dealers including addresses, plus equipment and spares that they are likely to have available. A valuable book only 40p. p.p. 10p.

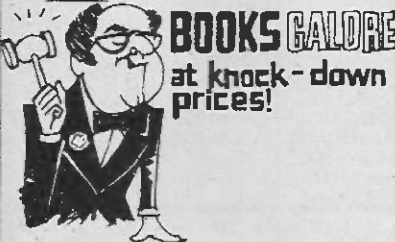

All the books in this section are at greatly reduced prices and are bargains of a lifetime making ideal gifts.

AN ILLUSTRATED ENCYCLOPAEDIA OF BALLOONING. This remarkable book is the result of several years research into aeronautical literature. With nearly 200 pictures, 20 of which are in colour. 13"x10". Published at £6.30. Knock down price £3.50. p.p. 50p.

THE THEORY OF GUIDED ELECTROMAGNETIC WAVES. The most comprehensive book yet written about waveguides, transmission lines, cavity resonators. Over 500 pages. Ideal for anyone interested in Radar & UHF. Published at £11.50. Knock down price £4. p.p. 50p.

THE SCATTERING AND DIFFRACTION OF WAVES. A goldmine of information for the experimenter, amateur and scientist. Profusely illustrated. Published by Oxford University Press at £1.60. Knock down price 80p p.p. 20p.

PRINCIPLES OF ELECTRICITY & MAGNETISM. Page & Adams. An important book for the student, electronics engineer and technician who wishes to improve his basic knowledge. 532 pages. Hard back. Fully illustrated. Published at £4.50. Knock down price £1.50. p.p. 25p.

THE FAMILY LAWYER. Provides a volume of answers to everyday problems. 750 pages fully illustrated concentrating on matters that affect the layman. Includes every conceivable aspect of the law. Published at £6.50. Knock down price £3.50. p.p. 50p.

HANDBOOK OF SATELLITES AND SPACE VEHICLES. A comprehensive working handbook that provides important data both tabular and graphical enabling space scientists, technicians and telecommunication engineers to acquire a greater working knowledge of satellite and space vehicle design, launching, orbiting etc. Includes a detailed coverage of

COMMUNICATIONS IN SPACE. An imposing book of 457 pages. Published at £8.20. Available at the trade price of £6.50 post free.

PERSONAL CALLERS WELCOME AT OUR NEW SHOWROOM & TRADE COUNTER, Hartleys Yard, Off Town Street, ARMLEY, LEEDS 12. Just past The White Horse Inn. The North's largest selection of Radio and Electronics Books plus thousands of books on all subjects at discount prices

All mail order to: Dept. ET4, GERALD MYERS (Bookseller & Publisher), 18 SHAFTSBURY STREET, LEEDS LS12 3BT.

CITY & GUILDS EXAMINATIONS

Make sure you succeed with an ICS home study course for C & G Electrical Installations, Telecommunications Technicians and Radio Amateurs. Free details from:—International Correspondence Schools, Dept. 755E, Intertext House, London SW8 4UJ.

COLOUR TV SERVICING

Make the most of the current boom! Learn the techniques of servicing Colour and Mono TV sets through new home study courses, approved by leading manufacturers. Also radio and audio courses. Free details from: International Correspondence Schools, Dept. 755E2, Intertext House, London SW8 4UJ.

TECHNICAL TRAINING

Get the qualifications you need to succeed. Home study courses in Electronics and Electrical Engineering, Maintenance, Radio, TV, Audio, Computer Engineering and Programming. Also self-build radio kits. Free details from: International Correspondence Schools, Dept. 755E3, Intertext House, London SW8 4UJ.

Are you having trouble building your electronic projects. Is it not working efficiently. We will design, assemble or repair most electronic projects.

LYNTON ELECTRONICS

Lynton House,
The Green,
Downham Market,
Norfolk PE38 9DX.

Tel. Downham Market (036 63) 3719.

WILMSLOW AUDIO

The firm
for
speakers!



Baker Group 25,2 8 or 15 ohm	£ 6.60
Baker Group 35,3 8 or 15 ohm	£ 7.50
Baker Deluxe 12" d/cone	£ 9.75
Baker Major	£ 7.50
Baker Major Module	£ 9.50
Baker Regent	£ 7.00
Celestion PST8 (for Unilex)	£ 2.55
Celestion MF1000 horn	£10.45
Celestion HF1300	£ 6.16
EMI 13x8,3 8 or 15 ohm	£ 2.15
EMI 13x8,150 d/c 3,8,15 ohm	£ 2.35
EMI 13x8,t/tw.450,3,8,15 ohm	£ 3.60
EMI 13x8 type 350 8 ohm	£ 8.25
Fane Pop 100 watt 18"	£22.50
Fane Pop 60 watt 15"	£13.00
Fane Pop 50 watt 12"	£11.00
Fane Pop 25/2 12"	£ 6.40
Fane Pop 15 watt 12"	£ 4.40
Fane Crescendo 18	£47.50
Fane Crescendo 15	£36.00
Fane Crescendo 12A or 12B	£29.00
Fane Crescendo 12BL	£30.00
Fane 807T 8" roll surr. 8or15 ohm	£ 3.85
Elac 59RM109 15 ohm, 59RM114 8 ohm	£ 2.65
Elac 6 1/2" d/c roll surr. 8 ohm	£ 3.35
Elac 4" tweeter TW4	£ 1.21
Goodmans 8P 8 or 15 ohm	£ 4.49
Goodmans 10P 8 or 15 ohm	£ 4.70
Goodmans 12P 8 or 15 ohm	£11.65
Goodmans 15P 8 or 15 ohm	£18.00
Goodmans 18P 8 or 15 ohm	£31.00
Goodmans 12PD 8 or 15 ohm	£15.25
Goodmans 12PG 8 or 15 ohm	£14.50
Goodmans Audiomax 12AX	£39.65
Goodmans Audio 100	£ 9.50
Goodmans Axent 100	£ 6.60
Goodmans Axiom 401	£15.10
Goodmans Twinaxiom 8	£ 6.79
Goodmans Twinaxiom 10	£ 7.61
Kef T27	£ 4.75
Kef T15	£ 5.75
Kef B110	£ 6.75
Kef B200	£ 7.50
Kef B139	£11.75
Kef DN8	£ 1.92
Kef DN12	£ 4.12
Kef DN13	£ 2.75
Richard Allan CG8T 8" d/c 8ohm	£ 6.35
Wharfedale Super 10 RS/DD	£ 9.80
Wharfedale Linton 11 kit (pair)	£17.50
Wharfedale Glendale (pair)	£31.50
Wharfedale Dovedale (pair)	£48.50
Richard Allan Twinkit each	£ 7.95
Richard Allan Triple 8 each	£11.75
Richard Allan Triple each	£17.50
Richard Allan Super Triple each	£20.75
Goodmans DIN 20 each	£ 8.75
Fane Mode 1 each	£ 9.90
Helme XLK25 (pair)	£18.17
Helme XLK50 (pair)	£37.18
Kefkit 11 each	£23.50
Kefkit 111 each	£34.00

PRICES INCLUDE VAT.

Cabinets for Hi-Fi and PA., wadding, vynair etc. Send for free booklet—"Choosing a Speaker".

FREE with orders over £7-HiFi Loudspeaker enclosures book.

All units guaranteed new and perfect.

Prompt despatch
Carriage and insurance: Speakers 35p each, Kits 75p each (£1.50 pair)
Tweeters and crossovers 20p each.

WILMSLOW AUDIO

Dept ET1

Swan Works, Bank Square, Wilmslow,
Cheshire SK9 1HF.

INDEX TO ADVERTISERS

Adelta	64	Gerald Myers	65
Amtron	2	Henry's Radio	7,8
Aston University	64	Laboratories.	64
Bell's Television Services	64	Lynton.	65
B.H. Component Factors	45	Maplin Electronic Supplies	66
Bi-Pak	12,13	Minikits Electronics	27
BIET	68	Ramar Constructor Services.	64
Bi-Pre-Pak	4	Trampus Electronics	64
Bywood	67	Wilmslow Audio	65
Decon	4		

MAPLIN ELECTRONIC SUPPLIES

***SAME DAY SERVICE**

P. O. Box 3, Rayleigh, Essex. Tel: Southend-on Sea (0702) 44101

VAT Please add 10% to the final total. Post and Packing FREE in U.K. (10p handling charge on orders under 50p)



SYNTHESISER

We shall be stocking all the parts for this sensational new E.T.I. design. Send s.a.e. now for our detailed price list. (One available each month as the parts are published.)

YOU SIMPLY MUST SEE OUR PRICES!

ORGAN BUILDERS
MES announce the very latest development in organ circuitry.

THE DMO2
13 Master Frequencies on ONE tiny circuit board.

LOOK AT THESE AMAZING ADVANTAGES

- ★ 13 frequencies from C8 to C9. ★ Each frequency digitally derived from a SINGLE h.f. master oscillator.
- ★ Initial tuning for the WHOLE ORGAN: ONE SIMPLE ADJUSTMENT. ★ Relative tuning NEVER DRIFTS! ★ External control allows instant tune-up to other musicians. ★ Outputs will directly drive most types of dividers including the SAJ110. ★ And each output can also be used as a direct tone source. ★ Variable DEPTH AND RATE tremulant optional extra.
- ★ Gold-plated plug-in edge connection. ★ Complete fibre glass board (including tremulant if required) ONLY 3.7in. x 4.5in. ★ Very low power consumption.

★ EXTREMELY ECONOMICAL PRICE. ★ Ready built, tested and fully guaranteed.
DMO2 (with tremulant) ONLY £14.25.
DMO2 (without tremulant) £12.25.

★ S.a.e. please for full technical details.
Trade enquiries welcome.

SAJ110 2stage frequency divider in one 14 pin DIL package. Sine or square wave input allows operation from almost any type of master oscillator including the DMO2 (when 97 notes are available). Square wave outputs may be modified to saw-tooth by the addition of a few components. SAJ110: £2.63 each OR special price for pack of 12: £25.00. S.a.e. please for data sheet.

WE KNOW YOU NEED IT!

The MES 1974 Catalogue has over 75 pages and is STACKED with dozens of tempting new lines. BRIMMING OVER with clear illustrations and detailed data.

WE'RE WAITING TO RUSH YOU A COPY.

You'll be IMPRESSED with our POST FREE ordering system. EXCITED by our BIG VALUE discount vouchers, STAGGERED by our UNBEATABLE speed of service. Take the first step towards real service NOW! Send ONLY 25p for our beautifully produced catalogue and leave the rest to us!



QUALITY ICs AT LOWEST POSSIBLE PRICES

CA3046	14-pin DIL	Transistor Array	69p*
LH0042C	TO5	FET I/P Op.Amp	£3.88*
LM301A	8-pin DIL	Op. Amp	55p*
NE555V	8-pin DIL	Timer	79p*
NE561B	14-pin DIL	Phase Locked Loop	£4.45*
SG1495D	14-pin DIL	Four Quadrant Multiplier	£2.75*
SG3402N	14-pin DIL	Wideband Amp/Multiplier	£1.69*
µA723C	14-pin DIL	2-37V Voltage Regulator	85p*
µA741C	8-pin DIL	Op. Amp	36p*
ZN414	TO5	A.M. Radio TRF	£1.20
MC1303L		Stereo Preamp	£1.39
MC1310P		FM Stereo Decoder	£3.15
MFC8010		1W Power Amp	£1.20

*Full data in our catalogue. Price 25p

APOLOGY!

We would like to apologise to all of our LM380 customers for the delay in despatching their orders. The manufacturers supplied us with the 8-pin package of this device instead of the 14-pin package, the 8-pin device has limited

power output due to lack of heatsink. We attempted to find another supplier but to no avail. We have however the following devices in stock as at 16th January 1974.

INTEGRATED CIRCUITS

MM5311	6 digit clock chip with BCD and seven-segment outputs, interfaces with most display types.	£ 9.00
MM5314	As MM5311 but no BCD outputs.	£ 7.20
MM5316	Four digit alarm clock with alternate seconds display, Sleep and Snooze features. Interfaces directly to DG12 and TA8055 displays.	£15.00
MK5017AA	Six digit clock chip with alarm and Snooze, interfaces to DG12, DL34 and TIL360. As used in ETI Sept. 73 TIMTRONIC.	£14.00
CT7001	Six digit clock/alarm/calendar chip.	£18.00
ZN414	AM radio chip, as used in many articles.	£ 1.10
LM380	2½W Audio Amp in 14-pin pack, (out of stock).	£ 1.50
LM377	Two LM380s in one pack, 14-pin DIL.	£ 2.70
LM381A	Stereo pre-amp, very high spec, lower noise figures than LM381 (which are not available).	£ 4.47
LM. . .	Other National audio chips available to order we will have the 1800, 1805, etc when available.	
555	General purpose Mono/Astable timer.	90p
LM322	High stability precision timer.	£ 2.50
CA3081	16-pin DIL containing 7 NPN Common-emitter transistors, for 7 seg LED drivers.	£ 1.47
CA3082	As CA3081 but common-collector connected.	£ 1.47
OTHERS	We have a few calculator ICs at special prices, please ring for details.	

SEVEN SEGMENT DISPLAYS

DG12	Phosphor-diode (Fluorescent) tubes digit 12.5mm.	£ 2.00
DL707	Light-pipe LED in 14-pin package, 0.3ins.	£ 2.00
DL747	Light-pipe LED in DIL package, Giant 0.6ins.	£ 2.62
DL34	Four 0.1in digits in 14-pin DIL pack, Common C.	£10.00
TIL360	Six 0.1in digits in 16-pin DIL pack, Common C.	£15.00
TA8055	Four 0.6in Liquid-crystal digits (delivery expected this week).	£13.00

KITS AND PCBs

TIMTRONIC	Kit for ETI article, MK5017AA, four DG12s, IC socket, PCB and full instructions.	£24.00
5316-LC	MM5316, socket, TA8055, PCB and instructions.	£32.00
5314-Jumbo	MM5314, socket, 4 x DL747, 2 x DL707, CA3081, PCB and full instructions.	£26.80
CASES	Complete kit less case, etc.	£30.00
PCBs	Perspex Timtronic case 2.50, Wood 5314 case £4.50. Timtronic or 5316 or 5314 kits £2.50. PCB for six DL707 for Digitronic type project £1.00.	

LEDS, SOCKETS ETC.

TIL209	These and similar LED lamps, Red colour.	20p
RED & GREEN	We still have a few pairs of LEDs which we are clearing at a special price. 1 red & 1 green.	50p
24 & 28-pin LSI sockets, high quality gold contacts, etc.		£1.15
40-pin LSI sockets, high quality gold contacts etc.		£1.35
16-pin low insertion force sockets for IC testing, etc.		£2.00

Pin Headers.	14 and 16-pin units which may be used as DIY ICs or as a plug for DIL sockets.	40p
Flat cable.	16 way flat cable for use with pin headers, metre.	35p
DILSWs	A range of miniature switches in a 16-pin DIL pack. 1 pole 8 way 75p, 2 pole 4 way 80p, 4 pole 2 way 85p, DILVARI four 1 pole 2 ways 90p.	

CLOCK DATA SHEETS - SAE. ADVICE - PHONE 0442-62757

POST & PACKING - 10p. OVERSEAS (AIRMAIL) 50p. VAT - ALL PRICES EXCLUDE VAT.

PAYMENT C.W.O. or ACCOUNT. ACCESS. ORDERS & PAYMENT BY PHONE ACCEPTED.

QUANTITY DISCOUNTS ON MOST ITEMS - STATE REQUIREMENTS FOR QUOTATION.

BYWOOD

BYWOOD ELECTRONICS
181 EBBERNS ROAD
HEMEL HEMPSTEAD
HERTS. TEL.0442-62757.
24 HOUR ANSAPHONE ON-LINE.

FREE!

Over 150 ways to engineer a better future

HIGHER PAY

A BETTER JOB

SECURITY

find out how in just 2 minutes

That's how long it will take you to fill in the coupon. Mail it to B.I.E.T. and we'll send you full details and a free book. B.I.E.T. has successfully trained *thousands* of men at home - equipped them for higher pay and better, more interesting jobs. We can do as much for YOU. A low-cost B.I.E.T. home study course gets results fast - makes learning easier and something to look forward to. There are no books to buy and you can pay-as-you-learn.

Why not do the thing that really interests you? Without losing a day's pay, you could quietly turn yourself into something of an expert. Complete the coupon (or write if you prefer not to cut the page). No obligation and nobody will call on you . . . but it could be the best thing you ever did.

Others have done it, so can you

"Yesterday I received a letter from the Institution informing that my application for Associate Membership had been approved. I can honestly say that this has been the best value for money I have ever obtained - a view echoed by two colleagues who recently commenced the course".—Student D.I.B., Yorks.

"Completing your course, meant going from a job I detested to a job that I love, with unlimited prospects".—Student J.A.O. Dublin:

"My training with B.I.E.T. quickly changed my earning capacity and, in the next few years, my earnings increased fourfold".—Student C.C.P., Bucks.

FIND OUT FOR YOURSELF

These letters - and there are many more on file at Aldermaston Court - speak of the rewards that come to the man who has given himself the specialised know-how employers seek. There's no surer way of getting ahead or of opening up new opportunities for yourself. It will cost you a stamp to find out how we can help you. Write to B.I.E.T. Dept. BE111 Aldermaston Court, Reading RG7 4PF.

Practical Radio & Electronics Certificate course includes a learn while you build **3 transistor radio kit.**

Everything you need to know about **Radio & Electronics** maintenance and repairs for a **spare time income** and a **career** for a better future.



CUT OUT THIS COUPON
Tick or state subject of interest.
Post to address below.

- | | | |
|---|--|---|
| <input type="checkbox"/> MECHANICAL | <input type="checkbox"/> Man. Prod.—cont. | <input type="checkbox"/> Constructional-cont. |
| <input type="checkbox"/> A.M.S.E. (Mech.) | <input type="checkbox"/> Quality Control | <input type="checkbox"/> Building |
| <input type="checkbox"/> Boiler Inspect. & Operation | <input type="checkbox"/> Salesmanship | <input type="checkbox"/> Building Drawing |
| <input type="checkbox"/> C & G Eng. Crafts | <input type="checkbox"/> Storekeeping | <input type="checkbox"/> Build. Foreman |
| <input type="checkbox"/> C & G Fabricat. | <input type="checkbox"/> Work Study | <input type="checkbox"/> Carpentry & Join. |
| <input type="checkbox"/> Diesel Eng. | <input type="checkbox"/> Works | <input type="checkbox"/> Civil & Municipal |
| <input type="checkbox"/> Eng. Inspection | <input type="checkbox"/> Management | <input type="checkbox"/> Engineering |
| <input type="checkbox"/> Eng. Metallurgy | <input type="checkbox"/> DRAUGHTSMANSHIP | <input type="checkbox"/> Constructional |
| <input type="checkbox"/> Inst. Eng. & Tech. | <input type="checkbox"/> A.M.I.E.D. | <input type="checkbox"/> Engineering |
| <input type="checkbox"/> Inst. Motor Ind. | <input type="checkbox"/> Design of Elec. Machines | <input type="checkbox"/> Construction |
| <input type="checkbox"/> Mainten. Eng. | <input type="checkbox"/> Die & Press Tool Design | <input type="checkbox"/> Surveyors |
| <input type="checkbox"/> Mechanical Eng. | <input type="checkbox"/> Electrical Draughtsmanship | <input type="checkbox"/> Institute |
| <input type="checkbox"/> Sheet Metal Work | <input type="checkbox"/> Gen. Draughtsmanship | <input type="checkbox"/> Clerk of Works |
| <input type="checkbox"/> Welding | <input type="checkbox"/> Jig & Tool Des. | <input type="checkbox"/> Council Eng. |
| <input type="checkbox"/> ELECTRICAL & ELECTRONIC | <input type="checkbox"/> Tech. Drawing | <input type="checkbox"/> Health Eng. |
| <input type="checkbox"/> A.M.S.E. (Elec.) | <input type="checkbox"/> RADIO & TELE-COMMUNICATIONS | <input type="checkbox"/> Heat & Vent. |
| <input type="checkbox"/> C & G Elec. Eng. | <input type="checkbox"/> Colour TV | <input type="checkbox"/> Hydraulics |
| <input type="checkbox"/> C & G Elec. Inst. | <input type="checkbox"/> C & G Radio/TV/ Electronics | <input type="checkbox"/> Inst. of Builders |
| <input type="checkbox"/> C & G Elec. Tech. | <input type="checkbox"/> C & G Telecomm. Tech. | <input type="checkbox"/> Inst. Works & Highway Sup. |
| <input type="checkbox"/> Computer Elect. | <input type="checkbox"/> Pract. Rad. Elec. (with kit) | <input type="checkbox"/> Painting & Dec. |
| <input type="checkbox"/> Elec. Maths | <input type="checkbox"/> Radio Amateurs Exam. | <input type="checkbox"/> Public Hygiene |
| <input type="checkbox"/> Elec. Science | <input type="checkbox"/> Radio Servicing & Repairs | <input type="checkbox"/> Road Engineer. |
| <input type="checkbox"/> Electronic Eng. | <input type="checkbox"/> Radio & TV Eng. Trans. Course | <input type="checkbox"/> Structural Eng. |
| <input type="checkbox"/> Electrical Eng. | <input type="checkbox"/> TV Main. & Serv. | <input type="checkbox"/> Surveying |
| <input type="checkbox"/> Install. & Wiring | <input type="checkbox"/> AUTO & AERO | <input type="checkbox"/> GENERAL |
| <input type="checkbox"/> Meters & Measuring Instruments | <input type="checkbox"/> Aero Eng. | <input type="checkbox"/> Agricultural Eng. |
| <input type="checkbox"/> MANAGEMENT & PRODUCTION | <input type="checkbox"/> A.M.I.M.I. | <input type="checkbox"/> Council of Eng. Inst. |
| <input type="checkbox"/> Auto. Control | <input type="checkbox"/> A.E.C. Cert. | <input type="checkbox"/> Inst. |
| <input type="checkbox"/> Computer Prog. | <input type="checkbox"/> Auto Engineer. | <input type="checkbox"/> Farm Science |
| <input type="checkbox"/> Electronic Data Processing | <input type="checkbox"/> Auto Repair | <input type="checkbox"/> General Educat. |
| <input type="checkbox"/> Estimating | <input type="checkbox"/> C & G Auto. Eng. Garage | <input type="checkbox"/> Gen. Plastics |
| <input type="checkbox"/> Foremanship | <input type="checkbox"/> Management | <input type="checkbox"/> Pract. Maths |
| <input type="checkbox"/> Inst. Cost & Man. Accountants | <input type="checkbox"/> MAA/IMI Dipl. | <input type="checkbox"/> Pract. Slide Rule |
| <input type="checkbox"/> Inst. Marketing Management | <input type="checkbox"/> Motor Vehicle Mechanics | <input type="checkbox"/> Pure & Applied Maths |
| <input type="checkbox"/> Metrication | <input type="checkbox"/> CONSTRUCTIONAL | <input type="checkbox"/> Refrigeration |
| <input type="checkbox"/> Motor Trade Man. Network Plan. | <input type="checkbox"/> A.M.S.E. (Civil) | <input type="checkbox"/> Rubber Tech. |
| <input type="checkbox"/> Numerical Cont. | <input type="checkbox"/> Architecture | <input type="checkbox"/> Sales Engineers |
| <input type="checkbox"/> Operational Research | <input type="checkbox"/> Coaching for many major exams. including ONC, C & G. etc. | <input type="checkbox"/> Tech. Report Writing |
| <input type="checkbox"/> Personnel Man. Planning Eng. | | <input type="checkbox"/> Timber Trade |
| <input type="checkbox"/> Production Eng. | | <input type="checkbox"/> University Ent. |

G.C.E.
58 'O' & 'A'
LEVELS SUBJECTS
Over 10,000
group passes

POST TODAY FOR A BETTER TOMORROW

To B.I.E.T., Dept. BE111 Aldermaston Court, Reading RG7 4PF

NAME _____
Block Capitals Please
ADDRESS _____

OTHER SUBJECTS _____ AGE _____

Accredited by C.A.C.C.
BRITISH INSTITUTE OF ENGINEERING TECHNOLOGY