

NOVEMBER 1973

electronics

today INTERNATIONAL

20p

SPECIAL OFFER:
ADVANCE INTERNATIONAL
CALCULATOR KIT FOR
£26.95!

SUPPLEMENT:
DIRECTORY OF HI-FI
STEREO AMPLIFIERS
FULL SPECIFICATIONS OF OVER 80 TYPES

PRODUCT TEST: BEGRAM 4000

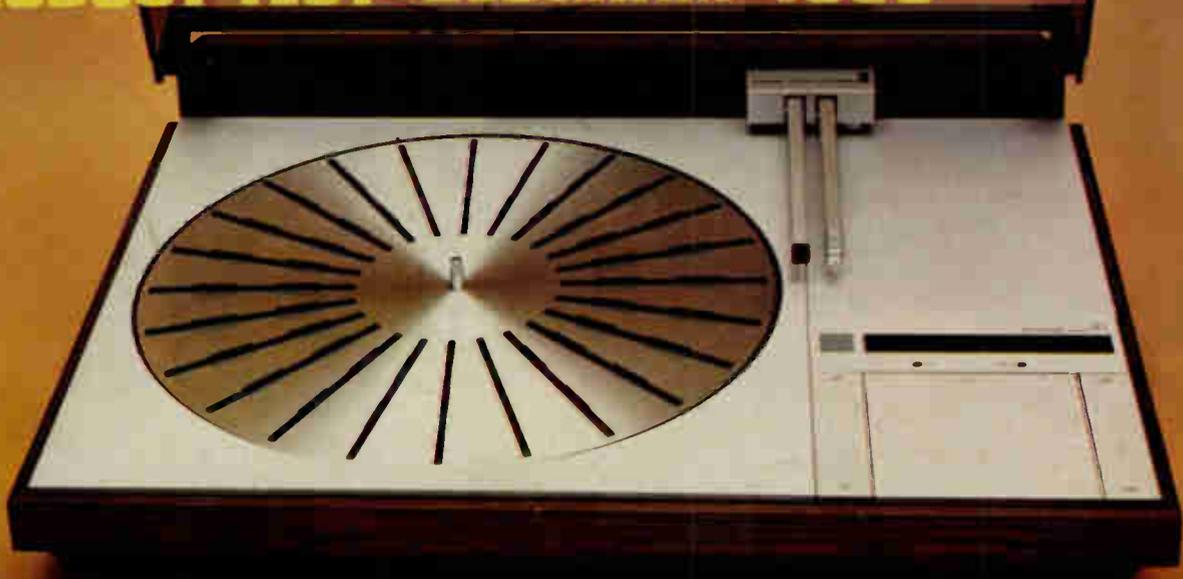

PLUS:
NEW LOUDSPEAKERS - BATTERY CHARGER

HI-FI... CONSTRUCTION... COMMUNICATIONS... DEVELOPMENTS

Awaken to the sound of Teleton



**Join the procession
in Aida.
Smell 1812 gunsmoke.
Shiver
on Bare Mountain.
Awaken to the
sound of Teleton.**

There's a new world of high fidelity in a Teleton sound system, with the GA 202 amplifier at its heart to bring you new standards of purity, new heights of quality in the faithful reproduction of the world's greatest music.

The Teleton GA 202 combines all the latest advances in hi-fi technology—calibrated slider controls for bass, treble and channel volume, hi-cut filter, loudness contour, head-phone socket, tape and auxiliary inputs, to give you 16 watts per channel (RMS) at under one per cent distortion, 30-30,000 Hz—the soaring choruses and the whispers of a cathedral inside an elegant walnut and brushed aluminium cabinet.

Listen to the Teleton GA 202—your ears have been asleep. Price £49.94 inc. VAT., recommended retail.

Teleton Electro (U.K.) Co. Ltd.,
Teleton House, Waterhouse Lane,
Chelmsford CM1 3DW.
Tel: Chelmsford 62442.

 **Teleton**
Sound Sense

electronics TODAY INTERNATIONAL

NOVEMBER 1973

Vol.2 No.11

main features

- SPEAKERS - AN EXPLOSION OF NEW DESIGNS** 18
Significant advances in the technology of loudspeaker design
- THE LOUDSPEAKER HOUSE** 22
There's a man 'down - under' who lives in a loudspeaker!
- HORN LOADED LOUDSPEAKERS** 26
How they work - Why they are used
- DIRECTORY OF HI-FI STEREO AMPLIFIERS.** 37
Full specifications on over 80 types
- UNREASONING RADIATION** 48
Is microwave radiation a hazard?
- FOIL CONSTRUCTION FOR BATTERIES** 68
New method could bring great improvements

projects

- OVER - LED** 56
A visual indicator of the onset of clipping
- INTERNATIONAL BATTERY CHARGER** 64
Unit is fully protected against all fault conditions

product tests

- STEREO 21** 16
How good is a stereo system costing less than £20?
- KLIPSCHORN FOLDED HORN SPEAKERS** 30
A very expensive, superb unit, shortly to be available in Britain
- BEOGRAM 4000.** 52
Brilliant unit combines good looks with fine engineering

news & information

EDITORIAL -5; NEWS DIGEST -7, 80; PREVIEW OF DECEMBER'S ETI -34; ELECTRONICS TOMORROW -60; DX MONITOR -72; EQUIPMENT NEWS -75; COMPONENT NEWS -77.

SPECIAL OFFER: THE ADVANCE INTERNATIONAL CALCULATOR FOR £26.95 35

Cover: B & O's Beogram 4000 uses new engineering techniques and looks superb. Complete review on page 52.



Page 26

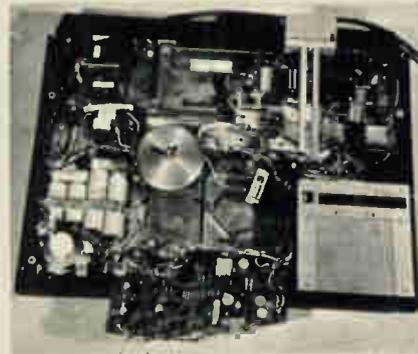

Page 52

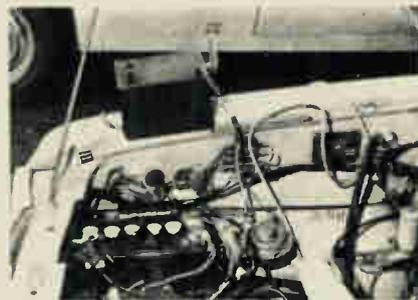

Page 64

EDITORIAL & ADVERTISEMENT OFFICES
36 Ebury Street, London SW1W 0LW
Phone: 01-730 2136/9

Published by WHITEHALL PRESS LTD

Printed in England by: Alabaster Passmore & Sons Ltd, London & Maidstone
INTERNATIONAL ASSOCIATES: Modern Magazines (Holdings) Ltd, Ryrie House, 15 Boundary Street, Rushcutters Bay 2011, Sydney, Australia. ACP, Room 401, 1501 Broadway, New York, USA. Bancho Media Service, 15 Sanyocho, Shinjuku-Ku Tokyo, Japan, Distributed by: Argus Press Ltd
© Copyright Worldwide
Subscription rates per year: Home-£3.60
Overseas-£4.00.

The only thing in common with other £54 amplifiers is the price.



Not surprisingly, for most people quality of hi-fi equipment is largely governed by quantity of money.

Which means if they start off with around £50 to spend on an amplifier the most they'll end up with is, say, 15 watts per channel RMS, a frequency response of around 25-20,000Hz and a fair level of distortion.

Take a quick look down any specification and you'll see for yourself this is true. But for one notable exception:

Eagle's AA4 amplifier. Which not only outperforms other amps in its price range, but in many cases others costing a lot more.

For a start it has 20 watts RMS power per channel both channels driven.

And a frequency response of 20-36,000Hz ± 2 dB.

There are scratch and rumble filters and a distortion that's better than 0.2% even at full rated output.

We could go on, but sending the coupon for our Audio colour brochure will tell you more than we can ever say here.

It will also give you details of our AA2 amplifier which for £38.00 has all the quality and looks of the AA4 with an output power of 10 watts per channel.

To complete either set, you might also be interested in the AA8, our AM FM MPX stereo tuner.

It has an FET front end, switched AFC and interstation muting. And though it can be used with any amplifier, it's specially designed to go with the AA4 and AA2, for which it's a perfect match in terms of looks and performance.

One other fact we feel worth mentioning is that every single unit undergoes a pre-test programme.

This way you're not only sure of a reliable unit but of one other feature that's hard to find in this price range: a two year guarantee.

Eagle International[®]

AA4 STEREO AMPLIFIER

Power output 20+20 watts RMS \bullet 8 ohms (both channels driven)

Recommended retail price £54.00 (excl. VAT)

AA2 STEREO AMPLIFIER

Power output 10+10 watts RMS \bullet 8 ohms (both channels driven)

Recommended retail price £38.00 (excl. VAT)

AA8 AM FM MPX STEREO TUNER

FM Sensitivity for 30dB quieting 3 μ V

Recommended retail price £56.00 (excl. VAT)



Please send me your Audio colour brochure containing full specification details of the AA4, AA2 and AA8 plus details of the complete range of Eagle equipment.

Name

Address

Eagle International, Precision Centre, Heather Park Drive, Wembley HA0 1SU. Telephone 01-903 0144.

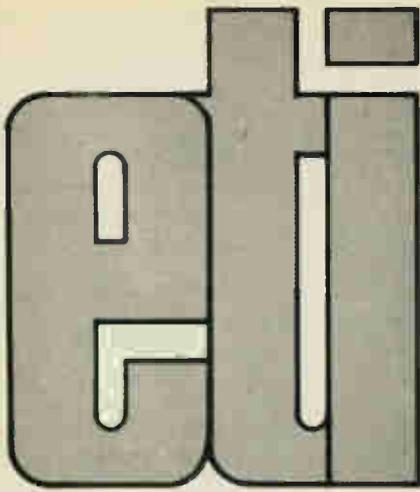

HALVOR MOORSHEAD

Editor

HELEN GIMPLE

Editorial Assistant

JEAN BELL

Production Assistant

Electronics Today International
36 Ebury Street
London SW1W 0LW
01-730 2136

International Editions

COLLYN RIVERS

Editorial Director

Australia

BRIAN CHAPMAN

Technical Editor

WENDY ROY

Assistant Editor (Hi-Fi)

BARRY WILKINSON

Engineering Manager

Electronics Today International
Ryrie House, 15 Boundary Street
Rushcutters Bay 2011
Sydney, Australia

France

DENIS JACOB

Editor-in-chief

CHRISTIAN DARTEVELLE

Editor

Electronique Pour Vous
International
17 Rue de Buci
Paris, France

LONG LIVE RADIO

FIFTEEN YEARS AGO few people would have given any future for sound radio: television was the new medium which took all the money and the best personnel while 'steam' radio took a back seat.

Ten years ago there was only one choice of radio programme available for part of the morning when both BBC Home and Light Services put out 'Music While You Work'. Today in London (and soon in many other parts of the country) there is a choice of seven programmes: the four BBC National Networks, BBC Local Radio and the two IBA commercial stations. Unlike many other parts of the world, these stations provide a real choice and cater for most tastes. The choice at times is even more as the BBC are 'splitting' the AM and FM networks for educational and sports programmes.

This growth has been gradual but none the less remarkable. The expansion owes a lot to the faith placed in the medium by the BBC who resisted the temptation in the difficult years to reduce choice or lower standards. In a cautious, and very British way, the BBC modified radio and in our opinion improved it considerably.

With the abolition of the radio licence fee (which held back the growth of car radios) and the continued reduction in the price of radios (especially AM/FM combinations) taken with increased choice of programmes, the future of radio looks more promising than ever.

BBC television improved immeasurably after the introduction of ITV and this in turn improved the commercial network; this has led to what many informed foreigners say is the best TV service in the world. If the same thing happens with radio it has a rosy future. We wish it well. — H.W.M.

ZN414 RADIO CHIP **£1.10** EX-STOCK

LM380 AUDIO AMP **£1.65** EX-STOCK

TIL209 TYPE LEDS **25p** EX-STOCK

MM5311 CLOCK CHIP **£11.50** EX-STOCK

MM5316 ALARM CHIP **£16.00** EX-STOCK

DG12 DISPLAYS **£2.00** EX-STOCK

DL707 DISPLAYS **£2.00** EX-STOCK

By now you may have got the point - we have them and they are ex-stock. We are usually the cheapest, all our products are guaranteed by the manufacturers (not industrial rejects), in most cases we are the *only* suppliers to the amateur.

Our catalogues and advertising are always out of date, the 3rd edition of our catalogue (Sept '73) will cost you 15p or send the cover of our earlier catalogues and S.A.E.

PHONE for help, advice, or orders 0442-62757.

CLOCK DATA SHEETS—SAE. ADVICE—PHONE 0422-62757

POST & PACKING - 10p. OVERSEAS (AIRMAIL) 50p. VAT - ALL PRICES EXCLUDE VAT.
PAYMENT C.W.O. or ACCOUNT. ACCESS. ORDERS & PAYMENTS BY PHONE ACCEPTED.
QUANTITY DISCOUNTS ON MOST ITEMS - STATE REQUIREMENTS FOR QUOTATION.

BYWOOD

BYWOOD ELECTRONICS
181 EBBERNS ROAD
HEMEL HEMPSTEAD
HERTS. TEL. 0442-62757.
24 HOUR ANSAPHONE ON-LINE.

TELEVISION

TEN YEARS OF COMMUNICATIONS SATELLITES

When the fifth Intelsat IV communications satellite achieved a successful 22,300-mile-high orbit over the Atlantic Ocean recently, it marked a decade of progress since space scientists proved that satellites could appear to "hover" in the sky by synchronously matching the earth's rotational speed.

The latest Intelsat IV was launched from Cape Kennedy on August 23, exactly 10 years to the day that Syncom, the world's first synchronous satellite, became operational.

It was on August 23, 1963 that President Kennedy officially inaugurated the new age of synchronous satellite communications by speaking by telephone across the Atlantic to the Prime Minister of Nigeria via the 1471b, single-channel syncom, launched July 26, 1963.

Today, five 3100lb Intelsat IVs, each with a capacity to provide an average of 5,000 two-way telephone calls or 12 simultaneous colour television programmes, are operating in synchronous orbit over the Atlantic, Pacific and Indian Oceans, effectively linking most of the world's population.

The latest Intelsat IV, the fifth to be launched and positioned successfully in five attempts, was developed and built by Hughes Aircraft Company, El Segundo, California, and a team of subcontractors from Europe, Japan and Canada for the 83-nation International Telecommunications Satellite Corporation (Comsat).

The new satellite will undergo two weeks of tests before it is placed in commercial service, Comsat said. By the end of this year 91 antennae at 73 earth stations in 55 countries are expected to be operating with the five Intelsats.

The first two Intelsat IVs were launched in January and December 1971 over the Atlantic to provide commercial operations between the U.S. and Europe. The third spacecraft was launched over the Pacific in January 1972. The fourth was launched last June over the Indian Ocean. Each satellite has a design lifespan of seven years.

The satellites have brought to the world's living rooms live colour tele-

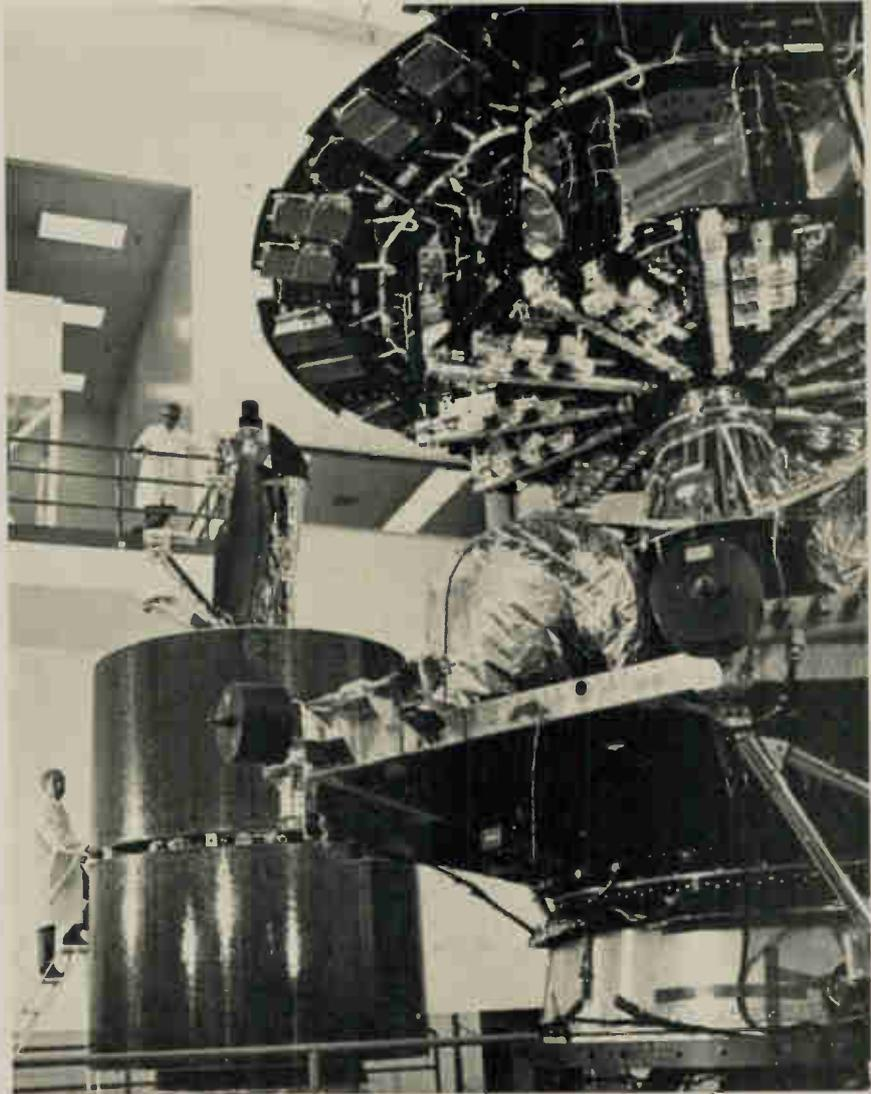

In the background an Intelsat IV communications satellite is undergoing final testing whilst in the foreground another unit is being assembled.

vision coverage of such historic events as three Apollo moon walks, President Nixon's visit to Peking, the Munich Olympic Games and celebrations of the 2,500th anniversary of the Persian Empire.

SIX NEW CALCULATORS

Advance Electronics have recently introduced six new calculators, shown for the first time at the 1973 Business Efficiency Exhibition. Two of these, the Advance 88 and Advance 80 are handheld units, the other four are a range of compact desk calculators.

The Advance 88 has been developed specifically to offer features that are normally associated with larger and much more powerful desk calculators.

It is claimed to be the most sophisticated general purpose handheld business calculator available from a U.K. manufacturer. The calculator is a full 16-digit floating point unit with 2 accumulating memories and automatic square root key. Although strictly a handheld model the 88 has full size key switches and will operate for several hours on built-in rechargeable batteries. When required the calculator can be used in conjunction with the special mains powered desk top recharger unit, Advance claim this unit to be a World first at the recommended price of £115.

The Advance 80, ideally suited to financial calculations, incorporates a percentage feature enabling mark-up and

BI-PRE-PAK

SUPPLIERS OF SEMI-CONDUCTORS TO THE WORLD

COMPLETE TELEPHONES



EX. G.P.O. NORMAL
HOUSEHOLD TYPE

ONLY £1.05

POST & PACKING 45p EACH

TELEPHONE DIALS



Standard Post Office type.
Guaranteed in working order.

ONLY 27½p

POST & PACKING 16½p

TESTED AND GUARANTEED PAKS

B79	4	IN4007 Sil. Rec. diodes. 1,000 PIV lamp plastic	55p
B81	10	Reed Switches 1" long ½" dia. High speed P.O. type	55p
B99	200	Mixed Capacitors. Approx. quantity counted by weight. Post and packing 15p.	55p
H4	250	Mixed Resistors. Approx. quantity counted by weight. Post and packing 15p.	55p
H7	40	Wirewound Resistors. Mixed types and values	55p
H9	2	OCP71 Light Sensitive Photo Transistor	55p
H28	20	OC200/172/3 PNP Silicon uncoded TO-5 can	55p
H30	20	1 Watt Zener Diodes. Mixed Voltages 6.8-43V.	55p
H35	100	Mixed Diodes, Germ. Gold bonded, etc. Marked and Unmarked	55p
H38	30	Short lead Transistors. NPN Silicon Planar types	55p
H39	6	Integrated Circuits. 4 Gates BMC 962. 2 Flip Flops BMC 945	55p
H40	20	BFY50/2, 2N696, 2N1613 NPN Silicon uncoded TO-5	55p
H41	2	Sil Power transistors comp pair BD131/132	55p

UNMARKED UNTESTED PAKS

B1	50	Germanium Transistors PNP, AF and RF	55p
B66	150	Germanium Diodes Min. glass type	55p
B83	200	Trans. manufacturers' rejects all types NPN, PNP, Sil. and Germ.	55p
B84	100	Silicon Diodes DO-7 glass equiv. to OA200, OA202	55p
B86	100	Sil. Diodes sub. min. IN914 and IN916 types	55p
H6	40	250m W. Zener Diodes DO-7 Min. Glass Type	55p
H15	20	Top Hat Silicon Rectifiers. 750mA. Mixed volts	55p
H16	30	Experimenters' Pak of Integrated Circuits. Data supplied	55p
H17	15	3 amp. Silicon Stud Rectifiers, mixed volts	55p
H20	20	BY126/7 Type Silicon Rectifiers 1 amp plastic Mixed volts	55p
H34	15	Power Transistors, PNP, Germ. NPN, Silicon TO-3 Can	55p

MAKE A REV COUNTER FOR YOUR CAR

The 'TACHO BLOCK'. This encapsulated block will turn any 0-1mA meter into a linear and accurate rev. counter for any car with normal coil ignition system.

£1.10 each



OVER

1,000,000

TRANSISTORS IN STOCK

We hold a very large range of fully marked, tested and guaranteed transistors, power transistors, diodes and rectifiers at very competitive prices. Please send for free catalogue.

Silicon planar plastic transistors

Unmarked, untested, factory clearance. A random sampling showed these to be of remarkable high quality.

Audio PNP, similar to ZTX500, 2N3702/3, BCY70 etc.

Audio NPN, similar to ZTX300, 2N3708/9, BC107/8/9, BC168/9 etc.

Please state Audio NPN or Audio PNP when ordering.

ALL AT 500 for £3.30. 1,000 for £5.50. 10,000 for £44 P. & P. 11p/1,000.

OUR VERY POPULAR 4p TRANSISTORS

TYPE "A" PNP Silicon alloy, TO-5 can.

TYPE "B" PNP Silicon, plastic encapsulation.

TYPE "E" PNP Germanium AF or RF.

TYPE "F" NPN Silicon plastic encapsulation.

TYPE "G" NPN silicon similar ZTX 300 range.

TYPE "H" PNP silicon similar ZTX 500 range.

**8 RELAYS FOR
VARIOUS TYPES £1.10**
P & P 27½

Our famous PI Pack is still
leading in value for money.

Full of Short Lead Semiconductors & Electronic Components, approx. 170. We guarantee at least 30 really high quality factory marked Transistors PNP & NPN and a host of Diodes & Rectifiers mounted on Printed Circuit Panels. Identification Chart supplied to give some information on the Transistors. Please ask for Pak P.1 Only 55p. 11p P & P on this Pak.



A CROSS HATCH GENERATOR FOR £3.85 !!!

YES, a complete kit of parts including Printed Circuit Board. A four position switch gives X-hatch, Dots, Vertical or Horizontal lines. Integrated Circuit design for easy construction and reliability. This was a project in the September 1972 edition of Television.

This complete kit of parts costs £3.85, post paid.

A MUST for Colour T.V. Alignment.

ELECTRONIC TRANSISTOR IGNITION

Now in kit form, we offer this "up to the minute" electronic ignition system. Simple to make, full instructions supplied with these outstanding features:—

Transistor and conventional switchability, burglar proof lock up and automatic alarm, negative and positive compatibility.

This project was a "star" feature in our September issue.

Our kit is recommended by the ETI magazine.

Complete kit including p&p £7.92

Ready built and tested unit £3.02
extra

FREE CATALOGUE

FOR
TRANSISTORS,
RECTIFIERS,
DIODES,
INTEGRATED
CIRCUITS,
FULL PRE-PAK
LISTS



PLASTIC POWER TRANSISTORS

NOW IN TWO RANGES

These are 40W and 90W Silicon Plastic Power Transistors of the very latest design, available in NPN or PNP at the most shatteringly low prices of all time. We have been selling these successfully in quantity to all parts of the world and we are proud to offer them under our Tested and Guaranteed terms.

Range 1. VCE. Min 15. HFE Min 15.

40 Watt	1-12	13-25	26-50
	22p	20p	18p
90 Watt	26½p	24½p	22p

Range 2. VCE. Min 40. HFE Min 40.

40 Watt	1-12	13-25	26-50
	33p	31p	29p
90 Watt	38½p	36½p	33p

Complementary pairs matched for gain at 3 amps. 11p extra per pair. Please state NPN or PNP on order.

INTEGRATED CIRCUITS

We stock a large range of I.C.s at very competitive prices (from 11p each). These are all listed in our FREE Catalogue, see coupon below.

METRICATION CHARTS now available
This fantastically detailed conversion calculator carries thousands of classified references between metric and British (and U.S.A.) measurements of length, area, volume, liquid measure, weights etc.
Pocket size 15p. Wall Chart 18p.

LOW COST DUAL IN LINE I.C. SOCKETS

14 pin type at 16½p each } Now new low
16 pin type at 18p each } profile type.

BOOKS

We have a large selection of Reference and Technical Books in stock.

These are just two of our popular lines:

B.P.I. Transistor Equivalents and Substitutes: 40p

This includes many thousands of British, U.S.A. European and C.V. equivalents.

The Iliffe Radio Valve & Transistor Data Book 9th Edition: p. & p. 23½p 75p

Characteristics of 3,000 valves and tubes. 4,500 Transistors, Diodes, Rectifiers and Integrated Circuits.

Send for lists of publications

N.B. Books are void of VAT

Please send me the FREE Bi-Pre-Pak Catalogue.

NAME

ADDRESS

ALL PRICES INCLUDE 10% VAT
MINIMUM ORDER 50p. CASH WITH ORDER
PLEASE. Add 11p post and packing per order
OVERSEAS ADD EXTRA FOR POSTAGE.

Buy these goods with Access

BI-PRE-PAK LTD

Co. Reg No. 820919

DEPT. H. 222-224 WEST ROAD, WESTCLIFF-ON-SEA, ESSEX

TELEPHONE: SOUTHEND (0702) 46344



The Advance 88 (above) at £115 is claimed to be the most sophisticated general purpose handheld calculator available in the U.K.



discount calculations to be performed without re-entry of data or the need for preliminary calculation. Answers are displayed to eight significant digits with fully floating decimal point. The user may optionally fix the decimal point to display answers 'round-off' at two decimal places, and the instrument will chain calculate, square automatically, and features the very important 8-digit constant facility in both multiply and divide.

The Advance 80 may be used on internal dry batteries or operated on an optional mains adaptor which doubles as a desk plinth. This mains unit is also designed for re-charging optional rechargeable cells whilst the calculator is in use on the stand. The recommended price is £57.50.

The Advance 160 family of desk calculators have been introduced to replace the very successful Executive 16 range. Market demand has led to the incorporation of new features.

The four models each have simple key operations for both arithmetic and percent functions. A full 16-digit resolution is provided with four-rule automatic constant, self clearing and underflow features. The normally floating decimal point may be optionally fixed between 0 and 6 places.

Provision is made for automatic accumulation into memory of answers and in two memory models the accumulation of percent extensions.

VAT calculations can be performed in the simplest possible way on these new machines.

The four models are:

Advance 161 1 memory £115.

Advance 161R 1 memory with square root £130.

Advance 162 2 memory £145.

Advance 162R 2 memory with square root £175.

"PIECES OF EIGHT"

"Aargh! Jim lad, shiver me timbers! I've found 'em. At long last, me pieces of eight!" So said Athena's Peter Mills who was aptly cast in the role of Long John Silver when we called by the electronic component distributor's Egham office to discuss the subject of eight-pin DIL packages. It's a real treasure island at Athena for "pieces of eight" and the old apple barrel hasn't looked better! As for the owl - well he flew by just to be wise after the event - thought the whole exercise was a bit of a hoot...

To be serious, Athena report a very good stock position on 8-pin DIL packages, linears and hybrids at Egham - despite a shortage effecting other distributors. Pricing, Athena reports, is competitive.



HIGH POWER LASERS FOR THERMONUCLEAR FUSION

The use of High-power lasers to produce controlled thermonuclear fusion is under study at the University of Rochester USA under the joint sponsorship of the University, General Electric Company of the USA, Esso Research and Engineering Co., and Northeast Utilities.

Dr. Leonard M. Goldman, a physicist on loan to the project from GE(USA)'s Research and Development Centre in Schenectady, New York, adjusts instrumentation on the target chamber within which fuel pellets of deuterium or lithium deuteride will be heated and vaporizes by bursts of light from a high-power laser system. Nuclear fusion, the basic reaction by which the sun converts matters into energy, requires temperatures of 100 million degrees.

TAPE NOW, PLAY LATER



with the

JONAN "FAB"



Dial features accurate clock plus pre programming controls

Important radio programmes. **ITS SECRET** is a remarkable clock which is preset to start its built-in cassette recorder at any hour.

If you find a programme scheduled inconveniently you merely set the clock and leave JONAN "FAB" to its job and return to hear the recorded version whenever you wish. JONAN "FAB" can also be used as an ordinary radio, cassette-recorder or clock radio.

Two simple controls preset the recorder; one dial selects the time, a second dial sets programme length. Sixty minutes can be recorded on one cassette. JONAN "FAB" receives medium wave and FM on battery or mains and is fitted with automatic level control, socket for external speakers, microphone (of course, there's one built-in as well) or telephone pick-up.

I enclose 3p stamp for illustrated leaflet

NAME _____

ADDRESS _____

JONAN

Bush & Meissner

Send 3p for leaflets to:
275 West End Lane,
London N.W.6
01-794 9611

HARDWARE

Screws, nuts washers etc.

Sheet aluminium cut to size or in standard packs, plain or punched/drilled to spec.

Printed circuit boards for published designs or individual requirements, one-off or small runs.

Fascia panels, dials, nameplates etc in etched aluminium. 6p for details.

Ramar Constructor Services,
29 Shelbourne Road,
Stratford on Avon, Warwicks.

WILMSLOW AUDIO

The firm
for
speakers!



Fane Pop 100 watt 18" 8/15 ohm.....	£21.45
Fane Pop 60 watt 15" 8/15 ohm.....	£12.26
Fane Pop 50 watt 12" 8/15 ohm.....	£10.17
Fane Pop 25/2 25 watt 8/15 ohm.....	£5.94
Fane Pop 15 12" 15 watt 8/15 ohm.....	£4.40
Fane 122/10a or 122/12.....	£9.90
Fane Crescendo 15" 8 or 15 ohm.....	£27.20
Fane Crescendo 12" 8 or 15 ohm.....	£24.50
Fane 8" d/cone 808T 8 or 15 ohm.....	£2.64
Fane 8" d/cone, rollsur. 807T 8 or 15 ohm.....	£3.85
Baker Group 25 3, 8 or 15 ohm.....	£6.60
Baker Pop 35, 3, 8 or 15 ohm.....	£7.50
Baker De Luxe 12" d/cone.....	£9.62
Baker Major.....	£7.50
EMI 13 x 8, 3, 8 or 15 ohm.....	£2.03
EMI 13 x 8 type 150 d/cone, 3, 8, or 15 ohm.....	£2.25
EMI 13 x 8 type 450 t/w, 3, 8, or 15 ohm.....	£3.60
EMI 13 x 8 type 350 8 ohm.....	£8.25
EMI 6 1/2" 93850 4 or 8 ohm.....	£2.80
Elac 9 x 5 59RM 109 15 ohm.....	£2.53
Elac 9 x 5 59RM 114 8 ohm.....	£2.53
Elac 6 1/2" d/cone 6RM220 8 ohm.....	£2.59
Elac 6 1/2" d/cone, rollsur. 6RM171 8ohm.....	£3.22
Elac 4" tweeter TW4 8 or 15 ohm.....	£1.21
Celestion PS8 for Unilex.....	£2.16
Celestion MF 1000 25 watt horn 8 or 15 ohm.....	£10.45
Elac 5" 3 ohm.....	£1.75
Elac 7 x 4" 3 or 8 ohm.....	£1.52
Elac 8 x 5", 3, 8, or 15 ohm.....	£1.93
Wharfedale Bronze 8 RS/DD.....	£3.11
Wharfedale Super 8 RS/DD.....	£5.50
Wharfedale Super 10 RS/DD.....	£9.80
Goodmans 8P 8 or 15 ohm.....	£3.80
Goodmans 10P 8 or 15 ohm.....	£4.49
Goodmans 12P 8 or 15 ohm.....	£11.55
Goodmans 15P 8 or 15 ohm.....	£17.05
Goodmans 18P 8 or 15 ohm.....	£29.70
Goodmans Twinaxiom 8.....	£6.79
Goodmans Twinaxiom 10.....	£7.61
Goodmans Axent 100.....	£6.60
Eagle DT33 dome tweeter 8 ohm.....	£5.45
Eagle HT15 tweeter 8 ohm.....	£3.66
Eagle CT5 tweeter 8 ohm.....	£1.25
Eagle MHT10 tweeter.....	£3.74
Eagle CT10 tweeter.....	£2.54
Eagle Xovers CN23, 28, 216.....	£1.10
Kef T27.....	£4.67
Kef T15.....	£5.50
Kef B110.....	£6.16
Kef B200.....	£7.42
Kef B139.....	£10.72
Kefkit 2.....	£24.75
Richard Allan 12" d/cone 3 or 15 ohm.....	£2.20
Richard Allan 8" 3, 8 or 15 ohm.....	£2.27
10 x 6" 3, 8 or 15 ohm.....	£1.92
8 x 5" 3 or 8 ohm.....	£1.38
7 x 4" 3 or 8 ohm.....	£1.38
3" 8 ohm or 80 ohm.....	£0.65
2 1/2" 64 ohm.....	£0.65
Speaker matching transformer 3/8/15 ohm.....	£1.10
Adastra Hiten 10" 10 watt 8 or 15 ohm.....	£2.80
Adastra Top 20 12" 25 watt 8 or 15 ohm.....	£6.32

STEPHENSPEAKER KITS AND CABINETS
Send for illustrated brochure and list of recommended speakers.

CAR STEREO SPEAKERS - ask for leaflets
PA/DISCO AMPLIFIERS: (carr. and ins. £1.00).

Baker 100 watt.....	£46.00
Linear 30/40.....	£25.00
Linear 40/60.....	£30.00
Linear 80/100.....	£55.00

FREE with speaker orders over £7—"Hi-Fi Loudspeaker Enclosures" book.

All units guaranteed new and perfect.

Prompt despatch

Carriage and insurance 35p per speaker

(Tweeters and Crossovers 20p each)

(All prices quoted inclusive of V.A.T.)

WILMSLOW AUDIO

Dept ET1

Swan Works, Bank Square, Wilmslow,
Cheshire SK9 1HF.

ESSENTIAL BOOKS

HANDBOOK OF TRANSISTOR EQUIVALENTS AND SUBSTITUTES. Includes many thousands of British, USA and Japanese transistors. 78 pages. 40p. p.p. 5p.

HANDBOOK OF RADIO, T.V. & INDUSTRIAL TUBE & VALVE EQUIVALENTS. Includes many thousands of British, USA, European, Japanese, CV Types of Radio, TV, and industrial valves & tubes 40p. p.p. 10p.

HOW TO MAKE WALKIE-TALKIES FOR LICENSED OPERATION. Only 40p., p.p. 10p. 2 Copies sent for 80p. post free.

MOBILE RADIOTELEPHONE EQUIPMENT HANDBOOK. Gives circuits, data and illustrations plus some valuable modification details for commercial radio telephone equipment including Pye and other popular manufacturers. Price £4 including postage

HOW TO MAKE 2 & 4 METRE CONVERTORS FOR AMATEUR USE. 50p. p.p. 10p. ADVANCED BOOK OF CRYSTAL SET DESIGNS. 40p. p.p. 10p

THE GOVERNMENT SURPLUS WIRELESS EQUIPMENT HANDBOOK. Gives circuits data and illustrations plus valuable information for British/USA receivers, transmitters, transmitters. With modifications to sets and test equipment. Latest impression £3.25 including postage.

DIRECTORY OF GOVERNMENT SURPLUS WIRELESS EQUIPMENT DEALERS. Gives details of surplus wireless equipment stores and dealers including addresses, plus equipment and spares that they are likely to have available. A valuable book only 40p. p.p. 10p.

CONSTRUCTORS MANUAL OF ELECTRONIC CIRCUITS FOR THE HOME. 50p. p.p. 10p

HI-FI, P.A., GUITAR & DISCOTHEQUE AMPLIFIER DESIGN HANDBOOK. Includes circuits up to 1100 watts output, Tremolo, Vibrato, and Fuzz-Box etc. 75p. p.p. 10p

PRINCIPLES OF ELECTRICITY & MAGNETISM. A handbook of Electricity & Magnetism for anyone interested in improving their basic knowledge in this important subject Utilised by universities, colleges, and schools throughout the world Highly recommended for anyone taking examinations in electronics

532 pages Fully illustrated Published at £4.50 Special offer to readers of £2.25 per copy p.p. 30p.

THE SCATTERING & DIFFRACTION OF WAVES. A goldmine of information for the experimenter, amateur and scientist Profusely illustrated. Published by Oxford University Press Price £1.60 p.p. 15p

HANDBOOK OF SATELLITES AND SPACE VEHICLES. A comprehensive working handbook that provides important data both tabular and graphical enabling space scientists, technicians and telecommunication engineers to acquire a greater working knowledge of satellite and space vehicle design, launching, orbiting etc. Includes a detailed coverage of COMMUNICATIONS IN SPACE. An imposing book of 457 pages. Published at £8.20 Available at the trade price of £6.50 post free

ANY BOOK IN PRINT ON ANY SUBJECT OBTAINED. PLEASE STATE TITLE. AUTHOR, PUBLISHER.

ELECTRONIC NOVELTIES FOR THE MOTORIST. Full circuits instructions and parts lists 50p. p.p. 10p

HANDBOOK OF PRACTICAL ELECTRONIC MUSICAL NOVELTIES. 50p. p.p. 10p

A DICTIONARY OF SCIENTIFIC UNITS. Lists and defines units which have been or still are being used in the Common Market Countries and throughout the world. 204 pages 50p. p.p. 15p

PERSONAL CALLERS WELCOME AT OUR NEW SHOWROOM & TRADE COUNTER, Hartleys Yard, Off Town Street, ARMLEY, LEEDS 12 Just past The White Horse Inn The North's largest selection of Radio and Electronics Books plus thousands of books on all subjects at discount prices

Send S.A.E. for free lists of Radio Electronics Books Any book in print on any subject obtained. Please state title, author and publisher. All mail order to Dept. ET2, GERALD MYERS (Bookseller & Publisher), 18 SHAFTSBURY STREET, LEEDS LS12 3BT.

SCOPELESS ANALYSER



An entirely new engine analyser incorporating unique features intended to simplify operation, has been introduced by Leslie Hartridge Ltd., the Lucas group test equipment manufacturers.

Known as the Hartridge Scopeless Analyser (H.S.A.) it dispenses with the difficult to interpret, traditional oscilloscope. Instead, all readings are presented simply and graphically on four large scale meters, which feature 'pass or fail' zone illumination.

After 'hook-up' using clip-on inductive sensors, the operator presses the test sequence buttons, one after another for all 18 tests, noting down any 'fail' readings on a detachable record card. Each meter and its 'pass

or fail' zone is only illuminated when the relevant test selection button is pressed.

The H.S.A. is also the only analyser available in the U.K. which can be supplied with a self test unit, to check and guarantee the accuracy of the analyser.

No adjustment is necessary for vehicle polarity and there is an automatic cut-out on the ignition circuit during contact breaker and cranking tests.

The use of digital and analogue intergrated components mounted on plug-in printed circuit boards is claimed to maximise reliability and ease of maintenance.

NEW UHF TV STATIONS

The high power main stations and four relay stations have recently been added to the IBA's network. The main stations are Presely, Pembrokeshire, Channel 43 carrying HTV Wales programmes and Llanddona, Anglesey, Channel 60 with the same programme.

The Relay stations are Abergavenny, Channel 49, Ebbw Vale, Channel 59, Bethesda, Channel 60 and Ventnor (Isle of Wight), Channel 49.

The main stations are horizontally polarized, the relay stations vertically polarized.

NO TUBE TV

A TV camera without a conventional vacuum tube has been developed by Fairchild. In place of the vidicon there are a series of charge-coupled device (CCD) sensors. These are arranged in an array of 10,000 photosensors assembled on a 24-pin DIL Package.

CCD sensors are basically bulk silicon that releases charge carriers in proportion to the light falling on them. These sensors are scanned by a clocking system and fed to a receiver as a conventional signal.

The new camera utilising these sensors is known as the MV-100 and is remarkable in other ways. Power consumption is less than 1W and the size is a mere 3½ x 1½ x 2¼in. The whole unit weighs only 6oz. and will operate in conditions varying from bright sunlight to subdued room lighting.

Applications envisaged for the MV-100 are security, industrial and medical applications.

SKY NOISE RESEARCH

Engineers at the Post Office Research Station on Martlesham Heath near Ipswich, are measuring "sky noise" - not sonic booms but the "sound" of the weather. The work is a vital part of the development of satellite communication systems using higher radiowave frequencies than the present generation of satellites which will be working to maximum capacity in a few years. One of the big problems in using these frequencies is that signals to and from satellites are seriously weakened by adverse weather conditions, such as rain and snow. So, to enable such systems to operate economically and efficiently, engineers need accurate



measurements of loss of signal strength.

The aerial pictured here will be producing the data once suitable satellites - being provided by the Italians and the USA - are available. In the meantime, radio noise from outer space is being measured in much the same way that a microphone picks up sound waves. Mr. Dennis Knox, head of the aerial research group at Martlesham, is comparing a photograph of the areas surrounding the aerial with a "sound trace" produced as the aerial scans the horizon; buildings and trees are indicated by high signal loss. The aerial operates continuously, producing a record of the "sound of the weather".

PLESSEY AVIONICS & COMMUNICATIONS

PRODUCT GROUP ONE

Test Engineers and Assistant Test Engineers

Widen your experience and knowledge of Advanced Micro-electronic Equipment Test & Troubleshooting Techniques

Peter Sackman our Quality Control Manager is looking for experienced Test Engineers to join his team working on airborne VHF/UHF radio and secondary surveillance radar equipments for military and professional customers. Participating in these exciting new projects will enable you to keep abreast of the rapid advance of micro-electronic equipment technology and its associated test and troubleshooting techniques.

Applicants for Test Engineer positions should be academically qualified to C & G/ONC/HNC standard or equivalent and have had at least three years' experience of test and troubleshooting microelectronic/solid state equipment.

Assistant Test Engineer applicants should have had at least three years' experience, preferably in the communications or radar fields, but consideration will also be given to applicants experienced in general radio test and troubleshooting methods.

These positions hold staff status and offer excellent working conditions in a modern test facility.

Find out more

Ring Peter Sackman on
01-478 3040 Ext. 3139
or send this coupon to
Rob Nutting, Employment
Department, The Plessey
Company Limited,
Vicarage Lane, Ilford, Essex.

NAME _____

ADDRESS _____

PLESSEY 



news digest

LOW-LIGHT LEVEL TV CAMERA

A highly sensitive "see-in-the-dark" TV camera originally developed for use by military pilots is being tested and evaluated for commercial fishing at night in the Gulf of Mexico, RCA reports.

The camera, which also has the same type of imaging as that used in cameras that transmitted colour pictures from the moon, is being tested by Zapata Corporation's Remote Sensing Group in association with Zapata Protein, a commercial menhaden fishing operation based in Louisiana, USA.

The menhaden are processed into fish meal or use by poultry and animal feed producers as a high protein food supplement. Most of the fish oil is shipped to Europe for use in the manufacture of shortening.

Mounted atop a mast of one of Zapata's 170-foot boats "mother ships", the RCA camera is employed to direct two smaller 40-foot boats to schools of menhaden. Once in the vicinity of the school, the ship's captain directs the "netting" operation by viewing the scene on his television monitor.

The sensitive camera spots the fish by observing the bioluminescence given off by the schools as they move through the water. The movement is readily apparent on a TV monitor connected to the camera by cable, he said.

The camera employs RCA's Silicon Intensifier Target tube, a type used in the colour TV camera that sent back live pictures from the Moon during the last three Apollo missions.

COMPUTER FILE SECURITY

Accessing a remote computer over Post Office telephone lines can raise some difficult security problems. Anyone in possession of the computer's telephone number and user's code word (password) can obtain all the confidential data in any files stored in that computer.

Personnel authorised to use a terminal may leave the company to work for a competitor. Even if they are above reproach, the vital information may be inadvertently disclosed if it is written down to aid the memory.

A new unit, designed and manufactured in Britain, eliminates the security problem by allowing authorised people to gain access to their company's computer without knowing its telephone number or the file password.

The security unit is connected between the user's terminal and the Post Office modem and stores both the computer telephone number and the user's unique file access password. Once the correct key is turned in a lock on the security unit, dialling is performed automatically at the press of a button. When connection with the computer is established, the file password is transmitted automatically by pressing a button on the unit.

Only one person need know the computer telephone number and the file access password, thereby greatly decreasing the chance of this vital information falling into the wrong hands.

Each standard unit will store one telephone number of up to 13 digits and four passwords each of eight ASCII characters; each password has a separate high-security lock and each lock requires a different key. The locks are approved by the British Insurance Association and have no serial numbers, as is normal high-security practice. If desired, the Computer File Protector will store several telephone numbers and more than four passwords to special order.

There are three standard models. One version differs substantially from the others in that it outputs a digital code which is then converted to dialling pulses by a Post Office automatic dialler. This is model CFP-301.

The simplest model in the range, the CFP-101, stores the password but does not store any telephone numbers.

Type CFP-201 connects directly into the telephone line and can, if necessary, be programmed with inter-group dialling pauses which are needed for trunk dialling on the Continent.

For additional security, the passwords can consist of non-valid ASCII characters; that is, one of the many combinations of eight binary digits that are not used in the ASCII 64 character set. This means that additional security is assured because it is impossible for the Teletype to print out the passwords as the character codes will not be recognised.

Programming the units with telephone numbers and passwords can either be carried out by the manufacturers or by the user. The task involves soldering short wire links into a matrix of holes. The matrix is 'scrambled' in a haphazard way so that it is not possible to read the numbers by inspecting the links unless one is in possession of a list of detailed instructions. The telephone number or the password can easily be changed at any time.

HANDHELD DIGITAL MULTIMETER

A new battery powered digital multimeter, so small that it can be held and generally operated with only one hand, has been announced by Hewlett-Packard.

The new HP 970A measures A.C. and D.C. volts (up to 500V) and ohms ($1k\Omega$ to $10M\Omega$) quickly and accurately, selecting automatically from five ranges. A $3\frac{1}{2}$ digit LED display features fully automatic decimal placement and polarity indication.



Heart of the new instrument is a postage stamp-sized thin film hybrid, integrating both digital and analog circuitry.

The probe tip and display are both located at the top of the HP 970A whose size is roughly that of a thick pen. After setting the wristband-type function selector (A.C., D.C. or $k\Omega$) and clipping on the common lead, a user simply touches the test point with the probe and the solid state LED display automatically indicates the correct reading -- in volts or kilohms. The minus sign turns on if the voltage is negative. The decimal point positions itself automatically.

Since the display is close to the point of contact, one need hardly shift ones eyes off the probe while working in closely packed wiring.

continued on page 15

TRANNIES

1 DOCKYARD, STATION ROAD, OLD HARLOW ESSEX (Tele. 37739) Prices include VAT P.P. 10p

Our NEW BIGGER 1973 Catalogue now available 10p.

74 Series TTL

Part No.	Price	Part No.	Price
SN7400	0.17	SN7450	0.17
SN7401	0.17	SN7451	0.17
SN7402	0.17	SN7453	0.17
SN7403	0.17	SN7454	0.17
SN7404	0.17	SN7460	0.17
SN7405	0.17	SN7470	0.32
SN7406	0.39	SN7472	0.32
SN7407	0.39	SN7473	0.41
SN7408	0.20	SN7474	0.41
SN7409	0.20	SN7475	0.50
SN7410	0.17	SN7476	0.44
SN7411	0.28	SN7480	0.74
SN7412	0.39	SN7481	1.32
SN7413	0.32	SN7482	0.96
SN7416	0.48	SN7483	1.21
SN7417	0.48	SN7484	1.10
SN7420	0.17	SN7485	3.96
SN7422	0.53	SN7486	0.35
SN7423	0.53	SN7489	6.05
SN7425	0.55	SN7490	0.68
SN7426	0.30	SN7491	1.10
SN7427	0.50	SN7492	0.74
SN7428	0.77	SN7493	0.74
SN7430	0.17	SN7494	0.85
SN7432	0.50	SN7495	0.85
SN7433	0.88	SN7496	0.96
SN7437	0.71	SN74100	1.82
SN7438	0.71	SN74104	1.07
SN7440	0.17	SN74105	1.07
SN7441	0.74	SN74107	0.44
SN7442	0.74	SN74110	0.61
SN7443	1.43	SN74111	1.38
SN7444	1.43	SN74118	1.10
SN7445	1.98	SN74119	1.49
SN7446	0.71	SN74121	0.44
SN7447	0.98	SN74122	1.43
SN7448	1.10	SN74123	3.04



Linear Integrated Circuits

Part No.	Price
301 DIL	0.50
301 TO99	0.58
301 8 Pin DIL	0.45
301A DIL	0.69
301A TO99	0.69
301A 8 Pin DIL	0.66
307 DIL	0.69
307 TO99	0.69
307 8 Pin DIL	0.66
308 TO99	6.90
308A TO99	7.40
709C DIL	0.35
709C TO99	0.34
710C DIL	0.44
710C TO99	0.46
723C DIL	0.99
723C TO99	1.00
741C 8 Pin DIL	0.35
741C 14 Pin DIL	0.36
741C TO99	0.38
747C DIL	0.80
748C DIL	0.52
748C TO99	0.42
1437 DIL	1.30
1458 TO99	1.30
3046 DIL	0.84

*Devices may be mixed to qualify for Price Breaks
*100 plus less 10% off 25 plus Break

TRANSISTORS and DIODES

AC124	14p	BF111	70p
AC127	14p	BF244	27p
AC128	11p	BF750	20p
AD140	55p	BFY51	20p
AD149	55p	MP111	41p
AD161	33p	MP113	41p
AD182	35p	OC25	55p
AF118	14p	OC28	55p
AF119	14p	OC35	55p
AF117	14p	OC44	9p
BC109	12p	OC45	9p
BC107	11p	OC71	14p
BC108	11p	TIP11A	85p
BC109	11p	TIP14A	85p
BC177	14p	2N3926	11p
BC178	14p	2N3930	56p
BC179	15p	2N702	13p
BC180	11p	2N704	13p
BC181	15p	IN411	8p
BC184	11p	IN416	8p
BC222	16p	IN4148	5p
BC218	14p	OA200	8p
BC214	16p	OA301	8p
BD131	70p	OA200	11p

For full range see our price list

Electrolytic Capacitors

Value	Price	Value	Price	Value	Price
4 VOLT		16 VOLT		40 VOLT	
47µF	61p	15µF	61p	47µF	61p
100µF	61p	33µF	61p	100µF	9p
220µF	61p	100µF	61p	80µF	10p
300µF	61p	220µF	61p	220µF	11p
1000µF	13p	500µF	61p	470µF	19p
4700µF	29p	1000µF	17p	800µF	25p
6.3 VOLT		1000µF	25p	2200µF	44p
33µF	61p	2000µF	43p		
68µF	61p				
100µF	61p	25 VOLT			
470µF	11p	10µF	61p		
680µF	13p	22µF	61p		
1000µF	18p	47µF	61p		
2000µF	26p	100µF	61p		
10 VOLT		200µF	8p		
22µF	61p	470µF	13p		
47µF	61p	800µF	22p		
100µF	61p	1000µF	22p		
220µF	61p	2000µF	39p		
300µF	10p	2000µF	68p		
470µF	10p	40 VOLT			
1000µF	11p	6.8µF	61p		
1500µF	20p	15µF	61p		
2200µF	24p	33µF	61p		

MULLARD POLYESTER CAPACITORS C280 SERIES

350V P.C. mounting. 0.01µF, 0.015µF, 0.22µF, 0.33µF, 0.47µF, 0.68µF, 0.82µF, 1.0µF, 1.5µF, 2.2µF, 3.3µF, 4.7µF, 6.8µF, 10µF, 15µF, 22µF, 33µF, 47µF, 100µF, 150µF, 220µF, 330µF, 470µF, 680µF, 1000µF, 1500µF, 2200µF, 3300µF, 4700µF, 6800µF, 10000µF, 15000µF, 22000µF, 33000µF, 47000µF, 68000µF, 100000µF, 150000µF, 220000µF, 330000µF, 470000µF, 680000µF, 1000000µF, 1500000µF, 2200000µF, 3300000µF, 4700000µF, 6800000µF, 10000000µF, 15000000µF, 22000000µF, 33000000µF, 47000000µF, 68000000µF, 100000000µF, 150000000µF, 220000000µF, 330000000µF, 470000000µF, 680000000µF, 1000000000µF, 1500000000µF, 2200000000µF, 3300000000µF, 4700000000µF, 6800000000µF, 10000000000µF, 15000000000µF, 22000000000µF, 33000000000µF, 47000000000µF, 68000000000µF, 100000000000µF, 150000000000µF, 220000000000µF, 330000000000µF, 470000000000µF, 680000000000µF, 1000000000000µF, 1500000000000µF, 2200000000000µF, 3300000000000µF, 4700000000000µF, 6800000000000µF, 10000000000000µF, 15000000000000µF, 22000000000000µF, 33000000000000µF, 47000000000000µF, 68000000000000µF, 100000000000000µF, 150000000000000µF, 220000000000000µF, 330000000000000µF, 470000000000000µF, 680000000000000µF, 1000000000000000µF, 1500000000000000µF, 2200000000000000µF, 3300000000000000µF, 4700000000000000µF, 6800000000000000µF, 10000000000000000µF, 15000000000000000µF, 22000000000000000µF, 33000000000000000µF, 47000000000000000µF, 68000000000000000µF, 100000000000000000µF, 150000000000000000µF, 220000000000000000µF, 330000000000000000µF, 470000000000000000µF, 680000000000000000µF, 1000000000000000000µF, 1500000000000000000µF, 2200000000000000000µF, 3300000000000000000µF, 4700000000000000000µF, 6800000000000000000µF, 10000000000000000000µF, 15000000000000000000µF, 22000000000000000000µF, 33000000000000000000µF, 47000000000000000000µF, 68000000000000000000µF, 100000000000000000000µF, 150000000000000000000µF, 220000000000000000000µF, 330000000000000000000µF, 470000000000000000000µF, 680000000000000000000µF, 1000000000000000000000µF, 1500000000000000000000µF, 2200000000000000000000µF, 3300000000000000000000µF, 4700000000000000000000µF, 6800000000000000000000µF, 10000000000000000000000µF, 15000000000000000000000µF, 22000000000000000000000µF, 33000000000000000000000µF, 47000000000000000000000µF, 68000000000000000000000µF, 100000000000000000000000µF, 150000000000000000000000µF, 220000000000000000000000µF, 330000000000000000000000µF, 470000000000000000000000µF, 680000000000000000000000µF, 1000000000000000000000000µF, 1500000000000000000000000µF, 2200000000000000000000000µF, 3300000000000000000000000µF, 4700000000000000000000000µF, 6800000000000000000000000µF, 10000000000000000000000000µF, 15000000000000000000000000µF, 22000000000000000000000000µF, 33000000000000000000000000µF, 47000000000000000000000000µF, 68000000000000000000000000µF, 100000000000000000000000000µF, 150000000000000000000000000µF, 220000000000000000000000000µF, 330000000000000000000000000µF, 470000000000000000000000000µF, 680000000000000000000000000µF, 1000000000000000000000000000µF, 1500000000000000000000000000µF, 2200000000000000000000000000µF, 3300000000000000000000000000µF, 4700000000000000000000000000µF, 6800000000000000000000000000µF, 10000000000000000000000000000µF, 15000000000000000000000000000µF, 22000000000000000000000000000µF, 33000000000000000000000000000µF, 47000000000000000000000000000µF, 68000000000000000000000000000µF, 100000000000000000000000000000µF, 150000000000000000000000000000µF, 220000000000000000000000000000µF, 330000000000000000000000000000µF, 470000000000000000000000000000µF, 680000000000000000000000000000µF, 1000000000000000000000000000000µF, 1500000000000000000000000000000µF, 2200000000000000000000000000000µF, 3300000000000000000000000000000µF, 4700000000000000000000000000000µF, 6800000000000000000000000000000µF, 10000000000000000000000000000000µF, 15000000000000000000000000000000µF, 22000000000000000000000000000000µF, 33000000000000000000000000000000µF, 47000000000000000000000000000000µF, 68000000000000000000000000000000µF, 100000000000000000000000000000000µF, 150000000000000000000000000000000µF, 220000000000000000000000000000000µF, 330000000000000000000000000000000µF, 470000000000000000000000000000000µF, 680000000000000000000000000000000µF, 1000000000000000000000000000000000µF, 1500000000000000000000000000000000µF, 2200000000000000000000000000000000µF, 3300000000000000000000000000000000µF, 4700000000000000000000000000000000µF, 6800000000000000000000000000000000µF, 10000000000000000000000000000000000µF, 15000000000000000000000000000000000µF, 22000000000000000000000000000000000µF, 33000000000000000000000000000000000µF, 47000000000000000000000000000000000µF, 68000000000000000000000000000000000µF, 100000000000000000000000000000000000µF, 150000000000000000000000000000000000µF, 220000000000000000000000000000000000µF, 330000000000000000000000000000000000µF, 470000000000000000000000000000000000µF, 680000000000000000000000000000000000µF, 1000000000000000000000000000000000000µF, 1500000000000000000000000000000000000µF, 2200000000000000000000000000000000000µF, 3300000000000000000000000000000000000µF, 4700000000000000000000000000000000000µF, 6800000000000000000000000000000000000µF, 10000000000000000000000000000000000000µF, 15000000000000000000000000000000000000µF, 22000000000000000000000000000000000000µF, 33000000000000000000000000000000000000µF, 47000000000000000000000000000000000000µF, 68000000000000000000000000000000000000µF, 100000000000000000000000000000000000000µF, 150000000000000000000000000000000000000µF, 220000000000000000000000000000000000000µF, 330000000000000000000000000000000000000µF, 470000000000000000000000000000000000000µF, 680000000000000000000000000000000000000µF, 1000000000000000000000000000000000000000µF, 1500000000000000000000000000000000000000µF, 2200000000000000000000000000000000000000µF, 3300000000000000000000000000000000000000µF, 4700000000000000000000000000000000000000µF, 6800000000000000000000000000000000000000µF, 100µF, 15000000000000000000000000000000000000000µF, 22000000000000000000000000000000000000000µF, 33000000000000000000000000000000000000000µF, 47000000000000000000000000000000000000000µF, 68000000000000000000000000000000000000000µF, 1000µF, 1500µF, 2200µF, 3300µF, 4700µF, 6800µF, 100µF, 15000µF, 22000µF, 33000µF, 47000µF, 68000µF, 1000µF, 1500µF, 2200µF, 3300µF, 47000000

news digest

A switch inverts the display so it will be readable with the probe in any position.

Nickel-cadmium rechargeable batteries and a battery charger are standard with the Model 970A. Battery life permits more than 2000 measurements using "Press to Read" switch or 2½ hours of continuous operation. The case is made of highly resistant plastic, measuring 15cm long by 4cm wide. The instrument weighs just 180 grams with batteries.

DC voltage from 0.1000V full scale (0.0001V resolution) is read to an accuracy of ± 0.7 per cent of reading + 0.2 per cent of range.

AC voltages from 0.003V to 500V are read to ± 2 per cent of reading + 0.5 per cent of range at frequencies below 1kHz. From 1kHz to 3.5kHz, the Model 970A measures 1V to 500V.

Ohms ranges are 1 kilohm full scale (0.001kohm resolution) to 10,000 kilohms. Maximum current

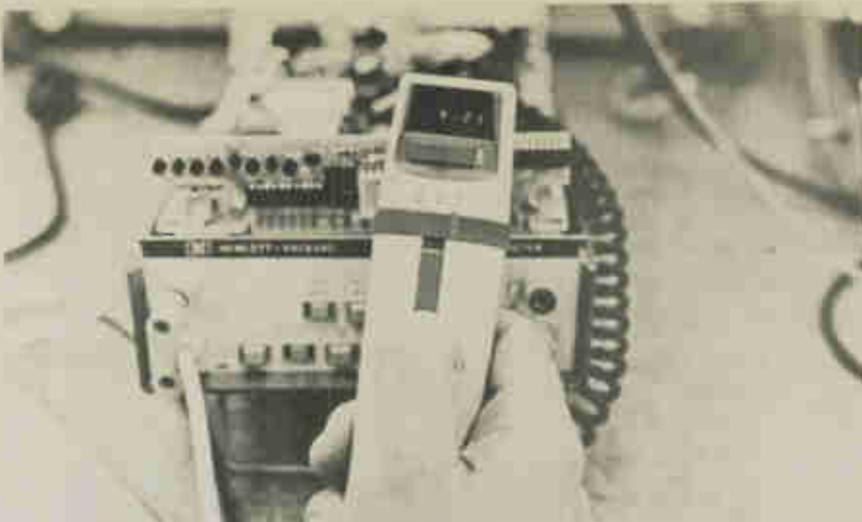

will not exceed 10mA.

Input resistance on the voltage ranges is 10 megohms. Input capacitance on A.C. is less than 30pF. Input voltage protection is 1000V peak.

Autorangeing is quick. On the D.C. and ohms settings it takes less than two seconds to settle to a proper reading.

Three probe tips are included with the Model 970A: Short, long and concave. The tips detent to three

angular positions and fold for storage. A standard banana jack can be inserted instead of the tip, facilitating constant monitoring via two clip leads.

An optional bench cradle converts the DMM to bench use and adds A.C. and D.C. current measuring capacity - from 100 microamperes to 1 ampere full scale. Here, range selection is manual.

The price of the HP 970A in the UK is £138, exclusive of VAT.

FIREMAN'S PERSONAL RADIO PAGING SYSTEM

For the first time in Scotland, the noisy public-disturbing sirens traditionally used for calling out retained fireman from their homes or from where they work will be replaced by a personal radio paging system.

The vital significance of this innovation is that proving trials carried out by the Scottish Central Area Fire Brigade showed that there was a 30 per cent increase in response from retained firemen, compared with the number reacting to sirens, and that there was a significant saving of time in their arrival at the scene of the fire. The Multitone system reduced the callout time by as much as 2 minutes 11 seconds.

One of the principle disadvantages of sirens is that because of competing noise factors such as strong winds and traffic, they often go unheard. In addition, even house bells can be missed if a man happens to be at the bottom of his garden.

The paging system, developed by London-based Multitone Electric Co. Ltd. in co-operation with the Communications Branch of the Scottish Home and Health Department, is designed to selectively and simultaneously alert a group, or groups of retained fireman to assemble at their unattended fire station.

As a result of the success of pilot trials, carried out by the Scottish



Central Area Fire Brigade, the Multitone paging system has become fully operational and is now being used to cover a station district - this includes a wholtime/retained station at Falkirk and three retained stations at Larbert, Denny and Slamannan involving a total area of 110 square miles.

Fifty-six retained fireman are each equipped with a small 5 oz radio receiver which fits easily into a jacket pocket. When a fireman is

required, his receiver sounds a 'bleep' alert tone, warning him to proceed immediately to the station. As the paging system covers a wide area, retained fireman can be 'bleeped' if they are several miles from the fire station.

The receivers possess a one-way speech facility so that the officers are able to receive on-the-spot instructions from control.

continued on page 80



STEREO 21

electronics
TODAY
INTERNATIONAL

product test

How good can a kit for a stereo system be which costs less than £18? We asked an inexperienced constructor to build it up — no problems. Then we asked an experienced technical reviewer to test it.....

MAKERS SPECIFICATION

Power Output:	2.7W (tested at 2.5W 8 ohms)
Output (Speakers)	Suitable 8 or 15 ohms (lower output at 15 ohms)
Aux Input:	120mV
Tape Input:	600mV
Speaker Cabinets:	15½ x 8 x 4 inches
Speakers:	8 x 5 inch elliptical
Plinth with cover:	15 ⁵ / ₈ x 12¼ x 6 inches
Record Playing Unit:	BSR autochanger deck C129R complete with cartridge.
Price UK:	£17.95 inc. VAT. Packing and postage £1.45

Manufacturers and suppliers:
*Radio and TV Components (Acton) Ltd.,
21, High Street, Acton, London W3 6NG.*

THIS IS a compact stereo record player system, supplied in kit form but one involving only very simple assembly work. For example, the amplifier is supplied ready built, wired and tested and the woodwork for the record plinth and loudspeakers is pre-cut, drilled and finished. Soldering has been eliminated and the few connections that have to be made are done with push-on tags. The makers claim that any young teenager could build the system in an evening by following the step by step instructions.

The system is not intended for serious Hi-Fi listening, rather as one suitable for youngsters and their 'pop' records, at a not too high sound level, or for quiet listening with reasonably good sound quality. The maximum power output is in fact about 2.5W per channel. The record player deck is a B.S.R. C129R which operates at 33 1/3, 45 and 78 r.p.m. and is an auto-changer that will accommodate 7, 10 or 12 inch records. This is supplied with a pick-up cartridge.

The amplifier employs an integrated circuit and each channel has its own volume control to facilitate stereo balance. There is an output (jack) socket for stereo headphones, a tone

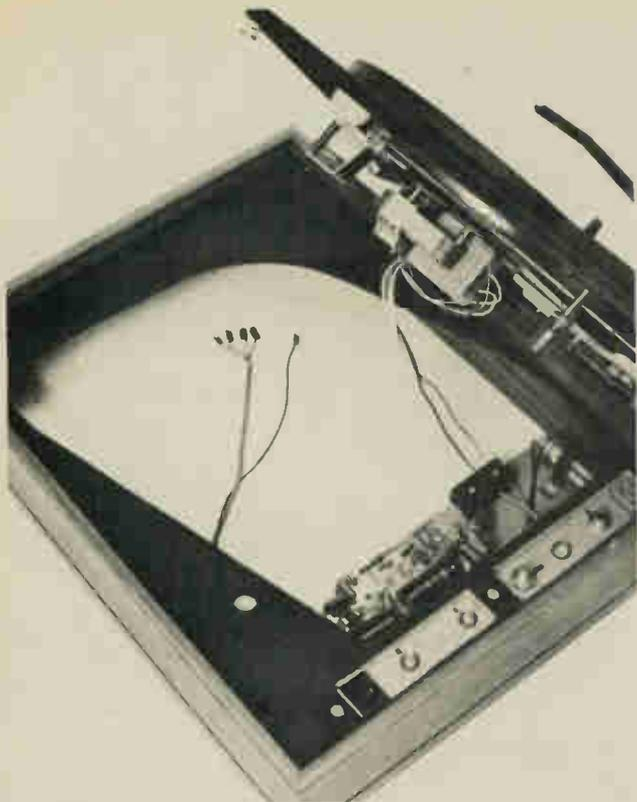

Assembly of the amplifier within the plinth. Wires shown are the only internal connections required.

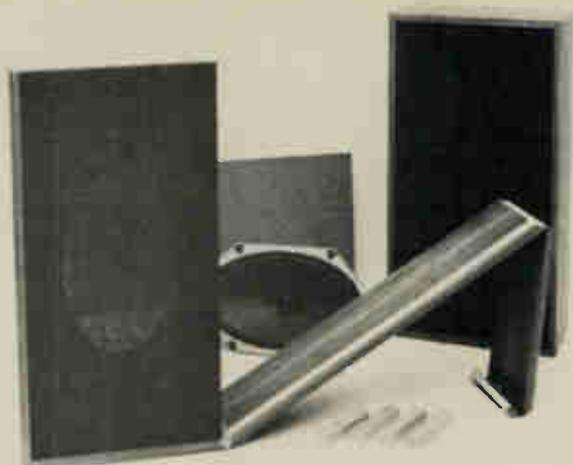

Parts and assembly of the loudspeakers. All the wooden parts are pre-cut, slotted and finished.

control for treble lift or cut, an output for connecting to a tape recorder, for taping discs and also an input for a radio tuner, tape recorder or cassette player etc.

CONSTRUCTION

Fully illustrated instructions are supplied covering stage by stage assembly, connections and operation plus a fault finding table should the constructor go astray somewhere. Photographs clearly show all the wood parts for the plinth and loudspeakers with each part numbered. Few tools are required other than a screwdriver and a hand drill with a few bits up to 1/4 inch diameter. Glue is also required and any wood-to-wood type will do. No difficulty was experienced in assembling the woodwork because all the various pieces are accurately cut and drilled. Once this work is completed and the glue is dry it is only a matter of fitting the amplifier into the plinth and the two elliptical loudspeakers into their respective boxes. Wiring is no problem because of the push on connecting tags but do double check on this before switching on for initial tests.

PERFORMANCE

The power output was measured across an 8 ohm load and was 2.5W

r.m.s. With a 4 or 15 ohm load the power barely reaches 2W before clipping occurs so if alternative loudspeakers are contemplated at any time they should be 8 ohm types. The distortion factor at 1000Hz and with 2.5W output was well under 1% a figure that would be unacceptable for high fidelity but is low enough for good quality reproduction. The hum and noise level was in the region of -30dB, also an acceptable performance figure for such a simple low cost system.

The auxilliary and tape inputs were as specified but the frequency response via these does, as the graph shows, rise rather considerably at the low frequency end. This was not however, the case from the pickup input and a test record showed a fairly uniform response. The tone control affects treble response only and, if set midway, provides the response shown in the graph.

Increasing the control to maximum then lifts the treble by about 5dB at 10,000Hz. The rising bass response from the auxilliary and tape inputs could of course be advantageous since the loudspeakers are fairly small and themselves have little useful response

FREQUENCY RESPONSE

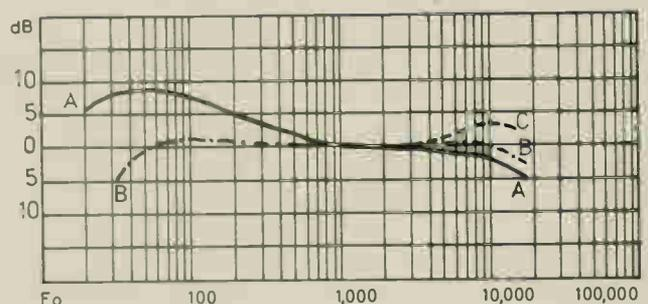

A-A: Overall response from tape or auxillary input.
B-B: Response (via pickup) from frequency test record.
C-C: Amount of treble lift (A) at 10kHz.

below about 100Hz. It is possible that the makers intended this performance i.e., to provide a constant bass boost to offset the lack of response from the speakers. From a listening point of view the system produces a very pleasant sound *providing* the volume is not turned too high. The treble response is good but, because of the small size of the speakers, bass response is limited as one would expect despite the lift at around 100Hz from the amplifier. Better loudspeakers might well be a worthwhile proposition if only to enhance the bass. An alternative would be to build larger speaker boxes with an 8 or 10 inch bass-midrange speaker and use the elliptical, in the same box, as a tweeter fed via 2 or 4μF capacitor as a simple frequency divider.

The Stereo 21 kit retails at £17.95 including VAT and packing and postage is £1.50. For a total outlay of £19.45 the kit is good value for money, well turned out and for a few hours work builds into a very acceptable little stereo system but one I must repeat that cannot be regarded as, or is intended to be capable of true Hi-Fi performance. ●

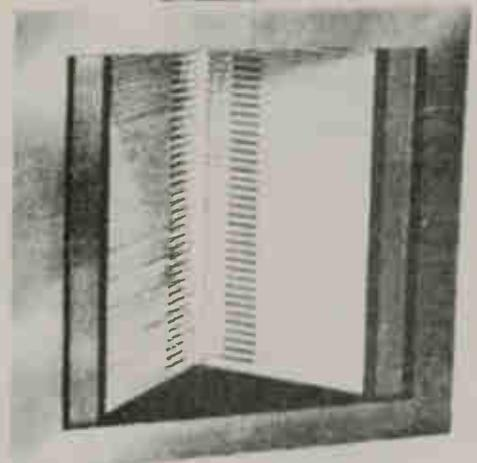

Heil Air Motion Transformer handles mid range and treble in conjunction with conventional woofer — the manufacturers, ESS, are believed to be actively developing a bass version of the Heil unit.

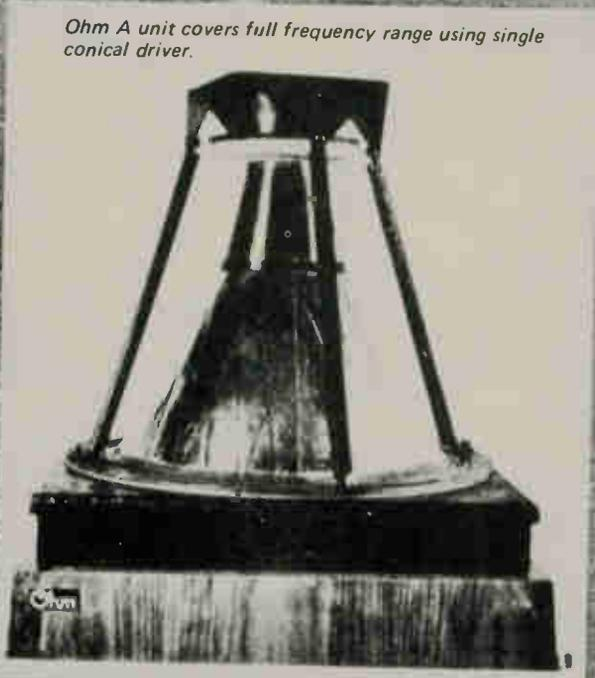

Ohm A unit covers full frequency range using single conical driver.



LOUDSPEAKERS

-an explosion of new designs

by Irving M. Fried

Some of the most revolutionary innovations in years are coming onto the market in various parts of the world. Not all these speakers are available in the U.K. but no doubt those which prove themselves will appear sooner or later.

THIS year, as every other year, will find old and respected manufacturers and brand new companies alike presenting their "new" "improved" or "breakthrough" loudspeakers to the general public. Once again, you will be asked to accept each system as "the speaker of the future," one that "makes all others obsolete." Just as surely many new models will, like so many previous "break-throughs," sink quietly into oblivion. The number of enduring advances in the art of loudspeakers is very small.

But from time to time, manufacturers do manage a significant advance in basic design principles, largely by using new materials and technologies. And 1973 is such a time. I believe that some of the new loudspeakers described below will endure and find their market niches — but possibly not in the positions their proponents envisage.

Every twenty years or so a wave of fruitful innovation overtakes the loudspeaker industry. The last such broad advance was back in the middle 1950's when the first air-suspension systems and the first successful electrostatic, ribbon, and ionic drivers appeared.

I'd like to begin this survey of some of the more interesting new loudspeakers with those systems whose basic driver principles are the main subject of interest. I'll try, whenever possible and for the sake of the record, to mention past products that bear a resemblance. Manufacturers' claims for their products always are difficult to assess until the products themselves can be evaluated fully, and a certain extravagance is to be expected in someone who has worked hard on what he considers to be a successful design. The many quotes, some of which come from product literature, rather than directly from engineers and company executives, are to be understood in this light.

The most radically different new loudspeaker is the Ohm A. Invented and patented by the late Lincoln Walsh, famous in high fidelity history for his Brook all-triode amplifier, it has no direct antecedents in the art (though some claim the Hegeman tweeters of the fifties worked on the same principles). The Ohm A driver looks like an inverted funnel, the large end of which is fastened to an infinite baffle box. The funnel, or cone, is made of copper and titanium, forming a composite cone of rather large size and heavy mass. The theory of operation is, for the bass below 200 Hz, that of mass loading; and, for the midrange and treble, high-velocity wave-train propagation down the cone, with radial propagation of all frequencies of musical interest.

The Ohm A has been publicly demonstrated and is in limited production. It is very inefficient, but when driven by amplifiers of sufficient power seems to give a good account of itself — according to many auditioners. Traditionally the British metal-cone speaker designs of the past (G.E.C., Jordan-Watts, and Jordan) have been lauded for their clarity, while drawing some complaints of a metallic edge to high-frequency sounds. None has been precisely of the Ohm A shape, of course, and it will be interesting to see what the final evaluations of the Ohm A will be.

Very similar in design and built under the same basic Walsh patents — but intended only for treble propagation — is the Infinity Wave Transmission Line tweeter, which is used in the new Infinity Holosonic Monitor. Replacing the electrostatic drivers that have characterized the company's deluxe offerings, the tweeter also resembles a funnel, but with the large diameter upward. This cone is made of plastic with a thin aluminum skin — a laminate that, it is stated, will support a sound transmission speed of 11 000 feet per

second (about ten times that of sound in air). A voice coil at the cone apex "plucks" it, causing it to emit waves orthogonally: i.e., in circles, spreading outward from the cone surface. The design objective is the simulation of that Grail of speaker theory, the perfect pulsating sphere.

As incorporated into the Monitor of Infinity, the tweeter is intended to handle up to 200 watts of programme input and is said to display a flat impedance characteristic to 100 kHz. The designer says it can be driven at living-room level with a 25-watt amplifier — transistorized or valved.

ESS (formerly Electrostatic Sound Systems), also known heretofore for expensive "hybrid" (electrostatic and dynamic) designs, now presents the Heil Air Motion Transformer as "the loudspeaker of the future". Invented by Oskar Heil, the unit is a midrange and treble driver whose corrugated plastic diaphragm (with imprinted voice coil, called a "conduction cortex") folds on itself, reducing and expanding the volume of the "multiple interfacing cavities" presented by the magnet's vaned pole pieces and projecting sound outward with an "almost perfect transfer of kinetic energy." Dr. Heil further claims near-instantaneous acceleration of the diaphragm, very low distortion, and omnidirectional dispersion in the horizontal plane since sound is "squeezed" out from both front and back of the driver.

First demonstrations of the Heil unit have led to marked disagreements among those present, which always seems to happen with dramatically unconventional loudspeakers. Part of the problem, it appears, is that the first design to be offered publicly has a new enclosure shape, a truncated pyramid, in which response below 500 Hz is handled by a decidedly conventional ducted woofer. More advanced bass systems are projected for future use with the Heil.

Needless to say, the Heil unit will be endlessly discussed and described. Among other things it claims to be "the first new principle of sound propagation in fifty years." Various aspects of the design suggest past

LOUDSPEAKERS

products such as the Kelly Ribbons of the fifties, the compression-throat tweeters of the twenties, the perennial acoustic lens, and so on — all of which principles seem to be amalgamated in the Heil.

Another company claiming to make obsolete all electrostatics is Audio Research, famous for its all-tubed amplifiers. The Magneplanar loudspeaker is offered as a replacement for free-standing, full-range electrostatic loudspeakers, intended to solve their inherent problems (particularly the need for a power supply) and to improve their quality and performance.

The Magneplanar stands six feet tall, four feet wide, and *one inch* thick! Each speaker is hinged twice like a folding screen, forming three panels that are set up in zigzag fashion: two with woofers, the other with the tweeter. Each woofer or tweeter diaphragm is made of thin Mylar (as in electrostatics), to which are glued closely spaced vertical wires. The diaphragm is stretched over a frame; bar magnets are attached to the same frame and inter-leaved with the wires, which make up the voice coil. A crossover operates at 3 200 Hz, though there is provision for using two amplifiers if desired.

The Magneplanar bears a strong family resemblance to the short-lived Ge-Go Orthophase from France a few years back, though in modern dress. It sounds like no other loudspeaker, and is thus (again, as with the Heil) the center of brisk debate. One valid criticism is acknowledged by the manufacturer: its lack of extreme bass. A new add-on flat-panel subwoofer now is available.

Another flat loudspeaker is the Fisher Sound Panel. While not claimed to be state-of-the-art, the unit is offered as an alternative to bookshelf loud-speakers. A single flat slab of acoustic polymer has two voice coils fastened to it. Because of the panel's physical design and the placement of the two coils, one acts as a woofer and the other as a tweeter. Sound is produced equally from front and rear.

More mundanely, several manufacturers claim to have developed improved woofers, with better "attack", power handling, and distortion characteristics. Infinity's new woofer (in its Monitor, already discussed) uses what is described as a patented magnetic system that permits it to handle 200 watts of continuous power without damage — including the demagnetization that conventional woofers can suffer with superpower

amplifiers.

Also mentioned are ported-dustcap woofers (Onkyo), copper caps over magnetic poles (Sony, Pioneer), huge magnetic systems (SAE), and laminated magnets (LDL). None of these, properly speaking, is a new idea, though some appear to have been patently innovative in their present forms. Two points are interesting here, however. First, the emphasis on unconventional refinements in magnetic structures surely represents a step forward from the insistence on sheer magnet mass that characterized loudspeaker advertising only a few years ago. Second, manufacturers are now agreeing that woofers as well as tweeters need improving. To coin a phrase: A woofer and a tweeter do not a speaker make — meaning that as one art advances so must the other, and that the advances must be co-ordinated.

Other new loudspeakers, rather than presenting new drive principles as such, seem primarily to be concerned with the way in which the energy at the driver is presented to the air in the room — and hence to the ears of the listener. Some of the systems we have discussed — the Ohm A and the Heil Air Motion Transformer for example — adopt unusual means to this end, of course; and there are others.

Leslie, heretofore known for its electric-organ speakers, has a new design for home use, including its own built-in amplifier. A baffle in the woofer system of these speakers slowly rotates, "sweeping" the room. Built into the electronics is a phase-shifting system: as a unit the baffle and phase shifter is intended to subdue standing waves in the listening room. The phase shifter, which can be turned off, also is intended to produce quasi-quadraphonic spatial effects when a pair of Leslies are used in the back of the room, supplementing a conventional pair of the front.

Several new companies have combinations of small drivers, generally in omni or reflecting arrays

— each product with its own special claims and virtues, though some readers doubtless will see the interest in this type of design as a reflection of the phenomenal success the Bose 901 system has enjoyed. Design Acoustics uses small drivers on multiple intersecting planes, operating above a conventional woofer which faces vertically. Epicure Products has its various "tower" loudspeakers. APL (Applied Physics Laboratories) uses sixteen full-range drivers, each one "individually equalized" for optimum performance. The Array 12 employs eleven 4½-inch drivers, each with its own "special network" — to smooth the midrange, claimed by Array to be rough in all comparable multidriver systems. The eleven drivers are in a ducted enclosure; a high crossover feeds a single tweeter described as a polycarbonate dome. LDL, whose novel magnet system was mentioned earlier says its multiple-driver array may be used without an equalizer.

In complete contrast to all the above is a fascinating new approach demonstrated last September at the New York High Fidelity Music Show. It is the product of a new group headed by Saul Marantz (founder of Marantz, which now is owned by Superscope). The unit is called the Jon Dahlquist loudspeaker after its designer, and it should be available this year. The Jon Dahlquist Phase Array speaker is planar. (The first samples looked like the Quad electrostatic). It is not, however, a dipole (or doublet), radiating front and rear; Dahlquist strongly rejects such concepts. Rather he states that the flat shape is a device to avoid the diffraction distortions common to conventional enclosure loudspeakers. Mounted on the flat baffle are five dynamic speakers, each chosen for a special range of frequencies. These are joined by a complex crossover network, which equalizes their on-axis response with special compensation for on-axis time-delay distortions. The purpose of all this is to keep all phase

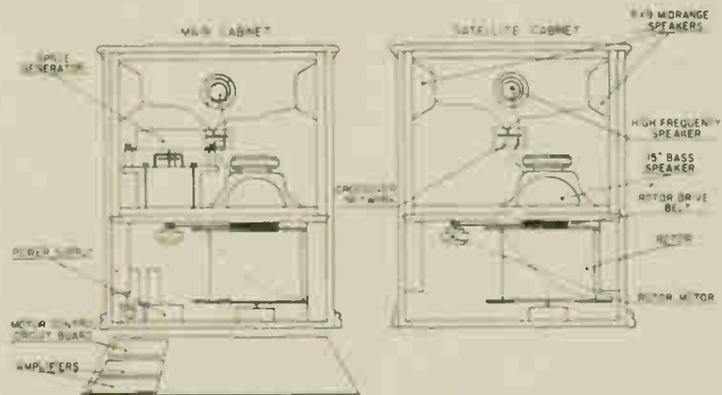

Woofer system of the Leslie Plus 2 enclosure. The driver faces downwards into a revolving baffle that "sweeps" the room. System is similar to that used in electronic organs.

LOUDSPEAKERS

relationships coherent — that is, in step with each other at all frequencies — just as they would be in radiating from a live source.

Dahlquist believes that a good loudspeaker should only operate on the frontal hemisphere, and never backward; that good dispersion forward is a virtue; but that it is better to have poor dispersion than to let any signals be reflected. Indeed, the design concept of the loudspeaker is to keep from "wasting energy" in either directions and to keep from confusing the stereo image. Mr. Dahlquist, it might be noted, speaks from a vast background of research and development on other kinds of loudspeakers — and sounds like a spokesman for the English (BBC) school of speaker research, or the corresponding French (ORTF) school. His ideas and his patented speaker represent a divergence from the prevailing US school of wide, or even omnidirectional, dispersion. The design is a refreshing restudying of the principles of sound propagation and of the relationship of the speaker to the room and to the listener. I suspect that the Dahlquist will have a lasting effect on speaker design.

Despite some evidence of a trend away from electrostatics, two speakers have come out with that ever-glamorous drive in new formats, each claiming to correct all the problems of its predecessors.

The Crown International Auralinear is a hybrid. It has paralleled electrostatic cells used for the full range above 350 Hz, with dynamic woofers in acoustic-suspension enclosures used below that frequency. The cells stand free in the room, radiating from both front and back. Electronic protection circuits are built into the crossovers. Crown claims that the Auralinear represents enormous advances over the "timorous, touchy, and crackling old electrostatics." All the virtues are there, with a new ruggedness and ability to reproduce at very high levels.

The Dayton-Wright (named not for two men but one, Mike Dayton-Wright), from Canada, is a free-standing full-range electrostatic, claimed to cover the full range of sound with "electrostatic quality" in all frequency bands. Each speaker has eight electrostatic cells mounted in two ranks, one above the other, and with provision for coupling the cells in various ways, depending on the configuration that best suits the room's acoustics. Normally, each cell is used full range. The driver assembly is encased in a plastic bag filled with a nonconductive gas. Designer Dayton-Wright claims to have solved

The Infinity tweeter is related to the Ohm A's operating principles though cone orientation is reversed. It is combined with transmission — line bass driver.

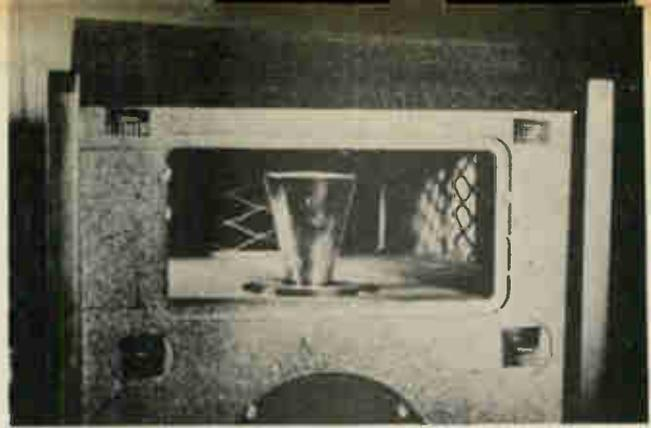

problems "inherent in other electrostatics" — lack of efficiency, nonlinearity, inability to handle extreme dynamic range — by eliminating insulating sheathing in the drivers in favour of the nonconductive gas so that the speaker can take high signal voltages and produce long excursions without arcing and thus be low in distortion and high in output. He also says his design eliminates the phase distortion of crossovers and keeps wave fronts from the various elements coherent.

While Crown and Dayton-Wright have developed interesting (and expensive) new designs, some manufacturers are trying to get better performance from less floor space — an important practical consideration, particularly in quadraphonics. Noteworthy are the JBL sound columns and the EPI Microtower, two adaptations of the tuned columns that date back to high fidelity's earliest days. The results are excellent in terms of cost and space and show how much one can improve on old designs with modern materials and know-how.

The search for more realistic bass reproduction in speakers take several forms; most manufacturers are offering "new approaches" of varying complexity and cost. Perhaps most newsworthy are the various transmission-line loudspeakers turning up in the deluxe sector of the market.

The transmission-line concept is not new; old hands will remember the acoustical labyrinths of the late thirties and early fifties. A decade or so ago the British revived the idea of enclosing a driver in a long tube leading from the back of the driver. According to its proponents, the principle can be used wherever the criterion is more *natural* bass propagation, or wherever it is more *accurate* midrange or bass propagation. Thus some manufacturers have adopted transmission lines for both bass and midrange, justifying the complexity and expense by the more accurate reproduction made possible by high-quality drive systems. Properly executed, the technique provides a dead acoustic environment for the driver, killing reflections back to it from the enclosure and sound feed through enclosure walls. In addition, bass lines can be tuned like organ

pipes, lowering the free-air resonance of a driver (to get deeper fundamentals in the bass) and smoothing the impedance characteristics of the loudspeaker (thus making more efficient the transfer of power from the amplifier).

All of these virtues contribute to the transient performance claimed by transmission-line advocates. There are some vices, however, lowered overall efficiency and susceptibility to subsonic disturbances being the most important. But the designers have been busy, and a number of successful transmission-line systems are available from Infinity Systems, ESS, Radford Music and Sound, and IMF. The configurations vary of course from model to model.

A related idea, again from England, is the active-line loudspeaker. The transmission lines we have been discussing are passive — i.e., driven from one end only. In the new IMF ALS-40 loudspeaker the bass line is driven conventionally at the top end, and driven at its "port" end by a subsonic-resonance woofer through a complex phase-shifting network. The design team at IMF makes the following claims for the active-line principle: that it reduces cabinet size for equivalent performance; that it increases efficiency and power-handling capacity (i.e., acoustic power into the room); and that it eliminates subsonic problems.

Certainly no one has repealed the laws of physics, though speaker designers are wont to accuse each other of claiming to do so. All that can be said about the current state of the loudspeaker art is that some manufacturers are succeeding in making sonic advances, by a better understanding and application of the laws of physics, acoustics, and psychoacoustics. In short the art is not standing pat even though the laws within which it operates are. We are seeing more and more fresh design ideas; and some of them are, I think, better solutions to the eternal quest for the ideal loudspeaker. At the worst, there is a rebirth of excitement in loudspeaker design, and the purchaser this year is given some real choices. But the verdicts on today's new designs is of course that of the market place. ●

The loudspeaker

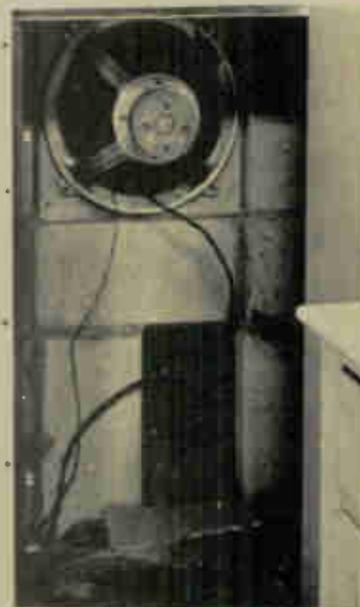

Fig. 2. A 38cm (15") bass driver is mounted in a concrete enclosure at the throat of the horn (see Fig. 1.). This driver is driven by a signal common to both stereo channels.



Fig. 3. The speaker system for the stereo channels is unobtrusively mounted. Concrete pressure horns will be hidden in a cupboard.

'There was an old women who lived in a shoe...' Well we can't prove that one but our Australian edition have come across a man who lives in a loudspeaker!

AUDIO fans are forever saying "If only I had a better bass response — perhaps if I used a . . .". Most go no further than the day-dream stage as the cost and sheer magnitude of obtaining really good bass response is usually beyond them.

There are some, however, who determine that the day-dream shall become a reality, regardless of the work, cost and self sacrifice involved.

Such a man is Peter Schmedding of Canberra.

Peter has had a life-long love of organ music and, having for one reason or another missed the opportunity to learn the organ himself, decided to build an audio system capable of reproducing recordings of the "King of Instruments" with sound as faithful to the original bass as possible.

It soon became obvious that the main limitation to reproduction at 20

house

IT'S NO JOKE — THERE REALLY IS A MAN WHO LIVES IN A LOUDSPEAKER

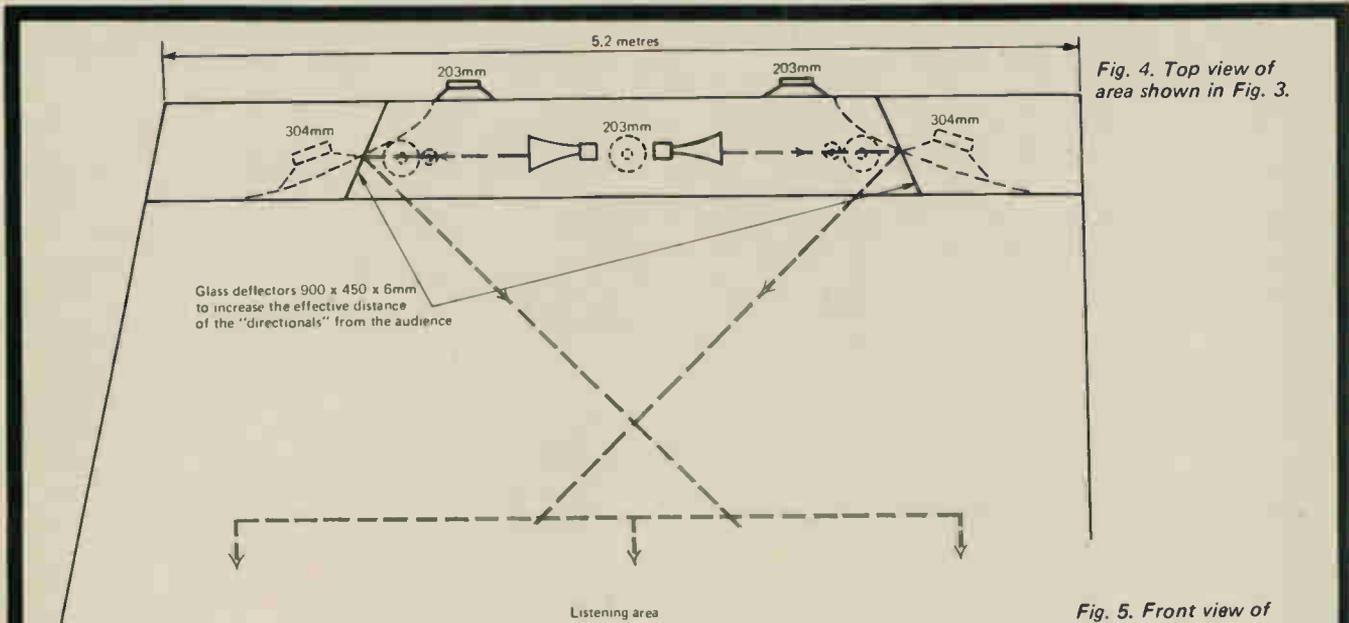

Fig. 4. Top view of area shown in Fig. 3.

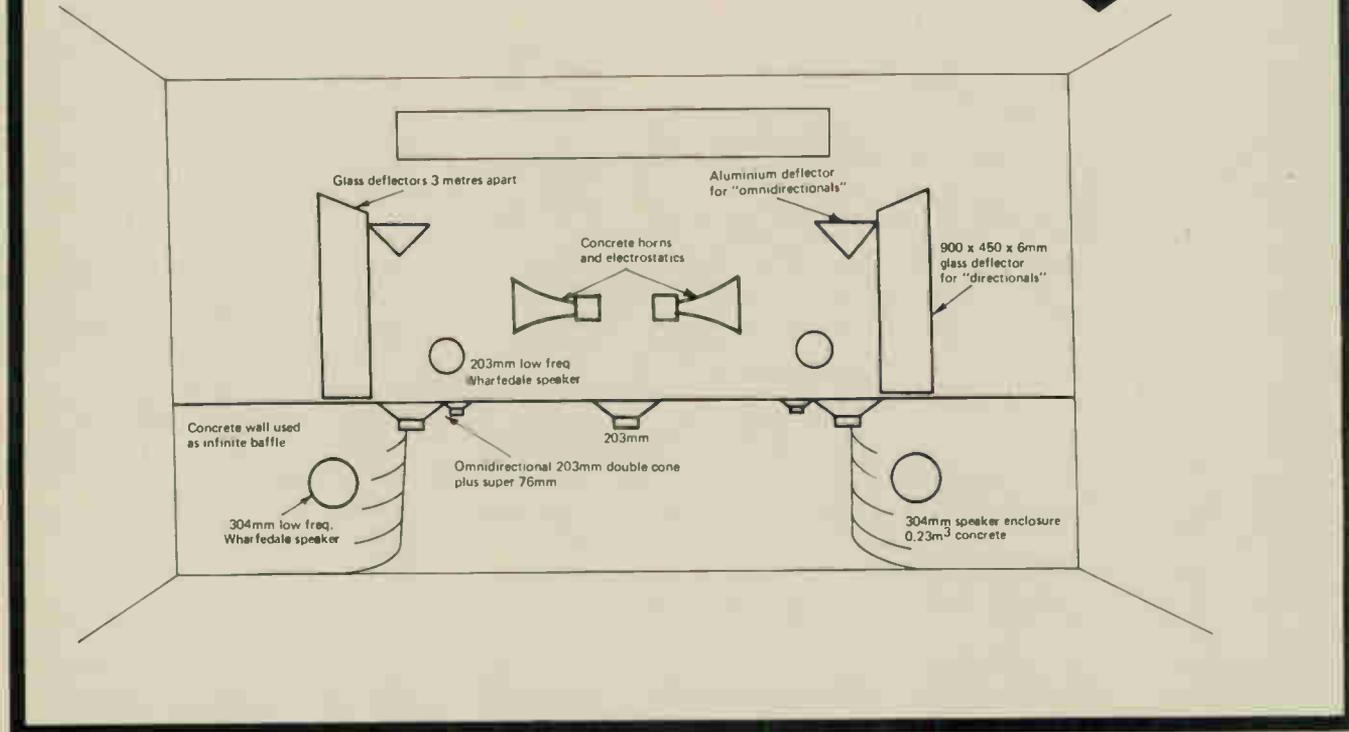

Fig. 5. Front view of area shown in Figs. 3 and 4.

to 30 Hz was the acoustic properties of the room itself and hence, undaunted, Peter decided to design a special music room as an extension to his house which could at least reproduce the octave 30 to 60 Hz.

He sought the aid of Brian Sudding of the Australian Broadcasting Commission (ABC) who designed the room and furniture to the, one would think, incompatible standards of building

codes and acoustic requirements.

Apart from the roof, the entire extension including the reinforced concrete block walls, was built by Peter himself with the aid of his wife who mixed up the odd batch of mortar etc. — what a wife!

We heard about Peter and his music room from a friend at the ABC who said 'you really must go and see it. He's actually designed the room as an

exponential horn — and it sounds good'. So, somewhat tongue in cheek, we decided to go and see and hear it — together with our acoustical consultant Louis Challis and a stack of test gear and records.

The layout of the room can be seen from Fig. 1. It is of concrete block construction with the new front wall extending from the original house at an angle of 40°. The design of the

The loudspeaker house

room started with this basic angle and was calculated in wavelengths rather than feet and inches to fabricate an LF horn to cover one octave only, 30 to 60 Hz. The driver for this horn is a 38 cm (15") woofer in a concrete enclosure at the throat of the horn. This is carefully installed so as to be invisible until a louvred door is opened, at the end of what is otherwise used as a sewing room. The ceiling of the room slopes from 3.15 metres at the centre to 2.65 metres at the sides.

The sounds from this low frequency unit propagate out with diminishing intensity towards the main music room and surprisingly, through a louvred-panel room divider which introduces some reflections and some minor degree of transmission loss in the sound path. The drive for the horn is the summed left and right signals in the 30 to 60 Hz octave. The other speakers for the two stereo channels are mounted on one 'side' of the horn and propagate their sound by direct radiation to the listeners.

From the description it may be assumed that Peter has built a room and a system, with money as a secondary consideration — but such an assumption is far from the truth.

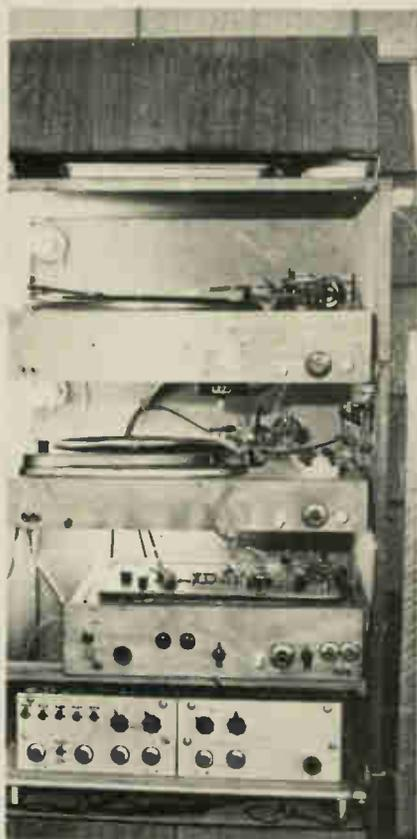

Fig. 8. The equipment rack contains two turntables (one with a homemade arm), a tape recorder and the four Sinclair 25 watt amplifiers.

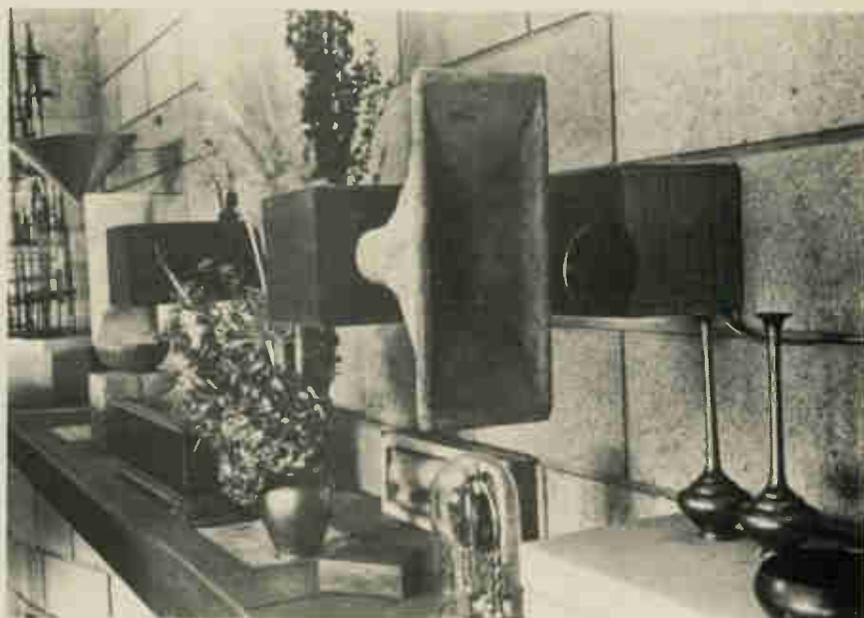

Fig. 6. The concrete pressure horns and Magnavox electrostatics will eventually be hidden in a cupboard in accordance with Peter's view that speakers should be heard and not seen.

The power amplifiers, for example, are Sinclairs — two Z30's and two Z50's. Preamplifiers are home constructed using locally available components.

Loudspeakers are mainly Wharfedales, but with carefully modified crossover networks to provide an almost flat frequency response in the middle of the listening area.

Whilst most speaker manufacturers favour direct radiators at high frequencies, Mr. Schmedding has chosen to use plate glass reflectors which are intended to provide — but do not do so totally successfully — added diffusion. In fact, off axis, the high frequency performance above 12 kHz suffers a significant loss of level due to the directivity of the source and the reflectors. A slight curvature in the glass would probably cure this minor problem.

MEASURING ROOM CHARACTERISTICS

Our signal source was a beat frequency oscillator, Bruel & Kjaer type 4014 to which was coupled a high speed level recorder. (Bruel & Kjaer type 2305B). A signal from this source was fed directly into the auxiliary input of the main amplifier system.

The acoustical signal was detected by a 1.25 cm diameter. Bruel & Kjaer pressure microphone fitted to a remote preamplifier of a Bruel & Kjaer sound level meter. This functioned as a signal amplifier for the level recorder.



Fig. 7. The 3 inch and omnidirectional speakers are mounted face up in the bench top. A copper cone reflector (visible in Fig. 3 and 6) disperses the sound horizontally.

The first signals were recorded with the microphone in the middle of the room. The results were excellent. Firstly, the overall response was better than ± 10 decibels from 20 Hz to 20 kHz, and although the response was not flat, the notches in the response were not excessive.

For comparison we repeated this measurement with the beat frequency oscillator's output modulated by an 8 Hz signal with a 20 Hz deviation. This clearly showed up the overall

shape of the room's response which is unusually flat to 17 kHz.

By opening the windows it was found that the audible low frequency response was boosted by as much as 10 dB between 25 Hz and 100 Hz, and simultaneously the response between 200 and 600 Hz was depressed.

Having established the room characteristics we then used a swept tone frequency response test record to measure the real performance of the built-in record playing system. This test record, which requires external equalization, provides a correctly equalized performance between 20 Hz and 1 kHz.



Fig. 9. The listening area with the equipment rack on the right. (Extraordinary looking device held by Louis Challis is a sound level meter)

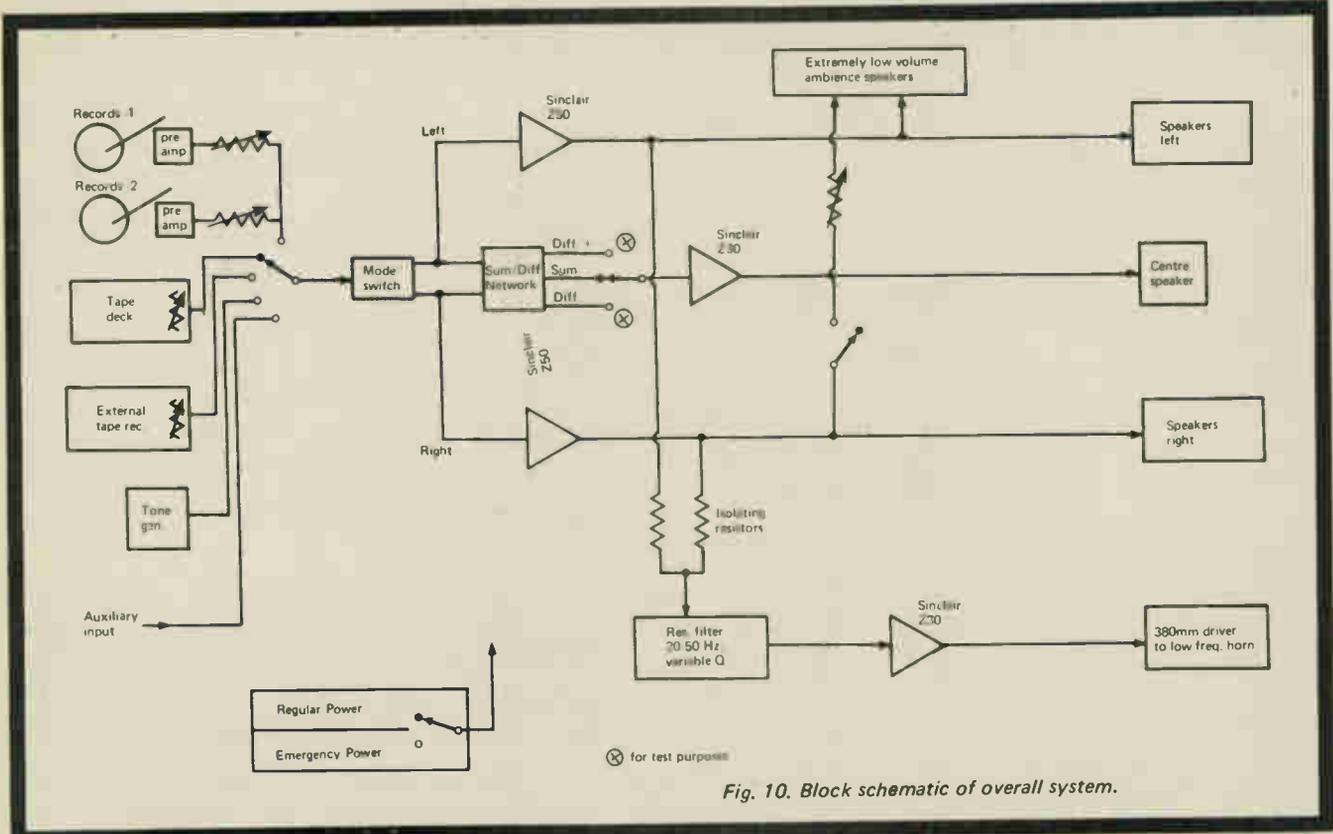

Fig. 10. Block schematic of overall system.

This measurement showed that the record player preamplifier provides exemplary performance above 30 Hz but degrades the basic room and speaker performance between 20 Hz and 30 Hz.

Peter Schmedding's system has two minor limitations. Firstly, recordings of classical music with any real content below 40 Hz are few and far between — although, surprisingly this is less true of contemporary music. Secondly, the main cartridge fitted to Mr. Schmedding's tone arm is a low cost unit which does not provide the trackability that his system so justly deserves.

But overall, Peter has achieved his aim. The bass response is clean and very dramatic. On records that do have content down round 30 Hz, those reinforced concrete block walls could be felt to shake!

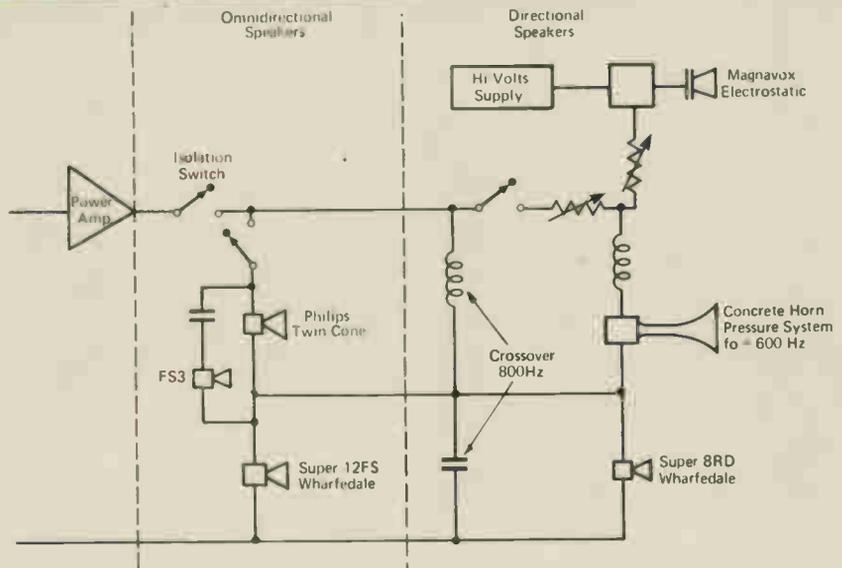
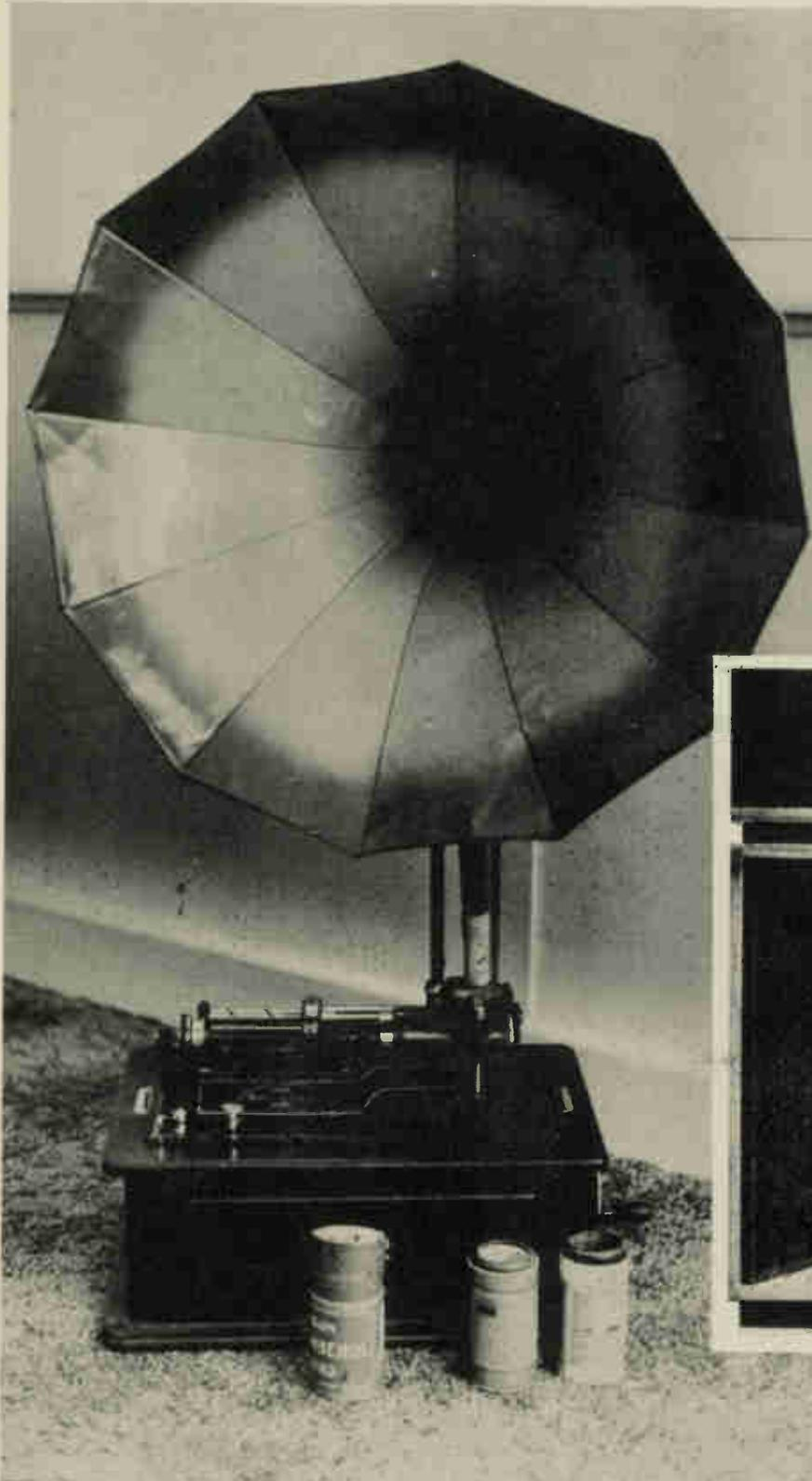

Fig. 11. Speaker system for one channel of stereo system.

Horn loaded loudspeakers

— Terry Mendoza reports



THE function of a loudspeaker is to *transduce* electrical energy from an amplifier into corresponding mechanical movements. Under the influence of these movements the loudspeaker cone impresses similar pressure fluctuations on the body of air adjacent to itself, and it is these pressure variations reacting with the tympanum of the outer ear that produce what we perceive as sound.

Generally loudspeakers are very inefficient, in fact most direct radiating types convert only about 1% of their electrical energy input into sound. This means that to produce the 0.5 acoustic watts that is generally considered to be the minimum requirement for hi-fi reproduction at least 50 watts of power must be supplied by the amplifier.

Numerous factors contribute to this low efficiency. Some energy is lost within the loudspeaker coil in the

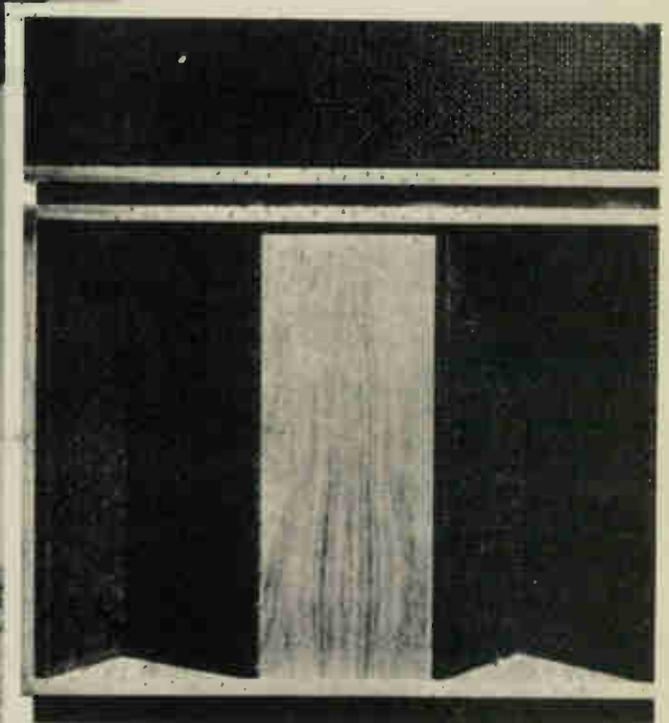

Belle Klipsch is a domestic horn loaded speaker derived from Klipsch units made for theatre use.

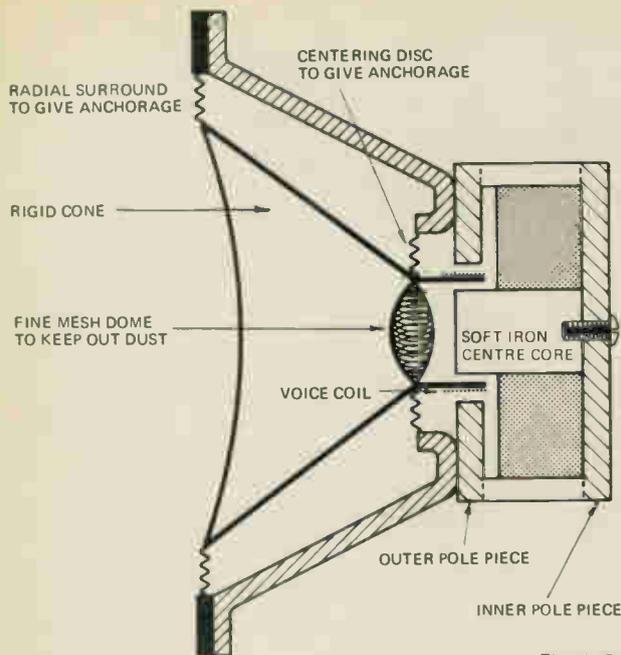

Goodmans Midax 650 mid-range driver

Fig. 1. Section through typical moving coil loudspeaker.



Fig. 2

form of heat. More is lost overcoming the inherent stiffness of the coupling of the paper cone to its radial anchorage. The stiffness is a deliberate attempt to hold the cone such that it can only rigidly pump the air — faithfully following the electrical variations in the coil. (Fig. 1). Loose radial anchorage would permit cone oscillation after the sudden cessation of a signal.

The majority of the efficiency loss however is due to the poor coupling between the 'piston' of the loudspeaker cone and the body of the air that the cone has to push before it.

In Fig. 2 'A' and 'B' represent two frictionless perfect pistons within a cylinder. If the gap between 'A' and 'B' is filled with air and 'A' pushed in, 'B' will move out — though not exactly in phase with 'A' due to the compressible nature of gases. When 'A' is suddenly halted the inertia of 'B' will cause it to overshoot. The lower pressure thus caused will 'suck' it back and this cycle will then be repeated until B oscillates to a halt. A situation similar to this is found in two separate aspects of loudspeaker systems.

Firstly, when a signal is impressed across the speaker voice coil, the coil and cone (known collectively as the driver) will move in one direction; when the voltage polarity across the coil is reversed (half a cycle later) an

ideal driver would start to move in the opposite direction. This it does, but only after first overcoming the inertia of cone and driver that only half a cycle earlier had been intent on impelling itself forward.

Secondly consider the loudspeaker cone which has been pushing a volume of air before it. As the cone begins to retrace its steps, the thin layer of air nearest to the cone, with less mass (and consequently less inertia) than the cone/voice coil combination, follows them back again instead of transmitting its energy to the next (hypothetical) thin layer adjacent to it.

Reverting to Fig 2, piston 'B' can only exactly complement the action of piston 'A' if the gap is filled with an incompressible fluid. Unfortunately, with actual loudspeakers the driver 'A' has a harder task than to pump incompressible liquid or compressible air down an enclosed 'energy link' to react on an eardrum — represented by piston 'B' — the driver has to pump into the open air. It is like trying to power a car with the cylinder head removed from the engine block!

But if the air could be made to behave like an incompressible liquid, a very efficient coupling between the driver and the air would result. A number of methods have been devised to approach this ideal; by far the most effective of these, with efficiencies of up to 50%, is the method known as 'horn loading.'

The acoustic properties of horns have been understood for thousands of years — the 'bell' of wind instruments relies on the horn principle for efficiency, directivity, and

characteristic tone. The antiquated 'hearing trumpet' was another application utilising the horn for sound reinforcement.

As already discussed, the task of the horn is rigidly to link the movements of the driving diaphragm to the air in the vicinity. The more rigid the linkage, the better the transfer of energy will be, thus giving the desired increase in efficiency. When energy is transferred, work is performed. Work, as far as the driver is concerned, is the overcoming of the acoustic impedance presented to it. This impedance has two components — a resistive one due to the energy radiated (the productive part of the work), and a reactive one due to the energy stored. This is where there is fruitless cyclical interchange with the driving surface (which is in fact happening in the example quoted earlier when the thin air layer follows the cone on its return journey).

Essentially, the horn acts as an acoustic transformer; it works on the principle of trying to avoid a rapid expansion of wavefront area at any frequency.

This avoidance assumes especial importance in the region near the driver. To understand why this should be so, consider a theoretical point source of sound. It pulsates at a constant frequency and near the source the wavefronts rapidly grow in area. Further away the percentage increase in wavefront area is not nearly so marked. This can be seen by considering wavefront expansion near the sound source.

Let us assume that the radius of this expansion increases from 1 unit to 2 units. The surface area of a sphere is

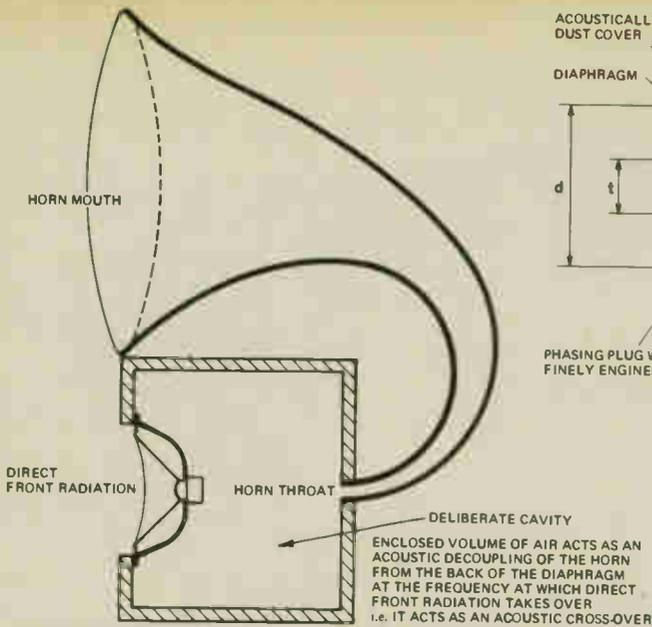

Fig. 3. Horn loading is used for the output of the rear of this speaker to augment the direct radiation from the cone.

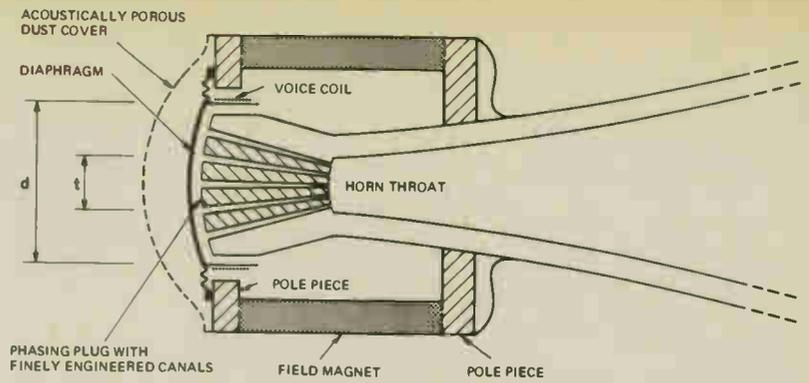

Fig. 4. Cross-sectional drawing of a typical horn-loaded high frequency driver. Note the difference between diameter 'd' and throat diameter 't' that is necessary for efficient loading.

Horn loaded loudspeakers

$4\pi r^2$ therefore the percentage increase in area is

$$\frac{4\pi (2^2 - 1^2) \times 100}{4\pi 1^2}$$

This equals 300% increase. But considering adjacent wavefronts further away, where the radius is going from 10 units to 11 units the area increase is less rapid.

$$\frac{4\pi (11^2 - 10^2) \times 100}{4\pi 10^2} = 21\% \text{ area increase}$$

So it can be seen that the narrower end of the horn, nearest the source, is the most critical area for satisfactory acoustic loading.

The horn throat, as it is called, has an aperture lying between one third and one quarter of the active area of diaphragm driving it. Increased loading is possible with a smaller throat/diaphragm ratio, but this is never carried out in practice as it leads to distortion due to friction of the air as it enters the throat.

Horn loaded speakers nowadays are designed to cover an audio range of no more than three octaves, additional horn loaded assemblies being used as required.

However it is fairly common practice to use horn loading for the rear of a loudspeaker — to provide good bass response, the front of the cone being used to directly radiate the output above that handled by the horn. (Fig. 3).

When horns are to be used for high frequencies, a phasing plug is

interposed between the diaphragm and throat to ensure the correct phase relationships by reducing any effective cavities. Even a small cavity can become a resonating chamber at high frequencies — this will give rise to a shrill harsh output from the horn. (Fig. 4). The extremely small clearances used for the phasing plug of a high frequency horn ensure that such cavity resonances as do occur will fall above the range handled by the horn.

HORN CONFIGURATIONS

After the throat comes the horn itself. There are five inter-related

variables involved here — flare shape, flare rate, horn length and cross-sectional shape, and size of mouth.

The ideal would be a horn possessing a shape that would provide an acoustic resistance that remains constant and of high value for all frequencies within the audible spectrum.

The rate of flare expansion will be dependant upon the algebraic function chosen for the flare curve (Fig. 5) and on the length of horn between throat and mouth. The slower the flare rate, the deeper will be the lower frequency

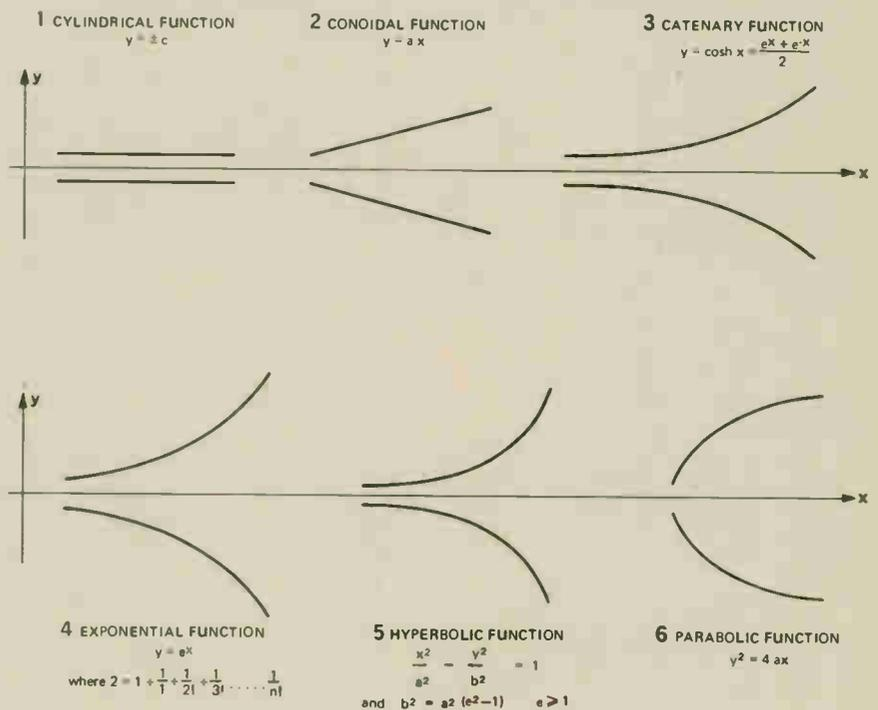

Fig. 5. Flare curves generated by various algebraic functions (see text). Note that 'a' and 'c' are constants.

cut-off e.g. for a particular flare curve, if the flare length is doubled (i.e. flare rate reduced by 50%) the cut-off at the lower end of the frequency spectrum will drop by one octave. (Fig. 6).

The flare curve may follow any algebraic function from phase (where $x = 0$ for all values of y) which is known as infinite baffle, to cylindrical — passing through parabolic and hyperbolic.

The hyperbolic group covers conical, exponential and catenary curves. The first type of horn to be used in conjunction with a sound reproducer was the conical variety. This became popular in the days of Berliner's phonograph.

However a conical horn, with zero flare, has an acoustic loading that changes almost continuously throughout the frequency spectrum. It has very poor frequency response because of its extremely low acoustic impedance at the bass end — as can be seen from Fig. 7. Nevertheless, a zero flare gives the lowest distortion of all the curves.

It should be noted that the theoretical results illustrated in Fig. 7 can never be fully achieved in practice because an actual horn system has a finite length and mouth size dictated by space considerations. Even disregarding the enormous horn sizes that would be involved, the cut-off frequency found in practice varies between 1.2 and 1.7 times the theoretical cut-off frequency.

A cone shaped horn has a constant slope giving zero flare. The parabola is one case in which the flare is negative i.e. the slope decreases with distance from the throat. It can be seen from Fig. 7 that the acoustic resistance afforded by a parabolic curve is even less consistent than for a conical one. Taking cases where the flare has a

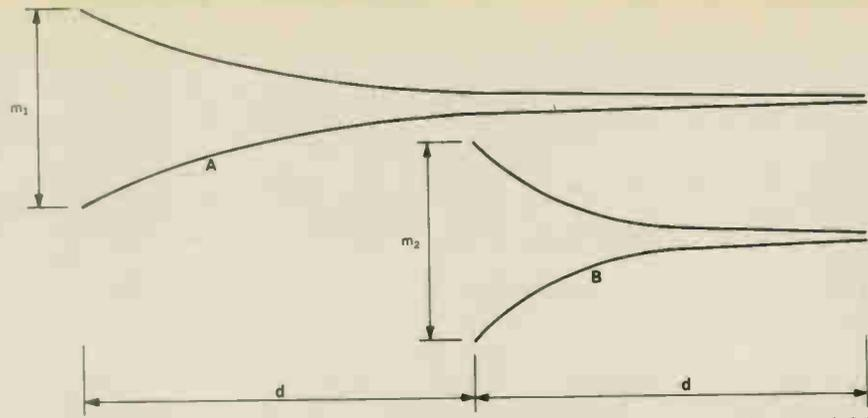

Fig. 6. $m_1 = m_2$ and flare curves for both horns are the same however horn A has length $2d$ and horn B has length d , \therefore horn A has a cut-off frequency one octave below that of horn B.

positive value we can see that the graph of acoustic impedance continues to improve up to the point where an exponential function is reached. The exponential or logarithmic horn gives the best overall compromise and this is the most commonly used curve for domestic and public entertainment speaker horn applications.

If the positive flare is increased still further, one comes to the shape known as the catenary curve (this is the curve taken up by a slack rope or chain hanging freely under the action of gravity). The catenary function has the property of providing a virtual cylinder at the throat with almost no wavefront expansion in this area. At regions remote from the throat it approaches the exponential shape.

Finally we come to the cylindrical form of horn. At first sight this comes nearest to our already stated 'ideal' with its uniform acoustic resistance throughout the spectrum. But a moment's consideration will reveal that at the remote 'mouth' end the wavefronts will still be in the same (plane) configuration as they were at the throat. There will be a 'virtual source' at the mouth end and no means to prevent the rapid spherical

wavefront expansion — the very condition we are seeking to avoid.

The wider extremity of the horn terminates in the mouth. The greater the mouth area, the lower is the bass frequency that it can effectively handle. A mouth circumference of around forty feet and a diameter of thirteen feet is required to propagate a frequency of 100Hz.

How then could the reproduction afforded by such devices as the Edison Bell Phonograph be tolerated? The answer is to be found within the mechanism of the ear which produces difference tones corresponding to the successive pairs of partial tones of a musical note. Thus it can provide a bass even when none is given out by the apparatus.

Several compromises are often adopted to bring the dimensions of a bass horn to a manageable size.

One method is to employ 'horn folding' so that the horn is compacted to a cabinet-like enclosure. (Fig. 8). This solution has two main disadvantages; firstly it is almost impossible to retain a true exponential curve if the horn is folded. In addition, the treble frequencies, which tend to travel along the horn axis, have their relative phase affected by successive reflections and this leads to various peaks and troughs in the response curve. Apart from this, unless the reflecting material is chosen with great care, diffusion and absorption can occur.

A second solution, usually combined with the folded-horn design, is to create a triangular cabinet termed a corner horn. The principle — somewhat loosely applied in this case — is that the corner of the listening room can be utilised as an extension of the horn flare. This is intended to provide loading down to a lower frequency than that permitted by the horn alone. Of course it is a rare corner of a room that has an exponential shape, but this approximation does in practice lead to an enhancement of the bass end of the frequency spectrum.

Continued on page 33

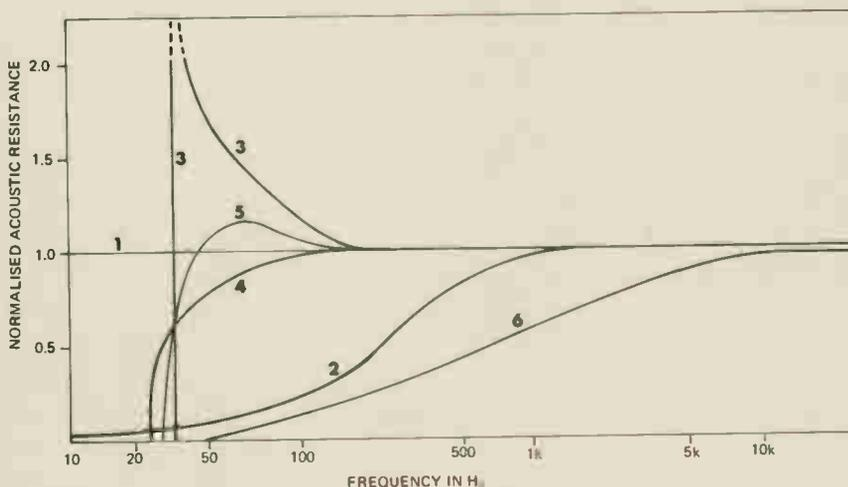

Fig. 7. Acoustic resistance at horn throat for various flare shapes — numbers on curves relate to functions shown on Fig. 5.

Klipschorn folded horn speakers

In the U.S.A. these speakers are highly respected and will shortly become available in the U.K. through their Germany

distributors: Audio International, 6 Frankfurt/main 56, Gonzenheimer Str. 2a, Box 560 229, West Germany.



THIS is an unusual review, in that, to a greater degree than any we have previously published, it highlights the present lack of internationally agreed standards for audio equipment measurements.

The review is that of the Klipschorn KDFB, one of the range of speakers manufactured by Klipsch and Associates in America.

Paul Klipsch originally demonstrated the folded horn technique back in the 1940's, as a means of improving bass response of horn loaded bass speaker units. The basic physical design of the Klipschorn has not changed since 1948, and units built since then can be brought up-to-date with minor modifications.

Our review is unusual in that Paul Klipsch — a well-known and thoroughly respected engineer and manufacturer — claims efficiencies of 50% to 80% for his products. Yet our most carefully conducted measurements — using several (and duplicated) methods — consistently resulted in efficiency figures around 3% — higher than most other speakers of course — but far short of what is claimed.

Over the past years we at Electronics Today International have been plagued, as have other reviewers, with difficulties in performing measurements on a diverse range of speakers, many of which seem to have a different set of physical characteristics, thus complicating our task of reviewing, evaluating and measuring the performance of the system. One of the most difficult of these tasks, by and large, is that of measuring speaker efficiency, which by definition is the ratio of acoustical output to electrical input. At first sight such a measurement seems particularly simple, but this is not in fact so, and measurements of acoustic power output require very carefully controlled conditions in order to be able to provide an accurate result.

THE MEASUREMENT OF ACOUSTIC POWER

There are two main methods available for the measurement of acoustical power. The first is to place the loud speaker (or other acoustical source) in a free field, and perform a large number of measurements on either a full sphere, or hemisphere, around the object, thus providing the integrated sound pressure level from which sound power can be derived. The second method is to place the acoustic source in a reverberant chamber to measure the reverberant sound energy (preferably using pink noise as the excitation if the source is a loud speaker). These methods

provide particularly accurate measures of acoustic power.

Until recently, we did not have a suitable reverberant chamber at our disposal, but we have now built our own 340 cubic metre reverberant chamber. This has a nominal cut-off frequency of 63Hz and an upper limit of 10kHz. This provides us with an excellent means of measuring the acoustical output from any loudspeaker. In particular, frequencies above 250Hz require a minimal number of measurements precisely to quantify the sound pressure level, and thus the sound power being radiated from the source. Electrical power input to the speaker is measured by a precision high-frequency watt meter which has a nominal 0.1% precision, this being considerably more accurate than the degree to which anyone can specify the acoustical power.

The Klipschorn enclosure is extremely large, measuring 125 cm high in its most elaborate form, and requires a corner location, preferably with two hard reflective walls, with no obstructions for some distance on either side. These walls then form an extension of the bass horn.

The front panel is 75 cm wide and may be veneered in a range of timbers with various finishes to suit all tastes. (The unit tested was the 'decorator' model and is intended for finishing to the purchaser's requirements). The top section, which contains a mid-range horn, and the horn type tweeter, is covered with a black grille cloth extending around the side for approximately four inches.

The main enclosure contains a 36 cm (15") bass speaker radiating into a double folded horn via twin passages, which approximate an exponential shape. The claimed cut-off frequencies for the bass speaker are 28Hz and 550Hz, and the cross-over network for the bass horn rolls off at approximately 440Hz at the top end.

The mid-range unit has a cast horn approximately 55 cm long, and is mounted on a separate panel that mounts on to the top of the bass enclosure. This panel also supports the horn tweeter which has a moulded plastic horn 3.6 cm long. The mid-range unit covers the frequencies

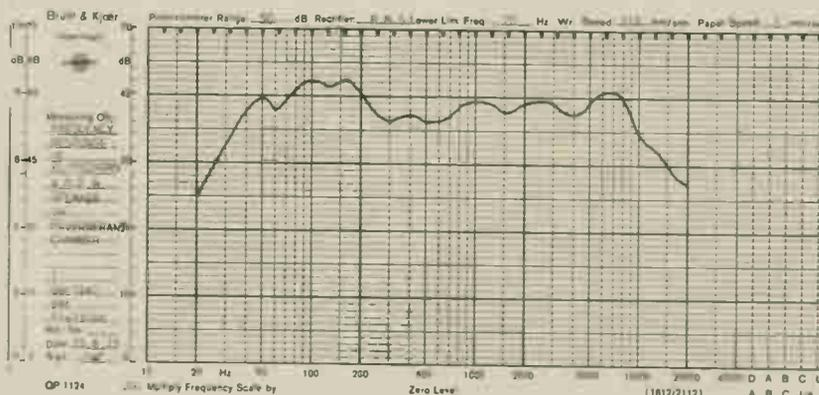

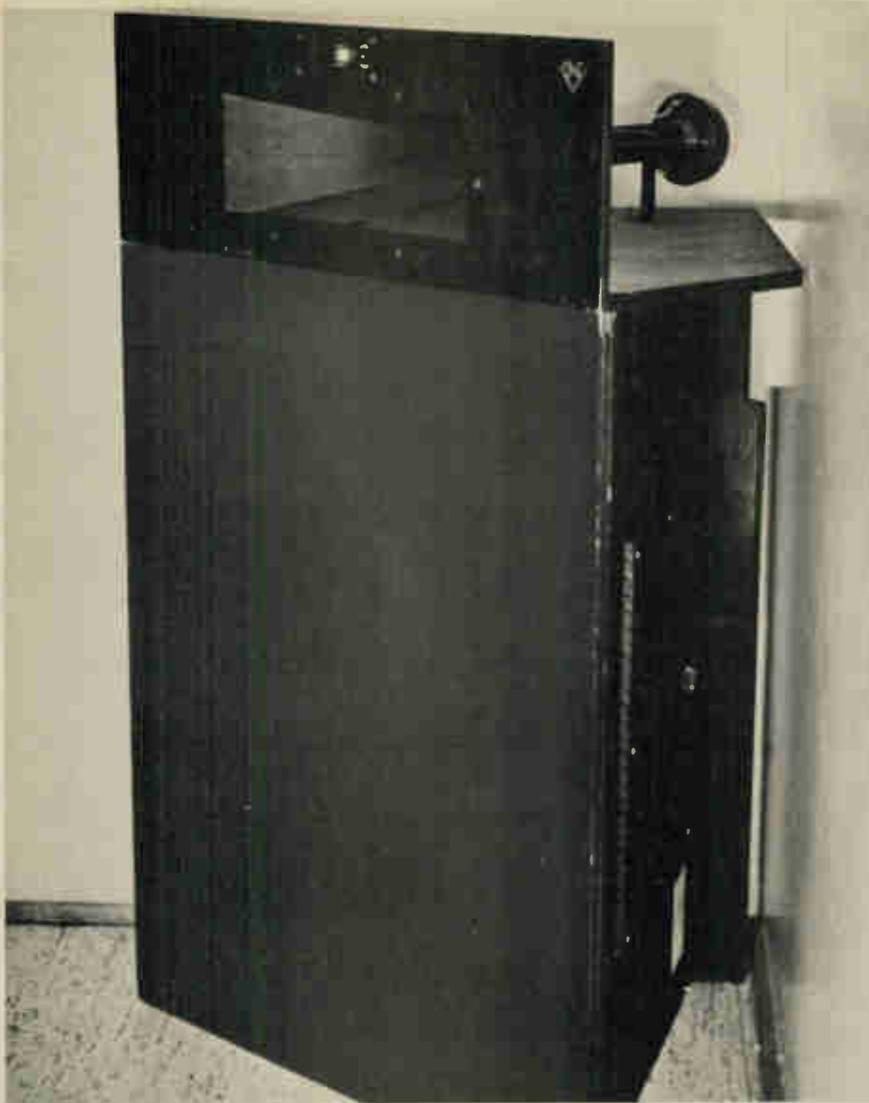

The Klipschorn enclosure must be located in a corner of the listening room.

from 400Hz to 6kHz, and the tweeter covers the range from 5kHz to 19kHz. The cross-over network is complex and includes an ideal protection circuit around the tweeter. The circuit arrangement is shown on the diagram attached. The two zener diodes wired back to back in parallel with the tweeter started limiting the tweeter voltage above 3.5 volts, with an upper limit of approximately 5 volts. In the past the manufacturers experienced considerable problems with transients burning out the tweeter driver. This modified network has almost completely eliminated damage to the tweeters, at the expense of generating distortion, which however is not audible.

A removable panel on the side of the main enclosure facilitates easy removal of the woofer by the loosening of four wing nuts. The woofer itself is particularly interesting for a number of reasons: Firstly, it has a huge magnet assembly, measuring 15 cm by 15 cm by 3.6 cm; and secondly,

because of the lack of the roll surround which is seen on most woofers today. The omission of the roll surround is because the excursions required by the speaker are smaller than for the standard acoustical suspension type, or similarly loaded bass units.

DOPPLER DISTORTION

Klipsch has stated that a major design aim of his speaker systems is the reduction of distortion caused by a Doppler effect. Briefly, as a speaker cone radiates complex sound waves into a room, a Doppler shift of some frequencies is necessarily caused by its very back and forth motion. Hence, many spurious tones, or sidebands not related to the desired sound, are created by the frequency modulation action, thus introducing a form of intermodulation distortion. This form of intermodulation is more serious (its magnitude is higher, and its audible

effects more disagreeable) than the more familiar kind of intermodulation in which relatively isolated tones interact.

Paul Klipsch has stated that the bass diaphragm motion should not exceed 0.15 cm if this type of distortion is not to be created. Careful computation shows that diaphragm distortion is not significantly different in its components to intermodulation distortion, and these cannot be readily disassociated from one another. To prove this we carried out a series of measurements on a number of different types of speakers driving them with simultaneous low frequency high level signals together with a standard imposed high frequency low level signal.

We computed that by feeding the speaker with a two-tone signal consisting of a 50Hz component together with a 500Hz component, the measured significant components ($f_2 + f_1$ and $f_2 - f_1$) which lie respectively at 450 and 550Hz should be -30dB with respect to the 500Hz component when the 50Hz component has a peak velocity of 0.24 cm/sec. These components are known technically as the first order sideband components. We then proceeded to carry out extensive laboratory measurements to assess the subjective effect resulting from the generation of such components, and then to correlate these with our computations. The results of our measurements show excellent correlation between the theoretical and practical results.

The results of our subjective tests were that, on most — but not all — programme material, it is particularly difficult to detect this phenomena even if listened for by trained musicians.

To evaluate a speaker such as the Klipschorn subjectively or in fact, even to use them in his house presents the intending purchaser with a significant number of very real problems. The first of these is that in order to utilise them in the manner in which they are intended one needs a considerable spacing between the pair, (Paul Klipsch recommends 10 metres). Secondly, to develop the full low frequency response down to approximately 30Hz, one needs a room with unusually large dimensions. Last but not least, each speaker has to be mounted in a corner of the room with no obstructions near the speakers.

At the time of performing our evaluation we experienced difficulty in finding any room which met these requirements. Hence, the tests that we performed were conducted in rooms the dimensions of which were significantly smaller than those recommended, and out of fairness to

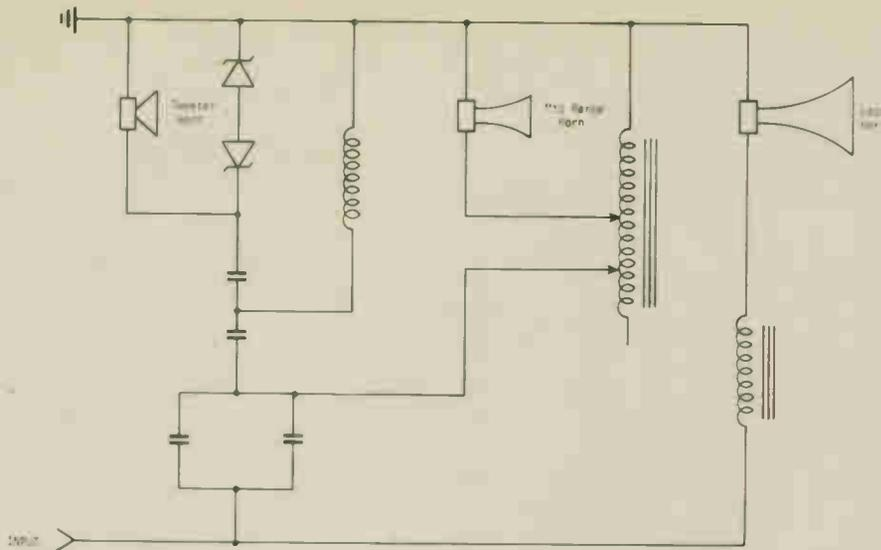

Circuit diagram of Klipschorn cross over network

the speakers we must emphasize that the low frequency performance was of necessity degraded. Nevertheless, when tested under conditions which were imperfect in terms of the criteria stated, the results were still gratifying, and the performance would satisfy most audiophiles in terms of clarity and lack of colouration.

Due to the speaker response being dependent on a corner location, we had to measure the response in a reverberant chamber and make corrections for the room characteristics. To perform this test, pink noise was used as a source and the spectrum was scanned with a third-octave spectrometer. The resultant hand plot of the frequency response does not show the peak to trough excursions normally seen on our free field frequency response test. Tests at different points on the spectrum however, showed that the peak and trough deviations were not greater than 3dB above or below the spectrum shown. The overall frequency response from 30Hz to 15kHz is within $\pm 6\text{dB}$.

The impedance curve for this speaker system was the most non-linear that we have measured to date. In particular there is a very significant peak at 32Hz — of 27 ohms impedance — and another peak at approximately 2kHz, in excess of 32 ohms impedance. Such a range of impedances would have bothered a valve amplifier but would be unlikely to cause significant distress to most modern transistorised amplifiers, unless it was desired to use an additional speaker system in parallel with the Klipschorn horns.

In his literature, Paul Klipsch claims a typical efficiency of 50 per cent and maximum efficiency of 80 per cent, depending upon frequency. But we cannot see how these claims can be substantiated if efficiency is measured by generally recognised methods.

We proceeded to measure efficiency using a number of different methods. All of these methods gave us answers which were consistent within the order of accuracy of the acoustical measurements $\pm 3\text{dB}$ ($\pm 30\%$). Our measured results show that the typical

efficiency was 3% in the octave band centred on 500Hz. A close examination of Klipsch's papers leads us to believe that the discrepancy between our measured results, and those quoted by Klipsch, is the result of our performing our measurements on the basis of total radiated acoustical power over a total electrical power input in accordance with current international practice. We believe that Paul Klipsch most probably carried out his measurements with a microphone on axis of one or more of the drivers, so that his measurements were based on the combination of the directivity of these speakers together with the resultant sound pressure level. If our efficiency of 3% is multiplied by the computed directivity factor for the mid-range horn, our apparent efficiency (on axis of the speaker) is approximately 50%. Whilst Paul Klipsch may be completely correct in his appraisal and statement of the efficiency, the lack of standardisation in measurements for such speakers does leave much to be desired.

We would like to emphasize to prospective purchasers, that Klipschorns *will* sound louder — at any point in a room — than conventional speakers. But it is only when the listener is positioned within a 90° (horizontal) and 30° (vertical) sector in front of the speaker that the sound will be *dramatically* louder. But such a segment of a room is quite extensive and the serious listener is unlikely to find this limitation to be a major handicap. We also wish to emphasize that, despite our different results, these speakers *are* more efficient than most. To illustrate this, if a typical

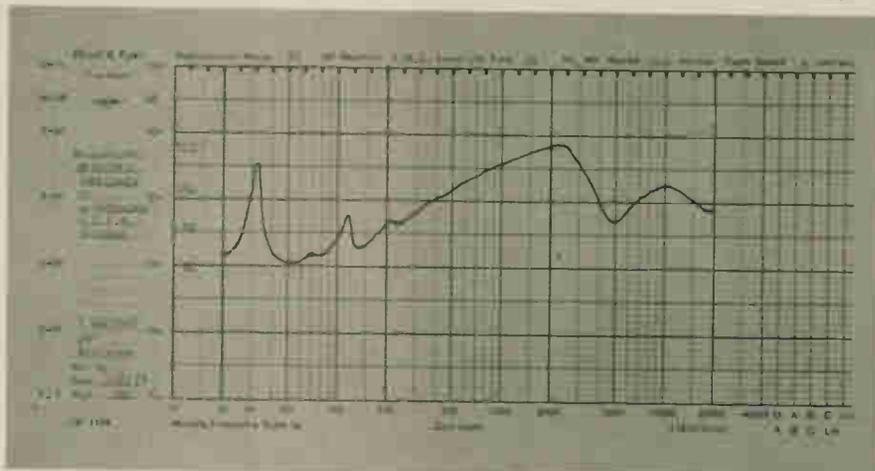

MEASURED PERFORMANCE OF KLIPSCHORN SPEAKER SERIAL NO: 4K475

Frequency Response:
30Hz to 15kHz $\pm 6\text{dB}$
Total Harmonic Distortion
(for 1 watt input):
100Hz 1.7%
1kHz 1.7%
6.3kHz 1.4%

Electro-acoustic Efficiency at 1kHz:
3%

Cross-over Frequencies:
250Hz
5000Hz

Measured Impedance:
100Hz 8 Ω
1kHz 27 Ω
6.3kHz 13 Ω

Dimensions:
124.8cm x 75cm x 67cm.
Weight:

67kg

acoustic suspension speaker were to require 100 watts to generate a certain (high) sound level, the Klipschorns would need a mere five watts to generate a similar level anywhere in the listening room — and even less than that if heard directly in front of

them.

Klipschorns are for serious audiophiles. They are large, heavy and costly — and for optimum results it is almost literally necessary to design the listening room around the speaker.

But serious audiophiles willingly

tolerate such idiosyncracies and for such people Klipschorns have a lot to offer.

The sound produced is most certainly one of the cleanest we have heard to date, and there is a distinct advantage in the smaller cone excursions of the bass unit in reducing distortion.

As our measured figures for efficiency were so much at variance with those quoted by Klipsch, we telephoned the company — in Arkansas, USA — for their comments.

A company spokesman, Richard R. Moore made the following comments:

"Klipsch have never had the opportunity to perform measurements of efficiency using a reverberant chamber. Because of this we have not been in a position to reconcile many of the earlier figures quoted in our literature with our more recent data."

"Whilst not disagreeing with ETI's measurements of efficiency, we would have expected a figure somewhere between 5% and 10%."

Mr. Moore pointed out that our choice of 500 Hz for the octave band pink noise centre frequency used in our measurement would have been close to the Klipschorn's lower crossover frequency (nominally 400 Hz) and this would have affected our figure by 2-3 dB.

"We totally agree that measurements such as these should be standardised and approve of your use of a reverberant chamber for efficiency measurements."

Recommended retail price: approximately £1200 pair. ('decorator' model as tested).

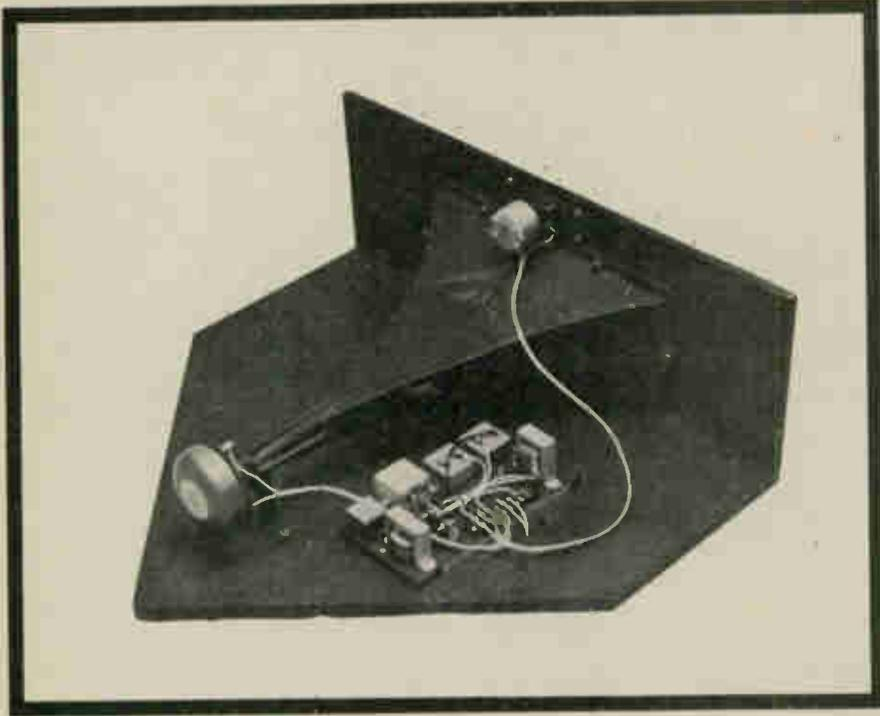

Horn loaded loudspeakers

Continued from page 29

SPEAKER COLOURATION

Commercial loudspeaker units tend to each have their own distinctive 'sound' — largely attributed to colouration by the speaker unit or cabinet.

The main component that can lead to colouration in horn loudspeaker systems is flimsiness of horn cabinet construction materials — lack of rigidity leads to resonance of the panel materials thereby absorbing low frequency energy. Thus the advocacy by the experts of sand-filled panels or concrete slabs for the walls of the horn.

Many compromises are involved to bring the chief benefit of vastly improved efficiency of transduction between electrical fluctuation and air-pressure fluctuation.

A major advantage of horn loading is that a smaller, lighter diaphragm can be used, this has less inertia and a correspondingly reduced tendency to 'overshoot'. Also the cone movement

is less and therefore mechanical resistance on the driver can be made much higher than for a direct radiator type speaker. This improves the acoustic damping on the cone.

Horn loading, to sum up, is the principle of the effective coupling of a loudspeaker drive device to the

surrounding air. It is exactly parallel with transformer practice — the horn transforms high-pressure high impedance conditions at the driver to low-pressure, low-impedance conditions, facilitating the effective transmission of sound waves through the air.

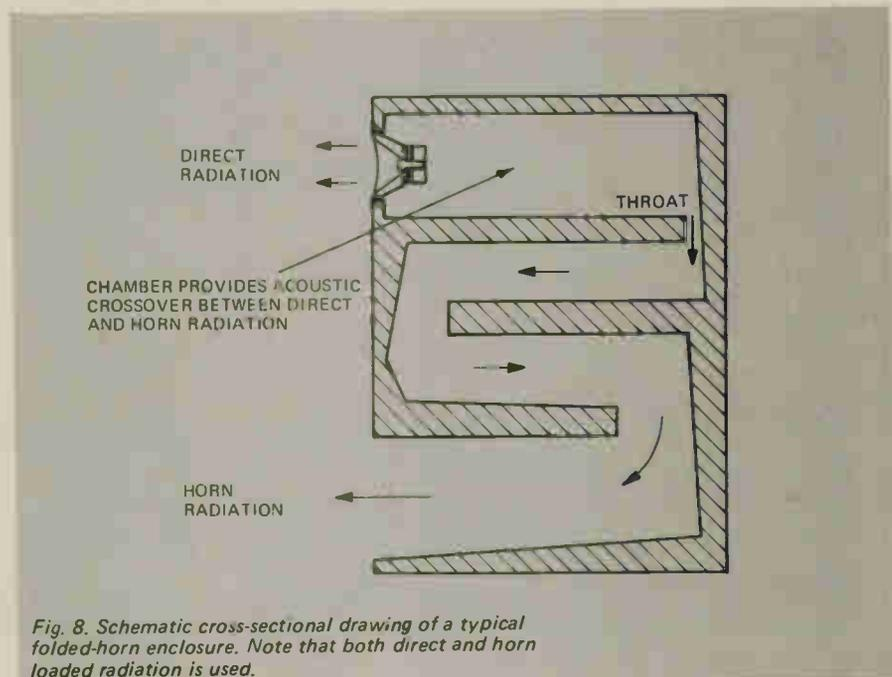

Fig. 8. Schematic cross-sectional drawing of a typical folded-horn enclosure. Note that both direct and horn loaded radiation is used.

eti



NUCLEAR FALLOUT

The recent French nuclear tests at Mururoa Atoll have once again highlighted the danger of nuclear fallout. This article describes the effects, the history and the future dangers. Is the effect minimal compared to background levels of radiation, as some people say, or could the effects be long term and prove a hazard to our grandchildren? How far does fallout reach in miles? These questions and others are covered in this feature.

ON SALE MID-NOVEMBER—20p

ETI TAKES A PRIDE IN BEING REALLY UP-TO-DATE, SO WE OURSELVES DO NOT ALWAYS KNOW WHAT WILL BE IN THE NEXT ISSUE SO THE FEATURES MENTIONED ON THIS PAGE ARE ONLY SOME OF THOSE THAT WILL BE INCLUDED.

WHAT TO LOOK FOR IN DECEMBER..

LINEAR ELECTRIC MOTORS

There has been a big row about the Government's handling of the future of the 'Hovertrain'. What principle do these work on? Could magnetically levitated ground transportation be the saviour of the railways? In this feature, written by Professor E.R. Laithwaite of Imperial College, the leading authority and designer, the principles and potential are discussed.

MIXER PREAMPLIFIER

The 100W Guitar Amplifier, described in our February issue, was truly a success but required a mixer preamplifier. Our Master Mixer in April was one alternative but many readers have requested a far simpler, and thus cheaper, version. Next month's ETI describes a very simple circuit using two IC's which will have many uses other than with the 100W amplifier.



CREATIVE AUDIO

"Sound is, potentially, one of the most creative of media..." So starts part one of *Creative Audio* in next month's ETI. In this part, tape editing is discussed in some detail, not only general information but practical methods and tips for the home enthusiast.

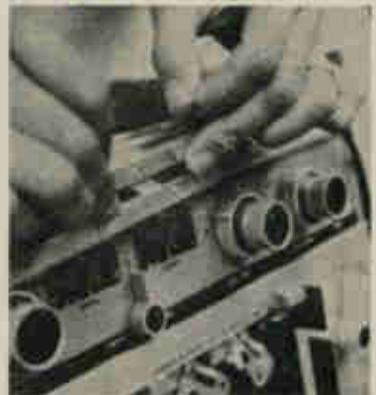

electronics
today INTERNATIONAL

SPECIAL OFFER!

THE ADVANCE 'INTERNATIONAL' CALCULATOR KIT FOR £26.95

EXCLUSIVE OFFER FOR ETI READERS ONLY



In ETI we have recently said quite a bit about the Advance Executive Pocket Calculator in recent issues. There was the competition in July for three of these which attracted over 2000 entries and this response encouraged ETI and Advance to arrange for the supply of the kit version, known as the International, to our readers at £3 less than usual. This offer only applies to readers using the form on the right. A very large demand is expected and readers should allow a reasonable time for clearing all orders.

The Advance International is a kit version of the Executive and has the same facilities: Add, Subtract, multiply and divide together with a constant facility on multiply and divide and with fixed or floating decimal point. There is also a 'clear last entry' key.

A prototype kit was reviewed in last month's ETI and the kit is discussed and compared with others in the *Electronics Tomorrow* feature on page 60. This has been prepared by an outside contributor who was asked to say what he thought, ignoring our offer.

The offer expires on 30th November.

Cut

To: ETI/ADVANCE INTERNATIONAL KIT OFFER,
ADVANCE ELECTRONICS LIMITED,
RAYNHAM ROAD,
BISHOPS STORTFORD,
HERTFORDSHIRE.

Please find enclosed a cheque/P.O. for £26.95 for a complete kit of the Advance International Calculator.

Name

Address

Please allow 28 days for delivery. Offers expires on November 30th.

Only from Advance Electronics. A professional digital multimeter for so very little.

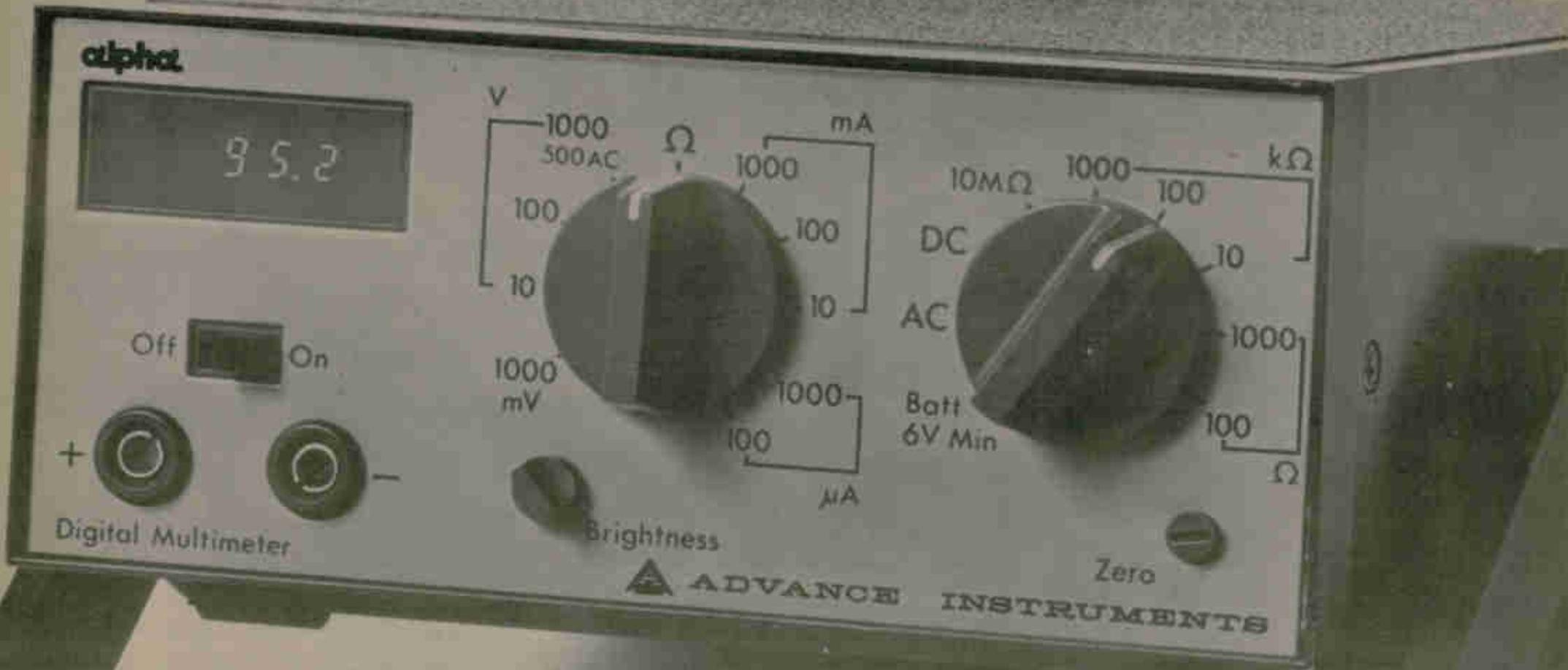

Enough said.



DIRECTORY OF HI-FI STEREO AMPLIFIERS

THE DIRECTORY OF HI-FI STEREO AMPLIFIERS has been compiled by ETI in co-operation with the manufacturers, importers or distributors. It is intended as an instant comparison chart with the specifications given in common form where possible.

Considerable care has been taken in the compilation but readers are advised to check with the maker's literature before coming to any decision (incidentally makers literature often contains serious errors and any compilation from this is bound to be invalid.) One maker of superb equipment quote THD as 15% instead of 0.15%.

Manufacturers vary considerably in their methods of quoting specifications and frequently have very strong views with regard to the method they use. Where possible we have tried to resolve these or convert them. This applies mainly to output power where several methods are used. For this reason, manufacturers leaflets may show a different figure, though not if r.m.s. is used.

Listings are made by price. This method has been chosen over the alternatives as we feel that most people will know what they have available to spend. All prices quoted are manufacturer's recommended prices including VAT. High discounts are available on most of the amplifiers quoted. However the price listing puts the majority

of amplifiers in a similar order to that which discount houses will show.

The floating pound has led to several price increases for imported units and even during the preparation of this feature literally dozens of prices have changed. All changes that have been notified to us have been included.

A number of blank spaces have been left. These are usually due to the manufacturer not having the information in a suitable form or where ETI have been unable to accept the information supplied. It should not be assumed that the absence of specification means that it is poor.

It is emphasised that all figures are those quoted by the makers and units have not been tested to ensure that they meet these. However experience has shown that tested results rarely vary from the quoted figures to any significant extent.

Considerable care has been taken in this compilation and the information is given in all good faith. Proof copies of the listings were sent to everyone included on the list for checking. ETI cannot however accept responsibility for errors or omissions.

Further information on the amplifiers quoted is available from the makers or distributors, these are listed on page 46 and the index number corresponds to the number given against each unit.

DIRECTORY OF HI-FI STEREO AMPLIFIERS

MODEL	PRICE INC OF VAT £ p	POWER OUTPUT (R.M.S.) W INTO Ohms		FREQUENCY RESPONSE RANGE			TOTAL HARMONIC DISTORTION AT 1 kHz				HUM & NOISE (-dB) *	Channel separa- tion at 1 kHz (-dB)	
				Hz-kHz	+	-	LOW O/P % AT W	HIGH O/P % AT W					
SINCLAIR "PROJECT 605"	32.94	15	4	27	23	0	3	0.1	1	0.1	15	70U	50
PHILIPS RH580	33.55	6	8	65	20	3	3	1.5	1	1.5	5	55U	30
EAGLE TSA 149	35.20	7	8	25	18	0	2	.8	1	.8	7	56W	46
TEXAN	38.50	20	8	15	22	0	1	.07	50mW	.09	20	60U	51
SONY TA 70	38.50	8	8										
KELETRON KSA 1000 II	39.05	10	8	10	100	0	3	.08	1	.08	10	70W	50
TELETON SAQ307	39.60	8	8	20	20			1	1	1	8		
TELETON SAQ206B	39.60	8	8	20	20			1	1	1	8		
AUDIOTRONIC LA.1700	41.25	17	8	20	50	0	1	.8	1	.8	17	60U	
AMSTRAD INTEGRA 4000 II	41.25	15	8	20	20	0	2	.3	1	.5	12	54W	36
EAGLE AA.2	41.80	10	8	25	20	0	2	.5	1	.5	10	58W	48
TRIPLETONE HI-FI 77 II	42.35	10	8	10	100	0	3	.08	1	.08	10	70W	50
TRIO KA2000A	42.90	16	8	20	30	0	2	.8	1	.8	16	70U	
SINCLAIR SYSTEM 2000	43.94	8	4	40	25	0	1	.06	1	.06	8	65U	50
KELETRON KSA 1500 II	44.10	15	8	10	100	0	3	.08	1	.08	15	70W	50
METROSOUND ST20 II	46.20	10	8	30	30	0	2	1	1	1	10	65W	
ALBA UA 700	47.96	15	8	30	18	0	1	.1	1	.1	15	55U	38
SONY TA.88	49.50	11	8			1	3	.5	1	1	11		
EAGLE TSA 151	49.83	15	8	20	32	0	2	.2	1	.2	15	58W	50
ROTEL 211	49.90	10	8	20	65	0	3	1	1	1	10	45U	
TELETON GA202	49.94	16	8	30	30			1	1	1	16		

* W = weighted; U = unweighted



Sinclair Project 605

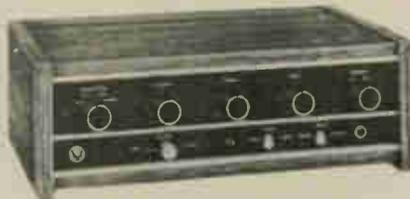

Eagle TSA149. The TSA151 also listed is of a very similar appearance.



Teleton SAQ307



Texan



Teleton SAQ206B

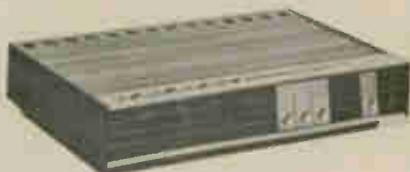

Philips RH580



Sony TA 70

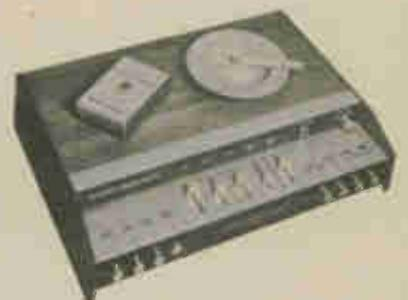

Amstrad Integra 4000 II

MAG. PU		INPUTS			Mic.	FACILITIES					SIZE (APPROX.) (IN INCHES)	FURTHER INFORMATION (INDEX NO.)
1	2	CERAMIC	TUNER	TAPE & REPLAY		HEADPHONE	HIGH FILTER	LOW FILTER	LOUDNESS	TAPE O/P		
3/50												13
3/47		100/100	100/140	100/140								6
3/47		80/100	180/100	180/100		✓						10
7/47						✓	✓	✓				7
3.5/50			250/100	440/100		✓	✓	✓				25
4/47		3/47	100/50	100/50		✓	✓	✓				15
3				235		✓	✓	✓				27
3				235		✓	✓	✓				27
2.6	2.6		150	150		✓	✓	✓				23
3.5/47		55		100/150		✓	✓	✓				16
3/47		80/100	180/100	180/100		✓	✓	✓				10
2.5/47		30/47	100/50	100/50		✓	✓	✓				15
2			130	130		✓	✓	✓		✓		28
3/47		30/220		125/1		✓	✓	✓				13
4/47		30/47	100/50	100/50		✓	✓	✓		✓		15
2.5/47			150/100	100/500								5
5/50			100/150		2.3/50	✓		✓				4
3/50			250/50	250/50			✓					25
3/47		100/100	200/100	200/100								10
2.7/45		140/100	170/50	150/50				✓	✓			14
3				130		✓	✓	✓	✓			27



Eagle AA2



Keletron KSA 1500 Mk.II



Sony TA 88



Trio KA2000A



Alba UA700



Sinclair System 2000



Teleton GA202

DIRECTORY OF HI-FI STEREO AMPLIFIERS

MODEL	PRICE INC OF VAT £ p	POWER OUTPUT (R.M.S.) W INTO Ohms		FREQUENCY RESPONSE			TOTAL HARMONIC DISTORTION AT 1 kHz				HUM & NOISE (-dB) *	Channel separa- tion at 1 kHz (-dB)
				RANGE	dB		LOW O/P	HIGH O/P				
				Hz-kHz	+	-	% AT W	% AT W				
TRIPLETONE HI-FI 1818 II	53.35	20	8	10 100	0	3	.08 1	.08 20		70W	50	
SANSUI AU101	53.42	15	8	20 60	0	2	.2 1	.7 18		70U	50	
SINCLAIR SYSTEM 4000	54.94	17	8	40 25	0	1	.04 1	.04 17		65U	50	
AMSTRAD IC 2000 Mk.II	55.00	20	8	15 30	0	2	.18 1	.2 20		60U	60	
PIONEER SA 500A	55.96	13	8	30 50	1	2	.09 1	.09 10		75		
TRIO KA2002A	57.75	17	8	20 50	0	2	.8 1	.8 17		70U		
METRO SOUND ST40	59.40	20	8	20 30	0	1	.1 1	.1 20		65W		
AUDIOTRONIC LA.4000	60.50	40	8	5 70	0	1	.4 1	.4 40		65U		
EAGLE AA4	61.60	20	8	15 36	0	2	.2 1	.2 20		64W	56	
ROTEL RA 311	62.90	20	8	15 70	0	3	1 1	1 20		45W		
RAVENSBROOK	63.25	20	8	20 50	0	3	.1 1	.3 18		53U	40	
SANYO DCA 1400K	64.95	20	8	15 70	0	3	.1 1	.8 20		70U		
SHARP SM-510H	69.22	46	8	30 30	0	1.5	.15 1	.15 15.5		65U	40	
JVC VN-300	69.85	60	4	20 40	0	1.5	.5 1	.5 60				
TRIO KA4002A	71.50	58	8	20 40	0	1.5	.5 1	.5 58		60U		
WHARF DALE LINTON	71.50	15	8	30 20	0	1	.1 1	.1 10		63U	56	
SHARP SM-511H	73.95	82	4	30 30	0	1.5	.1 1	.1 20		65U	40	
EAGLE AA6B/AA68	74.80	20	8	15 36	0	2	.2 1	.2 20		64W	56	
ARMSTRONG 621	75.90	40	8	25 25	0	1	.08 1	.08 40		65U	45	
LEAK DELTA 30	76.98	15	8	30 20	0	1	.1 1	.1 10		63U	50	
METRO SOUND ST60	77.00	30	8	20 50	0	2	.08 1	.08 30		65W		
SONY TA 1055	77.00	23	8	10 60	0	3	.1 1	.5 23				
J.E. SUGDEN A21	79.75	20	8	30 20	0	1	.02 1	.1 20		73W	40	

* W = weighted; U = unweighted



Sansui AU101



Metro Sound ST40



Sanyo DCA 1400



Amstrad IC 2000 MkII



Eagle AA4



Sharp SM-510H



Pioneer SA 500A



Rotel RA311



Trio KA-2002



Rogers Ravensbrook



JVC VN-300

MAG. PU		INPUTS			Mic.	FACILITIES					SIZE (APPROX.) (IN INCHES)	FURTHER INFORMATION (INDEX NO.)	
1	2	CERAMIC	TUNER	TAPE & REPLAY		HEADPHONE	HIGH FILTER	LOW FILTER	LOUDNESS	TAPE O/P			SHORT CIRC. PROT.
2.5/47	2/50	30/47	100/50	100/50		✓	✓		✓	✓		15 x 3.7/8 x 9.1/2	15
3/50				200/50								4.17/32 x 16 x 10.15/16	11
3/47		30/220		125/1		✓	✓	✓		✓	✓	12 x 6 x 2	13
3/47		55		70/150			✓	✓	✓			17.1/2 x 6.5/8 x 3.5/8	16
2.5/50			200/100	200/100								13 x 4.5/8 x 12.7/16	22
2/50	2/50		150/50	150/50					✓	✓		13 x 4.5/8 x 9.7/16	28
2.5/50			100/150	100/150						✓	✓	14.7/8 x 3.3/4 x 10.1/2	5
50/100	2.5/50		150/50	150/50	2.2/22	✓	✓	✓		✓	✓	16 x 5.1/8 x 11.1/2	23
3/47		80/100	180/100	180/100		✓	✓	✓		✓	✓	13 x 4 x 10.1/2	10
2.5/40		140/94	170/46	150/46			✓		✓	✓		14 x 7.1/2 x 4.1/2	14
2/47	3/47			100/100			✓	✓				14.1/2 x 9.7/8 x 4.3/4	3
2.5/50												11.5/8 x 10 x 4.1/4	21
3	3	160	160	200					✓	✓		14.1 x 5.1 x 9.4	18
3			120	120			✓	✓	✓	✓		5.1/2 x 15 x 12	26
2.5/50	2.5/50		150/100	150/100		✓	✓	✓	✓	✓		13 x 4.5/8 x 9.7/16	28
3.5/47	20/33		60/50	400/47			✓		✓	✓			19
3	3	150	150	200		✓			✓	✓		14.7 x 5.1 x 9.4	18
3/47		80/100	180/100	180/100		✓	✓	✓	✓	✓		15 x 4.1/2 x 10.1/2	10
2.7/68	10/47		120/68	250/68			✓	✓	✓			12.1/4 x 3.1/4 x 11.1/4	8
2/47	10/33		25/47				✓					13.5 x 4.7 x 10	19
3/47			50/120	50/120			✓	✓				20.1/8 x 3.3/8 x 12.1/2	5
2/47			250/50	250/50	2/47		✓					16.1/8 x 4.3/4 x 11.1/8	25
2.5/47		60/100	100/200	100/200		✓	✓	✓		✓	✓	15.9 x 5.8 x 11.1	9



Trio KA-4002



Eagle AA6



Metrosound ST60



Sharp SM-511H

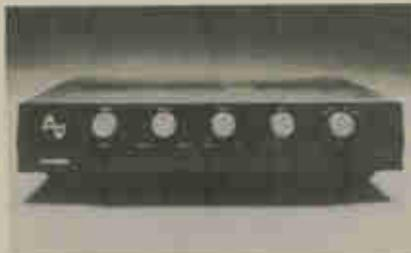

Armstrong 621

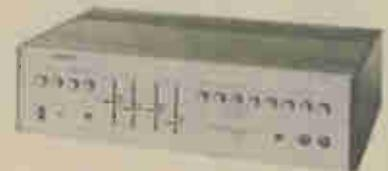

Sony TA1055



Wharfedale Linton



Leak Delta 30



JE Sugden A21

DIRECTORY OF HI-FI STEREO AMPLIFIERS

MODEL	PRICE INC OF VAT £ p	POWER OUTPUT (R.M.S.) W INTO Ohms		FREQUENCY RESPONSE			TOTAL HARMONIC DISTORTION AT 1 kHz				HUM & NOISE (-dB) *	Channel separa- tion at 1 kHz (-dB)	
				Hz-kHz	+	-	LOW O/P % AT W	HIGH O/P % AT W					
MARANTZ 1030	82.50	15	4	20	20	0	1	.5	1	.5	15		30
RAVENSBOURNE	82.50	35	8	25	35	0	3	.06	1	.1	35	60U	45
PHILIPS RH520	85.00	15	4	15	30	2	2	.3	10	.5	15	60U	40
FERROGRAPH 20+20	85.80	20	8	20	25	0	1	.18	1	.18	20	60U	60
SANSUI AU505	86.58	25	8	20	60	0	2	.1	1	.5	25	70U	50
ROTEL RA611	92.90	30	8	5	100	0	3	.5	1	.5	30	40U	
AKAI AA5200	93.50	20	8	20	50	0	3	.1	1	.1	20	65U	60
LEAK DELTA 70	94.49	35	9	30	20	0	1	.1	1	.1	25	66U	50
YAMAHA CA-500	98.00	22	8	15	50	0	3	.05	1	.05	20	60W	50
SONY TA 3130F	99.00	70	8	10	20	0	2	.05	1	.1	70		
J.E. SUGDEN A48	104.50	40	8	30	20	0	1	.015	1	.07	38	75W	40
CAMBRIDGE P50	104.50	25	8	25	25	0	0.5	.02	1	.05	25	60U	45
SONY TA 1140	110.00	40	8	15	80	0	2	.05	1	.1	40		
PIONEER SA6200	114.95	22	8	15	80	0	1	.08	1	.08	16	75W	
ROTEL RA810	116.05	40	8	4	75	0	3	.3	1	.3	40	65U	
AKAI AA5500	118.80	30	8	20	50	0	3	.05	1	.05	30	65U	60
MARANTZ 1060	121.00	30	4	20	20	0	1	.5	1	.5	30		30
SANSUI AU555A	121.81	25	8	20	40	0	1	.1	1	.5	25	70U	60
PHILIPS RH521	125.00	30	4	15	40	2	2	.3	25	1	30	90W	45
QUAD 33-303	125.40	45	8	20	35	0	1	.03	1	.03	45	90W	40
TRIO KA6004	126.50	40	8	20	20			.5	1	.5	40	75U	

* W = weighted; U = unweighted



Marantz 1030



Ferrograph 20+20

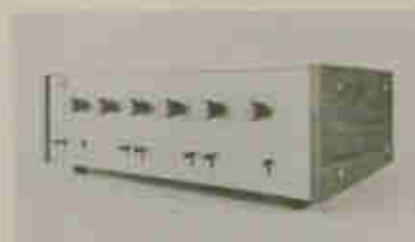

Akai AA-5200



Rogers Ravensbourne

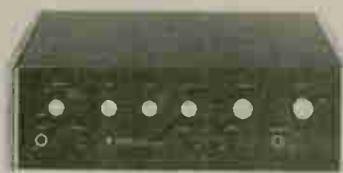

Sansui AU505



Yamaha CA500



Philips RH520



Rotel RA611



Sony TA 3130F

MAG. PU 1 2		INPUTS			Mic.	FACILITIES					SIZE (APPROX.) (IN INCHES)	FURTHER INFORMATION (INDEX NO.)
CERAMIC	TUNER	TAPE & REPLAY	HEADPHONE	HIGH FILTER		LOW FILTER	LOUDNESS	TAPE O/P	SHORT CIRC. PROT.			
2.1/47										✓	14.1/4 x 12 x 4.3/4	24
2/47	4/47			200/100		✓	✓			✓	14.3/4 x 10.1/4 x 5.1/4	3
2/50		50/100	100/100	250/100		✓		✓	✓	✓	16.1/2 x 11.3/4 x 4.3/4	6
3/47	3/100	100/2000	100/2000	150/50			✓	✓	✓		18 x 5 x 8.3/4	17
3/50			200/50		4/50						4.17/32 x 16 x 10.15/16	11
2.5/47	2.5/47		150/40	230/47			✓	✓	✓		16.1/2 x 9.1/2 x 5	14
3				150			✓	✓	✓		17.2 x 5.7 x 13.2	14
2/47	10/33		25/47				✓	✓	✓		13.5 x 4.7 x 10	19
3/50			200/50	200/50				✓		✓	15.3/4 x 11.3/4 x 5.1/2	2
										✓	7.7/8 x 5.7/8 x 12.3/4	25
2.5/47	10/47		100/200	100/200		✓	✓	✓	✓	✓	3.8 x 6.8 x 11	9
3/47	100/100					✓			✓	✓	16.1/2 x 9.5/8 x 2	29
1.2/47	1.2/47		130/100	130/100			✓	✓	✓		15.3/4 x 5.3/4 x 12.1/2	25
2.5/50			150/100	150/100							16.11/32 x 5.3/16 x 12.29/32	22
2/100	2/100		200/45	200/45							18.1/2 x 12 x 5.1/2	14
3				150	3		✓	✓	✓		17.2 x 5.7 x 13.2	14
1.5/47										✓	14.1/4 x 14 x 4.3/4	24
2/50			180/50	180/50							5.3/8 x 15.9/16 x 10.15/16	11
2/50		100/100	100/100	250/100	1/2	✓	✓	✓	✓	✓	18.1/2 x 4.3/4 x 11.3/4	6
2/68	5.6/68	100	100/100	100/100			✓	✓	✓	✓	4.3/4 x 6.1/4 x 12.3/4	1
2.5/50	2.5/50		200/100	200/100	3/50		✓	✓	✓	✓	17.1/8 x 6.1/32 x 11.13/16	28



J.E. Sugden A48



Rotel RA810



Philips RH521



Cambridge P50

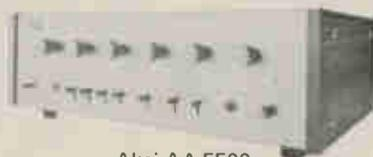

Akai AA-5500



Quad 33-303

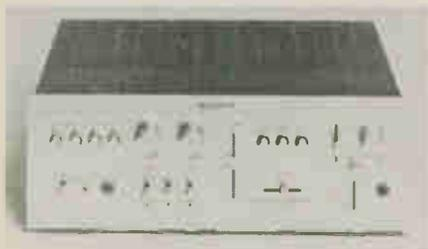

Sony TA1140



Pioneer SA6200



Marantz 1060



Trio KA6004

DIRECTORY OF HI-FI STEREO AMPLIFIERS

MODEL	PRICE INC OF VAT £ p	POWER OUTPUT (R.M.S.) W INTO Ohms		FREQUENCY RESPONSE			TOTAL HARMONIC DISTORTION AT 1 kHz				HUM & NOISE (-dB) *	Channel separa- tion at 1 kHz (-dB)
				RANGE	+	-	LOW O/P % AT W	HIGH O/P % AT W				
JVC VN-700	130.25	50	4	10	23	0	3	.05	1	.05	50	
ONKYO 725	130.54	22	8	15	70	0	1	.05	.5	.1	22	
YAMAHA CA-700	141.19	60	8	15	50	0	3	.05	1	.05	50	50
PIONEER QL600A	141.32	13	8	20	20	0	1.5	.09	1	.1	10	
ROTEL RA1210	141.90	60	8	3	100	0	3	.3	1	.3	60	
J.E. SUGDEN P51/C51	143.00	45	8	30	20	0	1	.01	1	1	45	40
PIONEER SA7100	144.65	25	8	7	80	0	1	.05	1	.04	20	
FERROGRAPH 60+60	148.50	60	8	25	20	0	1	.03	1	.08	60	60
SANSUI AU6500	159.52	30	8	10	30	0	1	.04	1	.1	30	50
TRIO KA8004	165.00	80	8	10	50	0	2	.4	1	.4	55	110U
JVC VN900	169.40	60	8	10	23	0	3	.05	1	.05	60	86
ONKYO 733	176.24	34	8	10	70	0	1	.03	.5	.1	34	
AKAI AA5800	178.20	45	8	10	50	0	3	.05	1	.05	20	60
REVOX A78	179.30	40	8	20	20	1	1	.1	1	.1	40	60
SANSUI AU7500	194.21	40	8	10	30	0	1	.04	1	.1	40	50
PIONEER SA8100	202.72	50	8	7	80	0	1	.05	1	.04	40	80W
ONKYO 732	229.70	56	8	10	80	0	1	.03	.5	.1	56	
MARANTZ 1120	242.00	60	4	20	20	0	.5	.2	1	.2	60	140U
PIONEER SA9100	249.25	75	8	7	80	0	1	.04	1	.60	.04	80U
SANSUI AU9500	310.85	80	8	15	40	0	1	.04	1	.1	80	75U
MARANTZ 1200	412.50	100	4	20	20	0	.25	.15	1	.15	100	40

* W = weighted; U = unweighted



JVC VN-700



Rotel RA-1210



Sansui AU6500

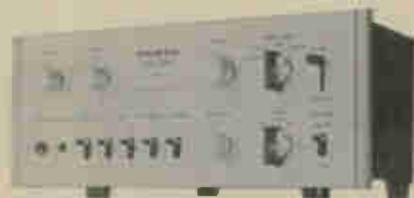

Onkyo 725



Pioneer SA-7100



Trio KA-8004



Yamaha CA 700

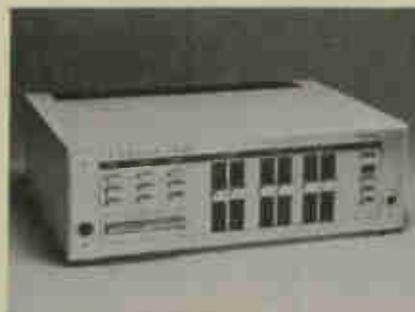

Ferrograph 60+60

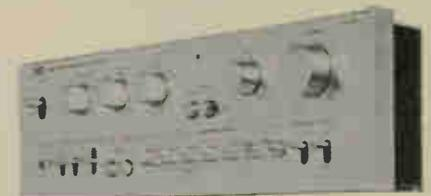

JVC VN-900



Onkyo 733

MAG. PO 1 2		INPUTS				FACILITIES						SIZE (APPROX.) (IN INCHES)	FURTHER INFORMATION (INDEX NO.)
		CERAMIC	TUNER	TAPE & REPLAY	Mic.	HEADPHONE	HIGH FILTER	LOW FILTER	LOUDNESS	TAPE O/P	SHORT CIRC. PROT.		
2.5/68			200/100	200/100								5.3/8 x 16.5/8 x 12.1/2	26
2.4/50	2.4/50		100/100	100/100								12.5 x 15.6 x 5.4	12
3/50	0.2/100		200/50				✓	✓	✓		✓	15.3/4 x 11.3/4 x 5.1/2	2
			100/120									16.15/16 x 5.7/16 x 13.1/4	22
1/100	1/100		200/45		200/45							16.1/2 x 12 x 5.1/2	14
2.5/47	2.5/47		150/200	150/200	2.5/47							11.5 x 5.5 x 9.8	9
2.5/50			150/100	150/100								16.15/16 x 5.7/16 x 13.7/16	22
2.5/47				200/470								14 x 17.3/4 x 6	17
2.5/50			100/50									5.9/16 x 17.3/8 x 12.11/16	11
2.5/30	2.5/50		150/100	150/12	2.5/50	✓	✓	✓	✓	✓	✓	17.1/8 x 6.1/32 x 11.13/16	28
2.5/68			200/100	200/100								5.3/8 x 16.5/8 x 12.1/2	26
2.4/50	2.4/50		100/100		1.8/50							17.5 x 14 x 5.4	12
3				180	3							17.2 x 5.7 x 13.2	14
3/47		230/800	100/100	100/100	3/100	✓	✓	✓	✓	✓	✓	16.38 x 6.1/4 x 9.5/8	20
2.5/50			100/50		2.5/50							17.3/8 x 5.9/16 x 12.11/16	11
2.5/50			150/100	150/100								16.15/16 x 5.7/16 x 13.7/16	22
2.0/50	2.0/50		100/100		1.8/50							17.5 x 14 x 5.4	12
1.1/47											✓	15.3/8 x 13.1/4 x 5.3/4	24
2.5/50			150/100	150/100								16.15/16 x 5.3/16 x 13.7/16	22
2.5/50			100/50		2.5/50							5.9/16 x 19.11/16 x 13.11/16	11
1.35/47											✓	15.3/8 x 14 x 5.3/4	25

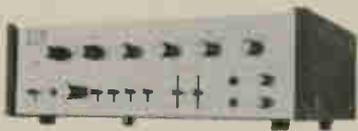

Akai AA5800



Pioneer SA8100



Pioneer SA9100



Revox A78

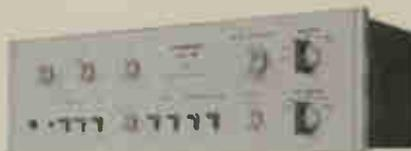

Onkyo 732



Sansui AU 9500



Sansui AU7500



Marantz 1120



Marantz 1200

INDEX NO.	MANUFACTURER OR DISTRIBUTOR	INDEX NO.	MANUFACTURER OR DISTRIBUTOR
1.	The Acoustical Manufacturing Co. Ltd., St. Peters Road, Huntingdon.	16.	AMS Trading (Amstrad) Ltd., 89 Ridley Road, Dalston, London, E8.
2.	Jonathan Fallowfield Ltd., Strathcona Road, North Wembley, Middlesex.	17.	The Ferrograph Co. Ltd., 442 Bath Road, Cippenham, Slough, Bucks, SL1 6BB.
3.	Rogers Developments (Electronics) Ltd., 4/14 Barmeston Road, London, SE6 3BN.	18.	Sharp Electronics (U.K.) Ltd., Sharp House, 107 Hulme Hall Lane, Manchester, M10 8HL.
4.	Alba (Radio & Television) Ltd., Tabernacle Street, London, EC2A 4DY.	19.	Rank Radio International, P.O. Box 596, Power Road, Chiswick, London, W4 5PW.
5.	Metrosound Audio Products Ltd., Cartersfield Road, Waltham Abbey, Essex, EN9 1JF.	20.	C. E. Hammond & Co. Ltd., Lamb House, Church Street, London, W4 2PB.
6.	Philips Electrical Ltd., Century House, Shaftesbury Avenue, London, WC2H 8AS.	21.	Sanyo Marubeni (U.K.) Ltd., Sanyo House, Bushey Mill Lane, Watford, Herts.
7.	Henry's Radio Ltd., Sales Department, 303 Edgware Road, London, W2 1BW.	22.	Shriro (U.K.) Ltd., Shriro House, The Ridgeway, Iver, Bucks.
8.	Armstrong Audio Ltd., Wartlers Road, London, N7 0RZ.	23.	All branches of Lasky's Radio Ltd. or G.W. Smith, c/o Audiotronic House, The Hyde, London, NW9 6JJ.
9.	J.E. Sugden & Co. Ltd., Carr Street, Cleckheaton, Yorks.	24.	Pyser-Britex (Swift) Ltd., Fircroft Way, Edenbridge, Kent.
10.	Eagle International, Precision Centre, Heather Park Drive, Wembley, HA0 1SU.	25.	Sony U.K. Ltd., Pyrene House, Sunbury Cross, Sunbury on Thames, Middx.
11.	Vernitron Ltd., Thornhill, Southampton.	26.	Denham & Morley (Overseas) Ltd., Denmore House, 453 Caledonian Road, London N7 9BA.
12.	J. Parkar & Co. (London) Ltd., 1 Beresford Avenue, Wembley, Middx., HA0 1YX.	27.	Teleton Electro (U.K.) Co. Ltd., Teleton House, Waterhouse Lane, Chelmsford, Essex.
13.	Sinclair Radionics Ltd., London Road, St. Ives, Huntingdonshire, PE17 4HJ.	28.	B.H. Morris & Co. (Radio) Ltd., Trio House, The Hyde, London, NW9 6JP.
14.	Rank Audio Products, P.O. Box 70, Great West Road, Brentford, Middx.	29.	Cambridge Audio, The River Mill, St. Ives, Huntingdon.
15.	K & K Electronics Ltd., 60 St. Marks Rise, London, E8 2NR.		

THE HIGHEST PERFORMANCE DIGITAL FREQUENCY
COUNTERS AT THE PRICE IN THE WORLD
EVERYBODY BUYS THEM



301 5 DIGIT 32 MHz
STABILITY 3 parts in 10⁹
SENSITIVITY 50mV **£75**



401 6 DIGIT, 32 MHz.
STABILITY 1 part in 10⁹
SENSITIVITY 10mV **£110**

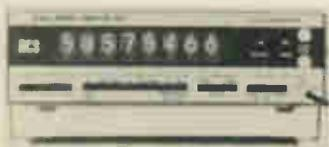

501 8 DIGIT, 32 MHz.
STABILITY 3 parts in 10⁹
(crystal oven)
SENSITIVITY 10mV **£160**



701 8 DIGIT, 50 MHz.
STABILITY 3 parts in 10⁹
SENSITIVITY 10mV **£170**



801A 8 DIGIT, 300 MHz.
STABILITY 3 parts in 10⁹
SENSITIVITY 10mV **£260**

PRICES EXCLUSIVE OF VAT

ELECTRONIC START/STOP version PLUS £10
MEMORY version PLUS £25
DIRECTLY COUPLED INPUT AND SPECIALS TO ORDER

Write for illustrated leaflet.

Supplied to and acclaimed by professional engineers everywhere
who have purchased our electronic instruments for the
past 10 years.

Norwegian Agent: ELECTRO-TRADE, TRONDHEIM, NORWAY.



R. C. S. ELECTRONICS
NATIONAL WORKS, BATH ROAD,
HOUNSLOW, MIDDX. TW4 7EE
Telephone: 01-572 0933/4

P. C. BORED?

— not with the

DECON— DALO 33PC



A unique drafting aid for the
electronics engineer enabling
him to prepare in minutes a
perfect PCB.

A fine-tipped marker charged
with a free-flowing etch-resist
ink. Simply draw the
desired circuit onto copper
laminated board—etch—
clean.

The circuit is ready to use.

**NO MESS—
NO MASKING**

A perfect circuit every time!

*The Decon-Dalo 33 PC marker is now available in France, Ger-
many, Italy, Switzerland, Austria and all Scandinavian countries.
Send for details of local supplier.*

Please send me further details on the 33PC:

Name

Address

Post to: **DECON LABORATORIES LTD.**
FREEPOST
PORTSLADE, BRIGHTON
(No Stamp Needed)

E.T.I.O.

UNREASONING RADIATION



MODERN life has brought a plethora of man-made sources of radiation. Among the most subtle are those generated in the microwave spectrum, at frequencies from 30 Megahertz to 300 Gigahertz — nestled between radio and infrared waves at wavelengths from 1,000 to 0.1cm.

The Russians have long maintained that microwaves can cause a wide range of psychological and physiological abnormalities; particularly the "asthenic" syndrome: irritability, fatigue, headache, loss of memory and indecisiveness. Soviet scientific faith in microwave-induced aberrations is based on several years' observation of workers in industrial microwave environments conducted by the Academy of Medical Sciences (Moscow) during the late 1950s and early 1960s. As a result of these studies, permissible microwave exposure levels in the Soviet Union are one-thousandth of the U.S. ASA Standard for continuous exposure in industrial and military situations.

American scientists have remained generally sceptical about the potency of low-energy microwaves; it was not until the late 1960s that their researchers were able to replicate Soviet laboratory experiments. Thus, the U.S. project charged in 1957 by the three military services with determining microwave hazards, mainly investigated large-scale thermal effects; it set a 10 milliwatt/cm² exposure ceiling which is still in widespread though not mandatory, use in the United States. However, recent American findings indicate that microwaves *do* produce seemingly inexplicable physiological effects.

THE SOUND OF MICROWAVES

Exploring low-power-induced biological responses for several years, Allan Frey of Randomline, Inc., Willow Grove, Pa., has shown that human beings can hear microwaves directly. He reports in *IEEE Transactions on Microwave Theory and Techniques* for 1971 that his subjects report a variety of sounds, including buzzing and humming, when they are irradiated with trace amounts of radio frequency energy in the UHF and VHF spectrum. However,

according to Frey, the microwave beam must be amplitude modulated or pulsed at audible frequencies to produce the effect. He says that some researchers who failed to confirm the phenomenon used unmodulated microwaves.

The intensity of the sensation is a function not of the average energy of the pulsed waveform, Frey maintains, but of the peak energy. Those familiar with high fidelity equipment are aware of the controversy about "peak music power" versus the more useful rms power ratings. Frey has shown that as far as hearing microwaves is concerned, peak power is a better measure than rms power. Since a microwave beam of low average power can be highly modulated, people can hear such low rms, high peak power beams; Frey reports a statistically significant threshold — about 0.3 mW/cm² average power — at which highly modulated signals become audible.

It is not clear how microwaves produce the sensation of sound, but Frey has ruled out one possibility: fluctuations in external air pressure impinging on the eardrum. In the hope of learning something about the mechanism, he looked for the periodicity pitch phenomenon associated with ordinary hearing: perception of tone from a pair of conventional acoustic pulses is related to the time delay between them. No relationship between delay and perceived frequency was observed for microwave hearing. In fact, trained musicians, irradiated with low level UHF energy carrying a 200 Hertz signal, reported hearing a mixture of higher frequencies, including harmonics of the original tone. Thus, Frey concludes that microwaves do not act directly and exclusively by a simple linkage with the ear-brain network.

STRAIGHT TO THE NERVES

Another possibility is that microwave electric fields trigger nerves directly; nerves transmit pulses electrochemically, the balance of sodium and potassium ions on either side of a nerve cell membrane being critical to the hearing process.

Hermann P. Schwan of the Moore School of Electrical Engineering, University of Pennsylvania, has argued against direct stimulation of nerve tissue. Using a theoretical model of nerve action, he has shown that the electric field strength required across the boundary of a nerve cell is about 500 kilovolts per centimetre; a microwave beam of such intensity would burn a living organism to cinders. Frey, however, says that very intense microwave beams may not be required for nerve tissue stimulation; he suggests that the imperfect state of knowledge of nerve operation is sufficient reason for not rejecting out of hand a possibly delicate and subtle interaction between microwaves and flow of information to the brain.

In experiments with cats, Frey has evoked brain stem electroencephalographic activity with microwave pulses as small as 30 microwatts/cm² average energy with 60 milliwatts/cm² peaks. Different neural phenomena associated with microwaves have been observed by other researchers: G.E. Hearn has shown that microwaves influence the frequency at which a flashing light is seen as a continuous image — an accepted indication of neural dysfunction; A. E. Bourgeois, Jr. has found that the sound threshold required for auditory perception decreases during microwave irradiation.

AN AVERSIVE RESPONSE

There is also evidence from American scientists that low-level microwaves can affect behaviour. In 1965, for example, Dr. Susan Korbel and W. D. Thompson, University of Arkansas psychologists, reported increased activity from rats irradiated with 1 mW/cm² rf energy. Allan Frey has constructed a shuttle box — a miniature room divided into two compartments by a low barrier; when he illuminated one side of the box with 1 mW/cm² UHF microwaves, lab rats distinctly avoided the irradiated side, spending only 30 per cent of their time there. Microwaves are clearly responsible for this behaviour, Frey concludes, although he has no explanation for how the rats sense the

UNREASONING RADIATION

radiation — at such low power levels, body temperature rise is insignificant — or why they dislike it.

Drs. Don R. Justesen and Nancy Williams King of the Neuropsychology Research Laboratories, U.S. Veterans Administration Hospital, Kansas City, Mo., and Rex L. Clarke, University of Kansas, have pursued microwaves' aversive effects further. In a conditioned suppression environment, they found that the radiation stimulates an aversive response in rats — the cessation of licking associated with a photoelectrically triggered sugar solution reward — by warning the animals of impending electric shock. The conditioning of aversive behaviour is impressive because the subjects have no natural inclination to make such responses, as they would with appetitive behaviour; in situations where the biophysical mechanisms are mysterious and conclusions based on statistical analysis of behaviour, it is absolutely essential to exorcise artifactual uncertainty.

These researchers suggest that modulated microwave cues suppress licking almost as efficiently as do audible tone cues. The subjects reacted to microwave signals as low as 1.2 milliwatts/gram of body weight, and one rat was able to sense .6 mW/gm — equivalent to about 1 mW/cm². The team writes in the US magazine *Science* for April 23, 1971, "We offer our data as evidence that confirms and extends the generality of Frey's findings; mammals are sensitive to something that inheres in or accompanies illumination by microwaves at low levels of available power."

Although U.S. scientific findings of specific low power biological effects are growing in number, the only microwave health hazard officially recognized in the USA is general body heating. The present exposure tolerances appear to be more than adequate in safeguarding against known heating effects: heat prostration, testicular damage and the formation of cataracts. However, scientific opinion and government concern, partly engendered by the Radiation Control Act of 1968 and the Occupational Safety and Health Act of 1970, appear to be motivating much more comprehensive studies.

THE NAVY INVESTIGATES

Is there a clear and present microwave danger? If not, what is the precise nature of the phenomena? The United States Navy, in particular, has

embarked on an extensive research programme. One of their most ambitious experiments is being conducted by Dr. Dietrich Beischer at the Naval Aerospace Medical Institute, Pensacola Florida. Beischer has constructed an 8x8x10-foot chamber in which Navy volunteers will live for several months at a time; they will be under uniform exposure to microwaves beamed from a 16-foot antenna outside their quarters. (*Microwaves*, April, 1972) Beischer will be looking for long-term effects of extremely low power microwaves, initially less than 1 mW/cm², on a gamut of physiological and psychological variables: body weight, temperature, EEG and ECG rhythms, decision making, reaction time, anxiety, etc.

Dr. Beischer was reluctant to tell me more; the Navy has become sensitive since the appearance of a columnist's story about the project. The use of human guinea pigs is less shocking than it appears, however; communications technicians and plywood workers, who use microwave ovens to dry their products, are routinely exposed to the low level radiation that will be employed in the experiment. Except for cases of inadvertent overexposure, there have been no reports of microwave injury. The possibility of insidious long term damage exists, of course; high-power-microwave-induced cataracts have gone undetected for years. In any case, Beischer has had difficulty in procuring volunteers because of manpower shortages in the Navy, and it will be some time before any firm conclusions can be drawn from the project.

A DIFFERENT KIND OF HEAT

Animal experiments have highlighted phenomena which may represent clear hazards to man. Although these studies used not insubstantial amounts of microwave energy, the injuries they produced may not be of thermal origin in the usual sense. In 1961, for example, C.A. Van Ummersen, a Tufts University biologist, exposed chick embryos to microwaves for five hour periods, elevating their temperature only 3.5°C above the normal incubation temperature, but producing many abnormal embryos. Raising embryo temperature by other means had no serious consequences.

Dr. Russell Carpenter of HEW's North-eastern Radiological Health Laboratory and Elliot M. Livstone, Presbyterian University Hospital, Pittsburgh, reproduced Van Ummersen's results with the meal-worm beetle. Irradiating 140 pupae in 80 mW or 20 mW waveguides for 20-30 minutes or 120 minutes, respectively, they found that only 36

developed into normal adults. Again, pupae exposed only to the equivalent temperature ambient were mostly normal. Speculating about the mechanisms responsible for microwave-stymied growth, the researchers write, "Successful development and metamorphosis depend upon a system of delicate chemical balances involving so many enzymes and hormones and their interactions that there must indeed be almost countless targets for microwave radiation to strike." (*IEEE Transactions on Microwave Theory and Techniques*, February, 1971).

Carpenter has also attempted to understand how microwaves cause cataracts. The lens of the eye is particularly susceptible to microwave damage; Carpenter has shown that microwave injury is cumulative at subthreshold doses, i.e. repeated exposure to small amounts of microwave energy can create the same opacities produced by much larger single doses. Thus, cataract formation cannot be a purely temperature dependent phenomenon. In collaboration with Dr. Jin Kinoshita, Harvard Medical School, Carpenter detected a significant decline in ascorbic acid in rabbit lenses soon after irradiation. Drs. Van Ummersen and Frances Kogan found the DNA-synthesis-and-mitosis inhibition were also characteristic concomitants of microwave exposure.

The combination of microwaves with another stressor, such as physical





A microwave transmitter, one of more than 6 million in the US. Government agencies are undertaking a new look at the radiation hazards to man.

subjective observations of behaviour changes, a practice going back to Pavlov; American scientists are more reductionist. They must have hard objective statistics on behaviour and a microscopic understanding of the mechanism involved. Moreover, Russian experiments have frequently been reported without sufficient detail about experimental procedure. When US scientists have learned of these crucial fine points, they have often been able to confirm results which originally appeared to be dubious.

But a research effort of significant proportions is finally getting under way. The Office of Telecommunications Policy, part of the Office of the President, is co-ordinating the research activities of various government agencies implicated in microwave safety: Defence HEW, Environmental Protection Agency, FCC, FAA. The Electromagnetic Radiation Management Advisory Council (ERMAC) associated with the OTP has drawn up plans calling for an expansion of microwave study and an increase of funds from the presently allocated \$4 million to an impressive \$63 million.

In a report issued in December, 1971, ERMAC emphasized the uncertain safety of the 6,000,000 transmitting devices now in use and the 200 000 microwave ovens predicted for the seventies. Using such phrases as "increasing anxiety" and "an era of energy pollution," the report concludes on this note: "Thus, the consequences of undervaluing or misjudging the biological effects of long-term, low-level exposure could become a critical problem for the public health, especially if genetic effects are involved."

The document, which was prepared with the obviously tendentious purpose of obtaining a major increase in funds, may exaggerate the urgency of the situation. Allan Frey, who is a member of the U.S. Standards Institute committee on microwave safety, told me there is insufficient reason to tighten the present 10mW/cm² limit, at least until more evidence is in. However, the pioneer in low level effects did say that he is still bothered by the sight of a major radio station opposite an elementary school.

Reprinted from the Sciences Volume Thirteen Number Three April 1973 Gerald Silverberg copyright by New York Academy of Sciences.

restraint, can synergize, according to Dr. Justesen. Harnessed rats subjected to 10.5 mW/gm radiation showed rises in body temperature 1°C greater than those of unharnessed rats exposed to the same radiation. Indeed, a few of the restrained rats succumbed to hyperthermia at a deep colonic reading of 43.5°C, while their untrammelled peers sweated it out at a more comfortable 39°C for a full four hours. Justesen told me that the irritation of the restraint, coupled with the novel stress introduced by the microwaves, can lead to a potentially lethal endogenous release of heat. "The heat at the seat is a good reflection of an animal's emotional state," he said. Microwaves can precipitate an emotional upheaval.

Concern about the biological effects of microwave radiation has been slow in coming in the U.S. One reason, ironically, is the thoroughness of the earlier military research on the thermal hazard. For years, the vast Russian documentation on the subject has been relegated to the back rooms of scientific establishments — the catch basins for persistent irritations which do not conform to prevailing patterns of thought.

The explanation of this benign neglect is complex. Allan Frey has pointed to the generally inadequate quality of available translations from the Russian. But perhaps of greater importance is the great gap between the scientific traditions of the two nations. The Soviets are satisfied with

BUILD THE

TREASURE TRACER

MK III

METAL LOCATOR



- Incorporates varicap tuning for extra stability
- Weighs only 22oz and has perfect balance
- Loudspeaker or earphone operation (both included)
- Handle knocks down to only 16in for transport
- Ministry approved design
- Excellent sensitivity and stability
- Kit can be built using only soldering iron, screwdriver, pliers and wire snips
- Drilled, tinned, fibreglass p.c. board with component siting printed on
- Incorporates Faraday screen

Send for s.a.e. for leaflet

Complete kit with pre-built search coil

£9.80
Plus 35p Post
(inc. VAT)

Built, tested and Guaranteed

£13.75
Plus 35p Post
(inc. VAT)

MINIKITS ELECTRONICS,
35d Langley Drive, Wanstead,
LONDON E11 2LN
(Mail order only)

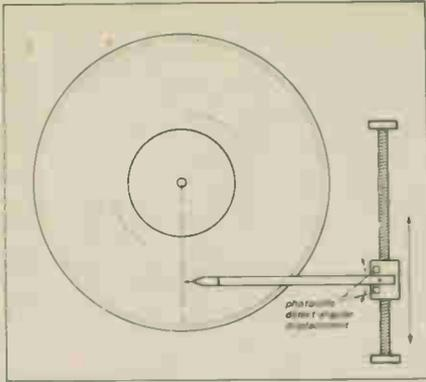

Fig. 1. Simplified drawing of Beogram 4000 shows how tone arm is free to pivot in horizontal plane. Photocells detect angular displacement and servo mechanism then drives complete arm assembly longitudinally to maintain the arm tangentially to record groove. (For simplicity the sensing arm and assembly guide rails have been deleted).



BEOGRAM 4000 TURNTABLE



THE BEOGRAM 4000 reviewed in this article is as ahead of its time in terms of engineering, styling, and operating philosophy, as in the field of motor engineering was the ID series Citroen.

The most obvious difference between this and other turntables is the tangential arm which ensures that the pickup moves in a straight line across the full playing width of the record, thus ensuring that the stylus tracks the record groove at the same angle as that

of the original recording cutter. This avoids distortion that is otherwise introduced due to the stylus tracking the record groove at a continually changing angle.

The tangential tone arm, plus a second 'sensing' arm, is cantilevered out from a slide which in turn is positively located but free to move longitudinally along a pair of guide rails. The complete slide assembly is driven up and down these rails, via worm gearing, by a small servomotor.

This brilliant example of Scandinavian design combines unique appearance with state of the art technology.

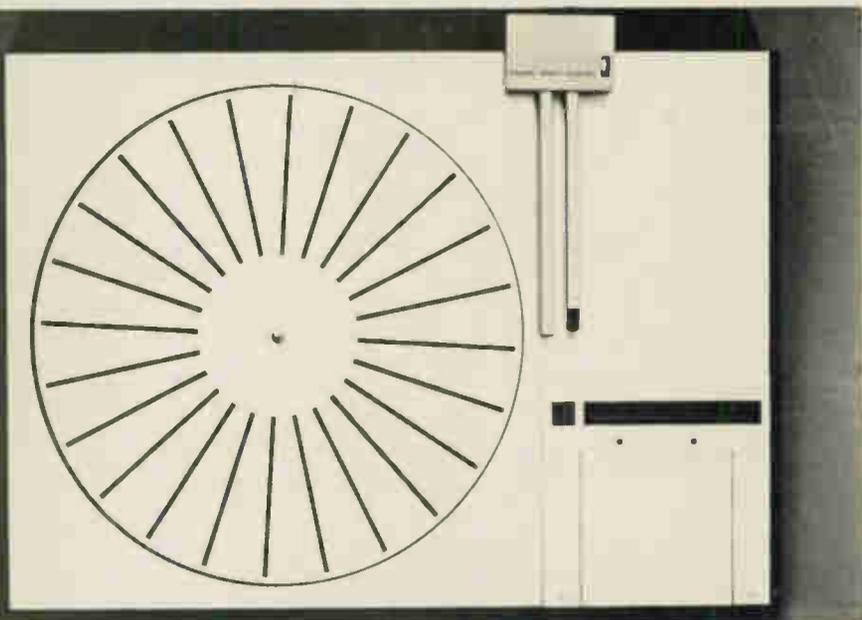
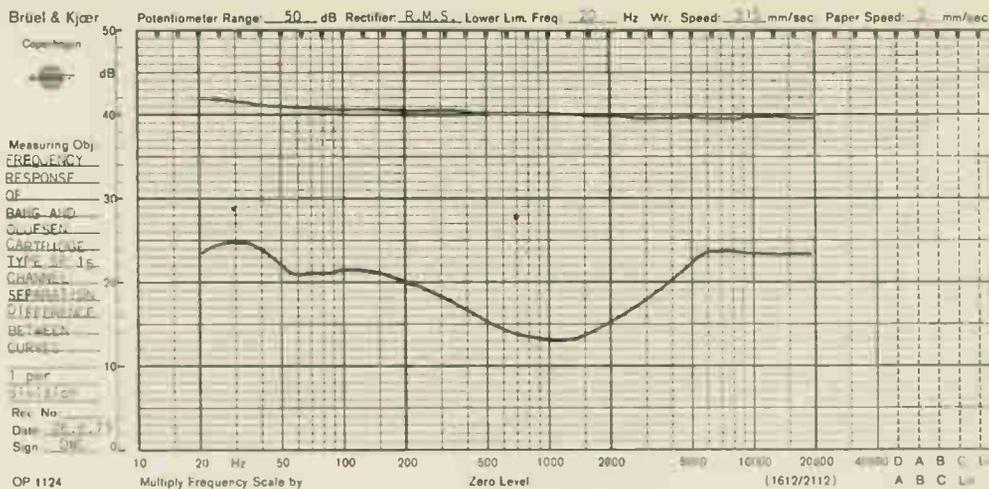

The tone arm is pivoted in both vertical and horizontal planes. The horizontal angle is monitored by a small lamp and shutter assembly in conjunction with a pair of light sensitive cells, such that as the tone arm deviates slightly to the left or right as the stylus advances across the record, a change in the light sensitive cells drives the tone arm assembly to the left or right as is required, seeking always to maintain the arm tangentially to the record groove, and never allowing the error in tracking angle to exceed 0.04° . This unusual system eliminates all the problems inherent in previous attempts to produce a linear tracking tone arm. There is negligible sideways resistance and because of this there is no noticeable difference between left and right-hand channels. Also it will accurately track an eccentric record

even to the extent of driving in reverse if necessary.

The turntable platter has a reflective metal surface on which are mounted a number of radial black plastic 'spokes'. A small lamp and photo-cell housed in the tip of the sensing arm (this is the arm to the left of the tone arm) detects the presence (or otherwise) of a record on the revolving platter. If a record is on the platter, the light reflected back to the photo-cell will be fairly steady, but if the platter is uncovered, the reflected light from the polished metal turntable will be regularly interrupted by the black radial spokes, hence a chopped dc voltage will be generated by the photo-cell.

When the turntable is switched on, and the record playing sequence initiated, the sensing arm and the tone arm move steadily along their guide

rails until the sensing arm is over the edge of the record. If no pulse signal (from the spokes) is received, the sensor assumes that a 12" record is on the turntable. At this point the tracking sensor motor is de-energised and the tone arm automatically lowered. If a 10" record were on the platter then the sensing arm would continue to track inward until the edge of the record was detected and at that point the tone arm would be lowered as previously described.

Should a 7" record be resting on the turntable then the arm would automatically track across to the 7" position, and, apart from lowering the arm, the mechanism would cause the platter drive motor to switch to 45 rpm. A manually operated '33 rpm' overriding facility is provided for those 7" records that must be played at that speed. If there is no record on the platter at all, the sensor detects the moving spokes as the arm tracks across the platter, until, when the centre is reached, the arm is returned automatically to the rest position.

Manual over-ride controls are provided to enable the user to lower the tone arm on to any required part of the record. A calibrated scale assists the user to select any desired track — these manual controls are interlocked with the spoke sensing circuitry ensuring that the arm can only be lowered if a disc is on the platter.

The raising and lowering arrangement for the tone arm operates electropneumatically and incorporates an electromagnetic to overcome the spring loaded mechanism.

The advantage of this electropneumatic system is that should the power be removed from the turntable the arm will immediately rise, thereby protecting the record and the needle against possible damage should power be reconnected.

The Beogram 4000 is not only

BEOGRAM 4000 TURNTABLE

unusual in its method of operation, it is also a very fine example of modern industrial design, it is extraordinarily sleek — approximately half the height of nearly every other turntable on the market. The actual unit itself is a mere two inches high and the tinted perspex cover adds a further two inches.

The finish is exceptional. It consists of a black tapered base approximately one inch thick surmounted by an oil timbered surround also one inch thick. The top panel is manufactured from brushed aluminium in six sections, each neatly interlocking into the one next to it.

The platter, located on the left-hand side of the control panel, is also brushed aluminium on which are located the radial rubber spokes described above.

The turntable, tone and sensing arm assemblies are supported on a die-cast frame which is completely separate from the rest of the unit. This frame is supported on three horizontal springs and provides isolation to vibration in both the horizontal and vertical planes. The resonance frequency of this sprung assembly is approximately 4.5 Hz.

The control panel is divided into four sections, the rearmost of these is approximately one inch wide. The turntable speed checking strobe light is at the left hand end of this section, and a calibrated scale showing the position of the stylus on the record is across the remainder. Just below the scale are two red slotted adjustment buttons for 33 and 45 rpm speed control. These little red buttons illuminate to indicate the speed that has been selected.

The remainder of the panel is divided, from left to right into a 3/4"

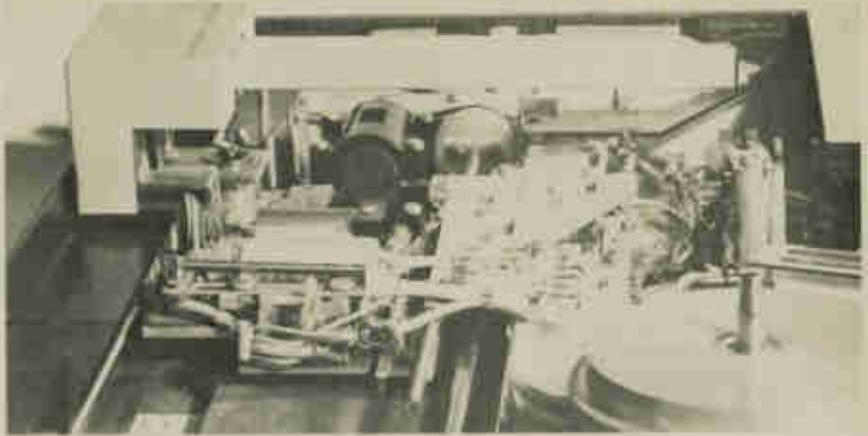

wide strip, a 3" wide strip and another 3/4" wide strip.

The left hand panel is labelled 33 at the front and 45 at the back. If the '33' end of this panel is pressed, the turntable will rotate but the tone and sensing arm assembly will not move across the record. This facility is provided so that a dust remover may be used on the record, prior to playing.

The centre panel has four arrows, one at the centre of each side. Pressing the panel at the appropriate place causes the tone arm to be lifted or lowered, or the arm driven to the left or right.

The right hand panel is labelled 'ON' at the front and 'OFF' at the rear and in most instances this is the only control that needs to be touched when one wishes to play a record. Pressing the panel at the 'ON' position immediately causes the turntable to rotate, the arm to track towards the centre and the automatic sensing and lowering process to take place as previously described.

All the electronic circuitry is located below deck on six printed circuit boards. These consist of a power supply board, a motor speed control board, a small computer board (to use

B & O's terminology) that provides all the necessary interlocking between the lowering and raising modes of the tone arm, and two boards that contain the relay providing motor speed change control, and a pair of contacts that short the output from the cartridge until the tone arm is actually resting in the record groove — thus eliminating the obtrusive noise that one normally hears as the stylus drops onto the record and engages the groove. These boards are individually shaped so they fit into the available space below the turntable and the tone arm drive assemblies.

The cartridge is unusual for a number of reasons, firstly, because of its miniature size, and secondly, because the stylus is not replaceable. Rather, an exchange arrangement is involved whereby a damaged stylus may be exchanged for a new one at half price. Another unusual characteristic of the cartridge is the use of a naked diamond which is pressed into the stylus bar rather than the construction common to cheaper cartridges which generally use a diamond chip glued on to the stylus bar.

Each cartridge is supplied with an individual calibration graph. An interesting feature of the graph

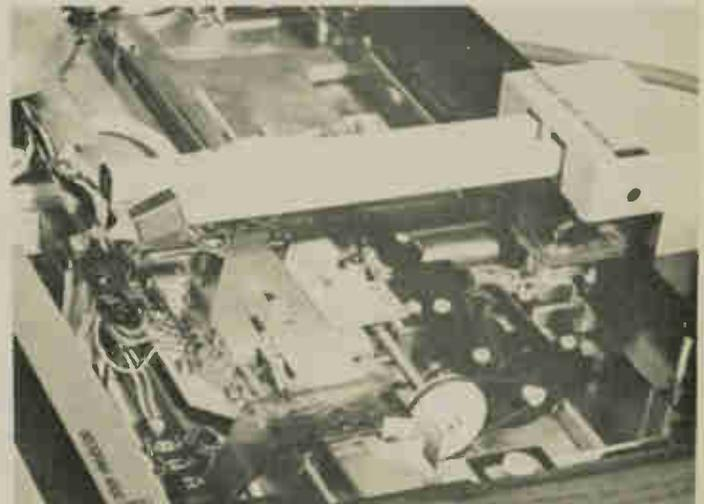
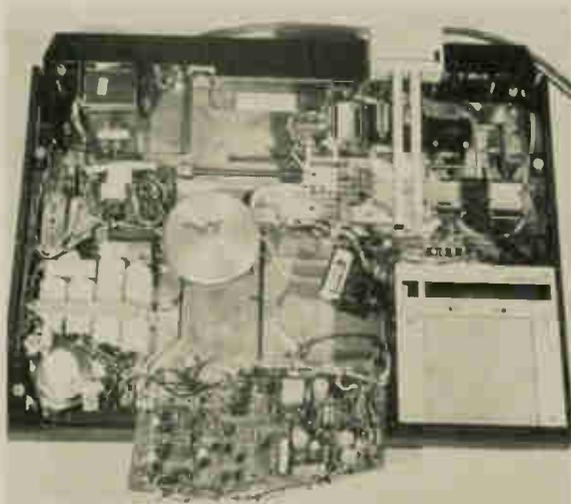

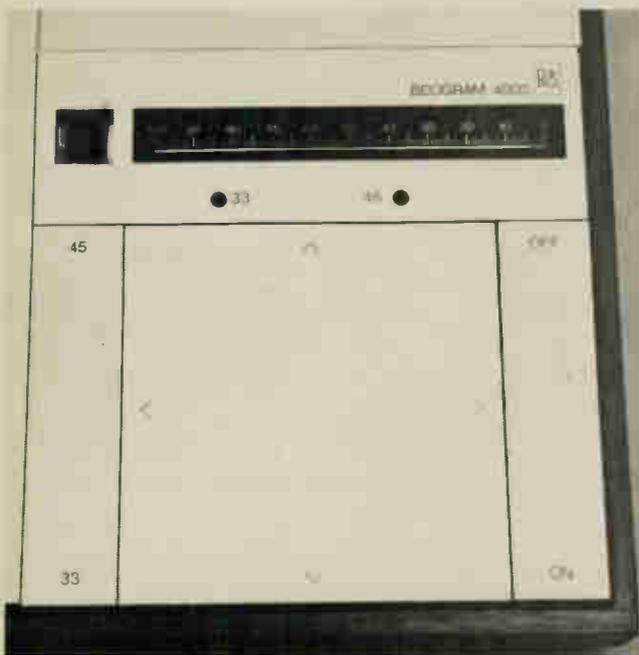

**MEASURED PERFORMANCE OF BEOGRAM 4000
WITH BANG & OLUFSEN SP15 CARTRIDGE
SERIAL NOS: 61446 & 8002699**

Frequency Response:
20Hz to 20kHz ± 1 dB
Channel Separation at 1kHz:
27dB
Channel Difference:
0.2dB
Sensitivity:
(Re 1kHz at 5 cm/sec)
3.1mV
Speed Accuracy:
Accurately Variable $\pm 2\%$
Hum & Rumble:
50dB (A)
Wow & Flutter:
0.15% rms.
Dimensions:
10 x 48 x 38 cm.
Weight:
12 kg.

supplied is a resonance peak around 18 kHz. This peak is not in fact a fault or characteristic of the cartridge but rather is characteristic of the Bruel and Kjaer test record on which the calibration is performed. Surprisingly few testing authorities seem to be aware of this phenomenon.

The performance of the cartridge was very good in some respects and average in others. The frequency response was exceptionally smooth with no noticeable resonance in the audible range. The manufacturer's claim that the cartridge has useful response up to 45 kHz makes it suitable for discrete four-channel records if used with a suitable decoding unit.

The performance of the tone arm was very good, firstly in terms of operational simplicity and secondly in terms of excellent clarity. This was most noticeable on the AR demonstration record, band 5, side 2. Towards the end there is a quick succession of notes played on the flamenco guitar, and it was pleasing to

hear the clarity with which these notes were produced. With some cartridges these notes tend to blur due to mistracking. Although the cartridge trackability was not quite as good as the *very* best that we have encountered, its frequency response and the advantage gained with the tangential tracking system provided very good performance.

Some mistracking was noticed at very high levels on such instruments as bells, triangles and harpsicords, but this slight mistracking is more than compensated for by the exceptional clarity and crispness of all type of program material, whether orchestral or electronically generated. Particularly noticeable was the added depth, which on some records resulted in notes being heard that we had never noticed before — presumably due to masking because of tracking angle error, particularly near the centre of the record.

The measured performance was in accordance with the manufacturer's

test data in nearly all respects, the only difference being a slightly higher wow figure. This is almost certainly due to differences in measuring equipment used by ourselves and the manufacturers — our equipment measuring right down to dc.

Hum was measured at a almost unbelievable low of 61dB. The combined hum and rumble figure of 50 dB (A) is predominantly rumble, possibly from the drive system; the figure is still totally acceptable.

The speed adjustment is very easy to use and provides a change of approximately $\pm 2\%$.

Despite its apparent complexity, the Beogram 4000 is by far the simplest unit to use that we have ever encountered. Its almost totally automatic operation and inbuilt protection against misuse means that it may safely be used by young children.

It has a number of exceptional features including the tangential arm motion which puts it way ahead of its class in engineering design. ●

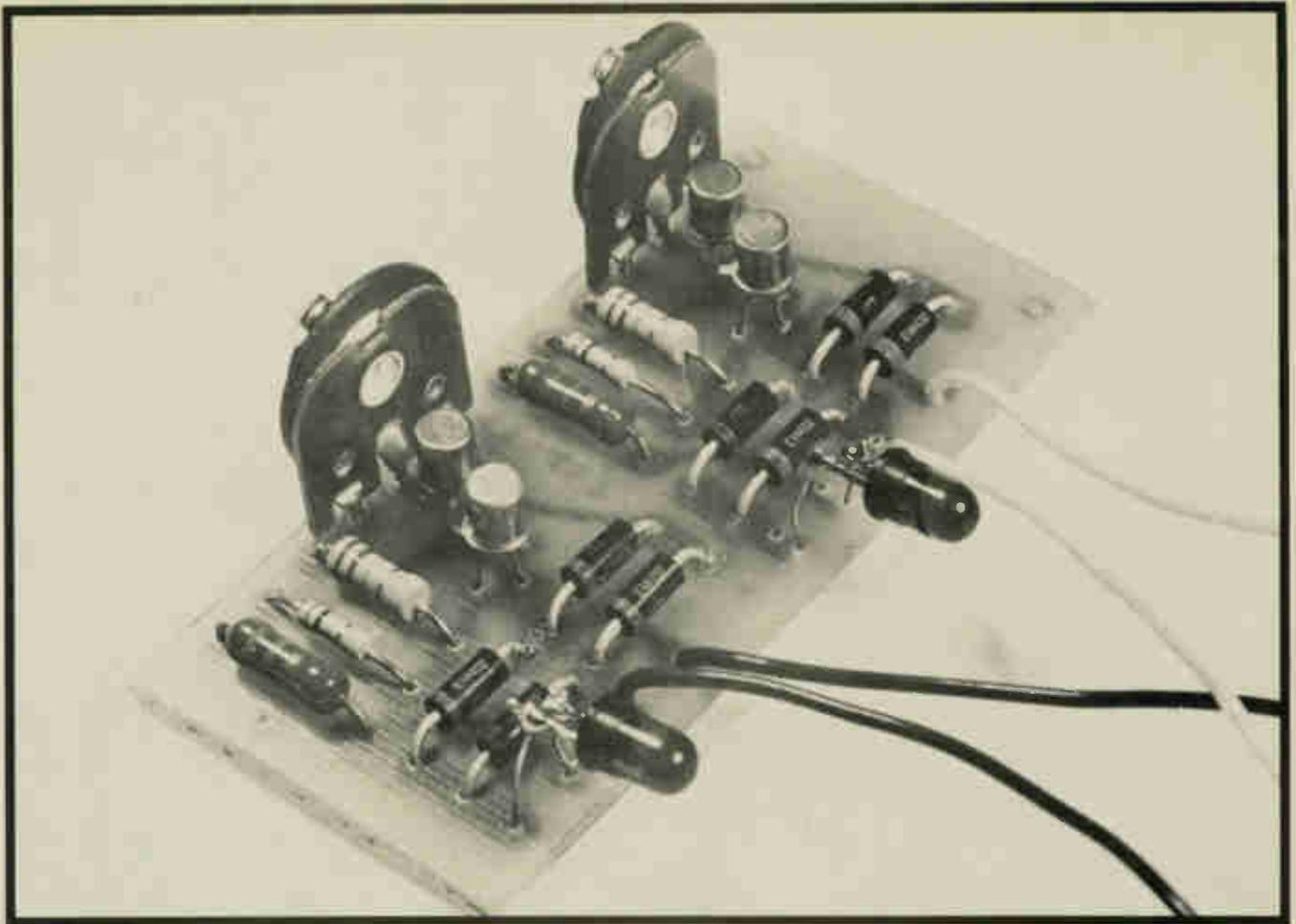

PROJECT 417

THE OVER-LED

Is your power amplifier clipping? This simple monitor lets you know.

TABLE 1

RMS watts per channel	SPEAKER IMPEDANCE					
	4Ω		8Ω		16Ω	
	R1	R3	R1	R3	R1	R3
5	68	5.6k	82	8.2k	120	12k
10	82	8.2k	120	10k	180	18k
15	100	10k	150	15k	220	22k
20	120	12k	180	18k	240	24k
25	150	15k	220	22k	270	27k
35	180	18k	240	24k	330	33k
50	220	22k	270	27k	390	39k
75	240	24k	330	33k	470	47k
100	270	27k	390	39k	560	56k

MANY people are aware of distortion when they turn up the volume control on their hi-fi equipment — but are usually unaware of the cause.

Nine times out of ten this distortion is caused by 'clipping'. That is, the amplifier does not have enough reserve power to handle the peak music transients at the required volume.

During such peaks, the amplifier is driven into an overload condition and as a result the music peaks are 'clipped'. This results in harsh sounding reproduction.

This simple device, which may be built into your existing amplifier, or separately located, flashes a warning light if the power level at which clipping occurs is exceeded.

Two completely independent circuits are provided so that each channel of a stereo system may be monitored separately.

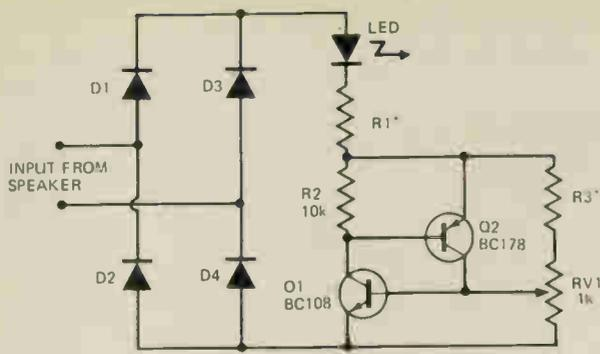

SEE TABLE 1 FOR VALUES
ONE CHANNEL ONLY SHOWN

Fig. 1. Circuit diagram of overload detector. One channel only shown.

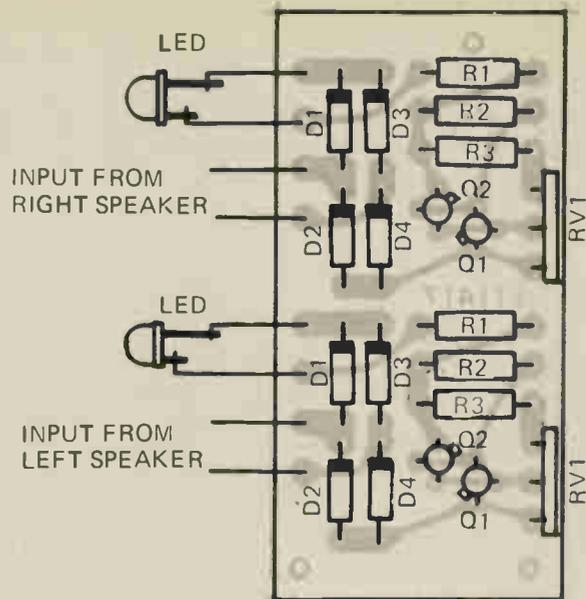

Fig. 2. Component overlay.

HOW IT WORKS

The output of each power-amplifier channel is monitored at the speaker terminals. The output is bridge rectified by D1-D4 so that both positive and negative transients may be detected.

Transistors Q1 and Q2 (together) are equivalent to a sensitive gate SCR (silicon controlled rectifier). If the voltage at the base of Q2 is more than about 0.6 volts above its emitter, Q1 and Q2 will each turn hard on and latch on, until the current through them drops to zero.

When transistors Q1 and Q2 are on, the current flowing through them also flows through the LED causing it to illuminate. Resistor R1 limits the peak current through the LED to about 100 mA. The range of calibration potentiometer RV1 is set by resistor R3. The values of R1 and R3 are provided in Table 1 for various amplifier power ratings and speaker impedances. These values are not critical. If your amplifier has a power rating other than that specified, the nearest values will do.

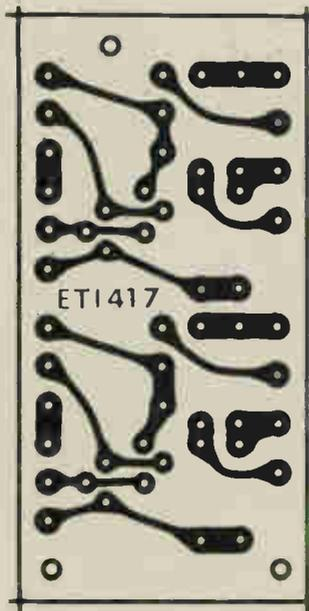

Fig. 3. Printed circuit board (full size).

PARTS LIST

One set required for each channel.

R1	resistor	as Table 1
R2	"	10k 5% 1/2 watt
R3	"	as Table 1
Q1	transistor	BC 108 or similar
Q2	"	BC178 or similar
D1 to D4	Diode	1N4001 or similar
LED	light emitting diode	TIL209 etc.

PCB ET1 417 (1 only required — each board has provision for two channels)

CONSTRUCTION

Mount all components on to the printed circuit board in accordance with the component overlay. Make sure that all diodes are correctly orientated, in particular the LED's. The LED's will not be damaged by reverse polarity but will not operate in that mode.

Whether the unit is mounted inside the amplifier or external to it in a small box will be a matter for the individual constructor. The printed circuit board may be mounted in any suitable position within the amplifier and leads extended to front-panel mounted LEDs if required.

Polarity of the leads to the amplifier output terminals is immaterial but make sure that the leads of separate channels are not mixed. This is best avoided by twisting each pair of leads to each channel.

CALIBRATION

There are several ways of calibrating the unit.

By far the best way is to connect an audio oscillator to the input of the amplifier (both channels driven at the same time), then, with the amplifier volume control at a low setting, adjust the oscillator to provide a 1 kHz sine-wave.

Set both trim potentiometers (RV1) so that their wipers are nearest R3.

Now increase the amplifier volume until clipping occurs. This is very easily identified as a sudden harshness of tone. Do not leave the volume control at this setting for more than a second or two, as apart from the pounding you are giving to your ears, some amplifiers will not tolerate a sine-wave input at clipping level for extended periods without damage.

Once the clipping point has been established, turn the volume down again, and then quickly turn up to the clipping point momentarily, meanwhile adjusting the trimming potentiometers RV1 until a point is reached where the light emitting diodes just come on.

Repeat the procedure a few times — finally arriving at a setting at which the LED's come on just before the clipping point.

If you do not have access to an oscillator, the device can be set by playing a test record that contains a sine-wave tone — or failing this — by playing a record of a solo instrument such as a flute. A recording of the human voice is also very effective. In such cases the same calibration procedure described above should be followed.

Henry's

U.K.'s LARGEST RANGE OF BRANDED AND GUARANTEED DEVICES. (Quantity Discounts 10% 12+, 15% 25+, 20% 100+)
(Any one type except where quantity discounts show) Min. Order £1.00 please. Post 10p.

INTEGRATED CIRCUITS

VERY IMPORTANT. ONLY Henry's IC's are the FULL manufacturer's specification. All other IC's are inferior. Buy Henry's branded integrated circuits. From TEXAS I.T.T. FAIRCHILD... SIGNETICS. Send for FREE-POST list of IC's. Best quality. Buy direct from the manufacturer. Free postage.

Type	1-11	12	29	30	99
SN7400N	0.20	0.18	0.16		
SN7401N	0.20	0.18	0.16		
SN7402N	0.38	0.38	0.33		
SN7403N	0.20	0.18	0.16		
SN7404N	0.20	0.18	0.16		
SN7405N	0.38	0.38	0.33		
SN7406N	0.24	0.21	0.18		
SN7407N	0.30	0.27	0.25		
SN7408N	0.44	0.44	0.38		
SN7409N	0.40	0.38	0.35		
SN7410N	0.40	0.38	0.35		
SN7411N	0.25	0.22	0.19		
SN7412N	0.33	0.33	0.28		
SN7413N	0.44	0.44	0.38		
SN7414N	0.20	0.18	0.16		
SN7415N	0.25	0.23	0.21		
SN7416N	0.28	0.28	0.25		
SN7417N	0.38	0.38	0.33		
SN7418N	0.30	0.27	0.25		
SN7419N	0.30	0.27	0.25		
SN7420N	0.20	0.18	0.16		
SN7421N	0.28	0.28	0.25		
SN7422N	0.38	0.38	0.33		
SN7423N	0.37	0.34	0.32		
SN7424N	0.37	0.34	0.32		
SN7425N	0.43	0.43	0.37		
SN7426N	0.43	0.43	0.37		
SN7427N	0.30	0.27	0.25		
SN7428N	0.20	0.18	0.16		
SN7429N	0.37	0.37	0.32		
SN7430N	0.43	0.43	0.37		
SN7431N	0.43	0.43	0.37		
SN7432N	0.57	0.57	0.50		
SN7433N	0.43	0.43	0.38		
SN7434N	0.57	0.57	0.50		
SN7435N	0.43	0.43	0.37		
SN7436N	0.43	0.43	0.37		
SN7437N	0.43	0.43	0.37		
SN7438N	0.43	0.43	0.37		
SN7439N	0.43	0.43	0.37		
SN7440N	0.57	0.57	0.50		
SN7441N	0.96	0.86	0.75		
SN7442N	2.16	2.16	1.89		
SN7443N	1.00	0.90	0.83		
SN7444N	1.10	1.00	0.90		
SN7445N	0.75	0.70	0.63		
SN7446N	0.75	0.70	0.63		
SN7447N	0.85	0.80	0.75		
SN7448N	0.85	0.80	0.75		
SN7449N	1.00	0.90	0.83		
SN7450N	2.16	1.89	1.89		
SN7451N	0.60	0.53	0.45		
SN7452N	0.60	0.53	0.45		
SN7453N	0.51	0.51	0.45		
SN7454N	0.57	0.57	0.50		
SN7455N	0.96	0.86	0.75		
SN7456N	2.16	1.89	1.89		
SN7457N	1.00	0.90	0.83		
SN7458N	1.92	1.92	1.68		
SN7459N	1.05	1.05	0.92		
SN7460N	0.57	0.57	0.50		
SN7461N	0.80	0.80	0.70		
SN7462N	1.44	1.44	1.26		
SN7463N	0.69	0.69	0.60		
SN7464N	0.69	0.69	0.60		
SN7465N	0.72	0.72	0.63		
SN7466N	0.63	0.63	0.55		
SN74141N	1.50	1.27	1.13		
SN74142N	2.88	2.88	2.52		
SN74143N	1.44	1.44	1.26		
SN74144N	2.30	2.30	1.83		
SN74145N	2.01	2.01	1.63		
SN74146N	2.30	2.30	2.01		
SN74147N	1.15	1.15	1.10		
SN74148N	2.01	2.01	1.63		
SN74149N	2.30	2.30	2.01		
SN74150N	2.30	2.30	2.01		
SN74151N	1.09	1.09	0.95		
SN74152N	2.30	2.30	2.01		
SN74153N	1.15	1.15	1.10		
SN74154N	2.30	2.30	2.01		
SN74155N	1.15	1.15	1.10		
SN74156N	1.09	1.09	0.95		
SN74157N	1.09	1.09	0.95		
SN74158N	2.44	2.44	2.14		
SN74159N	1.58	1.58	1.38		
SN74160N	1.58	1.58	1.38		
SN74161N	1.58	1.58	1.38		
SN74162N	1.58	1.58	1.38		
SN74163N	1.58	1.58	1.38		
SN74164N	2.01	2.01	1.76		
SN74165N	2.01	2.01	1.76		
SN74166N	2.16	2.16	1.89		
SN74167N	4.10	4.10	3.59		
SN74168N	2.88	2.88	2.52		
SN74169N	5.76	5.76	5.04		
SN74170N	1.66	1.66	1.45		
SN74171N	1.80	1.80	1.57		
SN74172N	1.80	1.80	1.57		
SN74173N	1.44	1.44	1.26		
SN74174N	1.44	1.44	1.26		
SN74175N	1.44	1.44	1.26		
SN74176N	1.44	1.44	1.26		
SN74177N	1.44	1.44	1.26		
SN74178N	1.44	1.44	1.26		
SN74179N	5.18	5.18	4.53		
SN74180N	1.44	1.44	1.26		
SN74181N	2.16	2.16	1.89		
SN74182N	1.72	1.72	1.51		
SN74183N	6.48	6.48	5.67		
SN74184N	2.30	2.30	2.01		
SN74185N	2.30	2.30	2.01		
SN74186N	2.30	2.30	2.01		
SN74187N	2.30	2.30	2.01		
SN74188N	2.30	2.30	2.01		
SN74189N	2.30	2.30	2.01		
SN74190N	2.30	2.30	2.01		
SN74191N	2.30	2.30	2.01		
SN74192N	2.30	2.30	2.01		
SN74193N	2.30	2.30	2.01		
SN74194N	1.44	1.44	1.26		
SN74195N	1.44	1.44	1.26		
SN74196N	1.58	1.58	1.38		
SN74197N	1.58	1.58	1.38		
SN74198N	3.16	3.16	2.77		
SN74199N	2.88	2.88	2.52		

EASY TO BUILD KITS BY AMTRON - Everything supplied

- Model No.
- 10 Radio control receiver 3.00
- 300 4 channel R/C transmitter 5.75
- 141 Superhit R/C receiver 5.08
- 450 TV sound generator 10.24
- 455 AM signal generator 9.25
- 460 FM signal generator 9.91
- 69 Simple transistor tester 1.18
- 115 8 watt Amp. 2.87
- 130 10 watt amplifier 3.88
- 125 Stereo control unit 4.20
- 128 Electronic vibrator 3.52
- 102 Power supply for 230 3.88
- 101 Power supply for 120 3.88
- 115 Power supply for 230 4.85
- 122 AM/FM signal generator 2.79
- 140 Auto parking light 5.18
- 111 Mic. pre-amplifier 5.83
- 180 Electronic vibrator 17.51
- 455 6 channel ASTAB supply 9.68
- 375 LF amplifier 10H, 1mH 12.60
- 372 Super audio oscillator 24H, 20KHz 12.87
- 130 SWR meter 10.24
- 120 N. CAO Chamber 1 Watt 7.47
- STAB Power amplifier 10W 0.5-30A 7.65
- OC motor speed control 2.63
- 100 Electronic Clock 5.96
- 105 Windscreen wiper motor 5.56
- 103 Audio system 8.87
- 104 Metal Detector (electronic) 7.27
- 106 Sparkless Burglar alarm 6.16
- 110 Quartz Converter 6.79
- 112 G.M. pickup 3.75
- 147 Data card alarm 5.20
- 375 CAP. Discharge indicator for car battery (V & E) 10.68
- 30 Simple Control 1.98
- 290 Loud speaker 5.50
- 430 50Hz Motor 18.23
- 500 120-180kHz VHF tuner 9.33
- 115 Photo eye sensor 6.93
- 785 Electronic continuity tester 3.88
- 1000 Photo timer 12.04
- 111 Slide projector auto. lens control 8.72
- 112 Acoustic A. Alarm driver 6.96
- 180 Quartz XTAL 7.89



ALL KITS OFFERED SUBJECT TO STOCK AVAILABILITY

FREE BOOKLET

All types of Transistors Rectifiers—Bridges SCR's—Triacs Integrated Circuits F.E.T.—Light Devices
OVER 1500 DIFFERENT DEVICES ENTIRELY NEW 1973 EDITION
More Devices ★ New Prices ★ New Ranges ★
This is a must for all Semi-conductor Users. (Ask for booklet No. 36.)
SEND FOR YOUR FREE COPY TODAY



TBA800 5 WATT IC

Suitable alternative to SL4030 5.30 volt operated 8W OHM 5 watt output. With circuits and data £1.50.

Toshiba Power and Pre-amplifier modules TH9013P 20 watt Power amplifier 22-0-22 or single 45 volt output. £4.57. TG9014P Stereo on two channel pre-amplifier £1.50 (circuit book No. 42 price 10p).

Sinclair IC12

With circuits and data. 6 watt IC with printed circuit board. 28 volt operated £1.80.

Ultrasonic Transducers Operate at 40KHz up to 100 yds. Ideal remote switching and signalling. Complete with data transmitter and receiver new IC circuits. Per pair £5.90. TA860 £1.80.

ZN414 IC

Integrated circuit radio as featured by many magazines (PW Jan 73 Reprint Ref. No. 19 for 10p). £1.20.

3015F 7 SEG. I.C. size complete with data. price £2 each or 4 for £7 (digital clock circuits ref. No. 31, 15p).

LARGER QUANTITY AND O.E.M. PRICES PHONE (01) 723 3546. PRICING OF SN7400 SERIES IS CALCULATED ON THE TOTAL NUMBER ORDERED REGARDLESS OF MIX. SN74 HIGH POWER SN74 LOW POWER SERIES IN STOCK. SEND FOR LIST 36, FREE ON REQUEST. LOW PROFILE SOCKETS 4PIN 15p, 16PIN 17p, 8PIN 14p.

EXCLUSIVE SPECIAL OFFERS

MW LW CAR RADIO £6.50 (circuit book No. 36)

B TRACK CAR STEREO £12.50 (circuit book No. 40)

HANIMAX HC1000 £10.50 (circuit book No. 36)

HANIMAX HC2000 £13.50 (circuit book No. 36)

AKAI GX40 £59.96 (circuit book No. 36)

5 WAVE BAND PORTABLE TWIN SPEAKER RADIO £6.96 (circuit book No. 36)

PORTABLE CASSETTE TAPE £10.45 (circuit book No. 36)

HANIMAX POCKET CALCULATOR WITH KEY £33.50

NEW RANGES BRIDGE RECTIFIERS

FEATURES SMALL SIZE AND LOW COST. Sizes are approximate.

250M A QUARTER AMP B025 05 50 PIV 16p B025 10 100 PIV 16p B025 15 150 PIV 20p

1 AMP 1-11 Pricing Type P I V Price B05 05 50 20p B05 10 100 22p B05 20 200 25p B05 40 400 25p B05 60 600 25p

4 AMPS P.I.V. B4100 100v 55p B4200 200v 59p B4400 400v 65p B4600 600v 75p B4800 800v 81p

6 AMPS P.I.V. B6105 50v 65p B6110 100v 70p B620 200v 80p B640 400v 90p B6610 600v 100p

All prices correct at time of press 10% VAT to be added to all orders (UK only) Export & UK Manufacturers/Colleges supplied. E.&O.E.

TRANSISTORS

A SELECTION FOR FULL LIST SEND FOR BOOKLET 36 TODAY

Type	1-11	12	29	30	99
AA210 10p	BC182 12p	BYZ13 35p	OC36 65p	ZTX108 10p	2N3714 46p
AC100 35p	BCY1 85p	CID60 55p	OC44 18p	ZTX300 14p	2N3771 25p
AC110 35p	BCY39 1.00	GET111 55p	OC45 18p	ZTX302 18p	2N3773 2.25
AC120 20p	BCY55 2.50	GET115 75p	OC71 15p	ZTX500 15p	2N4190 2.25
AC130 35p	BCY71 1.50	GET189 55p	OC72 25p	ZG301 40p	2N4191 35p
AD170 50p	BCY73 1.50	L7309K 1.87	OC77 55p	ZN697 15p	2N3866 75p
AD180 35p	BD0124 80p	MAT121 1.87	OC81 28p	2N706 10p	2N3903 15p
AD190 35p	BD0145 25p	MAT121 1.87	OC83 25p	2N930 20p	2N4002 14p
AF11 20p	BF151 22p	MJE140 50p	OC140 65p	2N987 45p	2N4126 15p
AF15 30p	BF160 33p	MJE520 65p	OC170 25p	2N1132 25p	2N4871 35p
AF18 50p	BF194 13p	MJE3035 75p	OC200 55p	2N1304 22p	2N5457 36p
AF19 40p	BF194 13p	MJE3035 75p	OC202 90p	2N1513 20p	2N5001 3.00
AF20 40p	BF214 55p	MPI105 46p	ORP12 55p	2N1247 75p	2S303 70p
AS1 30p	BF218 22p	NKT217 45p	ORP60 45p	2N2160 69p	40250 45p
BA10 10p	BFY10 20p	OAS40 60p	P346A 20p	2N2926 10p	40361 45p
BAK1 5p	BFY51 20p	OKT 60p	TIL209 25p	2N3053 20p	40362 40p
BC10 12p	BFY64 45p	OAB1 10p	TIP29A 9p	2N3054 45p	40408 50p
BC10 12p	BFY90 75p	OA200 8p	TIP30A 9p	2N3055 45p	40486 75p
BC20 12p	BLY16 6.25	OA202 10p	TIP31A 61p	2N3440 50p	40636 1.00
BC30 14p	BSX20 15p	OC16 85p	TIP41A 74p	2N3432 1.10	40420 85p
BC4 16p	BJY1 2.20	OC20 1.25	TIP42A 90p	2N3525 80p	
BC14 12p	BY100 15p	OC28 65p	TIS46 26p	2N3614 59p	
BC14C 14p	BY15 15p	OC35 55p	V405A 25p	2N3702 11p	

TRIACS

Std. mounting with accessories

Type	1-11	12	29	30	99
3 AMP RANGE	SC45B 100v £1 15	SC45D 400v £1 45	SC45E 500v £1 85		
15 AMP RANGE	SC50A 100v £1 45	SC50B 200v £1 65	SC50C 400v £1 95	SC50E 500v £2 25	
6 AMP RANGE	SC40A 90p	SC40B 95p	SC40D £1 20	SC40E £1 50	
10 AMP RANGE	SC45A 100v £1 05				

SILICON CONTROLLED RECTIFIERS

Type

Type	1-11	12	29	30	99</
------	------	----	----	----	------

Henry's

U.K.'s LARGEST RANGE OF ELECTRONIC COMPONENTS AND EQUIPMENT AT BARGAIN PRICES
Latest Catalogue price 55p post paid. Complete with Discount Vouchers



Now built and used by thousands of satisfied customers. Features slim design overall size in cabinet 15 1/2" x 2 1/2" x 6 1/2". 10 transistors, stabilisers, Gardners low field transformer. Fibre Glass PC Panel, complete chassis work. Now available built and tested as well as in kit form. **HIGH QUALITY AND STABILITY ARE PRE-DOMINATE FEATURES** - DEVELOPED BY TEXAS ENGINEERS FOR PERFORMANCE, RELIABILITY AND EASE OF CONSTRUCTION. FACILITIES.

BUILD THE TEXAN

20 + 20 WATT IC STEREO AMPLIFIER
As featured by Practical Wireless 1972



BUILD THE NEW HENELEC STEREO FM TUNER



You pay less VAT with Henry's Low Prices

A completely new high stability stereo FM tuner. Features variable capacity diode tuning, stabiliser power supply, IC Decoder, high gain low noise, IF stages, LED indicators. Tuning meter, AFC, easy to construct and use. Mains operated. Slim modern design with fibre glass PC, teak cabinet etc. Available as a kit to build or ready built. Overall size 8" x 2 1/2" x 6 1/2". Produced to give high performance with a realistic price. (Parts list and constructional details Ref. No. 530p). Henry's are sole distributors UK and Europe.

Kit price **£21.00 (+ VAT)**



OR BUILT AND TESTED £24.95 (+ VAT)

FREE—Teak cabinet with complete kit.
KIT PRICE £28.50
(+VAT+50p carriage) or built and tested **£35.00 (+VAT+50p carriage)** as illustrated.

EARN YOURSELF EASY MONEY, WITH PORTABLE DISCO EQUIPMENT



- DISCO MINI** A complete portable disco, fitted mixer/preamp, 2 decks all facilities **£98.50**
- 100 watt amplifier for above **£38.75**
- SL100** 100 watt mixer/amplifier with slider controls **£89.00**
- R50** 50 watt mixer/amplifier **£49.50**
- DISCO AMP** 100 watt mixer/amplifier chassis unit **£65.85**
- DISCO MIXER/PREAMPLIFIERS** (OP for up to 6-100 watt amplifiers)
- SDLI** (rotary controls) **£49.50**
- SDLI** (slider controls) **£58.50**
- DISCO VOX** (slider controls) the complete disco unit **£69.50**
- DJ100** 100 watt power amplifier for above **£38.75**
- DJ30L** 3 channel 3kw sound to light **£29.50**
- DJ40L** as 30L plus built in microphone **£38.75**
- DIMAMATIC** 1 kW adjustable speed auto dimmer **£25.00**
- SCENE STROBE** **£19.00**. **ROAD STROBE** **£25.00**
- Disco anti-feedback microphone **£11.95**
- Colt 150 watt liquid wheel projector **£22.50**
- 150 watt QI liquid wheel projector **£50.00**

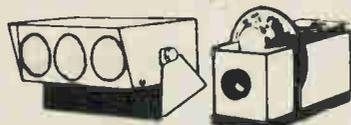

- 150 watt C/I cassette wheel projector **£50.00**
- Spare Effects cassettes large range of patterns **£9.00**
- Mini spot bank fitted 3 lamps **£11.00**
- Auto Trillite (mini with flashers) **£17.00**
- Mixer/Misc/Speakers/Lighting UK's largest range. **FREE** stock list ref. No. 18 on request.

TEXAN STEREO SYSTEM PLUS PRICE SAVINGS

The Texan Stereo Systems Include the high quality Texan Stereo amplifier assembled and ready to use. A pair of Type 200 20 watt Speaker-Tweeter systems size 2 1/2" x 12" x 10" and a choice of Garrard players built into a plinth with cover with Goldring G800 magnetic cartridge. Systems 25 uses Garrard SP25 Mk III and system 76 the Garrard AP76 de luxe turntable. All necessary leads are supplied. **System 25 (list approx. £109) £79.50**
System 76 (list approx. £117) £89.50
(plus 10% VAT and plus £1.45 carriage)



LOW COST HI-FI SPEAKERS

SPECIAL OFFER
EMI 13" x 8" full range speakers (post 20p each or 30p pair)
*150TC—8 ohms Twin Cone 10 watt £2.20 each or £4.00 pair.
*450 10 watt C/Io Twin Tweeters 3, 8 or 15 ohms £3.50 each or £6.80 pair.
EW 15 watt 8 ohms C/Io Tweeter £4.30 each or £7.90 pair.
350 20 watt C/Io Tweeters 8 or 15 ohms £7.50 each or £14.20 pair.
* Polished wood cabinet £4.40 post 35p.



8 ohms full range (post 20p)			
FR4	4"	5 watt	£4.00
FR65	6 1/2"	10 watt	£5.50
FR8	8"	15 watt	£7.60
FR23	9 x 6"	15 watt	£9.00

BASS & MID RANGE—8 ohms (post 20p)			
BA12	5"	15 watt	£3.20
B110	5 1/2"	15 watt	£5.40
B200	8"	15 watt	£6.45
B139/2	13" x 8"	30 watt LF	£10.25

TWEETERS AND CROSSOVERS (post 20p)			
K2006	10 watt	8 or 15 ohms	£1.90
FHT6	15 watt	8 ohms	£3.20
K2011	30 watt	8 ohms	£3.75
T27	KEF		£4.25
Ascant 100	30 watt	8 ohms	£4.90
K4009	1kHz/5kHz	C/Io	£2.00
SN75	3kHz var.	C/Io	£1.75

SPEAKER KITS (carr. etc. 35p)			
20-2	8"	30 watt	£10.00 each
20-3	8"	40 watt	£15.00 each
LINTON 2	20 watt		£15.95 pair
GLENDALE 3	30 watt		£28.95 pair
DOVEDALE 3	50 watt		£42.00 pair
KEF KK2			£20.40 each
KEF KK3			£32.00 each

MINIATURE AMPLIFIERS

- 4-300, 0.3 watt 9 volt **£1.75**
 - 104, 1 watt 9 volt **£2.20**
 - 304, 3 watt 9 volt **£2.50**
 - 555, 3 watt 12 volt **£2.85**
 - E1208, 5 watt 12 volt **£4.50**
 - 608, 10 watt 24 volt **£4.10**
 - 410, 10 watt 28 volt **£4.95**
 - Z30, 15 watt 30 volt **£3.57**
 - E1206, 30 watt 45 volt **£9.75**
 - Z50, 30 watt 50 volt **£4.37**
 - E1210, 2 1/2 + 2 1/2 watt 12 volt **£5.25**
 - RE500, 5 watt IC mains operated Amplifier with controls **£8.30**
 - SAC14, 7 + 7 watt Stereo with controls **£8.00**
 - SAC13, 15 + 15 watt Stereo with controls **£11.00**
 - SINCLAIR UNITS** (carr. 20p) **£30-£37, £20-£4.37**
 - Stereo 60 Pre-amplifier **£7.97**
 - PZ5 **£3.97**, PZ6 **£6.37**, PZ8 (for Z50) **£4.77**
(TRANS £2.95)
 - AFU £4.45, PROJECT 805 KIT **£19.85**
 - NEW SINCLAIR PROJECT 80**
 - Stereo Pre-amplifier **£11.95**
 - Audio Filter Unit **£8.95**
 - Z40 15 Watt amplifier **£5.45**
 - Z80 25 Watt Amplifier **£8.95**
 - PZ5 Mod for 1 on 2 Z40 **£4.98**
 - PZ6 Mod (S Tab) 1 on 2 Z40 **£7.98**
 - PZ8 Mod (S Tab) 1 on 2 Z80 **£7.98**
 - TRANSFORMER FOR PZ8 **£2.85**
 - NEW FM TUNER** **£11.45**
 - STEREO DECODER** **£7.45**
- All items post paid — Best price on request

POWER SUPPLIES FOR EVERY PURPOSE

- (All cased unless stated chassis)
- 470C 6 7/8" 9 volt 300 MA (Includes Multi-Adaptor for Tape Recorders, etc.) **£1.95 post 20p**
 - Car Lighter Voltage Adaptors 300mA (State voltage 6v, 7 1/2v, 9v) **£1.95 ea. post 25p**
 - SC202 3 1/6" 7 1/2 volt 400mA **£3.25 carr. 30p**
 - HC244R Stabilised version **£4.25 carr. 30p**
 - P500 9 volt 500mA **£2.80 post 20p**
 - P11 24 volt 500mA (chassis) **£2.00 post 20p**
 - P15 26/28 volt 1 amp (chassis) **£2.70 post 20p**
 - P1080 12v 1 amp (chassis) **£3.25 post 20p**
 - P1081 45v 0.9 amp (chassis) **£4.40 post 20p**
 - P12 4 1/2 volt 0.4-1 amp **£8.75 post 30p**
 - SE101A 3 1/8" 9/12 volt 1 amp (Stab.) **£9.15 post 25p**
 - RP164 6 7/8" 9/12 1 amp (Stab.) **£8.95 post 30p**



GARRARD BATTERY TAPE DECK

GARRARD 2 speed 9 volt tape decks. Fitted record/play and oscillator/erase heads. Wind and rewind controls. Takes up to 4" spools. Brand new complete with head circuits. **£9.50 carr. 30p.**



FIBRE OPTICS
0 01 Diam Mono Filament **£1.50 per 25 metre reel**
0 13 Diam. 64 Fibres Sheathed **£1.00 per metre**
SPRAYS 15mm Diam. Mares Tails **£8.50**

TOP QUALITY SLIDER CONTROLS

80mm stroke high quality controls complete with knobs (post, etc. 15p any quantity)
Slipcase Log and Lin 10K, 22K, 50K, 100K, 250K, 500K, 1 Mega **45p each**
Slipcase Log and Lin 10K, 22K, 50K, 100K, 250K, 500K each (Quantity discounts available) Complete with knobs

MARRIOT TAPE HEADS

4 TRACK MONO or 2 TRACK STEREO 17 High Impedance **£2.00**, 18 Medium Impedance **£2.00**, R730E73 2 track mono Record/Erase low imp. 75p pair. Erase Heads for 17 and 18 75p. 63 2 track mono Hi Imp. **£1.75**, 43 Erase Head for 63 75p. (Post etc. 15p any quantity)

SPECIAL PURCHASES

- AVOMETER MOVEMENTS**
AVO 8 or 9 50MA MOVEMENTS
Ex Brand New AVO's **£3.50 Post 20p**
- UHF TV TUNERS**
CHANNELS 21 TO 64
Brand new transistorised geared tuners for 625 Line Receiver 1F output. **£2.50 Post 20p**
- 
- 

All types offered subject to availability. Prices correct at time of press E. & O. E. 10% VAT to be added to all orders.

TEST EQUIPMENT MULTIMETERS

(carr. etc. 30p)
200H 20k/Volt Slimline with case **£4.95**, TLH33D 2k/Volt Robust with case **£4.95**, U437 10k/Volt Steel case. AC up to 40kVz **£4.95**, U4324 20k/Volt with AC current ranges **£8.00**, AF105 50k/Volt with Leather case **£9.50**, U4313 20k/Volt AC current. Steel case **£10.50**, U4341 Plus Built in transistor tester **£10.50**, Model 500 30k/Volt **£9.95**



OTHER EQUIPMENT

SE250B Pocket Signal Injector 1.90 carr. 15p, SE500 Pocket Signal Tracer 1.50 carr. 15p, TE15 Grid Dip meter 440kHz-280MHz 13.45 carr. 30p, TE40 AC Millivoltmeter 1.2mHz 18.75 carr. 35p, TE65 28 Range valve voltmeter **19.25 carr. 40p**, TE20D 120kHz-500MHz RF Generator 16.95 carr. 40p, TE22D 20Hz-200kHz Audio Generator 18.75 carr. 40p, SE350A Deluxe Signal Tracer 9.95 carr. 20p, SE400 Volts/ohms/R-C sub/RF field/RF gen. 11.25 carr. 20p.

Henry's RADIO LIMITED

EDGWARE ROAD, W2

404-406 Electronic Components and Equipment 01 402 8381
354-356 High Fidelity and Tape Equipment 01-402 5854, 4736
309 PA-Disco-Lighting High Power Sound 01-723 6963
303 Special offers and bargains store
All mail to 303 Edgware Road, London W2 1BW

Hi-Fi and Tape Equipment **BIG DISCOUNTS. DEMONSTRATIONS**
Phone 01-402 5854 For quotes or stock list. You can order by phone with Barclay or Access Card. **EASY TERMS FOR CALLERS.**

Open: 9 am-6 pm 6 days a week

All stores open all day Saturday

electronics tomorrow

CHEAP CALCULATOR COMPONENTS

WHERE is the cheapest place to buy calculator components if you wish to build up your own machine to your own specifications? Well first consider what you need based on one of the available LSI chips.

The prices (right) are based on recommended manufacturers one off prices and rough approximations on resistors, etc.

Before starting on the design of your calculator decide which main chip you are going to use. The two types mentioned above are the most popular and used in most available machines although other chips are available from MOSTEK and a new range from CALTEX will be available soon. A table of features of some of these chips is shown as Fig. 1, some features may seem unimportant but things like leading zero suppression can be most annoying if missing.

One point worth considering before buying is the availability and service. Texas chips are reasonably ex-stock at TISCO at Slough but Texas are a bit reticent about giving away too many data sheets, GIM are more helpful and their chips are available from Semi-Specs. Both Mostek and Caltex stocks are in a state of flux at present with Mostek changing to a new distributor after Emihus and Caltex have only recently reached franchise agreements with Guest International.

Having purchased your chip you are now faced with the choice of display. For a pocket machine the small LED (MAN3 type) is best with four (DL34) or six (TIL360) digit packages available for ease of wiring. Alternatives are phosphor-diode (DGI2H), Sperry, Large LEDs (MAN7, DL707) Panaplex, Nixies, Liquid-Crystal, etc. The phosphor-diode need very little in the way of interfacing whereas the others require segment and digit drivers, the high voltage displays are only really suitable for mains desk machines. When comparing prices of displays add on the cost of interfacing before comparing different types. Interface chips such as the SN75491, SN75492, CA3081 and CA3082 are available for space saving but not necessarily cost savings.

Keyboards for a desk machine can be made from simple push switches but for a pocket machine it might be best to purchase a ready made board, Guest International carry quite a good range.

Well so far you could have spent £50-£70, a lot of work, bought from several different places with different delivery times and

COST OF A TRUE 'OO-IT-YOURSELF' CALCULATOR

Texas TMS0100 family (previously 1802)	£29.00	
General Instrument C500 family		£13.50
Keyboard (approx price)	8.00	8.00
Case (assuming a good plastic box)	1.00	1.00
Display 9 of MAN3 Type LEDs	13.50	13.50
Resistors (about 20-30)	.60	.60
Capacitors	.40	.40
Transistors & Diodes	1.50	1.50
Display Driver ICs	4.00	2.00
Hardware	1.00	1.00
BASIC POCKET MACHINE	59.00	41.50
Mains power supply	4.00	4.00
BASIC DESK MACHINE	63.00	45.50
Rechargeable Cells	5.00	5.00
POCKET MACHINE (RECHARGEABLE)	68.00	50.50

Manuf.	Chip	Digits	Constant	Other Features
Texas Instr.	TMS0103	8	Yes	$\%$, $1/x$, \sqrt{x} on other chips in this range.
General Instr.	C500	8	On all 4 functions	No leading Zero suppress.
" "	C550	4+4	"	"
Mostek Corp.	MK5010	10	No	
" "	MK5013/4	12	Yes	Memory, can be interfaced with printer chip.
Caltex Corp.	CT5032	12	Yes	Memory, Average, Print interface available.

ended up with a rather unprofessional looking machine. (I am still waiting for someone to make decent cases available to the amateur for this and similar projects). How would you like to be able to buy all the components from one place with a guarantee and 50% discount? "Sounds a good idea", you say, "but where do I buy from? Well here is a list -

1. Advance Electronics, Raynham Road, Bishops Stortford, Herts. 0279-55155.
2. Advance Telecommunications Equipment, Jafam House, Boundary Road, Woking, Surrey. 0486-25011.
3. Sinclair Radionics, St. Ives, Hunts.
4. Heath (Gloucester) Ltd., Gloucester, 0452-29451.

'Ah', you say, 'those are all kit calcula-

tor manufacturers'. Of course, buying a kit is the simplest and cheapest way of building a calculator even if you wish to modify it to your own specifications.

Advance Electronics (not connected with Advance Telecommunications) brought out a desk machine kit in September 1972, this proved to be an extremely popular kit which sold at £40, there may be some left but stocks are probably low. The author had several of these and modified them to give fixed and floating decimal places and then put clock chips in them as well (sharing the same display). The kit was based on the TMS1802 chip with MAN3 type LED display, the finished machine had an attractive case and a nice positive keyboard.

Heathkit brought out a similar machine with a TMS0119 chip and Sperry display and, although I have not seen one, it would seem a good basis for a desk machine, the price is £39.60 (including VAT?) and is presently available. As this has a Sperry display it is a better bargain from the contents point of view than the Advance desk kit but as I haven't seen one I cannot comment on the finished product.

Advance Telecommunications brought out the first pocket machine kit in conjunction with Semicomps Ltd. of Wembley. This kit is based on the C500 chip and comes complete with a 600mAH NiCD battery and mains charging unit. Unfortunately the finished product was not very attractive but this might be a good point if you are only interested in the components as it has a nice display and 30 transistors. Price of the Supercal kit was just under £40. Heathkit followed with their IC2009 kit with the TMS0103 chip and a preassembled board of nine LEDs, 13 transistors, 4 driver ICs (SN75491/2s), 35 resistors, etc. Heath describe this as a portable rather than pocket machine, the price unfortunately is £59.40.

SINCLAIR CAMBRIDGE

Sinclair followed their Executive success with the Cambridge and the Cambridge kit. This was first announced at about the £33 area and advertised as such. Sinclair then received such large orders for the finished machine that they were able to buy larger quantities of components and thus to reduce the price of the kits, I have been assured that anybody who bought at the old price will obtain a refund on the price difference. The kit is based on the C500 chip with a nine digit LED package, one driver IC, one transistor, ten diodes and a scattering of resistors and capacitors. The author put together one of these kits in two and half hours, the assembly instructions were full of errors and a set of errata sheets covered most of the errors but one of two were missed out and I think it is worth mentioning them here:

1. It is not clear how to fit the battery clips as they may foul a line on the other side of the PCB, mine did and the batteries boiled.
2. It takes a few minutes to orient yourself with the PCB, it would have been best to mark them as side A and side B.
3. Diodes D2-D10 were incorrectly identified. They are 1N914s and are described as black with a white band marking the positive end, in my kit they were half pink and half black and with these the black end is positive, there was no description of these at all and I think a lot of people would insert the diodes incorrectly.
4. The worst part about this change is that the zener diode supplied is described as half pink and half brown and therefore looks identical at first sight to the 1N914s supplied. However Sinclair also supplied another zener diode in a different package type with an errata sheet but did not say why this should be used in preference to the other, I built mine with the pink and brown one and it works.

Assembling the ON/OFF switch presented a small problem, the metal contact is a spring circlip designed to fly into a far corner of the room at the slightest provocation. Those of you who know the authors study will know why it took 20 minutes to find it again. The most galling thing was that when offering the keyboard up to the PCB the switch did not pass through the hole in the metal keyboard plate and the melinex washer. On checking I found a note on one of the errata sheets to say that I should have assembled the switch at this stage not earlier. Considering the earlier problems and adding those of holding keyboard and PCB together during refitting of the switch I decided to enlarge the hole until the switch would pass through, it works.

These are no functional tests throughout construction, as I had no suitable batteries I tested my machine by connecting the

battery clips to a 6V battery and apart from one easily cured solder bridge (desolder braid in the kit) the machine worked. When the batteries were inserted the machine did not work due to the short mentioned earlier without my (accidental) functional test finding this short would have been impossible.

The finished product works well, although I haven't yet found why the DP key doesn't work. The case seems a bit insubstantial and I haven't yet tried my usual test of dropping it on a concrete floor. If Sinclair are after the schoolboy and housewife market with this machine the case (beautiful looking though it is) needs attention. I have taken mine apart several times to show people its guts and I think Sinclair might consider offering a clear plastic case for those who are schoolboys at heart.

Despite the above problems the Cambridge is a good machine as a finished product. The keyboard is more positive and has larger keys than most other comparable machines. The display has small lenses on each digit easily legible from two or three feet and a large readout aperture makes reading easy even at an angle.

The beautifully designed little brown case (despite the comments above) is only the size of a small pack of cigars or 20 kingsize cigarettes. Sinclair have obviously taken a lot of trouble, time and money to design a case so beautifully compact and yet reasonably sturdy. Sinclair have said that the case would withstand the concrete floor test, but I think that the components would go flying - perhaps a screw to hold the case halves together would correct this problem.

For the market that it is intended for, the built version Cambridge is probably the best value for money by £10 or so. If anything goes wrong with either the bit or the finished product then there is a Sinclair guarantee to fall back on.

Sinclair have changed their instruction book and this should clear up most of our criticisms.

The last (at present) of the kits is the
continued on page 67

Manufacturer	Kit	Based On	Approx Price (Inc.VAT)	Points out of Ten as -			Modification Ability	Comments	Available From
				Finished Unit	Kit	Component Set			
Advance Electronics	Desk Kit	TM51802	£44	8	9	8	9	Lots of room in the case. Sockets can be used for all SC's	Advance Electronics Bishops Stortford Herts.
ditto	International	TMS0100 Family	£27	9	9	7	4		See this issue
Advance Telecommunications	Supercal	C500	£38	4	*	7	4	Not very attractive case	Semicomps Ltd. Wembley, Middx.
Heathkit	IC2108 (Desk)	TM50119	£40	*	*	8	*	Heathkits offer good-looking products and their kits are world famous so these two kits should score where * appears	Heath (Gloucester) Ltd. Gloucester.
ditto	SC2009 (Portable)	TMS0103	£60	*	*	6	*		
Sinclair	Cambridge	C500	£28	6	5	5	4	See text.	Sinclair, St. Ives, Henry's Radio.

N.B. An asterisk shows that the kit has not been evaluated from that point of view.

The largest selection

EX-COMPUTER BOARDS

Packed with transistors, diodes, capacitors and resistors. COMPONENT VALUE £1.50
The ONLY 55p p/p p 90p

SPECIAL: As above PLUS Power Transistors, ONLY 55p each p/p p 15p

STABILISED POWER MODULES
Complete with circuit diagrams
99p each p/p p 15p

PANOLINE BOARDS 71, 90 approx
1 for 30p p/p p 20p

FIBRE-GLASS PRINTED CIRCUIT BOARDS

161 84 approx 2 for 55p

DECON-DALO 33pC Marker

Irish resistant printed circuit marker pen 90p each

VEROBOARDS

Packs containing approx 30 components each, all 1 circuit, 55p

REPANCO CHOKES & COILS

RF Chokes: C11 2.0mH 25p C12 3.0mH 25p
C13 7.0mH 25p C14 10mH 25p
C15 1.0mH 25p
Cable DRN1 coaxial 0.56p DRN2 Dual core 45p

COIL FORMERS & CORES

NORMAN 1 Core and Formers 7p
2 Cores and Formers 8p

SWITCHES

DP DT Tough 25p SPST Tough 10p

FUSES

1 1/2" and 20mm 100mA 100mA 250mA 300mA
1A 1.5A 2A
QUICK BLOW 4p each AXTE SURGE 5p each

EARPHONES

Crystal 2.5mm plug 35p Solenoid 2.5mm plug 22p
3.5mm plug 35p 4.5mm plug 22p

DYNAMIC MICROPHONES

HD221 200 ohms plus on-off switch and 2.5mm and 3.5mm plugs £1.60

3-WAY STEREO HEADPHONE JUNCTION BOX

HD102 £1.87

2-WAY CROSSOVER NETWORK

K1007 80 ohms Imp. In-Dom. loss 4dB £1.21

CAR STEREO SPEAKERS

(Amplified) £3.85p per pair

BI PAK CATALOGUE AND LISTS SEND S.A.E. AND 10p

INSTRUMENT CASES



In 2 sections. Black Vinyl covered top and sides and handle

No.	Length	Width	Height	Price
RV1	8"	5"	2"	10p
RV2	11"	6"	3"	£1.20

ALUMINIUM BOXES

No.	Length	Width	Height	Price
BA1	5 1/2"	3"	1 1/2"	42p
BA2	4"	2 1/2"	1 1/2"	41p
BA3	4 1/2"	2 1/2"	1 1/2"	41p
BA4	5 1/2"	2 1/2"	1 1/2"	41p
BA5	4"	2 1/2"	1 1/2"	41p
BA6	5"	2 1/2"	1 1/2"	41p
BA7	7"	3"	2"	98p
BA8	8"	3"	2"	84p
BA9	6"	3"	3"	94p

Send complete with circuit diagram
Please add 10p postage and packing for each box

VISIT OUR COMPONENT SHOP

18 BALDOCK ST. WARE, HERTS. (A10)

OPEN MON-THURS 9.15-6pm SAT 9.15-5.30 LATE NIGHT

SHOPPING UNTIL 7pm FRIDAYS Tel 61593

BIB HI-FI ACCESSORIES

De Luxe Groov-Kleen

Model 42 £1.84

Chrome Finish Model 60 £1.50

Ref. 36A	Revised Stereo Cleaning Kit	25p
Ref. 43	Revised Groov-Kleen	£2.35
Ref. 41	Complete Head Cleaning Kit	54p
Ref. 42	Tap Cleaning Kit	£1.54
Model 60	Wax Strippers	43p

ANTEX SOLDERING IRONS

N25 25 watt £1.93 O/N 210 110 watt £2.15
Model G18 watt £2.15 SK28 18 watt £2.86

STANDS
S11 £1.21 S12 77p

SOLDER
188W/18 18 watt 82p 228W/18 22 watt 92p
188W/22 18 watt 82p 228W/22 22 watt 92p

ANTEX BITS AND ELEMENTS

BITS N°			
102	For model N240	28p	
102	For model N240	28p	
1100	For model G18N240	28p	
1101	For model G18N240	28p	
1102	For model G18N240	28p	
1020	For model G1240	28p	
1021	For model G1240	28p	
1022	For model G1240	28p	
50	For model N2	37p	
51	For model N2	37p	
52	For model N2	37p	
ELEMENTS			
FXN 240	Al 16	FXN 140	£1.16
FXN 240	Al 16	FXN 25	£1.16

ALL PRICES SHOWN INCLUDE V.A.T.

NEW COMPONENT PAK BARGAINS

Pack No.	Qty	Description	Price
C 1	250	Resistor Types 100 ohms approx 5% tolerance	0.58
C 2	200	Capacitors approx 100pF	0.58
C 3	30	Variable Resistor 100K 10% tolerance	0.63
C 4	75	10W 1/2W Resistor mixed tolerance	0.53
C 5	5	Photo-coupled Transistor Buffer	0.55
C 6	2	Thermistor MW LW VHI	0.65
C 7	1	Peak Wave 30 ohms 50 ohms	0.55
C 8	10	10W 1/2W Resistor	0.55
C 9	3	Mixed Resistor	0.55
C10	15	Assorted 100 ohm 1% Resistor	0.55
C11	5	Jack Socket 1/2" 3mm 5mm	0.53
C12	40	Paper 1/2W Resistor 5% tolerance	0.55
C13	20	Electronics Device 100pF	0.55
C14	1	Peak-assisted Hybrid	0.55
C15	4	Mixed Resistor Series 2 Watt - 100W	0.55
C16	20	Assorted 100 ohm 5% Resistor	0.55
C17	10	Assorted 100 ohm 5% Resistor	0.55
C18	4	Binary Weighted Impedance Standard	0.55
C19	4	Binary Weighted Impedance Standard	0.55
C20	4	Standard Impedance Standard	0.55

Please add 10p postage and packing for each box
Please add 10p postage and packing for each box



Ref. P	Hi-Fi Cleaner	31p
Ref. Q1	Service Battery	£1.36
Ref. J	Tap Head Cleaning Kit	51p
Ref. 44	Complete Groov-Kleen	£1.27
Ref. 20	Hi-Fi Stereo Head and Taps	32p

PLUGS AND SOCKETS

SOCKETS		
PS6	DIN 2 Pin Speaker	0.06
PS9	DIN 3 Pin	0.10
PS7	DIN 3 Pin 180	0.10
PS8	DIN 3 Pin 240	0.10
PS9	Jack 2 Pin Standard	0.09
PS10	Jack 3 Pin Standard	0.10
PS11	Jack 2 Pin Standard	0.17
PS12	Jack 3 Pin Standard	0.26
PS13	Phone Socket	0.06
PS14	Phone Socket	0.10
PS15	Car Axial	0.09
PS16	Car Axial Socket	0.09
PS17	Car Axial	0.14
INLINE SOCKETS		
IS21	DIN 2 Pin Speaker	0.13
IS22	DIN 3 Pin	0.17
IS23	DIN 3 Pin 180	0.17
IS24	DIN 3 Pin 240	0.17
IS25	Jack 2 Pin Phone	0.10
IS26	Jack 3 Pin Phone	0.12
IS27	Jack 2 Pin Phone	0.24
IS28	Jack 3 Pin Phone	0.28
IS29	Jack 2 Pin Phone	0.22
IS30	Jack 3 Pin Socket	0.32
IS31	Phone Socket	0.14
IS32	Car Axial	0.15
IS33	Car Axial	0.17

PLUGS		
PS 1	DIN 2 Pin Speaker	0.11
PS 2	DIN 3 Pin	0.12
PS 3	DIN 3 Pin	0.15
PS 4	DIN 3 Pin 180	0.14
PS 5	DIN 3 Pin 240	0.15
PS 6	DIN 3 Pin	0.15
PS 7	DIN 2 Pin	0.15
PS 8	Jack 2 Pin Standard	0.10
PS 9	Jack 3 Pin Standard	0.09
PS10	Jack 2 Pin Standard	0.12
PS11	Jack 3 Pin Standard	0.13
PS12	Jack 2 Pin Standard	0.18
PS13	Jack 3 Pin Standard	0.29
PS14	Phone	0.06
PS15	Car Axial	0.15
PS16	Car Axial	0.10

CABLES		
CP 1	Single Shielded	0.06
CP 2	Twisted Shielded Stereo	0.08
CP 3	Shielded Stereo	0.08
CP 4	Four Core Stereo Stereo	0.23
CP 5	Four Core Stereo Stereo	0.30
CP 6	Microphone Cable Braided Cable	0.10
CP 7	Three Core Stereo	0.07
CP 8	Twisted Shielded Stereo	0.06
CP 9	Spring Cable	0.04
CP10	Low Loss Hi-Fi Axial	0.10

CARBON POTENTIOMETERS

Low noise 4.7K 10K 22K 47K 100K 220K 470K 1M 2M		
WT	Single Low Noise	0.14
VT	Single O.P. Stereo	0.26
VA	Two Channel Stereo	0.44
VA 1	1K Lin Low Noise	0.14
VA 2	100K Log non Lin	

HORIZONTAL CARBON PRESETS

91 range 0.06	
100 220 470 1K 2.2K 4.7K 10K 22K 47K 100K 220K 470K 1M 2M 4.7M	

BOOK BARGAIN BUNDLE

8 Books comprising:
2 Transistor Equivalent Books
1 Radio & Electronic Colour Code & Data Chart
1 Radio Valve Guide PLUS
3 other Constructional books on Receivers, FM Tuners etc.
Also 1 General Constructional book

Value £3. Our price £2

RP1	Handbook of Transistor Equivalents and Substitutes	40p
RP2	Handbook of Radio TV and Industrial Tube & Valve Equiva	40p
RP3	Handbook of Tested Transistor Circuits	40p
RP4	International Handbook of the World's Short Wave Medium and Long Wave Radio Stations and FM TV Listings	35p
RP5	Handbook of Simple Transistor Circuits	35p
RP7	Radio & Electronic Colour Codes & Data Chart	15p
RP8	Sound & Loudspeaker Manual	50p
RP9	38 Practical Tested Diode Circuits for the Home-Constructor	35p
RP11	Practical Transistor Novelty Circuits	40p
120	Universal Gram Motor Speed Indicator	8p
138	How to make FM & TV Aerials - Books 1 2 & 3	18p
141	Radio Servicing for Amateurs	20p
146	High Fidelity Loudspeaker Enclosures	37p
156	Transistor Circuits Manual No. 1	15p
161	Cad Design & Construction Manual	30p
161	Radio, TV & Electronics Data Book	25p
170	Transistor Circuits for Radio Controlled Models	40p
174	Transistor Subminiature Receivers	35p
175	Transistor Test Equipment and Servicing Manual	25p
176	Transistor Audio Amplifier Manual	40p
177	Modern Transistor Circuits for Beginners	40p
178	A Comprehensive Radio Valve Guide Book 5	30p
183	How to Receive Foreign TV Programmes on your set by simple modifications	32p
185	Tested Shortwave Receiver Circuits using MAT's	30p
187	The TSL Mark 1 Valved FM Tuner and its construction	20p
198	Resistance-Frequency Chart for Audio & RF use	15p
	Resistor Colour Code Disc Calculator	10p

CARTRIDGES

GCOS G191 180	200mV at 1.2µsec	£1.16
G199 1	200mV at 1cm sec	£1.65
G196 1	100mV at 1cm sec	£2.65
TCO J 2045	Crystal Hi Output	95p
J 20 100	Crystal Hi Output Complete	£1.10
J 204 CS	Stereo Hi Output	£1.60
J 2105	Crystals Mod Output	£1.64

CARBON FILM RESISTORS

The E12 Range of Carbon Film Resistors 1/4 watt available in PAKS of 50 pieces, assorted into the following groups:

R1	50 Mixed 10ohms	820ohms	40p
R2	50 Mixed 1Kohms	8.2Kohms	40p
R3	50 Mixed 10Kohms	82Kohms	40p
R4	50 Mixed 100Kohms	1Megohm	40p

THESE ARE UNBEATABLE PRICES LESS THAN 1p EACH INC. V.A.T.

BI-PAK SUPERIOR QUALITY LOW-NOISE CASSETTES

C100	32p	C100	41p	C120	52p
------	-----	------	-----	------	-----

BI-PAK QUALITY COMES TO AUDIO!

AL10 AL20 AL30 AUDIO AMPLIFIER MODULES



The AL10, AL20 and AL30 units are similar in their appearance and in their general specifications. However, careful selection of the plastic power devices has resulted in a range of output powers from 3 to 10 watts RMS.

The versatility of their design makes them ideal for use in record players, tape recorders, stereo amplifiers and cassette and cartridge tape players on the car and at home.

PARAMETER	CONDITIONS	PERFORMANCE
HARMONIC DISTORTION	Po 3 WATTS @ 1 KHz	0.25%
LOAD IMPEDANCE		8, 16Ω
INPUT IMPEDANCE	1 KHz	100 KΩ
FREQUENCY RESPONSE (AUB)	Po 2 WATTS	50 Hz - 25 KHz
SENSITIVITY (at RATED OP)	V _r 2V @ 80Ω 1KHz	700mV RMS
DIMENSIONS		3" x 2 1/2" x 1"

The above table relates to the AL10, AL20 and AL30 modules. The following table outlines the differences in their working conditions.

PARAMETER	AL10	AL20	AL30
Maximum Supply Voltage	25	30	30
Power output (at 2% THD) (RL 8Ω @ 1 KHz)	3 watts RMS Min	5 watts RMS Min	10 watts RMS Min

AUDIO AMPLIFIER MODULES

AL10 3 Watt	£2.19
AL20 5 Watt	£2.39
AL30 10 Watt	£3.01

POWER SUPPLIES

PS12 Use with AL10 & AL20	88p
SPM80 Use with AL30 & AL20	£3.25

PRE-AMPLIFIERS

PA12 Use with AL10 & AL20	£4.35
PA100 Use with AL30 & AL50	£13.15

TRANSFORMERS

T401 Use with AL10 p8p 15p	£1.38
T508 Use with AL20 p8p 15p	£1.93
BMT80 Use with AL30 & AL30 p8p 25p	£2.15

FRONT PANELS PA12 With knobs £1.00

PA 12. PRE-AMPLIFIER SPECIFICATION

The PA12 pre-amplifier has been designed to match into most budget stereo systems. It is compatible with the AL10, AL20 and AL30 audio power amplifiers and it can be supplied from the associated power supplies. There are two stereo inputs and two outputs designed for use with 50mm cartridges while the auxiliary input will suit most magnetic cartridges. Full details are given in the specification table. The four controls are: from left to right Volume and on/off switch, balance, bass and treble. Size 132mm x 84mm x 35mm.

Frequency response	20Hz - 20KHz ± 3dB
Bass control	±12dB at 60Hz
Treble control	±14dB at 14 KHz
Input 1	Impedance 1 Meg ohm
	Sensitivity 300 mV
Input 2	Impedance 30 K ohms
	Sensitivity 4 mV

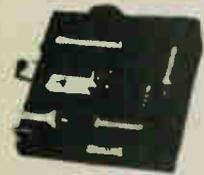

EA1000 AUDIO AMP MODULE

Matched, Tested and Guaranteed. Full block up diagrams and complete technical data supplied free with each module. Available separately at 10p each.

SPECIAL OFFER £2

The STEREO 20

The Stereo 20 amplifier is mounted, ready wired and tested on a one-piece chassis measuring 20 cm x 14 cm x 5.5 cm. This compact unit comes complete with on/off switch, volume control, balance, bass and treble controls, Transformer, Power supply and Power Amps. Attractively printed front panel and matching control knobs. The Stereo 20 has been designed to fit into most turntable plinths without interfering with the mechanism or, alternatively, into a separate cabinet. Output power 20w peak. Input 1 (er.) 300mV into 1M. Freq. res. 25Hz-25kHz. Harmonic distortion typically 0.25% at 1 watt. Bass control ±12dB at 60Hz. Treble con. ±14dB at 14 kHz.

£13.48



BI-PAK DO IT AGAIN!

50W pk 25w (RMS)

0.1% DISTORTION
HI-FI AUDIO AMPLIFIER
THE AL50

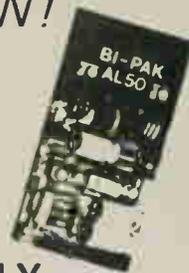

- ★ Frequency response 15Hz to 100,000 - 1dB. **ONLY**
- ★ Load - 3, 4, 8 or 16 ohms. **£3.58 each**
- ★ Distortion - better than 0.1% at 1KHz.
- ★ Signal to noise ratio 80dB.
- ★ Supply voltage 10 - 35 Volts.
- ★ Overall size 63mm x 105mm x 13mm.

Tailor made to the most stringent specifications using top quality components and incorporating the latest solid state circuitry and ALSO was conceived to fill the need for all your A.F. amplification needs. **FULLY BUILT - TESTED - GUARANTEED.**

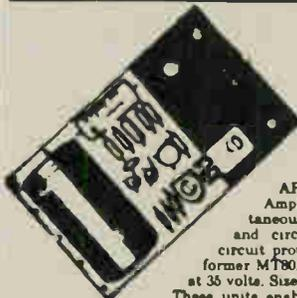

STABILISED POWER MODULE SPM80

SPM80 is especially designed to power 2 of the AL50 Amplifiers, up to 15 watt (rms) per channel, simultaneously. This module embodies the latest components and circuit techniques incorporating complete short circuit protection. With the addition of the Main Transformer MT80, the unit will provide outputs of up to 15 amps at 35 volts. Size 62mm x 106mm x 30mm. These units enable you to build Audio Systems of the highest quality at a hitherto unobtainable price. Also ideal for many other applications including: Disco Systems, Public Address, Intercom Units etc. Handbook available 10p. **PRICE £3.25**

TRANSFORMER BMT80 £2.15 p. & p. 25p.

STEREO PRE-AMPLIFIER, TYPE PA100

Built to a specification and NOT a price, and yet still the greatest value on the market, the PA100 stereo pre-amplifier has been conceived from the latest circuit techniques. Designed for use with the AL50 power amplifier system, this quality made unit incorporates no less than eight silicon planar transistors, two of these are specially selected low noise NPN devices for use in the input stages.

Three switched stereo inputs, and rumble and scratch filters are features of the PA100, which also has a STEREO/MONO switch, volume, balance and continuously variable bass and treble controls.



SPECIFICATION

Frequency Response	20Hz - 20KHz ± 1dB
Harmonic Distortion	better than 0.1%
Inputs: 1. Tape Head	1.25 mV into 50KΩ
2. Radio Tuner	35 mV into 50KΩ
3. Magnetic P.U.	15 mV into 50KΩ
All input voltages are for an output of 250mV. Tape and P.U. inputs equalised to RIAA curve within ± 1dB, from 20Hz to 20KHz.	
Bass Control ± 15dB @ 20Hz	Treble Control ± 15dB @ 20KHz
Filters: Rumble (High Pass)	100Hz
Scratch (Low Pass)	8KHz
Signal Noise Ratio	better than - 65dB
Input overload	+ 26dB
Supply	+ 35 volts @ 20mA
Dimensions	29mm x 82mm x 36mm

Price **£13.15**

SPECIAL COMPLETE KIT COMPRISING 3 AL50's, 1 SPM80, 1 BMT80 and 1 PA100 ONLY £25.30 FREE p. & p.

All prices quoted in new pence Giro No 388 700b

Please send all orders direct to warehouse and despatch department

BI-PAK

P.O. BOX 6, WARE · HERTS

Postage and packing add 10p Overseas add extra for airmail
Minimum order 50p Cash with order please

Guaranteed Satisfaction or Money Back



NOTE

This battery charger described in this article has been designed specifically for charging 12 volt lead acid batteries.

Six volt batteries may be charged but there will be no automatic voltage cutoff. Six volt batteries should therefore not be permanently connected to the charger.

International 309 battery charger

This battery charger is fully protected against ALL fault conditions.

AT first sight there would seem few circuits simpler to design than a battery charger.

But this is not so – to the extent that during our preliminary research we could not find a single unit that offered the protection against misuse that a charger really does need.

To be fully protected a charger must be able to:—

1. Operate into a short circuit.
2. Not be damaged by, or attempt to charge, a reverse connected battery.
3. Operate into a totally flat battery.
4. Be regulated for both current and voltage.
5. Be capable of floating a fully charged battery for extended periods.

In the International 309 charger all these conditions have been met.

Both current and voltage regulation are provided – initially the unit will charge at its maximum current limit of four amps – then, as the battery voltage rises, the charger changes automatically to a voltage limiting mode (maximum 14 volts).

In the voltage regulator mode of operation the current will be in the form of pulses with a relatively long time between them and the LED will noticeably flicker if the current falls to

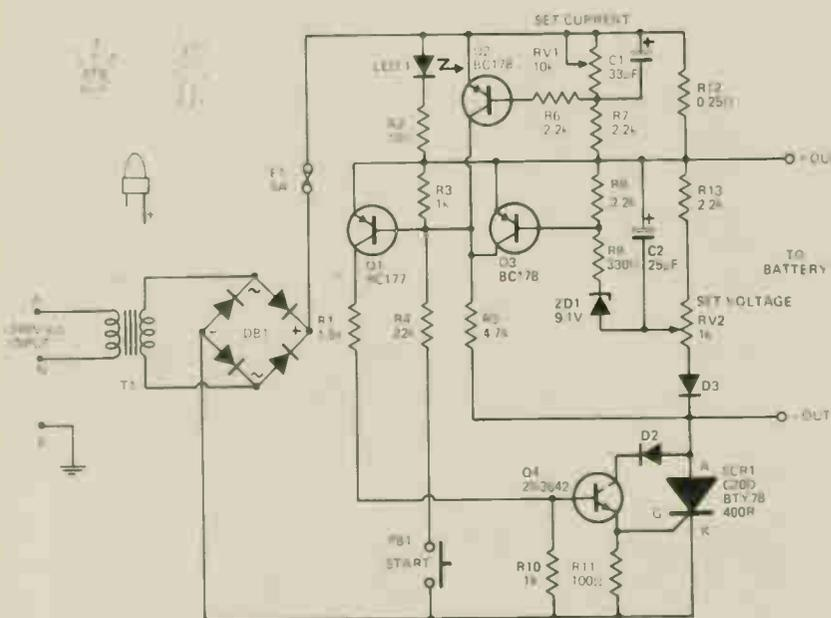

Fig. 1. Circuit diagram of battery charger.

SPECIFICATION

Charging Current

Within battery voltage range 1V to 14V 4 amps.

Cutoff Voltage

14 volts

Starting

Automatic self start range 4-14 volts
Push button start 0-4 volts

Protection

Constant current charging of 4A for all battery voltages from 1V to 13.5V.
Protected against reversed battery.
Protected against reversed battery with start button pressed.

Charge Indication

Illumination of LED indicates charging.
Flicking of LED indicates charge current has fallen to less than 1 amp.

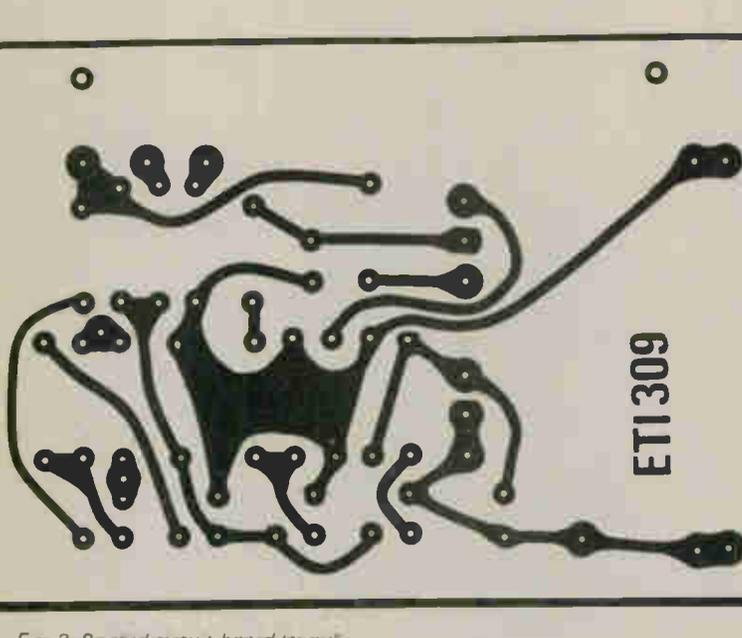

Fig. 2. Printed circuit board layout.

HOW IT WORKS

The battery charger is basically a switching regulator limiting the output voltage to 14 volts and the output current to four amps. Thus there are two modes of regulation, current and voltage, the changeover between these two modes being quite sharp. An increase of 0.1 volt above 14 volts causes the output current to drop from four amps to zero.

The 17 volt secondary of transformer T1 is bridge rectified by diode bridge DB1 to provide pulsating dc to the regulator. The main control element is SCR1 the gating sensitivity of which is increased by transistor Q4. A current of 2.0 mA through R1 is sufficient to turn Q4 and SCR1 on.

When a battery is connected with correct polarity across the output terminals, current will flow through RS and the base emitter junction of Q1 turning Q1 on. This produces current in R1 sufficient to turn on Q4 and hence SCR1. The current flowing through SCR1 is sensed by R12, and if this current exceeds four amps average Q2 turns on and is held on for a short time by virtue of the charge on C1. Hence the turn on of SCR1 on the next half-cycle is delayed thus reducing the average current. This control action ensures that the current stabilizes at four amps.

When the battery reaches 14 volts, transistor Q3 will turn on, the turn-on point being set by RV2. This again prevents SCR1 from turning on until later by by-passing the base current of Q1. Thus the current falls until the voltage across the battery stabilizes at 14 volts.

International 309 battery charger

one amp or less. On batteries of 30 amp hour rating or less which are in good condition this flickering of the LED indicates the fully charged condition. On older batteries, or those of greater than 30 AH capacity, the float current may never drop below one amp and no flickering will be seen.

In applications where it is required, batteries may be 'floated' continuously across the charger without damage to charger or battery.

The unit is normally self-starting (into batteries that are already charged to four volts or over). For totally flat batteries — or those charged to less than four volts — a starting button is provided to initiate the charging cycle; after an initial couple of seconds the battery voltage will have risen sufficiently to maintain operation.

The charger will not start if a battery is connected to it with reversed polarity — even if the start button is pressed. Nor will the charger be damaged if the output leads are accidentally shorted together — however if the start button is pressed whilst the leads are shorted, the protection fuse will blow.

This last condition is most unlikely to occur and it is solely to protect against this eventuality that the fuse has been incorporated. A blown fuse should therefore be a rare occurrence.

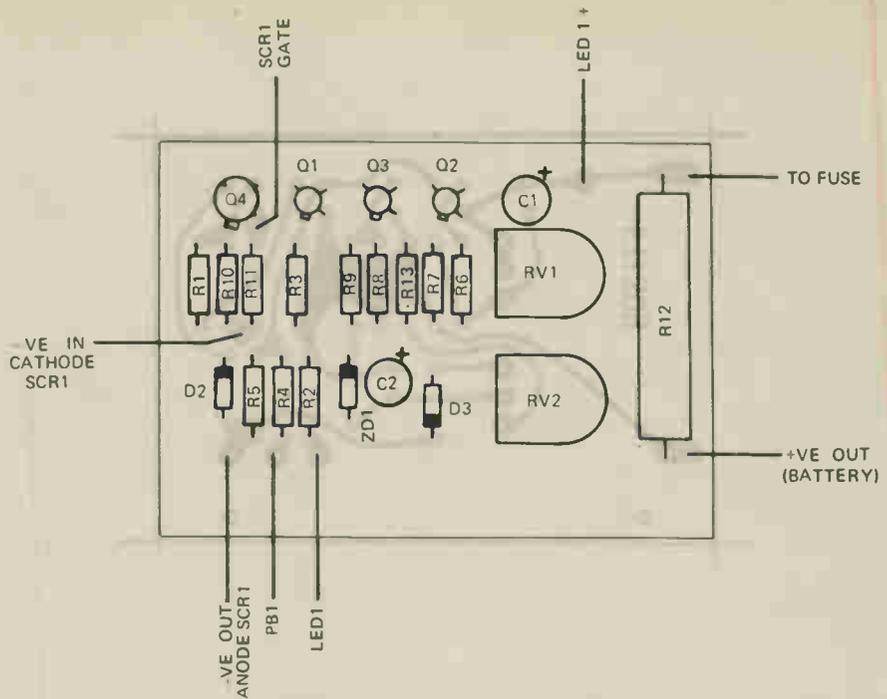
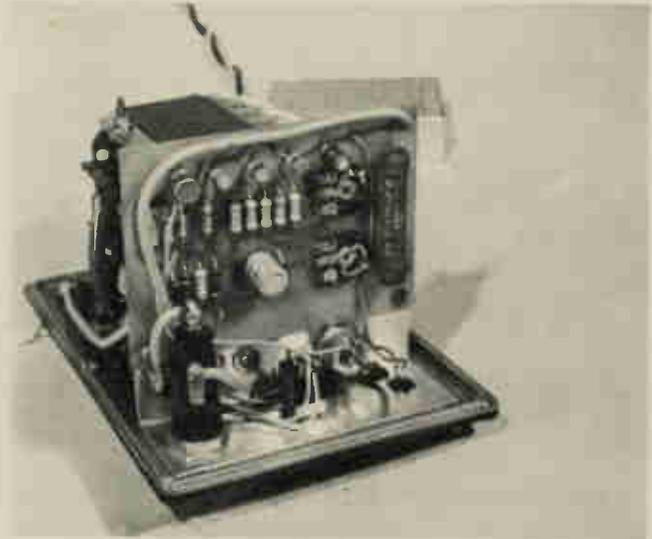

Fig. 3. Component overlay.



PARTS LIST			
R1	Resistor	1.5 k	5% ½ watt
R2	"	10 ohm	" "
R3	"	1 k	" "
R4	"	22 k	" "
R5	"	4.7 k	" "
R6	"	2.2 k	" "
R7	"	2.2 k	" "
R8	"	2.2 k	" "
R9	"	330 ohm	" "
R10	"	1 k	" "
R11	"	100 ohm	" "
R12	"	0.25 ohm 5%	15W (or 2 0.47 ohm 10W in parallel)
R13	"	2.2 k	" ½ watt
RV1	Large trimpot	10 k	
RV2	Large trimpot	1 k	
C1	Capacitor	33µF	6.3 volt electrolytic
C2	"	25µF	25 volt electrolytic
Q1	Transistor	BC177	or similar
Q2	"	BC178	"
Q3	"	BC178	"
Q4	"	2N3642	"
SCR1		C20D, BTY78-400R	or similar
D2, D3	Diode	1N4001	or similar
DB1	Diode bridge	BY164	or similar
ZD1	Zener	9.1V, BZY88C9V1	
LED 1	Light emitting diode	TIL209	or similar
T1	Transformer	17 volt at 4A	or similar
PCB		ET1 309	

Die-cast box 4 ¼ x 6 ¾ x 4", metal bracket, 3 core flex, two grommet mains terminal block, fuse holder, 5A fuse, single pole push button (push to make).

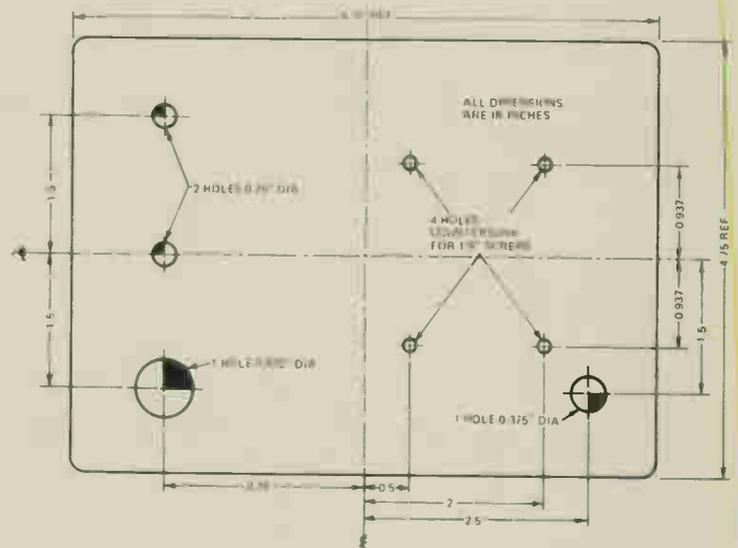

Fig. 4. Drilling details for lid of die-cast box.

CONSTRUCTION

We built our unit into a diecast box $4\frac{3}{4}'' \times 6\frac{3}{4}'' \times 4''$, all the components being mounted on the lid, drilling details for which are provided in Fig. 4.

Most of the components are mounted on a fibre-glass printed circuit board.

Assemble all components to the printed circuit board in accordance with the component overlay, making sure that all diodes and electrolytic capacitors are correctly orientated.

The transformer should be mounted onto the lid using countersunk screws making sure that the 240 volt input leads are away from the lid. The printed circuit board mounting bracket is secured to the front panel, such that it passes through the bracket, but is screwed directly to the front panel. The hole through the bracket provides clearance for the light emitting diode.

The diode bridge is mounted on the transformer side of the bracket and the SCR on the opposite side. The SCR must be insulated from its heat sink by mica or similar insulating

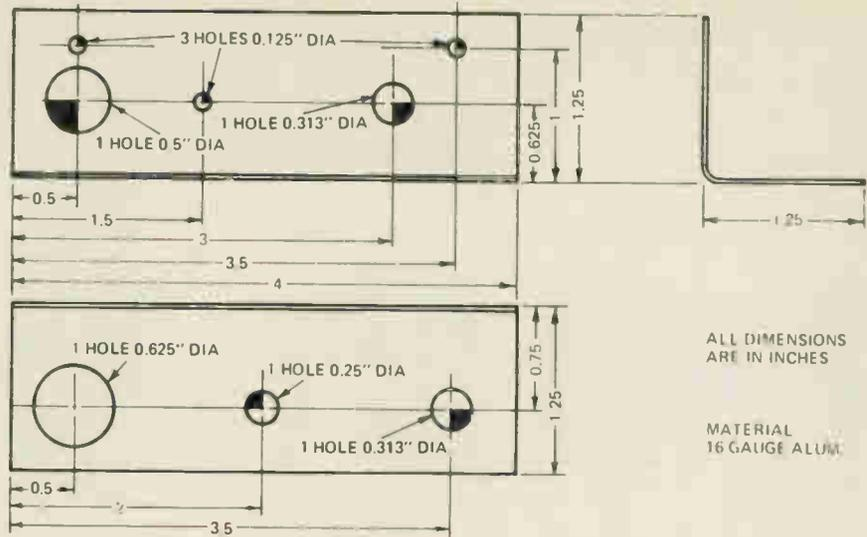

Fig. 5. Mounting bracket for printed circuit board.

washers. These should preferably be smeared with silicon grease to aid heat transference. The printed circuit board is then mounted to the bracket and connected as shown on the overlay and circuit diagrams.

For all four amp wiring use reasonably heavy gauge wire.

ADJUSTMENT

Current — Using an ammeter (10 amp range) in series with a flat battery,

adjust RV1 for a four amp charge current. A four or five amp meter range may be used providing the meter does not have internal diode protection.

Alternately the voltage across R12 may be adjusted (using RV1) to one volt whilst charging a flat battery. Use a 2.5 volt or higher meter range.

Voltage — When the battery is fully charged the current will fall. When it has fallen to 2 amps, adjust RV2 for 14 volts across the battery. ●

ELECTRONICS TOMORROW

-continued from page 61

Advance International as appears in this issue of ETL. I have no experience of the kit or its contents but the kit is based on the Executive Mini, a good looking machine that passes the "concrete test" unscathed. By the way both Advance and Sinclair announced their "Executive" at the same time, the coincidence in name is accidental.

A visual summary of the various kits is given in Table 2.

All of the manufacturers have been asked for their feelings on modified kits and they all said that although they are willing to help with data they cannot suggest modified circuits and they cannot guarantee their products if modified. I think that most people will agree that this is reasonable, especially as some will replace destroyed components at a special price.

To summarise, if you want to build a calculator to your own specification, or on a chip for which there is no kit, the best place to start is with an existing kit. If you do not use the chip supplied with the kit you can advertise it in the classified columns and recover some of your costs, but do not ask the manufacturers to supply a kit without a chip. Similarly you can change displays and sell the unused units or use them in another project, a clock, frequency meter, counter, etc. Happy Calculatings.

APOLOGY

We incorrectly identified the red and green LEDs offered in our August issue as the

The Heathkit SC2009 calculator kit.



SLA5 and SLA15 the codes should have been OSL5. We apologise for any inconvenience caused by this mistake which was due to data sheets not arriving on time.

MORE PRODUCTS

Electronics Tomorrow exists on data fed to us by manufacturers and distributors, some continuously send information on products likely to be of interest but we would like to hear from a few more. Please make sure that your technical department and PR department know of our requirements and write to *Electronics Tomorrow, ETI, 36, Ebury Street, London SW1W 0LW.*

USEFUL ADDRESSES

- 1 Advance Electronics, Raynham Road, Bishops Stortford. 0279-55155.
- 2 Advance Telecommunications, Jafam House, Boundary Road, Woking. 0486-25011
- 3 Heathkits, Heath (Gloucester), Gloucester. 0452-29451.
- 4 Sinclair Radionics, London Road, St. Ives, Hunts. 0480-64311.
- 5 Semicomps Limited, Nortfield Estate, Wembley, Middlesex.
- 6 Semi-Specs, Premier House, Fairfield Road, West Drayton, Middlesex.
- 7 Guest International, Redlands, Coulsdon, Surrey.

FOIL CONSTRUCTION FOR BATTERIES

BY ISRAEL BERKOVITCH

COULD existing batteries be made more efficient by switching to foil type construction? A strong advocate of this system is Dr. Paul Eisler - well - known as the inventor of printed circuits - who argues that the uses for batteries could be widely extended by this means. Since the active area of the interface between the electrodes and the electrolyte is greatly and reliably increased by using foil electrodes as compared with other systems where the minute channels within the plate are liable to blocking, this construction gives big improvements in power to weight ratio in energy density to weight ratios. It can be operated at higher charge and discharge rate and - for a given capacity - becomes lighter; it also has lower internal resistance. Perhaps its most important claim - in view of the advantages that it may give to the electric car for use in town traffic - is the simplicity in charging and the very short time required.

As far as it is possible to judge prior to prototype development, the claims made by Dr. Eisler appear soundly founded and his battery could develop entirely new markets. There are of course many practical problems still to be solved and the battery will need to be put through an endurance

A new type of battery construction which promises great improvements in performance. Dr. Paul Eisler, who invented the printed circuit, has recently patented this new type of construction which amongst other advantages allows for very heavy charge and discharge currents.

test of charge-discharge cycles to assess reliability of structure and materials. But in the first patent (BP956,553) - the key one of a series on this theme - the inventor developed in great detail the application to a conventional lead-acid secondary cell.

In its simplest form the cell comprises a pair of spaced foils disposed opposite each other and secured by insulating tapes to form a chamber. This chamber contains electrolyte. The foils are made in at least two layers. The inner one forms the electrode and it is supported on barrier material that is electrically conducting but electrochemically is virtually inert. A series of such cells, naturally connected in series, may form a module, say a module of a 12V battery; several of these modules would then be connected in parallel to give the total capacity required for the whole battery. Within the module, for ease of construction, it would not be necessary to have double barriers between each cell and the sequence would therefore be active layer e.g. positive electrode/barrier layer/negative electrode of neighbouring cell. So this system dispenses with the need to connect electrically the neighbouring cells; this connection is made through the barrier directly.

The maximum current density per square inch of superficial electrode area may be the same as in a standard battery but the total current can be very large without excessive development of gas and heat. This is be-

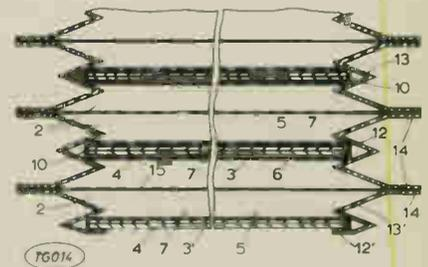

cause of the total current is, of course, the product of this current density times the foil surface area and it flows through the foil thickness perpendicular to the foil surface. In turn this means that heavy charge and discharge rates are possible. Furthermore, in this system it is easy to allow for passages of cooling fluid (air or water) between modules. The modules are thin and do not have any heat-insulating barrier which an electrical insulator would otherwise provide.

The end of the module needs only a barrier layer, the final electrode being on the inside of this. The general layout is shown in the diagram where the structure has been expanded at right angles to the foils for clarity in presentation. Within the cell each active layer (electrode) is covered by a previous separator film of such material as nylon or p.v.c. gauze. It can be seen that the series of cells is held within a concertina folded

tape which may be of thermoplastic material and finally the bottom of the module is sealed by potting in an elastomeric sealing compound. The completed module, of very small thickness, will in use be kept under endwise pressure so that it constitutes almost a multiple laminate. This ensures there is pressure contact all over the area of the foil and that the current path in the module is of maximum cross-section and minimum internal resistance.

A top slit allows the cell to be filled and there are also spilling channels for excess liquid when topping up. The slit serves as a gas vent. The final feature within the cell is a centre separator of fabric, crimped filter paper or other thin porous material. This holds the electrolyte but must also have a structure that allows a ready flow of liquid particularly in the vertical direction.

It can readily be seen that these concepts lend themselves to automatic production. So much of it is laminating films on to each other and sealing the edges of films, then cutting the

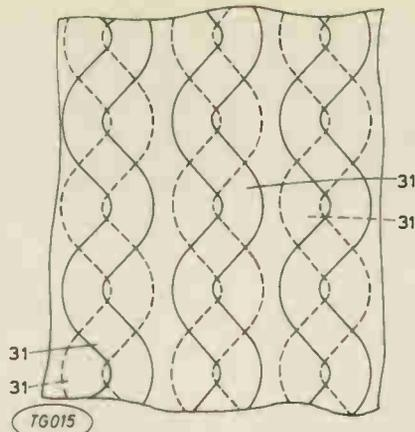

laminated foil into sizes required for the modules. Naturally the detail of the active layer depends on which battery is being constructed, since the principle can be widely applied. But if we confine ourselves to the lead-acid battery and consider both sides of a barrier layer covered with lead by electro-deposition, the active layers can be formed like a modern Plant plate. Alternatively powder layers can be used. Several methods have in fact been considered and this gain would presumably be one of the issues finally to be settled by appraisals

linked with practical production.

The foils may be made with grooves to increase the surface area, to aid the anchoring active layer on to barrier layer and, by making them generally vertical, to aid vertical movement of liquids and gases. This grooving may be affected mechanically or by printing and etching.

Finally, what is a foil? For this purpose the term is discussed in terms of thickness but that does not really define what is involved in the system, proposed. What is critical is that however the thickness is built up by the successive layers described, the material shall be flexible enough to be reeled and treated by what are known as foil techniques. This is what will control and reduce the production costs. And it is the combination of of this feature of manufacturing with the improved operating properties that should result in enhancing the prospects of the electric car and greatly extend the range of battery driven vehicle - a consummation that will be widely welcomed by present trends in public opinion.

FREQUENCY COUNTER

If you want a frequency counter, either 10MHz or 40MHz guaranteed, you should consider our modules. Our crystal timebase has been supplied to industry, Government research and Universities—now we can supply everything for measuring frequency.

COUNTER GATE: This unit converts TTL decade displays into a frequency counter, using only a reference and power supply. It provides the rest 'O' pulse and has display 'hold' facility, 10MHz guaranteed, 7-pin package, with data £9.90 each.

TIMEBASE I. Our popular G8 timebase gives 13 simultaneous TTL frequencies (10Hz to 10MHz) with good stability (0.005%) normally from stock, £23.00 each.

TIMEBASE II. Electronically switched version, covers 1Hz to 100kHz with outputs at 1MHz and 10MHz. Ideal for counters or ATE, £24.00 fibreglass pcb.

Ditto, but larger pcb to take our counter-gate package £24.50

DISPLAYS. Our LED displays at £12.00 each will be announced this month. They will be built and 10MHz tested. Supplied on fibreglass pcb. All normal counter facilities.

PRESCALERS and **PREAMPLIFIERS** will be available next month.

LOGIC DETECTOR for TTL, a LED shows Logical 1. Operation to 12MHz, input 150kΩ with protection to mains voltage. These units do not have to be hand-held. Supplied boxed, with leads and clips £6.50 each. Quantity discounts 10-up.

Send for further details (private enquiries: 3p stamp, please).

Our module catalogue available at 25p + 5p P & P.

All goods sold subject to our Terms and Conditions.

SPOTRON (U.K.) LTD.

P.O. BOX 81, WALLINGTON, SURREY

Telephone (normal office hours) 01-669 0571

DOLPHIN DESIGNS



TRANSISTORISED IGNITION

Utterly reliable but, like a Rolls Royce with its starting handle, can be switched in and out of operation from the dashboard.

General Specification:

- * Instant reversion from electronic to conventional ignition by means of a dash-mounted switch
- * Burglar lock up
- * Negative or positive chassis compatible
- * Indicator light shows correct operation
- * Continuous operation up to 20,000 r.p.m. in Arctic or sub-Tropical temperatures
- * Heavily built, stove enamelled, splash-proof case

Each unit is guaranteed to give the following performance with a normal coil: At least ½" spark with an 8V supply; smooth operation with ½" gap over a total range up to 20,000 r.p.m.

Price: £14.95 inc. VAT and postage. Ex-stock.

(Dolphin Designs are the named suppliers for the ETI Electronic Transistorised Ignition, also available:

Price £9.90 inc. VAT and postage)

DOLPHIN DESIGNS, New Farm House, Shoeburyness Essex. Telephone: Shoeburyness (0702 28) 4362

NEW VAT INCLUSIVE PRICES

OVERSEAS CUSTOMERS DEDUCT ONE ELEVENTH

74 Series TTL

INTERNATIONALLY KNOWN BRANDS
1st. GRADE DEVICES AT NEW
ROCK BOTTOM PRICES

7401	16p	7402	40p
7404	16p	7403	40p
7406	18p	7405	50p
7408	17p	7407	44p
7410	30p	7411	69p
7412	16p	7413	74p
7414	f1.10p	7415	74p

The standard TTL common emitter inverter
These standard TTL devices are available in many other forms

PRICE BARRIER SLASHED

LED READOUTS



0.3 High contrast 14 pin Dip Ref LED 1
£1.99 + 20p VAT = £2.19

Veroboard

Copper clad	Plain	Extra p & p
0 1" x 0 15"	0 15"	
6 1/2" x 6 1/2"		11p
22p x 18p		13p
26 1/2" x 23p		
30p x 30p		19p
74p x 55p		41p
99p x 77p		57p
		82p

Dip Breadboard 4 15" x 6 15" 110p
Verostrip 8 5" x 1 5" 26p
Spot Face Cutter 40p
Pin Insertion Tool (state 0 1" or 0 15") 52p
Terminal Pins (packs of 36) state size 20p

I.C. SOCKETS

13 pin	17p	39p
15 pin	26p	44p
	30p	

DUAL IN LINE

BRIDGE RECTIFIERS



P.I.V.	1 AMP	R.M.S.	2 AMP
100V	20p	30p	35p
200V	22p	35p	40p
300V	25p	40p	45p
500V	38p	50p	50p

RECTIFIERS

P.I.V.	1 AMP	3 AMP
100V	6 1/2p	15 1/2p
200V	7 1/2p	16 1/2p
300V	9p	17 1/2p
400V	11p	22p
500V	13 1/2p	26 1/2p
600V	16p	30p
800V	16 1/2p	33p
1000V	16 1/2p	23p
1500V	22p	55p
2000V	16 1/2p	£1.65
3000V	16p	£1.65
5000V	16 1/2p	25 1/2p

OR FILAMENT INDICATOR MINITRON 3015F & G



16 pin Dip at **BREAKTHROUGH PRICE £1.49**

Cheapest Opto yet GaAsP LED's



RED LED 2.0-125"	26p
RED LED 3.0-175"	17p
GREEN LED 4.0-125"	89p
GREEN LED 5.0-175"	75p

Remember **Vat Inclusive Prices**

DIGITAL CLOCK



on a chip

just imagine, one MOS LSI I.C. eliminating 15 MSI I.C.s & numerous other components. Either

12 or 24 hour, 4 or 6 digit 50 or 60Hz operation leading zero suppression single voltage supply similar to DIGITRONIC in P.W. March 1973
Only £7.99

With 4 LED's £17.69
With 6 LED's £20.75

HEAT SINKS

TV2 for TO 66 15p 5F for TO 5
TV3 for TO 3 16p 18F for TO 18

TV4 for TO 126	51p
TV5 for TO 220	SL403D
	DIP14 5 for EA1000
	16p
10DN400 4	4Y 1 4
	46p
	3 1/2p

CHROMASONIC electronics

RESISTORS

RATING	TYPE	TOLERANCE	RANGE	PRICE EACH
1/16 Watt	Carbon Film	± 5%	51Ω - 100KΩ	5p
1/8 Watt	Carbon Film	± 5%	5.1Ω - 330KΩ	1 1/2p
1/2 Watt	Carbon Film	± 2%	10Ω - 1MΩ	4 1/2p
1/2 Watt	Carbon Film	± 2%	56Ω - 150KΩ	8p
1/2 Watt	Carbon Film	± 5%	10Ω - 10MΩ	1 1/2p
1/2 Watt	Carbon Film	± 0.5%	2.2Ω - 2.7Ω - 3.3Ω - 3.9Ω - 4.7Ω	4 1/2p
1 Watt	Carbon Film	± 10%	5.6Ω - 6.8Ω - 8.2Ω	5 1/2p
1 Watt	Carbon Film	± 5%	10Ω - 10MΩ	3p
2 Watt	Carbon Film	± 5%	10Ω - 10MΩ	6p
2 1/2 Watt	Carbon Film	± 10%	0.22Ω - 0.47Ω	10p
2 1/2 Watt	Carbon Film	± 5%	1Ω - 270Ω	10p
5 Watt	Carbon Film	± 5%	0.5Ω - 8.2KΩ	10p
10 Watt	Carbon Film	± 5%	0.5Ω - 8.2KΩ	11p
10 Watt	Carbon Film	± 5%	10KΩ - 15KΩ - 20KΩ - 25KΩ	17p
15 Watt	Carbon Film	± 5%	10Ω - 8.2KΩ	13 1/2p

DISCOUNTS 10% on orders over £10.00. Extra 5% on orders over £25.00.
Postage & Packing - Extra 8p any quantity

CAPACITORS

MULLARD C333, 629 & 630 Series Ceramic	5p
CERAMIC DISC - Low Voltage	5p
200V	6p
POLYSTYRENE 160V	3p
MYLAR PLATE - 100V	2p
250V	3p
500V	9p
MULLARD C280 250V Polycarbonate	3p
4p	4p
7p	5p
12p	14p
22p	14p
MULLARD C281 400V Polycarbonate	5p
6p	6p
7p	6p
11p	11p

SILVERED MICAS TUBULARS FEEDTHROUGHS
HIGH VOLTAGE TYPES TANTALUM PULSE
CERAMICS & MONOLITHIC CERAMICS ARE
ALL DETAILED IN LEAFLET NO 13

new stabilised POWER PACK CONVERTER

Switched 3, 6, 7 or 9 Volts
Up to 400 mA Output

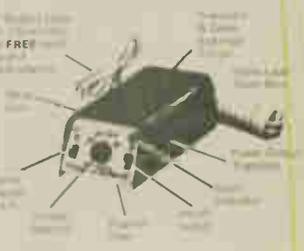

Our Price £3.99 p & p 16p
Standard Voltages of output
Other Standard Voltages
5 Volt (regulated) 50mA £1.65
6 Volt (regulated) 50mA £1.65
7 Volt (regulated) 50mA £2.09
9 Volt (regulated) 50mA £2.75
3, 6, 7, 9 Volt (unregulated) 50mA £2.75
3, 6, 7, 9 Volt (unregulated) 100mA £3.75
Fully Regulated Low Voltage Converter
specifying standard voltages of 3, 6, 7, 9 Volt
Voltage p & p extra 16p

TRANSISTORS and DIODES

2N3638	90mV	30p	110p	2N3639	80p	100p	41p
2N3639	71p	110p	2N3640	100p	22p	22p	50p
2N3640	110p	110p	2N3641	40p	100p	100p	18p
2N3641	110p	110p	2N3642	44p	100p	27p	18p
2N3642	100p	100p	2N3643	19p	100p	100p	100p
2N3643	27p	10p	2N3644	11p	22p	4p	22p
2N3644	80p	10p	2N3645	19p	10p	10p	10p
2N3645	22p	15p	2N3646	81p	51p	52p	52p
2N3646	20p	20p	2N3647	11p	11p	11p	11p
2N3647	24p	9p	2N3648	5p	4p	20p	20p
2N3648	21p	9p	2N3649	11p	11p	11p	11p
2N3649	25p	9p	2N3650	11p	11p	11p	11p
2N3650	12p	13p	2N3651	11p	11p	11p	11p
2N3651	40p	12p	2N3652	11p	11p	11p	11p
2N3652	50p	14p	2N3653	11p	11p	11p	11p
2N3653	11p	11p	2N3654	11p	11p	11p	11p
2N3654	20p	11p	2N3655	11p	11p	11p	11p
2N3655	20p	12p	2N3656	11p	11p	11p	11p
2N3656	14p	12p	2N3657	11p	11p	11p	11p
2N3657	11p	11p	2N3658	11p	11p	11p	11p
2N3658	11p	11p	2N3659	11p	11p	11p	11p
2N3659	11p	11p	2N3660	11p	11p	11p	11p
2N3660	11p	11p	2N3661	11p	11p	11p	11p
2N3661	11p	11p	2N3662	11p	11p	11p	11p
2N3662	11p	11p	2N3663	11p	11p	11p	11p
2N3663	11p	11p	2N3664	11p	11p	11p	11p
2N3664	11p	11p	2N3665	11p	11p	11p	11p
2N3665	11p	11p	2N3666	11p	11p	11p	11p
2N3666	11p	11p	2N3667	11p	11p	11p	11p
2N3667	11p	11p	2N3668	11p	11p	11p	11p
2N3668	11p	11p	2N3669	11p	11p	11p	11p
2N3669	11p	11p	2N3670	11p	11p	11p	11p
2N3670	11p	11p	2N3671	11p	11p	11p	11p
2N3671	11p	11p	2N3672	11p	11p	11p	11p
2N3672	11p	11p	2N3673	11p	11p	11p	11p
2N3673	11p	11p	2N3674	11p	11p	11p	11p
2N3674	11p	11p	2N3675	11p	11p	11p	11p
2N3675	11p	11p	2N3676	11p	11p	11p	11p
2N3676	11p	11p	2N3677	11p	11p	11p	11p
2N3677	11p	11p	2N3678	11p	11p	11p	11p
2N3678	11p	11p	2N3679	11p	11p	11p	11p
2N3679	11p	11p	2N3680	11p	11p	11p	11p

ZENERS

All 5% tolerance	11p
BZY83	18p
1/4S	27p
BZX70	27p

DX MONITOR



Compiled by Alan Thompson

YOU MAY RECALL that in our September issue I dealt with "gear" and took you on a short conducted tour of my shack. A number of readers have asked where they can obtain the heavy-duty mains switch-cum-neon that I mentioned as controlling all the shack circuits. These ought to be generally available throughout the country but in case of difficulty you can obtain one from Tom Whitehouse Ltd., The Market, Swansea, Glam. for 72p (including p. and p. and VAT), if you will refer to "DOT" mains switches complete with red neon indicator. This firm are not normally mail-order suppliers, by the way, but will service orders for this item. The switches, as well as being very suitable for controlling the numerous circuits that one finds in a shack, are most decorative being of the rocker-type and fit into an oblong hole in a control panel by means of integral spring clips.

And down to work! A 4-page pamphlet that recently came my way is a reprint by the North American Shortwave Association of an article by Dr. Richard E. Wood entitled "*Recognition of Languages*". In this sort of work, Dr. Wood pinpoints some of the recognition clues to be found in various languages that may be heard on the air and it is very useful to anyone who has logged just about all the English stations he can hear and wants to spread his wings into the wider DX world. Copies can be obtained for a 9in. x 4in. addressed envelope and two International Reply Coupons (available at all main Post Offices) from NASWA, P.O. Box 8452, South Charleston, West Virginia 25303, U.S.A. If your local reference library has a copy of "*How to Listen to the World*" (the 1969-70 Edition), you can take the subject a bit further with another article by Dr. Wood entitled "*Languages in International Radio*".

Personally, I always consider Arabic to be one of the more difficult languages to monitor for a Reception Report because there are so many types of the language to be heard. Generally, it can be recognised as the language that sounds harsh and as if the speaker was having to work really hard to get through his script: the other clear indication is the oft-repeated sound "el" or "al" which has the effect of making the language sound somewhat breathless, and the numerous guttural and throaty sounds that occur in the language all add to the general effect of something quite unlike any European language: in fact, it is difficult to mistake Arabic for anything other than allied languages like Somali, Kabyl, Hebrew or Persian. The Key words to listen for in an Arabic transmission are "Huna" or "Id'ha" followed by the station name - don't be too disappointed if the rare DX station broadcasting in Arabic suddenly identifies as "Huna London" as Arabic services are broadcast by the B.B.C., Voice of America, Radio Moscow and Radio Peking amongst other international broadcasters.

In the U.K., the Arabic World is medium-range DXing and most of the following ought to be audible throughout the darkness hours without too much trouble. Quite a number of the stations may be heard, too, during daylight hours on the 25, 19 and 16 metre bands so you can try your hand at identifying some of the ones that you hear as your experience grows. Here then are a hand-picked bunch that should get you attuned to Arabic speech and, maybe, give you a liking for the very special quality of Arab music:

ALGERIA: The Arabic Home Services (it has others in Kabyle and French) is broadcast on a variety of frequencies so let's concentrate on the External Service from 1800-2100 GMT. and was last reported on 11920, 9685 and 7270kHz. Radio Algiers has a habit of changing frequencies fairly often so don't be surprised if they moved by the time you read this!

EGYPT: The Arab Republic of Egypt to give it its correct title has a bewildering collection of Home and External Services on a whole range of channels. For starters, try the "Voice of the Arabs" programme which is on the air from 0200 until about 2330 GMT. - best frequency for evening listening is 9850kHz, just outside the official 31 metre band.

IRAN: Radio Iran's Home Service is in Persian (not Arabic) and, being easy to hear gives the newcomer to this form of DXing a chance to note some of the differences between the two languages. Another wanderer around the bands, Radio Teheran can, at the moment, be found on 15085kHz where its 150kW output puts in a very potent signal until it closes somewhere around 2030 GMT. If you can't find it on that channel then give 9022 or 9040kHz a try - one or other is usually to be heard in parallel with the 19 metre band transmitter.

IRAQ: Nightingales seem to have a fascination for station staff - quite a number use its song as an interval signal and Radio Baghdad is no exception. If memory serves me correctly it is described as "the notes of a mechanical nightingale": whether the bird has been brainwashed into being mechanical in performance or is just a mechanical contrivance, look for that tune on or about 9740kHz at about 1800 when the "Voice of the Masses" External Service programme starts operating.

KUWAIT: One of my favourite radio stations for its pleasant music (in its English Service!) and one that issues what must be the most attractive QSL card complete with replicas of lots of Kuwait stamps. You really can't be trying very hard if you can't hear its potent signal on 15415kHz (or your radio wants a spot of re-alignment!) - nice English programme with lots of music starts up at 1630 and goes into Arabic about 1900 until finally signing-off around 2215 GMT.

LEBANON: Radio Beirut is one of those stations that is a so-and-so to log! If you do manage it, it has a most attractive QSL with a picture of the famed Cedars of Lebanon. You could try 5980kHz which has its Home programmes throughout the evening, but a better bet might be 15200kHz (or thereabouts - it has tried quite a few frequencies of late) with English between 1830 and 1900 followed by an hour of Arabic programmes.

SAUDI ARABIA: Like many other Arab states, Saudi Arabia has a number of different services. The English service is a very

professionally presented job with the identification "This is the Broadcasting Service of the Kingdom of Saudi Arabia", and you can hear this on 11855kHz from 1700 to 2000 daily: for Arabic programme give 9670kHz a try (this is Jiddah) or 9720kHz (which is Riyadh) from early evening until about 2300. The BSKSA does verify but not as consistently as one would like.

UNITED ARAB EMIRATES: If you haven't kept up with your geography this is the new name for what we used to call the Gulf States. Abu Dhabi is one of the Emirates in the Union and after a period of broadcasting in the 60 metre band has settled down on 9620kHz. Is audible most evenings and signs-off at 1950 GMT, a good deal earlier than most.

Those eight should give everyone - newcomers and old-hands alike - something to try in the weeks ahead and lots of them do QSL and accept reports in English: it is well to enclose reply postage in all cases (International Reply Coupons - remember? 10p at your Post Office - or mint stamps of the country if you have a supply available).

Changing back to English - gratefully as the tube of my hookah was getting caught up in the typewriter! - the long-awaited commercial radio should be with us by the time that you read this. The London Broadcasting Company's News Service will be going out on 719kHz (and 97.3 MHz VHF), with Capital Radio providing the entertainment service on 557kHz (and 95.8MHz VHF). Those

whose beards reach their knees, like your compiler's, will, I am sure feel some nostalgia for the long departed pre-World War II commercial radio stations which used to enliven the rather dreary Sunday fare of the B.B.C. some 30 more years ago. Do you remember Radio Fecamp, Radio Lyons, Poste-Parisienne, Paris Eiffel Tower and the rest? Radio Luxemburg, of course, is still with us, having survived the war years, but it will be of much interest in months ahead to watch the development of a pattern of commercial local broadcasting in Great Britain and to compare it with, say, the vast diversity of local radio stations operating in the U.S.A. What is the future for the 'pirates'? Will they survive when advertisers will find it easier to 'spot' their coverage to particular areas as the commercial network of stations develops? Who can tell - certain it is that radio is likely to get a real shot in the arm from the arrival of these newcomers in the midst of established operations which have established a kind of peaceful co-existence over the last few years. On the pure DX front, the great interest will be the extent of the coverage of these stations since BBC local radio stations keep turning up in the most unexpected places - here on the South Wales coast, Radio Solent, Radio London and Radio Leeds are regularly heard in late evening hours although Radio Bristol's groundwave seems to get drowned in crossing the Bristol Channel.

Letters with your comments and queries are welcomed but, please, enclose a s.a.e. if you want a direct reply. If possible, send them by the 12th of each month to: Alan Thompson, 16 Ena Avenue, Neath, Glamorgan SA11 3AD.

QSL COLLECTORS CORNER

Our illustration shows the variety of QSL cards issued by Deutschlandfunk (DLF) and also depicts their massive pennant - a striking black, red and gold affair with inscription in black and white. DLF is one of the easier medium-wave stations to hear and they broadcast in English (Monday-Saturday) from 1745-1830 GMT. on 1268kHz, with some 600kW of power going to their aerial array. If you would like to hear Alan Thompson, he has his own DX programme on DLF on alternative Wednesdays just about 1800 GMT. The next sessions of DX-CIRCLE, as the programme is called, will be aired on 17 and 31 October, and 14 and 28 November, and you can send your reception reports to English Service, DLF, 5 Cologne 51, West Germany, or, for DX-CIRCLE only, direct to Alan Thompson, 16 Ena Avenue, Neath, Glamorgan SA11 3AD. On request, correct reports are verified with QSL card and pennant -- nice additions to any collection.

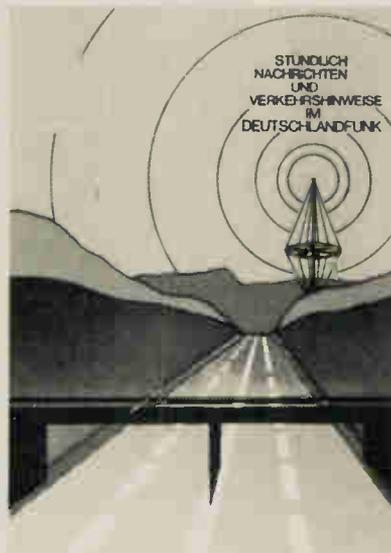

Could the reader who wrote to Alan Thompson about early British call signs please let him know his address. There is a reply waiting for him but the address has been mislaid!

J. T. EDEN ELECTRONICS

TRANSISTORS

AC 102	0 20	BC 168	0 12	BF 37	0 30	2N 1613	0 20
AC 110	0 20	BC 169	0 12	BF 84	0 25	2N 1631	0 25
AC 116	0 20	BC 170	0 13	BF 85	0 30	2N 1711	0 20
AC 117	0 30	BC 171	0 12	BF 86	0 25	2N 1893	0 35
AC 118	0 20	BC 172	0 12	BF 87	0 25	2N 2147	0 75
AC 119	0 20	BC 173	0 20	BF 91	0 20	2N 2148	0 60
AC 121	0 15	BC 174	0 23	BF 92	0 20	2N 2160	0 60
AC 122	0 16	BC 175	0 17	BF 93	0 15	2N 2192	0 40
AC 123	0 18	BC 176	0 20	BF 94	0 40	2N 2193	0 40
AC 124	0 15	BC 177	0 20	BF 95	0 60	2N 2197	0 25
AC 125	0 18	BC 178	0 20	BF 96	0 60	2N 2214	0 25
AC 126	0 15	BC 179	0 20	BF 97	0 30	2N 2218	0 20
AC 127	0 15	BC 180	0 10	BF 98	0 15	2N 2219	0 20
AC 128	0 15	BC 181	0 10	BF 99	0 15	2N 2219A	0 20
AC 129	0 15	BC 182	0 10	BF 100	0 15	2N 2220	0 20
AC 130	0 15	BC 183	0 10	BF 101	0 15	2N 2221	0 20
AC 131	0 15	BC 184	0 10	BF 102	0 15	2N 2222	0 20
AC 132	0 15	BC 185	0 10	BF 103	0 15	2N 2222A	0 20
AC 133	0 15	BC 186	0 10	BF 104	0 15	2N 2368	0 18
AC 134	0 15	BC 187	0 10	BF 105	0 15	2N 2369	0 12
AC 135	0 15	BC 188	0 10	BF 106	2 25	2N 2389A	0 15
AC 136	0 15	BC 189	0 10	BF 107	1 75	2N 2646	0 45
AC 137	0 15	BC 190	0 12	BF 108	0 50	2N 2711	0 15
AC 138	0 15	BC 191	0 12	BF 109	0 20	2N 2712	0 30
AC 139	0 15	BC 192	0 12	BF 110	0 20	2N 2714	0 20
AC 140	0 15	BC 193	0 10	BF 111	0 35	2N 2694	0 15
AC 141	0 15	BC 194	0 10	BF 112	0 25	2N 2904	0 20
AC 142	0 15	BC 195	0 10	BF 113	0 25	2N 2904A	0 25
AC 143	0 15	BC 196	0 10	BF 114	0 30	2N 2905	0 25
AC 144	0 15	BC 197	0 10	BF 115	0 20	2N 2905A	0 25
AC 145	0 15	BC 198	0 10	BF 116	0 60	2N 2906	0 18
AC 146	0 15	BC 199	0 10	BF 117	0 40	2N 2906A	0 25
AC 147	0 15	BC 200	0 10	BF 118	0 85	2N 2907	0 70
AC 148	0 15	BC 201	0 10	BF 119	0 40	2N 2907A	0 12
AC 149	0 15	BC 202	0 10	BF 120	0 40	2N 2923	0 12
AC 150	0 15	BC 203	0 10	BF 121	0 60	2N 2924	0 12
AC 151	0 15	BC 204	0 10	BF 122	0 35	2N 2925	0 12
AC 152	0 15	BC 205	0 10	BF 123	0 30	2N 2926	0 10
AC 153	0 15	BC 206	0 10	BF 124	0 40	2N 2926G	0 10
AC 154	0 15	BC 207	0 10	BF 125	0 42	2N 2926Y	0 10
AC 155	0 15	BC 208	0 10	BF 126	0 50	2N 2926Z	0 10
AC 156	0 15	BC 209	0 10	BF 127	0 20	2N 3053	0 20
AC 157	0 15	BC 210	0 10	BF 128	0 15	2N 3054	0 60
AC 158	0 15	BC 211	0 10	BF 129	0 15	2N 3055	0 50
AC 159	0 15	BC 212	0 10	BF 130	0 15	2N 3133	0 30
AC 160	0 15	BC 213	0 10	BF 131	0 50	2N 3391	0 20
AC 161	0 15	BC 214	0 10	BF 132	0 12	2N 3390	0 45
AC 162	0 15	BC 215	0 10	BF 133	0 15	2N 3393	0 15
AC 163	0 15	BC 216	0 10	BF 134	0 20	2N 3394	0 15
AC 164	0 15	BC 217	0 10	BF 135	0 30	2N 3404	0 25
AC 165	0 15	BC 218	0 10	BF 136	0 25	2N 3405	0 25
AC 166	0 15	BC 219	0 10	BF 137	0 15	2N 3414	0 10
AC 167	0 15	BC 220	0 10	BF 138	0 40	2N 3415	0 10
AC 168	0 15	BC 221	0 10	BF 139	0 20	2N 3416	0 15
AC 169	0 15	BC 222	0 10	BF 140	0 20	2N 3417	0 15
AC 170	0 15	BC 223	0 10	BF 141	0 25	2N 3440	0 85
AC 171	0 15	BC 224	0 10	BF 142	0 20	2N 3563	0 18
AC 172	0 15	BC 225	0 10	BF 143	0 23	2N 3564	0 18
AC 173	0 15	BC 226	0 10	BF 144	0 25	2N 3565	0 18
AC 174	0 15	BC 227	0 10	BF 145	0 25	2N 3566	0 20
AC 175	0 15	BC 228	0 10	BF 146	0 55	2N 3572	0 98
AC 176	0 15	BC 229	0 10	BF 147	0 25	2N 3692	0 10
AC 177	0 15	BC 230	0 10	BF 148	0 25	2N 3702	0 10
AC 178	0 15	BC 231	0 10	BF 149	0 30	2N 3703	0 10
AC 179	0 15	BC 232	0 10	BF 150	0 40	2N 3704	0 10
AC 180	0 15	BC 233	0 10	BF 151	0 75	2N 3705	0 10
AC 181	0 15	BC 234	0 10	BF 152	0 50	2N 3706	0 10
AC 182	0 15	BC 235	0 10	BF 153	0 40	2N 3707	0 10
AC 183	0 15	BC 236	0 10	BF 154	0 75	2N 3708	0 10
AC 184	0 15	BC 237	0 10	BF 155	0 75	2N 3709	0 10
AC 185	0 15	BC 238	0 10	BF 156	1 00	2N 3710	0 10
AC 186	0 15	BC 239	0 10	BF 157	0 50	2N 3711	0 10
AC 187	0 15	BC 240	0 10	BF 158	0 20	2N 3714	0 10
AC 188	0 15	BC 241	0 10	BF 159	0 40	2N 3714	0 10
AC 189	0 15	BC 242	0 10	BF 160	0 40	2N 3714	0 10
AC 190	0 15	BC 243	0 10	BF 161	0 40	2N 3714	0 10
AC 191	0 15	BC 244	0 10	BF 162	0 40	2N 3714	0 10
AC 192	0 15	BC 245	0 10	BF 163	0 40	2N 3714	0 10
AC 193	0 15	BC 246	0 10	BF 164	0 40	2N 3714	0 10
AC 194	0 15	BC 247	0 10	BF 165	0 40	2N 3714	0 10
AC 195	0 15	BC 248	0 10	BF 166	0 40	2N 3714	0 10
AC 196	0 15	BC 249	0 10	BF 167	0 40	2N 3714	0 10
AC 197	0 15	BC 250	0 10	BF 168	0 40	2N 3714	0 10
AC 198	0 15	BC 251	0 10	BF 169	0 40	2N 3714	0 10
AC 199	0 15	BC 252	0 10	BF 170	0 40	2N 3714	0 10
AC 200	0 15	BC 253	0 10	BF 171	0 40	2N 3714	0 10
AC 201	0 15	BC 254	0 10	BF 172	0 40	2N 3714	0 10
AC 202	0 15	BC 255	0 10	BF 173	0 40	2N 3714	0 10
AC 203	0 15	BC 256	0 10	BF 174	0 40	2N 3714	0 10
AC 204	0 15	BC 257	0 10	BF 175	0 40	2N 3714	0 10
AC 205	0 15	BC 258	0 10	BF 176	0 40	2N 3714	0 10
AC 206	0 15	BC 259	0 10	BF 177	0 40	2N 3714	0 10
AC 207	0 15	BC 260	0 10	BF 178	0 40	2N 3714	0 10
AC 208	0 15	BC 261	0 10	BF 179	0 40	2N 3714	0 10
AC 209	0 15	BC 262	0 10	BF 180	0 40	2N 3714	0 10
AC 210	0 15	BC 263	0 10	BF 181	0 40	2N 3714	0 10
AC 211	0 15	BC 264	0 10	BF 182	0 40	2N 3714	0 10
AC 212	0 15	BC 265	0 10	BF 183	0 40	2N 3714	0 10
AC 213	0 15	BC 266	0 10	BF 184	0 40	2N 3714	0 10
AC 214	0 15	BC 267	0 10	BF 185	0 40	2N 3714	0 10
AC 215	0 15	BC 268	0 10	BF 186	0 40	2N 3714	0 10
AC 216	0 15	BC 269	0 10	BF 187	0 40	2N 3714	0 10
AC 217	0 15	BC 270	0 10	BF 188	0 40	2N 3714	0 10
AC 218	0 15	BC 271	0 10	BF 189	0 40	2N 3714	0 10
AC 219	0 15	BC 272	0 10	BF 190	0 40	2N 3714	0 10
AC 220	0 15	BC 273	0 10	BF 191	0 40	2N 3714	0 10
AC 221	0 15	BC 274	0 10	BF 192	0 40	2N 3714	0 10
AC 222	0 15	BC 275	0 10	BF 193	0 40	2N 3714	0 10
AC 223	0 15	BC 276	0 10	BF 194	0 40	2N 3714	0 10
AC 224	0 15	BC 277	0 10	BF 195	0 40	2N 3714	0 10
AC 225	0 15	BC 278	0 10	BF 196	0 40	2N 3714	0 10
AC 226	0 15	BC 279	0 10	BF 197	0 40	2N 3714	0 10
AC 227	0 15	BC 280	0 10	BF 198	0 40	2N 3714	0 10
AC 228	0 15	BC 281	0 10	BF 199	0 40	2N 3714	0 10
AC 229	0 15	BC 282	0 10	BF 200	0 40	2N 3714	0 10
AC 230	0 15	BC 283	0 10	BF 201	0 40	2N 3714	0 10
AC 231	0 15	BC 284	0 10	BF 202	0 40	2N 3714	0 10
AC 232	0 15	BC 285	0 10	BF 203	0 40	2N 3714	0 10
AC 233	0 15	BC 286	0 10	BF 204	0 40	2N 3714	0 10
AC 234	0 15	BC 287	0 10	BF 205	0 40	2N 3714	0 10
AC 235	0 15	BC 288	0 10	BF 206	0 40	2N 3714	0 10
AC 236	0 15	BC 289	0 10	BF 207	0 40	2N 3714	0 10
AC 237	0 15	BC 290	0 10	BF 208	0 40	2N 3714	0 10
AC 238	0 15	BC 291	0 10	BF 209	0 40	2N 3714	0 10
AC 239	0 15	BC 292	0 10	BF 210	0 40	2N 3714	0 10
AC 240	0 15	BC 293	0 10	BF 211	0 40	2N 3714	0 10
AC 241	0 15	BC 294	0 10	BF 212	0 40	2N 3714	0 10
AC 242	0 15	BC 295	0 10	BF 213	0 40	2N 3714	0 10
AC 243	0 15	BC 296	0 10	BF 214	0 40	2N 3714	0 10
AC 244	0 15	BC 297	0 10	BF 215	0 40	2N 3714	0 10
AC 245	0 15	BC 298	0 10	BF 216	0 40	2N 3714	0 10
AC 246	0 15	BC 299	0 10	BF 217	0 40	2N 3714	0 10
AC 247	0 15	BC 300	0 10	BF 218	0 40	2N 3714	0 10
AC 248	0 15	BC 301	0 10	BF 219	0 40	2N 3714	0 10
AC 249	0 15	BC 302	0 10	BF 220	0 40	2N 3714	0 10
AC 250	0 15	BC 303	0 10	BF 221	0 40	2N 3714	0 10
AC 251	0 15	BC 304	0 10	BF 222	0 40	2N 3714	0 10
AC 252	0 15	BC 305	0 10	BF 223	0 40	2N 3714	0 10
AC 253	0 15	BC 306	0 10	BF 224	0 40	2N 3714	0 10
AC 254	0 15	BC 307	0 10	BF 225	0 40	2N 3714	0 10
AC 255	0 15	BC 308	0 10	BF 226	0 40	2N 3714	0 10
AC 256	0 15	BC 309	0 10	BF 227	0 40	2N 3714	0 10
AC 257	0 15	BC 310	0 10	BF 228	0 40	2N 3714	0 10
AC 258	0 15	BC 311	0 10	BF 229	0 40	2N 3714	0 10
AC 259	0 15	BC 312	0 10	BF 230	0 40	2N 3714	0 10
AC 260	0 15	BC 313	0 10	BF 231	0 40	2N 3714	0 10
AC 261	0 15	BC 314	0 10	BF 232	0 40	2N 3714	0 10
AC 262	0 15	BC 315	0 10	BF 233	0 4		

UNIVERSAL FIRE ALARM

Since the passing of the Fire Precautions Act 1971, there has grown a demand for a fire alarm system which can easily be fitted and which will be relatively inexpensive so so that it can be used for the smaller size of premises.

To meet this requirement Photain Controls Limited have developed their new Universal Fire Alarm Unit Type FB-73. The unit is a complete fire alarm system in that it incorporates Smoke Detection, Heat Detection and Manual Operation in the one unit and is also complete with an alarm bell which produces a noise in excess 85dB/m. Installations merely consists of fixing the unit on the wall and connecting it to a 220/240v 50/60 HZ mains supply. It is then ready for immediate operation.



It is contained in a pressed steel housing 155mm x 100mm x 70mm and is complete with 2 metres of 3 core cable for the mains connection.

The fire sensors are incorporated in the unit:-

Smoke Detector The alarm will operate within 30 seconds of the unit detecting a level of smoke equivalent to 20 per cent obscuration of a light beam over a distance of one metre.

Heat Detector The alarm will operate when the ambient temperature reaches 60°C and will automatically re-set when the temperature falls below 55°C.

In addition a manual pull switch is fitted so that the alarm can be operated at any time either to provide warning in the event of fire or for test purposes.

The price is £36.00 complete (plus 10% VAT in U.K.)

Photain Controls Limited, Randalls Road, Leatherhead, Surrey.

PRECISION SOUND LEVEL METER TYPE 1404B

Dawe Instruments Limited, have announced their Precision Sound Level Meter Type 1404B. This instrument is the latest addition to the DAWE range and has been designed for applications which require the highest possible accuracy. Like the successful general purpose Sound Level Meter Type



1405C introduced last year, the new model provides exceptionally good value for its price.

The Type 1404B covers the range 34 to 130dB(A) and fully complies with B.S. 4197:1967 and IEC Publication 179:1965 for precision sound level meters. This grade of instrument is now called for in many specifications and is recommended in the Department of Employment's Code of Practice for reducing the exposure of employed persons to noise where the measurement is likely to be used for legal enforcement of a noise limit. As with many other specifications, this calls for dB/A measurements which correlate best with subjective noise ratings.

The instrument is compact and robust for field use and may be held in one hand. It employs solid-state circuitry throughout and consists of a condenser microphone, weighting network, attenuators, high-gain amplifier and an easily read taut-band meter.

The Type 1404B is powered by a small battery which gives a typical operational life of 80 hours. The complete unit, including battery weighs less than 1kg and is provided with a carrying case. An optional Wind Shield Type 1404-1B is available for the microphone to greatly reduce wind noise when taking measurements out of doors.

Dawe Instruments Ltd., Concord Road, Western Avenue, London W3 OSD.

WIRE STRIPPER

As part of their range of OK Machine and Tool Corporation, Wire Wrapping Equipment, Vero Electronics have introduced a Wire Cut and Strip Tool. This is a revolutionary new concept for easy and clean stripping of wires for wirewrapping, elect-

ronic and electrical applications. It has been designed for maximum efficiency and its slim size makes it ideal for storing in a tool kit. Operation is extremely easy, up to 4 wires being placed in the stripping slot, with the ends extending beyond the cutter blade. The tool is then pressed together and the wire pulled from between the blades. The wire is thus cut and stripped to the correct wire wrapping length.

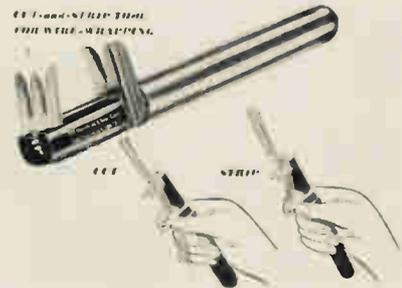

The hardened steel cutting blades which are replaceable and the sturdy construction of the tool itself, ensure maximum life.

Vero Electronics Limited, Industrial Estate, Chandlers Ford, Eastleigh, Hampshire.

PORTABLE MANOMETER

A new type of portable manometer has been introduced by the Glasgow firm, Mercury Electronics (Scotland) Ltd.

Said to be the first truly portable, battery/mains instrument of its kind in the UK, the new M8 model is about a quarter the size and weight of previous models and has a response time three times faster - at 30 milliseconds.

Used to measure air pressures or, with suitable transducers, air flow, the instrument has applications ranging from the



medical field, in anaesthetics, respiratory tests, physiology and pharmacology through to industrial measurements on engines, pumps, in wind tunnels, in heating and ventilating systems and pressures on building structures. Pressure ranges within the scope of the instrument are from 1 to 3000mm water gauge.

The measurement cell uses an optical diaphragm and an electrical resistance bridge circuit, a principle said to be exclusive to Mercury Electronics, which enables high sensitivity, accuracy and versatility to be incorporated at about 40 per cent less cost than is usual in equipment of this kind.

The instrument gives a direct reading of air pressure or flow on a Sifam large-scale centre-zero panel meter. Pushbuttons on the main panel allow different degrees of sensitivity, as well as electronic damping to be switched in if required.

Mercury Electronics (Scotland) Limited, Pollok Castle Estate, Newton Mearns, Glasgow.

NEW MULTI-METER

For service applications Eagle International have introduced two new multimeters to their range of test equipment. These are the KEW.66 and KEW.6610, 20,000 O.P.V. Multi-meter.

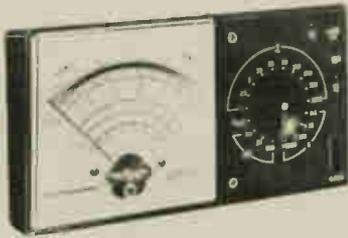

The KEW.66 has 28 measuring ranges and the KEW.6610 incorporates an additional 0-10A a.c. range for high current, heavy duty work. Both models feature overload protection, positive action rotary switch and an anti-parallax mirror scale for accurate read out. Supplied with test leads, batteries, manual and fitted case they are completely portable and thus ideally suited to site work.

Eagle International, Precision Centre, Heather Park Drive, Wembley, Middlesex, HA0 1SU.

SOUND LEVEL METER

The latest Sound Level Meter to be added to the very wide range of indicators, industrial meters and precision meters manufactured by Castle Associates in the CS16A.

At only £44.50, the CS16A is expected to be in great demand. It offers industry a Meter complying with BS 3489 as recommended in the Department of Employment's Code of Practice etc., at a price at least £10 cheaper than competitive meters.

The CS16A compliments its big brother, the famous, very sophisticated CS17A. While the CS17A offers every facility one

could wish for on such a meter, the CS16A is a reduced specification unit offering everyday measuring equipment at a saving in cost. The controls of the CS16A have been kept to a minimum to help eliminate possible operator error. It has a range of 60dBA. "Slow" response and is the first British meter to use the new technology electret microphone. This is mounted on a 8in Goose-neck extension to improve the acoustic performance.

A Calibrator is an essential, but usually very expensive accessory for a Sound Level Meter. The Castle PSQ 101A Falling Ball Calibrator offers the ideal answer at only £19. Giving a broad spectrum of noise instead of the more usual 1kHz tone, the PSQ 101A eliminates error due to microphone peaks.

Custom Electronic Associates Limited, Castle Associates Division, Redbourn House North Street, Scarborough, Yorkshire, YO11 1DE.

INVERTERS

Those requiring the use of mains operated electrical equipment when away from a mains power source, will be interested in a new range of inverters from J. Lampitt & Co. (Engineers). These inverters produce mains voltage with outputs from 150-300W from 12V and from 300-600W from



24V. Applications in the fields of boating, Camping, Caravanning and on the site requirements are innumerable. Prices start from £39.05.

J. Lampitt & Co. (Engineers) 82 Bath Street, Walsall, WS1 3DE.

X-Y AND T-Y RECORDERS

Advance Electronics Ltd. is poised to make substantial in-roads into the X-Y and T-Y Recorder market with its extensive range of instruments offering a choice of modules covering a broad spectrum of applications. There are three ranges: the LR100 and HR2000 are X-Y recorders and the 'Omni-Scribe' is a T-Y Strip Chart Recorder. Together the instruments cover most market requirements.

The British made low-cost LR100 Series is now available from stock with an increasing range of plug-in modules, with a.c. and log a.c. measurement modules soon to be made available. Amplifier and time base modules can be fitted to either axis. The

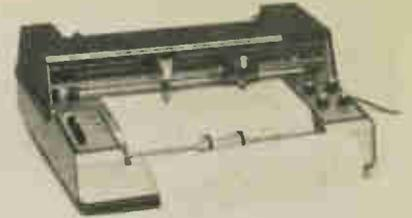

LR100 Series X-Y Recorders is suited to industrial and analytical applications, and in the fields of medicine and education. The cost of basic LR100 is £182.

For a wider coverage of sensitivities, and the advantages of automatic features such as vacuum paper hold, electric pen lift with remote control and facilities for two-pen multiplexing, HR2000 X-Y Recorder is an instrument designed to satisfy the majority of X-Y plotting requirements.

Modules available give a choice of sensitivities, with or without timebase. Each module, which may be used on X or Y axis, is self-contained and plugs directly onto the recorder main frame, maintaining the assembly as one compact unit, although if required, e.g. for some rack mounting applications, the modules may be operated away from the main frame.

The Strip Chart Recorder market is catered for by the 'OmniScribe' 5000 series in a wide range of specifications and capabilities. These units have several novel features, including a capacitive re-balance system which is unaffected by noise and wear, and web feed sprocketless chart drive.

The basic instrument, with pushbutton selection of chart speeds, sells for £186.

Advance Electronics Ltd., Instrument Division, Raynham Road, Bishop's Stortford, Herts.

CONTINUITY TESTER

To meet the needs of the electronic and electrical manufacturing industry, Highams Electronic Communications Limited have produced a mains operated, bench model continuity tester. It has been specifically designed to overcome some of the problems in production and inspection testing.

The three main features are: 1. As the tone tester has a variable range from 0-10 ohms it can be set to any value between these and will give you an audible and visual signal up to the value it has been set to. The tone tester can be set as low as 0.1 ohms. 2. Because ambient noise levels in industry are so varied the volume is adjustable mainly to overcome a high degree of ambient noise. In addition to this, there is a visual signal, as this may be preferred. 3. The main feature of HTM is that the voltage across the probes is only 10 millivolts and only draws 1 microamp. It will detect any form of connection that is going even slightly high resistance to a low level signal, that cannot be detected with any form of conventional meter.

Its size is 190 mm x 60 mm x 120 mm and finished in a rugged aluminium case. Mains operated 110/240v A.C. 50-60Hz. The audio signal is 1,500Hz. The continuity range is adjustable from 0-10 ohms. It has pluggable probe clips. The HTM is priced at £22.00.

Highams Electronic Communications Ltd., 58-60 Redchurch Street, London E2.

CALCULATOR INTEGRATED CIRCUIT

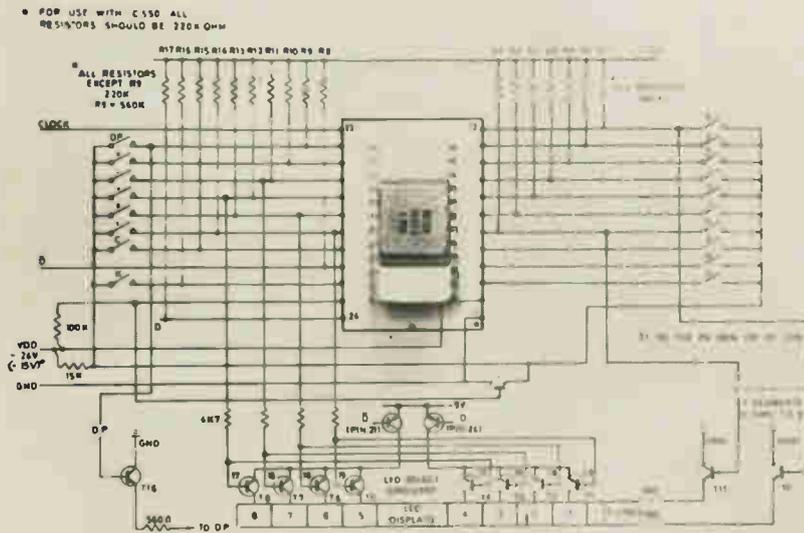

A second-generation MOS calculator integrated circuit is the latest in the C500 series manufactured by General Instrument Microelectronics and differs in several important ways from "standard" calculator chips which have been offered so far.

Called the C550, the I.C. is intended for use with eight seven segment displays which can be light emitting diodes, liquid crystals or the hot filament variety. Although the display is limited to eight digits, answers can fall anywhere in the enormous range from 10^{-20} to 10^{+79} ; the I.C. has the capability to operate with numbers over a range of 99 decades. The C550 achieves this by automatically internally changing to scientific notation when the capacity of the display is exceeded. The chip stores the answer with its sign together with a positive or negative exponent between -20 and +79. The true result is recovered by multiplying or dividing by powers of ten. An important side benefit of this approach is that it obviates the need for a ninth display for under and overflow indication and therefore cuts production and component costs.

A second feature of the C550 is that, unlike many other calculator I.Cs, partial results can be stored in the register normally employed for constant storage. This is achieved by merely pressing the constant key and enables partial results to be

used as a divisor in a subsequent operation. Hence a calculation such as $(5.6 + 6.8) \div (5.6 \times 6.8)$ can be formed without first having to calculate the value of the divisor and having to clear the machine before proceeding (as has to be done with most eight digit calculators on the market today).

The clear key performs two functions. If the clear key and then a function key is pressed the last entry is cleared. If the clear key followed by a digit key is pressed the whole machine is cleared. This obviates the need for the usual "clear last entry key".

In addition to the special features the I.C. will add, subtract, multiply and divide. It will perform chain calculations and the constant store can hold a multiplier, divisor, subtrahend or addend. When the result is negative the minus sign shows and of course the decimal point facility is as usual.

The I.C. requires a single nominal 15V power supply and a 70kHz single phase clock pulse input; power consumption is typically 150mW. The C550 chip is housed in a 24 lead dual-in-line ceramic package and operation over the temperature range 0 to 50°C is possible.

The C550 costs £16 in small quantities.

SDS Components Ltd., Hilsea Trading Estate, Portsmouth, Hants., PO3 5JW.

KNOB FAMILIES

A.F. Bulgin & Co. Ltd., Swiss manufactured range of 'RITEL' Collet fixing Control Knobs to be known as "BULGIN MULTI-RANGE".

These Control Knobs cover four basic styles of which there is five sizes in each style, all conforming to accepted standards of modern 'matched family design' and manufactured to high specifications.

There are two styles of knob (circular or bartype), three styles of cap (plain flat, flat with indicator line or bevelled top), an option of pointer or dial, and three styles of 'not cover' (plain, with indicator line for circular knob, or with indicator line for bat knob). These components clip together to help you make up the knob you want.

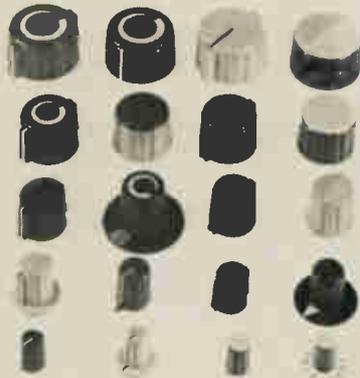

All these component pieces are available in a variety of sizes. Knobs and nut covers come in black, light grey dark grey or red. Caps and pointers are available in blue yellow or green as well as the knob colours. Dials are transparent and can have any of a wide range of legending.

This range will no doubt prove of great interest to the engineer wanting a front panel of matched controls.

A.F. Bulgin & Co. Ltd., By-Pass Road, Barking, Essex.

SCHLUMBERGER PANEL METERS

Electroplan now distribute the Daystrom Schlumberger range of digital panel meters.

The photograph shows the 1220 bipolar, 3½ digit portable model, designed to operate from a battery source without regulation. The 1220 requires less than ¼ watt to operate from any DC source between 4.8

and 6 volts. This DPM does not require a warm up period and is therefore 'instantly' accurate. It has an accuracy of 0.2% over temperature range 0-50°C. A mains operated version, model 1221, is also available.



Another DPM, the 1295 DPM, uses a single 24-pin M.O.S. L.S.I. plug-in chip which contains all the digital logic, the polarity sensing logic, the comparator to sense threshold crossing, the overrange sensing logic, synchronisation of the 3½ digit display setting and storage register.

A 1294 is a 4½ digit bipolar DPM with a 1.9999 nixie tube display and a resolution of 10mV on the 200mV range. It is available in ten standard voltage and current ranges.

Electroplan Limited, PO Box 19, Orchard Road, Royston, Herts. SG8 5HH.

EX-STOCK PANEL COMPONENTS

A new range of British made miniature indicator lamps, push-button and micro-switches, made by Feltec Components, is now available.

The Feltec range consists of over 3,000 different components, including neons and light-emitting diodes. The switches have a mechanical life of 100,000 operations, and are available with or without illumination,



in nearly 400 different configurations, whilst the lamp range gives a choice of over 2,000 variations. The range includes a tri-colour miniature cartridge lamp, available with any three of eight colours and twelve voltage ranges.

Components Division, FieldTech Limited, Heathrow Airport, London, Hounslow, Middlesex. TW6 3AF.

FAST TURN-OFF THYRISTORS

International Rectifier range (IR140 and IR141) are fast turn-off Thyristors with

very low turn-on losses. The units are designed for use in such applications as radar pulse modulators, ultrasonic cleaning equipment, and high frequency inverters and convertors.

Maximum turn-off time is 15µsec for the IR140 and 10µsec for the IR141; re-applied dv/dt is 200 volts/µsec for both types. The devices operate at up to 4KHz with no reduction in peak current capability, and can handle up to 28 amps peak current at 20KHz. They are housed in a TO-48 package.

Versions are available from 50 to 400 volts.

International Rectifier, Hurst Green, Oxted, Surrey.

MULTILAYER CAPACITORS

The CKO5 and CKO6 capacitors are manufactured for operation over the temperature range -55 to +125°C, and are primarily intended for by-pass, coupling and filtering applications.

All the capacitors are of the axial lead type and are housed in small rectangular epoxy packages. Transfer moulding is standard for the smaller capacitance values while precision moulded epoxy shells are used to encapsulate the larger components.

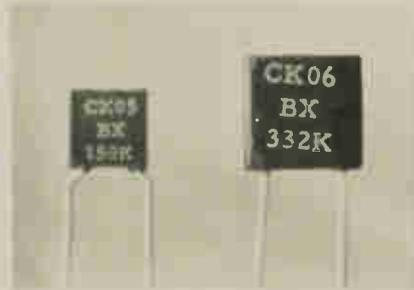

The range stocked by SDS is divided into two by package size. Type CKO5 capacitors are housed in packages which measure 4.83 x 4.83 x 2.29mm and CKO6 capacitors measure 7.37 x 7.37 x 2.29mm. CKO5 capacitors are available from 10pF to 1nF (200V), 1.2nF to 10nF (100V) and 12nF to 100nF (50V) in both the 10% and 20% preferred values. Type CKO6 capacitors range from 1.2nF to 10nF (200V), 12nF to 100nF (100V) and 120nF to 270nF (50V) also in 10% and 20% preferred values.

The leadout wires (made from 22AWG tinned copper wire) are set at 5.08mm (0.2 inch) centres.

SDS Components Ltd., Hilsea Trading Estate, Portsmouth, Hants., PO3 5JW.

MAINS FILTERS

The Maple SR range is a new range of interference filters, based on the use of high permeability ferrite cores. The design of the filters allows their use for the suppression of both symmetric or asymmetric interference in the 0-250v 50/60Hz

region. Available in 5 standard values (1½, 3, 5, 10 and 15 Amps), the filters are encapsulated in epoxy resin and are housed

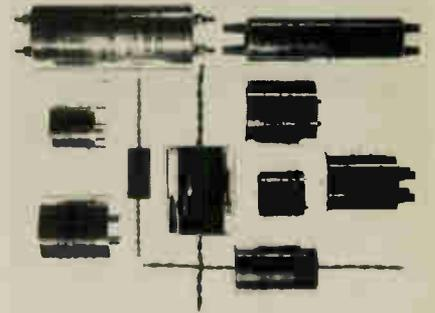

in extruded aluminium cans of two basic sizes - 34 mm x 38 mm dia. and 50mm x 51mm dia.

Components used are approved by both VDE (W. Germany) and SEV (Switzerland), and the filters are said to be particularly suitable for mains interference suppression in electronic instruments and equipment and also in preventing illegal levels or interference from being generated by thyristor controls, electrical machines, domestic appliances, etc.

Roxburgh Electronics, 22 Winchelsea Rd., Rye, Sussex.

SOLID-STATE METER RELAY

A new solid-state meter relay using operational amplifiers combines high sensitivity with an unusually fast response time. The unit has a low power consumption and good resistance to vibration and shock. It is self-contained and designed for easy panel mounting. Its uses are mainly in the medical and industrial fields, where monitoring and control of electrical signals are required and applications include the control of temperature, levels, rate of flow and speed.

The meter has twin set-points adjustable over the full 103mm scale. Input signals down to 10 mV can be accepted and thermocouples connected directly for temperature control with cold junction compensation if required. The high sensitivity of measuring circuit is achieved by using electronic rather than electro-mechanical measurement, and response time of the relay circuit is less than 250 milliseconds. A slower response can be built in, if required. The trip circuit operates independently of the indicator and is unaffected by shock or vibration.

In operation, the input signal is amplified and fed to both the indicator and to twin comparator circuits. The appropriate circuit is triggered when the amplifier signal exceeds a stable voltage obtained from an adjustable set-point potentiometer. The comparator output is then amplified to operate a highly dependable relay which is free from flutter regardless of vibration, shock and long periods of inactivity.

Crompton Parkinson Ltd., 50/52 Marefair, Northampton NN1 1NY.

GIANT SIZE PHOTOCELL

This new high power photoconductive cell has a viewing area of 29.5 mm diameter and is hermetically sealed in a plastic case 9.5 mm thick. It is capable of operating in an ambient temperature range from -30°C to $+70^{\circ}\text{C}$.

This giant cell is ideally suitable for automatic lighting control where it can monitor varying ambient lighting conditions. It can also be used for any type of application where a large area has to be monitored and variations in illumination on any part of the cell will produce a variable output.

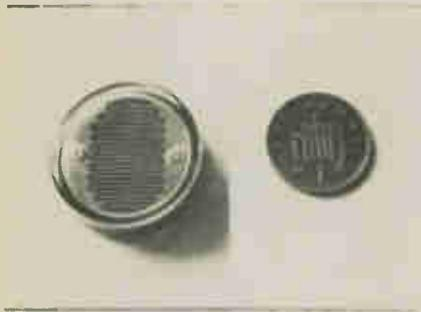

The cell will operate from any AC or DC supply up to 500v and has a continuous power dissipation of 500mW with a peak demand dissipation of 750mW. Its resistance at 10 lux is between 10-20k ohms and in dark its resistance is a minimum of 5M ohms.

It is available at £0.50 (plus 10% VAT) in small quantities.

Photain Controls Limited, Randalls Road, Leatherhead, Surrey.

LED CATALOGUE

Litronix, the California-based developers and producers of solid state, light-emitting devices, have brought out an 8-page catalogue of their product range. The catalogue entitled *Our Line*, contains detailed electrical, optical and physical specifications for more than 70 products, including multi-diode array indicators; infra red, indicator and panel-mounted LED lamps; numeric and alphanumeric, single - and multi-digit displays; and opto isolators, or solid state relays. *Our Line* is available by return of post, from:

Litronix, Bevan House, Bancroft Court, Hitchin, Herts SG5 1LW.

NEW EEV GAS DETECTOR

Early warning of the presence of hydrocarbon gases in the atmosphere, essential

in potentially hazardous areas such as the gas and petro-chemical industries, is provided by a small detector type VQ2 made by English Electric Valve Co. Ltd. under N.R.D.C. licence.

The VQ2, which will detect methane in air mixtures in concentrations from 0.1 per cent upwards, comprises two low power matched elements to form two arms of a Wheatstone bridge. One element contains a catalyst which causes methane



to burn on contact, with a resultant variation of its resistance. The other is a non-active compensating element so that variations in atmospheric pressure, humidity and ambient temperature have negligible effect on the bridge output.

The output from the bridge is virtually linear up to 3 per cent methane in air, with a minimum sensitivity of 15mV/per cent methane.

When used in a recommended bridge circuit maximum bridge power consumption is 0.48W, so making the device particularly suitable for portable battery operation.

EEV, Chelmsford, Essex CM1 2QU.

LOW-COST INFRA RED EMITTING DIODE

Following closely on their announcement of the MLED500 light emitting diode in a transparent TO-92 package, Motorola Semiconductors have just introduced an infra-red emitting version in the same style package.

Known as the MLED92, the device has a reverse breakdown voltage (BVR) of 3V and a maximum forward current of 100mA. Output at a forward current of 50mA is 0.66mW.

The device is ideally suited for use with the TO-92 2N5777-80 infra red detectors to form infra-red couplers or interrupt modules.

MLED92 is a low-cost device, the price being less than 10p each for 100 up.

Motorola Semiconductors, York House, Empire Way, Wembley, Middlesex.

DISCOUNT COLOUR!

Perfect working order. Repolished cabinets. 30 DAY GUARANTEE!

19" DECCA £77

19" GEC £88

22" PHILIPS/DECCA £132

25" DECCA/BUSH/GEC/BRC 2000/
PYE £110

CASH AND COLLECT PRICES, V.A.T. included.

3 or over less 10% discount

BRAND NEW 26" COLOUR TV CABINETS

Slight seconds without backs. All with doors in Dark Teak. Delivered for £10 cwo

MONO UHF TV'S

Sold complete but unserviced with tube tested. Good cabinets. Valve tuner type inc.:-

BUSH 128, SOBELL 1000, GEC 2000, THORN 900. Singles £5 each (add £2 delivery). 6 for £25 (delivery extra).

Transistorised tuner type makes inc.: THORN 950, BUSH 141, GEC 2010 to 2038. Philips style 70. Singles £10 each (add £2 delivery). 6 for £50 (delivery extra).

UHF TUNERS EX TV TESTED

PYE 11U type. Sobell 1000. Thorn 850/900. Adaptable to most models. Send £2.50 cwo.

Send SAE for list of UHF tuners, valves, tubes, washing machines etc. Open 6 days every week.

TRADE DISPOSALS

1043 Leeds Road, Bradford 3.
Tel Bradford (0274) 665670

and

Peacock Cross Industrial Estate,
Burnbank Road, Hamilton.
Tel Hamilton (06982) 29511

BACK NUMBERS

A limited quantity of back numbers of **Electronics Today International** are available at 25p each plus 7p postage (32p in all). Requests for these should be addressed to:

BACK NUMBERS DEPT.,
Electronics Today International,
36 Ebury Street,
London SW1W 0LW

Protronic 24
for the best in prototype
and pre-production
PCB's
Mount Road Hanworth Middlesex Tel: 01-898 2427

continued from page 15

ACOUSTO-OPTIC DEFLECTOR ENABLES LASER SCANNER TO TAKE, PROJECT AND FACSIMILE PICTURES WITH HIGH RESOLUTION

Employing a newly developed, simple, highly efficient acousto-optic deflector, RCA scientists have built a laser beam scanner that operates at TV rates, but projects a picture with 3 to 4 times the detail of conventional TV.

The laser scanner -- constructed as part of on-going electro-optic research at RCA Laboratories in Princeton, N.J. -- can be used for taking pictures as well as projecting them, according to Dr. George D. Cody, Director of the RCA Physical Electronics Laboratory.

Thus, it could be the forerunner of an advanced, high resolution facsimile system that, in effect, photographs at the sending terminal the picture it reproduces at the receiving terminal. Conventional facsimile systems require a photograph, rather than the object itself, in transmitting picture copies to receiving terminals, he explained.

The RCA system's pickup tube "photographs" spot by spot and line by line, the reflection of the laser beam as it sweeps over a three-dimensional object. The signal from the pickup tube is electronically processed and then sent to the receiving terminal for conventional facsimile reproduction.

Laser scanners have many other potential applications. These include, scanned optical radar, computer print-out, and optical memories and image storage.

The highly efficient acousto-optic deflector in the experimental RCA scanner was developed by a research team headed by Dr. Istvan Gorog and including Peter V. Goedertier, Dr. Joseph D. Knox and Dr. Igal Shidlovsky.

The scanner has two deflectors vertical and horizontal. Since TV vertical deflection is relatively slow, a conventional oscillating galvanometer driven mirror is employed to direct the beam vertically. The fast moving horizontal deflector, however, is an anisotropic Bragg device, constructed out of paratellurite (TeO_2). It is capable of scanning up to 15,750 lines per second.

Although initial investigations by RCA scientists and other researchers indicated that anisotropic deflectors -- those made from crystals whose properties depend upon the direction of propagation of both the sound and light waves -- suffered severe dips in



efficiency at mid-frequency ranges, experimental work by Dr. Gorog's team indicated that this problem could be overcome. As a result, they developed TeO_2 deflectors with efficiencies as high as 90 per cent operating at television rates.

In developing these high efficiency deflectors, the RCA scientists found it necessary to devise a cold press bonding technique for attaching r.f. transducers to the TeO_2 crystals. In addition to its high efficiency, the paratellurite deflector has the advantage of simple fabrication, as it does not require the beam-steering mechanism of comparable deflectors. Furthermore, 1000 TV line limiting resolution can be achieved with a deflector having a using optical aperture of only 0.5cm.

This smallness facilitates diffraction-limited operation and ease of alignment, thereby permitting the use of relatively inexpensive, simple optical elements of just average quality in the scanner, Dr. Gorog states. Another advantage of the anisotropic TeO_2 deflector is that it operates at low r.f. drive power levels, and thus can be compatible with integrated circuitry.

LASER-INDUCED ELECTRICAL EFFECT DISCOVERED

An unusual and totally unexpected electrical effect has been discovered by Robert J. von Gutfeld and Eugene E. Tynan at IBM's Thomas J. Watson

Research Centre at Yorktown, New York.

Von Gutfeld and Tynan have found that when the surface of a thin film of a metal such as molybdenum and tungsten is irradiated with brief pulses of laser light, voltage pulses of up to 0.05V are generated in the plane of the film, for 1kW of incident power. Such pulses can readily be detected without special amplification, and the planar direction of the voltage makes for simple attachment of electrical connections on the film surface.

Exploitation of the new effect could result in inexpensive arrays of fast photodetectors responsive over a broad optical spectrum and operable over a wide temperature range. Moreover, detectors based on the new effect would be resistant to the heat-degradation characteristic of such now-common photodetectors as silicon-based devices. Some experimental detectors based on the new effect in fact show an actual increase in sensitivity with rise in temperature.

The new phenomenon was discovered during studies of heat conductivity in which a pulse laser was used to 'inject' bursts of thermal energy into small samples of various materials under controlled and monitored conditions. A temperature gradient - a progressive change in temperature with distance - through the depth of the irradiated films does appear to play a central role in giving rise to the voltage, which nonetheless is at

right angles to the gradient.

At least as surprising as the voltage direction is the fact that the voltage polarity remains the same, for fixed contacts, no matter how one rotates the film in its own plane around the axis of the laser beam. The only way to reverse polarity for a sample to which measurement contacts are fixed is to shine the laser beam on the other side of the film. This constancy is decidedly unusual; other voltage effects have shown reversability, since they arise from asymmetries in either the laser beam or the detector circuit. Absence of such reversal seems to show that asymmetry at this level is not involved.

In a paper in the August 15 issue of *Applied Physics Letters*, Dr. von Gutfeld suggests that underlying the newly found effect is an asymmetry within the films themselves; microscopic distortion caused by such factors as stress arising while the film is being deposited and/or misplacement of atoms as they stack up while the film is being formed. This type of asymmetry would be independent of rotations around the laser-beam axis and could result in the 'crosswise' voltage observed, as von Gutfeld shows by an analysis of the so-called Boltzmann transport equations, which relate symmetry structure to electrical and thermal parameters. The voltage would, in fact, be a photo-induced transient thermoelectric effect. Such an interpretation is strengthened by the observation that the voltage is produced only by pulses of laser light, not by continuous irradiation - which would 'wash out' a temperature gradient between the near and the far sides of the film. Additional evidence that a temperature gradient is at work is that as pulses are lengthened or pulse rise-times become longer - giving the film a greater opportunity to reach front-to-back thermal equilibrium - the voltage diminishes.

Indeed, for the best results so far, the laser pulses should be extremely short, of a few nanoseconds long; the resulting duration of voltage pulses is roughly comparable.

Detectors exploiting the new effect should be versatile; voltages of comparable magnitude have been produced by selected laser wavelengths from blue through orange and red, in the visible spectrum, and then out to the near infrared. In addition, the new detectors promise to be extremely hardy. Where-

as the performance of silicon-based photodetectors declines as ambient temperature rises, experiments at IBM's Research laboratory with molybdenum show an actual increase in sensitivity which seems to be linear. At an ambient temperature of 250°C, the voltage produced for a given laser energy is about 15 per cent higher than when the film is at room temperature. (This improvement may be related to the fact that temperature-rise may produce stresses of its own under certain conditions - stresses distinct from the 'locked in' stress of deposition mentioned earlier - or simply due to a linear dependence on temperature of the thermoelectric coefficients).

At present, von Gutfeld and Tynan are continuing study of the new effect in hopes of enhancing it, extending it to a broader range of light frequencies, and discovering other - possible superior - materials.

NEW ARMY COMMUNICATIONS SYSTEM

A multi-million pound programme for the development of a secure tactical trunk communication system for the British Army in the 1980s has been awarded to The Plessey Company Limited under a Ministry of Defence contract announced today. Known as "Ptarmigan", it is the largest military communications development project ever undertaken in Britain.

Ptarmigan will provide the military equivalent of an STD type of person-to-person telephone service between units - either fixed or mobile - anywhere within the combat zone. Transmission channels are carried almost entirely by means of u.h.f. and v.h.f. radio links instead of by cables so that the necessary mobility is obtained.

The Ptarmigan System results from many years study of a new system concept of communications for the Army and supporting tactical Air Forces. It reduces the weaknesses of earlier military communications systems by departing from the chain of command principle which required local communication switching centres at each formation headquarters. Instead, a number of stored program controlled switching centres, located at suitable geographical points, are interconnected by multi-channel radio relay to form a grid network covering the whole tactical area.

The heart of the switching centres will be the Plessey PP250 processor which was developed by Plessey Telecommunications for its stored program control project.

Formation Headquarters will be connected by radio relay to any switching centre from which a multiplicity of routes can be provided

to interconnect the different levels of command. Mobile system through a 'radio-telephone' subsystem known as Single Channel Radio Access.

Some of the special service features provided by Ptarmigan are:-

1. secure communication by speech, telegraph, facsimile and data;
2. provision of Conference and Broadcast facilities;
3. priority service for nominated subscribers;
4. a unique never-changing directory number for each subscriber;
5. automatic call transfer facilities;
6. designed to meet the standards agreed by the Eurogroup nations and NATO.

The commencement of Ptarmigan engineering development marks the end of a long period of study by the Ministry of Defence (Army), the Signals Research and Development Establishment and The Plessey Company Limited to arrive at the present state of project definition.

B.A.S.C. GETS GOING SETTING TELEVISION AERIAL STANDARDS

The principals of five major U.K. UHF aerial manufacturers met recently to reconstitute the British Aerial Standards Council, which although formed as long ago as 1963 confined itself primarily to technical interchange. Recent developments have prompted it to extend its activities considerably with the object of promoting high standards of performance, design and construction in television and VHF radio aerials available to the public.

Mr. James W. Woods, deputy chairman of J. Beam Aerials Ltd., of Northampton, who has been appointed chairman of B.A.S.C. says:

"There have been ever-increasing comments over the last year or so, both by the public and in the press, about the poor standard of many aerials now on the market. Considerable quantities of these are often the product of small part-time operators with little mechanical expertise and inadequate electronic measuring equipment. One recent newspaper article referred to them as 'fly-by-night manufacturers producing poor quality aerials at rock-bottom prices'.

"Poor television reception due to inefficient aerials inevitably provokes criticism and complaint by television set owners to the Ministry of Posts and Telecommunications. We, of the Aerial Standards Council, feel that the climate is right for much more attention to be given to the situation with a view to improving and maintaining the standard of aerials offered to the public. It will be the job of B.A.S.C. to do precisely this".

INDEX TO ADVERTISERS

Advance Electronics	36
Bi-Pak	62,63
BIET	Cover iii
BNRS	14
Bi-Pre-Pak.....	8
Bush & Meissner	10
Bywood	6
Chromasonic Electronics	70,71
Decon	47
Dolphin Designs	69
Eagle International	4
Gerald Myers	10
Greens Telecom	79
Henry's Radio	58,59
J T Eden	74
Marco Trading	14
Minikits	51
Plessey	12
Protronic	79
Ramar Constructor Services.....	10
RCS	47
Sansui	Cover iii
Spotron	69
Teleton	Cover ii
Trade Disposals	79
Trannies	14
Wilmslow Audio	10

NEWSAGENT: _____

Please deliver **ELECTRONICS TODAY INTERNATIONAL** for 12 months, starting with the _____ issue:

NAME _____

ADDRESS _____

GIVE THIS COUPON TO YOUR LOCAL NEWSAGENT

**USE
THIS COUPON**



**costs
no
more
delivered
to your
door ...**

...by your local newsagent

For only £2.40 a year (12 issues at 20p each) you ensure that every copy of **ELECTRONICS TODAY INTERNATIONAL** will arrive on your doorstep as soon as it is published — and that you'll never miss out on it if an issue happens to sell out.



FREE!

Over 150 ways to engineer a better future



HIGHER PAY **A BETTER JOB**

SECURITY

find out how in just 2 minutes

That's how long it will take you to fill in the coupon. Mail it to B.I.E.T. and we'll send you full details and a free book. B.I.E.T. has successfully trained *thousands* of men at home - equipped them for higher pay and better, more interesting jobs. We can do as much for YOU. A low-cost B.I.E.T. home study course gets results fast - makes learning easier and something to look forward to. There are no books to buy and you can pay-as-you-learn.

Why not do the thing that really interests you? Without losing a day's pay, you could quietly turn yourself into something of an expert. Complete the coupon (or write if you prefer not to cut the page). No obligation and nobody will call on you... but it could be the best thing you ever did.

Others have done it, so can you

"Yesterday I received a letter from the Institution informing that my application for Associate Membership had been approved. I can honestly say that this has been the best value for money I have ever obtained - a view echoed by two colleagues who recently commenced the course".— Student D.I.B., Yorks.

"Completing your course, meant going from a job I detested to a job that I love, with unlimited prospects".— Student J.A.O. Dublin.

"My training with B.I.E.T. quickly changed my earning capacity and, in the next few years, my earnings increased fourfold".— Student C.C.P., Bucks.

FIND OUT FOR YOURSELF

These letters - and there are many more on file at Aldermaston Court - speak of the rewards that come to the man who has given himself the specialised know-how employers seek. There's no surer way of getting ahead or of opening up new opportunities for yourself. It will cost you a stamp to find out how we can help you. Write to B.I.E.T. Dept. BE1 10 Aldermaston Court, Reading RG7 4PF.

Practical Radio & Electronics Certificate course includes a learn while you build **3 transistor radio kit.**

Everything you need to know about **Radio & Electronics** maintenance and repairs for a **spare time income** and a **career** for a better future.

CUT OUT THIS COUPON

Tick or state subject of interest. Post to address below.

<input type="checkbox"/> MECHANICAL	<input type="checkbox"/> Man. Prod.—cont.	<input type="checkbox"/> Constructional-cont.
<input type="checkbox"/> A.M.S.E. (Mech.)	<input type="checkbox"/> Quality Control	<input type="checkbox"/> Building
<input type="checkbox"/> Boiler Inspect.	<input type="checkbox"/> Salesmanship	<input type="checkbox"/> Building Drawing
<input type="checkbox"/> & Operation	<input type="checkbox"/> Storekeeping	<input type="checkbox"/> Build. Foreman
<input type="checkbox"/> C & G Eng. Crafts	<input type="checkbox"/> Work Study	<input type="checkbox"/> Carpentry & Join.
<input type="checkbox"/> C & G Fabricat.	<input type="checkbox"/> Works	<input type="checkbox"/> Civil & Municipal
<input type="checkbox"/> Diesel Eng.	<input type="checkbox"/> Management	<input type="checkbox"/> Engineering
<input type="checkbox"/> Eng. Inspection	<input type="checkbox"/> DRAUGHTSMANSHIP	<input type="checkbox"/> Constructional
<input type="checkbox"/> Eng. Metallurgy	<input type="checkbox"/> A.M.I.E.D.	<input type="checkbox"/> Engineering
<input type="checkbox"/> Inst. Eng. & Tech.	<input type="checkbox"/> Design of Elec.	<input type="checkbox"/> Construction
<input type="checkbox"/> Inst. Motor Ind.	<input type="checkbox"/> Machines	<input type="checkbox"/> Surveyors
<input type="checkbox"/> Mainten. Eng.	<input type="checkbox"/> Die & Press Tool	<input type="checkbox"/> Institute
<input type="checkbox"/> Mechanical Eng.	<input type="checkbox"/> Design	<input type="checkbox"/> Clerk of Works
<input type="checkbox"/> Sheet Metal Work	<input type="checkbox"/> Electrical	<input type="checkbox"/> Council Eng.
<input type="checkbox"/> Welding	<input type="checkbox"/> Draughtsman-ship	<input type="checkbox"/> Geology
<input type="checkbox"/> ELECTRICAL & ELECTRONIC	<input type="checkbox"/> Gen. Draughts-ship	<input type="checkbox"/> Health Eng.
<input type="checkbox"/> A.M.S.E. (Elec.)	<input type="checkbox"/> Jig & Tool Des.	<input type="checkbox"/> Heat & Vent.
<input type="checkbox"/> C & G Elec. Eng.	<input type="checkbox"/> Tech. Drawing	<input type="checkbox"/> Hydraulics
<input type="checkbox"/> C & G Elec. Inst.	<input type="checkbox"/> RADIO & TELE-COMMUNICATIONS	<input type="checkbox"/> Inst. of Builders
<input type="checkbox"/> C & G Elec. Tech.	<input type="checkbox"/> Colour TV	<input type="checkbox"/> Inst. Works & Highway Sup.
<input type="checkbox"/> Computer Elect.	<input type="checkbox"/> C & G Radio/TV/ Electronics	<input type="checkbox"/> Painting & Dec.
<input type="checkbox"/> Elec. Maths	<input type="checkbox"/> C & G Telecomm. Tech.	<input type="checkbox"/> Public Hygiene
<input type="checkbox"/> Elec. Science	<input type="checkbox"/> Prac. Rad. Elec. (with kit)	<input type="checkbox"/> Road Engineer.
<input type="checkbox"/> Electronic Eng.	<input type="checkbox"/> Radio Amateurs Exam.	<input type="checkbox"/> Structural Eng.
<input type="checkbox"/> Electrical Eng.	<input type="checkbox"/> Radio Servicing & Repairs	<input type="checkbox"/> Surveying
<input type="checkbox"/> Install. & Wiring	<input type="checkbox"/> Radio & TV Eng.	<input type="checkbox"/> GENERAL
<input type="checkbox"/> Meters	<input type="checkbox"/> Trans. Course	<input type="checkbox"/> Agricultural Eng.
<input type="checkbox"/> & Measuring Instruments	<input type="checkbox"/> TV Main. & Serv.	<input type="checkbox"/> Council of Eng. Inst.
<input type="checkbox"/> MANAGEMENT & PRODUCTION	<input type="checkbox"/> AUTO & AERO	<input type="checkbox"/> Farm Science
<input type="checkbox"/> Auto. Control	<input type="checkbox"/> Aero Eng.	<input type="checkbox"/> General Educat.
<input type="checkbox"/> Computer Prog.	<input type="checkbox"/> A.M.I.M.I.	<input type="checkbox"/> Gen. Plastics
<input type="checkbox"/> Electronic Data Processing	<input type="checkbox"/> A.E.C. Cert.	<input type="checkbox"/> Pract. Maths
<input type="checkbox"/> Estimating	<input type="checkbox"/> Auto Engineer.	<input type="checkbox"/> Pract. Slide Rule
<input type="checkbox"/> Foremanship	<input type="checkbox"/> Auto Repair	<input type="checkbox"/> Pure & Applied Maths
<input type="checkbox"/> Inst. Cost & Man. Accountants	<input type="checkbox"/> C & G Auto Eng. Garage	<input type="checkbox"/> Refrigeration
<input type="checkbox"/> Inst. Marketing Management	<input type="checkbox"/> Management	<input type="checkbox"/> Rubber Tech.
<input type="checkbox"/> Metrication	<input type="checkbox"/> MAA/IMI Dipl.	<input type="checkbox"/> Sales Engineers
<input type="checkbox"/> Motor Trade Man.	<input type="checkbox"/> Motor Vehicle Mechanics	<input type="checkbox"/> Tech. Report Writing
<input type="checkbox"/> Network Plan.	<input type="checkbox"/> CONSTRUCTIONAL	<input type="checkbox"/> Timber Trade
<input type="checkbox"/> Numerical Cont.	<input type="checkbox"/> A.M.S.E. (Civil)	<input type="checkbox"/> University Ent.
<input type="checkbox"/> Operational Research	<input type="checkbox"/> Architecture	<input type="checkbox"/> G.C.E.
<input type="checkbox"/> Personnel Man.	<input type="checkbox"/> Coaching for many major exams including ONC, C & G, etc.	<input type="checkbox"/> 58 'O' & 'A' LEVELS SUBJECTS Over 10,000 group passes
<input type="checkbox"/> Planning Eng.		
<input type="checkbox"/> Production Eng.		

POST TODAY FOR A BETTER TOMORROW

To B.I.E.T., Dept. BE1 10 Aldermaston Court, Reading RG7 4PF

NAME _____
Block Capitals Please
ADDRESS _____

OTHER SUBJECTS _____ AGE _____

Accredited by C.A.C.C.
BRITISH INSTITUTE OF ENGINEERING TECHNOLOGY

Harry Saunders The entrancing world
of SANSUI's quadrasonic 4-channel stereo.



The complete range of Sansui's sophisticated
4-channel equipment at your dealer's now!

England : VERNITRON(UK)LTD. Thornhill Southampton SO9 5QF Tel : Southampton 44811

SANSUI AUDIO EUROPE S.A. Diacam Bldg., Vestingsstraat 53-55, 2000 Antwerp, Belgium
SANSUI ELECTRIC CO., LTD. 14-1, 2-chome, Izumi, Suginami-ku, Tokyo, Japan

Sansui



4-CHANNEL STEREO