

# Electronics & **MUSIC Maker**

INCORPORATING COMPUTER MUSICIAN

## ULTRAVOX

CURRIE & CROSS  
(& CANN)



BUILD POWERTRAN'S MIDI CONTROLLED SAMPLER

## WIN AN OSCAR

EXCLUSIVE COMPETITION



### REVIEWS:

YAMAHA CX5M COMPUTER ROLAND MIDI SYSTEM

KORG DDM220 DRUM MACHINE

GREENGATE DS3 SAMPLER TAMA ELECTRONIC DRUMS



## Roland makes it happen

MKB 1000 keyboard 88 keys .....	£1665
(MKB 300 keyboard 76 keys .....	£990)
MKS 10 Piano Module .....	£990
MKS 30-Synth Module .....	£875
MKS 80 Super Jupiter .....	£1800
MPG 80 Programmer .....	£395
KS 1000 Stand .....	£150
(KS 330 Stand .....	£115)

### REMOTE MIDI KEYBOARD

Back stage-rack mounted polysynth and programmer, 6 voice polysynth, piano sound source, plus sound effectors.

– All packed together with cables in and out.

No more complex multi-keyboard set-ups.

The mother MIDI keyboard controls everything – patches, benders, parameters.

One MIDI cable controls each module.

Layer module on module, split the keyboard. All selected from the mother keyboard.

Today's concept – a total MIDI system – from Roland.

## Roland makes it happen

The Roland logo consists of a stylized 'R' symbol followed by the word 'Roland' in a bold, sans-serif font.

Roland (UK) Ltd., Great West Trading Estate,  
983 Great West Road, Brentford, Middx. TW8 9DN  
Telephone: 01-568 4578

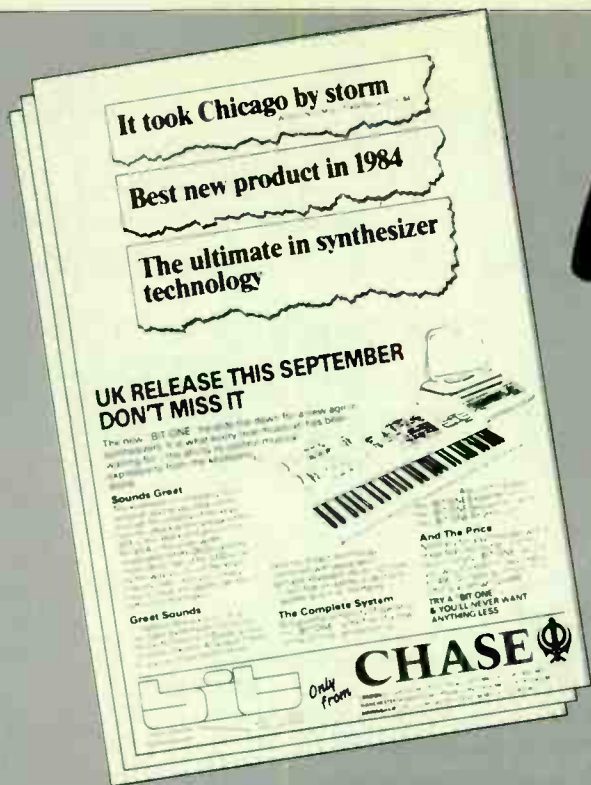

# IT'S HERE NOW!

## THE SENSATIONAL NEW CHASE "BIT ONE"

### Have you tried it yet?

The new "BIT ONE" heralds the dawn for a new age in synthesizers. It is what every true musician has been waiting for – the ability to control musical expressivity from the keyboard alone.

#### Sounds Great

The keyboard is completely touch sensitive giving you total control through the velocity of the keys over the attack and envelope of the VCF's, the attack and amount of the VCA's, the pulse width modulation of the DCO's and the modulation rate of the LFO's – all by the way you touch the keys – note by note ...but you'll really have to hear it to appreciate the difference this makes.

#### Great Sounds

In addition this six voice dual oscillator synthesizer combines the perfect blend of Digital access controls linked to Analogue filters to give a unique blend of the

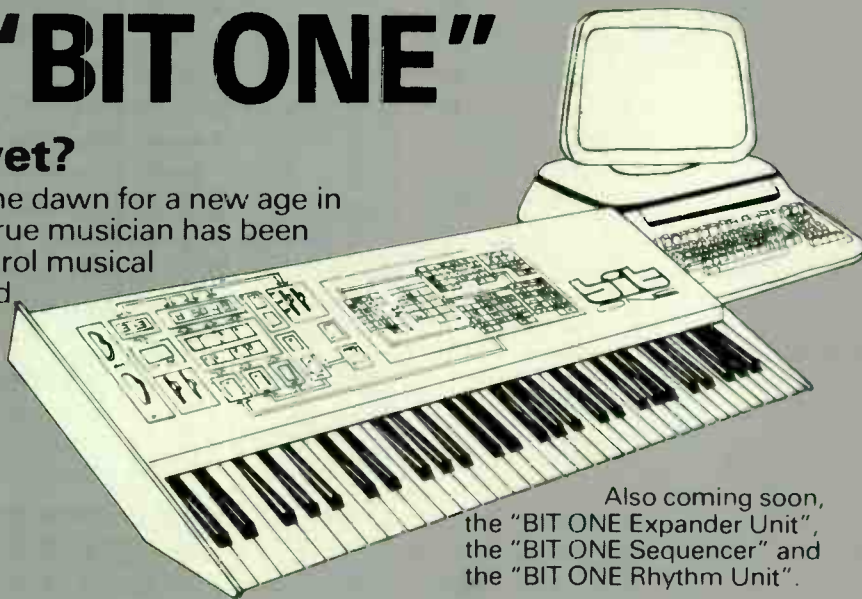

benefits of each technology combined with assignable splittable keyboard, doubling mode, unison feature, stereo output and cassette and midi interfaces.

#### The Complete System

Designed for simplicity of operation the "BIT ONE" is the first of a new series of modular electronics.

Also coming soon, the "BIT ONE Expander Unit", the "BIT ONE Sequencer" and the "BIT ONE Rhythm Unit".

#### And The Price

Normally for a synthesiser with all these features, but still not the revolutionary "BIT ONE" sound, you would expect to pay nearly £1,400. Our special introductory offer during September only is an amazing £699.

TRY A "BIT ONE" TODAY – & YOU'LL NEVER WANT ANYTHING LESS

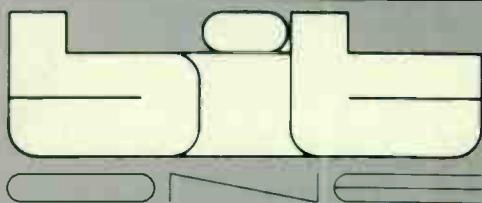

Only  
from

# CHASE

LONDON 22 Charlton Street off Euston Road, London NW1 Tel 01 387 7626/7449  
 MANCHESTER 58 Oldham Street off Piccadilly, Manchester M4 1LE Tel 061 236 6794 5  
 BIRMINGHAM 10 Priory Queensway Birmingham, B4 6BS Tel 021-236 8146



# Rod Argent's

# Keyboards

20 Denmark Street London WC2

Telephone 01-379 6690 (sales) 01-240 0085 (service)



## YAMAHA

**RX11 and RX15 DIGITAL DRUM MACHINES MIDI-EQUIPPED**

RX11 - 16 instrument voices - store memory on ROM  
 RX15 - 12 instrument voices - store memory via cassette interface

**NOW IN STOCK**

DX7-FM Polysynth - DX9-FM Polysynth - PF10-Digital Piano  
 PF15-Digital Piano - R1000-Digital Reverb

**COMING SOON**

RX5-Remote Keyboard for DX7  
 ZX1-Digital 8 Channel Sequencer  
 T8PR-Modular FM sound source for QX-1  
 CX5-Music Computer



# Roland

**MPG 80 SUPER JUPITER PROGRAMMER**

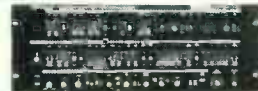

**MKB 1000 MIDI KEYBOARD CONTROLLER**

**THE ROLAND TOTAL MIDI SYSTEM**  
 (keyboard controllers and modules)



**MKB-1000**

MIDI keyboard controller, 88 note, wooden keys, touch sensitive split keyboard.

**MKB-300**

MIDI keyboard controller, 76 note (touch sensitive) split keyboard.

**MKS-80**

Super Jupiter 8 voice MIDI Poly synth module (19" rack) 128 memory dynamic facility after touch.

**MKS30**

Planet S 6 voice MIDI Poly synth module (19" rack) can be controlled from any MIDI keyboard

**MKS 10**

Planet P Midi Compatible piano sound module, eight onboard sounds.

**SBX80**

Sync Box programmable tempo controller. Roland's answer to Doctor Click (phone for the amazing story).

All current Roland products are available from Rod Argent's Keyboards. Call for details on availability and price.

**MKS10 PLANET B**



**ROD ARGENTS ARE THE MAIN AGENTS FOR THE FOLLOWING PRODUCTS:**

SIMMONS - DRUMULATOR - SEQUENTIAL CIRCUITS  
 WAL CUSTOM BASSES - D-DRUMS - CHAPMAN STICK  
 OSCAR MONO SYNTHS - BOSS PRODUCTS  
 KAWAI PIANOS - MXR PRO. PRODUCTS  
 CP. & PACKHORSE CASES

**THE PRO ROOM**

You may book a personal demonstration or take time to evaluate any product we stock, simply by booking an appointment 10.30am-6.00pm Monday-Friday

**REPAIR DEPT.**

Our service dept. is one of the most professional in England. For all modifications and repairs call Tim on 01-240 0085

# Rod Argent's Musicstore

15 The Butts Worcester Telephone 611774

# CONTENTS

E&MM October 1984 Volume 4 Number 8

## NEWS

- Comment** ..... 4  
An overview of reviews.
- Interface** ..... 6  
A selection of opinions and queries from the E&MM postbag.
- Newsdesk** ..... 8  
Upcoming products, books, records and events.
- Forum** ..... 32  
Start of a new series in which readers are invited to submit 'extended letters' on an electronic music topic that's of interest to them.

## HARDWARE

- Yamaha PS6100** ..... 10  
The world's most advanced portable domestic keyboard is just about to hit the UK. Dan Goldstein finds out what FM voices, PCM drums and MIDI add up to.
- DDrums Electronic Percussion** ..... 12  
Marketed in the US as E-Drums, these Swedish-built percussion units combine high quality digital samples with immense constructional sturdiness. Dan Goldstein again.
- Yamaha RX Series** ..... 16  
Yamaha's first-ever self-contained programmable drum machines have PCM-encoded voices and MIDI. Kendall Wrightson gives his verdict.
- 360 Systems Update** ..... 20  
First reviewed in prototype form over a year ago, the 360 has been the subject of some significant hardware modifications since then, and Paul White reports on a more recent production sample.
- Tama Techstar Electronic Drums** ..... 26  
Tama are the first acoustic percussion manufacturer to enter the electronic arena: Paul White tested the first example in the country to see if the Japanese could make something more than a Simmons copy.
- Korg DDM220 Drum Machine** ..... 34  
The Latin percussion variant of Korg's new budget drum machine duo comes under the scrutiny of Trish McGrath. Is its beauty more than skin deep?
- Frazer Wyatt Speakers** ..... 38  
Almost every keyboard exhibitor at the British Music Fair was using these British-designed and built speakers to play their products through. Paul White tries to find out why.
- Roland Mother Keyboard System** ... 40  
A new prestige keyboard line-up that fuses traditional modular synthesis con-

cepts with the latest interface technology. The complete system surveyed by Dan Goldstein.

## MUSIC

- Love's Great Adventure** ..... 44  
Seven years old and still going strong, Ultravox discuss writing, recording and performing with Dan Goldstein. They also explain why they've got four OSCars . . .
- On Cassette** ..... 54  
Oblivious of all the pitfalls that await him, Chris Heath has taken on the task of reviewing our readers' demo tapes. Here's his first round-up.



- On Record** ..... 57  
Album releases by Brian Eno, Neuronium, 400 Blows and others, plus a sprinkling of singles.
- Studio 3D** ..... 58  
We highlight three recording studios that place the emphasis on music hardware rather than expensive recording equipment: in order of price, East London Community Studio, Hollow Sun, and Computer Music Studios.

## COMPETITION

- Win an OSCar** ..... 50  
Answer one set of questions on featured band Ultravox and a second set on the instrument itself, and you could find yourself winner of the first MIDI-equipped version of this versatile British monosynth.

## TECHNOLOGY

- Powertran MCS1** ..... 62  
MCS stands for MIDI Controlled Sampler,

E&MM's most exciting build-it-yourself project yet. Tim Orr gets the ball rolling with a discussion of the effects this Powertran unit can be used to produce.

**Analogue Electronic Drum System** 66  
Reader Marek Bokowietz has constructed a complete electronic drum kit from E&MM's own percussion modules, the Syntom, Synbal and Synclap.

**Patchwork** ..... 68  
Readers send in details of their own synth sounds and how to play them.

**Understanding the DX7** ..... 70  
The end of our quest to make Yamaha's revolutionary DX synths easier to comprehend and program. Jay Chapman performs the closing ceremony.

**Modular Synthesis** ..... 74  
Steve Howell looks at different methods of triggering modular sequencers from click-tracks on tape.

## COMPUTER

## MUSICIAN

- Editorial** ..... 77
- Rumblings** ..... 78
- E&MM Digital Music** ..... 80  
The resumption of our series describing the design of Clef Products' new computer music system for the BBC micro, the PDSG. Designer Alan Boothman takes up the story.
- Yamaha CX5M and Software** ..... 82  
1984's most eagerly-awaited electronic music product is finally making its way into dealers' showrooms. David Ellis has been taking a look at the micro itself, Yamaha's exclusive FM sound chip, the controlling keyboard and the first batch of software.
- The Fairlight Explained** ..... 86  
Part three, and Jim Grant outlines the basics of sound sampling.
- OMDAC Update 2** ..... 89  
Two alternative hardware modifications for adapting our music control micro-peripheral for use with the BBC B.
- Greengate DS3** ..... 92  
Mainframe's sound-sampling add-on for the Apple is now available to the general public. David Ellis puts the system through its paces.
- EmmSoft** ..... 95  
October sees the official launch of E&MM's own music software division. We tell you what's available now, and a little of what you can expect from us in the future.



...ive electronic and av...  
...e popular and mass media  
... this issue went... pres  
... significant  
... unexpected  
... The campaign  
... or to E&MM

# COMMENT

## Portrait of the Artist as a Reviewer

Judging from both the response to our most recent readership survey and the amount of feedback we receive on the subject in readers' letters, it would seem that it's E&MM's equipment reviews that are the most widely and attentively read part of the magazine. In a sense, it's nice to know that what we write about a certain product is going to be taken seriously by a great many musicians, but the other side of the coin is that the attention of our readers places a heavy burden on the shoulders of the magazine's regular equipment reviewers. If they make one tiny error of judgement, that error is magnified thousands of times over throughout the UK, and indeed the world.

So what should a review comprise?

I put the question a week or so ago to Technical Editor Paul White, and his reply was surprisingly straightforward. 'I write in a review exactly what I'd say if a friend of mine asked me my opinion of a product.'

Now while such an attitude is an honourable one, it does not mean that passing judgement on a particular piece of equipment is a simple matter. After all, a reviewer will make a subjective appraisal that may not entirely agree with that of another reviewer having different tastes.

An example of this could be a

budget polysynth that cuts costs by using only one VCF: Reviewer A may condemn this out of hand while Reviewer B accepts the compromise as a reasonable way of keeping costs down.

It would be nice if some sort of inflexible yardstick could be applied to all products, but even with the best of intentions, personal preferences make this extremely difficult.

The most obvious candidate for being awarded yardstick status is value for money. Does Product X compare favourably with others in its price range? Or is it the victim of a price tag too heavy for it, and does its competitiveness suffer as a result? Those are questions every reviewer should take into consideration as soon as a piece of equipment's RRP is announced by its manufacturer, because musicians – even the wealthy ones – have only a finite amount of money and a similarly finite quantity of gear they can spend it on.

However, value for money is not an objective quality, because one person's perception of what is good value can be vastly different from another's.

What this boils down to is that a review should be used to assist your own judgement and should not be used as a complete substitute.

Some aspects of a review will of

course be solid fact: how much it weighs, what it costs, whether it has a MIDI Thru socket, for instance. But there are other areas that are not so clear cut, such as the control layout, the facilities sacrificed in the name of economy, and of course the sound.

Even if a reviewer started out with the intention of writing an utterly comprehensive and completely unbiased report, the late arrival of the review sample, the lack of a user manual, or the unfinished 'prototype' state of the equipment may all conspire to make that task an impossible one.

One thing you can rely on is that our reviews are unbiased by commercial influences. After all, we are not trying to sell the instruments, nor do we have any reason to criticise a good product unduly. We simply assess how well the unit performs within its price range and point out any facts that we think you should know. We will also tell you whether we liked it or not!

Over the years, E&MM has succeeded in gaining a reputation for detailed and helpful reviews and we'd like to think that every report we publish strengthens that reputation.

Read the reviews, weigh up the facts. But remember that it's *your* needs, not the reviewer's that are of the greatest importance, so ultimately the decision must be yours. ■

**Editor** Dan Goldstein **Technical Editor** Paul White **Production Editor** Tosh McGrath **Consultant Editor (Computer Musician)** David Ellis **Administration** Sandra Young **Technical Administration** Paul Gilby **Art Editor** Stuart Catterson **Deputy Art Editor** Eddie Allen **Art Assistant** Sam Masters **Features Photographer** Matthew Vashburgh **Staff Photographer** Paul Gilby **Technical Illustrator** Len Huxter **Consultants (Music)** Warren Cann, Ian Boddy, Geoff Fogg, Paul Wiffen **Consultants (Technology)** Ken McAlpine, Jay Chapman, Steve Howell, Jon Grant, Paul Williams, Peter Maydeav **Advertisement Manager** Tony Halliday **Accounts Secretary** Soupy Betts **Mail Order/Subscriptions** Cheryl May **Director** Dennis Hill **Publisher & Managing Director** Tony Day

Electronics & Music Maker is published monthly by Music Maker Publications, Alexander House, 1 Milton Road, Cambridge CB4 1UY ☎ (0223) 313722. Typeset by Goodfellow & Egan, Cambridge. Printed by Thomas Reed Printers Limited, Sunderland. Distributed by Punch Distributors' Services, London. All material is subject to worldwide copyright protection, and reproduction or imitation in whole or part is expressly forbidden. All reasonable care is taken to ensure accuracy in the preparation of the magazine but Music Maker Publications Ltd cannot be held legally responsible for its contents. The Publishers cannot assume responsibility for the return of unsolicited manuscripts, photographs, artwork, or projects. Permission to reproduce printed circuit board layouts or to market kits commercially must be sought from the Publisher.

Subscriptions: UK £15.50. Europe & Overseas (surface) £16.20. Europe (airmail) £23.50. Overseas (airmail) £37.50. Binders: £3.95 (inc. postage).

© Copyright 1984 Music Maker Publications Ltd.



# BRITAIN'S BEST CHOICE

## BUY WITH CONFIDENCE!



Roland HP80 Piano	£225
Roland HP30 Piano	£220
Roland HP80 Piano	£425
Roland HP70 Piano	£495
Roland EP600 Piano	£195
Roland HP400 Piano	£950
Roland HP300 Piano	£750
Roland PR800 Digital piano recorder	£350
Roland PB300 Rhythm plus	£275
Roland SH101 Synth.	£295
Roland MGS1 Optional extra for SH101	£29
Roland JX3P Poly Synth	£795
Roland PG200 Programme for JX3P	£175
Roland Juno 106	£725
Roland Jupiter 6	£1150
Roland Jupiter 8A	£2250
Roland MC200 Micro composer	£175
Roland TR909 Rhythm composer New	£699
Roland TR605 Drumatrix	£220
Roland TB303 Bassline	£220
Roland CR900 Compuhythm	£399
Roland CR500 Compuhythm	£299
Roland MX200 Digital keyboard recorder	£950
Roland JSD90 Digital keyboard recorder	£249
Roland MK31000 Midi Master Keyboard	£1665
Roland MK510 Midi Piano Module	£990
Roland MK530 Midi Poly Synth Module	£875
Roland MKC100 Digital Keyboard Recorder	£450

### WE MATCH OR BEAT ANY GENUINE ADVERTISED ROLAND PRICE

Roland JC 501 120 x 12 50W	£250
Roland JC 120 2 x 12 120W	£425
Roland C-20 Cube 20	£125
Roland C-40 Cube 40	£165
Roland C-60 Cube 60	£199
Roland C-60B Cube 60 Bass	£215
Roland C-40K Cube 40 Keyboard	£185
Roland C-60K Cube Keyboard	£235
Roland C-40CH Cube 40 Chorus	£175
Roland C-60CH Cube 60 Chorus	£199
Roland BN 60 Bass Chorus 80 watt	£349
Roland BN 100 Bass Chorus 100 watt	£495
Roland Spirit 10A	£79
Roland Spirit 25A	£139
Roland Spirit 30B Bass amp 30 watt	£159
Roland Spirit 50B Bass amp 50 watt	£199
Roland Spirit 15P Bass amp 15 watt	£115
Roland HK20 Home K/Board amp wood finish	£115
Roland PA-150 8 ch mix amp	£575
Roland PA-250 8 ch mix amp	£650

<b>DIGITAL DELAY MACHINES</b>	
New Roland SDE 3000	£699
New Roland SDE 1000	£350
Roland SST 40 Speaker Cabinet 40W	£150
Roland SST 60 Speaker Cabinet 60W	£180
Roland SST 80 Speaker Cabinet 80W	£215
Roland SST 120 Speaker Cabinet 120W	£425
<b>BOSS MIXERS, AMPLIFIERS &amp; SPEAKERS</b>	
PW-1 Rocker Wah	£83
PV-1 Rocker Volume	£79
PSM5 Power Supply Effects Loop Pedal Inc. Including PSA 220	£62
BCB6 Boss Effect Pedal Carry Case	£57
HA5 Play Bus Headphone Amp	£95
RH11M Stereo Phones and Microphone	£95
DM3 Stereo Antiqua Delay	£95
<b>BOSS TUNERS AND RHYTHMS</b>	
TU-12 Chromatic Tuner	£43
TU-12H Chromatic Tuner	£45
DR-110 Dr. Rhythm	£115
<b>BOSS MIXERS, AMPLIFIERS &amp; SPEAKERS</b>	
J-5 Junction Box	£18
J-44 Junction Box Phono Mini - RCA	£17
BX-400 4 Channel Mixer	£83
BX-600 6 Channel Stereo Mixer	£125
BX-800 8 Channel Stereo Mixer	£225
KM-01 Compact 1-1 Mixer	£46
MA 15A Monitor Amp 15W	£105
MA-5 Monitor Amp 5w	£62
MS 100A Monitor Speaker 100w	£83
MSA 100 Monitor Speaker Stand Adptr. for MS 100C	£21
(Add £1.00 carriage per item)	

### Roland New Products

NEW ROLAND GUITAR SYNTHESISER AVAILABLE NOW!



Roland GR707 and GR700 £1895

### TOTAL MIDI SYSTEM

**MKB-1000** MIDI KEYBOARD CONTROLLER

**MKS-10** PLANET-P

**MKS-80** SUPER JUPITER

**MKS-30** PLANET-S

**MSQ100** IN STOCK

**MPC-8** MIDI PAD CONTROLLER IN STOCK

### BOSS BUY NOW AND BEAT THE PRICE INCREASE!

PSA 220 Minis Adaptor to FSM5 or SH101	£14
ACA-10 Minis Adaptor	£14
BF-2 Flanger	£79
CE-2 Chorus	£75
CE-2 Chorus with Stereo modes	£75
DS-1 Distortion	£49
SD-1 Super Overdrive	£49
GE-1 Blend Graphic	£75
GE-10 10 Band Graphic	£99
NF-1 Noise Gate	£43
PH-1 Phaser V Resonance	£75
TW-1 Trem Wah	£59
DD-2 Digital Delay	£149
OC2 Overtone	£54
VB2 Vibrato	£65
HM2 Hitting Metal	£45
HC2 Hard Core	£49
PC2 Praticum Synth Processor	£49
RX-100 15 Line Reverb Pre	£135
DE-2 Digital Delay	£265
FV-100 Fuzz Vibe Vol. Pedal	£53
FV-100 Fuzz Vibe Vol. Pedal	£62
PD-1 Phaser Distortion	£75

**SEQUENTIAL CIRCUITS INC**

**New six tracs & Drum tracs in stock**

Six tracs **£749**

MODEL 64 MIDI SEQUENCER complete with Commodore 64 Micro Computer **£375**

Drum tracs Digital drum machine **£895**

**MIDI**

Roland MC202 microcomputer RRP £399 **£175+£3 P&P**

Now you can link your home computer to your Midi keyboard, a great range of software is available with more on the way. CALL IN FOR A DEMONSTRATION AND SEE HOW THE MIDI MICRO LINK OPENS UP A WHOLE NEW DIMENSION IN MODERN MUSIC.

For Commodore 64	
RMS 20L Multi Track Composer	49.95
RMS 11L Sound Editor for DX7	45.95
RMS 21L Sound Library for DX7	49.95
RM-1 JL Arpeggiator	19.95
<b>FOR SPECTRUM</b>	
RMS 105 Live Recording	29.95
RMS 110 Arpeggiator	19.95
RMS 125 Multi Track Composer	49.95
<b>HARDWARE</b>	
RMS 1M Midi Interface for Commodore	29.95
RMS 2H Midi Interface for Commodore/Spectrum	89.95
RMS 3H Double Footswitch	18.95
RMS 4H Syncro Lable	5.75
RMS 3H Syncro Lable (Commodore user port)	15.50
All carriage free	

**YAMAHA**

**CX5M Music Computer**

YAMAHA DX7 £1299  
YAMAHA DX9 £799  
YAMAHA PF10 £699  
YAMAHA PF15 £949  
YAMAHA RX15 £449

SEE HEAR AND TRY THE NEW YAMAHA CX5 MUSIC COMPUTER

**KX5** IN STOCK **£449.00**

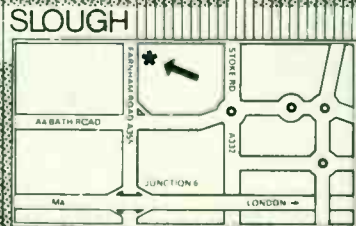
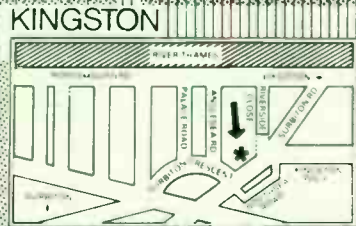
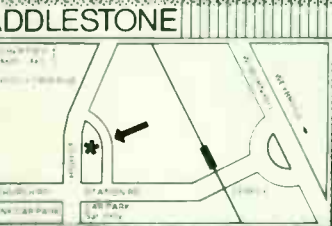

**Where to find ABC music**

**KEYBOARD REPAIR DEPT. NOW OPEN**

ABC MUSIC 14-16 High St. Addlestone Tel. Weybridge 40139/54877

ABC MUSIC 56 Surbiton Rd. Kingston Tel. 01-546 9877

ABC MUSIC 324-326 Farnham Rd. Slough Tel. Slough 822754

● 7 DAY MONEY-BACK GUARANTEE

● INSTANT CREDIT

Phone in your credit card number for instant dispatch!



Dear E+MM,  
 review of  
 to upgrade  
 Pro 1 set  
 polysynth. I've looked at the new  
 synth but in a bit of the

# INTERFACE

Write to: Interface, E&MM, Alexander House, 1 Milton Road, Cambridge CB4 1UY

If you've a view, query or problem write to Interface at the above address. We will endeavour to answer each query so please include your full address and phone number.

## MIDI Sequencing

Dear E&MM,  
 Since I wrote to you last I have disposed of my Roland SH101 and now own a Korg Poly 800. Could you please recommend a MIDI interface for the ZX Spectrum (48K version) and some suitable software that's easy to use and simple to set up.

Perhaps something along the lines of the SCI Model 64 is available for the Spectrum, though I would like a multi-timbral real-time sequencer if possible.

Robert Byrne  
 Southampton

Thus far, we've reviewed two MIDI software packages for the Spectrum, from Jellinghaus Music Systems and Electromusic Research respectively. The JMS programs were examined in E&MM July '84, and further details can be had from Rosetti, 138-140 Old Street, London EC1V 9BL, ☎ 01-253 7294.

The EMR MIDitrack Composer was reviewed in August '84, albeit in conjunction with the BBC Micro, but EMR's distributors, Rose Morris, tell us that a similar package for the Spectrum will be available towards the end of September.

The Poly 800 is capable of receiving up to eight monophonic tracks on any MIDI channel between 1 and 16, but these lines will all replay using the same preset voice. The Poly 800 is not, therefore, capable of multi-timbral sequencing.

Incidentally, an information sheet (separate to the Owner's Manual) relating to the Poly 800's MIDI Implementation is available from Rose Morris, 32 Gordon House Road, London NW5, ☎ 01-267 5151, at no charge, though we reckon they'd appreciate a large SAE.

## Dividing Down

Dear E&MM,  
 It seems a very high proportion of your printed letters concern triggering/ interface problems between different pieces of equipment. I have a similar problem. I wish to trigger a Clef Master Rhythm drum machine (at one pulse per 16th bar in 4/4 time) from the DIN sync socket of a Roland MC202. Playing around with a voltmeter and logic probe has shown one of the DIN pins to be pulsing, but at too high a rate. Could you possibly design a divider circuit to give the required pulse rate from this socket?

D Stevenson  
 Somerset

The circuit below will divide a pulse train by two, and may be cascaded to provide the necessary division. Any D-type flip-flop will do but we recommend the CMOS 4013: this will operate at any power supply between 5V and 18V. See also the letter headed 'Odd One Out' for the wiring connections of Roland DIN sockets.

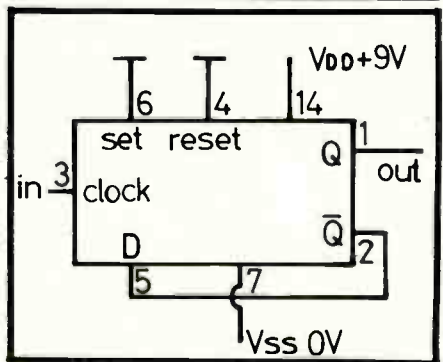
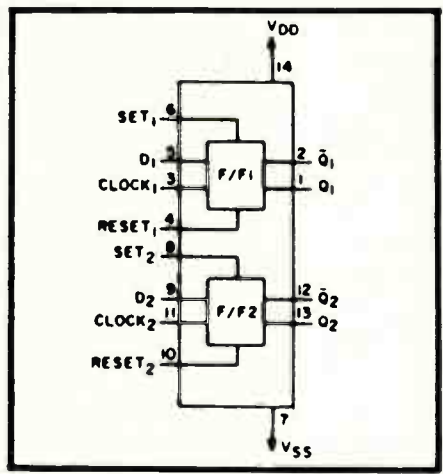

Readers' letters detailing problems with triggering and interfacing equipment reach the Interface desk daily, a situation that's prompted us to start a series explaining the ins and outs of triggering. See 'Everything But the Kitchen... starting in next month's E&MM.

## Odd One Out

Dear E&MM,  
 I have a music system based around a Commodore 64, SCI Model 64 Sequencer, Prophet 600, SCI Drumtraks, and Roland Bassline. I have tried (to no avail) to trigger and run the Bassline in sync with my system, but all it does is light the Run/Stop LED. The Roland gear triggers at 24 pulses-per-quarter-note and I have set the Drumtraks to give this output from the clock, but still no joy. Can you help?

Michael Palin  
 Hants

The wiring connections of the five-pin DIN socket on Roland products are as follows: Pin 1 - start/stop signal; Pin 2 - ground, Pin 3 - clock signal (5 volts pulse). The Bassline, therefore, needs a 5V trigger pulse on Pin 1 to start and stop the clock, with the switch, of course, set to the 'Sync' position.

## Micro Wasp

Dear E&MM,  
 Glancing through the 'Synthesis On A Budget' feature in your July issue, I was interested to read that the Wasp monosynth could be interfaced directly with a microcomputer. As I already own a 48K ZX Spectrum and have recently bought a secondhand Wasp, could you tell me if it is possible to interface the two?

S J Normanton  
 Lancaster

It so happens that E&MM contributor Peter Maydew has this exact system up and running, and he replies as follows:

'The Link sockets on the Wasp are a sort of primeval MIDI, enabling lots of Wasps and Gnats to be played in unison from one keyboard. The Spider sequencer also uses these sockets, and a polyphonic keyboard (called the Caterpillar) was also available which could control up to four Wasps.

'To interface your Wasp to a computer, all you need is a parallel output port: the Spectrum isn't equipped with one of these, but many small companies market add-ons which plug into the back. The Wasp codes were reproduced in E&MM January '82, but here are the connections summarised again:

Link Socket Pin No	Output Port Bit No
1	0
2	2
3	4
4	1
5	3
6	7
7	5
case	Ground

The output code required is (11-note no.) + 16\* (2-octave no.) + 128\* gate, where note number is between 0 and 11 (0 = C), and the octave number is between 0 and 2, 0 being the lowest. Gate codes are 0 for note not sounding, 1 for note sounding.



# WE HAVE MOVED TO (Soundwave's old shop)

66 Victoria Rd, Romford, Essex, RM1 2LA. Tel: Romford 754548 and 25919  
CREATING THE LARGEST GROUP MUSIC STORE IN THE SOUTH EAST!

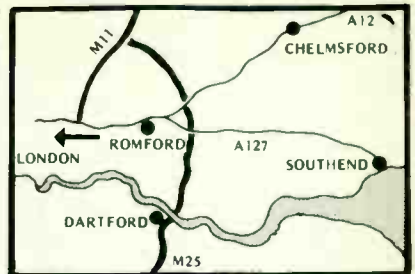
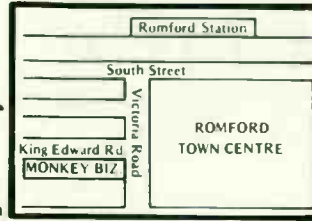

"The Best Shop We Visited In The Last Two Years"  
International Musician

## STATUS BASSES

Handmade Carbon Graphite Headless Bases  
Described by I. M. (and many of our customers) as  
"The Best Available Anywhere".  
Fretted or Fretless..... £1.096

## JAYDEE CUSTOM BASSES

The Supernaturals (As used by Mark King).  
"Especially suited for the jazz funk slapping technique".  
Unique Active Circuitry.  
The 'Mark King' Model..... £675  
The Roadie Active..... £549  
All Other Models Available On Request.

## WAL CUSTOM BASSES

The most individual handcrafted instruments available.  
Large choice of exotic hardwood finishes.  
Balanced D.I. Output. Active Electronics  
Fretted or Fretless..... £670

## VIGIER 'PASSION' BASSES

"We've rarely encountered such a speedy neck on any bass".  
Music U. K.  
Active Parametric E. Q. Beautifully Hand Made.  
Passion, Fretted..... £699  
Passion, Delta Metal Fretless..... £699  
Arpegge and Memory Bases..... P. O. A

## OTHER FRETLESS BASSES

Fender Precision in Sunburst..... £325  
Tokai Pastorius Jazz..... £299  
Ibanez SB55 Special II..... £275  
Le Voi Hand Made, Active..... £275  
Westone Thunder 1A, Black..... £175  
Steinbergers - The Ultimate!..... £1,300  
PLEASE NOTE: We charge only £40 to de-fret any bass purchased from ourselves.

## OTHER FRETTED BASSES

Musiman Stingray, Clear Red..... £599  
Ibanez MC924, Active..... £425  
Ibanez Roadstar RB850..... £299  
Ibanez Roadstar, S/Hand..... £175  
New Ibanez Models Due This Month..... PHONE!  
Aria, New Five String, Black..... £399  
Aria, R5B Deluxe 2, Blue..... £299  
Aria, R5B Standards..... £159  
Aria, SB600, Oak..... £250  
Tokai Jazz Bases..... £225  
Tokai Hard Puncher, S/Hand..... £169

## FENDER BASSES DOWN IN PRICE!

New U.S.A. Precisions..... £265  
New U.S.A. Jazz..... £335  
Fender Squier Precision Popular..... £195  
Fender Squier Vintage Precision..... £219  
Fender Squier Vintage Jazz..... £235  
Riverhead & Washburn Bantams..... £445  
Encore Electro-Acoustic..... £199  
Westone Thunder I..... £135  
Westone Thunder I, Active..... £149  
Westone Thunder 1A, Black..... £159  
Westone Thunder I, Jet Black..... £159

## TRACE ELLIOT Exclusive Essex Dealer

Trace Elliot GP11 Pre-Amp..... £239  
Trace Elliot AH150 Amp..... £333  
Trace Elliot AH250 Amp..... £567  
Trace Elliot AH500 Amp..... £682  
Trace Elliot 4x10" Cab..... £305  
Trace Elliot 1x15" Cab..... £324  
Trace Elliot 2x15" Cab..... £621  
Trace Elliot 8x10" Cab..... £598  
Trace Elliot 1115 Combo..... £665  
Trace Elliot 1110 Combo..... £641  
Trace Elliot 7115 Combo..... £604  
Trace Elliot 7410 Combo..... £580

## DYNACORD AMPLIFICATION

These Much Respected And Sought After Guitar & Bass Combo's NOW IN STOCK. Call For A Demo.

## GUITARS

Gordon Smith Gypsy I..... £275  
Gordon Smith Gypsy II..... £350  
Washburn Falcon Vibrato..... £299  
Washburn Falcon, S/Hand..... £195  
Washburn Hawk, Left Hand, S/Hand..... £249  
Washburn Stage A20V, S/Hand..... £399  
Washburn Tour, Trem, Black, Red..... £325  
Tokai 1959 Style L. P. Standards..... £299  
Tokai 1959 Style 335 Semi..... £399  
Tokai Aluminium Talbo, Black..... £369  
Tokai TE Model, Paisley Pink..... £299  
Tokai TE Model, Bond Edge..... £265  
Tokai TE Model, Quilted Mahogany..... £252  
Tokai TE Standards..... £225  
Tokai ST Vintage Models..... £225  
Tokai Vintage Flying V..... £299

## LEFT HANDED TOKAI'S

NOW IN STOCK!!!  
B. C. Rich Mockingbird, Black..... £235  
Kramer Van Halen - In This Month..... £ PHONE  
Aria Explorer Z2 Special..... £199  
Aria Urchin U60, Trem..... £175  
Aria Urchin U60, Deluxe..... £199

## Overwater Customs - NOW IN STOCK

Ibanez Ruidster 505, Trem..... £265  
Ibanez Ruidster II, Trem..... £199  
Ibanez Cimarr, 3 Pick-Up..... £125  
Ibanez Cimarr, 3 Pick-Up, S/Hand..... £99  
Ibanez Blazer, Trem, S/Hand..... £135  
Ibanez 'Gary Moore' Black, Trem..... £165  
Many Excellent New Ibanez Models Due In Epiphone Crestwood, 1959..... £195  
Epiphone Riviera Semi-Acoustic..... £299  
Baldwin 1960's Vibrolam..... £150  
Gibson Marauder, S/Hand..... £195  
Bond Guitars, Arriving Soon..... £ PHONE  
Fender Squier Popular Tele's..... £199  
Fender Squier Popular Strats..... £199  
Fender Squier Vintage Strats..... £199  
Fender Tele, Double Guitars..... £495

## FENDER (USA) PRICES DOWN!

Latest Model Stratocasters..... £295  
Latest Model Telecasters..... £265

## SESSION AMPLIFICATION

New Mosfet Models NOW IN STOCK!!!  
Sessionette 75w. 1X12" Reverb..... £245  
Sessionette 75w. 2X10" Reverb..... £275  
Sessionette 100w. 1X15" Bass Combo..... £339  
Sessionette 100w. 4X10" Bass Combo..... £355

## RACK EFFECTS

Ibanez HD1000 Harmonizer..... £365  
Ibanez DM1100 Delay Line..... £299  
Ibanez DM500 Delay Line..... £262  
Ibanez DM2000 Delay Line..... £424  
JHS Digital Delay With Modulation..... £235  
Aria 10 Band Stereo Graphic..... £130  
Maxim 12 Bit Digital Delay..... £299  
Roland SDE3000 Digital Delay, 8 Memories..... £836  
Roland SDE1000 Digital Delay, 4 Memories..... £409  
Boss DE200 Digital Delay With Modulation..... £287  
Vestafire Stereo Spring Reverb..... £225  
Aces Mono Spring Reverb..... £99  
Cutech Echo & Reverb..... £139  
Dynacord Digital Reverb..... £ PHONE  
Dynacord Digital Echo..... £ PHONE  
Korg SDD1000 Delay..... £337

## HOME RECORDING

Cutech MR402, High Speed 4 Track..... £425  
Cutech Octette, 8 Track..... £899  
Clarion XD5, High Speed 4 Track..... £499  
Clarion XA5, Master Cassette/Mixer..... £799  
Tascam 244 Portastudio's..... £599  
MTR 6/4/2 Mixer..... £225  
Cutech 12 Channel Stereo Mixer..... £335  
Dynamix 12 Channel Stereo Mixer..... £259  
Dynamix 16 Channel Stereo Mixer..... £368  
CUTEC OCTETTE, 8 TRACK £ PHONE

## REHEARSAL ROOMS AND 8 TRACK RECORDING

### ROLAND MAIN DEALER

New Juno 106 Polysynth, 128 Memories, Midi Etc  
JX3P Polysynth, Memories, Sequencer, Midi Etc  
Jupiter 6 Polysynth, Split Keyboard, Midi Etc  
S1101 Mono Synth With Arpeggiator & Sequencer  
MKB1000 Midi Mother Keyboard, 88 Keys  
MKB3000 Midi Mother Keyboard, 76 Keys 76 Keys  
MKS 10 Planet P Midi Module, Piano  
MKS-30 Planet S Midi Module, Polysynth  
MKS 80 Super Jupiter Midi Module, Polysynth  
MPG-80 Super Jupiter Programmer  
Axis Midi Remote Keyboard, 49 Keys  
Juno 6 Polysynth, Arpeggiator, Stereo Chorus Etc.  
Juno 60 Polysynth, Arpeggiator, 56 Memories Etc.  
GR707 Guitar Synth, 64 Memories, Ram Pack, Midi Etc.  
GR707 Guitar Controller For GR700 Synth. (With Case)  
MSQ100, Digital Keyboard Recorder, Midi  
MSQ700, Digital Keyboard Recorder, Midi/DCB  
MPC8, 8 Pad Midi Controller  
JSQ60 Sequencer For Juno 60 Or Jupiter 8  
MC202 Microcomposer, Built In Synth, Twin Channel  
TR909 Drum Machine - Price Reduced!  
TR606 Drumatrix, 32 Memories, 8 Tracks  
TB303 Bassline, 64 Memories, 7 Tracks  
CR5000 Preset Rhythm Unit With Arranger  
CR8000 Preset Rhythm Unit With Memories  
New Model Jazz Chorus Combo's NOW IN STOCK  
Cubex Combo's In Stock For Bass, Keyboards, Guitar Etc  
Spirit Lead And Bass Combo's In Stock  
PA150 And PA250 Stereo Powered Mixers  
New RM84 Mixers And SRA Power Amps  
SR580 And SR5120 Compact Speaker Systems.  
As a Roland Main Dealer, we guarantee the best deal on all Roland equipment with the full backing of Roland U. K. Ltd. PHONE FOR DETAILS

## BOSS EFFECTS

BF2 Flanger..... £86  
CE2 Chorus..... £81  
CE3 Chorus..... £81  
CS2 Compressor..... £67  
DD2 Delay..... £159  
DF2 Dist/Feedback..... £61  
DM3 Delay..... £102  
DS1 Distortion..... £56  
GE7 Graphic..... £81  
HC2 Handclapper..... £61  
HM2 Heavy Metal..... £49  
NF1 Noise Gate..... £46  
OC2 Octaver..... £58  
OD1 Overdrive..... £58  
PC2 Perc. Synth..... £53  
PH1R Phaser..... £81  
PH2 Phaser..... £86  
Mains Adaptors..... £14  
SD1 Overdrive..... £56  
TW1 Touch Wah..... £66  
VB2 Vibrato..... £71  
MS100A Monitor..... £89  
HAS H/Phone Amp..... £102  
RH11M Phones/Mic..... £61  
TU1212 Tuner..... £46  
KM04 Mixer..... £48  
BX400 Mixer..... £89  
BX600 Mixer..... £135  
BX800 Mixer..... £246  
GE10 Graphic..... £110  
RX100 Reverb..... £148  
DE200 Delay..... £287  
DR110 Rhythm..... £123  
PSM5 Master Switch..... £67  
J5 Junction Box..... £19

## KORG KEY CENTRE

DDM110 Digital Programmable Rhythm..... £229  
DDM220 Digital Latin Percussion..... £229  
KPR 77 Rhythm Unit..... £249  
PSS50 Super Section..... £399  
Poly 800 Synthesizer..... £499  
Poly 61 Synthesizer..... £650  
Poly 61M Synthesizer..... £699  
RK 100 Remote Midi Keyboard..... £450  
Ex-800 Midi Synth, Mobile..... £399  
Trident Polysynth, S/Hand..... £799  
KMX-8 Stereo Mixer..... £199  
SAS20 Personal Keyboard..... £495  
SP80's Piano + Strings..... £799  
PME40X Pedalboard..... £89

## IBANEZ EFFECTS

-AD9 Echo..... £99  
TS9 Overdrive..... £37  
CP9 Compressor..... £39  
SD9 Distortion..... £37

Name \_\_\_\_\_

Address \_\_\_\_\_

Tel. \_\_\_\_\_

Please send me the following goods/leaflets.

I enclose a S. A. E.

I enclose cheque/P.O. for £ \_\_\_\_\_

or debit my Access/Visa Account Number \_\_\_\_\_

Tick if H.P. form is required

66 Victoria Rd, Romford, Essex, RM1 2LA. Tel: Romford 754548 and 25919

FAST & EFFICIENT MAIL ORDER. IMMEDIATE DESPATCH ON ACCESS OR VISA CARDS.  
INSTANT NO DEPOSIT H.P. (APR 36 7) PRICES INCLUDE VAT. PART EXCHANGE WELCOME.



THE EVENING NEWS

# art NEWSDESK

witches & ... rrying ... and dis ... toda

The Staff, R... of the R... and dis ... toda

Emery, ... aborket, last ... e... ...

... source per ... athletes, we ... -ready ... aid po ...

## TECHNOLOGY

Following the success of their Multitrack Courses, Gateway Education Services are planning to run additional courses in the creative use of synthesisers and synthesiser technology. The *Primary Course in Music Synthesis* will cover such topics as basic sound wave theory, additive and subtractive synthesis, harmonics, filters, audio mixers, time delay effects, signal processing, syncing, digital synthesis, MIDI, computer-based systems, and so on. The course will be held over at least five days and Gateway are anxious to hear from anyone, whether or not they are potential participants, with any further ideas as to the content and structure of the course. Further information from, and observations to Dave Ward, Gateway Education Services, 1A Salcott Road, London, SW11 6DQ, ☎ 01-350 0340.

Roland UK have made available two booklets aimed at helping the newcomer to drum machine programming tackle their budget DR110 and TR606 drum machines. Written in the US by Sandy Feldstein, these step-by-step guides to creating rhythm patterns explain the actual function of the machines (perhaps duplicating part of the Owner's Manual?) before showing the user how to compose simple rock and blues beat patterns.

Both are priced at £2.95 and are available from Roland (UK), Great West Trading Estate, 983 Great West Road, Brentford, Middx TW8 9DN, ☎ 01-568 4578.

## STOP PRESS

Newport Pagnell has witnessed the opening of a new Tim Gentle Music shop stocking a wide range of Yamaha, Roland, Sequential Circuits, Marshall, Fender, Gibson and Peavey products. Check it out now at 78 High Street, Newport Pagnell, Milton Keynes.

Romford readers may like to know tht their local Monkey Business music shop is moving to larger premises during September, and from then on will be hanging out at 66 Victoria Road, Romford, ☎ (0708) 754548.

'Electro-Acoustics and Music' is the title of a one-day seminar being organised by the Institute of Acoustics, EMAS, and the Institute of Musical Instrument Technology to be held in the Department of Musical Instrument Technology, London College of Furniture, 41 Commercial Road, London E1, on Friday, October 5, 1984.

E&MM contributor Tim Orr will deliver a talk on 'Electronic Speech' and other lectures include 'Vocal Synthesis', 'Approaches to Control Room Design', and 'The Recording Environment'. The fee (including lunch) is £15 for members of IOA, EMAS, and IMIT, £12 for student members, and £20 for non-members.

Leisuretronics, Royal Horticultural Hall,

Victoria, London SW1 – November 8/9/10/11, 10am – 6pm. (Exhibitors include E&MM, Home Studio Recording, and Guitarist magazines).

Musicom '84, Hilton International Hotel, Rotterdam, Holland – November 9/10/11.

## HARDWARE

Oberheim DMX owners may like to know that a new retrofittable Memory Expansion Update is now available, while the new user-changeable Voice Cards include a complete set of electronic drums. Further information from Atlantex Music, 3 Cadwell Lane, Hitchin, Herts, ☎ (0462) 31511.

The SBX80 Sync Box from Roland is designed to solve the problems of varying synchronisation codes used by film, video and



electronic musical instruments. It's a multi-timebase, SMPTE and MIDI compatible clocking device and, used as a master controller, can read a variety of signals including audio click-tracks and live performance cues while simultaneously sending synchronising information to other devices that use different time codes. SMPTE functions as the common denominator for all the other timing codes that the Sync Box reads or generates, and enables the user to search, retrieve, insert and delete individual sections. The SBX80 accepts inputs from SMPTE, MIDI, Audio Clock, and its manual Tap button, while its outputs include 2 x MIDI Outs, 2 x Sync Outs (Roland's 24-clock DIN signals), a programmable Time Base (1, 2, 3, 4, 24, 48, 64, 96, or 120 pulses-per-quarter-note), SMPTE (for multitrack recording, video, TV and film production), and Metronome Out.

RRP is £900, and further information can be obtained from Roland UK, Great West Trading Estate, Brentford, Middx TW8 9DN, ☎ 01-568 4578.

## MUSIC

Paradise Studios is a new 24-track recording studio equipped with a wide range of the latest synths, sequencers and samplers, from DX7 to Fairlight. At only £18 per hour, inclusive of the use of all equipment and the services of

an expert programmer, Paradise sounds very tempting. Full details from Paradise Studios, 13 Queensberry Mews, London SW7, ☎ 01-589 6751.

The 1984 Nettlefold Festival taking place during October provides six evenings of new music, with two concerts each evening, one comprising live music, the other recordings from various studios. The programme, supplied by organisers Simon Desorgher and Lawrence Casserley, runs as follows: *Friday October 5* – Circle, Denis Smalley; *Saturday 6* – Harry Spaarnay, Stephen Montague; *Friday 12* – Tube Sculpture, Hugh Davies; *Friday 19* – Melvyn Poore, Richard Orton; *Saturday 13* – Yoshikazu Iwamoto, Jonty Harrison; *Saturday 20* – Vocem followed by tapes from London studios.

Tickets are £2.50 for each evening (both concerts) from Lambeth Amenity Services, 164 Clapham Park Road, London SW4, ☎ 01-622 6655 Ext. 355, or at the door. Nearest train station is West Norwood (from Victoria or London Bridge) or buses 2, 2B, 68, and 196.

The 8th Annual Synthesiser Tape Contest is an international extravaganza of music produced with computer and synthesiser instruments, and is open to musicians from all parts of the world. Entry classifications comprise Class A for professional musicians and Class B for amateurs, and this year's prizes include new Roland products, Fostex speaker systems, TEAC Syncaset 234s, and more. Further details and entry forms from ESSP, Sound House, PO Box 37B, East Molesey, Surrey KT8 9JB, ☎ 01-979 9997. Closing date for the receipt of applications and tapes is October 31, 1984.

'Towards a Theatre of Sound '85' to be held at the Shaw Theatre, London, on March 23/24 next year, offers another opportunity for composers of electro-acoustic and computer music to gain recognition. Promoted by the Society for the Promotion of New Music in collaboration with EMAS (Electro Acoustic Music Association), the two-day event will consist of lectures and demonstrations culminating in a concert on the second evening of a programme of music for computer, tape and live electronics. Equipment will be provided from EMAS' Equipment Pool or as required. Tapes and scores for possible inclusion in the event are invited and the closing date for submissions is October 31, 1984. Application form and full details from SPNM, 10 Stratford Place, London W1N 9AE, ☎ 01-491 8111.

Mention must be made of Don Slepian's cassettes *Sea of Bliss* and *Rhythm of Life*, both of which landed at E&MM's offices recently. Don's music is aptly described by his record label as 'effervescent, stimulating, soothing and harmonious electronic music', and both cassettes are available at \$8.95 each, plus \$2.00 postage per cassette. Further information and a catalogue of over 400 titles from Fortuna Records, PO Box 1116, Novato, CA 94947, USA.



# J S G MUSIC

Tel: 0274 568843/564389

ACCESS +  
BARCLAYCARD  
PHONE DETAILS  
FOR IMMEDIATE  
DESPATCH

OPEN  
MON 11-9 pm  
CLOSED TUESDAY  
WED 10.30-5.30  
THUR 11-9  
FRI 10.30-5.30  
SAT 10-5.30

WE HAVE ONE OF THE LARGEST SELECTIONS OF KEYBOARDS IN THE UK  
IN STOCK ALL PRICES INCLUDE VAT

**Roland**

ROLAND MAIN AGENT  
JUNO 106



JUPITER 8  
JUPITER 6  
JX3P  
JUNO 60  
TR909  
TR808  
TR606  
MXQ700

JSQ60  
HP30  
HP60  
HP70  
HP300  
HP400  
MD8 INTERFACE  
PHONE FOR PRICES

MC202 SPECIAL OFFER £175

THE ULTIMATE KEYBOARD  
360 SYSTEMS IN STOCK!



DIGITAL KEYBOARD  
8 note polyphonic  
splitting and doubling and  
layering modes.  
Sounds may be ordered individually

**Oberheim**



OB8 8 VOICE POLY, 120 PROGRAMS  
DMX 24 SOUNDS, 100 SONG MEMORY  
DX 18 SOUNDS, 50 SONG MEMORY  
DSX SEQUENCER, 6000 NOTES  
& 16 VOICE CONTROL



**YAMAHA**  
YAMAHA  
FM KEYBOARDS



PF10 STEREO 10 PRESETS 73 NOTE  
PF15 STEREO 10 PRESETS 88 NOTE  
KX5 16 NOTE POLY REMOTE KEYBOARD  
RX11 DIGI DRUMS 16 VOICE 10 OUTPUTS  
RX15 DIGIDRUMS 12 VOICE STEREO OUT

**moog**



**MOOG**  
Memory Moog  
£2395

ROGUE SPECIAL PRICE £157  
SOURCE SPECIAL PRICE £350

**SIMMONS**



SDS5  
SDS7 ALL IN STOCK  
SDS8

**SEQUENTIAL**  
CIRCUITS INC

6 TRAKS  
DRUMTRAKS  
PRO 600  
64 SEQUENCER  
PROPHET T8  
ALL IN STOCK

DRUMTRAKS



PROPHET T8

**KORG**

POLY 61  
POLY 61M (MIDI)  
POLY 800 } IN STOCK



POLY 800  
4-octave 8-note  
polyphonic keyboard  
with MIDI 64 programmes,  
2 DCOs and 250 note sequencer

MPC 5 DRUMS  
MODULAR SYSTEM £675  
CACTUS KITS £535

KEYBOARD COMBOS  
PEAVEY KB100 £229  
PEAVEY KB300 £343  
H/H K150 £319  
CARLSBRO COBRA 90 £225  
MCGREGOR 200 £335  
ROLAND CUBE60 POA

INSTANT CREDIT  
SUBJECT TO STATUS

HOME COMPUTERS, SOFTWARE, AND PERIPHERALS IN STOCK

WE ALSO HAVE A HUGE SELECTION OF GUITARS, AMP, & RECORDING EQUIPMENT

SALES CALL  
MARTIN or PAUL. Tel. 0274 568843/564389

Free delivery UK Mainland

104-108 MAIN ST., BINGLEY, W. YORKSHIRE

HP Facilities (HFC Trust)



# HARDWARE

## Yamaha PS6100 Personal Keyboard

Novel packaging, FM preset voices and MIDI compatibility set Yamaha's latest Portatone product well apart from the crowd, but how efficiently have its designers used the technology at their disposal? *Dan Goldstein*



As we reported in last month's round-up of new products at the recent British Music Fair, the latest trend among personal keyboard designers seems to be to put more in the way of 'professional' facilities into their machines, introducing a measure of playing and programming flexibility whilst retaining basic features that are essentially easy to use. It's a perfectly logical step to make, since on the one hand even the least exploratory home keyboard user is bound – sooner or later – to tire of an instrument that offers little or no scope for musical experimentation, while on the other, there are still a good many people (most E&MM readers excepted, I hope!) for whom the complexity of, say, a fully programmable polysynth is simply too much to cope with.

Yamaha's first attempt at glamorising the humble personal keyboard manifested itself a couple of months back in the shape of the MK100, which introduced the concept of user-programmability to miniature instruments via its versatile 'Multi Menu' section (see review E&MM July). The PS6100 takes some of the MK's features and develops them a stage further, so that whereas, for example, the 100 had only seven percussion voices in its semi-programmable rhythm section, the 6100 has no fewer than 21 – and they're of superior quality.

### Design

The major problem facing this instrument's designers must have been lack of

space: a multitude of pushbutton selectors and slider controls but only a standard five-octave keyboard width over which to mount them. However, the ergonomic solutions adopted by Nippon Gakki are both elegant and functional. Briefly, the 6100's controls are laid out on a flat metal panel that also acts as a foldaway lid when the instrument is not in use: a much smaller panel flips up over the bottom of the instrument, so that the keyboard is covered completely and can be transported without fear of, say, water infiltrating vital working parts.

The 6100's output is ordinarily mono, but this becomes stereo when the stereo chorus/ensemble circuitry is activated, so twin speakers are included at either end of the keyboard. The top of the control panel contains a built-in music stand, while a neat foldaway stand for the instrument as a whole was also included with the review sample. At a time when almost all modern keyboard instruments (and especially those from the Orient) seem to be made up of one giant plastic moulding, it's refreshing to see a machine that's solidly constructed from good old metal, so the aesthetics are as well executed as they are conceived. If the PS6100 were British, it would be on display at the Design Centre before it reached any music shop.

### Facilities

Like many of Yamaha's domestic keyboards, the 6100 has two banks of factory preset voices, the first being polyphonic (labelled 'Orchestra') and the other mono (labelled 'Solo'). The latter

contains 18 different sounds, the best of these being the vaguely 'synthetic' tones like Funny, Fantasy and Synthe. These are enhanced by the inclusion of an after touch facility (activated by the 'Touch Response' button), though the 6100's keyboard is perhaps a little spongy for the effect to be a real pleasure to use. A sustain option is also included, but strangely, none of the Solo section's voices seem to benefit greatly from its use.

In common with the remainder of the Yamaha's various control sections, the Solo voices are brought into operation by means of colour-coded switches and indicated by red LEDs: a further LED is connected to the section on/off switch that lies above the voice selectors.

The Orchestra section is split into two parts, and these correspond to the upper and lower halves of the keyboard, though 'halves' is something of a misnomer, because the split-point can be at any of three user-selectable points. The 'upper' bit offers 18 polyphonic voices, a sustain section (with two different sustain times available), and a stereo chorus/ensemble facility. Of the voices themselves, a few (Chimes, Marimba, Jazz and Pipe Organs) stand out as being very effective over the whole range of the 6100's keyboard, but some of the others (notably Strings, Brass, Jazz and Hawaiian Guitars) are considerably less agreeable: thin, weak sounds that bear almost no relation whatsoever to their real-world counterparts.

Frankly, if I hadn't been told beforehand that this Yamaha used FM for sound-generation, I'd never have guessed it – the voices are nowhere near DX standard. Having said that, in the context of the personal keyboard market the sounds are quite presentable, and it's only because the 6100's design has professional overtones that I've adopted such a critical attitude to the quality of its preset voices.

### Rhythm Unit

I don't think it would be inaccurate to suggest that the PS6100's machine is



the most comprehensively-equipped unit in the entire domestic keyboard arena. There are no fewer than 32 preset rhythms to choose from, while an innocent-looking button marked 'Variation' effectively doubles this range. There are also three different fill-ins available for each rhythm – accessed by the fill-in switch above the lowest octave of the keyboard – while selecting 'Break' eliminates the percussion track for one bar.

What really gives the rhythm machine its edge however is the quantity and quality of the percussion voices employed. There are 20 of them in all (excluding the handclaps, which are selected separately), and these are divided into two groups – drum percussion and Latin percussion. All the sounds use PCM encoding techniques for tone reproduction, and with the possible exception of the snare drum (why do electronic snares *never* sound absolutely right?), sound quality is exemplary. Listening to the Latin congas, for example, you could be forgiven for thinking that Working Week's rhythm section had been incarcerated within the PS6100's sleek exterior, and my only grumble is that the (non-user-programmable) stereo positioning of the voices is a little disconcerting, even using the instrument's built-in speaker system.

Like the MK100 alluded to earlier, this Yamaha rhythm section features a semi-programmable feature that goes by the name of 'Custom Drummer'. This enables the user to create personalised rhythm patterns by adding new percussion voices in real-time using specific notes on the Portatone's keyboard, and two such customised variations can be stored and recalled at the touch of a button.

The 6100's Auto Bass Chord section also contains more than a few surprises. Comprising pre-programmed monophonic bass lines and arpeggiated chords, the section offers some pretty agreeable backing tracks in conjunction with the drum machine, and what's particularly interesting is the way the lines change depending on the configuration of the chords you're playing. The bass and chord voices are also variable (though not by the user), and the section's bass guitar impression is especially impressive. Less wonderful is the fact that, no matter where you set the split-point between auto and manual sections on the keyboard, the Auto Bass Chord section can only span one octave: severely limiting to all but the most narrow-minded of keyboardists, I'd have thought.

The final section on the PS6100 control panel – located at the extreme right of same – is the Music Programmer, a four-track real-time recorder whose capabilities and operation will be familiar to anyone with previous experience of Yamaha's upmarket personal keyboards. Basically, the programmer allows you to store the output of the

Solo, Orchestra, Rhythm and Auto Bass Chord sections individually, and you can play back what you've recorded for one section and layer another section on top of it. If that sounds a little confusing, just imagine a four-track tape recorder in dedicated, solid state form – the 6100's music programmer is just as straightforward to use as its magnetic tape counterpart. A further section called 'Tape' allows digital data from both the Custom Drummer and Music Programmer sections to be stored on conventional cassette tape (to be accessed at a later date), while the extreme left of the panel contains a transpose selector, the master volume control, and a further selector that allows you to choose which of several functions comes under the control of the supplied footswitch.

The Yamaha's rear panel contains a number of sockets, some of them fairly typical of personal keyboards, others more unexpected. Phono sockets take care of Aux In and Out, the tape recorder connections are on mini-jacks, while standard five-pin DINs take care of MIDI In and Out – another nod in the direction of the pro keyboard market. The rear panel also houses the master pitch con-

'If I hadn't been told that this Yamaha used FM for sound-generation, I'd never have guessed it – the voices are nowhere near DX standard.'

trol, but although this is undoubtedly the safest point to mount such a fundamental item, the fact that it has no locking function or centre detent means that the chances of some accidental detuning occurring are still a little on the high side.

## In Use

The first thing that struck me on powering up the review model was an inordinate amount of RF interference appearing at the PS6100's output. This increased when the Orchestra section's chorus/ensemble section was brought into play, and since the 6100 has no earth lead incorporated into its mains cable, I can only assume earthing was the cause of the problem. Maybe Yamaha's metal case wasn't such a good idea after all . . .

Even without the interference problem, the chorus circuitry was unacceptably noisy in operation, and there was a fair bit of digital noise in evidence on some of the machine's preset voices, too, though this phenomenon manifests itself on the DX polysynths as well, so it isn't something that's confined to this particular version of FM.

As already mentioned, some of the preset voices – in both the mono and poly sections – were a lot more usable than others, though the chorus/ensemble circuit did beef up some of the

Orchestra voices (strings, for example). By contrast, the Yamaha's auto-accompaniment section was a joy to use, and a constant source of entertainment to anyone who happened to stroll into the E&MM offices while the machine was under test. If only Yamaha made a self-contained, programmable drum machine with Latin percussion sounds as good as these!

Connecting the 6100 to external amplification did more justice to the quality of the machine's sonic output (though as built-in units go, the Yamaha's four-inch speakers aren't at all bad) as well as ameliorating the interference problem, though I was a little surprised to find no option for DC powering from batteries – if you haven't got a mains point nearby, you can't use your PS6100.

## Conclusions

The PS6100 appears to be something of an enigma. Its paper specification would indicate a domestic keyboard that could justify being associated with the 'semi-pro' tag, yet in reality its design has a number of niggling faults which lessen its appeal by a not insignificant degree. Most of these – the quality of some of the preset voices, the one-octave accompaniment span, and so on – should be fairly easy to rectify given Yamaha's proven technological and engineering skill in other market areas, but that fact only serves to make them more annoying.

As a competent multi-purpose instrument, the 6100 will no doubt find a market amongst cabaret performers and home organists seeking a more contemporary-looking keyboard, but for the serious modern musician – and especially considering the model's formidable RRP – it doesn't quite take professionalism far enough.

Separate outputs for each of the sections, a somewhat less noisy stereo chorus unit, and some method of modifying the preset voices (the MK100 has this facility, so why hasn't Yamaha's flagship model got it too?) are just a few of the facilities serious keyboardists will want to make use of but which the PS6100 does not, as yet, provide.

I should imagine that Yamaha see the rôle of the PS6100 as two-fold: to introduce the domestic hobbyist to the world of programmability and (using MIDI) computer control, and to improve the basic specification of a home keyboard to make it suitable for the professional user. As you'll have gathered from the foregoing, there can be no question that the 6100 performs the former function admirably, even if the requirements of the latter rôle would seem to have been afforded rather less attention.

So call it the dabbler's DX, rather than the professional's Portatone. ■

*RRP of the PS1600 is £1100 including VAT. Further information from Yamaha Kemble Music (UK) Ltd, Mount Avenue, Bletchley, Milton Keynes, Bucks. ☎ (0908) 640202.*



# DDrums

## Electronic Percussion System

They're DDrums in Europe and E-Drums in the States, but either way, these digitally-sampled percussion modules sound pretty impressive.

*Dan Goldstein*

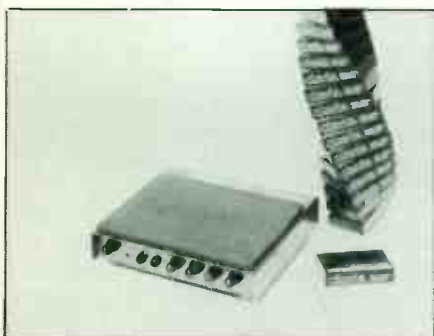

There can be no denying that digital technology is about to have a drastic effect on the way modern drummers, play and sound – if it hasn't done so already. Digital drums enable the advantages of analogue electronic percussion – instantly – repeatable, easily-recorded sounds at a fraction of an acoustic drum kit's setting-up time – to be enjoyed without making analogue's sonic sacrifices. In other words, with digital, you can sound how you like, where you like, when you like. Or so the theory goes.

### Background

The DDrum originates in Sweden, of all places, where engineer Hans Nordelius has been busy getting the best out of standard, commercially-available EPROMs and where they are manufactured by one Greg Fitzpatrick. In the meantime, the Swedes have entered into an agreement with E-mu Systems in the States, whereby the latter company has the sole rights to manufacture and distribute Nordelius' design and market it as the E-Drum. However, since no E-Drums will be appearing in the UK, it's probably safe to confine our attention to the Scandinavian variant.

Each DDrum unit is sold with one sound EPROM of the buyer's choice, of which there are some 39 from which to choose – but more about those later. Each unit has a series of front panel controls, these being concealed under a metal lip at the bottom of each pad out of harm's way, though fortunately the corresponding legend for each control is screen-printed on a flat surface at the top of the pad.

The controls are pitch (continuously variable over one octave), sensitivity (just about anything from finger to stick response), pitch sensitivity (whereby pitch can be made to lift depending on how hard the pad is struck), decay (continuously variable from 50mS to the maximum length available on the cartridge being used), and active bass and treble EQ controls. In addition, two pushbuttons take care of sound selection, as some DDrum EPROMs have two or four sounds, depending on the amount of memory space taken up by each sample.

The back panel contains DC mains connections (several DDrum modules may be powered from one mains source by daisy-chaining units together in series), external trigger and

CV inputs, the audio out connector, and the all-important cartridge bus connector. Now, I must say the DDrum solution to the problem of how to protect sound chips from the ravages of being transferred from storage to triggering module and back again is just about the most elegant I've seen. Each EPROM is encased in a light, black-painted plastic cartridge box – small enough to be carried around but the dozen yet strong enough to withstand all but the worst rigours of life on the road/in the studio. What's more, changing cartridges takes all of about five seconds, I should think, which is pretty quick by anyone's standards.

'The range of available samples includes a selection of off-the-wall sounds such as elephant bells, pistol shots, and even a bass tone from a Yamaha grand piano.'

### Sounds

DDrum cartridges come in three guises: 'B' cartridges, which use 16K EPROMs, 'C' cartridges (32K) and 'D' cartridges (64K), though none of the last-mentioned variety are yet in production. 'B' cartridges are used for the vast majority of samples in the DDrum library, the only exceptions being the orchestral tympan and large gong sounds, which are on Cs.

The 'B' EPROMs give a maximum sample length of 0.6 seconds – not quite long enough to capture the last decaying nuance of sound generated by some percussion instruments (most notably cymbals), but on the other hand, judicious use of the decay control can bring any side-effects down to manageable proportions.

One of the most attractive aspects of the DDrum system is the sheer variety of percussion samples on offer. At the time of writing, these include no fewer than eight different toms, a similar number of cymbals, five snares (with rimshot being an alternative sample on two of them – a nice, logical touch), and a selection of more off-the-wall sounds such as elephant bells, pistol shots and even a bass tone from a Yamaha grand piano.

And according to Mark Hickling, DDrums' European marketing manager, the company's engineers are at this very moment working on more samples to expand the range even further. These will include plenty of Latin and ethnic percussion voices, as well as some 'industrial' (for want of a better word) samples such as hammers hitting garbage containers and so-called 'mystery sounds'. The percussionist's mind boggles.

As far as sound quality goes, I can only report that – the odd slight decay time problem

excepted – the DDrum samples are some of the best I've yet heard. As I mentioned in last month's Trade Show report, some of the drum voices were recorded with the aid of digital reverberation equipment, which certainly adds a feeling of space to, say, Simmons toms, but even samples that were recorded dry have an uncannily realistic quality about them: all in all, they turn the DDrums into highly desirable units.

The standard bass drum cartridge contains four different (and all highly usable) samples, from a Ludwig 22" acoustic kickdrum to a sampled Linn voice – essentially a sample of a sample, but it sounds great! A conventional-looking bass drum pad, complete with stand and suitable pedal, is available as an option. Meanwhile, some of the less commonly-used percussion voices (the ethnic samples, for instance) look set to add spice to many a drummer's sonic vocabulary, and although the looping techniques employed to obtain the gong sample's seven-second decay time are audibly apparent, many people will still consider its use preferable to carrying around a 16' diameter version of the real thing.

### Conclusions

Cost of one DDrum unit in the UK is expected to be in the region of £295, including a 'B' cartridge of your choice, a mounting bracket, and full instructions, while additional 'B' cartridges will be about £59 each, 'C' variants £145. Now whichever way you look at them, those prices are not cheap, but although the cost of one unit is certainly a little on the excessive side, the EPROMs aren't too bad considering the drastic fluctuations in chip supply rates that most of 1984 has witnessed.

In addition to the extensive and expanding range of factory-sampled voices, the Swedes are also in the process of offering a custom recording service that'll enable owners to have a recording of their own percussion sound sampled onto EPROM for about £60, though DDrums are reserving the right to reject users' own samples on sound quality grounds. An exchange service is also in operation whereby if a DDrum owner gets bored with a particular sample, he/she can send it back to Sweden and get a new one put in its place for something like £15, which can't be bad.

Although a complete 'kit' comprising six or more DDrum modules may be beyond the financial reach of many people (though they'll doubtless be of interest to studios and the like), it shouldn't be too long before a number of drummers start adding the odd module or two to complement their existing set-up, especially as changing sounds in a live situation is so straightforward.

In that context, the DDrums are both a revolution and a revelation. Roll on those mystery sounds. ■

*RRPs for DDrum modules and EPROM cartridges are given in the text. Further information from: AB Greg Fitzpatrick, Box 19042, 10432 Stockholm, Sweden.*



## Do you know how to make music?

We are a record company with a problem.

Some of our artists need help. They have terrific voices, style, originality and musical inspiration – but need help to turn their ideas into reality.

If you think you can take a good song or idea and turn it into a great demo – or if you have stimulating and original ideas of your own –

Send us a tape.  
 Roger Jackson, TLO Ltd.  
 PO Box 4YY,  
 London W1A 4YY.

The  
 Warehouse

**HOBBS  
 MUSIC**

### JUNO 106



New Poly programmable from Roland featuring polyglide and midi interface.

### MC202 MICRO COMPOSER

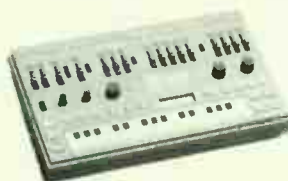

This super-value 2-channel micro-composer with built-in synth will directly interface with SH101, TR606, TB303 and incorporates tape-sync. (very useful for home recording). Phone for details.

### OSCAR MONO SYNTH

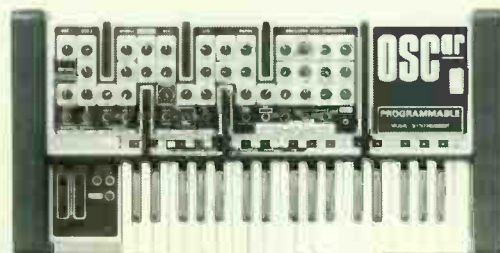

Mind-blowing new state-of-the-art mono synth, fully programmable – see rave review. (And it's British, chaps!)

### DDM110 and DDM220



The super-budget price digital drum machines from KORG. The latin percussion expander is truly excellent for that Frankie Sound. (U2 can go to Hollywood). Should directly interface with TR606. (We sincerely hope they are in stock by the time you read this ad.)

**ALL PRODUCTS CARRY  
 FULL MANUFACTURERS WARRANTY  
 ACCESS—BARCLAYCARD—AMERICAN EXPRESS**

**0524, 60740 or 34443**

**HOBBS  
 MUSIC  
 LIMITED**

**MARY STREET  
 LANCASTER  
 LA1 1UW  
 0524 60740**

## HAMMOND DIGITAL PERCUSSION MACHINE

Compare the  
 features—  
 Compare the price

STILL ONLY **£699** S.R.P  
 INCLUDING VAT

**STOP PRESS** New alternative voicing chips and drum pad interface unit now available

For illustrated brochure write to Hammond Organ (UK) Limited  
 42 Blundells Road, Bradville,  
 Milton Keynes MK13 7HF  
 Telephone (0908) 321414  
 Trade enquiries welcome



# TANGERINE DREAM

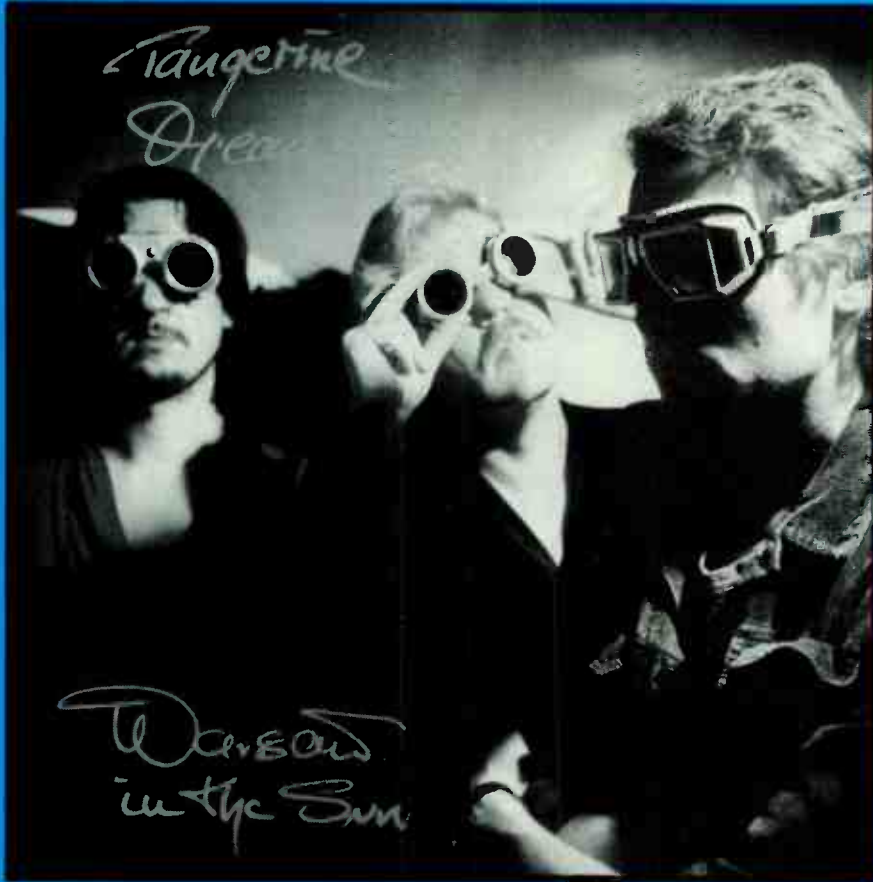

NEW SINGLE  
**“WARSAW  
 IN THE  
 SUN”**

AVAILABLE ON THE  
 NEW  
**JIVE ELECTRO LABEL**

7" AND 12"



# Subscribe Now!



**SUBSCRIBE NOW** to the biggest selling UK music monthly with a world wide readership from Cambridge to Cape Town! With coverage of all the latest in instruments, amplification and accessories, plus interviews with the leading artists and performers of the day – can you afford to do without it?

For 12 issues:

UK & Eire .....	£15.50
Europe & Overseas(surface) .....	£16.20
Airmail (Europe).....	£23.50
Airmail (outside Europe).....	£37.50

(Would overseas subscribers including Eire please note that payment should be covered by bankers draft in pounds sterling.)

Subscriptions normally start with the current issue of **E&MM**.

**Please fill in the coupon below, and enclose it with your cheque (or bankers draft) to: Mail Order Dept, ELECTRONICS & MUSIC MAKER, Alexander House, 1 Milton Road, Cambridge CB4 1UY.**

Please send me the next 12 issues of Electronics & Music Maker, I enclose a cheque/postal order for £15.50/£16.20/£23.50/£37.50, made payable to Electronics & Music Maker.

Please print or type carefully:

Name.....

Address.....



# Only the creativity and expertise of the people using Neve mixing consoles limits their sound quality

It's true. Neve mixing consoles — whether analogue or digital — are of such a high standard and quality that it is only the people who use them that limit their capability and sound quality.

When you specify or use Neve products, you have the backing of the world's most creative manufacturers of mixing consoles; you have the backing of some of the best production experts in the world; and you have the backing of the international resources of Neve.

The end result is the sound quality *you* want.



Digital and Analogue mixing consoles for recording studios, television and radio broadcasting and the film industry.

For full details of sound mixing consoles and systems phone the Neve technical information service on Royston (0763) 60776.

**Neve Electronics** International Ltd Melbourn, Royston, Herts SG8 6AU

---



# Yamaha RX11 & RX15

## Programmable Rhythm Machines

Yamaha's first-ever programmable drum machines are beginning to filter into music shops' displays. They're not as revolutionary as the DX synths, but they are excellent value. *Kendall Wrightson*



To say that Yamaha's digital drum machines have been eagerly awaited is something of an understatement. Some three years have elapsed since Linn started the digital drum revolution with their LM1, while it's now seven months since Yamaha announced their entry into the field with the RX11 and 15 reviewed here. The wait has not been in vain, since Yamaha have spent the last three years carrying out intensive research and development, and that time has resulted in a pair of machines that are simply stunning in terms of both facilities and price – the RX15 is under one sixth of the cost of the original Linn... The long wait has also ensured that the RXs are supplied with a useful implementation of MIDI as standard, MIDI having been around for only 18 months – though it seems much longer!

### Construction

The RXs are styled to match Yamaha's DX range of synthesizers, not only in appearance but also in operating procedures – hence the data entry controls and Function button. Once you've become familiar with the layout and operation of the controls, the units are very simple to use.

The RXs are light (about 3kg), the innards being held together by two pieces of moulded black plastic. Inside there are two PCBs, one attached to the base and one to the front panel moulding. Care has to be taken when opening an RX because the PCBs are connected together by short ribbon cables. The only IC given its own socket is the 27128 16K EPROM that contains the operating system. The drum sounds are stored on four (RX15) or six (RX11) Yamaha ROMs. It's clear from these observations that Yamaha do not intend for users to change the sounds in their drum machines.

### Programming

Programming the RXs is eased considerably by the inclusion of a 16-character liquid crystal display, though unfortunately this is not back-illuminated. The LCD guides the user through the programming procedure, and control parameters may be displayed instantly: the RX11 also boasts a two-digit LED display to indicate song or pattern number.

The instrument keys are firm enough to inspire confidence, yet require only the lightest touch to trigger a sound. The Quantize (time correct) facility can be set from 1/4 to 1/192, the latter setting programming flam effects in real time, and four levels of Swing make life even more interesting.

In Step Write mode, the bar is divided up into beats depending on the Quantize value. Beats are advanced by pressing the +1 key (which programs a rest), or by pressing one of the instrument keys. In general, step time is most useful for fast, intricate patterns or for locating an offending drum beat.

Patterns may be edited either by Clearing instruments from a pattern when the machine is stopped, or by holding Clear and pressing the appropriate instrument button while in real time Write mode.

Up to ten Songs can be constructed from as many as 255 different patterns. Full editing is possible, and Songs may also contain repeats (to save memory), and Tempo changes, ie. the initial tempo of a song is set up by the user and a tempo change value is entered as part of the song memory. If the tempo change is part of a repeat loop, then the tempo will increase/decrease every time the repeat loop is executed. The initial tempo can be set accurately using the +1/-1 buttons.

The RX11 can store up to 2000 'events', the RX15 1500. This is significantly lower than the figure achieved by most of the RXs' rivals: in practice I found that the RXs could hold two or three reasonably complex songs, but that may not be enough for some users. Pity. Both machines are fitted with a tape dump facility for program storage, but the RX11 is also equipped with a cartridge slot for Yamaha RAM packs, and so is well suited to live use as cartridge data loads in only a few seconds.

### MIDI

DX synth owners will be pleased to hear that buying an RX drum machine will also get them a mini-sequencer! This is because each drum sound can be allocated a note value which it will transmit via MIDI Out. A note value of 36 is bottom C on a DX7, for example. Each instrument can also be allocated its own MIDI channel, but the fact that this feature works only on DXs is somewhat annoying, and I hope Yamaha update the RX software to cure this problem.

The RXs generate the 24 pulses-per-quarter-note MIDI clock signal, and can also be set to run from an external clock (via the Tape In socket) at 24 (Roland), 48 (Linn) and 96 (Oberheim) pulses-per-quarter-note. Drum voices may be played by an external MIDI keyboard or from pads with full velocity information, but not programmed in the same way. Unfortunately the RXs will not sync to tape directly, but this can be overcome either by using a sequencer which does, such as the Roland MSQ700, or by amplifying the sync signal coming back off tape and cleaning it up at the mixing desk.

### Sounds

Yamaha make a big thing about the drum sounds in their advertising for the RXs, and rightly so. (Just as well, bearing in mind my earlier comment about changing sounds!) The bass and snare drums are Linn-like but warmer, the toms are slightly reminiscent of those on the Drumulator, and the claps are Roland-ish. The remainder of the sounds are bright and powerful, the only slightly weak sound being the open hi-hat, which takes a bit of getting used to. The toms can sound together on the same beat (which I think is a world first in the digital drum machine market) and the Accent, which is per instrument rather than overall, makes life generally more dynamic.

The following is a list of the sounds available on each machine:

<b>RX15 (15 sounds)</b>	<b>RX11 (29 sounds)</b>
Bass Drum	Bass Drum x 3
Snare Drum x 2	Snare Drum x 8
(Medium, Hi Tune)	
Rimshot	Rimshot x 2
Hi-Hat Open	Hi-Hat Open x 2
Hi-Hat Closed	Hi-Hat Closed x 2
Hi-Hat Pedal	Hi-Hat Pedal
Tom Tom x 3	Tom Tom x 4
Cymbal Ride	Cymbal Ride
Cymbal Crash	Cymbal Crash
Hand Claps	Hand Claps x 2
Cowbell	Cowbell x 2
Shaker	Shaker

Both RXs have stereo mix outputs rather than sockets for individual voices or groups of voices: the instrument levels, accent levels and pan settings are set up by the user via the data entry controls. These levels (together with MIDI status) are retained in memory even if the machine is turned off, thanks to good old battery back-up.

### Conclusions

There's no escaping the fact that Yamaha's first-ever programmable drum machines are excellent products indeed. Cheap-sounding rhythm machines and poorly-recorded acoustic drums are the ruination of many an otherwise competent demo tape, but now that digital percussion technology is becoming more readily accessible, those problems could soon be a thing of the past.

The RXs' PCM-encoded sounds are all usable, and some of them are very impressive indeed, which helps make up for the lack of user-tunability or separate instrument outputs. Most important of all, both machines (and especially the RX15) are good value, and when you consider both devices' aesthetic elegance and ease of programming, there can be no dispute over the final verdict. Go out and hear them. Now. ■

The RX11 and 15 carry RRP's of £799 and £449 respectively including VAT. Further information can be had from Yamaha-Kemble, Mount Avenue, Bletchley, Milton Keynes, Bucks. MK1 1JE. ☎ (0908) 649222.







# THE MUSIC VILLAGE



# YAMAHA

**HIGH-TECH DEALER.**



**CX 5M COMPUTER**  
with remote k/board & built-in FM generator  
**PHONE FOR INFO!**



## NEW DIGITAL DRUM MACHINES



**RX-15**  
13 sounds  
100 patterns  
10 songs  
MIDI

**RX-15 & RX-11**

Sampled drum sounds for less than £450!

**FOR UNDER £450!**

**KX-5 remote MIDI keyboard controller** with 32 accessible sounds & touch sense. Ideal for DX7 & linkable to any MIDI instrument

**ALL DX ACCESSORIES IN STOCK PLEASE RING**

## DIGITAL DELAY

**D1500 16 memories plus MIDI**  
The worlds first MIDI delay system!



**DIGITAL REVERB**  
R1000 astounding quality without any spring!

## HOME STUDIO SUPER LOW PACKAGE PRICE!

Complete system includes:  
★MT-44 4 track deck  
★MM-30 mixer with echo & graphic EQ  
★RB-20 rack & patchbay

## S-250 X

A brand new high power (250W) ultra portable PA speaker  
Small PA is very BIG this year & the S-250 X we think is the best we've heard! - and you'll get change out of £800 for a pair



FUTURE-PROOFING FOR YAMAHA USERS!  
TWO NEW COMPATIBLE PRODUCTS COMING SOON FROM YAMAHA

8-TRACK DIGITAL COMPOSER SEQUENCER  
8-MODULE FM SOUND GENERATOR



## HOME RECORDING TASCAM MAIN DEALER

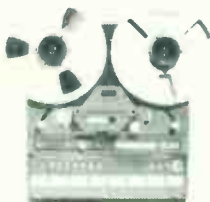

32 2 track reel to reel ..... £735  
34 4 track reel to reel ..... £995  
38 8 track reel to reel ..... £1699

## HOME STUDIO PACKAGE

22-4 4 track ..... £999  
MM-20 mixer  
  
244 Portastudio ..... £595  
234 'Syncaset' 4 track ..... £525  
122 Master Cassette ..... £460  
2A 6 → 4 mixer ..... £237  
M09 4 → 2 mixer ..... £162  
Model 30 8 → 4 mixer ..... £795  
PE-40 parametric EQ ..... £295  
MX-80 microphone mixer ..... £275  
MU-40 meter unit ..... £125  
MH-40 multi-phones amplifier ..... £125  
DX2D 2 channel DBX ..... £189  
DX4D 4 channel DBX ..... £229  
PE-20 4 ch parametric EQ ..... £  
EX-20 4 ch mixer expander ..... £  
GE-20 Graphic EQ

**BEST U.K. DEALS ON ALL TASCAM!**

FOSTEX A-8 8-TRACK  
FOSTEX X-15 4-TRACK  
MR-808 'Octette' brand new 8-track cassette recorder ..... EPOA

**Cutec**

Cutec MR-402 4 track cassette ..... £395  
Cutec MX-1210 12 → 2 mixer ..... £325  
Cutec MX-1610 16 → 2 mixer ..... £399  
MTR 12 → 8 → 2 ..... £399  
MTR 6 → 4 → 2 ..... £199  
Aces 12 → 4 → 2 ..... £699  
Aces 16 → 8 → 2 ..... £1199  
  
Fostex powered personal monitor ..... £69  
Teac LS-X7 mini monitors (pair) ..... £69  
Electrovoice sentry 100A monitors ..... £482  
Teac micro-powered monitors (pair) ..... £69  
Aria 4-track rack cass. recorder ..... £385

**WE CAN SUPPLY CASES & FLIGHT CASES TO FIT ANY ITEM. PRICES DEPEND ON SIZE. E.G. 'PORTASTUDIO' CASE £49**

## KORG



POLY-800 MIDI PROGRAMMABLE 8 VOICE DIGITAL SYNTH  
EX-800 8-VOICE MIDI EXPANDER  
POLY 61M THE CLASSIC 'POLY 61' NOW WITH MIDI  
RK-100

REMOTE MIDI KEYBOARD IN BLACK, WHITE, RED OR NATURAL  
MONOPOLY 4-VOICE POLY  
POLYSIX 6-VOICE PROGRAMMABLE TRIDENT II 8-VOICE PROGRAMMABLE

PSS50 PROGRAMMABLE SUPER SECTION  
KPRF-77 RHYTHM PROGRAMMER  
DDM110 DIGITAL PROGRAMMABLE RHYTHM  
DDM220 DIGITAL PROGRAMMABLE PERCUSSION

**JUST PHONE FOR A SUPER DEAL ON KORG!!**

## CASIO



CT-7000 ..... £425  
CT-610 ..... £345  
CT-310 ..... £199  
CT-602 ..... £299  
CT-501 ..... £249  
CT-101 ..... £169  
CT-202 ..... £189  
MT-200 ..... £129  
MT-800 ..... £249  
MT-70 ..... £175  
MT-68 ..... £129  
MT-65 ..... £119  
MT-46 ..... £99  
MT-41 ..... £69  
PT-50 ..... £69  
PT-30 ..... £69  
PT-80 ..... £69  
PT-20 ..... £49  
VL-1 ..... £29

**ALL PRICES INC. DELIVERY & FREE MAINS ADAPTOR ALL CASIO ACCESSORIES IN STOCK**

## DRUM MACHINES

### RACK UNITS

Ibanez DM2000 ..... £395  
Ibanez DM1100 delay ..... £269  
Cutec CD424 delay ..... £249  
Washburn WD-1400 delay ..... £249  
Vesta Fire RV-1 reverb ..... £225  
Vesta Fire RV-2 reverb ..... £249  
Fostex 3050 delay ..... £149

### DRUM MACHINES

Roland TR909 ..... £599  
Roland TR606 ..... £169  
Roland Baseline ..... £189  
Boss DR110 ..... £99  
Boss DR55 (1 only) ..... £40  
Hammond DPM-48 digital ..... £599  
Roland TR-808 ..... £350  
Roland CR-8000 ..... £295  
Yamaha MR-10 ..... £79  
Synsonics (1 only) ..... £55

### EFFECTS

CE-2 chorus ..... £  
CE-3 chorus ..... £  
BF-2 flanger ..... £  
HM-2 heavy metal ..... £  
PH-1R phasor ..... £  
GE-7 graphic ..... £  
DS-1 distortion ..... £  
OD-1 overdrive ..... £  
SD-1 super o/drive ..... £  
CS-2 compressor ..... £45  
HC-2 handclap ..... £48  
PC-2 perc synth ..... £48  
TW-11 touch wah ..... £49  
TV-12 tuner ..... £35  
OC-2 octaver ..... £38  
KM-2 mixer ..... £19  
KM-04 mixer ..... £37  
Add £1.50 post

Ibanez CS-9 stereo chorus ..... £65  
Ibanez SD-9 sonic distortion ..... £35  
Ibanez PT-9 phasor ..... £43  
Ibanez FL-9 flanger ..... £49  
Ibanez CP-9 compressor ..... £44  
Ibanez AD-9 delay ..... £95  
Ibanez CS-505 stereo chorus ..... £65  
Ibanez TS-9 tube screamer ..... £35  
Ibanez PO-401 parametric ..... £49

### YAMAHA

TB-01 tone boost ..... £29  
DI-01 distortion ..... £29  
CO-01 compressor ..... £34  
MP-01 volume pedal ..... £37  
OC-01 octaver ..... £39  
  
FL-01 flanger ..... £49  
CH-01 chorus ..... £44  
LI-01 limiter ..... £35  
NE-01 noise gate ..... £32  
SA-01 adaptor ..... £13  
  
Aria 2 stage chorus ..... £68  
Loco stereo chorus ..... £46  
Loco delay ..... £79  
Loco flanger ..... £49  
Frontline flanger ..... £49  
Frontline handclap ..... £59  
Frontline distortion ..... £23  
MXR mains flanger ..... £69  
MXR Loop selector ..... £19  
E.H. Electric mistress flanger ..... £49  
Colorsound vocalizer ..... £39  
Colorsound overdrive ..... £29  
E.H. Space drum ..... £49  
Chord Computer (guitar or k/board) ..... £21

## NEW & USED KEYBOARDS

Roland Jupiter 6 ..... £990  
Roland Juno 106 ..... £595  
Roland JX3P ..... £595  
Roland SH-101 ..... £195  
Roland Juno 6 ..... £395  
Roland SH-3A mono ..... £120  
Korg Polysix ..... £499  
Korg Monopoly ..... £299  
Korg CX3 organ ..... £299  
Korg 80S piano/strings ..... £499  
Korg MS-20 mono ..... £179  
Korg PE1000 poly ..... £199  
Yamaha CS50 poly ..... £399  
Yamaha CP-7 piano ..... £299  
Yamaha CS-50 ..... £395  
Yamaha CS-20M mono ..... £299  
Yamaha CS-10 mono ..... £149  
Yamaha CS-5 piano ..... £129  
Yamaha SS-30 strings ..... £199  
Sequential Pro-1 ..... £269  
Oberheim OB-1 + cass. dump ..... £289  
Rhodes stage 73 II ..... £499  
Rhodes stage 73 I ..... £369  
Jen SX-1000 mono ..... £129  
Solina strings ..... £199  
Elka 610 strings ..... £169  
Hohner EK-4 strings ..... £199  
Kawai SX-210 8 voice poly ..... Offers!  
Cavendish organ/strings/piano ..... £299  
  
FLIGHT & SEMI FLIGHT CASES AVAILABLE FOR ANY KEYBOARD FROM ABOUT £45  
X K/board stands ..... £19  
Extensions ..... £9

## SHURE MICROPHONES

PE25L ..... £59  
PE 45L ..... £88  
PE 65L ..... £94  
PE 66L ..... £86  
PE 47L ..... £103  
PE 15H ..... £57  
PE 35H ..... £81  
PE 75L ..... £103  
PE 86L ..... £101  
SM 58 ..... £133  
SM 57 ..... £109  
SM 10A headset ..... £108  
517 SA or SB ..... £33  
518 SA or SB ..... £40

## AKG

D80 ..... £25  
D190E ..... £47  
D125 ..... £49  
D310 ..... £49  
D320 ..... £81

## AUDIO TECHNICA

Pro 2 inc lead ..... £19  
Pro 3 ..... £29  
Pro 4 ..... £41  
Pro 5 ..... £58  
ATM41 ..... £67

## CUTEC

CDM2 Inc. lead ..... £18  
CDM4 ..... £27  
CDM6 ..... £41



# SEQUENTIAL CIRCUITS INC

## MAIN DEALER AND SERVICE CENTRE

### YOU CAN SEE THE WHOLE RANGE OF SUPERB SCI PRODUCTS ON DISPLAY AT 'MUSIC VILLAGE' AT THE BEST PRICES

## MUSIC VILLAGE



T8 - The Ultimate VCO Polysynth  
76 wooden weighted keys - touch response  
128 memories - 8 voice - sequencer  
MIDI

Prophet 600 - 2VCO, 100 programmable memories - sequencer - arpeggiator polyphonic glide chord tracking 6 voice poly + MIDI

- ★SIXTRAK - FULLY PROGRAMMABLE  
6 VOICE MULTI TIMBRAL SYNTH;  
100 MEMORIES, 6 TRACK DIGITAL  
RECORDER + MIDI ETC.
- ★DRUMTRAKS - THE ONE  
THAT SETS THE STANDARD  
13 DIGITALLY SAMPLED SOUNDS  
TOTALLY TUNEABLE + MIDI
- ★MODEL 64 SEQUENCER/  
INTERFACE - PLUGS INTO  
COMMODORE 64 COMPUTER  
4000 NOTE MEMORY  
ON 6 TRACKS

### SPECIAL PACKAGE DEALS

1. SIXTRAK + DRUMTRAKS £1499.00
  2. SIXTRAK + DRUMTRAKS  
+ ,PFRi 64 + 900 SOFTWARE £1669.00
  3. SIXTRAK & DRUMTRAKS  
+ MODEL 64 + 910 SOFTWARE £1699.00
- COMMODORE 64 COMPUTER £199.00
- ALTERNATIVE DRUMTRAKS  
CHIPS FROM £39  
4 CHIP SET TO REPLACE CYMBALS £99



### AMPLIFICATION

SESSION	
Sessionette 75 210.....	£249
Sessionette 75 112.....	£235
Bass 100 1x12.....	£275
Bass 100 4x10.....	£375
CARLSBRO	
Wasp lead 10w combo.....	£89
Scorpion 20w lead combo.....	£95
Scorpion 20w bass combo.....	£95
Home: 45w lead combo.....	£139
Hornet 45w bass combo.....	£129
Hornet 45w k/board combo.....	£159
Cobra 90w lead combo.....	£189
Cobra 90w bass combo.....	£189
Cobra 90w k/board combo.....	£229
Stringray pro bass 150w combo.....	£399
Stringray pro bass 150w head.....	£244
Stringray std bass combo.....	£299
Stringray std bass head.....	£229
Cobra 90w PA head.....	£129
Cobra 90w k/board head.....	£159
Cobra 90w PA head.....	£156
Marlin 150w 6ch PA head.....	£235
Marlin 300w 6ch PA head.....	£313
1 x 15 200w bass cab.....	£159
OHM	
KA-125w keyboard combo.....	£275
Tramp keyboard combo.....	£115
Tramp bass combo.....	£99
Tramp lead combo.....	£89
2x 12 PA cabs 150w (pair).....	£230
1x 12 horn PA cabs 75w (pair).....	£150
LANEY	
Laney pro bass 100w combo.....	£299
Laney theatre 850 150w PA.....	£225
Laney theatre 750 150w PA.....	£155
Laney 100w k/board combo.....	£249
Laney 45w k/board combo.....	£169
FENDER	
Sidekick 10 combo.....	£75
Sidekick 20 reverb.....	£127
Sidekick 30 reverb.....	£150
Sidekick 30 bass.....	£144
BOSE	
802 PA cabs.....	£845
302 Bass PA bins.....	£1195
101 PA cabs.....	£
802C equalizer.....	£165
Bose stands (pair).....	£189
KUDOS	
6 x 5 PA cabs.....	£399
2 x 5 PA monitors.....	£139
6 channel 300w PA + echo.....	£499

### AMP CLEARANCE!!

S/H AMPS & CABS TO CLEAR!

Sound City 200w head.....	£95
Selmer 100w head.....	£65
Wem 100w slave.....	£45
Selmer 100w bass cab.....	£35
Vox 100w bass cab.....	£55
Selmer Lesley cab.....	£35
Total 100w combo.....	£95
Carlsbro 100w valve head.....	£95
Lab series 200w 4x12 cab.....	£75
Custom Sound 50w combo.....	£95
ATC 150w 1x12 bass bin.....	£95
Selmer 50w combo.....	£55
Wem Westminster combo.....	£45
Wem Dominator 35w combo.....	£65
Wem Sapphire 100w combo.....	£95
Custom Sound 100w bass head.....	£125
Hi-Watt 4x12.....	£65
Marshall MV 100w combo.....	£195
Peavey 200w bass head.....	£145
Peavey 2x15 bass cab.....	£145
H/H IC 100s head.....	£95
H/H BL200 2x15 bass cab.....	£99
H/H VS100 1x15 bass combo.....	£195
H/H Multi tape echo.....	£95
H/H MA-100 IV PA head.....	£145
H/H Pro 150 1x15 cab.....	£95
H/H 200w 4x12 cab.....	£95
Marshall 50 lead head.....	£95
Vox Escort 50 combo.....	£95
Fender Princeton combo.....	£95
Fender Champ combo.....	£65
Ohm 1x15 bass cab.....	£65
Kay 50w lead combo.....	£55
Kay 50w bass combo.....	£55
Laney 100w reverb PA head.....	£95
Sound City 50w PA head.....	£75
Loco 60w micro combo.....	£95
Ohm GB 60w bass combo.....	£135
Custom Sound 65w 2x10 combo.....	£135
Peavey TKO bass combo.....	£95
Bass Boogie 10w combo.....	£60
Wem 2x12 PA cabs (pair).....	£80
Sound City 4x12 PA cabs (pair).....	£80
Marshall 4ch PA head.....	£95
Marshall 4x12 PA cabs (pair).....	£95
Peavey 1x12 PA cabs (pair).....	£180
H/H Pro-80 PA cabs (pair).....	£180
Peavey Centurion 130w bass head.....	£195
Peavey MP-4 4ch PA head.....	£135
Carlsbro 1x15 mini bass bin.....	£85
Ohm SC-70 2x10 combo.....	£195
JHS 6 ch reverb mixer.....	£75
Peavey XR-500 130w 6 ch PA head.....	£230
Fender Princeton II combo.....	£230
Tim Gentile 1x15 bass cab (Yeuch).....	£99

### GUITARS

Rickenbacker 620 12 solid 12 string (60's).....	£395
Rickenbacker 330 1963 (Lennon).....	£395
Gretsch Country Club.....	£395
Gibson Marauder.....	£195
Fender USA Strats from.....	£199
Fender Elite Strats.....	£495
Fender Std. Strats.....	£249
Fender Vintage Strats.....	£299
Squier Vintage Strats from.....	£149
Squier Popular Strats.....	£199
Selmer USA Teles from.....	£249
Squier Vintage Teles.....	£139
Westone Thunder Jet.....	£145
Westone Thunder I trem.....	£139
Westone Thunder II.....	£169
Westone Prestige 150.....	£179
Westone Concord II trem.....	£136
Westone Concord II.....	£129
Fender Lead I.....	£115
Tokai ST-50.....	£149
Ibanez Blazer 500.....	£149
Aria U60-T Urchin.....	£199
Aria TA-50 semi.....	£249
Aria TA-30 semi.....	£179
Aria XX-deluxe.....	£169
Aria PE-R80.....	£249
Aria ES-500 semi.....	£199
Westone Rainbow I semi.....	£199
Vox Std 25 trem.....	£99
Vox Custom 25.....	£149
Vox Custom 24.....	£149
Shergold Masquerader.....	£129

### BASSES

Waf Customs.....	£870
Fender USA precision from.....	£199
Squier precision from.....	£199
Squier jazz bass.....	£225
Tokai jazz.....	£199
Westone Thunder Jet.....	£145
Westone Thunder I.....	£135
Westone Thunder IA.....	£159
Westone Thunder II.....	£221
Westone Thunder II w/less.....	£199
Kramer 4001.....	£199
Mighty White Walnut p/bass.....	£199
Walshum Force 8.....	£199
Walshum Vulture II.....	£119
Rickenbacker 4001, 1963.....	£375
Rickenbacker 4001.....	£325
Yamaha BB400S w/less.....	£249
Yamaha BB VIS.....	£279
Westone Concord II.....	£179
G & L L100.....	£299
Ibanez Roadstar 920.....	£249
Aria SB special II.....	£232
Aria SB special II w/less.....	£252
Westone Thunder IA w/less.....	£167
Guild B301.....	£150
Guild B302 w/hand.....	£160
Guild Active 302 custom w/less.....	£199
Shergold Marathon.....	£115
Vox Std 25 trem.....	£95
Westone Concord I.....	£90
Ibanez BL70H w/hand.....	£179
Kay p/bass copy.....	£79

### MAIL-ORDER ANYTHING ANYWHERE!!

Name.....  
Address.....  
Goods required.....  
Access  Bank & Card  VISA  cheque/PO

'Music Village' 10 High Road, Chadwell Heath, Romford, Essex.

01-599 4228/01-598 9506



1981

**MARCH (SOLD OUT) Music** BBC Radiophonic Workshop **Hardware** Yamaha SK20 **Computer Musician (CM)** Using Microprocessors **Technology** Advanced Music Synthesis (VCOs, FM), Spectrum Synth, Hi-Fi Sub-Bass Woofer

**APRIL Music** Warren Cann (Ultravox) **CM** Using Micros Pt2, Programming Micros **Technology** Advanced Music Synthesis (PWM), Spectrum Synth Pt2, Syntom I

**MAY Music** Tim Souster **CM** Apple Music System, Using Micros Pt3 **Technology** Spectrum Synth Pt3, Noise Reduction Unit

**JUNE Music** David Vorhaus **Hardware** Fairlight CMI, Yamaha PS20 **CM** Using Micros Pt4 **Technology** Mosfet Amp

**JULY (SOLD OUT) Music** Duncan Mackay **Hardware** PPG Wave 2 **CM** Using Micros Pt5

**AUGUST Music** Irmin Schmidt **Hardware** Resynator Synth, Casio VL1 **Technology** Harmonics, PA Signal Processor Pt1

**SEPTEMBER (SOLD OUT) Music** Kraftwerk **Hardware** Linn LM1 **CM** Using Micros Pt6 **Technology** Noise Gate, PA Signal Processor Pt2

**OCTOBER CM** Using Micros Pt7 **Technology** Harmony Generator, Effects Link FX1, dbx Explained

**NOVEMBER Music** Landscape **Hardware** Casio MT30, Roland GR300 and CPE800 **CM** Using Micros Pt8 **Technology** Speech Synthesis, EMT (Phasing), Auto Swell Pedal

**DECEMBER (SOLD OUT) Music** Rick Wakeman, OMD **Hardware** Yamaha CS70M, Vox Custom Bass & Custom 25, Roland CR5000 & CR8000, Elka-Orla X50, Vox AC30, aphaSyntauri, Fostex 250, ElectroVoice Mics **Technology** Synclock

1982

**JANUARY Music** Tangerine Dream **Hardware** Casio 701, Teisco SX400, Aria TS400, MCS Percussion Computer, Soundchaser, Beyer Mics **Technology** EMT (Flanging), Spectrum Synth Update Pt1, Volume Pedal

**FEBRUARY Music** Ike Isaacs **Hardware** Korg Trident, AKG Mics, Roland TR606, Fostex A8, Tokai ST50 and PB80 **CM** PolySequencing on ZX81 **Technology** Yamaha GS1&2 (FM) Explained, Digital Delay Line Pt1, Spectrum Synth Update Pt2

**MARCH (SOLD OUT) Music** Klaus Schulze, Robert Schröder, Kraftwerk 'Computer World' **Music Hardware** Firstman SQ01, SCI Pro One, Tascam 124AV, Shure Mics, Hamer Prototype **Technology** Power 200 Speakers, Digital Delay Line Pt2

**APRIL Music** Martin Rushent (Human League) **Hardware** Korg MonoPoly, Fostex 350, Roland TB303 **Technology** MF1 Sync Unit, MultiReverb

**MAY Music** Holger Czukay, Depeche Mode **Hardware** Moog Source & Rogue, Calrec Soundfield Mic **Technology** Soft Distortion, Quadramix

**JUNE Music** Jean-Michel Jarre, Classix Nouveaux **Hardware** Emulator, Carlsbro Minifex **Technology** Panolo, Multisplit

1983

**JANUARY Music** Richard Barbieri (Japan) **Hardware** Westone Bass, BGW 750C Amp, Korg EPS1, Clef BandBox, Zildjian Cymbals **Technology** Synblo, Transpozer Pt2

**FEBRUARY Music** Isao Tomita, Human League **Hardware** Novatron, LinnDrum, Simmons SDS6, Klone Kit, Movement Drum Computer 2, Korg KPR77, MemoryMoog, Synclavier II, Powertran Polysynth, Vigier Guitars, Pearl Mics **Technology** Synbal, Caltune

**MARCH Music** Klaus Schulze, Michael Karoli, Francis Monkman, Bernard Xolotti, Chris Franke **Hardware** RSF Kobol Expander, Korg Poly 61, Aria Mics, BGW 7000 Amp, Ibanez Pedals, Tokai Flying V **Technology** Shaper, 842 Mixer Meter Bridge

**APRIL Music** Naked Eyes, Gabor Presser **Hardware** Casio 7000, SCI Prophet 600, Chroma/Apple Interface, Eko Bass pedals, Vox Guitars **Technology** Syntom II

**MAY Music** Keith Emerson **Hardware** Roland MC202, Fostex X15, Carlsbro Cobra 90 Kbd Combo, M&A K1/B Kit, Echo Unit Supplement (13 reviews,

inc. Roland SDE2000, Fostex 3050, Korg SDD3000) **Technology** Introducing the MIDI, MicroMIDI, Active Speaker

**JUNE Music** Steve Hillage, Arthur Brown **Hardware** Synclavier II, Syntom Syrinx, Emu Drumulator, Vestafire Dual Flanger, Aria AD05 Delay, Suzuki Mics, Clarion and Cutec four-tracks **Technology** OMDAC

**JULY Music** Marillion, Hans Zimmer **Hardware** Trident VFM Mixer, Kawai SX210, Aria U60 Deluxe BBS, Deanvard VA30K Amp, MXR Omni FX, Milab Mics **Technology** Yamaha DX synthesisers, Ditigal Signal Processing Pt1, Tap Tempo

**AUGUST Music** Bill Nelson, Hubert Bognermayr, Barclay James Harvest **Hardware** Roland JX3P/PG200, OSCar, 360 Systems Digital Kbd, MPC Music Percussion Computer, Yamaha SG200, Fender 100W Stage Lead, Frontline FX **Technology** Digital Signal Processing Pt2

**SEPTEMBER (SOLD OUT) Music** Peter Dinklage **Hardware** Prophet T8, Oberheim DX, SCI Pro-FX 500, Rick-enbacker 360 12-string & TR75 GT Combo **Computer Musician (CM)** Music Composition Languages Pt1, Sounding Out the Micro Pt1 **Technology** Which Synth Gulde, Synclap

**OCTOBER (SOLD OUT) Music** John Miles, Andrew Powell **Hardware** Yamaha DX1, OctavePlateau Voyetra 8, Siel Opera 6, MXR 185 Drum Computer, Ross Pedals, Fender Elite Precision Bass 1, Steinberger six-string **CM** Sounding Out the Micro Pt2, Speech Synthesis, **Technology** Digital Signal Processing Pt3, Mains Distribution Board

**NOVEMBER Music** Tony Banks, John Foxx **Hardware** Seiko Digital Keyboards, Eko EM10, UC1 Sequencer for SCI Pro One, Doctor Click, Klone Kit 2, Ibanez HD1000, Korg KMX8 Mixer, Ibanez RS315SC Guitar **CM** Music Composition Languages Pt2, Software Envelope Generator (ZX Spectrum), MUZIX 81 (ZX81) **Technology** Digital Signal Processing Pt4

**DECEMBER (SOLD OUT) Music** Gary Numan, Psychic TV, Philip Glass **Hardware** Prophet T8, Yamaha PC1000, Carlsbro AD1 Echo, Personal Keyboard Guide **CM** Decillionix (sound sampling for Apple) **Technology** Valve Driver

1984

**JANUARY Music** Simple Minds, Saga, Hawkwind, Dave Hewson **Hardware** Oberheim OB8, Vigier Bass, Siel Cruise, Ibanez DM2000, The Kit + Accessories **Technology** Using Sequencers, Electronic Metronome

**FEBRUARY Music** Daniel Miller, China Crisis, Don Airey **Hardware** Korg Poly 800, Siel PX, Yamaha PS55, Eko EM12, Boss DE200, Roland Chorus Cube 60, Washburn Bantam Bass, Carlsbro Marlin, Dr Böhm Digital Drums **CM** Mainframe **Technology** Drumatrix Mods, Voltage-Controlled Clock

**MARCH Music** Vince Clarke & Eric Radcliffe, Blancmange **Hardware** SCI SixTrak, Roland SDE3000, Roland System 100M, Electronic Percussion Guide (nine reviews inc. SCI Drumtraks, Boss DR110, AHB Inpulse One, Hammond DPM48) **CM** Music Composition Languages Pt3 **Technology** S-trigger Converter, Lead Tester

**APRIL (SOLD OUT) Music** Fad Gadget, Vic Emerson (Sad Café) **Hardware** Simmons SDS7 & SDS8, Jupiter 6, Roland TR909 & MSQ700, Yamaha PS Kbd, Crumar Composer, Ibanez UE400 & UE405, Klone Dual Percussion Synth, Vox White Shadow Bass **CM** Gentle Art of Transcription Pt1, Ins & Outs of Digital Design **Technology** Understanding the DX7 Pt1, Syndrom Pt1, Bass Pedal Synth

**MAY Music** Wang Chung **Hardware** PPG Wave 2.3 & Waveterm, Roland Juno 106, Roland JSQ60, Casio 310, M&A Electronic Drums, Dynacord PDD14 **CM** PDSG Pt2, **Technology** Understanding the DX7 Pt2, String Damper **MIDI Supplement Pt1** Specification, Theory & Practice, Product Guide, MIDI By Numbers (Steve Levine)

**JUNE Music** OMD **Hardware** Roland GR700/G707, SynthAxe, Siel Expander, SCI Model 64 Sequencer, MFB512 Digital Drum m/c, Jen Musipack 1.0, Boss DD2 Delay Pedal **CM** Gentle Art of Transcription Pt2, PDSG Pt2 **Technology** Understanding the DX7 Pt3, Syndrom Pt2, Multiwave LFO **MIDI Supplement Pt2** Inside MIDI, MIDI & The Micro, BeeBMIDI Interface Pt1

**JULY Music** Human League, Steve Jolliffe, Jade Warrior **Hardware** Yamaha DX9, Korg Super Section, Yamaha MK100, Microsound 64 Kbd, TED Digisound, Ibanez DM1100 DDL **CM** JMS MIDI Software, PDSG Pt3 **Technology** Spectrum MIDI (SCI SixTrak and DX7 Patch Dump), Understanding the DX7 Pt4, RackPack, BeeBMIDI Pt2

**AUGUST Music** Rusty Egan (Visage), Cocteau Twins, Hans-Joachim Roedelius **Hardware** Synclavier Update, Technics SXK250, Yamaha PF10 & PF15, Siel Piano Quattro & PX jr, Roland HP300, HP400, PB300 & PR800, Garfield Electronics MiniDoc, Electro Harmonix Instant Replay & Super Replay **CM** EMR BBC B MIDI Software Fairlight Explained Pt1, **Technology** Understanding the DX7 Pt5, BeeBMIDI Pt3, Syndrom Pt3, Miniblo, SynthMix Pt1

**SEPTEMBER Music** Thomas Leer, Chris & Cosey **Hardware** Oberheim Xpander, Korg EX800 & RK100, Digi-Atom 4800, Cutec MX1210, Microlink ML10 System, Roland MPU401, Sycologic AMI & MX1 **CM** OMDAC Update, Passport MIDI/4 Software, Fairlight Explained Pt2, Steptime Composition on the SCI Model 64 **Technology** SynthMix Pt2, Dual VCLFO, Understanding the DX7 Pt6

Back issues are available at £1.30 each (inc. p&p) for 1983/84, while 1981/82 issues are available at a special price of 80p each (inc. p&p). All prices refer to the UK and surface mail to Europe and Overseas. Photocopies of articles from SOLD OUT issues can be obtained at 50p per article. Orders please to: E&MM Mail Order Department, Alexander House, 1 Milton Road, Cambridge, CB4 1UY.

This back issues page supercedes all previous listings, and the contents of each issue are presented in summarised form. See E&MM Feb 83 and Feb 84 for full Indices of 1981/82 and 1983 issues respectively.



# SEQUENTIAL CIRCUITS INC

MAIN DEALER AND SERVICE CENTRE  
 YOU CAN SEE THE WHOLE RANGE OF SUPERB  
 SCI PRODUCTS ON DISPLAY AT 'MUSIC VILLAGE'  
 AT THE BEST PRICES  
**MUSIC VILLAGE**



T8 - The Ultimate VCO Polysynth  
 76 wooden weighted keys - touch response  
 128 memories - 8 voice - sequencer  
 MIDI

Prophet 600 - 2VCO, 100 programmable  
 memories - sequencer - arpeggiator  
 polyphonic glide chord tracking  
 6 voice poly + MIDI

- ★SIXTRAK - FULLY PROGRAMMABLE  
 6 VOICE MULTI TIMBRAL SYNTH;  
 100 MEMORIES, 6 TRACK DIGITAL  
 RECORDER + MIDI ETC.
- ★DRUMTRAKS - THE ONE  
 THAT SETS THE STANDARD  
 13 DIGITALLY SAMPLED SOUNDS  
 TOTALLY TUNEABLE + MIDI
- ★MODEL 64 SEQUENCER/  
 INTERFACE - PLUGS INTO  
 COMMODORE 64 COMPUTER  
 4000 NOTE MEMORY  
 ON 6 TRACKS

## SPECIAL PACKAGE DEALS

1. SIXTRAK + DRUMTRAKS £1499.00
  2. SIXTRAK + DRUMTRAKS  
 + ,PFRi 64 + 900 SOFTWARE £1669.00
  3. SIXTRAK & DRUMTRAKS  
 + MODEL 64 + 910 SOFTWARE £1699.00
- COMMODORE 64 COMPUTER £199.00  
 ALTERNATIVE DRUMTRAKS  
 CHIPS FROM £39  
 4 CHIP SET TO REPLACE CYMBALS £99



## AMPLIFICATION

SESSION	
Sessionette 75 210.....	£249
Sessionette 75 112.....	£235
Bass 100 1x12.....	£275
Bass 100 4x10.....	£375
CARLSBRO	
Wasp lead 10w combo.....	£69
Scorpion 20w lead combo.....	£95
Scorpion 20w bass combo.....	£95
Hornet 45w lead combo.....	£139
Hornet 45w bass combo.....	£129
Hornet 45w k/board combo.....	£159
Cobra 90w lead combo.....	£189
Cobra 90w bass combo.....	£189
Cobra 90w k/board combo.....	£229
Stingray pro bass 150w combo.....	£399
Stingray pro bass 150w head.....	£244
Stingray std bass combo.....	£299
Stingray std bass head.....	£229
Cobra 90w bass head.....	£129
Cobra 90w k/board head.....	£159
Cobra 90w PA head.....	£156
Marlin 150w 6ch PA head.....	£235
Marlin 300w 6ch PA head.....	£313
1 x 15 200w bass cab.....	£159
OHM	
KA-125w keyboard combo.....	£275
Tramp keyboard combo.....	£115
Tramp bass combo.....	£99
Tramp lead combo.....	£89
2 x 12 PA cabs 150w (pair).....	£230
1 x 12 horn PA cabs 75w (pair).....	£150
LANEY	
Laney pro bass 100w combo.....	£299
Laney theatre 850 150w PA.....	£225
Laney theatre 750 150w PA.....	£155
Laney 100w k/board combo.....	£249
Laney 45w k/board combo.....	£169
FENDER	
Sidekick 10 combo.....	£75
Sidekick 20 reverb.....	£127
Sidekick 30 reverb.....	£150
Sidekick 30 bass.....	£144
BOSE	
802 PA cabs.....	£845
302 Bass PA bins.....	£1195
101 PA cabs.....	£
802C equalizer.....	£165
Bose stands (pair).....	£189
KUDOS	
6x5 PA cabs.....	£399
2x5 PA monitors.....	£139
6 channel 300w PA+echo.....	£499

## AMP CLEARANCE!!

### S/H AMPS & CABS TO CLEAR!

Sound City 200w head.....	£95
Selmer 100w head.....	£65
Wem 100w slave.....	£45
Selmer 100w bass cab.....	£35
Vox 100w bass cab.....	£55
Selmer Lesley cab.....	£35
Total 100w combo.....	£95
Carlsbro 100w valve head.....	£95
Lab series 200w 4x12 cab.....	£75
Custom Sound 50w combo.....	£95
ATC 150w 1x12 bass bin.....	£95
Selmer 50w combo.....	£55
Wem Westminster combo.....	£45
Wem Dominator 35w combo.....	£65
Wem Sapphire 100w combo.....	£95
Custom Sound 100w bass head.....	£125
Hi-Watt 4x12.....	£65
Marshall MV 100w combo.....	£195
Peavey 200w bass head.....	£145
Peavey 2x15 bass cab.....	£145
VH IC 100s head.....	£95
VH BL200 2x15 bass cab.....	£99
VH VS100 1x15 bass combo.....	£195
VH Multi tape echo.....	£95
VH MA-100 IV PA head.....	£145
VH Pro 150 1x15 cab.....	£95
VH 200w 4x12 cab.....	£95
Marshall 50 lead head.....	£95
Vox Escort 50 combo.....	£95
Fender Princeton combo.....	£95
Fender Champ combo.....	£65
Ohm 1x15 bass cab.....	£65
Kay 50w lead combo.....	£55
Kay 50w bass combo.....	£55
Laney 100w reverb PA head.....	£95
Sound City 50w PA head.....	£75
Loco 50w micro combo.....	£95
Ohm GB 60w bass combo.....	£135
Custom Sound 65w 2x10 combo.....	£135
Peavey TKO bass combo.....	£95
Bass Boogie 10w combo.....	£60
Wem 2x12 PA cabs (pair).....	£80
Sound City 4x12 PA cabs (pair).....	£80
Marshall 4ch PA head.....	£95
Marshall 4x12 PA cabs (pair).....	£95
Peavey 1x12 PA cabs (pair).....	£180
HH Pro-80 PA cabs (pair).....	£180
Peavey Centurion 130w bass head.....	£195
Peavey MP-4 4ch PA head.....	£135
Carlsbro 1x15 mini bass bin.....	£85
Ohm SC-702x10 combo.....	£199
JHS 6ch reverb mixer.....	£75
Peavey XR-500 130w 6ch PA head.....	£230
Fender Princeton II combo.....	£230
Tim Gantle 1x15 bass cab (Yeuch).....	£90

## GUITARS

Rickenbacker 620 12 solid 12 string (60"s).....	£395
Rickenbacker 330 1963 (Lennon).....	£395
Gretsch Country Club.....	£395
Gibson Marauder.....	£195
Fender USA Strats from.....	£199
Fender Elite Strats.....	£495
Fender Std. Strats.....	£249
Fender Vintage Strats.....	£299
Squier Vintage Strats from.....	£149
Squier Popular Strats.....	£199
Fender USA Teles from.....	£249
Squier Vintage Teles.....	£199
Westone Thunder Jet.....	£145
Westone Thunder I trem.....	£139
Westone Thunder II.....	£169
Westone Prestige 150.....	£179
Westone Concord II trem.....	£136
Westone Concord II.....	£129
Fender Lead I.....	£115
Tokai ST-50.....	£115
Ibanez Blazer 500.....	£149
Aria U60-T Urchin.....	£199
Aria TA-50 semi.....	£249
Aria TA-30 semi.....	£179
Aria XX-deluxe.....	£169
Aria XR-80.....	£349
Aria ES-500 semi.....	£199
Westone Rainbow I semi.....	£199
Vox Std 25 trem.....	£99
Vox Custom 25.....	£149
Vox Custom 24.....	£149
Shergold Masquerader.....	£129

## BASSES

Wal Customs.....	£670
Fender USA precisions from.....	£199
Squier precisions from.....	£199
Squier jazz bass.....	£225
Tokai jazz.....	£199
Westone Thunder Jet.....	£145
Westone Thunder I.....	£135
Westone Thunder II.....	£159
Westone Thunder II /less.....	£221
Westone Thunder II /less.....	£199
Kramer 4001.....	£199
Mighty Mike Walnut 2/bass.....	£199
Washburn Force 8.....	£199
Washburn Vulture I.....	£119
Rickenbacker 4001, 1963.....	£375
Rickenbacker 4007.....	£325
Yamaha BB400S /less.....	£249
Yamaha BB-VIS.....	£279
Westone Concord II.....	£179
G & L L100.....	£249
Ibanez Roadstar 92C.....	£249
Aria SB special II.....	£232
Aria SB special II /less.....	£252
Westone Thunder IA /less.....	£167
Guild B301.....	£150
Guild B302 /hand.....	£160
Guild Active 302 custom /less.....	£199
Shergold Marathon.....	£115
Maya p/bass /less.....	£95
Westone Concord I.....	£90
Ibanez BL700 /hand.....	£179
Kay p/bass copy.....	£79

## MAIL-ORDER

ANYTHING ANYWHERE!!

Name.....  
 Address.....

Goods required.....



cheque/PO

'Music Village' 10 High Road, Chadwell Heath,  
 Romford, Essex.



01-599 4228/01-598 9506



# 360 Systems Digital Keyboard

E&MM first looked at this American sampled-sound keyboard in prototype form in August 1983, but several modifications have turned the 360 into an altogether more impressive instrument. *Paul White*



To re-cap, the 360 Systems is a four-octave digital keyboard which can reproduce the sounds of real instruments stored in banks of EPROMs within its circuitry. Up to 32 different voices may be installed in the instrument at any one time, and the keyboard may be split so that two voices can be played simultaneously. The system is eight-note polyphonic, and Moog-style performance wheels allow some degree of expression to be imparted to appropriate voices. Likewise, these controls allow you to do outlandish things such as pitch-bending a grand piano, an effect that is normally impossible without hydraulic jacks and a sympathetic insurance company.

## Construction

The 360 is an unremarkable looking machine, having a simple wooden case and a row of rather unimpressive controls. Appearances can be deceptive, however, and the inside reveals a veritable sea of chips.

When we looked at the original – prototype – 360 last year, the circuitry ran rather hot, and a cooling fan has now been fitted to alleviate this situation. A lot of the internal space is taken up by voice cards, and the most impressive of these contains the piano samples, amounting to about 50 EPROMs in all. The reason for using so many memory chips is that each voice is built up from several samples, so that no note is transposed by more than a tone either way from its original pitch.

Output of the 360 is in stereo and, where appropriate for a particular instrument, the sampled sounds are split where the original instrument has a natural range less than the keyboard span. A good example of this is the saxophone setting which has baritone, alto and tenor samples to cover a four-octave range.

The bass guitar sound uses a similar trick, whereby pulled notes are available to the right of the keyboard and slapped notes are to the left, and in the hands of a sympathetic player, the 360 can make an excellent impersonation of a funk bassist.

On the rear panel there is provision to connect a sustain pedal, a foot pedal for control of dynamics or brightness, and of course the stereo output.

The 360 weighs 43 lbs and measures 5 1/4" x 32" x 22".

## Controls

The row of instrument selectors allows any voice to be placed instantly under keyboard control, and the split point may be set wherever the user wishes for dual voice operation, a Swap button changing the voices to opposite sides of the keyboard when needed. In addition, a stack switch lets you play two voices together for a fatter sound – though this limits the system to four-note polyphony – and the transpose facility lets you set any interval between sounds within the limits of the individual voice capacities. The two voices may be mixed by means of the balance control, while a filter circuit permits independent tonal modifications to be made to each voice. Lastly, notes may be set to last their full duration once keyed, or to end as soon as the key is released.

'Once you've heard the string sound produced by the 360, conventional synths or string machines become more than a little artificial.'

## Sounds

The only real limitations imposed by the 360 are its four-octave keyboard and lack of touch-sensitivity. As with any synth that attempts to replicate a traditional instrumental sound, the 360 must be played in something approximating the manner of the instrument being imitated in order to be convincing.

All the samples are beautifully recorded, and some of them last up to eight seconds so that the full natural decay of the original instrument can be reproduced. The acoustic guitar sample is particularly impressive, and once you've heard the string sound produced by the 360, conventional synths or string machines become more than a little artificial. The sound requiring the most memory is the grand piano, and as a result of this the piano voice card costs around £700. Mind you, it is superb.

All the voicings are good (some are exceptional) and unlike our August '83 reviewer, I could detect no quantisation noise or other nasties in the final output, which was monitored at quite a high level via a pair of Tannoy studio monitors.

There is of course some compromise caused by the 360's lack of touch-sensitivity but, in any event, this probably wouldn't sound right even if it was fitted since the timbre of a conventional instrument changes with playing

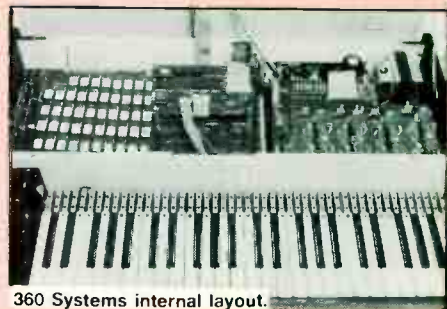

360 Systems internal layout.

intensity, and this effect would be difficult to duplicate authentically by purely electronic means. Another point worth considering is that when a musician records a touch-sensitive instrument, there's more often than not some wretched engineer compressing it flat again just to keep the VU meters happy.

Although the review model's MIDI sockets were unsupported internally, it appears that all new production instruments have their MIDI sockets fully functional, with all the usual features. As already mentioned, the keyboard is not velocity sensitive but the voices will apparently receive the relevant MIDI data from a controlling velocity-sensitive MIDI synth, thereby eliminating one of its weaknesses.

## Conclusions

The 360 is what a Mellotron always wanted to be but could never quite manage. There's no user-sampling capability and little that can be done to vary the factory sounds, but there is a good choice of instruments and all of these are superbly sampled.

The samples sound natural because no looping or other memory-saving tricks are used, and the maximum note length is around eight seconds, depending on the voicing being played.

The greatest setback is the high price of the instrument which unfortunately puts it in the professional-only bracket. It will probably be used extensively in studios where instant access to a selection of good sounds is a distinct advantage, the cost being justified by the amount of studio time saved.

The 360 points the way for future developments, and since technology has a way of percolating down through price barriers in a relatively short space of time, maybe this quality of instrument will eventually be accessible to the semi-professional musician.

For now, the 360 is probably the most sophisticated instrument of its kind, capable – in the right hands – of performing musical miracles.

The 360 Systems basic keyboard (without any voice cards) is available at an RRP of £3200 excluding VAT. A wide selection of voices are available at varying prices (eg. the 12-voice Pop Collection at £917.00 excluding VAT). Full details from Atlantex Music Ltd, 3 Cadwell Lane, Hitchin, Herts, ☎ (0462) 31511.



turnkey **BY MAIL**

Studio Supply for Creative Recording

# Cassettes with Brains

stereo  
mastering for  
every studio  
application

Free  
New 72 pg  
Catalogue  
on  
request



**AIWA F770** Includes automatic tape alignment, full complement of Dolby, flar keyboard, automatic demagnetisation plus real time counter. Combination head for off tape monitoring . . . . . **£255**

**AIWA recorders, new at Turnkey.** We believe that their latest cassette decks have much to offer to the home studio owner.

**AIWA F990** Top of the range, features flar keyboard control, realtime counter, music search, Dolby, B, C and the HX (headroom extension), plus DATA. A mastering quality recorder that does it all . . . **£295**



**Tascam Price Crash**  
Half inch eight track at the lowest price ever. Limited stocks only, at this special price  
**Tascam 38** . . . . . **£1299**



**TEAC V350C** The budget recorder that we recommend for use with basic four track systems. Wide range of features catering for all types of tape. LED bargraph metering and a truly time proven tape transport. . . . **£96**



**AIWA WX220** Your own tape factory, high speed dubbing of your master tapes (including four track) Host of convenience facilities also. . . . . **£230.00**



**TEAC 122B** Designed for professional use, balanced XLR type connection, rack mount, accurate metering. Servo capstan with varispeed and Dolby B plus HX noise reduction. . . . . **£429**

**IMPORTANT NOTICE**  
Pressure from various musical copyright authorities means only limited numbers of the WX220 are available. Orders are processed on a first come, first served basis

## Rack Shop Update - Low prices on our Top Five Selling Effects

**Drawmer Lim/Comp** every dynamic control facility for tight, punchy sound . . . . . **£325.00**

**MXR 01 Reverb** the newest multi-programme stereo digital reverb system. . . . . **£1595.00**

**Yamaha Mono Reverb** A true breakthrough in digital price and quality . . . . . **£489.00**

**Drawmer Gate** Stereo noise gate offering full control and sidechain patching . . . . . **£275.00**

**Bel BD80** Short term digital recording is the most desirable delay effect today. Up to two seconds are possible, with all sample and hold facilities. Full studio performance specs . . . **£590.00**



**PhonoPro**  
Custom made cables for personal multitrack users. Gold plated connectors, positive grip and non kink cable. Packed in useful audio lengths: 2 x 4m: **£5**  
4 x 2m std: **£6.00**  
8 x 5m patch: **£7.50**

## Widest choice in four track systems.



**1 Fostex Producer System** the 250 complete with AEG D80 microphone, leads and ten cassettes, so you get started the minute you get home.  
**Fostex 250** . . . . . **£589**

**3 MT44 Challenger** This is Yamaha's contender. Full simulsync and the latest Dolby C are featured. **FREE** Model 1478 four channel mixdown mixer with bass, treble and pan controls when you buy.  
**Yamaha MT44** . . . . . **£294**



**2 244 Producer Packages** from Tascam, includes the same package of start up accessories as with the Fostex.  
**Tascam 244** . . . . . **£619**

**4 Fostex Tracker Package** The X15 or special offer including the brand new MN15 ping-pong mixer/compressor plus a pack of ten C60 cassettes.  
**Fostex X15** . . . . . **£295**



## Ampex Tape on Sale

Ampex tape at reduced prices

	406	456
1/4" NAB	£9.90	£12.50
1/2" NAB	£18.90	£24.90
1" NAB	£31.90	£39.90

1/4" 7" spool, GM1800 . **£8.00**  
Edit block **£4.00** Edit tape **£2.51**  
Leader, R/W **£4.39** Cleaning kit **£3.00**. Tape head demagnetiser **£18.50**. Single edged blades (10) **£0.67**. Pencils (12) **£3.00**.

**15% VAT must be added to all prices shown.**

**Our Postage charges are:**  
up to £9 . . . . . **£1.00**  
over £40 . . . . . **£2.00**  
over £40 to £300 . . . . . **£3.00**

Please check directly for bigger items.  
We accept telephone orders and payment by credit card. We operate a daily delivery into the London area. Call us for details.

## Quad Monitor Plus

Despite a recent price rise these packages are still the best monitor deal you can buy

<b>Quad 303</b> . . . . .	<b>£148.50</b>
<b>303 &amp; Stratfords</b> . . . . .	<b>£255</b>
<b>303 &amp; JBL 4401</b> . . . . .	<b>£389</b>

**we OPEN**  
for sales & demos  
**Mon-Fri, 9.30-5.30**  
**Saturday, 10-2**

**Instant credit of up to £1000 is now possible for credit card holders. Call for details.**

Brent Vlew Road, LONDON NW9 7EL. Tel 01-202 4366 Telex 25769



1981

**MARCH (SOLD OUT) Music** BBC Radiophonic Workshop **Hardware** Yamaha SK20 **Computer Musician (CM)** Using Microprocessors **Technology** Advanced Music Synthesis (VCOs, FM), Spectrum Synth, Hi-Fi Sub-Bass Woofer  
**APRIL Music** Warren Cann (Ultravox) **CM** Using Micros Pt2, Programming Micros **Technology** Advanced Music Synthesis (PWM), Spectrum Synth Pt2, Syntom I  
**MAY Music** Tim Souster **CM** Apple Music System, Using Micros Pt3 **Technology** Spectrum Synth Pt3, Noise Reduction Unit  
**JUNE Music** David Vorhaus **Hardware** Fairlight CMI, Yamaha PS20 **CM** Using Micros Pt4 **Technology** Mosfet Amp  
**JULY (SOLD OUT) Music** Duncan Mackay **Hardware** PPG Wave 2 **CM** Using Micros Pt5  
**AUGUST Music** Irmin Schmidt **Hardware** Resynator Synth, Casio VL1 **Technology** Harmonics, PA Signal Processor Pt1  
**SEPTEMBER (SOLD OUT) Music** Kraftwerk **Hardware** Linn LM1 **CM** Using Micros Pt6 **Technology** Noise Gate, PA Signal Processor Pt2  
**OCTOBER CM** Using Micros Pt7 **Technology** Harmony Generator, Effects Link FX1, dbx Explained  
**NOVEMBER Music** Landscape **Hardware** Casio MT30, Roland GR300 and CPE800 **CM** Using Micros Pt8 **Technology** Speech Synthesis, EMT (Phasing), Auto Swell Pedal  
**DECEMBER (SOLD OUT) Music** Rick Wakeman, OMD **Hardware** Yamaha CS70M, Vox Custom Bass & Custom 25, Roland CR5000 & CR8000, Elka-Oria X50, Vox AC30, aphaSyntauri, Fostex 250, ElectroVoice Mics **Technology** Synclock

1982

**JANUARY Music** Tangerine Dream **Hardware** Casio 701, Teisco SX400, Aria TS400, MCS Percussion Computer, Soundchaser, Beyer Mics **Technology** EMT (Flanging), Spectrum Synth Update Pt1, Volume Pedal  
**FEBRUARY Music** Ike Isaacs **Hardware** Korg Trident, AKG Mics, Roland TR606, Fostex A8, Tokai ST50 and PB80 **CM** PolySequencing on ZX81 **Technology** Yamaha GS1&2 (FM) Explained, Digital Delay Line Pt1, Spectrum Synth Update Pt2  
**MARCH (SOLD OUT) Music** Klaus Schulze, Robert Schröder, Kraftwerk 'Computer World' **Music Hardware** Firstman SQ01, SCI Pro One, Tascam 124AV, Shure Mics, Hamer Prototype **Technology** Power 200 Speakers, Digital Delay Line Pt2  
**APRIL Music** Martin Rushent (Human League) **Hardware** Korg MonoPoly, Fostex 350, Roland TB303 **Technology** MF1 Sync Unit, MultiReverb  
**MAY Music** Holger Czukay, Depeche Mode **Hardware** Moog Source & Rogue, Calrec Soundfield Mic **Technology** Soft Distortion, Quadramix  
**JUNE Music** Jean-Michel Jarre, Classix Nouveaux **Hardware** Emulator, Carlsbro Minifex **Technology** Panolo, Multisplit

**JULY Music** Ronny with Warren Cann & Hans Zimmer, J-M Jarre 'Magnetic Fields' **Music Hardware** Roland Juno 6, Peavey Heritage, Steinberger Bass **Technology** Universal Trigger Interface  
**AUGUST Music** Kitaro, Jon Lord **Hardware** Synergy, Korg Polysix, Tascam M244 Portastudio, Shergold Modulator 12-string, Yamaha Pro-FX **Technology** 8201 Line Mixer, Guitar Buddy practice amp  
**SEPTEMBER (SOLD OUT) Music** Richard Pinhas **Hardware** Yamaha CS01, Jen SX1000, Casio 1000P, Fender Squier, Carlsbro Stingray, Pearl Effectors **Technology** Comp-Lim, Twinpak  
**OCTOBER (SOLD OUT) Music** Kate Bush, Ken Freeman **Hardware** Fender Vintage Series, Rhodes Chroma, Kay Memory Rhythm **Technology** EMT (Performance Controls), ElectroMix 842 Pt1  
**NOVEMBER Music** Patrick Moraz, Robert Moog, Bill Nelson **Hardware** Yamaha PC100, Technics SXK200, Casio MT70, Hohner P100, JVC KB500, Gibson Firebird 2, Alligator AT150, AHB 1221 Mixer **Technology** ElectroMix 842 Pt2, Sweep Equaliser  
**DECEMBER Music** Cliff Richard **Hardware** Elka Synthex, Crumar Stratus, Tokai Basses, Shure PE Mics, The Kit **Technology** Transpozer Pt1, Canjak

1983

**JANUARY Music** Richard Barbieri (Japan) **Hardware** Westone Bass, BGW 750C Amp, Korg EPS1, Cief BandBox, Zildjian Cymbals **Technology** Synblo, Transpozer Pt2  
**FEBRUARY Music** Isao Tomita, Human League **Hardware** Novatron, LinnDrum, Simmons SDS6, Klone Kit, Movement Drum Computer 2, Korg KPR77, MemoryMoog, Synclavier II, Powertran Polysynth, Vigier Guitars, Pearl Mics **Technology** Synbal, Caltune  
**MARCH Music** Klaus Schulze, Michael Karoli, Francis Monkman, Bernard Lolotil, Chris Franke **Hardware** RSF Kobol Expander, Korg Poly 61, Aria Mics, BGW 7000 Amp, Ibanez Pedals, Tokai Flying V **Technology** Bridge, 842 Mixer Meter Bridge  
**APRIL Music** Naked Eyes, Gabor Presser **Hardware** Casio 7000, SCI Prophet 600, Chroma/Apple Interface, Eko Bass pedals, Vox Guitars **Technology** Syntom II  
**MAY Music** Keith Emerson **Hardware** Roland MC202, Fostex X15, Carlsbro Cobra 90 Kbd Combo, M&A K1/B Kit, Echo Unit Supplement (13 reviews,

inc. Roland SDE2000, Fostex 3050, Korg SDD3000) **Technology** Introducing the MIDI, MicroMIDI, Active Speaker  
**JUNE Music** Steve Hillage, Arthur Brown **Hardware** Synclavier II, Synton Syrinx, Emu Drumulator, Vestafire Dual Flanger, Aria AD05 Delay, Suzuki Mics, Clarion and Cutec four-tracks **Technology** OMDAC  
**JULY Music** Marillion, Hans Zimmer **Hardware** Trident VFM Mixer, Kawai SX210, Aria U60 Deluxe BBS, Deanevar VA30K Amp, MXR Omni FX, Milab Mics **Technology** Yamaha DX synthesisers, Ditgal Signal Processing Pt1, Tap Tempo  
**AUGUST Music** Bill Nelson, Hubert Bognermayr, Barclay James Harvest **Hardware** Roland JX3P/PG200, QSCar, 360 Systems Digital Kbd, MPC Music Percussion Computer, Yamaha SG200, Fender 100W Stage Lead, Frontline FX **Technology** Digital Signal Processing Pt2  
**SEPTEMBER (SOLD OUT) Music** Peter Vettese **Hardware** Prophet T8, Oberheim DX, SCI Pro-FX 500, Rick-enbacker 360 12-string & TR75 GT Combo **Computer Musician (CM)** Music Composition Languages Pt1, Sounding Out the Micro Pt1 **Technology** Which Synth Guide, Synclap  
**OCTOBER (SOLD OUT) Music** John Miles, Andrew Powell **Hardware** Yamaha DX1, OctavePlateau Voyetra 8, Siel Opera 6, MXR 185 Drum Computer, Ross Pedals, Fender Elite Precision Bass 1, Steinberger six-string **CM** Sounding Out the Micro Pt2, Speech Synthesis, **Technology** Digital Signal Processing Pt3, Mains Distribution Board  
**NOVEMBER Music** Tony Banks, John Foxx **Hardware** Seiko Digital Keyboards, Eko EM10, UC1 Sequencer for SCI Pro One, Doctor Click, Klone Kit 2, Ibanez HD1000, Korg KMX8 Mixer, Ibanez RS315SC Guitar **CM** Music Composition Languages Pt2, Software Envelope Generator (ZX Spectrum), MUZIX 81 (ZX81) **Technology** Digital Signal Processing Pt4  
**DECEMBER (SOLD OUT) Music** Gary Numan, Psychic TV, Philip Glass **Hardware** Prophet T8, Yamaha PC1000, Carlsbro AD1 Echo, Personal Keyboard Guide **CM** Decillionix (sound sampling for Apple) **Technology** Valve Driver

1984

**JANUARY Music** Simple Minds, Saga, Hawkwind, Dave Hewson **Hardware** Oberheim OB8, Vigier Bass, Siel Cruise, Ibanez DM2000, The Kit + Accessories **Technology** Using Sequencers, Electronic Metronome

**FEBRUARY Music** Daniel Miller, China Crisis, Don Airey **Hardware** Korg Poly 800, Siel PX, Yamaha PS55, Eko EM12, Boss DE200, Roland Chorus Cube 60, Washburn Bantam Bass, Carlsbro Marlin, Dr Böhm Digital Drums **CM** Mainframe **Technology** Drumatix Mods, Voltage-Controlled Clock  
**MARCH Music** Vince Clarke & Eric Radcliffe, Blancmange **Hardware** SCI SixTrak, Roland SDE3000, Roland System 100M, Electronic Percussion Guide (nine reviews inc. SCI Drumtraks, Boss DR110, AHB Inpulse One, Hammond DPM48) **CM** Music Composition Languages Pt3 **Technology** S-trigger Converter, Lead Tester  
**APRIL (SOLD OUT) Music** Fad Gadget, Vic Emerson (Sad Café) **Hardware** Simmons SDS7 & SDS8, Jupiter 6, Roland TR909 & MSQ700, Yamaha PS Kbds, Crumar Composer, Ibanez UE400 & UE405, Klone Dual Percussion Synth, Vox White Shadow Bass **CM** Gentle Art of Transcription Pt1, Ins & Outs of Digital Design **Technology** Understanding the DX7 Pt1, Syndrom Pt1, Bass Pedal Synth  
**MAY Music** Yang Chung **Hardware** PPG Wave 2.3 & Waveterm, Roland Juno 106, Roland JSQ60, Casio 310, M&A Electronic Drums, Dynacord PDD14 **CM** PDSG Pt2, **Technology** Understanding the DX7 Pt2, String Damper **MIDI Supplement Pt1** Specification, Theory & Practice, Product Guide, MIDI By Numbers (Steve Levine)  
**JUNE Music** OMD **Hardware** Roland GR700/G707, SynthAxe, Siel Expander, SCI Model 64 Sequencer, MFB512 Digital Drum m/c, Jen Musipack 1.0, Boss DD2 Delay Pedal **CM** Gentle Art of Transcription Pt2, PDSG Pt2 **Technology** Understanding the DX7 Pt3, Syndrom Pt2, Multiwave LFO **MIDI Supplement Pt2** Inside MIDI, MIDI & The Micro, BeeBMIDI Interface Pt1  
**JULY Music** Human League, Steve Jolliffe, Jade Warrior **Hardware** Yamaha DX9, Korg Super Section, Yamaha MK100, Microsound 64 Kbd, TED Digisound, Ibanez DM1100 DDL **CM** JMS MIDI Software, PDSG Pt3 **Technology** Spectrum MIDI (SCI SixTrak and DX7 Patch Dump), Understanding the DX7 Pt4, RackPack, BeeBMIDI Pt2  
**AUGUST Music** Rusty Egan (Visage), Cocteau Twins, Hans-Joachim Roedelius **Hardware** Synclavier Update, Technics SXK250, Yamaha PF10 & PF15, Siel Piano Quattro & PX jr, Roland HP300, HP400, PB300 & PR800, Garfield Electronics MiniDoc, Electro Harmonix Instant Replay & Super Replay **CM** EMR BBC B MIDI Software Fairlight Explained Pt1, **Technology** Understanding the DX7 Pt5, BeeBMIDI Pt3, Syndrom Pt3, Minibio, SynthMix Pt1  
**SEPTEMBER Music** Thomas Leer, Chris & Cosey **Hardware** Oberheim Xpander, Korg EX800 & RK100, Digiatom 4800, Cutec MX1210, Microlink ML10 System, Roland MPU401, Sycologic AMI & MX1 **CM** OMDAC Update, Passport MIDI/4 Software, Fairlight Explained Pt2, Steptime Composition on the SCI Model 64 **Technology** SynthMix Pt2, Dual VCLFO, Understanding the DX7 Pt6

Back issues are available at £1.30 each (inc. p&p) for 1983/84, while 1981/82 issues are available at a special price of 80p each (inc. p&p). All prices refer to the UK and surface mail to Europe and Overseas. Photocopies of articles from SOLD OUT issues can be obtained at 50p per article. Orders please to: E&MM Mail Order Department, Alexander House, 1 Milton Road, Cambridge, CB4 1UY.

This back issues page supercedes all previous listings, and the contents of each issue are presented in summarised form. See E&MM Feb 83 and Feb 84 for full Indices of 1981/82 and 1983 issues respectively.





# TELECOMMS

(A Division of Mike Devereux Music Ltd.)

**THE UK'S FASTEST MAIL ORDER SERVICE  
- SAME DAY DESPATCH  
SIMPLY RING OUR HOTLINE QUOTING CREDIT CARD  
HOTLINE (0705) 660036**

**LOWEST  
UK PRICES**

## SYNTHESIZER AND KEYBOARD BARGAINS

Yamaha Portasound s/h	£75
Casio 403 s/h	£120
Roland SH101 s/h	£199
1 only Trident II s/soiled	£POA
Yamaha DX9	£750
Roland JX3P	£775
Roland Juno 60	sale price
Roland Juno 106	£599
Roland SH101	£250
Roland RSo9	£299
Roland PG200	£169
Roland MC202	£299
KORG Poly 61	£499
KORG Poly 800	£429
KORG Mono Poly	£399
KORG Micro preset	£120
KORG Delta	£299
Casio PT30	£55
Casio MT45	£77
Casio PT50	£79
Casio MT70	£167
Casio CT1000P s/h	£170
Casio MT800	£199
The Gnat	£89

Yamaha DX9 owners look  
160 memory expansion board .... £270

## RHYTHM UNITS

Roland TR909	£625
Roland TR606 Drumatix	£199
Roland TR303 bassline	£179
BOSS DR110	£95
BOSS DR33 Dr Beat	£36
Yamaha MR10 s/h	£59
Roland Rhythm 33 s/h	£39
Roland TR808 s/h	£375

Roland GR700 guitar synth  
Roland G707 guitar controller  
Phone for best price

## RECORDING EQUIPMENT

TEAC Portastudios M244	£599
TASCAM 22-2 2 track	£399
TASCAM 32	£765
TASCAM 34	£899
TASCAM 38	£1799
TASCAM DX2D	£186
TASCAM DX4D	£258
TASCAM M30	£699
TASCAM M09	£169
TEAC MB20	£149
TASCAM EX20	£99
TASCAM RC71	£42

## PA RACK EQUIPMENT

Aces stereo elec. crossover	£69
Aces Graphic EQ	£120
Aces stereo bass bin filter	£60
Aces spring reverb	£94
Aces graphic slave	£349

## PEDALS AND EFFECTS

BOSS CE2 Chorus	£53
BOSS CE3 Stereo chorus	£57
BOSS DS1 Distortion	£38
BOSS DD2 digital delay	£139
BOSS HM2 heavy metal	£39
BOSS DM2 delay	£73
Carlsbro 10 board graphic s/h	£30
BOSS NF1 Noise gate	£39

BOSS GE7 Graphic	£55
BOSS PHIR Phaser	£55
BOSS BF2 Flanger	£61
BOSS CS2 Compressor	£44
BOSS SD1 Super overdrive	£39
BOSS PC2 Percussion	£44
BOSS HC2 Handclapper	£45
BOSS DP2 Damper	£12
BOSS PSA220 mains adaptor	£12
BOSS ACA 220 mains adaptor	£12
BOSS VB2 Vibrato	£49
BOSS OD1 Overdrive	£38
BOSS SP1 Spectrum	£39
BOSS SG1 Slow Gear	£29
BOSS TW1 Touch Wah	£49
BOSS MA1 Mascot amp	£31
BOSS Rocker Distortion	£69
BOSS DM3 stereo echo	£81
Ibanez AD9 delay	£89
Ibanez TS9 tube screamer	£33
Ibanez SD9 sonic distortion	£35
Ibanez CP9 compressor	£39
Ibanez PT9 Phaser	£39
Ibanez CS9 Stereo Chorus	£59
Ibanez GE9 Graphic	£59
Super Echopet EP250	£150
Melos DE1 Digital echo	£79
Melos 350E Tape echo	£69
Analog Delay w reverb AE205R	£145
Ibanez Hd1000 harmonic delay	£POA
Carlsbro AD1 echo	£125
Carlsbro Protex ADR1	£336
Carlsbro Flanger Miniflex	£48
Carlsbro Compressor miniflex	£34
Schaller volume pedal	£19
Electro Harmonix gold throat s/h	£40
MXR Blue box	£39

## TUNERS

BOSS TU60	£35
BOSS TU120	£65
BOSS TU12	£39
KORG Micro 6	£19
KORG GT60X	£25
KORG GT6	£38
BANANA Tuner	£24

## SANOX PEDALS

(same as FRONTLINE)

SANOX 15SX Octaver	£20
SANOX 65SX Junction box	£7
SANOX 71 SX Perc Synth 1	£20
SANOX 82SX Perc Synth	£30
SANOX 75SX Parallel Box	£10
SANOX 96SX Line Selector	£15
SANOX 98SX Power supply	£13
SANOX 110SX Exciter	£20
SANOX 95SX 6 channel mixer	£15
SANOX 32SX Crossover 11	£20
SANOX 55SX Graphic EQ	£20
SANOX 14SX Super phase	£25
SANOX 70SX Pocket amp	£15
SANOX 85SX Flanger	£35
SANOX 112SX Parametric	£20
SANOX 84SX Chorus	£29
SANOX 87SX Pre-amp	£10

Add £1 P&P on all pedals and tuners

## MICROPHONES

Beyer M200	£49
Beyer M380 NC	£65
Beyer M400 NCS	£99
Beyer M69	£93
Audio Tech ATM 41 gold	£63
Audio Tech Pro 3	£37
Audio Tech Pro 4	£47
Electro Voice PL88L	£53

Electro Voice PL80	£92
Electro Voice PL95A	£94
Electro Voice PL11	£85
Electro Voice PL77B	£105
Shure PE86L	£108
Shure 588SA	£66
Fender D1	£65

## OVATION GUITARS

Fender F65	£99
Fender F03	£53
Applause Elec Acc	£164
Electric Anniversary	£599
Electric Glen Campbell	£499
Electric Legend	£499
Ultra Acoustic	£239
Ultra Electric	£270
Electric Balladeer	£349

WANTED FOR CASH  
USED SYNTHS, GUITARS  
AMPS AND COMBOS  
NEED THE CASH?  
RING US NOW

## GUITARS

Fender Precision Bass M/N	£335
Fender Precision Bass s/h	£199
Fender Precision Special	£495
Fender Telecaster R/N white	£279
Fender Telecustom R/N Black	£299
Fender Musicmaster	£139
Squier 52 Telecaster	£235
Squier 62 Pre: Bass	£199
Bullett Bass Deluxe M/N red w/c	£199
Bullett Deluxe 111 M/W w/c	£199
Tokai TST 50 (all colours)	£199
Tokai TTE50 (all colours)	£199
Tokai Talbo	£285
Ibanez Roadstar guitar (cols)	£165
Ibanez Roadstar natural	£139
Ibanez Roadstar bass from	£188
Shergold Masquerader 1/2 s/h	£95
Shergold Meteor s/h	£149
Shergold Bass s/h	£99
Gibson RD custom s/h	£250
Westone Thunder 11A guitar	£182
Westone Thunder 1 guitar	£159
Westone Thunder 11 Bass F/less	£240
Westone Thunder 111 Bass	£320
Vox Custom bass	£199
Vox White Shadow lead	£135
Vox White Shadow bass F/less	£182

SESSION COMBOS  
NOW IN STOCK

## AMPS CABS COMBOS

Roland spirit 10 combo	£75
Roland spirit 10a combo	£69
Roland spirit 30 combo	£125
Roland spirit 25W combo	£129
Roland JC 120	£435
Yamaha JX30 combo	£153
Yamaha G50112 combo	£299
H/H MA 150 amp	£299
H/H S150 slave	£182
H/H Pro 100 spkrs - each	£199
H/H MA80 amp	£186
Carlsbro S300M power amp	£315
H/H Studio 60B combo	£199
H/H Bass amp 10W	£168
Vox Venue Lead combo 100w	£192
Vox Venue 4Ch PA amp 120W	£192
Vox 15w 2 x 10	£106
Carlsbro Marlin 6-150	£279

Carlsbro Marlin 6-300	£345
Carlsbro M150 slave	£185
Carlsbro Stingray bassamps from	£170
Carlsbro Stingray multichorus amp	£275
Carlsbro Cobra 90 Bass combo	£199
Carlsbro Cobra 90 Lead combo	£199
Carlsbro 150 bass combo	£254
Carlsbro Hornet 45 lead combo	£147
Carlsbro Wasp lead combo	£58
Kudos K653 speakers (pair)	£463
BOSS MS100 monitor	£72

## USED AMPS CABS COMBOS

MET Mic stand	£15
MET Boom stand	£20
H/H MA100 amp	£160
H/H VS bass amp	£85
H/H IC 100 amp	£95
H/H VS musician amp	£95
Fender bandmaster	£135
Roland SPA 240 amp	£295
H/H Bass cabs	£95
Marshall cabs	£120
Music man 112 combo	£225
Fender bassman 100	£150
Yamaha JX30B combo	£165

A COMPLETE RANGE  
OF PEAVEY AMPS -  
CABS - COMBOS AND  
PRO PA NOW ON SHOW

Keyboard stands	£19.95
Stand extension	£8
Speaker stands	£32
P&N mic boom stand	£17

## CHASSIS SPEAKERS

JBL E120-8 12" speaker	£120
Tannoy 15" re-cone	£99
RTC 15" 100 watt	£46
McKenzie 15" 150 watt	£79.95
McKenzie 12" 80 watt	£34.50
Piezo horns	£6
H/H bullet horns HF200	£25

## MARSHALL AMPLIFICATION

The UK's largest stockists of new and used MARSHALL. Stock changes daily. Ring for quote.

Marshall Super Bass amp MkII s/h	£195
Marshall Super Bass (old style)	£170
Marshall 4x12 1960B cab s/h	£120
Marshall 4x12 1935A cab s/h	£120
Marshall 280W 4x12 1960B cab	£120
Marshall 75W 1x12 tran combo 5275 POA	£120
Marshall 100W 2x12 valve combo 4103	£120
Marshall 100W M.V.	£120
Marshall 50W M.V.	£120
Marshall 260W 4x12 cab	£120
Marshall 200W 2x15 bass cab	£120
Marshall 30W transistor	£120
Marshall 12W transistor	£120
Marshall 100W valve 2x12	£120
Marshall 20W 1x10 keyb.	£120

## TRACE ELLIOT

(Full range in stock)

Trace Elliot AH250	£539
Trace Elliot AH150	£317
Trace Elliot 1048 cab	£305
Trace Elliot 1514 cab	£327
Trace Elliot 1110 combo	£641

## HIGH QUALITY PA

Bose 1800 amp	£POA
Bose 302 Bass bins	£POA
Bose 802 series 11	£POA
JBL 4612 speakers each	£465

ACCESS - BARCLAYCARD - AMERICAN EXPRESS - HP - PART EX. - CASH!

**WE HAVE OVER 2,000 SQUARE FEET OF SHOWROOMS CRAMMED  
FULL WITH GOODIES - WELL WORTH A VISIT! HP P/X NO PROBLEM**

**Telecomms** 189 London Rd., North End, Portsmouth PO2 9AE



# Studiomaster 6-2-1

'THE MINI THAT THINKS IT'S A MAXI'

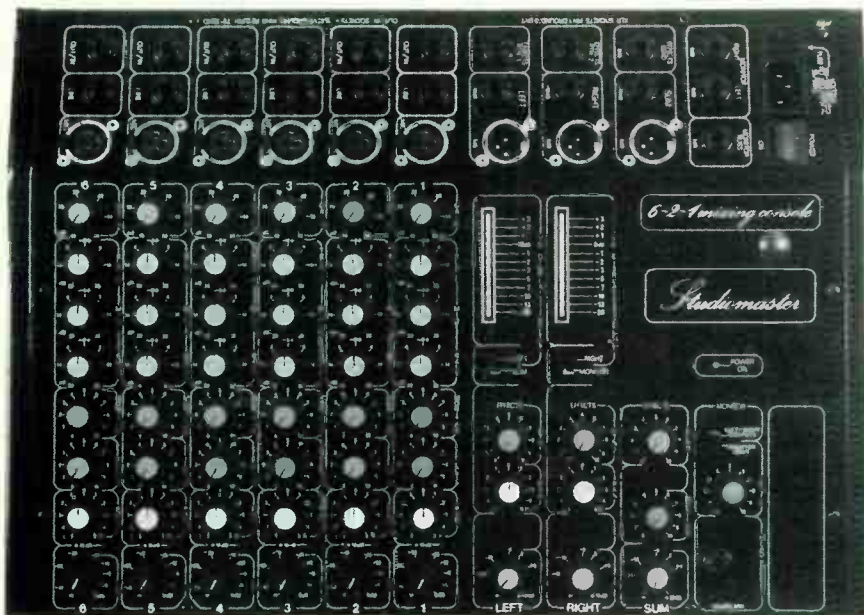

The Studiomaster 6-2-1 mixing console is proof that small can sound beautiful.

The 6-2-1 is only 17 inches wide, excluding rack adaptors, just over 12 inches high, and three inches deep. Yet its all-round performance is equal to many a larger mixer.

If you're starting up a disco or your band's ready to go on the road – but money is naturally tight – the 6-2-1 is the console you can afford.

For conference work, for a church PA system, a community hall, or an office communications board, the 6-2-1 is made with your tight budget in mind.

And Studiomaster care and thought in design makes certain that even the relatively inexperienced home hi-fi enthusiast finds the 6-2-1 easy to handle.

Whether you're a dedicated amateur or a hardworking professional, you'll rapidly discover the big advantages that the compact 6-2-1 has to offer.

And as soon as you're ready to grow the 6-2-1 grows with you. Six input expanders instantly convert the 6-2-1 into a 12-2-1.

That's flexibility for you, the Studiomaster way.

## STUDIOMASTER

STUDIOMASTER, Chaul End Lane, Leagrave, Luton, Beds, England. Tel: 0525 221331/221272  
Telex: 85612 Studio G.

### SEE IT PERFORMING AT...

**Audio Services, Stockport** 06632-4244   **A1 Music, Manchester** 061-236-0340   **Alpha Music, Leeds** 0532-457500  
**Blackpool Sound Centre** 0253-25544   **Dougies Music, Northwich** 0606-782522  
**Gigsounds, Streatham** 01-769 5681   **Gigsounds, Catford** 01-690 8621   **Hessy's, Liverpool** 051-236 1418  
**JSG, Bingley** 0274 568843   **KG MUSIC, Wakefield** 0924 371766   **Music Stop, Wolverhampton** 0902 29352  
**Musical Exchanges, Birmingham** 021-236 7544   **Rock City, Newcastle** 0632 324175  
**Sound Control, Dunfermline** 0383 733353   **Wisher's, Derby** 0332 48156   **Tim Gentle, Leigh on Sea** 0702 72926  
**Tim Gentle, Milton Keynes** 0908 613909   **Rea Sound, Northern Ireland** 06487 64059  
**Axe Music, Colchester** 0206 65652   **Turnkey** 01-202 4366   **Autec, Hitchin** 0402-58961  
**Michael Stevens & Partners, Bromley** 01-460 7299   **Don Larking, Luton** 0582 450066







# Tama Techstar TS500 Electronic Drum Kit

Electronic drums need four things to be successful – playability, durability, good basic sounds and good looks. The Tama Techstar would appear to offer all these features. *Paul White*



Ever since Dave Simmons got the concept of electronic drums to be universally accepted, everyone has been waiting to see when the Japanese would try to break into the market, and with what. In terms of facilities and sounds, the Techstar would appear to be a direct competitor for the Simmons SDS8, as it's a five-drum hexagonal kit with a choice of one factory preset or one user-programmable voice per pad, but there are some important differences.

First, the heads are real drum heads which may be tensioned to give a suitable playing feel without in any way affecting the sound, and second, the snare drum has a rimshot capability which is routed to an extra channel on the control module.

## Construction

The pads themselves are moulded from a tough black plastic, and the snare drum has an extra section in order to trigger the rimshot. All the stands are made by Tama and, when set up, everything stays firmly where it's been put. The bass

drum has an isolated striking pad at the centre, ostensibly to reduce crosstalk, and two massive spurs hold this firmly in place. A metal plate is secured to the bottom of the bass drum pad so that a conventional bass drum pedal may be easily fitted.

The drum pads accept conventional twelve-inch heads which are tensioned by means of six conventional lugs protruding through the plastic casing, foam being fitted to the underside of the head to minimise stick sound.

## Electronics

The control module is mounted in a smart steel box with lugs for rack mounting and, if the box is placed with the controls facing upward, the connections run along the back edge. In practice, these would be inaccessible if the unit were to be mounted in a conventional rack, so I suppose most users will stand it on the most convenient object to hand (in my case, this was the cardboard

box that the pads came in). There are six channels of electronics in all, and the ingredients which make up the sounds are tone, filtered noise and stick click, with variable tone bend and decay. Additionally, a control labelled emphasis adds a degree of lower mid boost to beef up the basic sound.

Each channel has its own sensitivity control, and the outputs may be taken separately to a mixer or from the mixed output. The latter provides a pre-panned stereo drum mix, but if only one socket is used, a normally balanced output is achieved useful for stage monitoring. All the channels have identical facilities, except for the rimshot channel which has no noise filter.

## Sounds

Using the factory preset sounds give a reasonable impression of Simmons toms but the snare is a little short of noise and sounds too much like another tom as a result. The bass drum is deep and punchy but not at all like an acoustic bass drum. Still, the 'electronic' bass sound has become quite popular in modern music, so doubtless the standard Tama preset will find plenty of use. Now to the rimshot. Perhaps they don't have rimshots in Japan, but this sounded more like a ricochet: *definitely* over the top.

On selecting the user-programmable function, the snare was duly made snarier, the rimshot made rimshotier and the bass drum sound tightened up to what I (probably misguidedly) thought was a good bass drum sound. (I used to be a drummer before I took up a musical instrument you know!)

Pitch sweep may be either up or down, and the stick click adds a burst of noise to the beginning of each beat, just like a Simmons. One useful addition is the Emphasis control, and I was tempted to use a lot of this to fatten out the sound. I eventually yielded to this temptation, and said fattening was duly achieved.

Each drum may be triggered by a positive pulse rather than by a pad if required. I used my Roland TR606, and



this makes sequencer operation possible (providing you've got a suitable sequencer) though it also means you lose out on the touch-sensitivity afforded by pad control. An LED is fitted to each channel so that triggering can be monitored and, if you hit the drums hard with the sensitivity turned well up, a certain amount of crosstalk is shown by the LEDs, though in practice this isn't too serious.

## Playing

The heads feel very much like real drums but although they look large enough to hit, it's a little too easy to hit the rims instead. This doesn't matter much as the electronics will still trigger, but on the snare drum this action also triggers the rimshot sound, which could be a mite embarrassing on stage. The rimshot sensor is in fact a raised piece, about three inches long, fixed along one of the flat sides of the snare drum, and when not in use acts as a convenient device for holding drum sticks.

In use, everything on the Tama felt very secure and playing was natural but the pads *do* make an acoustic sound when you hit them, so it's necessary to monitor at quite a high level to get the proper feel of things, otherwise all you hear is the stick striking the pad. One slight mounting problem was also

encountered. I found it difficult to get the toms mounted low enough – the stands had plenty of capacity to get longer but not to get shorter. Still, I managed it in the end.

## Conclusions

Tama already have a strong reputation for producing acoustic drums, and this



kit should extend that reputation into the electronic field. The stands shouldn't let you down, and the real drum heads may well woo a few drummers who'd never previously ventured into electronic percussion because it was too much like playing on top of someone's crash helmet.

In terms of sound, I think it's probably fair to say this kit has been designed to sound as Simmons-like as possible but this kit is not a cheap copy. In fact, it will retail for about £100 more than the

Simmons SDS8, but the Tama's striking looks and real drum feel could well tip the balance for some players. If you already have an acoustic drum kit you feel at home with, you could always supplement it with the Techstar TS600 (not tested here), which provides four toms, a versatile synth sound and hand-claps, instead of the TS500 – the circuitry works from the same pads.

The Tama Techstar is further evidence that electronic drums are here to stay, and I have a feeling that once a good choice of digital kits hits the market, acoustic drums may well become a thing of the past: after all, the public won't accept (or even recognise) a drum sound these days without compression, reverb and gating. A good digital kit could provide all the studio drum sounds for less than the cost of a good set of drum mics and these, combined with synthesised drums such as those reviewed here, could well provide the drummer with more versatility than ever before, and in an easier to amplify form.

Now that the Japanese have made an inroad into the market, who knows what electronic miracles the future will bring?

*RRP of the TS500 is £930 inclusive of VAT while the TS600 retails at £989 inclusive of VAT. Further information from Summerfields, Saltmeadows Road, Gateshead, NE8 3AJ.*

# GET YOURSELF A BETTER DEAL WITH JONES & CROSSLAND LTD.

**J**  
♣



## GUITARS

**WASHBURN**...New headless basses...black & red guitars, real eye catchers, now in stock along with **IBANEZ** guitars, best prices available  
**FENDER**...U.S.A. guitars at low prices...Strat now lowest ever at £299.  
**TOKAI**...full range in stock from £169!

## RECORDING EQUIPMENT

**TASCAM**...244 Portastudio best U.K. price.  
32- 34- 38- always in stock. AHB mixers...full range on demonstration. Handfuls of GBS springs, Accessit, Beyer, Sennheiser, Audio Technica, JBL, Ampex 406 & 456 all formats.  
**DYNAMIX**...A new desk at a great price, phone us  
**IBANEZ HD1000** harmonizer/delay £325  
Also new model Ibanez DM1100 3.6 second delay...Now only at £299.  
**THIS MONTH'S SPECIAL PRICES...**  
**YAMAHA MT44** only £325 inc. VAT.  
**TASCAM 234** for only £450!  
**IBANEZ DM2000** digital delay just £299.

Demonstrations...Advice?

## LET US GIVE YOU A HELPING HAND

Drop in or phone us for a chat at 4-8 Smallbrook Queensway Birmingham B5 4EN Tel: 021-643 4655

**A**  
♣

## ACE DEAL...

Roland MC202  
Microcomposer £165  
Only while stocks last!

## ELECTRONIC PERCUSSION

Full range of Simmons available including the SDS7 Digital/Analog drum system...The SDS8, all colours in stock (Free delivery in U.K. mainland). SDS6 midi sequencer for SDS7 & SDS5, plus the Simmons EPB digital sampler & e-prom blower for use with the SDS7  
(NEW) **TAMA TECHSTAR**  
Electronic drums...6 voices, 5 pads plus rim shot feature for £950.  
**DYNACORD PERCUTTER KIT**  
8 voice digital drum kit...sampled drum & cymbal sounds, features plug in ROM modules...large library available. Also in stock...**DYNACORD DIGITAL HIT**...only £125!

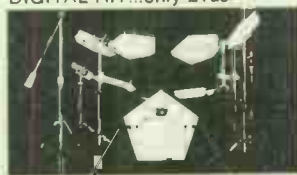

**C**  
♣



## NEW ROLAND PRODUCTS

**GR700/707** Guitar Synthesiser. "The guitarists dream come true!" Plus the **G707** Guitar Controller now available in red, black or silver.  
**MSQ100** Polyphonic Midi Sequencer...New budget priced version of the MSQ700.  
**MKB1000** & **300** Midi Keyboard Controllers.  
**MKS10** Midi 19" Piano Module & **MKS30** Midi 19" Polysynth Module. Also **MKS80** Super Jupiter 19" Midi 8 Voice Synth Module.

## YAMAHA HI-TECH DEALER

New...**RX11** & **RX15** Digital drum machines...The best priced digitals on the market...**RX11** £749 **RX15** £449.  
**R1000** Digital reverb in stock.  
**KX5** Remote midi keyboard 37 keys, touch response...32 access sounds!  
**CX5** Music computer, internal FM sound module and mini keyboard for just £549.

## COMPUTER MUSIC

We have MIDI music programs for Spectrum, Commodore, BBC, Apple and IBM computers. Please phone for details. We also have large stocks of peripherals, midi cables, interfaces etc. Mail order anywhere!



# FANTASTIC NEW Roland PRODUCTS JUST IN!!



## MSQ100 POLYPHONIC MIDI SEQUENCER

FOLLOWING THEIR SUCCESS WITH THE WORLD'S FIRST MIDI SEQUENCER THE ROLAND GROUP NOW INTRODUCE A NEW BUDGET VERSION PACKED WITH FEATURES AT A PRICE FOR ALL

## NEW EPOA MPU 401 INTELLIGENT MIDI COMPUTER INTERFACE FOR APPLE, IBM, ETC.

INTELLIGENT MIDI HARDWARE AND SOFTWARE NEW SOFTWARE ENABLES YOU TO PROGRAM JUNO 106 FROM COMPUTER WITH ALL PARAMETERS DISPLAYED IN BRILLIANT GRAPHIC COLOURS



NEW EPOA £695



## MKB 1000 & MKB 300 MIDI KEYBOARD CONTROLLERS

MKB 1000

NOW WITH NEW MODULES! ROLAND'S SYSTEM OF THE FUTURE AVAILABLE RIGHT NOW! THE FANTASTIC VELOCITY SENSITIVE MIDI KEYBOARD HAS ACOUSTIC PIANO FEEL WITH REAL WOOD KEYS IT CAN CONTROL ALL MIDI PIANOS SYNTHS GUITAR OR DRUM MACHINES AS WELL AS ITS OWN SELECTION OF MIDI MODULES WITH A TOTAL OF 128 PROGRAMMABLE MEMORY BANKS PLUS DUAL SPLIT WHOLE PARTS OF THE KEYBOARD CAN BE ASSIGNED AND MEMORISED IN ANY TIMBRE!! ROLAND'S BUDGET MKB 300 KEYBOARD CONTROLLER OFFERS THE SOLUTION FOR A HIGH QUALITY MASTER MIDI CONTROLLER PACKED WITH FEATURES AT A LOW PRICE!! ROLAND'S NEW PLANET SERIES RACK MOUNT MIDI MODULES POINT TO THE FUTURE OF MIDI EXPANSION! THE 6 VOICE PLANET AND 8 VOICE SUPER JUPITER OFFER FULL SYNTH FEATURES IN A CONVENIENT AND COMPACT 19" RACK SYSTEM

## MKS 10 PLANET P MIDI PIANO MODULE



## MKS 30 PLANET S MIDI POLY SYNTH MODULE



## MKS 80 SUPER JUPITER MIDI 8 VOICE SYNTH MODULE



NEW EPOA

## G707 GUITAR

## G700 MIDI GUITAR CONTROLLER

THE GUITARIST'S DREAM COME TRUE!! AT LAST GUITARISTS JOIN THE WORLD OF SYNTHESIS WITH THE MIDI CONNECTION! UNLIMITED SOUND CREATION AND CONTROL FROM YOUR GUITAR EXCELLENT TRACKING FROM THE G707'S NEW DAMPENED PICK WITH 89 PROGRAMMABLE SOUND MEMORIES AVAILABLE WITHIN THE G700 PLUS UNLIMITED EXPANSION POSSIBILITIES THROUGH THE MIDI BUS!

## JUNO 106 6 VOICE POLY MIDI KEYBOARD

UNIQUE 6 VOICE POLYPHONIC SYNTH WITH 64 TIMBRE MEMORY AND MIDI OUTPUT AT A BUDGET PRICE! NOW YOU REALLY CAN AFFORD A PROGRAMMABLE SYNTH WITH THE MIDI CONNECTION! ENDLESS FEATURES AND SOPHISTICATION COME AND TRY ONE NOW!



NEW EPOA



NEW EPOA

# FUTURE MUSIC

## FANTASTIC NEW ROLAND PRODUCTS COMING SOON

### SBX-80 SYNC BOX



THE SBX-80 IS AN AFFORDABLE PROGRAMMABLE TEMPO CONTROLLER THAT CAN GENERATE AND READ SMPTE TIME CODE IT GENERATES PULSE SIGNALS CONTROLLED BY MIDI DATA 24 CLOCK DIV SIGNALS OR SMPTE TIME CODE. THUS THE SBX-80 CAN BE USED AS A MASTER TEMPO CONTROLLER FOR ALMOST ALL ELECTRONIC INSTRUMENTS. THE TEMPO IS CONTROLLED BY THE TEMPO KNOB OR THE TAP SWITCH ON THE FRONT PANEL OR BY THE CLICK SIGNALS STORED IN EXTERNAL EQUIPMENT. THE SBX-80 ALLOWS A MUSICIAN TO CONTROL AN INSTRUMENT

NOT ONLY IN TIME WITH THE METRONOME RHYTHM OF A DRUM MACHINE OR A SEQUENCER BUT ALSO IN TIME WITH HIS OWN RHYTHM. THE SBX-80 CAN MEMORIZE ALL THE CHANGES OF TEMPO IN ANY COMPOSITION. A DISPLAY SHOWS ALL THE DATA REQUIRED INCLUDING THE TEMPO VALUE AND TIME SYNCHRONIZATION WITH A TAPE RECORDER INDISPENSABLE FOR MULTI TRACK RECORDING - IS ACHIEVED USING SMPTE TIME CODE INSTEAD OF ORDINARY FSK TAPE SYNC SIGNALS. IN THIS WAY THE SBX-80 ALLOWS EQUIPMENT TO BE SYNCHRONIZED WITH A TAPE RECORDER FROM THE MODULE OF A COMPOSITION. IT IS ALSO POSSIBLE TO OVERDUB A RHYTHM MACHINE OR A SEQUENCER OVER A COMPOSITION THAT IS RECORDED WITHOUT FSK TAPE SIGNALS. THE SBX-80 ALSO FEATURES A FUNCTION THAT ALLOWS THE SBX-80 TO SEND A MEASURE NUMBER TO A MIDI DEVICE THAT CAN ACCEPT THE MEASURE NUMBER AS MIDI DATA. SUCH DEVICES INCLUDE ROLAND'S TR-909 RHYTHM COMPOSER MSQ-700 OR MSQ-100 DIGITAL KEYBOARD RECORDER BECAUSE THE SMPTE STANDARD IS THE MOST POPULAR STANDARD FOR PROFESSIONAL BROADCASTING RECORDING AND FILM EQUIPMENTS. THE SBX-80 WILL PROVE TO BE ESSENTIAL NOT ONLY FOR MUSIC PRODUCTION BUT ALSO FOR VIDEO, TV AND FILM PRODUCTION

### SRA 4800 POWER AMPS AND SPEAKER SYSTEMS

### JC120H LEAD AND JAZZ COMBOS

### SUPERCUBE LEAD AND BASS COMBOS

### MCP-8 MIDI PAD



THE MCP-8 IS A COMPLETELY NEW MIDI CONTROLLER. IT ALLOWS YOU TO PERFORM ANY INSTRUMENT THAT HAS A MIDI IN JACK BY SIMPLY HITTING THE MCP-8'S PADS. THE MCP-8 HAS EIGHT PADS. SENSITIVITY CAN BE ADJUSTED FOR EACH PAD. WHEN A DRUM MACHINE IS CONNECTED WITH THE MCP-8 ONE SOUND SOURCE IS ASSIGNED FOR EACH PAD. WHEN A KEYBOARD INSTRUMENT IS CONNECTED WITH THE MCP-8 ONE KEY IS ASSIGNED FOR EACH PAD. IN ADDITION FOUR DIFFERENT SOUND COMBINATIONS CAN BE MEMORIZED AND RECALLED BY JUST PRESSING A BUTTON. IT IS ALSO POSSIBLE TO PLAY A MIDI INSTRUMENT BY CONNECTING EXTERNAL PADS TO THE EXTERNAL INPUT JACKS ON THE REAR PANEL. THE MIDI CHANNEL IS ASSIGNABLE. DYNAMICS CAN ALSO BE CONTROLLED. WHEN A DRUM MACHINE IS CONNECTED YOU CAN PLAY THE BASS DRUM AND CONTROL THE OPEN/CLOSE OF THE HI HAT USING FOOT SWITCHES. THE MCP-8 CAN EVEN BE USED AS A PERCUSSION INSTRUMENT THAT CREATES ANY SOUNDS YOU LIKE.

BOSS  
Pedal Bargains  
DR110 £99 H4 £75  
PC £45 H3 £45  
DD110 £99 DD3 £109  
CE £49 CE3 £55  
BP £55  
ALL ABOVE 20% OFF

## ROLAND SALE SPECIAL OFFERS

KEYBOARDS		SEQUENCERS	
Roland JP 8 (ex-dorm)	£399	NEW JX3P - PG 200	£775
NEW JP 8	£1150	NEW Juno 106	£785
NEW Juno 6	£495	MSQ700	£195
NEW Juno 60	£599	MC 202	£39
NEW JX3P	£875	MSQ100	£39
		TR-909	£999
		TR-808	£299
		TR-707	£299
		TR-606	£299
		TR-505	£299
		TR-404	£299
		TR-303	£299
		TR-202	£299
		TR-101	£299
		TR-000	£299
		TR-909	£299
		TR-808	£299
		TR-707	£299
		TR-606	£299
		TR-505	£299
		TR-404	£299
		TR-303	£299
		TR-202	£299
		TR-101	£299
		TR-000	£299
		TR-909	£299
		TR-808	£299
		TR-707	£299
		TR-606	£299
		TR-505	£299
		TR-404	£299
		TR-303	£299
		TR-202	£299
		TR-101	£299
		TR-000	£299
		TR-909	£299
		TR-808	£299
		TR-707	£299
		TR-606	£299
		TR-505	£299
		TR-404	£299
		TR-303	£299
		TR-202	£299
		TR-101	£299
		TR-000	£299
		TR-909	£299
		TR-808	£299
		TR-707	£299
		TR-606	£299
		TR-505	£299
		TR-404	£299
		TR-303	£299
		TR-202	£299
		TR-101	£299
		TR-000	£299
		TR-909	£299
		TR-808	£299
		TR-707	£299
		TR-606	£299
		TR-505	£299
		TR-404	£299
		TR-303	£299
		TR-202	£299
		TR-101	£299
		TR-000	£299
		TR-909	£299
		TR-808	£299
		TR-707	£299
		TR-606	£299
		TR-505	£299
		TR-404	£299
		TR-303	£299
		TR-202	£299
		TR-101	£299
		TR-000	£299
		TR-909	£299
		TR-808	£299
		TR-707	£299
		TR-606	£299
		TR-505	£299
		TR-404	£299
		TR-303	£299
		TR-202	£299
		TR-101	£299
		TR-000	£299
		TR-909	£299
		TR-808	£299
		TR-707	£299
		TR-606	£299
		TR-505	£299
		TR-404	£299
		TR-303	£299
		TR-202	£299
		TR-101	£299
		TR-000	£299
		TR-909	£299
		TR-808	£299
		TR-707	£299
		TR-606	£299
		TR-505	£299
		TR-404	£299
		TR-303	£299
		TR-202	£299
		TR-101	£299
		TR-000	£299
		TR-909	£299
		TR-808	£299
		TR-707	£299
		TR-606	£299
		TR-505	£299
		TR-404	£299
		TR-303	£299
		TR-202	£299
		TR-101	£299
		TR-000	£299
		TR-909	£299
		TR-808	£299
		TR-707	£299
		TR-606	£299
		TR-505	£299
		TR-404	£299
		TR-303	£299
		TR-202	£299
		TR-101	£299
		TR-000	£299
		TR-909	£299
		TR-808	£299
		TR-707	£299
		TR-606	£299
		TR-505	£299
		TR-404	£299
		TR-303	£299
		TR-202	£299
		TR-101	£299
		TR-000	£299
		TR-909	£299
		TR-808	£299
		TR-707	£299
		TR-606	£299
		TR-505	£299
		TR-404	£299
		TR-303	£299
		TR-202	£299
		TR-101	£299
		TR-000	£299
		TR-909	£299
		TR-808	£299
		TR-707	£299
		TR-606	£299
		TR-505	£299
		TR-404	£299
		TR-303	£299
		TR-202	£299
		TR-101	£299
		TR-000	£299
		TR-909	£299
		TR-808	£299
		TR-707	£299
		TR-606	£299
		TR-505	£299
		TR-404	£299
		TR-303	£299
		TR-202	£299
		TR-101	£299
		TR-000	£299
		TR-909	£299
		TR-808	£299
		TR-707	£299
		TR-606	£299
		TR-505	£299
		TR-404	£299
		TR-303	£299
		TR-202	£299
		TR-101	£299
		TR-000	£299
		TR-909	£299
		TR-808	£299
		TR-707	£299
		TR-606	£299
		TR-505	£299
		TR-404	£299
		TR-303	£299
		TR-202	£299
		TR-101	£299
		TR-000	£299
		TR-909	£299
		TR-808	£299
		TR-707	£299
		TR-606	£299
		TR-505	£299
		TR-404	£299
		TR-303	£299
		TR-202	£299
		TR-101	£299
		TR-000	£299
		TR-909	£299
		TR-808	£299
		TR-707	£299
		TR-606	£299
		TR-505	£299
		TR-404	£299
		TR-303	£299
		TR-202	£299
		TR-101	£299
		TR-000	£299
		TR-909	£299
		TR-808	£299
		TR-707	£299
		TR-606	£299
		TR-505	£299
		TR-404	£299
		TR-303	£299
		TR-202	£299
		TR-101	£299
		TR-000	£299
		TR-909	£299
		TR-808	£299
		TR-707	£299
		TR-606	£299
		TR-505	£299
		TR-404	£299
		TR-303	£299
		TR-202	£299
		TR-101	£299
		TR-000	£299
		TR-909	£299
		TR-808	£299
		TR-707	£299
		TR-606	£299
		TR-505	£299
		TR-404	£299
		TR-303	£299
		TR-202	£299
		TR-101	£299
		TR-000	£299
		TR-909	£299
		TR-808	£299
		TR-70	





# YAMAHA HI-TECH DEALER

**BULK PURCHASE  
SPECIAL OFFER**

MT44 SYSTEM COMPLETE  
with MIXER, PATCHBAY, RACK  
£479+VAT



**DX7  
WORLD'S MOST  
POPULAR DIGITAL  
SYNTH!!**



CALL FOR INFORMATION AND PRICES ON MIDI  
INTERFACES AND SOFTWARE FOR DX SERIES

**MIDI RETROFIT FOR  
CP70 AND 80  
CALL FOR DETAILS**

**DX9 SPECIAL DEAL  
£750  
CP70B  
SPECIAL OFFER  
£1995!!**

HUNDREDS OF OTHER  
YAMAHA SPECIAL  
BARGAINS! CALL IN FOR  
INFO AND UNBELIEVABLE  
LOW QUOTES!

**NEW**



**COMING SOON AMAZING NEW PRODUCTS**

**RX11.....£749  
RX15.....£499**

FABULOUS NEW PCM MIDI DRUM MACHINES  
AT NEW AFFORDABLE PRICES  
RX15 HAS 13 SOUNDS, 100 PATTERNS, 10  
SONGS  
RX11 HAS 16 SOUNDS, 2000 EVENTS, 10  
SONGS  
16 LETTER LCD DISPLAY AND LED DISPLAY



**KX5 Remote  
Keyboard  
£449**

**CX5 MUSIC  
COMPUTER.**

10 BADDOW ROAD,  
CHELMSFORD, ESSEX.  
TEL: 0245-352490

104-106 ELM GROVE,  
SOUTHSEA, PORTSMOUTH,  
HANTS.  
TEL: 0705-820595

202 NEW KINGS ROAD,  
FULHAM, LONDON SW6.  
(OPP. PUTNEY BRIDGE TUBE).  
TEL: 01-731 5993

Instant Credit Available



85 ST. MARY'S STREET,  
SOUTHAMPTON, HANTS.  
TEL: 0703-26798

## SEQUENTIAL CIRCUITS

## SIMMONS



**SIXTRAK 6 VOICE  
MULTI TIMBRE KEYBOARD**

**SIX TRAK IT'S THE HEART OF YOUR MULTI-TIMBRAL  
SYSTEM**  
To start with the Six-Trak sounds good because it features  
real VCO's and individual 4-pole filters per voice like all  
Prophet synthesizers. You can play the Six-Traks as a  
standard fully programmable 6-voice synthesizer.  
Or you can use its powerful built-in multi-track digital  
recorder to build your songs one track at a time. Since each  
of its six tracks are completely independent you can record  
a different instrument sound and melody line on each. The  
volume control for each track is also fully independent and  
programmable (a built-in mixer).

**DRUMATIK DIGITAL MIDI  
DRUM MACHINE**

An equally important player in the Traks Music System  
the Drumtraks digital drum machine. Through MIDI,  
Drumtraks connects directly to your Six-Trak.  
This lets you synchronize the playback tempo  
of the sequences which you have stored in the  
Six-Traks memory with

the rhythm patterns you have programmed in your  
Drumtraks. Standard clock inputs and outputs are  
also provided for controlling traditional sequencers  
and synthesizers. The Drumtraks feature 13 digitally  
recorded real drum and cymbal sounds. However,  
since you can program both volume and tuning  
individually for each of these 13 sounds, you can  
further expand your 'drum set' to include the sound of  
gongs, 32-tomrills, gorilla claps, and more. And just  
for fun, you can program all your volume dynamics  
and accents in real time from any MIDI equipped  
velocity sensitive keyboard instrument such as the  
Prophet T8!

**NEW MODEL 910 EXPANSION SOFTWARE FOR SIX  
TRAK AND MODEL 64**

The Six Trak is an amazingly powerful instrument by  
itself but with addition of a 910 its even more so for  
example the 910/64 package allows you to create  
multi-timbre sequences and songs (just like the Six  
Traks basic operational model) with a total memory  
capacity of 4,000 notes! Plus model 910 multi-timbre  
sequencer program will drive two Six Traks at once.  
This lets you utilize 12 voices in your song  
arrangements. When the SCI Drumtraks is added to  
the system the model 910 also provides full rhythm  
auto correction. Auto correction is a nifty feature that  
automatically corrects your minor timing  
imperfections when the song or sequence is played  
back. Six Trak programmer portion of the software  
lets you create and store groups of 100 programs  
turning your computer screen into a fully synthesizer  
front panel showing all knob and switch values.  
**NEW SOUND CHIPS FOR DRUM TRACKS FROM  
DIGIDRUMS**

**NEW**

**SDS7  
Digital  
Analogue  
System  
£2156**

**SDS8  
Electronic  
Kit  
£775**

**Sound  
Sampler for  
SDS7!! £349**

Sample your own  
sounds and add  
to the SDS memory

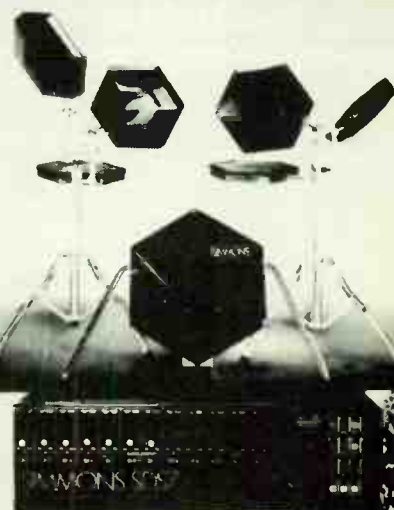



# Fostex

## PERSONAL MULTITRACK AT FUTURE MUSIC

B16 Another Fostex First Sixteen tracks high speed recording on 1/2" tape with Dolby C £3445 inc. VAT  
B16 Remote £345 inc. VAT

We have a number of Mixers available for use with the B16, all of which are subject to special package prices. Here are a few examples:  
B16, Remote, Dynamix 24.8.16 £4755 inc. VAT  
B16, Remote, RAM 18.8.16 £3999 inc. VAT  
B16, Remote, Allen & Heath 24.8.2 £5450 inc. VAT

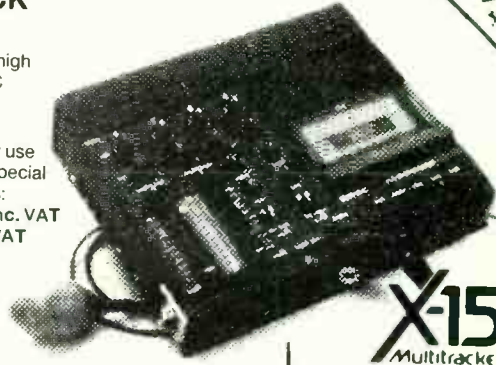

**X-15**  
Multitracker

**£249 inc VAT**

NEW MN15 Compressor/Mixer only £35

Mains supply, punch in/out switch ALL IN STOCK NOW

**NEW LOW PRICE**  
**£249!!!! INC. VAT**

## Accessit

FOSTEX SIGNAL PROCESSORS  
3070 DUAL COMPRESSOR/LIMITER £260 inc. VAT  
3050 DIGITAL DELAY £275 inc. VAT  
3030 STEREO 10 BAND GRAPHIC EQ £160 inc. VAT  
3180 STEREO REVERB £335 inc. VAT  
2050 LINE MIXER £140 inc. VAT  
3010 32 WAY NORMALISED PATCHBAY £45 inc. VAT

FOSTEX A8 SYSTEM  
CALL FOR PACKAGE PRICE ON A8 SYSTEM INC. A8 TAPE RECORDER, 350 MIXER 3060 METER BRIDGE

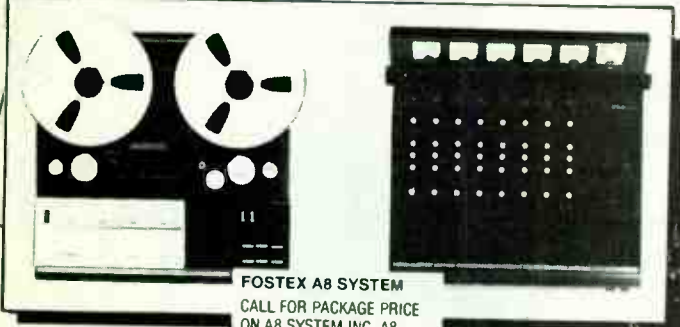

# FUTURE MUSIC

## RAM

## Promark

*Working with the right People*

AVAILABLE IN 10 AND 16 INPUT CHANNEL VERSIONS (RM10/RM16) THE RAM HAS 4 ROUTABLE SUB-GROUPS, TWO MASTER OUTPUTS AND 8 TRACK MONITORING FACILITIES.

IT IS TOTALLY COMPATIBLE WITH ALL 4 AND 8 TRACK RECORDING APPLICATIONS ON EITHER - 10 OR + 4 DBM TAPE MACHINES.

EACH INPUT CHANNEL OFFERS THE FOLLOWING:

- XLR BALANCED MICROPHONE INPUTS
- RCA TYPE PHONO AND JACK LINE LEVEL INPUTS
- INSERT POINTS
- 3 BAND EQUALISATION (INCLUDING VARIABLE SWEEP MID BAND PARAMETRIC CONTROLS)
- 2 AUXILIARY BUSES
- SWITCHABLE PHANTOM POWERING
- PEAK OVERLOAD INDICATOR
- PAN CONTROL AND PFL CIRCUITRY
- AFL ON THE TWO MASTER AUXILIARY RETURNS
- MONITOR DIM CONTROL
- 2 HEADPHONE OUTPUTS

RM 10 £635 INC VAT  
RM 16 £860 INC VAT  
RM 18 £1865 INC VAT

FULL FEATURE MIXERS AT INCREDIBLY LOW PRICES



**MX3 8/4/2 MIXER**  
**IDEAL FOR ALL 8 TRACK SYSTEMS**

Ideal for Fostex A8 system only £459 8-4-2.

**IDEAL FOR FOSTEX A8 SYSTEM ONLY £466 incl VAT**



### Applied Ergonomics

Since its inception the MX3's designers have interpreted the needs of the user from a human as well as technical point of view. A unique approach to graphics and colour has given the MX3 a high degree of User Friendliness. Signal paths are clearly visible to all the other colour coded RCA type connectors. Control knobs

have raised pointers for easy setting. From the moment you switch on the MX3 you will appreciate the refinements achieved through advanced construction techniques and applied ergonomics.

**SPECIAL OFFER**

**SDS 5 ELECTRONIC DRUM KIT COMPLETE**

★ £999 ★

**ONLY A FEW LEFT**



# OBERHEIM

## 360 SYSTEMS DIGITAL KEYBOARD

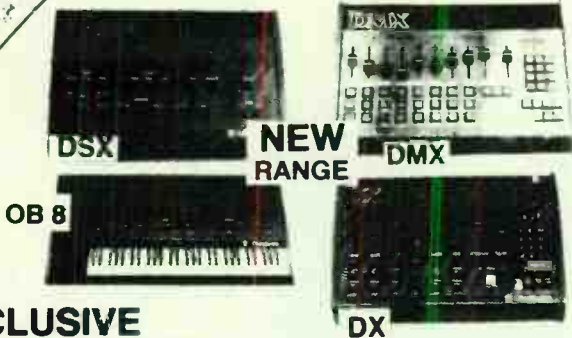

The 360 System 8 note digital polyphonic keyboard offers 32 on board memories of real sounds digitilised from a selection of over 100 instruments from a 9' Bosendorfer Grand Piano to a steel drum! New sounds just in include Tympani, Vibes, Xylophone, Violins, Cello sections etc!

## EXCLUSIVE SOUTH EAST AGENT



## ★ XPANDER

### NEW EXPANDER MIDI SYNTH MODULE

Imagine being able to control each of these voices easily and independently. A Matrix Modulation™ system that lets you connect 27 sources to any of 47 destinations per voice, with an interactive block diagram and 120 display characters to make it easy to use. Imagine being able to interface all of this to anything you wish, Velocity Keyboards, Sequencers, Guitars, Computers, MIDI and CVs simultaneously, and of course, the Oberheim System. We've had these fantasies, too. The Oberheim Xpander... the fantasy realized. Realize your fantasy at your local Oberheim dealer or write for more information.

**CALL FOR INFO ON 360 SYSTEMS AND OBERHEIM VIDEO DEMO TAPE!**

202 NEW KINGS ROAD,  
FULHAM, LONDON SW6.  
(OPP. PUTNEY BRIDGE TUBE).  
TEL: 01-731 5993

10 BADDOW ROAD,  
CHELMSFORD, ESSEX.  
TEL: 0245-352490

104-106 ELM GROVE,  
SOUTHSEA, PORTSMOUTH,  
HANTS.  
TEL: 0705-820595

85 ST. MARY'S STREET,  
SOUTHAMPTON, HANTS.  
TEL: 0703-26798

Instal. Credit Available



## Drumulator

NEW LOW PRICE!!

£795

inc. VAT

Drumulator new sound ROMS  
Drumulator pads and  
Graphic Software  
for Apple IIE in stock!

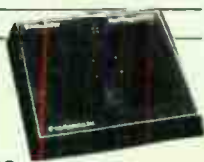

**NEW**

D Drum Digital  
Percussion Plates  
with  
wide  
variety of  
sounds on  
cartridge.  
£299



**NEW**

New Ted  
Digital Percussion  
Modules now available  
with Dynamic Sensing  
From £99



## MAINFRAME DS3

### DIGITAL SOUND SAMPLER

INCREDIBLE PRICE BREAKTHROUGH  
SOUND SAMPLE BOARD FOR APPLE II ONLY  
£250! WITH MIDI OPTION!  
DIGITAL SCAN KEYBOARD 4 NOTE  
POLYPHONIC £

### COMPLETE APPLE IIE SYSTEM £1450

COMPRISING APPLE II AND 2 DISC DRIVES -  
CARDS APPLE MONOCHROME MONITOR PLUS  
MAINFRAME BOARD AND KEYBOARD  
SEND SAE AND £1 FOR BROCHURE AND DEMO  
TAPE

Demo LP now available. Send £2.50 inc. postage



## Future Music Store

FUTURE MUSIC STORES CARRY THE BIGGEST SELECTION OF MIDI  
KEYBOARDS, SYNTHS, DRUM MACHINES AND SEQUENCERS  
ANYWHERE!! PLUS THE LARGEST RANGE OF MIDI INTERFACE  
HARDWARE SOFTWARE AND MIDI SOUND SAMPLING SYSTEMS! WE  
ARE EXPERTS. ALLOW US TO SHOW YOU AROUND MIDI LAND.

### MIDI

#### KEYBOARDS

ROLAND JP6  
JX3P  
JUNO 106  
MCK 100  
MKS 3C  
MKS 10  
HP 400

YAMAHA DX 7  
DX 9  
DX 1  
SEQUENTIAL CIRCUIT T8 6 TRACK  
OBERHEIM  
KORG POLY 800  
KORG POLY 61M  
360 SYSTEMS  
MAINFRAME 4 VOICE SOUND

**MIDI**



### MIDI COMPUTER INTERFACES

YAMAHA CX5 FOR MSX COMPUTER  
ROLAND MPU401 FOR APPLE, IBM, BBC  
EMR INTERFACE FOR BBC  
SIEL FOR CM64 AND SPECTRUM  
SEQUENTIAL CIRCUIT 64 FOR COMMODORE 64  
MAINFRAME SOUND SAMPLER MIDI BOARD  
FOR APPLE IIE  
PASSPORT 'POLYWRITER' APPLE MIDI BOARD  
FOR POLYPHONIC MUSIC PRINT

### MIDI GUITAR SYNTHS

ROLAND GR 70D  
G 707

### MIDI REMOTE KEYBOARD

### MIDI SEQUENCERS

ROLAND MC4B - MD8B  
MIDI INTERFACE  
SPECIAL PACKAGE PRICE £399

### MIDI DRUM MACHINES

ROLAND MC P8 PADS  
DELTA MIDI PAD  
YAMAHA RX11  
YAMAHA RX15

DEMONSTRATION VIDEOS: YAMAHA DX  CHROMA  FOSTEX MULTI-TRACKS  SIMMONS ELECTRONIC KITS   
SEQUENTIAL CIRCUITS DRUM TRAXX & SIXTRAXX  ROLAND COMPUTER PERIPHERALS  360 SYSTEMS  OBERHEIM   
YAMAHA  BETA  U-MATIC

Telephone No

Please send me the following goods

I enclose a cheque/P O for £  
or please debit my Access/Visa/Diners Club/American Express

No

Signature  
Please send me details on the following goods (enclose a large sae if

FOR DELIVERY CHARGES PLEASE PHONE FOR QUOTATION

EMM10



# FORUM

A new series in which readers are invited to contribute short articles on subjects that particularly interest them. This month sees a personal look at the shortcomings of modern analogue synthesiser design. *Martin S*



The Yamaha SK30 – is it irreplaceable?

Having been involved in analogue synthesis for a few years now, I get a feeling of pleasure tinged with pain whenever I look at the latest offerings from the major synth manufacturers.

I can't deny there hasn't been progress in many directions, of course. Programmability is now available at a price that would have been almost unthinkable little more than three years ago, while features such as arpeggiators, variable keyboard follow, and cross-modulation are no longer met with open-mouthed bewilderment by synthesists and music shop owners.

Not all the changes have been for the better, however.

It's difficult to forget the look on a keyboard player's face when the realisation suddenly dawns on him that his two grand's worth of polysynth simply cannot do what his old monophonic museum piece could achieve with ease, especially if it's going to be a couple of years of HP instalments before he's going to be in any position to rectify the situation.

I think anybody who's gone from a £300 antiquity to a modern polyphonic must be aware of how horribly jagged the VCO can sound when it's modulated by a sawtooth LFO instead of the sine wave that used to be so commonplace. Most designers/manufacturers seem to have signed the death warrant on sine wave low frequency modulation, which means the end not only of smoothly undulating voices but also of a whole range of clever effects that can be obtained using noise in conjunction with the VCF and LFO. Some instruments do

have a sine wave available on a performance control which improves matters a little, but it should be a standard feature, not an afterthought or a luxury.

A sawtooth waveform – fitted to just about anything with a keyboard attached to it these days, it seems – can also be very useful, of course. Demonstrate this to yourself by setting up a harpsichord-like patch on your synth (with lengthened decay and release), and use the LFO to modulate the cutoff frequency and you'll see what I mean. You should get a mildly astonishing echo effect that's more or less unobtainable by any other means, which is why I consider the sawtooth option just as desirable as any other...

Back in the gripes department, the chorus/ensemble/phaser device is a further source of contemporary synthetic discontent, at least as far as I'm concerned. Several older instruments (the old ARP Quadra springs to mind) had an impressive phaser resonance that served two purposes. First, the standard resonant phasing effect could produce a truly memorable depth of sound that was equally at home in a fast-moving bass-line or a sustained chord of silky strings; and second, the manual override (activated via a footpedal) produced an additional controlled resonant peak that was just about the best analogue way of creating a realistic heavenly choir effect outside of the Roland Vocoder Plus, itself no longer in production. OK, so plenty of today's synths offer phasing or chorus sections, but more often than not it seems they're installed to cover for what are otherwise pretty weak preset voices, and whatever happened to the resonance?

Then there's the rather delicate question of the keyboards themselves: it's my contention that they simply aren't what they used to be. OK, so the manufacturers have given us five octaves (or in some cases, more), touch-sensitivity, and instant arpeggiators, and I'd concede that all these are noble developments. But the once-standard CV and Gate outputs for the lowest and highest notes played are rapidly vanishing into the sunset. These notes can be used to great effect in the context of, say, a set-up containing one polysynth and two cheaper monophonic synths, allowing – as an example – a heavy synth bass line, a delicate set of middle and treble strings and a punchy lead voice to be controlled from one keyboard.

MIDI is great for layering chords, but controlling a monophonic bass line while playing your MIDI polysynth with more than one finger requires a mass of gadgetry worse than the multiplicity of cables the new interface was supposed to replace.

Still, I remain a fan of the sprouting DIN sockets and wish them well.

What's needed is a modern MIDI synth with ten voices, in which the keyboard is eight-note polyphonic with an additional voice sounding on the highest and lowest notes played, the same set of controls being used to program all three sounds (or four sounds if keyboard splitting is employed). The instrument should also include a sine wave on the LFO, resonance on the phaser, and CV, Trigger, and Gate In and Out for the highest and lowest voices. Ideally, a polyphonic string section should also be provided, with traditional AR envelope control.

The above description may sound absurd, but in fact it's not all that far removed from existing older keyboards such as the Yamaha SK series, the Korg Trident and the ARP Quadra.

It's up to us as musicians to first, recognise what we're missing, and second, ensure that the synth manufacturers are aware of our needs, so that any current drawbacks can be eliminated for good. ■

*If you've got a set of opinions you'd like to share with the rest of E&MM's readership, send them to 'Forum', Electronics & Music Maker, Alexander House, 1 Milton Road, Cambridge CB4 1UY.*



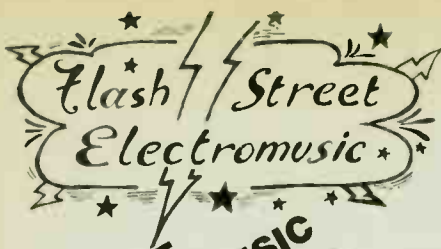

**FLASH ST  
ELECTROMUSIC**  
(above Jamm Studios)

AFTER 5 YEARS OF HONEST TRADING  
**DOUGIE'S**  
Music Store

**0606  
782522**

for all enquiries

**5-7 CHESTER ROAD  
NORTHWICH  
CHESHIRE**

**GRAND OPENING SAT 6th OCTOBER  
OF NORTH-WEST'S BIGGEST MUSIC STORE  
2,500 sq. ft. OF LATEST ELECTROMUSIC PRODUCTS  
YAMAHA - ROLAND - KORG - S.CIRCUITS - FOSTEX  
APPROVED OFFICIAL MAIN DEALER - OPEN 10-6 SIX DAYS**

**OPENING OFFERS**

KDRM1 Rhythm DX	£49
Jen SX1000 synth	£99
Roland MC202	£159
Korg MS10 synth	£159
Korg KPP77 rhythm	£179
Roland JSQ60	£150

**S/H KEYBOARDS**

Korg MS20	£189
Yamaha CS5	£99
SC Sixtracks	£530
Roland Juno 6	£399
Korg Delta	£250
ARP Quartet	£250
Crumar Performer	£250
Crumar Multiman S2	£350
Casio 101	£139
Casio 202	£189
Yamaha DX9	£599
SC Prophet V Rev 2	£1099

**S/H MISCELLANEOUS**

Roland TR606 (Drumatix)	£150
Polymoog keyboard	£750
Polymoog synth	£1250
ARP Axxe	<b>OBSOLETE?</b> £200
ARP Solus	<b>MY ASS</b> £180
ARP Odyssey	£400
Multimoog	£350

**KEYBOARD AMPS**

Vamp 10w	£69
Ohm Tramp 16w	£89
Vamp 30w	£159
Roland Cube 40	£215
Vamp 60w	£185
Roland Cube 60	£279
Ohm 140w	£335

**KEYBOARD ACCESSORIES**

X stars	£18
X stars text	£32
I-Tie 2-tier	£69
I-Tie 3-tier	£99
Ultimate Support (USA)	£199
(expensive but the set)	
Good selection of footswitches, pedals etc.	

**SYNTHESIZERS**

Yamaha KX5	£385
Yamaha DX9	£779
Yamaha DX7	£1295
Roland SH101	£250
Roland Juno 6	£550
Roland Juno 60	£599
Roland Juno 106	£775
Roland Jupiter 6	£1250
Roland JX3P	£850
Roland Jupiter 89	£2750
Korg MS10	£159
Korg Poly 800	£439
Korg Poly 61	£539
Korg RK100 remote	£425
Korg Poly six	£699
SC Pro one	£350
SC Sixtracks	£689
SC Prophet 800	£1250
SC 64 Sequencer	£175
SC 910 expansion	£65
Rhodes T-8	£3500
Rhodes Polaris	£1499
Oscar in residence	£469

**YOUR SYNTH IS WANTED  
FOR P/EX OR CASH**

**ELEC. PIANOS/ORGANS**

Hohner Pianett	£150
Hohner Duo	£299
H/H P73	£550
Wurlitzer EP200 S/H	£300
Yamaha PF10	£699
Yamaha PF15	£899
Rhodes Domestic 73	£750
Siel PX junior	£399
Korg CX3 organ	£475
Korg BX3 organ	£799
Hammond L1W split S/H	POA
Korg EPS1 as new	£550
Korg EPS1 new	£899

**BOTH STORES OPERATE  
A MINIMUM 12 MONTHS  
GUARANTEE (on new goods)  
PLUS INSTANT  
REPLACEMENT ON FAULTY  
(subject to availability)  
WE KEEP DA GUYS  
ON DA ROAD**

**ELECTRONIC PERCUSSION**

Roland TR606	£199
Roland TR808 S/H	£399
Roland TR909	£699
Yamaha RX15	£449
Hammond DPM48	£579
MXR	£950
SC: Drumtracks	£850
Korg PSS50	£350
Korg DD7 110	£195
Korg DD7 220	£195
Korg KPR 77	£179

**RECORDING/RACKERS**

Yamaha MT44	£299
Fostex MN15	£39
Fostex X15	£299
Fostex 250	£599
Akai 4000DS	£229
Fostex 8-track system	POA
Accessit in stock	
Ibanez OM1100	£289
Boss DE200	£299
Roland SDE2000	£389
Yamaha R1000 reverb	£599

**MIXERS**

Star Sd dynamix 8:2	£179
Star Sd dynamix 12:2	£229
Promaric	£425
Studiomaster 6:2:1	£345
Studiomaster 8:4	£650
Studiomaster 12:2C	£699
Studiomaster 16:4:2	£899

**WE HAVE GUITARS!**

**WE HAVE DRUMS!**

**NEW PRODUCTS**

**ON WAY INCLUDE:**

- ROLAND MK KEYS**
- ROLAND GR707 GUITAR**
- SYNTH**
- YAMAHA CX5 COMPUTER**
- ROLAND MXQ 700**

**SEQUENTIAL CIRCUITS**

- + COMMODORE 64**
- + 910 EXPANSION**
- ALL READY & RUNNING**
- CUMSEE & DISBELIEVE**

**ROLAND/SC. DEMOS & ROADSHOWS  
COMING!**

**ALL ABOVE IN STOCK AT EITHER (OR BOTH) STORES PRE-CHECK FIRST!**

**0606-782522**

**ALL PRICES INCLUDE VAT. MAIL ORDER POSSIBLE. ACCESS VISA.  
DELIVERY POSSIBLE**

**MOTSUC - RUOY - ROF - SDRAWK CAB - REVO - DNEB - LIW - EW**



# Korg DDM220

## Programmable Percussion Machine

Fed up with conventional drum machine noises? Korg's Super Percussion unit offers nine PCM-encoded Latin sounds at a price that makes it both an attractive add-on and a highly usable unit in its own right. *Trish McGrath*

This year's British Music Fair saw the debut of two new Korg drum machines, the 'Super Drums' and 'Super Percussion' units. Both of these employ PCM-encoded drum voices and have provision for full programmability and editing, all at a price that's as difficult to believe as a *Dallas* script . . .

The two machines sync together painlessly and Korg's KMS30 MIDI Synchroniser allows them to be incorporated into a MIDI system. The DDMs are due for release sometime during November, but we managed to get our hands on an early Super Percussion to whet your appetite.

### Layout

The DDM220 measures a compact 226(W) x 49(H) x 196(D) mm and weighs just 800g – as indeed does the DDM110 Super Drums unit. The top panel controls consist of a three-digit LED display (the memory's 'window'), two tempo controls (coarse and fine), and three volume controls (for Master, Metronome and Cabasa/Tambourine). The last-mentioned is the only attempt the 220's designers have made to offer individual level control over the percussion voices – levels cannot be set during programming and the audio outputs comprise stereo left and right/mix only.

Ten Number keys (0–9) are situated along the bottom of the panel, and these can be effective in four different modes, more of which later. Below the LED display lie the Record Enable/Disable selector and the Song and Pattern multi-function keys. The Song key can be cycled through Edit, Song and Pattern modes, while the Pattern key cycles through Pattern, Instrument, and Initial modes. These modes determine what effect pressing one of the Number keys has on the programming of the unit, and the currently-selected mode is indicated by the green LEDs situated to the right of the Song and Pattern buttons. If the Record selector is set to Enable, two further (red) LEDs indicate whether or not the unit is set to either Song or Pattern Record. Centred on the panel is the ubiquitous Start/Stop key, the Up/Enter key and Shift keys. These latter controls are used when programming the unit in step time (the Up/Enter key changes to Down/Cancel when Shifted).

Right side panel sockets comprise Phones, the stereo outputs mentioned above, Start/Stop socket (used in conjunction with optional footswitch), and Trig Out (for connection to a suitable Trigger In on, say, a synth). The left-hand side panel includes a DC 9V socket (for the mains adaptor supplied, though the DDM220 can run on batteries as an alternative), the Power On/Off switch, Tape Interface sockets, and Sync (five-pin DIN) socket with In/Out selector.

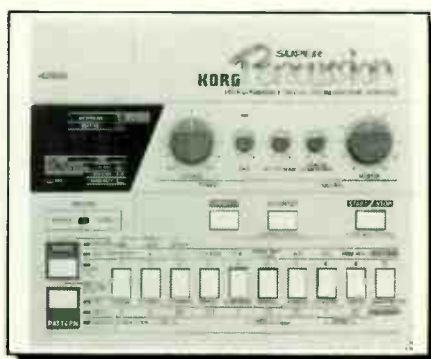

### Operation

Programming of the Super Percussion can be carried out in step or real time, or indeed a mixture of both, and with the help of the display and function mode LEDs, the necessary operations are easy to follow and even easier to pick up. Depending on the mode selected, the Number keys 0–9 have the following effects:

**Pattern** allows the selection of any pattern number between 01 and 32, which is then activated by the Start/Stop button. If a second pattern is selected, this 'waits in line', is displayed as the 'Next No.' to play, and begins immediately the pattern playing has completed its cycle.

**Initial** prepares the unit for programming and comprises Pattern Erase, Time Signature and Resolution options. Each pattern can be one to two bars long, while the resolution can be set to 1/16ths, 1/16 triplets, or 1/32s. Pattern numbers 01–16 have a step capacity of 32, while Patterns 17–32 won't accept more than 16 steps.

**Instrument** brings the drum voices under the individual control of the number keys, and allows them to be programmed in step or real time. The drum voices themselves cannot be described as anything short of excellent, especially considering the 220's price tag. From left to right, the Super Percussion offers Hi Conga, Lo Conga, Timbale, Wood Block, Cowbell, Hi & Low Agogo, Cabasa and Tambourine, while a fixed-level Accent can be implemented on any step in the pattern.

**Song** – Up to six songs can be stored – by chaining patterns – up to a total of 390 bars. However, it would have been nice if the display 'blinked' as a pattern was written into Song memory, as the Enter button itself does not inspire much in the way of confidence. Unlike some rhythm units, this Korg does not have an elephantine memory (the maximum for one song is 385 bars), but the facility to save to, and reload from, cassette tape should placate the greedy.

**Edit** mode is where the Song takes shape,

and bars can be inserted or deleted, a new End selected, and the whole Song looped if necessary. A section can be repeated (by inserting Repeat Start and End signs) and the number of repeats specified. Bar Select displays the pattern residing in any particular bar, but sadly the unit counts all patterns as one bar, so that if you program a song with a mixture of one and two bar patterns, the 'bar number' count won't correspond to the actual number of bars in your song. Definitely an oversight on Korg's part, and one which might render the facility to start the Song from a selected bar number a bit of a waste of time.

Finally, Memory Avail flashes the number of bars left for programming, and Song Initial clears that Song's memory. If a Song is interrupted during playback, it can be recommenced by keying Shift and Start: Songs can also be played in series if needed.

### Impressions

Recording in both step and real time is quite straightforward, full editing of both patterns and songs is possible, and the display takes enormous pleasure in letting you know *exactly* where you stand at all times. In general, niggles are few and far between, and I guess it's unreasonable to expect some sort of individual voice level control on such a low-cost machine.

Although I can't blame Korg for adapting the Super Percussion manual from that originally written for the Super Drums, as they incorporate essentially similar functions, I found the repeated references to snare, bass and hi-hats a bit silly at first and downright tiresome by the time I'd reached the halfway point.

Allowing the two DDM units to be purchased individually obviously allows the user the choice of obtaining the conventional drum machine and adding the percussion voices at a later date; however, I wonder how expensive a 'combined' unit would have been, especially when you consider the duplication of much of the hardware? It would have been nice to have had the Super Drums to test alongside the Super Percussion, but I found the Roland TR606 (sorry Rose Morris!) to be a syncable companion (*via* the Sync In and Out sockets intended for the Super Drums, KPR77 etc.), while the Trig Out (generated at steps where the Tambourine is programmed) successfully activated the Arpeggio clock on a Korg Polysix. I had a lot of fun . . .

If Latin percussion is your sound, what are you waiting for? ■

*The Super Percussion DDM220 tested and Super Drums DDM110 each carry an RRP of £229. Further details from Rose Morris, 32–34 Gordon House Road, Kentish Town, London, NW5 1NE ☎ 01-267 5151.*



# Nothing to Hide.

You want to hear the character of your instrument - not the sound of your speaker cabinets.

We specially created the new dX range of 200 Watt cabinets to have outstanding clarity so that nothing gets hidden. And that includes the bass response which is deep and powerful to let you feel the really low notes.

**dX Fullrange** Clarity over 9 octaves for Synthesisers, Drum Machines, PA, Vocals and all other instruments.

**dX Bass** Selectable Bright or Rich sound for Bass Guitar. Either way, the bass is deep, accurate and powerful.

Judge the sounds for yourself at:

Rod Argents

West End

Future Music.

Southampton.

Gigsounds

Streatham

Future Music.

Portsmouth.

The Bass Centre

Wapping

Jones & Crossland

Birmingham

Further details from our U.K. distributor:

**SIEL (U.K.) LTD**  
**AHED HOUSE**  
**REIGATE ROAD**  
**HOCKWOOD, HORLEY**  
**SURREY RH6 0AY**

*Frazer Wyatt*



## A1 MUSIC

THE MANCHESTER SYNTHESIZER CENTRE

88 OXFORD ST., MANCHESTER 1

061-236 0340

FASTEST KEYBOARD REPAIR  
 SERVICE IN THE NORTH WEST

### Roland

ROLAND JUNO 106 .....£650  
 ROLAND JUNO 60 .....£479  
 ROLAND JX3P .....£655  
 ROLAND MC202 .....£173  
 ROLAND SH101 .....£245  
 YAMAHA KX5 remote .....£390  
 YAMAHA PF15 .....£820  
 YAMAHA DX7 .....£1094  
 YAMAHA DX9 .....£703

### KORG

KORG POLY 800 .....£450  
 KORG POLYSIX .....£808  
 POLY 61M .....£664  
 KORG MONO POLY .....£346

TRACE ELLIOT AH150 ..... £POA  
 TRACE ELLIOT AH250 ..... £POA  
 SESSIONETTE 1x12 .....£230  
 SESSIONETTE 2x10 .....£253  
 MARSHALL 4210 .....£329  
 MARSHALL 5210 .....£214  
 MARSHALL 2210 .....£341  
 ROLAND JC120 .....£429  
 CARLSBRO COBRA 90PA .....£154

MEMORY MOOG (New).....£1303  
 MOOG ROGUE .....£137  
 MOOG SATELLITE S/H .....£65  
 KORG 700 S/H .....£86  
 KORG MICRO PRESET S/H .....£65  
 KORG MS10 S/M .....£134  
 KORG SIGMA S/S .....£217  
 YAMAHA CE20 S/S .....£346

TEAC 244 PORTA STUDIO .....£478  
 TEAC 34 4-TRACK .....£778  
 TEAC 3440 4-TRACK .....£604  
 TEAC 38-REMOTE .....£1130  
 TEAC 6 into 4 MIXER .....£228  
 TEAC M30 8 into 8 MIXER .....£585  
 RSD 621 MIXER .....£273  
 YAMAHA MT44 .....£312

ROLAND RE501 .....£421  
 ROLAND SRE555 .....£500  
 ROLAND SDE1000 .....£343  
 BOSS DE200 .....£252  
 BOSS DD2 .....£140  
 IBANEZ HD1000 .....£315  
 IBANEZ DM2000 .....£365  
 VESTA FIRE DIG400 .....£216  
 YAMAHA R1000 .....£481  
 CARLSBRO PROFEX ADR1 .....£160

DRUMULATOR .....£850  
 ROLAND TR909 .....£591  
 ROLAND TR606 .....£214  
 BOSS DR110 .....£108  
 SIMMONS SDS7 .....£1826  
 SIMMONS SDS8 .....£673  
 KORG KPR77 .....£225

PV BANDIT .....£278  
 PV XR600B .....£449  
 PV ROCKMASTER HEAD .....£295  
 PV BACKSTAGE PLUS .....£125  
 FENDER CONCERT 1x12 .....£465  
 CARLSBRO KEYBOARD 90 .....£158

Fast repairs to Keyboards, Amps and Guitars in our own workshops. Huge stocks of spares available.

All prices EXCLUDE VAT at current rate, and carry the A1 Workshop Warranty  
 Phone with ACCESS/BARCLAYCARD No. for fast Mail Order. All sales carry the  
 A1 workshop warranty



A1

MUSIC CENTRE (Inc. G.M. services)

Guitar - Drum & Amplification Equipment Specialists



# At a stretch, just match the real

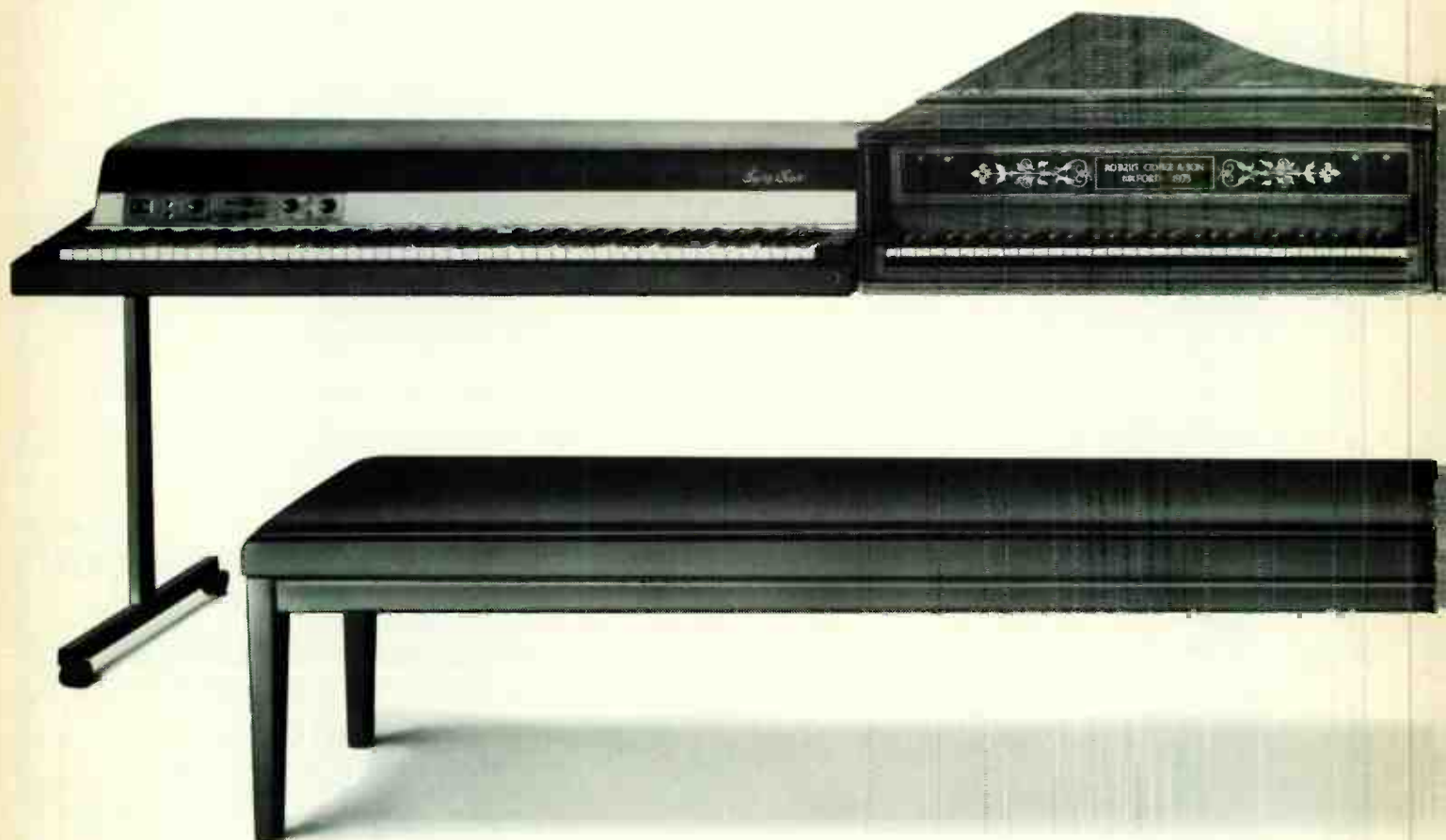

Above, we present four of the world's top keyboard instruments: electric piano, harpsichord, acoustic piano and clavinet.

And, below, a rather more convenient way of playing them: the Technics Digital 10 with PCM sound.

Are we stretching credibility a little?

Not if you know anything about PCM sound sourcing.

It's a digital encoding system that stores the actual waveform produced by an instrument.

Then lets you reproduce it as though you were playing the instrument itself.

(We've even put in weighted keys to give

you the feel of a genuine keyboard.)

Not that we've stopped at giving you four keyboards in one.

Our polyphonic line-up includes acoustic guitar, jazz guitar, banjo, glockenspiel, vibraphone and steel drum.

Nor do we expect you to live by our Digital 10 alone.

It comes equipped with a MIDI interface to synchronize with other compatible electronic keyboards and synthesizers.

Not to mention a pair of pop-up speakers for practice or monitoring your performance.

Add transpose, tuning and harmonic con-



# you might sm of our Digital 10.

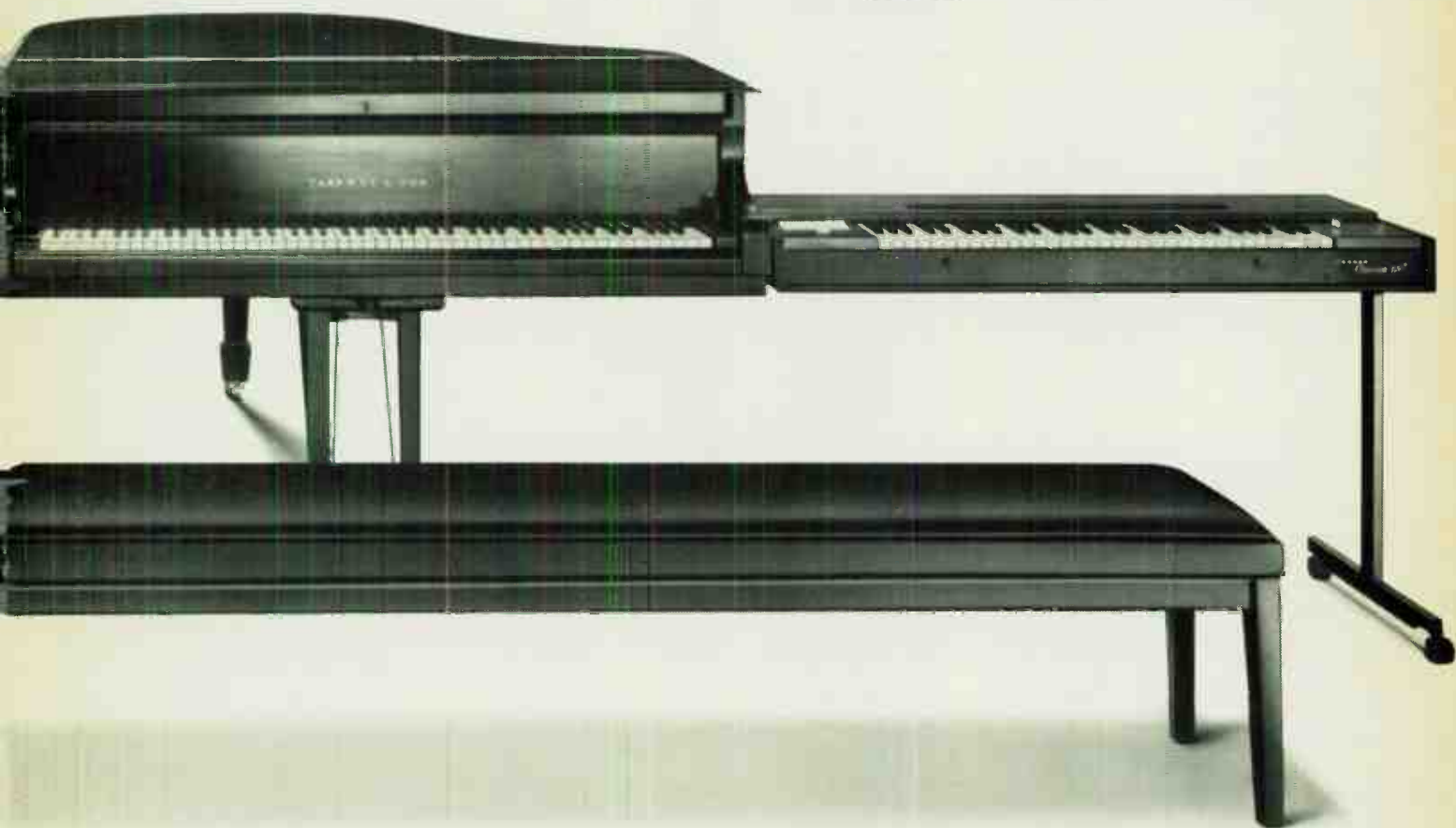

trols, and you'll appreciate our Digital 10 is every inch the professional's keyboard.

You won't need to stretch yourself to afford one, either.

The Technics Digital 10, complete with sus-

tain pedal and music rack, retails for just £899.

Just think what you'd have to pay for the line-up above.

**Technics**  
PCM SOUND SERIES

300-318 Bath Road, Slough, Berks SL1 6JB. Telephone: Slough 34522.



Digital 10.



# Frazer Wyatt Speakers

The amplification of electronic instruments places specific demands on loudspeaker design, and Frazer Wyatt have met this design challenge head on. *Paul White*

One of the most prominent features of this year's British Music Fair was the way almost everyone seemed to be using Frazer Wyatt speakers to demonstrate their equipment, so we wasted no time in getting hold of a pair to find out what all the fuss was about.

The philosophy behind these speakers is that modern PA and instrument amplification deserve better specifications than conventional designs currently provide. To explain: most instrument speakers are based on designs that have changed little since the sixties; that is, several speakers mounted in a box with the intention of providing as much volume as possible, and with little or no consideration for the quality of reproduction. It's all too easy to hear the consequences of this method if you play a record or tape through a conventional four-by-twelve cabinet: nine times out of ten, it'll sound horrible.

## Design

With the advent of synthesisers, which are normally recorded directly into the mixing console, an approach more akin to that of hi-fi design is required, and in fact this is made all the more necessary by the wide frequency spectrum of such instruments – often equal to or exceeding that of human hearing at both ends of the range. Domestic hi-fi designs achieve a reasonably flat frequency response at the expense of power handling and efficiency, but this Frazer Wyatt design changes all that.

Designed and built in Britain, these speakers utilise a new type of ported enclosure, the loading of which actually shifts the system resonance down below that of the bass drive unit, effectively out of harm's way. This makes possible a reasonably flat frequency response which, in the case of the full-range unit, provides a useful response between the limits of 30Hz and 20kHz.

## Construction

The Frazer Wyatt speakers are neither particularly small nor particularly large, measuring 766×520×490mm. Sturdily constructed from high density 18mm chipboard, the ported cabinet is conventionally covered in vinyl and fitted with bar-type carrying handles.

Two versions are currently available – a full-range and a bass model. The full-

range variant contains a specially-built Fane 12" driver and a Fane HF250



tweeter driven via a three-pole crossover operating at around 5kHz. This gives a power handling of 200W with an acoustic efficiency of 103 dB/watt at 1m in the midrange – remarkably high for such a system – the nominal impedance being eight ohms.

Identical in size, the bass unit has the same bass driver but no tweeter, and features a switchable high-frequency roll-off filter that operates above 500Hz, for use as the bass end of a multi-speaker system. This version comes as standard with an eight-ohm impedance, but four or 16 ohm alternatives can also be supplied on request. XLR connectors are standard on both models, and a soft

'Even at high levels, these speakers do not sound particularly loud, but this is due largely to their lack of coloration and rogue resonances.'

transit cover is included in the price.

## In Use

Initially, and even at high levels, these speakers do not sound particularly loud, but this is largely due to their lack of coloration and rogue resonances, since I am assured that the efficiency figure is

correct. Keyboards sound particularly good through the full-range model: the bottom end is full but uncluttered, while the mid and high ends cut through well without being unnecessarily abrasive.

Results are also satisfactory on bass guitar but since both players and audiences are accustomed to hearing this instrument played through highly coloured, resonant cabinets, it may be a while before the advantages of a flat-sounding system are appreciated, though I hope not! Of course, EQ may be applied to make these speakers sound just like a cheap and nasty four-by-twelve cab, but there doesn't seem a lot of point.

Where the Frazer Wyatt scores particularly is in the context of the modern 'slap-and-pull' bass style, where the midrange clarity and low bass give the benefits of both large and small speakers simultaneously.

On vocals, the 'hi-fi' nature of the Frazer Wyatts gives a more natural sound than many alternatives, and there is a slight presence peak at around 3kHz which undoubtedly aids clarity of diction.

## Conclusions

At £365 each for the full-range speaker and £320 for the bass version, the Frazer Wyatt may seem a little pricey for what is at first sight a single 12" speaker in a box, but their sonic performance makes them considerably more cost-effective, particularly in the areas of keyboard and vocal amplification. For bass guitar, it's largely up to the individual to decide whether a flat response is likely to be advantageous, but the midrange responsiveness could well prove attractive. Discos, perish the thought, could also dramatically improve their quality of sound by buying a pair of full-range units, though that's probably one market area the manufacturers hadn't previously considered selling to!

To conclude, the Frazer Wyatt is a British development that points the way speaker design must eventually go if the full potential of electronic instruments is to be exploited to the full. ■

RRPs are given in the text, and are correct at time of going to press. Further information from Frazer Wyatt's UK distributors, Siel UK, Ahed House, Reigate Road, Hockwood, Horley, Surrey RH6 0AY.



# Where to get your hands on four keyboards in one.

**Aberdeen** Bruce Millers 0224 592211  
**Ashington** George Harrison Organs 0670 855736  
**Aylesbury** Leisure Play 0296 23378

**Banbury** Glen Derges M.I. 0295 65896  
**Barnsley** Fox's Music 0226 82676  
**Barrow in Furness** Northern Sounds 0229 27100  
**Basingstoke** Modern Music 0256 64663  
**Bedford** Potters Bar Music 0234 213471  
**Belfast** Wilmor & Co. 0232 681521  
**Birmingham** The Organ Shop 021 643 2985  
**Blackpool** Ken Astin Organs 0253 22753  
**Bolton** Harker & Howarth 0204 26623  
**Boston** Middletons Music 0205 52411  
**Bournemouth** Eddie Moors Music 0202 35135  
**Bradford** J. Wood & Son 0274 20014  
**Bradford** Stanley R. Woollett 0274 42806  
**Brighton** Brighton Organ Studios 0273 412877  
**Bristol** John Holmes Music 0272 46136  
**Bromley** Roland Friday Keyboards 01 698 0915  
**Buckie** Music Matters 0542 32020  
**Burnley** Dawsons Music 0282 25829

**Cambridge** Jack White Organs 0223 61091  
**Cambridge** Millers Music Centre 0223 354452  
**Canterbury** Kennards of Canterbury 0227 60331  
**Cardiff** Gamlins Music Centre 0222 20828  
**Carlisle** Creighton & Tweedie 0228 35628  
**Carmarthen** Western Organs 0267 233696  
**Chelmsford** Allegro Music 0245 83527  
**Cheltenham** Wayne Butler Music 0242 519618  
**Chester** Dawsons Music 0244 48606  
**Chichester** Bees Music 0243 780536  
**Chobham** Arthur Lord Organ Studios 09905 6363  
**Clacton-on-Sea** Magic Music 0255 422789  
**Clevedon** Franks of Clevedon 0272 873352  
**Colchester** Manns Music 0206 572783  
**Coventry** Greens Organs 0203 87814  
**Crawley** Riverside Organ Studios 0293 25362  
**Croydon** Riverside Organ Studios 01 680 9747

**Derby** International Organs 0332 32005  
**Doncaster** Fox's Music 0302 67333  
**Dublin** McCullough Pigott 0001 773138  
**Dudley** Roy Jevons Organ Studios 0384 237736

**Eastbourne** Peter Bonner Musical 0323 639335  
**Edinburgh** Edinburgh Organ Studios 031 556 3005  
**Ely** Lynn Music 0353 61723

**Falkirk** Edinburgh Organ Studios 0324 27100

**Garstang** Ken Astin Organs 09952 5329  
**Glasgow** Glasgow Keyboard Centre 041 552 8966  
**Grimby** Humberside Organs 0472 361144  
**Great Yarmouth** Allens Music 0493 2887  
**Guernsey** Gilroy's TV Electrics Ltd 0431 56828  
**Guildford** Arthur Lord Organ Studios 0483 570088

**Halifax** J. Wood & Son 0422 62751  
**Harrogate** Blackburn & Swallow 0423 69249  
**Hatfield** Leisure Music 07072 71247  
**Hastings** Peter Bonner Musical 0424 421885  
**Hereford** Hereford Music 0432 270069  
**High Wycombe** Sound of Music 0494 27413  
**Hitchin** Stocker Jennings 0462 34960  
**Huddersfield** J. Wood & Son 0484 27455  
**Hull** Gough & Davy 0482 26525

**Inverness** Bruce Millers 0463 33374  
**Ipswich** Jack White Organs 0473 57223

**Keswick** Brooks Music Centre 0596 73933  
**Kettering** Kettering Organ Studios 0536 512031  
**Kings Lynn** Lynn Music 0553 4390  
**Kingston-on-Thames** Riverside Organ Studios 01 546 1231

**Lancaster** Harker & Howarth 0524 69456  
**Ledbury** Western Organs 0531 4183  
**Leeds** Steve Baker Home Organs 0532 488277  
**Leicester** Intasound Organs 0533 545456  
**Lerwick** The Music Box 0595 3993  
**Leyland** Frank Rimmer Keyboards 07744 33281  
**Lincoln** Fox's Music 0522 37141  
**Liverpool** Frank Hesty 051 236 1418  
**Llanelli** Falcon Music 05542 3072  
**London** Chingford Organ Studios 01 524 1446  
**London** Freedmans 01 539 0288  
**London** Lewisham Organs Centre 01 690 2161  
**London** R.W. & B. Hall (Sound Venture) 01 441 1050  
**London** Harrods 01 730 1234  
**London** Sound of Music 01 994 6561  
**Lowestoft** Huw Morgan Organs 0502 4802  
**Lowestoft** Allens Music 0502 511624

**Macclesfield** Macclesfield Organs 0625 27062  
**Maidenhead** Sound of Music 0628 20117  
**Mansfield** The Music Scene 0623 31174  
**Mauchline** Billy McEwen 0290 50790  
**Melrose** Clinkscale Radio & Musical 089682 2525  
**Mirfield** Peter Brocklehurst Organs 0924 493697  
**Morecambe** Harker & Howarth 0524 410202

**Newcastle-upon-Tyne** George Harrison Organs 091 414 4333  
**Newcastle-upon-Tyne** Northumbria Keyboards 0632 614749  
**Newport** Gamlins Music Centre 0633 63867  
**Newquay** Newquay Music Centre 06373 3656  
**Northampton** Harmony Keyboards 0604 22936  
**Norwich** A.W. Cooke & Son 0603 25970  
**Nottingham** Fox's Music 0602 474221  
**Nottingham** Frank Eugene 0602 786563  
**Nuneaton** Taylors Musical 0682 382645

**Oxford** John Holmes Music 0865 57923

**Paignton** Torbay Organ Centre 0803 550094

**Penrith** Creighton & Tweedie 0768 64331  
**Plymouth** City Electronics 0752 23011  
**Porthcawl** Arjay Keyboards 065 671 5886  
**Portsmouth** Bees Music 0705 818814  
**Potters Bar** Potters Bar Music 0707 57764  
**Preston** Preston Organ Centre 0772 50430

**Reading** Modern Music 0734 51954  
**Redditch** Pied Piper Music 0527 64333  
**Ripley** Fowlers Organs 0773 43124  
**Romford** Wells Music 0708 64583

**St. Albans** Stocker-Jennings 0727 32765  
**St. Helens** Dawsons Music 0744 30424  
**St. Helier** Easy Play Organs 0534 79570  
**Salisbury** Bryan Cowshall Music 0722 337878  
**Sawbridgeworth** Alec Leader Keyboards 0279 725876  
**Scarborough** Gough & Davy 0723 374610  
**Scunthorpe** Humberside Organs 0724 855515  
**Sheffield** Fox's Music 0742 24070  
**Shifnal** Jon Barrie Organs 0952 461714  
**Solihull** The Organ Shop 021 705 0403  
**Southampton** Bees Music 0703 331844  
**Southend-on-sea** Essex Organ Studios 0702 348476  
**Southport** Frank Rimmer Keyboards 0704 32145  
**Spalding** Spalding Music 0775 617177  
**Stockport** Dawsons Music 061 477 1210  
**Stoke-on-Trent** Keith Baddeley Organs 0782 411401  
**Stratford-on-Avon** Stratford Organs 0789 205896  
**Sunderland** George Harrison 0783 42646  
**Sutton Coldfield** The Organ Shop 021 354 1867  
**Swindon** John Holmes Music 0793 34095

**Uxbridge** City Electronics 0895 30127

**Wakefield** J. Wood & Son 0924 374446  
**Watford** Hammonds of Watford 0923 39733  
**Warrington** Dawsons Music 0925 32591  
**Watton** Adcock & Sons 0953 881248  
**Wednesfield** John Howl Organ Studios 0902 722753  
**Westbury** Albry Organs 0373 864255  
**West Bromwich** John Howl Organ Studios 021 553 5269  
**Weston-Super-Mare** Algan Music 0934 513073  
**Whitehaven** Brooks Music Centre 0946 2116  
**Wigan** Dawsons Music 0942 44680  
**Worcester** Roy Jevons Organ Studios 0905 20397  
**Workington** Northern Sounds 0900 4797  
**Worthing** S.M.C. Organs 0903 211181

**York** Gough & Davy 0904 32421

**Technics**  
PCM SOUND SERIES  
300-318 Bath Road, Slough, Berks SL1 6JH. Tel. Slough 34522.



# Roland Mother Keyboard MIDI System

Two controlling keyboards and three rack-mounting voice modules make up Roland's new top-of-the-line synth system. It looks to be the most comprehensive MIDI set-up currently available, but it's expensive. *Dan Goldstein*

**B**ack in the days of analogue interfacing, Roland had two 'prestige' synth systems that served two separate markets: the Jupiter 8 self-contained polysynth for the musician on the road and the studio on a budget, and the complex (but infinitely expandable) System 700 modular network for larger studios and the likes of Tangerine Dream to take on tour round the world.

It's probably fair to say that Roland have realised the potential of MIDI – and put that potential into production reality – better than any other manufacturer. Just about every new piece of hardware they introduce has it, and in addition to designing instruments that use MIDI from scratch, the company have also introduced a number of products (eg. the MSQ700, OP8M, and SBX80 Sync Box) that allow musicians to use MIDI instruments in conjunction with older hardware.

So it came as no surprise when Roland UK unveiled a modular MIDI system aimed at filling the 'top-of-the-line' gap vacated by the analogue-equipped products. What was rather more surprising was the amount of time it took for the mother keyboard system to get into series production, since some of the hardware was displayed in prototype form over a year ago while production versions of the system are only now beginning to appear in dealers' showrooms.

As you will have gleaned from the introduction to this review, there are two keyboards from which the budding modular synthesist may choose – a 76-note plastic keyboard (the MKB300) and an 88-note version with wooden keys and full touch- and velocity-sensitivity (the MKB1000). The latter was used in assessing the relative merits of Roland's accompanying voice modules, since all three of these incorporate dynamic control in their specification.

## MKB 1000

Readers of all but the most recent generation can probably still recall a time when the wondrous circuitry inside a synthesiser could only be accessed via poorly-designed, non-dynamic keyboards – in effect, little more than a set of glorified electronic switches that allowed little room for expression on the part of the musician. Nowadays, with the arrival of instruments such as the Prophet T8, Yamaha DX7 *et al*, it seems that designers have recognised that synth players needn't be the poor relations of guitarists and drummers when it comes to injecting 'feel' into their musical output.

Roland's MKB1000 is another important step in the direction of giving keyboard players their due by placing as much emphasis on how the pitch of an electronic instrument is controlled as is placed on the design of the sound-generating hardware itself. Now, at an RRP of £1665 (that includes VAT, so be thankful for small mercies), every musician has a right to expect big things from the 1000, and in most respects it delivers: even from the brief time I had in its company, I can report that its action is really Very Good Indeed. There's something about encountering a really good keyboard that makes one concentrate more on how sounds are being manipulated rather than the sounds themselves, and more often than not (in my experience, anyway) this results in a sudden increase in creative flow. Even if you've never laid fingers on a piano in your life, you should find the 1000 a delight to use: I'd say its action was about two-thirds piano, one-third organ/

synth, so there should at least be something about it that's reasonably familiar.

As befits a piece of hardware that incorporates no sound-generating circuitry of its own, the MKB1000 has the bare minimum of controls and switches. Storage space for 128 patches (arranged in eight banks of 16) is accessed by familiar Roland pushbuttons-with-LEDs, but what isn't immediately obvious is that these memory locations are capable of storing information relating to MIDI channel and mode, modulation data and keyboard split point. Two MIDI instruments can be controlled from the keyboard simultaneously, and these can be positioned either side of the split point (itself user-programmable to be at any point along the keyboard's length) or layered atop one another. If you only want to control one instrument in the context of a given patch, the 1000 gives you the option to do so, and the whole business of voice and channel assignment is quickly and simply controlled by means of pushbuttons and associated numeric LEDs on the instrument's front panel.

One notable omission (indeed the only serious one I can find) is some means of controlling the MIDI instruments' relative levels direct from the mother keyboard. This means having to reach over to the instruments themselves to set the levels, and seeing that one of the prime motivations behind the whole mother keyboard philosophy is that the system enables players to leave all their sound-generating equipment off-stage, I can only assume Roland's designers have made a rare unforced planning error.

Moving back to the goodies, the 1000 has a transpose slider control that allows you to increase or decrease the keyboard's overall pitch instantly in

'At an RRP of £1665, every musician has a right to expect big things from the MKB1000, and in most respects it delivers.'

semitone steps, while the pitch-bend wheel can also be used to initiate modulation by a simple push of the wheel's control lever, a method whose merits appear to be the subject of some debate among keyboard players, though personally I rather like it.

Reference was made in last month's Trade Show report to the MKB1000's high standard of aesthetic design and finish, but while there can be no doubting the sturdiness of the mother keyboard's construction (it does weigh nearly 50kg, after all), I still have a feeling the instrument's elegance might not last longer than one extended British tour, for instance. Roland's magnificent chrome-plated stand is extra, too, which is a nuisance.

## MKS 10

Simplest of Roland's three sound-generating modules is the MKS10 (or 'Planet P'), a straightforward electronic piano box that incorporates eight different voices onboard and a further eight that are only accessible via MIDI on the mother keyboard. The tones available on the module are two Pianos, two Clavis, two



Harpichords and two Electric Pianos, but only a couple of these are particularly striking without recourse to the MKS10's built-in chorus/flanger and tremolo units. The latter has a choice of sine and square waveshapes, and both incorporate rotary pots for control of rate and depth, though again, neither of these parameters is controllable from the mother keyboard, so unless you intend playing with standard settings throughout a live set, say, you're going to have to reach across to the Planet P module itself to change anything.

The extreme right of the MKS10's front panel contains sliders for overall volume and brilliance (quite effective, that one), while at the opposite end of the module you'll find the MIDI Channel selector (complete with numeric LED readout) and a further green LED that illuminates whenever the Planet P is transmitting or receiving a MIDI message. This feature is common to the other two voice modules, and could well be of value if you hit trouble getting any sort of output from your set-up but don't know where to start in tracking down the source of the problem. If the MIDI message light doesn't come on when you play a note, it's your MIDI connections that are at fault.

It goes without saying that the MKS10 responds fully to key velocity information from the mother keyboard, and if your technical skill is up to it, the Planet P – and especially its Electric Piano voices – can be an impressive source of percussive voices that are delicate without lacking the ability to cut through other instruments in a mix.

## MKS 30

The less expensive (and correspondingly less complex) of Roland's two MIDI synth modules is the MKS30 (otherwise known as 'Planet S'), whose configuration is internally similar to that of the popular JX3P self-contained polysynth and the GR700 guitar synthesiser, i.e. a six-voice polysynth with two DCOs per voice. However, the Planet S scores in having 64 internal patch memories (with a further 64 memory spaces available on the 16 RAM cartridge, the slot for which is located to the left of the module's front panel) and in incorporating full keyboard dynamics, controllable by MIDI velocity information.

Like the JX3P and GR700, the MKS30 adopts digital parameter selection and control (using eight push-buttons and corresponding numeric LED displays) but the now-familiar PG200 Programmer can be connected via a six-pin DIN socket on the front panel for those who prefer to control things by conventional rotary pots and switches. Indeed, the lack of any graphic representation or parameter listing on the module itself (to be fair to Roland, there's nowhere they could have put such a listing except on the top of the MKS30's metal casing, where other rack-mounting hardware would most likely have obscured it) makes use of the PG200 almost obligatory for all but the most determined of programmers.

In common with the MKS10, Planet S has sliders for volume and brilliance, controls for MIDI Channel assignment, a master tune pot and a headphone socket, while an additional pushbutton switches in the keyboard dynamics. Frankly, I'm not sure why Roland have given users the option to switch the dynamics out at all, unless it's to demonstrate just how much more effective the module sounds when connected to a velocity-sensitive keyboard. And contrary to popular belief, you don't need to be a virtuoso player to get the best out of a dynamic keyboard, particularly if you've got two different MIDI instruments available at the touch of a finger.

If you've gone anywhere near a decent music shop at some time in the past year or so, you'll be aware that the JX3P's oscillator and filter circuitry is capable of providing a pretty wide range of both 'synthetic' and





# Roland Mother Keyboard MIDI System

pseudo-acoustic voices, and in addition to the dynamics already mentioned, the MKS system introduces the additional possibility of combining a piano sound with, say, a string tone from the Planet S. Which, given a certain degree of playing and programming sensitivity, can be an effective combination indeed.

## MKS 80 & MPG 80

Undoubtedly the star of Roland's *nouveau* MIDI lineup is the MKS80 – or 'Super Jupiter' – module, an eight-voice polyphonic synth with two VCOs per voice, eight VCFs and eight VCAs. Now, just in case you think you've seen something akin to that specification before, I should point out that this module's internal circuitry bears more than a passing resemblance to that of the Jupiter 8, Roland's previous flagship poly alluded to earlier, though Roland insist that substantial modifications have been made to the design in general and the filtering in particular. Another discrepancy is that the Super Jupiter adopts some of the programming functions of the newer JP6 polysynth so that, for example, patch information can be stored in two different sorts of memory space – Tone Memories, which contain data relating only to the generation, filtering and envelope of a sound, and Patch Presets, which contain combinations of tone memories (not the tone colours themselves) and performance control and effect data. The MKS80 is capable of storing up to 64 tone memories and 64 patch presets internally, while a further 128 of each can be stored (in two banks, A and B) on external RAM cartridge M64C, available at extra cost.

Like the Planet S module, the Super Jupiter uses digital parameter selection and control, and while it scores over the lesser synth in having a reasonably comprehensive 16-character liquid crystal display that shows you which parameter you've selected and what you're doing with it (as well as additional information pertaining to patch number and MIDI status), the fact that it's a considerably more complex piece of hardware doesn't really make the budding programmer's job any easier, which is why a 'conventional' programming module, the MPG80, is available as an optional extra. This splits 'tone memory' and 'patch preset' functions logically into colour-coded areas, and simply pressing the 'manual' button on each section brings the programmer's editing facilities into play.

It should be pointed out at this point that although the MPG80's controls are essentially similar in composition to those found on the Jupiter 6 and 8, their layout is somewhat different, so players used to either of the self-contained synthesizers will probably need a fair amount of 'breaking-in' time before programming becomes the rapid and enjoyable activity it should be.

The Super Jupiter system does in fact contain a number of novel features that should be of interest to the majority of musicians, and these include a convenient (and extremely quick) Auto Tune option that tunes all the VCOs in to the same pitch at the touch of a button, variable dynamics (operated by a slider on the MKS80's front panel), and an After Touch facility (transmittable *via* MIDI) capable of controlling either VCO modulation depth or VCF cutoff frequency.

I won't bore you with an exhaustive run-down on the Super Jupiter's sonic capabilities, since on the evidence of the factory voices alone, I'd say that all the standard analogue synth sounds (plus a good many more besides) can be reproduced with excellent clarity and power. Instead, I can only marvel at how the MKS80's designers have managed to cram so much into a standard 2U-high rack-mounting case, since both the JP6 and 8 are considerably bulkier both outside and in. Soon they'll be able to get a Micro-composer on a digital watch . . .

## System Conclusions

The first thing to mention is that whatever your views on MIDI, the merits of Roland's synthesiser circuitry or the concept of modular systems in general, you can't but acknowledge the competence with which the mother keyboard system's design has been executed. The argument over the potential usefulness of dynamic keyboards in synthesis is probably one that will never be resolved fully, but I for one was singularly impressed by the way the MKB1000's action livened up both my own playing and the output of the rack-mounting modules. The absence of some form of remote level control is a serious failing, however, since it means having to store whatever MIDI instrument is being controlled somewhere adjacent to the keyboard itself on stage, which would seem to negate much of the *raison d'être* of the modular concept.

Another major grouse concerns Roland's current pricing policy, since by any standards both the controlling keyboards and the synth modules are expensive for what they comprise. Roland UK are at great pains to point out that, for example, the combination of MKB1000 mother keyboard, MKS80 synth module and MPG80 programmer can now be bought for less than the Jupiter 8 cost when it came out, but that fails to take into account the technological advances that have been made since that time and the downward cost spiral those advances brought with them.

Now, it's possible that purchasing one of the mother keyboards could be an investment when you consider that it should prove capable of shielding the musician from the worst ravages of planned obsolescence, but that theory presumes (a) that MIDI will be around for a considerable while to come and (b) that modular synths won't go out of fashion again in 12 months time.

The other possibility is that major studios and session players (whom Roland see as being the system's most likely prospective purchasers) will opt to use one of the mother keyboards in conjunction with sound-generating modules from other manufacturers, since although there's no denying the competence of both the Planet S and Super Jupiter units (the Planet P's merits are a little more debatable, or at least, they are at a price of £990), Roland's lamentable lack of new synth hardware will not have gone unnoticed by professional performers, who depend on having the latest in sound-generating technology for their survival.

On the credit side, Roland have at least given users the option – albeit at a not insignificant extra cost – of programming their synth modules in a convenient and user-friendly way, while the keyboard split and channel assignment modes offered by the mother keyboards allow an almost limitless number of controlling permutations.

On balance, there's a lot more that's praiseworthy about this set-up than there is to fault, and the only reason I'm being so critical is that, as the flagship system of one of the world's leading synthesiser companies, the mother keyboard system is going to be examined very closely by anyone considering investing in either one part of it or the whole shooting match. Whether or not you can justify spending this sort of money on a system of this nature is something only you and your bank manager can decide.

Me, I give it ten out of ten for concept, nine for sonic capability, eight for ease of use and six for value for money. ■

*RRPs are as follows: MKB1000 – £1665; MKB300 – £990; MKS10 – £990; MKS30 – £875; MKS80 – £1800; MPG80 – £395. All prices include VAT, and further information can be obtained from Roland UK, Great West Trading Estate, 983 Great West Road, Brentford, Middx TW8 9DN. ☎ 01-568 4578.*



# Soho SOUNDHOUSE

18a Soho Square,  
London W1V 5FB,  
Tel: 01-434 1365

# SOHO SYNTH HOUSE

## Roland

NEW: MSQ 100 ● GR700 ● MKS 30 & 80 ● MPU 401  
● MKB 1000 & 300 ● SBX-80 ● MCP-8

Over the last couple of years, we have become established as one of the country's leading Roland sales and service centres.

In addition to all the main product lines (synths, sequencers, rhythm composers, effects, amps, computer peripherals, pianos, echos etc.) we carry all the accessories from pedals, switches and interfaces to flight cases and carrying bags.

Our approach to Roland is total. Our staff have been trained in demonstrating the features and functions of each piece of equipment (when you get your sequencer home and have difficulty getting the best results, we won't tell you to "ring Roland") yet retain a musician's approach to Electronics. Serving largely professional clients, our service has to be, and is, like lightning.

Roland's emphasis has always been on hookup-ability. The capabilities of any system are far greater than the sum of the capabilities of its component units. We have several systems running.

You may end up wasting time, money and effort if you don't check us out before you buy. We think you'll be impressed.

### SESSION

Best Prices

SESSIONETTE 75 Guitar 1x12  
SESSIONETTE 75 Guitar 2x10  
SESSIONETTE 100 Bass 1x12

### KORG KEY CENTRE

All Korg prices include P & P and free leads

- NEW Super drums sampled sound £229
- NEW Super percussion sampled sound £229
- NEW Ex 800 expander £425
- NEW RK 100 remote £499
- Poly 800 ..... £POA
- Poly 61 mid. .... £POA
- KPR 77... £235

### BOSS

ALL PRODUCTS IN STOCK

### moog

NEW MEM MOOG Seq .. POA

### CARLSBRO

Comb 90 KBD Combo £228  
Hornet 45 KBD Combo £158

### MATTEL ELECTRONICS



synsonics drums

AS ADVERTISED ON T.V.

- Bass, snare, 2 toms, Cymbal and HH ● Use sticks or hands ● Drum pads are touch sensitive ● Tom Tom 1 can be tuned over a 5 octave range ● 3 separate 16 beat memories allow storage of patterns. Each memory may be layered indefinitely with patterns ● Accent button ● Roll button comes with leads to plug directly into your Hi-Fi/guitar amp.

Rec Retail Price £99.95  
UNREPEATABLE OFFER  
WHILE STOCKS LAST  
FULLY GUARANTEED

£59

inc p&p



West End agents for  
HAMMOND DIGITAL  
PERCUSSION DPM-48  
Real sound and  
great programming  
£575.00 inc. p&p

### YAMAHA

CX5, QX1, RX11,  
RX15, DX7, DX9,  
PF10, PF15, MT44.

IN STOCK NOW  
PRICE ON APPLICATION

### SEQUENTIAL CIRCUITS

- PRO ONE ..... £375
- PROPHET 600 ..... POA
- PROPHET V ..... POA
- PROPHET T8 ..... POA
- SIXTRAX ..... POA
- DRUMTRAX ..... POA
- VOICE CHIPS FOR DRUMTRAX ..... POA
- COM 64 SEQUENCER ..... POA
- 64 REAL TIME SOFTWARE ..... POA

### Fender

UK'S LARGEST SALES & SERVICE CENTRE

NEW USA FENDER STD STRATS

with trem £299 inc P&P

New Squiers from £175. Phone or write for details. New Precisions RH, LH and Fretless. Selection, £299. All hi tech amps in stock. Details on application B300, 300W bass amp parametric, complete, soiled £299. 1982 4-bolt strat, small headstock. Two in the boxes offers.

### BOND GUITARS

We are central London's agent for these remarkable new instruments.

- Phantom Chrome Hardware - Less Trem with case £490.00
  - Phantom Chrome Hardware - With Trem with case £525.00
  - Phantom Gold Hardware - Less Trem with case £515.00
  - Phantom Gold Hardware - With Trem with case £555.00
- In Stock Now

### SALE SALE SALE SALE SALE SALE SALE SALE SALE SALE

#### NEW KBDS

- Korg MS 20 ..... £210
- Korg MS 10 ..... £149
- Casio CT7000 ..... £350
- Jen SX1000 ..... £115
- Moog Rogue ..... £189
- Memory Moog ..... £1695
- Moog Source ..... £395

#### SECOND HAND KBDS

- Hohner Clavinet ..... £119
- Wurlitzer Pianos ..... £325
- Rhodes 73 from ..... £375
- Guaranteed
- Roland CSQ 100 Seq ..... £99
- Roland CSQ 600 Seq ..... £165
- Roland Compumusic ..... £165
- Korg analog Sequencer for m.s. 10/20 ..... £115

#### S/H SOUND EQPT

- Roland Rack guit pre amp ..... £99
- Roland Rack Bass pre amp ..... £99
- Roland Rack 31 band Eq ..... £155
- Roland Rack 8 ch line mix ..... £99
- Twin Reverb std ..... £299
- Twin Reverb JBL ..... £399
- Vox AC30 Blue spkrs ..... £229

# Walt's New Superstore

### TASCAM

TEAC Production Products

244 PORTASTUDIO £595 inc P & P

Remotes, punch-ins, flight cases for 244 all in stock.

- 234 Syncaset ..... POA
- 122B Master cassette 2 speed ..... POA
- 32 Open Reel Master ..... POA
- 34 Open Reel 4 on 1/4" ..... POA
- 38 Open Reel 8 on 1/2" ..... POA
- M2-A 64 Mixing Desk ..... POA
- M/30 8/4 Mixing Desk ..... POA
- Enhancement Series in stock eg
- PE-40 4 Band 4ch Parametric ..... POA
- PB-64 64 way Patch Bay ..... POA

plus all Teac multitrack accessories cleaners, demagnetizers, cables etc.

#### TASCAM MULTITRACK PRIMER

Well written, extensive book on how to get the best results from the smallest of setups.

£4.99 postage free

### Fostex

### X-15 Multitracker

SPECIAL OFFER

AT ONLY

£239.00

+ £35.85 VAT

£274.85

inc P & P

4 Tracks, EQ, Master Mix Faders, Batt or mains

#### OTHER FOSTEX PRODUCTS

- Mains adaptor for X-15 ..... £22
- Orange punch IN OUT for X15 ..... £4.95
- A-8 Open reel 8 on 1/4" ..... POA
- B-16 Open reel 16 on 1/2" ..... POA
- 350 8/4 2 desk ..... POA
- 3070 Compressor/Limiter ..... POA
- 3180 Stereo Reverb ..... POA

WE GUARANTEE THE ABSOLUTE LOWEST U.K. PRICE ON ALL FOSTEX PRODUCTS

### 14 BIT MAXIM DUAL DIGITAL DELAY MDD-1500

- 1024 m.s. delay time
- 50-764 m.s. variable sub delay for 'pattern' (tape echo type) repeats
- level control for sub delay
- attenuable db for input and output
- LED metering for input and delay signals
- E-Q on delay channel
- All metal 19" rack mounting construction

RRP £345 REDUCED TO ONLY £165 inc P&P

### YAMAHA MT44

Other bits in stock

- MIXERS (See Tascam & Fostex)
- MTR 6:4:2 Unbeatable value ..... £225
- BOSS 6:2 Pan E.Q. Effects ..... POA

#### DIGITAL DELAYS

- Roland SDE 1000 ..... POA
- Roland SDE 3000 ..... POA
- Boss DE 200 ..... POA
- Boss DD 2 Pedal ..... POA
- Ibanez DM 200 ..... POA
- Ibanez HD 1000 Harm ..... £329
- Yamaha Midi ..... POA
- Maxim Dual Delay ..... £165

#### ANALOG DEL

- Evans EP 100 ..... £89
- Evans Mm ..... £69
- Boss DM2 ..... £69
- Rozz R-8 ..... £49
- 200 m.s.

#### REVERBS

- Great British Spring ..... £229
- Accessit Spring ..... £132
- Vestafire Spring 19" ..... £219
- Aces Spring 19" ..... £89
- Yamaha Digital RV 1000 ..... £459
- Alantex Rooverb Spring ..... £39

#### COMPRESSOR/NOISE GATES

- FOSTEX 3070 Comp/limiter 19" ..... POA
- Vestafire 19" ..... £225
- Accessit Compressor ..... £52
- Accessit Noise Gate ..... £52

#### MISCELLANEOUS

- MPC Sync Trac (Drum Machine-Tape) £39
- Headphones ..... from £15
- Mikes Shure. Audio technica
- Prices start from £25
- Boom stands from £18
- Many other effects and accessories in stock
- Phone for prices

No Stamps Required

Scissors icon

Walt's New Superstore

Freepost 38 London W1E 6QZ

To: Soho Soundhouse Mail Order

Name \_\_\_\_\_ Address \_\_\_\_\_

Please send me Model (No/s) \_\_\_\_\_

I enclose cheque/postal order for £ \_\_\_\_\_

debit my Access/Visa account No \_\_\_\_\_

Tel \_\_\_\_\_

P & P inclusive in all prices

24 hour despatch

Cheques 7 days

Telephone orders welcome

EMM 10/84





# LOVE'S GREAT ADVENTURE

In which Ultravox discuss the rigours of being one of the world's foremost recording and touring bands, seven years of musical development, and the instruments that have played the biggest part in shaping their career. *Dan Goldstein*

Up until the day I started writing this feature, I'd never devoted much attention to the fact that it really is inordinately difficult to classify Ultravox accurately. The commercial success the band has experienced over the past three or four years tempts critics to call them simply a pop group, but such a title places them in the same pigeon-hole as the many singles artists whose musical output is controlled entirely by commercial considerations. Others refer to them simply as an 'electronic' band, but from the start, conventional band instruments have played just as important a part in Ultravox's writing as synthesisers and drum machines.

Seeing as each year of the band's existence has seen a fresh musical experiment, perhaps the phrase 'innovators' or 'adventurers' would be more appropriate (though unlikely to find favour with the band's detractors). The latter description seems particularly apt, since Ultravox have just put the finishing touches to a new single entitled 'Love's Great Adventure'. The record marks something of a departure for the band, since it's the first single they've released that hasn't been taken from an accompanying long-player.

The decision to make the record in the first place was based on a reluctance to take any further tracks from the *Lament* album, as keyboardist Billy Currie, a member of Ultravox since the band's inception seven years ago, explains:

'We wanted to do something different, to get out of the way singles that are taken from an album tend to sound the same as each other. You know, when any band puts out several singles from the same album, they might appear to be very different in some ways, but because they were all recorded at the same time, they have the same feel to them. We wanted to get away from that – do a one-off single totally separate from any album.

'The recording was a lot more immediate than *Lament*. We decided not to go into the studio and spend a long time doing it, because things can become really sluggish when you're doing albums. For the single there was

well as being an occasional contributor to the pages of E&MM from time to time), explains that 'Love's Great Adventure' is as much a musical departure as it is a logistical one.

'It's in threes, and it's got a very up,



plenty of momentum going, and the momentum thing is important: having done the single like that, I'd now like to do an album in the same way – do it with just a couple of days' rehearsals, or none at all, which was what we did for the single.'

Percussionist Warren Cann, who's also been with Ultravox from the start (as

happy melody, which is why we decided to persevere with it in the first place. We'd tried things in that time signature before, but they'd always sounded contrived, but this one doesn't. There's no real technical trickery in making it, it's the strength of the song that carries it through.'

The release of the single comes



towards the end of what has been another hugely successful year for the band – both commercially and artistically. *Lament*, the band's seventh album in as many years (discounting compilation LPs and live efforts) was one of their most innovative projects for some time, while their concerts – both at home and abroad – have been amongst the best they've ever played.

Do they ever get tired of life in such a consistently successful outfit? Apparently they do – Warren illuminates.

'I'm sure it's something a lot of bands find themselves doing. You write, record and release an album, go on tour to promote it, take a holiday because you're tired, by which time it's nearly a year since the album came out, which is about as long as you can leave it, so you have to get writing again. It's a cycle that's very, very difficult to get out of once you're in it. The thing is, there are lots of different ways of working, but none of the others are compatible with achieving success worldwide and maintaining that success level.

## History

The Ultravox of today might be a healthy group of musicians trying to make the best of the rock star life cycle whilst still striving to be consistently creative and

three albums for Island Records (Shears being replaced by Robin Simon along the way) before Foxx left to pursue a solo career.

It looked for a time as though Ultravox as a band would never re-appear, but Currie, Cross and Cann eventually found a replacement for Foxx in the shape of singer and multi-instrumentalist Midge Ure, and the new-look Ultravox signed a deal with Chrysalis, for whom their first album, *Vienna*, marked the commercial turning point in their career.

Yet even in the early days, the band's recordings (and indeed their live appearances) were notable for the originality of their instrumental arrangements and the vitality of their presentation. Warren Cann, for instance, was one of the first drummers in modern music to recognise the potential of using electronically-generated rhythm patterns in conjunction with acoustic drumming.

He looks back on those pioneering days with some fondness.

'The drum machine I started off with was the Roland TR77, quickly followed by the CR78 Compurhythm. Its programming facility was a step ahead of anything else available at the time, but it was so limited, so inherently awkward to program. Then again, it enabled me to do *Vienna*.

of real drums from a machine, but my own feeling is that even if it had had totally analogue sounds, it would have been just as big a success.'

And what's Warren's view of the state of electronic percussion in 1984?

'The thing that's most important to me is simply programmability. Maybe it's just a personal bias, but I lean towards programmable drum machines as opposed to player-activated electronic percussion. It's my feeling that when you program a drum machine, things are dependent on brain power rather than just how quickly you can hit the pads. With a drum machine you can have an idea and input it into the machine and it'll remember it instantly, but playing drums doesn't allow you that creative freedom.

'The biggest recent breakthrough was the SCI Drumtraks, not only because of its price but also because programmable tuning and level was such a natural development. It really was the way things had to go, and now I think all the other machines will have to go in the same direction – improving the area of programmability.'

## Keyboards

As already mentioned, classically-trained Billy Currie has been tickling the ivories for Ultravox since day one, and even their earliest recordings are characterised by his willingness to experiment with new sound textures and new methods of manipulating them from the keyboard. However, he remains best remembered for his raunchy lead-line synth sound, something he discovered quite by accident, it seems.

'Well, I got an ARP Odyssey for the first album back in '77, and I just stumbled on the lead sound by sticking it through a flanger. I used it a lot in the early days, and carried on using it on later records because it went so well with that particular rhythm guitar sound Midge gets.

'To a certain extent I think instruments dominate the way you work. If I can I'd like to avoid the workshop image of someone being surrounded by technology, but there are some sounds – like the strings on a Yamaha CS80 or even a couple of things on a great dinosaur of an instrument like the GS1 – that when we sit down and talk about as a band, I say I simply have to have, so I hang on to them.'

Warren takes over, on what proves to be the first of many occasions.

'Synths do allow you to create sounds that are more atmospheric and more romantic – for want of a better word – than what could be achieved if you had to do that kind of thing with massed overdubbed or E-bow guitars. So you could say that melodically technology has influenced us a lot.

'Rhythmically it's affected us a great deal, too, because it's enabled us to explore syncopations and generate bass pulses that are completely different to what a bass player would play. 'All Stood Still' and 'The Thin Wall' are examples of that. I'd say that particular combination of



forward-looking, but the Ultravox of yesteryear was an altogether different affair. Formed around singer John Foxx (see this month's *Home Studio Recording* for interview), the band was originally a five-piece comprising Foxx, Cann, Currie, bass player Chris Cross and guitarist Stevie Shears. They made

'I look upon those two machines as being what set me up for the Linn LM1 when it appeared: I guess the Linn was probably the most important instrument in my career. The thing that I latched on to about it was the extent of its programmability. At the time everyone went wild about the fact that it gave you the sound



acoustic drums and triggered synth bass has been especially important for us, in fact.

'On balance I think we go through two phases of looking at new gear as it comes along. The first phase takes place when you're about to write a whole load of new songs and you're interested in all the new equipment that's become available. So you ask yourself a certain set of questions. Is it going to broaden my horizons? Is it going to make my job any easier? Is it going to be fun to experiment with?

'Then once you've settled on some new instruments that you think are going to be good to use, you do the writing and recording, and the second phase takes over: you have to weigh up the advantages of the equipment you used to do the recording against something else that may give you almost the same results, but is a lot more practical to use live. Don't forget that the main criteria for gear for live work are simplicity and reliability. You want something that's going to make your job as easy as possible because then you can get on with concentrating on your performance.'

## In Concert

This brings us nicely to the subject of Ultravox on stage, a spectacle that's always been well worth seeing, largely because the band themselves set great store by the possibilities a live performance affords them. Warren Cann again:

'We've always felt that playing live was our forté. Making records is all very fine, but you can't re-create what you can get out of playing in front of an audience. For me, every consecutive running order that we've drawn up is more exciting than the last, because it contains the old songs you still love to play and a whole load of new ones, which you're naturally very enthusiastic about. We've never had any problem making room for new material when we've sat down to decide what to play at the start of a tour. The songs we used to enjoy a lot – but have played so much we can no longer relate to them – go first, and they make room for the new ones.'

For Billy Currie, Ultravox's most recent major tour was particularly rewarding, partly because he discovered a new instrument – the OSCar – that assisted his live performance greatly.

'Yeah, I was particularly pleased with the last tour we did. You're always on a high when you're in front of an audience – or I am anyway – and it's even better if you've got a new instrument that stimulates you, like the OSCar did for me this time around.

'I got it just before we went on tour, which looked as though it was going to be a problem. But when an instrument excites you that much, it gives you so many new ideas that it doesn't matter if you haven't quite figured out how to play the damn thing yet. If you make a mistake you can probably bluff your way through it anyway, and there's a possibility the audience might actually get off on it

because it shows you're fallible – that you're not just some studio musician who doesn't care about the music.

'The OSCar has basically taken the place of the Odyssey. The Odyssey was still just about usable in the studio, but live it was becoming a liability because it went out of tune so easily. I really don't think I could have done another tour with it, so the OSCar arrived at just the right time. I like almost everything about it, and it's not just the sound. There's the duophonic facility, the simple facility to play two notes at a time, which is a big bonus for me, and the sequencer on it is so easy to use: I put a sequence in it and triggered it in threes for the single, as well as doing the main synth solo on it.

'The other thing about the OSCar is that it just *feels* right as an instrument,

'Right now I'd say the OSCar is the most exciting synth in my line-up – even though I'm using it with a PPG and a Yamaha GS1 on stage.'

which is a rare thing for a synth, I think. In fact, it's one of the few electronic things that seems to have been designed for musicians, as opposed to a lot of stuff – especially the stuff coming out of Japan – which is just developed in laboratories. I've been in touch with OSC and they've always been very helpful, which makes a change from a lot of other companies. They've maintained my enthusiasm for the instrument and right now I'd say it's the most exciting synth in my line-up – even though I'm using it with a PPG and a Yamaha GS1 on stage.'

But if there's a big change in instrumentation between the recording studio and the live gig, do the band have any worries about their live sound bearing little or no resemblance to what they've released on vinyl?

'Well, there's no point in duplicating the sounds of records totally,' Billy muses philosophically. 'The thing I enjoyed so much about the tour was that I was only trying to remind the audience of the way the albums sound about 25% of the time. The rest of the time I was doing what pleased me, which was to change the way things sounded and the way they were played.

'You can't do that all the time, though, because it can be quite hard to instil new life into songs that have been kicking around for a while. For instance, I've been playing the keyboard parts on 'New Europeans' the same way for so long that it's just impossible to think of them being any other way – that's just how it's got to be.

'Sometimes we come to start rehearsing for a tour and we wonder how some of the things we've just recorded are going to come out live, but usually we take a look at the component parts of a song and it becomes surprisingly easy to

reproduce. And once you've played a song live on five or six occasions, you just don't think about the complexity any more.'

## Production

If Ultravox live are a consistently exciting and moving spectacle, their records are if anything even more fulfilling. Their seven albums make up a rich tapestry of innovation and experimentation, yet all within a package that remains eminently accessible. The originality of their arrangements and their songwriting ability are beyond question, but one area that's received somewhat less in the way of laurels, even though it's played a significant part in shaping the band's career, is studio production.

Warren Cann takes me through the production story.

'The *Lament* album was the first one that was actually promoted as being 'Produced by Ultravox', but we've always played a big part in the production of our records. Our second album was produced by Steve Lillywhite, who was our mate, and our first one was produced by Brian Eno, who was someone we respected and had always wanted to meet – it was a great way of meeting him!

'The most interesting part of recording that first LP with Brian was when the tape wasn't running – when we just sat down and discussed our ideas. At that time, he was far more interested in the procedure than the end result. The end result might be lousy and it wouldn't bother him in the least, because he realised that if you pay attention to the procedure, you learn a lot and your end results become good in time.

'After the first two albums we started working with Conny Plank. Conny was really just an *astounding* engineer, though he does do some production work with other people. The chemistry he had with us was such that we felt he was doing more than is required in an engineer's role, so we gave him the same co-producer's credit that Brian and Steve had had.

'For *Quartet* we worked with George Martin, and actually it was in his contract that he had to go down as producer, but when it came to doing *Lament* we couldn't think of anyone exciting we wanted to work with and who was available, so we did it totally ourselves. That was interesting in itself, because there was no sort of referee around . . .'

Billy recalls that the *Quartet* saga was the first – and so far only – attempt the band have made to get out of the rock star life cycle mentioned earlier – it wasn't a success.

'We tried to get round things by taking a lot longer over writing and rehearsing, but then we had nothing like enough time to record it properly and it became so enormously laborious. We just felt that what we were doing really wasn't conducive to making good music: it wasn't a very creative process – it was more like having a regular nine-to-five job!'

So *that's* what being famous is all about. Think I'll stick to writing. ■



# FREEDMANS



THE BIG MUSIC STORE FULL OF  
PRE-CHRISTMAS BARGAINS

## AMDEK EFFECTS KIT

- FLANGER £49
- PHASER £30
- DISTORTION £25
- RHYTHM MACHINE £33
- MAINS DELAY £55
- POWER DISTRIBUTOR £16

## BOSS EFFECTS PEDALS

- BF2 FLANGER £54
  - CE3 STEREO CHORUS £53
  - CE2 MONO CHORUS £67
  - DS1 DISTORTION £36
  - PH1R PHASER £45
  - MA1 MASCOT AMP £22
  - TU12 TUNER £32
  - OD1 OVERDRIVE £38
  - HC2 HANDCLAP £48
  - PC2 PERCUSSION SYNTH £48
  - SD1 SUPER OVERDRIVE £36
  - OC1 OCTAVE £38
  - US2 VIBRATO £49
  - DAL10 DRUM MACHINE (PROGRAMMABLE) £99
- ALL BOSS PRODUCTS NORMALLY IN STOCK

## DRUMS

- JMS PRO RHYTHM DRUM SYNTH w/stand £85
  - MINI DRUM SYNTH - CLIP ON TYPE £45
  - LUDWIG BIG BEAT OUTFIT S/HAND 26" B/D
  - 13, 14 & 16 TONS + 400 S/DRUM WITH STANDS & PEDALS ALMOST NEW £850
  - GRETSCHEM OUTFIT S/HAND 20" B.D 16 R
  - 16" TONS GREAT VALUE £220
  - PREMIER ROYALE STANDARD KIT 5 DRUMS & HARDWARE £325
  - PREMIER POWER TOM 5 DRUMKIT INC STANDS & PEDALS SUIT £395
  - LARGE RANGE OF LATIN PERCUSSION
  - L.P. TYPE PRO CONGAS £49
  - COOPERED WOOD TUNABLE CONGAS £27
  - F/CLASS CONGAS WITH STAND STILL ONLY £190
  - WOOD " " " " £230
- (CARRIAGE FOR CONGAS £6.50)

## NEW ROLAND ITEMS

- MKB 3000 LOW PRICE MOTHER KEYBOARD
  - MKS 80 SUPER JUPITER
  - MKS 10 PIANO MODULE
  - MKS 20 SYNTH MODULE
  - MPG 800 PROGRAMMER
  - HP 20 BUDGET PIANO
  - MPC 80 MIDI PERCUSSION PADS
  - AXIS FRONT LINE MIDI KEYBOARDS
- (ALL ARRIVING SOON)

## SEQUENCERS

- ROLAND MC202 £199
- ROLAND JSQ 60 £199
- ROLAND MC48 WITH INTERFACE S/S £999
- ROLAND MTR 100 RECORDER FOR MKS £50
- BBC B MIDI INTERFACE COMPLETE £155
- JMS MIDI INTERFACE £89.95
- JMS MINI INTERFACE £29.95
- JMS SPECTRUM SOFTWARE IN STOCK
- JMS COMMODORE 64 SOFT/W IN STOCK
- FROM £19.95 PHONE FOR DETAILS

DRUMKIT TR 606P £169 PRP £150

## ELECTRIC PIANOS

- ROLAND EP11 £199
- ROLAND HP30 £235
- ROLAND HP60 £245
- ROLAND HP70 £435
- YAMAHA PF10 £899 (WITH CASE)
- YAMAHA PF15 £1064 " "
- LOGAN PIANO £599 WITH STAND

## INSTRUCTION TAPES

- HOT LICKS TAPES £7.95 EACH EXCEPT WHERE PRICE STATED
- CARRIAGE £0.75 ORDER 3 OR MORE FOR FREE POSTAGE
- JAZZ GUITAR 1-6, ROCK GUITAR 1-6
- ADVANCED GUITAR 1-6, ROCK PIANO 1-6
- JAZZ/ROCK FUSION 1-6, BLUES GUITAR 1-6
- NASHVILLE GUITAR 1-6, REB GUITAR 1-6
- HOW TO PLAY GUITAR 1-6, LEAD GUITAR 1-6
- STEVE MORSE COURSE (2 TAPES) £16.90
- HOT TRAX £8.95
- TAL FARLOW MASTER COURSE (2 TAPES) £16.95 COMPLETE

NEW SYNTHWORKSHOP 1-6 TAPES £7.95 EACH



## CASIO KEYBOARDS

- CASIO 7000 £625
- CASIO 310 £199\*
- CASIO 610 £345
- CASIO 501 £265
- CASIO MT200 £129\*
- CASIO MT800 £269\*
- CASIO PT80 £69\*
- CASIO PT50 £69
- CASIO PT30 £69\*
- CASIO MT46 £99\*
- CASIO MT68 £129\*
- CASIO MT20 £169.45\*
- CASIO MT35 £79\*
- CASIO MT70 £175\*
- CASIO VL1 £29
- CASIO CT701 £395
- CASIO CT601 £225

\* ALL CASIO MARKED WITH STAR ARE COMPLETE WITH MAINS ADAPTOR AND ARE POST FREE \*

**SUPER DEAL**  
YAMAHA CS01 MONO SYNTH  
R.R.P. £189  
OUR PRICE £99  
CARRIAGE £2.50

## MICS

- SHURE 565 D £69 (w/ CABLE)
- SHURE 565 D £76
- SONY DUAL AMP WITH LEAD & MULTI USE PLUG (GREAT VALUE) £
- ATM 61 WITH LEAD £59
- ATM P601 WITH LEAD £19
- CARRIAGE ON MICS £1.50

## BASS PEDALS

- ELKA PEDALS £125
- SYNTH BASS £249
- GODWIN WITH RHYTHM, CHORDS, ARPEGGIO & BASS
- GREAT FOR 1 MAN BAND £520

## ROLAND SYNTHS

- JUNO 6 £499
- JUNO 60 £650 WITH CASE
- JUNO 106 £799
- SH101 MONO £245

## EASY PARKING

NEAREST TUBE:- LEYTONSTONE CENTRAL (RING FOR FREE COURTESY CAR)

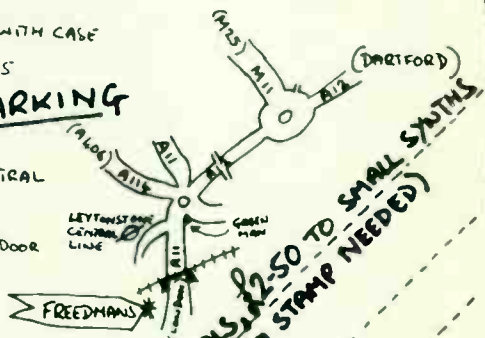

EXPORT OVERSEAS BUYERS VAT REFUND SCHEME RING FOR DETAILS

\* HANDS ON TRIAL \* SOUNDPROOF AMP STUDIO \* P/EX \* INSTANT HP \* REPAIRS \* SHEET MUSIC

ALL PRICES INCLUDE VAT AT 15%

**FREEDMANS**



A.P.R. 30.2%

627-631 HIGH ROAD LEYTONSTONE  
01-539 0288 LONDON E.11 4PA  
(CLOSED THURSDAYS) 20/7/86

\* MAIL ORDER PLEASE ADD £1.50 POSTAGE TO PEDALS £2.50 TO SMALL SYNTHS  
SEND TO FREEDMANS FREEPOST LONDON E.11 4PA  
NAME ADDRESS  
PLEASE SEND ME I ENCLOSE CHEQUE FOR £ OR CHARGE TO MY ACCESS/VISA CARD NO



# **Dawn of a new technology**



**FANE**  
*Towards Perfection*

Professional products division

Fane Acoustics Limited, 286 Bradford Road, Batley, West Yorkshire WF17 5PW, England.  
Telephone: Batley 476431. Telex: 556498 FANEG.



Featured  
in this issue

# TAKE COMPLETE CONTROL OF YOUR MUSIC with the MCS-1 MIDI CONTROLLED SAMPLER

Once again, Powertran and E&MM combine to bring you versatility and top quality from a product out of the realms of fantasy and within the reach of the active musician.

The MCS-1 will take any sound, store it and play it back from a keyboard (either MIDI or V/octave). Pitch bend or vibrato can be added and infinite sustain is possible thanks to a sophisticated, looping system.

All the usual delay line features (Vibrato, Phasing, Flanging, ADT, Echo) are available with delays of up to 32 secs. A special interface enables sampled sounds to be stored digitally on a floppy disc via a BBC microcomputer.

The MCS-1 gives you many of the effects created by top professional units such as the Fairlight or Emulator. But the MCS-1 doesn't come with a 5-figure price tag. And, if you're prepared to invest your time, it's almost cheap!

## Specification

Memory Size: Variable from 8 bytes to 64K bytes.

Storage time at 32 KHz sampling rate: 2 seconds.

Storage time at 8 KHz sampling rate: 8 seconds.

Longest replay time (for special effects): 32 seconds.

Converters, ADC & DAC: 8 bit companding. Dynamic range: 72 dB.

Audio Bandwidth: Variable from 12 KHz to 300 KHz.

Internal 4 pole tracking filters for anti-aliasing and recovery.

Programmable wide range sine wave sweep generator.

MIDI control range: 5 octaves.

+1 V/octave control range: 2 octaves with optional transpose of a further 5 octaves.

## Digital Delay Line



Introduced in 1982, Powertran's DDL has brought digital quality effects to thousands of musicians. Still available in kit form at only £179.00 + VAT.

£499+  
VAT IN KIT  
FORM  
£699+VAT  
READY  
BUILT



professional quality MIDI-controlled sampling unit

Write or phone now to place an order.  
Powertran Cybernetics Limited,  
Portway Industrial Estate,  
Andover, Hants, SP10 3EM.  
Telephone: 0264 64455



**POWERTRAN** cybernetics Ltd

PORTWAY INDUSTRIAL ESTATE, ANDOVER, HANTS SP10 3NN



# WIN AN OSCAR

## ENTRY FORM

### PART 1

1 The new MIDI OSCar makes all 36 voices user-programmable. How many were preset on the original instrument?

.....

2 How are tuning and transposition intervals selected on the OSCar?

.....

3 How does the OSCar's filtering enable the programmer to create a more powerful lead or bass sound?

.....

4 How are digital waveforms created on the OSCar?

.....

5 How many different modes of Glide does the OSCar have provision for?

.....

6 Which of the OSCar's facilities allows it to cope with various different triggering and sync inputs?

.....

### PART 2

1 Most people know that Billy Currie is Ultravox's main keyboardist, but which acoustic instrument does he also use?

.....

2 Which Ultravox album subsequently gave its name to a John Foxx solo track?

.....

3 Ultravox recorded several albums at Conny Plank's studio. In which German city is it located?

.....

4 Name the powerpop band Midge Ure left to join Ultravox as singer and guitarist.

.....

5 Ultravox's three LPs for Island Records were used as the basis for a compilation album. What was it called?

.....

6 Three singles have been taken from Ultravox's latest album, 'Lament'. Name two of them.

.....

When you've completed all the questions above, send this entry form to: OSCar Competition, E&MM, Alexander House, 1 Milton Road, Cambridge CB4 1UY. Closing date for entries is second post, Wednesday October 31, 1984. We regret that photocopies of forms cannot be accepted.

Name.....

Address .....

.....

Daytime ☎ .....

## IN E&MM'S EXCLUSIVE COMPETITION

Due to the unprecedented popularity of our Korg competition in the August and September issues, we've decided to run another one – this time with all the questions printed in one issue and with the world's most advanced monophonic synthesiser, the OSCar, as first prize.

All you have to do to enter is answer the questions on the entry form below. There are 12 puzzlers in all: six on the OSCar itself and a further six on the history of this month's featured band – chart-toppers Ultravox. However, you won't find the answers to these questions printed elsewhere in the magazine as was the case with our Korg competition, so if there are some points you're not sure of, you're going to have to pay a visit to your local OSC dealer and/or record shop.

The OSCar has been on sale for about nine months, and is the only synthesiser currently being manufactured in the UK. It's made by the Oxford Synthesiser Company, and the instrument itself is the brainchild of veteran synth designer Chris Huggett.

Since its release, the OSCar has proved a world-beater among lead line synthesisers, and is currently being used by such renowned keyboardists as Asia's Geoff Downes, Dave Stewart (*Which? The boring one or the one with the Eurythmics? – Ed*), and of course Ultravox, who own no fewer than four!

However, since the OSCar was designed, MIDI has become the universally-accepted interface system, so as from this month, all OSCars are fitted with MIDI. The new-specification machine has provision for the following MIDI functions:

- Note information transmit and receive (including sequencer and arpeggiator)
- Wheel information transmit and receive
- Program change transmit and receive
- MIDI On/Off transmit
- Polyphonic MIDI keyboard information transmit (can be used as master keyboard)
- Omni and Poly (16-channel assignable) modes
- Voice, programmable waveform and sequencer data selectively dumped and re-loaded
- MIDI In, Out and Thru sockets
- MIDI status display via LEDs

The MIDI OSCar also allows all 36 voices to be user-programmed and increases the sequencer storage capacity to 1500 events. Any existing OSCar owners can have their machines updated to the spec of the new MIDI version (this will include the voice and sequencer expansion) via a simple plug-in retro-fit board.

E&MM has managed to acquire the world's first MIDI OSCar for this exclusive competition, and the winner will be presented with it by Ultravox's Billy Currie at an agreed time and venue during November. Even if you don't win the first prize, there are a further ten copies of the latest Ultravox album – *Lament* – to be given away as runners-up prizes, with the compliments of Chrysalis Records.

So what are you waiting for? Get scribbling!

### RULES

All entries must be on the official entry form published in E&MM October 1984: no photocopies can be accepted. The winner will be the competitor whose entry is the first all-correct to be picked out of the hat during the week following the closing date. The winner will be notified by post or by telephone no later than November 9. Closing date for all entries is second post, October 31, 1984. The judges' decision is final, and no correspondence regarding the choice of winner or runners-up will be entered into. Employees of Music Maker Publications, Oxford Synthesiser Company and Chrysalis Records and their relatives are ineligible for entry.



# the OSCar digital synthesiser



## Features:

- analogue and/or digital voicing
- 24 harmonic waveform construction
- 36 sound memory location
- fully programmable
- powerful dual VCF
- monophonic/duophonic operation
- versatile performance controls
- 1500 event sequencing
- 12 sequences and 10 sequence chains
- MIDI — In, Out and Thru
- MIDI channel assignment
- tape dump & load.

**We think the OSCar is amazing, and so do the UK**

**music press: "The OSCar has the lot" *International Musician***

**"... bloody brilliant" *Music UK* "Stunning" *Sounds***

**.....and so do Ultravox — they've bought 3.**

**Send just £499 (plus £25 worldwide delivery) to: OSCAR SALES, CHROMATIX, OAK ROAD, LONDON W5, ENGLAND, or for further details call 01-567 3623.**

# OSCar

## NOW AVAILABLE WITH MIDI!

+ 1500 EVENT SEQUENCER

+ 36 USER PROGRAMMABLE MEMORIES

All earlier models can be updated to the new specification

- Fully programmable monophonic with duophonic option, and new note priority keyboard
- 24 factory preset sounds plus 12 user programmable sounds
- Two digital oscillators that never go out of tune
- Full complement of "standard" waveforms, plus the option of creating and storing your own digital waveforms, by adding any of 24 different harmonics up to 16 times each
- Unique dual peak filter with low pass, high pass and band pass modes
- 6 option L.F.O. with variable delay
- 6 different glide modes including a unique constant glide time function
- Programmable wheel amounts
- Programmable arpeggiator with up, down, up/down and hold functions
- Fully comprehensive sequencer with 12 sequences and 10 chains. Voice changes, legato phrasing, repeat event, rests and tied notes can all be incorporated
- Cassette interface to selectively save programmable waveforms, voices and sequences

The OSCar is unrivalled for performance and sound creation. Contact your local dealer now for a demonstration.

### MAIN DEALERS

- Rod Argents, London WC2 01-379 6690
- Chromatix, Ealing Broadway W5 01-567 3623
- Dougies Music, Northwich 0606 782 522
- Gig Sounds, Catford SE6 01-690 8621/2
- Live Wire, Cardiff 022 496619
- McCormacks Music, Glasgow 041-332 6644
- Flash St. Electro Music, Bolton 0606 782522
- Musical Exchanges, Birmingham 021 236 7544
- Rock City, Newcastle 0632 324175
- Sound Control, Dunfermline 0383 733353
- Sounds Control, Edinburgh 031 557 3986
- Sounds Plus, Bury St. Edmunds 0284 703366
- White Electric Music, Sunderland 0783 780589
- Eddie Moors, Bournemouth 0202 35135
- JSG, Bingley 0274 564389/566843
- Carlsbro Sounds Centres:
  - Nottingham 0602 581888
  - Leicester 0533 24183
  - Sheffield 0742 640000
  - Mansfield 0623 651633
  - Norwich 0603 666891
- Sensomania, Amsterdam 020 230398



**OXFORD SYNTHESIZER COMPANY LTD., 5 Gladstone Court, Gladstone Road, Headington, Oxford.**  
Tel: (0865) 862856/67065.



ON ONE INSTRUMENT...  
 BRASS ON TRAK 1  
 GUITAR ON TRAK 2  
 BASS ON TRAK 3  
 VIOLIN ON TRAK 4  
 SAX ON TRAK 5  
 ELECTRIC PIANO  
 ON TRAK 6

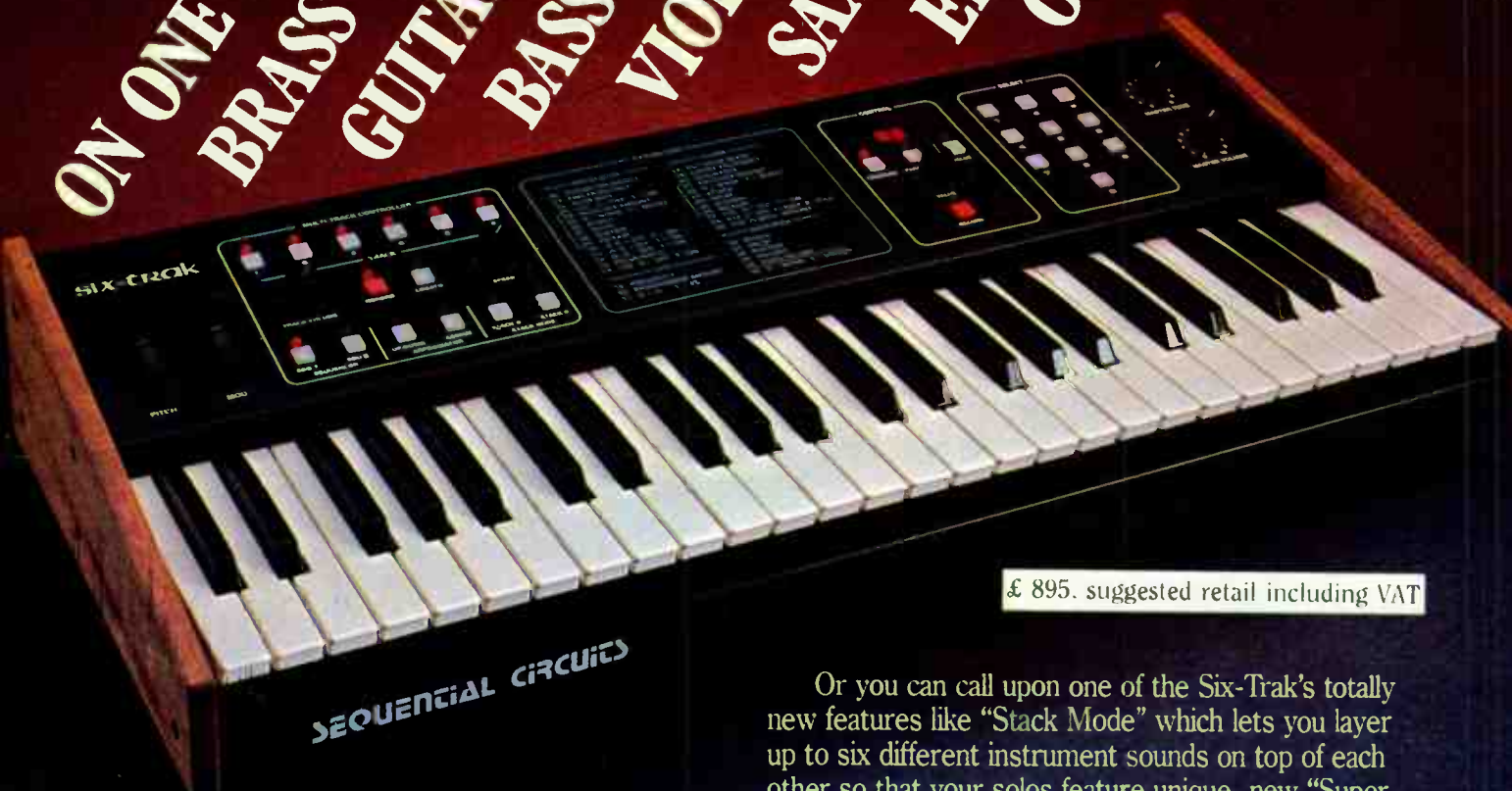

£ 895. suggested retail including VAT

**THE SIX-TRAK. A MULTI-TIMBRAL SYNTHESIZER THAT LETS YOUR MULTI-TALENTS SHINE THROUGH!**

You can play it as a standard, fully programmable 6-voice synthesizer, featuring any one of 100 custom programs using the full, bold sound of six *real* VCO's and six 4-pole filters like all Prophet synthesizers.

Or you can use its powerful, built-in six track digital recorder to build your songs one track at a time, with each track playing a different instrument sound and melody line. *Reserve tracks and play a live solo with the playback!*



Or you can call upon one of the Six-Trak's totally new features like "Stack Mode" which lets you layer up to six different instrument sounds on top of each other so that your solos feature unique, new "Super Patch™" sounds.



The Six-Trak is expandable into an even more powerful performance and composing system by interfacing with drum boxes (Drumtraks!) and home computers through MIDI. Expansion software for the inexpensive Commodore 64 is available now.

This powerful new multi-timbral instrument makes a musician's work all play.

*We Listen to Musicians.*



For more information contact: Sequential Circuits Europe, Nijverheidsweg 11c, 3641 RP Mijdrecht, Netherlands.



# CLEF ELECTRONIC MUSIC

## The NEW CLEF DIGITAL C.M.S. WHEN WE SAY 'PROGRAMMABLE' WE MEAN IT!

The new Clef Computer Music System is a FULLY programmable Digital Synthesizer. It's so programmable that you need a BBC Microcomputer to run it. Programmable waveforms on 32 independent oscillators. Programmable shape and keyboard touch response on 32 envelopes. Programmable stereo on each Osc/Env. Up to four different Osc/Env's per note. 5 Octave touch sensitive keyboard, real time polyphonic sequencing and massive potential for future software. In short, the Musical control you've always wanted at an affordable price. Just £475.00 inc. VAT!!! Complete with software disc.



Phone or write for full details  
**EXPERIMENTERS! PDSG,**  
P.S.U. & Keyboard available  
separately as promised in  
E&MM. Demonstrations by  
appointment at

**BAND-BOX**  
Programmable backing trio  
**THREE PIECE BACKING BAND**  
Generates the sounds of three  
instrumentalists to back  
Soloists & Cabaret Acts  
**DRUMS+BASS+KEYBOARDS**  
Over 3,000 chord changes (60  
scores) on 132 different chords  
- 16 chord sounds  
**RRP £499.00**



**CLEF PRODUCTS (ELECTRONIC) LIMITED**  
(Dept E&MM/10/84) 44a Bramhall Lane South, Bramhall,  
Stockport, Cheshire SK7 1AH. 061-439 3297

**IT'S HOT STUFF ... AND IT'S HERE FROM NEW YORK**

**16-20 OCTOBER**  
**THE LAR LUBOVITCH**  
DANCE COMPANY

**ARNIE ZANE & COMPANY**

With music by Philip Glass  
and Steve Reich  
"Creates a totally new look"  
New York Times

**Sadler's Wells Theatre**  
01-278 8916

In association with **DANCE UMBRELLA '84**



**BILL T. JONES**  
**11-13 OCTOBER**  
Music by  
David Cunningham  
of The Flying Lizards  
"The Freshest, most  
innovative Dancing"  
Boston Globe



**& COMPANY**

**ddrum**

**HEARING IS BELIEVING\***

**ddrum**

**ddrum**

**ddrum**

\* At selected dealers





PPG Wave 2.2 and 2.3, Waveterm  
Processor Keyboard, PRK Sound Pack  
Expansion Voice Unit.

PPG-UK Ltd, 505-507 Liverpool Road,  
London N7 8NS  
Tel 01 609 8501 Telex 295931 UNICOM



## ON RECORD

E&MM's monthly look at the latest vinyl releases in both album and single formats. *Dan Goldstein*

## Harold Budd & Brian Eno

### *The Pearl*

Editions EG EGED 37

In between producing U2's new album and working on a new solo project of his own, Eno has somehow managed to find time to renew his musical alliance with Californian keyboardist and percussion player Budd. The duo's last collaboration, *The Plateaux of Mirror*, formed part of Eno's Ambient series, but this accolade is not afforded *The Pearl*, though I don't see why not: the music is very similar.

If simple, melodic, semi-improvised piano lines and 'organic' background synth sounds are your cup of tea, you won't find much objectionable in this latest offering, since it follows that recipe unerringly. Personally, I'm obsessed with it. There's a beauty to Budd's performance that's simply lacking in the playing of so many of his contemporaries, while Eno's synth touches lend the music just the right degree of ambient unease to prevent *The Pearl* from being just so much muzak – albeit muzak of a very pleasant and rewarding kind.

If there is a criticism to be made of *The Pearl*, it's that it doesn't really display any artistic or creative development on the part of either of its creators, since it sounds a little bit too much like *The Plateaux of Mirror* for its own good. Mind you, if this is the musical rut Budd and Eno are stuck in, they can stay there as long as they like as far as I'm concerned.

Definitely the New Age Music album of the year.

## Neuronium

### *Heritage*

Jive Electro HIP 19

An album of unexpected power from Michel Huygen and Santi Pico, Spain's most celebrated electronic music composers and Jive Electro's most prestigious signing after TD. 'Unexpectedly' because the sleeve artwork of *Heritage* would seem to indicate an unhealthy preoccupation with early seventies heroic imagery and pretentiousness, though fortunately the music is both original and forward-looking.

Huygen's strength would seem to lie as an arranger rather than a composer, since there's little in the way of inspiring melody on *Heritage* and not an original musical structure on the record. However, he makes the best of some fairly ordinary (by the standards of today's technology) synth sounds by placing each one in exactly the right musical context, something very few of today's EM artists seem capable of.

Ablly assisted by Pico, who's very convincing both as a sensitive classical guitarist and as HM hero, Huygen crafts some splendid music from what are clearly quite humble resources. The closing 'Lethal Dose' (no, I don't know why it's called that, either) is particularly moving, despite an unpromising beginning and a truly awful drum machine

sound. Still, if the idea's good, who cares about the execution?

A Huygen solo effort, *Capturing Holograms*, with upbeat tempos and vocals, is also being released by Jive Electro this month. I found it a little immature and rather less satisfying, but it might be what you're after.

## 400 Blows

### *If I Kissed Her . . .*

Illuminated JAMS 42

400 Blows first came to my attention about a year ago with 'Return of the Dog', a giant of a twelve-inch single consisting of deep, impassioned vocals and keyboard touches laid over a solid-as-a-rock rhythm section. Sadly, 'Return . . .' isn't on the band's first album, *If I Kissed Her I'd Have to Kill Her First*, but there's plenty more on offer to catch the ear, not least of which are stunning re-mixes of the Blows' two subsequent singles, 'Groove Jumping' and 'Declaration of Intent'.

Like any band for whom musical experimentation is a way of life rather than an interesting sideline to be explored as and when circumstances allow, 400 Blows let their output drift just the wrong side of accessibility now and again (as on the uncompromising 'Love', for instance), but when the same trio of musicians come up with something as spell-bindingly beautiful as 'Men of the Divine Wind (The Kamikaze)' or as stunning in its impact as 'Conscience', such meanderings are more than excusable – they're essential.

The Blows' ambitious deployment of studio effects and original use of taped dialogue extends their sonic vocabulary further still, and my only worry is that the lack of a commercially-acceptable side to the band's music will stifle a major talent while it's still in its formative period.

But don't let that put you off. Go out to your local record dealer and insist on hearing a copy of this album.

## Fontana Mix

### *The Noise Spiral*



### Compact Organisation COMP 5

Yet more obscurity. What has happened to the major labels just lately? Oh well, if it's on

vinyl and it's got a hole in it, I'll review it . . .

Fontana Mix are a synth-ish two-piece that claim to have no musical influences other than the likes of Stockhausen, John Cage *et al*. On the evidence of this, their first album, I'd doubt that very much, though they've certainly got an original sound: simple drum patterns overlaid with minimal bass guitar and keyboard lines and thoughtfully delivered – if rather dry – vocals.

FM have got no shortage of what is fast-becoming a forgotten commodity – the memorable tune. How about 'From A Speeding Car', 'The Double' and 'Opal O' for starters? The duo also do a nice line in tongue-in-cheek lyrics, which is to their credit.

The only real problem area I can find is that of production, which is decidedly low-key throughout. If you've got some good music and the words to go with it, what's the use of hiding it all under a wrapping so non-descript and lacklustre?

Perhaps I'll never know the answer to that one, but I'll keep an eye out for what Fontana Mix might do in the future, as should you.

## Singles

First off this month are the evergreen threesome of Franke, Froese and Schmoelling, aka **Tangerine Dream**. 'Warsaw in the Sun' (Jive Electro JIVE 74) is the Tangs' first single in goodness knows how long, and was recorded live at the band's concert in the Polish capital on December 10 last year, though you'd never guess it from the quality of sound – it's unfaulable! The track itself is a pleasant, uptempo synth pop that could well elevate the band to the 'household name' status already enjoyed by the likes of Jarre and Vangelis, while at the same time not offending stalwart TD fans too much. It isn't that commercial.

Those other German die-hards **Kraftwerk** haven't actually released anything new for well over a year now, but a re-mix of 1983's excellent 'Tour de France' as featured in the film *Breakdance*, is now available on EMI (12 EMI 5413). Man at the faders is Francois Kevorkian, who's performed similar mixing miracles with Thomas Dolby and the Eurythmics, to name but two. His effect on Kraftwerk's cycling tribute is more subtle than might have been expected, so if you can take the isolated heavy breathing at the start, the new version should be a worthwhile investment.

Back to Britain now, where two of the nation's best young duos, **Tears for Fears** and **Naked Eyes**, are on particularly fine form. The Fears' effort, 'Mother's Talk' (Mercury IDEA 7) has an incredible twelve-inch variant containing the most gut-wrenching drum sound since Genesis' 'Mama', and even I've got to admit that the song's crashing rhythm guitar line is instantly memorable. Naked Eyes, meanwhile, have come up with a real stunner in the shape of 'What (In The Name Of Love)' (Parlophone R6078), a splendidly-constructed pop ditty that should put them firmly on the road to success in their homeland. Who produced it? Well, well, if it isn't that old New York wizard Arthur Baker, the man who did for the Roland TR808 what Winston Churchill did for cigars . . .



# Studio 3D

With the possibilities afforded by multitrack sequencing becoming greater by the moment, we highlight three recording studios that take the emphasis away from complex recording equipment and place it instead on music and computer hardware. *Dan Goldstein and Paul White*



General view of East London Community Studios.

There was a time – not all that long ago – when only the likes of residential 24-track recording establishments provided a decent range of electronic musical instruments as part of their service to customers, and the ill-equipped synthesist wanting to get his/her music on tape was forced either to pay those studios' formidable hourly rates (even though only a third of the tracks available would be likely to see any use) or to spend a small fortune on hiring instruments into four- or eight-track facilities.

However, the recent trend towards multitrack recording of instrument parts – brought on by the advent of MIDI and its related computer interfaces – has led many musicians away from magnetic tape storage towards solid state memory for their compositions. As a result, there seem to be a growing number of studios offering more in the way of musical hardware than recording gear, and their popularity among synth players is increasing daily.

## ELCS

A small flat above an off-licence round the corner from West Ham United's football ground may not sound a very likely location for one of London's busiest synthesiser recording venues, but then again, East London Community Studios is not exactly a common or garden set-up. For one thing, their range of music

hardware gives potential for more tracks of real time recording than the mind can comfortably conceive, and for another, use of the studio's facilities is absolutely free, without charge, and for nothing.

There is a catch, of course. Your musical output must come up to the high standards set by the studio's owners, but if you're lucky enough to be selected for some studio time, ELCS offers a veritable treasure trove of synth equipment both old and new.

The studio is run full-time by Tony Chapman, who started the venture in order to provide a facility where mus-

icians could come in and work at their leisure, without the constraints imposed by having to pay for the services of a commercial studio and the continuous clock-watching that implies. His enthusiasm is for just about any sort of music so long as it's composed and performed in an original way, and it was the lack of such music being commercially-available that first put the idea of ELCS into his head.

The recording side of the studio's hardware revolves around a TEAC A3440 four-track recorder (for which Tony has boundless praise) and an RSD 16-into-4 desk (ditto), and for the present there are no plans to take the number of tracks any further, simply because the music equipment offers so much in the way of storage capability.

Star of the music hardware line-up is a full Sequential Circuits 'Traks Music System', complete with SixTrak polysynth, Drumtraks percussion machine, Commodore 64 home micro, CBM64 interface/sequencer and black and white monitor. Not surprisingly, this system has proved popular with both Tony and the people who use his studio, but that hasn't detracted from the possibilities offered by ECLS' older analogue equipment, which includes a Yamaha CS15 ('a brilliant machine: you can do almost anything with it if you work on it long enough' – TC), a Solina string synth, and the popular Roland combination of SH101 monosynth and MC202 micro-composer. Latest acquisition is a Roland

ELCS' Tony Chapman.





Junio 106, which offers a 'completely different set of sounds to the SixTrak', and just about all bits of gear can be interfaced together by the use of ingenious clocking devices that Chapman has either 'discovered' in music dealers ignorant of what they were really capable of or built from scratch.

At the time of writing, East London Community Studios are entirely self-sufficient, and it's not a state of affairs that's likely to change in the near future, as Tony explains.

'When we first started, we wrote to all the equipment distributors and manufacturers asking them to donate gear, but none of them helped, so we had to go it alone, financing the studio from my accountant partner's income and a little bit of money I managed to earn from repairing bits of audio equipment and building electronics projects for people.'

But given that they offer their facilities entirely free of charge, why didn't ELCS go to a government organisation for funds?

'Well, we did consider it, but the way I see things is that as soon as you accept backing from organisations, you compromise your independence. You lose total control over what you record and what you don't, and that's something we've never wanted to do, even though it would have made things easier.'

Perhaps not surprisingly, ELCS are constantly inundated with demo tapes from musicians and composers hoping to make use of their generous facilities, despite the fact that the studio's major – indeed only – form of promotion is by word of mouth. Tony doesn't deny that most applicants are unsuccessful, but if a particular group of musicians do get to win ELCS' seal of approval, they'll find they don't just get an eight-hour day in which to find out how to use all the studio's facilities, perform a series of pieces, and then record and mix them.

'It's not unusual for us to let someone just stay in here and muck about with the synths before they even start recording. It's almost impossible for anybody to come to a synth for the first time and do brilliant things with it, so it's pointless asking people to. If we're enthusiastic about someone's music, if they're doing something that's fresh and original, we'll give them as much time here as we can.'

That attitude, of course, results in a full diary and a long waiting list of budding composers, but Tony is happy so long as what they're doing is interesting, and so long as their music can stand up to being reproduced outside his studio.

'I can't deny the fact that a recording studio enables a musician to do things that aren't possible live, but the beauty of our enormous sequencing capability is that it allows you to perform the music you've recorded on stage as well, and we've always considered that a very important part of our work – encouraging people to make their music live as well as in the studio.'

So, with only another ten years or so of HP repayments ahead of them before ELCS becomes financially viable, the electronic musicians of East London look to have a bright future ahead of them, with a free studio whose proprietors (if that's the right word) are as committed enthusiasts of new music as you're likely to find.

## Hollow Sun

Moving a good 250 miles westward, we find E&MM contributor Steve Howell (he of *Modular Synthesis* fame) and his Cardiff synth studio, Hollow Sun. Steve is one step ahead of ELCS in that his recording facility is based around eight-track equipment, but then again, Hollow Sun doesn't claim to offer its services free of charge . . .

Steve first got into recording about six years ago in a very basic way, using two Sony domestic reel-to-reel machines to record his own synthesiser compositions and, although this was very limiting, it did provide a valuable grounding in studio techniques. With such a simple system, a lot of thought has to be given to track organisation and life is a constant battle against noise but, judging by Steve's early tapes, he was wringing the last ounce of performance from his equipment, and that resulted in some impressive-sounding demos.



now you don't.

The original intention was for Steve to record only his own work, but a number of people, impressed by the results he was getting, persuaded him to take on work for other musicians, predominantly synth players.

Almost by accident, Steve got into writing TV music after being asked to provide incidental music for a play, and in fact the majority of his work is now for television. I asked him what differences there are in producing incidental music as opposed to pieces of composition in their own right.

'Yes, there are big differences. The approach has to be much more disciplined when you have to fit the music into specific lengths of time, typically 30 seconds or so, and of course what you record has to be sympathetic to the subject matter of the TV programme.'

The list of Hollow Sun's available equipment is an impressive one. MIDI polysynths are well represented by a Yamaha DX9 and Roland JX3P, but as



Hollow Sun studio and its proprietor, Steve Howell – now you see him,

with ELCS, these by no means overshadow older analogue synths, in this case an ARP 2600 modular synth with an Avatar guitar synth as an expander. Drum machines and sequencers include the Roland Drumatix/Bassline combination and CSQ100 monophonic digital sequencer, while an MPC Sync Track has proved an invaluable syncing aid in recent months, and any of the system's

components can be fed through a number of outboard effects such as a Yamaha R1000 reverb, Boss DE200 digital delay, and Ibanez HD1000 harmoniser.

On the recording side, Steve's pride and joy is an eight-track Cadey recorder, a one-off built for one of the directors of the Cadey company. The machine operates with one-inch tape and features valve electronics, while each track has a built-in noise gate that can be switched in and out as required.

'The Cadey does look a bit antiquated', Steve admits. 'But with Branch &



Appleby heads and Papst motors, it's built to last, and its basic sound is good. There are no refinements (not even a tape counter!), but it was either this or a Fostex A8 at the price and I think I made the right choice.'

Ask Steve to name the most important musical instrument in his collection, and he won't hesitate in replying . . .

'Definitely the ARP 2600 modular system – there are so many things you can do on it that simply aren't possible using non-modular synths. That isn't to say that there isn't a place for the polysynth – the DX9 and JX3P are both great synths – but I consider them a supplement to the 2600, rather than vice versa.'

As with any dedicated electronic music studio, it's of paramount importance that the equipment at Hollow Sun should not get in the way of the music and that patching should be as straightforward as possible. To this end, Steve has built two patchbays – one for audio signals and one for CV and trigger connections.

'It was essential really, as trigger connections vary from synth to synth and it's no fun groping around at the back of the equipment trying to trace interface leads – the patchbays make things so much more simple.'

Steve's knowledge of synthesisers and how to record them has extended his studio activities to tuition, though he stresses that this is in the use of equipment rather than playing technique (truth be told, Steve's no mean ivory-tinkler – he just doesn't want to set himself up as an authority on the subject). Hollow Sun as a facility costs musicians £7.50 per hour, but for that you get the studio, use of all the instruments in it, and Steve's expertise: in many cases, he ends up playing as well!

In conclusion, Hollow Sun's geographical location ensures that it's busy for much of the time and is likely to get even busier in the future, while Steve himself is hoping to get more involved in television and film work, though he's already got to the stage where his synthesiser studio has risen in status from being a hobby to becoming his livelihood . . .

## Computer Music Studios

Returning to London, we find another Welshman, Terry Lloyd, at the helm of one of this country's most forward-looking recording facilities, Computer Music Studios.

Originally intended simply as a means of demonstrating the advanced technological equipment Terry sold (he is the official UK importer for such prestigious brand names as Syntauri Corporation and Octave Plateau), CMS' recording equipment (consisting of a Tascam eight-track and RSD 24-into-16 desk) has now become so popular with musicians that the 'shop' part of Computer Music Studios is having to be re-

located in a room adjacent to the studio itself.

'We got the eight-track equipment because it's always easier to demonstrate an instrument if you can show a customer how it'll work in a studio,' Terry explained. 'But things have got a bit out of hand. So many people want to use the gear as a recording studio that we're having to put the shop equipment in another room.'

It's not hard to see why.



Inside Computer Music Studios.

In addition to the alphaSyntauri and O/P Voyetra systems already mentioned, CMS offer two Apple-based sampling systems in the form of the Decillionix DX1 and Greengate DS3 (see review elsewhere in this issue) add-ons, as well as a full range of hardware from the likes of Roland, Yamaha and MXR.

The studio side of the operation also offers a number of elderly and/or secondhand equipment that nonetheless



CMS' Terry Lloyd, carefully lit to disguise black eye.

sees a lot of use, viz a Roland SH2 monosynth and CSQ600 sequencer, and

a recently-acquired Simmons SDS5 electronic drum kit.

'The Simmons has been surprisingly popular,' Terry reflects. 'A lot of people are using it in conjunction with our MXR drum computer, which is interesting.'

The studio's success can be measured by the fact that the radio and TV jingle clients (who form a large part of CMS' custom) just keep coming back for more, and in the fact that the studio was recently the scene of the recording of a

new album of Hawkwind's Bob Calvert, testimony to the quality that can be achieved using only eight recording channels.

Meanwhile, Computer Music Studios have been lucky enough to acquire the agency for some Apple-based MIDI software from LEMI in Italy. Although the first batch of software is yet to arrive in this country, Terry has boundless enthusiasm both for the versatility and user-friendliness of the programs and for the usefulness of the Master Clock, LEMI's version of the Mini Doc, for want of a more accurate expression.

'We got the first one in here a few weeks ago, and it'll sync just about anything. In fact, it's proved so useful, I can't really imagine how we ever coped without it!'

And the future?

Well, in addition to spreading his retail wings and thereby dividing his sales and recording activities more decisively into two parts, Terry Lloyd has now opened his studio to students on the Cass London recording course (the first batch were taking their lunch-break when E&MM arrived at CMS' West London headquarters), as well as to bands not requiring all the computer and electronic instruments – they get charged a nominal £6 per hour as opposed to the standard rate of £8.

Wherever you look, it seems, the small synthesiser studio is doing better than ever. Long may they continue to prosper.



## POWERTRAN APPROVED SERVICE AND KIT ASSEMBLY

Economical work by Professionals.  
Specialists in Commercial Electronic  
Design, Assembly and Test for the  
Hi-Fi and Music Industry.

FOR REPAIRS ETC  
PLEASE CONTACT:  
COLIN MAXTED

**01-646 5686**  
CIRCOLEC

TAMWORTH MANOR  
302-310 COMMONSIDE EAST  
MITCHAM, SURREY  
Telephone: 01-646 5686



**Roland**

Main Dealer

9 THE BROADWAY  
BRIGHTON ROAD  
WORTHING, SUSSEX  
TEL. WOR. 202458

ALL ROLAND PRODUCTS IN STOCK  
JUNO 106 ★ JUPITER 6 ★ JX3P  
NEW GR700 MIDI GUITAR SYNTHESIZER  
JUPITER 8 ★ SH-101  
MSQ700 ★ BOSS PEDALS  
YAMAHA DX7 DX9 PF15 PF10  
ON DEMO NOW

SPECIAL ROLAND MC-202  
MICROCOMPOSERS £399

**£179** CARRIAGE PAID

ACCESS - BARCLAYCARD - INSTANT CREDIT

*Computer Music Studios*

62 BLEINHEIM CRESCENT, LONDON W11 1NZ



WITH DATA  
PROFILE LTD

MAIN DEALER

# COMPUTER MUSIC STUDIOS WOULD LIKE TO CONGRATULATE ROBERT CALVERT ON HIS NEW ALBUM **FREQ** RECORDED AND PRODUCED AT COMPUTER MUSIC STUDIOS

available 22nd September on Flickknife Records

For more information please contact 01-221 0192

COMPUTER MUSIC STUDIOS GIVES YOU  
TOMORROW'S TECHNOLOGY TODAY!

P.S. . . . CMS ARE ALSO YAMAHA AND ROLAND DIGITAL DEALERS  
WITH DX7 AND DX9 AT LOW, LOW PRICES



# TECHNOLOGY

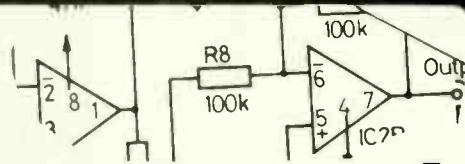

## Powertran MCS1

### Part 1: Playing with Time

This issue sees the start of a series of articles describing the design and construction of the MIDI Controlled Sampler, E&MM's most advanced project ever. To kick things off, we present an in-depth analysis of the effects the MCS1 can generate and how they are used, plus an insight into the workings of digital audio.

MCS1 Design: *Tim Orr, R Monkhouse, and Paul Bird*

Editorial Presentation: *Tim Orr*

Put simply, the MCS1 is a digital sampling unit, though it is in fact capable of a great deal more than that description would suggest. Any sound can be stored within the unit's memory and played back via either a MIDI instrument or a one-volt-per-octave keyboard. The controlling keyboard determines the pitch of the reconstructed signal, thus making it possible for the user to make music from a single natural sound: pitch bend and vibrato effects can also be added as required.

A sophisticated looping system is used to turn sound endings into a sustained loop of infinite duration, and this allows the controlling keyboard to be played without the risk of 'running out' of sound due to lack of memory space. Sampled sounds can be stored on floppy disk for later retrieval.

Recordings can be made in free-running or auto-triggered modes, and on replay the sounds can be gated or triggered. Gated operation produces a sound output - including any loops - for as long as notes on the keyboard are depressed, while triggered operation requires only a start signal.

Sound-sampling is only one aspect of the MCS1's potential, however.

The machine can also be used as a conventional digital delay line. It can be used to generate all the usual time delay effects such as phasing, flanging, vibrato, ADT and echo, and the theory and application of these effects will be discussed later. The available delay times range from a few milliseconds to tens of seconds, and other features include bypass, repeat, and infinite freeze functions. Memory size and sample speed are both continuously variable, while a pair of tracking filters takes care of anti-aliasing and recovery filter considerations, a software power clear ensures a quiet power-up, and a click-track is provided to aid timing during long sequences.

The MCS1 front panel incorporates 24 illuminated push-switches and a continuous rotary encoder to modify parameters, a four-digit 0.6" LED display indicating parameter information. Controls for level, repeat, mix and tune are also provided, along with a level indicator.

MCS1 memory size is variable from eight bytes to 64Kbytes: storage time at a 32kHz sampling rate is two seconds, while at 8kHz, the time is eight seconds, the longest possible replay time (for special effects) being 32 seconds. Eight-bit companding analogue-to-digital and digital-to-analogue converters are

employed in the sampler's design, and the unit has an overall dynamic range of 72dB, audio bandwidth being variable from 12kHz to 300Hz. There are internal four-pole tracking filters for anti-aliasing and recovery, and a programmable wide-range sweep generator, generated in software.

Control range using a MIDI keyboard is five octaves, and using a one-volt-per-octave instrument, two octaves, though transposition can be employed in the latter case to provide a range of a further five octaves.

### Effects

Before going on to how the MCS1 itself works and how it can be built, it's worth



unit such as the MCS1, the notch spacing being equal to the reciprocal of the delay time. Figure 3 shows how notch spacing expands and contracts with varying time delays, but what it doesn't show is that subjectively, phasing is quite a subtle effect, adding depth to the output of an electric guitar, for example.

**Flanging** was first heard on records in the late sixties and was initially generated by extending recording tape around the 'flange' of the play head (using something like a pencil), thereby producing a varying time delay which was then mixed with the undelayed

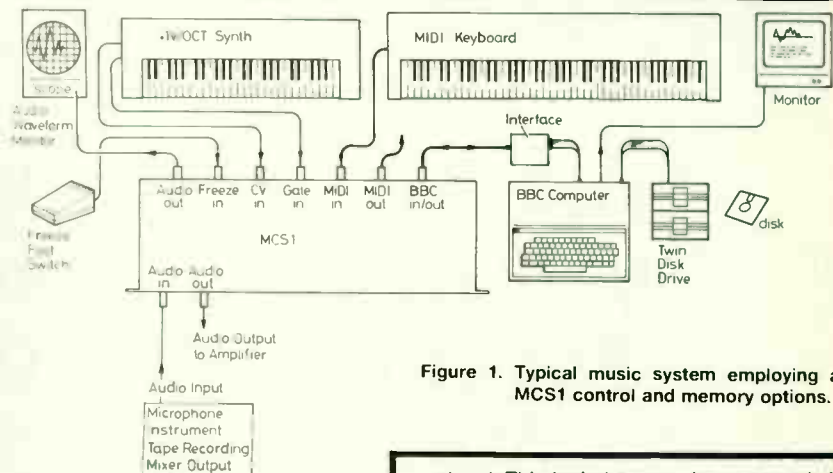

Figure 1. Typical music system employing all MCS1 control and memory options.

devoting some time to how the various time delay effects it produces work out in theory. Figure 2 shows how these effects vary in their delay time.

Many of the effects commonly heard on today's modern music records are generated by manipulating natural sounds through a time delay unit. When a time delay is short, its effects are observed as frequency coloration, but longer delays move the effect out of the frequency domain and into the time domain. What follows is a guide to how these effects work.

Most **phasing** devices use an analogue all-pass phase-shift circuit to generate a mobile comb filter, the number of notches commonly being between two and six. The same mobile comb filter can be simulated with a time delay

signal. This technique produces a comb filter with lots of notches, which move in the frequency domain as the time delay is altered.

This effect - illustrated in Figure 4 - can be simulated relatively easily with a delay line, and by adding feedback, the filter response can be made excessively peaky, which gives modern-day flanging its characteristic tubular or 'drain-pipe' sound coloration.

By varying the time delay with a sinewave modulator, a natural sound becomes frequency modulated, and modulation frequencies between 3Hz and 8Hz produce a standard **vibrato** effect: see Figure 5. Increasing the modulation depth causes something of an extreme effect, as does increasing the modulation frequency.

Short time delays in the order of 5-50mS can be used to simulate the addition of another instrument to the one being fed into the delay





line. This effect comes off because when several instruments are being played together, perfect timing between their players is something of a rarity, to put it mildly. Since sound travels at about one-foot-per-millisecond, two instruments separated by a distance of ten feet may well be out of time by 10mS, though that delay is unlikely to be constant.

These effects are known in modern technological parlance as **ADT** (auto double tracking) and **chorus**, and delay lines can simulate this natural phenomenon quite easily – see Figure 6.

Natural **reverberation**, on the other hand, is a very complex phenomenon (Figure 7). Thousands of separate time delays and reflections conspire to achieve the final sound, but it is still possible to simulate their effects, even though the hardware required to do this is also complex. However, a simple reverberator can

The effects described above can be applied to all common input signals and are available on a large number of digital delay lines from various manufacturers. However, the MCS1 adds a further dimension to effect manipulation by allowing the pitch of the unit's output to be controlled by an electronic keyboard.

The stored sound is transposed up or down in pitch by varying the replay rate, though the lower the replay pitch, the longer it takes for the sound to be reproduced. When a key is pressed on the controlling keyboard, reading starts from the beginning of memory and continues until either the key is released or the memory is exhausted, whichever is sooner. However, the MCS1 incorporates a looping facility that enables a continuous loop to be constructed at the end of a sound, giving it sustain for as long as a note on the keyboard is depressed. This method is widely employed

by designers of electronic percussion units whose budget does not allow them to use ten EPROMs to store the sound of a cymbal! Figure 8 gives a graphic illustration of the looping process.

## Digital Audio

In order for any audio signal to be stored in digital memory or held on a magnetic storage medium (eg. a floppy disk), it must first be converted into binary code. Once the signal has been digitally encoded, it can be stored and manipulated without any of the risks associated with analogue storage methods: noise does not accumulate, and the distortion level remains constant when the audio data is transferred from one unit to another.

A typical digital audio system is shown in Figure 9, where the sample and hold unit is used to freeze the input signal so that the ADC can perform a conversion on a static signal. The low-pass filter removes out-of-band frequency components after both stages of conversion have taken place. The audio signal is converted into a stream of digital information by the ADC (analogue-to-digital converter) and is then re-converted into an audio signal by the DAC (digital-to-analogue converter, simple isn't it?)

How do these converters work?

Well, think of the ADC as a sort of rapid digital voltmeter that measures the magnitude of the input voltage at regular time intervals. Each time it completes a measurement (the process is known as 'performing a conversion') it outputs a binary word representing the magnitude of the input voltage at that point in time. If the binary word is eight bits wide, the converter is capable of resolving the input voltage into 256 (2 to the power of 8) individual levels. The resolution of an ADC is proportional to the size of the binary word it produces, so that, for example, a 12-bit system has a resolution of one part in 4096 and a 16-bit system has a resolution of one part in 65,536.

The DAC is then used to convert the binary words back into an analogue voltage, and because the voltage is directly proportional to the magnitude of the binary code, the bit size of the DAC determines the number of separate voltage levels. However, the DAC's output is only a 'square wave' approximation to the original analogue input (which can move up and down smoothly) and this effect is known as quantisation – the digital equivalent of distortion, shown in Figure 10. Its effect can be reduced by increasing the bit size of the system as a whole, but as is the way of things, this invariably increases the system cost.

When we digitise an audio signal, we sample it at regular intervals of time, and in doing this, we define the time-varying shape of the signal as a series of points. By joining up these points (this is accomplished by the DAC) we can reconstruct the original signal. But how often should the signal be sampled, and does the sampling rate affect the system bandwidth? The answers to these questions lie in sampling theory. This states that a sinusoid defined by only two samples is recoverable, which in turn implies that the system bandwidth can be as much as half the sample frequency. In practice, however, the bandwidth is usually limited to about one-third of the sample frequency, due to filter limitations.

If a signal is sampled at a frequency of less

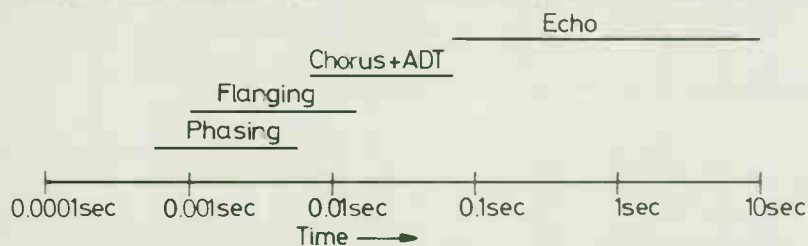

Figure 2. Some popular time delay effects.

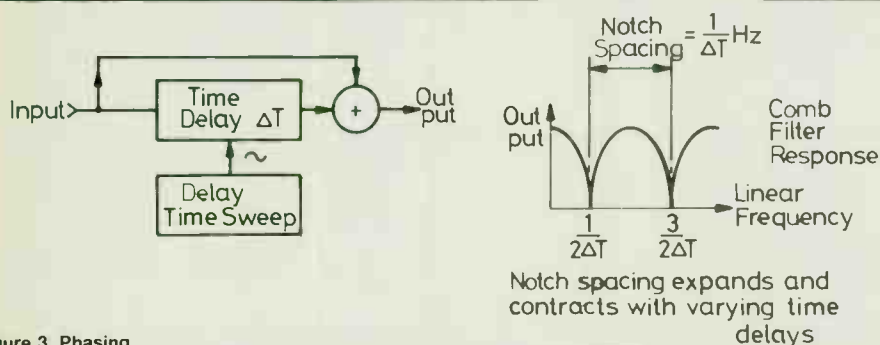

Figure 3. Phasing.

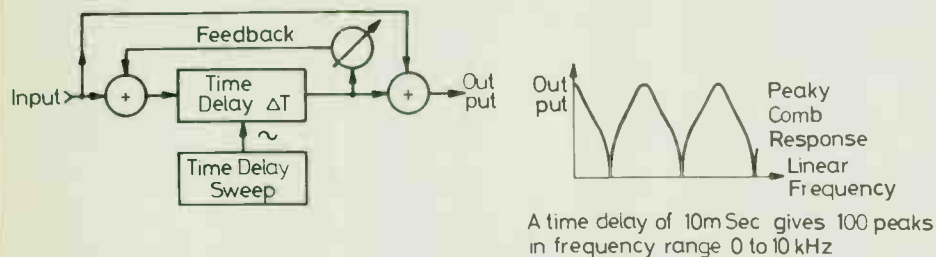

Figure 4. Flanging.

be constructed using a single time delay: using this method, the reverb is highly coloured and is often used on human speech to simulate a metallic or robotic quality.

Time delays greater than 50mS can be heard as distinct echoes. A short single echo is often used in modern music to provide a sharp 'slapback' sound, while longer echo times can be used with a little repeat to simulate Alpine echoes, for example.

More recently, time delays of the order of a few seconds have been widely used to build up sequences of rhythm tracks. To achieve this effect, the delay line's repeat control is kept fully on so that the inputted sound takes several trips around the loop before it disappears. On the MCS1, a click-track gives the user an audible indication of the loop's length, while a freeze function inhibits further writing to the memory so that the stored sound(s) can repeat indefinitely without any degradation in signal quality. The replay rate can then be altered to create dramatic pitch-shifting effects.

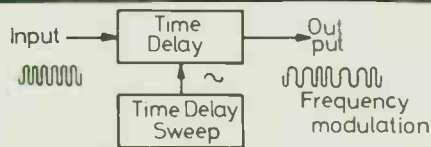

Figure 5. Vibrato.

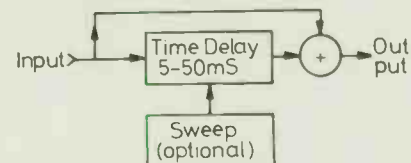

Figure 6. ADT and Chorus.

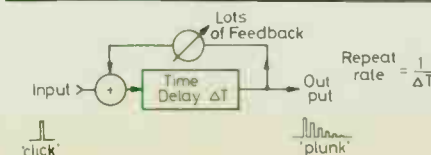

Figure 7. Reverb.



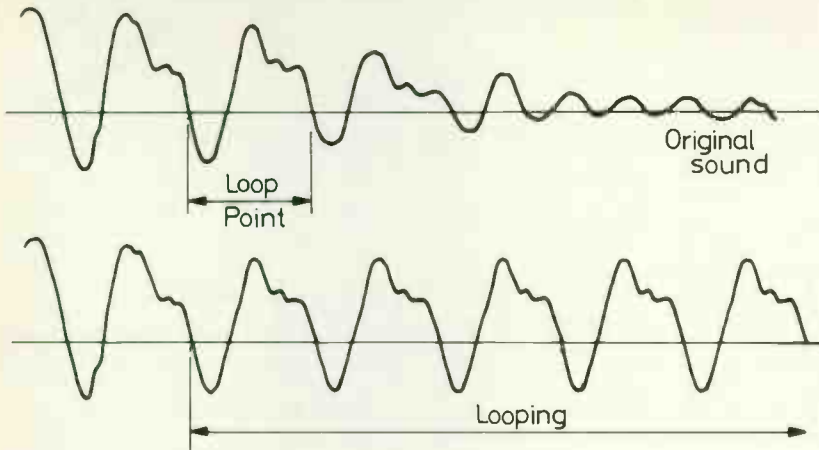

Figure 8. Sustaining a sound by turning a single cycle into a loop.

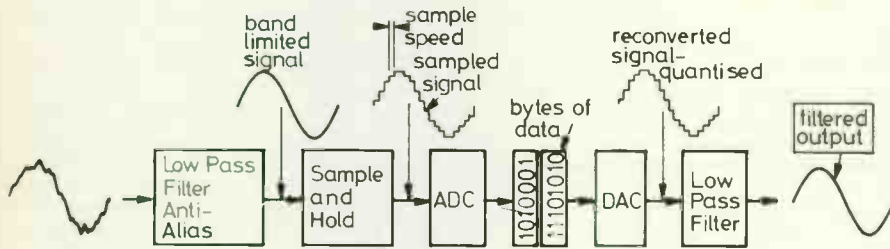

Figure 9. Digital Audio.

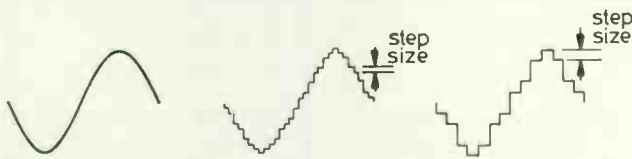

Figure 10. Quantisation distortion.

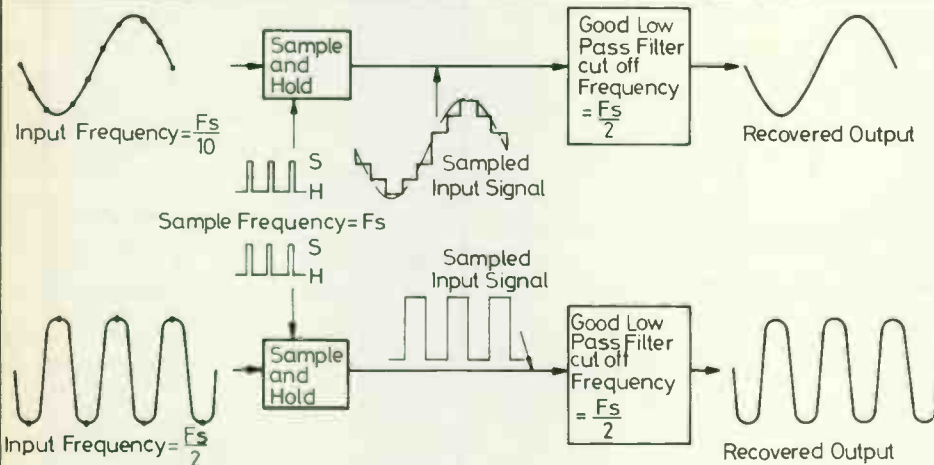

Figure 11. Recovering a sampled signal with a low-pass filter.

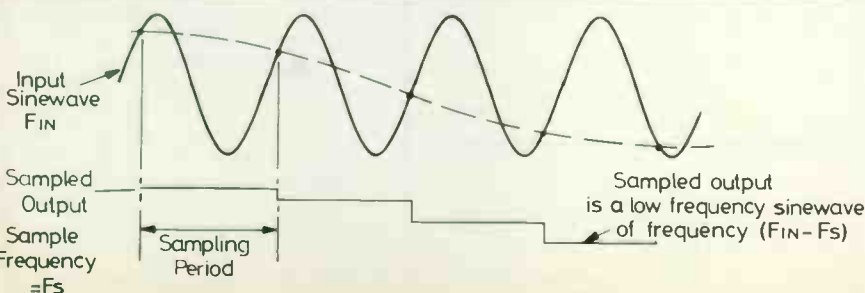

Figure 12. The sampling process generating a difference frequency.

than twice the signal bandwidth, there's a chance of frequency domain distortion – or 'aliasing' – taking place. Consider the sinewave being sampled at a frequency less than its own, as in Figure 12. The sampling process is meant to result in the original signal being recovered, but what is generated instead is a difference frequency. The resultant sound is something akin to ring modulation or detuned SSB reception, ie. very disturbing when applied to complex signals such as music or speech.

However, aliasing can be prevented by bandlimiting the input signal to one-half of the sample frequency using a good low-pass filter, which merely removes the signals that would cause aliasing products.

There's always a temptation to slow down the conversion frequency so that long time delays can be obtained from a fixed memory size, so it has become a practical necessity to incorporate a tracking low-pass filter in the design of some delay line products. The low-pass filter that precedes the ADC is known as the anti-aliasing filter.

In the first graph in Figure 13, the shaped area represents the power density spectrum of a typical audio signal, while the second drawing shows the same spectrum sampled at a frequency of  $F_s$ . Note that the lower sideband has an inverted spectrum and that the sideband pairs repeat at integer multiples of  $F_s$ . In the third diagram, the sample frequency has been reduced to  $2 \times F_A$ , and the lower sideband is close to the audio base band: as a result, the system is on the verge of generating aliasing components. Finally, the fourth graph shows what happens when the sample frequency is reduced below  $2 \times F_A$ . The low-pass filter is now allowing frequency components which generate aliasing signals to pass through, and aliasing begins.

## Quantisation Noise

This phenomenon is caused by the inability of digital components to reproduce an arbitrary analogue signal accurately: a smooth analogue signal is presented to the ADC at the start of the process, but a crunchy output signal is reproduced by the DAC at the end of it. We can use distortion measuring techniques, normally used to measure THD (total harmonic distortion) in linear amplifiers, to examine quantisation noise. Figure 14 demonstrates the effect of quantisation.

Generally speaking, quantisation distortion has the spectral properties of noise. Because there is no simple integer relationship between the input signal and the sample frequency, the quantisation distortion bears no simple relationship to the input signal and therefore sounds noise-like.

Now, if a 1kHz sinewave were sampled 20 times faster at 20kHz, the resulting output would contain no quantisation noise as such, because the quantisation distortion would always be in the same place on each cycle of the sinewave and would therefore be heard as harmonic distortion.

A linear converter has quantisation levels at fixed, linearly-spaced intervals, and the best signal-to-quantisation noise ratio for a linear converter is given by the formula  $S/QN = (N \times 6)dB$ , where  $N$  is the bit size of the converter. Thus, an eight-bit converter has quantisation noise 48dB below the maximum signal level. When the maximum signal level is only a quarter of the maximum, the ratio is poorer by 12dB, falling to 36dB, and if the input signal is so small that only the LSB (least significant bit) of the code is changing, then the S-to-QN ratio is only 6dB! However, when the input signal is so small that no bits are changing at all, then



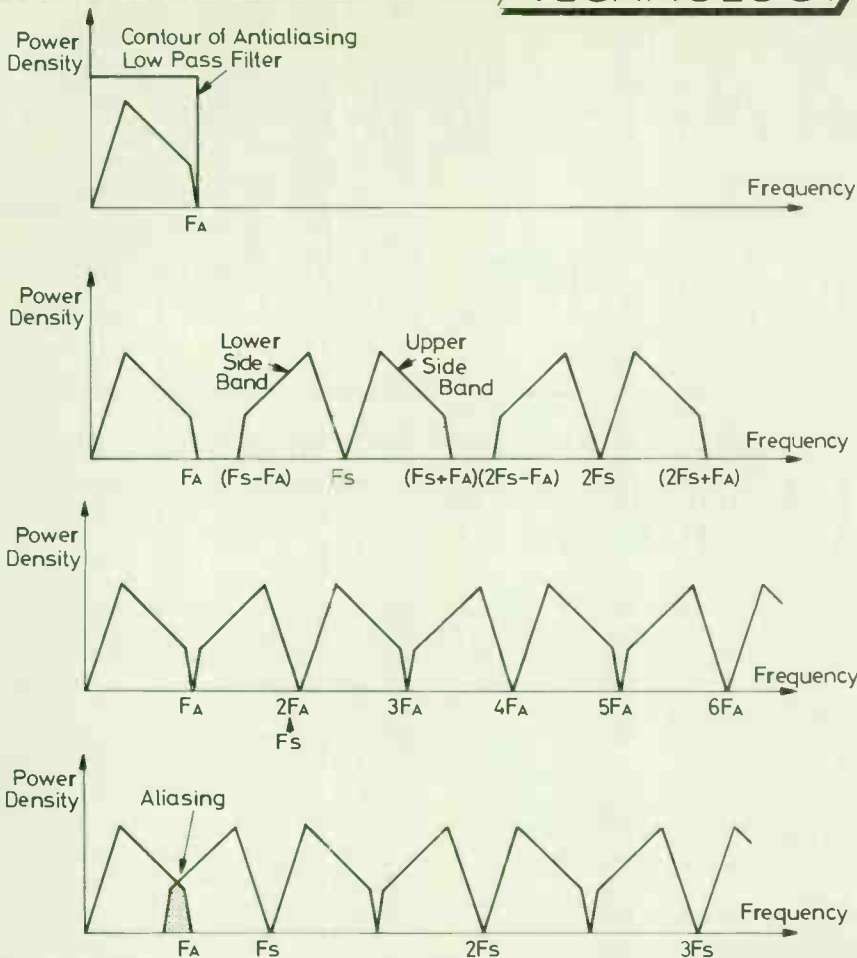

Figure 13. Aliasing.

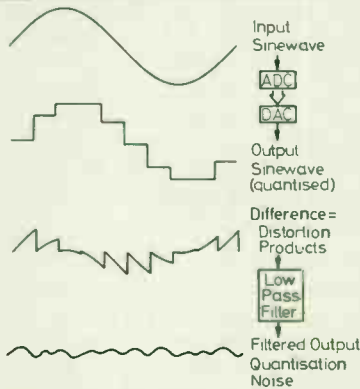

Figure 14. Quantisation noise.

no quantisation noise is generated, thus proving that the process is a distortion mechanism rather than a noise one.

Dynamic range is the ratio of the biggest signal level divided by the smallest the converters can handle. For linear converters, the dynamic range is represented by the S-to-QN ratio, or 48dB for an eight-bit system. If the quantisation levels are logarithmically spaced, ie. with small step sizes for low signal levels and large step sizes for higher ones, a somewhat larger dynamic range can be obtained. This is illustrated in Figure 15.

The DAC88 used in the MCS1 has a dynamic range of 72dB, and the log law is used to compress the signal at the ADC and expand it again at the DAC. For obvious reasons, this

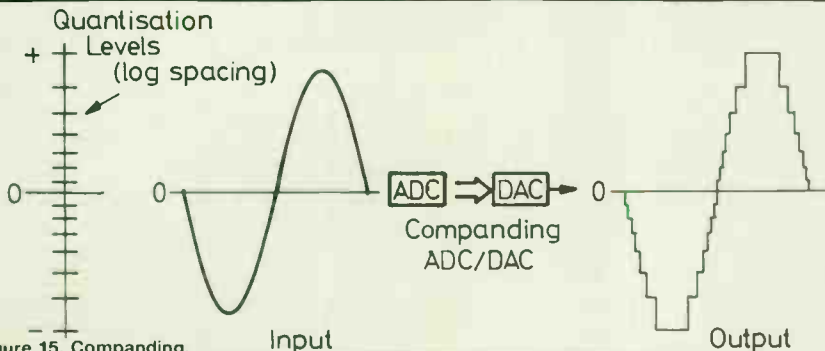

Figure 15. Companding.

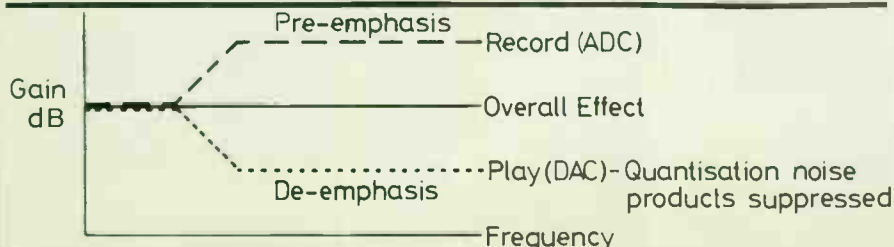

Figure 16. Pre-emphasis noise reduction.

form of converter is known as a companding device, and is well suited to handling natural sounds such as speech and music, which require a large dynamic range if they are to be reproduced with any realism. However, it should be remembered that whenever an improvement is made to the dynamic range, quantisation distortion is invariably made worse.

Some of the effects of the degradation caused by quantisation distortion can however be masked by using a frequency pre-emphasis before the ADC and an equal (but opposite) de-emphasis after the DAC. This principle is shown in Figure 16.

How does it work? Well, because the spectral energy of sound rolls off with increasing frequency, it's possible to add high-frequency lift without running into any clipping problems, though if the sounds being processed are a little on the bright side, the system has to be run at a lower operating level.

That about wraps up the theory side of digital audio and the effects that can be generated by digital delay lines: I hope what we've discussed has cleared up a few grey areas that might have existed in some people's minds, as well as providing some 'food for thought' for budding designers and constructors. Next month, we'll take a closer look at the MCS1's circuit operation.

Pricing and availability details of the MCS1 will be announced in a forthcoming issue of E&MM, but in the meantime, you can get further information from the suppliers, Powertran Cybernetics, at Portway Industrial Estate, Andover, Hants, SP10 3EM.

# Learn Synth with T. Lavitz



**T. LAVITZ**, keyboard whiz with the Dregs, with no less than four Grammy nominations for his instrumental work, has now created a six-tape series for Hot Licks that is the most comprehensive synthesizer course available today.

## THE SYNTHESIZER WORKSHOP

Over the course of six hour-long cassettes, you'll work on:  
 ● Clavinet, organ, string and brass sounds.  
 ● Using delay and reverb for lead patches.  
 ● Lead sounds, single-note and chordal.

● Getting realistic string sounds. Application of pitch bending.  
 ● Improvising. Scales and modes using pitch bends. Pentatonics. Minor and dominant blues. Tips on using synth on live gigs and in the studio.  
 ● Arranging. Programming drum machines. Dozens of examples covering Rock, Jazz and Country styles.

Truly a must for every synth player!

Also available for keyboard players.

## ROCK PIANO (6 tapes) by John Jarvis

**JOHN JARVIS**, Rock 'n Roll piano giant, with credits that include Rod Stewart, Leo Sayer and Diono Ross, has recorded a Rock Piano series for HotLicks that will have you playing hot right from the first tape!

Each HotLicks cassette lesson is available individually at **£7.95** from good music stores.

**Yes! I want to learn those Hot Licks.**

Please send me full details and the name of my nearest stockist.

Name .....

Address .....

labtek international Middlewich Road, Northwich, Cheshire CW9 7DX  
 Tel. (0606) 48684

EMM10

on **HOT LICKS** Instruction Tapes



# E&MM Analogue Electronic Drum System

A step-by-step guide to constructing a complete electronic drum kit out of E&MM's Synclap, Synbal and Syntom II analogue percussion modules.

*Marek Bokowietz*

I started construction of this project in September 1983, mainly because I wanted some form of convenient practice kit. An electronic kit (together with a pair of suitable headphones) seemed to be the ideal way of going about things without unduly upsetting any of the neighbours! It's also one of the most satisfying ways of learning to play drums, since it's easy to mix the output of the kit with that of a cassette player, enabling the budding percussionist to play along with as many recorded examples of great drumming as time will allow.

10" flower pot saucers were used for the drum pads. This may sound like an unlikely choice, but in practice they work very well and have the added advantage of being very cheap – about 50p each from any garden centre. A circular piece of 18 gauge aluminium was cut and mounted into the bottom of each saucer in order to provide some additional rigidity, and a piece of 1" foam rubber was inlaid on top of each of these to isolate each pad from the rest of the kit.

The pickup device is mounted on a piece of veroboard inlaid into the foam. A small piezoelectric sounder (normally used as an audible warning device) was used for the pickup itself: using this 'the wrong way round' gave the best sensitivity. A few strips of gaffa tape can be stuck over the pickup and foam to reduce the sensitivity slightly and to make sure everything is held firmly in place.

The housing for the seven modules was constructed from a piece of 3/8" laminated chipboard (Contiplas), glued and pinned together and then covered with black Rexene leathercloth. The front panels were cut from a piece of 16 gauge aluminium sheet. This aluminium was also used to make small right-angled brackets which hold the PCBs at right-angles to the panels.

## Controls

These are miniature plastic knob presets that were soldered directly onto

a small PCB, etched to suit the control spacing. This board is mounted on the rear of the front panel, held off from the panel with quarter-inch brass spacers. Connections from the control PCB and main PCB are *via* short flying leads.

Using Letraset lettering on a clear acrylic sheet as a master, a panel print label system was employed to give the desired professional finish to the front panels.

The pickup outputs are connected to standard quarter-inch jack sockets mounted at the side of each saucer.



For the actual playing surface, I was lucky enough to find a local DIY shop that was selling large sheets of polycarbonate for only £2.50 each, more than enough for a seven-piece kit. The polycarbonate was then cut to size using a bandsaw, the pieces then being laid to rest on a small lip that runs around the saucer's perimeter edge, approximately a quarter-inch below the rim. Some ordinary draught-proofing strip, cut to length and stuck around the circumference of the saucer, holds the surface firmly in position.

The pads can now be bolted through some old aluminium shower rail (or something similar), which is in turn bolted through the stands.

## Stands

The stands themselves were made up from secondhand music stands: even new, these represent a considerable saving over standard cymbal stands. For

the bass drum mounting I hunted round a scrapyards and came up with a metal base and a one-inch wide bar. A frame was cut to size and the entire assembly was then welded together by a local garage. The 'bass drum' saucer is bolted straight through a one-inch bar, again using a piece of cut aluminium as the saucer base.

The finished panel/PCB modules were then screwed directly to a rebate in the housing, the power and bus connections being made with flexible wire.

The rear panel was cut from the 18 gauge aluminium and contains seven quarter-inch jack inputs, seven phono sockets, four quarter-inch jack foot-switch inputs, and two further jacks are provided for stereo output and a hi-hat open/close switch respectively. The phono sockets are used as individual module outputs for additional control *via* a mixer.

An under-the-carpet-type security pressure switch was used for the hi-hat open/close selector, and this works surprisingly well, providing a fair measure of feel and requiring only a small tap of the foot to be activated.

## Modifications

Some modifications should be made to all three types of E&MM percussion modules, though none of these is particularly complicated.

First, it's a nice idea to select different frequency ranges for the metallic voicing circuitry of each Synbal module being used. To this end, the values of C8 to 13 should be changed from 10nF to 220pF for the first module, 330pF for the second, and 680pF for the third.

Secondly, it was found necessary to change two of the Synclap's resistor values in order to increase the signal level feeding the stereo bus. The components affected are R36 and R42, which should be changed to 4K7 and 1K respectively.

Lastly, E&MM have proposed a few changes to the circuit design of the



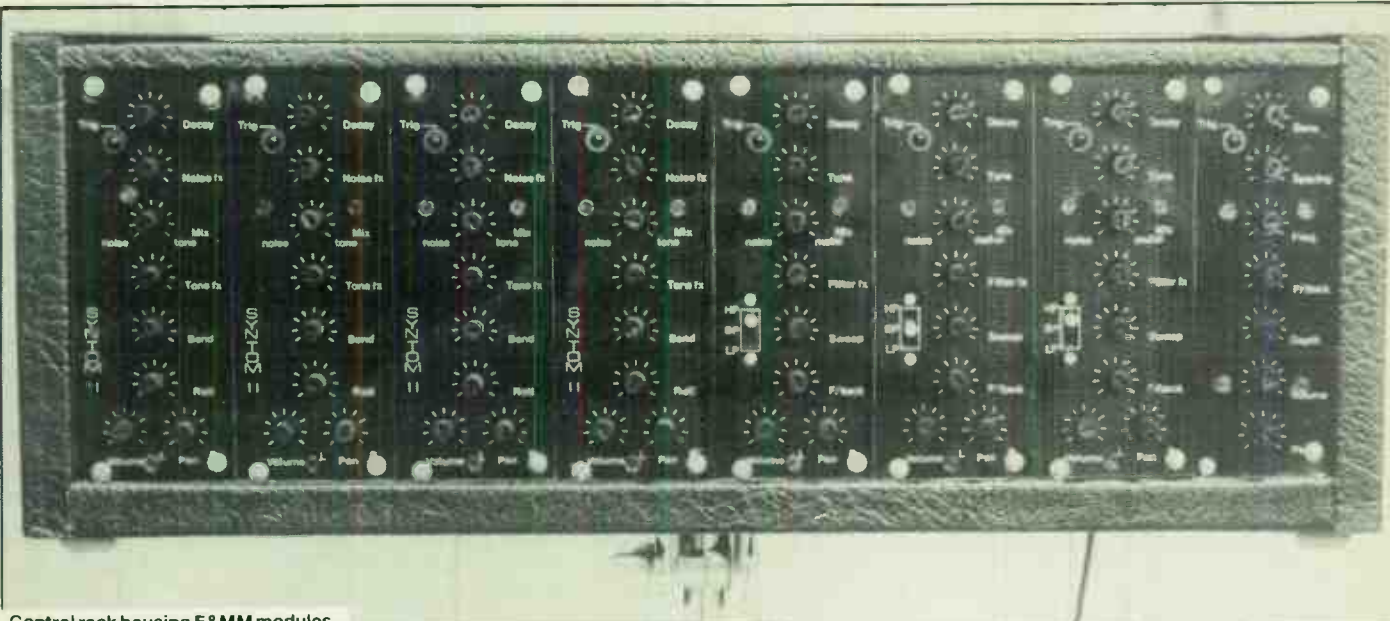

Control rack housing E&M modules.

Syntom II modules, the main one being the addition of a stick click, and these should bring their sound closer to that of competing ready-built analogue electronic kits, and these are detailed in the accompanying (modified) circuit diagram.

prototype kit, but the only components that may cause serious headaches are the piezoelectric sounders and the knob presets. In fact, both of these are standard RS Components products and should be available from your local component retailer. They'll probably cost about £1.50 each and 75p each respectively.

So how does the kit sound?

Well, I've played on a number of commercially available kits, and while the best of these undoubtedly sounds

superior to the set-up described above, at a total cost of about £130 I think the E&M system is hard to beat. ■

PCBs for all the percussion modules used in the drum system are still available from E&M at the editorial address, price £3.25 each including VAT and postage and packing. Please make cheques/POs payable to Music Maker Publications Ltd., and allow 28 days for delivery.

## Summing Up

It's not inconceivable that you may have problems in obtaining exactly the same materials as were used in the

# SYNTOM II

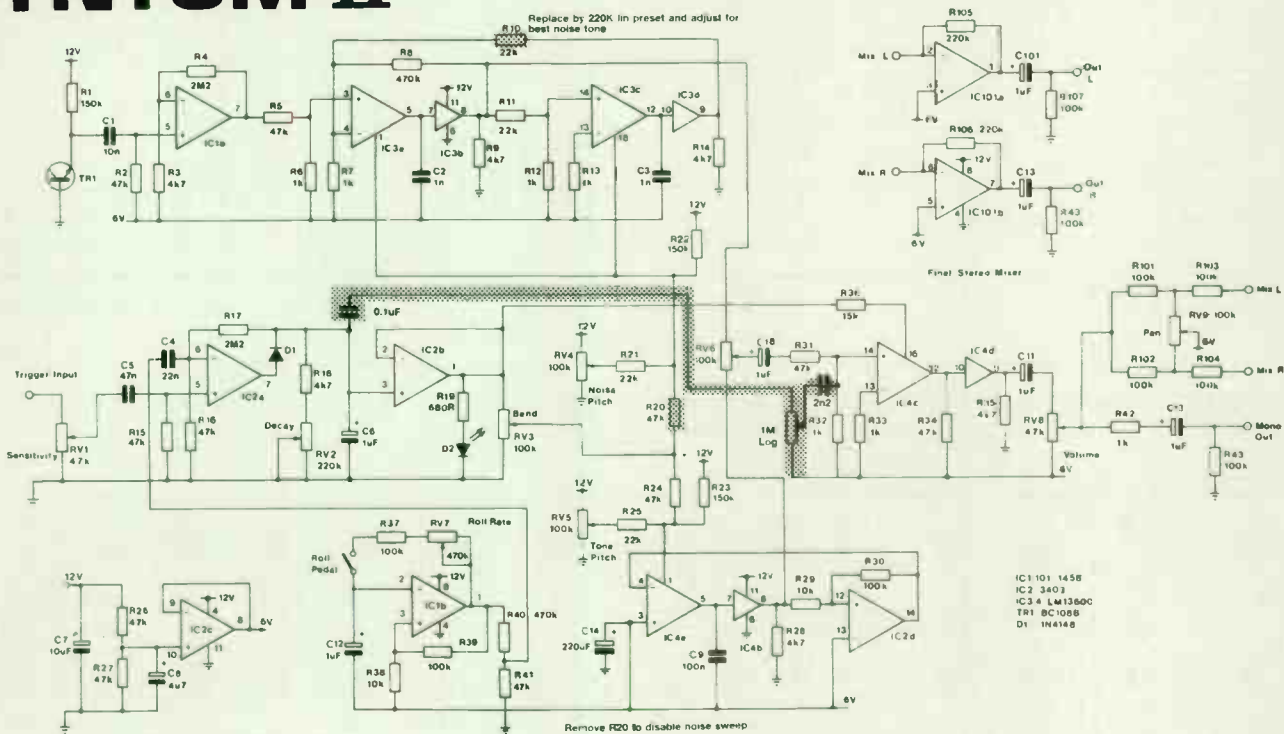

Modified Syntom II circuit diagram.











# Understanding the DX7



The final episode sees some new areas investigated and a few loose ends tied up. The rest is up to you. *Jay Chapman*

It's my opinion that the velocity/touch-sensitivity feature *on its own* justifies the difference in price between the DX7 and the DX9, and is a major contributory factor in putting the DX7 into a class of its own when compared to the other polyphonic synths available in the same price range.

The use of touch-sensitivity as applied to carrier Operators should be obvious, since the effect is exactly that obtained when playing with more or less strength on a piano keyboard. Those synth players who haven't had much experience of piano playing will find a whole new world of musical expression opening up before them – though at the expense of having to learn some new technique. Personally, I'm happier with the action of the DX7 keyboard than with that of a real piano, but if you aren't, there's always the DX1.

The DX7 goes further than this simple amplitude effect, however, since it's also possible to alter the harmonic content of a sound depending on how hard a key is struck. The ability to vary harmonic content *via* touch-sensitivity is an important factor in the synthesis of acoustic instrument sounds. Consider the different tones you get from striking a note on the piano (or picking a guitar string), gently and then heavily – the difference, which may well be quite subtle, is *not* merely one of volume. Consider the 'slap and pull' method of bass guitar playing, which is a more exaggerated example of the same string played in different ways to produce sounds with very different harmonic content. To be fair, the above is an oversimplification – the 'pull' on a bass guitar string gives harmonic movement (both actual and subjective) for various different reasons, including the way the human ear reacts to the fast initial attack and decay. Using touch-sensitivity on both modulating and carrier Operators allows realistic synthesis of such sounds.

A good first voice to investigate for the effect of touch-sensitivity on carrier Operators is ROM 1A Voice 9 'PIANO 2', which uses algorithm 18 (shown in Figure 1a). Since there is only one carrier Operator, we can try the different values (0 to 7) of the Key Velocity Sensitivity (KVS) parameter without any complications caused by other carriers. Go into Edit mode, press the relevant green keypad (it has '28' on it) and select Operator 1 with the purple Operator

Select keypad. You should keep the DX7 volume control high during this exercise so that you can hear the KVS effect clearly.

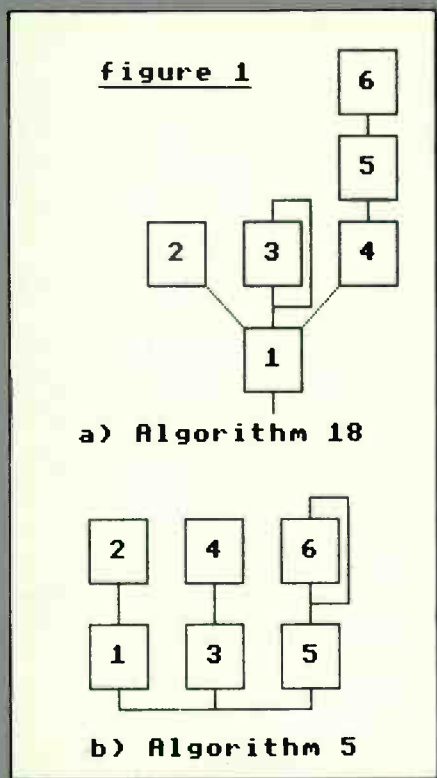

With the parameter value at 0 there is no touch-sensitivity, while with a value of 7, you have to strike the keys inordinately hard to get any sound at all. Most of the time, a value of between 2 and 4 should be used for the carriers, otherwise the effect becomes a little unmanageable. Where a voice uses more than one carrier, the KVS values can be set differently for each, so that striking the keys with different strengths alters the mix of the sounds. In other words, we get different relative amplitude levels of carriers for different key velocities. We'll see this in action in the next example.

The other possibility is to apply touch-sensitivity to the effect of the modulating Operators by effectively varying their output levels (as we've just discussed for the carrier Operators) which alters the harmonic content output by the modulated Operator. This latter Operator need not be a carrier but may also be part of a vertical stack of Operators – experiment with *all* the possibilities.

Typically, KVS is applied to both

modulators and carriers to allow the musician to add plenty of 'feel' to the performance, since both the mix and the harmonic content of the components of the mix can be varied *via* keyboard touch. If you examine ROM 1A Voice 11 'E. PIANO 1', which is a pretty convincing imitation of a Fender Rhodes piano, you'll find both carrier and modulator Operators being affected through KVS. 'E. PIANO 1' uses algorithm 5 (shown in Figure 1b), which provides three sound components *via* the Operator pairs 1/2, 3/4 and 5/6 whose amplitude mix is controlled *via* carrier Operators 1, 3 and 5. Further investigation shows that Operator 1 is responsible for the amplitude of the 'Fender Rhodes Tines' part of the sound, and this Operator has a KVS parameter value of 2, compared to Operator 5 which has a KVS value of zero. So, the harder you strike the keys, the more apparent the 'tines' component will be in the overall mix (relative to the Operator 5/6 component at least – you can clarify this effect by toggling Operator 3 off).

Finally, if you look at Operator 2 you'll see that it has a KVS value of 7, which has a (very) subtle effect on the harmonic content of the Operator 1/2 component. Try varying the KVS from 7 to 0 with Operators 3 and 5 toggled off: you might *think* such a small variation is of little consequence, but you'd be wrong – such subtlety is the secret not only of accurate imitative synthesis but also of giving your own voices character.

## Performance Controllers

This section groups together all the obvious controllers, as well as some that are perhaps not so obvious! They are: the pitch bend wheel, the modulation wheel, after touch, breath, modulation footpedal, volume footpedal, poly/mono, portamento and the data entry slider.

Most of what follows is simply advice based on my own experience – less in the way of explanation is needed since the controllers do not present the same theoretical problems as the principles of FM synthesis.

Four of the controllers are governed by the four identical sets of parameters titled Range, Pitch, Amplitude and EG Bias (green keypads 17 to 32 in Function mode). Pitch and Amplitude simply





# If the strap fits...

The KX-5 Remote Keyboard offers you total performance control without physical restriction.

Via its MIDI port you can access any number of electronic MIDI instruments—synths, drum machines, sequencers— from the front of the stage.

It's as light as a guitar yet incorporates a full set of performance controls plus a velocity and pressure sensitive keyboard to allow full exploitation of the most sophisticated instruments like Yamaha's inimitable DX7. No other over-the-shoulder keyboard can come close.

## The Yamaha KX-5

A genuine step forward for keyboard players

- 32-way programme select
- 3-Octave transpose
- Mono and poly modes
- Touch-strip pitch bend
- Volume/Modulation wheels
- Partamento control
- Sustain
- Breath control facility

£449.00 R.R.P.



# YAMAHA

## MUSICAL INSTRUMENTS

● MOUNT AVENUE, BLETCHLEY, MILTON KEYNES, BUCKS, MK1 1JE  
 ☎ (0908) 640202 24hr Ansaphone (0908) 649222

Please send me further information on the KX-5 Remote Keyboard

Name \_\_\_\_\_

Address \_\_\_\_\_

Yamaha-Kemble Music (UK) Ltd, Mount Avenue, Bletchley, Milton Keynes, Bucks. MK1 1JE.

EMM/10/84



govern whether or not any Low Frequency Oscillator modulation is to be applied to Operator pitch and amplitude – see E&MM August '84 for full details of LFO routing.

The Range and EG Bias parameters warrant a little further comment before moving on, however. The Range parameter, as its name indicates, sets the range over which the relevant controller has effect. At one extreme we have a very wide range (RANGE=99) which you'll find rather difficult to control with any accuracy, whilst at the other end (RANGE=20, say) the maximum effect available is subtler but far more controllable. I often find that the wider range is best kept for special effects while some smaller range is more suitable for general performance.

After Touch can be used to control the timing and amount of vibrato. This is useful when the left hand is playing chords and so cannot get to the modulation wheel: I find it 'feels' better too! By way of experiment, try setting up a suitable voice so that it will respond to pitch modulation (see the LFO Routing mentioned above if you don't know how) and set up After Touch to control the vibrato. Press the brown FUNCTION keypad followed by the green '30' and '+1' keypads to get After Pitch set to On. Now press the green '29' keypad so that you can play with the After Range parameter value via the data entry slider. If you push the slider right up so that RANGE=99 and then try to play, you'll find that the slightest extra pressure and the vibrato sounds like somebody strangling the voice! All right, I *am* exaggerating slightly, but if you try the Range value around 30 I think you'll agree it becomes a lot easier to use. Also, there's less chance of vibrato coming on by accident when you're playing the keyboard with different strengths using touch-sensitive effects.

## Pitch Controller

I mention the pitch controller at this point because exactly the technique we've just discussed for After Touch applies to *any* controller that has a Range parameter. In the case of the pitch controller, this is particularly significant because the human ear is very sensitive to pitch changes, so the need for accuracy is great.

Many of the pitch bends used for *musical* purposes (as opposed to specifically dramatic effects) on a synth can mimic the bends a guitarist uses. Due to the width of the guitar fretboard and the fact that strings won't stretch infinitely, these bends are usually restricted to about one-and-a-half tones, and are more often than not simply one whole tone. On the DX7, we can use the pitch bend wheel, set at the full RANGE=12, to bend up or down a whole octave, which I'd put into the dramatic class of bends! Trying to bend just one tone accurately, especially in the heat of a performance, is an almost impossible

task with Range set to 12, so why not step it down to 2, which gives a whole tone bend?

The data entry slider, and the '-1' and '+1' keypads can be used *during* performance if it makes sense. For example, if you need to bend octaves during the chorus of a song and whole tones during the verse, don't leave the Pitch Wheel Range set to 12 and thereby mess up all the whole-tone bends. Instead, select the voice you're going to use in the normal way and then press the brown Function keypad followed by the green '3' keypad so that the data entry controls can vary the Pitch Bend Range parameter.

When you want octave bends, simply push the slider right up, while for whole-tone bends push the slider right down and then hit the green '+1' keypad twice – that way you don't need to fumble about with the slider trying to see whether or not a '2' has come up on the display!

Another possibility with the data entry slider is perhaps best explained by actually doing it. Select ROM 1A Voice 6 'Strings 3', get into Edit mode, and select the Frequency Coarse parameter on Operator 1. Play chords with your right hand and move the data slider up and down: it's a sort of cross between a stepped filter and somebody singing 'wah' into a vocoder. Good isn't it? No? Oh well, tastes *do* differ!

You can also switch into Edit mode (having selected a voice) and then use your knowledge of how the sound works to let you 'toggle off' some of the Operators to switch part of the sound in and out. Of course, you could simply keep the two different versions of the same sound in adjacent voice slots, but the 32 internal voice memories can soon all get used up in a three hour set. Buy a RAM pack – or alternatively, a micro-computer!

I'll let you experiment with leaving other Function or Edit mode parameters 'open' to be changed by the data sliders – you'll find that some are useful, others less so.

## Breath Control

The Breath Controller, as used for 'blowing' sax, harmonica and brass voices like those found among the Yamaha pre-programmed sounds – their names end with the letters BC – needs a lot of practice before you'll get really good results. It can be well worth editing the supplied voices to make more use of this controller. As an example, try altering the ROM 2A Voice 5 'SAX BC' to give more of a rasping sound when you blow over hard, thereby imitating the same effect on the real instrument. To get you started, try increasing the Output Level of Operator 3 to around 85 and its Amplitude Mod Sensitivity (green keypad '16') from 2 to 3. You'll find that the increase in output level more or less balances the attenuation introduced by the sensitivity change until you blow

fairly hard, at which stage Operator 3's output asserts itself. I picked Operator 3 because it has a feedback loop and was therefore likely to produce the 'harsh' component of the voice. This change is too crude as it is – I would continue editing the voice (perhaps by playing with Operator 2 in a similar fashion) so that the rasping sound is fuller and less buzzy.

Some nice effects are possible by using the Breath Controller (or After Touch if you don't have the BC) to give independent control of part of a voice. The obvious example is ROM 2B Voice 19 'E.P-BRS BC' which sounds like an electric piano until you blow, at which point a brass sound comes in. This is useful for sharp rhythmic brass 'punches' or slow brass crescendos over fading piano chords, for example. With careful use of Keyboard Level Scaling, it should be possible to separate piano and brass and play clean brass fills (ie. without the piano sound 'doubling') over piano chords.

All I want to say about the Poly/Mono and Portamento sections is that you should experiment carefully to make sure you understand the possibilities available. In particular, the use of Portamento with chords controlled by a footswitch can give dramatic results, and different Portamento effects under each of 'Poly' and 'Mono' should all be investigated. The *Voice Library with Performance Notes* sheet that comes with the synth is very useful and gives plenty of guidance in this area, eg. ROM 1B Voice 31 should be played in Mono mode with some fingered portamento to give a fretless bass sound.

## Conclusions

Having read through this series of articles you should have seen by now that the DX7 is not the mysterious and uncontrollable beast that some reviewers (having made no attempt to understand its use) make it out to be. I hope that I've succeeded in liberating a few DX7 (and DX9) owners from the misconception that it will forever remain a 128 voice preset synth in their hands.

This series is necessarily incomplete in the sense that there are many possibilities and combinations of factors that have not been touched upon. The articles were intended merely to set the ball rolling, so to speak, and with luck, the hints and pointers given will have set you off on your own exploration of what is a marvellous musical instrument.

Happy DXing! ■

*Formed only a few months ago, the DX Owner's Club has gone from strength to strength in that time and now has over 300 members within its ranks. Facilities offered include a quarterly newsletter and discount prices on DX-related equipment, in conjunction with Yamaha and several other manufacturers. For further details, write to Tony Wride, DX Owner's Club, 28 Balk Top, RAF Dishforth, Thirsk, North Yorkshire.*



# Carlsbro

## SOUND CENTRES

**Roland**  
WE DESIGN THE FUTURE

### SYNTHESIZERS & PROGRAMMERS

SH101	£339
MGS1	£31
JUN106	£775
JX3P	£945
PG200	£199

### MIDI MODULAR SYSTEM

MKB1000	£1465
MKB800	£870
MKS10	£870
MKS30	£769
MKS80	£1585
MPC80	£345
M16C	£35
M64C	£70
KS1000	£132
KS330	£99
AXIS1	£439

### MIDI UTILITIES

SBX80	£790
MD8	£255
MM4	£47
OP8M	£485

### OTHER UTILITIES

OMU802	£89
CMU810	£163

### SEQUENCERS

JSQ60	£249
MSQ700	£836
MSQ100	£459

### MICROCOMPOSERS

MC202	£199
-------	------

### ECHOES

SRES55	£749
SDE1000	£399
SDE3000	£836

### RHYTHM UNITS

TR606	£255
TB303	£255
TR909	£789
CR5000	£395
CR8000	£469

### GUITAR SYNTHESIZERS

GR700	£1449
G707	£675

## SIMMONS

The fantastic new electronic kits now in stock. Newly improved drum pads with softened playing surfaces for unparalleled dynamic control.

SDS 8	£699
SDS 7	£1999
Cymbal Pad & Module, inc Lead	£211



£1000 INSTANT CREDIT AVAILABLE SUBJECT TO STATUS. COMPREHENSIVE HIRE AND RENTAL SERVICE

## YAMAHA

ALL IN STOCK!  
DON'T TAKE PROMISES!  
HAVE ONE TODAY!  
ALL AT THE BEST PRICES!

KX 5 Remote Keyboard	£449
RX 15 Digital Rhythm Composer	£449



## Oberheim

The fantastic range of Oberheim now in stock in Mansfield and Leicester.

OB 8 Synth	£3961
DMDI Drum Machine	£2649
DX Drum Machine	£1257
DSX Digital Sequencer	£1798

Call in for a professional demonstration NOW!

## SESSION

These remarkable amplifiers are now in stock. INCREDIBLE PRICE All with 2 year warranty.

75 watt 1 x 12 black	£245
75 watt 1 x 12 beige	£255
75 watt 2 x 10 black	£275
75 watt 2 x 10 beige	£285

## SEQUENTIAL CIRCUITS INC

SLI TRAK 100 programs in memory. Six separate polyphonic sounds all variable in volume and program. Also includes 800 note plus sequencer and sound stacking. And of course MIDI for only £795.

PROPHET 600	£1375
6 note poly synth with built-in poly sequencer	£1375
DRUM TRAKS	£825
Digital Drum Machine	£825

## Fostex

X15 Multi-Tracker £299  
inc. Free Power Adaptor worth £28.95  
While stocks last!!

## TRACE ELLIOT

### MK IV BASS AMPLIFICATION

GP 11	£239
PS 1	£38
AH 280	£567
AH 500	£721
RA 500	£475

### GP 11 COMBO AMPLIFIERS

1115	£665
1110	£641

### SPEAKER CABINETS FOR GP 11

AMPS, PRE-AMPS & POWER AMPS	
1048	£305
1518	£324
1524	£621
1084	£598
1824	£607
1024	£265

### GP 7 RANGE

AH 150	£333
1514	£327
7115	£604
7410	£580

### VINYL COVERS

\*All Trace Elliot Amp Heads include a Vinyl Cover at no extra cost\*

All Combo Amplifiers and 1048, 1518, 1024 and 1514 Cabinets	£14
1524, 1084 and 1824 Cabinets	£20

## H I H electronic

### FULL RANGE NOW IN STOCK!

#### MOSFET POWER AMPLIFIERS

V150L 150 Watts	£325
V200 100 Watts per channel	£389
V500 250 Watts per channel	£575
V800 400 Watts per channel	£695
M900 400 Watts per channel	£585

## KORG

POLY 800	£499
PSS 50 SUPER SECTION	£449
KPR 77 Drum Machine	£229
RK 100	£449



## PEAVEY ELECTRONICS

Basic 40	£153
TKO 65	£206
TNT 130	£284
Combo 300	£429

### SINGLE UNIT GUITAR AMPS

Audition	£84
Backstage Plus	£129
Studio Pro 40	£176

### SOLO SERIES

Bandit 65	£229
Special 130	£289
Renown	£345
Session 500	£575

### CITY SERIES

Vegas 400	£383
Nashville 400	£364
Austin 400	£429
Reno 400	£359
LA 400	£364
Rhythm Master 400	£383

### VTX SERIES

Classic VTX	£365
MX VTX	£421
Heritage VTX	£459
212 Heritage	£535

### ALL TUBE GUITAR AMPS

Road Master	£459
Rock Master	£306
Encore 65	£288

### GUITAR/BASS POWER PAKS

Century	£184
Centurion	£268
Mark IV Bass	£383
Max Bass FC	£839
Citation	£306
Musician	£421
MX Flite Case	£459

### KEYBOARD AMPS

KB 100	£229
KB 300	£344
KB 400	£459

### GUITAR/BASS ENCLOSURES

212 SX	£172
212 SX BW	£267
215	£237
215 BW	£337
215C	£344
412S	£286
412F	£306

### P.A. AMPS

MP 4	£175
XR 400	£276
XR 500	£333
XR 600B	£459
XR 600B Case Mount	£499
XR 700	£539
XR 800	£770
XR 1200	£999

ALL ITEMS MAIL ORDER DELIVERY U.K. MAINLAND FREE.

**VISIT OUR CUSTOM DESIGNED MULTITRACK STUDIO SHOWROOMS**  
Our showrooms are fully equipped for demonstrations, from Portastudios to 8 Track including signal processing equipment and studio monitor. Get it right! Get expert advice.

**NORWICH FUTURESTORE NOW OPEN!!!!**

*Musical Futurestores*

**MANSFIELD**  
182-184 Chesterfield Rd North  
Mansfield Notts NG19 7JD  
Tel: (0623) 651633

**NOTTINGHAM**  
11-13 Hockley  
Nottingham NG1 1FH  
Tel: (0602) 581888

**OPENING TIMES:**  
Mon-Fri 9.30am-6.00pm  
Saturday 9.30am-5.30pm  
Nottm & Sheff Closed Thursday  
Norwich Closed Wednesday

**SHEFFIELD**  
720 City Road  
Sheffield S2 1CJ  
Tel: (0742) 640000

**LEICESTER**  
22 Humberstone Road  
Leicester LE5 0AR  
Tel: (0533) 24183

**NORWICH**  
2 Sovereign Way  
Anglia Square  
Norwich NR3 1ER  
Tel: (0603) 666891

### Mail Order Form

Please send the following goods

I enclose a cheque/P.O./or debit my Access, Barclaycard, Diners, Amex (Delete where appropriate)

Credit Card No. .... Tick if H/P form is required:

Name .....

Address .....

Postcode .....

Tel: ..... Signature .....

To Carlsbro Sound Centres Limited  
FREEPOST Mansfield Notts NG18 1BR.

**NO STAMP REQUIRED**



# MODULAR SYNTHESIS

## Using Sequencers with Modular Systems

As a foretaste to the start of our 'Everything But the Kitchen . . .' series on musical instrument syncing, this month's column looks at running sequencers from a click-track. *Steve Howell*

Over the past two months we've been looking at the use of sequencers with a modular synthesiser. As I hope you've seen, the applications are considerably more varied than they would be using a smaller, 'off-the-shelf' synth and sequencer and I hope that some of the advantages of the simpler and more humble analogue sequencer have been made more apparent. Some of the techniques we've covered are just as useful today as they were when these sequencers were all you could get hold of, and I hope none of you have been tempted to think that, because it is not the very latest in technology, this hardware and the possibilities it offers are an anachronism in today's world of micro-composers and computer-based controllers. Indeed, that way of thinking is as Luddite and as peurile as the Musicians Union's attempted ban on synthesisers. There are still a lot of avenues of analogue and modular synthesis that have yet to be explored, and I'd like to think that some of the techniques we've looked at will inspire you to experiment because, let's face it, experimentation is what synthesis is all about.

Having said that, this month's column may also be of use to owners of every type of synthesiser, be it an SH101, a giant Moog Modular or even a more computer-based instrument, because the topic is syncing sequencers to tape. This has been something of a problem for many people in the past, but it's actually a fairly easy procedure that needn't cause too much of a headache.

As every schoolboy knows, before a sequencer can do a great deal it needs a trigger or a gate pulse, and normally this

pulse is provided by the unit's own internal clock. It is possible, however, to override this internal clock so that pulses from an external unit can step through it. Figure 1 shows a patch in which a drum machine's clock output has replaced that of a sequencer so that it steps the sequencer through its pattern which, in turn, 'plays' the synthesiser.

What happens if you want to add more pre-programmed parts but only have the one sequencer? There are a few options, the first of which uses an audio output from the drum machine. Take a separate voice out from a spikey percussive sound (such as claves or rimshot), program it in on every beat and then feed that to a separate track on your tape machine so that on, shall we say, track 3 you have the percussive sound (the click track), on 4 and 5 you have the stereo mix of the drum machine and on 6 your first sequencer part (See Figure 2). Having recorded your basic track, you can rewind the tape, reprogram your sequencer and then route the output from track 3 to the step input of the sequencer so that when the tape starts, so will your sequencer, routed to, say, track 7. This can be done as many times as you have spare tracks available – well, that's the theory anyway. In practice you may well find that the output level of the percussive sound off-tape is not high enough to have any effect on your sequencer and must therefore be amplified in some way. This can be done by routing track 3 through a channel on the mixer and setting the gain very high so that the track is boosted to a level more suited to triggering. You can then route that channel to the input of the sequencer via either the auxiliary sends

or the direct channel output. Should this fail, try EQing the channel to see if that affects its performance – you may well find that a boost in treble will be the answer.

If you're still experiencing difficulties, you could employ the following technique. In fairness, this method is more suited to owners of a modular system as it uses modules not normally found outside of them. If your synthesiser possesses a simple preamp (with a gain of anything up to  $\times 1000$ ) for boosting external audio signals for processing through the instrument, you should try using that card, and in the event of this not being suitable, you could route the output of the preamp to an envelope follower if your system possesses such a thing. This will turn the audio signal into an envelope voltage that follows the 'shape' of the input signal, and the level of this voltage will probably be sufficient to step through your sequencer and should solve most of your problems. In fact, this is the method I've been using myself and it's given me no problems that are really worth mentioning.

### Voltage Mixing

If your synthesiser doesn't possess either of these you could use voltage processors to achieve much the same result. You might, for instance, have a voltage multiplier that can be used in much the same way as the preamp. Another option is to use a voltage mixer patched up as in Figure 3. Here, a DC bias voltage is fed into one channel of the mixer, which is then mixed with the click-track on the other channel. The principle behind this patch is based on the theory

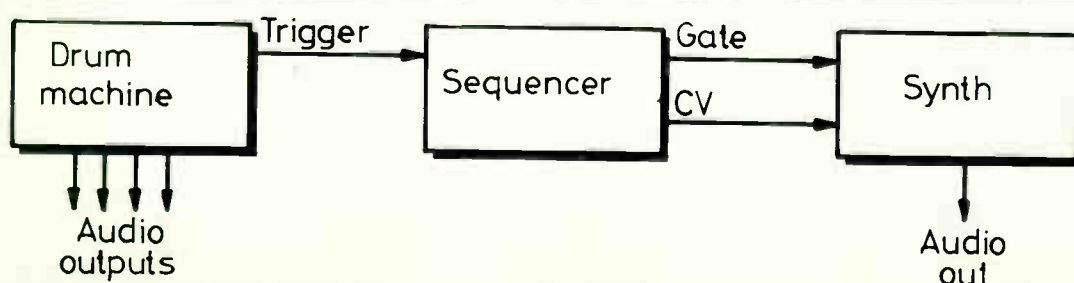

Figure 1.



that your sequencer requires an input of, say, four volts. Anything below that voltage will not be sufficient to trigger the sequencer, but as soon as the voltage rises above the four-volt threshold the sequencer will advance a step. So, if your sound on tape is only about 500mV or so, by setting the bias voltage to 3½volts (or perhaps slightly more) the arrival of the 500mV from the click-track will push the output of the voltage mixer to over four volts and this will trigger your sequencer. To set this patch up, push the control handling the level of the bias voltage up so that it triggers the sequencer of its own accord, back it off slightly and run the tape – you should find that the sequencer will now run in time with the click-track successfully.

Many of these problems have been sorted out with the arrival of the excellent MPC Sync Track which is a godsend to would-be sync-to-tapers. This innocent box of tricks encodes a trigger signal onto tape and then decodes it into something the sequencer can understand. Its real beauty lies in the fact that it caters for

the new breed of digital sequencers and drum machines that require 12, 24, 48 or 96 pulses for one event as well as a start/stop pulse, and as a result allows such equipment to be synced to tape, something none of the above techniques will do. However, if you're not using any of this newer equipment, the methods outlined above should enable you to multitrack sequences quite easily.

## Clock Outputs

As I have said, there are a number of ways you can lay down a click-track, and another technique involves recording an actual clock output. There are a variety of sources for such a thing, such as the clock output of a drum machine or sequencer or, alternatively, the square wave output of a low frequency oscillator. To do this, you simply record the output of your clock or LFO onto tape as if it were an audio signal. You'll hear a series of clicks as the voltage swings up and down abruptly, and it's these audible clicks that trigger your sequencer. Figure 4 shows the signal going onto tape in relation to

the signal coming off-tape (i.e. the recorded version). Note that off-tape there is a spike as the square wave rises and falls. This means that the pulses off-tape will be twice as fast as the LFO output, so you'll have to compensate accordingly, either by running the LFO or clock at half the speed of the sequence when recording or by programming rests into the sequencer so that it runs at the right tempo.

## Recording

The art of laying down a click-track is not a particularly complex one and I imagine that each of you will find a solution to the specific problems of your system. Top artists use various techniques to generate their click-tracks: Larry Fast used to use a good, old-fashioned metronome with a pickup on it to generate his, whilst Wendy Carlos generates hers manually using a spikey sound. There are no hard and fast rules, but then again, there are a few things you should bear in mind if you want to achieve the best results:

- 1 Try to avoid noise reduction systems as their action on a sound can confuse things: this is especially true of companding types.
- 2 Try to avoid recording the click on an edge track, as dropout is more likely on outside tracks than on internal ones. Also, keep your tape recorder heads clean if you want to avoid signal dropout generally.
- 3 Record the click-track at as high a level as possible, but be careful not to let it spill onto other tracks, otherwise you'll hear it breaking through the music. One way round this is to record the click-track and then rewind and clean the other tracks by recording over them.
- 4 Be careful when recording sequencer parts onto the track adjacent to the click-track, as crosstalk may be enough to spill onto the click-track which will, in turn, throw the sequencer out of sync.

If you bear these points in mind and spend some time experimenting with any (or all!) of the methods we've looked at for 'translating' the off-tape signal into

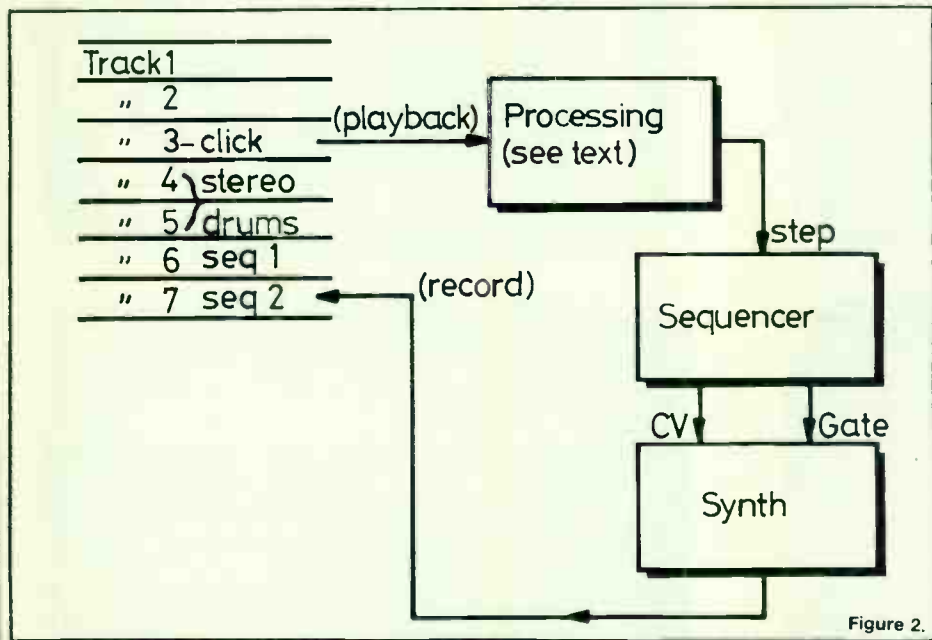

Figure 2.

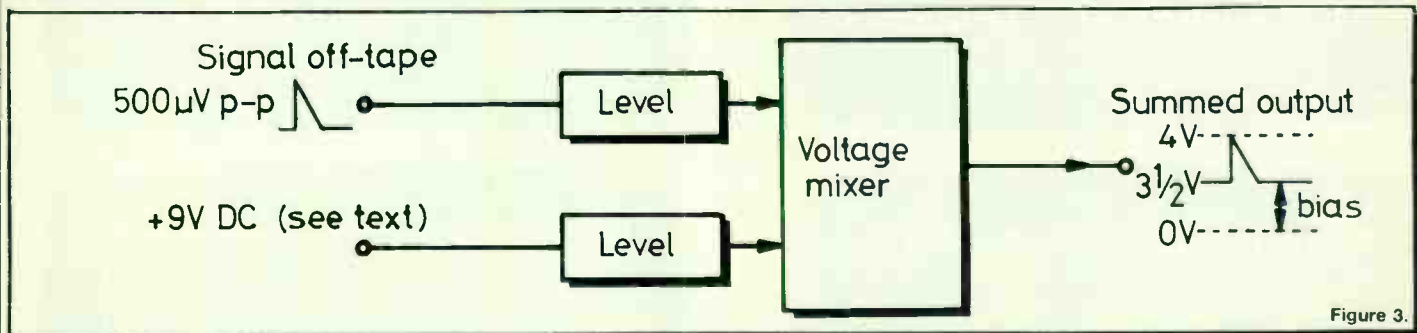

Figure 3.

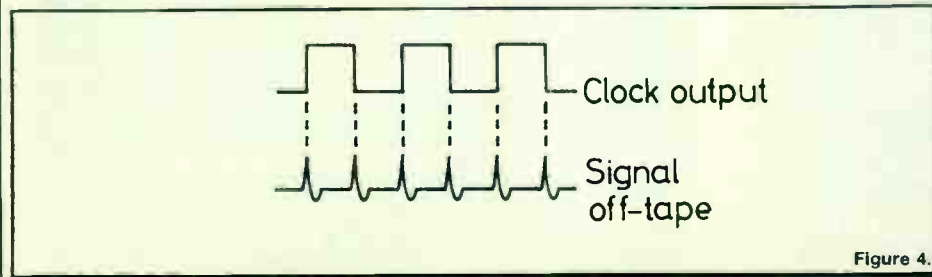

Figure 4.

something more suitable for the sequencer, you should succeed in syncing your sequencer(s) to tape. I've used most of these techniques in various different situations using a variety of tape machines including humble little Portastudios, Teac A3440s and 80-8s, with little or no problem, so don't fall into the trap of assuming that these methods will only work with top grade 16- or 24-track machines in megarecording studios.



Our new, air-conditioned computer music MIDI showroom in London is now open !

Completely re-designed, our London store now has the very best in MIDI software on display.

Here is just a selection :

### U M I

written by Lynton Naiff  
distributed by SoftRock  
Systems Ltd.

a professional MIDI  
sequencer programme  
for the BBC "B" micro.

Exclusively available from  
The London Rock Shops.

### YAMAHA CX-5M MUSIC COMPUTER

available November 1984  
we are now taking orders  
for this staggering MSX  
micro-computer with built-  
in FM synth and sequencer.

### Other computer MIDI software :

Jellinghaus (RMS)  
Siel  
Roland DG (Amdek)  
EMR Miditrack  
Sequential Circuits

all available from stock.



01-267 7851

01-267 1771

01-267 5381

MIDI  
MADNESS !

### MIDI KEYBOARDS :

Yamaha  
Roland  
Siel  
Korg  
Sequential Circuits  
Oberheim

+ many, many more....



All mail order enquiries:

0272 276944



# COMPUTER MUSICIAN

In an article in the September '84 issue of *Hi-Fi for Pleasure*, Tony Horkins (he of IM&RW) made the very pertinent comment that the race for audio perfection that hi-fi buffs are always at such pains to pursue is somewhat at odds with the reality of the average studio situation. The undeniable fact of the matter is that many rock instruments don't actually have an authentic bone in their body, which makes the search for the authentically reproduced snare sound somewhat dubious. Come to that, the journey from synth or digital drum machine to vinyl may be so circuitous (in both senses of the word) that the latest audiophile fad for removing tone controls (eg. the new Rotel RA820B amplifier) is probably about as meaningful as porridge on a hot summer's day.

What raises these thoughts is primarily the fact that I've just succumbed to the delights of the Compact Disc by splashing out on a Marantz CD73. Now, this is a truly wonderful machine, it really is. Indeed, with all around saying things like 'price for price I don't think that as of now this can be bettered' (*Hi-Fi for Pleasure*, July '84), I was sure I'd made the right choice.

But then along comes some other reviewer with a different machine and rather different comments: '(Linda Rondstadt) with the MCD (Meridian Compact Disc) the reverb behind the voice was clearer than via the CD73 . . . bass via the CD73 also seemed more stodgy . . . (Handel) an open, clear sound with the MCD. The CD73 produced a coarser sound with a droning ill-defined bass line which confused the string bass playing and seemed to rob the whole performance of life, verve and energy . . . (Joan Baez) slow and muffled on the CD73 while via the MCD you could clearly hear the chords being played.'

Get the picture? Makes you sick as a parrot, doesn't it? But the story doesn't end there. The point about the Meridian Compact Disc player is that it makes use of 'psychoacoustics in audio design'.

Good word, psychoacoustics. Lots of advertising mileage to be made out of it. But there are psychoacoustics and there are psychoacoustics: the Aphex Aural Exciter, for instance. What Meridian have done is to take a standard Philips CDP101 player and then re-design all the analogue circuitry, including the post-DAC filtering, output cables, power supply cables (yes, power supply cables!), and a good deal more besides. And what's worrying is that it's just those changes, rather than anything to do with the laser tracking, error correction, or DACs, that led to the critical differences quoted above.

If all this is valid, various questions beg to be asked from our side of the mixing desk: what about all the digital keyboards, drum computers, and computer music systems being produced – are we really missing out on their inherent sound quality just because of the wrong routings of power supply cables and inadequate low-pass filters?

But jokes at the expense of the audiophile apart, don't you think something's a mite unbalanced if hi-fi critics carp on in such a finicky way about the technology that all of us are so eagerly taking under our belts? Is it merely that we're too preoccupied playing the things to really listen critically? Come to think of it, isn't it somewhat bizarre using the 16-bit resolution of the Compact Disc standard to sample drum machines and digital synths all beavering away with just a paltry eight bits?

Now that's what I call over-sampling!

*David Ellis*





# Rumblings . . .

This month's round-up of all that's new in the world of computer music.

David Ellis

## Beat It!

The ingenuity of some of these Apple add-ons never ceases to amaze me. Latest in a long line is the DrumKey from the somewhat cryptically named PVI in Pennsylvania. According to their press release, this is an interface board/software package for the Apple II/IIe that lets you create percussion tracks with 28 different digitally-recorded sounds. DrumKey offers full programmability and storage for 100 rhythm patterns and 26 songs (with up to 250 patterns per song), and a scrolling high-resolution screen display of instrument staves for quick notation and editing. Other features include real-time or on-screen composition, selectable timing correction (from whole notes to 64th note triplets), and a sync out facility.

And all for just \$139.95.

Also rather interesting is the hardware PVI have used to do all this: a custom chip complete with all 28 burned-in sounds and a DAC. And the people behind it? Well, remember the CM feature on the SID chip back in August '83 and the mention of its designer, Bob Yannes? It turns out that PVI actually stands for Peripheral Visions Inc., the custom music chip company that Bob and Dave Yannes started when the former left MOS Technology. And if the DrumKey chip is a representative sample of their ingenuity, theirs should be a company worth watching . . .

To hear DrumKey in action, you're invited to call PVI's demo line on ☎ 215-296-8242. For credit card holders, PVI can be reached on ☎ 215-647-3930, or at Great Valley Parkway, Malvern, PA 19355, USA.

## Hal I

That guru of computer music technology, Hal Chamberlin, has recently put his money where his pen is and come up with the DigiSound 16, a two-channel, 16-bit digital processing unit for interfacing with any computer that has two eight-bit parallel ports. Specs are as follows: digitising/playback in mono or stereo, 16-bit resolution (96dB S/N, 0.0015% distortion), and programmable sample rates from 3.5kHz up to 100kHz (mono) or 50kHz (stereo). Other features include either single-shot or continuous-with-disk operation, a 32K sample buffer, three programmable data formats (16-bit, 12-bit companded, or eight-bit companded), and plug-in low-pass filter modules complete with proper de-glitching circuits.

Now, all this is unlikely to come cheap (we haven't discovered the actual price), but for your free DigiSound 16 brochure, write to

Micro Technology Unlimited, 2806 Hillsborough Street, Raleigh, NC 27607, USA.

## Hal 2

It's curious, isn't it, how jokes get blown out of all proportion.

Which reminds me, how about the piece that's published on page 16 of the July 1984 issue of *Keyboard*? You know, the one that starts: 'The Soviet Union may be gaining ground on the electronic music battleground. At a recent meeting of the Ukraine Society Academy of Scientists at Minsk, a new digital computer-synthesiser system, the HAL-ICM FRIGIT, was unveiled. A member of the British Union of Sound Synthesists, invited to the gathering by the Soviet cultural attaché in London, sent us a report.'

And so it goes on, a verbatim rendering of ESSP organiser David Tuffnell's HAL press release. Well, almost verbatim – *Keyboard's* assistant editor forgot to look at the date on the aforesaid: April 1, 1984.

So, who was it that said you can't fool some of the people all of the time . . . ?

## Floppy Audio

Continuing the bizarre angle, news is emerging of a project aimed at using conventional 5.25" floppy disks for storing digital audio. The claim of US company Compusonics is that their CSP1000 ('scheduled for retail delivery during the first quarter of 1985') will sell for around \$1000 and record up to 45 minutes of Compact Disc-quality digital stereo on a single floppy!

Let's think about that for a minute. A double-density 5.25" floppy is pushed to get beyond a couple of megabytes of storage, translating to a bit count in the region of 20 megabits. In contrast, Compact Disc works with 16 bits at a rate of over four megabits per second. So, viewed in those terms, what chance is there of getting more than five seconds of Compact Disc quality from the standard floppy? Well, there are ways and means of improving the chances – going for 12-bit companding rather than 16-bit linear, using Delta Modulation techniques to conserve bits, and so on – but 45 minutes?

To give them their due, Compusonics say that they are expecting new high-density disks that hold 20 megabytes and expect to be able to reduce the head gap size from 20 microns down to 8, both of which will improve their prospects considerably. So, all we can realistically say is: watch this space.

## S100 Synth

These digital synth designs sure keep on coming.

David Rayna Software Systems have just announced their new S100 programmable digital synth board. This generates up to 59 oscillators with a 14kHz sampling rate, or 15 oscillators at a very respectable 50kHz sampling rate. These are fed from 16 on-board, logarithmically-coded, 1K wavetables with 16-bit frequency resolution and eight-bit amplitude resolution. Rayna has also developed a multi-tasking operating system for driving the synthesiser card which includes an editor for the creation of notes lists and instrument definitions prior to performance, but also allows real-time adjustments.

For more info, contact David Rayna Software Systems at 865 President Street, Brooklyn, NY 11215, USA.

## And Then . . .

Finally, take a look at this rewrite of the Old Testament – according to James A. Mooror, the head of the Lucasfilm digital audio group and designer of the incredible Audio Signal Processor (a 32-track digital recording and synthesis studio in a standard 19-inch rack, capable of score editing, orchestration, and composition – all for about \$700,000):

*In the beginning there was the sample,  
and the sample was with God,  
and the sample was God,  
and yea there rose one from the East,  
who writeth the gospel according to Mathews,  
and he did take that sample and compute it,  
and he did convert it,  
saying 'Let there be music'  
And there was music.  
And he said 'Go forth to the whole nation and multiply and add.'  
And there rose one from the West,  
who writeth the gospel according to John,  
and he did take these oscillators two by two,  
and he did modulate them,  
saying 'Bring me forth samples,  
and with only one multiply.'  
And then there came Lucas,  
and he assembled a mighty amount of money,  
and with it he did smite a problem,  
saying 'Bring me forth samples in ever-increasing number.'  
And they did multiply and multiply and multiply.*



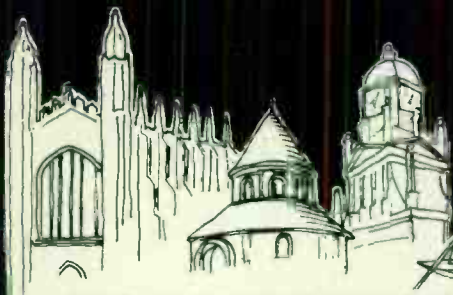

# The CAMBRIDGE ROCK Shop

**UP TO £1,000 INSTANT CREDIT AVAILABLE (SUBJECT TO STATUS)**

"It amazes me just how much stock they have crammed into the shop"

*Guitarist Mag. zine*

## KEYBOARDS



Come and try the amazing new Digital F.M. Synths and the new compact electronic pianos from Yamaha. The PF10 & PF15 have 10 pre-set sounds, touch sensitive keyboard, pitch transposer and stereo chorus. Playing is believing on both these revolutionary products. Come and believe!

- DX7 Synth
- CX9 Synth
- KX5 Remote K/board
- PF15 Piano
- PF10 Piano
- CP7 Piano

All in stock now at very sensible prices



Just about the fastest selling range of keyboards on the market today - You can't lose with Roland

- Juno 106 Polysynth
- JX3P Polysynth
- Jupiter 6 Polysynth
- SH101 Monosynth
- MC202 Microcomposer
- PG200 Programmer for JX3P
- JSQ60 Sequencer for Juno 60
- JSQ100 Sequencer
- RS09 Strings

THE ABOVE ITEMS ARE ALL IN STOCK AND ARE VERY KEENLY PRICED

## KORG

We always have the best products from KORG in stock. POLY 800 (MIDI) Synth RK100 (MIDI) Keyboard EX800 (MIDI) Expander Poly 61M (MIDI) Synth

AMAZING NEW BUDGET PRICED DIGITAL DRUMS BY KORG NOW AVAILABLE - SEE UNDER "DRUM MACHINES"

## HOME RECORDING



PERSONAL MULTITRACKER  
ONLY £249  
WHILE  
STOCKS LAST



The new X-15 multitracker is a battery/mains operated 4-track recorder with Dolby B Mixer and plays standard cassettes. This incredible machine sells for the unbelievable low price of £249 and is selling very fast. Also in stock the amazing 250 portable four track studio at £599

### "SUPER PACKAGE"

- X15, 4 Track Recorder
- MN15 mini Mixer/Compressor
- X15 carry case

ALL FOR ONLY £299 WHILE STOCKS LAST

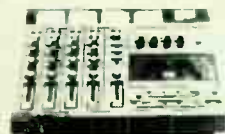

**TEAC TASCAM**  
244 Portastudio  
£599

We are the Cambridge agents for TEAC/TASCAM the company that started it all. The 244 Portastudio is always in stock for demonstration and features a stereo effects facility and has the capability of 'punch-in' by foot-operated control. Records on all 4 tracks £599

## GUITARS & BASSES

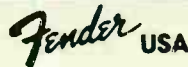

The new Fender USA guitars have been totally revamped by the new design team in the USA and have come up with sure fire winners. Surprisingly enough they have not only improved the technology of the guitars and kept the feel and sound the way the traditional Fender players like it, but they have in most cases been able to actually reduce the price on most models. Strats from £249

Standard Strat L/T	£249	Standard Jazz	£339
Standard Strat W/T	£299	Elite Strat W/T	£499
Standard Tele	£289	Elite Prec	£499
Standard Precision	£299	Elite Prec F/Less	£499

"Cambridge Rock is a veritable Aladdin's Cave especially for The Guitarist"

*Guitarist Magazine*

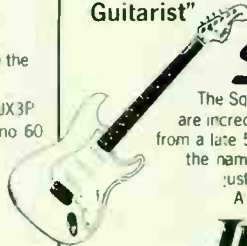

The Squire series vintage replica guitars are incredible. Everything you would want from a late 50's early 60's Fender (including the name) at a very realistic price. Also just arrived the new 70's Squire's. A knockout Fender for only £199



The superb new "Roadstar Series" Now in Stock



It had to happen. The search for sound improvement has produced the stepped neck. This allows for faster playing action. A unique design combined with a carbon fibre body for unprecedented sustain and attack. Coming soon, phone for details.



The full range of Westone guitars are always in stock.



Amazing new range of replica guitars £269 with trem and padded cover.

We always have plenty of secondhand electric and acoustic guitars in stock at very sensible prices - give us a ring for the current stock situation.

## DRUM MACHINES

We carry a comprehensive range of Drum Machines and Rhythm units including Roland Drumatix, Boss DR110, Korg KPR77, Soundmaster SR88, Soundmaster Stix, Mattell Synsonics, M.P.C. Kit II Boss Hand Clap, Boss Perc. Synth, Yamaha MR10 plus others including secondhand machines. "Just arrived" the amazing new budget priced digital drums from Korg, the DDM110 rhythm machine and the DDM220 percussion machine at only £199 each. Get in Quick!



Simply the best electronic drum kits on the market. Phone for demo & prices.

## AMPS & PA's



WE DESIGN THE FUTURE

New low prices on all Roland amplification. We stock the complete range and can offer some very competitive prices on the Cube, Jazz

Chorus & Bolt Combos. We feel Roland are the most reliable Japanese sound equipment manufacturers on the market and offer the very latest technology in both solid state and tube amplification



We are the Fender Soundhouse for Cambridgeshire and always have a good range of amplification in stock including the amazing "Sideficks"



We are the sole agents for the Cambs area for this superb British made product which has been called the 'Roll-Royce' of bass amplification. Please ring us for latest stock position and prices or call in for demo



Full range of Carlsbro gear in stock at all times at greatly discounted prices.



## SESSIONETTE LEAD & BASS COMBOS

These incredible little British made amplifiers are always in stock at the best prices around.

## EFFECTS & MICS



	RRP	SALE
Phase 90	£99	£27
Phase 100	£132	£34
Dynacomp	£71	£34



The Boss range of pedals is quite easily the fastest selling effects in the UK. We carry the complete range of Boss pedals and our prices are most competitive. We also carry the other top names in effects pedals such as Ibanez, MXR, BOSS, LOCO, Carlsbro, Electro Harmonix, Colorsound, and Arion.

Always in stock is a superb range of quality microphones from the following companies, all at very good prices. Shure, AKG, Beyer, Audio Technica, Chaser, etc.

## MAIL ORDER

We can supply almost any product by our efficient mail order service. Barclaycard, Access and American Express sales can be conducted over the phone. Bank drafts, Building Society cheques and Postal Orders have immediate clearance while personal cheques will take 5 working days to clear before goods can be sent.

**TELEPHONE SALES**  
**(0223) 316091**



**SEND FOR YOUR FREE ROCK POCKET**

Cambridge  
Rock Shop's own  
FREE mail order  
catalogue



8 Burleigh Street Cambridge Tel: (0223) 316091/65093 Next to the new 'Grafton Shopping Centre'



# E&MM Digital Music

## The Programmable Digital Sound Generator

### Part 4: Further Hardware Details

Clef Products' computer music system is now reaching the production stage, and this month's editorial resumption sees details of the system's keyboard, among other things. *Alan Boothman*

The software interface information given in E&MM July could be applied to a wide range of home computers. A page within the memory map of the host will need to be decoded in a similar manner to NPGFD, where +5 Volts represents the inactive state and a zero level indicates that the page incorporating the PDSG is being addressed. The extended page circuitry can be disabled by cutting the track to pin 4 of the extended page gate and linking from that pin to the positive supply on pin 14. The extended page gate is within the package 74LS08, immediately above the 4069 on the lower left-hand side of the board.

The circuitry for the front end of the PDSG is given in Figure 1. Disabling the extended

page makes NPGFC redundant, so that the addressing of the PDSG is controlled entirely by NPGFD in conjunction with 1MHzE. The latter is equivalent to 00 in a 6502 system, where address stabilisation occurs whilst 1MHzE is low and data becomes stable during the period when it is high. Combination with the R/W control line results in the RD and WR pulses shown in the diagram which control the PDSG: either read or write operations set up the address latch. It can be seen from the diagram that other signal inversions could be carried out if required. In addition to the lower eight address lines and the data bus, an interrupt request to the host is normally required, although it is possible to program this within the computer, ignoring the

interrupt oscillator present in the PDSG. A pull-down reset from the host is desirable but not essential, since its only function is to clear the control register and this can be carried out by programming, ie. write zero to address 128.

### Keyboard Unit

Whilst the PDSG can be programmed to operate as an independent sound producing unit, in conjunction with the host computer, a music keyboard unit has been designed which plugs into the auxiliary port of the PDSG, giving a much wider range of application for the system.

The prime design criterion for the keyboard

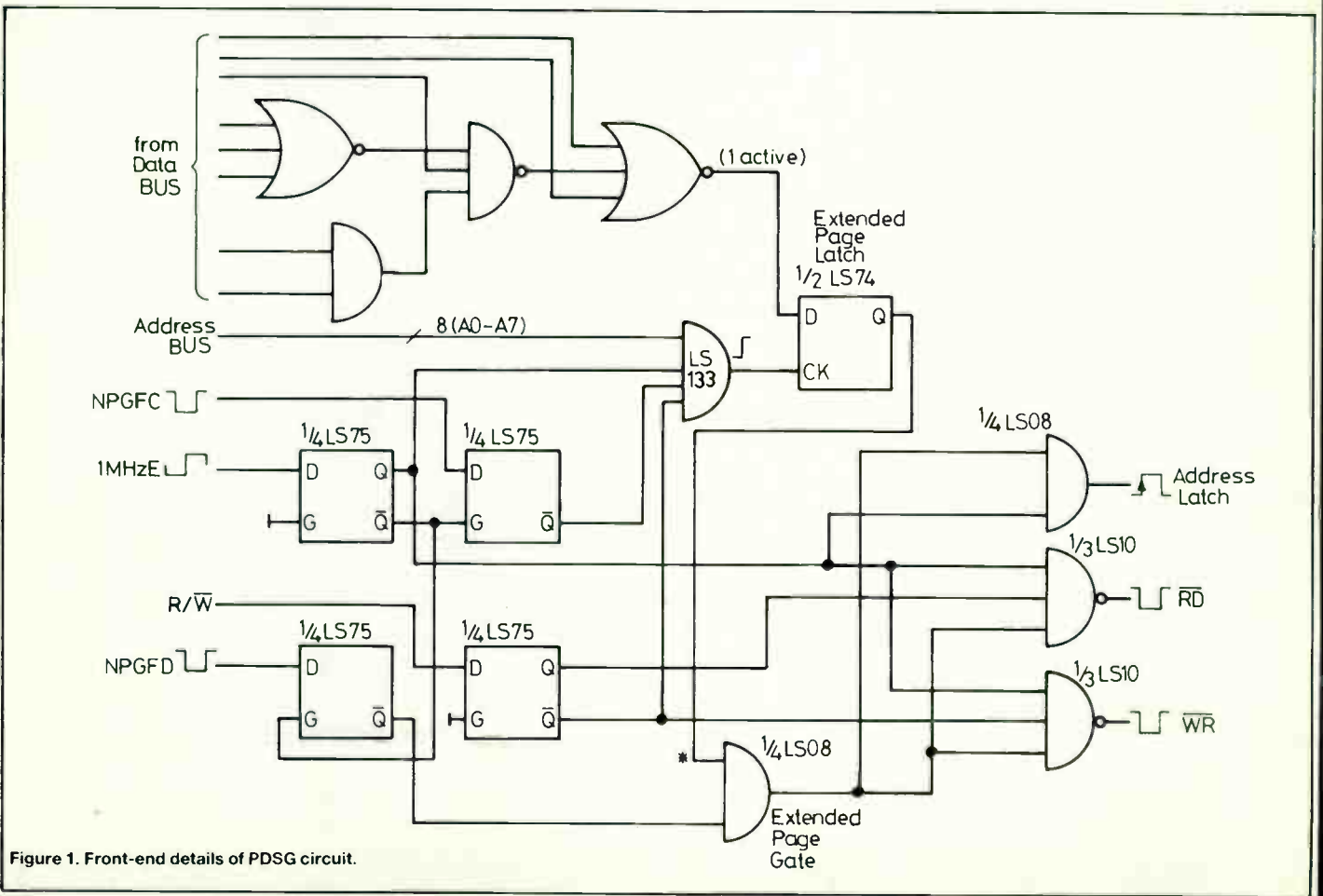

Figure 1. Front-end details of PDSG circuit.



INSTRUMENT	AVAILABLE	PEDAL	MODE	D
1	HARMON	7	PELEC1	54 SYNTH1
2	CHURCH	8	PELEC2	55 SYNTH2
3	STRINGS	9	PIANO1	56 VIRES
4	STRNG4T	81	PIANO2	57 GUITAR1
5	BRASS2	82	COMBLEC	58 GUITAR2
6	BRASS1	83	CLAV'D	59 BAG

\* MODE D-ON S-SEQ. C-CONT. R-REC. \*  
 \* SPACE TO STOP : L-LOAD F-FILL A SEQ. \*  
 INSTRUMENT-COMBLEC M-MENU MODE-OFF

Figure 2. Display of sample instrument set.

CURRENT INSTRUMENT	P-TO CHANGE
(1) OSCILLATORS USED 3	NO1 NO2 NO3
(2) VEL. CURVE (1-4)	3 3 3
(3) FREQ. TAB. (1-4)	1 2 3
(4) W.F. NO. (1-32)	22 27 20
(5) CHANNEL (1-3)	3 1 2
(6) LOG-LIN (1-2)	2 2 2
(7) MAX. LEV. (0-255)	255 255 255
(8) ATT. RTE. (0-100)	55 50 50
(9) DEC. RTE. (0-100)	20 18 18
(10) DEC. LEV. (0-255)	160 160 160
(11) SUS. RTE. (0-100)	0 0 0
(12) REL. RTE. (0-100)	40 40 40
(13) PED. RTE. (0-100)	10 10 10

MODE D-ON S-SEQ. C-CONT. R-REC  
 SPACE STOP : A-ALTER L-LOAD F-FILE INSTR  
 INSTRUMENT-STRNG4T M-MENU MODE-OFF

Figure 3. Instrument specification - 'STRING4T'.

CURRENT INSTRUMENT	P-TO CHANGE
(1) OSCILLATORS USED 2	NO1 NO2
(2) VEL. CURVE (1-4)	1 3
(3) FREQ. TAB. (1-4)	2 1
(4) W.F. NO. (1-32)	17 20
(5) CHANNEL (1-3)	2 1
(6) LOG-LIN (1-2)	1 1
(7) MAX. LEV. (0-255)	255 150
(8) ATT. RTE. (0-100)	1 2
(9) DEC. RTE. (0-100)	30 18
(10) DEC. LEV. (0-255)	120 99
(11) SUS. RTE. (0-100)	23 10
(12) REL. RTE. (0-100)	50 50
(13) PED. RTE. (0-100)	23 10

MODE D-ON S-SEQ. C-CONT. R-REC  
 SPACE STOP : A-ALTER L-LOAD F-FILE INSTR  
 INSTRUMENT-PELEC1 M-MENU MODE-OFF

Figure 4. Instrument specification - 'PELEC1'.

was that it should have accurate touch response, and it was therefore decided to reject simple mechanical approaches - using cut sections of rod or flimsy bent wires in favour of full-length substantial rods which give reproducible and long-lasting uniformity. A relatively quiet action is then achieved using soft coiled springs, and the scanning order is determined by electronic switching.

The keyswitch is produced in 32-note modules, and up to four modules can be controlled via the PDSG to give 128 two-way switches. The standard keyboard unit is five octaves in length, using half the available capacity, and includes two switch positions dedicated to foot operation. Interlinking of the 32-note modules is via a 17-way bus, allowing easy adaptation to other keyboard configurations, eg. 2½ octaves, 7¼ octaves or two 44-note keyboards plus pedals.

When reading a single five-octave keyboard, the majority of notes will be inactive at a given moment in time so, in order to give a fast scan, it is desirable to detect the unused areas quickly and then remove them from further processing. Consequently, the electronic scan is carried out in blocks of eight consecutive notes rather than spread across

the keyboard compass, and in the current software this allows a further split into half-blocks of four notes. This gives a reasonable simulation of the natural positions for two human hands and, on average, reduces the amount of host computer time used in the scanning operation. In the software, it is necessary to cope with switch bounce at both ends of the key travel, carefully defining the onset or completion of a movement, as well as synchronising the touch-counting information to give valid results.

## Frequency Definition

To complete information on the parameters which need to be fed into the PDSG, it's necessary to look at the derivation of the two bytes used to define the frequency of operation of each oscillator. A falling scale of frequencies can first be created by using the formula  $F=FO/2^{1/12}$ , corresponding to a progressive division by 1.05946309 to produce the next lowest frequency.

In order to pitch the five octave keyboard with middle C positioned as two octaves above the lower end, the top C (note 63) can be given a frequency of 2093Hz. A basic program can be written to carry out both this and subsequent calculations, and it's useful to incorporate a displacement factor in order to obtain different frequency tables for providing a chorus effect. A suggested level of displacement is  $\pm 0.5\%$  over the frequency range, and a fixed minimum change of  $\pm 1$  can be superimposed on the low order byte.

The increment required to produce a particular frequency will vary with the Clock rate, which is adjustable in the range 1.8 to 2MHz. With a 2MHz clock (0.5µs period), each sample for an oscillator occurs every 32µs (64×0.5µs), so an increment of 1 in the high order byte will lead to the 256 count cycling in 8.192ms (equivalent to 122Hz). The formula to derive the increment is  $I = F \times 256 \times 64 / C \times 10^6$ . The top seven bits of the high order byte are used as bits 0-7 in the waveform memory to give a 128 byte cycle from the 256 count so that the lowest bit is the first fractional component. The two bytes can now be split using  $I1 = INT(I)$  for the high order byte and  $I2 = INT((I - I1) \times 256 + 0.5)$  for the low order byte.

Sufficient information has now been given to allow advanced programmers to use the PDSG in a complete sound system of their own choice. However, a considerable amount of programming detail is required to translate user requirements into a practical operating scheme, and flow chart instructions will be given later to assist in that process. However, since it would be difficult for readers to follow the detail involved without having a full appreciation of the overall purpose, it is first necessary to define what the system does at the present time.

## Sound System 1

The present system (referred to from now on as 'Sound System 1') is real time and covers a range of relatively conventional musical instruments, playable polyphonically from a keyboard with velocity-sensitive control. It particularly aims to simulate the subtle dynamic tone changes within this class of instrument and the chorus effect of ensemble playing. However, whilst this gives a multi-voice preset machine for immediate live performance, it is assumed that a prime purpose for having the system is to develop one's own sounds. This process is assisted by the incorporation of a single-track digital recording facility which can be used to provide musical

data for the instrument under development, allowing the user to change parameters subtly in the instrument specification until the required result is obtained. Development of the instrument can progress with or without the keyboard attached provided that the sequence recorded on the keyboard has been filed for recall. Individual instrument specifications may be filed or recalled at any time and then grouped into sets of 18 for instant call on the computer keyboard.

A typical instrument set is shown in Figure 2 and covers Organs, Strings, Brass, Guitars and Pianos of electric and conventional types. This represents a miscellany which may suit some users but could just as well be regrouped to give 18 preset stops in a classical organ application or 18 preset synthesiser sounds, for example.

Some of the instrument titles indicate that the specifications have been optimised to give the effect of two instruments on the same keyboard eg. 'B & G' (Bass and Guitar), and 'COMBLEC' (Organ without touch plus Electric Piano with touch). This form of instrument development can be very effective, avoiding the limitations imposed by splitting the keyboard with alternative software.

Choice of current instrument is made by pressing the appropriate numeric key with or without the Shift key, and the format of Figure 2 represents the normal display whilst playing the system. Two pedal sustain modes have been adopted in Sound System 1, the first simulating the normal piano sustain action whilst the second cancels sustain for any key held down - a mode that is particularly useful when playing long-sustaining strings.

Keys O, S, C and R enable the keyboard, play the currently loaded sequence, continuously play the sequence, and allow recording from the keyboard respectively. The keyboard remains active on sequence and continuous playback. The current instrument and operating mode are continuously displayed, and the filing and loading of a recorded sequence are both controlled from this display.

## Instrument Specification

Specifying the form of parameters required to define an instrument can be entirely subjective and different types of instruments can benefit considerably from different approaches. For sound system 1, the instrument specification format is as shown in Figures 3 and 4. When an instrument has been selected, its full specification can be called to the screen by pressing key I on the computer keyboard. All parameters are then ready for immediate alteration if required. The instrument shown in Figure 3 has the title 'STRING4T', which is a touch-sensitive version of a string ensemble effect using three logical oscillators per note. By contrast, Figure 4 shows an electric piano using just two logical oscillators per note. A full description of the two specifications will illustrate the computer programming requirements which arose during the development of Sound System 1, and this will be appearing in next month's E&MM.

*PDSG pricing and availability details from: Clef Products, 44a Bramhall Lane South, Bramhall, Stockport, Cheshire SK7 1AH. ☎ 061-439 3297. See this month's Back Issues page for details of how to obtain previous instalments in the 'E&MM Digital Music' series.*



# Yamaha CX5M

## Music Computer and Software

Take a standard MSX micro, give it an FM chip, a MIDI controlling keyboard, and some music software, and you've got this year's most eagerly-anticipated electronic music product. It's almost ridiculously good. *David Ellis*



With so much ballyhoo about the hitherto intangible CX5M in the past six months, it's been a mite difficult to separate fact from fiction. And it has to be said that leaning over the shoulder of Dave Bristow, Yamaha's principal CX5M demonstrator, is hardly the same as honest-to-goodness hands-on experience. In fact, the situation as regards reviews of the machine has been greatly complicated by the fact that Microsoft, the American company behind MSX BASIC, have been allowing computer magazines to review a Yamaha micro called the YIS503, which to all intents and purposes is the same as the CX5M but *without* all the software goodies that transform a fairly standard micro into something rather special. Indeed, as Yamaha-Kemble have repeatedly and patiently pointed out to telephone enquirers, this was a machine aimed at the Japanese home market, not the UK micro arena. So, all in all, it wasn't particularly sensible of Microsoft to release it for review.

And, of course, the problem with this premature exposure created was a flood of interest in a product that didn't actually exist on the UK market, and therefore succeeded in causing a great deal of frustration to one and all – including Yamaha-Kemble. As Martin Tennant of said company put it, 'If I'd had a quarter per cent share in every CX5M that people wanted to buy when it wasn't available, I'd be holidaying in the Bahamas now!' So, if you'd wondered why E&MM hadn't reviewed the YIS503, or even given space to an over-the-shoulders-of-Bristow account of the CX5M, there's the answer.

In contrast, the CX5M is Yamaha's official MSX micro for the UK market. But as most readers will already have gleaned, it's also a great deal more than just a standard MSX micro. In fact, its musical capabilities are such that its clonal parentage is little more than of

passing interest. First, though, some background to fill in the whys and wherefores of Yamaha's MSX endeavours.

### Background

As anyone who's been following the progress of micros through the late seventies and early eighties will know, the one thing that can be relied upon is diversification from anything like a common standard. Whether that's such a bad thing in a rapidly expanding field is a moot point. To be honest, I'm inclined to side with Sir Clive Sinclair in his opinion that MSX freezes technology and software at a stage when it would be more profitable to look ahead. To make matters worse, the MSX standard laid down the law on a particularly uninspiring sound chip – the AY-3-8910 – which didn't exactly augur well for the musical side of MSX. But be that as it may, this was the *fait accompli* that Yamaha were faced with.

So, how does a manufacturer of high class synths, pianos, harps and even motorbikes produce an MSX micro without getting egg on its face in the sound department? Well, quite simply, by combining their expertise in FM synthesis and the design of custom chips. So, just as the DX7 polysynth saw the use of custom operator and envelope-generation chips churning out 12-bit data for our delight and edification, so Yamaha's new MSX micro gained precisely the same sort of squashing of FM principles onto rather less than a handful of chips.

In fact, Yamaha approached the problem in two stages: first, they designed their own version of the AY-3-8910 for use within the basic machine (a necessary evil to ensure compatibility with other MSX software); and second, they parcelled up a custom FM LSI with a keyboard interface and MIDI in a special

add-on called the SFG01, which was available separately for their MSX micro along with a choice of mini or full-size (macro?) music keyboards and a range of software.

Over in the land of the Rising Yen, Yamaha released this MSX micro in two different guises: the YIS503 (32K RAM) and YIS303 (16K RAM). Like other MSX micros, the YIS503 was priced at around the £200 mark, whilst the SFG01 FM sound module and MK01 mini keyboard were available together for a further £100.

Now, all this happened more than a year ago in Japan. The UK situation is, of course, rather different. First, it's the CX5M, not the YIS503, that's coming onto the market shortly. Second, it's being marketed only as a £599 package consisting of the CX5M, SFG01, MK01 and YRM12 FM voicing software cartridge. It's hard not to notice that rather steep price increase, but as Martin Tennant pointed out to me, air freight is expensive, service facilities have to be provided, and on the other side of the value for money coin, a CX5M purchaser is actually getting considerably more than a DX9's capabilities for rather less outlay.

### SFG01 Module

The crux of the CX5M is the SFG01. Without this FM sound module, the CX5M would be yet another MSX micro without the 'M' for music. In fact, the SFG01 is the sort of add-on that just about everyone working in the micro music industry has been itching to get their hands on. The actual module measures about five inches square and slots into a recess on the underside of the CX5M, where it's bolted into place. Opening the module up reveals plenty of metal screening to avoid radio interference from the FM chips, and a well-constructed, double-sided PCB holding about 12 chips and various bits and bobs.

The important ones to note are those with the Yamaha code 'YM-'. Locked inside just one of those large chips (YM2151) is the secret to the DX sound. From the come data lines *et al* to a dual DAC (YM3012), and hence to ops-amps and the output. Just two chips doing all that – makes you think, doesn't it? Alongside, a couple of other chips look as if they're having something to do with MIDI communications (YM2210) and keyboard scanning (YM2148), while at the side are a bevy of sockets – namely MIDI In and Out, the keyboard connector, and left and right audio outputs.

On the FM synthesis side, the SFG01 has 32 Operators available at your beck and call. Eight-note polyphony is the norm, so these Operators get assigned four-a-time to each voice. Then, like the DX9 (which also uses four Operators/note FM synthesis), these Operators can be arranged in eight different patterns – what Yamaha somewhat confusingly term 'algorithms'. However, where the SFG01's



capabilities zoom ahead of both the DX7 and DX9 is in the delicious fact that eight different algorithms/instruments can be played at once. So, if you want to multitrack different parts with different instruments, it's no problem. In addition, rather than limiting the output of the SFG01 to just the monophonic output of the DX range, Yamaha have sensibly seen fit to endow the module with stereo outputs. More than that, each of the eight voices can be altered between output left, right and centre.

And the sound quality? Well, like its DX brethren, the SFG01 is whisper-quiet when nothing's sounding. More to the point, the sounds themselves have a breathtaking clarity to them. If there's any criticism to be made, it's when sounds are output at the low end of the spectrum, because here, in common with the DX7/9, some carrier noise does tend to creep through. Interestingly, when this appeared with the CX5M, it was most obvious on instruments using algorithm 3 (brass, strings, and pianos mainly), and manifested itself as a sort of added whistle whenever notes of an Fm7 chord were played below middle C. A bit like a certain frequency making something in the body of an instrument and its resonant pennyworth, really. Now, you could argue that this adds to the organic appeal of FM, ie. simulating even the behaviour of resonating bits of wood and metal, but personally I found it a mild annoyance. Still, one way around it may be to take greater care in the initial construction of sounds. Just remember that most things are both achievable and avoidable with FM synthesis!

## Software

Of course, without software the SFG01's as dead as a dodo, and the proof of Yamaha's musical pudding ultimately rests on what they're providing to goad all those FM parameters into action.

First, though, a word about the MSX attitude to software. Well, total compatibility and fast-loading are the two main requirements. The software side of MSX (it stands for MicroSoft extended BASIC) ensures that programs will at least run happily across the entire range of machines, so that in theory, any MSX software should run on the CX5M. Whether this will include other music programs using the SFG01's capabilities remains to be seen, but clearly there's no reason why other manufacturers shouldn't produce their own FM voicing or sequencing software, though Yamaha haven't as yet provided any indication of the entry points needed to run the SFG01. The fast-loading requirement of MSX software is achieved by providing the software in ROM form in a top-loading cartridge. Since the CX5M (or any other MSX machine, come to that) doesn't come equipped with a disk drive, this clearly makes a lot of sense, though it carries the disadvantage of cost (ROMs are more expensive to produce in smallish quantities than disks or cassettes) and in-built updating difficulties.

The software Yamaha are producing for the CX5M includes the following cartridges: YRM11 Music Macro, YRM12 FM Voicing Program, YRM13 DX7 Voicing Program, YRM14 DX9 Voicing Program, and the YRM15 FM Music Composer. Apart from the YRM12 cartridge, which is included in the £599 price tag for the CX5M, all the rest are extras costing £49 each.

## YRM11 Music Macro

Problems here. I plug in the cartridge, switch the machine on, and the usual display comes up informing me that I'm using MSX BASIC

Version 1.0, after which the Yamaha Music Macro takes over. Fine, but it doesn't tell me what I can do with it. Solution: look for English translation of manual. There isn't one. Panic. Flick through Japanese manual to get some gist of what's going on.

Well, from what I can see through a maze of Japanese calligraphy, Music Macro is an extension to MSX BASIC that allows all (or most) of the SFG01's formidable facilities to be used from within the user's own programs, though only by using BASIC commands. It also allows speech to be synthesised (using the keyword 'SAY'), though all attempts to get the machine to produce anything other than Japanese proved fruitless. I'd always wondered what 'onseigousei' sounded like: hope it's not rude. Trying to get it to say 'hello' only produced a stream of Japanese inceptive reminiscent of the worst sort of airport PA system, ie. totally unintelligible. A bit beside the point if your interests are musical, though as this also uses the SFG01, it shows once again what FM is capable of.

Conclusions: I reserve final judgement, but it should be very useful to those of a self-programming bent once the English manual has materialised.

## YRM12 FM Voicing Program

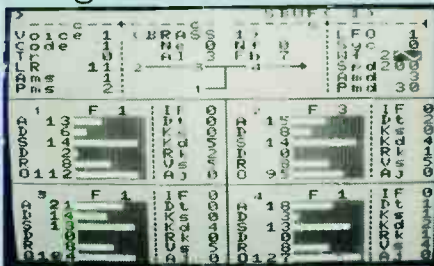

Lots of menus, lots of parameters: even a command called 'Kill'. Shame Yamaha couldn't apply this to the side of this software accessed with the command 'Call Music'. The latter gives you access to the least favourable side of the CX5M's activities - auto-playing replete with rinky-dink rhythms and 'instant funk bass' patterns. Not for the faint of heart or, indeed, the musically sensitive.

Moving rapidly back to the main menu, and pressing the 'F1' function key, takes you to far more interesting territory - the edit display for the FM voices, which also allows you to play the attached YK01 keyboard. This is of the mini variety, which belongs to the school of evolution that believes in musicians adapting and growing miniature fingers. Well, you do adapt - sort of - but to be frank, this is a toy keyboard, not the real thing.

As an alternative to the YK01, there's the 'not-yet-available' YK10, which we're promised offers a full-size option for less than £100. The only problem here is that the CX5M package deal obliges you to get a YK01 first, which is a bit thick really. However, that's only one of the annoying features. Let's suppose you've got a DX7 that you want to use with the CX5M via MIDI, with the DX7 providing the velocity-sensed notes. Well, the short answer is you can't. For some bizarre reason, Yamaha saw fit to allow the MIDI In on the SFG01 module to receive only voice parameter data (in the context of the YRM13 program), not anything remotely musical. 'Grrr!' is what I say.

Still, moving on to the 46 preset voices available for use with these keyboard options. Of these, nine are excellent, about the same are bearable, and the rest should have taken an honourable way out. If it's any consolation, the excellent ones are the sort you'd use time

and time again, ie. brass 1, guitar, electric bass 1, electric piano 3, piccolo, clarinet, glockenspiel (printed as 'grockenspiel', would you believe), vibraphone, xylophone, and clavinet.

Now, assuming you're of a reasonably inventive nature, you'll soon get the itch to construct your own FM voices. Fortunately, the edit side of the program makes this relatively painless - it's really just a question of using the cursor keys to send a brown box hopping around from one value to another, the numeric keys to change a value, and return to enter the same. To make things easier, a buffer store is provided so that your changed voice data isn't lost for all eternity. Your own instruments can be allocated to voices 49-96, and when you're satisfied with what you've got, the whole shooting match of both preset voices and your own can be saved onto cassette (or disk, should one become available) under the filename 'VOICE'. The idea is that this can then be loaded subsequently for consumption by the FM Music Composer program.

As far as similarities and differences to DX7/9 programming are concerned, you'll find both. One area that's considerably simpler is that of envelope generation. With the CX5M, this gets cut down in complexity to just five parameters for each Operator, ie. Attack rate (0-31), 1st Decay rate (0-31), Sustain level (0-15), 2nd Decay rate (0-31), and Release rate (0-15). But it's really no good having fancy envelopes if you can hear audible steps. So what's important to take home from this side of the FM voicing story is that the envelopes sound utterly smooth and seamless. In general, the range of all parameters is smaller, which makes for easier decision-making.

Conclusions: It's a shame the auto-playing side of the program hasn't been jettisoned for the UK market. The fact that it's still there shows (a) the original marketing angle of the YIS503 - a home micro with very advanced sound capabilities, and (b) the inflexibility of putting software onto ROM. The FM voicing side, on the other hand, looks very good. Furthermore, it shows that the sound and timbral quality of the SFG01 is right up to the standard of the DX7/9, though the noise on notes below middle C could be an annoyance.

## YRM13 DX7 Voicing Program

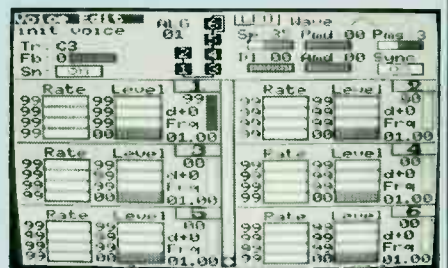

Yamaha-Kemble claim that 'it's worth having a CX5M just for this'.

Briefly, when the CX5M is powered up with a DX7 connected to the SFG01's MIDI In and Out, all the voice data in the DX7 is transferred to the CX5M and a directory of voices shows what's where. The next stage is the edit mode which, as on the YRM12 software, displays all the parameters for each voice. Here, though, we're talking in DX7, rather than SFG01 language, so there's rather more to take account of. But, let's be honest, it really does look very pretty, which is all highly conducive to an enjoyable relationship. And aside from the fact that seeing everything at once helps you to understand rather more clearly what's actually happening FM synthesis-wise, the



▷ program also allows you to spell out graphically certain areas of the DX7's programming, ie. the pitch envelope generator (sic), the envelope generator, and the keyboard scaling. All pretty useful stuff.

Other things you can do include displaying all the effect data, transferring voice data from the CX5M to a RAM cartridge *en masse*, and generally taking part in all manner of loading, saving, copying, and swapping operations with the DX7.

In addition, all the voice data can also be printed out as hard copy, assuming you've got a printer to hand that will interface with the CX5M. Still, the one thing the software doesn't do is help you visualise what FM is actually doing to the sound you're hearing. I'd really love to see some software that spelled out the effect of one Operator modulating another in the shape of graphic illustrations of the resultant dynamically-changing harmonics and inharmonics. If I had something like that, I think I'd then start to appreciate just how FM sounds evolve and devolve. Perchance to dream, and all that . . .

Conclusions: Yes, a very useful program. But no, I wouldn't buy a CX5M just for this. On the other hand, it does make a tricky task a lot easier, looks very pretty, and the hard copy printout feature should prove invaluable for members of the DX Owners' Club and 'Patchwork' contributors!

## YRM15 Music Composer

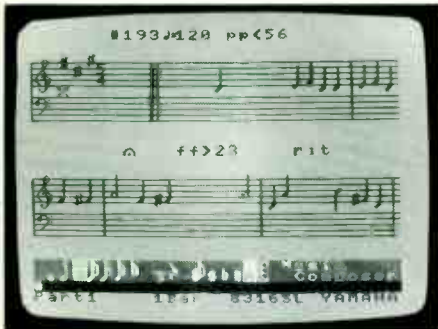

I can't pretend that I'm new to the game of putting up notes on screens and pretending that they duplicate the function of pen and paper. In fact, I remember reviewing some very similar (in intent, anyway) software from Mountain Computer back in E&MM May '81 and thinking that it was truly wonderful. To be honest, with hindsight and a lot of water under the bridge, I can see that I was duped, because although that software undoubtedly looked pretty, it was also slow, inflexible, bug-ridden, and generally everything you don't want in a supposedly interactive composing tool. Yamaha's YRM15 Music Composer cartridge, on the other hand, is simply the best I've seen on any micro. More than that, it's musical.

What the software essentially gives you is eight tracks that can be filled with up to 8359 events. How you use these tracks is really up to you, but it's important to realise at the outset that an 'event' can encompass not only a solitary note but also an indication to repeat a four-bar phrase a couple of hundred times or a host of other musical and control commands.

Still, you've got to start somewhere, and in the simplest application, you can enter a monophonic line on each of the tracks, assign a particular instrument to each line at the start, stick to the same dynamics and so on throughout, and then send the respective parts off to the CX5M's FM sound module. The typical home computer user's way of approaching composition, you might say.

Moving onwards and upwards, you might

elect to put polyphonic data on each track, with voice, dynamic, tempo, phrasing, vibrato, and spatial changes sprinkled liberally from note to note, and then send some of these parts off to the FM sound module and others to other synths *via* MIDI, or stagger the recording of all eight tracks by using the tape sync option.

The ways in which these notes can be entered is also pretty flexible. The first option is to use the QWERTY keyboard to select durations ('1' is a semibreve, '2' is a minim, and so on) and pitches ('V' is C, 'G' is C-sharp, 'B' is D, and so on across the keyboard). Nothing wrong with that, but you need practice and patience to work out which key is what when no help is given in the way of keyboard overlays. To add insult to injury, the Music Composer software appears to have forgotten to take into account the fact that the trans-mogrification of the YIS503 into the CX5M saw a good deal of key position shifting, with the consequence that something of the order of 18 of the 72 key characters are in a current state of identity crisis, including such things as '\_' being '=', '^' being '&', and so on. Even disregarding this cock-up, it does seem remarkably silly that a micro given the very grand label of a 'music computer' should provide so few concessions to informing the user about its relevant key functions. Why not, for instance, print the relevant musical characters on the front of the keys, as is often done with pre-programmed graphics on other micros?

The other option is a lot more sensible given the problem of identifying key functions, and that's to use the MK01 keyboard for inputting all the pitches. This works extremely well. Indeed, if you're entering a run of notes of the same duration, it's almost like a real-time transcriber, with the notes coming up on-screen virtually as they're played. In addition, you get immediate aural feedback of the note and selected instrument if you've selected the 'monitor' option. And although my first thought on seeing the MK01 was 'ugh', you get to appreciate its compact size when it's got to be sited alongside the CX5M or balanced on the lap in the manner of a detachable QWERTY keyboard. In addition, the MK01 approach to entering pitches is likely to prove marginally more comforting to the musician who's not particularly adept at reading music.

Mind you, fingers do have a habit of getting in a twist now and again, so editing facilities are essential things to have on your side. Those offered by the Music Composer program include the usual 'insert' and 'delete' modes, a bar count that's updated as you move through a part plus a 'goto bar n' feature, and, very useful indeed, a 'copy' feature that enables any number of bars to be copied from one part to another. Play facilities include either playing the entire piece, playing one part on its own, or looping all the parts. It's a shame that Yamaha didn't take this further and allow parts to be played from a particular bar rather than from the beginning. As it is, if you've filled up the CX5M's memory with all 8359 events, the only way you can hear whether an edit or sequence of notes right at the end fits in is by playing the entire piece from the beginning. Boring.

Conclusions: The combination of the Music Composer software and the FM sound module is an extremely powerful composing tool. More than that, it's also an extremely powerful production unit capable of producing multipart music with as much or as little expression and timbral variety as you like. To cap it all, the combination of the Music Composer and the SFG01 is also the most sensible way of dealing with MIDI I've seen so far, because it gets around the problem of trying to send too much

information down a pipeline that's inherently too slow for complex music. And though the MK01 keyboard is a complete no-no for real-time performance, it works well for pitch input, and should help non-reading musicians get used to visualising notes on staves whether or not they choose to avail themselves of the part-by-part printout facility.

But there *is* one very annoying feature, and that's that instruments can't be programmed from within the Music Composer. In fact, the only way of doing this at present is to (takes deep breath) save the piece on tape, whip out the Music Composer cartridge, replace it with the FM Voicing variety (preferably with the power switched off in between!), construct a new instrument, save the entire bank of presets to a clean cassette, repeat all the cartridge operations in reverse, load up the new bank of presets, load up the afore-constructed piece, and then play it.

So, at the risk of repeating myself, I'll make the point again that it would have been a lot more sensible and professional to have scrapped the auto-play side of the FM Voicing software in favour of amalgamating the voice construction side with the Music Composer as a neat, unified whole.

## System Conclusions

The end result of the combination of the SFG01 FM Synthesiser module and the YRM15 Music Composer is almost beyond reproach. Quite simply, it sounds superb. So, in theory at least, the CX5M has every chance of sweeping the micro music marketplace.

But at £599 for the package, I think that's unlikely. The stark reality is that the CX5M is a very ordinary MSX micro transformed into something special by Yamaha's prowess at FM synthesis technology. And whilst that will undoubtedly sway many musicians, I don't see the average computer buff reacting similarly. Of course, if the CX5M were priced at a level more in line with its MSX competitors, Yamaha-Kemble would be swamped with orders. And although it appears that demand for the CX5M will be more adequately met than was the case with the DX7 fiasco earlier this year, it's pretty clear that musicians alone will probably consume all the available supplies.

In short, I both envy and pity Yamaha's position!

Of course, the CX5M isn't actually in the shops yet. In fact, it's not expected until November. What Yamaha-Kemble should do in the meantime is give serious thought to correcting the shortcomings that (a) show the CX5M's music-around-the-fireside (or whatever they have in Japan) parentage, and (b) make it less than a truly professional system for the musicians that they're intending to sell it to.

To start with, the YRM15 Music Composer should be an integral part of the package deal (preferably with some means for constructing instruments within the same software), the multiple key identity crisis should be corrected, alternative key caps with music functions on the front should be provided, and a decent selection of presets and some imaginative demo pieces should be included to show what can be done with the system.

Hardly a radical rethink, but all very necessary if the CX5M is to deserve its 'music computer' label and justify the rather more professionally-inclined price tag. ■

All RFPs are given in the text and are correct at the time of going to press. Further information on the CX5M and its associated software is obtainable from Yamaha-Kemble, Mount Avenue, Bletchley, Milton Keynes, Bucks MK1 1JE. ☎ (0908) 649222.





# YAMAHA

Thinking of buying a **Yamaha Product**? Stop: and answer the following questions before parting with that hard earned cash.

- 1 Does the store you intend to purchase from carry the **complete** range of **Yamaha** products; including **9000 Series Drums, Acoustic/Electric/Bass and Classical Guitars, S250X PA Speakers and MC range of mixers**, those incredible **Power Amps, Home Recording and Producer Series, Digital Reverbs/Delays**, the full range of **Producer Keyboards** including the **MK100** and **PS6100**, the best of **PF Pianos** and not forgetting, everything and anything to do with the high-tech revolution – **DX/RX/CX/QX** and all?
- 2 Do they have **ALL** of the above in stock at most times?
- 3 Can they supply you **Free of Charge** special software/hardware packages with your **DX** purchase?
- 4 Can they also offer you an **Unbeatable Deal** on the **Yamaha** range.
- 5 Does the store believe, and as importantly, can they show, that they are selling the best musical equipment money can buy.
- 6 Are their staff fully trained in **ALL** aspects of **Yamaha** products and can they demonstrate all computer related items.
- 7 Have they a service dept. that can repair virtually anything, in the absolute unlikely event of any **Yamaha** product malfunctioning.
- 8 Can they guarantee you deliveries of '**Hot Products**' – **RX Drum M/C's, CX5 Computer**, and are they offering you important accessories in with the price.
- 9 Do they offer fair part exchange and free mail order.
- 10 Do they appear trustworthy and honest with a total commitment to the **Yamaha** product.

If you can't answer yes to the above, stop and think!

Do you really feel happy about purchasing a truly revolutionary product from a store that could be lacking total commitment to the **Yamaha** cause. If not you should be talking to us. – **ROCK CITY MUSIC ON 0632/324175.**

We are big in every sense of the word where **Yamaha** is concerned and when making your purchase you can feel secure that we regard you the customer, with premier importance. Try us and see if we come up to the test.

**Remember – Rock City** is an institution in the North East. We support the **DX owners' Club, Channel 4 – 'The Tube' – Tyne Tees Television 'Razzamataz'.**

REGISTERED OFFICE: 10 MOSELEY STREET, NEWCASTLE NE1 1DE  
10 MOSELEY STREET, NEWCASTLE UPON TYNE NE1 1DE  
TEL: 0632 324175



# THE FAIRLIGHT EXPLAINED

Part three, and a discussion of how the CMI samples a sound and why its own particular sampling techniques are employed. *Jim Grant*

At last we've covered enough of the CMI basics to concentrate on the more interesting sound creation Pages. Now, the single feature that characterises the Fairlight in many people's minds is its ability to sample natural sounds: this aspect is dealt with by Page 8, and is surprisingly simple to use.

At the rear of the CMI lies a selection of line and mic inputs to suit most applications. That about takes care of the hardware, because everything else is dealt with by software. Typing 'S' or touching 'Sample' with the lightpen initiates the sampling process. After a second or so, the Display box shows the sound envelope for quick monitoring of input levels (see Figure 1). If all is well with the Keyboard Maps on Page 3, the sampled sound will be playable on the music keyboard.

So far so good. But what are the other functions for? Well, some of them are self-explanatory. Sample Level is a software-based volume control and can be used to attenuate signals that exceed the input range of the Fairlight. Unwanted frequencies can be rejected by using digitally-controlled high-pass and low-pass filters: their cutoff points are set by Filter High and Filter Low. The actual circuitry lives on the ubiquitous Master Card, and takes the form of switched resistor networks using the much-loved CMOS 4051 chip.

Whenever a signal is converted to a stream of digital numbers, it's necessary to bandlimit it to one half, or less, of the Sample Rate. Stated simply, this means that we must have at least two sample values of the input signal's amplitude for the highest frequency present. If this condition is not met, the information that the sampling process has captured is not sufficient to reconstruct the original signal without frequency distortion. This type of distortion is known as 'aliasing' and is both extremely noticeable and rather unpleasant. The CMI guards against 'aliasing' by incorporating tracking filters controlled by the Sample Rate.

## Sample Rate

Although sampling itself is very simple, and impressive results can be obtained very quickly, it's well worth the trouble spending some time adjusting the Sample Rate to a value that suits the pitch of the input signal. The sound as played on the keyboard will only be in tune if one cycle of the resulting sampled waveform fits exactly into one segment of waveform RAM. (Remember, one segment is 128 bytes.) This is achieved when the Sample Rate equals the frequency of the input signal multiplied by 128, ie. 128 samples per cycle. Since we can adjust the tuning of the voices on Page 3, an out-of-tune sample is not in itself a problem. However, there is one more important aspect of the CMI that obliges us to pay attention to the correct sample rate.

The number of original samples taken is fixed and equals the length of the waveform RAM, ie. 16384. The faster these samples are taken, the shorter the duration of the sound becomes (although the fidelity increases). This

results in a short sound when the sample is played on the keyboard, and this becomes shorter as we ascend the octaves. To overcome this, the Fairlight allows sections of the waveform RAM to be read out repeatedly (or looped) as the key is held down, thus sustaining the sound. The smallest section of RAM

than can be looped is known as a Segment.

Here lies the crux of choosing a suitable Sample Rate. If we attempt to loop a Segment or group of segments that doesn't contain a whole number of cycles, the 'ends' of the loop won't join up without causing a sudden jump in amplitude. Choosing an inappropriate sample

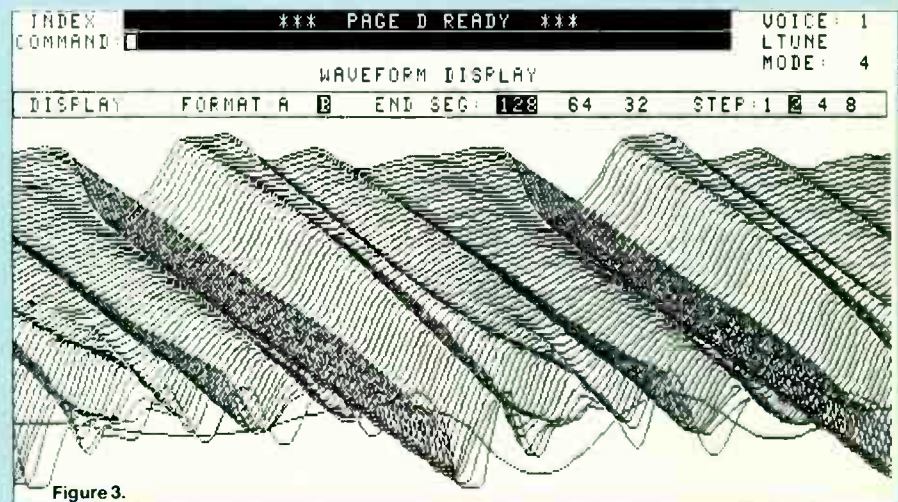
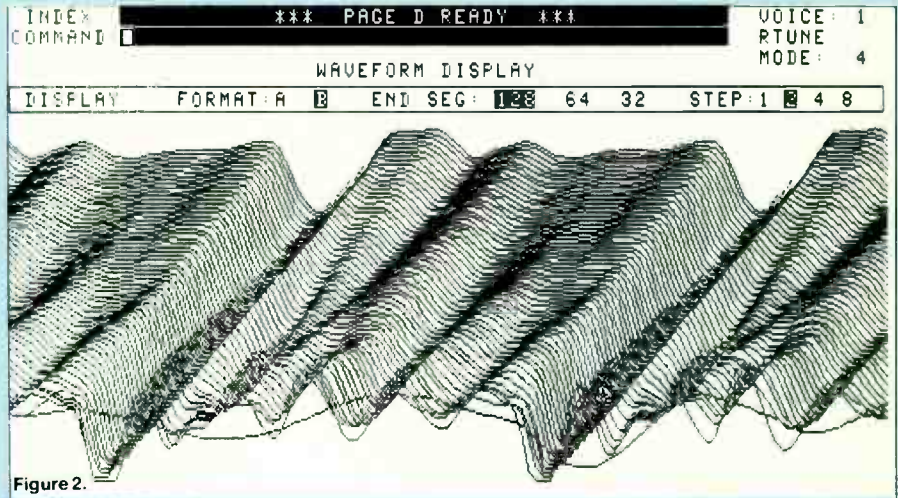
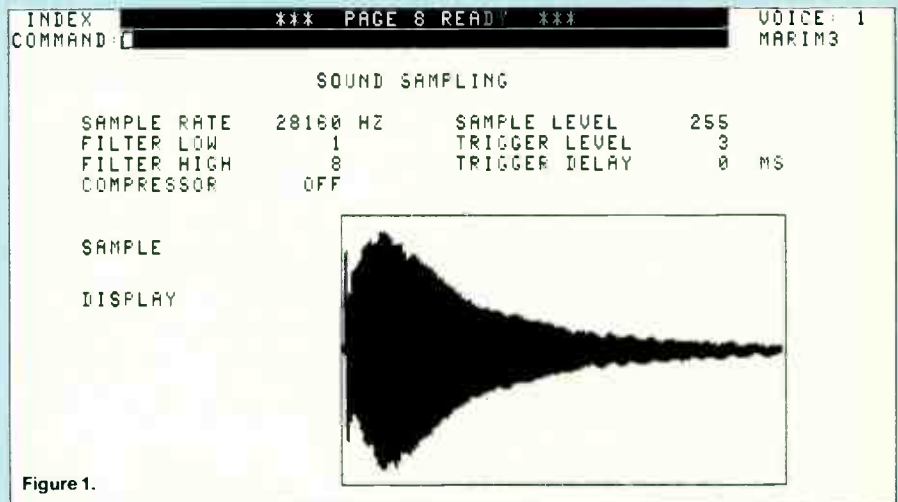



rate results in a dreadful glitch which increases at a rate proportional to the pitch played on the keyboard. If the sample rate is almost right, a one-segment loop produces a sudden slight pitch shift, and waveform crests and troughs 'drift' laterally through a Page D display. This is shown in Figures 2 and 3, where a drift to the right (sharp) is caused by the sample being set too high and a drift to the left (flat) by it being too low.

Figure 4 shows a sound which is in tune with the system and therefore loops perfectly. At the other end of the scale, if the sample rate is totally wrong the display becomes a hopeless jumble (Figure 5). The relationship between a whole number of cycles and each segment of waveform RAM is also the relationship required for a visually coherent display. Thus samples that look good will inevitably sound good, too.

Now, if all this sounds rather complicated and you're beginning to wonder how anyone gets anywhere near choosing the correct sample rate, then take heart. It's all in the help pages for Page 8 - see Figure 6. A useful sample rate table is included, and with a little practice it becomes quite easy to arrive at the correct setting within the space of a few trial samples.

## ADC

The actual analogue-to-digital conversion is accomplished by a 10-bit converter, even though the CMI is an eight-bit machine. Only the top eight bits of the sample values are stored, while the two LSBs (Least Significant Bits) are ignored. This improves the linearity of the conversion, which means that the signal step size required to cause a conversion value to change by one LSB is fairly constant over the range of the ADC.

The relationship between the amplitude of the input signal and the sample values generated is linear. When the signal level changes by a given amount irrespective of the absolute value the conversion code always changes by the same amount. This is where the Fairlight differs from most other sampling machines such as the Emulator. That uses a non-linear conversion method (called 'companding') which allows more codes to be generated for small signal values than for large ones. Whenever a signal is represented by a finite range of numbers - in this case 0-255 (eight bits) - two things suffer: noise and dynamic range. The noise is only heard when a sampled sound is actually being played through a DAC, ie. the ADC and DAC are not in themselves inherently noisy. Making sure that the peak of the input signal causes the maximum ADC code to be generated ensures that most of the noise is masked by the volume of the signal on playback.

The Display box in Figure 1 is an invaluable aid in this respect.

Dynamic range, on the other hand, is a measure of the range of different amplitude values that the ADC can handle. In a linear system, this is directly related to the number of bits used in the process and, roughly speaking, the dynamic range of the sampled signal is 6dB times the number of conversion bits. Since the Fairlight uses eight bits, this gives  $8 \times 6\text{dB} = 48\text{dB}$  dynamic range. Companding techniques result in a larger dynamic range (about 70dB) for the same number of bits used, but at the expense of greater noise at low signal amplitudes. The reasons for Fairlight's choice of a linear converter will become more apparent when we look at the functions on Page 6.

The actual sample rate is very cleverly generated on Channel card 1. Normally, the onboard circuitry is used to generate the

correct clocking rates required for digital-to-analogue conversion when a keyboard note is pressed. However, for the duration of the sampling period the CPU grabs Channel 1, and forces it to produce a stream of pulses at a frequency of 128 times the sample rate shown on Page 8. This is supplied to the ADC, which resides on the Master card, and once the sampling process is finished the CPU restores Channel 1 to its original task.

Trigger Level is the amplitude threshold at which the sampling process is triggered to begin. When the Sample command is given, the system waits until this level is reached before proceeding. Once the threshold has been exceeded, it's possible to delay the conversion by using the Trigger Delay, which has a range of 0-65533 milliseconds. This can be especially useful when sampling from tape, for example, as a tone burst can be recorded

shortly before the signal to be sampled and used instead of the signal itself to trigger the sampling process. Trigger Delay can then be used to define the precise point at which sampling will actually begin. This is extremely useful for sounds with a gentle attack such as slow strings.

Lastly, the Compressor is a software switch which controls a hardware option. Basically, this turns the conversion process into a non-linear system, thus enhancing the dynamic range. The electronics use the same type of circuitry as that in many analogue companding systems. However, very few Fairlights are fitted with this option as it can have a strange effect on the commands on Page 6.

Well, that about wraps it up for Page 8. There isn't room this month for a discussion on Page 7, so we'll have to leave that for next month.

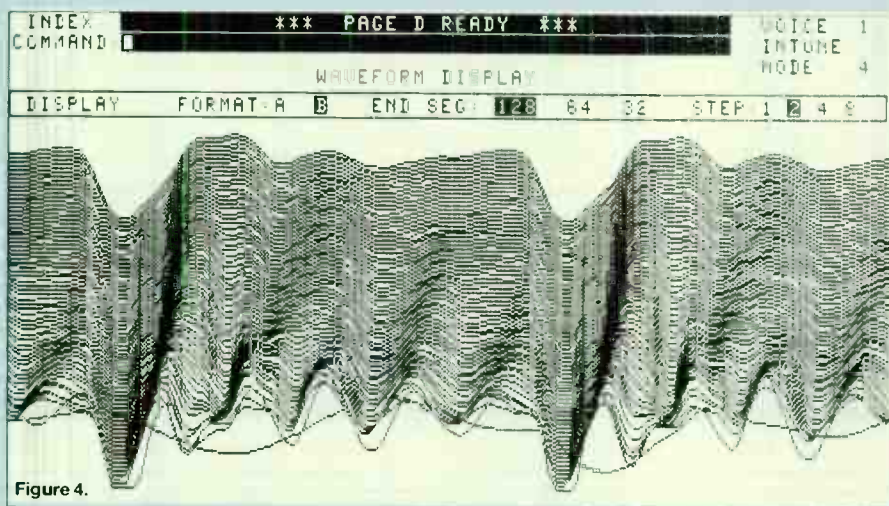

Figure 4.

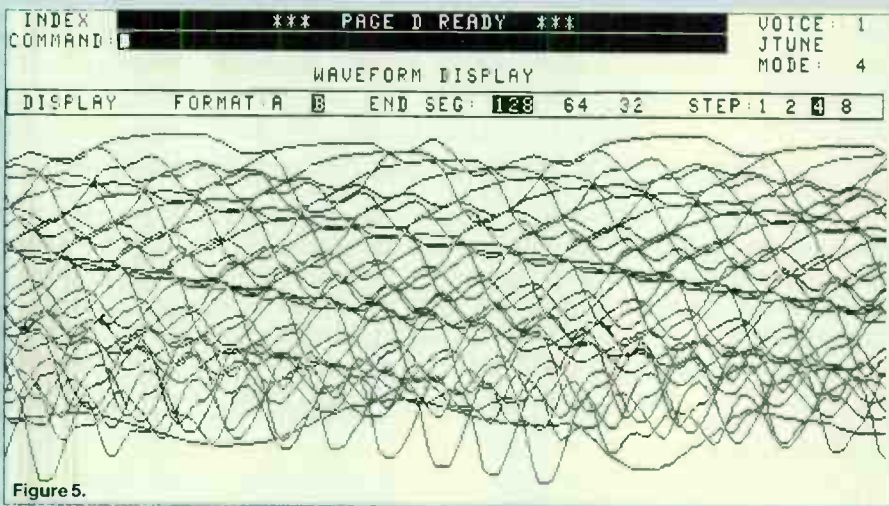

Figure 5.

PAGE 8 PAGE 8 - HELP SHEET 7 of 8 PFE TOP FWD END

SAMPLE RATE TABLE

note	SAMPLE RATES		
	+8va	-0va	-16va
A = 110 Hz	14000	28160	7040
A#	14317	28635	7459
B	15804		7902
C	16744		8372
C#	17740		8870
D	18795		9397
D#	19912		9956
E	21096		10548
F	22351		11175
F#	23680		11840
G	25088		12544
G#	26580		13290

Figure 6.



# WATCH THE AZ-TEC SALES BAROMETER ROCKET THROUGH THE ROOF

aug 84

jan 84

jan 83

MICROPHONE SALES 1984 1st HALF

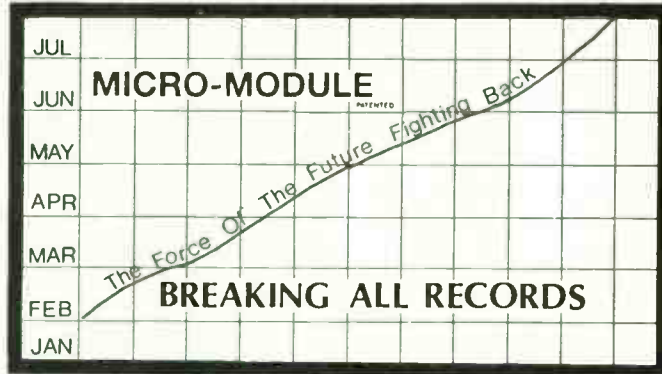

ORDER YOUR

• 1985 •

CATALOGUE NOW

BURSTING WITH

NEW IDEAS!!!

ALL PRODUCTS

MADE IN

U.K. P&P

30p

"THERE'S NOTHING LIKE  
AN AZ-TEC MIKE"

• 1985 •  
Name

AZ-TEC DIRECT SALES • CATALOGUE •

AZ-TEC-MICRO MODULE HI-TEC HOUSE.  
83 Whittaker Lane, Prestwich.  
Manchester M25 5ET

# MIDISOFT 1

Is a Package which consists of an extremely flexible MIDI Hardware Interface along with an advanced Software system for use with the following selected Microcomputers:

**BBC MODEL B, COMMODORE 64, AND ALSO THE HIGHLY ACCLAIMED SINCLAIR QL**

We have observed with interest the growing establishment of the MIDI standard. It soon became clear to us that the software supplied with most currently available MICO/MIDI interfaces is usually adequate but invariably includes compromises which can cause varying degrees of frustration and dissatisfaction with the whole system. We have now drawn upon our expertise in Software design and produced a system which we firmly believe represents current State of the Art in such systems.

Following are some extracts from the full specification of MIDISOFT 1:

**PRICE £189.95 including VAT at 15%**

**HARDWARE** – One MIDI IN, One MIDI THROUGH, and THREE MIDI OUTS Programmable Clock Output for Sync. with other units Clock Input – All events can Sync. to External Clock LED Status Indicators. 8 Fully programmable TTL Inputs and Outputs

**SOFTWARE** – Sophisticated EPROM based MUSIC COMPOSITION LANGUAGE which allows you to create complex POLYPHONIC Sequences in Segments and Chains, assign Sequences to Tracks and then assign Tracks to MIDI Output Channels.

User friendly Editing of Scores from graphically displayed standard Music Staves. Extensive use of default values takes the tedium out of composition.

Transposition to any key, Real time overdubbing, Hardcopy of Music Score for Graphic Printers.

Optimum usage of available RAM with dynamic Sequence allocation.

Many more features such as our Three way after sales support service to ensure you will always have the most up to date and bug free System.

Before you decide on which system to buy, why not send for our free brochure which gives the rest of the amazing specification of the above system. We know you will be impressed.

**CHANNEL 8 SOFTWARE**

51 FISHERGATE, PRESTON, LANCASHIRE. TEL. (0772) 53057

**SEE US AT  
THE P.C.W. SHOW  
OLYMPIA II 19-23 SEPT  
STAND 1312**



# OMDAC UPDATE 2

E&MM's music control microperipheral is already compatible with the Acorn Atom and Spectrum micros, and this month we present two alternative methods of modifying the original design for use with the BBC Model B. *Jim Grant and David Burden*

**N**ext month's E&MM will feature an extensive drum sequencing program that makes use of our OMDAC project, analogue electronic percussion modules (see elsewhere this issue for details of how to turn these into a complete electronic drum kit), and the BBC Model B home computer. However, since the OMDAC was originally designed for use with the Acorn Atom and Sinclair Spectrum micros, some hardware modifications must be carried out before it can be controlled by the Beeb.

Both approaches make use of the BBC's 1MHz bus and the memory page known as 'FRED'. In the first method address line A7 is used to select between the ADC and the 8255 PIA. Of course, this is a terrible waste of I/O space, but that doesn't matter too much if nothing else is mapped into page FRED. Due to the peculiarities of a 2MHz processor controlling the 1MHz I/O bus, Acorn recommend that the circuit shown in Figure 1 be used to 'clean up' the FRED page select. The new addresses are shown in Table 1. ▸



Figure 1.

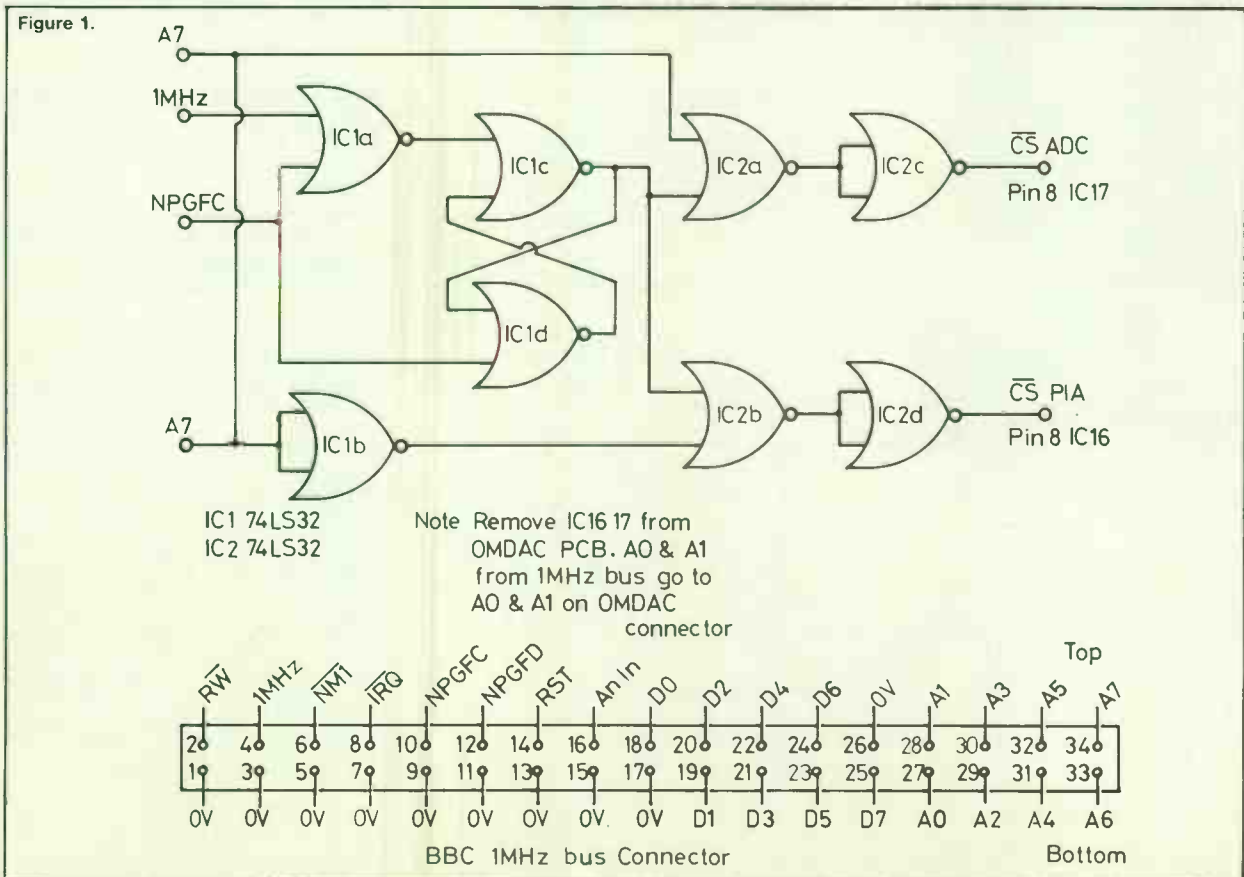



Figure 2.

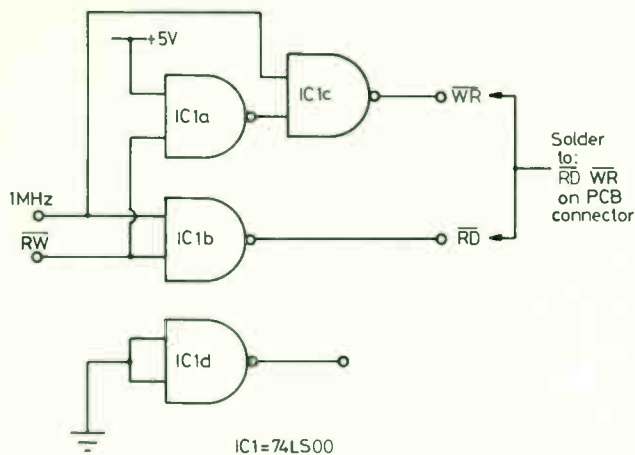

Figure 3.

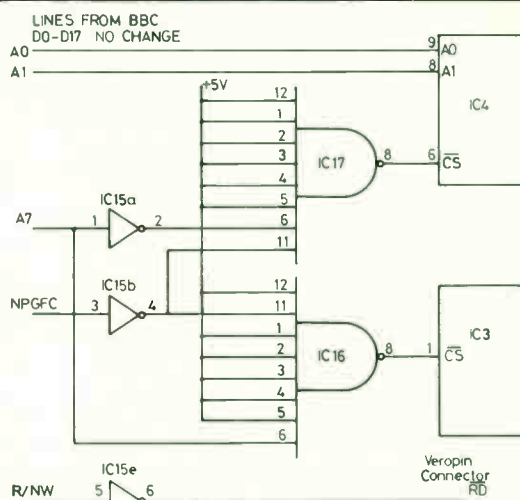

TABLE 1

**BBC ADDRESS SELECTION**

FC00	Part A
FC01	Part B
FC02	Part C
FC03	Control Word
FC80	ADC

**Port Addresses**

Figure 2, meanwhile, shows a simple circuit for generating separate R and W signals for the OMDAC. This is necessary because the 6502 uses a single R/W line while the 8255 PIA was intended for the 8080/Z80 microprocessor family. The best way to incorporate the BBC decoding circuits is to build everything on a piece of stripboard and mount it on pillars inside the case. Remove ICs 16 and 17 and solder flying leads from the stripboard to the OMDAC PCB.

The alternative method involves only a simple rewiring of the logic gates so that they respond to the new addresses. The

modifications required are shown in Figure 3. These put the DAC/VIA side of OMDAC at &FC00 – the bottom of FRED – and the ADC at &FC80.

However, it should be noted that the decoding is not complete, and that further work would be required if any other device were to be used on the 1MHz bus at the same time. To communicate with OMDAC, an OSBYTE call (with A%=146 to read or A%=147 to write) is used. X% holds the offset within the page (0-3 for the VIA registers, 128 for the ADC) and Y% holds the data. ■



## Bound to Please

### E&MM BINDERS

Keep your valuable back issues of E&MM in this attractive blue binder, with the E&MM logo and legend in white on the cover and spine. Price £3.95 each.

Prices shown include VAT, postage and packing. Overseas payments, including Eire, should be made in Bankers Draft in Pounds Sterling. Please allow 28 days for delivery. All items subject to availability.

### E&MM SWEATSHIRTS & T-SHIRTS

All the best people wear E&MM Shirts.

**Sweat shirt size guide:**

S 30-34; M 36-38; L 38-42; XL 40-44.

**T-Shirt size guide:**

3 28-34; M 34-36; L 36-40; XL 40-44.

Send completed coupon with cheque/P.O. to: Mail Order Dept, E&MM, Alexander House, 1 Milton Road, Cambridge, CB4 1UY.

Please send me:

		QUANTITY	PRICE	TOTAL
E&MM Binder (holds 12 issues)			£3.95	
	Red/Black	S/M/L/XL		
Sweatshirt			£5.95	
T-shirt			£2.95	
<b>TOTAL</b>				£

Name .....

Address .....

.....

.....

.....



# XRI SYSTEMS-MICON

## MIDI SYSTEM CONTROLLER

FOR A 48K

# ZX SPECTRUM

Features include:

- **SEQUENCER** – 24,000 EVENTS (8 TRACKS OF 3000)
- **EDITING** – music score displayed – ability to insert and delete notes
- **MIDI RECORD**
- **REPEAT BAR FACILITY**
- **MERGING**
- **SYNC** – 5 volt
- **SAVE** – sequences can be dumped to tape
- **COMPATIBLE** – with most makes of midi synth
- **MULTIPLE SYNTHS** – can be controlled
- **HARDWARE** – plugs into ZX Spectrum
- **DX7/9 PROGRAM DUMP** available as extra **£16.99**
- **PRICE** – Interface and Software – cheques and PO's payable to XRI Systems
- **TRADE** – enquiries welcome
- **ADDRESS** – Dept 1., 10 Sunnybank Road, Sutton Coldfield, West Midlands. Tel. 021-382 6048

**£108**

# Home Studio RECORDING

# Subscribe!

At last! A magazine set to cater for the growing demands of the home studio enthusiast. All the features and reviews, news, interviews and information that you need. With recording technology and techniques changing almost every day, **Home Studio Recording** will keep you informed.

For 12 issues:

UK .....£12.00  
 Europe & Overseas (surface mail) .....£14.00  
 Airmail (Europe only) .....£20.00  
 Airmail (Outside Europe) .....£27.50

Please fill in the form below and send it with your remittance to: **Subscriptions Department, HOME STUDIO RECORDING, ALEXANDER HOUSE, 1 MILTON ROAD, CAMBRIDGE CB4 1UY.**

Please send me the next 12 issues of Home Studio Recording. I enclose a cheque/postal order for £12.00/£14.00/£20.00/£27.50.

NB: Please make cheques payable to Music Maker Publications, and allow 28 days for delivery.

Name \_\_\_\_\_

PRINT OR TYPE CLEARLY

Address \_\_\_\_\_

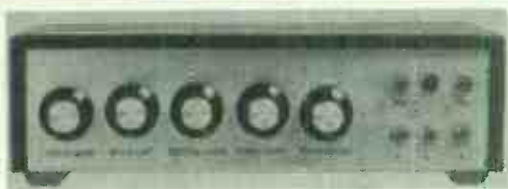

**P.E. ECHO-REVERB,  
 P.E. PHASER AND OTHER  
 SUPERKITS FOR BETTER  
 MUSIC AND EFFECTS**



*P.E. MONO-STEREO ECHO REVERB (SEP84) 200ms echo, lengthy reverb, multi-tracking kit as published – BLK box: SET 218 £55.66*

*P.E. FILTER-SHIFT PHASER (OCT 84). Enhanced Phasing with modulated filter shifting. Kit as published – BLK box: SET 226 £39.13*

PANEL CONTROLLED SUPERKITS	CODE	STD BOX	BLK BOX
BASS BOOST: Increases volume of lower octaves	SET 138B	£8.46	£11.46
BLOW BOX: Voice operated VCF & VCA for fascinating effects	SET 214	£24.33	£28.33
CHORUS UNIT: A solo voice or instrument sound: like more!	SET 162	£31.40	£34.90
COMPRESSOR: Limits & levels maximum signal strength	SET 133	£10.86	£13.86
DIGITAL TO ANALOGUE: 8-bit binary to Ln & Log voltage	SET 176	£23.96	£26.96
ENVELOPE SHAPER: Note triggered ADSR unit with VCA	SET 174	£17.15	£20.65
EQUALISER: Variable combinations of Low, Mid, Top & Notch	SET 217	£22.33	£25.83
EQUALISER: 10 Channels fully variable	SET 134	£37.83	£41.83
FADER: Voice operated with 5 response controls	SET 167	£14.21	£17.21
FILTER: For voice bandwidth enhancement over background	SET 142	£9.23	£12.23
FLANGER: Fascinating music effects, plus phasing	SET 153	£22.74	£26.24
FREQUENCY CHANGER: Tunable note & waveform modifier	SET 172	£34.46	£37.96
FREQUENCY DOUBLER: Guitar octave raiser & tone changer	SET 98	£ 9.80	£12.80
FREQUENCY GENERATOR: Multiwaveform, 0.4Hz-470KHz	SET 128	£19.04	£22.54
FUNKY WOBBULO: Modulates a singing voice	SET 149	£12.40	£15.40
FUZZ: Smooth distortion, retains attack & decay	SET 91	£10.57	£13.57
GUITAR OVERDRIVE: Heavy fuzz with selectable qualities	SET 56	£19.73	£23.23
GUITAR SUSTAIN: Extends note decay time, with noise gate	SET 222	£22.81	£25.31
GUITAR TO SYNTH INTERFACE: With voltage & ing outputs	SET 173	£32.87	£36.37
HAND CLAPPER: Auto & manual variable clap effects	SET 197	£22.69	£25.69
HEADPHONE AMP: 2 watts into phones or speaker, variable	SET 156M	£12.03	£15.53
HUM CUT: Tunable mains hum cut filter	SET 141	£11.26	£14.26
JABBERVOX: Voice disquiser with reverb & tremolo	SET 150	£23.84	£27.34
METRONOME: With audio output & visual beat & downbeat	SET 143	£13.81	£16.81
MIC PRE AMP: Variable gain & switched tone response	SET 147	£7.13	£10.13
MIXERS: Several in catalogue			
MOCK STEREO: Splits mono signal into stereo simulation	SET 213	£19.87	£23.37
MULTIPROCESSOR: Ping, Rvb, Faze, Fuzz, Waf, Trem, Vib	SET 189	£57.14	£61.14
MULTI-WAVEFORM VCO: Log voltage to frequency, switchable	SET 177	£16.98	£20.48
MUSIC MODULO: 8 variable tremolo & wah guitar effects	SET 196	£18.79	£21.79
MUSICAL CALL SIGN: Programmed call sign generator	SET 121	£12.91	£16.41
NOISE GATE: Reduces tape & system noise	SET 145	£9.97	£12.97
PHASER (SIMPLE): Auto & manual rate & depth controls	SET 164	£18.40	£21.90
POLYPROCESSOR: Tremolo, Fuzz, 3 Wah modes	SET 188	£35.40	£38.90
POLYWAH: Note triggered 3 filter wah-wah	SET 171	£14.33	£17.83
REVERB (SIMPLE) Mono/stereo, variable depth & delay	SET 203	£25.54	£29.54
RHYTHM GENERATOR: Computer driven, 9 drum effects	SET 185	£30.64	£34.64
RHYTHM GENERATOR: 15 pre-programmed rhythms, 9 effects	SET 170	£35.64	£39.14

BLK BOX – steel & all, black plastic finish. STD BOX – plain aluminium, lipped lid.  
 DC BOX – robust diecast. SET codes include PCBs, parts, instructions, boxes, wire, solder.  
 More details & kits in catalogue – send S.A.E. (Overseas £11 or 5 IRC's)

RING MODULATOR: Enhances music harmonic modulation	SET 179	£15.76	£19.26
ROBOVOX: Versatile robot type voice modifier	SET 165	£21.03	£24.53
ROGER CALL SIGN: Twin gongs, auto triggered	SET 126	£11.38	£14.38
ROGER CALL SIGN: Single tone auto triggered	SET 127	£9.04	£12.04
SIRENS: Auto triggered by sound or pulse	SET 199	£19.93	£23.43
SIRENS: Manually controlled, constantly varying	SET 151	£13.19	£16.69
SIRENS: Manually variable, incl gun & space type	SET 146	£9.96	£12.96
SPEECH PROCESSOR: Clearer speech and level control	SET 110	£9.68	£12.68
STORMS EFFECTS: Auto & manual wind, rain & surf effects	SET 154	£15.86	£19.36
SYNTH GENERATOR: Auto sine wave 20Hz-15KHz, variable	SET 169	£16.41	£19.91
SYNTHESIZER: 2-oct push sw, variable ES, Freq, Shape, Span	SET 182	£39.76	–
TOM-TOM SYNTH: Sound triggered, multivariable	SET 190	£15.05	£18.05
TOPE CONTROL: Bass, mid, treble, gain & cut	SET 139	£13.17	£16.67
TREBLE BOOST: Increases volume of upper octaves	SET 138T	£8.13	£11.13
TREMOLO: Panned twin output level modulation	SET 102	£22.16	£25.16
TREMOLO: Mono variable rate & depth modulation	SET 136	£9.71	£12.71
TUNING FORK: 96 note audio/visual tuning aid	SET 46L	£29.38	£32.88
VOLUME CONTROLLED FILTER: 12dB, variable modes	SET 178	£17.02	£20.52
VOCODAVOX: Modular vocoder, 7 chans, extendable	SET 137	£23.94	£27.44
VODALEK: Robot type voice modulator	SET 152	£64.31	£68.31
VOICE OP SWITCH: Variable sensitivity & delay	SET 155	£12.44	£15.44
WAH-WAH: Auto, manual & note triggered	SET 123L	£13.41	£16.41
WIND & RAIN: Manually variable effects	SET 140	£17.26	£20.76
WOBBLE-WAH: Oscillator controlled wah-wah, variable	SET 28	£ 9.03	£12.03
	SET 161	£12.60	£15.60

### MATCHED LINKING FOOT SWITCHED STAGE USE KITS

LINKAFEX CHORUS: Variable rate, depth, intensity, feedback	SET 204	£42.96
LINKAFEX DELAY: Delay 10ms-450ms, plus repeat, feedback	SET 206	£42.09
LINKAFEX DISTORTION: Variable level & tone, v. smooth	SET 209	£23.24
LINKAFEX EQUALISER: Low, mid, top, notch, width, 12dB	SET 216	£25.43
LINKAFEX FLANGE: Variable rate, depth, intensity, feedback	SET 207	£34.92
LINKAFEX MODULO: 8 tremolo & wah effects	SET 211	£24.41
LINKAFEX OVERDRIVE: 4 switchable heavy fuzz effects	SET 215	£25.13
LINKAFEX SUSTAIN: Extends note decay, plus noise gate	SET 223	£26.47
LINKAFEX TONE CONTROL: Bass cut, gain, treble cut, gain	SET 208	£24.09
LINKAFEX PHASER: Variable rate, depth, intensity, feedback	SET 205	£34.33
LINKAFEX NOISE GATE: Auto quiescent noise damper	SET 225	£22.80

Add 15% VAT & £1 P&P to all orders (overseas details in cat).  
 Payment CWO, CHO, PO, ACCESS, VISA, or pre-arranged collection.  
 Details correct at press E&OE. Despatch usually 10-14 days.

**PHONOSONICS, DEPT MM50, 8 FINUCANE DRIVE, ORPINGTON, KENT, BR5 4ED**  
**Tel: Orpington 37821 (STD 0689, London 66), Mon-Fri 10-7.**



## COMPUTER MUSICIAN

nome tick, so if you didn't keep up with it, you'll find that your sequence is somewhat transmogrified from the original. For the life of me, I can't understand why Greengate haven't done what everyone else does in this sort of situation, and that's to subdivide the quarter-note event with multiple pulses. The Roland standard of 24-pulses per quarter-note would have done fine, and the DS3 could then have offered degrees of autocorrection to boot. Oh well.

The nominal way of entering the aforesaid events is to trigger the sounds from the first four rows of the QWERTY keyboard. These are set up by another program (called 'Keyboard Setup'), which configures the first ten keys on each row with different sounds and pitches. Whatever 'kit' has been set up on each row will then get piped down its respective channel to the DS3 card.

So, to recap, each of the four channels can be fed with up to ten sounds at pre-programmed pitches. But if you've got the DS3 keyboard to hand as well, all this gets transformed, because these events can then be pitched across a five-octave range, which is great fun. Anyhow, once events have been entered into the sequencer, the next step is to decide what you're going to do with them. Well, while you're thinking about that momentous question, it's wise to put the sequence out of harm's way in one of the nine sequence stores by keying SHIFT plus 1 to 9. Next time round, you can play back that sequence, overdub with a different sound, and then store the overdub as a separate sequence in another sequence store. This can be repeated again and again, but the major constraint is the number of events that can be handled at once, ie. four channels — four simultaneous sounds.

The final stage is to manipulate all the sequences into a nice well-seasoned whole, and that's accomplished by first 'merging' up to four of the stored sequences into a single one, and second, by 'chaining' the composite sequences into a song. So for instance, the merged sequences might look like the following with the sequence chain just running 1 through to 8 in turn:

SHIFT 1	Intro
SHIFT 2	Verse
SHIFT 3	Fill
SHIFT 4	Chorus
SHIFT 5	Break 1
SHIFT 6	Middle 8
SHIFT 7	Break 2
SHIFT 8	Coda

Again, all very easy to understand when it's on paper. And, indeed, it's all very usable in practice — especially when the sync in/out facility (via the Apple's cassette port) is brought into play. So, where's the beef? Well, point one is that all this sequencing involves a lot of key pushing, which is confusing at the best of times. It's a shame, therefore, that the sequencer display merely pre-occupies itself with flashing LORES event blocks at you, rather than telling you what sound is where, which sound is located on the DS3 keyboard, and so on. Point two is that the manual has its own idiosyncratic way with the English language, which doesn't make understanding the DS3 inside-out any easier.

### Conclusions

Where Greengate go from here is difficult to see. They're talking about adding looping (so that the sample sustains when a key is held

down), pitch bend, and all sorts of other niceties, but the problem they're going to come up against is that all these sorts of real-time interactions with playback on four channels use up a fair amount of processor time. Frankly, I don't see how that's going to be possible given the Apple's rather slow processor. Still, proper step-time sequencing should be included in one of the three free software updates they're promising with the system, so that at least should make event entry a good deal easier than the present battle of minds with the metronome.

The MIDI side of the matter is clearly another problem altogether, and I gather that Greengate are giving a MIDI In retro-fit facility serious consideration.

If there are two clear messages that emerged from playing with the DS3, it's that (a) despite the frankly silly omissions in the hardware, it sounds remarkably good, and (b) even though the overall package is pretty impressive when it comes to facilities and flexibility, the software needs more work on the user-interface side. The truth is that however laudable a home-spun product might be, what counts in the final analysis is sheer professionalism, and whether we're talking about the hardware, software, or manual, the DS3 just doesn't quite live up to that requirement.

Let's hope they put it right in the next version!

*The sampling add-on card and software sell for an RRP of £250, while the five-octave polyphonic keyboard is a further £200. Further information can be obtained from Greengate Productions, 24 Missden Drive, Hemel Hempstead, Herts HP3 8QR. Tel (0442) 3496.*

## GREENGATE PRODUCTIONS and "MAINFRAME" announce their Digital Sound Sampling Sequencer, the DS:3. Starting at £250, this APPLE\*-based 4-Voice polyphonic system brings high-quality digital sampling within reach of every musician and studio.

When you buy a Greengate DS:3 you are entering a new world. Not only are you providing yourself with a high quality 4-voice Sound Sampler to match the best around for all-in performance but you are into a new kind of sequencing which is ONLY possible with a full-blown computer system.

The Sampler speaks for itself ... But what Drum Machine or sequencer unit can:

- Give you INSTANT access to 8 individual 4-note polyphonic sequences while playing live?
- Give you INSTANT drop-ins (Or drop-outs!)
- Provide single or multi-sequence triggering?
- Allow synch to or from external source at all times?



- Provide you with COMPLETE records of your song sequences on floppy disc in digital, non-degradeable form? ... AND ...
- Remember the instrumentation details as well as the sequences?
- Let you substitute ANY instrument ANYWHERE in your sequence at any time — live or step...?

We don't know of one. But we DO know that the DS:3 is one of the very best drum sequencers. We have a collectors item 12" record to prove it ... YYY001.

Ask around for a copy ... or send us a PO for two pounds and it's on its way!

Sampling AND Sequencing? For £250?

The Greengate DS:3 does JUST THAT...

# DS:3



GREENGATE PRODUCTIONS, 24 MISSDEN DRIVE, HEMEL HEMPSTEAD, HERTS, HP3 8QR. Tel: 0442 3496



# EMMSOFT

October sees the official launch of EmmSoft, the computer hardware/software marketing division of Electronics & Music Maker.

**E**mmSoft takes under its wing both past micro-based projects and future E&MM software developments. The following guide summarises the EmmSoft projects for which printed circuit boards and software packages are available, and will be updated every other month. All prices quoted are inclusive of VAT and postage and packing – please allow 28 days for delivery. Send your order, with payment in sterling cheque, postal order or bankers' draft payable to Music Maker Publications, to **EmmSoft, E&MM, Alexander House, 1 Milton Road, Cambridge CB4 1UY.**

## MicroMIDI May '83

A single-board serial interface that will link any MIDI synth to the Sinclair Spectrum microcomputer. Features include three parallel I/O ports, crystal-controlled data transfer, and opto-coupled output.

The PCB is available from EmmSoft at £4.25.

## MicroMIDI II July '84

A revised, simpler version of MicroMIDI was published subsequently which

incorporated the same facilities with the exception of the three parallel I/O ports.

The PCB is available from EmmSoft at £4.25.

*As part of the 'Spectrum MIDI' article in E&MM July '84, two software programs were published – a SixTrak Patch Dump and DX7 MIDI Dump – both of which will run on either version of MicroMIDI.*

*A cassette containing an expanded version of Steve Parr's DX7 MIDI Dump program (including a short sequencing routine) can be obtained from SDS, 18 Cambalt Road, London, SW15 6EW, for £5.95 including postage and VAT.*

## OMDAC June '83

The OMDAC, when used in conjunction with a Z80-based microprocessor, will provide eight sets of gate, trigger and control voltages compatible with most one-volt-per-octave synthesisers.

A 'Patch Change' program for the Spectrum was published in E&MM September '84, while the second OMDAC Update (see elsewhere in this issue) enables the hardware to be modified to run on the BBC B microcomputer.

Further OMDAC software is also in the pipeline.

## BeeBMIDI

June & July '84

A MIDI interface for the BBC Model B microcomputer, Part 1 of BeeBMIDI contained the technological and constructional details, while Part 2 continued with a full parts list and some MIDI software routines. The PCB is available from EmmSoft at £4.95.

## BeeBMIDI Software

August '84

A full listing of a comprehensive voice dump program written in BBC BASIC and 6502 Assembler for the Yamaha DX7, with the software also available on cassette (for the sore-fingered) from EmmSoft, price £7.95.

*Further software for BeeBMIDI is currently under development. This will include voice dump and MIDI polyphonic sequencing programs.*

### \* INTERESTED IN THE MUSIC & RECORDING INDUSTRY \*

We have devised a unique recording course designed to enhance the creative aspects of recording music and sound.

The course covers a wide variety of topics including:

**Home Recording \* Live Recording \* Recording in the Studio \* Instruments \* Equipment \* Computers in Music \* Latest Developments in Recording \* Drum Machines \* Vocoders \* Synths \* etc.**

Part of the course is carried out at

**ELEPHANT RECORDING STUDIO, WAPPING, LONDON.**

The Course is designed for those **with or without** experience of recording. Advanced courses are available for studio engineers.

Daytime, Evening & Weekend Courses, now booking for the Autumn.

### PROBLEMS WITH MUSIC ELECTRONICS AND COMPUTING!!

We are a team of qualified and experienced engineers offering the following services to the music industry. Music Electronics

Technical Consultancy, trouble shooting, custom design services, ideas on effective use of electronics in your music. Analogue & digital applications. Computers in Music, hardware applications, software applications, interfacing, programming hints and advice. Why not commission us to write a special program for your music applications.

**ELECTRONICS AND COMPUTING CONSULTANTS TO THE MUSIC INDUSTRY**

Check us out and put your creative mind at rest.

TEL: 01-265 0722 (24 hr ansaphone)  
01-480 6228 or write

## CASS LONDON

Unit 3D, Metropolitan Wharf,  
Wapping Wall, Wapping, London E1

### Advertisers' Index

A1 Music .....	35
ABC Music .....	5
Argents .....	2
Axe Music .....	25
Aztec Ltd .....	88
Broadway Music .....	61
Cambridge Rock .....	79
Carlsbro Sound Centre .....	73
Cass London .....	95
Channel 8 Software .....	88
Chase Musicians .....	1
Chromatix .....	51
Clef Products .....	55
Circolec .....	61
Computer Music Studios .....	61
DDrums .....	55
Dougies Music .....	33
Fane .....	48
Flash St. Electro-Music .....	33
Frazer Wyatt .....	35
Freedmans .....	47
Future Music .....	28, 29, 30, 31
Greengate Productions .....	94
Hammond UK .....	13
Hobbs Music .....	13
Honky Tonk Music .....	17
Jive Records .....	14
Jones and Crossland .....	27
JSG Music .....	9
Labtek International .....	65
London Rock Shop .....	76
Monkey Business .....	7
Music Village .....	18/19
Neve Electronics Int. .....	15
Oxford Synthesiser Co. .....	51
Panasonic UK .....	36, 37, 39
Phonosonics .....	91
Powertran .....	49
PPG UK Ltd .....	56
Rock City .....	85
Roland UK .....	IFC
RSD/Studiomaster .....	24
Sadlers Wells Theatre .....	55
Sequential Circuits Inc. .....	52, 53
Simmons .....	IBC
Soho Soundhouse .....	43
Summerfields .....	IBC
Telecomms .....	23
TLO Records Ltd .....	13
Turnkey .....	21
XRI Systems .....	91
Yamaha .....	71



# CLASSIFIED

Rates for 1984: Lineage 34p per word (min. 12 words); Box No. 80p extra. Semi-Display: £1.00 extra.  
Display: £10.00 per single cm. column.

All lineage advertisements must be pre-paid. Closing date: 5th of month preceding publication.  
Advertisements are accepted subject to the terms and conditions printed on the advertisement rate card (available on request).

## FOR SALE

**POWERTRAN TRANCENDENT DPX**, built in reverb, volume pedal, £250. **PHILLICORDIA ORGAN**, very full sound, stand, volume pedal, £175. St Albans 55005.  
**ROLAND SH101** good condition, £150 ono. Bristol (0272) 678479  
**R.S.D. STUDIOMASTER 8** to 4 mixer as new with four spare channel boards, £550. Also Fostex 2050 line mixer, £100. Phone 889 8463 anytime.  
**WASP** synthesiser, home use only £95. Echotech ET-100 analogue delay £75. Medway (0634) 723097.  
**ROLAND TR606** £130, TB303 £130, MC202 £185. Lowestoft 741238.  
**TEAC 3440, RC-70** remote, RX-9 DBX Model 5 8 into 4 mixer, GBS reverb, cost £2200, home use only, will accept £1500 ono. 01-519 0972.  
**JUNO 6** immaculate condition, still in box, will accept £390 ono. (will haggle). Shrewsbury 67133 work.  
**KORG VOCODER** with flight case £350 ono. (0249) 75300.  
**TEAC** x3 reel-to-reel + **E&MM** compander £150, **ROLAND MC202** + **DIGISOUND** modular synthesiser £350, **E&MM** Omdac components £30. Wantage 4146.  
**TR808**, as new £375. **RHODES** stage 73 £320.  
**PORTASTUDIO 144** £375, little used, all ono. Tel. (0242) 35114 evenings.

## WANTED

**KORG MS-50** wanted, around £150 paid for this expansion unit. (0222) 567850.

## SERVICES

**ENVIRONMENTAL CONSULTANT** sounds to fit your space hire fee: £50.00 per 3 hours. Contact Martin Howard Naylor, 34 Basingham Road, Wembley, Middlesex HA0 4RL.

Introducing **GS RAC-KABS** - Tough protective shells for rack mounting effect units etc. From only £19.95. Custom service available. Details from **GS LOUDSPEAKERS**, 9 Upperthorpe Road, Killamarsh, Sheffield S31 8EQ.

**JAPAN ELECTRONICS BUYERS GUIDE**. Free POB 503, Singapore 9144. Tlx: RS39194AB.

## GATEWAY STUDIO

Home of the Gateway Multi-Track Courses.

We have lots of up to date Gear, Synthesizers, Drum Computers, Digital Effects etc., and the Engineers who know how to interface them Creatively  
Telephone To Book or Visit

01-223 8901



Available now for

### 48K SPECTRUM/16K ZX81

comprising of cased interface plus software packages that include time processor (48K Spectrum/16K ZX81) incorporating:

- ★ Real time harmonizer
- ★ Echo/Reverb with forward and reverse playback
- ★ Double-tracking
- ★ Preset section with remote control facility, save/load etc.

#### THE SAMPLER (48K SPECTRUM)

- ★ Up to 12 samples
- ★ Programmable sequencers
- ★ Control over tempo, repeat, sample speed etc.
- ★ Review, edit, display wave form
- ★ Load save samples/pattern

Digital drum, bass, guitar, voices etc. are all possible. Cased interface with through bus connector, manual etc. £155.00 plus VAT

Software £9.95 inc. VAT each.

Send £1.00 for information brochure (refundable) to:

**INTEC ELECTRONICS**  
42 OLD COLEHAM  
SHREWSBURY SY3 7BU  
CALL 0686 24615/0743 50241



## HI-TECH MUSIC CENTRES

YES, we've got the latest gear you want from **YAMAHA, ROLAND, SCI, KORG** etc. like **DX-7's, PF-15's, JUNO 106, Six-trac, Drumtraks, Poly-800** all on demonstration and available at the right price! Plus **INTERFACES** for **BBC B** and **CBM 64 Computers**, all MIDI'd up and ready for you to try. Call 01-863 1841 for Catalogues, Prices, and Advice.

## City Music

Phone 01-863 1841 for an invitation to our next Midi Synth Show

**NORTH HARROW:** Pinner Rd. 01-863 1841  
**TORQUAY:** 65 Market St. 0803 25488  
**EXETER:** Queen St. 0392 51846  
**PLYMOUTH:** Drake Circus 0752 23011  
**TRURO:** 16 Pydar St. 0872 71359  
**JERSEY:** 8 Esplanade 0534 78901

## MUSIC LAB SERVICE

Officially appointed

## REVOX TEAC/TASCAM Service Agents

A fast, efficient repair service with collection and delivery available

Contact Nikki Antoniou on  
**01-388 5392**

72 Eversholt Street, London NW1 1BY

## Loudspeaker Cabinet Fittings

From Adam Hall Supplies:  
Coverings & frets • flight case parts  
• Celestion power speakers •  
Rean jacks & fittings • P&N stands  
Send 30p PO/cheque for Illustrated catalogue

**ADAM HALL SUPPLIES LTD**  
Unit M,  
Carlton Court,  
Grainger Road,  
Southend-on-Sea  
Essex

Celestion Cabinet Handbook Available NOW Extra **£1**

FOR CLASSIFIED ADS  
RING SANDRA  
ON 0223  
313722

## CLASSIFIED ORDER FORM

Please insert the advertisement under the heading of

.....  
in the next issue of E&MM for.....insertions

I enclose Cheque/P.O. for £.....

Cheques and Postal Orders should be made payable to:

**ELECTRONICS & MUSIC MAKER**

1	2	3
4	5	6
7	8	9
10	11	12
13	14	15
16	17	18
19	20	21
22	23	24

ENTER EACH WORD OF YOUR CLASSIFIED LINEAGE IN EACH BLOCK. COST: 34p per word. Underline words required in bold (add 10p extra per word)

NAME .....

ADDRESS ..... TEL. NO. (DAY) .....

Send this form together with your cheque to: -  
**E&MM CLASSIFIED, ALEXANDER HOUSE**  
1 MILTON RD., CAMBRIDGE CB4 1UY



# THE FINE LINE

In the world of digital signal processors there is a fine line between processors that are "loaded" with features and those that are truly useful processing tools. Carefully designed signal processors have features and functions that are designed to work with each other logically and efficiently. This makes the digital processor easier to understand, to control, and ultimately to integrate into live musical situations.

It is this fine line that separates Ibanez digital signal processors from the competition. Each Ibanez digital processor, from the low-cost, full-function DM500 to the top-of-the-line DM2000, stands on its own as a strong, logical and useful processing system. And each is engineered to be the most cost effective processor in its class. So cross over that fine line to Ibanez digital signal processors—they're on your horizon.



*New tool*

DM1100 is the latest issue of Ibanez digital delay line, relative simple to operate. New setting of maximum delay time, 3,600 mms expands applications dramatically. Ibanez is fully committed to providing professional and amateur musicians with the most powerful range of signal processors. Check out Ibanez and get the right and new tools for your job.

DM1100

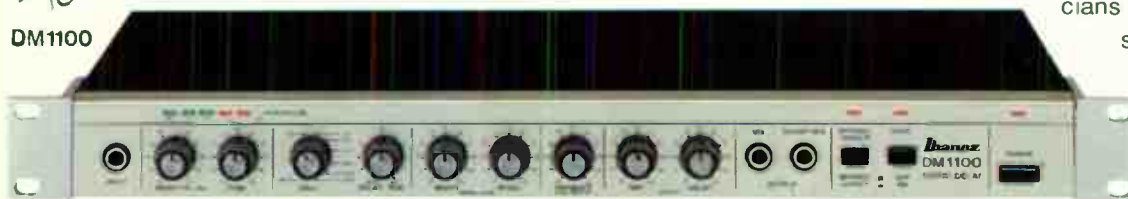

Tomorrow's Innovations  
**Ibanez**

For latest colour catalogue of Ibanez effects send 30 pence to:  
Summerfield (Dept. EMM), Saltmeadows Road, Gateshead, NE8 3AJ

World Radio History



91 STAMFORD RD,

Introducing the Simmons digital sampler and EPROM blower, the SDS EPB.

It can accurately record a percussive sound and if desired, "blow" it into a chip of solid state memory called an EPROM.

Hence owners of the revolutionary SDS 7 electronic drum kit can build up a library of personally sampled sounds to replace those installed in the factory.

The result is a truly creative percussion instrument, totally unique to you.

In the coming months, we will be giving some suggestions of places which provide a rich hunting ground for the "percussive sampler", but in the meantime, here's a good place to start.

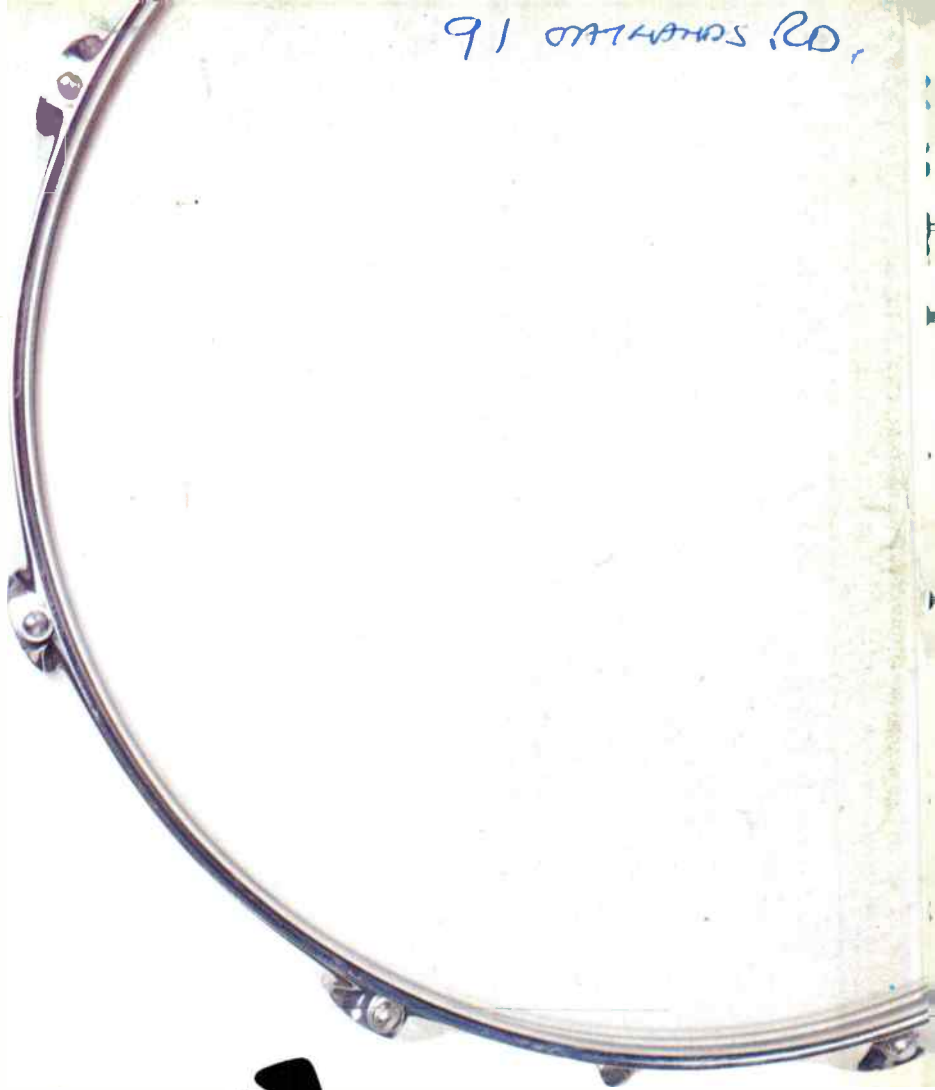

Start Here

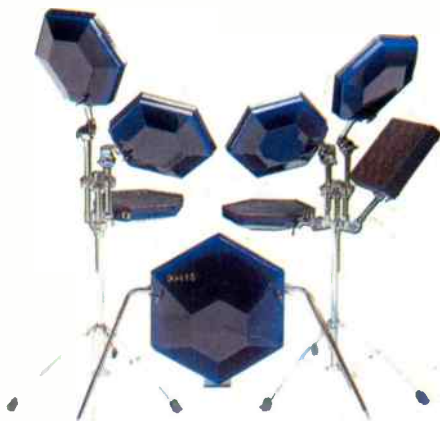
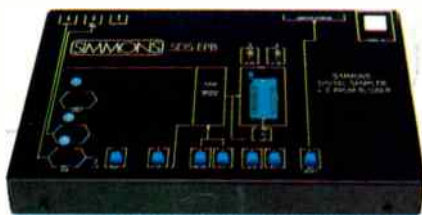

**SIMMONS**

**Electronics Ltd.**

912