

# The Broadcaster & WIRELESS RETAILER

APL. 1925  
NO. 33  
VOL. VI. PRICE 1/-  
7/6 PER ANNUM  
POST FREE  
TO THE TRADE

FORSTER

**Brandes**  
*The name to know in Radio*

*Brandes Matched Tone  
Radio Headphones*

**20/-**  
RETAIL

*Brandes Table-Talker*

**42/-**  
RETAIL

*Write now  
for copies of  
this showcard.*

**Brandes Limited**  
296, REGENT ST., LONDON, W.  
WORKS, SLOUGH, BUCKS.

# YOUR TRADE DEMANDS

## *Energo* PRODUCTS.

### LOW FREQUENCY TRANSFORMER



15/-

This transformer has a reputation built on results. It combines maximum amplification with purity of tone.

Sold under the usual *Energo* guarantee which assures permanent satisfaction.

### HIGH FREQUENCY TRANSFORMERS

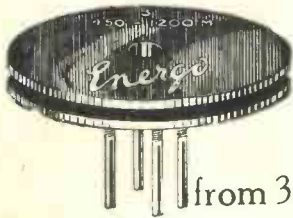

from 3/9 to 5/-

A highly efficient and selective method of high frequency coupling.

*Energo* H.F. transformers are matched and cover all wavelengths, are wound with silk covered wire, are attractive and efficient in design.

### LOW CAPACITY COILS

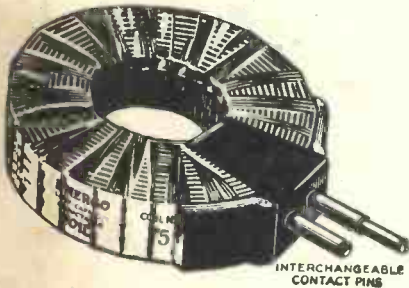

Will give you sharper and more selective tuning. Each coil is air-spaced and mounted in a light weight but rigid method.

USE THEM—NOTE THE IMPROVEMENT.

Wavelengths ranging from 25 to 500 metres at prices from 3/6 to 8/6 respectively.

## THE ENERGO GUARANTEE IS YOUR SAFEGUARD

Write or Phone for List

# Energo Products,

2, OLIVERS YARD, E.C.

Liberal Trade Discounts.

'Phone : Clerkenwell 7360.

Telegrams : Energostrad, Finsquare, London.

Agents for Scotland : THE HUDSON IRVING RADIO CO., LTD., 5, Pitt Street, Glasgow.  
Agents for Ireland : SOLOMON & PERES, 83, Berry Street, Belfast.

Wholesale Stockists  
LONDON : MANUFACTURERS' ACCESSORIES CO., LTD., 85, Great Eastern Street, E.C.2 ; V. ZEITLIN & SONS, 144, Theobald's Road, W.C.1 ; LISENIN WIRELESS CO., 12, Edgware Road, W.2.  
BIRMINGHAM : WINEBERG & CO., 114-118, Pershore Street. MANCHESTER : JOHN MOORES & CO., Raval Street Works, Blackfriars Road, Salford. LEEDS : H. WADSWORTH SELLERS & CO., Standard Buildings. PLYMOUTH : MUMFORD & SON, LTD., 68, Mutley Plain.  
NEWCASTLE-on-TYNE : WATSON'S, 2 Biggs Market.



# Cosmos Components for Efficient Radio Sets

## The Foundations--

of any Radio Receiving Set are sound, efficient and reliable when the tuning circuit embodies the Components shown above.

**Cosmos Strip Inductance Coils** are constructed on a new principle which results in Low Resistance, Low H.F. Resistance, Robust Construction, and Low Self-capacity. With regard to the last feature, a report on an independent test conducted by "The Wireless Trader" (issue March 4th) reads as follows:—

*"Our tests proved satisfactory, for the coil (tested on 377 metres) was found to have quite exceptionally low self-capacity. It was tested at the same time as a well-known and favourite type of plug-in coil, and the decrease in self-capacity was phenomenal, the other coil having approximately thirteen times the amount of self-capacity found in the 'Cosmos.'"*

**The Polar Precision Variable Condenser** is a remarkably Compact, Robust, Dustproof Component with low minimum capacity, low losses, high insulation, and a smooth movement. The last-named feature is so effective that a Vernier plate is really unnecessary, but to provide for those amateurs who require exceptionally fine tuning, a separate Vernier attachment can be obtained. The Polar Precision Condenser is conveniently mounted by means of one hole in the panel.

"COSMOS" STRIP PLUG-IN  
INDUCTANCE COILS are made in the following sizes:—

Coil No.	Inductance. Micro- henries.	Price.	
		s.	d.
20	12.5	4	9
25	25	4	9
35	50	4	6
40	100	4	9
50	150	4	9
75	300	5	0
100	700	6	0
150	1000	6	6
175	1400	7	0
200	2500	7	6
300	5000	8	9
400	9000	9	9

**POLAR PRECISION VARIABLE CONDENSERS** are made in the following capacities, all having the same outside dimensions:—

Max. Capacity.	Price.
	unmounted.
.001 mfd. .. .. .	12/6
.0005 mfd. .. .. .	12/6
.0003 mfd. .. .. .	12/6

Mounted 5/6 extra.  
Separate Vernier Attachment, 3/6.

IT WILL PAY YOU TO CALL THE ATTENTION  
:: OF YOUR CUSTOMERS TO THESE POINTS. ::

**METRO-VICK SUPPLIES Ltd**  
4, Central Buildings, Westminster, London, S.W.1

R  
C8

**ARE YOU MAKING  
THE "COSMOS"  
ADVERTISING CAM-  
PAIGN YOUR OWN?**

The extensive advertising in the national Press of "Cosmos" Universal Valve Sets will bring you profitable business if you are ready with a demonstration set. Apply for details to the Metro-Vick Office in your district. We say "Hearing is Believing." Are you inviting customers to hear (and believe) on your premises?

WHEN REPLYING TO ADVERTISEMENTS PLEASE MENTION "THE BROADCASTER."



UNIQUE CONSTRUCTION.  
MAXIMUM INDUCTANCE.  
MINIMUM SELF-CAPACITY.  
BARE-WOUND.  
AIR SPACED.  
PERFECT SELECTIVITY.  
INFINITESIMAL ABSORPTION.  
EACH COIL TESTED & GUARANTEED.

COIL NUMBER.	PRICE EACH.
25	5/-
35	5/-
50	5/2
60	5/4
75	5/6
100	7/-
150	7/10
200	8/8
250	9/-

PATENT No. 229157.  
(BRITISH MADE)

# SUPER-AIRMAX

(BARE - WOUND)

# TUNING COILS.

**J. DYSON,  
BRADFORD.**

ELECTRICAL & RADIO EQUIPMENT MANUFACTURER.

HEAD OFFICES: 7, GODWIN ST.

TELEPHONES: 6037, 6038 & 6039.

TELEGRAMS: "EQUIPMENT, BRADFORD."

WHEN REPLYING TO ADVERTISEMENTS PLEASE MENTION "THE BROADCASTER."

# LISENIN

## POSITIVE GRIP PLUG AND SOCKET

Pat. Applied for No. 248, 5/1/25.

FROM the accompanying illustration (enlarged) it will be realized that we have evolved a plug of unique and distinctive design, eliminating the use of all small finiking screws, and one that can be assembled in as little time as it has taken to read this. The strands of wire are turned back over the cone section, which is inserted into the recess of the plug and clamped down by the insulated sleeve, which holds it with a vice-like grip. By this means a positive connection is assured, and one that it is impossible to break.



THE "Lisenin" Positive Grip Plug is designed to take the smallest flex up to 5 m/m. cable, and single strand wire from 14 to 40 s.w.g. The metal parts are Nickel-Plated, the insulated sleeves are made in red and black, and red and black indicators are now supplied to fit under the head of the sockets. The sockets are designed to take standard valve legs, thus completing the uniform appearance of panels. Manufacturers are now fitting this wonderful little accessory standard on their new models. If you are a manufacturer it will pay you to investigate its claims. Special quotations for contract orders and to genuine Factors.

Patent Applied for No. 248, 5/1/25.

ELECTRICALLY PERFECT      RETAIL PLUG & SOCKET      **6<sup>D.</sup>** PRICE COMPLETE      MECHANICALLY PERFECT  
33 1/3% TRADE DISCOUNT.

**SPECIAL OFFER for ONE MONTH ONLY**  
TO ADVERTISE THE LISENIN POSITIVE GRIP PLUG & SOCKETS WE WILL SEND, CARRIAGE PAID, A SAMPLE DOZEN ON RECEIPT OF P.O. FOR 3s. 9d.

We can only accept one order from each Trader at this reduced price, but any quantity over one dozen may be had. Orders for Six Dozen and over are subject to a further 5% discount. Remittance in all instances must accompany orders.

**YOU CANNOT AFFORD TO MISS  
THIS SPECIAL OFFER**



# THE LITTLE PLUG, WITH BIG SALES

SOLE MANUFACTURERS

THE LISENIN WIRELESS COMPANY  
CONNAUGHT HOUSE, 1a EDGWARE ROAD  
MARBLE ARCH      LONDON, W. 2

PHONE: PADDINGTON 2734.

CODE: BENTLEYS.

WHEN REPLYING TO ADVERTISEMENTS PLEASE MENTION "THE BROADCASTER."



# “THREE STAR”

## The Best and Cheapest ACCUMULATOR.

No cheap Accumulator as good.  
No good Accumulator as cheap.

Prompt delivery. Price list on application. Special terms for Export.

**THREE STAR ACCUMULATORS, Ltd.**  
ROSEBERY AVENUE, TOTTENHAM, N.17.

Telephone : Tottenham 2473.

A. H. & Co.

### RADIO **BURWOOD** PRODUCTS

“ANVIL” COIL FORMER.

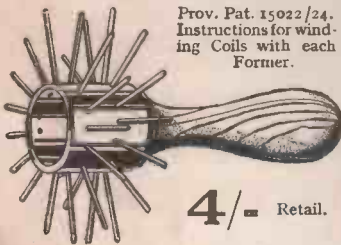

Prov. Pat. 15022/24.  
Instructions for winding Coils with each Former.

4/- Retail.

THE ONLY GENUINE DUOLATERAL FORMER  
Neatly Boxed. A Ready Seller.  
Pins Screw in. Takes 2 in. tube.  
Attractive Showcards Free

PLUGS & SOCKETS.  
RED OR BLACK.

“A Beautiful Job.”



6d.  
each Retail.



British Made. Note spring contacts.

ANTI-CAPACITY VALVE HOLDER.

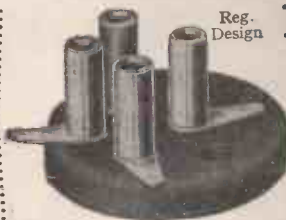

Reg. Design **1/3**  
Retail.

Now in demand.

Anti-Capacity Handle.

**1/3**  
Retail

A “Sight Seller.”  
Are You Stocking It?

Finer Tuning.  
Capacity Reduced to a Minimum.  
Neatly Boxed.  
Shows very liberal margin of profit.  
Write for ALL Lists **TO-DAY.**

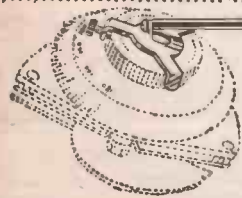

Head Office:  
41, Gt. Queen St., Kingsway.  
Telephone : Regent 666.

IMMEDIATE DELIVERIES.

Wholesale and Export Inquiries Invited.

## Famous “M.J.” Intervalve TRANSFORMER

STALLOY STAMPING. EBONITE PANELS.  
LACQUERED BRASS FEET & TERMINALS.  
NEW IMPROVED WINDING.

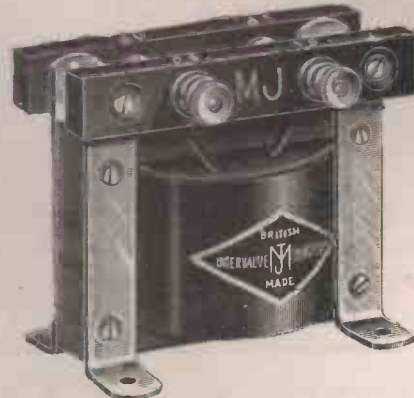

3/6

Shrouded Type.

**12/6**  
Retail Price.

Liberal Trade Discount.

Every one aerial tested and fully guaranteed.

**J. MAXWELL JOSEPH,**  
68, LUPUS STREET, VICTORIA, S.W.1.

'Phone : VICTORIA 4503.

WHEN REPLYING TO ADVERTISEMENTS PLEASE MENTION “THE BROADCASTER.”



# WE AGREE

There are several GOOD LOUD SPEAKERS on the market, but—

## The LINWOOD TYPE P POPULAR MODEL

(for which we are London Agents)

is THE SPEAKER for PURE TONAL QUALITY and FAITHFUL REPRODUCTION of MUSIC & SPEECH.

Volume without distortion. Natural Tone.  
Clarity and refinement.

A LOUD SPEAKER TO SATISFY THE MOST CRITICAL LISTENER.

All Linwood Loud Speakers are fitted with a patent device, the result of scientific knowledge and a thorough experience of Acoustics.

SEND FOR ONE AND TEST AGAINST ANY OTHER LOUD SPEAKER.

LIBERAL TERMS TO FACTORS.

Also all Components for Wireless.

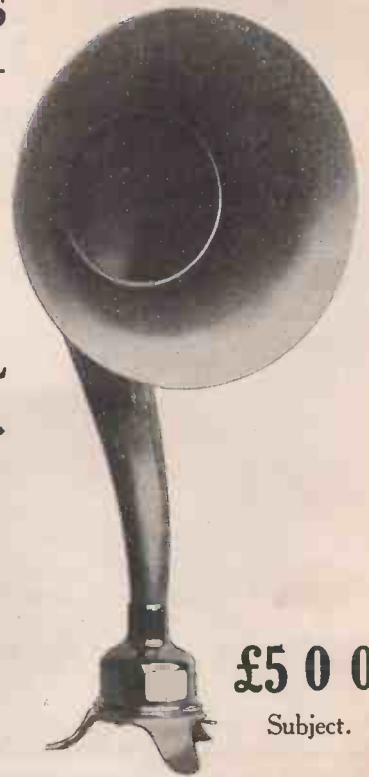

£5 0 0

Subject.

### VERNIER COILHOLDERS.



Perfect adjustment.

2-way ... 4/- each.

3 " ... 6/- "

Subject 25%.

All N.A.R.M goods.  
ELECTRON, Etc.

### A FEW NEW PRICES OF BRASSWORK.

5 gross lots and upwards.

W.O. Terminals, 7/6 gross.	
Telephone " 7/3 "	Best Polished Plating Terminals.
4 B.A. Pillar (small) 6/- "	3, 6 gross extra;
4 B.A. " (large) 7/6 "	Small Parts, 2/6
2 B.A. " 8/6 "	
Contact Studs ... 1/10 "	
Valve Legs ... 4/6 "	
One hole Fixing Bushes, 1/2" x 5/8" 7/6 "	

All Highly Finished Work.



TINNED TAGS for square wire, 1/- gross.

### TURNT & ROLLED THREAD SCREWS.

#### A NEW BASKET COIL HOLDER.



Shorting Switch.

2/6

Subject 33 1/3%. Polished Ebonite.

#### CRYSTALS.

Gil Ray. — Atomite.

T.C.C. CONDENSERS in stock.

SEND FOR COMPLETE LIST OF WIRELESS ACCESSORIES.

Orders for £5 and up carriage free.

Prices nett.

# SYDNEY JONES & Co. (LONDON) LTD.

GERRARD 7441.

DUDLEY HOUSE,  
28, Endell Street,  
LONDON, W.C.2.  
Near Princes Theatre

WHEN REPLYING TO ADVERTISEMENTS PLEASE MENTION "THE BROADCASTER."

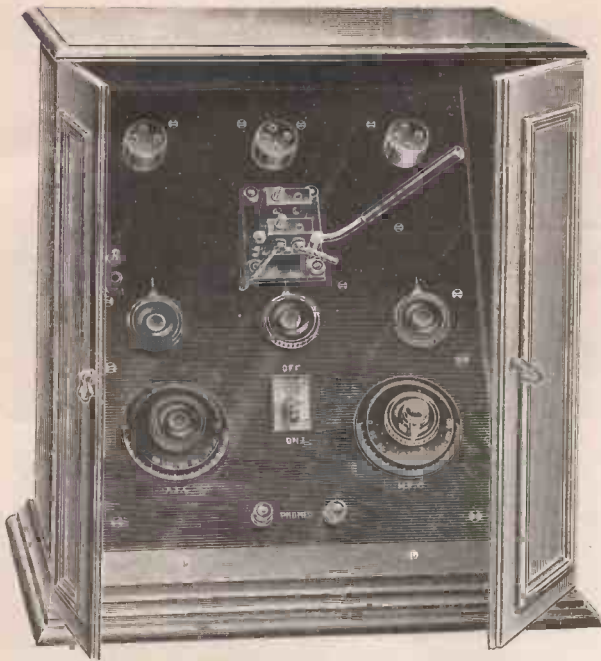

No. 106.  
3-Valve Cabinet Receiver.

## THIS IS A REAL GOOD SELLING LINE

and the Price is right. Only the best Quality Components used in Manufacturing our sets.

We shall also be pleased to quote you for Boxes and Cabinets only. We are known to be the Best and Cheapest House for these in the Trade.

Particulars and prices from:

**H. E. DAVIS, Ltd., 4, South St., London, E.C.2**

Telephone: Clerkenwell 6296.

Telegrams: "Delcoblast, Ave, London."

When a customer calls upon you to supply a perfect

**LOUD SPEAKER**

# SAY "99"

and you will earn his lasting goodwill.

NO Distortion. NON Gramophonic.

**PERFECT TONE  
AMPLE VOLUME**

*Sole Distributors.*

**H. HAYWARD & CO.,**  
Unity Works,  
Malmesbury Rd., Bow, E.

Telephone: East 5636.

**GOODCHILD &  
PARTNERS, LTD.,**  
56, 57, 58, Eagle Street,  
Holborn, W.C.1.

Telephone: Holborn 6406.



**£3 : 10**  
LIST

24" High.

WHEN REPLYING TO ADVERTISEMENTS PLEASE MENTION "THE BROADCASTER."



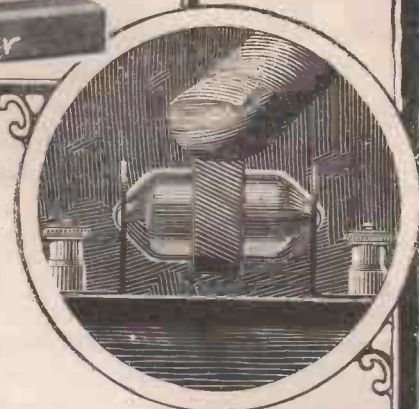

## Out of the welter of exaggerated claims comes the new Gravity Detector

**T**HE Eureka Gravity utilises all the sensitiveness of the catwhisker Detector, but with none of its disadvantages. Its principle is just this: The crystal is held in a cup within the centre of the cartridge. Around the periphery of the case is placed a row of catwhisker points, each one of which is weighted at the head. When the Gravity is rotated these points are caused to drop one by one to make contact with the Crystal. Thus it is only necessary to give the Detector a twist until the loudest signals are heard.

No factory-sealed permanent Detector<sup>1</sup> can ever hope to compare in efficiency with the Eureka Gravity because the user can utilise any favourite piece of crystal known to be absolutely sensitive.

Besides, no crystal lasts for ever—its sensitiveness is bound to fall off in time. In any case, the present immense popularity of catwhisker contact is proof positive that any double-crystal combination is of little value under present-day conditions.

To change the crystal in the Gravity is but a moment's work. Just lift it from the spring clips, separate the two halves, lift out the old crystal and drop in a new piece, and the job is done. Quicker in fact than describing it. And the crystal is protected against dust, fingering and light.

The Gravity Detector contains far more selling points than any other Detector on the market. Huge sales will result from our extensive advertising. The simplicity and efficiency of the Gravity will appeal to all—one does not have to be an expert to appreciate its wonderful advantages of design.

Place your order to-day and link up with our advertising in all the Wireless Magazines.

Portable Utilities Co., Ltd.,  
Makers of the Eureka Transformer,  
Fisher Street, London, W.C.1.

### Six advantages you get with no other Detector.

1. The Crystal is firmly held in a spring cup and the moving points fall to make contact with it as the holder is rotated.
2. When the Gravity Detector is in use the Crystal is fully enclosed and protected from dirt.
3. The Gravity Detector can be reloaded with a new crystal in a moment. Nothing to unscrew or solder.
4. The slightest turn of the Detector automatically brings into use a new spot on the crystal and a new contact point.
5. Nothing to wear out—the Gravity Detector will last a lifetime.
6. Stout plated spring clips are supplied, and the base can be removed for fitting the Detector direct to the panel.

Complete with Crystal.

6/6

**EUREKA GRAVITY** Detector

Gilbert Ad. 2429

The **Classiest**

# DIALS

FOR SETS AND CONDENSERS are

## “MANDEM”

made of REAL

## EBONITE

**Largest sale in the world. Sold at the same price as ordinary common or garden moulded dials. 50% greater value. Always the same—if used at the Equator or in the Antarctic. BRANDED “Ebonite 1000.” Price £2 5s. per 100 or £3 5s. per gross. Sample free on request. Cash with order saves delay. Money back if dissatisfied. 100,000 in stock.**

Sole Distributors:

**McLEOD & McLEOD,** 329, HIGH HOLBORN, LONDON, W.C.1.  
 EXPORT inquiries invited. Phone: Holborn 1092

# “PLATINITE”

The **KING** of  
 Wireless **CRYSTALS**

Known all over the world as the supreme Crystal for fullness and clarity of tone.

Agents for

<b>SWEDEN</b> Messrs. <b>GRAHAM BROS.</b> , Engineers, Stockholm.	<b>AUSTRALIA</b> Mr. <b>A. MAC DONALD</b> , 190, Punt Street, Prahran, Melbourne.
<b>ITALY</b> Messrs. <b>Meya-Rocchi</b> , Via Bigli 12, Milan.	<b>SCOTLAND</b> <b>F. LORIMER</b> , 70, Wellington Street, Glasgow.

**THE PLATINITE CRYSTAL CO.,**  
 (Proprietor J. W. COX, M.P.S.)  
 STRATFORD ROAD, BIRMINGHAM, ENGLAND.



RECP N° 457042

## Taking the Guess Out of Radio

Every individual **THERLA** Condenser tested and guaranteed by Faraday House.

Sell a reliable fixed condenser and radio becomes a great guess. Insist upon selling **Therla** Fixed Condensers and take the guess out of radio. You sell, not an arbitrary guaranteed capacity, but **Tested Capacity**. Therein lies the great advance from mass production with its inaccuracies to laboratory and scientific building.

Use the **Therla** Grid Condenser; the **Therla** across I.P. and O.P.; the **Therla** across the Telephones; the **Therla** for Constant Aerial Tuning; the **Therla** wherever a fixed condenser is employed. The **Therla** is more than accurate—it is tested capacity.

Sell the **Therla** Fixed Condenser and you sell a standard condenser of tested and proved capacity.

The plates are composed of brass foils specially prepared and, only the finest selected Indian Ruby Mica is used; consequently the dielectric losses are negligible.

They have been tested at 1,000 volts and are equally suitable for ordinary reception purposes and transmitting work.

By the special method of assembly, moisture is entirely eliminated.

<b>PRICES</b>	.0001 mfd. to .00015 mfd. ...	1/3 each
	.002 mfd. to .006 mfd. ...	2/- each.
<b>SUBJECT TO:</b>	6 doz. 1 gross. 5 gross. 20 gross.	25% 33 1/3% 40% 45%

IN ASSORTED CAPACITIES.

Contracts accepted for 20 gross lots, assorted, over a period of 6 months.



Sole Distributors:

**Sel-Ezi Wireless Supply Co. Ltd.**  
 6, GREEK STREET, LONDON, W.1. Regent 1140  
 20, OLD HAYMARKET, LIVERPOOL. Royal 1682

(Barclays Ad. 927).

Telephone: MIDLAND 2385

**S. LILLEY and SON**  
 80, Alcester Street, Birmingham

**HIGH-CLASS WIRELESS ACCESSORIES**  
 GOLD LACQUERED AND PLATED



NEARLY PACKED IN SEALED RED BOXES,  
 WRITE FOR LISTS AND SAMPLES

YOUR STOCK  
 ASCERTAINED  
 AT A  
 GLANCE

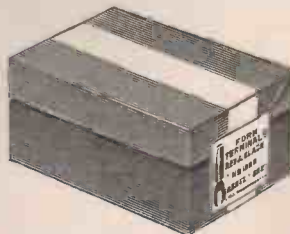

DISTRIBUTION  
 SIMPLIFIED

MANUFACTURERS TO THE WHOLESALE TRADE AND EXPORT ONLY.

WHEN REPLYING TO ADVERTISEMENTS PLEASE MENTION “THE BROADCASTER.”

**TWO  
GOOD  
LINES**

# For the Summer Season

This introduces two more good Electron lines — Loud Speaker and Telephone Extensions, etc.—in 300 ft. and 500 ft. boxes. They mean quick sales, good profits and big business, because they will be in big demand.



OF

## LOUD SPEAKER and TELEPHONES

NOTE.—This wire is of smaller gauge than the aerial wire—much more flexible—perfect quality and fully guaranteed.



**OUR EXTENSIVE  
ADVERTISING  
WILL BRING YOU  
BIG BUSINESS...**

PRICES for	Retail	Singles	1 Dozen	3 Dozen	6 Dozen
300 ft.	5/-	15%	20%	25%	33 $\frac{1}{3}$ %
500 ft.	8/-	15%	20%	25%	33 $\frac{1}{3}$ %

CARRIAGE PAID.

**POST YOUR ORDER TO-DAY.**

NOTE OUR NEW ADDRESS:

**NEW LONDON ELECTRON WORKS, LTD.**

(Members of the B.B.C.)

**EAST HAM, LONDON, E.6.**

Telephones: East Ham 1408 (Private Branch Exchange).

Telegrams: "Stannam, London."

(About 2 miles East of Blackwall Tunnel.)

Buses: 40, 101, 23, 5, 15.

District Railway: Upton Park Station.

WHEN REPLYING TO ADVERTISEMENTS PLEASE MENTION "THE BROADCASTER."

# This is an unusual Advertisement

Extract from an Article in  
 "Wireless Weekly," Feb. 25th, 1925.

"THE latest reports from the United States indicate that there is a tendency towards using accumulators and home-battery chargers for the supply of low-tension current to sets in the place of dry cells which have proved such an unsatisfactory substitute. I am glad to hear of this, as I am sure that in this country it is time manufacturers ceased to talk glibly about how easily sets can be run from dry batteries only when dull-emitter valves are used. It is true that with the '06 ampere type of dull emitter the current required is extremely small, but this very fact makes it unfair to talk about dry cells replacing large, hefty accumulators. A low-consumption valve requires only a small accumulator to run it satisfactorily, whereas the dullest of dull emitters requires quite a big dry cell to give a satisfactory discharge rate. To run a single '06 amp. valve satisfactorily requires three dry cells, each at least as large as the round cell with which we are familiar in connection with bell ringing. Then, again, it is not made sufficiently clear to the purchaser that the cost of the dry cell is no mean item in his annual expenditure. I have just been looking over a list of dry batteries recommended by one of the leading makers for filament lighting of dull-emitter valves. The size of cells recommended for one or two '06 amp. valves costs 9s., while for two or more valves not exceeding '3 of an ampere in all, the cell recommended (by cell here I really mean a combination of three cells to give the correct voltage) costs 1s.

you require two 2-volt units. One well-known maker sells a special dull-emitter accumulator which costs 5s. per cell; thus the cost would be 10s. for the two. It will supply three '06 amp. valves for fifty or sixty hours' continuous running without a recharge. Another maker supplies an unspillable cell no bigger than the ordinary electric bell-ringing dry battery for 12s., so that two of these cost 24s. You can easily slip them into an attache case next time you are passing the accumulator charging station, while, if you live in a country district, you can send them by carrier to the nearest town without any fear of the acid being spilled.

"Now that good small accumulators are available for dull-emitter work, it is definitely cheaper to use accumulators, for the cost of the charge is negligible compared with the cost of new dry cells, and the dry cells when discharged cannot be recovered or recharged in any fashion.

"Personally I consider one of the great disadvantages in using dry cells to light the valve filaments is that the voltage steadily drops and the filament resistances have to be readjusted from time to time to make up for this drop. Unfortunately, however, an adjustment which is good last thing at night will be inaccurate for the following evening, as during the night and day time the voltage will have recovered somewhat. Accumulators, on the other hand, preserve a steady voltage until they are practically discharged, when they have a fairly rapid drop which gives the necessary warning."

\* \* \* \* \*

"Now contrast this with the small accumulator which gives adequate current in working conditions. To run this particular type of valve

**I**N view of the strong Editorial comment above, it is easy to see why the Wuncell idea of a Dull Emitter—a Valve operating at 1.8 volts and drawing .3 of an amp.—is rapidly coming to the forefront.

All Cossor Advertisements are highly educational, and because they are educational they are good salesmen for you.

In order that you should thoroughly understand Cossor Policy we ask you to read the series of Wuncell advertisements now appearing in all the Wireless Magazines. You'll then be in a better position to advise those of your customers who want to know which Dull Emitter to choose.

A typical Wuncell advertisement is printed on the opposite page.

Dealers whose names are on our Mailing List receive regularly, free of charge, Giant Advertisements and Window Display material.

— and now read the opposite page . . .

WHEN REPLYING TO ADVERTISEMENTS PLEASE MENTION "THE BROADCASTER."



# Cossor discards the Dry Battery

**T**HEORY and practice—even in wireless—cannot always be said to progress hand in hand. Apparatus or circuits which according to all the laws of physics or electricity should perform perfectly frequently fail to function as they should. Such a case in point is the use of Dry Batteries with Dull Emitters.

\* \* \* \* \*

When the first Dull Emitters were placed on the market a new era was prophesied in which dry batteries would take the place of accumulators. That, at present, there is no likelihood of this being realised must be apparent to all clear-thinking wireless enthusiasts.

\* \* \* \* \*

Time and again it has been proved that unless the dry battery is very large—and consequently expensive—it cannot possibly cope with the requirements of several Dull Emitters in use at one time. You should remember that the working of a Valve—whether rectifying or amplifying—is a very delicate operation. The filament current must be absolutely constant, otherwise electron emission will vary and upset the whole balance of the Receiver.

\* \* \* \* \*

Dry batteries are not built to give a constant output—they were originally developed for ringing bells and other intermittent work. They have to generate their own electricity, and in so doing are apt to polarise. Their output fluctuates: at first it is high and then it falls off. All the time you need to keep constantly adjusting the rheostats to be getting the best results.

\* \* \* \* \*

But compare them with the small accumulator. No matter whether you use an accumulator for five minutes or five hours its output is perfectly constant. It does not generate its own electricity—it merely stores it against demand. For economy, too, the little portable accumulator stands supreme. A small initial cost and a few coppers every few weeks is all you need to spend if your Set is equipped with Wuncells.

\* \* \* \* \*

On every side there is marked evidence that the most popular type of Dull Emitter is the new Wuncell—the Dull Emitter that does not rely on an excessively fine filament and a dry battery of uncertain reliability; the Dull Emitter that possesses a filament every whit as robust as that used in a bright emitter—a filament, moreover, that operates at the dullest of dull red heat; the nearest approach, in fact, to the cold valve that has yet been evolved.

Wuncell exclusive advantages featured:  
No. 3

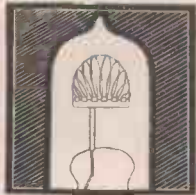

**A**N inherent disadvantage of all Dull Emitters—previous to the introduction of the Wuncell—has always been the annoyance of microphonic noises. A touch on the receiver, a tap on the table, or even footsteps across the room, have often caused the valves to transmit loud ringing noises to the phones or loud speaker.

This cannot happen with the Wuncell. Its rigid filament—arched and supported at its centre by an additional electrode—in combination with the world-famed Cossor Grid precludes the possibility of any undesirable noises being created. This is but one of the many exclusive Wuncell advantages fully described in the large illustrated Folder to be obtained free of charge from any dealer—or from us on receipt of a postcard.

**Prices :**

- W.1 For Detector or L.F. Amplifier
- W.2 (With red top) for long distance reception

18/- each

- W.R.1 Corresponding to W.1
- W.R.2 Corresponding to W.2

20/- each

\*Fitted with internal resistance so that Valve can be used with 2, 4, or 6-volt Accumulator without alteration to Set.



# Cossor Wuncell Valves

THE ONLY DULL-EMITTER VALVES SOLD IN SEALED BOXES

Advertisement of A. C. Cossor Ltd., Highbury Grove, N.5

WHEN REPLYING TO ADVERTISEMENTS PLEASE MENTION "THE BROADCASTER."

# The Royal

There are no shelf lingerers amongst these Royal Radio Products. Consistent advertising and first-rate quality have created a big demand for them. We invite your further enquiry.



No. 245D.

### BURNS LOUD SPEAKER.

This Speaker is an instrument of extreme sensitiveness, yet is capable of great volume and harmony. The quality of reproduction is of remarkable clearness and instantly attracts attention. The volume of tone surpasses that of many higher priced speakers. The shape of the bell has been designed to give best acoustic results, as also has been the selection of the materials, the aluminium sound column and pyralin bell being practically non-vibrating.

- No. 245D. Black Bell. List Price... £5 10s.
- No. 245D. Transparent pyralin Bell. List Price... £6 10s.



No. 5052.

### ROYAL PLUGS AND JACKS.

- |  |      |
|--|------|
|  | Each |
| 504 M. Open circuit Jack                     | 2/6  |
| 5050 M. Closed circuit Jack                  | 3/6  |
| 5052 M. Double circuit Jack                  | 3/6  |
| 5051 M. Filament Control Single Circuit Jack | 3/3  |
| 5053 M. Filament Control Double Circuit Jack | 3/9  |
| 256 M. Royal Plug                            | 1/6  |

### ROYAL RHEOSTATS.

Royal Rheostats are the highest grade filament controlling units obtainable. Beautifully made components which give perfect filament control.

- |  |      |
|--|------|
|  | Each |
| Royal Bakelite Rheostat, 6 ohms          | 5/6  |
| Royal Bakelite Rheostat, 35 ohms         | 5/6  |
| Royal Bakelite Vernier Rheostat, 6 ohms  | 6/9  |
| Royal Bakelite Vernier Rheostat, 35 ohms | 6/9  |
| Royal Bakelite Potentiometer, 400 ohms   | 6/9  |
| Royal Metal Rheostat (Vernier) 6 ohms    | 4/3  |
| Royal Metal Rheostat (Vernier), 35 ohms  | 4/3  |
| Royal Metal Rheostat, 6 ohms             | 3/3  |
| Royal Metal Rheostat, 35 ohms            | 3/3  |
| Royal Metal Potentiometer, 400 ohms      | 3/3  |

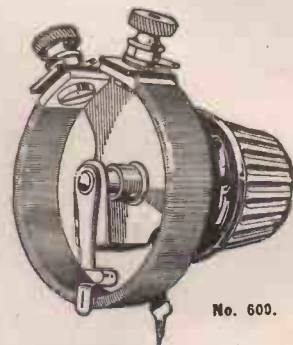

No. 600.

### ROYAL VALVE CONTROL UNIT.

Being Vernier Rheostat and Potentiometer combined on one spindle. Rheostat 6 ohms or 35 ohms. Potentiometer 400 ohms. Bakelite throughout. A very valuable addition to any set. Saves panel space.

- LIST... each 8/9

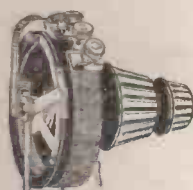
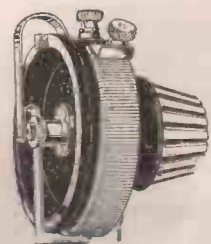

Royal Control Unit.

### ROYAL SWITCHES.

- No. 75 Y Switch (Black) Single Toggle, LIST PRICE... 2/-
- No. 75-3 Y Switch (Nickel) Single Toggle, LIST PRICE... 2/6
- No. 83 Y Push Pull Switch, N.P... 2/6
- No. 77 Y Push Pull Switch, black... 2/-
- No. 83-5 Y Push Pull Switch, single hole mounting... 2/6
- No. 55 Y Switch, 2 gong toggle (black) at LIST PRICE... 4/-
- No. 55-3 Y Switch, 2 gong toggle (nickel) at LIST PRICE... 4/6

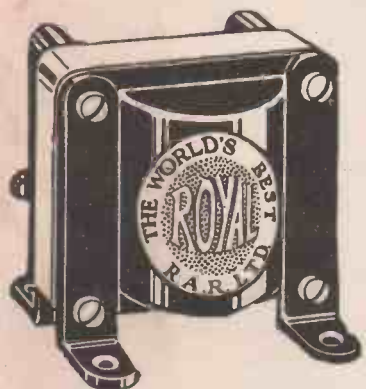

Explaining the great performance of the ROYAL L.F. Transformer. ROYAL Transformers are perfectly matched. The Inductance, resistance, reactance and impedance factors are as nearly alike as scientific manufacturing methods can make them. ROYAL Transformers have the comparatively low ratio of 4 1/2 to 1. But because of their ability to amplify fundamental frequencies and all higher harmonics with such remarkable equality, they cannot possibly introduce any distortion in either the first or second stage.

Retail Price, £1.  
Special discounts to manufacturers.

Barclays 960.

**ROYAL**  
The Mark of Sovereign Quality

**R. A. ROTHE**  
Manufacturers and Wholesale  
24-26, Maddox St

Telephone

WHEN REPLYING TO ADVERTISEMENTS PLEASE MENTION "THE BROADCASTER."

# Route

To cope with repeated requests from the Trade, we have now opened a special department to handle High-Class American Apparatus. A few terms are listed below.

We shall be pleased to forward particulars of our complete range of components, which include Super Heterodyne, Tropadyne, Ultradyne and Neutrodyne Kits, together with all types of Low Loss Condenser Coils, etc.

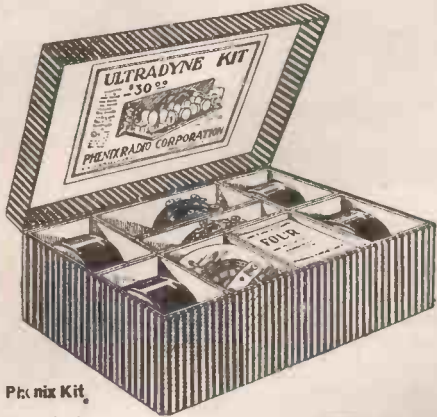

Phenix Kit

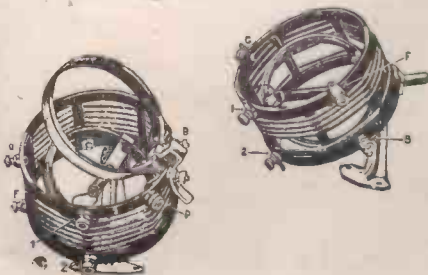

Bremer Tully Apparatus.



Heath Condenser



Haynes Griffin Transformer.

### THE TROPAFORMER.

The Royal Tropafomer is a long wave transformer designed for use in the Tropadyne and Super Heterodyne circuits. It has a tunable wave range of 2,000-10,000 metres. List Price, 35/- each.

### TROPADYNE KIT.

Contains four Tropafomers, improved type oscillator coupler and tuner, together with circuit diagram drilling template and complete instructions for building the Tropadyne receiver. List Price, £8 6s. 8d.

### PHENIX ULTRADYNE KITS.

The Ultradyne is an improved Super Heterodyne. The Phenix Ultradyne Kit consists of:—1. Special Low Loss Oscillator Coupler 180° with copper shield. 2. Oscillator Coils. Low Loss Design. 3. Low Loss Aerial Tuning Coil. Wave range 200 to 600 metres. 4. 1 type "A" Ultraformer and 3 type "B" Ultraformers. List Price of kit complete, £8

### APEX GEARED VERNIER DIALS.

The Apex Geared Vernier Dial provides the vernier control so essential to easy and selective tuning for long-distance stations. It can readily be adapted to any Condenser shaft. As used by Mr. T. W. James in "The Wireless World" Super-Heterodyne, described in the issue of March 4th. Made in two finishes— Each

- Royal brass and black... .. List price 10/6
- Set in silver and black... .. List price 13/6

### BREMER TULLY APPARATUS.

Bremer Tully Low Loss Bank Wound Tuners and Oscillator Couplers are famous the world over. Made in two types:— Type B, 200 to 565 metres. List Price, 26/6 each. Type SW, 50 to 150 metres. List Price, 26/6 each. The B.T. Oscillator Coupler is suitable for use in any circuit where an oscillator coupler is employed. Pickup rotor coil can be locked in position. List Price, 22/6 each.

### COCKADAY COILS.

The authorised Cockaday Coil built in accordance with Cockaday's specifications. Tapped at 1, 3, 7, 13, 21, and 43 turns. For use in four circuit tuner and other receivers. List Price, 29/6 each.

### THE ROYAL HEATH LOW LOSS CONDENSER.

Strictly low loss made in following capacities with or without dial:—  
 No. 11A. .00025 plain .. .. each 21/6  
 No. 23A. .0005 plain .. .. each 24/6  
 No. 43A. .001 plain .. .. each 28/9  
 No. 12A. .00025 Vernier .. .. each 26/6  
 No. 24A. .0005 Vernier .. .. each 28/9  
 No. 44A. .001 Vernier .. .. each 34/-  
 Prices include dials. Without dials, 3/- each less.

### HAYNES GRIFFIN TRANSFORMERS.

Haynes Griffin Intermediate Wave Transformers are specially suitable for use in Super Heterodyne Receivers. They are sold only in matched sets of four, consisting of one in-put and three inter-stage transformers. Used in an intermediate amplifier the amplification peak of Haynes Griffin Transformers using bright valves will be at about 2,000 metres. Set of four .. List Price £5 5s.

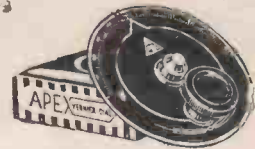

Apex Geared Dials.



Cockaday Coil



### THE MICRODYNE KIT.

This kit contains all necessary parts for building the 7-valve Microdyne Super-Heterodyne Receiver. Drilled and engraved panel, rheostats, dials, valve holders, together with a complete set of Microdyne Intermediate air core transformers, and everything required for assembling one of the most favoured Super-Heterodyne sets known. Apex Gold-Plated Vernier Controls are furnished with this kit. Kit complete .. .. List Price £25 10

**R.M.E.L., Ltd.**  
 Suppliers of Electrical Goods,  
 reet, London, W.1.  
 MAYFAIR 578 and 579.

WHEN REPLYING TO ADVERTISEMENTS PLEASE MENTION "THE BROADCASTER."

# MATCHED

H.F. TRANSFORMERS  
ARE IMPOSSIBLE  
UNLESS YOU USE THE

# STRADIO

VARIABLE CORE  
H.F. TRANSFORMER

RETAIL

9/-

RETAIL

9/-

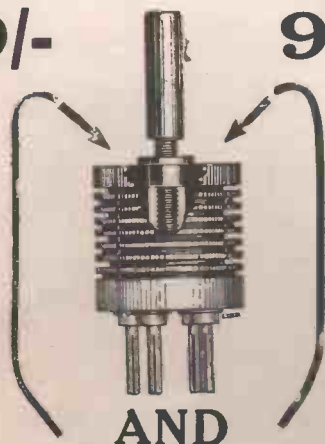

AND

## HERE'S THE SECRET

OF MATCHING THEM WITHIN 1%

By means of this device it is possible to use any number of stages of H.F. and to stabilise H.F. circuits to a hitherto unheard of degree.

This is a certain seller and shows a real profit.

Our idea and advertising is selling them for you. All you have to do is stock them.

Write to-day to

## STIRLINGS LTD.

17, Clarence St., KINGSTON-ON-THAMES

Agents Required All Countries.

Phone: KINGSTON 712.

# RAVALD (Regd.)

SQUARE LAW CONDENSERS



RAVALD Square Law Variable Condensers, complete with knob and dial.

*001 mf.	-	9/6
*00075 mf.	-	8/9
*0005 mf.	-	8/3
*0003 mf.	-	7/9
*0002 mf.	-	7/3
*00005 mf.	-	6/3

Subject to liberal trade terms.

RAVALD Square Law Variable Condensers with Vernier, complete with knob and dial.

*001 mf.	-	13/6
*0005 mf.	-	12/6
*0003 mf.	-	11/6
*0002 mf.	-	10/9

Subject to liberal trade terms.

## A GOOD LINE FOR THE TRADER.

Note the distinctive points:

- (1) Single hole fixing.
- (2) Best quality Ebonite top and bottom plates. Cut from Sheet (not moulded).
- (3) 20 s.w.g. Aluminium vanes.
- (4) Knob and Dial. (Best Quality—Polished).
- (5) Zero capacity lower than ordinary type condenser.
- (6) No play on centre spindle.
- (7) Entirely rigid construction.
- (8) Wavelengths and dial graduations evenly spaced.

**FULLY GUARANTEED.**

Applications for District Agencies invited. Exclusive Territories.

## J. MOORES & CO.,

KINGS WORKS, RAVALD STREET,  
SALFORD. LANCs.

W. J. H.

Phone: City 3739.



# O'YES!

## Ye New Dextraudion Valve

(ALL BRITISH PRODUCTION)

Protected by Patents.

### announcement.



THE DULL EMITTER VALVE is generally understood to be inferior in power, quality and lasting properties to the BRIGHT EMITTER, and this is invariably the case—BUT THERE IS ONE NOTABLE EXCEPTION—

—THE NEW 2½-3 VOLT ·06 “DEXTRAUDION,”—

which positively gives *greater power, superior tone* and equal life to any bright valve and withal is ABSOLUTELY NON-MICROPHONIC. The retail price, which will be rigidly maintained, is 18/-, but what is, perhaps, of more importance to the DISTRIBUTOR and DEALER, it *shows a better margin of profit than “ring” valves.* Deliveries are prompt and breakages in transit and complaints practically non-existent.

A SAMPLE MAILED POST FREE WITH GUARANTEED SAFE DELIVERY TO ANY BONA-FIDE TRADER ON RECEIPT OF REMITTANCE FOR 12/-

AN AGENT OF STANDING REQUIRED IN EACH IMPORTANT TOWN.

WRITE, putting forward your proposition to The Secretary, Valve Agency Department, Economic Electric Ltd., Fitzroy Square, London.

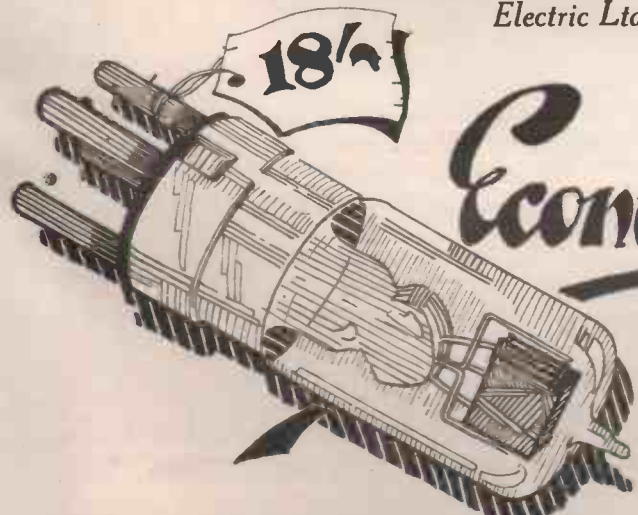

# Economic Electric Ltd

10, FITZROY SQ., LONDON, W.1

SHOWROOMS :

303, EUSTON ROAD, N.W.1

AND

64, LONDON RD., TWICKENHAM

ALSO AT

BUSH HOUSE, STRAND

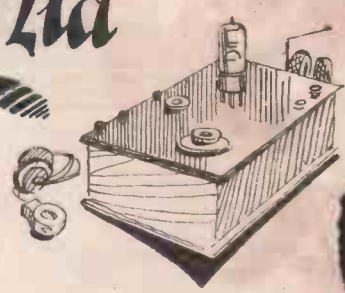

WHEN REPLYING TO ADVERTISEMENTS PLEASE MENTION “THE BROADCASTER.”

**If you're not handling these lines you're losing money!**

**"MICRO-RADIO" POTENTIOMETER.**

PAT. APPLIED FOR.

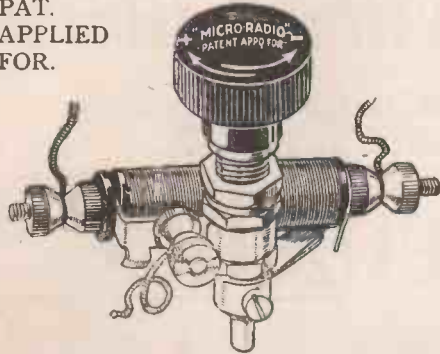

Gives additional power to any set, equal to an extra valve. Cheapest and best. Perfect graduation—cannot get out of order. Only requires 1" panel space—one hole fixing. Resistance 450 Ohms. Boxed separately. **TRADE PRICE 40/- Doz. (Retail 5/- each).**

**"MICRO-RADIO" RESISTANCE.**

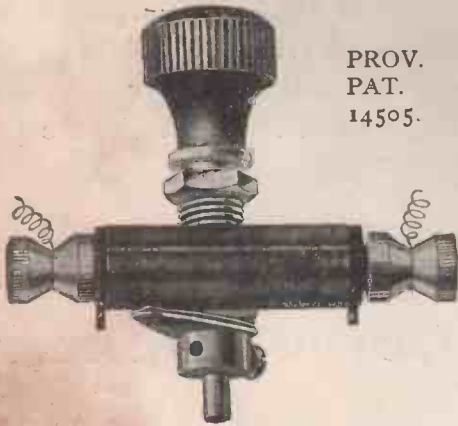

PROV. PAT. 14505.

Supersedes all other types of Rheostats. Resistance-Standard 12 Ohms D.E. 36 Ohms. Only requires 1" panel space—nothing to get out of order—no loose knobs—no felt or carbon to stick. **TRADE PRICE 24/- Doz. Boxed separately with full instructions. (Retail 2/9 each).**

**J. F. SMITH**

**94, HURST ST., BIRMINGHAM**

'Phone: Mid. 3333.  
'Grams: "Unlimited, Birmingham."

London Agent:  
A. F. BULGIN,  
9, Cursitor St.,  
Chancery Lane,  
London, E.C.4.

Write NOW for FREE illustrated Folder showing other QUICK sellers.



**"HARMO" CRYSTALS**

**GUARANTEED GENUINE**  
Screened, Selected and Tested Specimens.

**HERTZITE (RUSSELL & SHAW)** as originally named in 1913. Sold under sealed label, 6.9 dozen. **Permanite, Talite, Zincite, Bornite, &c., &c.** **ALL WIRELESS CRYSTALS** from 1/6 per dozen. Boxes or Glass Tubes. Send for List and Samples.

The Reflex Crystal

Retail 1/-  
5/9 per doz.



Also in sealed Boxes, Retail 2/-, 11/6 dozen.

**BULK CRYSTAL BULK**

**"Harmo" Super Sensitive**

GUARANTEED Sample oz.  
**Finest quality selected. 3/6**  
PRICES ON APPLICATION. Post Free

SHOWCARDS for WINDOW DISPLAY, 10/6 each.

**"HARMO" GUARANTEED TESTED RECTIFYING CRYSTALS.**

GENUINE HERTZITE	TALITE (TRADE MARK)	PERMANITE (TRADE MARK)	ZINCITE
PRICE 1/- PER TUBE			
BORNITE	COPPER PYRITES	CARBORUNDUM	SILICON GALENA IRON PYRITES
"Harmo" Assorted PRICE 6/- PER TUBE			

*Copyright*

**WHISKERS.** Gold, 7/- gross. Silver, 3/6 gross.  
Assorted packets (5 kinds), 17/6 gross.

**"HARMO" FIXED CONDENSER.**

Continental Agents: Messrs. **PETTIGREW & MERRIMAN, Ltd.**, 122, Tooley Street, London, S.E.1. Australian Agents: Messrs. **LOUIS COEN WIRELESS CO.**, 63, Swanston St., Melbourne. District Agents—Manchester: Messrs. **RIMMER & BREAR, Ltd.**, 51a, Broughton Road, Pendleton, Manchester. Scotland: Messrs. **LINTO ELECTRICAL CO.**, 38, Montrose Street, Glasgow.

SPECIAL TERMS FOR FACTORS.  
SEND FOR PRICE LIST AND SAMPLES.

**THE SCLERINE CRYSTAL CO.,**  
4a, AUBREY ROAD, WALTHAMSTOW, E.17.

**25 Years' British Manufacturing Experience.**



**The "Square Law" Type Variable Condenser.**

THE use of a "Square Law" Condenser renders the tuning of a Receiver a very simple matter indeed. A calibration chart may be made by the following simple means:—Tune in a Station of known wave-length on the lower part of the condenser scale and plot it on the chart. Repeat this process with another station of known wave-length which is received on the upper part of the condenser scale. Draw a straight line through the two points and the chart is complete.

Owing to details of its design, this type of Variable Condenser possesses a negligible minimum capacity, and the specially-shaped vanes give an ease of control which is entirely unknown to users of the ordinary type.

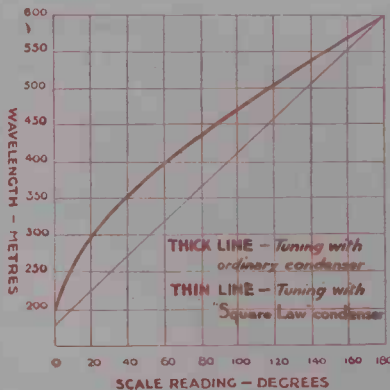

**Prices:—**

Without Vernier.	With Vernier.
•001 <b>9/-</b>	•001 <b>10/6</b>
•0005 <b>8/-</b>	•0005 <b>9/6</b>
•0003 <b>7/6</b>	•0003 <b>9/-</b>
•00025 <b>6/6</b>	•00025 <b>8/-</b>

**Delivery from Stock.**

All Cheques and Postal Orders should be crossed and made payable to "The Ormond Engineering Company."

We Specialize in turning Brass and Steel Screws and Machined Parts and Accessories of all descriptions.

Write for our New (1925) Catalogue. Trade Terms on request.

**ORMOND ENGINEERING CO.**

199-205 Pentonville Road, King's Cross, London, N. 1

Telegrams—"Ormondengi, Kincross."  
Telephone—Clerkenwell 9344 (3 lines).

**FACTORY:**  
WHISKIN ST., CLERKENWELL,  
E.C. 1.

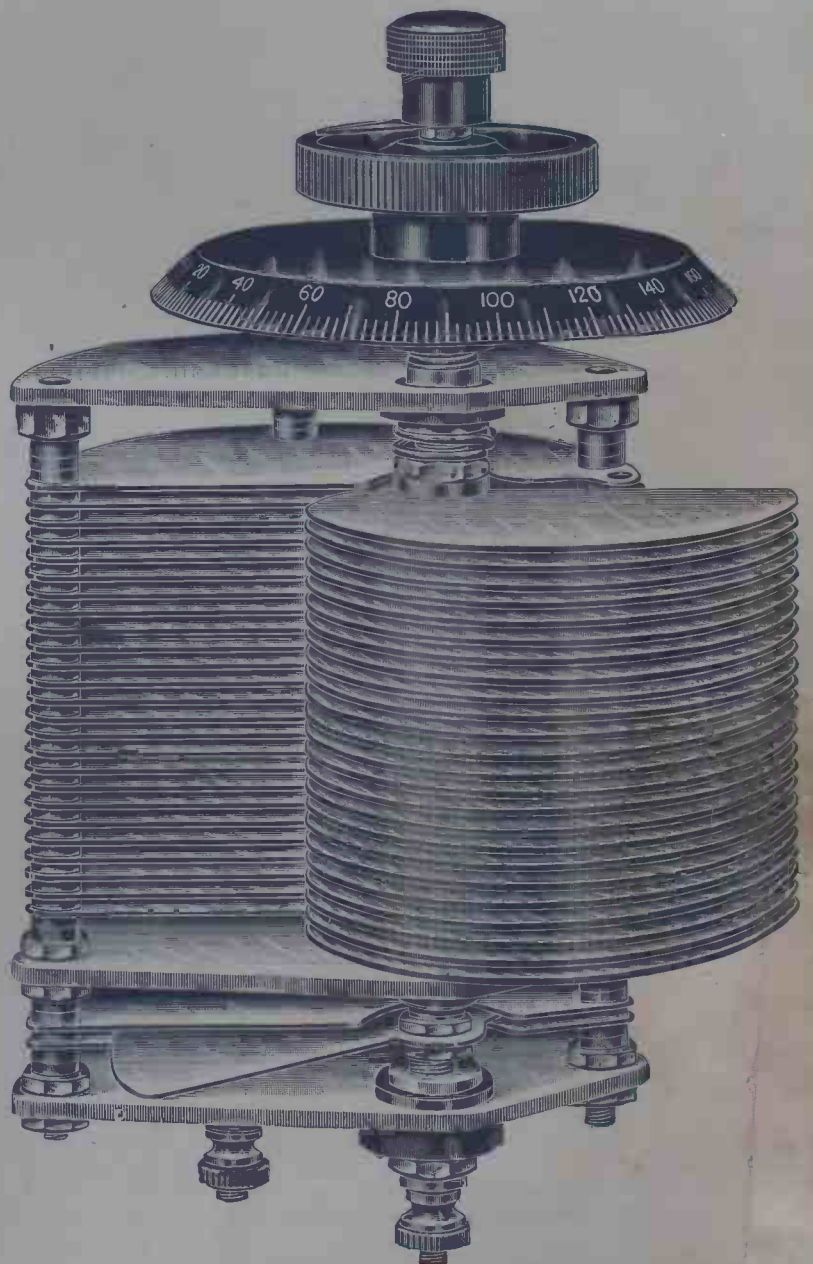

**Look for the name "ORMOND" on all our Products!**

WHEN REPLYING TO ADVERTISEMENTS PLEASE MENTION "THE BROADCASTER."



Do away with that crackling in your earphones and loud speakers, by using **KNIVETOWN CORD**. Each length guaranteed. Manufactured in England at our own works.

**HIGH AND LOW TENSION BATTERY CORDS.**

Battery Cords	.....	.....	.....	3/9
Headphone Cords	.....	7ft.	.....	3/9
Loudspeaker Cords	.....	6ft.	.....	3/3
Loudspeaker Cords	.....	12ft	.....	5/6

Subject to Liberal Discounts.

**The KNIVETOWN ELECTRIC WIRE Co., LTD.**

(INCORPORATING S, CORRE & CO.,)

**86, ROSEBERY AVENUE, LONDON, E.C.1**

Telegrams : Knivetown, London.

'Phone : Clerkenwell 7342.

**KNIVETOWN**

**RADIO PRODUCTS**

WHEN REPLYING TO ADVERTISEMENTS PLEASE MENTION "THE BROADCASTER."



A Loud Speaker you can  
be proud to sell \_\_\_\_\_

**T**HE new Brown Q type Loud Speaker illustrated here, is a veritable de luxe instrument—with its wonderful polished horn of hand selected Honduras mahogany and special reproducing mechanism it is worthy of the place of honour in the finest homes of the country. Certainly, in tone and in appearance, there is no other Loud Speaker that can compare with it at any price.

Wireless Dealers throughout the country are readily finding that the man with an ear for music and an eye for symmetry considers that the Brown Q type offers remarkable value at - - £15 15 0

S. G. BROWN, Ltd., Victoria Road, N. Acton, W. 3.

**Brown**

Gilbert Ad. 2418.

WHEN REPLYING TO ADVERTISEMENTS PLEASE MENTION "THE BROADCASTER."



# MOZZULLPHONE

## Maximum Efficiency at Minimum Cost

When you sell goods—complete sets or components—that give efficiency well above the average, yet at the same time are priced as low as production will allow, you can be sure of profit, repeat orders and steady turnover. In all parts of the country the "Mozzullphone" range is selling well. Repeat orders arrive every day. Sell "Mozzullphone" and be sure of giving satisfaction.

### THE "MOZZULLPHONE" SPHERICAL VARIOMETER.

The Stator and Rotor, constructed from first quality Ebonite, are moulded by our special process. Will tune in over B.B.C. Wavelengths from 260 to 600 metres. Mechanically sound and strong to the last degree. Silk-covered wire.

RETAIL PRICE.....6/-

# B.D.S.

## WIRELESS LTD

124, DEVONSHIRE St., BIRMINGHAM.

Phone: Northern 1972.

### THE "MOZZULLPHONE" CRYSTAL SET No. 488

incorporates a patent sensitive detector with Universal Adjustment. Detection can be made either by crystal and catswhisker, or crystal and crystal. Accommodation for 5 pairs headphones. All parts nickel-plated. Price, without accessories, £1-17-6. Designed for Chelmsford reception

£2-6-0 each.



Get our illustrated list and address of nearest wholesale stockist. Gladly sent by return.

# CRYSTALATE MOULDINGS



No. 241



No. 213



No. 212

MOULDINGS FOR EVERY REQUIREMENT, INCLUDING KNOBS AND DIALS FOR VERNIER CONDENSERS, SQUARE-LAW CONDENSER ENDPLATES, ETC.

Catalogues and Price Lists  
on request from



No. 239

## The Crystalate Mfg. Co. Ltd.

TONBRIDGE, KENT.

Telegrams "Crystalate" Hadlow. Telephone 33 Hadlow.

WHEN REPLYING TO ADVERTISEMENTS PLEASE MENTION "THE BROADCASTER."



# REAL POWER VALVES

WHEN your Customers want Power Valves for highly efficient power amplification, it will pay you to emphasise

## MULLARD D.F.A. MASTER VALVES

These Valves have been specially designed for maximum power work, with a low temperature, long-life filament for minimum current consumption.

**THEY'RE MULLARD, SO THEY'RE GOOD.**

*Note the Distinctive Types for Special Operation.*

For large loud speakers giving increased volume and clarity:—

- |  |           |
|--|-----------|
| D.F.A.0 (.35 amp.) and D.F.A.2 (.2 amp.)<br>(for 4-volt accumulators) ... .. | 26/- each |
| D.F.A.1 (.2 amp.) (for 6-volt accumulators)                                  | 30/- ..   |
| D.F.A.3 (.06 amp) (for dry cells or accumulators) (6 volts) ... ..           | 32/- ..   |

For Resistance Capacity Amplifiers:—

- |   |         |
|---|---------|
| D.F.A.4 (.2 amp.) (for 6-volt accumulators) | 30/- .. |
|---|---------|

*Leaflet V.A.4 gives full technical information.*

**WHEN YOU SELL, EMPHASISE**

# Mullard

## THE · MASTER · VALVE

Advt.—The Mullard Radio Valve Co., Ltd. (B). Nightingale Works, Balham, S.W. 12.

WHEN REPLYING TO ADVERTISEMENTS PLEASE MENTION "THE BROADCASTER."

# "UTILITY"

## VARIABLE SQUARE LAW CONDENSERS

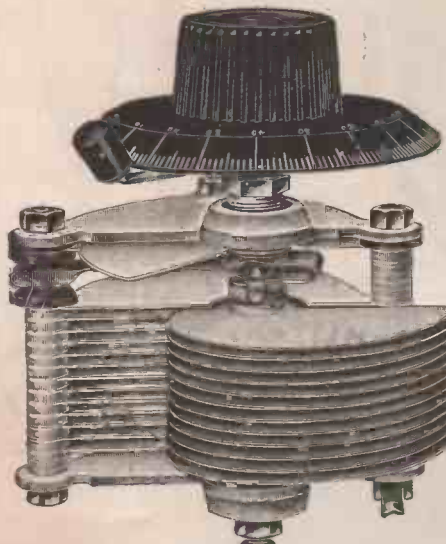

W.B. 124.

AT SAME PRICE AS OUR ORDINARY.

ONE HOLE FIXING. PRICES.

Ref. No.	Cap.	Price.
W.B.123.001		12/6
W.B.144.00075		11/9
W.B.124.0005		10/6
W.B.125.0003		8/9
W.B.145.0002		7/9
W.B.146.0001		7/6

Vernier 2/6 extra.

Our condensers are dependable, have close spacing, large adjustable bearings and perfect insulation.

FITTED WITH RADION DIALS.

# NO-CAPACITY

The "UTILITY" NO-CAPACITY SWITCH is specially designed by electrical engineers to reduce the electrostatic capacity, and has proved to be exceptionally reliable in action and has self-cleaning contacts.

Size.	Knob Type.	Price
1 Pole Change over.	W.B.130/1	3/6
2 " " "	W.B.130/2	4/-
3 " " "	W.B.130/3	5/-
4 " " "	W.B.130/4	6/-
5 " " "	W.B.130/5	7/-
6 " " "	W.B.130/6	8/-

Size.	Lever Type.	Price
1 Pole change over.	W.B.147/1	4/6
2 " " "	W.B.147/2	5/-
3 " " "	W.B.147/3	6/-
4 " " "	W.B.147/4	7/6
5 " " "	W.B.147/5	10/-
6 " " "	W.B.147/6	10/-

Black Bronzed.

Lever pattern, Nickel-plated, sixpence each extra.



W.B. 147/6.

# SWITCHES

Manufactured by

**WILKINS & WRIGHT LIMITED**

(Dept. 2),

UTILITY Works, Kenyon Street, Birmingham.

## "CLARKE'S ATLAS"

### FILAMENT CONTROL

*Patents Pending*

Works on an entirely new principle.

No wires to scrape and scratch.

No powder to cause troublesome "packing"

Gives astoundingly easy control of bright or dull-emitters—a marvel of noiseless efficiency.

Economises current; lengthens the life of valves, and is a deciding factor in bringing in those elusive stations.

50 OHMS RESISTANCE ONE-HOLE FIXING

*Sole Manufacturers:*

**H. CLARKE & CO. [Mc.] LTD.**  
 Atlas Works, Old Trafford, MANCHESTER  
 'Phones: 683 & 793 Trafford Park. 'Grams: 'Pirtoid, Manchester'

## CHARRON, BELLANGER & DUCHAMP,

Founded 1860.  
Electrical Manufacturers,

PARIS.
LONDON.

4 000 Ohms.

4,000 ohms, adjustable, also excellent for Loud Speakers as well as ear.

L.F. Transformers, also unshrouded. Valves.  
 Guaranteed Single and Double 'Phones, also Adjustable.  
 H.T. Batteries. Complete Sets. Loud Speakers.

Bell Transformers. Bell Supplies and Indicators.

**Buy the "Ceca" Crystal—it is the best.**

LIGHTING ACCESSORIES:—  
 Adaptors. Edison & B.C. Holders, etc.,

Sole Representative:—

**C. CAMPART, Engineer,** 34, Theobalds Road, London, W.C.1.  
 Telephone—MUSEUM 6290. Telegrams—CECAMPART, LONDON.

WHEN REPLYING TO ADVERTISEMENTS PLEASE MENTION "THE BROADCASTER."



# Distinctive and highly specialised Components that will build up your Sales—and your reputation for quality



**V.L.F. TRANSFORMER.**  
Of massive construction, produced not for cheapness—it is one of the highest priced, because its production cost is heavy. It is wound with 42 gauge wire, simultaneously with fine SILK. It shows most marked superiority on 2nd or 3rd stage of amplification, even on 200 or 300 volts pressure giving no trace of distortion, and its amplification factor is decidedly above the average of other good-class transformers. Insulation is perfect between P. and S. and between windings and frame, and the Transformer is one specially recommended for circuits of 23/6 the "reflex" type. List price 23/6



**SQUARE LAW CONDENSER.**  
Central Design. Takes up same room in set as plain type and can be used for replacing existing condensers. Functions with accuracy to true Square Law curve when operated in either direction. Very low minimum capacity with low loss and low ohmic resistance to H.F. currents. Single-hole mounting. Central spindle well insulated with large Ebonite bush. Nickel-plated finish. 22 gauge vanes. Terminals for easy connection off either of three spindles. .0003, 9/-; .0005, 10/6; .001, 12/6; Tandem (double .0003), 16/9.



**VARIABLE CONDENSER.**  
(Type 2.)  
Moulded end-plates. Not so heavy and massive, but identical in general construction with Type 1, and made with the same careful attention to detail. One-hole mounting. List prices, complete with knob and Anti-capacity Dial:  
.001 .. 8/- .0002 .... 4/6  
.0005 6/- .0001 .... 4/-  
.0003 5/6 .00005 .. 4/-



**No. 1 VARIOMETER.**  
The spindles of the Rotor are not screwed in, they are firmly moulded in, in perfectly true alignment. They cannot come loose or out of alignment, causing the Rotor to foul Stator. The spindle has a metal bearing, giving a smooth "feel" of rotation that makes extremely fine tuning possible. All connections are internal, by spring contacts from Rotor to Stator. Two terminals are provided. One-hole fixing for panel mounting; brackets adjustable for upright or horizontal mounting. Wave-length 250 to 750 metres on roof. aerial. List price 12/6



**VARIOMETER No. 2.**  
Bakelite—not to be confused with cardboard. The clearance is the minimum possible, involving great accuracy in construction. The bearings are metal-to-metal, and the movement smooth and permanently reliable. Terminal are provided; one-hole mounting. List price, with Knob and Dial .. .. . 7/-



**No. 2 L.F. TRANSFORMER.**  
An economically-priced Transformer that, whilst not possessing the current-carrying capacity of No. 1 L.F. T., is yet very efficient for single-stage or for first stage of amplification. It is compact in form, very suitable for panel mounting, or where space is restricted. List price 17/6



**FIXED CONDENSERS.**  
Guaranteed built with finest Ruby Mica and Copper Foil. These condensers are within 10 per cent. plus or minus of capacities stated, and each one is tested carefully before packing. Prices: .0001 .001 mfd. 1/3; .002 and .003, 2/-; .005, 2/6  
Grid-leak Condensers: resistance, 2 megohms. Capacities: .0002, .0003 and .0005 mfd. List Price 2/6.



**PANEL-MOUNTING COIL PLUG.**  
A very compact means of introducing a loading coil into existing sets; or for tuned anode, and other purposes. Mounted on panel from the back. Drilling template is provided with each plug. List price .. .. . 1/6



**VERNIER RHEOSTAT (Pat. No. 213030).**  
Combined plunger and rotary movement. Push-pull movement for coarse setting; rotary for vernier. Wonderfully smooth movement; best ebonite former one-hole fixing, 6 ohms, 2/6; 10 or 12 ohms, 3/-; 30 ohms, 3/6.



**VALVE HOLDER.**  
(Panel-mounting Type.)  
Attached through the panel from the back. Constitutes its own template for drilling. Connections are made to four screws tapped into the sockets, soldering tags being provided. List Price .. .. . 1/6

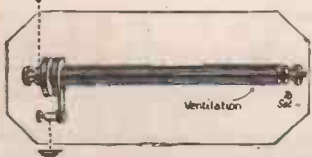

**THE PRESSLAND SAFETY LEAD-IN.**  
Has a self-contained discharge-gap, and provides for an external earth-wire, giving straight line from aerial to earth. Scientifically shaped to form a petticoat insulator, free from surface leakage. Sizes: 6in., 3/-; 9in., 3/3; 12in., 3/6.

## WOODHALL

Guaranteed Components.

Retailers order direct from usual Factors or Wholesalers; Wholesale enquiries to Sole Distributors:

**Pressland Electric Supplies, Ltd.,**  
Hampton-on-Thames. 'Phone: Molesey 22.

Stockists and Factors of  
**ALL GOOD QUALITY BRITISH MANUFACTURERS**  
INCLUDING:—  
Igranic Brands.  
Exide Accumulators. Re-Echo.  
Hellesen Batteries. W.M. Manufactures.  
Ormond Condensers. Ferranti Transformers.  
Lissen. Eureka Transformers.  
T.C.C. Condensers. Ledion Coils.

Official Distributors for the N.A.R.M.  
Official Distributors for the V.M.A.  
Sole Distributors of  
Woodhall Accessories, Oxford Scientific Instrument Co.  
Technical Adviser:  
Capt. St. Clair Finlay,  
Ph.D., M.S.C., D.S.E.  
Managing Director: CLIFFORD PRESSLAND  
(Late Chief Technical Adviser to the Inter-Allied Commission).  
A.M.I.E.E.

IMMEDIATE DELIVERY FROM AMPLE STOCKS.

Export Branch: Lyall Willis & Co., Ltd., Billiter House, London, England.



WHEN REPLYING TO ADVERTISEMENTS PLEASE MENTION "THE BROADCASTER."

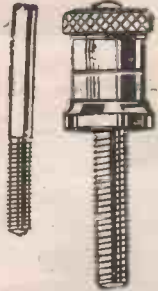
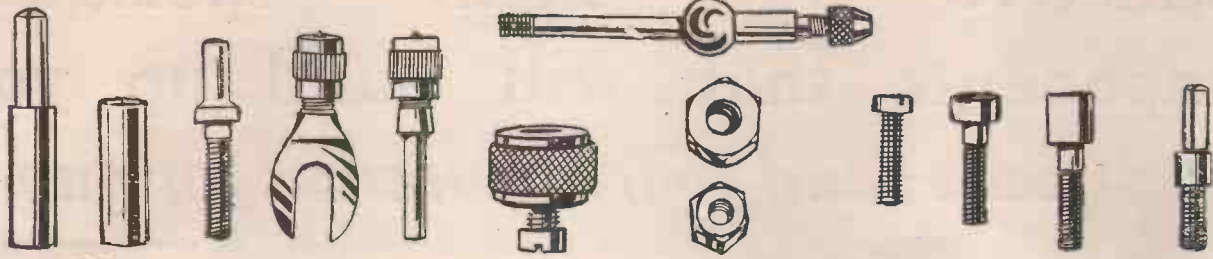

**WIRELESS  
BRASS  
PARTS  
SCREWS  
NUTS  
ETC.**



WE ARE HOLDING LARGE STOCK OF ALL PARTS SHOWN ABOVE  
MANUFACTURERS OF SCREWS & ALL PARTS TURNED IN  
HIGH PRECISION, IN ANY METAL & FOR EVERY PURPOSE.

**STANDARD SCREW MFG. Co.**

9, CHARTERHOUSE STREET,  
HOLBORN CIRCUS, LONDON, E.C.1.

'Phone Holborn : 4696.

Agent for Birmingham and District : H. FLAVELL, 147A, HOCKLEY HILL, BIRMINGHAM

WHEN REPLYING TO ADVERTISEMENTS PLEASE MENTION "THE BROADCASTER."

# The MONOPOLE L.F. TRANSFORMER

The latest innovation — consisting of two L.F. Transformers in the same case with the combined Ratio of 5 to 1 and 3 to 1.

A few outstanding points.

1. Absolute simplicity in mounting.
2. Economy of space as the "Monopole" takes the place of two transformers.
3. The results are equal to those given by any two other transformers, the reception is perfectly clear and there is no distortion.
4. Has an ebonite face plate.

Write for full information and trade terms to the  
Sole Distributor :

**P. CAPEL** 3-4, QUEEN ST., ARCADE,  
CARDIFF.

Wholesale Manufacturer and Factor. 'Phone : Cardiff 3298. Grams : "Waves Cardiff."

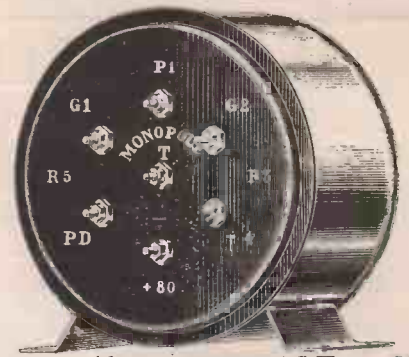

The MONOPOLE

RETAIL  
PRICE **24/-**

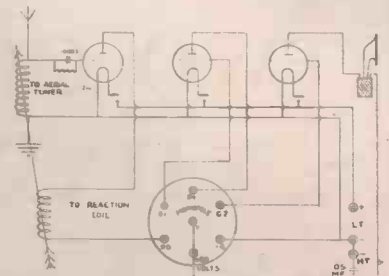

Diagram showing The Monopole taking the place of two L.F. Transformers.

# Accumulators = guaranteed 12 months



No. 2

NO trouble to sell, no trouble in use—is the plain truth about "A.B.L." Accumulators. Our 12 months' Guarantee is a promise of satisfactory usage which is honestly performed. Built of stout celluloid of best quality—with generous terminal knobs, Red and Black and non-corrosive, and extra heavy positive plates, the "A.B.L." Accumulator will give continuous and reliable service. We will give you quick delivery and very generous Trade Discounts. Let us send full information by return.

Special Terms to Factors and Shippers.  
Write now for Price List

**ACCUMULATORS (BIRMINGHAM),**  
EXETER ST., HOLLOWAY HEAD, BIRMINGHAM  
Telephone: Midland 77.

31E

## VALVE REPAIRS

READ THIS!

February 6, 1925

Dear Sirs, We are in receipt of the 23 valves which now brings up to date the valves sent you on Jan. 1, the total being 151. At the moment I have two of your old type valves working in my set, which give me entire satisfaction, and I can really say that they are, in my opinion, the best repaired valves on the market. Yours faithfully, (name on application)

Retail Price 6/6 each.

Prices of D.E. and Power Valves on application.

LIBERAL TRADE DISCOUNTS—Special terms for quantities



WIRELESS VALVES, LTD. Repair Dept.,

86, Rosebery Av., London, E.C.1.

## "ANTIVIBRADIO" PAD.

Have You Tried One?

If not, Send for Sample Pad.

You will find by its use under a set that all external vibration is eliminated, and that DULL EMITTER VALVES, so notoriously microphonic, become quite pure in tone.

Prevents that irritating loss of contact in crystal reception.

Prices 3/3 and 5/3 Retail.

AGENTS WANTED IN SEVERAL DISTRICTS.

ANTIVIBRADIO CO., 1, Parsonage, MANCHESTER.

# TWO OF THE BEST HAVE YOU GOT THEM?

A good trader is known by the goods he stocks.

If he stocks inferior goods he gives his competitors a clear field, because they will stock only the best, and therefore give satisfaction.

Their customers are the people you should have had.



Such Products as those of the  
**DUBILIER CONDENSER CO., LTD.**

**RADIO INSTRUMENTS, LTD.**

will build your Reputation as a Stockist of the best goods obtainable.

Please write for full details of these Specialities, which will be gladly furnished by us as Sole Distributing Agents for the Manchester district.

**THE MANCHESTER RADIO CO., LTD.,**

Radio Engineers,

155, OXFORD ROAD (Entrance, Boundary Street East), MANCHESTER.

*The Improved and Cheaper Coil Plug*

**SAVE 25%**  
Get REAL EBONITE Coil Plugs for 5/- per doz. (4/9 gross lots). Made of the best tested materials throughout, these Plugs offer the advantages of Nickel-plated Side Plate Contacts, having patent lip.

**CECIL RIDLEY**  
35 & 37 DUNDAS MEWS  
MIDDLESBROUGH  
Phone—1366

## "A.J.W." PLUG-IN BASKET COILS.

These are very strongly made of substantial gauge wire wound on Ebonite Spokes which are left in the coils, making them almost indestructible. They are not waxed.

Sample post free 2/6, returned in full if sample is sent back in 10 days' time.

**ARCHIBALD J. WRIGHT, Ltd.,**

Manufacturers and Factors,  
395, CITY ROAD, LONDON, E.C.1.



WHEN REPLYING TO ADVERTISEMENTS PLEASE MENTION "THE BROADCASTER."

**TRUE MUSIC  
: MINOR :**

**21/-**



The TrueMusiC Minor is being widely advertised at the extraordinarily low price of 21/-. It looks as well in the window as it does in the home, for its finish is tasteful and unique, the outside being in nigger brown and the inside in bright lacquered copper. It gives ample volume and perfect articulation for all general purposes. It has recently been fitted with a stand as shown in the illustration.

T.M.C. Headphones are as good as TrueMusiC Loud Speakers. See that you demonstrate T.M.C. products to your customers.

*Send us a card for literature and trade terms.*

LOUD SPEAKERS			
TrueMusiC Minor	....	£1	1 0
TrueMusiC Junior	....	£2	10 0
TrueMusiC Standard	....	£5	0 0
TrueMusiC Concert Grand	....	£6	10 0

*"British Made by British Labour."*

# T M C

The Telephone Manufacturing Co. Ltd.,  
(Makers of the famous Laryngaphone)  
Hollingsworth Works, West Dulwich, S.E.21.



T.M.C. No. 2A Headphones  
19/6  
4,000 ohms.

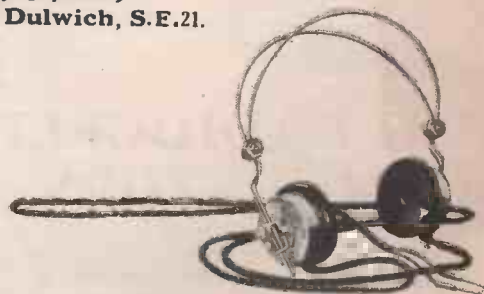

T.M.C. No. 3 Lightweight Headphones 22/6  
4,000 ohms. Weight 6½ ozs.

WHEN REPLYING TO ADVERTISEMENTS PLEASE MENTION "THE BROADCASTER."



The Original and Best

# MULTIPHONE ADAPTOR



FITS ANY SET

METAL THREAD SCREWS  
WHIT. AND B.A.

BRASS REPETITION WORK

## BIRMINGHAM PRODUCTS

LTD.

36 LUDGATE HILL

BIRMINGHAM

'Phones—Central 3334 (3 lines).  
Telegrams—Rolthred.

## "VAROTO" VALVE RECEIVERS.

ONE VALVE ... .. £3 10 0 Coils extra.

TWO VALVE—

Model B (H. F. & Det.)... £4 15 0 " "

" A (Det. & L. F.) ... £5 5 0 " "

THREE VALVE—

Model F (Det. & 2 L.F.)... £8 2 6 " "

If fitted in Upright Sloping Cabinet, 5/- extra.

THE "VAROTO" 2 VALVE RECEIVER.

Model C (H. F. & Det.).

£6 5 0

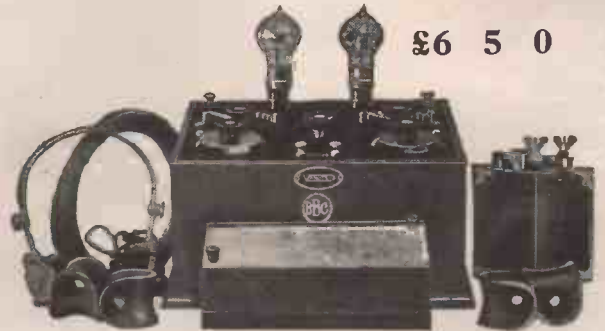

Complete as illustrated £10 5 0

Coils for the reception of High Wave Lengths extra.

THREE VALVE RECEIVER—

Model E (H. F. Det. & 1 L. F.) ... .. £8 2 6

FOUR VALVE RECEIVER (H.F. Det. & 2 L.F.) £10 15 0

A switch is provided for cutting out last valve if so desired. Fitted in upright sloping Cabinet.

All above prices are inclusive of Marconi royalties.

"VAROTO" CRYSTAL RECEIVERS from 16/6

Manufactured by

W. BIRD & SONS, 33, Fulham Palace Road, Hammersmith, W.6.

Phone: Riverside 2738.

Write for discounts and illustrated lists. Large stocks of all proprietary lines at full discounts.

Our Repeat-Order Files  
ARE FULL. These are our  
Testimonials!

HIGHEST  
QUALITY

Sole Manufacturer

KEENE  
ST  
PRICES

WORLD

FAMOUS

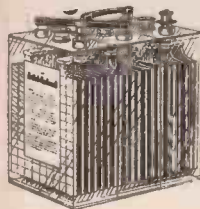

## BRITISH RADIOCELL ACCUMULATORS

ACCUMULATORS AND CELLULOID BOXES MADE TO CUSTOMERS' OWN REQUIREMENTS.

Can be obtained from all dealers, or direct from:

V. V. PASS, 20, ALBANY STREET, LONDON, W.

TELEPHONE: MUSEUM 7118.

WRITE FOR PARTICULARS. MORE AGENTS WANTED.

## "SISTOFLEX"

(Regd. Trade Mark).

INSULATING FLEXIBLE TUBES.

Original and Best. Reduced Prices.

Sample Card on Request.

S.L. EBONITE SHEETS.

Smooth matt finish, standard weight per square foot. An exceptionally good quality at a low price. Production 4 tons weekly.

EBONITE TUBES.

Actually in Stock—3½ by 2½; 2½ by 2½; 2½ by 3; 3 by 3½; 3½ by 4; 7/16 by 5/8, etc., etc.

MOULDED FITTINGS.

Of all shapes, especially Knobs and Dials, Valve Holders, Coil Plugs, Rotars, etc., etc.

Variometers—various grades. Ebonite Coil Holders.

Crystal Detectors on Bases and Cards. Essell Valve Legs.

HEADPHONE CORDS.

In high grade quality 52-in., 72-in. and 78-in. in stock.

Pressspahn, Fibre, Cloth, Silk, Tapes, Lebakite, Jointing Tapes, Chatterton's Compound.

Prompt Delivery—Efficient Service—Competitive Prices.

WHOLESALE ONLY.

## SPICERS LIMITED,

Insulation and Wireless Department,

19, NEW BRIDGE ST., LONDON, E.C.4.

YOUR ENQUIRIES SOLICITED.

Telephone: City 6251. Pte. Exchange: Ex 49.

Telegrams: "Nykoping" Lud, London.

**A 50-per-cent better Crystal**  
*-this enthusiast says:*

W. J. B. in Coventry, writes: "I had an unusual experience when I received your advertisement for Sylverex crystals. I had been using other crystals for some time, but I had never before had one which would not give me any trouble. I am convinced that the best of all crystals is the one which gives me the best results. I have used your crystals for some time and I am convinced that they are the best. I have used your crystals for some time and I am convinced that they are the best. I have used your crystals for some time and I am convinced that they are the best." *(Text continues with more testimonials)*

**Sylverex**  
 RADIO CRYSTAL

SYLVEREX LTD.,  
 25, Victoria Street, London, S.W.1.

2/-

**This means your discovery of a perfect Crystal**

These are the best crystals I have ever used. They are the best. I have used your crystals for some time and I am convinced that they are the best. I have used your crystals for some time and I am convinced that they are the best. I have used your crystals for some time and I am convinced that they are the best.

**Sylverex**  
 RADIO CRYSTAL

SYLVEREX LTD.,  
 25, Victoria Street, London, S.W.1.

2/-

**Better Sales—  
 better Profits—  
 better Quality—**

**The New Silver Alloy Rectifier**

Something entirely new! New in its chemical formula; new in its all-the-way-through and all-the-way-over sensitiveness; startlingly new in its loud and clear rectification.

**Sylverex** is superior in its performance to all other crystals. It is the only crystal that will give you the best results. It is the only crystal that will give you the best results. It is the only crystal that will give you the best results.

**Sylverex**  
 RADIO CRYSTAL

SYLVEREX LTD.,  
 25, Victoria Street, London, S.W.1.

2/-

**Make contact with this better 'Wireless' Line**

**Sylverex** Crystal means better Sales to you because it has behind it a virile Advertising Campaign, helped by the attractive and quite unusual display effect of the Cartons and outers (printed in Red, Gold and Black).

The exceptional Quality of Sylverex makes each purchaser of Sylverex an ambassador on your behalf, recommending Sylverex Crystal to his friends, and recommending the Radio Dealer from whom he bought it.

And—liberal and satisfactory discounts are offered to the trade.

**PRICE LIST.**

PROTECTED Retail Price	-	2/-
Trade :		
2 dozen at per doz.	-	16/-
1/2 gross ,, ,, ,,	-	15/6
1 gross ,, ,, ,,	-	15/-

Ratio of profit on selling price :

**33 1/3% upwards**

Less 2 1/2% cash with order.

Reproductions of Sylverex Advertisements appearing in the Leading Wireless Journals.

Showcards and Window Bills supplied with each order.



**Sylverex Ltd., 25, Victoria St., London, S.W.1.**

'Phone : Franklin 6003.

WHEN REPLYING TO ADVERTISEMENTS PLEASE MENTION "THE BROADCASTER"

**To the Trade**

Are you in a position to guarantee and test the grid leaks and condensers purchased by your customers? You can do this with the aid of the NEON TESTER. Trade terms on request.



# HENDERSON INSTRUMENTS

## The "NEON" TESTER—Invaluable to Every Serious Experimenter.

The "NEON" Tester has been designed to enable the experimenter to carry out quickly and without the aid of expensive apparatus many tests of the component parts of his apparatus which would otherwise be impossible. It can be used for all the following purposes:

1. To TEST and CALIBRATE fixed and variable condensers.
2. To TEST and CALIBRATE grid leaks and high resistances.
3. To TEST and MEASURE the capacity and insulation of Aerials.
4. To TEST any wireless apparatus for insulation and self-capacity
5. To TEST the E.M.F. of H.T. Batteries.
6. As a pole indicator to find the + or - of D.C. Mains; it will also show whether the current on the mains is A.C. or D.C.

The instrument is of Henderson quality both in materials and finish: replacements of the Neon tube, when necessary, are easily obtainable, and the upkeep cost is infinitesimal.



**2 WAY COIL HOLDER.**

Best Quality Ebonite throughout.  
Price Per Doz. **36/-**  
Subject N.A.R.M. Terms.

Price

**21/-**

Instrument with NEON tube and full instructions  
Postage 9d.

MANUFACTURERS

# W. J. HENDERSON & CO.,

351, Fulham Rd., SOUTH KENSINGTON, LONDON, S.W.10

Nearest Station: Earl's Court or South Kensington.

'Phone: Kensington 8983.

'Bus Routes: 31, 14, 96.



AS in everything else experience is an immense factor in the manufacture of batteries. When the enthusiasm for wireless first broke out in this country, we had been for nearly a quarter of a century engaged in making dry batteries, constructed to give better and better service. We were thus in a position to place on the market a high tension battery that immediately made its name and created a demand that forced us to extend our manufacturing facilities. Below we give our prices—let us have your enquiries, stating quantities required, and per return you will receive our best discounts.

15 volt - - 3/-	30 volt - - 6/-	36 volt - - 7/-
50 volt - - 10/6	60 volt - - 12/-	100 volt - - 21/-

**ECCO BATTERY CO. LTD. (East 4233).**  
Manufacturers of Dry Cells and Batteries, etc.  
**ECCO WORKS, BOW COMMON LANE, E.3.**  
Established 1899.

WHEN REPLYING TO ADVERTISEMENTS PLEASE MENTION "THE BROADCASTER."



# INTRODUCING



## The World's Greatest Transformer

Retail Price

# 9/6

Ratio 5 to 1

LIBERAL TRADE DISCOUNTS.

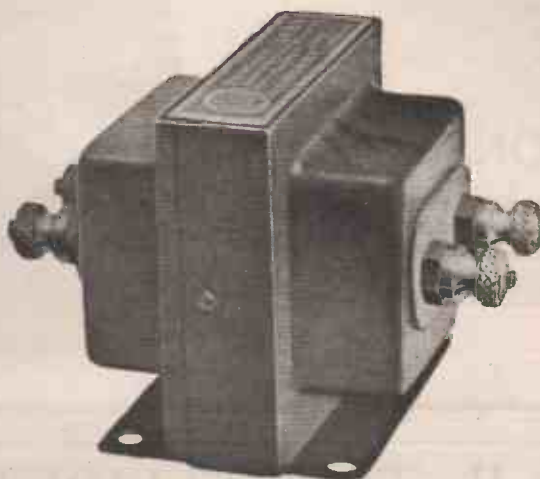

Retail Price

# 9/6

GUARANTEED LIBERAL TRADE DISCOUNTS.

### OVER 500,000 IN USE

The Croix Transformer has the largest sale of any Transformer in the world. It is manufactured by a firm whose long experience and improved manufacturing methods are the best guarantee of its performance. It is in extensive use in the **United States, France, Germany, Spain and Italy.** The Croix Transformer is guaranteed to give a greater volume of amplification without distortion than any other known Transformer approaching its price.

*Special Terms to Factors.*

*Sole Distributors for England, Scotland, Ireland, and Wales :*

**THE WHOLESALE WIRELESS CO.**  
**103, FARRINGDON ROAD ————— LONDON, E.C.**

Telephone : Clerkenwell 5312.

Representative for the British Colonies and Dominions : A. VANDAM, CAXTON HOUSE, WESTMINSTER, S.W.

Cables : AVANDACOMS, LONDON.

Telephone : VICTORIA 3135.

# The "LOWKE DANE TREE" CRYSTAL SET

(Wave-band 300/550 and 1500/1700 Metres)

## SPECIAL FEATURES :

- NO PLUG-IN COILS
- MICROMETER DETECTOR
- OAK CABINET
- NICKEL-PLATED FITTINGS

PRICE **35/-** SUBJECT

Manufactured by :

**LOWKE & SONS, Ltd.,**  
Central Works,  
Northampton



EST. 1859, CONTRACTORS TO THE WAR OFFICE, &c.  
MEMBERS OF THE BRITISH BROADCASTING COMPANY.

# "FAMA" THE SUPER VALVE

REDUCTION IN PRICES

## Amplifier

Fil Volts 3.5 to 4.0  
Plate Volts 30 to 80  
Amps. 0.5



## Trade PRICES

**3/9**

EACH.

All customers please note that we are still the only Importers and Factors of all "FAMA" Valves.



## Detector

Fil Volts 3.5 to 4.0  
Plate Volts 20 to 60  
Amps. 0.5

LIBERAL FACTORS DISCOUNTS FOR QUANTITIES

# 0.06 DULL EMITTERS

REDUCTION IN PRICE :

Fil Volts - - 1.6 to 2.0  
Plate Volts - - 20 to 100

**Amps. 0.06**

**Trade PRICE 9/3**

Keenest quotations for quantities.



"Zeal." Adjustable Diaphragm 4000 phones, 9/- pair.

"Zeal." Guaranteed 5 to 1 Ratio L.F. Transformer, 6/9 each.

60 Volt High Tension Batteries, 3 Volts Tapped, 5/6 each.

Case lot 25 Batteries, 4/9.

Terms Nett Cash with Order. Orders over £5 carriage paid. All the above are strictly nett Trade Prices.

Phone: AVENUE 1482. **H. D. ZEALANDER & CO., St. John's House, 124-127, Minories, London, E.1**

WHEN REPLYING TO ADVERTISEMENTS PLEASE MENTION "THE BROADCASTER."

# Two "BEST SELLERS"



On this page are illustrated two of the most popular models of AMPLIONS, the

"New" Junior Type AR.111 at £2 10s. 0d.

and the "New" Junior-de-Luxe—  
Type AR. 114 .... at £3 5s. 0d.

**T**HEY incorporate all the patented — and therefore *exclusive* — features embodied in the design and construction of the AMPLION Standard "Dragon" model, and by experience and tests against much larger and more expensive models of other makes, they have been proved supreme in every respect.

Handy in size, highly finished in appearance, and superlative in performance, they uphold to the full the world-wide reputation of the

The  
World's  
Standard

# AMPLION

Wireless  
Loud  
Speaker

*As a "Best Seller" Always*

*Obtainable from the leading Radio Manufacturers and Factors.*

Patentees and Manufacturers

ALFRED GRAHAM & CO. (E. A. GRAHAM),  
St. Andrew's Works, Crofton Park, London, S.E.4.

Phone: Sydenham 2820-1-2.

Wires: "Navalhada, Catgreen, London."



WHEN REPLYING TO ADVERTISEMENTS PLEASE MENTION "THE BROADCASTER."



# IN AND OUT

Excel Terminals Tags never stay long on your shelves. They come in and go out with astonishing rapidity . . . and every time they turn over they leave a very comfortable profit in your till.

You see the public are getting to know them as the highest quality tags on the market . . . and are asking for them.

You will do yourself a good turn by stocking up now.

★ ★ ★ ★ ★ **Test them free!**

- No. 1. Small, Bright Brass, Tinned Brass, Tinned Copper.
- No. 2. Large, Bright Brass, Tinned Brass, Tinned Copper.
- Nos. S.3, S.4, S.5, and No. 8, Nickel Finish.
- No. 9, No. 10, T.1, and T.2, Tinned Finish.

Send your letter heading and get our free sample outfit. Test the quality of the tags yourself then stock them if you want. You are under no obligation. This offer is free and unconditional.

Manufactured by  
**S. H. COLLETT**  
 52-54, Hampstead Road, LONDON, N.W.1  
 'Phone : Museum 688r. 'Grams : "Autofuse, London."

## "PREMIER BATTERIES" THE WORLD'S BEST.

Don't pay for the name.—Pay for the Battery.

ALL BATTERIES GUARANTEED SIX MONTHS IN STOCK.—TERMS CASH.

16 volt H. Tension	- -	1/8
36 do. do.	- -	3/10
60 do. do.	- -	6/-
66 do. do.	- -	7/-
100 do. do.	- -	10/6

**DULL EMITTERS.**

3 volt Giant, 300 hours	- -	4/9
3 volt Small, 30 do.	- -	3/-
4½ Giant, 300 do.	- -	7/-
1.5 Giant, 300 do.	- -	1/10
1.5 Medium, 80 do.	- -	1/4
1.5 Baby, 25 do.	- -	1/-
1.5 Mammoth -	- -	7/6

**INERT LECLANCHE CELLS,** 2/10  
 Add Water only for use. Last for Years. 1.5 Volts.

For Various Voltages add 2/- per 1.5 Volt. Example: 1.5 2/10. 3 Volt 4/10, etc., etc.

BOX BATTERIES, 4½ Volts, } 8/  
 for Cycles, Reading Lamps, etc. } per doz

FLASH BATTERIES, 3/6 doz. Nett

IMPORTED FLASH BATTERIES, (best quality); 3/1 per doz.

Every Type of Battery in existence made. Kindly forward when ordering Sizes and Voltage required.

Voltmeters, 0-8 reading - - - 3/3 each.

ILLUMINATED FLOWERS } 3/- each  
 for Decorations. Approx. 18 in. } 1000  
 high. Complete Bulb and Battery.) only.

**TRADE ONLY.**  
 NOTE. We are frequently asked by clients for free samples. Kindly NOTE we do not issue same.

CRYSTAL SETS, Less 'Phones, 7/- nett.

2-VALVE SETS, with Valves, Dull Emitter or otherwise, and 'Phones, £4 10 0.

"Premier Wave Traps." Your local station cut completely out. With coil 12/6; without 10/-.

Bell Batteries. Not to be used for D.E. Valves 1/-

D.E. Valves (Guaranteed) 7/6 each nett.

Frame Aerials (Coach made), 12/6. Excellent results.

French Transformers - - - 6/- each.

"Premier Crystal," 5/6 per doz. boxes.

## PREMIER BATTERIES,

17, RICHES ROAD, HARRINGAY, N.15.

WHEN REPLYING TO ADVERTISEMENTS PLEASE MENTION "THE BROADCASTER."



# Better Valve Protection

The **R.I. Dual Rheostat** is an entirely new departure in the design of filament resistances, in order to meet adequately the needs of both bright and dull filament valves. It permits sensitive adjustment to be made in the filament current of both types of valves to the highest degree, and gives as a result longer life and smoother action.

Your customers can use any valve with the **R.I. Dual Rheostat**, and be confident that its range of variable resistances will give wonderfully smooth current control.

*One hole fixing—perfect radiation.*

Full information is being given to the Radio Public regarding this **R.I. Rheostat**, and you should be in a position to meet the certain demand of this additional **R.I. Trade Proposition**.

Price **7/6**

*Write to-day for full particulars, and add another rapid seller to your wireless stock.*



**12 HYDE ST OXFORD ST LONDON W.C.1**

Contractors to the Admiralty and all Government Depts.

WHEN REPLYING TO ADVERTISEMENTS PLEASE MENTION "THE BROADCASTER."

# The "SONGSTER DE LUXE"

(2,000 ohms.)

## BRITISH MADE

Retail  
Price

# 15/6

*Subject to Liberal Discount.*

The Songster de Luxe Loudspeaker is highly finished in Chocolate Brown and stands 11 in. high. It gives the most perfect reproduction, the tone is Loud and Mellow and there is no distortion. Every one is guaranteed and has equal efficiency to that of instruments selling at double the price.

**SUPERLAMP Ltd.**  
92/94, PAUL ST., LONDON, E.C.2

also at

257, Hammersmith Rd., London, W.6.

7, Denmark St., Charing Cross Road,  
W.C.2.

197, Old St., London, E.C.2.



WHEN REPLYING TO ADVERTISEMENTS PLEASE MENTION "THE BROADCASTER."

# Truth in Advertising

**Whereas** it has come to my notice that tentative suggestions have been made by certain Traders, Manufacturers or Competitors that the samples of EBONITE tested by the National Physical Laboratory, whose report was published by me in this paper last month, were not samples of **TRELLEBORGS GENUINE EBONITE, QUALITY 140**, as supplied to the wireless trade

**-and Whereas** the samples sent by me to the N.P.L. and tested by them were actually samples of **TRELLEBORGS GENUINE EBONITE, QUALITY 140**, taken at random from my London Stock

**Now Know Ye** that I undertake **£1000** to pay the sum of to whomsoever proves that the above report refers to an Ebonite other than **TRELLEBORGS GENUINE EBONITE, QUALITY 140**, and that you are invited to call and select the samples necessary for testing at random from my London stock.

N.B.—The N.P.L. report certifies as follows:-

**Surface**—There was **no appreciable surface leakage.**

**Resistivity**—Over **200,000,000** for a centimetre cube.

**Electric Strength**—No. 1. Sample: **112,000** RMS Volts per m.m.

No. 2. Sample: **120,000** RMS Volts per m.m.



*Quality tells-!*

# F.W. LOWENADLER

**AUDREY HOUSE ELY PLACE HOLBORN CIRCUS E.C.1**

PHONE: HOLBORN 1825 (2 LINES.)

WHEN REPLYING TO ADVERTISEMENTS PLEASE MENTION "THE BROADCASTER."

SEPT.  
29,  
1924.

In the  
FIRST THREE  
MONTHS  
**£12,000**

DEC.  
31,  
1924.



“The Broadcaster” Radio Trade Showrooms proved of such immense value to the Trade that **£12,000** worth of business was concluded between visitors and manufacturers in the **First Three Months.**

“The Broadcaster and Wireless Retailer” scheme for **Better Trading**, therefore, has justified itself.

Mr. Trader, are *YOU* taking full advantage of “The Broadcaster” Radio Trade Showrooms?

Buy at Bush House.

“The Broadcaster” Radio Trade Showrooms offer a

**FREE SALES SERVICE TO YOU.**

“The Broadcaster”  
**RADIO TRADE SHOWROOMS,**  
Bush House, Aldwych, W.C. 2.  
Telephone - - **CITY 5587.**



# Guarantee

that

## TUNGSTALITE

## al Gold Label

Specimen  
is a synthe  
manufa  
tion a  
The p  
with th  
vendor  
to rece  
a new  
shewn  
is defect



irely British  
100% recep  
ontact.  
together  
ents and  
e bearer  
eferred,  
it can be  
on this crystal  
y whatsoever.

# Tungstalite Ltd

REGD OFFICES:-

47, FARRINGDON ROAD.  
LONDON, E.C.1



WHEN REPLYING TO ADVERTISEMENTS PLEASE MENTION "THE BROADCASTER."

# BRASSWORK

## AND WIRELESS COMPONENTS

*Every description of  
Machined Brasswork*

Terminals of every description  
assembled (nut and washer) in  
nickel plated and brass.



*Nickel Plating  
to the  
Trade*

*Prompt attention to orders.  
Send now for prices and terms.*

### J. CHURLY CANN, LTD.,

16 / 20, FARRINGDON AVENUE, LONDON, E.C.4,  
ENGLAND.

Agent for Austranlia, where stocks are held :  
C. A. CORNWELL, 75, Fitzroy Street, St. Kilda, Mel.



SWITCH ARMS  
NICKEL-PLATED  
*One Hole Panel  
Fixing.*

CRYSTAL DETECTOR  
FOR  
PANEL MOUNTING.



### TELEPHONE EXTENSION BOARDS

Made in two sizes, 3- and 6-way ;  
neat, efficient and compact ; in  
Polished Brass and Nickel-plated.

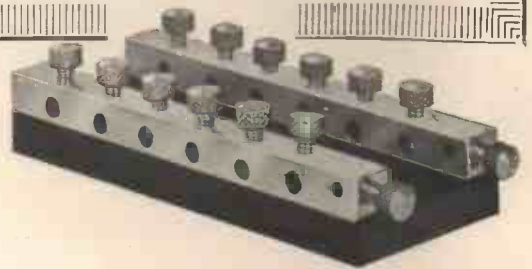

WHEN REPLYING TO ADVERTISEMENTS PLEASE MENTION "THE BROADCASTER."

# Sunny hopes for sunny days

The popularity of radio will continue during outdoor days. For music, song and speech so readily obtainable anywhere, will appeal as an additional pleasure on the river, in the garden or by the sea.

Convenient apparatus giving perfect results will enhance the endless enjoyment that broadcasting gives, and that is why the Sterling way is the sunny way in radio.

Demonstrate this fact to your customers and reap substantial profit with the backing of the Sterling national advertising campaign, for the Sterling Company are out to help the dealer this spring and summer, and co-operation will ensure success.

A selection of attractive showcards together with supplies of literature overprinted with your particulars will be supplied free on request.



## The STERLING "DINKIE" Loud

Speaker  
The little fellow with the loud voice! A loud speaker without equal in its class. Small in size but big in volume—small in price but big in value. "Dinkie" reproduces clearly, loudly and in perfect tone all that is broadcast. In brown-tinted finish.  
PRICE 30/-



## The STERLING "BABY" Loud

Speaker  
The most popular entertainer in the world, giving ample volume for all usual requirements and a reproduction that is consistently faithful and pleasing in tone. In black or brown-tinted finish.  
PRICE 55/-



The STERLING "ANODION ONE." A highly efficient one-valve receiver giving splendid results often at considerable distances under favourable conditions. The tuning units available for this set cover a wave-band of 275-7600 metres. With B.B.C. coil but without accessories.  
PRICE £7:7:0

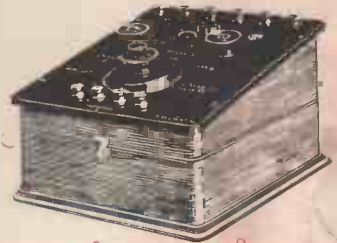

### STERLING TELEPHONE & ELECTRIC CO., LTD.

Manufacturers of Telephones and Radio Apparatus, etc.

Telephone House, 210-212, Tottenham Court Road, London, W.1

Telephone: Museum 4144 (7 lines).      Telegrams: "Cucumis, Wesdo, London."  
Birmingham: 150, Edmund Street.      Glasgow: 47, Hope Street.      Cardiff: 10, Park Place.  
Belfast: Gibson's Buildings, Castle Street.      Manchester: 14, St. Peter's Square.  
Dublin: 53-54, Lower O'Connell Street.      Newcastle-on-Tyne: 21, Mosley Street.  
Works: DAGENHAM, ESSEX.

WHEN REPLYING TO ADVERTISEMENTS PLEASE MENTION "THE BROADCASTER."

# THE DAIMON

## High-Tension BATTERY



60 v.  
**10/6**

100 v. 15/6  
36 v. 7/6  
(all Subject).

WHEN BETTER BATTERIES ARE MADE  
**DAIMON** WILL MAKE THEM.

Sole U.K. Agents:

'Phone :  
Clissold  
4480-4481.  
Head Office:

**S. D. H. MANUFACTURING CO.**  
24, Stoke Newington Road, London, N.16.

'Grams :  
SEDEH  
London.

## Our Latest Success

The

# “EXCELLAITE”

LOUD SPEAKER  
Excels all

We guarantee that this  
Speaker is the **Best**  
of its size **on the Market**



Price

**37/6**

Subject to  
Liberal  
Trade Discount

'Phone : Clissold 4480, 4481.

Enquiries to

'Grams : SEDEH, London

**S. D. H. MANUFACTURING COMPANY,**

HEAD OFFICE:

24, Stoke Newington Road, London, N.16.

WHEN REPLYING TO ADVERTISEMENTS PLEASE MENTION "THE BROADCASTER."



**Type 620.**

Similar to type 610, but for vertical panel mounting. Fitted with screw terminals.

- 0.0001-0.0009 mfd. 3/6
- 0.01 mfd. 4/-
- 0.011-0.015 mfd. 4/6

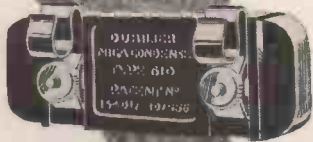

**Type 610.**

A new Mica Condenser, suitable for all purposes. Fitted with screw terminals and detachable grid-leak clips.

- 0.0001-0.009 mfd. .. 3/6
- 0.01 mfd. .. .. 4/-
- 0.011-0.015 mfd. .. 4/6

# Why Mica ?

These are two new and improved Dubilier Mica Condensers suitable for use in all circuits. They represent a considerable advance in convenience for general purposes over the Types 600 and 600a, and are known as Types 610 and 620 respectively.

\* \* \*

And now, why Mica ? Why not paper, or treated rubber, or some other and cheaper composition ? The capacity of a condenser depends on three things : the size of the plates, their distance apart, and that property of the di-electric that is measured in terms of " Specific Inductive Capacity " (S.I.C.). The greater the S.I.C. of a di-electric the smaller quantity is required to produce a given capacity; this also enables the whole condenser to be smaller, more compact, and less liable to inaccuracies and variations.

Now, Mica has a high S.I.C. It also has great " di-electric strength "—i.e., it will not break down electrically even under very high voltages. It is, therefore, easily the most reliable and constant di-electric there is, particularly for capacities of less than about 1 mfd.

Although they are a little dearer, it always pays to

*Specify Dubilier.*



*Advt. of the Dubilier Condenser Co., Ltd., Ducon Works, Victoria Rd., North Acton, London, W.3. Telephone : Chiswick 2241-2-3.*



E.P.S. 92

**WHEN REPLYING TO ADVERTISEMENTS PLEASE MENTION "THE BROADCASTER."**

# WARNING TO DEALERS

## GENUINE Dr. NESPER 'PHONES

← MUST BEAR THIS TRADE MARK →  
ON ADJUSTMENT SCREW.



**WARNING.**  
In the High Court of Justice (Chancery Division)  
Before Mr. Justice Eve  
The S.D.H. Manufacturing Co.  
v.  
G. Carter & Co.

In the Chancery Division of the High Court of Justice on Thursday last Mr. Justice Eve granted, on the motion of the Plaintiffs, an interlocutory injunction to restrain the Defendants from "passing off" and infringement of Trade Mark.

**15/6 per pair, subject to liberal discounts.**

*Particulars of the Headphones are :*  
4,000 ohms, Fitted with Adjustable Diaphragm, Detachable Receivers, Double Leather-covered Head Springs, Long Flexible Cords, Nickel-plated Parts, Very Comfortably Fitting to the Head. Recognised throughout the World as  
**The Perfect Headphones.**

*Good discounts allowed.*

*Special terms to Agents and Factors on application.*

**FACTORS and DEALERS—DON'T MISS OUR WONDERFUL SUCCESSES.**

*Enquiries to*

# S. D. H. MANUFACTURING CO.

HEAD OFFICE :

## 24, Stoke Newington Road, London, N.16.

'Phone :  
Clissold  
4480.  
4481.

'Grams :  
SEDEH  
London.

WHEN REPLYING TO ADVERTISEMENTS PLEASE MENTION "THE BROADCASTER."

# SPECIAL ANNOUNCEMENT

## S.D.H. MANUFACTURING COMPANY CHALLENGE TO W. RYBAEK, BERLIN.

With reference to the misleading circular to the Trade which has been sent direct from Germany by William Rybaek.

We, the S.D.H. Manufacturing Co., entirely and in every way, repudiate this misleading statement and furthermore we would be glad of the opportunity of dealing with William Rybaek through the medium of the law.

This unfortunately has not been possible, much to our disappointment, since service upon him is impossible and there appears to be no one of authority in this country to receive service on his behalf.

Do not be misled by this circular as we are the only concessionaires for the famous world-wide original Dr. Nesper 'phone, and have already obtained an interim injunction against one offender restraining him from infringing our rights, and we are prepared to take action to substantiate our claim against William Rybaek the minute he gives us the opportunity of serving a writ upon him.

The Original Dr. Nesper 'Phone is sold by us, and is still Supreme.  
S.D.H. MANUFACTURING CO.

### THIS IS FURTHER PROOF OF THE DR. NESPERPHONE POPULARITY

*Sole U.K. Agents :*

## S.D.H. MANUFACTURING CO.

'Phone :  
Clissold  
4480, 4481.

HEAD OFFICE :

'Grams :  
SEDEH  
London.

### 24, Stoke Newington Road, London, N.16.

WHEN REPLYING TO ADVERTISEMENTS PLEASE MENTION "THE BROADCASTER."



## I want a Loudspeaker fixed to my Crystal Set!

Dealer: That will mean a Valve Amplifier.

Customer: Oh! but I don't want a Valve Set — I've already got a Crystal Set!

Dealer: But you cannot, etc., . . . . . etc.,

and it takes him nearly 40 minutes to explain why — at the end of which time the customer leaves the shop THOROUGHLY CONVINCED OF THE DEALER'S DISHONESTY.

Similar arguments consume far too much of the dealer's time but they can now be avoided by educating the public before they enter your shop through the "WIRELESS AMATEUR'S HAND-BOOK," which explains the 'How and Why of Wireless' and is written in clear non-technical language. THIS BOOK also contains a retail list of N.A.R.M.A.T. etc. PRODUCTIONS including sets, loudspeakers, components etc. and is therefore a valuable piece of sales literature.

Published at 1/-, it is sold to the Trader at a figure sufficiently attractive to enable you to distribute free to likely prospects. The complete list of call signs and other useful data, ensures retention after purchase, whilst a valuable prestige is built for the dealer himself, whose name is prominently displayed on the cover.

The slack season will soon be here. You therefore owe it to your business to get fuller particulars of this scheme. Simply pin the coupon to "your heading" and mail it to:—

Advertising Department,  
**AUTOMOBILE ACCESSORIES  
(BRISTOL) LTD.,**

93-95 Victoria Street,  
Bristol.

**COUPON**  
To Automobile Accessories,  
Ltd., Bristol.  
Please send me FREE fuller  
particulars and specimen  
copy of the "Wireless  
Book,"  
BA1012.

■■■■■■ GLOVERS' AD. ■■■■■■

WHEN REPLYING TO ADVERTISEMENTS PLEASE MENTION "THE BROADCASTER."

FIRST INTRODUCED BY US IN 1913, BUT UN-  
FORTUNATELY WE DID NOT REGISTER SAME

# SHAW'S THE ONLY TRUE 'HERTZITE'

And the Best Crystal on Earth for Broadcast Reception

None Genuine without our Registered Signature.

### UNSOLICITED TESTIMONIAL

"BAWDSEY," SHELLEY ROAD, HUTTON, ESSEX.  
March 3, 1924.

"It may interest you to know I have received with Shaw's 'Hertzite' on an ordinary home-made set the following stations — London, Bournemouth, Newcastle and Glasgow."

(Signed) T. W. MACENNALS.

First House in the Trade to sell  
**RECTIFYING CRYSTALS**

NO CONNECTION WITH ANY OTHER FIRM.

## RUSSELL & SHAW,

Contractors to H.M. Admiralty, War Office, and the Imperial  
Japanese Navy

11, Walm Lane, Willesden Green,  
LONDON, N.W.2.

ESTABLISHED 1848.

TELEPHONE: WILLESDEN 2646.

# OMNIAPHONE HEADPHONES

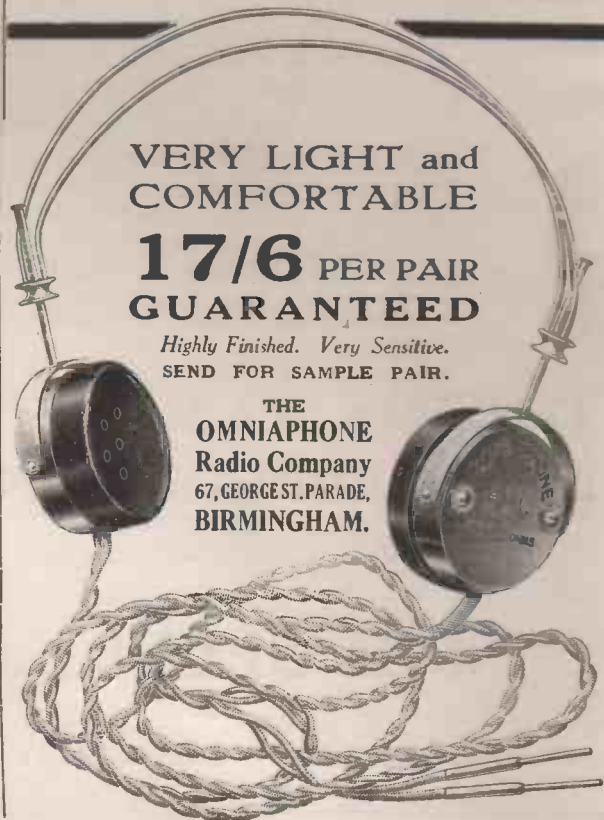

VERY LIGHT and  
COMFORTABLE

**17/6 PER PAIR**  
GUARANTEED

Highly Finished. Very Sensitive.  
SEND FOR SAMPLE PAIR.

THE  
**OMNIAPHONE**  
Radio Company  
67, GEORGE ST. PARADE,  
BIRMINGHAM.



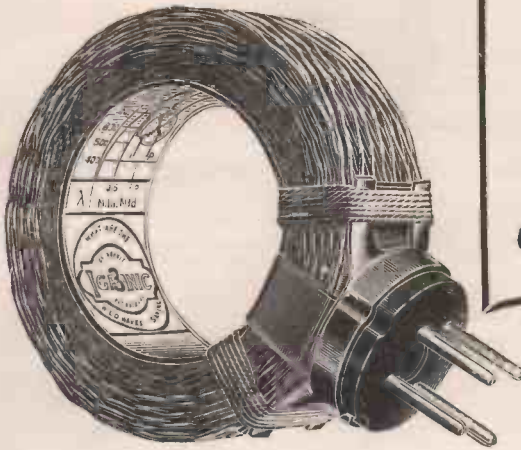

**IGRANIC**  
High Frequency Transformer.



4S X 8 IGRANIC  
"E" Type Transformer.

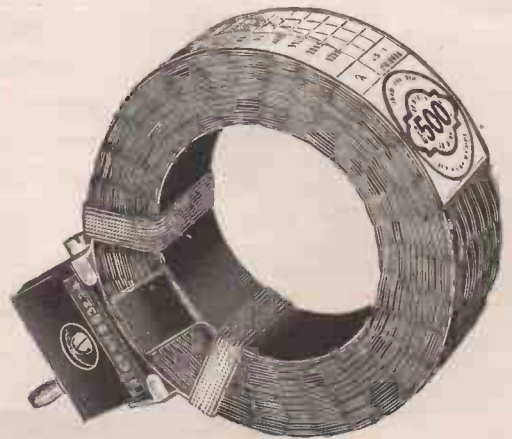

**IGRANIC**  
Honeycomb Duolateral Coil.

# There's always a steady demand for



Igranic radio products are always advantageous to the radio dealer, but especially so when the wireless trade is slack. The reason is not far to seek. When the wireless trade is booming an enormous number of uninstructed persons are attracted by the craze and rush in to buy. In the aggregate they spend a very large amount of money and this makes a large addition to the ordinary volume of trade. But not having the necessary knowledge to enable them to appreciate quality they are attracted by low prices and a very great deal of unworthy and trashy apparatus is disposed of to them. When their efforts meet with disappointment (largely as a consequence of having spent their money on cheap and inefficient apparatus) they forsake the pursuit of wireless and cease to buy. That causes a slump. But the knowing ones, who understand quality and who have purchased "Igranic" apparatus, are not disappointed; their interest continues and the demand for "Igranic" apparatus remains practically unaffected. Then the trader who has consistently stocked "Igranic" components and recommended them to his customers reaps his reward; his trade continues unabated and he has the pleasure of finding himself still on happy terms with the very pick of radio buyers. During the summer slump in 1923, when many people thought the bottom had dropped out of the wireless trade, the demand for "Igranic" Radio Devices held firmly on and has been growing ever since.

Write for List Z 450 and particulars of Trade Terms and Window Display material.

**IGRANIC ELECTRIC CO., LTD.**  
149, Queen Victoria Street, London.

Works: **BEDFORD.**

Branches—**BIRMINGHAM:** 73-74, Exchange Buildings. **CARDIFF:** Western Mail Chambers. **GLASGOW:** 50, Wellington Street. **LEEDS:** Standard Buildings, City Square. **MANCHESTER:** 30, Cross Street. **NEWCASTLE:** 60, Pilgrim Street.

**Igranic Radio Devices**  
include:

Honeycomb Duolateral Coils, Fixed Condensers, Filament Rheostats, Intervalve Transformers, Variometers, Vario-couplers, Bi-plug Coil Holders, Tri-plug Coil Holders, Battery Potentiometers, Vernier Friction Pencils, etc., etc.

All carry the IGRANIC guarantee.

*These are the foundations of a BETTER set  
and of BETTER business*



**IGRANIC**  
"E" Type Transformer



**IGRANIC**  
High Frequency Transformer



**IGRANIC-FRESHMAN**  
Fixed Condenser



**IGRANIC**  
Honeycomb Duolateral Coil

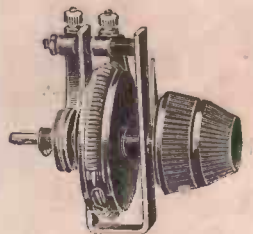

**IGRANIC**  
Rheostat (Vernier type)

WHEN REPLYING TO ADVERTISEMENTS PLEASE MENTION "THE BROADCASTER."

# The new Acme rheostat

(Patent applied for)

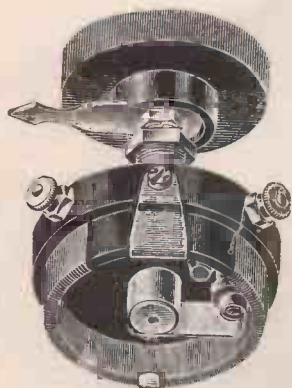

The Acme filament rheostat is of an entirely original and unique design, but is very simple in construction. The contact is of a new *roller* type, secured to a phosphor bronze spring, giving a constant pressure on the inner surface of the resistance—a marked departure from all other types, and one which results in smooth control and maximum gradation being achieved without any vernier adjustment.

One-hole fixing : super-quality material : best workmanship.

## The Acme Variometer

This variometer has now been long enough on the market and in daily use in so many thousands of sets as to have established itself thoroughly as the standard of efficiency. One-hole fixing : close coupled : skeleton wound : ball-type rotor and stator.



Price 6/6

Retail Prices :  
15 ohms ... 3/9  
30 ,, ... 4/-

CATALOGUE  
free on request

London Office  
and Showroom:  
102, Great Russell St.,  
Bloomsbury, W.C.1.

The Acme Production Co Ltd  
Smethwick  
Birmingham

The Crystal for the  
Connoisseur



**Russell's  
Hertzite**

You've stocked  
the rest—

Now *Sell*  
the Best!

In two grades, retail

**1/- and 1/6**

Per piece in Sealed Boxes.

### Agents

London :—Sun Electrical, 113, Charing Cross Road, W.C.2.  
Shenton & Co., Ltd., 68, Shoe Lane, E.C. 4.  
Apex Radio Co., 159, Usk Road, St. John's Hill, S.W.11.  
Lancashire :—Andrew Jackson & Co., 10, South Street, Manchester.  
Liverpool :—Ashcroft's Wireless Stores, 15-17, Smith Street.  
Bristol :—Central Wireless Depot, 24, North Street, Stokes Croft.  
Glasgow :—D. H. Purdon, 5, Battlefield Avenue, Langside.

The two grades in which Russell's Genuine Hertzite is now sold gives you a further opportunity of adding to your profits. You can satisfy the requirements of every wireless enthusiast—in the knowledge that he will remain a constant user of the only 100 per cent. pure crystal—Russell's Hertzite. There is a generous margin of profit for you in every sale. Write us for samples and terms, and for a supply of Blue Prints of Super Circuit.

**The L. G. RUSSELL Laboratories, 1-7 Hill St., BIRMINGHAM.**

(Opposite Empire Theatre.)

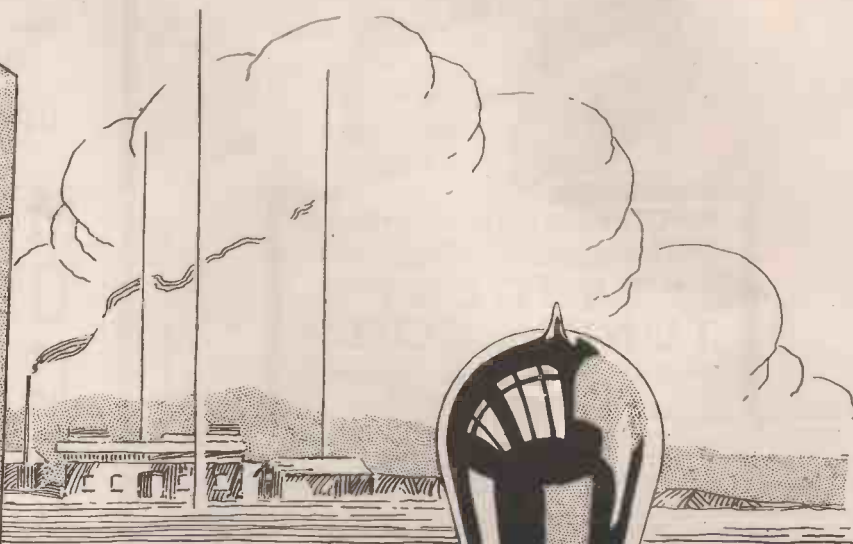

# A new Valve & a new Box

A handsome box is as valuable an asset to a valve as a well arranged window is to a shop. It does half the selling for you. The new blue and white box in which all Loudens, both Dull and Bright Emitters, are going to be sold in future, will create a good impression on the customer, besides drawing his attention to the valve's quality of Silver-Clear Reproduction. The boxes are also suitable for arranging effective window displays and making your shop both attractive and striking.



Type FER 1 for Detecting and Low Frequency Amplifying. Type FER 2 for H.F. Amplification.  
Price 13/6  
Filament Volts. 5-6  
Filament Amps. 0.1

## A Dull Emitting Louden for 13/6

Here is a valve with almost unlimited Sales possibilities—a valve which contains the best British materials, has the unique Silver-Clear qualities common to all Loudens, and which is priced at only 13s. 6d.

Such a valve is bound to sell in large quantities, as it removes the two chief objections levelled by the public against Dull Emitters.

The first objection of high first cost is gone. 13s. 6d. is very little more than the public has to pay for an ordinary bright filament valve.

The second objection, that the customer has to alter his existing set, is also removed, as the F.E.R. Louden will run off a 6-Volt Accumulator. No alteration or modifications to the set are necessary.

Every advantage the valve possesses, therefore, is a strong selling point, from its low initial cost to its current consumption.

If you are already selling Loudens sell the Dull-Emitter. If you are not, make a good start with this sound selling proposition.

Advt. of the Fellows Magneto Co., Ltd., Park Royal, London, N.W.10.

WHEN REPLYING TO ADVERTISEMENTS PLEASE MENTION "THE BROADCASTER."



**For Closest Selectivity and Sharpest Tuning use "TANGENT" TUNING COILS**

The Unshrouded Coil with a guaranteed LOW SELF CAPACITY.

Coil No. .. .. .	25	35	50	75	100	150	200	250
Self Capacity in Micro Microfarads .. .. .	8	9	25	31	22	16	22	22
Price .. .. .	4/3	4/3	4/3	4/6	5/-	6/-	7/-	7/6

Figures given above are taken from N.P.L. Report Copy sent on request.

**COMPLETE SETS.**

4 Concert Coils (W/L 250 to 1180) 16/- the Set.  
4 Concert Coils (W/L 250 to 9500) 67/- the Set.

All good dealers keep them.  
Any difficulty—write us.

**GENT & CO. Ltd. Est. 1872.**  
Faraday Works, LEICESTER.

London : 25, Victoria Street, S.W.1.  
Newcastle-on-Tyne : Tangent House, Blackett Street.

**EBONITE**

CUT TO YOUR OWN REQUIREMENTS.

**GUARANTEED. MATT FINISH.**

**M  
O  
U  
L  
D  
S**

- SHEETS,  $\frac{1}{8}$ "  $\frac{3}{16}$ "  $\frac{1}{4}$ "  $\frac{3}{8}$ " &  $\frac{1}{2}$ " Thick.
- PANELS, Machine Cut to any Size.
- DETECTOR BASES, " " & drilled
- COIL HOLDER PLUGS ( $\frac{3}{8}$ " and  $\frac{1}{2}$ " thick) " " " "
- COIL HOLDER SIDES " " "
- " " BASES " " "

**M  
O  
D  
E  
L  
S**

PRICES ON APPLICATION.  
CHEAPEST HOUSE in the TRADE.

We make Moulds and Models for Everything in Ebonite.

**W. J. WORMALD & SON,**  
MANGNALL STREET WORKS,  
Bradford Rd., Manchester.

ESTD. 20 YEARS Phone: CENTRAL 2168

**THE "MARK IV" PRODUCTS**

**THE "MARK IV" CRYSTAL.** It is an artificial crystal of the Galena type, is practically uniformly sensitive all over and is not easily put out of adjustment by vibration, etc.

It is very sensitive to large variations in temperature, and great care must be taken to ensure that the Wood's Metal is not too hot. All pieces selected and tested. Price 2/- per box (sealed).

**THE "MARK IV" ALLOY.** It is advised that our special "MARK IV" should be used for mounting the Crystal, as it has a melting point of 60° C. against 65° C. to 67° C. for the usual Wood's Metal. Price 9d. per box (two pieces).

**THE "MARK IV" CONTACT WIRE.** This is a special non-oxidisable alloy. The alloy is highly resistant to corrosion, its electrical conductivity is high, and its co-efficient of expansion with change of temperature very small. Therefore it forms an ideal material for contact wires. Price 6d. each (sealed).

Sole Proprietors :

**W. A. G. SMITH, LTD.,**

Radio Experts,  
93, HOLM STREET, GLASGOW.

Wholesale Rates on application.  
Phone : Central 2520.

**BRAHAMS**

(HOUNDSDITCH)

**LTD.**

90, Houndsditch,  
London, E.1.

Phone Avenue 208

**Wireless Accessories of Every Description.**

LARGEST IMPORTERS.  
OF

**BRASS PARTS (ASSEMBLED)**

Terminals, Contact Studs, Crystal Cups, Switch Arms, Detector Arms, &c., &c.

TRADE LIST ON APPLICATION.  
A Trial Order will Convince You.  
**TOOLS FOR WIRELESS.**

NO CONNECTION WITH ANY OTHER FIRM.

# PROFIT MAKERS! SNIPS FROM CARPAX CATALOGUE.

Here are a few items of intense interest to alert traders—a random selection from our catalogue—all money-making quick sellers showing good profit on retail prices quoted below.



**GRIP - TITE CLIPS**, for instant and positive connections. Sell like hot cakes to the experimenter. The jaws grip like a bulldog. Strong coiled spring gives a bite that makes perfect contact even through corroded surfaces. Small size (nickel finish), 4/- per doz.

Large size for charging stations, etc. (lead covered and extra powerful) 1/- each.

**CARPEX "VARIMEG."**—The ideal variable grid leak at last. Not a compression type. Smooth variation, stable resistance, 3/- Range ½ to 5 megohms.

**CARPEX VALVE PROTECTOR.**—Connect to one terminal of your H.T. Battery, and absolutely prevent valve blow-outs. 2/6.

**CARPEX "VARINODE."**—A variable anode resistance on same principle as Varimeg. Range 20,000 - 250,000 ohms. 3/-.

**FREE** Every trader ought to know that he can sell Complete Sets of our Models at less than the customer would pay for the components. Write at once for our Lists, which will be sent to you Free on request. Also if you will tell us type of current in your district we will inform you what types of battery chargers you will find a ready sale for. You can use them. Radio Societies want them.



## GOLD SEAL HOMCHARGER

Charges Accumulators from alternating current at a cost of only a few coppers for current consumed. The World's most popular battery charger. **STAR BATTERY CHARGER**, a smaller edition of the above. Also **BULB TYPE CHARGERS, D.C. CHARGERS and ROTARY TRANSFORMERS.**

Lists gladly sent.



You are missing trade if you don't stock this—it's one of our best sellers—and a good summer line, too.

### CARPAX "INDORARIAL"

Contains 600 feet of wire equally spaced between two pieces of heavy paper. Instantly collapsible and portable. Rolls up like a blind. Gives sharp tuning, loud and clear with valve or crystal set. Splendid seller. Leaflet free. **7/6**

CARPAX "INDORARIAL"



**ONE-VALVE CABINET RECEIVER** employs entirely new circuit. Gives tip-top reception simply using earth connection or few feet of wire thrown carelessly on floor of room. Also wonderfully selective. Price of Set alone, **£3 : 10 : 0**

(Including Marconi Royalty.) Complete with Batteries, D.E. Valve, and Phones, only **£6 : 5 : 0** Send for List of complete Sets, 30/- to £11 10s.

**THE CARPAX COMPANY LTD., 312, Deansgate, Manchester.**

Phone: CITY 7899. Telegrams: "Willingly, Manchester."

# Duodyne

## PORTABLE IV

### Loudspeaker Model

Complete with D.E. Valves, all Batteries, Headphones, etc.

Guaranteed range on own self-contained aerial. 25-30 miles loud speaker reception on 1½ k.w. (an earth connection will double this distance). Headphone range: 100 miles and under favourable conditions this distance may be considerably increased.

**THE MOST EFFICIENT and POWERFUL PORTABLE OBTAINABLE.**

NOW ON DEMONSTRATION.

Price **£21**

Guaranteed Delivery at Specified Dates.

Sales Organisation:

**PETER CURTIS, LTD.**

IN ASSOCIATION WITH

**THE PARAGON RUBBER MFG. CO., LTD., HULL, 75, CAMDEN RD., LONDON, N.W.1**

Telegrams: "PARACURTEX"

Telephone: NORTH 3112

BIRMINGHAM: 76, Newhall Street.

Telephone: CENTRAL 7236.

MANCHESTER: 312, Deansgate.

Telephone: CENTRAL 5095.

## REORGANISATION

The enormously increased demand for Paragon Products consequent upon the development of the Wireless Industry has necessitated a reorganisation of our Sales Department. As and from this date

## ALL SALES

will be handled by our associated company

**PETER CURTIS, LTD., 75, CAMDEN ROAD, LONDON, N.W.1.**

to whom all future correspondence, enquiries and orders should be addressed.

The Paragon Rubber Manufacturing Co. Ltd., Hull.



## QUALITY COUNTS

Because the very best materials, workmanship and finish are put into all our components, they appeal to the public from every point of view. This means sales are more readily made, and that is a good reason why you should get into touch with us. Our trade terms are liberal.

### THE L.E.S. MICRO-CONTROL

This resistance has a range of approximately 0 to 50 ohms, and will give micro-metrical control over filament potential on every type of valve.

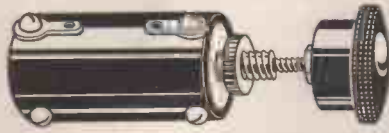

PRICE .. 3/6

Supplied in attractive cartons, each containing six. Just the thing for Window Display

### The L.E.S. COIL PLUGS

are made of Pure Ebonite.

Designed to meet the everyday needs of the wireless experimenter.

With Screw connections on face, 8½d. each

With Screw connections on side, 8½d. each



L.E.S. EXPERIMENTAL VALVE HOLDER.

PRICE .. 2/6

### THE L.E.S. FLUSH MOUNTING COIL PLUG.

A device to enable the experimenter to fit his loading coil or shorting plug flush with the surface of the panel.

As illustrated, 9d. each.

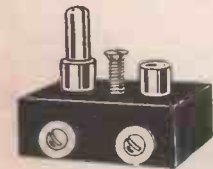

### L.E.S. BASKET COIL HOLDER.



A neat, rigid support for every Basket Coil, made to fit every standard Coil Holder.

As illustration, with solid ebonite base, 1/6 each. Cheaper type, 1/2 each



### L.E.S. SHORTING PLUG

Designed to avoid the possibility of touching a bare wire or shorting bar. As illustrated, 9d. each.

### MICRO-VERNIER COIL HOLDER.

The secret of the success of this Coil Holder lies in the wonderful perfection of the Vernier movement—one complete turn of the small knob only moving the Coil through 1.15 degrees. It has been specially recommended by the Wireless Press.

PRICE ... 7/6

As shown, with L.E.S. Patent Sub-Panel connections, 9/6. Three-way, with Vernier movement on one side only. Price 14/-



THE L.E.S. PANEL MOUNTING COIL PLUG.

A neat and efficient coil mount, suitable for any panel. All connections effected out of sight.

With sub-panel connections as illustrated, 1/- each.

All Prices quoted are RETAIL. See our Exhibit at "The Broadcaster" Showrooms, Bush House, Strand, W.C.2

WRITE FOR OUR NEW 42-PAGE CATALOGUE.

## LONDON ELECTRIC STORES LTD.

Oxendon Street, Haymarket, S.W.1.

Phone - - - Regent 2505 and 2506 - - - 'Phone

Barclays 950

## USE THE "BETTERWAY" FOR WINDOW DISPLAYS

Our signs are neat, effective and high class in finish—they are the best obtainable and always give satisfaction.

PRICE YOUR GOODS with the new Betterway Midget price tablets—the smallest interchangeable signs in the world.

BETTERWAYS LTD., DEPT. E, 33, Gt. Queen Street, Kingsway, W.C.2.

## THE BEST OF THE BUNCH

### SPECIFY ACCUDENSORS (TRADE MARK)



in your

### SETS.

USE

THE H.C.W. L.F.

## TRANSFORMER

### GUARANTEED EBONITE END PLATES.

.. PERFECT .. AMPLIFICATION.

Retail 15/6 Price

OTHERS NOT FULLY GUARANTEED

### RETAIL PRICES:

	ORD.	SQ. LAW	
.0003	... 6/-	... 7/-	} Subject
.0005	... 6/6	... 7/6	
.001	... 8/6	... 9/6	

With Vernier 1/6 each extra.

Liberal Discounts to the Trade and genuine Factors.

Controlled SOLELY by

S. T. HOSKEN, 153, Fleet Street, E.C.4

Phone: Central 9432

TRADE DECKO MARK

### QUICK SELLING. INEXPENSIVE.

UP-TO-DATE LINES. VALVE WINDOWS. BATTERY SWITCHES. DIAL INDICATORS. SOLDERLESS TAGS. BACK PANEL HOLDERS. AMERICAN ACCESSORIES.

SEND FOR LATEST LISTS.

A.F. BULGIN & CO.

9-11, CURSITOR STREET  
TEL. HOLBORN 2072 CHANCERY LANE E.C.6. WORKS CHISWICK

TRADE DECKO MARK

WHEN REPLYING TO ADVERTISEMENTS PLEASE MENTION "THE BROADCASTER."



# Uncle Fellows calling !!!

*A triumph of co-operation!  
- a two valve set for £4.10.0*

When business expert and wireless engineer co-operate, you can be certain the result is worth having.

Our wireless engineers have constructed one of the most ingenious circuits ever devised. Our business experts have decreed that the cost of production should be absolutely the lowest compatible with our policy of Quality Apparatus.

The success of their co-operation is evident. The set sells at the remarkably low figure of £4 : 10 : 0, and its range is exceptional. In fact, good results should be obtained with a loud speaker anywhere in the country.

Incidentally, the set retails at £10 : 5 : 0, complete with loud speaker and all accessories and extras.

I need say no more. As a selling proposition it must stand unrivalled.

*Uncle Fellows*

**LITTLE GIANT  
TWO VALVE SET.**



This set may be seen at **Yeates, Ltd.**, of 20, Store Street, Tottenham Court Road, W.C.1, who have well-equipped sales and demonstration offices for Fellows Wireless Products.



Cabinet only .. .. £4:10:0  
or  
Cabinet with 2 Louden Valves £5:7:0  
Marconi Tax extra in each case .. .. £1:5:0

Loud Speaker Set complete with all accessories, Tax, and FELLOWS JUNIOR LOUD SPEAKER, £10:5:0  
LIST OF ACCESSORIES AND EXTRAS.  
6 V. Accumulators £1:4:0 Aerial and  
H.T. Battery .. 12:6 Insulators 5:0  
2 Louden Valves 17:0 Marconi  
Set of Wiring .. 1:6 Tax £1:5:0  
and Fellows Junior Loud Speaker £1:10:0

or  
Set with Fellows Lightweight Headphones instead of Loud Speaker £9:11:6 complete.  
*All above prices are retail and subject to our usual and liberal discount. Except, of course, Marconi Tax, which is nett.*

*Advt. of the Fellows Magneto Co. Ltd., Park Royal, London, N.W.10.*

# WARNING!

Letters Patent No 222, 545

WE hereby give notice that we are the owners of the above letters patent and the Trade and Public are hereby warned against any or all infringements of this patent, whether resulting from the manufacture, sale or use of any apparatus which embodies this invention.

It must be borne in mind by the Trade and Public that the sale or use in this Country of any infringement renders the seller or user liable for action with the unlicensed manufacturer and importer.

It is this Company's intention to uphold its patent rights and the novelties protected thereby.

THE design of the H.T.C. Low Capacity Valve Holders is proved the only logical mounting for the four-pin valve. The ordinary type of Valve Holder with sockets embedded in a moulding of insulating material is absolutely unsatisfactory under any condition and in any circumstance. Any serious experiments conducted with this inefficient type of holder are, at the onset, doomed to failure.

The paralysing capacity effects of the socket valve-holder are of such serious dimensions that in every receiver H.T.C. Low Capacity Valve Holder should be standard equipment both from the experimenters' and the manufacturers' standpoint.

The phenomenal demand for the H.T.C. Low Capacity Valve Holders has given birth to imitations and palpable infringements.

In the light of our experience and extended experiments we make no apology when informing the trade that there is no type of Valve-Holder which has so high an efficiency; or so great a demand among the experimenters and home constructors.

Imitations are imitations—and by virtue of the imitation these merely imitate the extraordinarily high efficiency of the H.T.C. Low Capacity Valve-Holder.

H.T.C. Valve-Holders are obtainable from your usual wholesaler or factor; if they cannot supply, we can direct you to a house who can.

Factors and Shippers apply direct to the Manufacturers and Patentees.

PRICES—A TYPE (Above Panel) Templates Supplied .. .. . 1/9  
C TYPE (Below Panel) Templates Supplied .. .. . 1/6

Other Types in preparation.

## H.T.C. ELECTRICAL Co. Ltd.

2 and 2a, BOUNDARIES ROAD, BALHAM, S.W.12.

Telephone: Battersea 374

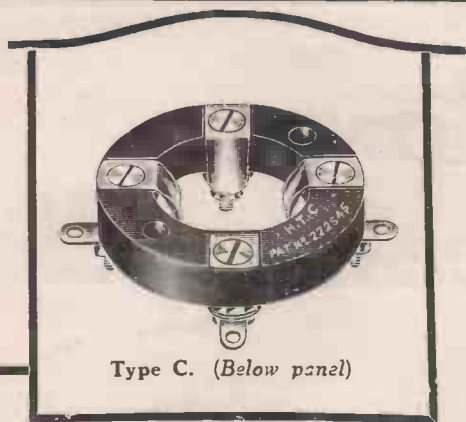

Type C. (Below panel)

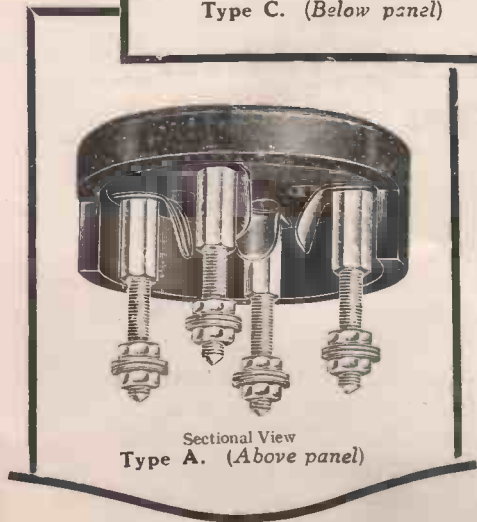

Sectional View  
Type A. (Above panel)

barclays 937.

# VALVES REPAIRED

## GUARANTEED EQUAL TO NEW.

### PRICE LIST.

All Standard Types of Bright Emitters  
6/6 each.

### REDUCED PRICES DULL EMITTER VALVES

TYPE.		Retail Prices.
Marconi D.E.R.	B.T.H. B. 3.	9/-
Ediswan A.R.D.E.	Mullard L.F.Ora.	
Marconi D.E. 3.	B.T.H. B. 5.	10/6
Ediswan A.R. '06.	Mullard D. '06.	
B.T.H. B. 4.	B.T.H. B. 6.	15/-
Marconi D.E.5.	Ediswan P.V.5 D.E.	
Mullard D.F.A.1.		

WRITE FOR TRADE DISCOUNTS.

Deliveries 3-7 days according to Type.

The following unsolicited testimonial is typical of the hundreds we have received :

Photographer,  
Studio Electric,  
Yiewsley, Midd'x.

Dear Sirs,

"It may interest you to hear that the 'R' Valve you have repaired for me has turned out a 'Super.' Last Wednesday I tuned in W.G.Y. and K.D.K.A. Last Thursday, I tuned in W.G.Y. and K.D.K.A. and W.B. ZEE., and last night I heard every item from N.G.Y., starting at 11.30—Item No. 6, A Pianoforte Recital—on the Loud Speaker, and it could be heard in an adjoining room with the door shut. Also a few items W.B. ZEE.

"I used the repaired valve as H.F., so you may take the credit. Thanking you.

(Signed) "ALAN SMITH."

## THE VALVE RENEWAL COMPANY,

4/5, Mason's Avenue, Coleman Street, London, E.C.2.

'Phone: London Wall 5184.

WHEN REPLYING TO ADVERTISEMENTS PLEASE MENTION "THE BROADCASTER."



# "GÖLTONE" REGD. WIRELESS CONSTRUCTIONAL SETS.

BEST BRITISH MAKE.

These Sets are dispatched with ready drilled Ebonite Panel, Assembled Condensers, Wound Transformers, etc., enabling the Set to be easily and quickly constructed.

The Circuits employed have been thoroughly tested under various conditions and can be recommended with every confidence. Blue Print diagram and full instructions supplied.

The prices shown include Set of Coils suitable for B.B.C. Stations.

- |  |   |   |
|--|---|---|
| 1 VALVE SET, £2 9 0.<br>Marconi Royalties, 12/6 extra net. | 3 VALVE SET, £6 17 0.<br>Marconi Royalties, 37/6 extra net. | 5 VALVE SET, £12 19 0<br>Marconi Royalties, 62/6 extra net. |
| 2 VALVE SET, £5 5 6.<br>Marconi Royalties, 25/- extra net. | 4 VALVE SET, £9 2 0.<br>Marconi Royalties, 50/- extra net.  | Subject Trade Discount.                                     |



The H. G. Co., Ltd., Silloth, Cumberland, write:—  
"A few weeks ago we ordered from you a three-valve wireless constructional set and are pleased to state that our client is having most excellent results and is more than satisfied. This is most pleasing to us, seeing that we had never tested any of your sets before and we were rather anxious as to the results. Now, however, we can recommend with confidence."

## "GÖLTONE" REGULATING COIL HOLDERS.

Patent No. 4037/24.

### MICROMETER

Excellent finish. Enables the finest possible tuning, considerably increasing the Efficiency, Reliability and Selectivity of the Receiving Set.

- Two Coil Type, No. R15/40 ... 7/6  
Three Coil Type, No. R15/41 ... 10/6

Subject Trade Discount: See Catalogue for details of other types.

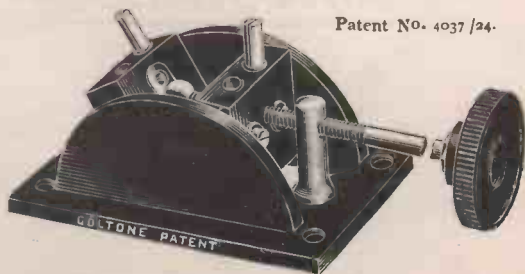

## "GÖLTONE" DUSTPROOF DETECTORS.



Excellent finish and appearance. Fitted with Glass Dust Shield. Mounted on Ebonite Base. Price 1/9 each, 18/6 doz. Parts only, without Ebonite Base, for Panel Mounting, Price 1/6 each, 15/- dozen. Vertical and horizontal types supplied. "Mercury" Type Dustproof Detector. (Patent Applied.) No searching for Sensitive Spots. Utmost volume assured instantly. Complete with Crystal and Bottle of Mercury, 3/6 each, 39/- dozen. Subject Trade Discount.

## "SAMPSON" ACCUMULATOR CARRIER.

Patent No. 214037/23.

Light, strong and exceedingly useful. The inconvenience of handling weighty, cumbersome accumulators is entirely obviated. Suitable for any size accumulator. Folds flat to fit the pocket ... 2/6 each Subject Trade Discount.

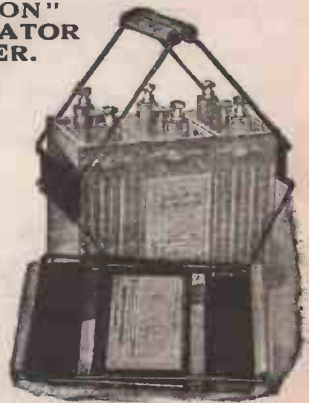

WARNING!—Rigorous action will be taken against infringements of this Patent.

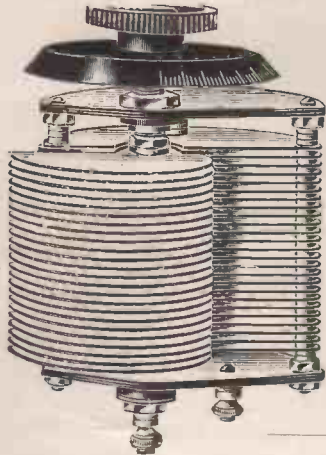

## High Grade SQUARE LAW VARIABLE CONDENSERS

ACCURATE AND RELIABLE. Fitted with Ebonite Knob and Engraved Dial. Single-hole fitting.

No.	Capacity Mfd.	Price.
R14/201 .. .001	.. 9/-	
R14/202 .. .0005	.. 7/6	
R14/203 .. .0003	.. 7/-	
R14/204 .. .0002	.. 6/6	
R14/205 .. .0001	.. 6/-	

Fitted with Vernier, 3/- extra Subject Trade Discount.

## "GÖLTONE" SUPER CRYSTAL.

Gives remarkably good results. Complete with Cat's Whisker and Crystal Tweezer, packed in attractive Carton. Price 1/- each. 10/6 doz. Subject Trade Discount.



## "GÖLTONE" (Regd.) LOW-FREQUENCY TRANSFORMER.

Size 3 1/4 in. by 2 1/4 in. by 3 3/8 in. deep. Thoroughly recommended as a remarkably efficient Transformer for use in any circuit, and with any type of Valve. Provides remarkable amplification with freedom from noise and distortion. No make of Transformer gives better results. Ratio 5 to 1 and 2 to 1. Price 17/6. Subject Trade Discount.

### W. & G.

## PANEL SWITCH

Size 1 1/2 by 1 in. Flush Type, high-grade appearance. Neat design. Price 1/6 each.

Subject Trade Discount.

None genuine without this trade mark on box.



## RADIO WIRES

We are actual Manufacturers. Silk, Cotton and Enamelled Wires supplied in Bulk or on Small Reels. Aerial Wires, Leading-in Wires, Telephone Receiver and Loud Speaker Cords and Wires and Cables of every description.

Send your Enquiries. Competitive Prices.

LARGE 32-PAGE ILLUSTRATED RADIO CATALOGUE POST FREE ON REQUEST.



Address all communications to Head Office and Works PENDLETON, MANCHESTER. Stocks also held at Glasgow Depot: 95, PITT STREET

WHEN REPLYING TO ADVERTISEMENTS PLEASE MENTION "THE BROADCASTER."

# LIGHTNING SALES

OF THE  
"BUSCO"

# LIGHTNING TAG

Pat. No. 8086/24.

THE ENORMOUS DEMAND HAS PROVED THE POPULARITY OF THIS UNIQUE DEVICE.

ITS SIMPLICITY AND EFFICIENCY

**GUARANTEE ITS SALE.**



NOT IN USE & SAFE FROM LIGHTNING



IN USE

THE TAGS ARE MADE TO FIT ONE INTO THE OTHER, SO THAT WHEN NOT IN USE THEY CAN BE CONNECTED TO MAKE

## A PERFECTLY SAFE EARTH SEND YOUR ORDER NOW

OR ASK FOR FREE SAMPLE,

AND CONVINCE YOURSELF OF THE UTILITY OF THIS

### 5 IN 1 TAG

- (1) LIGHTNING SWITCH.
- (2) EXTENSION LEADS.
- (3) BATTERY CLIP.
- (4) DOUBLE TERMINAL TAG.
- (5) UNIVERSAL CONNECTOR.

RETAIL PRICE 2d. EACH.

TRADE PRICES ON APPLICATION TO SOLE DISTRIBUTORS FOR THE UNITED KINGDOM:

**E. H. MILLINGTON & COMPANY, LIMITED,**  
VAUGHTON STREET SOUTH, BIRMINGHAM.

MANUFACTURERS AND PATENTEES—

**BUSBY & Co., Ltd.,**  
Price St. Birmingham.

WHEN REPLYING TO ADVERTISEMENTS PLEASE MENTION "THE BROADCASTER."

## Quality RADIO

## COMPONENTS.

Send for List  
and trade terms.

### Duplex Coils

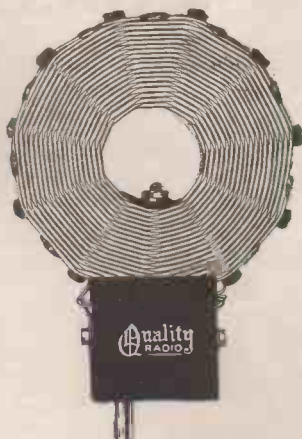

Number	Prices Mounted	Prices Unmounted
25	1 6	0 9
35	1 9	1 0
50	2 0	1 3
75	2 3	1 9
100	2 9	2 3
150	3 0	2 6
175	3 6	2 9
200	3 9	3 0
Set	20 6	15 3

Each packed in carton. Postage extra.



1/6 each, retail. Each wrapped in fixing instructions, packed one dozen in a box.

### ANTI-CAPACITY LEGLESS VALVE HOLDER

They are widely advertised, and we give you the SERVICE of showcards over printed lists and leaflets.

**GOSWELL ENGINEERING CO., LTD.**  
12a, PENTONVILLE ROAD, LONDON, N.1.

Liberal Trade Terms. Phone: North 3051.

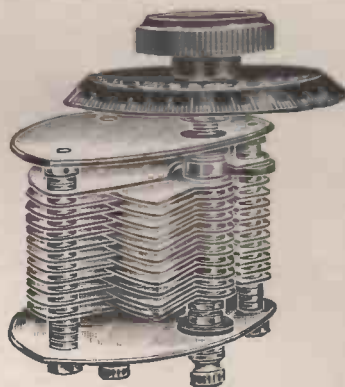

THE  
*Supreme*  
CONDENSER.

### STANDARD AND SQUARE-LAW.

Supreme in construction, design, detail and accuracy.

CHAMFERED METAL  
END-PLATES.  
HEAVY VANES 20G (.036").

NO WARPING OR DISTORTION.  
TROLITE KNOB AND DIAL.

CAPACITY IN M.F.	STANDARD		SQUARE-LAW	
	PLAIN	VERNIER	PLAIN	VERNIER
.001	8/-	9/6	9/9	12/-
.00075	7/-	8/6	9/3	11/6
.0005	6/-	7/6	8/6	11/-
.0003	5/6	7/-	8/-	10/6
.0002	4/9	6/3	7/6	10/-

Attractive Trade and Export Discounts.

Phones—  
HOLBORN 696  
MUSEUM 6837  
Telegrams—  
SHENMETERS

**SHENTON & CO., Ltd.**  
WIRELESS ACCESSORY MANUFACTURERS,  
68-69, Shoe Lane, London, E.C.4



**SELL RADION VALVES AND AMPLIFY PROFITS**



**WRITE TO-DAY FOR  
FREE DISPLAY**

**WE** have a well-equipped research department constantly working at full pressure in the interests of better and still better productions. And we are very proud and happy to say that as a direct result our files are simply chock-full of testimony from delighted users.

*The* **FINE PERFORMANCE  
of RADION VALVES has  
CREATED WONDERFUL SALES**

**WE** are the pioneers of high-grade BRITISH MADE VALVES at popular prices. And sales are simply soaring up! It's quality and value that count. Take a hand in selling RADION valves and learn what real customer satisfaction is.

**RADION VALVES ARE NOW AVAILABLE  
IN THE FOLLOWING POPULAR TYPES**

**RADION G. P. 10/-**

An economical Bright Emitter Valve, taking only .48 amps. at 3.5 to 4 volts. Note the economical current consumption. Magnification and impedance features are also excellent.

**RADION D.E.34 17/-**

A 2-volt D.E. of great efficiency.

**RADION D.E.06 20/-**

Admitted to be the best point-ought-six ever made.

**SPECIAL OFFER by our REPAIR DEPT.**

It is a fact that admits of no argument that we are top-dogs in the valve repair business—and that any business to be done in this might as well be done with the World's Leaders. Every bona-fide trader of any standing who writes in on his note-head (whether he has dealt with us before or not) will be given a beautiful coloured window streamer calculated to bring a lot of business. Just say you are willing to display it. We know what the result will be. This is business for you without carrying stock.

**PROFITS WITHOUT FINANCIAL RISKS!  
WRITE TO-DAY FOR FREE DISPLAY.**

**Advt. of RADIONS LTD., BOLLINGTON, NEAR MACCLESFIELD, ENGLAND.**



*Export Branch :*

**LYALL WILLIS & Co. Ltd.  
BILLITER HOUSE,  
LONDON, ENGLAND.**

**SYDNEY.—JONES & JOSEPH, LTD.**

**ADELAIDE.—ARTHUR GLOVER.**

**PERTH.—L. M. CULLEN & Co.**

**MELBOURNE.—BALDWIN & SLATTERY PTY., LTD.**

**BRISBANE.—GREGORY & COLLINS.**

**WELLINGTON.—BRITISH TIME RECORDERS (N.Z.), LTD.**

**CAPETOWN.—J. A. C. KERSLEY.**

**JOHANNESBURG.—MANN, LITTLE & Co. (S.A.), LTD.**

**DURBAN.—MANN, LITTLE & Co. (S.A.)**

**RHODESIA.—MANN, LITTLE & Co., LTD.**

**KARACHI.—NUSSERWANJEE & Co.**

**COLOMBO, CEYLON.—C. THIAGARAJAH & Co.**

**BUENOS AIRES.—VIVIEN VENN.**

**VANCOUVER.—D. W. BRADSHAW & Co.**

**AGENTS WANTED IN VARIOUS OTHER COUNTRIES.**

Apply either to MESSRS. LYALL WILLIS, or direct to ourselves.

WHEN REPLYING TO ADVERTISEMENTS PLEASE MENTION "THE BROADCASTER."

ECLIPSE

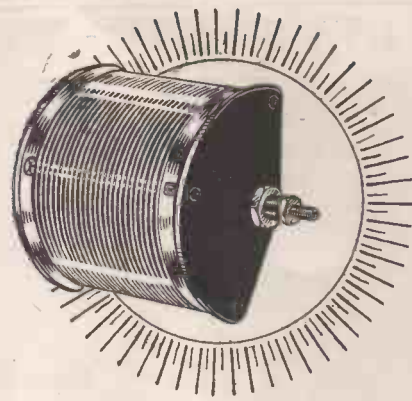

CONDENSERS

**-THE LATEST ECLIPSE!**

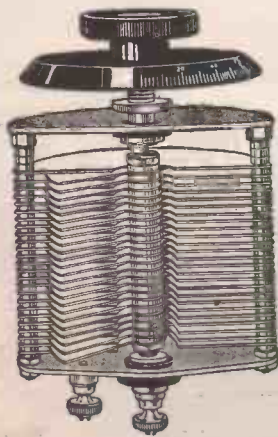

**STANDARD.**

RETAIL PRICES—ASSEMBLED.

·001	8/-	·0002	4/6
·00075	7/-	·0001	4/-
·0005	6/-	·00005	4/-
·0003	5/6		

**THE CONDENSERS THAT ECLIPSE ALL OTHERS.**

These Condensers are soundly constructed and entirely made in our own factory and guaranteed British Made throughout.

*Attractive discount to the trade, etc.*

**SPECIAL TERMS TO FACTORS**

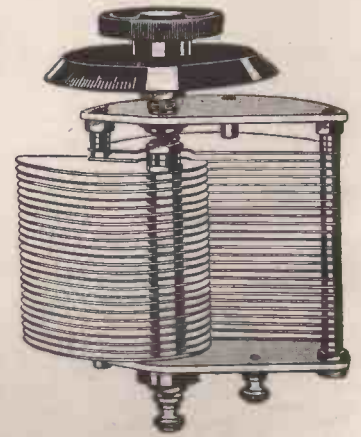

**SQUARE LAW.**

RETAIL PRICES—ASSEMBLED.

·001	10/6	·0002	8/-
·00075	10/-	·0001	7/6
·0005	9/6	·00005	7/6
·0003	9/-		

**CONDENSER VANES & END PLATES  
A SPECIALITY.**

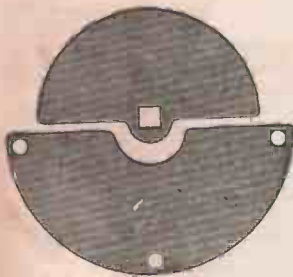

ORDINARY AND SQUARE LAW PATTERNS.

DELIVERY FROM STOCK.

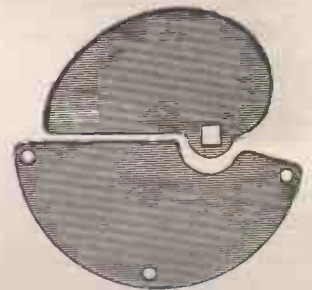

*For Prices apply to:*

**The P. & C. MANUFACTURING CO. Ltd.,  
6, BATH STREET, CITY ROAD, LONDON, E.C.1.**

Clerkenwell 1755.

WHEN REPLYING TO ADVERTISEMENTS PLEASE MENTION "THE BROADCASTER."

# EBONEX & IVOREX WIRELESS SCALES AND LABELS.

THESE ILLUSTRATIONS ARE TO HALF SCALE.

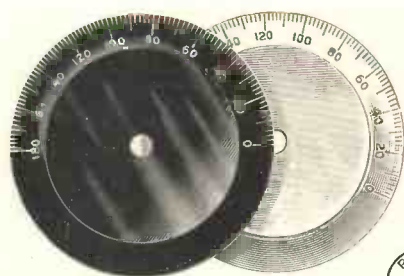

22

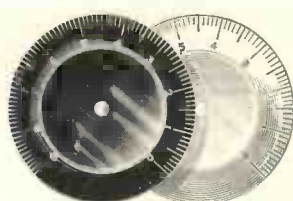

23

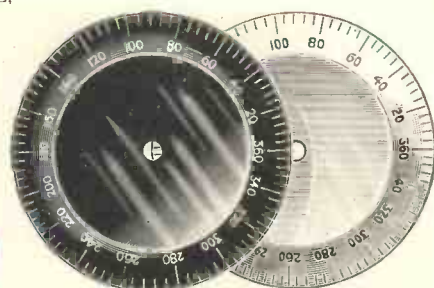

24

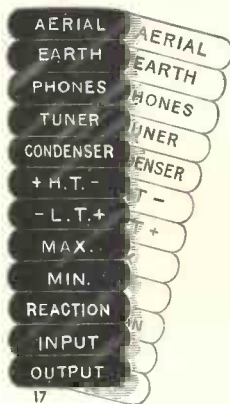

17



12



*Reduced Prices*



15

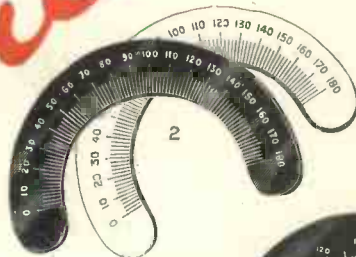

2

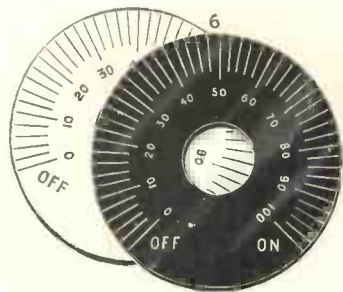

6

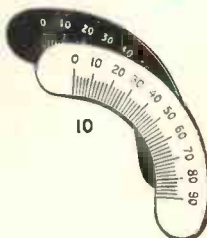

10

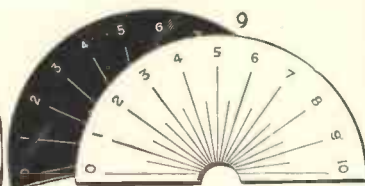

9

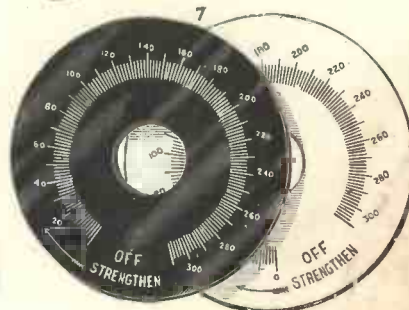

7

## GOOD NEWS!

Magnetic Advertising and Mass Production have enabled us to make some considerable reductions in prices as from 2nd March, 1925. The big cut in the price of the No. 12 Terminal Labels will make their great popularity greater than ever, whilst the new price of the No. 22 Bevelled Dial must increase its sale tremendously.

## PRICE LIST.

Ref. No.	Per 100	Ref. No.	Per 100
2	Condenser and Variometer Scales, 0-180 ... 12/-	14	Terminal Labels, Self-fixing ... 3/3
3	Reaction Scales, 0-30 ... 12/-	15	Terminal Labels, Ordinary with round ends... 2/6
4	Coupling Indicators (Loose and Tight) ... 12/-	17	Terminal Labels, Sets of 12 Popular Names with round ends 25/-
6	Rheostat Dials, 0-100 ... 17/-	19	Rheostat and Variometer Dials, 0-360 ... 18/-
7	Rheostat Dials, 0-300 ... 18/-	20	Ivorex Pointers ... 1/9
8	Scales, 0-10, Small Semi-circular ... 9/-	21	Tools for recessing No. 12 Labels into Panels 35/-
9	Scales, 0-10, Large Semi-circular ... 15/6	22	Condenser and Variometer Dials, 0-180, Bevelled 29/6
10	Scales, 0-90 ... 8/-	23	Rheostat Dials, 0-9, Bevelled ... 18/-
12	Terminal Labels, Self-fixing ... 2/9	24	Variometer Dials, 0-360, Bevelled ... 29/6

N.B.—Quantities of less than 100 of a line will be surcharged 12½ per cent.

Orders under £1 in value are strictly net. Orders of £1 and upwards are subject to 2½ per cent. discount for Cash.

Full value Range of Samples sent post free to any part of the World for 4/-.

All goods are sent Carriage Paid to any part of the World or may be ordered through any Wholesaler.

**IMPORTANT: When ordering, please quote reference number.**

We make Wireless Labels in all Languages and are always ready to make Dials, Scales and Labels to Customers' Special Requirements.

# MONEY HICKS & MILLS, LIMITED,

The Largest Makers of Wireless Scales and Labels in the World,

YORK ROAD, WIMBLEDON, LONDON, S.W.19, ENGLAND.

Telephone & Telegrams: WIMBLEDON 3031.

# A GAMBRELL ANNOUNCEMENT TO WIRELESS RETAILERS.

OUR RADIO SALES DEPARTMENT having been re-organized, we are now considerably increasing our advertising programme.

In order that Retailers may reap an immediate benefit from this extended publicity, we publish below a first list of Wholesalers from whom supplies of Gambrell Products can be obtained.

If you have any difficulty in procuring our components, please write us in order that we may arrange for stocks to be at your service.

Be prepared for the enquiries which you will receive—write for our latest lists.

## List of Wholesalers.

### ABERDEEN.

BROWN BROS. LTD.

### BELFAST.

DRAKE & GORHAM WHOLESALE LTD., 63, Victoria Street.

HOUGHTONS LTD., 6, Fountain Lane.

### BIRMINGHAM

S. WILDING COLE (Midland Agent), 116, Snow Hill.

BROWN BROS. LTD.

PRIESTLY & FORD, 3, Carrs Lane.

### BRADFORD.

FRANK RIDDIOUGH & SON, Westgate, Distributors for W. Riding of Yorkshire.

### BRIGHTON.

DRAKE & GORHAM WHOLESALE LTD., 24, Marlborough Place.

W. J. HENDERSON & Co., 3, Queens Road Quadrant.

### BRISTOL.

DRAKE & GORHAM WHOLESALE LTD., 35, Broad Street.

SIMPSON, BAKER & Co., 2-5, Nelson Street.

### CARDIFF.

BROWN BROS. LTD.

SIMPSON, BAKER & Co., 12, Westgate Street.

### DUBLIN.

BROWN BROS. LTD.

DRAKE & GORHAM WHOLESALE LTD., 2, Church Lane, College Green.

### DUNDEE.

BROWN BROS. LTD.

HOUGHTONS LTD., 9, Pannure Street.

J. F. IRVINE & Co., Ltd., Caird Hall.

### EDINBURGH.

BROWN BROS. LTD.

HOUGHTONS LTD., 2nd Flat, 20, St. James' Square.

### GLASGOW.

BROWN BROS. LTD.

DRAKE & GORHAM WHOLESALE LTD., 198a, Vincent Street.

HOUGHTONS LTD., 70-72, York Street.

### GRIMSBY.

T. BEADLE & Co., LTD., 370, Cleethorpe Road.

### HAMPTON-ON-THAMES.

PRESSLAND ELECTRIC SUPPLIES LTD.

### HANLEY.

HOUGHTONS LTD., Free Trade Bldgs., 2nd Floor, Percy St.

### HULL.

T. BEADLE & Co. LTD., 3, Castle Street.

### LEEDS.

BROWN BROS. LTD.

HOUGHTONS LTD., 67a, Briggate.

THE SUN ELECTRICAL Co. LTD., 29, Park Place.

### LEICESTER.

T. BEADLE & Co. LTD., Newport Place, Northampton Street.

### LIVERPOOL.

PULFORD BROTHERS LTD., 106, 108 & 110 Whitechapel.

### LONDON.

AUTOVEYORS LTD., 84, Victoria Street, S.W.1.

BRANSON, KENT & Co. LTD., 40, Great Eastern Street, E.C.2.

BROWN BROS. LTD., Brown's Buildings, Gt Eastern St., E.C.2.

CABLES & FLEC. SUPPLIES, Cable House, 234, Pentonville Rd., N.1.

A. J. DEW & Co., 33 & 34, Rathbone Place, Oxford St., W.1.

DRAKE & GORHAM WHOLESALE LTD., 67, Long Acre, W.C.2.

J. J. EASTICK & SONS, 2, St. Dunstan's Hill, E.C.3.

EAST LONDON RUBBER Co., 29/33, Great Eastern St., E.C.2.

A. W. GAMAGE LTD., Holborn, E.C.1.

W. J. HENDERSON & Co., 351, Fulham Road, S. Kensington, S.W.10.

HOBBAY BROTHERS LTD., 21, 23, 25, & 27, Gt. Eastern St., E.C.2.

HOUGHTONS LTD., Ensign House, 88-89, High Holborn, W.C.1.

SIMPSON, BAKER & Co., 32, Newman Street, W.1.

STOCKALL, MARPLES & Co. LTD., 6, 8 & 10, Clerkenwell Road, E.C.1.

THE SUN ELECTRICAL Co. LTD., 118 & 120, Charing Cross Rd., W.C.2.

### MANCHESTER.

BROWN BROS. LTD.

DRAKE & GORHAM WHOLESALE LTD., 29, Piccadilly.

HOUGHTONS LTD., 15, Blackfriars Street, Salford.

FRANKS (WHOLESALE) LTD., 3, South King Street

### MIDDLESBOROUGH.

ARTHUR JONES & Co., 15, Dock Street.

### NEWCASTLE-ON-TYNE.

BROWN BROS. LTD.

THE SUN ELECTRICAL Co. LTD., G. Floor, Milburn House.

### NOTTINGHAM.

T. BEADLE & Co. LTD., 3, High Pavement.

HOUGHTONS LTD., 61a, Long Row.

### STOCKPORT.

HENRY HOLLINGDRAKE & SON LTD., Prince's Street.

### SOUTHAMPTON.

BROWN BROS. LTD.

SWANSEA.

HOUGHTONS LTD., 20, Orange Street.

EFFICIENCY

GAMBRELL

GAMBRELL

EFFICIENCY

**GAMBRELL BROS LTD**  
76. VICTORIA ST.  
LONDON  
S.W.1.

PHONE  
VIC. 9938

WORKS  
SOUTHFIELDS.

— RADIO RETAILER —

Is YOUR Name on the

**N.A.R.M.A.T. Register of Radio Retailers?**

If not

**SEND YOUR NAME AND ADDRESS**

*(either by Trade Card or Printed Letter Head with, if you wish, some short details of your business)*

To THE NATIONAL ASSOCIATION OF RADIO MANUFACTURERS AND TRADERS, which, with a view to safeguarding the interests of the genuine Radio Retailer and removing the evils now existing in the Trade, is compiling a representative REGISTER OF BONA FIDE RETAILERS.

*If you are one of these, it can be only to your advantage to have your name and address registered.*

All communications to THE SECRETARY (Trade Register),

THE NATIONAL ASSOCIATION OF RADIO MANUFACTURERS & TRADERS,

Astor House, Aldwych, London, W.C. 2

**REGISTRATION FREE**

**THE MICROSTAT.**

(British Patent No. 218523)

**A Warning!**

Legal proceedings are now being taken against a firm for the infringement of the Patent Design of the "Microstat" Filament Resistance. The Trade are therefore warned against purchasing Microstats that do not bear the Patent No. 218523. Microstats are distributed solely by Messrs. Wates Bros., Ltd., and the retail price has always been

**2/9**

They are supplied in cartons of 12, each one in a separate box. The Microstat is giving wonderful satisfaction and selling remarkably well. If you do not stock you should send at once for terms. See that the Patent No. 218523 is stamped plainly on each instrument and on the box.

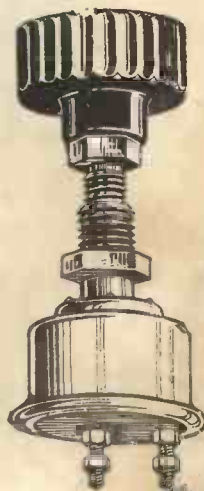

**PRI  
2/9**

**WATES**  
BROS., LTD.

Head Office :  
12, 13 & 14, Gt. Queen Street,  
Kingsway, London, W.C.2.

'Phone : Gerrard 575-576.

Works : LONDON, BIRMINGHAM AND WESTCLIFF.

'Grams : "Zywateseng, Westcent."

WHEN REPLYING TO ADVERTISEMENTS PLEASE MENTION "THE BROADCASTER."

# 5/- DOLLAPHONE 5/-

Per pair  
RETAIL

A PHONE for the Million

Per pair  
RETAIL

BRITISH MADE.

4000  
OHMS.



GUARANTEED

5/-

RETAIL

LISTENERS  
SAY:—  
THEY ARE  
FINE!

DEALERS  
SAY:—  
THEY  
DOUBLE MY  
TURNOVER!

# 5/- LIBERAL QUANTITY DISCOUNTS 5/-

Per pair  
RETAIL

Per pair  
RETAIL

Manufactured by

**TURNOCKS, TUNION WORKS,**  
ASTON, BIRMINGHAM.

## JOB LINES

9 Carat Gold Catwhiskers  
Spearpoint

Per Gross . . . . . 7/6

Silver Catwhiskers  
Spearpoint

Per Gross . . . . . 4/6

Thousand Star Crystals,  
neatly boxed, as used by the  
U.S.A. Navy

Retail at 1/6 per Box  
Per Gross . . . . . 40/-

Bulk Galena, very  
Sensitive

Per Pound . . . . . 20/-

TERMS: — CASH WITH ORDER

L. G. RUSSELL, 1-7 Hill Street, BIRMINGHAM

# POWQUIP

GUARANTEED

## TRANSFORMERS

# EXCEL



THE  
**POWER EQUIPMENT**  
COMPANY LIMITED

KINGSBURY WORKS, THE HYDE, HENDON, N.W.9

## A PERFECT SERVICE for RETAILERS

WE ALWAYS have a large stock of  
all Radio Components and Accessories  
ready for IMMEDIATE DELIVERY.

COSSOR, MULLARD, EDISWAN, MARCONI,  
B.T.H., FAMA AND METAL R VALVES,  
and all regular types of Bright and Dull-Emitter Valves  
always available.

### HEADPHONES—

BROWN'S, STERLING, BRUNET, SIDPE, and  
many other lines on hand.

**SPECIAL NOTICE.**—The Elkaphone high-grade headphones are  
specially recommended by us:—4,000 ohms, highly plated, leather covered,  
double spring head bands, exceptionally comfortable, price 8/6 per pair.  
ACCUMULATORS, H. T. BATTERIES, FLASH BATTERIES,  
CRYSTALS, EBONITE, BRASS PARTS,  
CABINETS, and Accessories of every description.

We are also manufacturers of all types of High-class  
CRYSTAL & VALVE SETS, AMPLIFIERS, Etc.

Send for our List now. Cut prices. Delivery by return.

**THE KAY & TEE**  
WIRELESS SUPPLY COMPANY,

Practical Radio Experts & Electrical Engineers,

5, High St., Shoreditch, London, E.1

Telephone : : Central 1029.

WHEN REPLYING TO ADVERTISEMENTS PLEASE MENTION "THE BROADCASTER."



(L. & P.)  
**"Ellanpee" Specialities.**  
 REGISTERED.



The Stamp

of Perfection

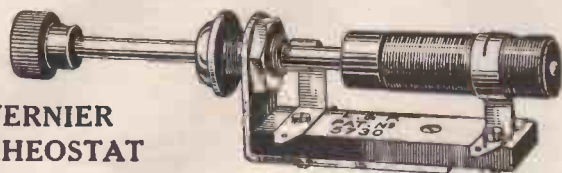

**VERNIER RHEOSTAT**

(Patent No. 5730.)

This ONE-HOLE FIXING Vernier Rheostat is wound with the best possible Resistance Wire and is guaranteed not to rust, get brittle or perish with heat—is unalterable in resistance. All the metal parts are heavily plated. It has a resistance of 6.5 ohms, and a current carrying capacity of .75 amp. This efficient Vernier Rheostat only takes up one inch of panel space. It is packed in separate cartons with full instructions for mounting.

Price 4/3 each.

Also supplied for .06 amp. D.E. Valves.

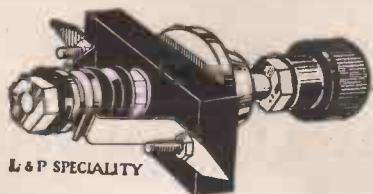

L & P SPECIALITY

**PULL AND PUSH SWITCH**

(Patent Applied for.)

Specially designed for High Voltage Current, the operator is guaranteed secure from shocks. A necessity in all Valve Receivers and Amplifiers. Lengthens the life of High Tension Batteries. ONE HOLE FIXING. All metal parts heavily plated. Positive action. Highest quality material and workmanship. Packed in separate cartons with full instructions for mounting.

Price 2/9 each.

Also supplied S.P.D.T. . . . . 4/3 each.  
 D.P.D.T. . . . . 5/9 each.

**MINIATURE SWITCH (D.P.D.T.)**

Indispensable to constructors and experimenters. Can be used in many ways. All metal parts heavily plated. Best quality materials and workmanship throughout. Supplied complete with Drilling Template. All necessary parts packed in waxed damp-proof envelopes.

Price 1/9 each.

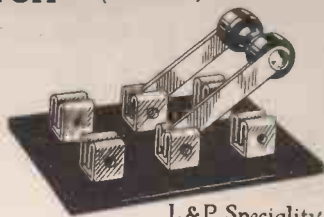

L & P. Speciality

**UNIVERSAL TWO-COIL TUNER**

(Patent No. 17376.)

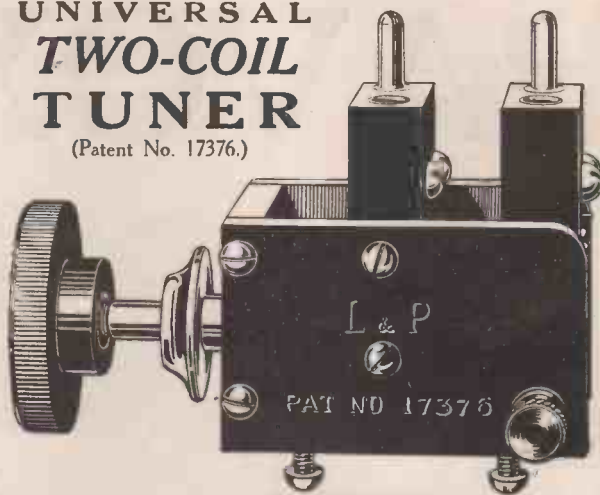

This Two-Coil Tuner is not only designed for panel mounting (SPECIAL ONE HOLE FIXING), but also for side, top, or even under cabinet. Whatever position the coils may be in, there is no back-lash; they are rigid. The worm action is exceptionally smooth, owing to the patented SPECIAL SPRING which balances the weight of the movable coil. Pure ebonite only used—there are no mouldings. All the metal is heavily plated and the whole coil is perfectly insulated.

Price 11/6 each. Long Shaft, 1/- extra.

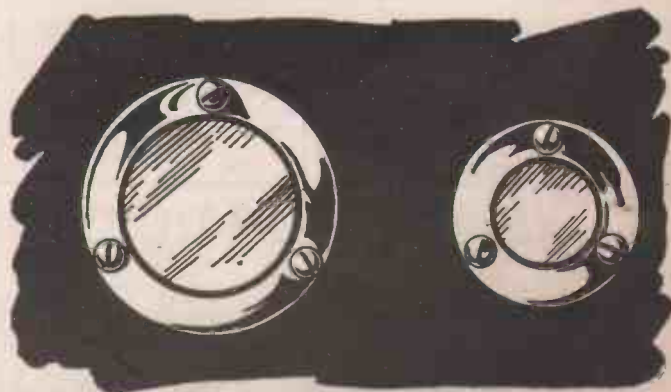

**L & P. Speciality**

**SUPERIOR VALVE WINDOWS**

Illustrated actual size—two sizes—with either gauze, clear or amber non-flam. celluloid. All metal parts heavily plated. Workmanship, finish and materials employed are above reproach. Packed complete with screws in waxed damp-proof envelopes.

Prices—Large size, 3½d. each. Small size, 3d. each.

COILS (Patented) to tune 3/500 M's (Set of 3) 17/6 set.  
 CONDENSERS. Totally enclosed. Positive Contact to Rotary Vanes.  
**HIGH GRADE RECEIVING SETS** in Oak or Mahogany Cabinets. Complete with all Accessories and Royalties.  
 2-Valve, £17 - 10 - 0. 3-Valve, £23 - 7 - 6.

Every detail of L. & P. Components and Sets has been the subject of much thought and experiment so that absolute perfection should be attained.

Full particulars of entire range of Ellanpee Specialities forwarded on request.

**LONDON & PROVINCIAL RADIO COMPANY, LTD.**

Manufacturers of High-Class Radio Instruments and L. & P. Specialities.

Phone : 94 COLNE (2 Lines).

(Dept. B) COLNE LANE, COLNE, Lancs.

'Grams : RECEPTION, COLNE.

WHEN REPLYING TO ADVERTISEMENTS PLEASE MENTION "THE BROADCASTER."

# RAVOX

## THE NEW VANELESS SQUARE-LAW CONDENSER

Retail Price **8/6**

·001, ·0005, and ·0003 mfd.

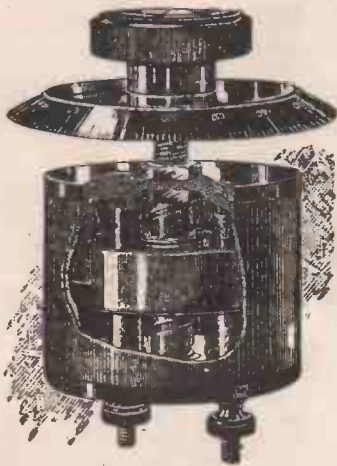

THE RAVOX Variable Condenser marks a distinct advance in condenser design and construction, and is superior to any other at present on the market.

IT GIVES THE SAME FINE TUNING IN ONE OPERATION AS IS POSSIBLE WITH THE BEST VERNIER CONDENSER, AND DISTANT STATIONS CAN BE TUNED IN WITH EASE.

The RAVOX, unlike the ordinary condenser with its number of easily damaged vanes, is of simple design and robust construction. It consists of two telescoping electrodes with a di-electric. Tuning is

effected on an even scale of graduation throughout the whole of its range, the knob revolving twice round the circle. A vernier effect is in consequence obtainable over the whole range.

Owing to the comparative smallness of the electrodes losses are reduced to a minimum.

The RAVOX is enclosed in a round fibre case. One hole fixing. Complete with dial and knob for panel mounting. It is compact, strong and foolproof, and is packed in a very attractive Carton.

Showcards and Folders overprinted with Retailer's name supplied free.

THE RAVOX IS BEING EXTENSIVELY ADVERTISED. IT IS THE CONDENSER YOU ARE ULTIMATELY BOUND TO STOCK, AS IT WILL SUPERSEDE THE PRESENT CLUMSY AND INEFFICIENT TYPE.

LIBERAL TERMS TO FACTORS AND DEALERS.

WRITE FOR FULL PARTICULARS.

RAVOX LIMITED (F. Dept.,) 10/11, Jermyn Street, Piccadilly Circus, LONDON, S.W.1.

S.S. 2.

*You'll be asked for "RAVOX"*

## The "STAR" NON-DUSTPROOF Rotary Crystal Detector.

PRICE :

BRASS - 2/9 each.

NICKEL - 3/- each.



*Special Discounts for April.*

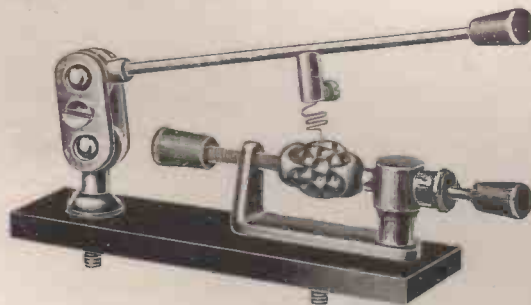

Patent No. 226691.

PRICE :

BRASS - 2/9 each.

NICKEL - 3/- each.



*Special Discounts for April.*

MAKE SURE

PROFITS

by stocking

**"STAR" PRODUCTS**

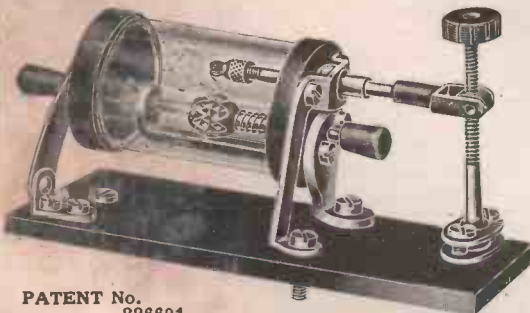

PATENT No. 226691.

THE "STAR" ROTATORY CRYSTAL DETECTOR (Micrometer Movement) (Improved Patent). Price 6/- (subject).

WRITE FOR ILLUSTRATED LIST.

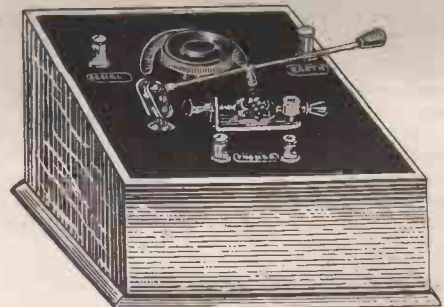

THE "STAR" CRYSTAL SET is fitted with Ebonite Variometer, "Star" Detector, Nickel-Plated or Brass Fittings, and highly-finished Mahogany or Oak Cabinet, and gives sharp tuning on all B.B.C. wave lengths. Price 15/- (subject).

**THE STAR ROTATORY CRYSTAL DETECTOR CO.**

1, BIRLEY STREET, BESWICK, MANCHESTER.

WHEN REPLYING TO ADVERTISEMENTS PLEASE MENTION "THE BROADCASTER."

These two lines will command a ready sale and show you good profits.

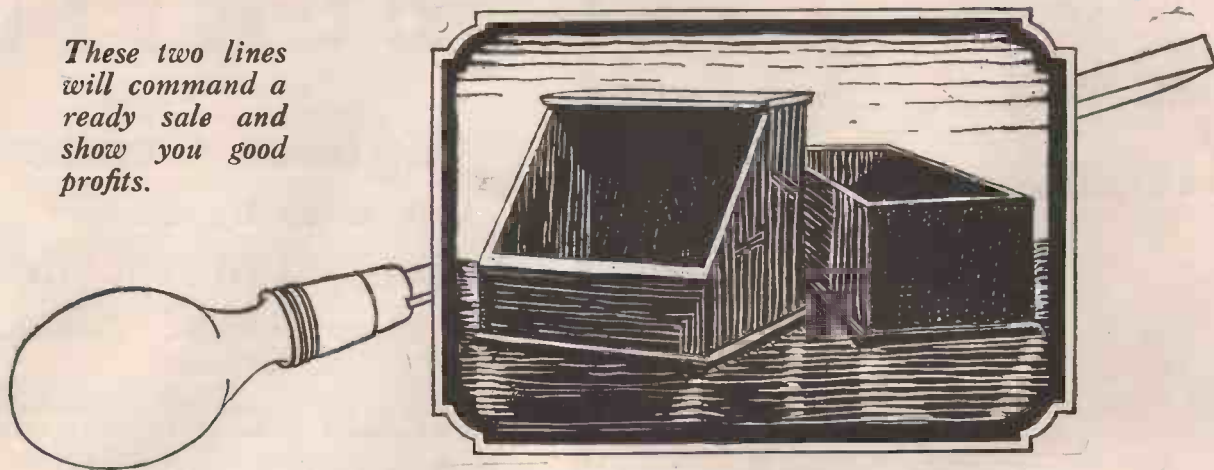

# There is a Big Demand for Cabinets in sets of parts

You could not possibly stock ordinary cabinets

They would fill your premises, but MORTONE cabinets are in flat parcels—easily stocked—easily sold.

GET your share of this trade. Mortone Cabinets are first-class specimens of the cabinet-maker's art. Made to last. Satisfaction guaranteed to the purchaser or you are authorised to refund his money. Both mahogany and oak are same price. Retail prices below:—

**PRICES FOR BOX TYPE, OAK OR MAHOGANY.**

	Panel Size.	Depth.	Price.	Ebonite Panel.
No. 2 ...	4½ x 5	3 ...	3/10	1/-
No. 5 ...	7 x 5	5 ...	5/-	2/3
No. 8 ...	10 x 7	5 ...	7/-	3/9
No. 11 ...	12 x 10	5 ...	8/9	7/-

Panels are of best quality British-made Post Office ebonite, matt finish, ¼ in. thick.

Prices for sloping type, Oak or Mahogany, 4 ins. back to front at top, 7 ins. at bottom. To hold panels of sizes mentioned.

	Panel Size.	Price.	Ebonite ¼ in. Panel.
No. 41 ...	12 x 8 ...	13/6	5/6
No. 43 ...	12 x 10 ...	15/9	6/-
No. 46 ...	16 x 12 ...	21/-	9/6
No. 47 ...	18 x 12 ...	23/6	10/6

Same first-class quality ebonite as above ¼ in. thick.

**GOOD TRADE DISCOUNTS.**

# MORTONE

CABINETS OF DISTINCTION  
SUPPLIED IN PARTS  
READY FOR ASSEMBLY.

**10/6**

**MORTONE FEATHER-WEIGHT**



## GUARANTEED

Every pair guaranteed 2,000 ohms each earpiece (4,000 ohms 'phones). Nicely finished. Retail 10/6. Good discounts.

Advert. of H. & G. O. LEWTAS, Chester Road, Manchester.

B. & D.

WHEN REPLYING TO ADVERTISEMENTS PLEASE MENTION "THE BROADCASTER."

It makes a  
wonderful  
difference

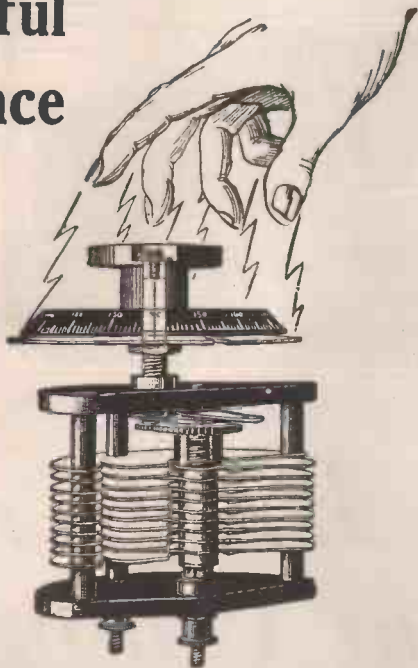

Congratulations continue to pour in from users of the "Fulstop" Variable Condenser.

**FROM SOUTH CROYDON.**

"We had a long experiment last night with your Fulstop Condenser and brought in 12 distant stations that other condensers would not look at."

**ORMSKIRK.**

"I tried one of your .0005 Condensers a few weeks ago and it has proved so satisfactory that I am discarding a more expensive .0003 condenser for yours."

**LIVERPOOL.**

"I replaced the 'Fulstop' in my set and in half-an-hour had tuned in thirteen stations. I also find it easy to get London and Bournemouth, quite separate from Manchester, which I have never managed before. This speaks volumes for the condenser."

"May I, therefore, once again express my satisfaction and appreciation of your condenser and method of business, which compare so favourably with other firms. A satisfied customer is the best advertisement possible, and I shall always be pleased to recommend you to others."

.001... 13/6      .0003... 10/3  
.0005... 11/3      .0002... 9/6

**Liberal Trade Discounts**

Write for full particulars to :

**J. H. NAYLOR LTD., WIGAN**



Guaranteed to Abolish Hand Capacity

**EBONITE**

of the  
**Highest Grade**  
as used by all the  
**Leading Manufacturers**  
in Sheets—Rods—Tubes.

**PANELS CUT** ACCURATELY AND SQUARE  
**NO LIMITS FOR SIZE.**

Send for particulars to:

**BRITANNIA RUBBER & KAMPTULICON CO., Ltd.,**  
7, Newgate Street, London, E.C.1.

Telephone: Central 2168 (2 lines).      Telegrams: "Britannia, London."  
Factory: Bow Common, E.

**QUALITY CABINETS**

STOCKED IN THE FOLLOWING SIZES:

Size of Panel.	Price.
12" x 12" ...	£5:15:0
12" x 18" ...	£6:10:0
14" x 20" ...	£7: 0:0
14" x 24" ...	£7:10:0
12" x 24" ...	£7:10:0

SOLID MAHOGANY  
25% EXTRA.

Trade Terms on Application.

SEND FOR PRICE LIST.

All Orders Sent Carriage Paid.  
Cheques and Money Orders made payable to

**THE CORANTO GRAMOPHONE COMPANY,**

104, BOLD ST., MOSS SIDE, MANCHESTER.

Telephone: Rusholme 455.  
Telegrams: "Coranto, Manchester."

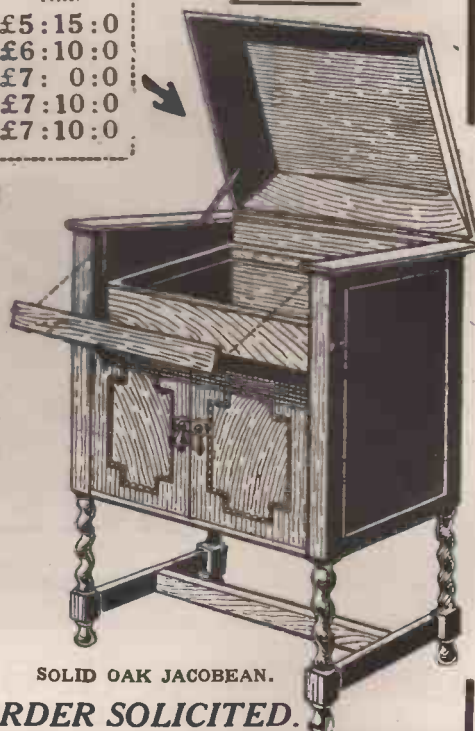

SOLID OAK JACOBEOAN.

A TRIAL ORDER SOLICITED.

WHEN REPLYING TO ADVERTISEMENTS PLEASE MENTION "THE BROADCASTER."

# REASONS

why you should Stock the

# “MIGHTY ATOM”

Regd.

## BRITAIN'S BEST CRYSTAL

CAN HONESTLY  
BE RECOMMENDED

IS WELL  
ADVERTISED

100 % EFFICIENT

GIVES YOU  
GOOD PROFITS

CARRIES A  
WRITTEN  
GUARANTEE



SELLS ITSELF

BRINGS YOU  
NEW BUSINESS

IS THE ONLY  
CRYSTAL OF  
ITS KIND

Samples, Trade Terms and Advertising  
Material at your disposal.

Wholesale Stockholders :

LONDON—Mechanical Utili-  
ties Co., Ltd., Junction  
Place, Praed St., W.2.  
S. T. Hosken, 153, Fleet  
St., E.C.

CARDIFF—W. A. Haggard  
& Co., Aerophone House,  
Ely, Cardiff.

Write :—

# BRITAIN'S BEST CRYSTAL, LTD.,

234/5, Salisbury House, London Wall, E.C.2

WHEN REPLYING TO ADVERTISEMENTS PLEASE MENTION "THE BROADCASTER."

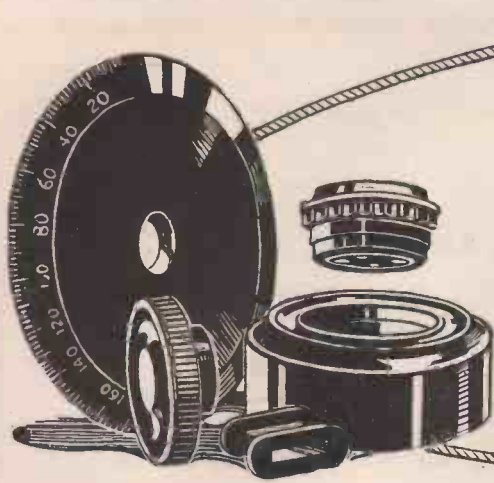

# Bakelite

—the ideal insulating material for all Electrical, Wireless and Telephone work.

*Mouldings to any design and shape, embodying highest degree of accuracy.*

In Colours, Black or Natural (Brown).

ENQUIRIES INVITED.

**THE GENERAL ELECTRIC CO., LTD.,**  
INSULATION DEPT., Magnet House, Kingsway, London, W.C.2.  
Insulation Works—Witton, Birmingham.



## FERRANTI A.F.2 INTERVALVE TRANSFORMER

Hirst, Ibbetson & Taylor, Ltd.,  
7a, BLACKFRIARS ST.,  
MANCHESTER.

LARGEST STOCKISTS IN THE KINGDOM.  
DELIVERY FREE.

Telephone :  
8162 Central (3 lines).

Telegrams :  
"Beforehand," Manchester.

SUPPLIERS OF ALL  
WIRELESS COMPONENTS  
AND APPARATUS.

### SQUARE LAW CONDENSERS.

NOTE REDUCED PRICES.

All metal - - - - -	.001	6/-	.0005	5/-	.0003	4/6
with Vernier - - - - -	"	7/-	"	6/-	"	5/6
Ebonite top and bottom	"	7/6	"	6/6	"	5/6
with Vernier - - - - -	"	8/9	"	7/9	"	7/-

Boxed complete with Knob and Dial less 10 per cent. Cash with Order.

SPECIAL.—Geared 2-way Coil Holder, 3/6 nett.  
*Send for Sample.*

All goods guaranteed best workmanship.  
Money willingly refunded if unsatisfactory.

**H. ORGEL,** Phone: Central 7203.  
308, BISHOPSGATE, LONDON, E.C. 2.

WIRELESS

### WHISKER WIZARDS

Have you tried the "ASHLO" Catwhiskers?  
They Sell Themselves !!

Made up in Glass Tubes and Carded in Dozens on Attractive Showcard.

GUARANTEED BRITISH HAND MADE.

Special Terms to Factors.

Wholesale only.

**ASHLO MANUFACTURING CO.**

Whisker Makers to the Trade

158 CLAREMONT RD., MOSS SIDE, MANCHESTER

WHEN REPLYING TO ADVERTISEMENTS PLEASE MENTION "THE BROADCASTER."

IF THE CASE IS FINISHED DULL SILVER  
AND IF IT HAS THE SIGN ENGRAVED OF THE  
**“OCTOPUS”**

IT IS **THE BEST** OF ALL

**MANSBRIDGE CONDENSERS,**



“OCTOPUS”  
USUAL TRADE  
DISCOUNTS.

- 01 ... 2/4
- 05 ... 2/4
- 25 ... 3/0
- 5 ... 3/4
- 1 M.F. ... 3/10
- 2 M.F. ... 4/8

*Do not accept colourable imitations  
Look for the “OCTOPUS” Engraved Sign*

**“OCTOPUS” Mansbridge Condensers**

Are Noiseless, Accurate, Reliable, Permanent,  
Atmosphere-Proof. Tested at 350 volts D.C.  
**G U A R A N T E E D.**

THERE IS NO BETTER CONDENSER

**“OCTOPUS” MANSBRIDGE CONDENSERS “BEST BY TEST”**

**“PERFECT” VERNIER COIL-HOLDER**

FOR BASKET COILS

Easily the Best on the Market

All others will become Obsolete. Have one on trial for  
48 Hours. You will be surprised at the improved results.

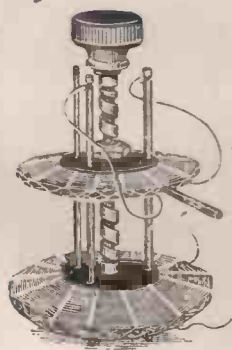

Provisionally Patented.  
**“PERFECT.”**

GOOD VALUE.

It Retail at

**6/6**

Usual Discounts

SAMPLE ON  
TRIAL for  
48 Hours.

Post Free **5/-**

- Micrometer Adjustment
- Dead Close Coupling
- Always Parallel Coupling
- Free from Hand Capacity
- Coils Changed Instantly
- No Coil Mounts or Plugs

- No Loose Connections
- No “Fiddling”
- Connections Under Panel
- Strong and Handsome
- Extremely Simple
- Occupies Smallest Space

Applications from Reliable Distributors for District Agencies are invited for the “OCTOPUS” Mansbridge Condensers and “PERFECT” Coil-Holders:

**We have some Remarkable Values in Regular  
Wireless Lines to Offer at Temporarily Low Prices.**

FULL PARTICULARS TO GENUINE TRADERS ON APPLICATION  
SEND YOUR ENQUIRIES AND SEND YOUR ORDERS WITH  
EVERY CONFIDENCE FOR EVERYTHING WIRELESS

**RADIO “STOCKS”** RADIO HOUSE, NEWMAN STREET,  
: LONDON, W.1. :

(B. HAINE, Proprietor)

Phone : Museum 3205

WHEN REPLYING TO ADVERTISEMENTS PLEASE MENTION “THE BROADCASTER.”

# "MIDITE" Reg. No. : 446787.

THE DEPENDABLE CRYSTAL  
**IS SMASHING ALL RECORDS FOR  
 LONG DISTANCE RECEPTION**

To F. H. MIDDLETON, Esq.,  
 15, St. John's Hill,  
 Clapham Junction, S.W. 11

Dear Sir,  
 We have much success in selling your "Midite" crystal in Holland. The crystals are very sensitive and any kind of catswhisker may be used.  
 They are much more sensitive than any other advertised English crystal we have tried.  
 We receive Chelmsford station splendid here on "Midite" and even 2LO which station is so much weaker is often heard.

VAN HOUTEN & Co.,  
 Holland.

From	To	Approx. Distance.
ROTTERDAM	2 LO LONDON	200 MILES
ON BOARD SHIP RED SEA	5XX CHELMSFORD	3,300 "
NORTHANTS	KDKA AMERICA	3,600 "

The reception from Northants to KDKA America was reported in "Amateur Wireless" Feb. 28 of this year.

**GET YOUR SUPPLIES AT ONCE**

SEE THE SIGNATURE "F. H. MIDDLETON" ON EVERY TUBE.

F. H. MIDDLETON,

15, St. John's Hill, Clapham Junction, S.W. 11

'Phone: Latchmere 4978.

## SELLERS OF LEEDS

Sole Wholesale Distributors of

# "KALEE" PRODUCTS

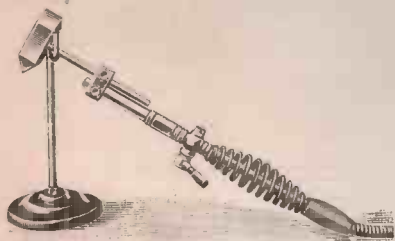

The "KALEE" Gas Operated Soldering Iron.

Of extra strong construction. Heavily nickel plated, fitted with adjustable Double-ended Bit. Automatic Valve for regulating gas and air supply, complete with stand.

Price Complete 7/6.

ATTRACTIVE DISCOUNTS TO THE TRADE.

Standard Buildings  
 LEEDS.

'Phone: 24246. 'Grams: Orion, Leeds



**H. WADSWORTH SELLERS**  
 AND CO.

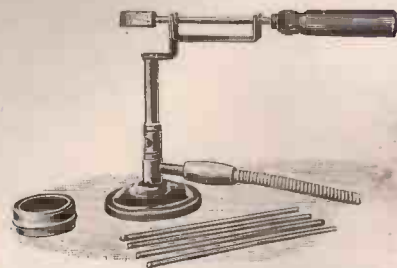

The "KALEE" Gas Operated Soldering Outfit.

Complete with Irons, fitted with handy size Copper Bit, Stand with self-contained adjustable Benzine Burner. Tin of Flux and Solder.

Price Complete 5/-

To fit 1 in. diameter hole. Flange 1 1/8 in. diameter. Fitted with Fine Mesh Gauze and Heavily Nickel Plated.

SEND ALONG  
 YOUR  
 ENQUIRIES.

330/2 Corn Exchange Buildings  
 Cathedral St., MANCHESTER.  
 'Phone—City 7105.

WHEN REPLYING TO ADVERTISEMENTS PLEASE MENTION "THE BROADCASTER."



Buy  
from the  
Largest  
and  
DIRECT  
Importers.



**E.H.M.**  
LIGHT WEIGHT  
4,000 Ohms

PRICE  
**9/9**  
(Subject)  
Special  
Terms  
to  
Factors.

Its efficiency, comfort and finish are well-known to the Trade.  
*(Every Pair Guaranteed)*

H.T. and Pocket Lamp Batteries in stock at keenest prices.

**E. H. MAISNER & Co. Ltd.**  
33, Margaret Street, Farringdon Road,  
LONDON, W.C.1.

Clerkenwell  
7482.

Telegraphic Address :  
Maisner Smith London.

**THE "KING" TRANSFORMER**  
SPIRELLA WOUND.  
INSURING UTMOST CLARITY OF TONE.

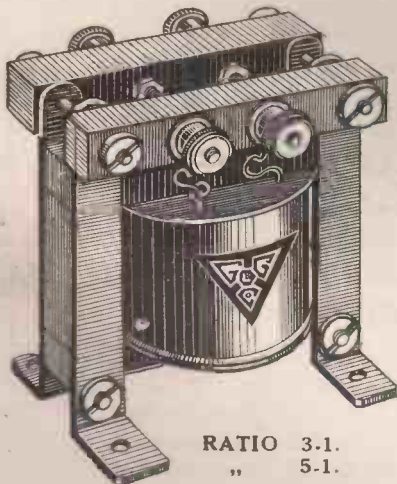

RATIO 3-1.  
" 5-1.

British Made.

Manufactured by  
**ELLIS & SONS (1923), LTD.,**  
6, PANYER ALLEY,  
NEWGATE ST., E.C.4.  
COILWINDING SPECIALISTS.

AN EXPERT'S  
OPINION :  
"EXCELLENT  
IN TONE  
AND  
VOLUME.  
PRICE  
IS  
EXTREMELY  
MODERATE."

SELLING PRICE  
**13/6**  
EACH.  
LIBERAL  
DISCOUNTS.

# IMPORTANT ANNOUNCEMENT

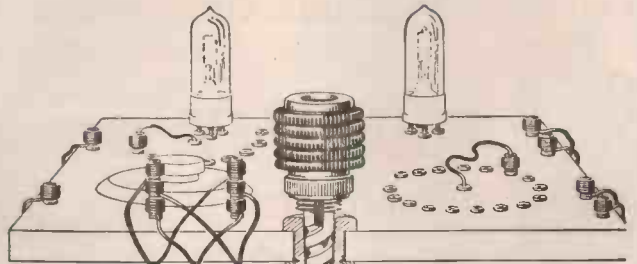

*Solder all connections,  
Where you can't - Use CLIX!*

CLIX PROVIDES AN IDEAL POINT FOR SOLDERING

## RETAIL PRICES

CLIX with Locknut - 3d.

CLIX Insulators (6 colours) 1d. each.

CLIX bushes (6 colours) 1d. pair.

CLIX Adapter with locknut 2d.

CLIX is now a better proposition than ever for your customers to buy—and a better proposition than ever for you to sell. We have revised our discounts on the improved model.

Its efficiency we could not increase, but we have improved its appearance. CLIX is now finished in nickel with a 1BA thread instead of a 2BA, and the insulators are highly polished. The retail prices remain unaltered.



The **Electro-Link** with **159 Uses**



Remember the popular response to the slogan:

*Solder all connections!  
Where you can't, use CLIX!*

And write to-day for our revised discount terms.



Radio Engineers and Contractors  
84 VICTORIA STREET, LONDON, S.W.1

WHEN REPLYING TO ADVERTISEMENTS PLEASE MENTION "THE BROADCASTER."

# Are you stocking our MULTIPHONE CONNECTORS ?

Patent No. 217338.

A pair placed on a set will enable the use of a number of headphones.

**AND THEY WILL SELL YOUR PHONES !!**



Made of  $\frac{3}{8}$  in. solid brass. Will last indefinitely.

## FOUR WAY

EITHER  
ROUND or LONG

9d. EACH RETAIL.



(Long pattern recommended where space between terminals limited, also for series parallel connections, each clearing hole taking either one or two phone tags.)

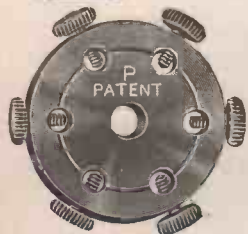

## SIX WAY ROUND

1/- EACH RETAIL.

Directions.—Unscrew terminal head on set, drop connector in position, replace terminal head.

## 4 WAY MULTIPHONE TERMINALS

A boon to trade makers and amateur constructors. Complete with nut and washer.

1/- EACH RETAIL.

The design which surmounts pillar can be screwed on to any existing 2B.A. thread (e.g., Large pillar terminal). 4B.A. also stocked.

9d. EACH RETAIL,  
including collar marked A.

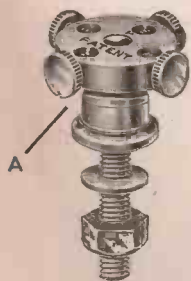

Above goods all carriage paid U.K.

## CRYSTAL SET

No. 447 (Regd.);

will take four pairs headphones. Has a long range. Plug-in fitment for high power stations, etc. Glass enclosed detector. Finest Finish. Brass parts lacquered. Mahogany Cabinet.

WITHOUT COVER. 18/6 RETAIL

WITH COVER 26/6 RETAIL.

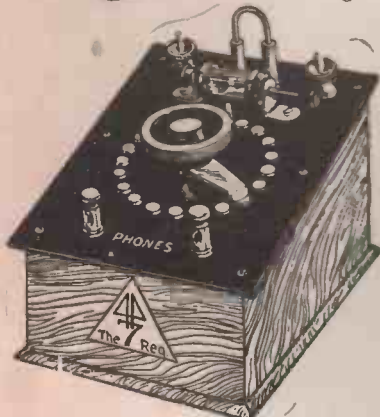

Distributors of EELEX and ENERGO products, and MULTICO Headphones

LIBERAL DISCOUNTS TO TRADE  
**MULTIPHONE TERMINAL CO.,**

'Phone: MUSEUM 3436.

21 Great Russell St., London, W.C.1.



## ENTERPRISE MACHINE SUPPLIES CO., LTD.,

SOLE U.K. AGENTS FOR

### Original Adjustable Headphones & Loud Speakers



ADJUSTABLE HEADPHONES, 4,000 ohms.

- A. 2 years guarantee ; retail, 15/6.
- B. Adjustable Headphones, 14/0.

Subject to following discounts up to 20 to 25 per cent. ; 20-50, 33 $\frac{1}{3}$  per cent. ; 50 to 100, 37 $\frac{1}{2}$  per cent.

H.T. BATTERIES, guaranteed A1 quality, 30-volt, 3/3 ; 60-volt, 5/3 ; 90-volt, 9/6.

VALVES — Bright and Dull Emitter, LOWE AUDION L.A. 75, 2 to 2.5 volts, 50-100 H.T., 0.15 to 0.17 amp. Try one and judge for yourself. The perfect Valve for Reflex Circuits. S.T. 100, etc., 9/6 each. L.A., A.R. 23, 2.4 to 2.8 volts, 50 to 70 H.T., 0.50 to 0.55. amps., 7/6. EMSCO Dull Emitter, A1, 2-volt, 40 to 100 H.T., .02 amp., a first-class general purposes Valve, 8/6. A2, 0.4 amp., 7/6. A II. 0.07 amp. ; this will stand comparison with the best, 10/6. All Valves Guaranteed.

L.F. TRANSFORMERS, 7/6.

VARIABLE CONDENSERS,  
33 $\frac{1}{3}$  per cent. off standard list.

FIXED CONDENSERS, 5/- per doz.

CRYSTAL DETECTORS,  
N.P.D., at 12/- per doz.

We can supply you with everything for Wireless and save you 25%. We can supply from Stock from our Depots in Nottingham, Crewe, Manchester, Southampton, Leeds and Belfast.

BUY

EMSCO WIRELESS COMPONENTS  
AND BE SATISFIED.

**ENTERPRISE MACHINE SUPPLIES  
CO., LTD.,**

17, OSBORN STREET, LONDON, E.1.

Telephone

Avenue 2178

WHEN REPLYING TO ADVERTISEMENTS PLEASE MENTION "THE BROADCASTER."



DELIVERY FROM STOCK.

# SERVICE

SQUARE LAW

## VARIABLE CONDENSERS.

THE BEST VALUE OBTAINABLE.

*001	9/6	With Vernier	Delivery
*0005	8/-	1/6	from
*0003	7/6	extra.	Stock.

## THE SERVICE DETECTOR

*The Detector with the Largest Sales.*

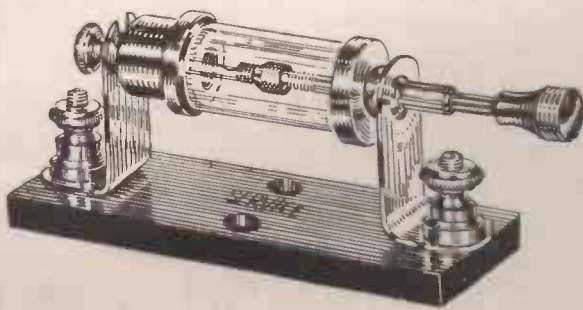

Patented Micrometer adjustment.  
Pro. Pat. No. 15224/24.

THE Service Detector is glass enclosed and therefore dustproof, and is not affected by vibration. By means of a patented micrometer adjustment the pressure of the cat-whisker on the crystal can be regulated as required. The crystal may be replaced in a few seconds, NO SOLDER BEING REQUIRED. Highly polished nickel-plated finish.

**Undoubtedly the finest value obtainable.**

Retail Price 2/6 (panel mounting).  
Mounted on ebonite base as in illustration 2/9.

*Write for latest Illustrated List.*

# SERVICE RADIO CO., Ltd.,

67, Church Street, Stoke Newington, London, N.16.

'Phone: Clissold 4934.

Telegrams: Clissold 4934, London.

WHEN REPLYING TO ADVERTISEMENTS PLEASE MENTION "THE BROADCASTER."

# "Hightensite" means "Quality"

and Quality means Efficiency. Long Specialisation in the manufacture of good

COIL STRIPS  
VALVE BASES  
PANELS  
SHEET  
TUBES  
ROTORS  
STATORS  
KNOBS  
COIL PLUGS  
DIALS

## EBONITE

ACCUMULATOR  
SEPARATORS &  
FITTINGS  
SOLID EBONITE  
HORNS for all  
Loud Speakers  
VARIOMETER &  
CONDENSER  
PARTS  
GRAINED  
EBONITE

IS OUR GUARANTEE THAT WE SHALL BE ABLE TO MEET YOUR MOST STRICT REQUIREMENTS.  
CONSULT OUR DESIGN DEPARTMENT IF YOU ARE THINKING OF BRINGING OUT A NEW IDEA.  
WRITE FOR NEW SEASON'S LIST. WHOLESALE ONLY. QUICK DELIVERY.

**Hightensite & Ebonite Manufacturing Co., Ltd.**

'Phone : East 3153.

NORMANDY WORKS, CUSTOM HOUSE, LONDON, E.16.

Wires : "Hitenite," "Vidcock."



# "ALTO"

## VARIABLE CONDENSERS

are the best of the all-metal condensers.

OF RIGID CONSTRUCTION. MINIMUM LOSSES. MAXIMUM EFFICIENCY. ONE-HOLE FIXING. EACH ONE TESTED AND GUARANTEED. ATTRACTIVELY BOXED. COMPLETE WITH BEST QUALITY KNOB AND DIAL.

No. 9610	No. 9611.	No. 9612.	No. 9613.
Ordinary Type	With Vernier	Square Law	With Vernier
Each	Each	Each	Each
'001 - 8/-	'001 - 9/6	'001 10/6	'001 - 12/-
'0005 - 6/-	'0005 - 7/6	'0005 - 9/6	'0005 - 11/-
'0003 - 5/6	'0003 - 7/-	'0003 - 9/-	'0003 - 10/6
'0002 - 4/6	'00025 - 6/6	'00025 - 8/6	'00025 - 10/-
'0001 - 4/-			
'00005 - 4/-			

Subject to liberal discounts. Special terms for quantities.  
Comprehensive illustrated catalogue of all wireless accessories sent on receipt of trade card.

### THE WHOLESALE FITTINGS CO., LTD.

23, 25, 27, & 37, COMMERCIAL STREET, LONDON, E.1.

Telephone (2 Lines): London Wall 1101. Avenue 5497. Telegrams: "Calottes, Norton, London."

Branches: 65, Newington Butts, London, S.E.11. 78-80, High St., Manchester. 14, North St., Stokes Croft, Bristol.

## THE RICHOCRYST.

Morocco Bound Wallet with Note Book and CRYSTAL SET combined. This Set works a Loud Speaker a mile from Broadcasting Station and receives effectively on 'Phones 25 miles from Station.

RETAIL **12/6** PRICE

Subject to Liberal Discounts.

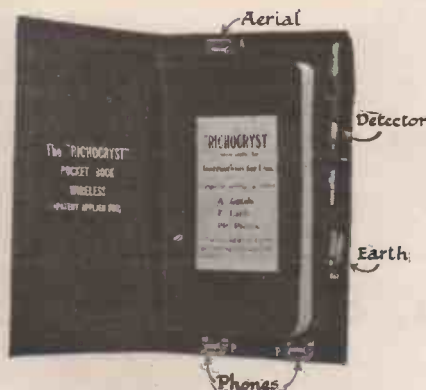

## WALLET SET.

### SPECIFICATION.

Celluloid covered Detector with easy movement and adjustment of crystal

Spring clips connecting Aerial, Earth and 'Phones; Spider wound Coils in covers for Tuning which is effected by means of opening and shutting the front cover.

Stockists should order early to avoid delay in delivery.

RICHMOND ELECTRICAL CO., 47, CHARLES STREET, MANCHESTER.

WHEN REPLYING TO ADVERTISEMENTS PLEASE MENTION "THE BROADCASTER."



*World Wide  
Appreciation*

Also the Sole Suppliers of the  
proved

**"A.B." BATTERY**

Purchase NOW the leading  
Battery from the leading firm.

**H.T. BATTERIES 60 VOLTS**

**H.T. BATTERY BOXES**  
63 VOLTS                      30 VOLTS

**LOUD-SPEAKERS.**

Voltmeters.

Various kinds Pocket Lamp Cases.  
and Cycle Lamps.

Black Wall Lamps.

White Lavatory Lights.

Electric Table Lights.

Green Egg Shaped Insulators.

2-inch Insulated Hooks.

Battery Clips.

Twisted Telephone Cords.

Single and Double Pole

Switches.

Transformers, ratio 1/5.

*Our Motto is*

*"To Give our Customers every  
conceivable satisfaction."*

**"A.B."**

**HEADPHONES**

**"HER DADDY'S VOICE."**

Since October upwards of 60,000 pairs have been sold and hundreds of appreciative letters have been received, convincing testimony of the world wide popularity and remarkable efficiency of "A.B." Headphones.

**PRICES.**

"A.B." adjustable, 4,000 ohms, weight 11 ozs. ...	...	17/6
"A.B." non-adjustable, 4,000 ohms, weight 10½ ozs. ...	...	15/6
"A.B." non-adjustable, 8,000 ohms, weight 10½ ozs. ...	...	18/3
"A.B." non-adjustable, 4,000 ohms, weight 9 ozs. ...	...	13/6

(Aluminium Cup.)

**SUBJECT TO LIBERAL TRADE DISCOUNTS.**

*Every Headphone carries our unqualified guarantee,  
if unsatisfactory money returned in full.*

**TRADE ONLY SUPPLIED**

**AMBATIELO BROS., LTD.,**

AMBATIELO HOUSE, FARRINGTON RD., LONDON, E.C.

Telephone: Clerkenwell 7440-7441.

Telegrams: "Ambatielo," London.

**WHEN REPLYING TO ADVERTISEMENTS PLEASE MENTION "THE BROADCASTER."**

# A WIRELESS RECEIVER

*is just as good as its worst component*

**I**T cannot be too strongly emphasised that it is extremely necessary, if good results are to be expected, that only the best quality of component is incorporated in a Wireless Receiver. The general public are becoming more and more educated to this fact and have more or less learned the necessity of appreciating the value of a high-grade component and to judge a product on its technical merits. As a consequence, it has become more and more difficult for a manufacturer of low-grade apparatus to command a market.

The City Accumulator Co. were the first to realise, even in the early days, when wireless generally (at least by the majority of the public) was an obscure and little-understood science, that sooner or later they would have to deal with an intelligent and even critical public. In spite of the multitudinous variety of utter rubbish put upon the market by unscrupulous dealers, we steadfastly adhered to our invariable rule:—"ONE QUALITY ONLY—THE BEST." The result—the inevitable one—is the unparalleled popularity which our products enjoy to-day.

Le meilleur Appareil Récepteur de T.S.F., s'il comporte une pièce défectueuse, n'a que la valeur de cette pièce.

On ne saurait trop insister sur ce que, pour obtenir de bons résultats, il est absolument nécessaire de n'utiliser dans la construction d'un Appareil Récepteur que des pièces détachées de la meilleure qualité. Le grand public se rend de mieux en mieux compte de ce fait, et il a plus ou moins reconnu la nécessité d'apprécier la valeur d'un matériel de première qualité et de juger un article d'après ses avantages techniques. Par suite, il a été, aux fabricants d'appareils bon marché, de plus en plus difficile de tenir la tête.

La City Accumulator Co. a été la première à se rendre compte même au début alors que la T.S.F. n'était (tout au moins pour la majorité du public) qu'une science obscure et inconnue, que tôt ou tard elle aurait à faire à un public intelligent et même connaisseur. Malgré les nombreuses variétés d'articles de pacotille mis en vente par des commerçants sans scrupule, nous sommes restés fidèles à notre invariable devise: "UNE QUALITE SEULEMENT—LA MEILLEURE." Le résultat inévitable a été la faveur sans égale dont nos produits jouissent aujourd'hui.

L'Efficienza di un Ricevitore per la Radio è appunto quella del suo pezzo costituente più scadente.

Non si può insistere abbastanza sul fatto che se si vogliono ottenere dei buoni risultati, è assolutamente indispensabile, che i pezzi costituenti da incorporarsi in un Ricevitore per la Radio debbano essere solamente della qualità assolutamente migliore. Già vediamo che il gran pubblico si va convincendo, a poco a poco, di questo fatto ed oramai si è educato più o meno ad imparare la necessità di poter apprezzare il valore di un pezzo costituente di qualità assolutamente superiore e di poter giudicare un articolo secondo i suoi meriti tecnici. Di conseguenza, un fabbricante di apparecchi di qualità inferiore trova oramai sempre più difficile di poter comandare un mercato.

La City Accumulator Co. anche nei primi tempi, quando la radio-telegrafia e telefonia generalmente (per lo meno per la massa del gran pubblico) rappresentava una scienza oscura e poco conosciuta, fu la prima Ditta a realizzare il fatto che presto o tardi avrebbe dovuto fare con un pubblico intelligente anzi un pubblico critico. Non ostante che il mercato venisse inondato da gente senza scrupoli di ciò che letteralmente era scarto inservibile, noi ci siamo tenuti tenacemente al nostro sistema invariabile, e cioè: "UNA QUALITÀ, UNICA SOLTANTO, . . . LA MIGLIORE." Ed oggi eccome il risultato—del resto il risultato matematicamente inevitabile—la popolarità impareggiabile che attualmente godono i nostri articoli.

Un aparato receptor de T.S.H. esta á la altura de los materiales más inferiores que lo integran. Si se quieren obtener resultados satisfactorios, no puede menos que reconocerse que es absolutamente necesario que los materiales que integran un aparato Receptor sean exclusivamente de la mejor calidad. El público en general cada día se hace mejor cargo de esta regla y hasta cierto punto ya ha comprendido la necesidad de apreciar el valor de un material de alta calidad y de juzgar el producto de acuerdo con sus méritos bajo el punto de vista técnico. Como consecuencia, para un fabricante de aparatos de baja calidad, cada día la resulta más difícil poder dominar el mercado.

A la City Accumulator Company le cabe el honor de haber previsto desde un principio, aún cuando la radio estaba en su infancia y era una ciencia vaga y poco comprendida por el público en general, que tarde o temprano tendría que tratar con un público inteligente y exigente. A pesar de los artículos de infima calidad puestos en el mercado por fabricantes poco escrupulosos, no nos hemos apartado en lo más mínimo de nuestra invariable norma: "UNA SOLA Y UNICA CALIDAD—LA MAJOR." El resultado obtenido, lo cual era inevitable, ha sido la incomparable popularidad que en la actualidad disfrutan os productos de nuestra fabricacion.

**IMPORTANT NOTICE.—OUR 1924-25 CATALOGUE IS NOW READY FOR DISTRIBUTION.** This contains particulars of several new sets and component parts and every reader should secure a copy AT ONCE.

We specialise in Accumulators for Motor Lighting and Starting, Ignition, Wireless, &c., Loud Speakers, Condensers (Variable, Fixed, Mansbridge, &c.), Transformers, Filament Resistances, Anti-capacity Switches, Potentiometers, Crystal Detectors, Grid Leaks, High-Tension Batteries, and every conceivable Wireless Accessory.

Agents wanted in all countries where not already represented.

## CITY ACCUMULATOR CO.

*The World's Largest Wireless Suppliers,*

10 RANGOON STREET, LONDON, E.C.3, ENGLAND.

Cables: Radiocity, London.

Code: Bentleys.

**AGENTS:**

SOUTH AFRICA: Shimwell Bros., Johannesburg and Branches.

MALTA: Muscat's Stores, 270, Strada Reale, Valetta.

AUSTRALIA: Geo, Pizzey & Son, Ltd., Melbourne, Adelaide, Perth, Hobart and Brisbane.



WHEN REPLYING TO ADVERTISEMENTS PLEASE MENTION "THE BROADCASTER."

*The World's Greatest Radio Crystal*



**NEUTRON**  
TRADE MARK

*Concert Tested  
and Guaranteed*

*Neutron Ltd. Sicilian House, Southampton Row, W.C.1.*

MUSEUM 2677

Sole Distributors: V. ZEITLIN & SONS, 144, Theobalds Road, London, W.C.1  
Phone: Museum 3795 and 6841.

WHEN REPLYING TO ADVERTISEMENTS PLEASE MENTION "THE BROADCASTER."

The . . .

# KLYBRO

## TRANSFORMER

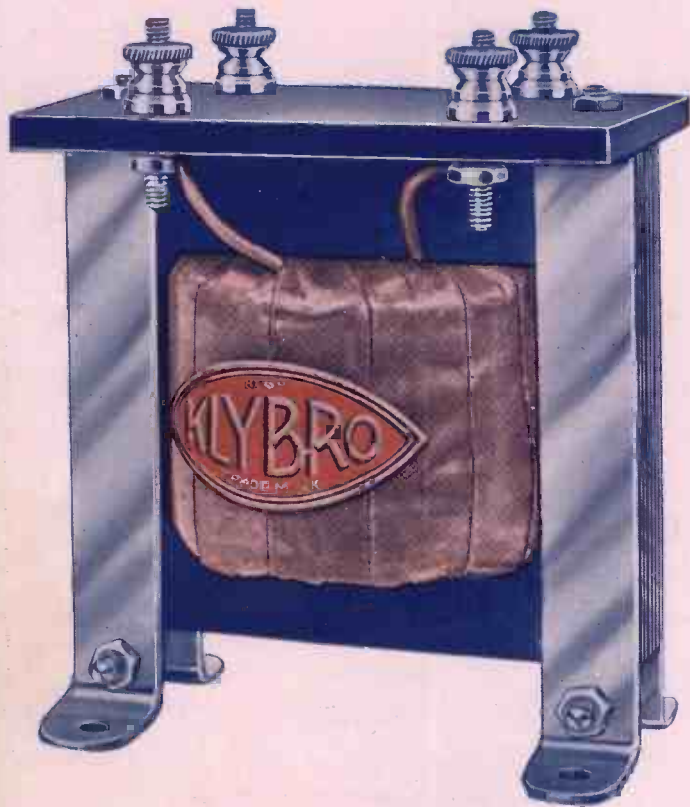

Ratio 5—1.

PRICE

# 15/6

SUBJECT TO USUAL DISCOUNTS.

.....

*GUARANTEED FOR  
TWELVE MONTHS*

.....

All fittings in highly finished nickel plate.

Ebonite Terminal board.

No bolts through iron laminations.

Guaranteed Distortionless.

Any faulty Transformers exchanged without query.

Report of National Physical Laboratories can be seen at our offices.

Have you tried  
**KLEINITE**  
crystal ?

Every piece tested  
and guaranteed.

*Klein Bros*  
Ltd

Head Sales, Warehouse and Trade Depot:

# 219, BISHOPSGATE, E.C.1.

'Phone: BISHOPSGATE 2491.

WHEN REPLYING TO ADVERTISEMENTS PLEASE MENTION "THE BROADCASTER."



The New Improved  
**“MICROSTAT”**  
 Filament Resistance.

**2/6**

each  
 Retail.

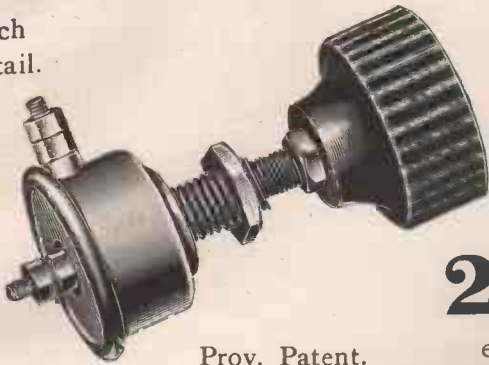

Prov. Patent.

**2/6**

each  
 Retail.

Have one fitted to your set if you want to get satisfaction.

Fitted with Screw Terminals.

Suitable for Bright or Dull Emitter Valves.

Will control any number of valves without getting hot.

Noiseless, and with Micrometer action.

**TRADE PRICE 33 1/3% discount.**

**THE**  
**“CLEAR-BELL”**  
 FIXED  
**CONDENSER**

·001 to

·0005

M.F.S.

**1/-**

each  
 Retail.

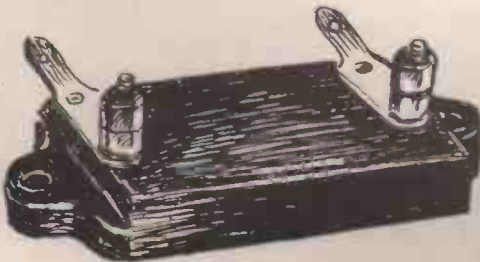

·002 to

·06

M.F.S.

**1/3**

each  
 Retail.

Every one is guaranteed perfect and accurate.

**TRADE PRICE 33 1/3% discount.**

Manufacturers:

**The Radio Resistance Co.**  
 35, Skinner Street, Birmingham.

**THESE ARE GOOD  
 SELLING LINES**

*The  
 “Full-o-Points”  
 Crystal*  
**1/-**  
 each.



*The  
 “Full-o-Points”  
 Crystal*  
**1/-**  
 each.

Absolutely the Purest Crystal in the Universe.  
 Every point a sensitive spot and as clear as a bell.

**TRADE PRICE 6/6 doz.**

**“VICTORY” VALVE  
 CONSTRUCTORS SETS**

Complete with Wiring Diagram.

**MODEL 1. ONE VALVE. Size 6 x 6.**

Comprising sloping oak cabinet, ebonite panel, drilled ready to assemble, variable condenser, fixed condenser, rheostat, terminals and wire, 2 coils.

**RETAIL PRICE £2.5.0.**

**MODEL 2. TWO VALVE. Size 10 x 8.**

Comprising sloping oak cabinet, ebonite panel, drilled ready to assemble, 2 coil holder, 2 variable condensers, 2 fixed condensers, grid leak, 2 rheostats, all terminals and wire.

**RETAIL PRICE £4.0.0.**

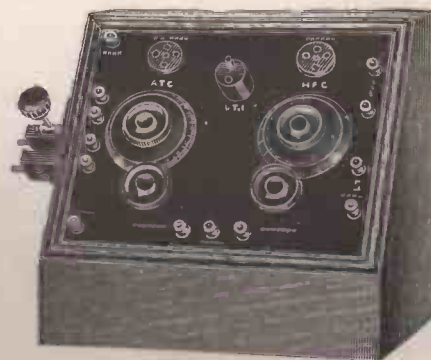

**TRADE  
 DISCOUNT  
 33 1/3%**

We can also supply 3 and 4 valve constructor sets.

Write for full particulars:

Sole Makers:

**Wineberg & Co.**  
 114-118, Pershore Street, Birmingham.



## RADION HEADPHONES.

Retail Price - 14/6  
Trade Sample - 9/-

Actual Manufacturers of these HEADPHONES, also of EBONITE VARIOMETERS, and RADION CRYSTALS, TUBES CARDED.

Visit our Stand 177 at Bingley Hall Exhibition, Birmingham.

## GREEN & CO.

27, Speedwell Road, Edgbaston, Birmingham.

Phone: MIDLAND 1768.

AGENTS:—BEADLE & CO., LTD., Hull, Nottingham, & Leicester. ALBION ELECTRIC STORES, 9, New Station Street, Leeds. MANCHESTER RADIO SERVICE, Great Ducie Street, Manchester. SHENTON & CO., LTD., 68, Shoe Lane, London, E.C.4.

The oldest Manufacturers in the Trade, we supply British made goods only.

Delivery guaranteed from stock.

FACTORS AND SHIPPERS QUOTED. AGENTS WANTED.

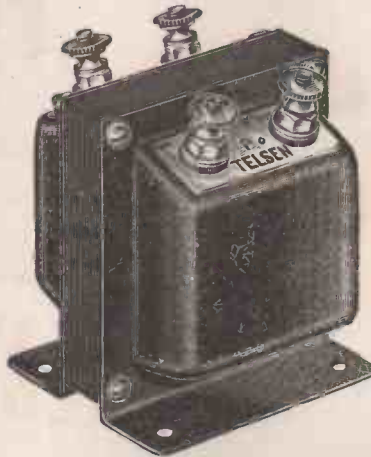

**TELSEN**  
L.F. TRANSFORMERS

*Radio's Choice*

NEW SHROUDED TRANSFORMER

RETAIL 15/6 PRICE

STANDARD TRANSFORMER, reduced to . . . 14/-

We are Wholesale Distributors of these favourite Transformers, and we can give immediate delivery of the Shrouded Model illustrated above.

Wholesale Distributors of SKETOPHONE LOUD SPEAKERS, TUNGSTALITE CRYSTAL, MEEPON SETS, RADION VALVES.

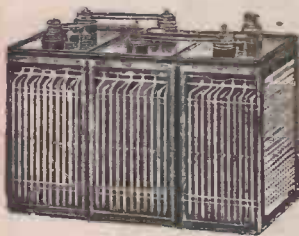

## "TAYLOR" SHORT CHARGE—LONG LIFE ACCUMULATOR.



RISK OF CHRONIC SULPHATION ENTIRELY REMOVED.

The general efficiency is increased—

Time required for fully charging "A" Type 2 to 6 hrs. "B" Type 12 hrs.

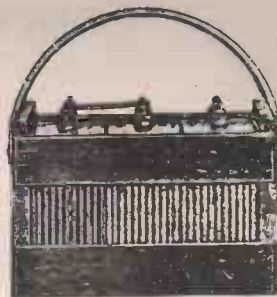

All types, 4-volt, 6-volt, etc., are made of heavy gauge material with separate cells built into block form.

Interleakage between cells is therefore impossible.

Special attention to detail has resulted in an attractive finish.

PRICES: "A" Type  
2 Volts 9/6 to £1 5 0  
4 Volts 18/- to £2 8 3  
6 Volts 26/6 to £3 12 0

Hardwood Crate  
and  
Rubber Handle  
Extra.

PRICES: "B" Type  
2 Volts 11/6 to £1 3 6  
4 Volts 16/- to £2 4 3  
6 Volts 23/- to £3 4 0

WRITE NOW FOR ILLUSTRATED CATALOGUE

ORR BROTHERS,

APPLICATIONS FOR SERVICE AGENTS TO HEAD OFFICE

1, GORTON LANE, WEST GORTON,

MANCHESTER,

Telephone: Openshaw 125.

Telegrams: "Dorsell, Manchester."

and at BALTIC CHAMBERS, 50, WELLINGTON STREET, GLASGOW.

WHEN REPLYING TO ADVERTISEMENTS PLEASE MENTION "THE BROADCASTER."

# Edison Bell Radio

**DISTINCT AND DIFFERENT**

## Just what Wireless Ought to be!



Model B  
Crystal  
Set  
Retail!  
**49/-**



Cat. No. 135.

### BRITAIN'S BEST CRYSTAL SET IS THE EDISON BELL MODEL B

The result of exhaustive experiment and research, combining the qualities of efficiency and simplicity. Tuning is effected by the Edison Bell Variometer (illustrated below); the Twin Crystal Detector is illuminated by an electric bulb fitted under the opal glass tubes, facilitating the setting of the crystals and rendering possible the most delicate contact. The lamp is worked from a dry battery contained inside the cabinet, but controlled by a switch on the top of the panel. The "B" Set is also provided with sockets for the addition of loading coils should greater wave-lengths be required. Terminals are fitted to enable the set to be linked with the Edison Bell Note Magnifier, which can be added at pleasure.

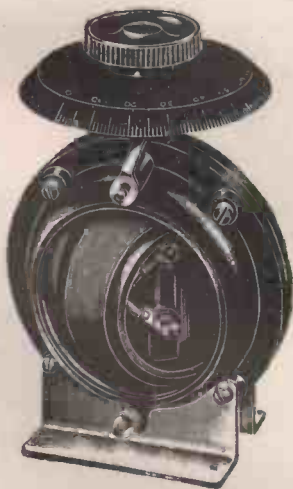

Cat. No. 136. Retail 10/-

The Edison Bell Variometer (inside winding) has justly been termed the Rolls-Royce of the Variometer class. It is wound suitably for reception on any P.M.G. aerial and is ready for immediate use. The close couplings between the Rotor and Stator windings ensure a large range for tuning. On a 20 ft. indoor aerial the maximum wavelength exceeds 420 metres and the minimum on a 100-ft. aerial is below 350 metres. The metal feet can be placed in four different positions.

### AUTOMATIC EARTHING PLUG AND LIGHTNING ARRESTER.



Protects home and set from the dangers of lightning.

By withdrawing the Plug (A) Aerial and Earth wires are automatically connected, and the Wireless Set can be taken away without having to disconnect any wires.

To connect up the Set all you have to do is to reinsert the Plug. This device is beautifully made of insulating material, the metal parts being highly polished Nickel-plated: the contacts are of pure silver and will not corrode.

Cat. No. R/123.

Retail 6/6

### WIDE RANGE OF DIALS, KNOBS & INSULATORS.

See  
Catalogue  
Just  
Issued.

Ask your  
Factor  
For Copy  
or write  
Direct  
to us.



Cat. No. 81.  
Milled Head Handle,  
Fitted Tapped Brass Bush.

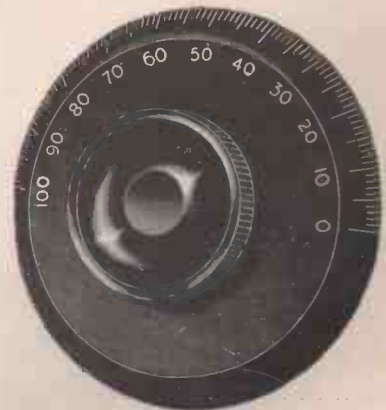

Cat. No. 75/128 (0-100 0-180).  
Condenser Knob and Dial.

### WHOLESALE AND EXPORT ONLY.

Don't forget that there is more than 30 years' reputation behind the name of EDISON BELL—a solid guarantee of good faith with the Trade and Public. For Trade Terms apply to your nearest Factor, or Write for Complete Catalogue of Radio Parts and Complete Sets to:

Manufacturers and Patentees,

**J. E. HOUGH, Ltd., EDISON BELL Works, Glengall Rd., S.E.15**  
AND AT HUNTINGDON.

WHEN REPLYING TO ADVERTISEMENTS PLEASE MENTION "THE BROADCASTER."

# SAVE POSTAGE

A  
FREE  
SERVICE.  
SUBSCRIBERS  
ONLY.

**Q** We have arranged to act as a "Clearing House" in connection with enquiries relating to advertisements in "The Broadcaster and Wireless Retailer."

Many readers desire to obtain further particulars of material advertised. This necessitates a considerable expenditure of time and money.

**Q** For instance, twelve firms may advertise loud-speakers in "The Broadcaster and Wireless Retailer." To obtain full particulars of these means the writing of twelve letters, and the expenditure, including notepaper, envelopes and postage, will amount to at least 2/-.

### Our Postage Saving Service saves you most of this expense.

Simply fill in the form below and post to "The Advertisement Manager, 'The Broadcaster and Wireless Retailer,' 93, Long Acre, London, W.C.2." We will do the rest.

Where a specific charge is made for a catalogue application should be made direct to the advertiser, mentioning "The Broadcaster and Wireless Retailer."

**EVERY FORM SENT MUST BE ACCOMPANIED  
BY A TRADE CARD OR LETTER HEADING**

## "The Broadcaster and Wireless Retailer" POSTAGE SAVING SERVICE.

To the Advertisement  
Manager "The Broadcaster  
and Wireless Retailer,"  
93, Long Acre, W.C.2.

Names of advertisers and articles advertised.

No. of advt. page

I wish to obtain further  
particulars regarding advts.  
specified :

Name .....

Address .....

.....

.....

**APRIL ISSUE**

WHEN REPLYING TO ADVERTISEMENTS PLEASE MENTION "THE BROADCASTER."

# PANEL MOUNTING SWITCH GEAR

For Factors and Manufacturers.  
 JACKS AND PLUGS, ALSO DEWAR SWITCHES.

ALL LONDON MADE.



Type No. 1 2/6 EACH.  
 Nickel Silver Blades. Silver Contacts.



Plugs 3/- EACH.  
 Special connections inside. Turned Ebonite Sleeve. Best Turned Brasswork.



Type No. 2 2/8 EACH.  
 Nickel Silver Blades. Silver Contacts.

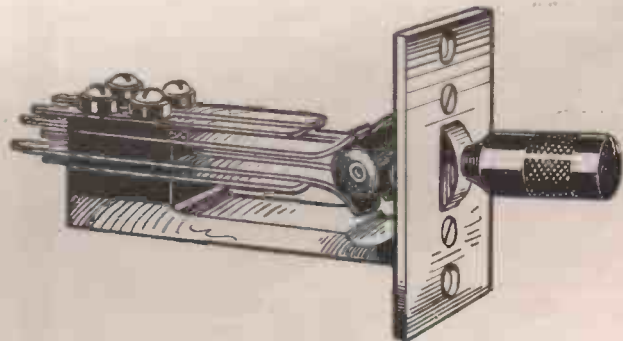

Type No. 3 2/10 EACH.  
 Nickel Silver Blades. Silver Contacts.

Dewar Switches.

2	Way	4	Point	-	-	-	4/6	Retail
2	"	6	"	-	-	-	5/-	"
2	"	8	"	-	-	-	5/6	"
2	"	12	"	-	-	-	6/6	"



Type No. 4 3/- EACH.  
 Nickel Silver Blades. Silver Contacts.

All Silver Contacts.

Single Hole Mounting 1/6 each extra.

N.A.R.M. DISCOUNTS.

## INTERNATIONAL WIRELESS MANUFACTURERS LIMITED,

Phone : Clerkenwell 3173  
 Telegrams : Simhobre Smith, London

125-131, ROSEBERY AVENUE, E.C.1.

WHEN REPLYING TO ADVERTISEMENTS PLEASE MENTION "THE BROADCASTER."



# HUNTS PROTECT YOUR VALVES

You cannot burn out valves if you fit the H.A.H. "Saveit" Fuse.

2/-

By spending 2s. on a Hunt's Patent Safety Fuse Wander Plug, you save several valves at a cost of 15s. or 20s. each. Accidents are bound to happen, and one which might have meant a burned-out valve costs only 6d. to replace a flash-light bulb. The fuse operates in the H.T. circuit, and may also be used as a battery tester, being designed with a special split Plug to fit standard battery sockets. Can be used with either bright or dull emitter valves. Complete instructions are sold with each "Saveit" Safety Fuse. Quote Fig. 828. Price 2s. each, packed in carton.



## Hunt's "HOLDER" made from Solid Rod.

The Hunt Valve Holder, the only type made by the firm, is manufactured from solid rod, and is superbly finished with counter-sunk sockets. When ordering quote Fig. 970. Price 1s. 3d. each.

These goods are also made up on attractive cards for window show purposes, and are well advertised and specially packed in cartons for sale. Write, wire or phone for lists.

1/3



**A. H. HUNT, LTD.,** Dept. 21, H. A. H. WORKS, TUNSTALL ROAD, CROYDON.  
Phone: Addiscombe 1584. Grams: "Keyage, Croydon."

H.P.

**Sells Well!!**



## The BI-RECTO Microphonic DETECTOR

Absolutely Automatic and Self-Adjusting.

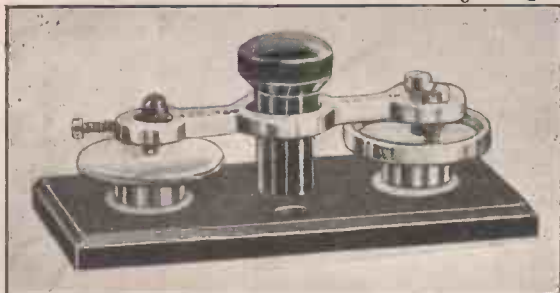

NICKEL-PLATED, mounted on best Ebonite, and fitted with crystal.

3/- Retail. TRADE DISCOUNT 33 1/3%

Write for particulars and sample at trade prices.

**ASSOCIATED WIRELESS,**  
289a, King's Road, CHELSEA, S.W.3.  
Phone: Kensington 7928.

## THE FORTEVOX STANDARD

HAS BEEN MAINTAINED IN THE NEW

### FORTEVOX

#### JUNIOR MODEL No. 2.

Designed to include all the NEW FEATURES.

Our "STAR" CRYSTAL HOLDER with "CORONET" Crystal in Enclosed Detector (Regd. Design) Mounted on Ebonite Top.

Our SPRING TUNING DEVICE with perfectly insulated knob.

Our MOULDED EBONITE BASE with all terminals in most convenient position, as illustrated, or supplied with

Our new Spring MULTI-PHONE Terminals which take up to 6 Pairs Phones.



Ranges from ZERO up to 600 Metres. Fitted with LOADING COIL DEVICE to take all Standard Plug-in Coils as well as wire connections for unmounted coils for LONG WAVE reception.

We can supply COIL HOLDERS and COILS for all wave lengths.

Licensed under Patent No. 214005/23. LONDON MADE.

This LATEST FORTEVOX PRODUCTION is the FINEST VALUE now being offered. A QUICK SELLER and a pleasure for the Retailer to handle. Bristling with new points, its attractive appearance and beautiful finish will ensure a ready market.

**PRICE 10/- RETAIL (LIBERAL TERMS TO THE TRADE.)**

**FRASER & GLASS,** MIDDLE LANE, HORNSEY, LONDON, N.8.  
Scottish Agents: Messrs. KEITH & IRWIN, 35, Robertson St., GLASGOW.

Phone: Mountview 2225.



**Finston Components**  
—always in demand—  
—because they stand the Test of Time.

Write for Particulars of **FINSTON VARIABLE, SQUARE LAW and FIXED CONDENSERS & VARIOMETERS.**

Finston Fixed Condenser guaranteed within 5 per cent. of stated capacity, and the only one-hole Fixing Condenser on the market.

First class well constructed Components, securely boxed and promptly delivered.

## LIGHTING SUPPLIES CO.

— 2 Finsbury Avenue, London, E.C.2. —

Barclays 957

## PHILLIPSON'S FOR FINISH

known throughout the trade as the finest.

### The New Two-Way Coil Holder

(Pat. App. for).

Micrometer adjustment, Ball bearing movement:

Write for lists.

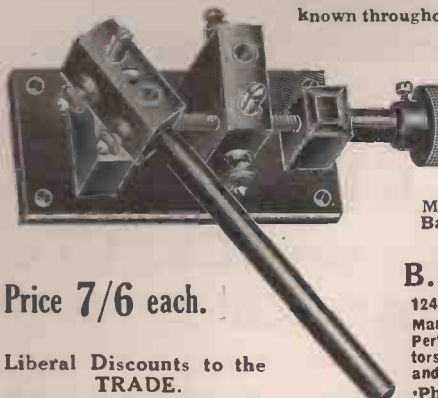

Price 7/6 each.

Liberal Discounts to the TRADE.

#### B. PHILLIPSON,

124, CITY RD., LONDON, E.C. Manufacturers of the Famous Perfect Adjuster Crystal Detectors, Combination Shorting Plugs and Basket Coil Holders, etc., etc. Phone: Clerkenwell 7920.

WHEN REPLYING TO ADVERTISEMENTS PLEASE MENTION "THE BROADCASTER."



## A FEW GOOD SELLERS

Shipton Products are designed with a practical sympathy for the experimenters' needs. This fact, coupled with our extensive advertising in the large circulation and popular technical journals, creates an exceptionally big demand for Shipton Products. Get them from your usual factor or wholesaler. If they cannot supply, send direct to the manufacturers. The prices named below are subject to the usual trade discounts.

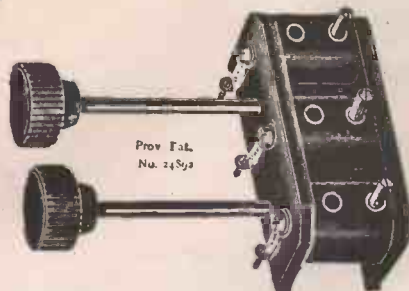

**SHIPTON NEW TYPE VERNIER COIL HOLDER.**

Gives perfect adjustment. Solid Ebonite. No loose connections. No backlash.

2-way, price 4/-  
3-way, price 7/6  
Nickel-plated,  
2-way, price 4/6  
3-way, price 8/-

For Panel Mounting.

**SHIPTON NEW TYPE STRIP RHEOSTATS. THE MOST PERFECT RHEOSTAT YET INTRODUCED.**

A specially designed spindle gives one-hole fixing and incorporates a tension spring which ensures perfect electrical contact-at all times; terminal connections are provided.

The 7 ohm. Model is fitted with a replaceable fuse, which little device may save the cost of an expensive valve. In operation they are noise free. One-hole fixing.

**SHIPTON New Type STRIP RHEOSTAT, 7 ohm (with fuse) ... 3/-**

**SHIPTON New Type STRIP RHEOSTAT, 30 ohm 3/-**

**SHIPTON New Type STRIP RHEOSTAT, 60 ohms 3/-**

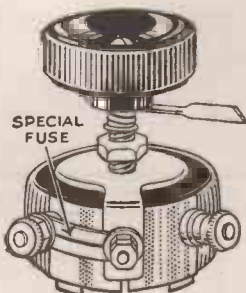

**SPECIAL FUSE**

**SHIPTON POTENTIOMETER.**

Essential for precise control of any H.F. Receiver. Makes Multi-stage H.F. work a pleasure. One-hole fixing.  
600 ohms. ... 4/6

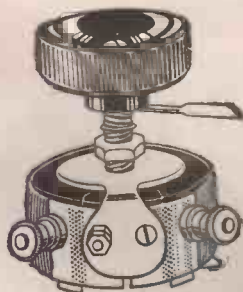

**SHIPTON GIRDER COILS.**

Double basket wound. Enamelled or cotton wire. A really highly efficient coil.

**THE SHIPTON NEW TYPE VARIABLE GRID LEAK.**

Here is another SHIPTON efficient unit. Mechanically perfect and thoroughly tested by experts to secure maximum and uniform efficiency.

Silent in operation. Constant under different settings. Can be calibrated accurately. Reliable under all conditions.

FARADAY HOUSE LABORATORY TEST REPORT:—

No. T/252/H.  
... The grid leak submitted was tested for resistance at various positions of its handle, and the resistances varied continuously from 0.5 megohms to 6.5 megohms

Price 3/-

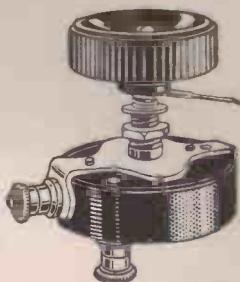

## E. SHIPTON & CO. LTD.

37, TOTHILL STREET, WESTMINSTER, S.W.1  
Telephone: Victoria 3171. Telegrams: "Rentfones, Parl."  
Also at 14, KING ST., COVENT GARDEN, W.C.2.

Barclays 976

## To Manufacturers of Wireless Sets

You can now get

# GLAZITE

REGD.

in 100-foot lengths

The sale of "Glazite," the new coloured connecting wire, in ten feet coils, to amateurs for making up their own wireless sets, has far exceeded all expectations. Frequent demands from the trade have now caused us to arrange for supplies of "Glazite" in 100 feet lengths. Packed in this convenient form "Glazite" can be used without waste in the manufacture of all types of wireless sets.

"Glazite" consists of tinned copper wire covered first with cotton and then with a film of heavy insulated material. Easily flexible, possessing high dielectric strength, "Glazite" is absolutely damp-proof, flame-proof, oil-proof, and will not deteriorate in any way.

Made in four different colours red, blue, yellow, and black, "Glazite" not only simplifies all "back-of-panel" wiring, but adds to the attractiveness of the finished set.

Write for full particulars of "Glazite" in 100 feet lengths. For ordinary use "Glazite" is made up in coils ten feet long, price 1s. 6d. per coil.



Makers of Electric

Wire for over 40 years

# GLAZITE

THE NEW COLOURED CONNECTING WIRE

THE LONDON ELECTRIC WIRE Co. AND SMITHS Ltd.,

Playhouse Yard, Golden Lane, London, E.C.1  
Grams: Electric, London. Phone: Clerkenwell 1388-9-90-91

JUDD

WHEN REPLYING TO ADVERTISEMENTS PLEASE MENTION "THE BROADCASTER."

# FOTH OPTICAL COMPANY,

2, Tower Royal, Cannon St., London, E.C.4  
 Manufacturers of Wireless and Optical Goods,  
 Cameras, Binoculars, etc.

## The Foth Phone



4,000 ohms.  
 2,000 ohms each earpiece—Black  
 enamelled—Adjustable magnets—  
 Highly magnetised  
 Pure and Mellow Tone.  
 RETAIL PRICE  
**10/6**

Immediate Deliveries  
 from Stock.

Wholesale only.

LIBERAL  
 DISCOUNTS.

NO AGENTS.

## The Foth Loud Speaker



4,000 ohms and  
 Adjustable Magnets

Height 12"

Pure and Mellow  
 Tone. Elegant Type.

RETAIL PRICE

**18/6**

Please Note we are the sole makers of all FOTH instruments.

The FOTH 'PHONES have been greatly improved on those formerly manufactured.

Teleg. Address: "Fothoptica, Cannon, London."

Telephone: City 5087.

Cable Address: "Fothoptica, London."

# Victoria Electrical (Manchester) Ltd.

Manufacturers of

## VICTORIA PRECISION CONDENSERS

### SQUARE LAW AND ORDINARY

	Without Vernier	With Vernier
.001	8/6	11/6
.00075	7/6	10/6
.0005	6/6	9/6
.00025	5/6	8/6



ENTIRELY BRITISH MANUFACTURE

DELIVERIES EX STOCK.

# 1, 3 and 5, Chapel Street, Salford.

'Phone: Central 4496

'Grams: "Lamplight," Manchester.

WHEN REPLYING TO ADVERTISEMENTS PLEASE MENTION "THE BROADCASTER."



# GOLD and SILVER GIVEN AWAY

with each box of

## "UKANTES" MARK × × × HERTZITE

two TRUE FORMED Catwhiskers are given **FREE** :—

- 1 Guaranteed 9ct. **SOLID GOLD**
- 1 Guaranteed **SOLID SILVER**

Make no mistake, this CRYSTAL is the best money can buy. If after you have tested every crystal and every Gold and Silver Whisker you are not more than satisfied, return the goods and your money will be refunded without argument.

Sample Dozen Box 6/9  
Per Gross - 75/-

All goods Carriage Paid.  
Factors and Shippers send for Prices.

**E. T. BREWIN**  
51, DANBURY ST., N 1.



# ST HELENS EBONITE

**EACH SHEET TESTED  
FOR SURFACE LEAKAGE**

SAMPLES AND PRICES FROM—

**ST HELENS** CABLE & RUBBER  
CO. LTD.  
(PHONE 333)  
**SLOUGH**

— Quality First —

THE  
**McREE**

AGENTS REQUIRED IN  
ALL DISTRICTS

THE  
**McREE**

L.F. TRANSFORMER



RADIO VALVE

Write at once for SAMPLE and test against others to:—  
199, BROAD ST., BIRMINGHAM  
Telephone: East 691.

RETAIL PRICE

# 12/-

33 $\frac{1}{3}$ % discount



Ratio 5—1

THE  
**MIDLAND COUNTIES RADIO  
and ELECTRICAL ENGINEERS,**  
199, BROAD ST., BIRMINGHAM.

Midland Agent: F. T. CARTER, 160, South Road, Handsworth

**DULL EMITTER TYPE**  
Fil. Volts 1.8 Fil. Amps 0.22  
Retail Price 14/6

**BRIGHT EMITTER TYPE**  
Fil. Volts 4.5 Fil. Amps 0.65  
Retail Price 8/6

**25% DISCOUNT**  
Special terms to factors.

Write for samples and test against others.

These Valves are entirely BRITISH and fully guaranteed.

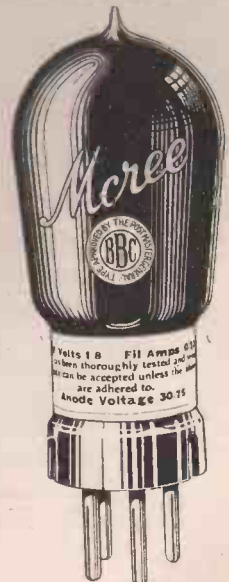

WHEN REPLYING TO ADVERTISEMENTS PLEASE MENTION "THE BROADCASTER."

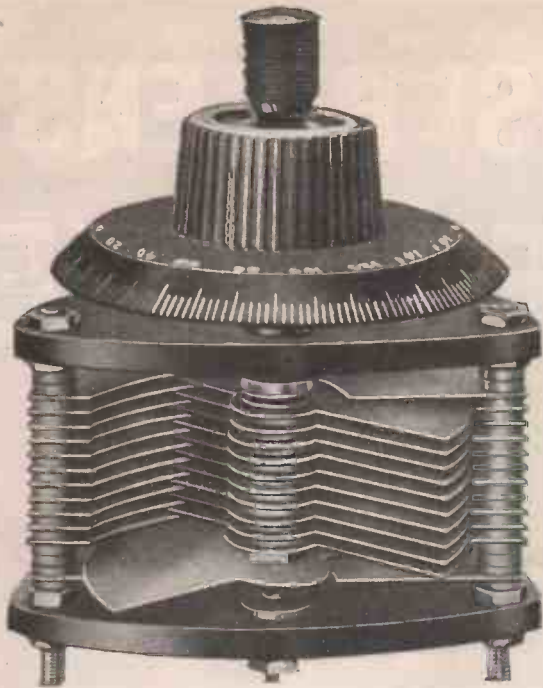

**THE NEW  
VERNILOR  
WITH  
BRASS VANES**  
*Square Law with Vernier.*

**PRICES**

·001 . .	1 1/6
·0005 . .	9/6
·0003 . .	8/6
·0002 . .	8/-

**END PLATES of BEST QUALITY  
EBONITE.**

**VANES of TEMPERED BRASS.  
DIAL & KNOB of HIGH QUALITY.  
PACKED in ATTRACTIVE CARTONS  
FOR HOME OR EXPORT.**

**BRITISH MANUFACTURE.**

**VERNILOR CONDENSERS, Ltd.,**  
*Grosvenor Works,*  
23, Boundary Street East, All Saints,  
MANCHESTER.



**NUTTS  
OF  
MANCHESTER**

**DISTRICT AGENTS:**  
**GRAHAM FARISH PRODUCTS.**  
**FIXED CONDENSERS**  
EACH BOXED AND GUARANTEED.  
·0001 TO ·002 1/- RETAIL.  
**INDUCTANCE COILS**  
35' 50' 75' 3/9 RETAIL.

**FACTORS, WRITE FOR LISTS!**

PHONE:—CENT. 4429. 16, THORNLEY BROW, DANTZIC STREET.

**PROTECTION FROM LIGHTNING**

This Success line has a place in every house where a wireless set is installed. The usual type of lightning switch which is fitted *inside* the house is valueless. A lightning switch should be fitted *outside* the house for obvious reasons.

When your customers ask for a lightning switch advise them a Success Ertharel lead-in switch, which combines a lead-in and earthing switch. It gives complete protection against damage to property and your set by severe electrical discharge. The Success Ertharel Switch operates from inside the house.

**Other Success Good Sellers include:**

Super Success L.F. Transformer	... ..	21/-
Silver Success L.F. Transformer	... ..	17/6
Success Choke	... ..	10/6
Success Vernier Coil Holders for Panel Mounting	... ..	5/6
" and the Success Variable Condenser.	for Behind Panel Mounting	8/6



**Retail  
Price  
6/6**

If your customers ask for a lightning switch advise them a Success. It is the only device which protects both property and the set.

**WHOLESALE DISTRIBUTORS:**

- London: Beard & Fitch, Ltd., 34, Aylesbury Street, E.C.
- Cable & Electrical Supplies Co., 234, Pentonville Road, N.
- Manchester: Beard & Fitch, Ltd., 1, Dean Street, Piccadilly.
- Birmingham: Cooke & Whitfield Wireless, Ltd., 24, St. Paul's Square.
- Bristol: Fred. Burris & Sons, 7/15, Redcliffe Street.
- Wholesale Fittings Co., Ltd. 14, North Street, Stokes Cross.

Full list of wholesale distributors appears in the Manufacturers Directory, November "Broadcaster and Wireless Retailer."

**BEARD and FITCH LTD.**

34, AYLESBURY STREET, LONDON, E.C.1.

Telephone: Clerkenwell 8941.

Barclays 922

**MIRACLE MASTER**

**1, 2 and 3 VALVE RECEIVING SETS.**

**EXTRACT FROM LETTER FROM IRELAND.**

**Re ONE VALVE SET.**

I received set as above, and certainly am pleased to say results obtained are marvellous. I got:—

- BELFAST (72 miles) on Loud Speaker.
- All B.B.C. Stations on 3 pairs of phones.
- BRUSSELS (550 miles) as clear and loud as any B.B.C. Station.
- MADRID (980 miles) and several other foreign stations, clearly and distinctly.

I am using a French Radio Micro Valve, 4v. Accumulator, and coils 3 and 4.

Words fail me to express my appreciation, and numerous persons, some "would-be experts" laughed when told of results, and were only convinced on hearing for themselves.

**SPECIAL TERMS AND OFFER TO THE TRADE.**  
**WORLD'S WIRELESS STORES, WALLINGTON.**

Globe Advert, 245

# GIL-RAY

*The Crystal of the age*

The "Gil-Ray" Super-Sensitive Crystal, retailing at 1/6, will give you over 50% profit.

Write at once for Illustrated Circular and Price List.



Obtainable from our Sole Agents:

Newcastle-on-Tyne.—F. K. Haddon, 2, Northumberland Road.

Leeds.—Ellison & Hillman, 123, Albion Street

Manchester.—Garnetts, Islington Grove Works, Salford.

Birmingham.—Priestley & Ford, 3, Carr's Lane.

AND ALL LEADING FACTORS.

We guarantee our Crystal and will exchange any piece not giving entire satisfaction.



K.5.—BASKET COIL HOLDERS.—Ebonite with slot, round or square bar .. 8/6 dozen

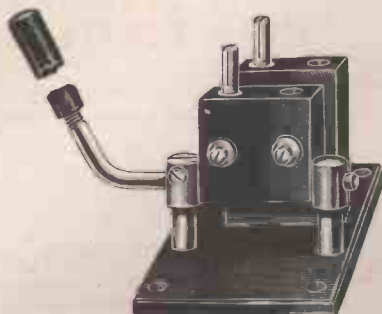

L.7.—COIL HOLDERS.—(Ebonite).—2-way 26/-  
L.11. 3-way 46/-  
L.10. Ebonite 2-way (with Vernier) 49/-

GIL-RAY BASKET COILS in labelled boxes—  
H. 2.—Chelmsford Coil, Retails @ 1/6 .. 12/-  
H. 3.—Set of 5 Coils, Retails @ 2/6 .. 20/-

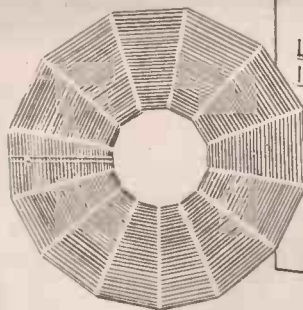

**GIL-RAY**  
**LOW SELF-CAPACITY**  
**INDUCTANCE COILS**  
Guaranteed Uniform in Construction, made from Finest Materials and Accurately Calibrated, give Great Selectivity over all Wave-lengths.  
SELF-SUPPORTING WITHOUT SHELLAC OR WAX.  
No. 6.—Wave Lengths. 1300 - 2100 Metres

**CONDENSERS.—**

K.15.—.0005 Sq. Law plain ..	56/6 dozen
K.16.—.0003 Sq. Law plain ..	52/6 "
K.17.—.0002 Sq. Law plain ..	49/6 "
K.18.—.001 Sq. Law plain ..	46/6 "
K.19.—With Vernier, 21/- per dozen extra.	42/6 "
K.20.—With Ebonite Tops and Bottoms, 5/9 per dozen extra.	75/- "

N.21.—MICRO CONTROL 26/6 dozen

N.22.—RAESTAT .. 25/- "

**STARWAT TRANSFORMER.—**

(Night Light), Retails @ 10/- each .. 90/- "  
All the above prices subject to 3 1/2 per cent., cash with order.  
All the above prices subject to 2 1/2 per cent., cash 7 days.

Country orders carriage paid over £10.

Special prices to Factors on Application.

**GIL-RAY TRADING CORPORATION,**

35, SICILIAN HOUSE, SICILIAN AVENUE, SOUTHAMPTON ROW, LONDON, W.C. 1

Telegrams: Gilraytrad, Westcent, London. Telephone: Museum 3206.



K.5.—BASKET COIL HOLDERS.—With Spike (Ebonite), on 1 1/2 in. x 1/2 in. bar 5/- dozen  
K.6. One Spike on Concave Plug 6/6 doz.  
L.K.6a. Two Spikes on Concave Plug 7/- doz.



K.12.—COIL PLUGS. Best quality ebonite. Square 5/- doz.  
K.13.—Ditto Concave 5/3 doz.  
K.14.—Ditto Wedge 7/- doz.

**We are ACTUAL MANUFACTURERS OF DEPENDABLE AND HIGHLY FINISHED EBONITE COMPONENTS**

Send 10/- with your trade heading for a liberal range of Samples, or a p. c. for your name to be added to our mailing list.



Ref. C. 140

Ref. C. 120

Basket Coil Holder (Ref. C. 120) highly polished; also supplied with bar for coil (Ref. C. 121). Cheaper pattern (Ref. C. 122) also fitted with bar (Ref. C. 123). Valve holder (Ref. V. 130) is turned from High Grade Ebonite and highly polished. Legless pattern with side contacts also supplied (Ref. V. 131). Two-way coil holder, base 2 1/2 in.

x 2 1/2 in., blocks 1 1/2 in. x 1 1/2 in., one block pivoting outwards, ebonite handle and knob 2 1/2 in. long. Polished all over — exceptionally high finish. (Ref. C. 142). High-grade enclosed Crystal Detectors, nickelled parts and plain glass, as illustrated. (Ref. K. 151). Ditto with matt ebonite base and ends, brass fittings and half opal glass. (Ref. K. 152). Super quality ditto with polished ebonite ends and base, nickelled fittings, half opal glass. (Ref. K. 153).



Ref. V. 13

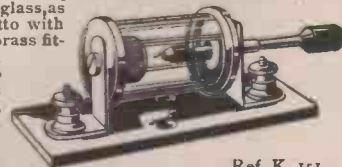

Ref. K. 151

A. H. Clackson, Ltd. (Dept.) 119, Fleet St., E.C.4. (Phone: City 8972)

WHEN REPLYING TO ADVERTISEMENTS PLEASE MENTION "THE BROADCASTER."

# FAMOUS FORMO RADIO COMPONENTS



## FORMO SHROUDED L.F. TRANSFORMER

World renowned for consistent high quality and reliability and UNCONDITIONALLY GUARANTEED.

Price **18/-** Subject.

## THE FORMO PORTABLE AERIAL

Supplied complete with insulators and lead-in terminal and can be erected anywhere in the course of a few minutes. **7/6** Subject

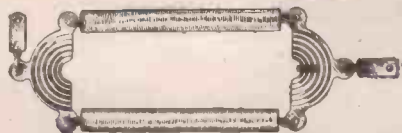

## THE FORMO COMPANY,

(Arthur Preen & Co., Ltd.)

Contractors to the Admiralty, War Office, India Office, Air Ministry and Post Office.

Chief Offices and Works :  
**CRICKLEWOOD LANE, N.W.2.**  
Scottish Branch: 22, York Place, Edinburgh. And at Birmingham, Newcastle, Manchester and Bournemouth.  
Sole Agents for Bristol and Cardiff: The Sloan Electrical Co., Temple Street, Bristol.

# COMPONENTS OF MERIT



**POTENTIOMETER**  
400 OHMS.  
VERY SMOOTH ACTION - 4/- LIST.



**TUBULAR FIXED CONDENSERS**  
.0001 to .0003 1/6 List  
.0005 to .003 2/- "  
.005 to .006 2/3 "



**RHEOSTAT**  
25 OHMS.  
ONE HOLE FIXING - 3/6 LIST.

## ONDIA WAVE METER

CAPABLE OF READING  
25 to 25000 Meters

SET WITH 4 COILS (80 to 4500) OR OTHER CHOICE - £4-4-0 LIST



## GRID LEAK

VARIABLE PENCILTYPE  
1-6 MEG. - 2/10 LIST.

## ONDIA WAVE-TRAP

COMPLETE WITH COILS  
£2 12 6 List.

Telephone:  
Holborn 6405.

**GOODCHILD & PARTNERS, LTD.,**  
56-57-58, Eagle Street, Holborn, W.C.1.

Telegrams:  
Whizzing, Westcen,  
London.

WHEN REPLYING TO ADVERTISEMENTS PLEASE MENTION "THE BROADCASTER."

# A Service that Will Help You to Build a Big Radio Business

**H**OUGHTONS—the Radio Wholesalers—are out to build big business for the Radio Dealer. Plans are being made to help and encourage enterprising Dealers in a dozen and one different ways. No expense will be spared in making the HOUGHTON Service by far the best wholesale service in the British Radio Trade. The services already rendered by HOUGHTONS to their Dealer Customers are but a mere indication of the enterprising programme for the future. Reap the full benefit of the programme by becoming a HOUGHTON Dealer Customer to-day.

## One Centralised Source of Supply

HOUGHTONS supply *all* the requirements of the Radio Dealer—*collectively*. This, in itself, is a service that saves the Dealer a worth-while amount of time, trouble and expense. It reduces overhead expenses to a minimum and eliminates duplication and delay. In addition to the obvious advantages of this system, the HOUGHTON Dealer Customer will get the powerful support of the HOUGHTON Service Programme for 1925—the service that will help you build big business.

*Send a trial order to HOUGHTONS to-day.*

## HOUGHTONS LIMITED,

The Radio Wholesalers, 88-89, HIGH HOLBORN, LONDON, W.C.1.

GLASGOW, 70-78, York Street  
(Principal Scottish Depot).

EDINBURGH, 20 St. James' Square  
DUNDEE, 9, Panmure Street.

MANCHESTER, 15, Blackfriars St.  
Salford.

LEEDS, 67b, Briggate.  
NOTTINGHAM, 61a, Long Row.

HANLEY (STAFFS), Free Trade Buildings (Second floor) Percy St.

BELFAST, 6, Fountain Lane.  
SWANSEA, 20, Orange Street.



Note the New Earthing Terminal.

Give your customers complete satisfaction & increase your sales

U.S. GOODS WILL BUILD GOODWILL

The U.S. Super Transformer provides all that superb design and good British workmanship can offer. Maximum magnification without hint of distortion; excellent performance in all stages; good finish, and absolute reliability, backed by the Makers' Guarantee.

Retail Price 18/6.

We will willingly supply One Transformer to enable you to test for yourself and will refund you the full price paid if you are not satisfied, providing the Transformer is returned to us in good condition within seven days from date of purchase.

Liberal Trade Terms apply to the—

U.S. RADIO Co., Ltd.  
(Dept. 15),  
155, High Street,  
Lewisham, S.E. 13.

Phone: Lee Green 2404. Wires: "Supertran, Lewis, London."

18/6

U.S.  
All British  
U.S.



Super Transformer

**S. O. S.**  
STICK OF STICKINESS

**CHATTERTON'S COMPOUND**  
"BULLDOG BRAND"  
(Regd.)

COVERS SCREW HEADS; FILLS HOLES; FIRMLY FIXES COMPONENTS TO PANEL; IS THE SAME COLOUR AS EBONITE — BLACK; A PERFECT INSULATOR.

THE ONLY ADHESIVE FOR EBONITE.

Write for Prices, Showcases, etc., to

Sole Manufacturers:  
**THE POMONA RUBBER CO.,**  
192, LONDON ROAD, MANCHESTER.  
Makers of INSULATING TAPES AND COMPOUNDS.

**RADIO**  
**LAMPLUGH**  
**PRODUCTS**

A typical example of Lamplugh Value

A variometer-tuned Crystal Set—in antique finish oak cabinet. With loading coil fitting for 5XX—easily picked up within 120 miles. A soundly-built receiver that sells on sight.

Retail Price 30/-

Write to-day for the Lamplugh Catalogue and terms.

S. A. LAMPLUGH LTD.,  
KING'S ROAD, TYSELEY,  
BIRMINGHAM.

Wireless **C.A.V.** Productions.

**LOUD SPEAKERS.**

TOM-TIT	2000 ohms	30/-
Black Crystalline or Bright Stove Enamel.		
JUNIOR.	2000 ohms	55/-
STANDARD		
120 ohms		£4 15 0
2000 ohms		£5 0 0
4000 ohms		£5 10 0
Black Crystalline or Black Satin Enamel		

The initials that stand for the highest class of DESIGN WORKMANSHIP & FINISH.

IMMEDIATE DELIVERY.

Write for catalogue of Loudspeakers, Transformers, and Wireless Accumulators and trade terms.

**C.A. Vandervell & Co. Ltd.**  
ACTON VALE, LONDON W. 3.

Transformer: L.F. For the first and second stages of amplification **27/6**

5150 High Ratio for first stage.

5151 Low Ratio for second stage.

**C.A.V. Accumulators** for wireless are the result of 39 years' manufacturing experience

WHEN REPLYING TO ADVERTISEMENTS PLEASE MENTION "THE BROADCASTER."

# "BECO"

## The HORNLESS LOUD SPEAKER

A REALLY EFFICIENT SPEAKER  
DESIGNED ON SCIENTIFIC EX-  
PERIENCE, AND AN ORNAMENT  
IN ANY HOME.

CLEAR AS A CRYSTAL.  
PURITY OF TONE.  
NO DISTORTION.  
RICH IN MELODY.



**British Made**  
Price

**52/6 Retail**

(Made in nickel plate)

**55/-** Retail: Silver Oxy.  
**55/-** „ Copper Oxy.  
**57/6** „ Gold Plate.

Size of Speaker:

Height...	...	...	6"
Diameter	...	...	5"
Thickness	...	...	2"



— "BRITISH" —

**"NUFONE"** Headphones.

Retail Price

**12/6**

CHEAPEST BUT MOST EFFICIENT.  
Cannot catch the hair.  
No screws to adjust.  
6 ft. 6 in. cords.  
All parts highly nickel plated.

*Liberal Terms to the Trade.*

MANUFACTURED BY THE  
PATENTEES:

WORKS:—BRITISH ELEC-  
TRICAL MFG. CO.,  
PUTNEY, LONDON, S.W.15.



**BRITISH ELECTRICAL  
SALES ORGANIZATION,**

**623, Australia House,  
Strand, London, W.C.2.**

Phone: City 7665.

WHEN REPLYING TO ADVERTISEMENTS PLEASE MENTION "THE BROADCASTER."

# 66 Tapa 99

REGD.

## PLUG & SOCKET TERMINALS

THE ORIGINAL AND ACKNOWLEDGED THE BEST FOR ALL WIRELESS CONNECTIONS.

GUARANTEED INTERCHANGEABLE.



## SPADE TERMINALS

Are of the same high-class quality and finish as all "Tapa" products.

*If your factor does not stock "Tapa" Terminals, write direct to the sole manufacturer.*



## WANDER PLUGS

Similar in design to the plug in the "Tapa" plug and socket terminal, but made to fit standard H T. batteries



All "Tapa" terminals can be supplied in red, black, green, yellow, pale blue, royal blue, amber or brown. (State colour when ordering.)

Sole Manufacturer :

**W. J. CHARLESWORTH**  
88 & 89, ASTON ST., BIRMINGHAM

(Phone : CENTRAL 981.)



## Can you doubt

the importance of the "BROWNIE" WIRELESS to every progressive dealer, when you consider it costs but 7s. 6d., will operate 4 pairs of 'phones, and at a distance of 25-30 miles from a B.B.C. station or 120 miles from Chelmsford gives perfectly clear reception? Moreover, it is well advertised, not only by Press announcements, but by the consistent recommendation of satisfied customers—a fact that ensures repeat sales.

With all fittings nickelled, the "Brownie"  
Wireless .. .. . 7/6  
Special coil for extending to Chelmsford  
wavelength .. .. . 1/6

### The Ebonite Base, 1/6

Specially designed to fit any "Brownie" model, it is in great demand. Just slide the "Brownie" into the hollow centre, and fix with the three screws supplied.

### The D.L.5 Crystal and Palladium Catwhisker, 2/- per box.

The D.L.5, the famous crystal which has played such a large part in the success of the "Brownie," is now separately boxed. Attractive cartons, consistent advertising and its undoubted efficiency ensure rapidly increasing sales. Send now for a sample.

*Send to-day for details of Trade Terms.*

**The J.W.B. Wireless Co.,**  
310a/312a, Euston Road, N.W.1

(Facing Warren Street Tube Station).  
Telephone : Museum 3747.



We are **ACTUAL IMPORTERS** of all lines shewn and can therefore sell at the **KEENEST PRICES** in England.

**INSULATORS FOR WIRELESS.**

**EGG INSULATORS.**



In case lots of 2000.

**LARGE SHELL INSULATORS.**



In case lots of 1000.

**BARREL INSULATORS.**

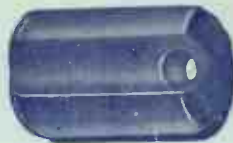

In case lots of 500.

**SMALL SHELL INSULATORS.**



In case lots of 2000.



**INSULATED SCREW EYES.**

(Brassed.)  
Sizes 1½ in. to 3 in.  
Standard cases of 50 gross.

**HIGH-TENSION BATTERIES.**

We hold large stocks of H.T. 60 volt Batteries—fitted with non-cracking compo and read well over 60 volts.

**WANDER PLUGS.**

No. 170, with red polished heads.  
No. 171, with black polished heads.  
25 gross pairs in case.

**TWO-PIN PLUGS.**

Black Ebonite, with Brass Metal Parts,  
2000 in case.

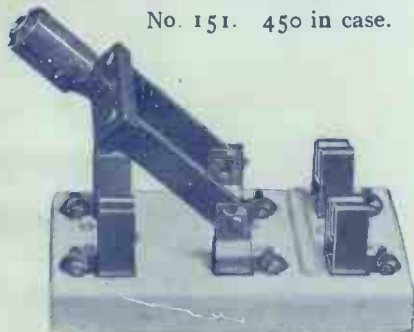

No. 151. 450 in case.

**KNIFE SWITCHES.**

With coppered Brass parts mounted on very strong china base.

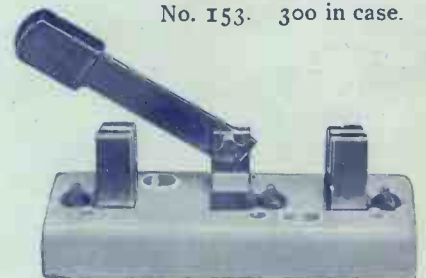

No. 153. 300 in case.

**TROLITE DIALS**

These dials are very highly polished and have clear white-filled engravings.

**PANEL SWITCHES**

with nickel Plate.

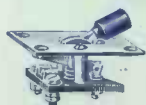

No. 180  
10 gr. in case



No. 181  
5 gross



No. 182  
2 gross

**TUMBLER SWITCHES**



No. 190  
5 gr. in case



No. 191  
2 gross



No. 192  
1 gross

LARGE STOCKS OF EACH LINE KEPT AND PROMPT DELIVERY GUARANTEED.

Please note we cannot undertake to split cases. Prices and particulars on application.

**THE "EGO" ENGINEERING COMPANY, LTD.**

220, SHAFTESBURY AVENUE, LONDON, W.C.2.

'Phone : Regent 2428 (2 lines).

Telegrams : "Regent 2428, London."

WHEN REPLYING TO ADVERTISEMENTS PLEASE MENTION "THE BROADCASTER."

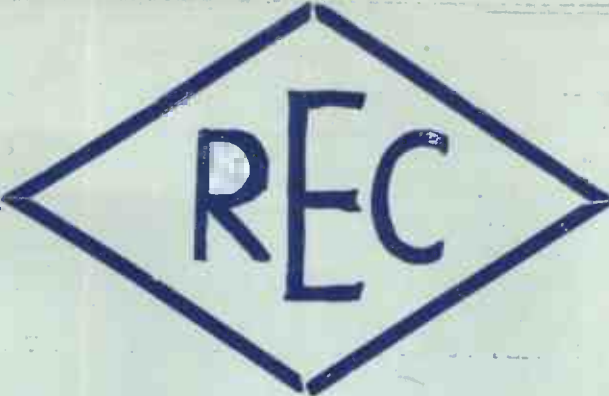

# A LOUD SPEAKER

Which, due to months of untiring experimental work has now been produced which embodies every quality that a high-class production should possess. The aim has been threefold.

1. Purity of Reproduction.
2. Volume of Tone.
3. Resonance without distortion.

We claim all have been attained in

## The AMBASSADOR

Height	- - 24½"	<b>PRICE</b>
Diameter of base	7"	<b>£4 : 15 : 0</b>
Diameter of flare	14"	Smaller model <b>£2 : 2 : 0</b>

SUBJECT LIBERAL TRADE DISCOUNTS.

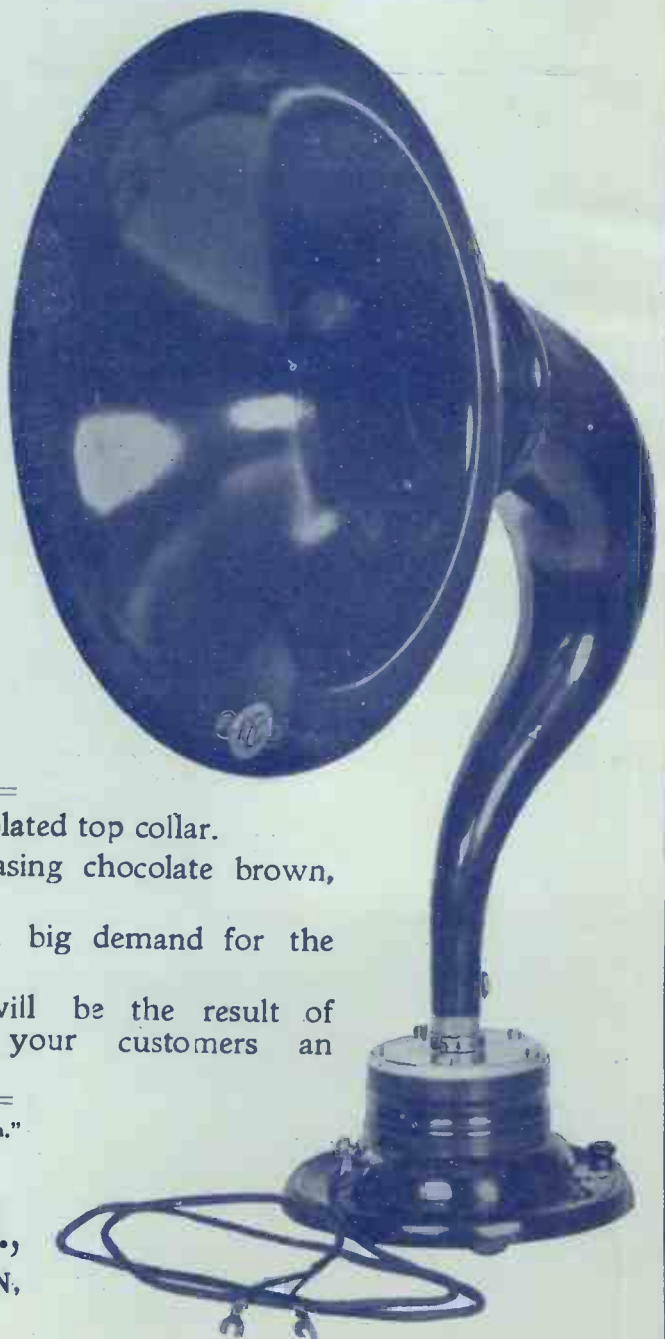

Its heavy base, mounted with highly nickel-plated top collar.  
 Its graceful swan-neck, finished in most pleasing chocolate brown, added to  
 Its wonderful efficiency will soon create a big demand for the **AMBASSADOR**.  
 And Confidence, Profit and Goodwill will be the result of your recommending and selling your customers an **AMBASSADOR Speaker**.

'Phone : Holborn 1229. 'Grams: " Exportation, Smith, London."



**THE**  
**Radio Equipment Co., Ltd.,**  
 5, DYERS' BUILDINGS, HOLBORN,  
 LONDON, E.C.1

WHEN REPLYING TO ADVERTISEMENTS PLEASE MENTION "THE BROADCASTER."

TRADE MARK

# EVER-READY

BRITISH MADE

**Batteries** continue to be the BEST for WIRELESS and all purposes.

Increased facilities should now enable you to obtain our BATTERIES and ACCUMULATORS anywhere—if you cannot, write the manufacturers :

Service E. Y. Dept.

THE "EVER-READY" CO. (Great Britain), LTD.,  
"Ever-Ready" Works,  
Hercules Place, Holloway, London, N.

Use **EVER-READY** Batteries and obtain satisfaction

BRITISH

**T.E.C.**

MADE

H. T. L. T.

## WIRELESS BATTERIES

Can be relied upon for electrical efficiency and long life. They are manufactured from only the best materials available, and as a result of prolonged experiment and research 'phone noises are entirely eliminated. Our competitive prices and stocking guarantee will interest you.

**FOR BUILDING UP "H.T." SETS.**

You are invited to investigate the T.E.C. 3-cell unit system with simple coil or clip-socket connections which ensures perfect contact. Write for our fully illustrated list.

**THE EFANDEM CO., LTD. (1),**  
Fallings Park Works, Wolverhampton.

# SUNLIGHT

BRITISH MADE

## WIRELESS BATTERIES AND ACCUMULATORS

**SUNLIGHT** Products are very popular among Wireless enthusiasts. Their good qualities are well known, and there is an ever-increasing demand for them. It will pay you to stock them.

Reduction in prices of both High Tension batteries and accumulators. Let us quote you our trade terms.

**SUNLIGHT MANUFACTURING Co. Ltd**  
PAXTON ROAD, TOTTENHAM, N.17.

Telephone: 2208 TOTTENHAM. Telegrams: TOTTLANE, LONDON.

WHEN REPLYING TO ADVERTISEMENTS PLEASE MENTION "THE BROADCASTER."



# sell "LANITE"

The new super crystal in the sales-making carton.

Scientific Research, after years of experiment, has now produced this laboratory crystal which we have called "LANITE." All natural product crystals now entirely superseded. Lanite is extremely sensitive all over on account of its unique crystalline structure, amazing volume and purity of tone

**Real Discounts for YOU** and remarkable results for your customers.

The carton retails at 1/9—and contains:—1 LANITE Ultra Sensitive Laboratory Crystal. 1 Laniidum Catswhisker. 1 Booklet containing Circuit Diagrams and other useful tips for experimenters.

Write to-day for details of our generous trade terms—before the agencies in your town are snapped up.

**LANITE Laboratories,**  
6, Booth Street East, C-on-M., MANCHESTER.

Advertised regularly in:  
Amateur Wireless,  
Popular Wireless,  
Wireless Weekly,  
Wireless World,  
Modern Wireless,  
etc., etc.



Box in Red and Black. Very attractive—a quick seller.

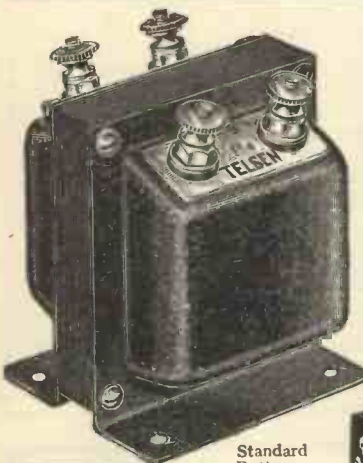

## The New Shrouded Telsen Transformer

The product of years of research and experience. A transformer that admits no superior on the market—irrespective of price. By scientific manufacturing methods it is offered at **15/6**

## The Original Telsen Transformer

—that has won fame for Telsen products—is now reduced in price. The same quality—the same wonderful results—now only **14/-**

Standard Ratios 5-1 and 3-1.



*Radio's Choice*

**TELSEN ELECTRIC CO.,**  
207, ASTON ROAD, BIRMINGHAM.

Phone: Central 5265 Wire: "Escort, Birmingham."

AGENTS:

London and South: Shenton & Co., Ltd., 69, Shoe Lane, London, E.C.4. Lancashire and Yorkshire: Green & Co., 27, Speedwell Road, Edgbaston, Birmingham. Notts and Leicestershire: Mayall & Co., Ltd., 8, Goldsmith Street, Nottingham. South-West Counties: Robinson & Hands Electrical Co., Ltd., Barwick Street, Birmingham. South Wales: Radio Supply Co., 41, Waterloo Street, Swansea. Scotland: Linto Electrical Co., 38, Montrose Street, Glasgow. Ireland: Thomas K. Turpin, 16, Luxor Gardens, Bloomfield, Belfast. Australasia: Engineering Supplies Ltd., 235a, Blackfriars Road, London, S.E.

ABRO

## ACTUAL MANUFACTURERS!

H.T.S. SUPER ACCUMULATOR CARRIER.

- ABRO FOR EMPIRE TAPE
- ABRO „ ADHESIVE TAPE
- ABRO „ EBONITE
- ABRO „ H.T. BATTERIES
- ABRO „ VARIOMETERS

THE MANCHESTER FIRM THAT GIVES AT A MINIMUM PROFIT  
*Quality and Cheapness!!*

Write for Prices, &c.—

**ABRO**  
184 & 186, LONDON ROAD,  
**MANCHESTER**

WORKS: HAGUEST.

'PHONE: CENT. 6142

ABRO

## Large Stocks & Quick Deliveries

of all the following Components

Messrs. EDISON BELL, S. A. LAMPLUGH,  
WOODHALLS LTD., DUBILIER CO.,  
IGRANIC, FERRANTIS.  
FINSTONE SPECIALITIES.

Square Law Condensers,  
Brass and Insulating Goods.

**BURLINGTON WIRELESS CO.,**  
313, OXFORD ROAD, MANCHESTER. Phone Central 1996.

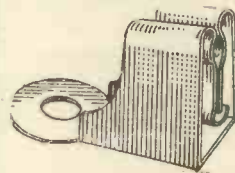

## The "KLUTCH"—terminates all terminal troubles.

The "Klutch" Terminal provides the perfect means of instantaneous connection and disconnection. Just press the lead through the slot, and it is instantly gripped—firmly and reliably. Yet should the lead be accidentally pulled, the "Klutch" immediately releases it, obviating any possible chance of damaging the receiver. Every "Klutch" terminal takes two leads, 2½d. brass, or 3d. nickelled (each).

**FREE!**

Write to-day. We shall be pleased to send you by return of post a pair of "Klutch" Terminals free of charge, together with particulars of trade terms.

**HENRY JOSEPH & CO., LTD.,**  
96 & 100, VICTORIA STREET, LONDON, S.W.1.

Telephone: Victoria 12.  
Telegrams: "Joskiwolf, Sowest, London."

WHEN REPLYING TO ADVERTISEMENTS PLEASE MENTION "THE BROADCASTER."



# SPARTA

Fuller  
ALL BRITISH

## LOUD SPEAKER

"Sparta" is a speaker that does its own sales talk. Its tone appeals at the first hearing. The reason lies in a construction that is different. That difference is the outcome of long experiment.

The large "Sparta" has a unique feature—an additional tone selector which enables very delicate refinement of tone values. The smaller "Sparta" model has the usual single adjustment only.

Type.	Ohms.
A	120
HA	2,000
HHA	4,000
<b>£4 : 15 : 0</b>	
B 1	120
<b>£5 : 15 : 0</b>	
HB	2,000
HHB	4,000
<b>£6 : 0 : 0</b>	
S	120
HS	2,000
HHS	4,000
<b>55/-</b>	

# -sells on the test of tone

FULLER'S UNITED ELECTRIC WORKS, LTD.,  
CHADWELL HEATH, ESSEX.  
Phone: Ilford 1200. Grams: "Fuller, Chadwell Heath."  
London Depot: 176, Tottenham Court Road, W.1.

174 EE

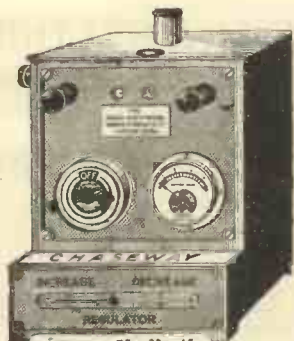

7" x 6" x 4"  
Prov. Patents

# "CHASEWAY"

## HOME BATTERY CHARGERS FOR DIRECT & ALTERNATING

Both these lines are in heavy demand ALL THE YEAR ROUND, and are undoubtedly the most practical and best on the market.

### DIRECT CURRENT CHARGER

Junior Model	10/6
Standard Model	25/-
Low Voltage Model	40/-
Garage Model	£4

### ALTERNATING CURRENT

Our own invention and manufacture, has got all foreign chargers "beaten to death" in efficiency, range and price. Full details on application or through your wholesaler.

ALL ADVERTISED LINES.

## "CHASEWAY" VARIABLE GRIDLEAK

Prov. Patents.

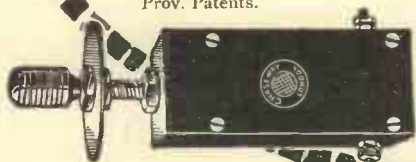

Reliable for ALL TIME.  
Infinitely variable .001—20 meg. A really fine instrument—no cardboard, no liquid, no pellets—and gives extraordinary results. Built to replace all old-fashioned types. Commended by Radio Journals.

Retail

4/-

The CHASE ELECTRICAL Mfg. Co., Ltd.,  
184B Fleet Street, London, E.C.4.  
Phone: Central 1539.

### Some Wholesale Distributors.

#### LEEDS :

Ellison & Hillman,  
123, Albion Street.

#### MANCHESTER :

Brown Bros., Ltd.,  
267/73, Deansgate.

#### LONDON :

Hobdays, Ltd.,  
27, Gt. Eastern Street.  
East London Rubber Co. Lt<sup>d</sup>.  
29/33, Gt. Eastern St., E.C.

Clark Hunt & Co., Ltd.  
159/61, Shoreditch, E.1.

J. Dew & Co.,  
33/4, Rathbone Pl., W.1.

Houghtons Ltd.,  
88/9, High Holborn, W.C.

Manufacturers Accessories  
Co.,

85, Gt. Eastern St., E.C.1.

#### CHANNEL ISLANDS :

Jersey Genl. Eng. Co.,  
Devonshire Place, Jersey.

#### EAST :

East Anglian Elect. Co.,  
Beccles.

Showcards, etc.,  
on application.

V. Prehick—Advertising—London.

WHEN REPLYING TO ADVERTISEMENTS PLEASE MENTION "THE BROADCASTER."

# QUICK SALES

are obtained by selling the best complete Aerial Wire—ECLIPSE.



TERMS AND PROMPT DELIVERY FROM—

**L. KREMNER,**  
49A, SHUDEHILL, MANCHESTER.

# RADIO MILLER'S IMPROVEMENTS

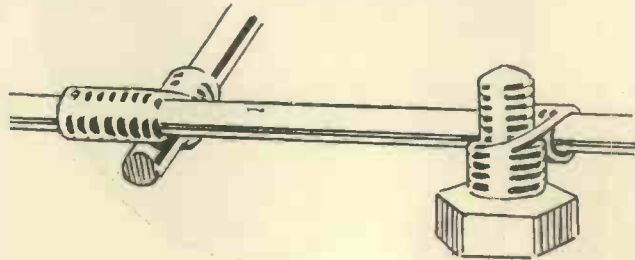

# SOLDERING ABOLISHED!

Usual Trade Terms. **Konnectus** Write for Literature.  
*"The more you shake them, the tighter they get."*

The most efficient method of wiring radio sets yet invented. No tools, heat or experience needed. Quicker and more effective than SOLDERING.

Complete in boxes 1/9 and 3/9.

JOHN W. MILLER, 68, Farringdon Street, E.C.4.  
2nd and 3rd floors. Telephone: Central 1950.

# Creating an international demand!

The Genuine Continental

# 'ERICSSON'

THE WORLD'S BEST HEAD SET

The wonderful strength, tone and purity of reception; the comfort, lasting efficiency and attractive appearance of the guaranteed Ericsson Headphones have created an enormous demand.

Compare them with any other 'phones and judge for yourself!



Get your stock now and stock well. Ready sales, more profit and a bigger business are assured by the ever-increasing demand for these superior 'phones.

Place your order now or write for sample phone, post free 10/6 to traders.

Send for **GENEROUS TRADE TERMS** to Sole Agents **CROWE Bros.**  
(DEPT. W) 45, ST. ORMOND ST. LONDON, W.C.1. ENGLAND.

RETAIL PRICE **13/9**

# GET THAT DISTANT STATION WITH A—

MICROHM

# VERNIER TYPE CONDENSER

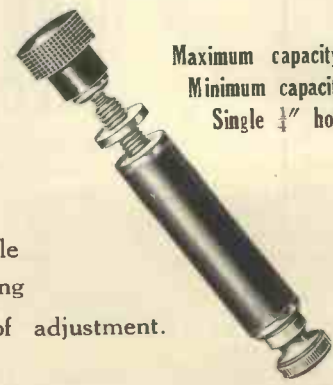

Maximum capacity .000015 mfd.  
Minimum capacity negligible  
Single 1/4" hole fixing.

PRICE **2/6**

Indispensable for fine tuning  
24 turns of adjustment.

Invaluable for "NEUTRODYNE" Circuits.  
**MICROHM ENGINEERING CO.,**  
Varsity Works, College Street, LONDON, E.9.  
'Phone: Clissold 2887.

WHEN REPLYING TO ADVERTISEMENTS PLEASE MENTION "THE BROADCASTER."

SEAGULL



PRODUCTS

No. 2.

**THE SEAGULL FOUR VALVE  
DE LUXE RADIO RECEIVER**

TRANSFORMERLESS—DISTORTIONLESS  
APHONIC—ECONOMIC—LONG RANGE  
VERNIER TUNING—VERNIER REACTION  
SIMPLE CONTROL—SELF CONTAINED.

SUPPLIED

Complete with all batteries ready for use. Fitted in superb walnut cabinet.

£25 0 0

Royalty £2 10 0

TRADE 33<sup>1</sup>/<sub>30</sub>%.

FACTORS SUPPLIED.



This receiver has logged all English and Continental, and several American stations, mostly on the loud speaker. It contains no Transformers, either H.F. or L.F.

A WORD TO THE TRADE.

Are your customers always satisfied with the sets you stock? Are your demonstrations always followed by sales? The SEAGULL FOUR sells every time it is heard, because it is the FIRST set on the English market with PERFECT reproduction coupled with ample volume.

*Write for particulars, or let our representative call and tell you about it.*

PHONE :  
PADD. 7751

SEAGULL LIMITED, R.N. Works, Newcastle Place, Edgware Road, W.2.

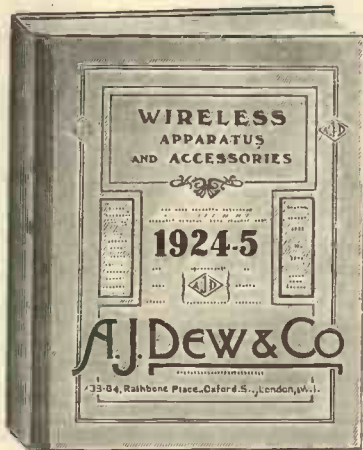

**CONCENTRATED BUYING**

Eliminates Waste, Reduces Cost and  
Increases Profits.

Place all your orders for radio equipment with A. J. Dew and Company. Extensive and comprehensive stocks ensure that they will be executed to your entire satisfaction, and the concentrated method of buying will greatly increase your profits.

*If you have not already received a copy of our Wireless Catalogue, write for one to-day, also for list of interesting and up-to-date lines added to our stock since publication of current edition.*

One of the earliest Wholesalers in the Wireless Trade, our huge business has been built on Service and Satisfaction. To-day we are in an unparalleled position to supply ALL your Wireless requirements.

Approved Distributors of N.A.R.M.A.T. Goods and V.M.A. Valves.

Telephones :  
Museum 8686.  
(10 Lines.)

**A.J. DEW & CO**

Telegrams :  
"Dewmofac,  
London."

Wholesale Distributors of Everything Wireless,  
33-34 RATHBONE PLACE, OXFORD STREET, LONDON, W.1.

WHEN REPLYING TO ADVERTISEMENTS PLEASE MENTION "THE BROADCASTER."

# YOUR CUSTOMERS WILL ASK FOR THESE

The demand for best quality in Wireless Components is steadily increasing, and WESTMINSTER Components are THE BEST.

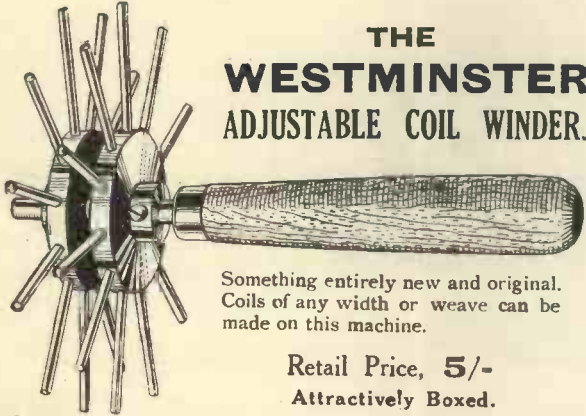

**THE WESTMINSTER ADJUSTABLE COIL WINDER.**

Something entirely new and original. Coils of any width or weave can be made on this machine.

Retail Price, 5/-  
Attractively Boxed.



**THE WESTMINSTER VALVE HOLDER**

For under-panel mounting,  
Retail 10d.



**THE WESTMINSTER COIL HOLDER**

Mounted as shown, 2/6  
Carded for panel mounting, 2/3  
Retail.

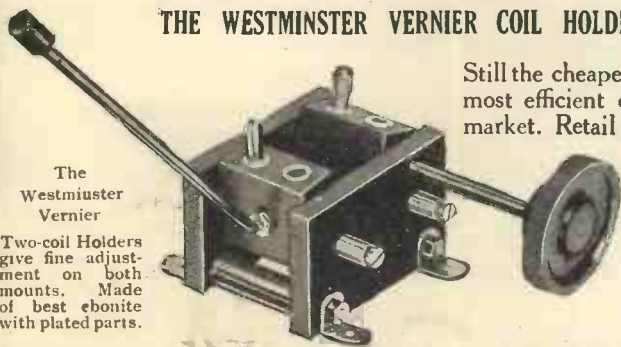

**THE WESTMINSTER VERNIER COIL HOLDER.**

Still the cheapest and most efficient on the market. Retail 5/6

The Westminster Vernier  
Two-coil Holders give fine adjustment on both mounts. Made of best ebonite with plated parts.

Stockists for every well-known make of Wireless Components  
**WATSON, JONES & CO.**  
ST. STEPHEN'S HOUSE,

'Phone : VICTORIA 7571.

VICTORIA EMBANKMENT  
LONDON—S.W.1.

WHEN REPLYING TO ADVERTISEMENTS PLEASE MENTION "THE BROADCASTER."

## "PERMION" DETECTOR.

We are the Original Manufacturers of Permion Detectors, and guarantee every one for six months.

PERMION is permanent, needs no adjusting, is always in action, can be adapted to any set, and means

**LOUDER RECEPTION.**

TUBULAR TYPE 5/-, Box Type 4/- Subject.

## CHRONICLE VARIOMETERS.

Wound with 1lb. 6oz. 15 D.C.C. Wire. Very close coupling.

**VERY LOUD RECEPTION.**

Send 5/6 for sample, post free.

**THE PERMION MANUFACTURING CO.,**

1a, DUKE STREET, OLD TRAFFORD, MANCHESTER.

Telephone : Trafford Park 521

## CONSIDER CAREFULLY

**SELL ONLY SQUARE LAW CONDENSERS THAT GIVE SATISFACTION.**

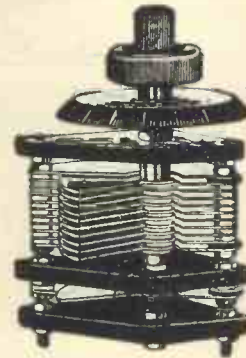

### PRICES

Vernier Pattern (with knob and dial)

.001 ..... 13/6      .0003 ..... 11/6

.0005 ..... 12/6      .0002 ..... 10/9

Prices for ordinary type on application.

### BIG BUSINESS BUILDERS

of guaranteed capacity, single hole fixing and stout aluminium vanes. (20 S.W.G.)

Prompt delivery from

**British Radio Instrument Manufacturing Co.**

5, GREENGATE, SALFORD, MANCHESTER.

'Phone—City 660.

## Buy "F.A.R." the Best

THE "F.A.R." LF Transformer has been proved on actual test to be considerably superior to other types selling at higher prices. Renders high amplification and distortionless speech and music over all frequencies.

**Shrouded, Ratio 5 : 1, 15/-**

Liberal discounts to the Trade.

Stocked by all leading Factors.

Sole Agent, **MAURICE BOBIN,**  
21, Warwick Lane, London, E.C.4

'Phone : Central 4872.





The  
M A R C O N I P H O N E  
V3A



**“ Ah! This is more to my taste ”**

is invariably the kind of remark you will hear from a discriminating customer when you point out and commence to demonstrate the Marconiphone V3A.

There is everything about this instrument which instantly wins the admiration of those people who judge by the highest standards. It is an example of a perfect union, of good-looking efficiency and outstanding quality in performance. It gives all the pleasure and wonder of broadcast, without the bother. It is simple to operate. Everything technical is out of sight, to remain out of mind.

Excellent loud speaker reception can be obtained direct from this instrument, at ranges up to 100 miles, putting it at a conservative figure. As far as long distance results are concerned, it is enough to state that the receiver part of this model is an edition of the Marconiphone Long Range V2.

Last but not least, the Marconiphone V3A is obviously a sound investment which will give lasting pleasure and satisfaction. In appearance and performance it is in the luxury class, but at its price of £34 17s. 2d., entirely complete, it is not a luxury to buy. It can be offered under the Marconiphone plan of deferred payments.

**C** Sales literature, show-cards, price tickets in a style worthy of the name Marconiphone. Supplies on application.

**District Offices :**

**LONDON :** Marconi House, Strand, W.C.2.

**CARDIFF :** Principality Buildings, Queen Street.

**GLASGOW :** 101, St. Vincent Street.

**MANCHESTER :** 17, Whitworth Street, West.

**BIRMINGHAM :** 3, Carr's Lane.

**BELFAST :** 6, Howard Street.

**CHELTENHAM :** 7, Rotunda Terrace, Montpelier.

**ABERDEEN :** 6, Windmill Lane.

**NEWCASTLE :** 23, Ridley Place.

**IRISH FREE STATE :** Marconi (Ireland) Ltd., 3, College Green, Dublin.

**Marconiphone**  
BROADCAST  
RECEIVING APPARATUS

THE MARCONIPHONE CO., LTD.  
Head Office : Marconi House, Strand, W.C. 2.

WHEN REPLYING TO ADVERTISEMENTS PLEASE MENTION "THE BROADCASTER."



## Discernment

TRADERS have searched everywhere and have found no crystal receiver to compare with this distinctive little set. The detector is enclosed and dust-proof. It has a shorting-plug and socket for long-wave-station Coils. The

### “Mastavox” Crystal Receiver

is finished in lustrous and enduring Mahogany. It is thoroughly efficient, it looks good, it IS good. Profits for you are assured.

There may be sets which look like the “Mastavox” at a glance, but to avoid substitutes get in touch, with us now.

Exclusive territory open for Agents where not already represented.

#### Agents Abroad:

<p>SPAIN: Anglo-Española de Electricidad, S.A. Barcelona.</p>	<p>NORWAY: Ak. Norsk Elektrisk &amp; Brown Boveri, Oslo.</p>	<p>SWEDEN: Aktiebolaget Ferd. Lundquist &amp; Co., Göteborg.</p>
---	--	--

The  
**MASTER RADIO**  
Manufacturing Company,  
Carver St., Old Trafford, Manchester,  
WJH. England.

# BRITEZITE CRYSTAL

USED  
NIGHTLY  
IN A  
MILLION  
HOMES

**“Britezite brings in Broadcast Best”**

4/- oz. subject. **AND BUSINESS.** 7/6 doz. in sealed box, subject.  
Send for Sample 1/- Post Free.

**BRITISH CENTRAL ELECTRICAL CO., LTD.,**  
6-8, Rosebery Avenue, London, E.C. Telephone: Clerkenwell 5848/9

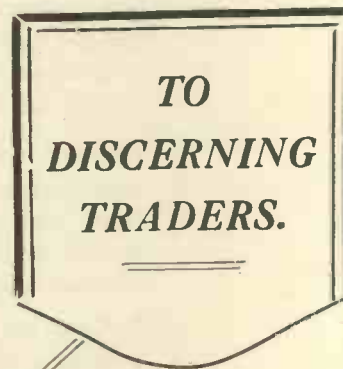

## Immediate Delivery of Quick Selling Lines

#### LEAD-IN TUBES.

6 in. 4/9; 9 in. 5/9; 12 in. 6/9 per doz.

#### “ENERGO” AND “ULTRA” PRODUCTS. LISTOLEON VARIABLE CONDENSERS. “NEUTRON” AND “GIL-RAY” CRYSTALS. At usual discounts.

Complete 1925 list on application. Send remittance with postage for samples.

#### COIL HOLDERS.

High grade polished ebonite, extension arm with knob, 2-way, 25/6; 3-way, 36/- per doz.

Vernier 2-way, very fine adjustment, accurately made and well finished. All parts nickel-plated. 42/- per doz.

#### COIL PLUGS.

Square	Per doz.	5/-
“ Screw Legs	“	6/-
“ Brass Brackets	“	6/-
Wedge, Brass Slide Plates	“	7/8

#### BASKET COIL HOLDERS.

Plug in, adjustable bar, fit any coil, full plug	Per doz.	9/6
“ Thin plug	“	8/-
“ Spiked	“	5/-
“ Full Plug	“	6/3

#### COILS.

Basket, Sets of 6, waxed	16/-
5XX, 4 Tappings	7/8
“ Duplex, Full, 1,600 M.	11/3
Tapped to Coarse and 10 fine, polished black former, green, S.C.W., B.B.C.	
Range	11/8

TERMS:—5 per cent. Cash with Order. Carriage paid on orders over £5. Special Quotations for Quantities.

**THE “TEES” RADIO CO.,**  
Manufacturers and Factors, 30, CITY ROAD, LONDON, E.C.1  
Phone: Clerkenwell 6610 Grams: Teesrad, Citifax, Finsquare.

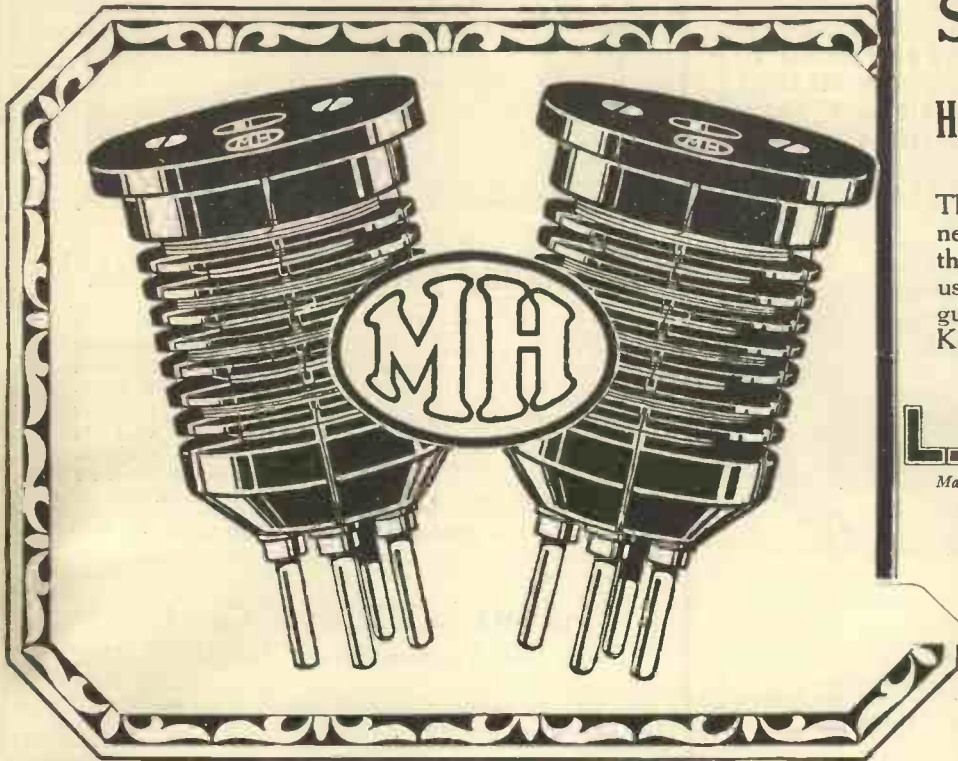

# ARE YOU SATISFYING

*the demand for these*

## H.F. TRANSFORMERS?

The public have realised the absolute necessity of using components of the highest efficiency only. The use of M.H. H.F. Transformers guarantees reliability of reception. Keep good stocks, you will need them.

### L.M<sup>c</sup>MICHAEL<sup>LTD</sup>

Manufacturers of Wireless and Scientific Apparatus,  
Hastings House, Norfolk Street,  
Strand, LONDON, W.C.2.

Barclays 977

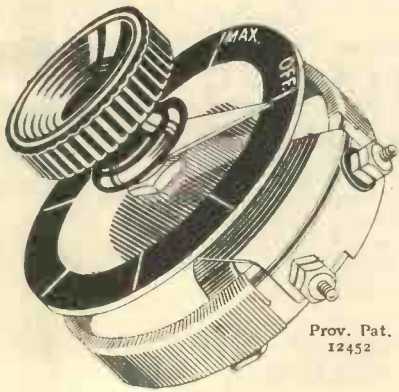

Prov. Pat.  
12452

The consistent demand experienced by dealers throughout the country for the "PEERLESS JUNIOR" RHEOSTAT speaks volumes for the quality and selling value of this popular product. Send for a dozen now—you'll soon need to send a repeat order.

One hole fixing.  
Handsome nickel dial.  
Phosphor Bronze contact arm.  
Winding cannot be damaged by ordinary use.  
Size  $1\frac{7}{8}$  in. diameter.  
 $\frac{1}{2}$  in. high.

Write now for trade terms.

The **BEDFORD ELECTRICAL**  
and **RADIO CO., Ltd.**  
Electrical Engineers  
and Manufacturers  
22 Campbell Rd., BEDFORD

**2/6**

MADE IN THREE SIZES—  
6, 15 & 30 OHMS

*Your Customers mean  
"PEERLESS JUNIOR"  
When they want  
a better  
Rheostat*

# Are you giving Battery Satisfaction?

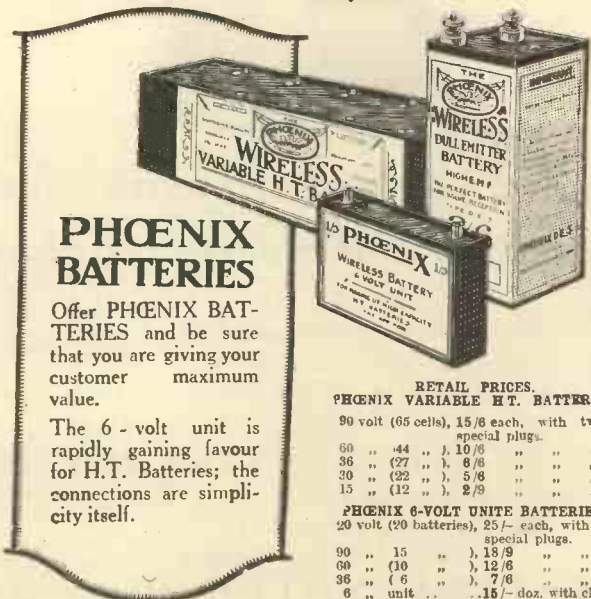

## PHOENIX BATTERIES

Offer PHOENIX BATTERIES and be sure that you are giving your customer maximum value.

The 6-volt unit is rapidly gaining favour for H.T. Batteries; the connections are simplicity itself.

**RETAIL PRICES.**

**PHOENIX VARIABLE H.T. BATTERIES.**

90 volt (65 cells), 15/6 each, with two special plugs.
60 " 44 " " 10/6 " " "
36 " (27 " " 6/6 " " "
30 " (22 " " 5/6 " " "
15 " (12 " " 2/6 " " "

**PHOENIX 6-VOLT UNITE BATTERIES.**

20 volt (20 batteries), 25/- each, with two special plugs.
90 " 15 " " 18/9 " " "
60 " (10 " " 12/6 " " "
36 " (6 " " 7/6 " " "
6 " unit " 15/- doz. with clips.

**PHOENIX DULLEMITTER BATTERY TYPE D.E.5.**

D.E.5 " " 3/6 each
--------------------

**THE LANGHAM ELECTRICAL SUPPLIES CO.**  
52, Dorset Street, Baker Street, London, W.

Telephone: Mayfair 262.

Telegrams: "Outillage, Baker, London."

WHEN REPLYING TO ADVERTISEMENTS PLEASE MENTION "THE BROADCASTER."

**SELL**  
**"HOLROSE" COMPONENTS**

**YOUR CUSTOMERS WILL THANK YOU.**

We Stock  
**"Holrose"**  
TRADE MARK  
**WIRELESS COMPONENTS**  
 FOR THE  
 DISCRIMINATING AMATEUR

"HOLROSE" ARE THE COMPONENTS YOU CAN ALWAYS RECOMMEND TO GIVE THE GREATEST EFFICIENCY AND SATISFACTION. OUR HUGE OUTPUT PROVES THIS. SEND FOR SHOWCARD

**"HOLROSE"**

**L. F. TRANSFORMERS.**

Perfect amplification without distortion.

Polished Brass Finish guaranteed for one year.

Ratio 4-1 and 5-1 down to 1-1.

**RETAIL PRICE**  
 Type H. 2 **14/- each.**



Type H.2.

HOLROSE TRANSFORMER, Type H.1, Upright Pattern, Retail Price 11/6 each.

HOLROSE L.F. TRANSFORMER, Type H.3, Shrouded, 16/6 each.

HOLROSE RHEOSTATS complete, with 3, 6, 10, or 30 ohm cartridge, 3/6 each.

HOLROSE POTENTIOMETERS. 300 ohms, 4/3 each.

**TRADE DISCOUNT 33 1/3%.**

**THE HOLROSE MANUFACTURING Co.,**

Dept. B, 43, LONSDALE ROAD, KILBURN, LONDON, N.W.6.

Phone: Willesden 3113.

**"Keeping pace with the times."**

There's a "Cabinet of Distinction" to suit every need of the home constructor. Here's the latest model, especially designed to accommodate the latest circuit—the super-heterodyne. Take advantage of the rapidly increasing popularity of this new receiver and make certain the distinctive mark is on every cabinet you stock—it is your protection.

Type A.M.L., perfectly finished in Deal, Oak or Mahogany, constructed with a movable base-board in the following sizes:—12 in. x 7 in., 14 in. x 7 in., 18 in. x 7 in., 21 in. x 7 in., 24 in. x 10 in., 36 in. x 8 in.

Send a card for details of trade terms, and also particulars of the complete range of cabinets and the new H.J. Set of coils 35-100, in a specially designed box.

**HENRY JOSEPH & Co., Ltd.,**  
 96 & 100, Victoria Street, London, S.W.1.

Telephone: Victoria 12. Telegrams: "Joskiwolf, Sowest, London."

Newcastle Stockists: Messrs. Hicks & Schofield,  
 17, Forth Street, Newcastle-on-Tyne.

**THEY SELL ON SIGHT**

*Its Obvious.*

**THE "HALES"**

**PATENT AERIAL AND LEAD-IN CONTROL.**

No more swaying wires and variable reception. Aerial and Lead-in Wires kept taut under all conditions. Definite and constant contact ensured. Improved reception guaranteed.

Fitted in a few minutes.

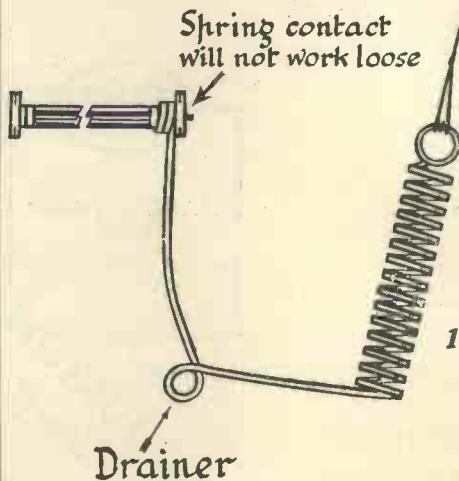

Retail price  
 1/- each.  
 Trade less  
 33 1/3%.

Sole Manufacturers and Patentees:  
**SPRING WASHERS, LTD.,**

ZOAR ST. WORKS, Tele.: 1386.  
 WOLVERHAMPTON. Grams: Soaring.

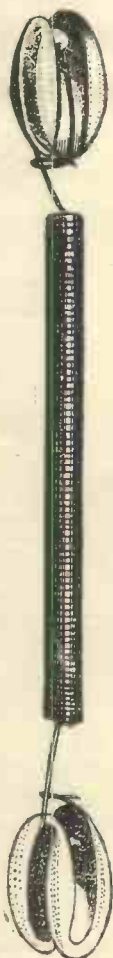

*A Sturdy Fellow*

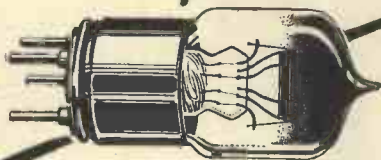

**built for hard work—but sensitive and always reliable.**

The C. & S. DULL EMITTER 2v. 0'2A (227) gives increased amplification and purer reception, without distortion—NEW ZEALAND & NEW YORK RECEIVED ON A SINGLE VALVE ... each 12/-

Also made 0'06a (227L) ... price 15/-

Special Process Dry Batteries for the one valve:—  
 227 ... 7/6 | 227L ... 4/6

Send for Illustrated Catalogue.

**CRAIK & SMITH (Desk 5),**  
 Allen Street, E.C.1

Showcards now ready

Phone: Clerkenwell 7346.

WHEN REPLYING TO ADVERTISEMENTS PLEASE MENTION "THE BROADCASTER."

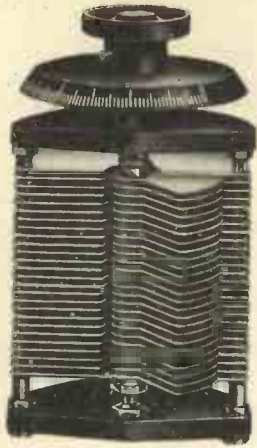

## Condenser Valve that sells at sight.

Stock these quality condensers—Ordinary or Square Law Types—they will multiply your profits—and add to your prestige. Finish is in nickel plate—workmanship throughout is perfection itself.

### TRADE PRICES.

Ordinary Type.	Square Law Type with Vernier.
·001- - - - 6/-	·0005 - - - 6/-
·00005 - - 4/6	·0003 - - - 5/9
·00003 - - 4/3	

*Ebonite end plates 6d. extra. Ebonite end plates 9d. extra.*

**FACTORS and SHIPPERS DISCOUNTS.**

**The NEWTON ENGINEERING CO.,  
35, Whittall Street, BIRMINGHAM.**

*Write for full Price List*

**ADDS CHARM & EFFICIENCY TO ALL RECEIVING SETS**

## “LOTUS” Cut Geared Vernier Coil Holder

P. Pat. 28397

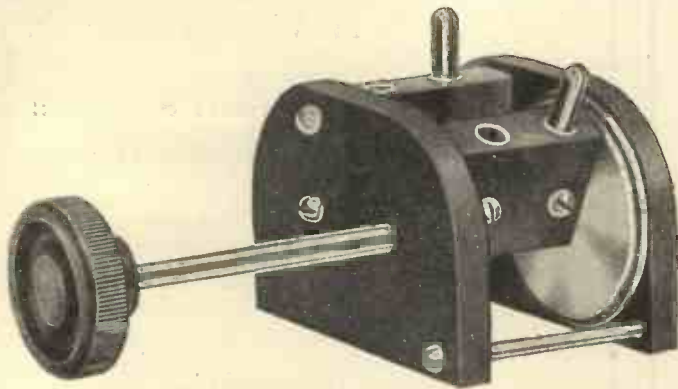

**VERNIER MOVEMENT ACTUATED BY THREE SETS OF ENCASED PRECISION CUT GEARS.**

REPRESENTING A REDUCTION OF

**8 to 1**

**MOVING BLOCK CANNOT FALL**

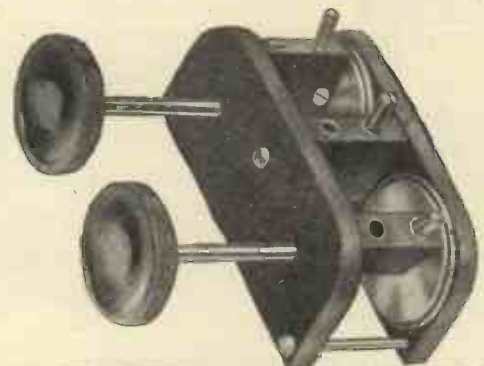

**LOTUS COIL HOLDERS ARE MADE FROM BAKELITE MOULDINGS.**

**WITH NICKEL PLATED BRASS PARTS**

RETAIL SELLING PRICES :—

TWO-WAY ... 7/- THREE-WAY ... 10/6

**GARNETT, WHITELEY & CO. LTD.,  
LOTUS WORKS, BROADGREEN ROAD, LIVERPOOL.**

WHEN REPLYING TO ADVERTISEMENTS PLEASE MENTION “THE BROADCASTER.”

*Wilkinson*

**Radio SPECIALITIES.**

Write for New Catalogue Now issued.

**CRYSTAL IN BULK**

We are large Importers of the very finest grade Galena in all grains—  
Sample 3/6 oz.

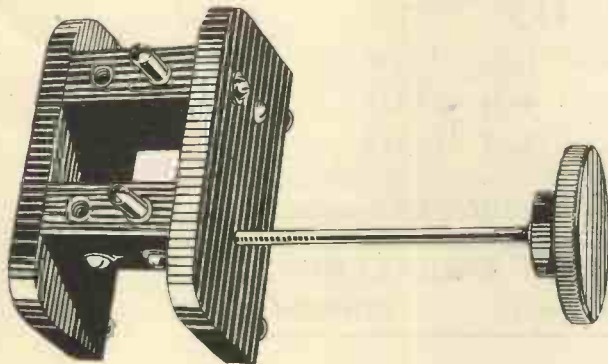

**2-way Coil Holder for Panel Mounting**  
30/- per doz.



**Basket Coil Holder.**

Slotted blade type, with large adjustable disc.  
1 1/2 ins. dia.  
11/6 per doz.

Unslotted fixed disc.  
10/6 per doz.

**Basket Coil Holders.**

Doublespike type  
7/6 per doz.



**Wedge Coil Plugs, real ebonite, 8/- per doz.**

**Moulded Wedge Plug, 5/- per doz.**

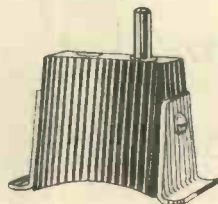

Distributing Agent for:  
**LEDION Basket Coils.**  
INSTRUMENTS, any type of moving coil or moving iron supplied.  
We manufacture all types of ebonite coil mounts.  
*Special prices for quantities.*

Manufacturer and Importer:  
**L. WILKINSON,**  
21, York Grove, Peckham, London, S.E.15.

— THE —  
**Neatest**  **Multiphone Connector Yet Made**  
TRADE MARK  
**NEW JUNIOR TERMINAL TYPE**

BRITISH MADE.



PROV. PATENT 5626.

Finish:—Red, Black and Nickel.  
**THE CHEAPEST, NEATEST, AND MOST EFFICIENT MULTI-TERMINAL ON THE MARKET.**

Can be fitted to all Sets using the existing Terminal Holes. Enables 4 pairs of phones to be attached to Set at a total cost of 1/-.

MANUFACTURERS AND PATENTEES—  
**F. E. WILSON & CO.,**  
79, New Street, Erdington, BIRMINGHAM

**H. J. HUNT**

Proprietors: H. J. HUNT & J. B. MCKENZIE.

*Specialist in Wireless Crystals.*

:: **H. J. HUNT'S** ::

- |                     |                       |
|---------------------|-----------------------|
| <b>FONEITE</b>      | <b>HERTZITE</b>       |
| TALITE (Large size) | (Large size)          |
| CARBORUNDUM         | HERTZITE (Small size) |
| ZINCITE             | PERMANITE             |
| SILICON             | BORNITE               |
| TELLURIUM           | SPECIAL GALENA        |
| COPPER PYRITES      |                       |

**ALL SELECTED CRYSTALS BOXED.**

*All Crystals Guaranteed.*

BOXES, TUBES, WEIGHT IN BULK.

*Orders by Post promptly attended to.*

**Terms: CASH WITH ORDER.**

Dept. B,

**4, Osterley Park View Rd., Hanwell, London, W.7.**

'Phone: Ealing 2330.

# GARNETTS,

ISLINGTON GROVE WORKS,  
SALFORD, M/C.

Makers of

"CRYSTOPHONE" COMPONENTS  
METAL STAMPERS, SCREW & RIVET MAKERS  
Nickel-Plated Work a Speciality.

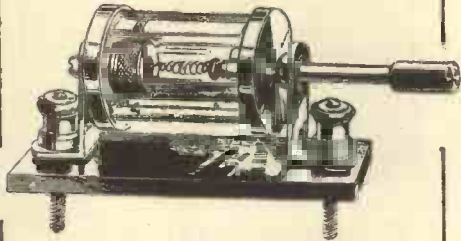

FROM 10/6 Per doz.  
according to finish.



PRICE  
PER GROSS  
NICKEL

1. 3 sizes  
A. B. C.

9/6 11/6 15/-

2. 4 sizes  
A. B. C. D.

8/6 10/6 12/6 5/-

3. 9/- gross

4. 8/6 "

5. 6/6 "

6. 5/- "

9. 2 sizes

1/8" & 1/4" 4/6

10. 12/- Gross

4 BA NUTS

1/3 Gross

2 BA NUTS

1/8 Gross



THE

WIRELESS WAREHOUSE,  
32, Swan St., Manchester,

is open to purchase complete Wire-  
less STOCKS to any amount for  
Spot Cash.

You can write us in confidence.

## WHY PAY MORE ?



THAN 11/6 PAIR

4,000 ohms Double Headband  
TRIED, TESTED AND TRUE

Hundreds of thousands of wireless  
enthusiasts are buying Headphones daily.

**DO THEY KNOW  
WHAT THEY ARE  
PAYING FOR ?**

If only they stopped to think and com-  
pared values, would they pay twice as  
much for practically the same article ?

**WOULD THEY ?**

We should think not ! And we can-  
not too strongly advise you to

**TAKE WARNING**

and insist on being shown the

I.M.I.

**"Astoria"  
HEADPHONES**

Handle them, screw off the cap and  
examine the inside, try them on and note  
the comfort over your head and the close  
fitting at the ears, and you will realise what  
satisfaction means at a small cost only.

A RECENT UNSOLICITED TESTIMONIAL  
FROM A SATISFIED CLIENT.

(ORIGINAL OF WHICH CAN BE SEEN)

"I am quite pleased with the Astoria  
Phones I had from you a few weeks  
ago. They are LIGHT, SIMPLE IN  
ADJUSTMENT AND SATISFAC-  
TORY IN OPERATION. They were  
bought for one of the younger members  
of the family who swears they are the  
BEST WE HAVE. Provided they last  
well, I shall consider they are  
REMARKABLE VALUE."

Obtainable from all dealers.

IMPERIAL MOTOR  
INDUSTRIES, LTD.,

Wireless Dept.,

Denmark Street, W.C.2

Tel. : 3347-8 GERRARD.

# KELLY'S

RADIO

Trade Supply Depot,

12, Jackson's Row,  
Deansgate, Manchester.

Keep  
Every  
Leading  
Line  
You  
Seek

Reliable  
Accessories  
Dealt  
In  
Only.

Tempitngly  
Reasonable  
Articles  
Delivered  
Everywhere.

See  
Us for  
Phones  
Parts  
Loud Speakers  
Y Go Elsewhere

Distinguished  
Everywhere  
Place  
Orders  
To-day.

THE  
FIRM  
THAT  
GUARANTEES  
SATISFAC-  
TION OR  
REFUNDS  
YOUR  
MONEY.

YOUR  
ORDERS  
ARE  
SAFE  
AND  
DISPATCHED  
PER  
RETURN.

# KELLY'S

RADIO

Trade Supply Depot

Ashton's  
Perfect  
Aerial  
Spreader  
(Protected)  
12/- pr.

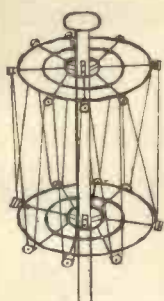

Gets  
All  
Stations.  
Fits any  
size pole.  
12/- pr.

Trade Price 9/8 pair.  
ASHTONS 8-10, Bull's Head Yard,  
Market Place, Manchester.

**H. D. BUTLER & Co., Ltd.**

Barclays Bank Buildings,  
222, Great Dover Street,  
Borough, S.E.1.

Telephone: Hop 3029.  
(Opposite Borough Tube Station.)

Cheapest and most reliable  
House for All Wireless  
Components

LISTS UPON APPLICATION POST FREE.

Finest Work & Promptitude.

Incomparable  
White  
Filling.

**HAND & MACHINE  
ENGRAVING  
ON ANY MATERIAL.**

Phone:  
Central 1137.

**CLIFFT & COCKLE**  
51, Arcade Chambers,  
St. Mary's Gate, Manchester.

# Brief Ads.—Big Offers.

The Perfect Contact Metal for Fixing Crystals.

As CRYSTALLOY retails at 6d. it is obvious that, for a line that SELLS and does not remain on hand for months, the Trade Profits are Extra Good.

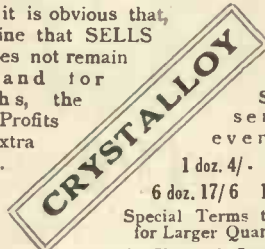

Attractive Showcards sent with every order.

1 doz. 4/- 3 doz. 10/-  
6 doz. 17/6 1 gross 30/-

Special Terms to Factors for Larger Quantities.

Send for Showcard, Sample, etc., to

Sole Manufacturers: **THE CITY VULCANISING CO.,** 28, CHESTER RD., MANCHESTER.

### ELECTRADIX.

A new and enlarged catalogue, in which are listed many interesting lines, has been published by Leslie Dixon & Co., of 9, Colonial Avenue, Minories, London, E.1. It contains about 300 illustrations, and in addition to wireless apparatus other electrical instruments are shown. Both the wireless dealer and electrician should find this list useful.

**ENGINEERING FIRM** with representatives covering Western Counties is prepared to accept sole agencies for remunerative lines of interest to motor and electrical firms.  
Box No. 114, "Broadcaster," 93, Long Acre, W.C.2.

### Natural Bulk Crystal

BEST QUALITY GUARANTEED

:: Super Sensitive all over ::

SAMPLE OZ. 2/- post free.

Special price for Quantity.

**T.E.S. SUPPLY, 37, Upper Baker St., N.W.1**  
(Direct Importers).

50 yd. ROLL NEW  
WHITE MUTTON  
CLOTH STOCKINETTE  
Finest material known for all kinds of cleaning and polishing sent carriage paid for 7/6; sufficient to make 100 cleaning cloths. Please send cash with order.

7/6

Special Terms to Trade for Quantities.  
S. J. GREEN Contractors to H.M. Government,  
Dept. B.W. 212, Gt. Homer Street, Liverpool.

"INITIAL" DUST COVER (For Motor Cars and Billiard Tables) 15 ft. x 9 ft. 16/6, 16 ft. x 12 ft. 20/-.  
Any size made.

Your initial embroidered in fadeless red silk—FREE. In a soft strong fabric that will not scratch or mark the polish. Will last for years.

DELIVERY BY RETURN  
WE PAY CARRIAGE

## BRASSWORK

DELIVERY FROM STOCK.

CRYSTAL TESTED and GUARANTEED  
40/- lb. SEND FOR SAMPLE OZ.

SWITCH ARMS (Brass) ... 5/6 doz.  
" (Nickel-Plated) 6/6 "

" One hole fixing.

DETECTORS, Glass Covered,  
Unmounted and Boxed, N.P. 8/- doz.

EGG INSULATORS ... 6/- Grs.

SEND YOUR ORDERS NOW!  
LARGE DISCOUNTS FOR QUANTITIES.

**H. HOWARTH,**  
288, Deansgate, MANCHESTER

**AGENTS:** The Master Radio Mfg. Co., Carver St., Old Trafford, Manchester, offer exclusive territory (where not already represented) to buying Agents of good standing, able to organise sale of products of proved merit. Already represented in Spain, Norway and Sweden. Apply: (BOX 22),  
**HULME'S ADVERTISING SERVICE,**  
9, Oxford Street, Manchester, England.



## MILLET for METERS

Every Type of Volt and Amp Meter.

Every Meter a Scientific Instrument.

Any readings in VOLTS AMPS or Combined METERS.

WATCH TYPE METERS  
SWITCHBOARD METERS  
DASHBOARD METERS  
MILLIAMPER METERS  
ACCUMULATOR CHARGERS for DIRECT CURRENT  
H.T. & L.T. VOLT METERS.  
100v/10 volts.

Every type and reading in stock  
- Every instrument guaranteed -



TERMS: NET CASH WITH ORDER.  
WHOLESALE ONLY.

ORDERS OVER £5  
DELIVERED FREE.

SPECIAL PRICES TO FACTORS.  
Phone: Holborn 293.

**J. MILLET, 22, Farringdon Avenue, London, E.C.**

WHEN REPLYING TO ADVERTISEMENTS PLEASE MENTION "THE BROADCASTER."





## OYLERONE FIXED CONDENSERS.

The Copper Foils and Mica Plates are guaranteed to be accurate.

0001, 0002, 0003, 0004, 0005, 0006.  
6/- per doz., Three doz. assorted 15/6

001, 7/-; 002, 8/-; 003, 9/-;  
004, 10/-; 005, 11/-; 006, 13/-;

For 3 doz. assorted. deduct 6d. per doz.

### INSULATED WALL HOOKS.

per Gross  
1½ in., 7/-; 2 in., 7/3; 2½ in. 7/9;

### PANEL SWITCHES.

Nickel Plated for Panel Mounting.

per Dozen

One Way, 11/-; Two Way, 21/-  
Three Way, 32/-.

### KNIFE SWITCHES.

On Heavy Porcelain Base.

per Dozen

S.P.S.T., 8/- S.P.D.T., 10/9  
D.P.S.T., 12/9 D.P.D.T., 18/-

Complete list of Components on application to:-

**OYLER** & Co.

35A, New Cavendish Street, W.1.

# The Postage Saving Coupon

will be found on page 80.

◆◆◆◆◆

Please note that this is for the use of subscribers to "The Broadcaster & Wireless Retailer" only, and all users are requested to enclose their Trade Card or Letter Heading.



### L.F. TRANSFORMER

Compare this with any others, irrespective of price. Powerful and distortionless. Guaranteed for a year.

**12/6**

Shrouded 15/- Heavy type 18/6

#### NOTE NEW ADDRESS

Bigger Business has necessitated bigger Works.

ACTUAL MANUFACTURERS:

**A. BEHM (LONDON) Ltd.**

FALKLAND WORKS,  
FALKLAND RD., HARRINGAY,  
LONDON, N.8.

Telephone No. : Mountview 4895 (2 lines)

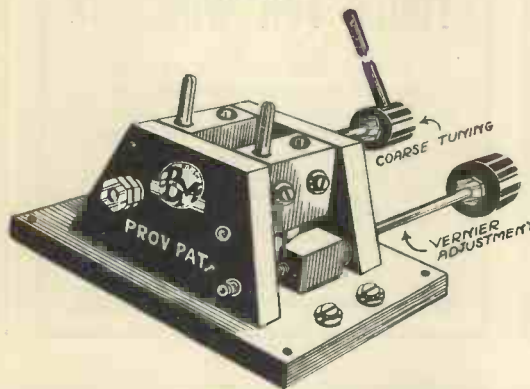

### THE B.M. MICRO-VERNIER COIL HOLDER

Marks an advance on all others. Coarse tuning is obtained in the usual manner, and then extraordinarily fine adjustment is made by means of the spindle operating the wedge-block which in turn moves the spring controlled coil block. Matt or polished finish

**6/-**

**LIBERAL TERMS.**



Prov. Pat.

### STONE PURIFIER FOR LOUD-SPEAKERS

Plugs into the last L.F. Valve sockets. Adjusting knob alters impedance of valve to suit that of the primary of transformer. Gives real purity of tone with an increase of volume.

**7/6**

WHEN REPLYING TO ADVERTISEMENTS PLEASE MENTION "THE BROADCASTER."

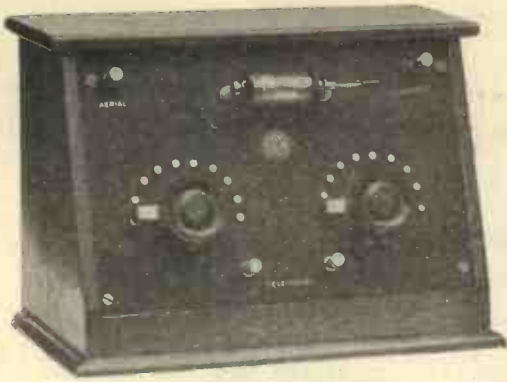

## The JANNOCK CRYSTAL SET

WILL RECEIVE 20-30 MILES FROM ANY B.B.C. STATION.

PERFECT RECEPTION AND TONE.

Mahogany Box with Ebonite Panel, nickel-plated fittings and glass covered detector.

Retail Price 20/- Usual Trade Terms.

**W. HOLLAND** Wireless Manufacturer,  
10, Watling Street . . . . . MANCHESTER.

# ! A SELLING LINE !

## THE "EASTWIRE" MICROMETER ADJUSTMENT CRYSTAL DETECTOR.

### 5 POINTS.

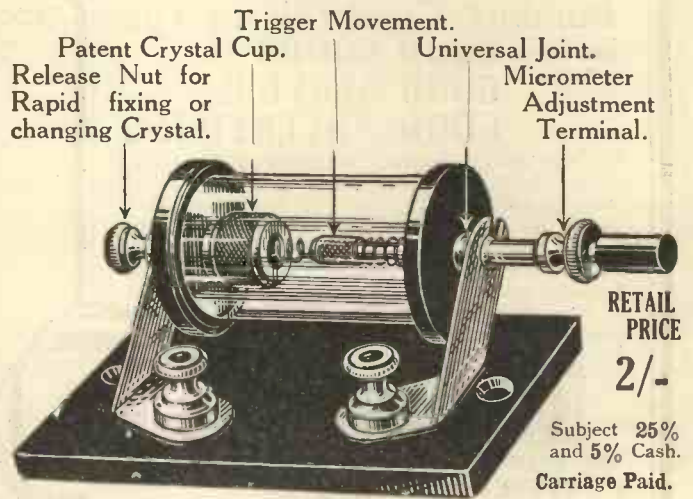

RETAIL PRICE 2/-

Subject 25% and 5% Cash. Carriage Paid.

Heavy Nickel Plated fittings. Moulded ebonite base and ends.

DETECTOR ARM DOES NOT ROTATE.

Sample Post Free.

Boxed separately and instructions in each box.

SPECIAL QUOTATIONS FACTORS AND SHIPPERS.

THE Eastern Wireless Company,  
"EASTWIRE WORKS,"  
THREE COLT STREET, LONDON, E.14.

'Phone: EAST 5433.



'Grams: "EASTWICOMP, POP, LONDON."



BRITISH MADE.

Type No. 2. 4,000 ohms.



GOOD DISCOUNTS.

### Sketophone :: Concert Grand

— a loud speaker with all the virtues of the most expensive instruments — at a price that will appeal to the man who studies economy. Superb volume and tone—lever adjustment of the diaphragm and attractive appearance. A line that sells at sight. Put it into your stock to-day. Retail price complete with flex leads

£3:10:0

Manufactured by **SKETT & CO.**  
Frederick St., St. Paul's, Birmingham.  
Telephone: Birmingham Central 879.

Sole Agents for Lancashire: L. J. Cooper & Co., 53, Bloom Street, Manchester.

WHEN REPLYING TO ADVERTISEMENTS PLEASE MENTION "THE BROADCASTER"

LATEST



DISCOVERY

**Electrify your sales by selling the latest in SUPER-SENSITIVE LONG RANGE CRYSTALS. Perfect Reception and Rectification at 35 miles. Trade Price 7/- Per doz. Special Prices for Quantities.**

VALVITE

**THE VALVE POWER CRYSTAL. Retailing at 1/8 Per Box. Makes satisfied Customers.**

Sole Proprietors: **GRAHAM & THOMPSON, 819, Rochdale Rd., Manchester.**

Every Constructor wants—

Patent applied for.



THE NEW  
A-C VALVE  
HOLDER

Because it is the finest system in existence. Increased efficiency at less cost.

Retails at 6d., 9d. and 1/3.

Send for particulars and generous trade terms.

The Fynetune Micro Adjuster is another good line. It can be fitted to any existing condenser and gives the finest possible Tuning.

SPARKS RADIO SUPPLIES,

43, GT. PORTLAND STREET, W.1. Phone: Langham 2463.

Building Goodwill for you  
by **GOOD GOODS  
GOOD SERVICE  
GOOD ADVERTISING**

We are building goodwill for every Retailer who stocks Efesca One-Hole-Fixing Components and Efescaphone Receiving Sets. Efesca products are of an exceptionally high standard of quality. Efesca dealers everywhere agree that the service and delivery we are able to give, and the advertising with which the general public are kept informed of Efesca products, make these goods a very profitable proposition.



ONE HOLE FIXING COMPONENTS.

EFESCA HEADPHONES

A popular priced headphone maintaining the usual Efesca standard of quality. 4,000 ohms, with 6 ft. flexible cord 21/-.

A Retailer writes:

"Capt. —, M.C. of this town, said that he had tried 9 different sorts of high-class Headphones, and that the Efesca were a complete revelation to him."



Send for Catalogue 522/15 describing all Efesca Products

Wholesale only:—  
**FALK, STADELMANN & Co., Ltd., 83-87, Farringdon Rd., London, E.C.1**  
 And at Manchester, Birmingham and Glasgow.

M  
A  
C  
I  
T  
O  
N  
E



S  
P  
E  
C  
I  
A  
L  
S

VALVESTATS

are compact, and being away from the panel give the **MINIMUM** amount of CAPACITY.

The RESISTANCE is wound on fibre strip, practically indestructible, smooth in action, and ready wired to the valve holder. Soldering tags are provided, so that either screws or tags can be used.

Saves multiple drilling. Price 6/-

Simplifies fixing.

Opal Windows with nickel plated finish to incorporate with this valvestat. Price 6d. each.

FILAMENT RESISTANCE

in 6 or 30 ohms.

Retail Price 4/-

Sole Manufacturers:

H. CLOUGH & Co.  
(Bacup) Ltd.,  
Yorkshire St. Mills,  
BACUP.

WATCH OUR ADVERTS  
FOR FURTHER  
QUICK SELLERS.



Your Customers know a good coil, and the

“DIAMOND SUNFLOWER”

INDUCTANCE COIL

will satisfy them because it is the neatest, cheapest and most efficient coil produced.

Fitted with Standard Plug and Swivel mounted for wider range of positions.

District Agents:—

WELLWORTH WIRELESS CO.,  
8, Withy Grove, Manchester.

WHO SUPPLY ALL COMPONENTS. PRICES RIGHT.  
PROMPT DELIVERY.

“THE LEYWAY MULTIPHONE”

Instantly connects up to twelve pairs of Headphones without any special Tags or Terminals.

STANDARD HEADPHONE PINS AND FLAT TAGS PLUG INTO OUR SPECIAL SILVER-PLATED SPIRAL SPRING CONTACT.

Best P.O. quality, Ebonite top with handsome polished wood base.



PRICE

STANDARD SIZE  
(to take 6 pairs of 'phones)

2/9

LARGE SIZE  
(to take 12 pairs of 'phones)

4/6

SUBJECT

ELECTRIC MACHINERY CO.,  
(Dept. M.), ANCOATS, MANCHESTER.  
Trade Enquiries Solicited.

WHEN REPLYING TO ADVERTISEMENTS PLEASE MENTION “THE BROADCASTER.”

# BULLPHONE

## Nightingale

*The World - Famous  
Super Loud - Speaker*



### MODEL DE LUXE

21 in. High, 14 in. Bell.

Black Bell, Polished Arm

£2 : 17 : 6

In Japanese Art Lacquer

£3 : 17 : 6

*Send for Sample*

**W. BULLEN,**  
38, HOLYWELL LANE,  
LONDON, E.C.2.

'Phone : CENTRAL 2163.



### CONCERT GRAND

26 in. High, 14 in. Bell.

For Large Halls and Outdoor Use.

In Oxidised Copper £3:3:0

In Japanese Art Lacquer £4:5:0

.....  
" We can certainly say that the ' Bullphone ' Concert Grand Loud-Speaker, both on low and high power, gave splendid results, and considering the attractive appearance and moderate cost we should imagine this instrument has an excellent future before it."

The above is an extract from the report of a test on the " Bullphone " Concert Grand Loud-Speaker carried out by the " Broadcaster " Technical Department. Read the full report on pages 163 and 164 of the March issue.

# ENORMOUS POSSIBILITIES EXIST FOR THE CRYSTAL SET...

COPY  
The Cottage, Bradshaw,  
Nr. Bolton,  
Lancs,  
February 15, 1925.  
Messrs. Tungstalite, Ltd.  
Dear Sirs,  
I enclose results with Gold Label Tungstalite of last Sunday between 6.30 and 8 p.m. I then received Manchester so loud that phones could be heard about 3 feet away. I also received Cardiff (160 miles away) as well as several Continental stations. These results were received on the crystal alone, the Gold Label Crystal being excellent.  
Yours faithfully,  
C. S. PRINCE.

as these  
bona-fide  
reports  
conclusively  
prove.

COPY  
RECOVERY, AGENT,  
68, Railway Street,  
Nelson.  
January 15th, 1925.  
Messrs. Tungstalite Ltd.  
Sirs,  
May I testify amongst other amateurs to the success of Tungstalite Blue Label. On a crystal set costing but 2/6 I get Bournemouth (220 miles) and Newcastle regularly (100 miles). They are distinct and clear, every word distinguishable. Wishing you every success.  
I am,  
Yours truly,  
ARTHUR BARRETT.  
P.S. The above is on two pairs of phones.

And any expert will tell you that the first and essential condition of success is the use of a *SYNTHETIC* crystal.

The Only guaranteed *SYNTHETIC* crystal is

# TUNGSTALITE

Regd. No. 447149

TUNGSTALITE will make all the difference to your trade—see that you stock it to-day.

**BLUE  
LABEL**

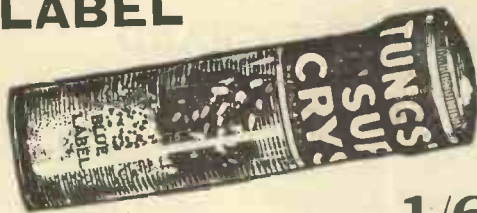

1/6

**GOLD  
LABEL**



2/-

OBTAINABLE FROM

# TUNGSTALITE LTD.,

LONDON & PROVINCES

47, Farringdon Road, London, E.C.1

'Phone: Holborn 2557.

'Grams: Tungslamp, Smith, London.



YORKSHIRE:

41, CALL LANE, LEEDS

'Grams: Tungslamp, Leeds.

'Phone: 21375 Leeds.

WHEN REPLYING TO ADVERTISEMENTS PLEASE MENTION "THE BROADCASTER."

Editorial and Business Offices:  
93, Long Acre, W.C.2  
All  
Advertisement Communications  
to  
The Advertisement Manager,  
The Broadcaster and  
Wireless Retailer,  
93, Long Acre, W.C.2  
Telephone:  
Gerrard 9870 (15 lines).  
Telegrams:  
"Southernwood, Rand,  
London."

# The Broadcaster and WIRELESS RETAILER

APRIL, 1925.  
VOL. VI. No. 33.  
PRICE ONE SHILLING.  
Subscription Rates:  
12 months: 7/6 post free.  
6 months: 4/- post free.  
TO THE TRADE ONLY.  
Branch Offices:  
4, Corporation St., Manchester  
115, Renfield St., Glasgow.  
Published First of each  
month.

## Contents

### Advertisements

	Page		Page		Page
Abro Motors	96	Cliff & Cockle	108	Crystalate Mfg. Co.	20
Accumulators (Birmingham)	25	Clough & Co.	112	Curtis, P., Ltd.	51
Acme Productions	48	Collett, S. H.	34	Davies	6
Ambatiello Bros.	73	Coranto	64	Dew, A. J.	99
Antivibradio	26	Corston Sinclair	186	Dewar	186
Ashlo Mfg. Co.	66			Dixon, L.	108
Ashton	108			Dubilier Condenser Co.	43
Associated Wireless	82			Dyson, J.	2
Athol Engineering Co.	109			Eastern Wireless	111
Automobile Accessories	46			Ecco Battery	30
Autoveyors	69			Ecco Radio	133
B. D. S.	20			Economic Electric Co.	15
Beard & Fitch	86			Efandem Co.	95
Bedford Electrical Co.	103			Ego	93
Behm	110			Electric Machinery Co.	112
Betterways	52			Ellis & Sons	69
Bird	28			Energo Products	Second Cover
Birkbys	131			Enterprise Machine	70
Birmingham Products	28			Ever-Ready	95
Black, Michael	186			Falk, Stadelmann & Co.	112
Bobin, M.	100			Fellows	53
Box 113	109			Formo Co.	88
Box 114	108			Foth Optical Co.	84
Brahams	50			Fraser & Glass	82
Brandes	Front Cover			Fullers	97
Brewin	85			G. E. C.	66
Britain's Best Crystal	65			Garnetts & Whiteleys	105
British Central Electrical Co.	102			Garnetts	107
British Electrical Sales Organisation	91			Gent & Co., Ltd.	50
British Radio Instrument Mfg. Co.	100			Gil-Ray	87
Britannia Rubber	64			Goodchild & Partners	88
Brown, S. G.	19			Goswell Engineering Co.	56
Bulgin	52			Graham, Alfred	33
Bullen, W.	113			Graham & Thompson	112
Burlington Wireless	96			Green & Co.	78
Burwood	4			Green, S. G.	108
Busby	56			H. T. C. Electrical	54
Butler	108			Hayward	6
Campart	22			Henderson	30
Cann, J. Churly, Ltd.	40			Hightensite	72
Capel, P.	25			Hirst, Ibbetson	66
Carpax Co.	51			Holland	111
Chase Electrical	97			Holrose Mfg. Co.	104
Charlesworth	92			Hosken	52
City Accumulator	74			Hough, J. E., Ltd.	79
City Vulcanising	108				
Clackson	87				
Clarke & Co.	22				

### Editorial.

	Page
A Crystal Controversy	141
Agency Attractions	163
Alleged Theft of Amplions	135
Around the Radio Trade	180
Brief Broadcasts	166
Burndept's New Factory	135
Current Communications	133
Current from the Mains	147
Elementary Theory	161
Exide Service Scheme	160
Have You Seen?	152
Late Trade News	144
Low-Frequency Transformers	155
More about the "Super-Het."	146
Napier-Kimber, Ltd.	142
New Patents	167
New Trade Marks	170
On the Commercial Waveband	175
Polar-Blok Adventures	159
Practical Points on the Installation of Receivers	154
Radio-Active Batteries	136
Radio Trade Showrooms Directory	136
Radio Wavelets	143
Selling Condensers	157
Selling and Demonstrating Sets	150
Spare Sparks	166
Standardisation of Ebonite	134
Tested for the Trade	137
The Manufacture of B. T. H. Valves	145
Trade Transmissions	171
Tuning-In	133
Wired Wireless	158
World-Wide Wireless	164

Editor:  
F. H. Robinson, A.M.I.R.E.

Cossor, A. C., Ltd.	10-11
Craik & Smith	104
Crowe Bros.	98

(Continued on page 130)

Contents

(Continued)

	Page		Page		Page
Houghtons .. .. .	89	Miller, J. W. .. .. .	98	Smith, J. F. .. .. .	16
Howarth .. .. .	108	Millett .. .. .	108	Smith, W. A. C. .. .. .	50
Hulme .. .. .	108	Moores .. .. .	14	Sophos Radio .. .. .	109
Hunt, A. H., Ltd. .. .. .	82	Mullard Radio Valve Co. .. .. .	21	Sparks Radio .. .. .	112
Hunt, H. J. .. .. .	106	Multiphone Terminal .. .. .	70	Spicers .. .. .	28
				Spring Washers, Ltd. .. .. .	104
Igranic .. .. .	47	N. A. R. M. A. T. .. .. .	59	Standard Screw .. .. .	24
Imperial Motor Industries .. .. .	107	Naylor .. .. .	64	Star Crystal .. .. .	62
International Wireless Mfrs. .. .. .	81	Neutron .. .. .	75	Sterling .. .. .	41
		New London Electron .. .. .	9	Stevens, A. J. .. .. .	176
J. W. B. Wireless .. .. .	92	Newton .. .. .	105	St. Helen's Rubber .. .. .	85
Jackson .. .. .	109	Nichol, J. O., & Co. .. .. .	109	Stirling .. .. .	14
Jones, S. .. .. .	5	Nutts .. .. .	86	Sunlight Mfg. Co. .. .. .	95
Joseph, H. .. .. .	96, 104			Superlamp .. .. .	36
Joyce, T. & H. .. .. .	Third Cover	Omniaphones .. .. .	46	Sylvex .. .. .	29
Joseph, Maxwell .. .. .	4	Orgel .. .. .	66		
		Ormond .. .. .	17	T. E. C. Supply Co. .. .. .	109
Kay & Tee .. .. .	60	Orr Bros. .. .. .	78	T. M. C. .. .. .	27
Keith & Irwin .. .. .	186	Oyler & Co. .. .. .	110	Tees Radio .. .. .	102
Kellys .. .. .	107			Telsen Electrical Co. .. .. .	96
Kirby Johnson .. .. .	186	P. & C. .. .. .	58	Three Star Accumulator .. .. .	4
Klein Bros. .. .. .	76	Pass, V. V. .. .. .	28	Tungstalite .. .. .	39, 128
Kniveton Electric Wire Co., Ltd. .. .. .	18	Permion Detector .. .. .	100	Turnock .. .. .	60
Kremner, L. .. .. .	98	Phillipson .. .. .	82		
		Platinite Crystal Co. .. .. .	8	U. S. Radio .. .. .	90
Lamplugh .. .. .	90	Pomona Rubber Co. .. .. .	90		
Langham Electrical Supplies .. .. .	103	Portable Utilities .. .. .	7	Valve Renewal .. .. .	54
Lanite Laboratories .. .. .	96	Postage Saving Coupon .. .. .	80	Vandervell, C. A. .. .. .	90
Lewtas, H. & G. O. .. .. .	63	Power Equipment Co. .. .. .	60	Vernilor Condensers .. .. .	86
Lighting Supplies .. .. .	82	Premier Batteries .. .. .	34	Victoria Electrical .. .. .	84
Lilley .. .. .	8	Pressland Electric Supplies .. .. .	23		
Lisenin Wireless .. .. .	3			Wadsworth .. .. .	68
Lissen, Ltd. .. .. .	Back Cover	R. I. .. .. .	35	Ward & Goldstone .. .. .	55
London Electric Stores .. .. .	52	Radio Equipment Co. .. .. .	94	Wates Bros. .. .. .	59
London Electric Wire & Smith's, Ltd. .. .. .	83	Radios .. .. .	57	Watmel Wireless .. .. .	109
London & Provincial .. .. .	61	Radio Stocks .. .. .	67	Watson Jones .. .. .	100
Louden Valves .. .. .	49	Ravox .. .. .	62	Wellworth .. .. .	112
Lowenadler .. .. .	37	Richmond Electric Co. .. .. .	72	Wholesale Fittings .. .. .	72
Lowke & Sons .. .. .	32	Ridley .. .. .	26	Wholesale Wireless .. .. .	31
Maddison .. .. .	109	Rothermel .. .. .	12-13	Wilkins & Wright .. .. .	22
Maisner .. .. .	69	Russell & Shaw .. .. .	46	Wilkinsons .. .. .	106
Manchester Radio .. .. .	26	Russell, L. G. .. .. .	48, 60	Wilson, F. E. .. .. .	106
Marconiphone .. .. .	101	S. D. H. Mfg. Co. .. .. .	42, 44, 45	Wineberg .. .. .	77
Master Radio Mfg. Co. .. .. .	102	Schlerine .. .. .	16	Wireless Valves .. .. .	26
McLeod & McLeod .. .. .	8	Seagull, Ltd. .. .. .	99	World's Wireless Stores .. .. .	86
McMichael, L. .. .. .	103	Sel-Ezi .. .. .	8	Wormald .. .. .	50
Metro-Vickers .. .. .	1	Service Radio Co. .. .. .	71	Wright, A. J. .. .. .	26
Microhm .. .. .	98	Shenton .. .. .	56		
Middleton .. .. .	68	Shipton .. .. .	83	Yeates, Ltd. .. .. .	109
Midland Counties Radio .. .. .	85	Skett & Co. .. .. .	111	Zealander .. .. .	32

Advertisement Manager: Gilbert R. Stevens.

**"The Broadcaster"**  
**Radio Trade Showrooms**  
**The MECCA**  
**of the Radio Trade**  
**Bush House, Aldwych, Strand, London, W.C.2.**

Tel. City 5587.

Pay a visit to the Showrooms and obtain increased business under ideal conditions.



*British - made and guaranteed*

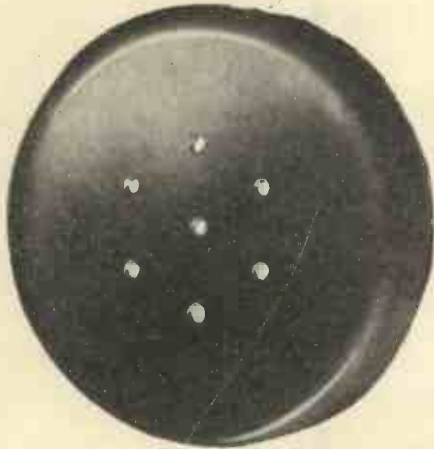

**'ELO' for all wireless mouldings**

"ELO" is supplied as Finished Mouldings accurately made to any shape for all Electrical work. It is also supplied in the form of Moulding Powders, Resin or Insulating Varnish, all of which possess the valuable "ELO" characteristics.

**The danger of Foreign made earpieces**

We have seen imported moulded earcaps which, if held to the ear for 10 minutes, actually softened and left pieces sticking to the ear. As the headphones are usually worn for hours on end, the risk of imparting diseases to the ear through the use of cheap mouldings is one that no responsible manufacturer would care to take.

In suggesting "ELO" for earpieces we are prepared to offer definite and unqualified guarantees that "ELO" contains nothing that is harmful to the human skin. "ELO" has no softening point. It can be brought into contact with boiling water and will emerge with its original hardness and polish unimpaired.

The principal telephone and headphone manufacturers use "ELO" with perfect success. Let us quote and submit samples for your requirements.



*for dielectric strength*

*The benefit of years of research and experiment is at your service. We invite you to submit your problems.*

**BIRKBYS LIVERSEDGE YORKSHIRE**

# SEE HERE !! HELP

your customers to obtain perfect reception

- A Fits all standard detector arms.
- B Self-contained spring.
- C Very fine needle point.

Cannot shake off or lose contact. Specially suitable for Reflex.

Neatly packed in glass tubes and boxed in dozens. Retail Price, 6d., less 33½ per cent.

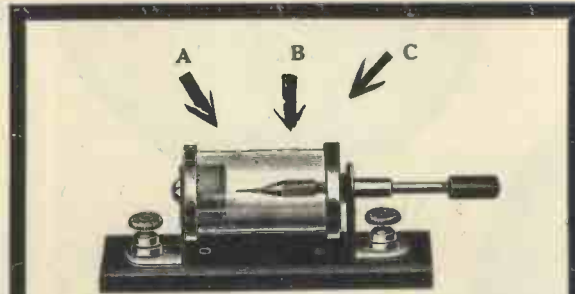

**"RECEPTO" Catswhisker**  
Known as the "WASP."



*Every piece tested and if faulty will be exchanged.*

These are actual labels on glass tube

**"RECEPTO" Reliable Crystal**

Neatly packed in glass tubes and boxed in dozens. Retail Price, 1/3, less 50 per cent.

Nickel-plated terminals. Recessed groove for winding. Close coupling. All ebonite knob and dial. Retail Price, 5/6, less 33½ per cent., including knob and dial.

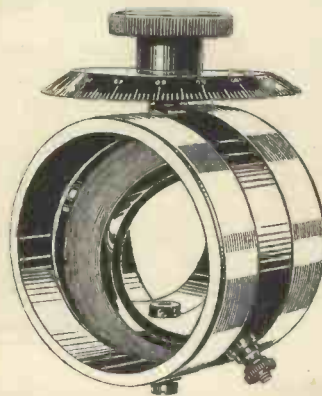

## THESE THREE LINES WILL DO IT.

Factors can obtain these lines and full particulars, terms, etc., only from

# ECCO RADIO LTD.

Ecco House, Princess Street, St. John's Wood, N.W.8.

ECCORADLIM PADD. LONDON.

PADDINGTON 6735.

WHEN REPLYING TO ADVERTISEMENTS PLEASE MENTION "THE BROADCASTER."

# Tuning In

**I**N view of the approaching holiday season and the fact that a large number of British people take annual vacation in Switzerland, the following information relating to licence conditions for foreigners in Switzerland, which we recently received from the Commercial Attaché at the Swiss Legation in London, may be of interest to dealers.

It is stated that travellers who wish to use wireless receiving apparatus in Switzerland must lodge an application at the "Direction Generale des Telegraphes et des Telephones" at Berne. This application should embody the (a) name and surname of the applicant; (b) address; (c) date of birth; (d) nationality; (e) date of arrival in Switzerland; (f) date of intended departure; and, if possible, (g) probable route and places of residence in Switzerland.

**A Foreign Item.** The Scandinavian-Baltic Fair, which will be held at Stockholm between June 14 and 21, will include a special radio section. The countries exhibiting at this fair include Sweden, Norway, Denmark, Finland, Estonia, Latvia, Lithuania and Poland.

There is considerable interest in broadcasting at present in several of these countries, and the fair affords the British manufacturer an admirable opportunity of displaying his products and attracting buyers.

**W. J. CHARLESWORTH**, the manufacturer of the "Tapa" plug and socket, tells us that, owing to the fact that a number of wholesalers have been supplying plugs and sockets other than "Tapa" make when these were demanded, he has decided to mark each plug with his trade mark.

**"Tapa" Plugs.** These were demanded, he has decided to mark each plug with his trade mark.

**TRADE** abuses are unfortunately very prevalent at the present time, and everyone, therefore, will welcome the news that the N.A.R.M.A.T. is now engaged in the compilation of a register of the retail trade. All wireless dealers who wish to be included in this register should send their names at once to the Secretary of the N.A.R.M.A.T., Astor House, Aldwych, W.C.2, marking the envelope "Trade Register."

We are officially informed that when full investigation has taken place these firms will be classified, and possibly a list of recognised dealers may be compiled, who alone will be entitled to trade terms from the N.A.R.M.A.T. manufacturers and wholesalers.

It should be understood that registration is entirely free, entailing no obligation on the firm registering.

**O**N page 154 of our March issue we published an illustration of a Mullard type D.3 valve, but the caption described the illustration as representing a Marconi-Osram D.3. We very much regret this error, and trust that no serious inconvenience has been experienced by either the Mullard Radio Valve Co. or the Marconiphone Co.

**An Apology.** We very much regret this error, and trust that no serious inconvenience has been experienced by either the Mullard Radio Valve Co. or the Marconiphone Co.

**THE** majority of dealers are aware that during the past two or three years the Amplion loud-speaker has experienced many changes — changes which have in some cases affected its outward appearance, especially in the introduction of the wooden horn.

**An Amplion Item** Alfred Graham and Co. inform us that many wireless dealers are still reproducing these original models in their catalogues and publicity matter, and ask us to inform all traders that old blocks illustrating Amplion models will willingly be exchanged for modern illustrations upon request.

**Carr and Childe, Ltd.**  
To the Editor,  
THE BROADCASTER AND WIRELESS RETAILER.  
DEAR SIR,—The report of the proceedings of a meeting of creditors of Alfred Alan Carr and Geoffrey Slade Childe, held at the London Bankruptcy Court on the 2nd inst. and reported in a great many daily papers, has caused numerous inquiries to be made regarding the standing of this company.

Neither of the above-mentioned has any connection with this company as directors, shareholders or in any other capacity whatever, the directors being Mr. C. J. Page and myself.

In view of the publicity which naturally attaches to bankruptcy proceedings, we shall be greatly obliged if you will publish that these proceedings do not in any way affect the company of Carr and Childe. Ltd., 10, Mill Hill, Leeds.—Yours faithfully,  
pp. CARR AND CHILDE, LTD.,  
(Signed) EDWARD A. BRAITHWAITE,  
Director.

10, Mill Hill, Leeds.  
March 9, 1925

**Improvement of Summer Trade.**  
To the Editor,  
THE BROADCASTER AND WIRELESS RETAILER.  
DEAR SIR,—As this is a matter of interest to the Traders as a whole, we venture to put forward a few possible suggestions to remedy the abnormal slump during the summer months.

1. That the B.B.C. should arrange to broadcast on a special wave-length all items of interest relating to sports, i.e., an International match at Wimbledon should be broadcast in detail by means of a land line, and similarly, details of special cricket matches, etc.
2. That the B.B.C. should, by similar arrangements (as in 1), broadcast in detail such horse races as the Derby and leading events at Ascot and Goodwood, etc.
3. That in the mornings the B.B.C. might use the special wave-length above referred to for the broadcasting of Stock Exchange prices.

**MR. W. A. HUNT**, Hon. Secretary of the Wholesalers' Section of the N.A.R.M.A.T., informs us that the monthly meeting of the London and Home Counties Division of the N.A.R.M.A.T. Wholesalers' Section will be held at Astor House, Kingsway, W.C.2, on April 21, at 2.30 p.m.

We hope to be able to publish notices of future meetings of this section in further issues of THE BROADCASTER AND WIRELESS RETAILER.

**THIS** month's issue of the WIRELESS RETAILER contains full particulars of a "Certificate of Membership" which is being issued by the Wireless Retailers' Association. The scheme is undoubtedly a praiseworthy one and should appeal to every bona fide dealer.

Every member of the Association has to sign an agreement that binds him to certain obligations, and the certificate is issued to an individual, not a company, and that individual therefore becomes responsible for the fulfilment of the conditions of membership.

## Current Communications

No one will dispute the fact that the British public is a keen follower of sports, and we think we are right when we say that the above suggestions would create fresh enthusiasm.

Whilst we appreciate the fact that the daily Press may try to raise objections on the grounds that if carried out their sales would be affected, we are of the opinion that it would actually increase their sales, bearing in mind that the average Britisher likes to see things in black and white.

The R.B.C. can either make or mar the Trade, and whilst we are grateful for their past efforts, we look to them to show a little more enterprise and initiative in the future, and in this way help to make the Trade steadier throughout the year.—We are, yours faithfully,

pp. THE AKU COMPANY,  
(Signed) C. CROOM-JOHNSON.  
33, Orchard Street, W.1.  
February 24, 1925.

# Standardisation of Ebonite

*A consideration of the needs of the market for ebonite amongst wireless traders.*

**W**E believe we are perfectly correct in stating that throughout the period during which ebonite has been manufactured, there has never been, at any rate as far as this country is concerned, such a demand for it as has been the case during recent years, when so much has been and is still being used in connection with wireless work. Now, with the possibility of a continued good demand for some long time to come, the question must have arisen in the minds of many as to whether the quality of the ebonite that is being built into the receiving sets which they are making is what is best suited to the purpose for which it is intended, and also whether it can be relied upon to be consistently regular in all essential details. This naturally at once raises the important subject of standardisation, or, at least, the possibility of arriving at a definite standard for quality which can be relied upon as being obtainable in the open market, that is, without having to depend upon any particular source of supply for a given standard of quality.

Arising out of this is another point, and that is, what is to be looked upon as being a suitable standard, having special regard to the question of sheet and panels.

There are on the market to-day many qualities which are being used for this work all more or less with certain necessary properties; but has not the time arrived when some definite line should be adopted as the division between what is acceptable and what must be at once rejected?

It is proposed to deal briefly with the subject in this article, with the object of assisting in arriving at something which, whilst having all the necessary properties, and, of course, with a reasonable margin of safety, will, at the same time, be a marketable proposition from the point of view of price.

There are several points to consider in dealing with this important subject, not the least of which is the one already mentioned, which, obviously, must have a very definite effect on the prices at which sets are to be sold, for ebonite plays a somewhat conspicuous part in the makeup of sets of any size, and in this connection it must be remembered that the price of raw rubber seems to be now, as it has been for some time past, almost a fixed one at about 1s. 6d. per lb., which is a considerable increase on what it was a few months ago.

So that, if the quality of ebonite employed is a good one, the comparatively high price of raw rubber will mean that the prices of the parts used will have a tendency to increase to a greater extent than in cases where cheaper qualities are employed.

This would, of course, affect ebonite sheet and panels more than anything else, as the amount of material used, as compared with the labour expended, in their manufacture is much heavier than in the case of moulded goods such as knobs, dials and other similarly small articles. In fact it may almost be taken for granted

that sheet and panels, and perhaps rods and tubes, would be the only items to be affected, and throughout this article it is these that are in mind.

During the few years that wireless receiving sets have been in use in this country, a good many grades of ebonite have been offered by the various firms who cater for this class of business, some, at the start in particular, being anything but suitable for the purpose for which it was required, whilst other materials have, perhaps, erred on the side of being unnecessarily good.

Having now arrived at the point when the wireless business can be looked upon as an important industry, it must, of course, be assumed that the efforts of manufacturers of ebonite are set in the direction of supplying the best possible material at the lowest possible prices, so that quality and prices are inseparably linked together, and it follows that manufacturers who can offer a suitable quality at the cheapest price and give reasonably quick delivery, are going a long way towards securing a big share of the business, as they will establish confidence amongst their customers.

Seeing that it is an accepted fact that ebonite is the best insulator that can be used, and remembering that the high grades of this material have an insulation resistance of about 80,000 volts per m/m or even more, it will easily be seen that a quality of this nature is totally unnecessary, and that something of a considerably lower order will meet the case, but it has to be borne in mind all the way through that whatever quality is decided upon will have to be one which is suitable for drilling, tapping, etc.

## Post Office Grades.

**A**MONGST the qualities being used for panels for radio work are some which conform to Post Office specifications "B" and "C," and tests have been carried out on samples of these materials with the object of discovering whether the latter is good enough for the purpose.

It is obvious from the composition of the two qualities and the various tests which they have to pass that the "B" quality must be of a better grade than "C," but bearing in mind the conditions under which the material is used, it seems reasonable to conclude that the latter will meet all the conditions required in a general way, and leave a sufficient margin to ensure the efficient functioning of the sets should small particles of dust or grit by some mischance have become incorporated in the material.

Having arrived at the conclusion as the result of tests made that Post Office "C" quality will meet the requirements, let us consider a few of the points in connection with this material which will be of general interest, and which recommend themselves as being sufficient evidence to warrant Post Office "C" quality being considered amply good for radio work.

Post Office "C" quality ebonite is made from rubber and sulphur and has to be free from inorganic loading material; it

must also be suitable for drilling and tapping satisfactorily. It has also to conform to specific cantilever test conditions and not be more than 1.22 S.G. Taking into consideration the specific gravity of the material, it will be seen that this quality must needs be of a fairly good mixture, so that heavy loading materials are excluded, and the composition of the ebonite must be such as to ensure good electrical results.

## Test Results.

**S**OME samples of this quality which have recently been tested gave an average breakdown of 40,000 volts per millimetre, so if a panel of, say, 3-16 in. thickness be taken as an example, it would need something between 180,000 and 190,000 volts to puncture the ebonite! The average tensile strength of samples of this quality worked out at over 6,000 lb. per square inch, which seems to be strong enough for any work which ebonite in sheet or panel form is called upon to stand on receiving sets.

Can it even be supposed that ebonite with a higher breakdown voltage and of greater tensile strength than is revealed by these figures is necessary? Freedom from surface leakage is, of course, a most important factor, and in this respect Post Office "C" quality with matt surfaces gives results which are highly satisfactory.

As has already been stated, there certainly should be a standard which allows a good margin of safety, and we are of the opinion that the results of the tests which have been mentioned show that the quality we have discussed possesses this.

Having put the case regarding "C" quality ebonite forward in this way there is another point which might be mentioned by way of suggestion, and that is, that buyers of large quantities of ebonite are very discriminating in their choice, and we put forward the suggestion that if a quality better than Post Office "C" can be offered at reasonably low prices—for example, something approaching Post Office "B" specification—at prices in the neighbourhood of those which would be charged for "C" quality, a large number of buyers would be prepared to pay two or three pence per lb. more so as to secure the better article, even though, from the point of view of necessity, a superior quality may not be required.

There is one more point for consideration and that is the finish of the surface.

If a polished finish is required Post Office "C" quality will not give such a brilliant black as a better quality, say, Post Office "B," but for matt surfaced panels it is eminently satisfactory. As, however, the majority of sheet and panels supplied have matt surfaces, it will be obvious that "C" quality again will meet the case, and this seems to strengthen the proposition that "C" quality could be adopted as standard in a general way if the price of "B" quality or some other similarly better grade cannot be brought sufficiently low to warrant its being taken up by wireless receiving set manufacturers.

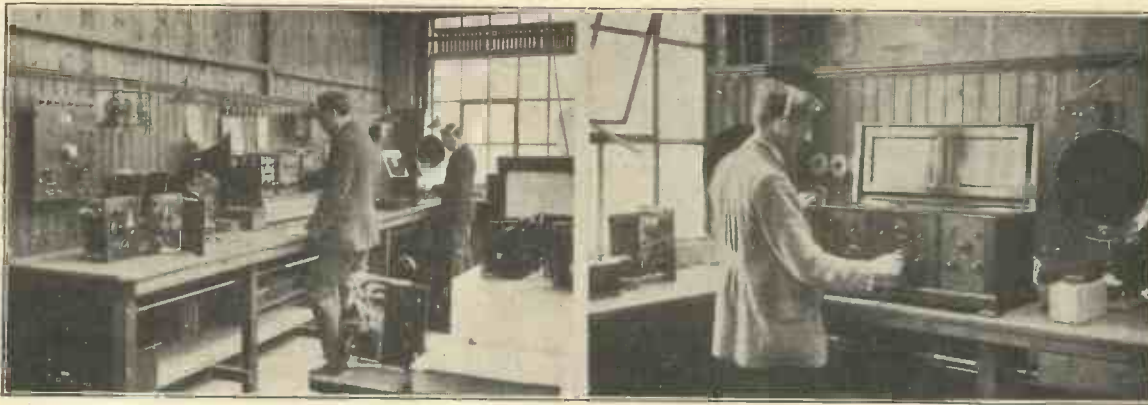

Two views of the test room showing, on the left, various Burndepts sets being tested, and on the right, an Ethophone Grand on its trial.

## Burndepts' New Factory

**W**E were recently afforded facilities for visiting the new section of Burndepts' factory at Aerial Works, Blackheath. The new building has been planned along modern lines with special regard to lighting and general working conditions for the employees.

It is being erected on the site of the original works and the work is being carried out by degrees so that up to the present a large amount of the work entailed in the manufacture of Burndepts apparatus is still done in the old building.

Our previous visit to the works was some twelve or eighteen months ago, and we found that astonishing alterations have taken place. The machine shop, for instance, contains more machinery, whilst it has been enlarged considerably.

The assembly shop is now installed in the new part of the works, thus allowing a greater volume of work to be handled. In this section the gradual assembly of complete receivers is carried out by allotting to each employee a certain definite piece of work, as, for instance, the fixing of variable condensers or some other component to each panel.

The panel is then passed to the next mechanic, who adds a little more to it. Thus, by the time the panel has travelled completely around the shop it is wired and assembled and ready for testing.

We were particularly interested in some models of the "Ethophone Grand" which were in course of construction and were able to inspect closely the details of this "Rolls-Royce of Radio."

One very interesting point is clearly seen in our photograph. That is the fact that all low potential leads are of rubber-covered wire, "cabled" together and bound with tape. These "cables" are known as "crocodiles" and are prepared on a special board using wires of various colours which are bent round pins and each cut to a pre-determined length.

A very interesting part of the new building is the test room, the importance of which will be understood when the testing process which Burndepts utilise is explained.

In the first place all components such as transformers and variable condensers are tested separately. Secondly, when the panel or panels of each receiver is finished, the instrument is tested on an actual aerial, and then the last test is applied when the receiver is complete and enclosed in its cabinet. For each com-

ponent and process, special testing apparatus is designed and made in the Burndepts Research Department, and as



The new assembly shop.

far as possible personal judgment is not required, as visual indications by means of

instruments show whether the desired result is being obtained.

The new test room, therefore, has been designed with an eye to the rapid, but none the less thorough, examination of every type of wireless instrument made by Burndepts. Our two top photographs show, on the left, the testing of various receivers, including an "Ethophone V" in the background, and on the right an examination of an "Ethophone Grand."

The "Ethophone Grand" has already been described in THE BROADCASTER AND WIRELESS RETAILER, but we would call our readers' attention to the fact that the set includes two power stages and has very fine but not elaborate tuning controls.

It is intended to extend further the new buildings at Aerial Works until gradually the old building will disappear and will be replaced by an up-to-date and modern factory that will enable Burndepts to increase their already large production.

## Alleged Theft of Amplions

**A**T Greenwich Police Court recently, William Thear Inglis (32), order clerk, 1, Richmond Terrace, Clapham, was charged, on remand, with stealing 207 wireless loud-speakers, the property of his employers, Messrs. Alfred Graham and Co., St. Andrew's Works, Crofton Park; Henry Norman Westgate (28), wireless engineer, 81a, Haverhill Road, Balham, was charged, on remand, with receiving the loud-speakers, which were valued at £640.

Mr. H. C. Scard, prosecuting, said that since the arrest of Inglis, it had been found that 207 loud-speakers had been stolen, and the charge of stealing 138 against Inglis had been altered. Inglis was an order entry clerk in the firm's employ, and entered details in duplicate in one book, and in duplicate in a dispatch notebook. No entries appeared in the order entry book as to those 207 loud-speakers, and Inglis must have got hold of some old order slips and then intercepted them on their return to the office; otherwise they would have been found entered in the dispatch notebook. Inglis was away ill, and certain goods were sent to a Mr. West at Balham. That was Westgate's address, and the firm communicated with him. Apparently he became frightened, and sent the six instruments back. Evidence would be given that articles were sent to the different addresses, and that Westgate went to these houses, told the occupants that goods were being sent to a wrong address,

and waited until the carrier came with them. Inglis had said that Westgate had bought the goods from him at a third or a quarter their value.

Ernest Coleman, of 103, Ardoch Road, Catford, manager for Messrs. Graham, said Inglis' duty was to enter approved orders in the entry books and to send the works order slip to the works. Certain slips produced, found by the police, should not have left the firm's works. Three slips showed the supply of goods, but did not correspond with any entries in the firm's books. He found one order for "West" entered in the dispatch notebook, but it was not in the order entry book. The slip for this order was found by him when Inglis was taken ill.

The six loud-speakers mentioned on this slip were subsequently returned. The value of the 207 loud-speakers was about £640. Having gone through the stock, it had been found that over 200 loud-speakers were missing. The utmost discount to retailers would be 25 per cent., with a cash discount of 3½ per cent., and payment in seven days. A greater discount was allowed to recognised wholesalers only. Mr. "West" would not be entitled to any discount at all, and only in two out of the 19 cases would any discount be allowed. In the case of "West," the invoice was incorrectly made out.

Prisoners were again remanded, bail being fixed at two sureties in £100 each.

# Radio-Active Batteries

## BIRMINGHAM SCIENTIST'S DISCOVERY

**I**N the December issue of THE BROADCASTER a description was given of the discovery by a Birmingham scientist, Professor J. B. Kramer, of a new generative source of electricity which it was suggested was fraught with interesting possibilities for the future of wireless. By the extremely simple method of packing radio-active material between plates of carbon and zinc a current was obtained; the carbon plates attracting the positive and the zinc the negative electrons, which are propelled from the constituent atoms in radio-active material at prodigious speeds. The battery made in this way may be regarded as a self-charging condenser, continually generating current without the aid of any chemical or dynamic stimulus, as is necessary in the methods at present commonly used for producing electricity.

The material which Mr. Kramer has used in most of his experiments has been the monazite sand which exists in immense quantities in various parts of the world.

Since December the experiments have been continued, with extremely interesting results which demonstrate the likelihood of a great commercial value in Professor Kramer's discovery. In the preliminary demonstrations he lit a small lamp from this newly-found source of power, and worked a model engine. Since then the

size of the batteries has been enlarged and a sufficient current generated to supply the plate voltage to a two-valve receiving set. The battery has been in steady use for several months, and it has yielded an extremely smooth and even current, quite free from annoying fluctuations and voltage drops. What is more, the current has been perfectly silent, a fact attributable to the absence of any internal disintegration in the batteries, which is caused in the usual cell by chemical action between the paste and the metal.

But the most remarkable feature, as previously indicated, is the fact that Mr. Kramer's battery will retain its activity undiminished for many scores of years. Scientists know that radio-active materials retain their activity for a very long time; in the case of monazite sand the average period is something like two thousand years. All this time the electron emission is going on, the electrons being whirled off at enormous speeds. To collect them and harness their energy seems better even than splitting the atom itself.

There is one point which may appear to weigh somewhat against Professor Kramer's battery, and that is its size. The battery which he has used in connection with the receiving set is 4 ft. by 3 ft., a rather hefty thing compared with the little tapped high tension battery.

But obviously, the greater bulk is more than compensated for by the advantages mentioned, and there is little doubt that if batteries can be made in this way they will be greatly welcomed by the wireless public. And as for the size, the batteries would not be so bulky as at first seems apparent: it would be a question of surface rather than bulk, and the battery could be readily stored in a convenient spot near the set and connected up by means of cable.

Brief announcements of the discovery have appeared in some of the London daily papers and there is an indication of the keen interest which will be aroused when more has been made known of the discovery in the fact that Professor Kramer has already received letters of inquiry from firms in various parts of the United Kingdom, from the Continent, America, and Australia. The commercial application of the discovery, if there is to be any, is, of course, a matter for the future. For the time being the experiments are being continued with a view to proving further how easily this latent supply of electricity which exists in common minerals may be collected and made to perform useful work. Professor Kramer hopes to produce current enough to illuminate the whole of his house, in addition to working the wireless set.

L. B. P.

# RADIO TRADE SHOWROOM DIRECTORY

**The following firms are displaying their products at THE BROADCASTER Radio Trade Showrooms, Bush House, Aldwych:—**

Associated Wireless, 289a, King's Road, S.W.3.  
Aston and Mander (1917), Ltd., 63, Old Compton Street, W.1.  
Automatic Coil Winder and Electrical Equipment Co., Ltd., Wellington House, Buckingham Gate, S.W.1.  
Autoveyors, Ltd., 84, Victoria Street, S.W.1.  
Baty, E. J., 157, Dunstable Road, Luton.  
Beard and Fitch, Ltd., 34, Aylesbury Street, E.C.1.  
Belling and Lee, Ltd., Queensway Works, Ponder's End, Middlesex.  
Birkbys, Liversedge, Yorks.  
Birmingham Products, Ltd., 36, Ludgate Hill, Birmingham.  
Brewin, E. T., 51, Danbury Street, London, N.1.  
British Electrical Sales Organisation, 623, Australia House, Strand, W.C.2.  
Burwood Electrical Supplies Co. (1924), 41, Gt. Queen Street, W.C.2.  
Cann, J. C., 16-20, Farringdon Av., E.C.4.  
Charlesworth, W. J., 88, Aston Street, Birmingham.  
City Accumulator Co., 10, Rangoon Street, E.C.3.  
Diamond Wireless, Ltd., 184a, Oxford Street, W.1.  
Dubilier Condenser Co., Ltd., Duceon Works, Victoria Road, N. Acton, W.3.  
Eastern Wireless Co., 90, Three Colt Street, London, E.14.

Economic Electric, Ltd., 10, Fitzroy Square, W.1.

Enterprise Manufacturing Co., Ltd., Electric House, Grape Street, Shaftesbury Avenue, W.C.2.

Fallon Condenser Co., Ltd., White Ribbon Works, Broad Lane, N.15.

Formo Co., Crown Works, Cricklewood Lane, N.W.2.

Goswell Engineering Co., 12a, Pentonville Road, N.1.

Hall and Brennard, Ltd., London Terminal Aerodrome, Croydon, Surrey.

Hough, J. E., Ltd., Edison Bell Works, G'engall Road, S.E.15.

Jackson Bros., 8, Poland Street, Oxford Street, W.1.

Joanes, W., 42, Jenner Road, N.16.

Jones, Sydney, and Co., Ltd., 28, Endell Street, W.C.2.

Joyce, T. and H., 210b, Shaftesbury Avenue, W.C.

Lamplugh, S. A., King's Road, Tyseley, Birmingham.

Lisenin Wireless Co., Connaught House, Edgware Road, W.2.

Lighting Supplies Co., 2, Finsbury Avenue, E.C.2.

London Electric Stores, Ltd., Oxendon Street, Haymarket, S.W.1.

Lowenadler, F. W., Audrey House, Ely Place, Holborn Circus, E.C.1.

M.E.L. Ltd., 45-47, King's Road, N.W.1.  
Midland Counties Radio and Electrical Engineers, 199, Broad Street, Birmingham.  
Money, Hicks and Mills, Ltd., York Road, Wimbledon, S.W.19.

Multiphone Terminal Co., 21, Gt. Russell Street, W.C.1.

Neutron, Ltd., Sicilian House, Southampton Row, W.C.1.

Portable Utilities, Ltd., 8, Fisher Street, W.C.1.

Power Equipment Co., Ltd., Kingsbury Works, The Hyde, Hendon, N.W.9.

Radiophones, Ltd., 7, Savoy Street, Strand, W.C.2.

Radio Equipment Co., Ltd., 5, Oyer's Buildings, Holborn, E.C.1.

Radio Instruments, Ltd., 12, Hyde Street, New Oxford Street, W.1.

Re-Echo Radio Co., Ltd., 109, Marsham Street, Horseferry Road, Westminster, S.W.1.

Rooke Bros., Regent Works, Seaford Street, Gray's Inn Road, W.C.1.

Russell, L. G., 1-5, Hill Street, Birmingham.

Shenton and Co., Ltd., 68-69, Shoe Lane, E.C.4.

Smith, J. F., 94-96, Hurst Street, Birmingham.

Standard Screw Manufacturing Co., 9, Charterhouse Street, Holborn Circus, E.C.1.

Superlamp, Ltd., 92-94, Paul Street, E.C.2.

S.D.H. Manufacturing Co., 24, Stoke Newington Road, N.16.

Telephone Manufacturing Co., Ltd., Hollingsworth Works, West Dulwich, London, S.E.21.

Tungstelite, Ltd., 47, Farringdon Road, E.C.1.

U.S. Radio Co., Ltd., 155, High Street, Lewisham, S.E.13.

Wilkins and Wright, Ltd., Utility Works, Kenyon Street, Birmingham.

# Tested for the Trade

## McRee Low-Frequency Transformer

FROM the Midland Counties Radio and Electrical Engineers, of 199, Broad Street, Birmingham, we have received a specimen of a new low-frequency intervalve transformer.

Its size over all is 3 inches by 1½ inches by 1½ inches, and the iron core is fairly substantial, while the coils are mounted in an upright position. Two metal feet are provided for attachment to the panel, and circuit connections are made to four bolts, provided with nuts, mounted upon two ebonite blocks.

We would suggest that terminal heads instead of nuts for securing the wires would be a decided improvement, for nuts are rather troublesome. This is but a small matter which could easily be done without, we should imagine, increasing the cost.

The makers state the ratio to be 5 to 1, but they did not inform us whether this is the ratio of the windings or the resistance ratio. On test the resistance was found to be just 5½ to 1. The insulation between the windings and the windings and the frame was exceptionally good.

On practical trial the build-up of signal-strength compared very favourably with our standard transformer, but in the second stage of low-frequency amplification there was a slight harshness upon the upper frequencies.

Taking the results altogether, the performance of the McRee intervalve transformer was very good for an instrument of such moderate price.



The "McRee" transformer, a very neat and efficient instrument.

## Belling-Lee Indicating Terminals.

THESE indicating terminals, which are manufactured by Belling and Lee, Ltd., of Queensway Works, Ponders End, Middlesex, have become very popular during the last few months, on account of the several splendid features which are embodied in their construction.

The most important, of course, is the engraving which is carried out on each terminal head. We are informed that this is done by a special process, and it certainly gives a very neat and attractive appearance to the terminal. The engraving is worked in white on some black material securely let in the top of the terminal head.

*We welcome all commercial apparatus for test upon the understanding that the right to withhold publication is agreed to. Instruments for test should be addressed to the Technical Editor, "The Broadcaster and Wireless Retailer," 93, Long Acre, W.C.2. Although all possible care is taken with apparatus sent us for test, we cannot accept any responsibility for damage or loss.*

Another good point of these terminals is that the heads do not screw right off, thus obviating the chance of losing the head when wiring up. They are also designed with a hole in the stem to grip a 'phone tag or stiff wire.

The Belling-Lee indicating terminals are supplied both in brass and nickel-plated with standard 4 B.A. threads, complete with nut and washer, and in a wide variety of engravings.

## Croix Low-frequency Transformer.

IT is very seldom that a week or two passes without a new transformer being placed upon the market. One of the latest is the "Croix," which is made in France and marketed here by the Wholesale Wireless Co., of 103, Farringdon Road, London, E.C.

This transformer is quite a small instrument, and is entirely shrouded by a substantial metal casing. It measures only 2¼ in. by 2¼ in. over all, and it is rather unusual in appearance, but it is nevertheless quite attractive.

On each side, mounted on a strip of some insulating material, are two terminals for connections. These are of good size and well separated.

Externally the workmanship and finish are exceptionally good. The stated turns ratio is 5 to 1.

On trial, in the first stage of low-frequency amplification—following a valve detector—the results obtained were quite satisfactory, there being a good build-up of signal strength and no appreciable distortion. In direct comparison with standard instruments about three times more expensive than the "Croix," the volume obtained with the latter was very commendable considering its size.

In the second stage of low-frequency amplification the results both as regards volume and purity were not so good, and the amplification was rather more accentuated on the upper frequencies than upon the lower, and the volume was hardly comparable to a 5 to 1 transformer of expensive make.

The "Croix" low-frequency transformer is, however, an instrument of sound construction and excellent finish, and for first stage low-frequency amplification we know of no transformer that could give such good results and be sold at such a low price.

## Quality Electric Soldering Set.

WE have just received a new item from the Goswell Engineering Co., Ltd., of 12a, Pentonville Road, London, N.1, which we think will be of great interest to those traders who are on the look-out for something out of the ordinary which has good "selling points" and can be sold at a price within the reach of people of strictly moderate means.

This is the Quality Electric Soldering Set, and with this apparatus soldering can be carried out in a fraction of the time usually

taken, and with much less trouble than by the usual means employed.

The set consists of a carbon electrode mounted on a convenient wooden handle, a carbon block, a pin connector, solder, a good-sized tin of "Fluxite," and a piece of emery paper. This apparatus is worked off a 4 or 6-volt accumulator, no other heating being necessary. The carbon electrode, which takes the place of the soldering iron, is connected by the flexible lead attached to the negative terminal of the battery, and the pin connector also by a flexible lead to the positive terminal.

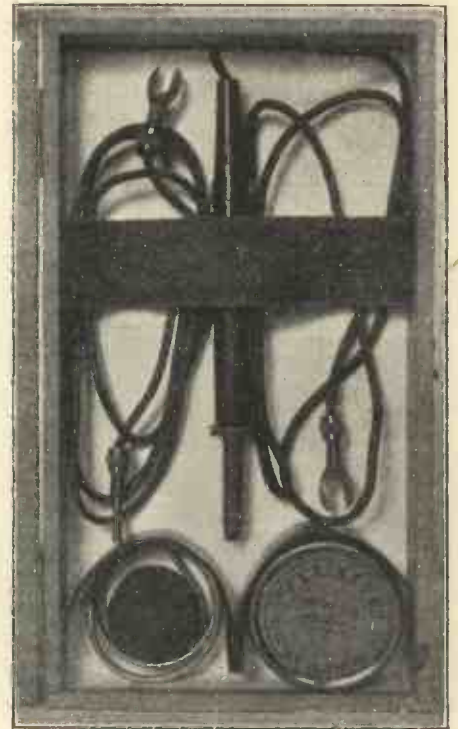

The "Quality" soldering set, a novel and inexpensive outfit marketed by the Goswell Engineering Co., Ltd.

If two wires have to be soldered, the pin connector is connected to one wire. Both wires are now held together in position, and a little "Fluxite" is applied where the two wires are to be soldered together. The solder is then held touching the wire, and the carbon electrode is allowed just to touch the solder, and a very fierce heat is produced by an arc which is thus made. A little solder is melted and allowed to fall upon the wire, and a few touches with the carbon electrode upon the connecting point of the two wires allows the solder to run, and a good joint is made. This same method can be utilised for the wide variety of soldering jobs which are called for when wiring most types of wireless instruments. This method of soldering is really much simpler than it sounds, and although it may seem strange at first, it can be easily managed after one or two trials. Each time the carbon electrode touches the metal which is connected to the pin connector an arc is caused, and this may lead people to think that the accumulator may become damaged, but the manufacturers state that they have used these sets continuously over a period of two months with a 6-volt 30-ampere accumulator, the efficiency of which has in no way become impaired.

The Quality Electric Soldering Set cer-

tainly makes for a reduction in the time, worry and trouble usually taken in soldering, and we should strongly recommend traders to get in touch with the manufacturers, who will gladly supply full particulars.

**Mar Co. Variable Condenser.**

THE most outstanding advance in the realm of wireless during the winter months has without doubt been the successful employment of the shorter wavelengths. Telephonic communication over immense distances has been accomplished using only the smallest amount of power at the transmission end with only a one or two-valve set for reception.

Although it is a fact that messages have been transmitted on a wavelength of a few metres, this must of necessity be regarded more or less as "freak," and we deal here with the wavelengths from 60 to 120 metres. When we get down to these wavelengths we have to contend with such high-frequencies that it is essential to obviate as far as possible those losses which generally occur in the usual type of receiver.



A new condenser of undoubted merit is the "Mar Co" low loss.

For general purposes the following may be taken to be the principal losses in connection with variable condensers:—

Resistance of metal surfaces (i.e., usually between spacing washers and plates and rubbing connections).

Dielectric hysteresis and other dielectric losses such as surface and bodily leakage. (This applies rather more to condensers with solid dielectric.)

Eddy-currents (produced in end plates and spindles, etc.)

Resistance of vanes (surface).

A condenser which has been constructed to obviate these losses is one sent to us for review by the Electrical Equipment and Carbon Co., of 109-111, New Oxford Street, London. W.C.1. This condenser is of American manufacture, and can be called a "low-loss" condenser in the strict sense of the term.

It will be seen by the photograph on this page that this condenser, although making use of the ordinary principle, is constructed in such a manner as to make it different in appearance to any condenser manufactured here. It will be noticed that skeleton end-plates are employed, and these are an unusual distance away from the vanes. The fixed spindles, of which there are five, are mounted as far away from the movable spindles as is practicable. A groove is cut along the movable spindle and also along one of the spindles holding the fixed vanes. Solder is dropped along these grooves, and this minimises the ohmic resistance between the plates and spacing washers. A milled metal knob is provided on the bottom end-

plate, and this controls the bush taking the spindle of the movable vanes, so that by means of this the movements can be made tighter or looser as required.

There are several other minor features in this excellent condenser; but space does not permit us to enumerate them.

On actual test the capacity was approximately .00025 M.F.D., while the minimum capacity was very low indeed.

On practical test in a straight two-valve receiver—detector and low-frequency amplification—and used on a short aerial 35 ft. in height in a suburb of London, KDKA on 63 metres came in at splendid strength. Volume was appreciably greater than when a standard condenser of the same capacity was inserted in place of the Mar Co, and we found that tuning was rather easier with the latter.

The Mar Co variable condenser is a splendid component, and the workmanship throughout could hardly be improved.

We understand the price is rather high, but nevertheless this condenser should prove popular with experimenters who want the best components and are usually willing to pay a little more to obtain them.

**Aerial Controls.**

IT is an established fact that to obtain uniform tuning of a given wavelength it is necessary, among other things, to have the aerial system free from sway.

On the short waves especially this is of the utmost importance, and we have known instances where listeners have complained of "fading" when it is really a change in the tuning due to the swaying of their aerials in the breeze.

To keep the aerial taut at all times needs attention every short while, which is probably inconvenient and a labour to which only the keenest enthusiast attends.

Two most ingenious devices for obviating aerial sway have just been brought to our notice. These are manufactured by Spring Washers, Ltd., of Zoar Street Works, Wolverhampton.

The first consists of a stout spring  $\frac{1}{2}$  in. in diameter and approximately  $4\frac{1}{2}$  in. in length, at each end of which is secured an egg-shape insulator. This is for insertion between the aerial wire and the halyard. The makers state that it is designed for use with a wire halyard, and not rope, for the extra expansion and contraction of rope needs a much larger spring.

We consider the wire halyard is more desirable than rope if only on account of its greater strength and longer life. The manufacturers also state that the aerial wire should be tightened until the spring is expanded two inches, leaving a pull of sixty pounds upon the aerial wire, and this stress keeps the aerial under control at all times.

The other control is for the lead-in wire. This is a stout wire wound in two coils forming a spring washer. One end is connected to the lead-in wire and the other to the tube entering the house.

Both these controls were inserted in one of our own aerials with marked improvement, for there was hardly any sway even in a very strong wind.

We shall expect these controls to become very popular in the near future, for their advantages can easily be seen.



Spring Washers, Ltd., have produced this new and effective aerial control.

**Microradio Rheostat and Potentiometer.**

A VARIABLE filament resistance and potentiometer, both of unusual design, have been submitted to us for test by the manufacturer, J. F. Smith, of 94, Hurst Street, Birmingham.

Both these components work on the principle of a controllable slider moving over an insulating cylinder wound with resistance wire.

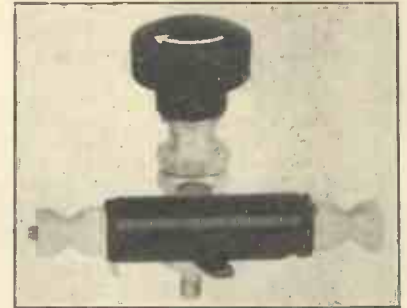

This filament resistance is by J. F. Smith, of Birmingham.

The slider takes the form of a stout oblong piece of metal, upon which is secured another piece of metal of the same shape. This arrangement enables the slider to move over the wire with a remarkably smooth action.

At each end of the slider is a good-sized terminal for connections, and, of course, on the potentiometer is a third terminal for the potential lead.

A well-made milled knob is provided with each, and suitably engraved with an arrow.

These components are very neat and compact, the size over-all of the filament rheostat being  $2\frac{1}{2}$  inches wide and  $1\frac{1}{2}$  inches in depth, and from top to bottom, including the knob, is only  $2\frac{1}{4}$  inches. The size of the potentiometer is the same, except that the cylinder is slightly wider.

On actual test the resistance of the rheostat was found to be variable from the lowest figure of 1.5 ohms to 9 ohms, and that of the potentiometer 400 ohms.

On trial in the reception of broadcasting both instruments carried out their particular work with efficiency, and their silence in operation and easy control were outstanding features.

The only criticism we have to offer is that the filament resistance is liable to be turned on too suddenly, but, of course, we always expect listeners to exercise a reasonable amount of care in lighting the filaments of expensive valves.

**"Neatson" Coils.**

SEVERAL specimens of a new type of plug-in inductance have been sent to us by John Godden and Co., of 6, Francis Street, Westminster, London, S.W., for our Test Department's report.

These coils, which are marketed under the name of "Neatson," are quite unusual in appearance, and the method of winding and the green silk-covered wire used makes them decidedly attractive.

They are wound upon ebonite "formers" approximately three inches in diameter, which are slotted upon each side, and the winding is carried out by means of this upon the inside and outside of the "former." It will be seen by the photograph on next page that this winding leaves plenty of air spacing and makes the "Neatson" coils quite out of the ordinary as far as appearances are concerned.

The four coils sent us were labelled 35, 50, 75 and 100, and they were practically



equal in inductance value to our standard type of manufactured plug-in coil, having the same number of turns respectively.

On actual test the resistance of each coil was normal, and the tuning range with a given condenser was rather wider than with our standard coils.

The measured signal strength obtained with the "Neatson" coils was equal to our own, which is rather higher than usually obtained with purchased coils. Each coil is clearly marked with its number of turns, and, as far as workmanship and finish are concerned, there could not be any improvement.



A coil of unusual design, but handsome in appearance and efficient in operation.

**"Gecophone" Tubular Earth.**

IT is surprising what a number of cases of poor reception are directly traceable to an inefficient earth.

Even when the importance of a good earth is realised it does not seem clearly understood that in times of dry weather the ohmic resistance of the earth becomes high, and, consequently, the soil must be made moist to overcome this.

A tubular earth which has been placed on the market by the General Electric Co., Ltd., of Magnet House, Kingsway, London, W.C.2, has several unique features which should recommend it as an efficient earthing device.

This is a metal tube nearly 1 ft. 9 in. in length, and has a pointed end to enable it to be easily driven into the ground. It is filled with carbon, which keeps it in a state of conductivity at all times.

Soldered to the top of the tube is a cap to which is secured a 15 ft. length of 7/22 bare copper wire, so that it can be seen that this device can be installed with very little trouble, no clamps or solder being necessary.

We found the "Gecophone" tubular earth entirely satisfactory, although, during our tests, the soil was damp from recent rains. We should imagine it would be almost as efficacious when the soil is dry, but we would rather feel inclined to recommend an occasional watering during dry weather.

**Two-way Coil Holder.**

THE Engineering and Colliery Appliances, Ltd., of Sheffield, have submitted to us for review a two-way coil-holder of standard design. This coil-holder has two plugs mounted upon a 1/4 in. ebonite base, 2 1/2 in. by 2 1/2 in., which is drilled at each corner to admit a countersunk screw for fixing.

The variable plug is mounted on two pillars, and is controlled by a 17-16 in. milled knob secured at the end of an extension arm of good length. Both plugs are made of good quality ebonite, and all metal parts are nickel-plated. Connections are made to two screws in each plug.

An attractive feature is the detachable metal plug in the fixed coil-holder, which enables the coil to be changed round without disturbing the circuit leads. We found the movements of the variable plug quite smooth and steady, and the insulation resistance of the ebonite was all that could be desired.

We are surprised that a coil-holder of this kind could be placed on the market at such a moderate price, and as this component is efficient inasmuch as it will give all that is required of a variable coil-holder, it should appeal to those who wish to stock components which are inexpensive and at the same time of good quality.

**"Eclipse" Variable Condenser.**

WE have received from the P. and C. Manufacturing Co., Ltd., of Bath Street, City Road, London, E.C.1, a variable square-law condenser which is marketed, among others, under the Trade name of "Eclipse."

This condenser is of the usual type, with movable vanes cut so as to give a square-law effect, and mounted towards one side. The vanes are well cut and accurately spaced, and the end plates are made of stout aluminium.

The one-hole method of fixing is employed, and with the condenser is supplied a well-finished ebonite dial suitably engraved from 0 to 130, and a moulded knob. The condenser is very rigid, and the movements of the variable plates can be made very smoothly, without any back-lash whatsoever.

On actual test the insulation resistance was found to be excellent, and the maximum rated capacity (.0005 M.F.D.) was substantially correct. The minimum capacity was as low as is usually expected with a condenser of this type.

The "Eclipse" variable condenser is very well finished, soundly constructed, and quite one of the best condensers in its class.

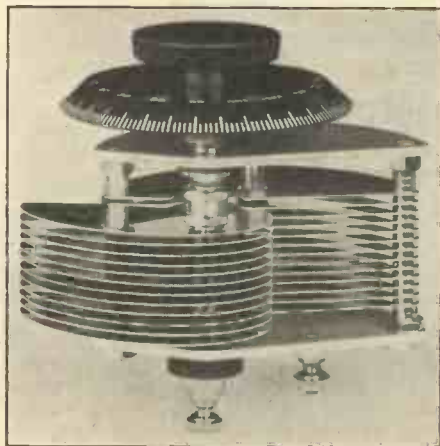

The "Eclipse" variable condenser, produced by the P. & C. Manufacturing Co., Ltd.

**"Decko" Battery Switch.**

A. F. BULGIN and Co., of 9-11, Corsitor Street, Chancery Lane, London, E.C.4, have sent us for review a battery switch which they are marketing. This switch is quite small, being only 2 in. in depth over all and just over 1 in. wide. Only one hole is needed for fixing to the panel.

Secured to a small ebonite base are two terminals for circuit connections, and attached to these are two spring arms. Upon pulling out the handle the arms are connected electrically, or for breaking the circuit the knob is pushed in.

This is quite an efficient little instrument, well made, and sold at a very reasonable price.

**G.R.C. Audioformer.**

FROM the General Radio Co., Ltd., of Radio House, 235, Regent Street, London, W.1, we have received for test a sample of their No. 83 low-frequency transformer.

This component can certainly be called good-looking, for it is enclosed in a highly polished nickel-plated circular casing 2 3/8 in. deep and approximately 1 1/2 in. in diameter. At the top and bottom are two round moulded plates, and the four terminals for connections are mounted on the top. The size over all is 3 1/4 in. deep and 2 5/8 in. in diameter.

We were pleased to observe that full particulars regarding the transformer, such as turns, ratio, etc., are clearly stamped upon the metal casing. This, we consider, is very commendable, and a detail which most manufacturers seem to overlook.

The G.R.C. transformer is apparently designed for second stage amplification or for power, for it has a low turns ratio, this being, the manufacturers state, 2.1 to 1.

On test in the second stage of low-frequency amplification, good volume was obtained with a purity equal to the best transformer we have ever heard, and without any parasitic noises, but the volume was not as great as that obtained with our standard, which has a rather higher turns ratio.

We also obtained excellent results in the first stage, and although this is a low ratio transformer there are apparently a sufficient number of turns on both windings, for the resistance of the primary was unusually high, being 1,500 ohms, with a resistance ratio of 3 to 1. The insulation resistance was found to be excellent, and the transformer, both as regards results and appearance, was very satisfactory.

The price of the G.R.C. audioformer is very moderate, and as it is an instrument of splendid capabilities, it should be a good line to stock, and will no doubt prove very popular.

**"Aristophone" Two-valve Receiver.**

A NEW two-valve receiver, in which are incorporated several clever devices, is the "Aristophone" receiver (type 147), manufactured by Messrs. C. F. Elwell, Ltd., of 138, Gordon Road, Peckham Rye, S.E.15.

We have received one of these instruments for practical test and, after an extended trial, we are able to give our report.

This receiver is of the cabinet type, with an upright panel and valves mounted behind in American fashion, all batteries being enclosed in the cabinet.

The latter, which is beautifully hand-polished, measures 14 3/4 inches by 10 inches by 8 inches, and upon each side are nickel-plated handles for moving the instrument when necessary. A hinged lid allows of easy access to the valves, batteries, etc. The panel is also polished and attractively engraved.

There are in all four controls—two for the filament lighting, one for the aerial tuning

condenser, and one for a patented method of switching, which enables three different wavebands to be covered—300 to 600 metres, 800 to 1,600 metres, and 1,400 to 2,800 metres—and this is, at the same time, the reaction control.

This method of single-control switching is, in our opinion, an outstanding feature, for the ease whereby one can change over from one waveband to another is simplicity itself, and not only is this method much simpler than using plug-in coils for aerial tuning, but with the Elwell switching method we found no noticeable trace of "dead-end" effect, which is usually the trouble with many devices utilising an inductance covering a wide range of wavelengths.



The handsome Elwell two-valve receiver. The combined wavelength changing switch and reaction control can be seen just above the name.

This two-valve receiver employs a straight circuit—detector and low-frequency amplifier—and is apparently designed to operate a loud-speaker at a reasonable distance from the broadcasting station, but we found it also received other stations over fair distances very easily.

Either one or two valves can be used at will, and this is accomplished by means of plug and jack switching. Two jacks are mounted on the panel, and the plug is attached to the headphone leads. Upon plugging into jack No. 1 the second valve is entirely cut out of the circuit, and at the same time its filament is automatically switched off. Plugging into jack No. 2 brings both valves into play and both filaments are lighted. Neither filament will light up unless the headphones are plugged in to one of the jacks.

The filament resistances in the receiver sent us were of the bright-emitter type, but we understand that dull-emitter rheostats may be fitted to order.

A commendable method is employed whereby the purchaser, however inexperienced, can easily attach the batteries.

Flexible leads are provided inside the cabinet, upon which are fixed small clearly engraved tablets indicating H.T. and L.T. leads. Grid bias for the low-frequency valve is also provided for.

We tested this instrument upon a standard P.M.G. aerial at a distance of seven miles from 2LO (Marconi House transmitter), and using 50 volts upon the detector valve and 120 volts with ample for grid bias upon the low-frequency valve, excellent loud-speaker results were obtained both as regards volume and purity. A number of other broadcasting stations, both British and Continental, were received at good headphone strength.

We were pleased at the degree of selectivity that we could obtain and with the delightfully smooth reaction control of this instrument.

5XX (29 miles) came in with splendid volume, and also Radio-Paris on 1,780 metres and Eiffel Tower on 2,600 metres.

The "Aristophone" two-valve receiver is certainly a first-class instrument, for the workmanship could hardly be improved or

the quality of the components bettered, and we have no hesitation in recommending it as an instrument combining efficiency with elegance.

**Curtis Mica Variable Condenser.**

A NEW type of variable condenser has been sent us for review by Peter Curtis, Ltd., of 75, Camden Road, London, N.W.1.

This condenser is of the mica dielectric type, with its vanes, etc., are completely enclosed by an aluminium casing.

The construction of this condenser is quite out of the ordinary. In the specimen sent us there are two pairs of fixed vanes mounted opposite each other. Between the fixed vanes are two movable ones, also mounted in opposite directions, and these are secured between two circular pieces of mica. The vanes are cut upon the Square Law principle, and two terminals mounted on insulated bushes upon the metal casing are provided for connections. The size of the body of the condenser, including terminals, is approximately 1½ inches in depth, with a diameter of 3 inches. The one-hole method of attachment to the panel is employed, and a well-finished knob and engraved dial are provided.

The metal casing is an excellent feature, for it keeps the condenser dust-proof and lessens inter-capacity effects. On test the maximum capacity was .00025, while the minimum was rather lower than usual.

We must admit that at first glance we were rather sceptical about the desirability of a condenser of this construction, but on practical trial our fears proved to be quite unfounded.

The Curtis Mica Condenser we found to be quite efficient in every way, and can certainly be recommended for general working.



The efficient Mica condenser marketed by Peter Curtis, Ltd. The metal casing is a noticeable feature.

**Six-sixty Valve.**

A DULL-EMITTER valve which is stated by the manufacturers to embody an entirely new type of filament is the "Six-Sixty" valve produced by the Electron Co., Ltd., of Triumph House, 189, Regent Street, London, W.1, who have submitted one to us for our report.

In appearance, the "Six-Sixty" is not unlike the "Peanut" type of valve, except that it is rather larger externally, and the elements especially so. This valve is fitted with the standard four pins and a specially moulded base made of some red and black mottled insulating material.

The bulb of the specimen we had was half transparent and half "silvered," and in appearance we consider the "Six-Sixty" rather more attractive than the usual run of small valves. Its length over all is ap-

proximately 4 in. In this valve the filament is composed of thorium covered molybdenum instead of the usual type of filament.

On test the filament emission was excellent.

The makers' voltage rating was 1.5 to 2 volts for the filament and 50 to 100 volts on the plate, but they did not state the filament current consumption. We found this to be fairly low, and it was just over .3 amperes in all three positions—high-frequency, detector and low-frequency.

On practical trial, using the "Six-Sixty" in a straight three-valve receiver, excellent results were obtained in the detector, high- and low-frequency stages.

The valve as a low-frequency amplifier gave a volume equal to a small power valve of average voltage.

The plate volts used were from 80 to 120, and there were no signs of softening, even above this voltage. The negative potential needed upon the grid was of the order of 3 to 4 volts with the anode voltage at 100.

In the detector and high frequency positions splendid results were also obtained, and the best plate voltage in each stage was somewhere in the region of 45 volts.

There was not a great deal of microphonic noise, and the "Six-Sixty" seemed hard enough to stand the usual amount of work expected from a valve with careful usage.

In conclusion, we consider this valve an excellent one both from the point of view of efficiency and attractiveness, and we feel sure that it is a proposition that traders would do well to bear in mind when next ordering their stocks of valves.

**National Crystal Detector.**

IMPROVEMENTS which tend to make crystal reception more efficient are always very welcome to the trader, for the vast number of crystal listeners are generally on the look-out for anything that will enable them to get better results without putting them to a great deal of expense.

A new crystal detector which should have a wide appeal is one sent to us by the National Wireless and Electric Co., of 42, Gray's Inn Road, London, W.C.1. This detector is of the usual horizontal glass type, but the adjustments of the catswhisker are made by a very effective micrometer screw which, although permitting of fine adjustments, does not rotate the whisker like many types of screw-motion crystal detectors on the market.

Apart from this feature the universal ball socket is incorporated, so that a wide variety of positions on the crystal face can be obtained.

The ball socket has an extension arm upon each side, and this acts as a "guide" to a metal "piston," which by means of a stout spring is moved backwards or forwards by a screw motion of an insulated knob three-eighths of an inch in diameter and just over three-quarters of an inch in length.

At the crystal end of the detector is a milled metal knob attached to a screw which enables the crystal cup to be taken out for changing the crystal with ease.

Altogether, this crystal detector is an admirable one, for it certainly does give a micrometer adjustment of the whisker and, as it is soundly made and well finished, it should be an excellent line for the progressive trader to stock.

**Mark IV. Alloy.**

W. A. C. SMITH, LTD., of 93, Holm Street, Glasgow, have sent us several specimen pieces of their Mark IV. alloy.

This is a fusible alloy of the Woods metal type, and is admirably suited for mounting crystals in their cups. The Mark IV. alloy has a decided advantage, inasmuch as its melting-point is only 60 degrees C., as

against the rather higher melting temperature of Woods metal.

We found the Mark IV. alloy could be easily melted in hot water, and we consider this method is rather more suitable than the usual means employed, for there is no risk of overheating the alloy and thereby destroying the sensitivity of the crystal.

#### Russell's Hertzite.

WE have received from the L. G. Russell Laboratories, of 1-7, Hill Street, Birmingham, some specimens of their new Hertzite crystal, which is placed on the market in the now well-known blue-and-white box.

These specimens, which are of the synthetic galena type, differ from the previous ones sent us, for they are finer grained and bright in appearance. We formed a very good opinion of the specimens sent us before, but L. G. Russell's latest are, if anything, rather better as far as results and stability are concerned.

On actual test excellent signals were received, both as regards volume and purity, and in a reflex receiver employing a piece of Russell's Hertzite in comparison with a crystal of known capabilities the former was rather superior.

The rectified current test with different specimens showed us that the Russell's Hertzite is, indeed, an excellent crystal. One or two pieces were broken, and the new surface gave just as good results in every way.

#### "Microstat."

FROM the Radio Resistance Co., of 35, Skinner Street, Birmingham, we have received for testing purposes one of their latest improved type of "Microstat" filament resistance.

These resistances have become widely used during recent months on account of the fine regulation of filament current which can be obtained by their use, and, further, on account of their size and moderate price.

Outwardly the "Microstat" sent us is practically identical with previous models, except that the circuit connections are taken to nuts on the bottom and on the side of the body.

This resistance is apparently of the carbon compression type, and the dome-shaped metal body is too well-known to need describing. The one-hole method of fixing is employed, and a well-finished concave milled knob one inch in diameter is provided for control.

On practical test a very fine control of a critical detector valve was obtained, using the "Microstat" for filament current regulation. Upon actual measurement the "Microstat" was found to have a variation of resistance value from zero to a very high figure, and a good constant variation from zero to approximately 40 ohms.

The "Microstat" will continue to be in good demand, for it is a neat and efficient little filament resistance sold at a popular price.

#### "Dawatcon" Variable Condenser.

ONE of the outstanding advances of recent months in variable condenser design is undoubtedly the "Dawatcon" condenser, manufactured by the Dubilier Condenser Co., Ltd., of Ducon Works, Victoria Road, North Acton, London, W.3.

It will no doubt have been realised by many that it has been up to now impossible to obtain an unbroken tuning range by means of a given variable condenser first in series and then in parallel with a given coil. This has been a decided disadvantage which has now been successfully overcome by the Dubilier Co.

The "Dawatcon" has two sets of fixed and movable vanes, but both the movable are controlled by a single knob.

The sets of vanes face in opposite directions, and one set is considerably larger

than the other. Three terminals are provided for connections, the two sets of fixed vanes being separately connected to two terminals, and both sets of movable vanes are electrically connected to another terminal.

A wiring diagram is supplied, and the "Dawatcon," coil and series parallel switch must be wired up as indicated thereon.

When the switch is in the series position the condenser, at 180 degrees, tunes to a wavelength rather beyond that obtained when the switch is in the parallel position and the condenser at zero, and thus an unbroken tuning range is thereby obtained. The maximum capacity of this condenser is .0007, and is designed for use in conjunction with aerials conforming more or less to the P.M.G. standard.

Our tests bore out the claims made by the manufacturers, and we welcome this instrument as a decided advance in variable condenser design when these are needed for aerial inductance tuning, and we feel justified in thoroughly recommending the "Dawatcon."

#### Seagull Wave Eliminator.

A GREAT deal of time and energy has been expended by manufacturers in the endeavour to provide a device which will eliminate from the receiving apparatus a powerful station broadcasting at a reasonable distance away. This device must, at the same time, allow the receiver to pick up distant stations without any decrease in the volume obtained without the wavetrap, and when the local station is silent.

We have received from time to time various devices, generally wavetraps of the acceptor or rejector type, but although in most cases a fair amount of success has been met with in reducing the local station



The Seagull wave-trap described in the accompanying paragraph.

to a whisper of its usual strength, there has always been a certain amount of loss in volume upon distant stations.

The latest instrument to be received by us is the Seagull Wave Eliminator, which is manufactured by Seagull, Ltd., of R.N. Works, Newcastle Place, Edgware Road, London, W.2. This is a wavetrap of the usual type, but with a trap circuit somewhat out of the ordinary.

It is enclosed in an oak box just over 6 in. square, and showing above the ebonite panel are four terminals, a condenser control knob and dial, and a plug and socket for the insertion of a suitable trap coil. The panel and condenser dial are suitably engraved.

We tested this instrument in conjunction with a three-valve receiver at five miles from 2LO. The set comprised one high-frequency, detector, and one low-frequency valves, and was used in conjunction with a standard P.M.G. aerial.

### The Broadcaster and Wireless Retailer

We found a 35-turn Igranite coil used with the wavetrap most suitable, and at one point of the condenser reading 2LO was entirely eliminated, and upon coupling the reaction coil closer to the tuned anode coil the London station was only just readable with careful listening.

Upon searching for other stations, Cardiff, Manchester and Bournemouth, and also Hamburg and Madrid, working on wavelengths not out of the range of 2LO, all came in at fair strength.

On comparing the strength of the distant stations when using the Seagull wavetrap, with their strengths when picked up upon the same receiver, but employing a wavetrap of known efficiency constructed by our own Testing Department, we could not agree with the manufacturers' claims. They state that the volume from distant stations is not decreased in any way, but we found the strength decreased by actual measurement some 35 per cent.

Although these results may not seem good, it must be understood that with this sort of device the loss is almost inevitable, and with the Seagull it is decidedly not as great as the majority of commercial wavetraps tested by us under similar conditions. The local station was certainly eliminated successfully, and we are of the opinion that this wavetrap is as good as, if not better than, any on the market.

#### New Dextraudion Valve.

WE have received from the Economic Electric, Ltd., of 10, Fitzroy Square, London, W., some specimens of their new type Dextraudion valve, which has a rated filament current consumption of .06 ampere at 2-2 volts.

We have not, however, yet completed our tests upon these valves, but up to the present they have given entire satisfaction.

A review will appear in our next issue.

### A CRYSTAL CONTROVERSY.

In the Chancery Division recently, Mr. Justice Romer heard a motion by Tungstalite, Ltd., for an injunction restraining alleged infringement by Kate Raymond, of Lisle Street, W.C., of their trade mark.

Mr. Moritz, for the plaintiffs, said they made crystals for use with wireless sets, and they had an enormous sale. They had bought from defendant upon information received some crystals which they found to be spurious. They were packed in tubular bottles which were like those of the plaintiffs, and the bottles bore labels which were a close imitation of those of the plaintiffs.

The defence, he said, was a curious one. It was that if spurious crystals were sold it was done innocently, and that no such purchases as the plaintiffs alleged were made on the day alleged, and that, in other words, said Mr. Moritz, this was a "plant."

Sir Duncan Kerley, K.C., for the defendant, said he repudiated entirely that he had sold anything spurious, or that he had sold the goods in question, or that the goods in question were spurious. He had asked for some means by which the alleged spurious articles could be distinguished, and none had been suggested to him. The sale of the crystals was of no particular importance to him, and he offered to sell nothing under the name of "Tungstalite" crystals that plaintiffs had not examined and found to be genuine, or not to sell at all, if he could have a speedy trial.

Mr. Moritz accepted the undertaking not to sell at all, in return for a cross-undertaking not to advertise the fact.

His Lordship thereupon granted facilities for a speedy trial of the action.

# Napier-Kimber, Ltd.

## Liquidation

Napier-Kimber, Ltd., 6, Percy Street, London, W.1, and St. George's Hall, Bradford, wholesale wireless distributors and dealers.

A meeting of the creditors was held recently at London. The chair was occupied by Mr. S. H. Gillett, of Messrs. Dixon, Wilson, Tubbs and Co., C.A., 24, Basinghall Street, E.C., who had been appointed to act as receiver by the bank, who held debentures, and also as the liquidator in the voluntary liquidation of the company. The statement of affairs presented showed gross liabilities of £23,960 16s. 8d., of which £15,000 was expected to rank for dividend. The assets were estimated to realise £11,840 18s. 4d., from which had to be deducted £429 2s. 9d. for preferential claims and £8,531 13s. 11d. due on debentures. The net assets, therefore, were £2,880 1s. 8d., or a deficiency so far as the creditors were concerned of £12,119 18s. 4d. The assets comprised cash in hand £8 10s. 5d.; stock-in-trade £6,823 3s. 6d., estimated to realise £4,900; motor-cars £50; furniture and fittings £75; plant and machinery £10; good book debts £6,557 19s. 2d.; and doubtful and bad debts £2,389 5s. 11d., valued at £239 8s. 9d. The issued capital of the company was £2,161, and, as regarded the shareholders, there was a deficiency of £14,280 18s. 4d.

The chairman reported that the company was registered as a private limited liability concern on November 25, 1913, with an authorised capital of £1,000, of which £752 was issued. He desired particularly to call attention to the small issued capital. The liabilities at the moment were £15,000, and it would appear that the company had spread its net rather widely. There were creditors interested for as much as £2,000, and he would suggest that in some instances the counting houses must have been at fault in allowing so much credit. The first members of the board were Messrs. R. N. Cunningham and A. W. Kimber, who were appointed permanent directors. There had been various changes in the directorate. In January, 1918, the company's issued share capital was increased by 752 ordinary shares of £1 each, which consisted of a dividend of 100 per cent. being reinvested as share capital. In June, 1920, a debenture carrying interest at 8 per cent. was issued to Mr. A. W. Kimber for £4,500 in satisfaction of his claim for commission against the company. In December, 1920, a fresh agreement was entered into between the company and Mr. Kimber, under which that gentleman was to receive a salary of £312 per annum, a commission of 2½ per cent. on all business transacted, and a further commission of 25 per cent. of the net profits. The old agreement provided for Mr. Kimber to receive 5 per cent. on all cash taken. In March, 1921, after returning to the company £1,500 of salary and commission, Mr. Kimber accepted a debenture for £2,500 to secure the amount due to him, and the old debenture for £4,000 was cancelled. Subsequently the nominal capital was increased to £5,000, and the issued capital was brought up to £2,161. In April, 1923, a further mortgage debenture was issued to Mr. Kimber amounting to £4,500, to secure that gentleman's guarantee to the bank. On June 5, 1923, the debentures in Mr. Kimber's favour, amounting to £7,000, were drawn, £4,500 being cancelled and £2,500 paid to Mr. Kimber in cash. At the same time a debenture in favour of the bank for £8,900 was created. The bank in that

way received debentures in its own name, and gave up in exchange the debentures in Mr. Kimber's name which had previously been held as collateral security. Mr. Kimber resigned his position as a director on October 24 last, and claimed £3,097 from the company as commission, of which sum £1,000 was paid to him in cash, and he also received a promissory note for £1,000, which was payable on demand, and the balance was to be payable at a future date. A week later a new banking account was opened jointly in the names of Mr. Kimber and the company. All the cheques were to be signed by Mr. A. W. Kimber solely, the object being to attempt to decrease the overdraft by paying all receipts into that account in relief of the liability of the guarantor. During the 15 months to December 31, 1921, the turnover was £36,638, with a gross profit of £8,643 and a net loss of £24. During the following year the sales were £36,298, with a gross profit of £8,281 and a net profit of £164. In the succeeding year the sales increased to £50,014, with a gross profit of £9,712, and there was a net loss of £36. During the 13 months to February 4 of the present year the sales were only £31,997, with a gross profit of £2,764. The purchases during that period were £25,396, whilst the wages absorbed £2,297, and the gross profit was £1,753, which was only a trifle more than 5 per cent. The expenses during the period included rent, rates, etc., £1,179; E.P.D. £1,798; salaries £2,109; commission £1,900; debt due to Mr. Kimber brought in £3,097; petty cash £761; bad debt reserve £2,700; and depreciation written off assets in the statement of affairs £3,200. After allowing for those items, the accounts showed a net loss on the trading during the last 13 months of no less a sum than £13,381. The chairman also pointed out that an agreement was entered into last August, under which the company gave to Mr. Kimber an indemnity against Excess Profits Duty amounting to £1,798. That matter might require some investigation. Before accepting the position of liquidator he consulted the principal creditors, and his appointment was approved by them. He had since held a conference of the six largest trade creditors, who had decided that the petition presented for the compulsory liquidation of the company should be opposed. At the same time he was also authorised to accept an offer which had been received for the Bradford branch of the business.

Turning to the statement of affairs, the chairman said that there were 262 unsecured trade and expense creditors, whose claims actually totalled £14,501 3s. 5d. That amount, however, would be increased, and he had been informed that there might be a claim for royalties. In addition, there was Mr. Kimber's claim of £1,793, which for the moment had not been included in the liabilities.

Mr. P. Wells, of the Wholesale Traders' Association, inquired if the creditors were to assume that the company did not keep its books properly?

The Chairman: They were not written up recently, but the accountants came in at intervals.

Mr. P. Houston, of the British Traders' Association, inquired who had purchased the stock at Bradford, and the chairman said that it had been sold to Mr. Kimber. The Bradford stock was sold at cost, less 15 per cent. There was no lease of the premises, only a quarterly tenancy, but Mr. Kimber gave £315 for the goodwill and

fixtures. Before accepting that offer, he consulted the principal creditors, who advised that it was one which should be accepted. The largest trade creditors were the Foster Engineering Co., and their representative inspected the stock at Bradford, and was satisfied that the transaction was an advantageous one, so far as the creditors were concerned.

A creditor inquired if anyone but Mr. Kimber had an opportunity of purchasing the stock at Bradford.

The Chairman: No.

Mr. Houston: It was obvious that there was no competition. He added that he would like to have known whether the Bradford business had been profitable.

The chairman stated that there were no figures available at the moment as to the Bradford trading. The voltage there was 230, which was different from London, and the electrical goods could not therefore have been removed for sale.

A creditor asked if the Bradford business was offered for sale by tender, and the chairman replied in the negative, and added that no one was invited to make an offer for it.

Mr. Wells: You did not advertise it for sale in the trade papers?

The Chairman: No.

Mr. Wells: Or attempt to get a better offer?

The Chairman: No. I consulted the largest creditors, who said that I was lucky to get such an offer and should take it. The largest creditors were all in the trade, and knew the value of the stock.

The representative of the Foster Engineering Co. stated that they were convinced that the offer was a good one, and the chairman acted wisely in accepting it.

A creditor said he thought that there were many wholesale houses who would have been glad to make an offer for the Bradford business.

The chairman said he disagreed with that statement.

In answer to questions, the chairman stated that the company had been recognised as wholesale distributors for lamps, but they were not graded for wireless.

Mr. Houston: Were they on the wholesale list of the N.A.R.M.?

The Chairman: No.

Mr. Houston remarked that it was a one-man company, and the effects of various transactions was that Mr. Kimber was entering into agreements with himself. He thought it was a case for compulsory liquidation.

A protracted discussion took place, and eventually a resolution in favour of the voluntary liquidation being continued was defeated on a show of hands, and Mr. Houston stated that the petition for the compulsory liquidation of the company would be proceeded with.

The following are amongst the principal creditors:—Accumulators Co., £63; Blackwell, F. C., and Co., Ltd., £116; Baxter and Simpson, £60; Berrys Electric Co., Ltd., £56; Brook Bros. and Dean, Ltd., £67; Bursleigh, £63; Cable Accessories Co., Ltd., £601; Callenders Cable Co., Ltd., £485; Crabtree, J. A., and Co., Ltd., £65; Clarke, H., and Co., £163; Castellina, £60; Credenda Conduits Co., Ltd., £146; Foster Engineering Co., £2,060; Fullers United Electric Works, £45; Geipel and Co., £132; Gremigne, A. L. T., £136; Hotpoint Electric Appliance Co., £56; Hewitt, L., £47; Hall, J., and Co., £73; Hayes Candy and Co. Ltd., £115; Harding and Ehriman, £297; Johnson and Phillips, £57; Joseph, A. and C., £59; Lechholz, £68; Lowenadler, F. W., Ltd., £37; London Battery and Cable Co., £65; Mines and West, £163; Metropolitan Vickers Electric Co., £315; Macintosh Cable Co., Ltd., £53.

# RADIO WAVELETS

*American Radio laws—Pilotless aeroplanes—  
Parisian Wireless Congress*

## Counting the Atoms.

**I**N the course of his lectures before the Royal Institute, Sir Ernest Rutherford pointed out that there were several different methods by which the modern physicist could calculate the size of the atom. Although these differed in their precise results, they were all in sufficiently close agreement to make it certain that our present estimates must be correct within a very small margin of error.

One hundred million atoms placed side by side will just cover the length of one inch. An elementary molecule, comprising two atoms in combination, occupies rather more space proportionately, varying from two to ten times that of the atom. An electron, on the other hand, is so small that it takes 60,000 placed in line to equal the diameter of a single atom. The disparity is not so great, however, as regards mass, as one hydrogen atom possesses the mass-equivalent of only 1,835 electrons.

## Electric Shocks.

**T**HE injurious effect of high-voltages varies enormously with different people, depending amongst other things upon the relative moisture (conductivity) of the skin, the condition of health, and the peculiarities of the nervous system. Habitual use is, of course, another factor. With practice a person can safely handle voltages that would prove extremely painful in the first instance.

While it is on record that the supposedly "safe" pressure of 120 from a domestic supply main has proved fatal, the amount used for official electrocutions in the United States is 2,000 volts. This is supplied from an AC dynamo, the electrodes being applied to the head and legs of the victim in the chair.

## Wireless Law for America

Although the new wireless Act is causing considerable protest in this country, the Americans do not appear to be entirely satisfied with the "liberty of the ether" as it exists there. The growing interference caused by the continual increase in the number of new broadcast stations has, in fact, led the Secretary of Commerce to press openly for immediate legislation in order to enable him to control the number and operation of new stations, assign definite wavelengths, and limit the power output. He does not, however, think any tax or licence fee is necessary from listeners.

## Wireless Controlled Aeroplane.

Further trials are to be carried out this month at Istres, in France, with a new type of aeroplane controlled by wireless from the ground. The system is the invention of M. Boucher, and tests have already been successfully made in which the pilot, after taking the machine off the ground, did not touch the controls again until about to land.

## A New Invention?

A Birmingham scientist is reported to have discovered a new method of generating electricity which is particularly suitable for supplying both the plate and

filament current of valve sets. No chemical action is involved, and the method is of general application. It is stated that the discovery may lead to the development of a cold-emitter valve, the necessary supply of electrons being liberated without the application of heat to the filament.

## Single and Double Aerials.

For wavelengths within the B.B.C. range it is a mistaken policy to use a single-wire aerial more than 100 feet in length. The same applies to the double aerial. The increased capacity due to the second wire lessens the selectivity of the aerial system as a whole, and increases the difficulty of cutting-out interference.

Moreover, the higher the capacity of the aerial, the less is the value of the "lumped" or coil inductance used to tune the system down to the B.B.C. wavelength. The voltage built up across the aerial coil is, however, proportional to its number of turns, so that with a small coil the effective voltage applied to the set is decreased and signal strength falls off.



*Sir Ernest Rutherford, the well-known scientist.*

## Chelmsford and 2LO.

Many people are puzzled why signals from 2LO come in at practically the same strength as those from Chelmsford, in spite of the fact that the latter uses a power output ten times that of the former. This condition applies generally to crystal sets within a fifteen mile range of the London station. Outside this radius the advantage of course lies with the Chelmsford transmission.

The reason is due to the fact that owing to technical difficulties at the transmitting end it is not possible to modulate the Chelmsford carrier wave so fully as in the case of the London station. So far as reception is concerned, it is the percentage modulation that determines signal strength—other things being equal. The carrier-wave actually represents so much waste energy, apart from its penetrative power, i.e., the distance through which it will convey the signals across the ether, so that at short range the highly-modulated radiation from the low-powered station has the advantage.

Strictly speaking the Chelmsford transmission should give a better quality of reproduction even if the signal strength is no greater, because a high percentage of modulation tends to create distortion at the receiving end. This effect is, of course, more noticeable with valve reception than in the case of a crystal.

## Radio Congress in Paris.

Some of the questions tabled for discussion at the forthcoming International Radio Congress to be held in Paris on the 14th to 19th April, involve interesting points in International law. In our own country the legal control of the ether rests in the hands of the Postmaster-General, who possesses very drastic powers of punishing any person who infringes his monopoly.

Matters are on a different footing, however, in other countries, and one of the tasks of the Congress is to evolve some scheme that will harmonise the different rules and regulations governing the use of the ether, particularly as between various European countries.

## The Neutrodyne.

The demand nowadays is for selectivity in reception. There is little merit in a multi-valve set having a long "reach" unless the owner is able to cut out undesired interference. The best approach to selectivity lies, of course, in the use of the indoor or loop aerial.

Unfortunately a loop aerial requires several stages of high-frequency amplification if it is to have a range of more than a few miles. With an ordinary straight circuit the use of more than one stage of HF amplification gives rise to considerable trouble, (a) in the difficulty of tuning, (b) in its tendency to self-oscillation. There are at present two ingenious methods of overcoming this difficulty. One is the Super-sonic or Super-heterodyne system of reception. The other is the Neutrodyne.

In the Neutrodyne receiver, self-oscillation is prevented and the valves are stabilised by the use of a special condenser inserted between the grid and plate circuits. Its purpose is to neutralise or counterbalance the unavoidable capacity leakage that takes place between the grid and plate electrodes inside the bulb. In practice the added condenser is found to achieve this result. All undesired back-coupling is cut out, and a set comprising several stages of HF amplification, and suitable for use with a portable frame aerial, is made perfectly easy to handle.

# Late Trade News

## Ediswan Valve Record.

**T**HE Edison Swan Electric Co., Ltd., have recently received back from one of their customers one of their A.R. valves. Although this well-known type of valve is only intended for use as a receiving valve, this particular one has been in constant use as a transmitting valve with 500 volts on the plate, and frequently up to as much as 7 volts on the filament. Under these conditions it gave better results than could be obtained with a 15 or 30 watt transmitting valve.

At a very conservative estimate, the valve has had a life of not less than 350 hours. It did not burn out then, but the valve was accidentally dropped, much to the regret of its owner.

The valve was not specially selected, but was bought out of stock, over the counter in the usual way, and its owner, resident in the Birmingham area, states that it was used regularly on two-way telephony with Aberdeen.

## Houghton's "Radio News."

**T**HE March supplement to Houghton's *Radio News* contains many items of interest to all wireless dealers. First and foremost are shown the revised prices ruling for many types of apparatus produced by a number of leading manufacturers. Then follow particulars of revised discounts, discontinued lines and new lines introduced.

A portion of the supplement is devoted to corrections to the "Radio Index" recently published by Houghton's, Ltd.

Dealers who are not yet acquainted with these publications should get in touch with the producers at Ensign House, 88-89, High Holborn, London, W.C.1.

## Special Notice.

**W**E have been asked by Mr. G. F. A. Stone, proprietor of the Lighting Supplies Co., of 4 and 5, Finsbury Avenue, London, E.C.2, to make known to our readers the fact that this firm has no connection with any other firm of a similar name carrying on a business as retailers.

The Lighting Supplies Co. manufactures only "Finston" and "Perfecta" products and does not conduct any form of retail business.

## B.T.H.

**A** TASTEFULLY produced 16-page catalogue dealing with the "Tungar" battery charger marketed by the British Thomson-Houston Co., Ltd., of Crown House, Aldwych, London, W.C.2, is now available to the trade. It contains many illustrations and full particulars of this useful apparatus and accessories. In addition some useful hints on actual battery charging are given.

Traders will no doubt receive inquiries from their customers re this instrument, and we therefore advise all dealers to get acquainted with the characteristics and uses of the "Tungar."

## Permion.

**T**HE Permion Manufacturing Co., of Duke Street, Old Trafford, Manchester, wish the trade to understand that they are the original manufacturers of the "Permion" detector, and that they have no connection with any firm bearing a similar name.

We would also point out that each of the detectors made by this firm is carefully tested before despatch, but should there be a faulty one sent out it will be exchanged without question.

## Manchester Fire.

**O**WING to an outbreak of fire, various of the stocks held by L. Kremner, of 49a, Shudehill, Manchester, were damaged.

Water materially assisted in the amount of damage done.

Fortunately, the fire occurred during the day and, the alarm being quickly given, it was got under way before it had a chance to spread to the adjoining buildings.

New stock arrived rapidly, and customers are assured of prompt delivery.

## Tape.

**E**MPIRE tape in ten-yard coils is supplied by the Pomona Rubber Co., of London Road, Manchester. This line, we understand, is proving a quick seller. Other interesting lines, particulars of which may be had on application, are also marketed by this firm.

## Bereavement.

**A**LL connected with the electrical industry will hear with regret of the death of Mr. W. W. Bradfield, late general manager of the Marconi International Marine Communication Co., Ltd.

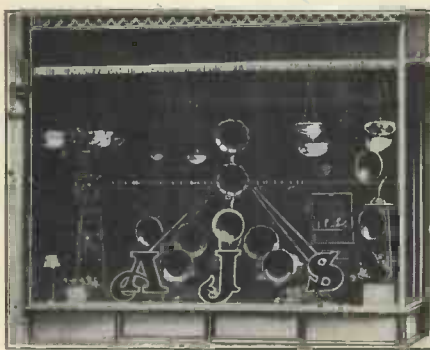

*This interesting display of A.J.S. loudspeakers was recently installed in the window of Mr. C. Gordon Smith, at Wolverhampton.*

Mr. Bradfield, to whom practical radio telegraphy owes much, had been in failing health for some time. Mr. Bradfield was born in London on March 18, 1879, and passed away a few hours only before the 46th anniversary of his birthday.

## An Offer.

**M**ANY remunerative lines are listed in the March trade price list issued by the Harwol Specialities Co., of 11, Strand Street, Liverpool. It is the intention of this firm to send a free gift to every bona-fide trade inquirer for the Harwol catalogue. The gift consists of a six-inch steel straight-edge rule, enclosed in a leatherette case.

## New Premises.

**O**WING to the considerable increase in business experienced by J. J. Eastick and Sons, new premises have been taken over by this firm. In future, all correspondence, orders, etc., should be addressed to "Elex House," 118, Bunhill Row, London, E.C.1. The telephone numbers at these premises are Clerkenwell 9282 and 9283.

Heavy goods and raw material should be addressed to "Elex Works," 26-36, Lamb's Passage, Chiswell Street, London, E.C.

The premises at 2, St. Dunstan's Hill, E.C.3, are still being retained by this firm, and will be used entirely as a testing laboratory.

J. J. Eastick and Sons are marketing a line of combined split plugs and sockets with insulating tops made in a variety of colours. A feature of these plugs and sockets is that flexible wire can be inserted from the top, this method preventing the appearance of frayed ends. The wire can

also be inserted from the side, underneath the insulating top, leaving the metal top of the plug free to admit another plug if desired. Sockets for use in conjunction with these plugs are also supplied.

Another item is a tubular connector for use with the plugs. This is made of brass, and is covered with a polished insulating material. This forms a connecting link for two plugs, the plugs being inserted one at each end of the tubular connector. Even without this connector any number of plugs and sockets can be connected together. These plugs can also be inserted in the end of a specially designed spade tag. A special type of terminal to take the plugs, ordinary wire and spade tag is also made.

## H. & B. New Apparatus.

**S**EVERAL new lines have recently been added to the range of apparatus manufactured by Hall and Brennard.

We think the most interesting is the vernier type coil holder, which is made in two and three-way patterns.

The coil plugs are barrel-shaped, and are mounted on an ebonite base, which is designed for panel mounting work with one-hole fixing. The angular movement of the coil plugs is controlled by the application of a very novel principle, the middle of each variable coil plug being fitted with a stout rubber ring which affords both rough and fine adjustment.

This is a well-made and efficient component, and although it has only been on the market for a short time, has proved an immediate success and is in great demand.

The works of Hall and Brennard are situated at the London Terminal Aerodrome, Croydon, Surrey.

## Improvement Made.

**W**E are informed by the Abro Motor Co., of 184 and 186, London Road, Manchester, that an improvement has been made in their accumulator carrier. This carrier is now fitted with an insulated handle which adds both to the appearance of the appliance and its efficiency.

## New Arrangements.

**W**E understand that the increased demand for Paragon products and the development of the wireless industry has resulted in a reorganisation of the sales department of the Paragon Rubber Manufacturing Co., Ltd., of Hull. For the future, Peter Curtis, Ltd., of 75a, Camden Road, London, N.W.1, will act as the central sales organisation for the productions of the two associated companies, so far as these appertain to the wireless industry.

The sales department of the Paragon Rubber Manufacturing Co., Ltd., has been transferred to 75a, Camden Road, N.W.1, to which address all future inquiries and orders should be directed.

## A Correction.

**I**N the business announcement of the Sel-Ezi Wireless Supply Co., Ltd., on page 8 of the March issue of THE BROADCASTER AND WIRELESS RETAILER an error was made in the discounts shown. Will all concerned, therefore, please note that the discounts for the condensers are as follows:—6 doz. lots, 25 per cent.; single gross, 33½ per cent.; 5 gross lots, 40 per cent.; and 20 gross lots, 45 per cent. We much regret any inconvenience caused by our error.

It should also be noted that the name for these condensers is now "Therla" and not "Erla" as previously.

# THE MANUFACTURE OF B.T.-H. VALVES

*There are some very interesting special features involved in the manufacture of B.T.-H. valves*

THE essential property of matter upon which the working of wireless valves, e.g., platinum, tungsten, depends is that when a metal wire, molybdenum or tantalum, is heated in vacuo, electrons or negative particles of electricity are emitted from the surface of the wire. It is necessary that the wire should be enclosed in an evacuated bulb, for, of course, if the wire were heated to the necessary temperature in air it would be immediately oxidised, and even if the wire were heated in some inert gas the electrons would be stopped by the molecules of the gas at the very beginning of their journey.

This phenomenon of electron emission takes place in ordinary incandescent electric lamps, but here after a short flight most of the electrons return to the filament. This they do because the filament becomes positively charged by the loss of the electrons, and therefore exercises an attraction over the lost electrons. It may be asked why, under these circumstances, electrons are emitted from the filament at all. This is due to the high temperature caused by the passage of the electric current through the filament and the consequent very vigorous vibrations of the component atoms. The emission increases rapidly with increase in the temperature of the filament, and also depends upon the area of the filament.

### The Electrodes.

A wireless valve, however, contains two other parts or "electrodes" as well as a filament. These are known as "anode" and "grid." The anode is usually in the form of a cylinder surrounding the filament; or may consist of two flat plates on opposite sides of the filament. When the valve is in use the anode is always charged positively with respect to the filament, and it will at once be seen that this will cause the electrons to flow from the filament to the anode and round the remainder of the circuit. If the anode be charged negatively with respect to the filament no current will flow from filament to anode, and upon this does the rectifying action of a two-electrode valve depend.

The grid usually consists of a spiral of wire, which also surrounds the filament, but is placed inside the anode. If this grid be charged positively it will encourage the flow of electrons through it to the anode, while if it be charged negatively with respect to the filament, it will repel some of the electrons and reduce the current flowing from filament to plate. Thus, if the grid is made positive and negative alternately, it will cause corresponding fluctuations in the current flowing through the valve, and very small changes in grid potential cause very much larger changes in the current flowing to the anode. Upon a proper use of the grid, and its effect on the electron stream, do the amplifying and detecting properties of the valve depend.

### The Stem.

The first step is the making of a stem on which to mount the electrode system. Two things are necessary—a piece of glass tubing of a specified length and diameter, and the "welds." Four welds are required for each stem: one supports the anode, another the grid and the remaining two make contact with the ends of the filament.

A "weld" is made up of three parts: (1) a length of copper wire, which ultimately connects one of the electrodes to the corresponding pin in the four-pin plug, (2) a short piece of platinum wire or some substitute having the same coefficient of expansion as glass, (3) a piece of nickel wire, which may be long or short as required. These are welded together, the platinum being welded to one end of the copper and the nickel to the other end of the platinum. Stems are made on machines whenever possible, and the operation consists in softening one end of the glass tube and then pinching it flat, the welds being held in position so that the short pieces of platinum become embedded in the pinch. The greatest care is necessary to ensure that no strains are set up in the glass during the operation, and that a perfectly airtight joint is made.

### Making the Grid.

Grid-making is an important preliminary to the building up of a mount. The grid consists of a spiral of molybdenum wire with a supporting wire, and each turn of the spiral is either lashed by thin molybdenum wire or is welded to the support.

to the dimensions determined as most suitable for each kind of valve.

### Fixing the Grid and Plate.

The next process is to get the electrodes into position. Care at this stage of manufacture is always profitable, as many of the faults which develop at later stages may be traced to lack of care in mounting the electrodes. The anode, which is of nickel, is usually mounted first, and this is done by means of an electrical welding machine, which welds the anode to the proper nickel wire projecting from the pinch. The grid is now placed inside the anode and welded to the appropriate lead. The filament is usually a straight piece of tungsten wire of specified diameter and carefully measured length. It is introduced down the grid, and the ends are secured to the nickel supports.

The mount is now complete, but at this point some types of valves require to be dipped in or painted with a mixture of chemicals, generally termed a "getter," the use of which will appear later. When the mount is dry, the positions of the electrodes are adjusted so that grid and anode are concentric and the filament is centrally situated within the grid.

### Sealing the Bulb.

The mount is next sealed into the bulb. To the top of the bulb is attached a short length of glass tubing, by means of which the valve is later connected to the exhaust pumps, while the bottom end of the bulb is cylindrical. The mount is placed on a peg on the sealing-in machine, the bulb is slipped over the mount and the cylindrical portion is softened by gas fires placed in suitable positions, so that it falls inwards round the bottom end of the stem and makes an airtight seal.

### Exhausting the Bulbs.

The next process, that of evacuating the bulb, is the most important of all. While a soft valve, properly handled, may make an efficient detector, for amplifying purposes a very high vacuum is necessary. To obtain such a vacuum the valves are heated to a high temperature while connected to a vacuum pump, capable of producing a high degree of vacuum. During the exhaust process it is necessary to drive the occluded gases out of the electrodes and to absorb these gases so that a permanent high vacuum will be obtained. This is done by passing a current through the filament while the anode and grid are maintained at a high positive potential, being thus subjected to bombardment by electrons from the filament. Anode and grid become very hot, the chemicals previously mentioned are deposited on the walls of the bulb, and they gradually absorb the gases driven out of the electrodes by the heat.

In some cases a different procedure is adopted. A special getter is used, and, when the anode becomes hot, the getter volatilises and is deposited on the bulb as a fine silvery mirror. The pumps carry away most of the gas liberated from the electrodes, but the getter involatilising completes the process and ensures a very hard vacuum. The valves are then sealed off.

### Adding the Shell or Cap.

The exhausted bulbs are now fitted with a nickel-plated shell, a suitable insulating

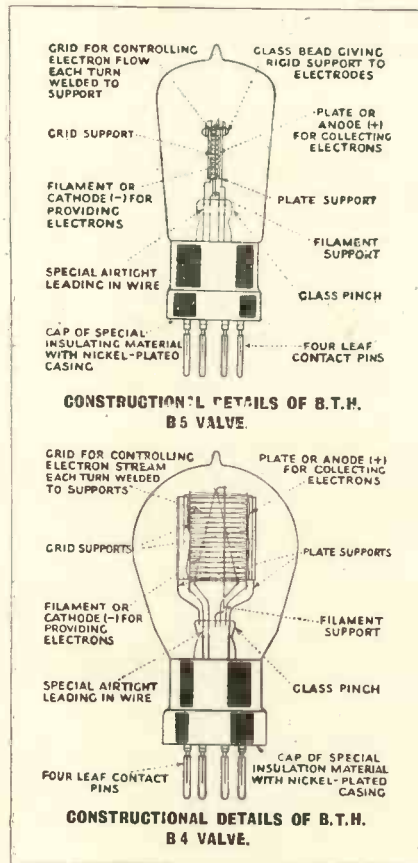

This gives rigidity to the grid and helps to preserve the spacing of the turns. The number of turns of wire in the spiral and the length of the grid must be checked before the grid can be used, and it is important that the turns should be evenly spaced. The diameter of the grid and the diameter of the wire used must also be kept exactly

paste being used to cause the shell to adhere to the glass. The standard four-pin plug is fitted inside the shell, the copper wires leading into the electrodes being threaded through holes in the disc beside the pins, and finally secured to the base of the pins by soldering. The shell is now pinched in three places so that it fits into three grooves in the edge of the disc. Thus the disc is prevented from being twisted round inside the shell and possibly causing a short circuit.

**Ageing the Valves.**

After a short ageing of the filament, valves of the bright emitter type are ready for testing. The total emission obtainable under specified conditions is measured, and must exceed a certain minimum value. The valves are further tested to ensure that they are sufficiently silent in working, and that they will function both as detectors and amplifiers. When the valves have passed all these tests satisfactorily, they are ready for cleaning, etching and packing.

**The Dull-Emitter and its Properties.**

At present a great deal of attention is being devoted to what are known as "dull-emitter" valves. The main advantages of this type are that a much longer operating

life can be obtained, that the filament energy required to give the necessary emission is much less, and that they are much quieter in operation. These advantages are all directly due to the lower temperature at which the valve operates.

The factor which allows of the necessary emission being obtainable at this comparatively low temperature is the presence in the filament wire of a small quantity of thorium. When the exhaust and capping processes have been completed, and in order that the emission may be developed, the valves undergo a much more complicated ageing process than is necessary for bright emitter valves. The result of this ageing process is that a layer of thorium, supposed to be one atom deep, is formed on the surface of the filament. We may note here that the wire used for dull-emitter filaments is much more liable to loss of emission by contamination with certain gases than is ordinary tungsten wire, and for this reason great care must be taken to have the best possible exhaust conditions.

When the valve is being used the thorium gradually evaporates from the surface of the filament, but the reactions taking place inside the filament are such that, so long as the valve is not run above its normal

voltage, the rate of evaporation is equalled by the rate at which the thorium is produced and diffuses to the surface. It will be seen then that the life of a dull emitter valve, again assuming that the valve is treated with ordinary care, will be terminated by loss of emission. The filament may still be intact, but unless there remains some thorium, the valve will not function at the normal filament voltage. At present the information on the performances of dull-emitter valves is still scanty, but it is known that some B.T.H. B5 valves have been burning continuously at normal filament voltage, and with 40 volts on the anode, for two thousand hours, and still the emission remaining would be sufficient for the continued working of the valves.

When the ageing process has been completed, dull emitters are tested in much the same way as other types. The total emission is measured, a very delicate test is applied to ensure that the vacuum is of a very high order, in other words, that there is no more than a certain maximum pressure of gas in the valve, and finally every valve is tested on a receiving apparatus. After the valves have passed all these tests, they are cleaned and etched, and are then packed ready for sale.

# MORE ABOUT THE "SUPER-HET"

by N. J. Rohan

*Many believe the super-heterodyne to be the set of the future. Here are some more interesting details of the latest developments*

ONE result of the continual increase in the number and variety of available broadcast programmes has been to set up a new standard of efficiency in reception. The ideal receiving set of the future must be capable of a range of several hundred, if not thousands, of miles on an indoor frame aerial. In addition, it must be competent to select any one desired programme to the exclusion of all the others.

Whilst at present such an installation appears to be merely a pious hope, the nearest approach to the realisation of this ideal is undoubtedly to be found in the super-heterodyne receiver.

In America, where the congestion of the ether is far more pronounced than here, the super-het has been generally accepted as offering the most promising solution to the troublesome problem of interference. Its popularity is also spreading in this country, and apart from the one drawback of expense, it seems most likely to illustrate

The receiver of the future must therefore essentially be one capable of dealing efficiently with short-wave transmission. Unfortunately the ordinary "straight" valve circuit is not suitable for this work. Short wavelengths mean very high frequencies, and currents of very high frequency are extraordinarily difficult to handle, because of their pronounced tendency to leak away wherever there is an available capacity path. They pass across a small condenser with practically the same ease as if it were a piece of conducting wire.

Accordingly as soon as the received aerial currents reach the grid of the first amplifying valve, a portion of the energy is lost altogether by shooting across the "capacity bridge" between the grid and filament inside the bulb. Some of it, of course, reappears as amplified energy in the plate circuit, but even here it gives rise to trouble.

In the first place, it tends to stray back again into the grid circuit, thus setting

long-range work on the indoor type of aerial, where the use of several stages of H.F. amplification is essential in order to compensate for the relatively small amount of energy picked up in the first place.

He therefore determined to convert the short-wave energy, as received by the aerial, into equivalent energy of a longer wavelength, i.e., of lower frequency. Once the energy has been so converted the difficulties of high-frequency amplification disappear. He found, in fact, that he could use as many as five or six successive H.F. stages without experiencing any pronounced tendency to instability or difficulty in control.

In order to convert the incoming short-wave energy into oscillations of longer wavelength, it is necessary to utilise a local oscillator, i.e., an ordinary back-coupled valve, tuned so as to generate oscillations of slightly different frequency to those being received by the aerial. This is the well-known process of heterodyning.

For instance, if the incoming signals are on a wavelength of 300 metres their frequency will be one million per second, because the speed of the wave through the ether is 300,000,000 metres per second. If, now, the local oscillator is set so as to generate oscillations having a frequency of 1,060,000 per second, the local oscillations will combine with the incoming signals, and will give rise to a resultant or "beat" wave having a frequency of 60,000 per second, i.e., the difference between the distant and local frequencies.

The combined currents are then passed through a first detector valve which separates out the 60,000 frequency. This intermediate frequency, it should be realised, corresponds to a wavelength of 5,000 metres. Such a frequency is, of course, quite inaudible to the ears, and is incapable of operating a pair of telephones or a loud-speaker. At the same time, it contains the original voice or music components, which can be extracted by a second process of detection.

In short, the intermediate or converted wave is still high-frequency energy as dis-

the rule of the "survival of the fittest" amongst any present-known type of receiver.

The principles underlying supersonic reception have already been explained,\* but it may be useful to recall them briefly. First and foremost, the whole trend of recent development in transmission lies in the use of shorter and shorter wavelengths. The day of the 10,000-metre signal is practically over. The merits of wavelengths ranging from a few hundred metres down to below 100 metres have been fully demonstrated both in ordinary and amateur transoceanic transmission, as well as in the specialised "beam" radiation used by the Marconi Company.

\*BROADCASTER, December, 1924.

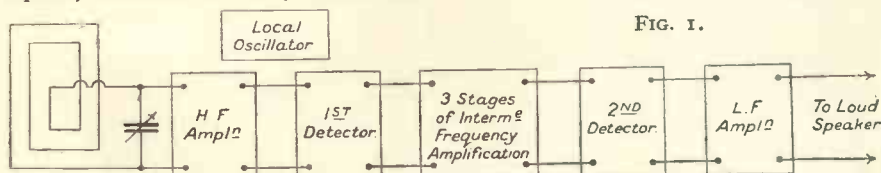

FIG. 1.

up a back-coupling which causes the valve to oscillate and so become useless for receiving signals. In the second place, it tends to pass across the windings of the inter-valve transformers, owing to their mutual capacity instead of flowing through the wire. Energy by-passed in this way is lost so far as the next valve is concerned.

PROFESSOR E. H. ARMSTRONG, the inventor of the super-heterodyne, was finally forced to the conclusion that this peculiar "straying," or by-passing of short-wave energy, rendered it impossible to use more than one stage of high-frequency amplification with any degree of success. Such a limitation was, of course, fatal to



tinct from low-frequency, and can be manipulated and amplified in just the same way as though it were a 5,000-metre signal received directly on the aerial. There is one great difference, however, and this lies at the root of the matter.

High-frequency energy, having a wavelength of 5,000 metres, has practically none of the "straying" propensities of the shorter wavelengths. It does not leak across the capacity paths between the electrodes inside the bulb, or across the windings of inter-valve transformers. It can therefore be amplified enormously and effectively without loss and without giving rise to self-oscillation. Moreover, the circuits of the high-frequency amplifiers can be definitely tuned, once and for all, to a constant "intermediate" frequency, so that the only variable controls are the aerial circuit and the local oscillator.

After passing through the last stage of high-frequency amplification, the output is fed to a second detector which separates out the voice frequencies. These are then sent through as many stages of L.F. amplification as may be necessary.

It should, perhaps, be mentioned that although a signal wavelength of 300 metres has been taken by way of example and for ease in calculation, the same principle holds with even shorter wavelengths, such as 100 metres and under. It is practically impossible to secure good reception on these wavelengths with the ordinary type of circuit, unless special low-loss components are used in combination with valves of the V24, or similar type, in order to cut down the stray losses as much as possible. By using a super-het, the 100 metres signals are at once converted into a 5,000 metre wavelength, which is then passed through the intermediate H.F. amplifiers as before.

**T**HE original type of super-heterodyne receiver comprised as many as eight or nine tubes. One typical eight-valve set, indicated diagrammatically in Fig. 1, consisted of a radio-frequency amplifier, a local oscillator or heterodyne, a first detector, three intermediate H.F. amplifiers, a second detector and a L.F. stage. In another model the number of intermediate amplifiers is increased to five, which, with a local oscillator, first and second detectors and one stage of L.F., make nine tubes in all. With this set using a three-foot loop aerial, the only limit to the range of reception is that imposed by the presence of atmospherics in the ether.

The drawback to such a receiver lies, of course, in the number of valves and in the difficulty of supplying sufficient filament "juice." The introduction of the dull-emitter helped to solve the latter difficulty, whilst recent fundamental improvements have resulted in the reduction of the number of tubes in the super-het, from nine to five—or only one more than the ordinary standard four-valve set—without any appreciable loss in range.

The first improvement consisted in using a single back-coupled valve to perform the double function of local oscillator and first detector. This did not prove a success at first, owing to the fact that the tuning of the oscillator had to be made slightly different to that of the aerial system in order to produce the necessary "beat" frequency. This detuning caused a loss of signal strength which more than offset the advantage of reducing the number of valves by one.

Fortunately, this defect was overcome by the ingenious substitution of a second harmonic of the oscillating valve, instead of the fundamental frequency for use as the local heterodyne wave. This is illustrated in Fig. 2. The aerial is tuned to the incoming wave, whilst a loop circuit L in the

grid of the first valve is tuned to half the signal frequency plus half the intermediate or "converted" wavelength. The signal wave then combines with the second harmonic from the valve to form the inter-

mediate frequency (5,000 metre wavelength), to which, of course, the intervalve transformer T is also tuned. As the tuning of the circuit L is now very different to that of the aerial circuit, any adjustment of the former has practically no effect on

the latter and no loss in signal strength occurs. Another new feature consists in reflexing the valve circuits by the parallel-feed method, so that the same tube is made to

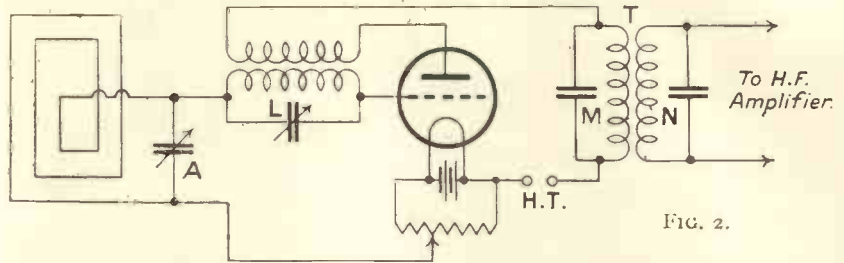

FIG. 2.

mediate frequency (5,000 metre wavelength), to which, of course, the intervalve transformer T is also tuned. As the tuning of the circuit L is now very different to that of the aerial circuit, any adjustment of the former has practically no effect on

amplify both radio and intermediate frequencies simultaneously. A five tube super-het of the latest design has been proved capable of giving loud-speaker strength over a distance of 1,000 miles on a frame aerial only 18 in. by 10 in. in size.

## Current from the Mains

**T**HERE can be no doubt that manufacturers have been making every possible endeavour to cater for the tremendously varied needs of the ever-increasing wireless public. At a glance it may seem that the listener, whatever his status, has a sufficiency of material at his command.

The wireless public can be divided, I should say, into four classes: firstly, there are the users of crystal receivers and valve instruments (professionally manufactured); secondly, there is the home constructor, who is usually what our American cousins term a "D.X. fiend"; thirdly, the experimenters, and, last, the man who wants to listen to his local station on a loud-speaker with the

The day of the "cold valve" still seems to be a long way off, even though the filament consumption of many valves is as low as .06 of an ampere. This being so, a new receiver which has just made an appearance upon the market seems to be a much-desired step in the right direction.

This receiver, which is being supplied by the L.H.M. Engineering Co., Ltd., of 17, Dartmouth Street, Westminster, S.W.1, is a three-valve instrument working from the electric light mains either direct or alternating current.

In the case of direct current D.E.3 type valves are used with the filament and anode current taken from the mains, and the supply to each is controlled by means of ordinary vacuum lamps. The voltage of mains differs and this set is adaptable for use with the different supplies by simply altering the vacuum lamps.

For alternating current supplies D.E.R. or similar type valves are used, and the supply to the filaments is obtained from a transformer. The anode circuits are supplied from a rectifier in conjunction with a smoothing system.

The receiver itself is composed of a detector followed by two low-frequency amplifying valves. The first is transformer coupled, and one resistance coupled. Closed circuit aerial tuning is employed with magnetic reaction. There are only two controls upon the receiver—one for the condenser tuning the aerial coil, and the other for varying the distance between the reaction and closed circuit coils held in a two-way coil-holder.

The manufacturers have apparently chosen the values of the components to avoid any overloading or resonance, and the reproduction obtained with the receiver on a 200 volt D.C. supply was certainly of splendid quality. The lamps controlling the anode and filament supplies do not burn at their full brightness, and consume approximately 12 watts, so that it can be seen that this receiver will work for about 80 hours at a cost of one unit, which is generally between fourpence and sixpence. With this receiver a very notable point is that the hum or ripple from the mains is almost entirely smoothed out—at any rate, the very slight hum that is left does not affect speech or music in any way.

The tuning is simplicity itself, so that the public have at their command a receiver which does give good loud-speaker results from a local station and can be controlled without having to learn the art of tuning in and at the same time needs no attention as regards batteries. D. E. M.



The "no batteries" receiver recently produced by the L.H.M. Engineering Co., Ltd.

usually associated with a crystal set and results equal to a first-class valve receiver.

The first three classes are apparently well catered for, but what of the latter?

This type of listener, I submit, has been rather neglected by manufacturers; even though this class is not as great as the others, there are a great number of people who are prospective listeners, but fear that the handling of a wireless receiver is much beyond their capabilities.

I feel sure that when the public can be certain that they can get good loud-speaker results from their local station with as much ease and as little trouble as they can use a gramophone, then a tremendous increase in the number of listeners will follow.

# Second Publication of

# The Broadcaster RADIO TRADE DIRECTORY

AS A SUPPLEMENT TO NEXT MONTH'S ISSUE OF  
"The Broadcaster & Wireless Retailer."

## C o n t e n t s

### Section 1. Section 2. Section 3.

#### Alphabetical Manu- facturers Directory.

Contains in strict alphabetical form the names and addresses of every British wireless manufacturer.

This section in particular will be invaluable to every retailer by reason of the fact that it will be the most up-to-date wireless trade directory yet published.

#### Alphabetical Brands Directory.

Here will be arranged all the known trade names used by manufacturers of wireless apparatus. Particulars will be given showing who makes the article.

We estimate that at least twice the number of "brands" listed in the first publication of the Directory, will appear in this section.

#### Classified Service Directory.

This is an additional section of the Directory and will contain detailed information regarding the manufacturers of various types of wireless apparatus.

Thus under the entry "Accumulators" will appear a list of all makers of accumulators. Similarly beneath the entry "Valve Receivers" will appear all the manufacturers of this type of receiver.

LATEST DATE FOR EDITORIAL PARTICULARS  
APRIL 10.

THE MOST UP-TO-DATE WIRELESS  
DIRECTORY YET PUBLISHED.

# SPECIAL NUMBER

MAY the FIRST

In addition to the publication of "The Broadcaster" Radio Trade Directory as a supplement to the May issue (see opposite page) there will also be an EXPORT SUPPLEMENT.

Every live dealer should acquaint himself with broadcasting conditions in foreign countries.

READ THE EXPORT SUPPLEMENT published free in NEXT ISSUE of "The Broadcaster & Wireless Retailer," which will be a SUPER NUMBER with a specially enlarged editorial section.

**LATEST DATE FOR EDITORIAL COPY  
APRIL 15.**

# SELLING & DEMONSTRATING SETS

Wherein the ideal demonstration room is described

**M**OST dealers will agree that it is not reasonable to suppose that anyone will buy a wireless set without first hearing its capabilities, and that the more expensive the set, the more necessary is it for a good demonstration to be arranged. But how few wireless dealers really do cater for the man who wishes to buy a complete set; how few really understand the outlook of people who have no interest in wireless except as a means of providing entertainment, the people who regard a wireless set as a kind of automatic gramophone which does not require to be wound up?

In order to induce such members of the public to buy wireless sets it is first essential to impress them with the fact that good apparatus does not require any expert knowledge to run it successfully, that the art of tuning is not difficult when once grasped, and that upkeep charges are not necessarily a heavy item of expenditure. Until the public are convinced of these points they will never become the large buyers of complete sets which they otherwise would be, and it is therefore essential that dealers who look forward to good sales in sets should do their utmost to give the public the best impression right from the start.

Unfortunately there are some wrong impressions in the minds of many members of the buying public which have first to be corrected, and this can only be done by judicious demonstration. For instance, there are very few people at the present time who have not a friend or friends who are keen amateur wireless "experts." We all know the type of person who, having just made a set embodying the latest "stunt" circuit, invites all his friends round to listen to it. These people make wonderful claims for their products, chiefly regarding the range of reception. They always overlook the fact that the first essential of speech is intelligibility, of music, faithfulness of reproduction, and of a set, stability in operation.

Imagine the feelings of a man who has read that wireless will give him pleasing entertainment in his home, and who makes a call on a D.X. fiend. He sees an array of instruments and wires not usually to be found outside a laboratory, hears speech that is frequently unintelligible, music that is invariably distorted. Atmospheres interrupt the "entertainment" at frequent intervals, while the set probably requires retuning at odd moments for no apparent cause. Such a man may admire his friend's cleverness, and consider it wonderful to hear over such distances, but he is led to believe that wireless as a means of pleasurable entertainment is not worth having. That this impression is widespread may be proved by asking most people who have the money and no wireless the reason for their decision not to buy a set.

Therefore, the first thing the dealer has to prove to his potential customer is that wireless is actually as good or even better than a high-class gramophone for reproducing speech and music, that it need not be an eyesore in a well-furnished room, and that any member of the family may work it—at least, on the local station, with only a few minutes' preliminary instruction.

To this end it is obviously worse than useless to keep one set in a store—usually one employing two power amplifiers—as so many dealers do, to connect this to a "super" loud-speaker, and await develop-

ments. The only developments that do usually occur from following out this plan is to cause a crowd of small but interested children to collect outside the shop, and to drive all save the most hardened experimenters away. There is little doubt but that demonstrations of this description have done more harm to wireless, as a means of entertainment as distinct from a scientific hobby, than anything else.

**T**HE ideal wireless demonstration room would be a fairly small chamber, comfortably appointed, containing a selection of three or four representative sets, chosen for (a) price, (b) ease of control and (c) selectivity and range. Reproduction quality is not included in the above list of characteristics, because it is the first essential in any complete wireless set design for purely entertainment purposes. No dealer should ever stock a set which is deficient in this respect, for it will harm himself directly and the whole industry indirectly.

The selection of sets having been made, they should be placed in convenient positions about the room, and their arrangement should be such that the customer is first impressed with their neat and unobtrusive appearance. All should be permanently wired to batteries, and some arrangement, such as one which will be described later, ought to be made so that they may immediately be connected to aerial and earth. Every effort should be made to conceal all batteries, and the very minimum of loose leads should be in evidence. Loud-speakers may be dealt with in a similar manner.

To pass into details, the sets must be allowed to stand either on tables placed round the room or on a bench along one or more of the walls. Probably the former method is the best, for it allows free inspection of the backs as well as the fronts of the sets. The tables or bench will do well to be covered with some heavy material, such as green baize, which will effectively prevent microphonic noises due to vibration from people moving about the room, or by accidentally knocking the tables.

The connections to aerial and earth will be an easy matter if the following suggestion is carried out. Arrange some simple brackets along one or two sides of the room. These brackets may be of wood, and should project some twelve inches from the wall. At two well-spaced points on each bracket ebonite faces should be fitted. The latter are to form the bases of clamps for carrying copper rod or tube about  $\frac{1}{4}$  in. in diameter. Two such rods are run right along the selected walls, and one rod is connected to aerial and the other to earth. It will then be a simple process to attach whatever set is required to the rods by means of flexible leads, to the ends of which spring clips are fixed.

**P**ROVIDING the selection of sets is a good one, a scheme is now in existence which fulfils all the prescribed conditions for demonstration. Further, the fittings involved are not of an expensive nature, and may all be carried out by the dealer himself, outside shopfitting assistance being quite unnecessary.

The existence of such a showroom in a district will soon become common property, and should need little or no direct advertising, consequently potential customers will

be attracted to it. Once there, it is a simple matter to form some idea of the requirements of an interested caller. Does he require loud-speaker results on the local station only? Is he interested in securing distant stations on the telephones or loud-speaker, or does he merely require telephonic reception on the local station?

**T**O satisfy the first and last-mentioned needs is comparatively easy, and the type of person who requires such an outfit is usually the very one who appreciates a set of the very utmost simplicity. Therefore, show him how simple it really is. Allow him to watch you connect aerial and earth, light the valves or set the crystal and tune in. Then, having once received the station at its best strength, switch it all off and allow the customer to tune in himself. It will only be a matter of memorising the numbers on the dials, and once done, he will be struck with the simplicity and given confidence right from the start. Once having heard the reproductive capabilities of a particular set, and being fully satisfied with them, it will not be a difficult matter to answer any queries which the customer is almost sure to ask regarding batteries, valves and renewals generally. He will already have seen that despite their apparent number, they can be arranged neatly and put out of sight, and he can be made to appreciate that by the use of valves of the .06 class the bugbear of accumulator charging is eliminated.

**R**ATHER more difficult to satisfy is the type of customer who requires good reception at long distances, especially if he knows nothing about wireless. Primarily, it is useless to put before him a set that will not receive distant stations whilst the local one is transmitting. To tell him that it will probably do so, and then let him discover afterwards that it will not, is asking for dissatisfied customers, and dissatisfied customers who have spent anything up to £40 or £50 may usually be relied upon to tell other people of similar buying capacity their troubles.

Such people must be informed of the fact that a selective receiver is necessarily more difficult to tune than one of a simpler type, and on that account it is probable that a few evenings will have to be spent in learning to tune it. It can be pointed out, however, that the dial settings for a given station, once learnt, will be constant, and may, therefore, be tabulated so that normally it will always be possible to bring in the desired station by resetting the dials at the required numbers.

Finally, a word as to quoting prices. Nothing is more exasperating to a layman than the present method of quoting for wireless sets. He sees a set marked £20, hears a good account of it from someone else, and imagines he will be able to buy it and have it installed for, say, £23. On going to the dealers, however, he learns that he also has to buy valves, batteries, telephones, loud-speaker, and finally, but by no means least, a patent royalty. Why not quote two or three alternative prices for complete outfit, varying slightly according to type of valves, batteries, loud-speaker, etc.? Not until some more direct and obvious method of pricing complete outfits is revised will wireless business be put on a par with others of a similar nature, such as any of the various branches of the music trade.

For Your London  
Headquarters

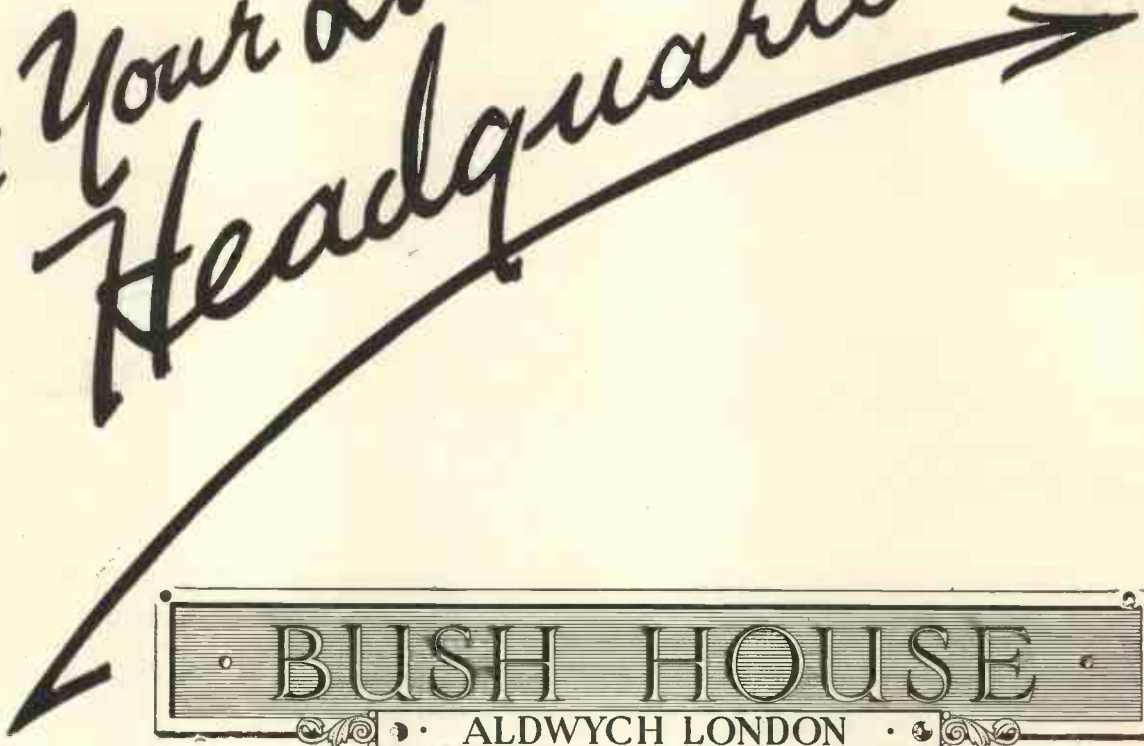

**BUSH HOUSE**  
ALDWYCH LONDON



*Bush House, Aldwych.*

*"The Broadcaster" Radio Trade Showrooms can be reached by lift from both Aldwych and Strand entrances.*

**SEE OVER**

# HAVE YOU SEEN—?

Being a description of a selection of the display at "The Broadcaster" Radio Trade Showrooms

[Photos by H. A. Key]

## Dubilier Condenser Co., Ltd.

**D**UBILIER condensers are so well known throughout the trade that it is difficult to find new points to put before our readers. In the display of the company at THE BROADCASTER Radio Trade Showrooms, at Bush House, Aldwych, there is the latest Dubilier product, the "Duwatcon."

This condenser has two sets of vanes operated from a single spindle, one set being larger than the other. The shape of the vanes enables the normal maximum wavelength to be obtained when the dial setting is at 120 degrees. Further rotation of the dial causes increase in wavelength until when the dial is at 180 degrees the coil is tuned to a slightly higher wavelength than would be given by switching the condenser to parallel and turning the tuning dial to zero.

Thus the gap that usually occurs in the tuning range between the series and parallel position is obviated.

The standard "Duwatcon" has a maximum capacity of .0007 mfd.

In addition to the "Duwatcon," the Dubilier Company is displaying the usual range of fixed condensers, grid leaks, anode resistances, and standard variable condensers, including a particularly handsome laboratory model.



A group of the well-known Dubilier condensers on show at Bush House.

## Multiphone Terminal Co.

The principal item in this display is the Multiphone terminal, which is made in two types, four-way and six-way. Both types are designed to allow multiple pairs of headphones to be used, and the four-way type consists of an oblong piece of brass drilled at one end to slip over the standard terminal head. Four other holes are drilled in the connector and fitted with screw terminals.



A neat displ. by the Multiphone Terminal Co. The initials "M.T.C." are formed by the terminals.

The six-way type consists of a circular piece of metal with a hole in the centre which is used to connect to the standard terminal in the same way as the four-way type. The six holes, which are, of course, fitted with screw terminals, are drilled equidistantly around the edge of the connector.

The remaining portion of this display is devoted to a tapped coil tuned crystal set, headphones, and a one-valve amplifier.

## Superlamp, Ltd.

Two types of loud-speakers are shown by this firm. These are the "Superadio" and the "Songster" de luxe. Both are stoutly made speakers, the "Superadio" being a moderate power instrument, and the "Songster" a small power, but none the less efficient, instrument. This latter loud-speaker, by reason of its neat appearance and extremely moderate price, is creating considerable interest.



The little but efficient "Songster" loud-speaker, shown by Superlamp, Ltd.

The "Superadio" crystal set No. 2 is also shown, and consists of a variometer tuned receiver mounted on a sloping panel case. Lightweight headphones and "Superadio" crystal, attractively boxed, complete the display.



A few more exhibits of Superlamp, Ltd.

## L. G. Russell.

Some two dozen types of the famous Russell crystals are displayed here, including "Valvox." There is natural and treated galena, iron pyrites, tellurium and silicon.

All these crystals are very attractively boxed, and they are undoubtedly

"sellers" and are creating considerable interest amongst all visitors to the Showrooms.

The display is itself very attractive and a lesson to the retailer in the art of displaying crystals to catch the eye of the public.



L. G. Russell's neat display of various types of crystal.

## British Electrical Sales Organisation.

In the last issue of THE BROADCASTER AND WIRELESS RETAILER, we commented upon the new "Beco" loud-speaker, which was recently placed on the market by the British Electrical Sales Organisation. This loud-speaker is displayed at the Showrooms in all models.

The "Beco" is certainly one of the most artistic speakers on the market, and its performance is good. It is made in four types, all the same so far as technical details are concerned, but differing in outward appearance so far as the decorative scheme is concerned.

These four types are finished in nickel plated, oxidised silver, oxidised copper and gold plated.

In the same display is shown the "Nufone," a lightweight, low-priced British-made headphone.



Three "Beco" loud-speakers and a pair of "Nufone" headphones exhibited by the British Electrical Sales Organisation.

## Portable Utilities Co., Ltd.

The famous "Eureka" transformer made its appearance at THE BROADCASTER Radio Trade Showrooms some time ago and has naturally been of keen interest to every visitor. Both types, the Concert Grand and the No. 2, are shown, and the display is most attractive.

The main features of this transformer are too widely known to be described here, but it may be stated that the No. 2 is specially designed for second and subsequent stages of low-frequency amplification.



A group of Eureka Transformers exhibited by Portable Utilities Co., Ltd.

The transformer is steel cased, and is provided with four "feet" for assembly on the panel. Attractive "Eureka" showcards are also included in the display.



A neat range of components, and the Bebephone crystal set, shown by Rooke Bros.

**Rooke Bros.**

The simple and efficient "Bebephone" is shown in this display. It is a variometer tuned set with a wave range of from 250 to 650 metres, and has a glass enclosed detector and provision for the insertion of a loading coil for the high power station.

A new two and three way coil-holder which has behind panel connections, is also shown.

**Dubilier Condenser Co., Ltd.**, Ducon Works, Victoria Road, North Acton, London, W.3. Telephone: Chiswick 2241.

**Multiphone Terminal Co.**, 21, Gt. Russell Street, London, W.C.1. Telephone: Museum 3436.

**Superlamp, Ltd.**, 92, 94, Paul Street, London, E.C.2. Telephone: London Wall 7869.

**L. G. Russell Laboratories**, 1-7, Hill Street, Birmingham.

**British Electrical Sales Organisation**, 623, Australia House, Strand, London, W.C.2. Telephone: City 7665.

**Portable Utilities Co., Ltd.**, Fisher Street, London, W.C.1. Telephone: Holborn 711.

**Rooke Bros.**, 7, Seaford Street, London, W.C.1. Telephone: Museum 2823.

**Standard Screw Manufacturing Co.**, 9, Charterhouse Street, Holborn Circus, London, E.C.1. Telephone: Holborn 4696.

In addition there are several types of crystal detectors both vertical and horizontal.

The remaining part of this interesting display is composed of two and three way coil-holders, basket coil adapters and coil plugs. All are well made, and have plated metal parts.

**Standard Screw Mfg. Co.**

The demand for brass parts, unfortunately, far exceeds the supply, and therefore traders who are looking for terminals, washers and brass work of various kinds will be especially interested in the display of the Standard Screw Manufacturing Company.

The exhibit consists amongst other things, of many types of terminals, crystal cups, nuts and washers and threaded rods.

The workmanship is of the highest order, and the "finish" is all that could be desired.



A range of brass parts exhibited by the Standard Screw Mfg. Co.

## "The Broadcaster" Radio Trade Showroom Postage Saving Service

Save postage and use the coupon printed below when you wish to make appointments at the Showrooms. We will communicate with the firms concerned.

To The Manager,  
"The Broadcaster" Radio Trade Showrooms,  
Bush House, Aldwych, London, W.C.2.

Dear Sir,

I expect to visit the Showrooms on ..... day next, the ..... inst., at ..... m. approximately.

I shall probably wish to purchase wireless goods as detailed below.

Yours faithfully,

Trade Name .....

Particulars of radio material required :

# Practical Points

## on the Installation of Receivers—III.

**A**CCUMULATORS are considered by a great many as the biggest drawback in valve wireless receivers. To a large extent there is some truth in this opinion, but there can be no doubt that a very considerable amount of the troubles associated with accumulators could be overcome if the installer were to educate the householder in their proper management.

In the first place it must be remembered that the accumulator is not in its proper place in the drawing-room or, indeed, in any living room in which the wireless set is probably installed. Very many listeners-in keep the accumulator either in the cabinet of the set or in some other place which is fairly close at hand. Where the accumulator is small and fitted with an acid proof top which is kept quite clean, it is easily possible to overrate the harmful effects which its presence might cause in a living-room.

Speaking generally, however, accumulators must not be placed in positions where the fumes may adversely affect the health and the property of the householder. Accumulator fumes can soon be detected by a sharp acrid smell, and silver and other metals coming into contact with the fumes soon tarnish. For a long time the accumulator is probably not suspected.

One method of overcoming the trouble, and probably the best, is to place the accumulator some distance from the set in a place where the obnoxious fumes can do no harm. Such a place might be a disused cupboard or even on the window-sill of a back window, providing a waterproof cover is used to keep out the rain. In many cases a convenient external place will probably not be available, but wherever possible its advantages should be pointed out to the householder. A length of heavy lighting flex having rubber insulation will form a suitable conductor from the accumulator to the set.

Where the accumulator must be fixed in the room in which the set is installed, precautions can be taken to minimise the effects of fumes. The accumulator should have every trace of spilled acid removed after recharging, and the vents fitted securely into position to prevent the possibility of further spilling.

**T**HE accumulator, when cleaned, may be housed in a substantial wooden box with a tightly fitting lid, and placed under the table. If room permits, a piece of absorbent flannel may be placed over the top of the accumulator to absorb any fumes which may be given off.

The great disadvantage of properly fixing the accumulator in an out-of-the-way place is the liability to forget all about it until the charge has become exhausted. This should never be allowed to occur, as damage is done to the accumulator by discharging it beyond its proper voltage, namely 1.8 volts per cell. The householder should keep a check on the voltage by means of a pocket type

voltmeter kept for the purpose. This the installer may be able to supply at a few shillings. The correct method of holding it should be demonstrated. The positive contact of the voltmeter should be firmly pressed on the positive terminal of the accumulator. Point out that a good metal to metal connection is necessary and that a connection taken from a corroded terminal will give a false reading. If the reading is 1.8 volts per cell or lower, the accumulator should be immediately recharged. The householder will know this voltage better by calling it a little more than  $1\frac{3}{4}$  volts. The exact position should be pointed out to him on the instrument he purchases. The fact that overdischarging an accumulator damages the plates must be explained.

It is more than probable that the purchaser will want to know how long his battery will run on one charge. The method of ascertaining the correct capacity for a given number of valves of a certain type is easily calculated in the following manner. The current taken by the valves should be added together.

This gives the amount of current demanded from the accumulator. For example, the Marconi-Osram "R" valve has a current consumption of .75 amperes, and in a four-valve set employing these valves, the current demanded from the battery will be 3 amperes. Having ascertained the current required by a set, the length of time that a battery will supply it may be found by dividing the amperes required into the actual ampere-hour rating of the accumulator. The result gives the hours of working that may be expected.

The maximum discharge rate of any particular accumulator will be found in the instructions supplied with it. Care should be taken not to confuse the "actual" rating with the "ignition" rating. It is the "actual" capacity which is of importance, the other being entirely ignored. The householder should be warned against the practice of overloading the battery by taking from it more current than the maximum discharge rate allows.

The householder may be saved a lot of trouble if the installer suggests that he calls regularly to take the battery for recharging, leaving a fully charged one for service during the meantime. This system does away with a lot of the bother connected with accumulators.

**F**OR the rapid and correct attachment of the high and low tension batteries, the use of easily identified discs or tabs to the ends of the connecting wires is recommended. For the high tension battery the use of red and black wander plugs for positive and negative wires is common. A good tip is to employ wander plugs of different sizes and shapes. In this way, colour is not the only distinguishing feature and the possibility of wrongly connecting the plugs is to a

large extent eliminated. Spade terminals form a useful means of attaching low tension wires to the accumulator and the householder should be told to scrape them periodically to ensure good electrical connection.

The dull emitter valve is so largely used at the present time that it bids fair to supersede the bright emitter entirely. The accumulator will probably not be entirely ousted from wireless work, however, as some types of dull emitter valves, such as the D.E.R. type of the Marconi-Osram Company, are designed to run off 2 volt accumulators. Dry batteries for filament lighting are growing in popular favour, but great care should be taken in their selection to see that they are suitable for the valves to be used with them. Valves designed to operate from dry batteries have a very small current consumption, the valve requiring .06 amperes being probably the most common dry battery type of valve.

The dry battery cannot be recharged when run down in the same way as an accumulator, and must be thrown away. Such batteries pick up their voltage for intermittent use and when used with a single valve of the .06 type may put in many more hours of work.

Connecting wires to a loud-speaker or to a telephone distribution board often gives rise to an accidental short circuit unless care is taken to provide against the possibility. When binding a flexible wire which consists of many strands of fine wire under a terminal, it often happens that one or two strands become detached and pass unobserved. The trouble arises when such stray ends touch each other or short circuit across to the opposite terminal. The stranded ends should be twisted round each other and soldered. Another method is to bind a fairly fine tinned wire in spiral fashion across the bared ends of the wires, and by continuing the binding over the end of the insulation, the unsightly frayed ends are neatly concealed.

In cases where several pairs of telephones are to be used, increased efficiency is often to be obtained by connecting them in a particular way according to their resistance and the circuit in which they are to be used. Where a step down telephone transformer is not used, telephones of high resistance are required. As a rule telephones of greater resistance may be used in a crystal set to those required by a valve receiver. Supposing four pairs of telephones, each of 2,000 ohms resistance, are to be used in a crystal set. By placing them all in parallel, the net resistance is very considerably lowered and better results would probably be obtained by a series-parallel arrangement. This consists of joining two pairs in series to the telephone terminals, the second two pairs being similarly connected to form a parallel arrangement with respect to the first two pairs.



# Low-Frequency Transformers

by Michael Egan

Some selling points to help you increase your transformer sales

FOR some time past the honours have been fairly evenly divided between low frequency transformers and loud speakers in the matter of distortion of signals. Although there have been times when *all* the blame was heaped on one or other of these two components, they have, on the whole, received more or less equal shares of blame in the course of the past couple of years. In the early days of broadcasting one rarely heard reports of distortion in connection with telephones; in nine cases out of ten the villain of the piece was a loud-speaker. Then someone with a sense of justice pointed out that distorted signals are also sometimes traceable to inefficient low-frequency transformers, and public opinion—fickle and unstable as it always is—immediately turned on the low-frequency transformer and tore its character to shreds. To-day, however, there is evidence of the fact that a large percentage of the amateur wireless public is beginning to realise that distortion of signals can be due to a number of causes.

Though the responsibility for distortion rests chiefly with the low-frequency transformer and the loud-speaker, this trouble may also be due to a number of other causes. A faulty valve is almost certain to distort signals. Even a good valve, if its impedance value does not suit the transformer in use (however efficient the latter may be) may be responsible for lowering the quality of signals. Again, if a set is wired badly, interaction effects may lead to distortion. And an even commoner cause of trouble of this kind is *unskilful operating*. The market to-day is well stocked with loud-speakers and transformers which, if used in suitable combinations, are capable of giving perfectly distortionless reproduction; yet even the best of these are also capable of yielding distorted signals in the hands of careless or inexperienced amateurs.

Coming to transformers themselves, the efficiency of these instruments for broadcast reception depends upon a number of things. Most of the transformers that were pressed into service when broadcasting first began were of the kind that had formerly been used for amplification in wireless telegraphic circuits. As all telegraphic signals fall within a comparatively narrow band of audio-frequencies, and as the problem of distortion had little significance in connection with the reception of such signals, these early transformers were designed primarily to give maximum amplification with minimum energy loss.

The result was that when one of these instruments was used in a set for the purpose of receiving broadcast programmes, certain frequencies were amplified excessively, whilst others were scarcely reproduced at all. In the case of musical reception this meant that practically all the finer tones that comprise the "soul" of music were lost.

One of the most important problems, therefore, in connection with transformer design for broadcast reception is that of securing equal amplification over the whole range of audio-frequencies.

This problem demands, in the first place, the reduction of self-capacity in the coils to a minimum. The larger the capacity of a coil, the more pronounced will be its natural frequency, and when a transformer has a definite natural frequency of its own all signals of that particular frequency are amplified excessively at the expense of signals of different frequency, and distortion inevitably ensues.

IF a curve be plotted showing the degree of amplification that such a transformer gives at various frequencies it will have a marked "peak" at one point, and a peaked characteristic curve is just the kind of curve that is *not* wanted for broadcast reception. The ideal curve for broadcast reception would be a perfectly straight line—*i.e.*, a curve which showed that the transformer magnified all frequencies to an equal degree. The characteristic curves of a number of transformers on the market to-day are quite straight over a fairly wide range of frequencies. With most of these, however, magnification drops in the neighbourhood of the lower audio-frequencies. This does not mean that signals at these frequencies

an iron path, therefore, it is desirable that the core be of large dimensions. Hysteresis effects are due to the lagging of the magnetic flux behind the current that produces it. The extent to which they are experienced depends almost solely upon the quality of the iron used in the construction of the core.

Many of the cheap transformers on the market to-day are open to criticism in respect of this latter factor. Again, when two of more low-frequency transformers are used in the same receiver there is a danger of interaction taking place, particularly if there is magnetic leakage. With a view to minimising the risk of inefficiency from this source, a number of manufacturers have adopted the practice of "shrouding" their transformers in a metal envelope.

ALTHOUGH these three latter factors have an important bearing on the ultimate efficiency of a transformer, the central problem of transformer design concerns the method adopted for winding the coils with a view to eliminating mutual and self-capacity. In this connection the new improved model of the well-known R.I. transformer represents a distinct advance in the design of transformers for broadcast reception. In this instrument the primary coil is wound outside the secondary instead of inside, as in the case of many other models (including the early R.I. model). Moreover, the bobbin on which the coils are wound is made up in six sections, the coils themselves being similarly divided into sections. This patent method of winding has resulted in decreasing the self-capacity of the coils considerably. Heavy gauge wire is used, thereby eliminating risks of "burn out," and the iron core is of ample dimensions. Though these factors tend to make the transformer somewhat large, few amateurs will deny that efficiency is more important than size. Moreover, it must not be forgotten that there are larger and less efficient transformers on the market. The new R.I. gives good amplification, with remarkably clear and full-toned reproduction over the full range of audio-frequencies.

The Igranic E type transformer is another instrument which stands well in the forefront of reliable standard transformers to-day. Its amplification factor is considerably higher than that of many other transformers of modern design, being in the neighbourhood of 32. This high amplification, as shown by the instrument's characteristic curve when used with an R type valve, is maintained over a wide range of frequencies. At 900 cycles, 75 per cent. of maximum amplification is obtained, whilst the curve shows 65 per cent at 600 cycles. In another model of the same transformer (type E2) the amplification is 75 per cent. of maximum at 600 cycles; this instrument has a lower ratio than the former, however, and its total magnification is somewhat less. I have found the Igranic type E



The Marconi "Ideal" L.F. transformer, a splendid instrument.

are necessarily distorted; small variations in magnification may not lower the quality of signals to any appreciable extent.

Apart from the problem of securing constant magnification, the efficiency of a transformer depends upon the extent to which eddy currents, magnetic leakage and hysteresis effects are eliminated. It is well known, of course, that laminated construction is universally employed to-day for the purpose of dealing with the first of these sources of trouble. Magnetic leakage is prevented by providing a low resistance path for the field; in order that all the lines of force shall have

very efficient in practice, a "silent worker" in spite of its big amplification.

The Ferranti transformer is a low-priced instrument which can also be relied upon to give a high quality of reproduction. This is one of the cheapest transformers on the market, and it also ranks amongst the most efficient. A characteristic feature of the Ferranti is its core, the stampings of which are assembled very closely and accurately, thus prohibiting even the smallest air gap. The good performance of this instrument is probably due in no small measure to the fact that it is built, as its manufacturers assert, of the "finest transformer steel available." At any rate, it is certainly capable of yielding practically distortionless signals over a wide range of frequencies.



Here is the Igranic E type, a very reliable transformer.

Its comparatively small, neat appearance, though of secondary importance, is also a noteworthy characteristic.

**M**OST manufacturers of transformers have now adopted the practice of giving away a small booklet containing practical hints with each instrument. In many cases a selection of standard circuits is also included. Almost invariably the use of grid bias is recommended for low-frequency amplification, for the purpose of enabling the valve to function on the centre point of the slope of its characteristic curve. In order to give a transformer a fair chance to work at its maximum efficiency, moreover, the use of a small condenser across the primary coil is also recommended. This should have a capacity of between .0002 and .0003 microfarads. Its function is to prevent high-frequency currents from passing through the transformer. It is advisable to use condensers for this purpose in every stage of low-frequency amplification.

Whilst by-pass condensers and suitable grid bias will do much to improve the quality of reception, however, they will not convert a bad transformer into a good transformer. They clear the ground, as it were, and give a transformer a fair chance to show what it can do; but that is all. Writers in wireless periodicals and text-books also sometimes recommend the use of a damping resistance across the secondary of the low-frequency transformer. This may have the effect of flattening the transformer's characteristic, thus reducing the amount of distortion that might otherwise be experienced, but it also reduces the efficiency of the transformer considerably. The fact is, there is no "short cut" to efficient, distortionless amplification of low-frequency signals. Dogged research, ceaseless practical experiment, and the unstinting use of first-

class material throughout are the only means whereby this can be achieved.

The truth of this is exemplified in the Marconiphone "Ideal" transformer, which I think might justly be defined as the Prince of Transformers. It would be superfluous to comment on the amount of research or the quality of material expended in connection with Marconi products. These are well-known "constants." And, anyhow, so far as concerns this particular instrument, the proof of the pudding is in the eating. I have used the "Ideal" in an ordinary, straightforward circuit, and the signals produced were—literally—perfectly free from distortion. Moreover, there were no extraneous noises of any kind to interfere with the clarity of signals: no rustling, no whispering, no resonance effects on the high notes.

In this transformer self-capacity is reduced to a minimum by interleaving the primary and secondary coils in sections and spacing adjacent sections at suitable distances. The instrument is enclosed in a metal case which effectively traps any field leakage that may occur. The "Ideal" is made in three ratios, viz.:—2.7 to 1, 4 to 1 and 6 to 1. The latter is intended chiefly for use with low impedance valves, particularly in the last stage of amplification, whilst the two former models are capable of yielding best results with valves of high impedance. A 6 to 1 ratio transformer gives a magnification factor of 33 with a low impedance valve; this factor is practically dead constant over frequencies ranging from 600 upwards, and the drop in magnification at 300 cycles is no more than 10 per cent. The makers of the "Ideal" inform me that, owing to the enormous demand they have had to meet for this instrument, it is impossible to promise deliveries to the trade before next June.

**T**HE "Powquip" is a well-made instrument which can be relied upon to give a good performance on all suitable circuits. In the design of this transformer the customary practice of winding the secondary over the primary is adhered to, efficient insulation being achieved by binding adhesive tape of a special kind periodically between the layers of the coils. The insulation on the wire itself is not cotton, or silk, but enamel—a form of insulation which, whatever its drawbacks may be, has certain advantages of its own. Enamel insulation certainly effects economy in space, which is always an important factor in transformer design. Moreover, being non-absorbent, its efficiency cannot be impaired by moisture. On the other hand, enamelled wire used for this purpose should be subjected to very exacting tests at every stage of the process of manufacture in order to ensure that the insulating properties of the enamel are not affected adversely. The results obtainable with a "Powquip" are an adequate guarantee that the importance of such tests has not been overlooked by its makers. The well-known "Success" transformer is another instrument in which enamelled wire is employed with satisfactory results.

One of the most popular transformers on the market at present is the "Eureka" Concert Grand. This instrument is capable of yielding considerably greater amplification than the majority of standard products. This quantitative result,

moreover, is not obtained at the expense of quality. The "Eureka" gives strong, full-toned signals throughout the audio-frequency range, with a quality of reproduction that is more nearly "distortionless" than that obtained with the majority of transformers. It is "shrouded" in a coppered steel case, the latter being fitted with "fixing legs" which are easily accessible. Another well-known model is the "U.S. Super" transformer. This is one of the biggest and strongest instruments on the market at present, with a core of ample dimensions. I have used it with satisfactory results in both first and second stages of a two-valve low-frequency amplifier.

**A**MONG the best of the smaller transformer models of which I have had practical experience, I would mention particularly the "Energo." The small size, weight and price of this little instrument do not prevent it from giving results which entitle it to rank beside many of its larger rivals in the matter of efficiency, especially in the first stage position. Its small size and weight also recommend it particularly for "portable" wireless work. The "Formo" transformer is another small instrument which can be depended upon to give a good standard of performance. It is very solid and robust, with a strong metal shroud.

It may be worth noting here that there has always been a general tendency among radio amateurs to associate "quality of signals" with "complexity of circuit," that simple receiving circuits are inherently inefficient, and that really satisfactory results can only be obtained by using involved circuits. I fully believe



The Powquip transformer, in which enamelled wire is used for the windings.

that this heresy is responsible for at least 50 per cent. of the disappointments that amateurs experience in connection with reception. In fact, it is becoming more apparent every day that the majority of amateurs who build complicated sets are quite incapable of operating them; moreover, some of the best reports of amateur reception come from those who have contented themselves with the simplest kind of circuits.

There are, of course, genuine experimenters who possess sufficient experience and technical skill to justify their using involved circuits—for long range, or short-wave work, etc. But these are certainly in the minority. In this connection a dealer can often play the role of angel in disguise by advising new clients to stick to simple, straightforward circuits, pointing out that complex circuits are rarely necessary for the purpose of ordinary broadcast reception and that unnecessary complexity in a receiver is frequently a potent cause of distortion.

# SELLING CONDENSERS

THE job of selling wireless components is not what it used to be. In the early days of broadcasting wireless components, more or less, sold themselves. The salesman's word was law. The public, knowing nothing of the mysterious cult of wireless, accepted what the salesman offered without a murmur. "I want a good one-valve set." "I want a three-valve set—not too expensive." "I want a set that will work on an indoor aerial at six miles range from 2LO." These were the kind of requests that flowed like soft music into the ears of salesmen once upon a time. With the rapid growth of a technical wireless Press, however, the public gradually became wise, and the tranquil harmony of the salesman's life began to be disturbed by such questions as: "Is a valve detector really any better than a crystal?" "Is one valve with reaction as good as two valves without reaction?" "What is to be gained by using a tuned anode circuit instead of a transformer?" And now, after two and a half years of intensive education in these matters, the public demands—and expects—all sorts of detailed information from the salesman.

It is no longer sufficient, therefore, for a salesman to be able to talk pleasantly about his wares. He must be able to support his pleasant statements by *convincing technical arguments*. Take, for example, the variety of purposes for which the condenser is used. There is the tuning condenser, the telephone condenser, the grid "leaky" condenser, the H.T. reservoir condenser, the intervalve coupling condenser, the transformer by-pass condenser, and so on. The efficient salesman should be able to explain the individual purpose of each type of condenser, and be able to advise as to suitable capacity values. The following notes suggest the kind of information he should have at his fingertips.

(the aerial, in this case, acting as one condenser), the resultant total capacity is less than the capacity of the smaller condenser. As it is sometimes desired to use the aerial condenser in such a way that it can be switched in series or parallel with the aerial, alternatively, it may be necessary to compromise in the matter of the maximum capacity. When required for use in this way, however, the maximum capacity should certainly not be less than .0007. For tuning a secondary circuit a maximum capacity of .0005 is usually quite sufficient for ordinary purposes; a capacity of .0007 is sometimes recommended, but it is on the large side.

The anode circuit of a high-frequency valve is sometimes tuned by means of a coil and variable condenser. The average value of a condenser used for this purpose is about .00035. Sometimes, again, a high-frequency valve is coupled to a detector (crystal or valve) with the aid of a high-frequency transformer. Better signals will usually be obtained by connecting a small condenser of .0002 or .0003 capacity across the primary winding of this transformer. A fixed condenser is usually employed for this purpose, though it may, of course, be variable.

Yet another method of coupling valves together is by means of what is usually termed a "resistance-capacity" coupling, the capacity element being usually supplied by a fixed condenser. When the coupling is between high-frequency valves the capacity of this condenser lies between .0002 and .002, the larger values (towards .002) being employed when it is desired to receive the longer wavelengths (i.e., lower frequencies). When used as a coupling element between low-frequency valves, the capacity of this condenser should lie between .005 and .1.

of this condenser may be in the neighbourhood of 1 microfarad. Its function is to smooth out the irregularities that are likely to occur in the voltage of the battery. When a detector valve is fitted with reaction a fixed condenser of about .002 capacity is sometimes connected across the primary of the low-frequency transformer. This acts as a by-pass condenser for the radio-frequency component of the current that flows in the anode circuit of the detector valve. When no low-frequency valves are used, and the telephones are connected directly in series with the anode of the detector valve, a similar condenser is employed—shunted across the telephones. In this case it acts as a reservoir condenser which stores up the high-frequency impulses as they flow into it in "batches" and passes them on to the telephones as low-frequency impulses. If a telephone transformer is used (with low resistance phones) the condenser is shunted across the primary of the transformer.

TO return to the subject of variable tuning condensers, many amateurs are still ignorant of the advantages to be gained by using "vernier" condensers. An inductively coupled aerial is frequently recommended as the best means of overcoming interference, but the value of this arrangement is sometimes doubled by the increased selectivity that can be obtained by using vernier condensers in both aerial and secondary circuits. Condensers of square law design also assist in eliminating interference inasmuch as they prevent "overcrowding" of signals of approximately the same wavelength at one point on the graduated scale, and thus facilitate accurate tuning. Hand-capacity effects sometimes make it extremely difficult to obtain fine tuning. This trouble is usually experienced in connection with the adjustment of condensers on the high-frequency side of a valve amplifier, particularly in the case of short wave reception. Long-handled condensers are always to be recommended for use in such circuits. As a further means of eliminating hand-capacity it is usually advisable to connect the moving vanes of the condenser to earth, though in the case of condensers fitted with metal end plates the earthing should be done from the fixed plates.

Experimenters are sometimes handicapped by the fact that, when switching over the aerial tuning condenser from the series to the parallel position, or vice versa, a "gap" occurs in the tuning range. That is to say, the maximum wavelength to which the aerial can be tuned when the condenser is in the series position is less than the minimum wavelength to which it can be tuned with the condenser in the parallel position. It is, therefore, impossible to get an unbroken tuning range with an ordinary condenser. The "Dawatcon" (produced by the Dubilier Company) has been specially designed to overcome this difficulty. This is a variable condenser with two sets of vanes, but with a single control knob. Owing to the setting and shape of the vanes there is always an overlap between the maximum-series and minimum-parallel valve. It is an excellent instrument, and one which should sell "on sight."

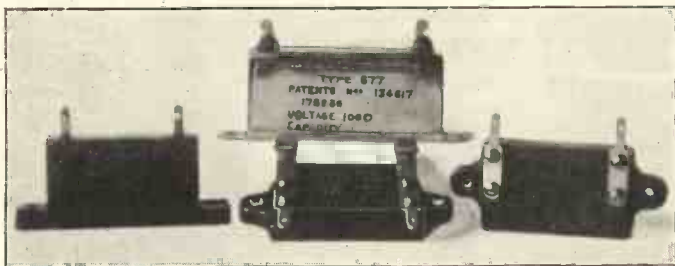

A group of Dubilier condensers. At the back is the Type 577, and the front ones, from left to right, are Types 600A, 600 with clips, and 600.

Variable tuning condensers are used for three main purposes—to tune the aerial circuit, the secondary circuit or the anode circuit of a receiver. (The latter only refers to valve circuits, of course.) An aerial tuning condenser can be connected either in series or parallel with the aerial inductance. When connected in series its capacity should be about .001 microfarads, or even .0015. When connected in parallel a maximum capacity of .0005 or .0007 will be sufficient. The reason why the larger condenser is recommended for series use is because a small condenser, when connected in series, reduces the total capacity of the aerial by a considerable amount; the smaller the capacity used the greater the reduction in the total capacity of the aerial. When two condensers are connected in series

ONE of the most popular methods of using a valve as a detector is that which utilises a "leaky" condenser. This is usually a small fixed condenser of about .00025 capacity, the leaking effect being obtained by connecting it to a very high resistance. The condenser is connected in series with the grid of the valve, and rectification is made possible by the accumulation of electrons on the grid side, from which they can only leak away very slowly through the resistance. The condenser that is used for this purpose may, of course, be variable, but there is little to be gained by this. It is much more usual to employ a variable resistance with a fixed condenser.

It is always advisable to connect a reservoir condenser across the high tension battery of a receiver. The capacity

# WIRED WIRELESS

*A system of communication which employs wireless apparatus for transmitting and receiving, but also requires "all wire circuits" between the transmitting and receiving stations*

**W** IRED wireless is the term applied to a system of telephonic or telegraphic communication which, although using metallic conductors, employs wireless methods of transmission and reception. As has been outlined in the "Elementary Theory" articles in THE BROADCASTER, the sole difference between a single phase alternating current and the wireless oscillatory current is one of frequency, the latter being very many times greater than that of the former. The use of high-frequency currents makes circuit conditions of no importance in ordinary A.C. work of very considerable importance and have marked effects on the high-frequency currents passing through them. With these currents circuit conditions may be designed which will enable a certain part of the current to become detached from the conductor, as it were, and radiated into the surrounding ether.

Radio transmission, of course, is dependent upon this fact, but it is also clear that by suitably designing the circuit so that the least possible proportion of the current is radiated, will enable such currents to be transmitted along wires in the same way as ordinary continuous or alternating currents. The simplest and best method of accomplishing this is to connect the output and input terminals respectively of an ordinary wireless transmitter and receiver to a coupling between the ends of two parallel wires suspended in air.

Under such conditions the current tends to travel in the ether surrounding the conductors rather than through the wires themselves. The latter, however, serve to guide the current along its path, and little current is lost through radiation in the accepted wireless sense.

At this stage one is inclined to ask what useful purpose is served by such a scheme. The reason is that by the adoption of suitably chosen frequencies it is possible to transmit more than one current along the same wire simultaneously, so that in the case of power lines carrying ordinary A.C., for instance, speech and music may be transmitted at the same time without interference. Again, providing sufficient disparity in frequency were arranged, two or more different high-frequency currents representing different messages or entertainment programmes may simultaneously be sent. All this is possible with a much greater electrical efficiency than obtains with ordinary wireless systems.

High-frequency currents possess the property of being able to pass through conditions which may prove insuperable to currents at ordinary power frequencies. For instance, they may readily and economically be passed through the medium of a small and weak inductive or capacitive coupling. Couplings of this description, therefore, could safely be applied to lines carrying electric power up to any amount, and although none of the main power would be lost through the coupling, the high-frequency currents would be able to pass and be used. No possible damage due to the main power could exist providing the insulation of the coupling device was sufficient to withstand the pressure.

Power lines of all kinds are not equally suitable for conveying high-frequency currents. Iron wires, for example, are unsuitable because of the high losses due to

hysteresis, while underground cables possess too great a self capacity. Overhead conductors are, therefore, best, and their ohmic resistance is not important.

It is important, however, that the lines do not suddenly vary in constants, as by sudden changes from overhead to underground and *vice versa*, and for this reason overhead power lines are usually to be preferred to telephone lines. With suitably chosen or designed conductors, the power required to traverse hundreds of miles is only some twenty watts input—very small compared with radio transmission.

Where circumstances render it impossible, or where accident has been the cause, wired wireless communication is still possible even over gaps in the actual conducting medium. As an instance of what can be done in this direction, an interesting example is that of some experiments which were recently conducted in England. Here high-frequency telephonic communication had been effected over some telephone wires running parallel with high voltage power lines. Quite unknown to the operators, some 200 yards of the telephone wires had been blown down, and no loss in strength or discontinuity of conversation was noticed.

**I**T is now possible to show what may be done in the way of transmitting more than one message simultaneously over the same pair of conductors. The wired wireless system possesses all the same possibilities and methods of wireless receivers for obtaining selectivity, so that it is comparatively simple to differentiate between different frequencies at the receiving end. It must not be thought, however, that the number of frequencies it is possible simultaneously to transmit is limited only by the selectivity of the apparatus employed.

The lowest limit in frequency is generally considered to be 20,000 cycles, for below that figure the alternations would themselves be heard by the human ear. The combination of two frequencies to produce a third by heterodyning must next be guarded against, and therefore all succeeding frequencies above that of the lowest must be so far apart that they cannot combine. This fixes a definite low limit of 40,000 for the second frequency, 60,000 for the third, and so on. The limit as regards the highest frequencies that may be employed is dependent chiefly upon the characteristics of the lines, but it must not be too high owing to losses due to attenuation.

In addition to the main frequency (which has just been considered) and which corresponds to the carrier wave of the wireless telephone system, there are also the modulated frequencies to be accounted for. These frequencies also tend to produce others, due to combining on the beat principle, and thus complicate the problem of complete selectivity. The use of suitable filter circuits will become necessary on systems employing simultaneous working, and these may be fitted either at the transmitting or receiving end or both.

The transmitters and receivers used are of standard wireless types employing valves but arranged for duplex working. This is accomplished by tuning the stations for two slightly different frequencies, and by both sending out a "carrier" current all the time, whether transmitting or receiving. The receiving instrument at either end is

thus impressed with the frequency due to its own transmitter, as well as that of the station with which it is working. Due to the heterodyne principle, these combine and produce a third, on which the receiver actually works. The result is that it is quite immaterial whether the opposing stations are both transmitting simultaneously or not, one station will hear only the sounds from the other.

Only one point in the general scheme now remains to be explained, and that is the means of calling up. The Marconi Co. have developed a device for this purpose which does away with the necessity for the receiving valves being continuously fed with current in readiness for the reception of any current which may come along the wire. This device consists of an electro-capillary tube actuated by a minute rectified current obtained from a permanently set carbonium detector. It acts as a relay, which brings a local battery into circuit, thus giving a signal.

**C**ONSIDER now a scheme employing four stations, A, B, C, and D, each of which is capable of ringing up and conversing with any other station. Each station will be allotted a definite receiving wavelength, and for convenience we may denote each as being  $\lambda A$ ,  $\lambda B$ ,  $\lambda C$ ,  $\lambda D$ , but each transmitter must be arranged to work on any of the above wavelengths. Should C wish to call A, then C transmits on wavelength A, thus calling him. A, on hearing his bell ring, does not yet know who is calling him, so that he uses his receiver only until he has ascertained the information. Having found it is C, A adjusts his transmitter to  $\lambda C$ . Conversation is then possible.

Should B now start up his transmitter, not knowing that A was engaged, and wish to speak to him, jamming would be caused. So that any station must first receive for a second on all frequencies to ascertain whether the man to whom he wished to speak is engaged or not. In actual practice the scheme adopted causes practically no loss of time, although on paper it may appear to, and conversations may be effected with just the same ease as with the ordinary speech-frequency telephone.

The above system of four stations would be very useful in a large electric power undertaking, in which the ordinary power transmission lines could be used as the wired wireless guides, and where one station would be the head-office or chief engineer's department, and the others could be substations.

In America whole districts have been served with wired wireless on electricity supply undertaking's systems, and consumers have been given entertainment through that means in addition to the ordinary electric light and power current. For such a purpose the consumer would employ a device such as the "Ducon" to provide the necessary loose coupling to the lines in order to obtain the high-frequency current. He would listen-in in the ordinary way on his wireless receiver. England does not offer the same advantages as America for the erection of such schemes, for the restrictions against overhead power lines are many, but there is no doubt that in countries where there are no such restrictions, the field of wired wireless is a large one, with many possibilities.

# Polar-Blok Adventures

by F. H. Robinson, A.M.I.R.E.

*A detailed description of the latest types of Polar-Blok apparatus*

**A**LTHOUGH we have "trifled" with the Polar-Blok system of elastic set construction on one or two occasions, it is only recently that we have been able to investigate thoroughly the merits of this wonderful "home construction" system. By the courtesy of the Radio Communication Co., Ltd., we have been able to experiment thoroughly with a number of Polar-Blok units, including the comparatively new "resistance capacity" unit for the coupling of low-frequency valves.

We feel strongly inclined to call Polar-Blok the "Meccano of wireless," but hasten to add that whereas Meccano is but at its best a toy, by means of which one may build a toy crane, Polar-Blok is a means of building, as easily as one would build a toy crane with Meccano, a receiver which is scientifically designed and which will give scientific results.

The toy crane built with Meccano will do a certain amount of "toy" work—Meccano is an admirable invention designed to teach the mechanically-minded the principles, say, of the construction of a modern bridge, by enabling the possessor to construct a model bridge. There is also the satisfaction of possessing a model that will work.

Polar-Blok, on the other hand, has all the advantages of the "toy" so far as ease of assembly is concerned, but in ad-

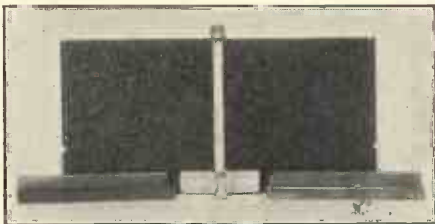

*A group of the parts which form the framework of the receiver.*

dition has the immense advantage of enabling the possessor to build a scientific receiving set.

How many budding wireless enthusiasts have had their ardour cooled because of the poor results obtained by constructing a receiver in the orthodox manner? The would-be experimenter expends hours and hours of labour and thought on a set and at the end obtains from the loud-speaker or headphones a collection of soul-searing howls and squeals.

The trouble is that although the novice may buy excellent components he will probably assemble them wrongly. With the Polar-Blok there is a guiding hand behind him all the time. Not only are the components scientifically designed, but the mind that designed them has also evolved a system which makes it impossible for even a tyro to nullify the efficiency of each individual component by inefficient assembly.

Whilst we are on the subject of the

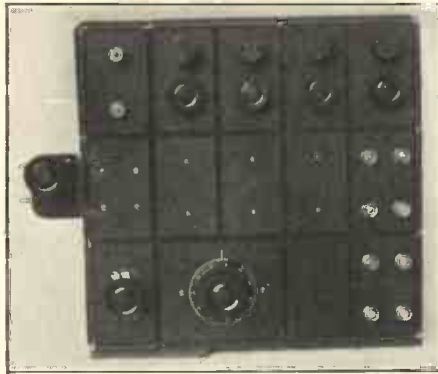

*A four-valve resistance-capacity coupled receiver, with detector and three L.F. valves.*

help given to home constructors by the makers of the Polar-Blok, we feel we should comment upon a certain journal—*Radio*—which makes an appearance every quarter.

We are not concerned with *Radio* as a wireless magazine, but we would like it known that with the "Blocs" supplied to us by the Radio Communication Co., Ltd., we tried out a number of Polar-Blok circuits as published by *Radio*. Every issue there is published in this journal a certain amount of extremely useful information for users of Polar-Blok, and dealers who find that they have a demand for this apparatus—and undoubtedly in the hands of a capable dealer, Polar-Blok creates its own demand by reason of its very evident efficient and attractive qualities—should make a point of informing every purchaser of Polar-Blok that circuits and constructional details regarding Polar-Blok sets are published in this form. *Radio* is certainly to be congratulated on the help it has extended to users—and therefore dealers and stockists—of Polar-Blok apparatus.

As it is possible to construct a large number of sets embodying different circuits by means of Polar-Blok parts, we do not propose to describe the circuits employed in the various receivers built,

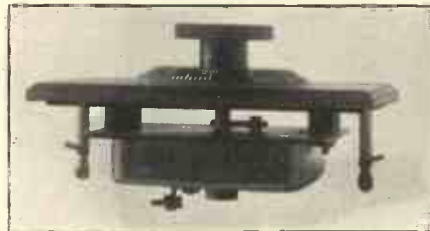

*The Polar-Blok condenser. The metal pillars, with clips for fixing the component to the framework of the set, are clearly seen.*

rather shall we describe the individual characteristics of the various parts.

It may be stated, however, that the

complete receiver built from Polar-Blok, which is illustrated in this feature, consists of a detector and four low frequencies, the low-frequency valves being coupled by means of resistance-capacity units. Reaction is embodied and the high-tension voltages used are fifty on the detector, eighty on the first and second L.F. valves, and one hundred and twenty volts on the last, in which a medium power valve was used. Grid bias was used on all L.F. stages. Whilst this receiver was not built for distant reception it received London and Chelmsford—the latter station being approximately sixty miles distant—on a loud-speaker with remarkable clarity, whilst volume was all that could be desired.

This may not strike many dealers as being a sound test, but we had in view the qualities of the set from the loud-speaker point of view, especially as resistance-capacity coupling was in use. From this standpoint, the performance of the instrument was truly excellent. It should be

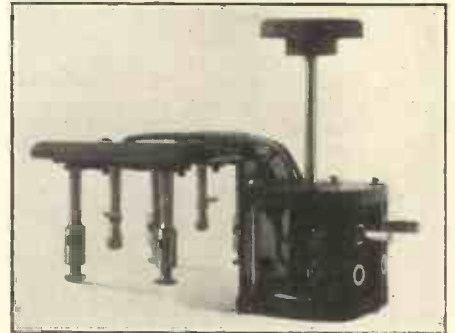

*The coil holder unit. The connections are flexible, and carries to the four terminals on the underside of the panel.*

added that the set illustrated was constructed in one hour and twenty minutes. Whilst no effort was made to assemble the set in record time, this illustrates the ease with which complete receivers may be built by means of the Polar-Blok system.

We do not propose here to discuss those units intended for use in sets employing transformer coupling for low frequency.

### The Framework.

**F**IRST of all there are the "foundations" of the set. The framework is supported on a number of lead pillars, some of which are fitted with angle pieces at the top, whilst the others have cross pieces. There are also small lead cross pieces, and these two means of support can be seen in one of our photographs. The sides of the framework are formed by pieces of square section springy metal which slip over and grip the lead pillars. These metal sections are made in two lengths of four inches and four and a half inches.

The reason for this is as follows. All Polar-Blok components are neatly mounted on ebonite bases, known as "Blocs" and

"half Bloks," the size of the full Blok being 4 in. by 5 in., whilst the half Blok is 4 in. by 2½ in. Thus the completed set, which in every case must have straight sides, may be formed by a framework of any number of metal frame pieces. The complete set illustrated is thus two and a half "Bloks" by three "Bloks." The actual size, therefore, is approximately 12½ in. by 12 in., not counting the projecting coil holder.

One point that should here be emphasised is the fact that nothing more than a screwdriver is required to assemble either the framework or the circuit itself, although a pair of ordinary wiring pliers will be found useful. There is no drilling or soldering to be done.

**The Components.**

**T**HE terminal panels, it will be noticed, are in two types, one type containing four and the other two terminals. The photograph showing the wiring will illustrate the method of connecting by specially designed terminals beneath the panel.

The two-way coil holder of the special Polar vernier type is provided with four connecting posts, and flexible connections from the coil plugs are made to these. The filament resistance units also incorporate the valve holders, and it will be noticed that the resistances themselves consist of two circles of resistance wire with which two metal spring contacts make connection. The action of these resistances is extremely silky and there is an "off" position for each resistance. An excellent point.

The variable condenser unit consists of the well-known Polar condenser with its neatly engraved knob and dial. This condenser is shielded with a brass case that can be "earthed" if required.

The resistance-capacity units which can be seen in the centre of the photograph showing the wiring, are exceptionally neat and efficient. Each consists of a cylindrical former carrying the resistance units mounted on top of the condenser unit. Mullard fixed resistances are used and can be seen making contact with the

small metal clips at the top of each cylinder. These resistances can be removed with ease and replaced if necessary.

The smaller components such as fixed and anode resistances and leaks are provided with clips and fix on to the underneath part of the metal framework. Fixed condensers are assembled in the same way and can be seen in our photograph.

**The Case.**

**T**HE surrounding case that gives the finishing touch to the set can now be obtained in two types. The original type was of polished wood, but the type supplied to us was composed of some metallic substance with an artistically treated surface finished in a kind of mottled black and grey.

This is supplied in sections of convenient size and is provided with a turned edge that fits over the top of the framework. In the centre of the lead pillars a hole is drilled and the side pieces are fixed by means of angle pieces and bolts screwed into these holes. These angle pieces and bolts are nickel finished so that although they show when the set is finished, they are not unsightly.

The wiring of the set is carried out by means of special stiff insulated tinned wire supplied by the Radio Communication Co., Ltd., for the purpose, so that soldering, if considered necessary, is made as easy as possible.

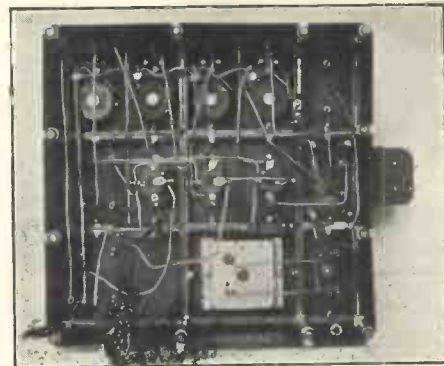

The four-valve resistance-coupled set, showing the wiring. The resistance capacity units can be seen in the very centre of the set.

## Exide Service Scheme

**W**E are able to give complete details regarding the extensive "service" which was inaugurated on March 1 by the Chloride Electrical Storage Co., Ltd., of Clifton Junction, near Manchester, and 219-229, Shaftesbury Avenue, London, W.C., the manufacturers of Exide Batteries.

It is common knowledge that valve users, especially in isolated parts, have up to the present time worked their accumulators under great difficulties. The Exide scheme will undoubtedly be a great boon to many hundreds of thousands of listeners-in.

It may be argued that a large number have already made arrangements to charge their own batteries from the mains. In our experience, however, this is not the case—the majority preferring to use the existing facilities offered by a small proportion of retailers for charging accumulators.

It is an undoubted fact that in most cases the charging services run by many dealers are absolutely inadequate. This is not often the fault of the dealer, but rather the result of the limited facilities at his disposal.

To all dealers, therefore, the news that the Chloride Co. has inaugurated a kingdom-wide charging service must be of intense interest.

**I**T is common knowledge that there have existed for some time a number of Exide Service Depôts—some five hundred or more, we believe—spread about the country. These depôts served the very useful purpose of looking after the needs of motorists carrying Exide batteries. But whilst this organisation was large enough for this purpose, the increasing demands of the listener-in made it imperative to extend the service.

Every Exide Service Depôt has, of course, facilities for accumulator charging, and in many cases for collecting discharged and delivering charged batteries. Some of these depôts deal with as many as seven or eight hundred batteries a week, and many are able to handle larger quantities if necessary.

The new scheme will not take any of the accumulator trade out of the hands of dealers; on the contrary, it will undoubtedly increase the retailers' business in many ways.

The Exide Service Depôt in each district will act as the charging station for batteries sent to the retailers of the district for charging. The depôt will make arrangements

to collect and deliver accumulators to the dealer as often as is necessary. Thus one depôt may serve the needs of forty or fifty dealers, who in turn will be able to pass such service on to the public.

The advantages of such a scheme are obvious. In the first place, when dealing with a large number of batteries the charging rate per battery is quite moderate, and the dealer will be able to make a fair and legitimate profit from accumulator charging without driving away potential customers because of "upkeep costs."

**I**T is obviously impossible to give any figures regarding the rates which will be charged, as the Chloride Co. is unable to make a fixed rate owing to the wide difference in electricity charges per unit throughout the country. Obviously, however, charging accumulators "in bulk" will be cheaper than handling a few cells, so that even with a fair margin of profit for the service agent and the retailer, the comparatively low cost of upkeep should attract many more valve users, all of whom will bring more profit to the trader.

It has yet, of course, to be seen what this scheme will bring forth in the way of results, but we feel sure that it is bound to be satisfactory, for a need for some such "service" as this has been felt by the public for some time.

To our congratulations to the Chloride Electrical Storage Co., upon what we feel will prove a really fine scheme, we would like to add a few remarks.

When this "service" organisation is complete, would it not be worth the company's while to consider the inauguration of a "hire-maintenance" scheme? Such a project would, we feel, when carried out on a large scale by an efficient organisation, be a huge success. Why not design a scheme of this nature for the use of every listener-in who uses an Exide battery, making it a condition, of course, that participants should own at least one Exide accumulator.

This scheme has necessitated the preparation of an agreement to be made between the Chloride Co., the service agent and the retailer. It is a very simple agreement, and does not in any way bind the trader in any of his business activities.

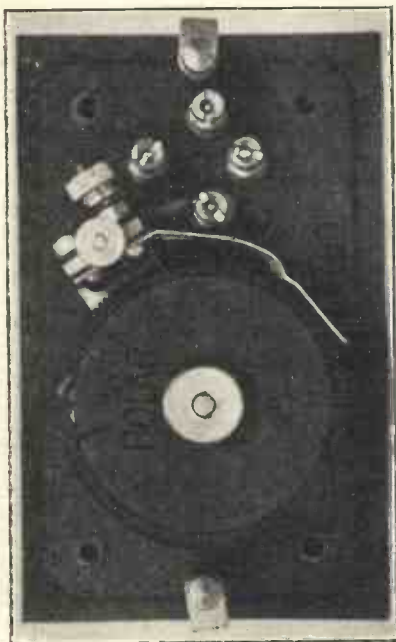

The filament resistance and valve holder panel. This component is remarkably neat, but not cramped.

# Elementary Theory

In which the functions of the telephones and the thermionic valve are explained

**T**HE standard and most obvious method of detecting received wireless in pulses is by means of some form of telephone. Telephones are extraordinarily sensitive instruments and will respond to most feeble currents, but are not suitable for direct insertion into the oscillatory circuits of a wireless receiver. Before the high-frequency received currents can be detected by the telephones, the process of rectification must be carried out. Rectification consists of converting alternating current into direct current, and in wireless receiver work implies that the direct current must not be "smoothed," but retain the original wave motion of the alternating current. The current, once rectified, therefore, is in the nature of a rapidly pulsating one, but at the same time does not alternately change its polarity.

It is unfortunate that the term "detector" has become a general one for describing the instrument in which a crystal or valve performs the operation of rectification. Actually, it is the telephones which detect the current, the crystal or valve which rectifies it. The subject of rectification will be dealt with a little later when considering the operation of the valve, but at this stage a word on the necessity for using high-resistance telephones in a crystal circuit will not be out of place.

High-resistance telephones are used purely because practical limitations of the telephone itself prohibit anything else if efficiency is to be maintained, and it will be shown that the actual resistance of a pair of telephones is not of necessity an indication of their sensitivity. The rating

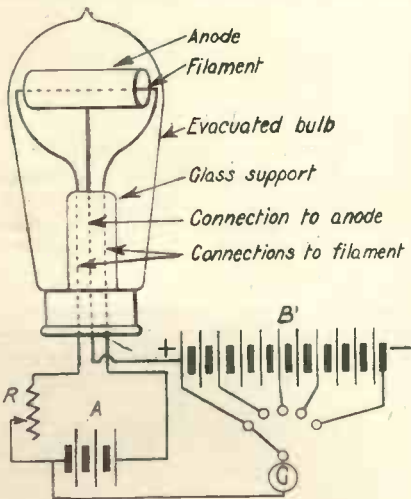

FIG. 1.

of a pair of telephones as being of so many ohms resistance is purely one of convenience.

Telephones are electrically efficient or inefficient according to the strength and design of the magnetic field which actuates the diaphragm. Obviously, for a magnet of given dimensions, the best will be that which produces the strongest and largest magnetic field; and as the latter is de-

pendent on the number of lines of force contained in it, and since the greatest number of magnetic lines for a given current will be produced by the largest number of turns on the limbs of the magnet, it is apparent that, generally speaking, the best telephone will be that with the greatest number of turns of wire.

Practical limitations of size prohibit magnets of a bulky nature, and, therefore, fine wire must be used to produce the greatest number of turns in a given space. To ensure good conductivity, copper wire must be used; but, still, owing to the number of turns which determine the length of wire used, and due to the fineness of the wire, a good pair of telephones will have a high resistance. Manufacturers of doubtful integrity have been known to use resistance wire in order to produce a high resistance and mislead buyers. Such construction is inefficient, for it means that few turns only will have to be made to obtain a high resistance.

**Electrons.**—It is now necessary to pass on to the subject of the valve, and in order to grasp the principles of its operation there are some points about the electronic theory which must be understood. The electronic theory of electricity is the one which at present holds the field, and although it is by no means certain that it is a true theory and may, indeed, give place to a newer and better one at any time, it is sufficiently analogous to explain in an intelligible manner most of the electrical phenomena.

Matter is said to be divided into small particles known as atoms, which are the smallest particles retaining the distinctive chemical structure of the body as a whole. The atom, according to the electronic theory, is itself composed of a definite number of electrons, which are thought to be the ultimate formation of all matter. Electrons are small particles of electricity of negative polarity, and are continuously in motion, revolving round a central nucleus in precisely the same way that the planets revolve round the sun. According to the theory, the number of electrons in the atom and their relative positions, which are constant, decides the exact nature of the body. Thus copper, carbon, oxygen and mercury all ultimately consist of the same matter, but due to the different arrangement of the ultimate electrons which compose them, their chemical natures differ. Were it possible to alter the number of these electrons, or to alter their relative positions, then we could immediately change one substance into another.

In addition to the above electrons, there are thought to be others which are "free," and which determine the physical properties of a substance. These may be removed without disturbing the essential chemical foundation. It is these free electrons which are responsible for electrical phenomena.

It has been previously stated that the electrons revolve round a central nucleus. Normally, this central nucleus is electrically positive, due to the balance of

polarity in the electrons which surround it, and the atom itself as a whole is neutral. Should at any time one or more of the negative electrons be removed, then the nucleus or core will become slightly positive, and the more electrons that are removed the more positive will the core and the atom as a whole become.

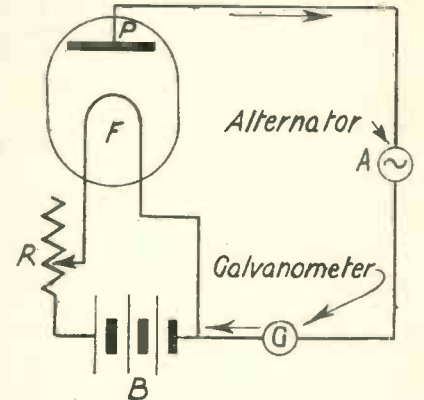

FIG. 2.

An electric current, according to the electronic theory, is said to be a flow of electrons from one part of a circuit to another. Where there exists a surplus of negative electricity over positive, the former will always attempt to run towards the latter, to make matters even, as it were. Fundamentally, therefore, electricity travels always from negative to positive and not, as was previously thought, vice versa. This point must continually be borne in mind.

It is possible to disperse electrons from a body by heating it; thus the filament of an electric lamp is continually emitting electrons. Many shoot off due to the internal disturbance within the material of the filament. Nearly all, however, return back to the filament.

In a lamp this electronic stream as it is called is not used at all, but it forms the foundation of the working of the thermionic valve. The original, or Fleming Valve, consisted of a filament surrounded by a sheath or plate, which now is always referred to as the anode. As electrons, which are themselves negative, always tend to fly to a body at a positive potential, it is obvious that by making the anode positive, it would be possible to attract the electrons from the filament to it.

**C**ONSIDER now Fig. 1. Here is shown a two-electrode valve connected to two batteries A and B; the former supplying current to heat the filament and the latter being connected at its positive pole to the anode, and at its negative pole back to the negative side of the filament. By means of a variable rheostat R the current to the filament may be varied so that the heat of the latter is under control. A switch in the circuit of the battery B, which is composed of a

large number of cells, allows different voltages to be applied to the anode. The galvanometer G will indicate any flow of current in the B battery circuit, however minute. It will be obvious that the anode is positively charged with respect to the filament, and for that reason the latter is frequently referred to as the cathode.

From Fig. 1 it is clear that the circuit of the battery B is metallically incomplete, there being no physical connection between the filament and the anode. But on lighting the filament it will be observed

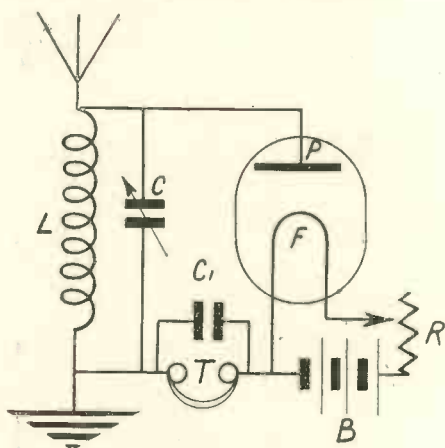

FIG. 3.

that a continuous deflection of the galvanometer needle will occur. It is therefore proved beyond doubt that a current must be flowing in the B battery circuit. It cannot be due to any capacity effect between the two circuits, for that would be indicated only by an instantaneous deflection which would immediately subside. According to the electronic theory it is due to the passing of electrons from the filament to the anode, and it is reasonable to assume this, for the higher the anode voltage applied, the greater the number of electrons that will pass and the larger will be the current.

Should the connections of the battery B be reversed, so that the plate becomes negatively charged, then no current will flow, no matter what negative potential is applied to the plate or how bright the filament. For this reason the two-electrode valve is said to possess unilateral conductivity, for it allows the passage of current in one direction only.

Clearly, therefore, it is possible to use the two-electrode valve for rectifying an alternating current. Fig. 2 shows a typical circuit for employing the valve for this purpose. Connected between filament and anode is the alternator A and the galvanometer G, and when the alternator is working, the plate P is made alternately positive and negative. Since the valve will only allow current to flow when P is positive, then the current in the circuit PAGF will consist of a number of short impulses whose polarity will be constant, and which will flow only in the direction of the arrows. No current can possibly flow when P is negative, so that a pulsating direct current will be the net result.

A SIMILAR circuit, but one in which the source of alternating e.m.f. is a wireless aerial and earth system, is shown in Fig. 3. Here the aerial and earth are connected by the inductance L and condenser C, this forming an oscillatory cir-

cuit. Leads from the aerial and earth ends of the inductance are taken to the plate P and the filament F respectively, but in the latter connection are the telephones T. A small fixed condenser C is shunted across T, while the filament may be heated at any desired temperature by the battery B controlled by the rheostat R.

Imagine now that a spark station was being received. This produces a damped train of oscillations which may be diagrammatically represented by A, Fig. 4. These current oscillations will themselves come to the plate P (Fig. 3) to be made alternately positive and negative, and as in the previous circuit with the alternator, only the positive current will be allowed to pass, so that the actual resulting current in the plate circuit of the valve will resemble the curve B.

It is now necessary to explain the necessity for the Condenser C. Imagine the telephones disconnected and the condenser left in circuit. Oscillatory current could still pass and will travel from F to P via C and L when P is positive, making the left-hand electrode of C negative in the process. These changes in the condenser C will build up to a high potential owing to the gradual accumulation of electrons on the left-hand electrode.

When the telephones are connected there is a path for the current to travel across C, and the condenser will discharge through that path, thus giving rise to an audible signal in the telephones, and the current which passes through the telephones will approximate an average of the small peaks, which are shown in Fig. 4 B. This average may be represented by the diagram at Fig. 4 C.

In actual practice it may be found that such a circuit, as for instance a crystal circuit, will work without a condenser across the telephones. This is due to the fact that the telephones themselves have a high self-capacity in their own windings and in the leads connected to them. In very few instances, however, is this really sufficient for the purpose, and it is always advisable to shunt them by a small fixed condenser of .001 or .002 mfd. capacity.

The three electrode valve may now be explained. Readers will be too familiar with the construction to require any description, but to avoid confusion the electrodes will be referred to in future as the filament, grid and anode respectively. The action of the filament and anode having been explained, it now remains to describe the functions of the grid. For this purpose, Fig. 5 should be referred to.

In this circuit the usual battery B<sub>2</sub> of variable voltage is inserted in the anode circuit, positive being connected to the anode. Between the positive end of the battery and the anode, however, is the

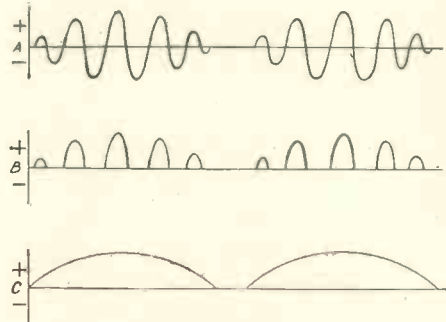

FIG. 4

milliammeter M. The filament is excited by the Battery B', controlled by the rheostat R'. To the grid a lead runs to the centre point D of a potentiometer PN, the two latter points being taken respectively to the positive and negative ends of the battery B. A further lead is connected from the potentiometer to the filament battery B', this lead terminating in the point D', which is capable of movement along the potentiometer winding PN. For purposes of experiment, it may be assumed that the voltage of B is 25, while the resistance of PN is 500 ohms.

IT is clear that if the point D' is moved above the centre point D the grid will be negative with respect to the filament, while if D' is moved below D, as shown in the diagram, the grid will become positive. Thus means are available for making the grid either positive or negative to the extent of either + 12½ or - 12½ volts.

The grid, being an open spiral of wire, when at zero potential will allow the free passage of electrons through its turns. Directly a potential is applied to it, however, the grid will either attract or repel electrons according to its polarity. Thus, by making it sufficiently negative, it is possible to prevent any electrons passing through it, and by making it positive it will attract electrons from the filament, and add to the effect of the positive potential on the anode. The net effect, therefore, with the grid positive is to assist the anode in the power of attracting electrons

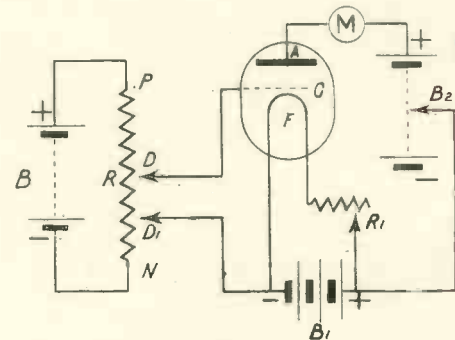

FIG. 5.

from the filament. From this is clearly shown how the name valve became generally applied to the triode, for the grid, according to its potential, is capable of closing or opening the electronic stream as desired.

To understand the action of the grid more clearly, it will be best to explain the formation of the electronic flow between filament and anode, known as the space charge. The latter is always negative, for the electrons themselves are negative, and normally, when the grid is at zero potential, the space charge may be considered more or less evenly distributed.

When the grid is given a negative potential, however, a negative body is introduced near to the filament, and this, due to the fact that like repels like, prevents most of the electrons from passing to the anode. Thus the density of the space charge between grid and filament is increased. The reverse is the case when the grid is positive and a direct increase in the electronic flow, which now passes right through the grid to the anode, is apparent, with a consequent increase in anode current.



The grid itself takes no appreciable current, the e.m.f. applied being in the nature of a pure potential only, but a very small increase or decrease in grid potential may produce a much larger corresponding variation in anode current. The result of applying different potentials to the grid, and obtaining different anode currents, may be plotted on squared paper as a curve. This curve, which is of fundamental importance, is known as the characteristic curve.

IN Fig. 6 is the characteristic curve of the D.E.3 valve. It will be seen that on the left vertical line is plotted anode current in milliamperes, on the bottom horizontal line the grid volts, with zero in the centre, negative on the left and positive on the right, while on the right-hand vertical line is grid current in microamperes. The latter we may disregard entirely as being negligible and unimportant from the ordinary user's standpoint. Such curves are obtainable from using a circuit such as that in Fig. 4, and in the following way.

With zero potential on the grid and an anode voltage of 20, the milliammeter reads 0.375. Therefore a point is made on the chart on the central thick vertical line at a height midway between 0.25 and 0.5 on the extreme left-hand line. If now 1 volt negative is put on the grid, then the milliammeter reads 0.25, while with 2 volts positive 0.75. Increasing the positive to 5 volts, a reading of 1.5 milliamps is obtained, and this is plotted. A curve can now be drawn through these three points, and it will result in the right-hand curve shown in Fig. 6.

Suppose now the anode voltage is increased to 50, then with zero on the grid, a current of 1.85 milliamps will flow.

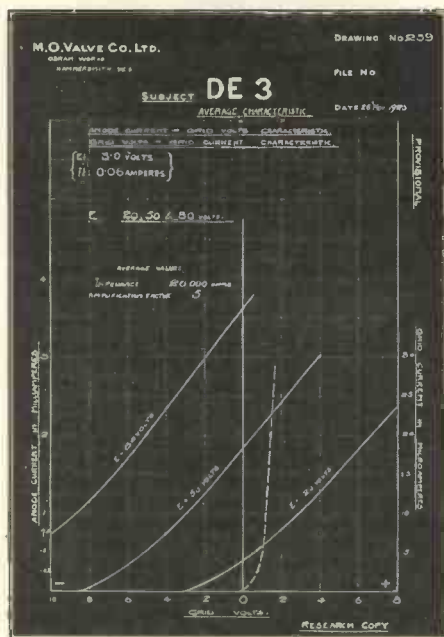

FIG. 6.

This is shown on the second curve, while on the third (left hand) curve, where 80 volts is applied to the anode, a zero grid potential gives 3.6. milliamps. From these curves also may clearly be seen the effect of putting different potentials on the grid when 50 and 80 volts are applied to the anode.

## AGENCY ATTRACTIONS

Some points which retailers should consider before taking up an agency proposition

AS a retailer in a trade which is subject to the competition of tobacconists, toyshops, marine store dealers, and other experts, I have naturally to keep my eye fixed upon the main chance very steadily, and my interest is readily aroused in any scheme which may seem to promise me advantages in meeting the competition I encounter from all quarters. It is for this reason that I have occasionally investigated what kind of preferential treatment it is possible to obtain under a district agency arrangement. Up to the present, however, I have not been able to see that the average proposition offers such self-evident advantages to the trader as some enthusiastic sales managers appear to believe.

It is interesting to take a typical agency proposition and endeavour to ascertain who stands to gain most from the arrangement—the manufacturer or the agent. Disregarding for the purpose of our inquiry the prolixity of its semi-legal phraseology, and paying no heed to the more simple and straightforward of its provisions, it will be found that a very usual agreement provides that the manufacturers will for their part grant a certain territory, will refer to the agent inquiries from private users, will supply catalogues, will advertise the establishment of the agency in the local press, will fix up a glass window plate, and will assist in designing the agent's advertisements as well as lending printing blocks.

The agent, on his side, pays a small deposit, has to keep one or two sets always in stock, agrees to purchase some two hundred pounds worth during twelve months.

undertakes to advertise sets frequently in the local papers, and binds himself not to sell certain competitive types.

Usually there seems to be no particular advantage offered in the way of discounts over what can be obtained by a casual buyer, but it might be possible to put a more or less approximate figure to each of the services which are rendered and the liabilities which are assumed by both parties, with a view to striking a rough balance in the transaction.

THE MANUFACTURER		
Contributes inquiries from private users	...	0 0 0
Supplies catalogues and showcards (say)	...	1 10 0
Advertises establishment of agency	...	4 0 0
Assists with suggestions for ads., and lends blocks	...	0 0 0
Fixes glass window plate	...	0 3 6

THE AGENT		
Confines his purchases of certain goods to manufacturer	...	0 0 0
Distributes catalogues and exhibits showcards (say)	...	1 10 0
Advertises sets regularly	...	16 0 0
Pays deposit of £5, carries £20-£30 worth of stock, and undertakes to purchase goods value...	...	200 0 0

IT might at first sight be assumed that the forwarding of private inquiries to the agent would be a fair equivalent for the relinquishment of possible sales of competing makes, but this interpretation will not bear strict investigation. Though private inquiries from the district will be referred to

## The Broadcaster and Wireless Retailer

the agent, nothing is said about trade inquiries, and I gather that these are considered as being quite outside the arrangement; so that though the agent may relinquish his right to sell other sets, a user can still purchase the goods covered by the agency through any other retailer, so that the arrangement is not by any means the sole agency which might be assumed at first sight. In fairness to manufacturers, however, I must admit that they can usually be induced to withdraw the limiting clause excluding the sale of certain other makes if the matter is sufficiently strongly insisted upon.

To take the next item, that of sales literature, though it is true that it costs the maker something to produce, yet on the other hand, it cannot be said to have any market value, so that if we put against its cost to the manufacturers the value of the services rendered by the trade in distribution, the two expenses will cancel each other out.

Then, though a manufacturer will advertise the establishment of an agency, inquiries will frequently reveal the fact that this is only by a couple of announcements, whereas a typical agency proposition provides that during the period of the agency the agent has to advertise the sets frequently. There will doubtless be a difference of opinion between the parties as to the exact meaning of the word "frequently," but if we assume for the purpose of our examination that it does not mean less than an announcement of a few lines once a fortnight at a cost of some 12s. 6d. a time, we see clearly how these two liabilities compare.

THE next item on the manufacturer's side deals with another aspect of the same subject. It must be frankly admitted that it is difficult to put an approximate value upon the time which would be spent by the manufacturer in assisting or advising the trader upon the design of advertisements, but for publicity of the comparatively trifling nature which is in question it is doubtful whether much assistance would be needed or could be given; while if the advertising scheme exceeded the small limits indicated, it is fair to assume that an occasional half-hour spent in suggesting the best wording would be more than rewarded by the opportunity thus afforded of introducing references and illustrations of his own productions in a retailer's announcement.

On the other side of the sheet, there is to be reckoned amongst the expenses or the liabilities actual and potential undertaken by the trader, the deposit, and the purchase of a couple of sets for stock, while the liability to take up two hundred pounds' worth of goods of a particular make during twelve months is one which would make many a cautious trader hesitate.

Naturally, we have to reassure us the example of the motor industry, in which contracts of this kind are common enough though they are never carried out, but the cautious trader in a sound financial position (and therefore worth "powder and shot") has an uneasy feeling that his own case might turn out to be the exception to the rule, and that he might find himself forced to take the full quantity of goods stipulated, no matter what was the poorness of the public demand in his district.

A careful summing up of the pros and cons of the district agency question will force one to the conclusion that unless a maker can envisage the problem more from the trader's point of view and propound a proposition making far more appeal than the majority of suggestions which are customarily put forward, it is best for a trader to hold himself entirely free of any entangling undertakings in the way of district agencies and concessions, and to preserve his freedom of purchase from whatever maker the requirements of the moment or the whim of the customer may dictate.



# World-Wide Wireless



## SOUTH AFRICA Johannesburg and District.

**Broadcasting News.**—The agreement in South Africa for broadcasting news made with the Newspaper Press Union and Reuter's is published. The agreement is terminable at six months' notice. Reuter's are to select and compile a service at Capetown of 150 words daily, except Sundays. The broadcasting stations pay Reuter the actual cost and broadcasters are to have the right to supply a local news service, obtained independently of the Press Union or Reuter's, of 100 words per day, but no comments. Market and weather reports may be broadcast and Government and municipal bulletins. No other news is to be broadcast without reference to the other parties to the agreement.

**Wireless "Pirates."**—In South Africa the Minister of Posts and Telegraphs has instructed the Postmaster-General to take legal action in the case of wireless "pirates," and the names of people who have not paid their fees are sought.

**Amateur Relays KDKA.**—The first amateur relay—and that of KDKA—in South Africa was that of a pioneer Johannesburg transmitter, Mr. Fisher (2BR). Listeners-in in Johannesburg and suburbs picked up the relay, which, of course, was not as powerful and clear as when the Johannesburg station relays KDKA. Another Johannesburg radio man is Mr. Grant Dalton, who has discovered the best aerial to use for low waves. He is using an iron curtain-rod sheathed with brass, the rod being 12 ft. long and 2 in. diameter. It rests in its ordinary brackets but with a layer of rubber intervening, the curtains hanging on it in the usual way. He gets reception free from atmospherics.

**Woman on Radio Society.**—The first woman in South Africa to be elected to the Council of Radio Society of South Africa is Miss M. Jones, B.Sc. For two years she has been a member of the society and an amateur enthusiast for five years. Mr. R. Oxenham, also just elected to the council, first entered the radio field with a spark transmitter and crystal receiver seventeen years ago.

**Time from Stars.**—Johannesburg listeners-in get their time signal from the stars. At 9 every night the Johannesburg station broadcasts the official observatory time, which is regulated by star observation. The 9 p.m. time is electrically flashed to the station transmission-room, where the automatic striking of a gong is broadcast.

**A new Wave Trap made in Johannesburg, South Africa,** is connected in series with the aerial, it is variable within wide limits, and the variable condenser is mounted inside the former of the coil, making a particularly neat job. The apparatus is made as follows:—

On a 3½-in. former the secondary is wound with 80 turns of 28 d.c.c. wire tapped every ten turns shellacked. The primary is wound exactly over the centre of the secondary with 30, or a few more, turns of the same wire tapped every five turns, and shellacked. The primary is connected in series with the aerial, and the aerial terminal of the set at the tapings which give the best results. The .003 variable condenser is mounted inside the former, so that its knob

and dial project, and the secondary coil is connected at the appropriate tapings (found by experiment) to the condenser terminals.

**KDKA and Johannesburg.**—Mr. G. Smit, of Hendrina, South Africa, who has had such wonderful overseas reception, particularly KDKA, uses a Burndept Ethophone V., four-valve receiver with no radical alteration. The Johannesburg broadcasting station has recently been relaying KDKA. Mr. Smit received KDKA in this way, and reports: It was the Westinghouse employees' dinner, and the programme started at 3.30 a.m. South African time. The company's band played "Star of India," and there followed an oboe solo from the "Mikado." A voice said that the programme was specially for South Africa, and that JB was relaying it.

**Church by Wireless.**—A microphone has been fixed in St. Mary's Cathedral, Johannesburg, and the Church service is landlined to the city's broadcasting station.

**An Aerial Suggestion.**—In wireless matters South Africa is noted for atmospherics, and it is suggested that vertical aerials would be better than horizontal. Mr. G. W. Smit, of Hendrina, South Africa, has success in receiving KDKA with its short waves, because he uses a vertical aerial.

**G. W. Smit's Feat.**—The American paper, *Pittsburg Post*, in an editorial, describes as "an international broadcasting achievement" the word-perfect reception of a New York City dinner speeches, broadcast by KDKA station, by Mr. G. W. Smit, of Hendrina, South Africa, and the report of the speeches published by the *Star*, Johannesburg, to which paper Mr. Smit telephoned his report. The dinner was at the Waldorf Astoria Hotel, New York City, to Mr. Owen D. Young, American Agent-General for Reparations, who gave for the first time first-hand observations on conditions in Germany and the effect of the Dawes plan. Mr. Young was decorated with the Cross of the Legion of Honour by the official representative of the French Government, and received a great ovation as he received the official kisses which accompanied the ceremony of investiture, the editorial goes on:—

"All of this was heard by Mr. Smit, who at the close of the banquet called the *Star* by telephone and gave that newspaper the complete report, which was published the same afternoon. One or two slight errors in proper names appear in the published report, but, aside from these minor details, the report is the equal of most of the American newspaper reports of this meeting.

H. B. A.

## U. S. A.

**Radio World's Fair.**—The new offices of the Second Radio World's Fair, located on the fifteenth floor of the Times Building, Broadway, at 42nd Street, were formally opened recently, and Directors U. J. Herrmann and James F. Kerr are already arranging the final details of the big Exposition, which is to be held in the 258th Field Artillery Armoury, September 14 to 19, the dates selected on the closing day of the 1924 Fair last September.

The 1925 show will be almost twice as large as the First Radio World's Fair, which completely filled both Madison Square Garden and the 69th Regiment Armoury, and

broke all records for attendance and business transacted.

The huge armoury is the only building in Greater New York large enough to house all of the 325 exhibits on the ground floor and still leave room enough to safely accommodate a daily attendance of 30,000 people. It is the largest building of its kind in America. The auditorium measures 300 by 600 feet, and does not contain a single pillar. The square footage of the open floor space is exactly five times that of the present Madison Square Garden.

There will be 275 nationally-known American manufacturers and 50 of the leading foreign concerns among the exhibitors, and the combined value of the devices on display will run close to \$10,000,000.

Public demonstrations will be held every afternoon and evening, in which a score of internationally famous wireless engineers will participate. Several will introduce inventions of a startling character.

Two large sections will be devoted to new inventions and amateur-built sets this year. Gold medals, silver cups and cash prizes will be awarded in both divisions by a jury of eminent authorities. Amateur and professional radio experts of all nations are cordially invited to participate in these competitions for which no registration fee will be required. Entry blanks, with full particulars, will be furnished to all who apply.

In an interview, General Manager James F. Kerr said:—

"The Radio World's Fair of 1925 will be the largest and most comprehensive industrial exposition ever held anywhere, unless I am badly mistaken. It gives every promise of outshining the First Radio World's Fair in almost every respect, and all indications point to a record-breaking attendance.

"I am also of the opinion that there will be a great increase in the amount of wholesale business transacted by our exhibitors this season. A survey just completed by our Special Service Department leads me to believe that over 5,000 native and foreign jobbers and dealers will attend the coming show. In fact, our Jobbers' and Dealers' Bureau is arranging to look after the interests of 6,500 of them.

"Our new business offices in the Times Building will remain open throughout the entire year hereafter, and in the future the special service bureaus, which we maintain for the benefit of all members of the radio fraternity, will operate from this centrally located headquarters."

C. H.

**Warner Bros.' Station.**—That the motion picture industry desires to co-operate with the radio has been evidenced in many different quarters. Recently two important transactions were put over between leading picture concerns and the radio interests. Warner Brothers, producers of "Beau Brummel" and many other well-known pictures, have announced the opening of a brand new station at their studio in Hollywood over which news of interest to picture "fans" as well as to the trade is broadcast. So cleverly were the preparations made that not one word appeared until everything was in readiness. Moreover, it will be the only station in California in a studio or any similar building, because it is the last permit to be granted for some time to come.

**Film Publicity by Radio.**—Universal Film Corporation is another company which is utilising the radio widely as a means of spreading its propaganda. A coast to coast publicity stunt was put over with Lon Chaney and Mary Philbin, stars of "The Phantom of the Opera," now nearing completion, speaking from Los Angeles, and answering questions which had been wired them earlier in the day over the Postal Telegraph lines. It was a sort of personal interview stunt put over the radio.

**The Radio Artistes' Association.**—A new organisation, known as the Radio Artistes' Association of America, has been formed for the protection of radio entertainers and the development of radio programmes. The belief that broadcasting is proving detrimental to a number of artistes in the line of their professional work has led to the formation to protect them by a mutual agreement with the radio companies.

**Hotel Radio.**—A radio service for guests has been inaugurated in the new Roosevelt Hotel, New York City. It is not the gift of the hotel management, but may be rented on a reasonable basis for a short or long period of time. The sets are six-tube portable ones, and are in charge of the chief electrician of the hotel. A dozen sets were ordered as an experiment from the Operadio Corporation of Chicago. The Operadio outfit resembles a suit-case, the top of which contains the loop antenna wires. The top can unfold and fits into a small socket in which it can be received as a loop antenna. It is claimed that this sort of apparatus is particularly adapted to an hotel of the type of the Roosevelt, because of the interference likely to be picked up from the many electrical lines in the nearby Grand Central station, one of the largest railway depots in the world. Other hotels are expected to follow the lead of the Roosevelt, where it is expected that a dozen sets will be all too few to supply the demands of radio-loving guests.

**U.S. Naval Radio.**—It is announced that the United States naval radio net consists now of thirteen high-power stations capable of covering from 2,500 to 5,000 miles, twenty-three stations that can reach between one and two thousand miles, seventy-two coastal stations with a range of a thousand miles, and fifty-five radio compass stations.

**Hoover on Broadcasting.**—So many applications have been received in Washington for radio broadcasting stations, that it is said the Secretary of Commerce, Mr. Herbert Hoover, is really worried! The number of stations already in operation numbers 563 with 455 of Class A (for 500 watts and over). One of the greatest difficulties, he says, arises from the tendency of stations to locate in the large cities, already overcrowded. Interconnection of stations has made great progress during the past half-year, and he hopes for further regular interconnection during the coming months. He hopes eventually that nationally organised interconnection for important events will be developed. It is only a question of time, he feels, when artistes will be paid, groups of stations combining for this end. There is no monopoly yet nor any chances of it, he declares. In all the United States not more than four or five companies control more than a single station, the largest number owned by any one concern being four.

**Radio and Fogs.**—Londoners should be interested in what happened along the East Coast in the U.S.A. during a recent fog, one of the worst, by the way, that we have had in many years. It held up traffic and led to a number of serious accidents, because signal lights could not be distinguished. Radio engineers believe that in the future much of this difficulty will be overcome by the use of radio direction finders, which are of marvellous value at sea in determining dis-

tances and directions. Radio compass stations along both coasts during the past year gave position reports to 57,836 ships involving more than 120,000 bearings. Radio engineers hope that this service will be largely extended during the coming year.  
E. L.

**F R A N C E**

**Monopoly Protest.**—The proposed State monopoly of wireless telephonic transmission, which has been put forward in Parliamentary circles, has called forth a campaign of violent protest. Apart from the French company which in October, 1920, concluded an agreement for working radio communication under State supervision, the many amateur transmitters have claimed a system of freedom.

The inquiry the Radio Club of France made among the provincial radio clubs resulted unanimously in opposition to the idea of State monopoly of the wireless transmission stations. Some Chambers of Commerce likewise addressed their protests to the Assistant-Secretary of State, M. Pierre Robert.

The Wireless Press Association, on its part, has manifested its opinion and view that the Decree of November 24, 1923, should be applied in its entirety; that consequently all applications for transmission for central and



*The Paragon Rubber Manufacturing Co.'s stand at the British Industries Fair. A comprehensive range of their well-known products was exhibited.*

regional stations conforming to this Decree should receive immediate satisfaction; in short, that in broadcasting there should be no monopoly of any kind.

**The International Congress of Amateurs.**—The French Associations are proceeding to organise an International Congress which will be held in Paris during the Easter holidays, 1925, and which will comprise two series of meetings: the International Congress of Wireless Amateurs and the Legal International Radio Congress.

The meetings of the two Congresses will be distributed over the period April 16 to April 20, 1925. The price of entry is 25 fr. for admission to each Congress and 40 fr. for admission to both. The General Secretariat of the Congress is at 2 rue de l'Echaudé, St. Germain, Paris.

The provisional agenda of the Congresses is as follows:—

- THE INTERNATIONAL LEGAL RADIO CONGRESS.**
1. Legal system of waves. Rights of transmitter and receiver. State supervision.
  2. International regulation of transmissions.

*The Broadcaster and Wireless Retailer*

3. Copyright and radio transmissions. Authors' rights. Interests of performing artistes. Copyright of news agencies. Advertising.

**CONGRESS OF THE INTERNATIONAL UNION OF WIRELESS AMATEURS.**

1. Organisation of an International Union of Wireless Amateurs.
2. Methodical organisation of the technical tests of amateurs.
3. Lengths of wave in wireless telephony and amateur transmissions.
4. Educational utilisation of wireless telephony.
5. International auxiliary language.

**Wireless in the Fishing Fleet.**—Wireless is destined to render the greatest service to the boats which go out for several months to fish in Newfoundland. Among the French flotilla leaving the ports of Brittany in the spring of each year there was only one single boat last year provided with wireless.

This year three other boats are equipped with transmitting stations, these are the three-masters *Americain*, *Côte Emeraude* and *Cancalais*. The station is installed in the captain's cabin, and there is no special operator, as only telephony is in question.  
L. D. F.

**S P A I N**

The number of radiophans is constantly increasing in Spain, and in Barcelona alone prominent retailers have calculated that there are now some seventy thousand instruments in use.

**Junk Merchants Prevalent.**—The result of the big demand for sets and parts has been that a lot of get-rich-quick firms have sprung up, selling cheap goods which fail to give satisfaction, and one of the leading papers, which has from the first done much to help radio in Barcelona, has taken the matter up strongly, and threatens to publish the names of the firms in question. Other firms handling well-known brands also are not inclined to stand for this class of trade which, if not checked, will do a considerable amount of harm to the whole business, and have promised to back the newspaper up in their campaign.

There is now a general demand for better-class apparatus with amplifiers in order to get the Madrid programmes in addition to the Barcelona Radio Difusion programme.

**More Stations.**—Applications for permission to establish fresh stations have been made to the Spanish Government, and it is proposed to remove the Hotel Colon Broadcasting station to a village on the outskirts of Barcelona, as the hotel accommodation is not sufficient for the needs of the promoters. Within a few months Barcelona will have some five stations, and retailers are looking forward to a big increase of business in consequence.  
L. A. G.

**Agencies Vacant.**—A. J. Wright, Ltd., of 395, Goswell Road, London, E.C.1, inform us that they are prepared to grant agencies to suitable firms in all parts of the world. The apparatus marketed by A. J. Wright, Ltd., includes receivers and components.

Applicants are requested to send full particulars of selling organisation and territory covered, together with business references from firms they have represented or may still represent.

We understand from the Watmel Wireless Co., Ltd., that the demand for their products is very great almost throughout the world, but especially in the Scandinavian countries. This speaks very well for these useful little components and we would advise those dealers in foreign parts, who are not yet acquainted with these components, to write to the Watmel Wireless Co., Ltd., at 332A, Goswell Road, London, E.C.1.

The products include variable grid-leaks and resistances.

# Brief Broadcasts

Wireless for air services—Beam station progress—  
The B.B.C.'s ambitions

**I**T has often been pointed out how important an aid wireless is to flying. Quite recently the Roumanian War Ministry ordered from Marconi's Wireless Telegraph Co. two aerodrome wireless stations and twelve aircraft sets, this being in connection with a programme for the development of Roumania.

The ground stations are to be of the same type as used at Croydon aerodrome, and include the Marconi 12 A Direction Finder. The aircraft sets are of the AD6 type, and can be used for both telephony and telegraphy. The transmitter has a power of 150 watts. The beauty of this particular type of aircraft set is that it is installed in one box, which can be stowed away in some convenient corner in the fuselage of the aeroplane, out of the way of the pilot. The latter, of course, controls the apparatus by remote control arrangements.

The telephonic range of the AD6 type is estimated roughly at 100 or 150 miles, while the distance over which telegraphic work can be carried out is approximately double the distance.

**W**ORK is progressing in Canada with the construction of the new "beam" stations which are to form part of the great Empire wireless chain. The stations are being erected at Drummondville and Yamachiche, the transmitting stations at the former and those for receiving at the last named town. Drummondville is about fifty miles east of Montreal, and Yamachiche twenty-five miles north of Drummondville. Both stations will be operated by remote control from the offices of the Marconi company in Montreal.

The work of erecting the stations has been carried out with great difficulty owing to the severe weather which was encountered during the months following November, when work was first commenced. Sometimes the temperature was as low as 20 degrees below zero, and necessitated the workmen wearing gauntlets the whole time in order to prevent frostbite due to contact with the iron-work.

**Q**UITE a number of letters have reached the B.B.C. from people who complain that they frequently find that their aerials are charged with static electricity. This, it is reported, generally happens during storms of snow or hail. The B.B.C. wish to remind listeners that they should always be sure and earth their aerials after they have finished listening-in, so that any charge that happens to collect will at once run harmlessly to earth.

**A**LTHOUGH it is common knowledge now that the power of 2 LO's new transmitting apparatus is 3 k.w., it is not so widely known that the actual power supplied to the station by the mains is far in excess of this. It is only the aerial which radiates the power of "3 k.w." The mains deliver 18 k.w. to

the station, and most of this is absorbed in the various intricate circuits, master oscillators, motors, generators and transformers, so that the actual power of 3 k.w. which is broadcast can be looked upon as a kind of filtered essence.

**T**HE King recently made a gift of a four-valve receiving set to his stable lads at Newmarket. The order for making the set was given to Hart Collins, Ltd., the well-known wireless manufacturers, who turned out truly a "de luxe" model with which the lads of Newmarket stables while away many a leisure hour.



An attractive display on the stand of Peter Curtis, Ltd., at the recent British Industries Fair.

## Spare Sparks

**T**HE King recently presented a receiving set to his stable lads at Newmarket. It is rumoured that the horses are contemplating a strike unless they are likewise provided.

**T**HE plumber who gave an estimate for repairing a grid leak has since been enlightened.

**T**HE conscientious listener in Glasgow who spoke of devising a plan whereby collections could be taken after Sunday broadcast sermons was able to leave hospital yesterday afternoon.

**"P**HYSICAL jerks" by wireless figure on the early morning programme of an American broadcasting station. Out of respect to the very delicate windings used in high-resistance phones, the services of an army drill sergeant for the job of instructor were declined.

**M**ANY people still appear to hold the absurd view that wireless causes rain. Mr. Noah must have had "some" radio station aboard the Ark!

D. P. H. E.

**T**HE special programme which was broadcast from 2 LO through all stations last month, including the wonderful singing of Tetrassini, caused great sensations. Practically every family possessing a set of some sort was listening that night. One can just imagine a few of the types of people eagerly listening-in. Parties of people in Mayfair mansions and flats all intent around wonderful "de luxe" cabinet sets—yet hearing only the same voice as are the parties in miners' cottages, who were probably gathered around Tommy's home-made set sharing one telephone! And we wonder how many listeners there were of the "foolish virgin" type, who lost the whole programme because they hadn't enough "juice" in the accumulator!

**A** PRACTICAL demonstration of the value of carrying wireless instruments aboard aircraft was afforded several weeks ago. Captain Barnard, the well-known pilot belonging to Imperial Airways, Ltd., was flying a machine from London to the Continent at the time the recent high winds were experienced. Just before crossing Cape Grisnez he sighted what appeared to be the hull of a merchant ship awash, being carried along by the wind and waves. Captain Barnard promptly sent out S.O.S. signals on his wireless transmitter until he was satisfied that they had been heard. Subsequently the crew of the unfortunate vessel were saved.

**I**T is estimated that eighty per cent. of the population of the United Kingdom is within crystal range of one of the broadcasting or relay stations. Thirty-five per cent. is within crystal range from the alternative high power station, and this figure the B.B.C. are trying to increase as far as possible. They are also endeavouring to make the eighty per cent. figure into one hundred; so that, no matter where one may be in the country, one is always within range of a station by crystal set.

It is, of course, a big task, and the B.B.C. are to be commended for their enterprise. The feats already accomplished by them in this direction have been remarkable, placing as many as eighty per cent. of the population within crystal range of any one of their stations. There are at present as many as twenty-one stations erected in Great Britain and Northern Ireland. Much of the apparatus belonging to these stations, and particularly that in connection with land lines, is to be improved, so that simultaneous broadcast will be better than ever.

**O**N April 4, Mr. Percy Scholes is giving his last lecture recital at the Æolian Hall in London. The title will be "Some of the Composers Since Beethoven," and should prove a very popular lecture. These recitals have been given in connection with education, and are much appreciated by all those who have been able to attend them.

# NEW PATENTS

This list is specially compiled for "The Broadcaster and Wireless Retailer" by **Rayner and Company, Registered Patent Agents**, of 5, Chancery Lane, London, from whom all information relating to Patents, Trade Marks, and Designs, can be obtained gratuitously.

## Applications.

- 3,529.—Dawson and Co., Ltd., S.—Loud speakers. February 9.
- 3,563.—McKelvie, H. W.—Thermionic valve. February 9.
- 3,593.—MacCullum, G. H. S.—Variable resistances. February 9.
- 3,609.—Ross, B.—Control for radio instruments. February 9.
- 3,656.—Mowbray, C. B.—Extension handles for wireless control. February 9.
- 3,678.—Thornhill, V. J.—Means for detecting and amplifying wireless signals, etc. February 10.
- 3,698.—Ledward, T. A.—Electric resistances. February 10.

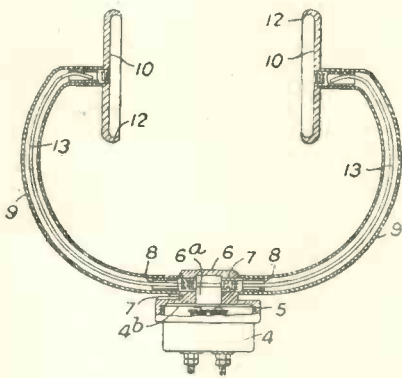

FIG. 1.

- 3,699.—McClelland, T.—Wireless coil holders. February 10.
- 3,713.—Donald, J. A.—Thermionic valve holders. February 10.
- 3,720.—Kersting, G. B.—Variable electric condensers, etc. February 10.
- 3,730.—Fricker, J. H.—Filament rheostat. February 10.
- 3,733.—Wood, E. A.—Terminals for electric conductors. February 10.
- 3,734.—Wood, E. A.—Connections, etc., for electrical apparatus. February 10.
- 3,763.—Moore, C. W. C., and Moore, T. C.—Inspection stand for wireless panels. February 10.
- 3,770.—Schweizerhof, E. G.—Wireless crystal detectors. February 10.
- 3,798.—Osborn, H. J.—Thermionic valves. February 11.
- 3,799.—Castell Evans, P. V.—Method of mounting wireless crystals. February 11.
- 3,827.—Dixon, F. H. I.—Terminal for wireless, etc., apparatus. February 11.
- 3,827.—Daniell, H. E.—Terminal for wireless, etc., apparatus. February 11.
- 3,848-3,849.—Palmer, W. J.—Telephonic receivers, etc. February 11.
- 3,891.—Cleghorn, C. A.—Electric circuits for wireless telegraphy, etc. February 11.
- 3,931.—Pohu, G. E. A.—Wireless aerials. February 12.
- 3,941.—Cullen, F. H. B.—Variable electric condensers, etc. February 12.
- 3,971.—Keller, H.—Two wire amplifiers. February 12.
- 3,991.—Winocour, P.—Crystal detectors. February 12.
- 3,999.—Dobbin, N. E.—High-frequency transformers. February 12.

- 4,034.—Juckess, R. W.—Circuit for wireless reception. February 13.
- 4,046.—McClelland, T.—Wireless plug in holders. February 13.

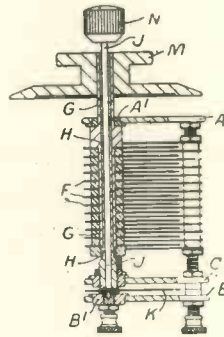

FIG. 2.

- 4,057.—Rorke, J. D. M.—Electric inductances. February 13.
- 4,060.—Hendrick, C. F.—Wireless aerial. February 13.
- 4,067.—Walker, F. A.—Wireless valve holders. February 13.
- 4,079.—British Thomson-Houston Co., Ltd.—Loop Antennae for radio reception. February 13.
- 4,088.—Palmer, W. J.—Productions of telephonic diaphragms, etc. February 13.
- 4,102.—Forster, E.—Loud speakers. February 13.
- 4,123.—Scott-Taggart, J.—Electric signalling systems. February 13.
- 4,126.—Schilovsky, P.—Wireless signalling. February 13.
- 4,176.—Hobbs, J. E.—Wireless earthing devices. February 14.
- 4,184.—Dubilier, W.—Electric condensers. February 14.
- 4,225.—Rider, J. J.—Anticapacity connection for wireless valves or terminals. February 16.
- 4,235.—Tarr, R. W.—Loud-speaker diaphragm. February 16.
- 4,238.—Fritsche, A.—Crystal detectors. February 16.
- 4,240.—Wilson, F.—Adjustment and control of wireless apparatus, etc. February 16.
- 4,250.—Trotman, A. E. R.—Wireless receivers. February 16.
- 4,323.—Escott, J.—Fine-adjusting device for wireless instruments, etc. February 17.
- 4,326.—Davis, H. C.—Earthing switches for wireless apparatus. February 17.
- 4,336.—Hall, N.—Crystal detectors. February 17.
- 4,337.—Hall, N.—Crystal detectors, February 17.
- 4,348.—Rider, J. J.—Variable electric condenser. February 17.
- 4,352.—Thomas, G. N. E.—Wireless receivers. February 17.

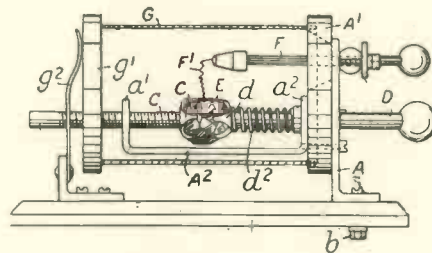

FIG. 3.

- 4,377.—Igranic Electric Co., Ltd.—Variable inductances. February 17.
- 4,431.—White, A. R.—Method of mounting and fixing wireless accessories. February 18.

- 4,455.—Osborn, H. J.—Apparatus for forming grids and anodes for thermionic valves. February 18.
- 4,473.—Cantle, L. G. H.—Wireless apparatus. February 18.
- 4,474.—Mason, M. A.—Audio-frequency transformers. February 18.
- 4,475.—Macrae, R. G.—Winder for loud-speaker leads. February 18.
- 4,483.—Ross, B.—Fine control for variable electric condensers. February 18.
- 4,485.—Belling, C. R.—Electric terminals, etc. February 18.
- 4,505.—Machin, F. R.—Variable electric condensers. February 18.
- 4,527.—Marconi's Wireless Telegraph Co., Ltd.—Four-Electrode valves, etc. February 18.
- 4,579.—Hales, E.—Aerials and lead-in wires for radio telephony. February 19.
- 4,609.—Castagnoli, G.—Indicating dials, etc., of wireless apparatus. February 19.
- 4,610.—Veal, E. J.—Wireless crystal detector. February 19.
- 4,612.—Brittain, E. H.—Ear pads for headphones, etc. February 19.
- 4,614.—Smith, S. A.—Fitting for wireless panels. February 19.
- 4,697.—Eckersley, J. P.—Crystal detectors. February 20.
- 4,719.—Beswick, R. E.—Variable electric condensers. February 20.
- 4,726.—Durrant, W. E.—Wireless aerials. February 20.
- 4,728.—Brown, J. H.—Spring clamping devices for electric terminals, etc. February 20.
- 4,731.—Cull, R. S.—Wireless detector. February 20.
- 4,751.—Holbrook, H. S.—Apparatus comprising a combined resistance and capacitance. February 20.
- 4,752.—Graham, E. A.—Telephonic receivers. February 20.
- 4,769.—Ross, J. A.—Head-bands for telephone receivers. February 20.
- 4,792.—Turner, R. G.—Crystal detector. February 21.

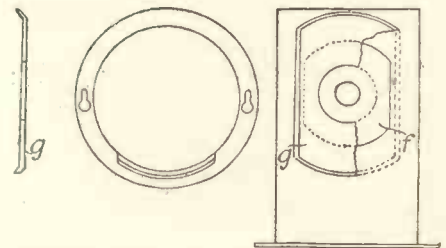

FIG. 4.

FIG. 5.

- 4,810.—Sanders, H. C. and Santon, Ltd.—Combined plug and socket devices for electrical services. February 21.
- 4,842.—Rapinet, H. P.—Basket coil-holder. February 21.
- 4,854.—White, A. S.—Electric condensers. February 21.
- 4,878.—Davies, C. A.—Reception of wireless signals. February 21.
- 4,889.—Angus, A. R.—Devices for amplifying, detecting, etc., electric oscillations, etc. February 21.
- 4,922.—Nevill, A. J.—Headphones. February 23.
- 4,979.—Telefunken Ges. fur Drahtlose Telegraphie.—Frequency reducing means for static frequency transformers. February 23.
- 4,989.—Marconi's Wireless Telegraph Co., Ltd.—Electro-acoustic devices. February 23.
- 5,084.—Watsham, N. de M.—Telephone receivers, etc. February 24th.
- 5,118-5,124.—Siemens and Halske Akt-Ges.—Incandescent cathodes for discharge tubes. February 24.

- 4,904.—Bapty, S. L.—Electric condensers. February 23.
- 4,963.—Hale, G. W.—Wireless apparatus. February 23.
- 5,029, 5,030.—Clarke and Co. (Manchester), Ltd., H.—Variable electric condensers. February 24.
- 5,031.—Goldstone, M. H.—Crystal detectors. February 24.
- 5,049.—Baines, F. J.—Diaphragm for telephone receivers, etc. February 24.
- 5,053.—Hofman, C. G., Hofman, L. C.—Variable electric condenser. February 24.
- 5,054.—Casse, C. W.—Switching devices for wireless apparatus. February 24.
- 5,061.—India Rubber, Gutta Percha and Telegraph Works Co., Ltd.—Diaphragms for sound reproducing instruments. February 24.
- 5,114.—Edwards, A. J.—Wireless apparatus. February 24.
- 5,119.—Tyers, P. D.—Electric resistances. February 24.
- 5,130.—Franklin, C. S.—Wireless telegraphy, etc. February 24.

FIG. 6.

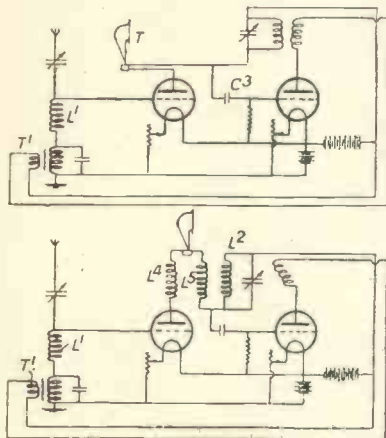

FIG. 7.

- 5,175.—Ivey-Rogers, W.—Radio inductance coils, etc. February 25.
- 5,181.—Potts, H.—Holders for thermionic valves, etc. February 25.
- 5,188.—Humphry, G. W.—Means for connecting wires, etc. February 25.
- 5,236.—Padmore, A. T.—Electric condensers. February 25.
- 5,239.—Lodge-Cottrell, Ltd.—Mechanically driven rectifiers for transformers. February 25.
- 5,255.—Atwater Kent Manufacturing Co.—Thermionic amplifying apparatus. Feb. 25.
- 5,262.—Appleton, W. A.—Variable resistances. February 25.
- 5,267.—Nicholas, J. S.—Earth switch. February 25.
- 5,271.—Mantle, H. D'O.—Tuning dial for wireless instruments, etc. February 26.
- 5,282.—Cooke and Whitfield Wireless, Ltd.—Wireless receiving apparatus. February 26.
- 5,283.—Smith, W. E.—Thermionic valves, etc. February 26.
- 5,317.—Perry, E. S.—Wireless aerials. February 26.
- 5,332.—Western Electric Co., Inc.—Acoustical apparatus. February 26.
- 5,336.—Robinson, L. M.—Inductance, etc., coils, and formers therefor. February 26.
- 5,402.—Torry, W. D.—Wireless receivers. February 27.
- 5,404.—Miller, W. R.—Thermionic valve socket holders. February 27.
- 5,413.—Wallis, S. V.—Electric contact makers. February 27.
- 5,414, 5,415.—Wallis, S. V.—Variable electric condensers, etc. February 27.
- 5,439, 5,440.—Rothermel, R. A.—Accumulator carriers. February 27.
- 5,450.—Western Electric Co., Ltd.—Telephone systems. February 27.

- 5,521.—Quayle, E. J.—Radio aerials. February 28.
- 5,528, 5,529.—Shannon, D. S. B.—Wireless receiving apparatus. February 28.
- 5,316.—Jones, E. H.—Method of uniting ends of wires, etc. February 26.
- 5,323.—Mackay and Orr.—Anticapacity lead-in tube for wireless aerials. February 26.

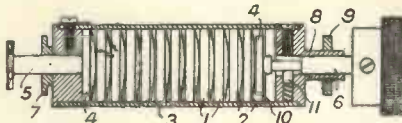

FIG. 8.

- 5,433.—Crombie, W. A. E.—Distributor for wireless reception. February 27.
- 5,468.—Grassmann, P.—Loud speakers for wireless telephony, etc. February 27.
- 5,512.—Baldwin, J.—Wireless instrument containers. February 28.
- 5,516.—Broadwood, R. L.—Thermionic valves, electric lamps, etc. February 28.
- 5,533.—Goodall Radio Manufacturing Co.—Wireless apparatus. February 28.
- 5,535.—Martin, A. J. G.—Inductance coil storage holders. February 28.
- 5,556.—Naamlooze Vennotschap Philips' Gloeilampenfabrieken.—Wireless receiving apparatus. February 28.
- 5,577.—Western Electric Co., Ltd.—Acoustic devices. February 28.

**Specifications.**

- 228,212.—Graham, E. A.—Microphonic transmitters.
- 228,216.—Graham, E. A.—Telephonic receivers.
- 228,243.—Mogridge, D. D. L.—Means for cooling thermionic valves.
- 228,267.—Evans, E. C. W.—Electric inductance coils and formers therefor.
- 228,281.—Henderson, J.—Electrical coils, more particularly for use in wireless telegraphy and telephony.
- 228,315.—Radio Frequency Laboratories, Inc.—Inductive coupling devices or transformers for electric circuits.
- 228,334.—British Thomson-Houston Co., Ltd., and Stace, A. T.—Crystal detectors.
- 228,357.—Goldstone, M. H., and Rodger, C. J.—Coil-holders for radio service.
- 228,428.—Rodo Patents, Ltd., and Sloop, F. A. L.—Wireless systems.
- 228,432.—Igranic Electric Co., Ltd., and Curtis, A. H.—Variable resistances devices.
- 220,312.—Rodman, I. P.—Variable condenser.
- 223,928.—Telefunken Ges. Fur Drahtlose Telegraphie.—Wireless receiving apparatus.
- 207,817.—Trantwein, Dr. F.—Thermionic tubes.
- 213,911.—C. D. Tuska Co.—Thermionic amplifiers.
- 221,808.—Siemens and Halske Akt-ges.—Thermionic amplifiers used in transmitting speech or like currents of varying frequencies.

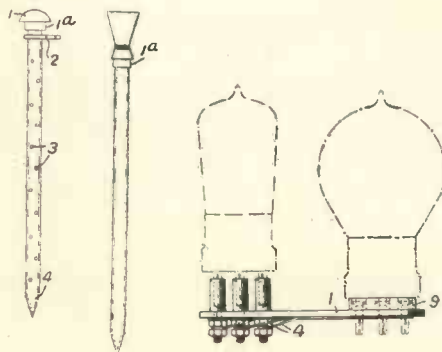

FIG. 9. FIG. 10.

FIG. 11.

- 225,238.—Bellini, E.—Radiogoniometers.
- 228,616.—Johnston, F. R.—Wireless receiving apparatus.
- 228,623.—Igranic Electric Co., Ltd.—Mackley, A. H., and Flight, W. S.—Wireless receiving apparatus.
- 228,675.—Hayward, E.—Receiver supports for telephone, wireless, or analogous apparatus.
- 228,693.—Murad, W. H.—Fixed condensers for use with grid leaks in wireless apparatus.
- 228,698.—Braid, T. B.—Adjusting devices for variable electric condensers and the like.
- 228,735.—Dilger, A.—Connecting holder for thermionic valves.
- 228,834.—Hesketh, B.—High-frequency amplifier transformers as applied to the art of wireless telegraphy.
- 228,839.—Taunton, H. R.—Multi-layer inductance coils.
- 203,701.—Dubilier Condenser Co. (1921), Ltd.—Apparatus for use with radio frequency amplifiers.
- 207,800.—British Thomson-Houston Co., Ltd.—Electron discharge devices.
- 207,818.—Connecticut Telephone and Electric Co., Inc.—Wireless receiving systems and electron discharge devices therefor.
- 215,317.—Western Electric Co., Ltd.—Seals for leading-in conductors of electron discharge devices, and an alloy therefor.
- 219,703.—Telefunken Ges. Fur Drahtlose Telegraphie.—Electric frequency transformers and choke coils.
- 220,629.—Marconi's Wireless Telegraph Co., Ltd.—Method of and apparatus for receiving radio signals.
- 227,445.—Westinghouse Electric and Manufacturing Co.—Electric telephone receivers.
- 228,961.—Western Electric Co., Ltd.—Electrical transmission of images.
- 229,019.—Ghyssaert, A. I. B.—Electric discharge tubes.
- 229,020.—Bradley, J. H.—Electric resistances, inductances, condensers and the like.
- 229,050.—Igranic Electric Co., Ltd., and Mackley, A. H.—Wireless apparatus.
- 229,058.—Makinson, E. E.—Wires or cables for wireless aerials, instruments, and the like.
- 229,119.—Williams, L. E., and Brooker, H. T.—Self-clamping binding or terminal posts for electrical apparatus.
- 229,127.—Graham, E. A.—Loud speaking telephonic apparatus.

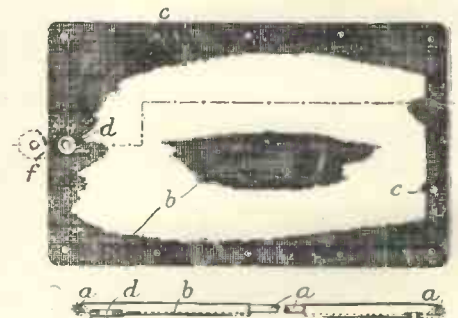

FIG. 12.

- 229,130.—Phillipson, B.—Wireless crystal detectors.
- 229,157.—Hunt, J. T. B., Stevenson, J. H., Cooke, W. A. C., and O'Neill, B.—Inductive coils for wireless receiving installations.
- 229,203.—Youldon, C. A., and Pearce, W. H. H.—Electrical resistances.

**Abstracts.**

226,659.—Telephones.—Marr, A., 23, Reynell Road, Longsight, Manchester.  
*Earpieces and attachments.*—A binaural telephone receiver comprises a sound reproducing instrument 4, Fig. 1, with vibratory diaphragm 4b and a cap 5 formed with a hollow extension 6 constituting a sound cham-

ber 6a. The wall of the sound chamber has diametrically opposite holes 7, in which are screwed short rigid tubes 8 on which are mounted flexible tubes 9, carrying ear-pieces 10. The ear-pieces 10 are formed with hook-like flanges 12 adapted to take over the ears of the user. Within the bore of the flexible tubes 9 is arranged a wire 13 which passes through the sound chamber 6a. The wire 13 prevents collapse of the tubes but is sufficiently resilient and is so shaped as to urge the ear-pieces towards each other when applied to the ears. The Provisional Specification describes the use of a stiffening member exterior to the flexible tube in place of the wire 13.

226,668.—Electric condensers.—Wallis, H. O., Gambles Factory, Newdigate Street, Nottingham.

A variable condenser comprises a main set of movable plates F, Fig. 2, carried by a hollow shaft G mounted on a fixed bearing tube H, and one or more auxiliary plates K, for giving a fine adjustment, carried by a spindle J mounted within the tube H. The tube H is secured to an intermediate frame member C, the shaft G and spindle J being mounted in insulated bearings A<sup>1</sup>, B<sup>1</sup> in the top and bottom frame members A, B. The two sets of plates are independently operated by knobs M, N, the arrangement permitting either set to be adjusted without affecting the other.

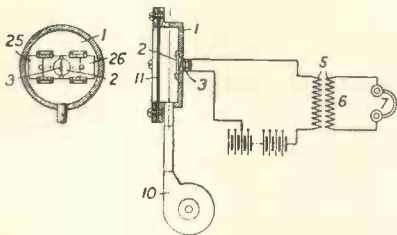

FIG. 13.

FIG. 14.

226,691.—Wireless receivers.—Gooch, A., 5, Roydale Street, Bradford Road, Manchester.

**Crystal detectors.**—The crystal is held between two claws carried on the ends of aligned rods, one claw being loosely mounted on a threaded rod, the other claw being fixed to its rod, which is rotatable and is movable longitudinally under spring control. The crystal E, as shown in Fig. 3, is held between a claw c rotatably mounted on a screwed rod C and claw d fixed to a rod D. The rod C screws through a tapped hole in bracket a<sup>1</sup> and the rod D slides through a bracket a<sup>2</sup>, both brackets forming part of a U-shaped frame A<sup>1</sup>, secured to an ebonite disc A<sup>1</sup>. A spring d<sup>2</sup> is compressed between the claw d and the bracket a<sup>2</sup>. The crystal is moved axially by turning the rod C, and is rotated around the axis by turning the rod D. The wire contact F<sup>1</sup> is carried by an arm F having a ball-and-socket mounting on the disc A<sup>1</sup>. Metallic connection from the two terminals b to the arms F, D is obtained by brackets A which also support the disc A<sup>1</sup>. The detector may be enclosed in a glass cover G which is mounted on a disc g<sup>1</sup> and enters a recess in the disc A<sup>1</sup>. It is retained in position by the pressure of a hinged spring arm g<sup>2</sup> on the disc g<sup>1</sup>. In a modification, the spring d<sup>2</sup> is enclosed in cups carried on the bracket a<sup>2</sup>.

226,708.—Wireless signalling.—Gandy, G. A., 137, Casson Street, Gorton and Leat, H., 100, Wayne Street, Higher Openshaw, both in Manchester.

**Crystal detectors.**—A transparent dust cover for the crystal comprises a chamber flanged as shown in Fig. 5 to provide a means of securing it to a base and provided with a fairly large hole in its side through which

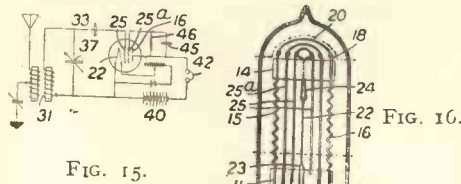

FIG. 15.

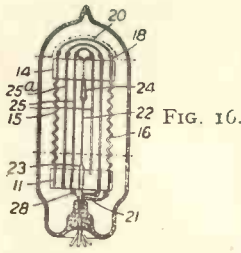

FIG. 16.

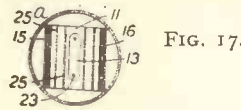

FIG. 17.

the contact arm passes. This hole is covered in any position of the contact arm by a loose piece of celluloid, etc., f with a small hole through which the arm passes. The loose piece f is held close to the chamber by a piece g of celluloid, etc., shaped as shown in Fig. 4, and secured to the outside of the chamber. According to the Provisional Specification the cover has metal end caps and flexible material is used instead of the movable piece f.

226,843.—Wireless receivers.—Taggart, J. Scott, and Radio Communication Co., Ltd., 34, Norfolk Street, Strand, London.

**Thermionic amplifiers and detectors.**—Relates to dual amplification circuits in which a valve is utilised to amplify high and low frequency currents simultaneously. In order to prevent any inherent tendency to instability one end of the secondary T<sup>1</sup>, Fig. 6, of the feed-back transformer is at earth potential, the other end being connected through an inductance coil L<sup>1</sup> to the grid of the first valve of the receiver. A pair of telephones or a loud speaker T is inserted in the anode circuit of the first valve, and is connected through a condenser C<sup>3</sup> to the grid of the second or detector valve. In order to eliminate difficulties caused by the loud-speaker being at a high frequency potential relatively to earth, two extra coils L<sup>4</sup>, L<sup>5</sup>, Fig. 7, are wound over the tuned anode inductance L<sup>2</sup>. A crystal detector may be used, coupled through a transformer to the grid of a low-frequency amplifying valve. A stabilising resistance is preferably connected across the grid and filament of the first valve.

226,861.—Electric resistances.—Cole, T. N., Ward, G. L., and Richardson, R. P., Woodger Road, Goldhawk Road, Shepherd's Bush, London.

**Contacting—solid resistances; powdered and granular resistances.**—A variable resistance consists of a pile of carbon discs 1, Fig. 8, alternating with resilient metal discs 2 and contained in an insulating tube 3. Through one end of the tube 3 passes an adjusting-screw 6 bearing on a stout metal disc 4. When the end of the tube is of metal, the screw 6 makes contact with the disc 4 through a hole in an insulating-washer 10, which permits the circuit to be broken when resting against the end of the tube. A screw 5, provided with a lock-nut 7, may be provided at the other end of the tube 3 for varying the range over which the resistance is variable by the adjusting-screw 6 as de-

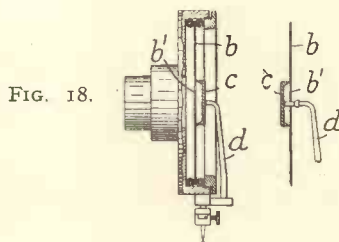

FIG. 18.

FIG. 19.

scribed in Specification 228,481. A spring-pressed plunger 11 engages a reduced portion of the screw 6 to take up wear and make metallic contact. For resistances of small size the screw 6 may be slightly bent for the same purpose. The metal discs 2 may be of phosphor-bronze foil and may be bent in one direction only, or may be dished or have tongues struck up from their plane. They may be replaced by spiral springs which can be compressed into one plane. A threaded stem 8 and nut 9 are provided for attachment to a panel. The screw 5 may be coarser in pitch than the screw 6. Both screws 5, 6 may be located at the same end of the rheostat, the pressure-varying screw 6 screwing through the range-adjusting screw 5. According to one of the Provisional Specifications the metal washers may serve as tapping points, and the carbon discs may be replaced by carbon or other granules.

226,869.—Earthing devices for wireless apparatus.—Quartermaine, H., Ferndale, Bath Road, Woking, Surrey.

A tubular earth pin for wireless purposes is provided with a cap 1 having a flange 1a extending round the tube. The cap may be rounded as in Fig. 9, or funnel-shaped as in Fig. 10. The tube may be provided with perforations 3 and a terminal-carrying band 2. Alternatively the terminal may be bolted through the tube. The tube is preferably pointed as at 4. It may be electro-plated, or may be provided with an external envelope of metallic gauze.

226,895.—Thermionic valves.—Mitchell, G. A., 349, Aylestone Road, Leicester.

In a wireless set or system employing valves, an additional valve is connected directly to one of the valves of the set, i.e., plate to plate, grid to grid, and filament to filament, for the purpose of amplifying the signals to be transmitted or received. A valve holder for this purpose consists of a strip or sheet 1, as shown in Fig. 11, of insulating material on which two or more

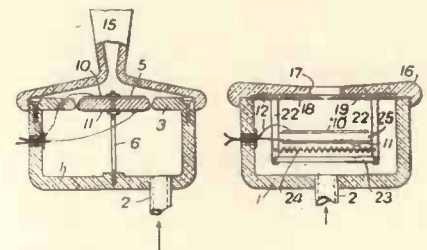

FIG. 20.

FIG. 21.

sets of valve legs are mounted, corresponding valve legs being connected to one another by wires. One of the sets of valve legs may be replaced by sleeves 9 inserted in the insulating material, so that the pins of a valve inserted therein may extend below the strip and may be then inserted in the holder in the set. Alternatively, the sleeves may be dispensed with, the wires 4 connecting the additional holder being formed into loops which engage the valve pins when they are inserted in the holes in the strip.

Reference has been directed by the Comptroller to Specifications 152,811, 153,553, 158,901, 164,105, and 167,584.

226,968.—Earth-plates for wireless sets.—Newton, W., 13, Rochdale Road, Blackley, Manchester.

An earth-plate for use with wireless receiving apparatus comprises a wire frame a, Fig. 12, covered with copper gauze b, the edges of which are turned over the frame and secured by eyelets c or other means. The earth lead is connected by means of a large eyelet d or a screw terminal, or a metal tab f may be soldered to the mat. Instead of using a frame, the edges of the mat may be beaded or rolled over.

227,173.—Microphones — Casc, T. W., Auburn, New York, U.S.A.

Relates to a hot-wire microphone of the kind in which the electrically heated resistance wire is mounted within an aperture in a wall of a chamber and is subjected to the action of sound waves as they pass through the aperture and to a current of air or gas produced, for example, by a blower 10, Fig. 14, to cool the resistance. The invention consists in the provision of an auxiliary aperture or apertures or a sheet of fabric 11 at the back of the casing 1 to allow the escape of gas independently of the aperture 2 in which the hot wire 3 is mounted. The aperture 2 may be of any shape, and may be adjustable in size by

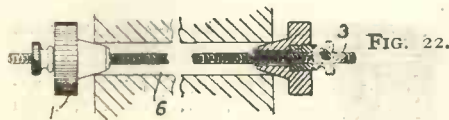

FIG. 22.



FIG. 23.

means of slides 25, 26, Fig. 13, or in any known manner. The electrical variations may be translated, as desired, by means of a transformer 5, 6 and telephone receivers 7.

227,224. — Thermionic valves. — Mills Novelty Co., 221, South Green Street, Chicago, U.S.A.

A valve has a filament, one or more grids, and an anode mounted in spaced slots on a block of insulating material, and spaced apart at their upper ends by an insulator supported on the electrodes. As shown in Fig. 16 a V-shaped filament 22, two pairs of grids 25, 25a, and two anodes 15, 16 preferably corrugated, are mounted in slots on a square insulator 11 of lava mounted on leads 21, 28, and fitting closely within the envelope. The upper ends of the electrodes are spaced in slots in an insulator 14. The supports 23 for the filament pass through a central slot 13, Fig. 17 in the insulator 11, and the bight is carried by a loop 24 of nickel. Stems 18, projecting from the anodes through the insulator 14, are connected together by a conductor 20. The grids are connected in pairs in a similar manner. The valve may be used in the regenerative amplifying system shown in Fig. 15, in which an input circuit, consisting of a variable inductance 31 and a condenser 37, is connected through a condenser 33 with one grid 25 and cathode 22, and the other grid 25a is connected through a condenser 45, shunted by a high resistance 46, with the anode 16, which is connected through a receiver 42 and a battery 40 with the cathode. Specification 204,317 is referred to.

227,240.—Acoustic diaphragms.—La Bourdonnais (Prince De Mahe) C. M. De C. De, Loventor Manor, near Totnes, Devon.

A diaphragm for use in a gramophone sound-box, a telephone loud-speaker, or like apparatus, is formed with a central aperture b<sup>1</sup>, directly over which, and spaced apart a slight distance therefrom by means of a short flange or the like, is fixed a disc c or similar member. In the application to a gramophone sound-box, as shown, the stylus-bar d is attached to the disc, which may be either in front of the diaphragm proper, b, Fig. 18, or behind it, Fig. 19. The flange of the disc, which contacts with the diaphragm, may be thinned to a knife edge as shown, and may have various forms. The disc or the like c is preferably made of silver, but may be of steel, mica, etc. When

the device is applied to a loud-speaker, the stylus-bar is replaced by a lever carrying a magnet armature.

227,445.—Telephone receivers.—Westinghouse Electric and Manufacturing Co., East Pittsburgh, U.S.A.

*Piezo-electric instruments; loud-speaking attachments.*—The flow of fluid under pressure through an orifice is controlled by means of a piezo-electric crystal in accordance with telephonic currents applied thereto. In one form, Fig. 20, the crystal 5 is supported in an opening in a plate 3 by means of a standard 6. The gaps at the edges of the crystal are very small and preferably of stream line shape. Elongations and contractions in the length of the crystal due to currents supplied to the plates 10, 11 control the flow of air, which is supplied under pressure to the casing 1 by a pipe 2. A horn 15 screws directly on the casing. In another form, Fig. 21, the crystal 25 moves levers 22, pressed against its ends by a link 23 and a spring 24, to move plates 18, 19, the ends of which form a small orifice opposite the opening 17 in the ear cap 16. The plates 18, 19 slide between the cap 16 and the casing 1.

226,284.—Electric couplings.—Bell, H. G., 4, Chelford Road, Manchester, and Metropolitan Vickers Electrical Co., Ltd., of 4, Central Buildings, Westminster.

An insulated leading-in conductor for a wireless aerial, or for other connections through a relatively thick wall, comprises a conducting rod 3, Fig. 22, maintained centrally in a hole 6 by self-centring insulating bushings 1 which are substantially conical, secured on the rod and engaging the entrances to the hole. These bushings may be screwed on the rod or screwed into the hole. To increase the creepage surface a projection may be formed on the side remote from the hole, and to carry off rain water, ridges and troughs may be formed upon the bushings as shown in Fig. 23. The rod may be provided with nuts or other terminals which may serve as lock-nuts for the bushings. The central portion of the rod may be covered with insulation. Specification 12,443/14 is referred to.

226,307.—Telephone instruments.—British Thomson-Houston Co., Ltd., of Crown House, Aldwych, London; Young, A. P., Borrowell, Borrowell Lane, Kenilworth, and Butcher, J. H., 9, Grosvenor Road, Rugby, both in Warwickshire.

*Magnetic instruments.*—In sound emitting or transmitting instruments, such as telephone receivers, in which a permanent magnet 12 is located centrally of a cup-shaped or bowl-shaped casing 11 of magnetic material, as in Fig. 24, a shunt flux is provided extending from the magnet to the side of the vessel. The shunt path may consist of a disc or spider 15 of magnetic material, and is preferably arranged between the coil 16 and the base of the casing. When the path is near the free end or the

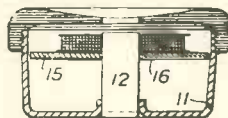

FIG. 24.

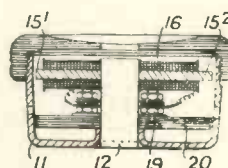

FIG. 25.

base of the permanent magnet, a small air gap is left, the disc or spider 15 being either secured to the magnet, Fig. 24, and the air gap left near the casing, or secured

to the casing and the air gap left round the permanent magnet. But when the disc or spider is near the middle of the magnet, it is secured both to the magnet and casing, no air gap being left. The actuating coil may be around the shunt path; preferably two or more coils, Fig. 25, are arranged symmetrically on arms 15<sup>1</sup>, 15<sup>2</sup> of the spider. The terminals 19 are mounted on a piece of insulating material 20.

Messrs. Rayner and Co. will obtain printed copies of the published specifications only, and forward on post free for the price of 1s. 6d. each.

## NEW TRADE MARKS

452,902.—Ronega, for all goods in Class 8.—Carroll, Parsons and Co., 12, Verney Road, London, S.E.16.

454,537.—Saba, for wireless telephonic headphones and transformers.—Schwarzwalder Apparate-Bau-Anstalt August Schwer Sohne, Villingen, Baden, Germany.

454,896.—Supaul, for all goods in Class 8, but not including optical instruments, and not including any goods of a like kind to optical instruments.—Superlamp, Ltd., 197, Old Street, London.

455,605.—Illustration of a flying witch in a circle, for instruments and apparatus included in Class 8, for use in wireless telephony.—Jose Marcel Ortega, Upper Wandle House, Garratt Lane, Earlsfield, London, S.W.18.

455,775.—Becop, for instruments and apparatus for use in wireless telegraphy and telephony, included in Class 8.—William James Palmer, trading as British Electrical Manufacturing Co., 27a, Bangalore Street, Putney, London.

455,096.—Beltona, for apparatus for use in wireless telegraphy and telephony, included in Class 8.—John G. Murdoch and Co., Ltd., 59 and 61, Clerkenwell Road, London, E.C.1.

455,527.—Hexaphone, for headphones.—William Clark, 53, Victoria Street, London, S.W.1.

453,153.—Accurect, for rectifiers and discharge tubes, being apparatus for use in telegraphy and telephony.—Naamlooze Venootschap Philips Gloeilampenfabrieken, Emmasingel la Eindhoven, Noord Brabant, Holland.

455,542.—The Hit, for all goods in Class 8.—Homophon Company Gesellschaft Mit Beschränkter Haftung, 108, Alexandrinenstrasse, Berlin, S.W.68, Germany.

455,543.—Heros, for all goods in Class 8.—Homophon Company, Gesellschaft Mit Beschränkter Haftung, 108, Alexandrinenstrasse, Berlin, S.W.68, Germany.

451,865.—Acrophone, for instruments and apparatus, included in Class 8, for use in connection with wireless telephony and telegraphy.—A. Watkins, The Hut, Ryton Road, Beckbury, Shropshire.

452,328.—Glazite, for cables for electrical purposes.—The London Electric Wire Co. and Smiths, Ltd., 7, Playhouse Yard, Golden Lane, E.C.1.

452,787.—Monogram for all goods in Class 8.—C. J. Whistler Hanson, 143, 145, 147, Rosebery Avenue, London, E.C.1.

453,215.—Radiobat, for electric accumulators and batteries, included in Class 8.—Radiobats, Ltd., 18, Snow's Fields, Brompton, London, S.E.1.

454,186.—Genie, for all goods in Class 8.—Austin Edwards, Ltd., Film Works, Wharf Street, Warwick.

453,329.—Black square device, for all goods in Class 8.—Deutsche Werke Aktien Gesellschaft, 90, Westfälische Strasse, Berlin-Wilmersdorf, Germany.



# Trade Transactions



## Davenport News.

SEVERAL new types of receivers have been produced by G. Davenport (Wireless), Ltd., of 69-70, Dean Street, Oxford Street, London, W.1.

One of the most interesting is the "D.W." universal two-valve cabinet set. The circuit consists of detector and low-frequency amplifier, transformer coupled, with direct aerial reaction with condenser and tuning coil. With this instrument most of the B.B.C. stations can be received on headphones, whilst several come in at loud-speaker strength. Plug-in coils are used, so that it is possible to cover an almost indefinite wave-band.

Separate control to the filament of each valve is provided, and the wiring of the set is carried out on the bus-bar principle, this being recognised as one of the best methods of wiring. Valves and coil-holder are enclosed inside the cabinet, the solid ebonite panel being equipped with view windows for the inspection of these accessories.

One of the special features of this receiver is the way in which the instrument is built into the mahogany cabinet. A tray carries the circuit and panel, and this can be slid out of the back of the cabinet for inspection of, or adjustment to, any part of the internal mechanism. Provision is made in the base of the cabinet for the high-tension batteries, and special clips are provided to take the grid bias battery.

The C.T.1, C.T.2 and C.T.3 are other new receivers, and are built into cabinets with exposed panels. These have been produced to meet the demand for inexpensive apparatus capable of tuning to any wavelength by means of plug-in coils, with direct aerial reaction. The circuit in each set is of the conventional type, the C.T.1 employing simply a detector valve, the C.T.2 detector and one-note magnifier and C.T.3 detector and two-note magnifiers. As in the "D.W." universal mentioned above, separate filament control is provided. Terminals for two pairs of 'phones are also fitted, and the two-way coil-holder is equipped with anticapacity handle, which permits of ample movement.

The polished ebonite panels are mounted in polished mahogany cabinets, and all metal parts are nickel-plated.

Though low in price, these instruments



The "D.W." Universal, a new two-valve receiver produced by G. Davenport (Wireless), Ltd.

Manufacturers should send notices of new apparatus, etc., to the Technical Editor. Dealers and factors communicating with manufacturers regarding announcements would oblige us by mentioning "The Broadcaster and Wireless Retailer."

are up to the usual standard of Davenport workmanship.

## New Switch for Wireless.

W. L. LANGMAID AND CO., of 54, Plumstead Common Road, Plumstead, London, S.E.18, are marketing a switch known as the "T.O.K." This switch is new to the wireless industry, and we think it will prove to be very useful to the majority of listeners-in. It is designed to operate in the aerial, earth and low-tension circuits of receivers, acting as an "on and off" switch for switching the aerial, earth and low-tension batteries at the same time. It is a two-way, four-pole rotary switch, with quick-break action, and is entirely British made. A porcelain base holds the electrodes, which are enclosed in a moulded fire-proof cover, with indicator and spring key. Before despatch each of these switches is subjected to a breakdown insulation test of 1,000 volts. When in the "off" position the aerial and earth are connected together and the batteries cut off, both these operations being carried out by one movement of the key. Full particulars and trade terms will be sent on application. It should be noted that W. L. Langmaid and Co. are sole distributors for the "T.O.K." wireless switch.

We would point out that this firm undertakes the winding of transformer coils, headphones and loud-speakers, also headphone and loud-speaker repairs.

## Trolite.

F. A. HUGHES AND CO., LTD., of 204-206, Great Portland Street, London, W.1, have for some time been producing panels and mouldings for wireless purposes, but it is only a comparatively short time ago that a special grade of "Trolite" for wireless uses was produced. This is known as grade "F," and is somewhat similar in appearance and electrical properties to ebonite, though its specific gravity is rather more than that of ebonite. This material has high insulating properties, and is entirely free from surface leakage. It takes a very high polish and considerably adds to the appearance of a wireless instrument. Not only is the material used for panels, but knobs, dials, telephone earcaps, valve-holders, and other mouldings and rods are made. Panels are cut to standard sizes, and we would advise traders to acquaint themselves with full particulars of this useful material. We understand it is easily machined and is suitable for use for all purposes for which ebonite is commonly employed.

## Window Transparencies.

SIEMENS BROTHERS AND CO., LTD., of Woolwich, S.E.18, have just issued two very attractive advertisement signs in the form of window transparencies. These are coloured reproductions of two showcards illustrating loud-speakers and headphones respectively.

The transparencies measure eight by six and a quarter inches. Retailers can obtain copies of these on application.

## Showcard.

ACCUMULATORS (BIRMINGHAM), of Exeter Street, Holloway Head, Birmingham, manufacturers of the "A.B.L." accumulators, have produced an attractive showcard for the use of retailers. It consists of a thick card with green background with red and yellow embossed lettering. Placed in a prominent position in the window, this card cannot fail to attract attention.



This illustration shows a display of "Amplion" loud-speakers in the window of Messrs. Selfridge and Co.

## Kingsway Radio.

THE "Kingsway" No. 3 receiver is a two-valve set employing detector and low-frequency valves with reaction. It is contained in a polished mahogany cabinet with matt panel 10½ by 7 in. One of the interesting features of this instrument is that the whole of the mechanism, including the panel, can be slid out from the back of the cabinet. This greatly facilitates the work of adjustments to the wiring, etc. Standard plug-in coils are used, so that reception on all wavelengths is possible. With the exception of 'phone or loud speaker terminals which are situated on the panel, all connections are made at the back of the cabinet.

The instrument is supplied as a complete loud-speaker outfit, either with dry batteries and dull-emitter valves or L.T. accumulators and bright valves.

It is stated that the range of this set on headphones is approximately 250 miles, and the loud-speaker range about 50 miles.

Another line marketed by this firm is the "Kingsway" wave-trap, which is claimed to cut out effectively local stations at a distance of two and three-quarter miles. This instrument is contained in a mahogany case and retails at the low price of 21s.

Many other interesting lines are manufactured by the Kingsway Radio Co., of 7, Railway Approach, Cannon Street, London, E.C.4, which firm offers good trade terms.

## Accessories.

SEVERAL of the accessories manufactured by S. Lilley and Son, of Alcester Street, Birmingham, have reached us. One is a valve-holder for panel mounting, and we find that it is a splendidly produced article. The four sockets which take the valve legs are sunk into a stoutly made insulating base, the connecting pins projecting over half an inch from the base, so that after mounting on the panel the pins project sufficiently to allow efficient connections to be made.

Another item is a telephone distributor to take two pairs of 'phones. This is designed for connection to existing telephone terminals, and it is, of course, necessary to have two of these distributors for each set of telephone terminals. This simple and inexpensive device will be found very useful to crystal-set users. It is made to take straight tabs, these being pushed into the slots provided on the distributors.

**M.A.L.**

FOR those traders who are not acquainted with the material handled by Merchants and Agencies, Ltd., of 45, Basinghall Street, E.C.2, we here give brief particulars of some of the leading lines.

One of the chief items is the M.A.L. battery. This is made in voltages of 30, 60 and 100, and is supplied complete with wander plugs. Flash-lamp batteries, with a voltage of 4.5 volts, are also made. These, of course, are suitable for grid bias use and for the construction of high-tension batteries.

The M.A.L. high-tension battery is constructed of 1½-volt cells, each cell being well

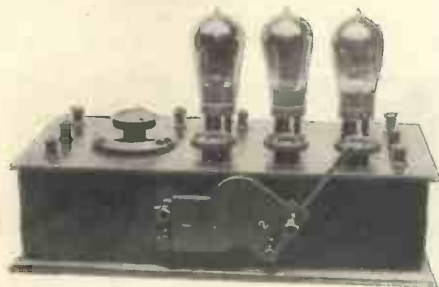

Marketed by Merchants and Agencies, Ltd., this three-valve receiver retails at a low price.

insulated from its neighbour. The tappings, which are well sunk into the pitch, are adequately spaced, so that the possibility of shorting is minimised. The makers guarantee these batteries a shelf life of three months. At the present time we have one of the M.A.L. high-tension batteries at our laboratory, where it will undergo tests, our report of which will appear later.

One, two and three-valve receivers are also made. The only difference in these instruments is the amount of amplification. The three-valve model employs detector and two low-frequency valves, the two-valve model, detector, and one low-frequency valve, and the one-valve model, of course, simply a detector valve. For these receivers special coils are made, the full range covering wavelengths from 150 to 5,750 metres. Two coils covering the B.B.C. wavelengths (with the exception of Chelmsford) are supplied with each receiver. Except for the coil holder all controls as well as terminals for aerial, earth, phones and batteries are situated on the panel.

The instruments are very efficient and cover a considerable range. One of the three-valve models was demonstrated to us, and we are pleased to say that good loud-speaker results were given.

Another line which retails at a low price is the "Superbe" loud-speaker. The tone of this instrument is quite good and an appreciable amount of volume is given. The flare has a diameter of 9½ in., and is finished in polished black. The swan-neck tone arm is of black crystalline. Overall the height of the loud-speaker is 16 in., and the resistance 2,000 ohms.

**B.T.H.**

FOR those dealers who have not received the coloured poster advising the public of the reduction in "B.T.H." headphones, we would point out that it is obtainable from the British Thomson-Houston Co., Ltd., of Crown House, Aldwych, London, W.C.2.

**Battery Charger.**

THE "Unlinkin" battery charger marketed by the Gran-Goldman Service, of 71, Fleet Street, London, E.C.4, is designed to work from existing D.C. electric fittings. The instrument is of simple construction, and can be operated by an amateur. It is equipped with double switches, an ammeter and two terminals mounted on a polished box frame, and, apart from these items, there

is nothing further that the user need worry over. The apparatus can easily be fixed in any convenient position, and takes up only a small amount of room. It measures 6½ by 6½ by 3 inches.

The "Unlinkin" is claimed to be a very efficient and economical instrument.

Three types are made—the "Standard," "Junior" and "Senior." The charging rate of the first two named is up to five amps per hour and the last up to ten amps per hour.

**New Accumulator.**

A NEW accumulator is being marketed by Rowland Edwards and Co., Ltd., of 317, High Holborn, London, W.C.1. The accumulator is termed the "Edwards' Non-Spilling." It may be knocked over on any of its four sides, but there is no possible chance for the acid to leak out, and, even though it is shaken there is still no sign of any acid leakage. Another feature is that it is unnecessary to remove any caps or plugs when recharging, as there is no creeping of the acid. This certainly may be termed an ideal accumulator, and we foresee a great future for the "Edwards' Non-spilling," as there is no risk of burnt fingers, clothes, carpets, etc. It is just an ordinary sized accumulator contained in a patented container. Several types are made for the standard voltages, and we think all dealers in, and users of, accumulators, will find this one very interesting.

**Extension of Premises.**

DUE to the excessive demand for the "Rondar" components manufactured by A. M. Young and Co., of Bordesley Street, Birmingham, it has been necessary for this firm to put down additional plant. Consequently the premises have had to be extended and the production of "Rondar" apparatus will be speeded up considerably.

In addition to manufacturing loud-speakers, headphones, transformers, rheostats, etc., this firm is noted for repetition brass work.

**Material Wanted.**

J. C. HOLLAND AND CO., of 27, Franklin Street, Belfast, will be pleased to hear from any firms who may at the present time have stocks of Army-designed wireless masts.

For the information of such firms we would point out that the masts required are the tubular steel type, and should be approximately 30 ft. high, made up of 4 ft. 3 in. sections. The quantity required is eighteen masts complete with mast gear if possible.

**New Apparatus.**

STOCKALL, MARPLES AND CO., LTD., of 6, 8 and 10, Clerkenwell Road, London, E.C.1, inform us that they have several new types of receivers in course of construction. These include portable one, two, three and four-valve sets and pedestal models, but at the moment no particulars are available. It is hoped, however, to include particulars of these models in the new illustrated catalogue shortly to be produced by this firm.

Two new terminals are being marketed by Stockall, Marples and Co. These are known as the "Big Ben," No. 1 and No. 2 terminals, and the illustrations on this page show their uses. The No. 1 type is so made that it will grip either spade or straight tags, and

This terminal is also made by Stockall, Marples and Co., Ltd. Known as "Big Ben," type No. 2, it will take both spade and straight tags at the same time. The straight tag is taken by the cross connecting piece shown.

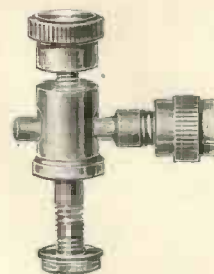

the No. 2 will take both spade and straight tags at the same time. These are obtainable either in brass or nickel-plated finish.

**To Manufacturers.**

WE have been asked by Thanet Electrical Factors, Ltd., to state that they have opened an electrical and wireless accessories factoring depot at Prospect Place, Broadstairs. This firm will be pleased to receive lists and lowest quotations for all types of accessories.

**New London Address.**

FULLER'S United Electric Works, Ltd., of Chadwell Heath, Essex, have removed their London depot from 58, High Street, W.C.2, to more commodious premises at Sparta House, 176, Tottenham Court Road, W.1. At this address large stocks of their well-known cable, accumulator, dry battery, and radio manufactures will be available. The telephone numbers are now Museum 9008 and 9009, and the telegraphic address, "Fullasparta," London.

We are also informed by Fuller's that their Leeds agent, Mr. F. Dawson, has also taken larger premises at 7, Park Square, where he will carry the usual comprehensive stocks of Fuller products.

**Sparta Radio Accessories.**

A NEW edition of their accessories catalogue has been published by Fuller's United Electric Works, Ltd., Woodland Works, Chadwell Heath, Essex. Traders can obtain same on application.

**Dubilier.**

THE Dubilier Condenser Co., Ltd., of Ducon Works, Victoria Road, North Acton, London, W.3, has produced an attachment for use in conjunction with their type 600 condenser when a series grid-leak connection is required. The attachment consists of a clip mounted on a moulded insulating base. It is an easy matter to add this attachment to the existing condenser, and it dispenses with the necessity for separate grid-leak clips when high-frequency amplification is embodied in a receiving set.

Large supplies are available for immediate distribution, the complete attachment retailing at 6d.

**To Save Delay.**

ALTHOUGH it is some considerable time since the National Wireless and Electric Co. removed their works from Acton to Gray's Inn Road, there is still an appreciable amount of correspondence being sent to the old address. To avoid further inconvenience and delay it should be noted that all communications should be sent to 42, Gray's Inn Road, London, W.C.1. The telephone number at this address is: Holborn 4756.

**Batteries.**

WE are advised by J. F. Smith, of 94-96, Hurst Street, Birmingham, that the "Sure-a-lite" high-tension battery is now made in all standard sizes. Low-tension batteries for dull-emitter valves have also been placed on the market.

**Wireless Valves, Ltd.**

THIS firm informs us that it is anxious to take up agencies for one or two first-rate wireless manufacturers, and would be pleased to receive communications from those firms who wish to establish new agents.

"Big Ben" terminal, type No. 1, is so made that it will grip either a spade or straight tag.

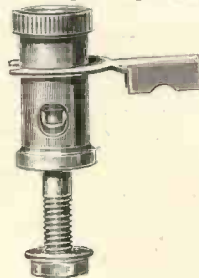

We understand from Wireless Valves, Ltd., that they have a good sales organisation and private trade connection throughout the British Isles, and are in a position to handle distribution in an efficient manner. The address is 86, Rosebery Avenue, London, E.C.1.

**Clix.**

**DUE** to the increased demand and the consequent saving in production cost, Autoveyors, Ltd., of 84, Victoria Street, London, S.W.1, have recently been able to revise the discounts for the well-known "Clix." The discount for "Clix" and "Clix" accessories is now 33½ per cent., whilst the cash settlement terms are 3½ per cent. cash with order, and monthly account 2½ per cent.

It should be noted that adequate production has been arranged, which will ensure prompt delivery.

New models of "Clix" and additional "Clix" accessory are now available. These have been produced to meet the demand for a somewhat cheaper form of panel insert. Full particulars of the new models can be had on application.

In the business announcement of Autoveyors, Ltd., on page 49 of the March issue of THE BROADCASTER AND WIRELESS RETAILER an error was made. Unfortunately, an out-of-date illustration was shown, and we trust no inconvenience has resulted.

**Watmel.**

**THE** Watmel Wireless Co., Ltd., of 332A, Goswell Road, London, E.C.1, have for some time past been considering the production of one or two entirely new components, but the demand for the well-known Watmel variable grid leak has been, and still is, so

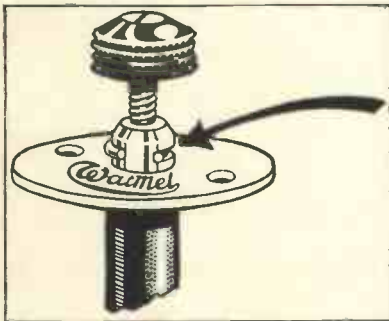

The well-known Watmel grid leak is now fitted with a special spring device, so that perfect contact between the bush and adjusting screw is maintained.

extensive that the firm has been unable to spare much time for the new lines.

It is not generally known that the latest Watmel grid leaks and resistances are being fitted with a special spring device for maintaining perfect contact between the bush and adjusting screw. This new device, briefly, consists of a bronze "D" spring fitted into a slot, which is milled through the bush allowing the "D" spring to make contact with the screw. This method effectively takes up any slackness, and always maintains perfect electrical contact.

To distinguish between the various values of the grid leaks different coloured knobs are fitted. There are now three colours being used, black, red and green, denoting respectively resistances of 5 to 5 megohms, 50,000 to 100,000 megohms, and 10,000 to 100,000 megohms. The grid leak with the green knob is a fairly recent production, and is specially made for the "P.W." selective circuit. Although graded for resistances between 10,000 and 100,000 megohms the instrument is particularly effective between 10,000 and 50,000 megohms.

**McLeod and McLeod.**

**TWO** new lines which should appeal to the trade are marketed by this firm. One is the "Macondo" pneumatic ear pad.

This little device is designed to fit over headphone earpieces, and to afford comfort to the wearer. These pads, though not bulkily built, give a decided cushion effect, and certainly relieve that uncomfortable pressure which many makes of headphones exert upon the head and ears. They are easily fitted to the 'phones, and when in position do not to any noticeable degree affect the volume given by the 'phones.

The other new line is the "Doelcam" knob designed for use on variable condensers, etc. It is claimed that these knobs will not break unless subjected to unfair usage, such as blows from a sledge hammer, etc. The knobs are well finished and the appearance is good.

**J. F. Smith.**

**PAMPHLETS** dealing with the lines, which include the micro-radio filament resistance and micro-radio potentiometer, marketed by this firm are published, and dealers will find a host of interesting items. The address of J. F. Smith is 94-96, Hurst Street, Birmingham.

**Radio Stocks.**

**AMONGST** the many lines marketed by Radio Stocks, of Radio House, Newman Street, London, W.C.1, is a vernier coil holder for basket coils. This is a very novel and, at the same time, efficient device which should appeal to users of basket coils. It is easily fitted to the panel and occupies but a small space. Changing the coils is a simple matter which can be accomplished without trouble in a few moments.

Full particulars of this and particulars of the special offers in standard stock lines will be sent to the trade on application.

This firm informs us that the demand for the "Octopus" Mansbridge condenser increases week by week, and it is fairly evident that this accessory is giving satisfaction.

**Wire.**

**NEW** price lists, covering the range of wires supplied by Kent Brothers Electric Wire Co., and E. H. Phillips, Ltd., of 15, Berners Street, London, W.1, have been issued. Many kinds of wire for the varied requirements of wireless work are supplied, and we think manufacturers and dealers alike would be interested in these new lists.

**Ellis and Son.**

**THIS** firm is in a position to undertake any kind of coil winding from power transformers to telephone bobbins, and also to manufacture transformers to customers' own specification.

Ellis and Son also market several types of components, one of the chief being the "King" low-frequency transformer. This is made in ratios of 3, 4 and 5 to 1, and is wound on the "Spirella" principle. It is claimed that this principle ensures great clarity of reproduction and the elimination of noise. The "King" transformer is sturdily built, and retails at 13s. 6d.

Another item marketed by this firm is an experimental valve-holder, known as type G.576. This is a well-made accessory, the plate socket of which is distinctly coloured and somewhat shorter than the filament and grid sockets. The object of this distinction

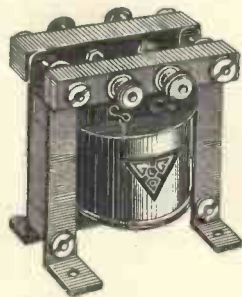

This sturdily constructed transformer is a product of Ellis and Son.

is to eliminate the possibility of burning out the filament of the valve.

This firm will be pleased to receive inquiries for turning work in ebonite and erinoid. The address is: 6, Panyer Alley, London, E.C.1.



A recent cut out counter card, illustrating some of the receivers manufactured by Falk, Stadelmann and Co., Ltd.

**Burndept.**

**A** SHORT time ago Burndept, Ltd., of Aldine House, Bedford Street, London, W.C., completed negotiations for the purchase of a company known as Baynton's Wholesale House, Ltd., at Winchester House, Victoria Square, Birmingham. At this address a further branch of Burndept, Ltd., has been opened, and it should be noted that stocks of the comprehensive range of apparatus manufactured by this firm are carried at this address and can be supplied immediately to order.

At the head office in London alterations have been made. The trade department has been considerably enlarged, the entrance to which is situated at 66, Chandos Street. It is now possible to carry approximately ten times the amount of stock previously carried, and the firm is now in a position to supply unlimited quantities of all customers' requirements.

**Igranic.**

**TWO** new leaflets, Nos. 6138 and 6139, dealing with the Igranic radio switch and combined knob and dial, have been published by the Igranic Electric Co., Ltd., of 149, Queen Victoria Street, London, E.C.4.

The switch will be found very useful in many circuits, and is particularly useful for switching the filament current on or off without the necessity for altering adjustment of the filament rheostats. It is a compact, self-contained, completely enclosed switch designed for use in all cases where a simple make and break switch are required.

Convenient screw terminals at the back of the switch provide a means of easy connections.

Specially suitable for use with any type of rheostat or potentiometer of the rotary type having a quarter-inch spindle, the combined knob and dial can also be adapted for a variety of other radio purposes. It is made of moulded bakelite, the knob being milled and slightly tapered. The bevelled dial is two inches in diameter, its scale divisions being clear and evenly spaced.

**M.A.P. Company.**

**WELL** known as manufacturers of motor accessories, this firm is also interested in the production of radio apparatus, and offers to the trade various types of complete receivers, loud-speakers and components under the name of "M.A.P."

Traders who apply to this firm can obtain a copy of their latest catalogue, which gives particulars of the range of "M.A.P." products. Address to: Great Lister Street, Birmingham.

**Britphone.**

SEVERAL types of receivers under this name, ranging from crystal to multi-valve de-luxe sets, are manufactured by the British Wireless Supply Co. (1924), Ltd., of 6, Blenheim Terrace, Leeds. Good workmanship is put into these instruments, and before despatch each individual set is subjected to rigid examination and test on aerial.

A nicely produced catalogue is published by this firm, and is available to the trade on application.

**Utility Components.**

WILKINS AND WRIGHT, LTD., of Utility Works, Kenyon Street, Birmingham, have recently published a new catalogue dealing with their "Utility" products. It contains particulars and illustrations of many interesting and well-made components. Traders should make a point of getting copies of this catalogue, especially those who may not be acquainted with the "Utility" components.

It should be noted that Wilkins and Wright, Ltd., specialise in all kinds of stampings, and quotations for this class of work will be sent on receipt of inquiry.

**A New Catalogue.**

A COPY of the latest catalogue produced by A. J. Stevens and Co. (1914), Ltd., of Walsall Street, Wolverhampton, has just reached us.

Much information and many illustrations of the well-known lines manufactured by this firm are given, and we think all dealers would be well advised to write for a copy.

The catalogue is produced on high-class glossy paper, and is held between neatly designed covers. Each page is a separate leaflet, and is held to the covers by means of slips, which can be adjusted to take further leaflets as required.

**Brandes, Ltd.**

A NEW eight-page booklet dealing with the "Matched Tone" headphones and Brandes "Table Talker," manufactured by Brandes, Ltd., of 296, Regent Street, London, W.1, has been issued to the trade. It is tastefully produced, and points out the special advantages to be obtained by the use of these instruments.

A supply of these booklets for distribution to your customers can be obtained on application, and we advise all dealers who have not as yet received copies to get in touch with this firm. Booklets such as this are undoubtedly an aid to sales.

**L.E.S.**

TRADERS should note that the micro controls produced by the London Electric Stores, Ltd., of Oxenden Street, Haymarket, London, S.W.1, are now being packed in coloured cartons. The cartons are well produced, and make an attractive window display, and we think this is likely to materially assist the dealer in his sales. If you have none of these cartons get in touch with this firm.

**Change of Address.**

TRADERS should note that A. Behm (London), Ltd., is now installed in new premises. Rapid increase in sales has made it necessary for this firm to secure a larger factory. This is situated at Falkland Works, Falkland Road, Harringay, London, N.8, and to this address all communications should be directed.

**Chaseway Products.**

ONE of the latest instruments marketed by the Chase Electrical Manufacturing Co., Ltd., of 184, Fleet Street, London, E.C.4, is the "Chaseway" charger for alternating current. This British-made charger is self-contained and measures approximately 7 by 6 by 4 inches. It is made for all voltages—100 to 250—and is adjustable for recharging

2, 4, 6, 8, 10 and 12-volt accumulators. The charging rate registered is from 0 to 5 amperes.

Another interesting line is the "Chaseway" variable grid-leak. This is designed for one-hole fixing, and takes up only a small amount of space at back of panel. Two terminals are provided, so that connecting is simplified. Unlike most other types of variable grid-leaks, the "Chaseway" resistance is controlled by a "pull-and-push" handle. It is claimed that this component is highly efficient.

A catalogue describing the various products of this firm is available, and can be had on application.

**Cosmos.**

METRO-VICK SUPPLIES, LTD., of Trafford Park, Manchester, have recently produced two new publications dealing with "Cosmos" Radiophones and Valves. These are nicely produced and should appear on every retailer's counter. A most attractive window-card (which we reproduce on this page) is also published.

These items are available for traders who are prepared to demonstrate the "Cosmos" receiving sets and thus obtain the benefits of the extensive national advertising campaign of this firm.

**Catalogues Wanted.**

RALPH OTTON, wireless dealer, of Station Road, Castle Cary, Somerset, will be glad to receive illustrated catalogues from manufacturers and wholesalers.

This firm is anxious to be in a position to give prospective customers full particulars of the various makes of apparatus on the market.

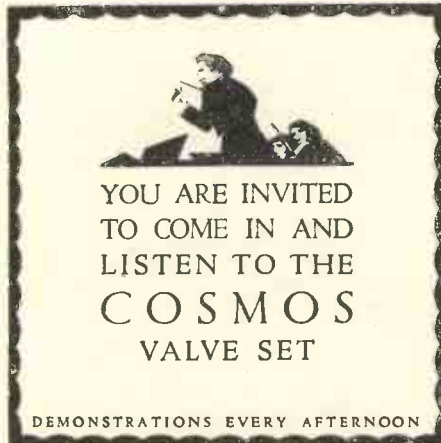

An attractive window card for the use of retailers who are prepared to demonstrate the "Cosmos" apparatus.

**Jeb Trading Co.**

THIS firm, whose address is 49a, Aubney Road, Acton, W.3, is marketing an appliance known as the "C.W." extending battery container. It has been designed to hold any quantity of 4½ volt flash lamp batteries up to thirty in number, so that a really good high-tension battery can be assembled with ease. The advantage of using a device of this kind is that any defective cell can be removed without disturbing the efficiency of the unit. The container is British made.

**Engraving.**

WE have recently inspected some of the engraving carried out by S. Marks and Sons, Ltd., of 7-8, Carthusian Street, London, E.C.1, and can say that the work is well done. This firm undertakes the engraving of panels in any quantity to specified design and requirements. We were informed that many of the leading wireless apparatus manufacturers have placed repeat orders with the firm for this class of work.

Panels for the "Omni," "S.T.100," and all concert circuits can be delivered from stock. These are ready cut to size, drilled to take the components recommended for each specific circuit, and fully engraved.

Panel cutting is another part of the business. They can be cut to any desired size and edges ground in polished ebonite, dead matt or mahoganite. The material used is guaranteed by S. Marks and Sons, Ltd., to be of high grade and non-metallic.

**U.S. Products.**

THE products of the U.S. Radio Co., Ltd., of 153, High Street, Lewisham, London, S.E.13, are undoubtedly well known to the majority of dealers throughout the country. There is, however, no reason why traders should not be in possession of one of the latest catalogues issued by this firm. Illustrations, particulars and prices of the various "Powercryst" receivers and amplifiers, as also the well-known "U.S." transformers and other components, are given.

To obtain a copy of this handy little booklet it is only necessary for you to send a letter or card giving trade address.

**Geepee Super Aerial.**

SUPPLIED by Goodchild and Partners, Ltd., of 56-58, Eagle Street, London, W.C.1, this aerial consists of nine strands of 13 bronze wires, each wire being 006 in. thick. The material is a special alloy, and is claimed to have a very low electrical resistance. The aerial is supplied complete with six mounted egg-shape insulators, the mounting consisting of rubber-coated copper wire neatly bound.

**Super-phone Receivers.**

A NEW leaflet dealing with the "Super-phone" crystal and valve receivers has been published by the Radio Supply Co., of Four Oaks, Birmingham. This illustrates and describes at length the various models manufactured by this firm, and we think dealers would be well advised to write for a copy.

The sets are well made, and the control systems are simple. Prices are low.

**Regent Radiophones.**

A HANDY little illustrated catalogue giving particulars of the various types of receiving sets under this name has been published by the Regent Radiophone Co., Ltd., of 210, Sherwood Street, Nottingham. The instruments made by this firm are claimed to be very efficient, and it is pleasing to note that testimonials from users bear out this statement. Full particulars will be sent to traders on application.

**Components.**

THE Standard Accessories Co., Ltd., who supply a great range of components, have a good stock of variable condensers of different makes, including their own, the "Standard." This is a well-made component, and retails at a competitive price. Further information can be obtained from this firm, at 56, High Street, Charing Cross Road, London, W.C.2.

**Additional Facilities.**

IN order to give still better service to their London customers, another telephone line has been added to the London offices of the St. Helens Cable and Rubber Co., Ltd., of Slough. The London address of this firm is 70, Petty France, Westminster, S.W.1, and the telephone numbers, Franklin 6181 and 6182.

**C.A.V. New Chief Engineer of Wireless**

MR. HERBERT G. WHITE, A.M.I.E.E., A.M.I.R.E., etc., who has for the past fourteen years been associated with Messrs. Gent and Company, Ltd., has relinquished his post as London manager with this firm to take up the appointment of chief engineer of the wireless department of Messrs. C. A. Vandervell and Company, Ltd., Acton, London, W.3. We wish Mr. White every success.

# On the Commercial Wave-Band

Wherein we tell the Financial Story of the Month

## New Companies

**Wilts Wholesale Warehouse Co., Ltd.**—Private company. Registered February 9. Capital, £5,000 in £1 shares. To carry on the business of wholesale dealers in drapery, clothing, etc., musical instruments, jewellery, cutlery, etc., wireless goods, etc. The permanent directors are: W. E. Morse and Mrs. Ethel W. Le Suetur. Qualification: 1 share. Solicitors: Wither and Pooley, Swindon.

**Aire Place Motor and Engineering Co., Ltd.**—Private company. Registered February 11. Capital, £500 in £1 shares. To carry on the business of manufacturers and dealers in automobiles, carriages, aeroplanes, hydroplanes, airships and vehicles of all kinds, and articles connected with wireless telegraphy, telephony, etc. The first directors are: J. H. Foster, W. H. Foster and C. L. Foster. Qualification: 50 shares. Remuneration: As fixed by the company. Solicitors: Booth and Co., Central Bank Chambers, Leeds. Registered office: Aire Place, 143, Kirkstall Road, Leeds.

**W. Skewes and Co., Ltd.**—Private company. Registered February 12. Capital, £1,000 in £1 shares. To take over the business of an electrical engineer and electrical fittings manufacturer and factor carried on by W. F. C. Skewes at Doncaster, and to carry on the business of manufacturers, repairers and dealers in telephones, telegraphs, phonographs, etc., wireless apparatus, etc. The first directors are: W. F. C. Skewes (permanent managing director), D. W. New, Dorothy M. Hornby and W. Hudson. Qualification: £50 shares. Remuneration (except managing director): As fixed by the company. Secretary: W. F. C. Skewes. Solicitor: G. S. Ward, 1, St. Sepulchre Gate, Doncaster. Registered office: Salutation Yard, South Parade, Doncaster.

**General Acoustics, Ltd.**—Private company. Registered February 12. Capital, £5,000 in £1 shares. To acquire the business of a manufacturer of, or dealer in, acoustic instruments carried on by P. V. Sumner, at 18, Hanover Street, W. 14, St. Anne Square, Manchester; 66½, Corporation Street, Birmingham; 75, Buchanan Street, Glasgow; 53, Lord Street, Liverpool; and 19, Shandwick Place, Edinburgh, as the "General Acoustic Company (Great Britain)," and to carry on business as manufacturers of and dealers in acoustic instruments, with or without electric or other power; to acquire and turn to account patents and the like relating to acoustics, optics, telephony, telegraphy, telautography or other kindred science or process; to make and deal in instruments for the deaf, anatomical and other appliances, etc. The subscribers (each with one share) are: P. V. Sumner and J. C. Wright. P. V. Sumner (director of Dictograph Telephones) is permanent governing director. Remuneration: Of G. V. Sumner as governing director or chairman, £2,000 per annum and a percentage of the profits. Solicitors: Windybank, Samnell and Lawrence, 28 and 29, St. Swithin's Lane, E.C. Registered office: 18, Hanover Street, W.

**Quality Radio Ltd.**—Private company. Registered February 13. Capital, £100 in £1 shares. To carry on the business of electrical, telegraphic, wireless, telephonic and mechanical engineers, etc. The first directors are: A. P. Partway and Miss D. S. Partway. Remuneration: As fixed by the company. Solicitors: Stow, Preston and

Lyttelton, 12, Lincoln's Inn Fields, W.C. Registered office: 26, Budge Row, E.C.4.

**H. E. M. Bourke and Co., Ltd.**—Private company. Registered February 13. Capital, £45,000 in £1 shares. To acquire the business of financiers, agents and brokers now carried on by H. E. M. Bourke and Co., at 21, Great Winchester Street, E.C., to institute, enter into, assist or participate in financial, commercial, mercantile, industrial, manufacturing, telegraphs, wireless, and other businesses, etc. The subscribers (each with one share) are: H. E. M. Bourke, W. D. Clark, and C. H. Bourke. The first directors are to be appointed by the subscribers, and shall be permanent. Qualification (except first directors, who require none): £1,000 shares. Remuneration: As fixed by the company. Solicitors: Francis and Johnson, 62, London Wall, E.C.2. Registered office: 21, Great Winchester Street, E.C.2.

**Radio Company of Great Britain, Ltd.**—Private company. Registered February 13. Capital, £100 in £1 shares. To carry on the business of electricians, manufacturers of generators, accumulators, suppliers and distributors of electricity and electrical energy for lighting, heating, telegraphic and telephonic communications, manufacturers and dealers in all wireless, telegraphic and telephonic apparatus, etc. The subscribers (each with one share) are: W. R. Smith and E. J. Burrows. The first directors are to be appointed by the subscribers. Qualification: £1. Solicitors: Herbert Smith and Co., 62, London Wall, E.C.2.

**Plessey and Co. (1925), Ltd.**—Private company. Registered February 14. Capital, £20,000 in 16,000 8 per cent. preference shares of £1 each and 80,000 deferred shares of 1s. each. To adopt an agreement with Plessey and Co., Ltd., and to carry on the business of manufacturers of electrical and scientific apparatus, electricians, etc., and manufacturers of all kinds of electrical machinery and apparatus, manufacturers of and dealers in accumulators or telegraphic apparatus, etc. The first directors are: C. T. Bazell, H. Morgan, A. Clark, and W. O. Heyne. The two last named are joint managing directors. So long as the Marconi-Phone Co., Ltd., or their nominees hold more than 50 per cent. of the issued deferred shares, they may have three nominees on the Board so long as the total number of directors does not exceed 5, and 4 nominees when the total number of directors is 6. C. T. Bazell and H. Morgan are two of the first nominees. Remuneration: £100 each per annum (chairman £150), all free of income tax. Solicitors: Steadman, Van Praagh and Gaylor, 4, Old Burlington Street, W.1. Registered office: Marconi House, Strand, W.C.2.

**Horley Manufacturing Co., Ltd.**—Private company. Registered February 14. Capital, £1,000 in £1 shares. To carry on the business of manufacturers, repairers, and dealers in all kinds of electric or gas lamps, wire, electric bells and wireless instruments, etc. The first directors are: C. R. Billyard-Leake, W. M. Rogerson and C. H. Horwood. Qualification: £50 shares. Remuneration: As fixed by the company. Secretary: G. F. Bve. Solicitors: Blyth, Dutton, Hartley and Blyth, 112, Gresham House, E.C.2

**Lawson's Cycles and Sports, Ltd.**—Private company. Registered February 14. Capital, £16,000 in £1 shares (2,000 8 per cent. cumulative preference, 7,000 10 per cent. non-cumulative preferred ordinary, and

7,000 deferred ordinary). To adopt an agreement with L. R. Davis, A. S. Davis, and A. J. Kempster, and to carry on the business of repairers, makers, and dealers in cycles, motor-cycles, and accessories, etc., wireless apparatus, talking machines, gramophones, etc. The first directors are L. R. Davis, A. S. Davis (joint managing directors), and A. J. Kempster (chairman). Qualification: £250. Remuneration: As fixed by the company. Solicitors: Henry Boustred and Sons, 70, Basinghall Street, E.C.2. Registered office: 225, Edgware Road, N.W.

**Northumberland and Durham Radio Engineering Co., Ltd.**—Private company. Registered February 16. Capital, £1,000 in £1 shares. To carry on the business of manufacturers and dealers in instruments, apparatus, accessories, and materials used in connection with radio or wireless telegraphy and telephony, etc. The permanent directors are W. Walton and Mrs. I. C. Walton. Qualification: £25. Remuneration: £10 per annum, divided between them. Solicitor: T. V. Devey, 88, Westgate Road, Newcastle-upon-Tyne.

**Gilwern Manufacturing Co., Ltd.**—Private company. Registered February 18. Capital, £7,500 in £1 shares (2,500 7 per cent. cumulative preference and 5,000 ordinary). To acquire the business of manufacturers, repairers, and dealers in gramophones, phonographs, and musical instruments of all kinds, and mechanical, electrical, and general engineers carried on by the Sitvato-Gramophone and Industrials, Ltd., at Gilwern, Breconshire, and to carry on the same and the business of manufacturers and repairers of and dealers in electric and all other apparatus required for the business of wireless, telephone, and telegraphic supply companies, etc. The first directors are E. Williams, J.P., T. E. Lloyd, T. J. Jones, J. R. Jacob, and J. L. Leech. Qualification: 200 shares. Remuneration: As fixed by the company. Secretary (pro tem.): A. Arkell. Solicitor: L. A. Wallen, High Street, Blairston, Mon.

**Basinghall Manufacturing Co., Ltd.**—Private company. Registered February 21. Capital, £2,250 in £1 shares (250 8 per cent. cumulative preference and 2,000 ordinary). To carry on the business of jewellers, silversmiths, goldsmiths, watchmakers, etc., manufacturers of and/or dealers in leather, rubber, and fancy goods, etc., scientific instruments, manufacturers of, agents for, and dealers in instruments in connection with radio or wireless telegraphy and telephony, etc. The provisional directors are Mrs. E. E. Morgan and T. J. Nesbitt. Qualification: 100 shares. Remuneration: As fixed by the company. Secretary (pro tem.): T. J. Nesbitt.

**Pell, Cahill and Co., Ltd.**—Private company. Registered February 21. Capital, £5,150 in 5,000 10 per cent. cumulative participating preference shares of £1 each and 3,000 ordinary shares of 1s. each. To carry on the business of engineers, electricians, founders, smiths, machinists, manufacturers and dealers in wireless apparatus of all kinds, etc. The first directors are L. H. Pell, M. R. Cahill, and J. C. I. McConnel. The said J. C. I. McConnel may nominate two other directors. Solicitors: Roney and Co., 42, New Broad Street, E.C.2. Registered office: 64, Newman Street, W.

**Ernest Verity, Ltd.**—Private company. Registered February 23. Capital, £1,000 in £1 shares. To carry on the business of manufacturers and dealers in radio instru-



"THE HALL MARK OF RADIO PERFECTION"

If you haven't seen the new A.J.S. Models you haven't seen the latest developments in Radio Construction

**:: A.J.S. LOUD SPEAKER ::**

Accurate proportions and non-resonant horn, giving correct acoustic properties and ensuring true reproduction. Utmost volume with complete absence of distortion. Price, with Metal Horn and Electro-plated Fittings, £4 15 0. With Oak or Mahogany Horn and Electro-plated fittings, £5 10 0

*A.J.S. Wireless Instruments make a strong appeal because our name is a sales-argument in itself. Our great 1925 Advertising Campaign in daily, weekly and monthly publications now covers the whole of Britain, and brings sales right to your door. Let us co-operate with you by supplying Showcards, descriptive literature, etc. Ask for Trade Terms and full details of these and other A.J.S. Wireless Instruments and Components.*

**THE A.J.S. "UNITOP" CABINET RECEIVER.**

forms top section of "Unit System" Cabinet and contains A.J.S. 4-valve Receiver. Complete in itself, it may be converted into a beautiful pedestal cabinet by subsequent purchase of first a centre section to contain both batteries and then base section containing special A.J.S. Loud-Speaker. Used alone, the "Unitop" is a compact and attractive piece of furniture and a highly efficient Receiver, easily portable for outdoor functions. In Mahogany, or Light, Dark, or Wax-polished Oak. Complete with all accessories, ready for use, 30 Guineas (without accessories, £24 10).

**A.J.S. PEDESTAL CABINET RECEIVER.**

Designed and constructed by experienced Cabinet makers to contain the A.J.S. 4-valve Receiver. Represents the highest standard yet achieved in the design of wireless receiving sets. Each cabinet is a complete unit containing 4-valve Receiver, H.T. and L.T. Batteries. Special A.J.S. Loud Speaker to match cabinet, and all accessories. In Mahogany or Oak 50 Guineas.

**A.J.S. "STANDARD" 4 VALVE RECEIVER.**

Noted for Selectivity, Power and Clearness. Extremely flexible, it functions on wave-lengths from 150 to 20,000 metres, giving most successful results on indoor aeri-als. Prices (including all Royalties), 4-valve set, complete with 4 Valves, Brandes' Phones, Batteries, Aerial Wire, Insulators and Lead-in Tube, £27 5. Panel only, £20 5.

**A.J. STEVENS & CO. (1914), LTD.**  
WIRELESS BRANCH — WOLVERHAMPTON

'Phone: 1550; W. Call Sign: 5.RI; 'Grams: 'Reception, Wolverhampton.'



WHEN REPLYING TO ADVERTISEMENTS PLEASE MENTION "THE BROADCASTER."

ments of all kinds, and parts used in connection therewith, etc. The first directors are E. Verity and C. W. C. Oliver. Qualification: £1. Remuneration: As fixed by the company. Secretary: H. R. White, 39, Wellington Avenue, Dunsmore Road, Stamford Hill, N.15. Registered office: St. Andrew's Works, Stamford Hill, N.16.

**Gaskin's Patents, Ltd.**—Private company. Registered February 24. Capital, £100 in 1s. shares. To acquire and turn to account patents, inventions, etc., and all manufactures, appliances, products, components, spirituous and other fluids, etc.; to manufacture, export, deal in and trade with iron, brass, copper, etc., and other goods. The directors are D. J. Brass and T. H. Gaskin. Qualification: 50 shares. Secretary: A. J. Smale. Registered office: 18, Laurence Pountney Hill, E.C.4.

**National Wireless Corporation, Ltd.**—Private company. Registered February 24. Capital, £1,000 in 1s. shares. To increase the popularity of wireless within the range of broadcasting areas by means of advertisement and otherwise, and to act as radio and general engineers, manufacturers, merchants and factors, etc. The first directors are W. Wrentmore and R. M. Reith. Qualification: 1 share. Registered office: 245, Shaftesbury Avenue, W.C.2.

**Scientific Radio, Ltd.**—Private company. Registered February 24. Capital, £1,000 in £1 shares. To carry on the business of electrical and mechanical engineers, manufacturers and repairers, agents and dealers in wireless and radio apparatus of all kinds. The first directors are F. G. Ketelbey, E. D. Gledall, and J. Hill. Qualification: 1 share. Secretary: J. Hill. Solicitor: T. Davis, 20a, Temple Street, Birmingham. Registered office: 14, New Street, Birmingham.

**Lilleker Brothers, Ltd.**—Private company. Registered February 25. Capital, £3,000 in £1 shares. To acquire the business of electrical engineers carried on by A. Lilleker and J. Lilleker at Howard Street, Rotherham, and to carry on the same and the business of manufacturers and dealers in instruments, accessories and materials used in connection with radio or wireless or other telegraphy or telephony, erectors of broadcasting and other stations, for the distribution or reception of radio or wireless waves, etc. The permanent directors are A. Lilleker, J. Lilleker, and W. Lilleker. Qualification: £100. Remuneration: As fixed by the company. Secretary: A. Lilleker. Solicitor: L. H. Brittain, Howard Street, Rotherham.

**Overseas Radio Co., Ltd.**—Private company. Registered February 25. Capital, £20,000 in £1 shares. To acquire the benefit of inventions relating to radio-telegraphy and radio-telephony and other methods of communication and to develop and work the same, and in particular to obtain licences to manufacture, use, sell, and let on hire radio apparatus under patent rights owned or controlled by Radio Engineering Co., Ltd. The permanent directors are C. H. C. Mellwraith and E. A. B. Snoaden. Qualification (except first directors): 500 shares. Remuneration: As fixed by the company. Solicitors: Amery, Parkes and Co., Effingham House, Arundel Street, Strand, W.C.2.

**Thanet Electric Factors, Ltd.**—Private company. Registered February 26. Capital, £500 in £1 shares. To carry on the business of wholesale factors and manufacturers of electrical accessories, etc. The first directors are T. F. Young and J. W. Reeves. Qualification: £1. Remuneration: As fixed by the company.

**R. E. Stitchling, Ltd.**—Private company. Registered February 27. Capital, £1,000 in £1 shares. To carry on the business of electrical and mechanical engineers, im-

porters, exporters, and manufacturers and dealers in electric, magnetic, telegraphic, telephonic, radio, and other appliances, etc. The first directors are W. E. Stitchling and R. E. Stitchling. Qualification: £50 shares. Remuneration: As fixed by the company. Secretary: R. E. Stitchling. Solicitors: Lees, Smith, Crass, and Tetlow, 3, Berners Street, W.1. Registered office: 52, Dorset Street, Portman Square, W.1.

**Electric and Radio Supplies, Ltd.**—Private company. Registered February 27. Capital, £100 in £1 shares. To carry on the business of dealers in electrical and wireless apparatus, etc. The first directors are A. Herbert (permanent director and chairman) and L. Paton. Qualification: £5 shares. Remuneration: As fixed by the company. Secretary: L. Paton. Solicitors: Blandy and Blandy, 1, Friar Street, Reading. Registered office: 2, Hosier Street, Reading.

**Paramount Wireless Co., Ltd.**—Private company. Registered February 27. Capital, £500 in £1 shares. To acquire the full benefit of an agreement between P. Winocour and H. P. Thompson for the transfer to the latter by the former of all rights in patents in an invention of a permanent crystal detector for wireless operations and for payment of all fees, costs, charges, and expenses in respect thereof. The subscribers (each with one share) are Mildred R. Porter and S. F. Thomas. The first directors are not named. Secretary (pro tem.): H. M. Beyfus. Solicitors: Beyfus and Beyfus, 32, Sackville Street, W. Registered office: 32, Sackville Street, W.

**Attaix, Ltd.**—Private company. Registered February 27. Capital, £1,000 in 900 7 per cent. preference shares of £10 each, and 200 ordinary shares of 10s. To carry on business as manufacturers of electrical appliances, manufacturers of and dealers in all classes of woodenware, etc. The subscribers (each with 5 ordinary shares) are D. Attaix, F. Nielson, and E. Brontman. The first directors are not named. Solicitors: G. C. Wallington, 5, Gray's Inn Square, W.C.

**Radiocraft Supplies, Ltd.**—Private company. Registered February 28. Capital, £3,500 in £1 shares. To acquire, as from January 1, 1925, the business of a manufacturer and dealer in apparatus and accessories for wireless telegraphy and telephony now carried on by H. R. Adams at The Arcade, Walsall, as Radiocraft Supplies. The permanent directors are H. R. Adams and B. D. Cook. Qualification: £200 shares. Remuneration: As fixed by the company. Solicitors: Loxton and Co., Walsall. Registered office: The Arcade, Walsall. Staffs.

**Wireless Warehouses, Ltd.**—Private company. Registered March 2. Capital, £5,000 in £1 shares. To acquire the business of a wireless and general electrician carried on by G. Busl in London, Liverpool, Leeds, Bradford, Hull, Stoke, and Hanley. The first directors are G. Busl, E. Gisiger, and J. Wyatt. J. Wyatt may retain office so long as any money is owing to him or to Albert Lee and Co. (1923), Ltd., or Lighting, Heating, and Glass, Ltd. No qualification required. Remuneration: £100 each per annum, free of tax. Solicitors: Hore, Pattinson and Bathurst, 48, Lincoln's Inn, W.C.2. Registered office: 37, Moreton Street, Pimlico, S.W.1.

**Crinvac, Ltd.**—Private company. Registered March 2. Capital, £100 in £1 shares. To carry on the business of manufacturers, agents and dealers in all kinds of wireless and electrical apparatus, etc. The subscribers (each with one share) are A. B. Geary and S. Geary. The first directors are to be appointed by the subscribers. Qualification: 1 share. Solicitor: G. H. Olley, 11, Queen Victoria Street, E.C.4.

**R. E. Whitaker and Co., Ltd.**—Private company.—Registered March 3. Capital,

£5,000 in £1 shares. To carry on the business of manufacturers, installers, and erectors of, agents and dealers in parts necessary or appertaining to receiving, distributing, and broadcasting, anything appertaining to wireless telegraphy and telephony, etc., electric engineers and contractors, etc. The first directors are R. E. Whitaker (permanent governing director) and Mrs. E. A. Whitaker. Qualification: £1. Solicitor: F. R. Martin, 34, Castle Street, Liverpool. Registered office: 9, York Street, Liverpool.

**Radio Experimental Co., Ltd.**—Private company. Registered March 3. Capital, £1,000 in £1 shares. To acquire the business of wireless engineers and factors of wireless goods and equipment carried on by the Radio Experimental Co. at Carver Street Works, 117, Carver Street, Sheffield. The first directors are W. D. Burnet, G. A. de Litvine, and H. Aitchison. Qualification: £50. Remuneration: Not more than £500 each per annum. Secretary: W. D. Burnet. Registered office: Carver Street Works, 117, Carver Street, Sheffield.

**Genuflex, Ltd.**—Private company. Registered March 4. Capital, £500 in 1s. shares. To acquire from N. A. T. N. Feary and E. L. T. Williams the benefit of certain inventions relating to gut-string devices and shuttlecocks, comprised in provisional specifications numbered 27,965 and 27,966 of 1924, and to carry on the business of manufacturers, importers, exporters and dealers in sports goods and wireless requisites of all kinds, etc. The first directors are Sir Lionel Alexander, Bt., Major G. Aylmer, N. A. T. N. Feary, A.F.R.A.S., G. W. McArthur, and E. L. T. Williams.

**Adams Brothers (Longton, 1925), Ltd.**—Private company. Registered March 4. Capital, £5,000 in £1 shares. To acquire the business of electrical engineers, manufacturers and dealers in electric, magnetic, and other appliances as formerly carried on by Adams Brothers (Longton), Ltd., at Ford Street, Longton, Staffs. The subscribers (each with one share) are A. P. Ford and W. H. Lawton. The first directors are to be appointed by the subscribers. Qualification: £25 shares. Remuneration: As fixed by the company. Secretary: W. H. Lawton.

**Belsam Trading Co., Ltd.**—Private company. Registered March 7. Capital, £1,000 in £1 shares. To carry on the business of manufacturers, agents and dealers in woollens, cottons, silks, etc., automobiles and accessories, etc., electrical and mechanical appliances whereby sound is recorded or transmitted, leather goods, trunks, and metal and woodwork, etc. The subscribers (each with one share) are S. Rykwert and G. E. Binsted. J. Rykwert signs as director, address not stated. Solicitor: H. Burford Judge, 317, High Holborn, W.C. Registered office: 34, Gresham Street, E.C.1.

**Radiators and Wings, Ltd.**—Private company. Registered March 7. Capital, £1,000 in £1 shares. To acquire the business of radiator and wing repairers carried on by Auto-Radiators, Ltd., at Whitfield Place, W.1, and to carry on the business of motor, electric, wireless, telephone or telegraphic engineers, etc. The first directors are F. E. Joyce and M. L. Scales. Qualification: £50 shares.

**Hawk Radio Devices, Ltd.**—Private company. Registered March 7. Capital, £1,000 in £1 shares. To carry on the business of manufacturers and dealers in wireless telephonic and telegraphic apparatus of all kinds, etc. The subscribers (each with one share) are S. Karet and Mrs. R. Karet. The first directors are not named. Solicitor: M. A. Pritchard, 161a, Strand, W.C.2.

**Sether and Co., Ltd.**—Private company. Registered March 11. Capital, £100 in £1 shares. To carry on the business of importers and exporters of fancy goods, jewellery, etc., wireless instruments and

parts, musical instruments, etc. The first directors are S. S. Sether and Mrs. S. Sether. Solicitor: L. C. L. Sparks, 161A, Strand, W.C. Registered office: 57, Chancery Lane, W.C.2.

**General Optical Co., Ltd.**—Private company. Registered March 11. Capital, £1,000 in £1 shares. To carry on the business of opticians, manufacturers and dealers in optical instruments, etc., wireless apparatus, headphones and fittings, etc. The subscribers (each with one share) are P. S. Edwards and F. D. Cohen. The first directors are to be appointed by the subscribers. Solicitors: A. M. Oppenheimer, 31, Queen Victoria Street, E.C. Registered office: 31, Queen Victoria Street, E.C.4.

**Conradi and Braun, Ltd.**—Private company. Registered March 13. Capital, £3,000 in £1 shares. To carry the business of an importer and exporter of electrical accessories carried on by L. F. Braun at 52, Theobalds Road, W.C., and to carry on the same, and the business of manufacturers and dealers in electrical apparatus, wireless instruments, apparatus and accessories, etc. The first directors are L. F. Braun and F. S. Conradi. Qualification: 1 share. Remuneration: As fixed by the company. Solicitors: D. A. Romain, 196, Bishopsgate, E.C. Registered office: 52, Theobalds Road, W.C.

**Metal Propellers.**—Metal Propellers, Ltd., was registered as a public company on February 16, with a nominal capital of £200,000 in £1 shares. The objects are to carry on in any part of the world the business of manufacturers, constructors, designers, and repairers of all classes of air propellers, air screws, fans, aeroplanes, seaplanes, flying boats, hydroplanes, airships, etc., aircraft of all descriptions, ships, etc., automobiles, cycles and conveyances of all kinds, whether by air, sea, river, canal, railway, road or otherwise, manufacturers and dealers in exhausters, etc., electric accumulators and accessories, internal combustion engines or motors, wireless apparatus, and electrical and mechanical machinery, flying instructors, etc. The subscribers (each with one share) are P. Kenny, J. R. Beckensall, and five other clerks. Minimum cash subscription: 7-shares. The first directors are not named. The holders of the first mortgage debenture stock intended to be issued shall be entitled, so long as any of the stock shall remain outstanding, to have nominees (called debenture directors) on the directorate, constituting a majority thereof by one. Qualification (except a debenture and a director appointed before the statutory meeting): £250 shares of stock. Remuneration (except managing director): £200 each per annum (chairman £400) and 5 per cent of the net profits in excess of 6 per cent., but not exceeding £5,000 in any year, except with the consent of the company, divided between them. Solicitors: Mayo, Elder and Co., 10, Drapers Gardens, E.C.2. The registered office is at 53, Parliament Street, S.W.1.

## Mortgages and Charges.

**B.M.A.S., Ltd.**—Debenture charged on the company's undertaking and property, present and future, including uncalled capital, dated February 12, 1925, to secure all moneys due or to become due from the company to the Union Bank of Manchester, Ltd.

**Hill's Wireless Stores, Ltd.**—Debenture dated February 11, 1925, to secure £400 charge on the company's undertaking and property, present and future, including uncalled capital. Holder: H. R. Hooker, 39, Warwick Avenue, Maida Vale, W.9.

**E. A. Brown and Co., Ltd.**—Mortgage dated January 1, 1925 (but executed on

January 28, as per statutory declaration), to secure £450, charged on leasehold land and premises in Brown Street, Collyhurst, Manchester, and known as Collinghurst Wire Works. Holder: T. R. Little, 23, Orchid Street, Harpurhey, Manchester.

**Peter Curtis, Ltd.**—Debenture dated February 18, 1925, to secure moneys and liabilities due or to become due not exceeding £5,000, charged on the company's undertaking and property, present and future, including uncalled capital. Holders: Paragon Rubber Manufacturing Co., Ltd., Scoutcoates, Hull.

**T. C. Gilbert and Co., Ltd.**—Mortgage on 9, Shellons Road, Folkestone, dated February 10, 1925, to secure all moneys due or to become due from the company to Lloyds Bank, Ltd., not exceeding £1,000.

**Eddystone Components, Ltd.**—Mortgage debenture dated February 12, 1925, to secure £500, charged on the company's undertaking and property, present and future, including uncalled capital. Holder: A. Bird, 13, Mincing Lane, Blackburn.

## Satisfaction.

**Electrical and Allied Instrument Manufacturing Co., Ltd.**—Satisfaction in full on February 23, 1925, of debenture dated May 10, 1924, securing £350.

**Siemens Brothers and Co., Ltd.**—Satisfaction to the extent of £28,000 on January 1, 1925, of debenture stock dated January 15, 1918, securing £1,320,000.

**Radio Improvements, Ltd.**—Satisfaction in full on February 19, 1925, of debenture dated December 19, 1923, securing £100.

## Receiverships (Appointment or Release).

**B. Barnett (Electrical Engineers, Leyton), Ltd.**—F. Ioveridge, of 47, Ratcliffe Road, Forest Gate, E.7, electrician, was appointed receiver and manager by order of court dated January 30, 1925.

**Bower Electric, Ltd.**—F. E. Kowley, of 1, Highbury Grange, Highbury, N.5, was appointed receiver and manager on February 5, 1925, under powers contained in debenture dated November 10, 1924.

**Radio Appliances, Ltd.**—E. J. Bell, of 17, Queen Victoria Street, E.C.4, chartered accountant, ceased to act as receiver or manager on February 19, 1925.

**Korland Manufacturing Co., Ltd.**—C. L. H. Martin, of 27, Chancery Lane, W.C., was appointed receiver and manager on February 26, 1925, under powers contained in debentures dated January 11, 1924.

## Private Arrangements.

**Frank Robert Hickson, 16, Dartmouth Park Hill, N.W.5,** electrical engineer and wireless dealer.

A meeting of the creditors was held recently at London, when Mr. W. Osborn occupied the chair. The statement of affairs was presented, which showed liabilities of £470 10s. 8d., of which £379 12s. 8d. was due to unsecured trade creditors and £90 18s. to cash creditors. There were fully secured creditors for £26 5s. The assets consisted of stock-in-trade, principally wireless material £97 7s. 4d., estimated to realise £45; book debts £53 12s. 1d., valued at £10; and household furniture estimated to realise £25, making total assets of £130, from which had to be deducted preferential creditors for £32 4s., leaving net assets of £97 16s., or a deficiency of £372 14s. 8d.

The following are amongst the principal creditors:—Brown Bros., Ltd., £45; Falk, Stadlemann and Co., £35; Houghtons, Ltd., £41; Sun Electrical Co., £53.

**Standard Accessories Co., Ltd., 56, High Street, Bloomsbury, London, W.C.**

A meeting of the creditors was held recently at the offices of the solicitors of the company. No detailed statement of affairs was presented, but it was reported that the liabilities were approximately £1,950, whilst the assets consisted of stock, fixtures, and fittings valued at £490. The company was registered on October 4, 1924, with a nominal capital of £500, of which £400 had been issued for cash. An offer was made to the creditors of 3s. 6d. in the £, payable within one month, but after some discussion the offer was amended to one of 5s. in the £, payable within four weeks and suitably guaranteed. That offer it was decided to accept, subject to a committee of the principal creditors being satisfied. The committee consisted of the representatives of Fellowes Magneto Co., Arthurs Wireless Co., and Mr. C. Latham.

**Richard Izon, trading as R. Izon and Co.,** wireless component maker, 62a, Bristol Street, and 10, Bishops Street, Birmingham.

A meeting of the creditors was held recently, when a statement of affairs was submitted which disclosed liabilities of £2,629 19s. 3d., made up as follows:—Trade creditors, £1,784 19s. 3d.; and cash creditors £845. The assets consisted of stock £600, estimated to realise £257; machinery and tools £45, expected to produce £10; office furniture £30, valued at £20; book debts £579 15s., expected to realise £350; cash in hands of accountants £15; and cash in bank £13 3s. 4d., making total assets of £665 3s. 4d., from which had to be deducted £41 for preferential claims, leaving net assets of £624 3s. 4d., or a deficiency of £2,005 15s. 11d. The accountant stated that the reason the stock had been depreciated to such a large extent was because much of it would have to be disposed of as scrap.

The matter was discussed at considerable length, and eventually it was resolved that a deed of assignment should be executed in favour of Mr. C. T. Appleby, of 26, Corporation Street, Birmingham, as trustee, while a committee of inspection was also nominated, consisting of Mr. Nichols, and the representatives of Messrs. North British Rubber Co., Ltd., and the Streetley Manufacturing Co. It was also resolved that the cash claims of the debtor's relatives, amounting to £645, should be withdrawn.

**Allan Leslie,** dealer in wireless goods, etc., 219, Buchanan Street, Glasgow.

The creditors were called together recently at Glasgow, when the chair was occupied by the representative of the largest creditors. A statement of affairs was submitted which disclosed liabilities of £1,108 16s. 4d., made up as follows:—Sundry creditors, £936 16s. 4d. and cash creditors £172. The assets consisted of stock £179 4s. 9d.; fittings £20; and book debts £62 12s., valued at £55, making total assets of £254 4s. 9d., from which had to be deducted £12 10s. for preferential claims, leaving net assets of £241 14s. 9d., or a deficiency of £867 1s. 7d. The statement therefore showed an apparent dividend of 4s. 4d. in the £, subject to the expenses of realisation.

The matter was discussed, and the creditors eventually decided to request the debtor to sign a mandate for summary sequestration.

## Voluntary Liquidation.

**William J. A. Keene, Ltd., 10, North End Road, Golders Green, London, N.W.**

The following are amongst the principal creditors herein:—Keene, W. J., London, £555; Edmondsons, London, £262; Electric Lamp Factors, London, £245; General Radio



Co., London, £186; Goswell Engineering Co., Ltd., London, £95; Mercure, Paris, £222; Mullard Radio Valve Co., Ltd., London, £230; Stevens, A. J., and Co. (1914), Ltd., Wolverhampton, £54; Robinson, Lionel, and Co., London, £84.

**Barclay's Radio Stores Ltd.**, 30, Stephenson Street, Birmingham.

A meeting of the creditors was held recently at Birmingham. The chair was occupied by Mr. C. T. Appleby, the liquidator in the voluntary liquidation of the company, who submitted a statement of affairs which disclosed liabilities of £1,286 1s., all due to unsecured creditors. The assets were estimated to realise £226, from which had to be deducted £51 14s. 9d. for preferential claims, leaving net assets of £174 5s. 3d., or a deficiency, so far as the creditors are concerned, of £1,111 15s. 9d. The assets consisted of stock-in-trade £163 6s. 10d., estimated to realise £100; plant, fixtures, and fittings £1; and book debts £167 9s. 1d., valued at £125.

After a short discussion the creditors decided to confirm the voluntary liquidation of the company, with Mr. Appleby as liquidator.

### Bankruptcies.

**Alfred Allen**, trading as **A. Allen and Son**, 26, Augusta Street, Birmingham, lately trading at back of 16, Hockley Street, Birmingham.

The first meeting of the creditors was held recently at Birmingham. According to the statement of affairs, there was a deficiency of £376 1s. 1d. Debtor attributed his failure to losses incurred on three patents, bad trade, keen competition, and ill-health.

The matter was left with the Official Receiver as trustee of the estate.

**Hyman Weiner**, trading as **Harry G. Weiner and Co.**, 112, Wellington Street, Leicester.

The public examination of this debtor was held recently at the Castle, Leicester. The statement of affairs showed gross liabilities of £11,457 19s. 3d., of which £11,430 15s. 11d. was expected to rank, against assets of £12,966 0s. 11d. Debtor attributed his present position to the failure of a certain firm to make payments to him in accordance with terms. It appeared that up to November, 1923, he lived in London, and traded principally in second-hand machinery. For health reasons he came to Leicester in that year, with £860 capital, comprising certain sewing machines and accessories, and £245 in cash. He commenced business in Higheross Street, Leicester, as a wholesale machine importer and manufacturer of electrical goods. The assets comprised book debt and the stock-in-trade valued £2,650, but it was pointed out that the stock would probably not realise the odd £650. He obtained large quantities of goods, chiefly in the wireless trade, by means of references issued by persons purporting to have had bona-fide business transactions with him, but it was stated that on investigation it had been found that no reliance could be placed on these references. In reply to questions, debtor said that he had been in business in London, and had also been director of a certain firm, while he had carried on a tobacco business in London. On coming to Leicester he gave various trade references, but he denied that the firms which he gave as references were "firms of straw." He said that in November he sold some machines, needles, and parts to a certain company in London. He received them back in February, as they were not paid for, while he also received £58 because some of the needles had gone rusty. He said he later sold £1,660 worth of boot machinery to the same firm, although they had not paid him for the other machinery. The company

went into liquidation two months later. The Official Receiver pointed out that there were hundreds of pounds worth of goods sold, but no names of purchasers were given in the cash-book. Debtor said he had never kept books of account in his life. Questioned as to what had become of the paid cheques and duplicate order books, debtor said they had been left at the office, but the Official Receiver pointed out that they could not be found. In reply to questions, debtor denied that he himself was the firm for whom he alleged he had acted as agent. He said that all the goods he had ordered went to the warehouse of that firm, but he did not know where that was situated. The examination was adjourned.

**W. J. Chambers** (Chas. Gustavus Hofman, trading as), Andrew Works, Cowthorpe Road, Wandsworth Road, and 7a, Victoria House, South Lambeth Road, London.

A sitting was held at the London Bankruptcy Court, on February 27, for the public examination of the above debtor, but it appearing that the Official Receiver was not in a position to examine the debtor, his investigations not being yet complete, the examination at his instance was adjourned to April 3.

**Alfred Alan Carr and Godfrey Slade Childe**, trading as **Carr and Childe**, wholesale wireless dealers, 38, Park Road, Leeds, and 38, Victoria Road, Scarborough.

On February 13 a receiving order was made on the petition of the Ashley Wireless Telephone Co. Ltd., against the above debtors, and on March 2 the statutory first meeting of the creditors was held at the London Bankruptcy Court.

It appeared that Alfred Alan Carr, in 1922, obtained the sole distributing agency for Yorkshire of the Ashley Wireless Telephone Co., Ltd., products and wireless products made by the Automatic Telephone Co., of Liverpool. Early in 1923 he was joined in partnership by Godfrey Slade Childe, who paid him £750 for a half-share in the business which was afterwards carried on at 38, Park Road, Leeds, and at Victoria Road, Scarborough. The nature of the business was to sell and to demonstrate with wireless apparatus supplied by the company mentioned, and they also endeavoured to effect other sales. The position of the firm to-day was stated to be due to the fact that the Ashley Wireless Telephone Co., Ltd., claimed £750 for wireless goods delivered on sale or return.

Carr estimated the firm's liabilities at about £600, and his personal liabilities at £6,000 or £7,000, of which £5,000 or £6,000, he states, is secured, and his assets at under £100.

Childe agrees as to the firm's liabilities and puts his personal liabilities at about £30 and his assets at £5. They attribute the failure of the firm to heavy overhead charges and working expenses of the partnership, lack of capital and depression in trade.

In the absence of a quorum of creditors the meeting was adjourned for a week.

**Albert Edward Eaton Lee**, described in the receiving order as **Arthur Edward Lee**, Dunster House, Hershall Road, Leigh-on-Sea.

The receiving order was made on a creditor's petition. The statement of affairs shows liabilities of £2,478 8s. 8d., while the assets are estimated at £161 15s. 7d., or a deficiency of £2,316 13s. 1d.

The following are amongst the principal creditors—American Hard Rubber Co., Ltd., London, £215; Bennett, H., London, £150; Cundell, Eve and Co., Ltd., London, £95; Clifton, Verney, Ltd., London, £140; Dunn, Ltd., London, £250; Foster and Co., Ltd., Allan, London, £220; Lyle, Ltd.,

B. S., London, £80; Lipton, Ltd., London, £180; Lowenadler, F. W., London, £270; Marshall and Co., London, £120; Pritchett, B. J., London, £70; Strong and Co., Ltd., Allen, London, £255; Page, Thomas J., London, £300.

### Bankruptcy Proceedings.

**Wadia Halim Murad**, trading as **W. H. Murad and Co.**, 126, Princess Street, Manchester. Wireless manufacturer. Receiving order, February 9.

**John Isherwood**, 91, Lee Lane, Horwich, Lancs. Wireless dealer, etc. Receiving order and order of adjudication, March 4.

**Ernest P. Higgins**, trading as **Western Union Wireless Co.**, 99, Regent Street, London, W. Order of adjudication, March 4.

### Notice of Intended Dividend.

**Samuel Lee Bapty and Neville Miles**, trading as the **Wireless Instrument Manufacturing Co.**, Avenue Works, Avenue Road, Willesden Junction, N.W. Wireless instrument manufacturers. No. 1,244 of 1925. Claims to **Ebenezer Henry Hawkins, I.A.**, 4, Charterhouse Square, London, E.C.1.

### Notices of Dividend.

**Lawrence Backhouse, Charles Henry Thornton, and Sydney Evans**, trading as the **Arc Electrical Co.**, Palatine Buildings, Victoria Street, Manchester. Wireless suppliers, etc. No. 91 of 1923. Second and final of 14s. 6d. in the £ and 4 per cent. interest. Payable at the offices of the trustee, **Arthur Tyldesley Eaves**, 15, Fountain Street, Manchester.

**Mitchell's Electrical and Wireless, Ltd.**, 188, Rye Lane, Peckham, S.E.15. No. 00510 of 1923. First and final of 10d. in the £. Payable at the office of the liquidator, **W. A. J. Osborne**, Balfour House, Finsbury Pavement, E.C.2.

### Dissolutions of Partnership.

**Walter Shaw and Harry Abraham Riche**, trading as the **London Radio Co.**, 20, Queen's Arcade, Leeds. Dealers in wireless components. February 9. All debts by **Harry Abraham Riche**, who will continue under the same name.

**George William Bagshaw, John Bower, and Austin Jenkinson Lambert**, trading as **Bagshaw, Tyas and Co.**, 32, Burgess Street, Sheffield. Wireless engineers and manufacturers, etc. February 16. All debts by **John Bower**, who will continue under the same name.

**Bertram Ashby Willmin and William Joseph Sturley**, trading as the **Western Wireless Co.**, 9, High Street, Ealing, Middlesex. Manufacturers and dealers in wireless sets. February 9. All debts by **William Joseph Sturley**, who will continue.

**Thomas Hyde Lockhead and George Sayer**, trading as **Lockhead-Sayer Radio Co.**, 35, Paradise Street, Birmingham. Manufacturers of wireless apparatus, etc. February 28. All debts by **George Sayer**, who will continue under his own name.

**William Heaney and Herbert Washington Hooper**, trading as **W. Heaney and Co.**, 12, 14, and 16, Market Place, Henley-on-Thames, Oxford. Wireless traders etc. February 21. All debts by **William Heaney**, who will continue.

**John Edward Dalton Dauncey and Alfred Edward Charles Ricketts**, trading as **Ricketts and Dauncey**, 34, Windmill Street, Birmingham, Warwickshire. Wireless component manufacturers. March 4.

**Sidney Gardner, James Melling, Lawrence Anthony Whitaker, John William Boddy, Harold John Ping, Claude Hartley, William Arthur Clifford Cooke, James Henry Stevenson, Leonard Allan Gamblen, and Edith Hainsworth**, trading as the **Adastral Wireless Manufacturing Co.**, 2, Sycamore Street, Sheffield. Wireless apparatus manufacturers. January 1, 1925.

**IMPORTANT.**—In order to afford retailers a guide regarding the conditions of trade which will probably prevail during the month of April, 1925, we give in this section, at the end of numerous reports of Provincial towns, a résumé of trade conditions operating in April, 1924.

# AROUND

## London and the South

### L O N D O N

The position of trade in London at present is hard to define. Some retailers report that business is on the decline, whilst others say that they have nothing about which to grumble. Now that spring has arrived, bringing with it the likelihood of fine weather, radio enthusiasts will again think of "wireless in the open," and we foresee the return of exceptional business.

**A Fire.**—On Saturday, March 14, a fire broke out at the premises of the Peto-Scott Co., Ltd., at 77, City Road, E.C.1. It commenced at approximately 11.20 p.m., but lasted only a short time. The site of the fire was the packing department, and only very slight damage was done. It is thought that the outbreak was due to the fusing of some electric wires.

**Wireless Demonstration at Selfridge's.**—Among the displays shown in the windows of Messrs. Selfridge, Ltd., of Oxford Street, W.1, during their birthday week, was a special exhibition in connection with the wireless department. One of the items demonstrated was the Igranio winding machine, the method of winding the well-known Igranio duolateral honeycomb coils being demonstrated by a lady operator. A great deal of interest was created by this exhibit.

S. W. D.

*Satisfactory trading was reported in London during April, 1924. Components formed the bulk, but complete receivers sold well.*

### I S L E O F W I G H T

**Steady Demand.**—Inquiries amongst retailers in this district show that, generally speaking, there is still a steady demand for sets and components. In the western half of the island, which is more favourably situated for reception from Bournemouth, crystal sets give excellent results, and the majority of sets sold are of this pattern, but in the rest of the island valve sets predominate. Two local retailers who make one-valve receivers a speciality, claim that every main station of the B.B.C. can be tuned in. The constructors are the West Wight Wireless Depot, of Totland Bay, and Mr. F. P. Fry, of Newport, and inquiries amongst users substantiate the claims. The Isle of Wight is undoubtedly a favourable position for reception, and this fact certainly gives a fillip to the Trade. The harsh criticism of the B.B.C. programmes coming from certain quarters of late is not shared here to any material extent. It is quite safe to say that 90 per cent. of listeners are very satisfied, particularly with the programmes from the Bournemouth station.

W. G. S.

*Good reports of trade were received during April, 1924.*

### R E A D I N G

Interviews on the condition of trade with local retailers during the past month have been of an exceedingly pleasing nature. They are unanimous in their opinion that the condition of trade is excellent. As has been the case for some considerable time, there is a big demand for components. This is easily explained by the fact that Reading is an industrial town, and the majority of radio "fans" are weekly wage-earners at the biscuit and other factories. Being for the greater part of the mechanical turn of mind they prefer to construct their own sets, and thereby save expense. Although there is not a great

demand for complete sets, many of the best-known makes have been sold during the month.

**Excellent Displays.**—The windows of Reading radio stores are as usual as well designed and as attractive as those of any other trade in the district. In conjunction with the Mullard film recently exhibited at a local cinema, Messrs. Phillips and Williams (Reading Radio Installations) presented an attractive display of Mullard valves, and increased sales were the immediate result. A second window contained a selection of Burndept sets, etc. Mr. Weight, who is responsible for these attractive displays, is frequently congratulated by customers on his ingenuity and originality. Messrs. Henderson and Sowden are as usual catering for the constructor, and although their windows contain a considerable number of components and accessories, the whole is not confusing, and one is able to note those which are of special interest.

**Macrae and Co.'s Activities.**—Recently added to the range of sets manufactured by Messrs. M. B. Macrae and Co., 100, King's Road, Reading, is a four-valve model in a Jacobean cabinet of handsome design. A special feature of this set is the total absence of plug-in coils. The retail price is £25. Messrs. Macrae have extensive works in Reading, where thousands of valves are repaired. The firm is now undertaking the repair of dull-emitter valves.

J. M. P.

*Fair demand for accessories during April, 1924; otherwise trade rather slack.*



*C. Hayward and Son, of Ashford, Kent, are fully alive to the value of publicity, and this demonstration van has proved very profitable.*

### B R I G H T O N A N D H O V E

**More Listeners.**—Aerials are being put up almost every day in all parts of the two towns, and an encouraging feature of the situation is that the Brighton and Hove Radio Society is getting more and more into touch with the ordinary listeners-in, the people who claim no scientific knowledge. Recently a section of the society was formed for the non-expert listeners, and this promises to be most advantageous for the development of wireless interest in the district. The society took prompt action in regard to the Wireless Bill, and approached the two local M.P.s and the Press.

**Big Sideline Business.**—Striking proof of the growth of the wireless industry locally is to be found in the number of well-established businesses which have added wireless departments. The great success which attended the starting of the Brighton Electrical and Radio Stores as a branch of Messrs. Carter

Bros.' well-known stationery business in Western Road has been followed by the opening of wireless departments, or at least counters, by many other firms. Messrs. Rowley and Son, old-established opticians and electricians, of 128, St. James's Street, are displaying components in their windows, and Messrs. Seymours, Ltd., art and antique furniture specialists, of Prince Albert Street and Western Road, show, among other things, pedestal valve sets at moderate prices. Mr. V. E. F. Walker, "The Kodak Specialist," of 68, Preston Street, has a big wireless window.

G. C. B.

*Very satisfactory trade indeed in Brighton and Hove during April, 1924. Especial demand for constructor sets and components.*

### P O R T S M O U T H

**A Steady Trade.**—Trade has been on the steady side during the past month. Both sets and components continue to find a demand, and those traders who have laid themselves out to give satisfaction to their customers are finding, by way of return, a steadily growing clientele for replacements and accessories. Quite an extensive business is also being built up in the re-charging of accumulators. These are now being collected and delivered free by several firms, and regular calls have been instituted to suit the customers' convenience.

**Price Cutting.**—Apparently, this has been too good a side-line to be missed, and the evil of price-cutting has already crept in. The chief offenders in this respect are not the wireless dealers, but some of the electrical engineers and contractors, who are not themselves interested in the sale of wireless sets, or only in a very small way.

**"Wireless Taught Here"!**—The expert advice offered gratis to prospective clients by traders is often an inducement to sales, but many people, to be "in the fashion," are now buying sets without the slightest knowledge of how to use them. Frequently traders are being asked to call to inspect sets sold by them to this class of customer, because the reception has been indifferent or the set will not act at all. In one actual case all that had happened was that the accumulator had run out!

**American Competition.**—American competition is now beginning to make itself felt in the market, and retailers are finding that American transformers, for instance, are frequently being asked for in preference to the British-made article. The removal of the restrictions on the licence is giving the foreign goods a better chance to get in, and the question of quality, as opposed to price, is not always considered. This is especially the case in regard to valves, and the wise retailer is careful to point out this fact to his customer.

**B.B.C. and Services.**—Mr. J. C. W. Reith, the managing director of the B.B.C., drew a very big crowd to the Portsmouth Brotherhood on Sunday, March 15, when he spoke on "The search for wisdom in everyday life." In the course of his remarks Mr. Reith had something to say on the broadcasting of religious services by the B.B.C.

**Loud-Speaker Publicity.**—The broadcasting of Tetraxini and Paderewski was made an excellent publicity service by several retailers in the town. Loud-speakers were fixed up outside their premises, and the fame of the artistes, with the splendid reception secured, brought together several hundreds of people while the outdoor concerts were in progress.

E. J. T. D.

# THE RADIO TRADE

## L U T O N

Equanimity rather than elation expresses the view entertained by Luton retailers with respect to the past month's wireless trade. It has not been as brisk as in the preceding month, and there has been no semblance of a rush, but it is considered that there is no need for serious complaint. "The falling off," said one, "is general in the town, and peculiar to no branch of trade. The truth of the matter is that the people have not the money to spend."

**"Junk" Sales Diminishing.**—Another reason given for a slackening of demand is that wireless users are beginning to realise the importance of using only the highest-class materials, if they wish to be entirely satisfied with the results achieved. It is the general experience that almost everything being sold is good stuff. The demand for "junk" is steadily dwindling.

**Tackling the Price Cutter.**—The organisation of the wireless retailers of the district is much nearer an accomplished fact than we imagined when emphasising its need in Luton in our last issue. Price-cutting is the principal factor that is bringing matters to a head. Experience has shown that this is having a bad effect on the trade, in that it creates the impression among the people that they are suffering from over-charging, and it is recognised that this is a matter which must be seriously taken in hand.

**A Newcomer.**—A new addition to the trade is the Luton Wireless and Electrical Company, New Bedford Road, the manager of which, Mr. W. Morton, has shown himself the possessor of considerable enterprise. Judicious Press advertising has brought the firm and its operations very much into the limelight, and these have not been confined to the town.

**Aerial Restrictions.**—The possessor of a wireless set at Luton has had to get the permission of both the Post Office and the local Town Council to the fixing of his aerial. It is affixed to a telegraph pole standing at the back of a footpath at the rear of the owner's house. The Post Office consented to the use of the pole subject to the Council assenting to the wire extending over the short portion of the highway between the pole and the house. As the wire will not in anyway interfere with the use of the highway the Council have given consent, but this can be terminable at any time by three months' notice.

**Public-House Wireless.**—The interesting point was established at Luton Division Sessions that the provision of wireless entertainments in village public houses in the area does not involve obtaining a music and dancing licence. Application for such a licence was made by the licensee of the Leather Bottle public-house, East Hyde, who was stated to be wishful of giving his customers the benefit of wireless entertainments, but the solicitor making the application intimated that he had discovered that Part 4 of the Public Health Act had not been adopted in the district, and in the circumstances a licence was not required.

H. W. M.

*Considerable improvement in April, 1924, trade over preceding month. Crystal sets in special demand.*

## B O U R N E M O U T H

There are no outstanding features connected with the retail wireless trade in the Bournemouth district at the moment. Business remains steady and there is a regular demand for components. With the advance of the spring and the approach of

summer, trade is likely to become a little more brisk, especially as visitors are always numerous in the neighbourhood at these seasons. It is thought that a good demand for inexpensive portable sets will follow as the weather grows warmer and more suitable to the needs of picnic parties.

**Keen Amateurs.**—The proximity of a broadcasting station gives many people a very keen interest in wireless matters and they pay considerable attention to the construction of sets and to the possibilities of improvements. This means that the wireless salesman to-day, in any district where there is a transmitting station, has to be particularly smart at his job, otherwise there is a danger that the "amateur" who comes

in to make a purchase will know more than himself.

**The Broadcasting Staff's Dinner.**—Recently the staff of the local broadcasting station were entertained to dinner by the directors of the Royal Bath Hotel, and afterwards they danced in the King's Hall, attached to the hotel. The function was a very pleasant one, and the wireless atmosphere was provided in the table decorations, which consisted of miniature wireless masts and aeriols. Mr. Fryer, the station director, on behalf of himself and the staff of the broadcasting station, thanked the hotel directors for an agreeable evening.

W. T. B.

*Retail trade in Bournemouth quiet during April, 1924. Valve sets in fair demand.*

## T h e M i d l a n d s

### B I R M I N G H A M

**Improving Trade in Belgium.**—Mr. S. Wilding Cole, of Snow Hill, Birmingham, who has a large distributing agency in Brussels, tells me that conditions in Belgium have been steadily improving since the beginning of the year, and British articles are coming more and more into favour with Belgian listeners.

Greater quantities of British valves are being imported to Belgium, especially the Cossor and Marconi types, made specifically for high-frequency amplification. Components which are selling well are variable condensers of the square-law vernier type, plug-in coils, low-frequency transformers, especially the well-known Eureka, and almost the whole range of Gambrell and Igranic products. Home construction among Belgian listeners has increased very considerably of late. There has also been a steadily improving demand for complete sets, particularly those which will give loud-speaker reproduction of the British stations, which are extremely popular among Belgian listeners. Chelmsford is a great favourite, for it is a very easily received station, often giving loud-speaker reception on two valves.

Chelmsford is, in fact, so popular that there is a widespread desire to have the announcements from this station repeated in Belgian or French. It is felt that this would not involve much inconvenience at 5XX, and, in view of the increasing progress of British trade, this little courtesy might well be extended, and could only serve to make firmer the amicable relations existing between the two countries.

**Outdoor Sets to be Popular.**—Inquiries which have been made amongst the wholesale manufacturers in Birmingham and the neighbouring towns during the month show that more concentration than ever is to be made this year upon sets for outdoor use. The limits of the purely portable set—the kind of thing one might carry about with as little inconvenience as an attaché case—are, of course, recognised, and while it seems scarcely likely that very much will be done in this direction, a great deal of attention is going to be devoted to the manufacture of sets suitable for outdoor use with motor-cars and motor-cycles and on the river.

**River Sets**—a line which will be developed by Birmingham manufacturers during the next few weeks—will consist of compact two and three-valve sets for use on the river. Here even more attention has had to be paid to size and weight, and the small hornless loud-speakers will therefore be fitted to many of the sets.

**Disappointment at New Station's Delay.**—Traders in Birmingham and the Midlands generally are beginning to ask when the

new high-power station which the B.B.C. are erecting at Daventry will be completed. Disappointment is beginning to be felt at the continued delay in the progress of the station.

This is particularly annoying to manufacturers in the Midlands, who during the past few months have been concentrating upon the manufacture of sets designed specifically for the reception of the new station.

L. B. P.

*Components in fair demand, otherwise trade quiet. Trade in Birmingham during April, 1924, suffered from a glut of inferior ebonite.*

### W O L V E R H A M P T O N

**Successful Year's Work.**—A capital year's work was recorded at the annual meeting of the Wolverhampton and District Radio Society, held a few days ago. The hon. sec., in his annual report, pointed out that their efforts had been again very successful. Many experiments of a highly technical nature had been carried out in the last twelve months, and generally a high standard of success had been achieved. New headquarters had been secured in Victoria Street, which had proved very convenient to the members, while the provision of a number of valuable instruments for general use had proved of very great use, and had been highly appreciated. The membership had been well maintained during the year, and was high having regard to the number of transmitters in the district. The financial statement was deemed satisfactory. The accounts and the report were the subject of favourable comment, and were adopted. Mr. J. A. H. Devey was re-elected hon. sec., Mr. A. E. Marlow hon. treasurer, Mr. D. P. Baker representative to the Radio Society of Great Britain, while Mr. A. E. C. Whatton was appointed auditor.

**Concerts and Wireless.**—The statement that wireless has had an adverse effect on popular concerts, and is therefore being assailed by concert promoters, has been the subject of a good deal of comment locally. The criticism arose originally from outside this district, which has no very great cause to complain, for local concerts have not been overdone, and those held have received a good measure of support. Among promoters, however, the subject has been commented upon in the direction more of the future effect to be expected from the "competition" of wireless. The consensus of opinion seems to be that the first-class concert has nothing to fear in this respect, but rather they stand to gain, because people who have heard a prima-donna or well-known virtuoso on the wireless, will in many cases be glad to hear more of them as opportunity offers.

**Trade Improving.**—Trade in Wolverhampton and South Staffs district has been steadily improving for the past month or five weeks, and both retailers and manufacturers have felt the benefit.

An official at the A.J.S. factory at Wolverhampton stated that they had experienced a brisk demand for their four-valve sets, and also for loud-speakers. For both of these the firm have attained a big reputation, and as the result of experiments claim to have evolved something in the very first rank in each case. The local experience seems to be that there has been a big transition from users of crystal sets to valve users, and four-valve sets preferably, and the use of the full power has greatly increased the call for loud-speakers.

**An A.J.S. Export.**—A.J.S. sent a big selection of their products for the Barcelona Exhibition, but, unfortunately, the heavy weather forced the boats into port, with the result that the goods arrived too late for showing in the Exhibition itself. This was unfortunate, but steps were taken to get good displays with leading tradespeople in Barcelona, Madrid, and other Spanish centres, and good business is expected.

The home trade has been steadily increasing, and the export business has been even better. The Bill in Parliament which threatened householders with search had a temporary effect, as did the announcement of the reduction of valves, customers looking for a sharp drop in sets as a result. The demand has again freshened, however, and business is quite good. H. E. J.

is also a demand for very large coils, sizes from 400 upwards being in request, in some cases necessitating special orders. Traders seem at a loss to account for these requests for "out-sizes."

Oldham accumulators, especially of the 2-volt type, are selling splendidly at present.

**A Striking Advertisement.**—An old-established local firm, who have recently opened a wireless branch, are to be congratulated on a novel advertisement which they are displaying in an outlying district of the town, far away from the shop.

Passengers leaving and waiting for cars at a terminus are confronted with an arresting tableau in a shop-window. A man is seen sitting in an armchair, a glass of comforting beverage within easy reach, and a loud-speaker on a table. In the corner of the window is a valve set. Prominently displayed on a card are the following words: "What More Could a Man Wish For?"

In another prominent position "This valve set can be obtained at —" meets the observer's eye. This novel and homely display is attracting considerable attention C. M.

**L E I C E S T E R**

**The Society's Meeting.**—At the meeting of the Leicestershire Radio and Scientific Society on Tuesday various types of loud-speakers were tested. A fine four-valve set, which had been constructed by Mr. A. E. Walker, the secretary, was installed at headquarters. For nearly two hours the society listened in to the programmes relayed from Chelmsford.

no significance whatever on the general run of trade.

**Five-valve Sets.**—There appears to be an increasing demand for three- and four-valve sets, and Messrs. Jardine's, of Basford, are out to produce even five-valve sets. A good deal of construction work by amateurs is carried on, and sales of components continue with very little fluctuation. Some dealers find it a paying proposition to study diagrams issued by Trade papers, and to cater for the parts required.

**Valve Royalties.**—The Nottingham Radio Traders' Association, of which Mr. J. T. Gillott is the chairman, at its last meeting discussed the 12s. 6d. Marconi royalty on valves, and considered that this was much too prohibitive. They expressed the opinion that a reasonable figure, say of 5s., would help traders considerably, and would do away with a lot of the illicit manufacture which is going on and which is injuring the Trade in this part of the country.

**Daventry Sets.**—Although the Daventry Station will not be open as early as fore-shadowed, Nottingham dealers are concentrating on sets specially designed to receive this station. Messrs. E. Gillott and Son, 17, St. Peter's Gate, Nottingham, have brought out a one-valve set specifically made for the opening of the Daventry Station. With this set, which is entirely enclosed in a mahogany case (polished panels and nickel fittings), it is possible to get Chelmsford and also Paris Radiola.

Messrs. Gillott have a handsome wireless cabinet (self-contained receiver) on the market. One section contains the loud-speaker, and the other the batteries. The instrument itself is a four-valve receiver. Special switches are fitted to cut out the batteries when not in use. In the lid is a neatly-fitted frame aerial. Terminals are provided for use with an outside aerial. The cabinet itself is beautifully finished in oak or mahogany. T. A.

**N O R T H A M P T O N**

**New High-power Station.**—Business houses and the general public are disappointed at the delay in the opening of the new broadcasting station being erected at Daventry, and buyers are consequently holding off. The delay appears to have been caused through the contractors to the B.B.C. being unable to obtain delivery of the plant and materials.

**Exhibition.**—A Wireless Exhibition was held at the Town Hall, Northampton, from March 2 to 7. The exhibition was considered to be quite a good one, bearing in mind the population of Northampton and district, and most of the exhibitors were satisfied with the results. The retail trade was very good, but wholesale business did not come up to expectations, chiefly on account of the postponement of the opening of the new station, the large and small trade buyers being very cautious. Sixpence was charged for admission, and the total attendance was about 10,000.

Mr. F. G. Cave had an admirable display of wireless sets and loud-speakers. Messrs. Tomlinsons were showing their own "Ideala" sets, including a very charmingly designed crystal set in the form of a metal casket, which they are calling the "Pandora." They also had on show a 15-valve experimental set. The other exhibitors included Messrs. Cowell, Wyatt, Messrs. The Cable Accessories Co., Ltd., with a complete range of "Revo" lines; Radio Productions, Ltd., of Leeds, the *Wireless World*, Hollingsworths, who are agents for Belling-Lee; Frys, with a complete range of tools; Twining Models, Ltd., and others.

**Steady Sales.**—Trade in Northampton and district is very steady, and it is considered that more business has been done in this district during the last six months than during the whole of the period since broadcasting commenced.



Some very novel ideas were incorporated in this attractive window display of "Siren" wireless receivers, staged by Christie and Hodgson, Ltd., of 246-8, West Street, Sheffield.

**D E R B Y**

**Sales Steady.**—Having gradually dropped from the high peak of the Christmas rush, the Trade in Derby has now returned to a steady level, and dealers are glad of the breathing space between sales that this state of affairs affords.

Listeners are showing a tendency to use simple sets with power valves in preference to receivers with complicated H.F. stages. Where H.F. valves are used there is a realisation that switchgear on the H.F. side is undesirable. It may be gathered from these illuminating points that the man in the street is obtaining a better grasp of the fundamentals of wireless, and no longer regards his set as a complicated box of mystery "with knobs on."

Possibly the advice so freely tendered by radio dealers is beginning to take effect.

**Best Sellers.**—The "Unidyne" H.T.-less system is once more coming into favour. Thorpe K4 valves and "Unidyne" sets of parts are in general demand. Good components appear to be vitally essential for the successful manipulation of this novel receiver.

Ready-made coils are selling well, especially the well-advertised brands. There

The different loud-speakers, ten in number, were connected in turn, and after listening to all of them, the society discussed their merits. Such meetings are extremely helpful to discriminating radio enthusiasts, who are enabled to discover the type of loud-speaker which pleases their fancy.

**Radio Appeal for Consumptives.**—Councillor W. E. Wilford (chairman of the Leicester Health Week Committee), speaking from the Birmingham station, recently appealed for help for a seaside sanatorium and convalescent home for the consumptives of Leicester. The establishment of sanatoria by local authorities had had a wonderful effect in stemming the invading tide of the disease, said Councillor Wilford. R. G. J.

Welcome trade revival in Leicester during April, 1924. Accessories and complete sets in good demand.

**N O T T I N G H A M**

**Spring Sales.**—Business in the Nottingham area continues to be brisk, and spring sales are maintaining the public interest in valve sets and components. One local firm has been obliged to close down, but this was on account of opening a costly shop in an already congested area, and the closure has

# North of England

## LEEDS

Business done here during March has not been less than that of February, but it has certainly not been greater, and competition has got to the cut-throat stage. Price-cutting is the order of the day; in fact, those who do not cut are the exceptions rather than the rule.

One reason for this, given by the local head of a representative firm of manufacturers, is that there is so much cheap foreign rubbish in the shops, marked at amazingly low prices, that dealers in reliable components are absolutely obliged to cut to get trade at all. While deprecating this, my informant said he did not see how it could possibly be obviated without a protective tariff. His firm, he said, had stopped supplies to one or two traders who were known to be cutting N.A.R.M. products, but he thought the legitimate retailer was not altogether to blame.

**Invalids' Sets.**—The fund organised by the *Yorkshire Evening Post* to provide wireless sets for invalids has been highly successful, and is now being wound up. Over £400 in cash was subscribed, together with sets and 'phones to the value of about £50. To date 180 sets have been installed, and it is probable that when the fund is finally closed 200 will have been given away.

**Notable Demonstrations.**—The visit of Mr. Baldwin and the Earl of Oxford on March 13 and 14 has been the means of bringing very forcibly to the notice of residents the high degree of efficiency which is possible in loud-speaker work. On March 13, when Mr. Baldwin spoke at the Coliseum, there was not, of course, nearly enough room to accommodate those who desired to hear him. The *Yorkshire Post* arranged with Messrs. H. Wadsworth Sellers and Co. to relay the speech to the town hall, and tickets for admittance to the town hall were offered free by the *Yorkshire Post*. So well was the job carried out that the large crowd who assembled in the town hall heard every word of the speech, and were loud in their praise of the technical perfection of the relaying.

All the apparatus used was by the Western Electric Co., supplied and operated by Messrs. H. Wadsworth Sellers and Co.

The Leeds-Bradford station excelled itself in the broadcasting of the speeches of the Earl of Oxford and the Premier at the presentation of the freedom of the city ceremony in the Majestic Picture House.

Mr. L. Harvey, the chief engineer of the station, was responsible for the work, and he is to be congratulated upon a thoroughly good transmission. E. C.

## YORK

**York Radio Society.**—Mr. F. E. Heigh presided at a meeting of the recently formed York and District Radio Society, for the purpose of considering means for developing the society. There was a large attendance.

The chairman pointed out that such a large meeting augured well for the future of the society. Up to the present they had received splendid support.

Outlining the objects of the society, he said that their main aim was to be the means of mutual help to one another.

They intended starting their programme with a lecture and demonstration to be held at the Y.M.C.A.

The subscription had been fixed at 5s. for members above 16 years of age, and for those under that age 2s. 6d.

The possibility of a workshop where they could carry out their ideas had been mooted, but nothing definite had been decided.

As a society they hoped to deal with many

matters affecting them as licence-holders. The society was not out to injure the "Trade" or to trade; in fact, they felt that by stimulating enthusiasm amongst the younger people particularly, they would be benefiting the Trade rather than hindering it. H. N. H.

## BRADFORD

**The Licensing Bill.**—The Bradford Wireless Society, of which the secretary and probably the most active spirit is Mr. S. R. Wright, A.M.I.R.E. (head of the radio department of Christopher Pratt and Sons, Ltd.), fully agrees that all broadcast listeners should pay a licence fee, but has taken definite action to oppose the drastic proposals of the Wireless Bill of 1925, which, it contends, is an unwarrantable interference with the liberty of the subject, giving the Postmaster-General powers quite out of accord with modern ideas of democratic rights. The society circularised eight members of Parliament for the Bradford district, and the Lord Mayor of Bradford, who is M.P. for Newcastle, urging their opposition to the Bill; and issued 1,500 post-cards asking listeners to sign the following protest:—"I wish to record my protest against the proposals of the Bill. I maintain that the right of the amateur to carry out experiments in wireless telegraphy should not be subject to the unwarranted and harsh restrictions proposed by the terms of the Bill."

**Dabblers Giving Way.**—It is as we thought. The slump in crystal sets is already weeding out the "hangers-on" of the radio Trade here. Tripe dealers, sweet dealers, hardware shopkeepers, and others who have absolutely no electrical knowledge, but stocked heavily with headphones and the cheaper items of equipment—the people whose over-stocking has been responsible for much of the ruinous price-cutting which has handicapped the trade for so long—are trying to get out.

**Sunday Trading in Radio.**—In Bradford we have followed up the "genuine sale" of wireless goods—the kind of sale, no doubt, that one has heard of in connection with



Part of a crowd of 10,000 people being entertained while waiting for the Keighley War Memorial to be unveiled. H. Wadsworth Sellers and Co., of Leeds, supplied and operated six Western Electric loud speakers for the purpose.

special stocks bought for a good many drapery sales—by the development of Sunday trading in wireless equipment. One suspect the writer has in mind, in a certain district of Bradford, is a tripe shop, a portion of which is turned over to wireless, where Sunday trading is carried on openly and blatantly. Wondering whether the shop was open for tripe, etc., only on a Sunday, a test purchase was made, and a crystal obtained without the slightest hesitation.

**The Radio Traders' Association.**—A very determined effort looks like becoming necessary to make the Radio Equipment Dealers' Section of the Bradford Chamber of Trade a

success. If one may say so without offence, it was started on a wrong basis. The thing that brought the traders together was the price-cutting evil. A most important matter, unquestionably; but the section has devoted most of its attention hitherto to the one subject—a subject, after all, only of import for a time. O.

## SHEFFIELD

**New Company.**—A well-known Sheffield firm, who manufacture wireless parts and cabinets, are interested in the new company of Messrs. Thomas Ward and Sons, Ltd. which was registered on March 18, with a capital of £30,000. The new company is to adopt agreements to acquire the business of Messrs. Ward, silversmiths, etc., Suez Street, Warrington, and Messrs. Grant's, cutlery and electrical apparatus manufacturers, Eldon Street and Bishop Street, Sheffield. Partners in the two firms comprise the directorate. Mr. A. Oldfield is the secretary, and the registered office is at Warrington.

**Relay Station Programmes.**—A lively controversy has been going on in the Sheffield newspapers, in which the local programmes have come in for considerable criticism. Head-Jenner, the director at the relay station, has declared that whilst ready and willing to answer constructive criticism, he will not answer anonymous letters.

**Sheffield Company's Failure.**—Some curious revelations were made in connection with the failure of Bertie Everard Dixon, trading as The Creswick Dixon Electrical Co., at Sheffield and Chesterfield. Deficiency was stated to be £2,534 19s. 2d., which debtor attributed to heavy expenses and incompetent assistants. Assets are expected to realise £329. Debtor started business without capital, and eighteen months later entered into partnership with George Creswick, who introduced £350 capital. Branch shops were opened in various parts of Sheffield, and in June, 1924, Dixon agreed to pay out Mr. Creswick with £400. The money was not paid, and Creswick continued to manage a branch shop at a salary of £5 a week, his daughter managing another branch. Towards the end of 1924 Dixon advertised for a man to manage a branch shop and pay deposit, the object, it is stated by the Official Receiver, being to obtain a number of men on that footing. From the hundreds of replies received six were selected at random, and it was arranged they should be found employment at the various branches at a salary of £3 per week and five per cent. commission on sales. Each man deposited £100, and accordingly, debtor received £600. About a fortnight before the receiving order was made these men claimed the return of their deposits, and debtor agreed to assign the Chesterfield business to them. Owing to a difficulty with regard to the Chesterfield lease, it was decided to float a company, the men being allotted shares for the amount deposited. Dixon was, however, pressed for money and was forced to file his petition. The matter has been left in the hands of the Official Receiver. W. M.

## DURHAM

Durham wireless retailers have, indeed, cause for satisfaction at the way business is treating them. They appear to be practically free from those signs of depression which, by all accounts, are making themselves known in other parts of the country. Why this should happen it is difficult to say, for the city depends for its trade mostly on the state of the mining industry, and this is well known to be not of the most healthy character, collieries having closed down all over the district. The fact remains, however, that every class of component is showing a substantial sale, and traders seem content to know as much.

**Build Your Own!**—For the purpose of a general survey, it may be taken that the time has arrived when completed sets are definitely "out." They still have their place among the well-to-do whose desire is only to receive programmes with a minimum of trouble, and makers will be wise to observe that there is a lasting market for the "posh" type of set. But the general body of listeners are no longer content to be spoon-fed. There exists a certain pride in showing their friends the apparatus they have constructed with their own hands.

**An Old Worry Solved.**—This, therefore, presents the natural solution to the problem of the illegitimate retailer, for the novice who intends to make his own set wants, above all things, advice, and will only get it from a skilled man. The completed set has in the past formed the main business of the "half-and-half" shopkeeper. The demand for parts gives the person who will give the most satisfactory sale of components his long-cherished reward.

**Variety and the Window.**—How often does the average shopkeeper change his window show? Few seem to realise what a lot this means in the maintenance of a regular stream of custom, but it is perfectly true that seeing the same set of goods, week after week, as people do in many places, gives a hint that the business is dormant. The firm of Devereux, Moodie and Co., Elvet Bridge, have made it a rule to alter the window once a week, and if any business can point to success it is this.

**Best Sellers.**—With the rapid decline in popularity of the crystal set, it is only natural that high-tension batteries should be one of the most successful features of the present trade. Basket coils are becoming exceedingly strong sellers, having come into favour with a large number of amateurs. Valves and headphones, *bien entendu*, are readily disposed of, and all the reputable makes are inquired for. Loud-speakers, the smaller types of which came so rapidly to the front a few months ago, are now steady.

**A Generous People.**—Over £150 has been subscribed towards the installation of wireless apparatus in the Durham County Hospital, a fund for which was opened just over a month ago by the Durham and District Radio Society. J. P.

**BISHOP AUCKLAND**

Natural optimism and cheeriness, and hopes for better conditions in the future, allow Bishop Auckland retailers to consider their present small measure of business as fairly satisfactory. Around them, collieries, their very life-blood, are closing down weekly; expensive sets stand idle (and in some cases dusty) on the shelves; but still each trader regards with joy the regular arrivals of customers buying now a valve, now a condenser, now some gadget, and more rarely a pair of 'phones. It is not easy to smile in such circumstances, yet they are philosophers all.

**Trade Details.**—A peculiar feature about last month's trade was a falling off in the demand for loud-speakers. Experimenters are creating a fair demand for valves, and smaller parts are doing well. Perhaps the brightest outlook is revealed in the accumulator-charging departments. Most of the former crystal-set owners have now gone over to valves, and the batteries brought in keep plants on the run. Two hundred a week is one estimate of the number done. J. P.

**DARLINGTON**

**Trading Behind the Scenes.**—The Trade is still afflicted with competition on the part of spare-time men, and this forms a subject of a complaint from more than one shopkeeper. It appears that men employed at works are handling stocks of wireless goods,

mostly of doubtful origin and quality, which are surreptitiously sold during work hours and after, apparently for the purpose of earning a little pocket-money. Having no upkeep charges, and with a fixed income behind them, these men can afford to part with the apparatus at ridiculous rates of profit, and the man-in-the-street usually jumps to the conclusion that "someone is profiteering" among the legitimate trade. The only people who seem to have the remedy for this type of dealing are the factors, who supply the articles wholesale.

**Preparing for the Summer.**—Now is the time, although few traders seem to have grasped the point, to prepare to meet the summer slackness, and, rather than decrease his energies in sympathy, the alert retailer should be working his hardest, by propaganda and window shows, to stimulate wireless interest.

**Effect of Star Programmes.**—The surprise occasioned by the broadcasting of the *Evening Standard* celebrity programme had the effect of dumbfounding the keenest of the local critics of the methods of the B.B.C. The so-called candid statements of a section of those whose lot is to be ever discontented has already done incalculable harm to the Trade here, and traders' thanks are due to the Broadcasting Company in arranging the excellent performances last month. J. P.

**HULL**

It is computed that there are still 10,000 unlicensed broadcasters in Hull who have failed to realise that they have a duty to perform to the State. However, there are some 22,000 who have taken out licences. The population of the city is 300,000 according to latest returns, and 30,000 is not a bad percentage of devotees to the wireless.

**An Exhibition.**—A Wireless and Electrical Exhibition is to be held in the city from April 18 to 25 inclusive. The venue is the City Hall, the most centrally situated building in Hull. Capt. Eckersley, who is extremely popular here, has made a provisional promise to be present at the opening ceremony, which will take place on the Saturday afternoon.

**The Society's View.**—Hull Wireless Society is, in conjunction with other societies in the country, taking a strong line of opposition to the Wireless Bill, and two of the Members for the city, Col. Lambert-Ward, of summer-time fame, and the redoubtable Commander Kenworthy, have promised their full support to the anti-movement.

**"Sideliners" Getting Out.**—An index of the state of the Trade in the city is gained by the number of shops that are now offering their goods at half-price. This is, perhaps, after all, to the good, for those firms who have taken up wireless to meet the boom will now find that it is a business that should be best left to experts to deal with.

**Society Talks from 6KH.**—The Hull Wireless Society have now arranged for fortnightly radio talks from 6KH.

**Writing of 6KH.** A new generator has been installed at the transmitter of the Hull relay station. E. E. C.

**SUNDERLAND**

There is, it is to be regretted, very little good to be said of the local Trade, which simply reflects the very severe depression which is prevailing in the town and district, which is passing through very bad times. Two more retail shops have gone out of business, and the advent of the summer and lighter nights may soon account for more. Meanwhile the bigger shops are making very good displays, and enthusiasts certainly need not go out of the town or write away for any special component, for all the latest things appear to be stocked. Valve sets are still being built up, mostly from the designs of a local Sunday newspaper, whose "S.S." sets

are really the most popular thing at the moment, and account for much of the best trade that is passing.

**The Association's Set.**—The Sunderland Wireless and Scientific Association has now got its new experimental receiving set completed—a task which has not been hurried, because the gradual building up of the set was in itself a very valuable lesson to the younger or more or less new enthusiasts. The set is a very fine one. J. W.

*During April, 1924, there were slight signs of improvement in Sunderland. The improvement in the programmes broadcast from the Newcastle station created quite a fair demand for crystal sets.*

**NEWCASTLE-ON-TYNE**

Trade up to the middle of March was fairly good, but towards the end of the month an appreciable falling off was noticed. The Paderewski recital had an excellent temporary effect, but traders complain of monotony in the local station programmes. Mr. E. L. Odhams, the station director, said recently that he thought that 5NO had probably the worst studio of any station in the B.B.C. service, not even excepting the relay stations. The smallness of the room, he added, made the handling of choral and orchestral artists exceedingly difficult. They were, however, hopeful of getting new and better premises.

**"De Luxe" Sets Out of Place.**—A point worth noting, by both retailers and wholesalers, is that while an expensive multi-valve set, housed in a beautiful cabinet, may be excellent to look upon, it is not likely to command a big sale. A little more attention to exhibiting, say, two-valve sets of moderate price would be of more practical value to many. The point was emphasised recently when I visited a Durham colliery village at which there was an electric and house furnishing exhibition. The wireless industry was represented by a £50 cabinet only. The idea of submitting this, and this only, to struggling pitmen was utterly ludicrous. A. T.

*Competition in the retail wireless trade in Newcastle during April, 1924, was keen and was increased by the advent of several new firms. Keen demand for components.*

**MIDDLESBROUGH**

Business is quiet. There is not the slightest sign of a revival, and now that summer approaches retailers are anything but hopeful. Portable sets for use in the open find little favour, probably as much on account of weight as of price.

**Traders' Association Drops Wireless.**—Disgusted with the chaos which they say exists in the Trade, the Tees-side Electrical and Wireless Traders' Association have decided to cut radio out of the sphere of their activities. It is felt, as one member remarked, that with the fishmonger and grocer being allowed to deal in wireless apparatus as a sideline, it is useless for an association to attempt to protect the interests of its members. The matter was thoroughly debated at the March meeting, and the members, feeling that no useful purpose could be served by maintaining the present organisation, decided in favour of deleting the word "Wireless" from the name of the association.

Their complaint is against the manufacturers and factors, and undoubtedly originates from the fact that apparatus is being supplied to individuals through local engineering and shipping firms at Trade rates. One retailer informed a BROADCASTER representative that no less than 75 per cent. of the wireless Trade on Tees-side is done in this way, while the legitimate retailer is literally fighting to make ends meet.

T. W. B.

# Cardiff and the West

## C A R D I F F

From some cause that cannot be fully explained, listeners in the Rhondda Valley, a huge mining area of South Wales, are unable to get any satisfactory results on their crystal sets, however expensive, whilst even valve users at times complain regarding the reception. The Cardiff Station receives hundreds of letters of complaint every week, but, unfortunately, they cannot remedy the trouble. When spoken to on the subject, Mr. E. R. Appleton, the Station Director, said: "The trouble starts within a few miles of the city, when the 'waves' strike the Welsh mountains. In some mysterious way they are affected by the land formation or the atmosphere—it has been suggested by minerals in the earth—and the result is a blurred intermittent reception. Then a large amount of oscillation is set up in the Rhondda and outlying districts by people with expensive sets, and this weakens the strength of the Cardiff station."

It is understood, however, that several firms are now producing sets which, it is believed, will overcome the difficulty explained above.

**A New Society.**—A radio society has just been formed at Abercarn, a mining town in the Monmouthshire Western Valleys. The inauguration gathering was attended by Mr. E. R. Appleton, director of the Cardiff Station, Capt. Ivor McClure (Uncle Ivor), and Mr. P. O'Sullivan (secretary of the Cardiff and South Wales Radio Society). All three gentlemen gave the meeting much valuable information, and it was following that that the local wireless enthusiasts decided to form a society for the area, and selected a strong committee.

**Components Selling Well.**—Wireless wholesalers and retailers are still reporting satisfactory business, though components take precedence over ready-made sets.

F. R. H.

*Brisk trade in April, 1924, in accessories and new types of components.*

## E X M O U T H

The first radio exhibition at Exmouth, Devon, March 18, was a classy event, and shows that broadcasting has a good footing in this seaside resort, thanks to the Exmouth and District Radio Society.

The Trade and amateur apparatus included a wide range, from a one-valve set to a five-valve set de luxe, with both receiving and transmitting sets, and a collection of 200 sets altogether received and richly deserved the popular attention and approval bestowed upon them. Rest assured that neither Mr. Walker, the president of the society, nor Mr. Trevenan, the secretary, having blazoned radio in this way, will be content with what they have done, but by-and-by will formulate their plans for a still larger show.

A. S. M.

## H E R E F O R D

A remarkable tribute to the efficacy of wireless as a means of hastening the progress towards recovery of patients in hospitals was paid by Lieut.-Col. J. L. Sleeman, C.M.G., C.B.E., M.V.O., a member of the Board of Management of the Hereford County Hospital. Distributing the prizes at a whist drive in aid of the installation of wireless at that institution, Col. Sleeman said he could not think of any greater need for a hospital than a wireless equipment.

**Chelmsford Popular.**—Single valve and

crystal sets are more in demand in Herefordshire than any other county. Chelmsford high power station gives best results here and is very popular.

**Set for Hospital.**—The governors of the County Hospital, Hereford, are installing wireless at the institution at a cost of about £150. The installation is by the Hereford Motor Co. Wireless Department, and comprises an A.J.S. four valve Unitop set with two valve amplifier, six loud speakers and headphones. The A.J.S. loud speaker is supplied.

This firm reports a marked improvement in the sale of A.J.S. metal and wood loud speakers.

**Business Fairly Brisk.**—Trade in Hereford, Leominster, Ludbury and Ross, particularly in the county town, is showing signs of revival, and some of the expert specialists are fully occupied in dealing with orders. One or two new businesses have started in the city. Mr. A. J. Rowberry, who was the local pioneer in wireless, has a particularly fine window and show-room display. Mr. Rowberry has been appointed sale stocker of Amphion loud speakers. Their customers have been greatly impressed by the Metropolitan Vickers 5L set.

F. T.

## P L Y M O U T H

Retail trade still continues brisk in the Plymouth area. There is a steady and continual increase in the numbers taking out licences, the recent announcement of legislation and penalties for non-compliance with the regulations having had a marked influence in this direction. Trade appears to be concentrating in the establishments that make wireless a speciality rather than being diffused over a large number of small shops that at first took it up merely as a side-line. The formation of radio societies in neighbouring towns is also reflecting itself in the wholesale trade in Plymouth, where the local demand for crystal sets is being supplemented by a steady sale of valve sets and equipment necessary for listeners outside 5PY relay area.

**New Assistant Director.**—Capt. J. E. C. Langham has joined the staff of the Plymouth Broadcasting station as assistant to the director. A native of Eastbourne, he served during the war from 1914 to 1919. For a brief period he was at 2LO, and after a few days at the Nottingham station came on to Plymouth.

**Interference Nuisance.**—One of the most serious interferences that has occurred recently at Plymouth covered practically the whole of an afternoon and consisted of a spark transmission estimated to have a power of at least three kilowatts. It was not a message but a series of dots on a wavelength of between 500 and 600 metres. So strong was the transmission that it drowned many of the afternoon broadcast programmes and spoilt most of the remainder. Apparently it was intended solely to cause annoyance or was done out of pure mischievousness. Listeners are demanding that no effort should be spared to trace the person responsible for such annoyance.

A. J. R.

## S W A N S E A

The poor crystal reception of the transmission of the Swansea Relay Station has prompted the trade in the town to write to the B.B.C., asking for something to be done. Signed on behalf of all the traders by Mr. Dan Morgan, the letter reads: "I have been requested by the wireless dealers of Swansea to draw your attention to the

crystal reception of broadcasts in the centre of the town of Swansea. The dealers were prepared for a large sale of crystal sets, and these sales have not materialised owing to the bad reception. We sincerely hope and trust you will investigate matters. We do not cast any reflection in any way on your engineers stationed at Swansea, as they have worked hard and done all they could to put matters right. We feel that it is due to the topography of the district. The Trade will be happy to co-operate with you in every way."

**Bad "Screening."**—Remarkable differences in the strength of crystal reception of the relay station exists in various parts of the town. Generally it is considered that the position of the aerial is unfavourable. It is erected on the Town Hill, just a little beyond the brow overlooking the town, and, as the most difficulty is experienced by people on the side and at the foot of the hill, it is evident that the screening is bad. Certainly the comparative failure has greatly affected the Trade, who can see no hope of improvement until something is done.

L.

## W E Y M O U T H

The keen competition introduced in local retail trade during the last two or three months is now bearing fruit to the advantage of the radio fan. Messrs. W. Smith and Son and Messrs. V. H. Bennett are both retailing handsome three-valve sets of their own manufacture and design at a figure round about £20, including accessories. The Smith III. will bring in America on a loud-speaker. A good trade in components is being maintained. The competitive element has been further strengthened by the advent of Mr. John Lewis, trading under the name of John Lewis (Wireless), Ltd. Mr. Lewis is a great believer in the "personal touch," and working on this principle, has already captured an extensive clientele.

**An Exhibition.**—At the time of writing arrangements are well in hand for the holding of the Weymouth Electrical Exhibition. Although the exhibition is chiefly for the demonstration of domestic uses for electricity, wireless is much to the fore, and local retailers, including Messrs. V. H. Bennett and the Weymouth and District Electrical Co., have co-operated wholeheartedly with the municipal authorities. Wireless demonstrations are being given. It is stated that one prominent firm has declined to take part in the exhibition owing to pressure of business! W. J. L.

*Dissatisfaction at "indiscriminate" trading by "side lines." Run on cheaper sets and small components during April, 1924.*

## B R I S T O L

We are now approaching the slack season for wireless, or what is regarded by many retailers as the slack season, and consequently traders who have other lines of a more reasonable nature are turning their attention to these, with the result that the wireless section is receding into the background. There are, however, a small number of traders who devote themselves exclusively to the sale of wireless goods who are planning summer sales campaigns in the belief that listening-in will retain its fascination for a large number of enthusiasts.

**A New Handbook.**—The attention of retailers is called to the "Wireless Amateurs' Handbook," a new work which is being published by Automobile Accessories, of Victoria Street, Bristol. The book contains a mass of information, written and prepared by leading authorities, which will prove invaluable to the novice and useful to the expert.

## R.I. P.M. DETECTORS

You have already heard of the reputation of this detector? Yes? Well, now is your chance to capture the summer trade. Prove that you are

### PERMANENT DETECTORS

by purchasing your wireless sets and accessories from us.

**J. CORSTON, SINCLAIR & CO.,**  
MANUFACTURERS,  
47, Waterloo Street, Glasgow.

BRANCHES:  
EDINBURGH - - - - - 127, Rose Street Lane South.  
NEWCASTLE-ON-TYNE - 56, Post Office Chambers.  
BELFAST - - - - - 36, Waring Street.

Always first with the latest.

## "JUNIT" SELF-SOLDERING WIRE . . .

IT IS THE NEATEST, EASIEST and MOST EFFICIENT METHOD OF WIRING.

**NO** CAPACITY LOSSES.  
BLOBS OF SOLDER.  
BAD JOINTS.



All British Production.  
Patd. Gt. Britain, U.S.A.,  
France, Germany, Belgium.

Endorsed by Prof. A. M. Low and others.

Light gauge 6d. per oard (3½ yds.)  
Heavy do. 2d. per 2 ft. rod.

Liberal Trade Discount.

Write, phone, or wire for  
Samples and Terms to sole  
Scottish Distributors:

**KIRBY, JOHNSON & CO.,**  
68, GORDON STREET, GLASGOW.  
Central 2617

## MULLARD

### MASTER VALVES

**W. K. DEWAR**  
Sole Agent for  
**SCOTLAND**

Large Stocks always  
on hand at Depot.

Telephone :  
Central 314.

145, QUEEN ST.,  
**GLASGOW.**



TRADE ONLY IN  
RELIABLE PARTS

**MAR-CO** COMPONENTS  
*The Rolls Royce  
of Wireless.*

VARIABLE CONDENSERS, RESISTANCES AND GRID-  
LEAKS.

RHEOSTATS, POTENTIOMETERS, TRANSFORMERS,  
ETC., ETC.

IF YOUR CUSTOMERS WANT THE BEST, STOCK THESE

Trade Terms from Sole Scottish Agents :

**KEITH & IRWIN, GLASGOW** 'Grams: "Speedily,"  
35, Robertson St., 'Phone : 3160 Cent.

"Try Black's First"

## MICHAEL BLACK

Summer Time  
makes  
no difference—

DON'T WORRY IF YOUR  
STOCKS ARE LOW.  
SUMMER OR WINTER,  
WE ALWAYS CARRY A  
LARGE STOCK OF THE  
VARIOUS PRODUCTS  
AND CAN GIVE—

**IMMEDIATE DELIVERY.**

**Wholesale Factors for** Burndep, Igranic, Sterling,  
Radio Communication, Amplion, Siemens, B.T.H.,  
Marconi, McMichael, Dubilier, S. G. Brown,  
Radio Instruments, Western Electric, G.E.C.,  
Lissen, Ormond, Brandes, Goswell, Eureka,  
G.R.C., Davenport, etc.

**Official Valve Distributors for** COSSOR, B.T.H.,  
MULLARD, MARCONI-OSRAM, EDISWAN.

*Official Valve and N.A.R.M.A.T. Factors.*

**TRADE ONLY SUPPLIED.**

## MICHAEL BLACK

WHOLESALE ELECTRICAL AND RADIO SUPPLIES,  
11, WEST NILE STREET, GLASGOW.  
Phone: Central 917 and 918. 'Grams: "Faneeka, Glasgow."

The Representative of

"The  
Broadcaster and Wireless  
Retailer"

for

**SCOTLAND**

is

**E. COUTTS, 115, Renfield Street,  
GLASGOW.**

'Phone : DOUGLAS 1067.

WHEN REPLYING TO ADVERTISEMENTS PLEASE MENTION "THE BROADCASTER."



**To Boost Wireless.**—Another scheme which is being prepared by this go-ahead Bristol firm is the creation of an advertising department for wireless retailers. Arrangements are being made whereby the services of a combined staff of wireless, advertising and printing experts will be placed at the command of any retail trader in wireless goods. This department will undertake the designing and printing of catalogues, booklets and other sales aids, will write copy for retailers' order advertisements, supply stereos and blocks of all descriptions, and, if required, will even book space for clients in any newspaper or publication in the country. The department will always be prepared to give advice on window displays, sales campaigns or any matter of publicity. The idea behind the scheme is to boost wireless and create an ever-growing demand on the part of the public; in short, it is intended as a live wireless publicity campaign. The service, which for the present will be confined to the West of England and South Wales, is to be worked by Automobile Accessories in conjunction with Messrs. Glover, a well-known firm of printers.

**Wireless in School.**—A four-valve set has recently been installed in St. Nicholas with St. Leonard's School, Bristol, which is used

during school hours when anything of an educational nature is being transmitted from the broadcasting stations.

**Broadcasting of Musical Competitions.**—Arrangements have been made to broadcast some of the competing choirs in the Mid-Somerset musical competitions this year. Selected choirs, not necessarily prize-winners, will be asked to attend at certain stations for this purpose at the end of the competitions.

**Items of Interest.**—Messrs. Fears, of Bristol Bridge, will shortly be extending their wireless department, to include new showrooms and demonstration lounge.

Messrs. Salason, of High Street, have been holding a fourteen days' sale of wireless goods lately.

I hear that Automobile Accessories are again increasing the staff at their Exeter depot, which was only opened a few months ago.

A new wireless supplies depot has been opened during the month by A. H. Ovens, at 171, Fishponds Road, Bristol. J. T.

*Trade rather slack during April, 1924, retailers showing an unfortunate inclination to make wireless a side line during summer months.*

## Scottish Section

### GLASGOW

The members of the Glasgow High School Radio Club are nothing if not enterprising, their latest project being an exhibition of apparatus of their own construction. Over fifty sets were on show, all built by school-boys, the sets ranging from simple crystal outfits to two-valve reflex receivers and power amplifiers. Prizes presented by W. A. C. Smith, Ltd., the well-known radio factors in Glasgow, were awarded to the boys responsible for the best-made apparatus.

**A New Set.**—The Radio Accumulator Service, 57, Oswald Street, Glasgow, are offering a new outfit. This is the "Yanka" one-valve receiver, which has many points in its favour, some of which are cutting out of local relay stations and a 200 miles distant station received direct with a difference of only 19 metres. American programmes are also received regularly. The "Yanka" appears to be really something good in sets, and should prove an easy proposition for this firm, who are the sole agents in Scotland.

**Current from Mains.**—Mr. A. Dunkinfield Jones, sole partner of the firm of Messrs. Jones and Stewart, 59, Robertson Street, Glasgow, will shortly put on the market a device—of which provisional patents have been taken out—which it is calculated will eliminate the necessity of using H.T. batteries. In general terms it may be explained that the instrument is constructed in a way that will make it possible for the "main" to take the place of the H.T. battery and at the same time consume an infinitesimal amount of current. Further particulars will be announced in our next issue.

**A Good Line.**—J. Corston Sinclair and Co., one of the most progressive wholesalers in the north, are controlling a new important line in Scotland and the North of England, in the form of the R.I. "Permanent Mineral" detector. There is, we believe, a big demand for these detectors, and satisfaction has already been proved.

**An Error.**—In an editorial comment in last issue on the Linto Electrical Company we mentioned the name of Mr. Haddon as being the principal of the firm, with the result that several readers have asked if there has been a change in the management of the concern, but we should point out that

this name is an error, the chief of the firm being Mr. Hammond, who, we are glad to say, is still going strong at 38, Montrose Street, Glasgow. E. C.

### EDINBURGH

**Good Trade.**—The Trade in Edinburgh continues wonderfully good, although with the advent of the summer months—if summer should come this year—there must be a falling off as the call of the outside becomes more insistent. The Edinburgh station is approaching its first birthday, and the number of listeners has quite come up to expectations. There is a good trade in parts as owners of crystal sets are inevitably succumbing to the temptation to go in for valves.

**Valve Users' Grouse.**—Valve users are, however, rather disgruntled over the situa-

## Leipzig Fair

The Leipzig Fair, which opened on March 1, was well attended by visitors from Great Britain, and it was estimated that the total number of visitors from all countries would be about two hundred thousand. The total number of exhibits at this Fair is sixteen thousand, three thousand being in the technical section, where most of the wireless exhibits were housed. It will be of interest to note that as far as broadcast receiving sets and accessories were concerned, Germany does not have such a fine selection as is offered to-day by the British manufacturers. The chief items of interest in the wireless section were complete sets built on the unit system, cabinet sets, loud-

speakers, especially those within a two miles radius of the station, who can only with difficulty cut out Edinburgh and get other stations. It was to meet this grievance that the wavelength of the station was altered, but the howl which went up from crystal users brought a return to the original length.

**The Programmes.**—The programme controversy seems to be getting a rest, as the B.B.C. have yielded to the almost unanimous demand for more of London and a great deal less of Glasgow. Messrs. Macrae Brothers, a firm of local traders, took a plebiscite on the subject, and as was to be expected got figures confirming the general outcry. They got 477 votes for London, only 46 for Glasgow, and 49 for no change. B.

### PAISLEY

**Broadcasting in Schools.**—Renfrewshire Education Authority has issued a report regarding broadcasting in schools which is of very considerable value and importance to other educational bodies. On May 8, 1924, a special sub-committee of the Authority was set up to act on the Advisory Committee set up in connection with the B.B.C. Glasgow Station. A local company, set up loud speakers in two higher grade schools in Paisley, one in Renfrew and one in Greenock. The reports of the headmasters are somewhat mixed. The whole success of educational broadcasting admittedly depends on really satisfactory reception, and for that purpose highly efficient loud-speaker apparatus is essential. For reasons not yet fully ascertained, concludes the report, the quality of the reception in some of the Renfrewshire schools was certainly not encouraging. There is a consensus of opinion (a) that there is a definite place for the periodical introduction of the educational wireless talk in the curriculum of the upper school; and (b) that the future of the development of the wireless lesson will depend very largely upon the improvement of the receiving and loud-speaking apparatus.

**Good Programmes Help Business.**—The Tetrzini concert on March 10 helped business immensely. All the local dealers express the hope that the B.B.C. will provide real star artiste programmes at intervals—not too far apart. W. MACC.

## Irish Section

### BELFAST

**A Good Valve.**—Messrs. J. C. Holland and Co., of Franklin Street, Belfast, are the sole agents for the "Radion" valve. Local traders should make a point of trying these valves.

**Plenty to Choose From.**—Mr. S. McCormick, manager for the Berry Street house of Pettigrew and Merriman, has lots of good things on view. The firm are agents for the Newey Snap terminal, which can

be had in either brass or nickel to choice. Radion Panels and Neutron Crystals are other agency items for which Mr. McCormick is experiencing a big demand. There is also a good selection of "Claritone" and R.I. loud-speakers.

W. K. D.

**The New Association.**—At last the retail trade in Ulster is banding itself together with a view to stabilising the trade and putting matters on a sound basis so far as possible. One of the chief objects of the

new association is to help the B.B.C. in the matter of programmes.

**The Men at the Head.**—Fifteen members have been already elected, and enrolments are fast coming in. Mr. Scott, of Messrs. R. and S. Scott, Queen's Arcade, Ulster agents for Burndep, Ltd., has been elected chairman. Mr. L. Scop, of the Electrical Installation and Repairing Co., Berry Street, is honorary secretary. A provisional committee has been formed, comprising the following:—Messrs. Webster, Gault, Robertson, Elliott, and Dobbin. Meetings will be held every third Wednesday of the month at 11 o'clock.

The new association carries with it the best wishes of THE BROADCASTER AND WIRELESS RETAILER. It should fill a want which has long existed, and during the months to come the effects of its working should become noticeable. Meanwhile every trader in Northern Ireland should apply for membership. The fee has been fixed at the nominal figure of 10s.

**A Progressive Firm.**—Messrs. Smyth and Co., of Donegall Street, the big H.M.V. and Columbia gramophone dealers, have had for a long time a big interest in the radio trade, and calculate that they have sold over £3,000 worth of radio goods since the opening of 2BE.

**Headphones Repaired.**—The Central Music Stores, 17, Gresham Street, Belfast, are making a special line of repairing headphones. Magnets can be re-wound and re-magnetised if desired. This firm keeps a pretty large stock of component parts, and is also in a position to cater for repairs of all kinds.

**A Crystal Agent.**—"Rexite" crystals—said to be the rage of Scotland—are represented solely in Ireland by Mr. F. E. Neely, of Kinvara, Clifton Road, Bangor, Co. Down

**A Battery Service.**—The Radio and Battery Service Co., 7, Queen Street, Belfast, have now extended their battery service to a range of six miles from Belfast. A fixed monthly charge is made, depending on how many batteries are required each week, or whether the firm have to supply their own accumulators. Messrs. Scop and Coulson are the proprietors of the concern. They also keep "everything from a crystal to a loud-speaker" in stock.

**A Loud-Speaker Agency.**—The "Celestion" loud-speaker is the latest agency acquired by Messrs. Dobbin, of North Street, Belfast. This instrument can be had in either oak, mahogany, or walnut, at prices ranging from £6 10s. to £6 15s. It is guaranteed for twelve months. Many have been sold already.

**Belast Ideal Homes Exhibition.**—It seems regrettable to us that more of the firms interested in the radio business in Ulster did not take stands in this Exhibition which took place in March. Regrettable inasmuch as we noticed, on each occasion we were there, the interested crowds round the stands of those firms who were sufficiently enterprising to exhibit.

In every case, too, the salesman-demonstrator was politely courteous, and no query, no matter how far-fetched or ridiculous, failed to call forth a reasoned and careful answer.

Special mention must be made of the wonderful exhibit of the Electrical Installation and Repairing Co., Ltd., of Berry Street, Belfast. Mr. Scop—one of the partners—computed that he had over 1½ tons of radio material on view. The firm secured an entire room near the main entrance of the Ulster Hall, and they divided the space into two sections. In the first, with the co-operation of the Central Furnishing Co., Ltd., York Street, Belfast, they placed divans and arm-chairs of luxurious comfort.

In the other section, one of the latest "Tangent" Radiomatic four-valve sets was also working through a "Tangent" loud-speaker.

An interesting item was the constructors' four-valve "Tangent" set, panel already drilled and fitted, leaving nothing but the wiring to the constructor, at the price of £10.

The products of the Radio Communication Co., Ltd., were also displayed, the Polar Blok system interesting many "prospects."

Before passing from this exhibit we might say that it was not the firm's intention to sell wireless at the moment of exhibiting, but rather to show what wireless really could be like given a first-class set and properly demonstrated.

Messrs. Dundee had a magnificent range of crystal and valve sets, loud-speakers and component parts. Messrs. Dundee have specialised in wireless for a considerable time, and have installed sets all over northern Ireland.

The Fountain and Berry Street firm, Messrs. Campbell, had a large and varied

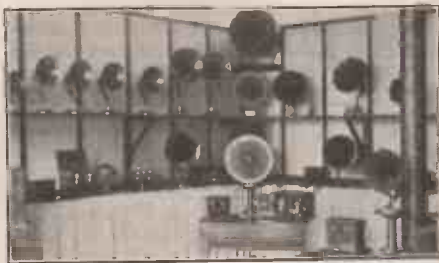

*D. H. Macleay, of Belfast, has a fine showroom, and in addition is fully aware of the best manner in which to display wireless apparatus.*

assortment of all the best-known makes of sets, parts and loud-speakers, and their stand was the centre of much interest.

Mr. G. T. Webster, "Westokit" House, Great Victoria Street, Belfast, had a most amazing display of interesting items on view. He is the sole agent for the City Accumulator Co. of London, and, perhaps, the centre of attraction on the stand was the C.A.C. four-valve portable set. This set gave fine results without earth or aerial on the loud-speaker, and Mr. Webster told us that he had received many orders for it during the course of the Exhibition. The "Duo" two-valve set also came into prominence. C.A.C. Simplex polish, the new "Gold Seal" crystal, Formo Portable Aerial, and Victoria Condensers, with or without vernier, were all to be found in profusion. In fact, Mr. Webster will supply any N.A.R.M.A.T. sets from a crystal to a multi-valve combination. Mr. Alan Douglas, chief technical expert of the City Accumulator Co., came over specially to assist Mr. Webster.

At an exhibit run by Mr. John Hill, the Wireless Corner, May Street, and Mr. J. E. Wild, of 17, Bark Street, Bolton, were to be found countless boxes containing the now-famous "Sparklite" crystal. A complete range of the "Jay-Gee" crystal-valve sets were on view, and an additional point of interest from the public point of view was the fact that each set was equipped with a different valve. The demonstration model was operated from a "Sparklite" aerial slung up the nearest stairs. Mr. J. E. Wild was in attendance most of the ten days of the Exhibition.

Messrs. Minimax, Ltd., of Feltham, Middlesex, who have branch offices in both Dublin and Belfast, had many of their crystal and valve sets on display, and the fine workmanship and neat colour-scheme of the sets was much commented upon.

As we have mentioned, it is a pity that more firms did not participate. However, we

hope that the newly-formed Ulster Wireless Traders' Association will see its way in the near future to have a proper wireless exhibition of its own. G. K.

## PROVINCIAL IRELAND

**Sterling Helps.**—At a recent dinner to the Moyallon B Specials, given by Sir S. Kelly, C.B.E., and Mr. H. S. Richardson, the guests were entertained to a wireless concert. The set was specially erected for the occasion by Messrs. J. and J. Canavan, Ltd., under the direction of Mr. S. M. Nesbitt, of the Sterling Telephone and Electric Co., Ltd.

**Connacht Way.**—A wireless set has been supplied and erected in the Hall, Oughterard, by Mr. J. W. Monaghan. On the opening occasion Paris, Munster and Brussels were all received, in addition to the several stations of the B.B.C. Thus is small-town life brightened.

**Ballymena Society.**—The Ballymena Engineering and Radio Society has just been formed, and it is expected that it will fill a long-felt want in that district. Mr. F. P. Gillies, B.Sc., gave the opening lecture, the subject being "The Foundation of Wireless." Meetings are to be held fortnightly, and it was decided to devote a portion of each meeting to engineering and radio matters.

**A Dungannon Agent.**—Mr. Samuel Langlands, of Park Road, Dungannon, Co. Tyrone, is in a position to supply all the best apparatus on the market. Aerials are supplied and fitted if desired. Those intending to purchase are invited to "listen-in" to a Gecophone at Mr. Langlands' own residence. Thus radio is heard under the best possible conditions—in somebody's home.

**In Cork.**—"Aerials and Earths" formed the subject matter of an interesting lecture given by Mr. John O'Connell to the members of the Cork Radio Society. Lectures of this kind cannot but be helpful to the Trade. Customers frequently pay little attention to the dealer's exhortations regarding a good aerial and a good earth, and if results are poor they blame the set. When they hear the same ideas from the experts of their own society they are more likely to take notice. A set working properly means very often another set sold.

**In Aid of Charity.**—Wireless concerts in the aid of charity are fast becoming one of the most popular ways of raising money in the country districts. Such a concert was the one held in the Town Hall, Clones, last month in aid of St. Vincent De Paul Society. Programmes from Belfast and Brussels were enjoyed.

**Mullingar News.**—The Mullingar Motor Co., Ltd., is perhaps the biggest motor firm in the Irish Midlands. They also engage in the radio business, and have been sending out pithy circular letters, in which they stress the point that wireless "... is quite a necessity for quiet winter evenings." They further state that they can supply a complete set for the moderate sum of £9 13s. 4d. Manufacturers may care to communicate with the firm at Mullingar, Co. W. Meath.

**A Gecophone Agent.**—Down Castlereagh way Mr. Charles Kelly, of St. Patrick's Terrace, is a local agent for the General Electric Co., Ltd., and has installed many sets in the West of Ireland. Possibly his most important undertaking was the supplying of a five-valve Gecophone to the residence of The O'Connor Don at Clonalis, Castlereagh.

**A Suburb of Everywhere.**—Thanks to the initiative and energy of Mr. Ralph Fellows, Dungiven, Co. Derry, Limavady and other districts have become suburbs of London, of Glasgow, of Manchester, of Paris, of Berlin, of Madrid—and even New York. Mr. Fellows is a practical experimenter, and his vast knowledge is at the disposal of everyone. Such men do much to popularise radio in the best sense. G. K.

# The WIRELESS RETAILER

The Official Organ of the  
Wireless Retailers' Association

Vol. 1. No. 12.

April, 1925

## RETAIL RADIOPINIONS

### An Important Development.

#### Issue of a Certificate of Membership.

ON page iii. will be found an announcement of the greatest interest to the Trade, and to members of the W.R.A. in particular—the issue of a certificate of membership.

The Association has frequently been commended for its progressive spirit and in this last development it has again endeavoured to live up to its reputation. Some means of identifying retailers who can legitimately claim to be genuine traders has long been a crying need in the Industry, and this want the certificate supplies. It is earnestly hoped that all legitimate dealers who uphold the principles of fair dealing, efficiency and service will make it their first object to possess the proof that they associate themselves with these principles. If they will do this it is our profound conviction that some of the most acute problems of the Trade will soon be solved.

We have it on the authority of one of the greatest experts in trade organisation that it is only by effecting a combination of traders in some such manner as is afforded by the issue of this certificate that price-cutting can be stamped out from the Wireless Trade.

If this is so then the suppression of the practice rests entirely in the hands of dealers themselves. Colleagues of theirs, in the Industry, by an entirely voluntary and gratuitous expenditure of time and trouble, have placed an opportunity of giving real effect to their views, and it only remains for them to accept it.

By the same means they can bring the weight of their views to bear on the question of Trade discounts, and the various other matters on which reform is essential.

In a word, united effort is required and the opportunity of achieving it is at hand. No additional charge is made for the certificate and we repeat that all legitimate dealers should make it their immediate aim to secure one.

#### Undercutting.

UNDER the heading of "More Price Cutting," in last month's issue we drew attention to the case of an offender who so rejoiced in the impunity with which he believed he could undersell neighbouring dealers that he exhibited a letter of complaint from one of the manufacturers concerned in a conspicuous

position in his shop. We understand that it (the letter) has now been removed, together with the price cards offering reductions on list prices.

Complaints of wholesale undercutting come from the Midlands with Leicester to the forefront, and the confines of Shepherd's Bank. The limelight has also been turned on London, E., with what, we trust, will be as salutary an effect as in the above-mentioned case.

#### Shipping Orders.

IT is commonly stated that great quantities of wireless goods ordered for shipment never reach their overseas destination. In other words, instructions are countermanded, and the apparatus by various ways and means finds a resting place in the shops of those firms who are wont to display components under the

legend "Makers price—Our price—" That these people have no difficulty in obtaining goods at almost any price is their accustomed boast, and this is believed to be one of their chief sources of supply.

It is high time, therefore, that manufacturers one and all should subject shipping orders to a very special scrutiny. There may be difficulties in the way of manufacturers satisfying themselves that such orders are not bona fide and that consignments actually reach their ostensible destination; but our information is that to anyone familiar with procedure at the docks every package is capable of being traced. In view of the great extent to which price-cutting is prevalent it is urgently hoped that manufacturers will keep this source of leakage constantly under their supervision.

## Patenting an Invention

by H. T. P. Gee

THE inventor may apply for a patent jointly with any other person, or persons, or a company, or a firm or partnership, and if he does this an agreement should be entered into in order to define the rights of the parties. In the case of a deceased inventor, his legal representative may apply for the patent.

A PATENT can be applied for in either of two ways, at the option of the applicant (unless the application is made under the provisions of what is known as the International Convention for Protection of Industrial Property):—

(a) With provisional specification, followed by a complete specification at any time within the ensuing nine months.

(b) With complete specification in the first instance.

Course (a) is usually adopted when the invention is not complete in all its details, or when it is desired to keep the initial expenses low. An inventor is allowed to incorporate improvements in his complete specification so long as they are legitimate developments of the original invention and are within the ambit of the provisional specification. It is, therefore, necessary that a provisional specification be properly worded, and not loosely worded, because it is the foundation document for the patent to be subsequently granted.

If the inventor has fully developed his invention, the patent can be applied for with complete specification straightaway.

IT is not necessary, for the purpose of the patent application, that the inventor should supply a model of his invention, but

it is, generally speaking, advisable for him, in his own interests, to make up a model, even if it be a rough one, for the purpose of testing the practicability of the invention and ascertaining the best way of carrying out the invention. For the exploitation of the invention, however, a well-made model is often very helpful.

Speaking generally, drawings are not necessary for a provisional specification, but except in certain chemical cases, drawings are usually necessary for the complete specification.

When the complete specification has been filed, the Patent Office makes a search, and in most cases the Patent Office Examiner refers to certain prior patents. It is then open to the applicant to endeavour to overcome the prior patents.

If and when the examiner's objections are overcome, the applicant's documents are laid open to inspection, and if no opposition is lodged, the patent is sealed upon payment of the sealing fee in due time.

Unless an inventor is familiar with the Patent Law and Practice, the prudent course is to employ skilled assistance, because, after all, the Patent Specification is a legal document. It is pertinent in this connection to quote the following words taken from one of the Rules of Practice of the United States Patent Office:—

"An applicant . . . is advised, unless familiar with such (Patent) matters, to employ a competent Patent Attorney, as the value of patents depends largely upon the skilful preparation of the specification and claims."

# Spring Trading

An interview with Mr. Chas. Hayward, member of the Executive Committee of the W.R.A.

"SPRING TRADING," said Mr. C. Hayward, "is undoubtedly a very difficult problem.

"I am afraid the market is too full to hope for a spring trade that will be as good, at any rate as far as components are concerned, as that experienced during last season. Nevertheless, I confidently look forward to a steady sale of the larger sets, and, of course, particularly portable receivers, or that type of receiver which is easily adaptable for portable use."

He was by no means pessimistic regarding the outlook for the wireless retailer during the coming months; he obviously realises that success would be achieved by those who "went out to look for it." It is his conviction, however, that next winter's trading will surpass even the last.

Mr. Hayward is a partner in the well-known Kent business of C. Hayward and Son, who are old-established automobile and electrical engineers. He was a wireless enthusiast before the war, and when demobilised from the Air Force saw the immediate possibilities of wireless, and before the advent of broadcasting a retail wireless department was opened. Although the retail side of wireless proved very successful, it was obvious to him that there was also a good opening for wholesale trade. New premises were procured and an excellent wholesale business was soon working.

Mr. Hayward, by the way, is a member of the Executive Committee of the Wireless Retailers' Association, and has been an active participator in Association matters for some considerable time.

It is obvious that he intends to make every effort to open up a special market in portable and complete receivers during the coming months, but he is too good a business man to refuse to recognise the difficulties which he, in common with every dealer, will meet this spring.

"I should like to see," said Mr. Hayward, "the hours of broadcasting greatly increased. It should be remembered that except in very few cases it is the retailer who has to visit the customer, not the customer who visits the retailer, and that satisfactory tests can only be made during transmission.

"In many cases the retailer has to give two or three demonstrations, also visit clients whose sets are not giving good results, and in many cases these people are five or even ten miles away. This means that two customers, or even one, per day can only be visited by one salesman or mechanic, owing to the restricted hours of broadcasting."

We were anxious to discover what Mr. Hayward considered the principal drawbacks with which the retailer has to contend.

"Firstly, there is the 'illicit' manufacturer," said Mr. Hayward. "In my district he is particularly active and it is extremely difficult to know how to combat his activities.

"Secondly, there is what I call the 'capabilities' of a set. Up to the present some manufacturers have been and

still are making wild and absurd claims for their products. For instance, there is the familiar claim that such and such a set will receive all British broadcasting stations on a loud-speaker. Now, the average customer who reads such an advertisement believes that he will only have to instal such a receiver in his home and turn the 'knobs' to be able to receive all the programmes sent out from these stations. When, however, he gets the set installed he finds that it will receive the local station and the high-power station almost perfectly, but other stations are received in such a manner that from an entertainment point of view the reception is practically useless.



Mr. C. Hayward.

"I know," continued Mr. Hayward, "that an expert could probably receive excellent music and speech from many of the B.B.C. stations on the same set, but we are not selling to experts.

"Why, therefore," he continued, "can-

not the manufacturer say, 'My set will receive all British broadcasting stations, but for entertainment and loud-speaker work we advise you to listen to your local station and the high-power station—if you want other stations, this set will get them for you on the headphones.'

"A large number of manufacturers have knowingly led the public astray regarding the capabilities of their instruments," said Mr. Hayward, seizing the editorial scissors in one hand and emphasising his points by beating them on the palm of his other hand. Some manufacturers' advertisements are evidently a sore point with Mr. Hayward.

"During the summer months when we try to sell a portable set as a loud-speaker receiver we shall have the prejudice created by this indiscriminate advertising to combat," he continued.

Mr. Hayward was emphatic upon the point that every retailer should make certain that his customers do realise the limits of their receivers.

Questioned upon the possible effect of the high-power station on sales of portable apparatus, Mr. Hayward said that he certainly thought that such sales should be aided by 5XX, "but," he added, "business in crystal sets in Kent has been temporarily killed by the announcement of the removal of the high-power station to Daventry."

We then touched upon the point of British *versus* foreign material.

"In company with every other right-thinking dealer," said Mr. Hayward, "I am out for British goods every time. But in order to give us the opportunity of pushing British goods the British manufacturer must give us an article as good or better than the foreign manufacturer, at a reasonable price and discount.

"Nevertheless, I consider that the restrictions imposed by the N.A.R.M.A.T. in effect ask the retailer to 'sell his birth right.'

"The N.A.R.M. missed a golden opportunity in the early days. I am certain that if they had co-operated with the Wireless Retailers' Association we should have had a very different atmosphere in the Wireless Industry to-day. I am not speaking without experience," continued Mr. Hayward, "for I commenced as a retailer, in fact, was bred and born a retailer, and, to conclude, this experience has made me realise for the retailer there must be a separate Retailers' Association; that is why I am a member of the W.R.A."

## Income Tax

### The Basis.

FOR income tax purposes the profits of a business for any income tax year (which runs from April 6 in one year to April 5 of the following year inclusive) are its average profits for the three preceding completed years.

Let us assume you prepare your accounts at April 30 every year. Your assessment for the coming year from April 6, 1925 to April 5, 1926, will be the average of your three years ended April 30, 1922, 1923 and 1924 respectively. (Note that your year ending on April 30, 1925, would be excluded from this average for the reason that it is not completed before the beginning of the fiscal year opening on April 6, 1925.)

### Arriving at a Year's Profit.

Your profits for those years must be ascertained in accordance with the rules laid

down under the Act. This will probably necessitate some alteration of the figures drafted for your own information. The rules are, briefly, to the following effect:—

Ascertain your total sales. Compare the total value of your stock at the end with that at the beginning of the period. If there has been an increase, add such increase to your sales; if a decrease, deduct such decrease from your sales. Deduct from the result your total purchases and wages paid to staff. Deduct also rent, rates, insurance, repairs, gas, electricity, cleaning, stationery, telephone, postage, printing, advertising, travelling for business, packing materials, carriage, bank charges, bad debts, and any other expenses incurred "wholly and exclusively" for the purposes of trade. If you own the freehold and therefore pay no rent, you may, never-

(Continued on page iii).

# Certificate of Membership

*How genuine retailers may be known.*

**T**HE issue of a certificate to members marks a step forward of the greatest importance in the history of the Wireless Retailers' Association. For the first time genuine dealers have a definite opportunity of differentiating themselves from those of the opposite category. That this has been a burning need all *bona-fide* dealers will agree, since, up till now, the shoddy dealer and the price-cutter have flourished, not equally with the legitimate dealer, but at his expense. A further parasite has been, and still is, the individual who by reason of a superficial smattering of technicalities, full trade discounts obtained by dubious methods and the non-payment of royalties, has been enabled to palm off at low prices large numbers of indifferent "sets" on unsuspecting purchasers. The general public have hitherto had no means of distinguishing dealers whom they can trust; but members of the association at least will now be in a position to display convincing evidence of their trustworthiness in their windows or above their counters. This should prove a boon both to the public and to the *bona-fide* dealer.

If all those who make fair-dealing and efficiency in their vocation and adequate service their watchwords, and it is such dealers that the association wants, will support their colleagues who are members by joining them, a line of demarcation may be drawn, and the public will very soon learn that membership implies a guarantee of reliability and will place their custom accordingly. It will then be possible to inaugurate a movement which, by isolating those who have never scrupled to take unfair advantage of the *bona-fide* trader, will leave them high and dry to meet a richly-merited fate. In the meantime the certificate should prove an asset of the greatest value to those dealers who have had the foresight to visualise the advantages of membership.



*The certificate is neat and attractive, as may be seen from this photograph.*

**F**OR its motto the association has adopted the words "Experto crede," which may be interpreted as "Trust one who has had experience," or, in its application to the Trade, "Place your reliance in the efficient dealer." A high standard of efficiency has always been encouraged amongst members of the association, and it is for them to live up to that standard, to see to it that they are truly efficient and are prepared, where necessary, to give adequate service. By so doing the confidence of the public will be secured; but let it be remembered that efficiency is not acquired without effort.

The Industry is essentially of the scientific order, and for a dealer properly to discharge his duties he must have a grasp of more than the rudimentary principles of "wireless." To advise adequately customers who are not experts—and these represent the very great majority of listeners in the country—he should be able quickly to estimate the requirements of each individual case, and to make recommendations accordingly. If customers have trouble with their sets it should not be beyond the dealer's powers to remedy the defect. The dealer who deserves to make his mark will, in fact, go far beyond elementaries, and it is to him that the bulk of the trade in his district will eventually gravitate. So technical, indeed, is the science, that there is practically no limit to the knowledge that may be acquired. While it is not necessary, however, for dealers to attain the proficiency of a scientist, it is towards this goal he should

strive, and the association will give him every possible help.

At the same time, it must, of course, be realised that owing to the very short life of the Industry, and the recent adoption of the calling by many dealers whose *bona-fides* are beyond question, the standard of efficiency cannot at present be as high as it will ultimately become. But the certificate is more than an indication of efficiency; it is intended to constitute a guarantee of fair-dealing and many other desirable qualities.

That the issue of the certificate meets a long-felt want, and will be welcomed alike by the manufacturers, factors, the radio societies, the Wireless Press, and, indeed, everyone who is interested in wireless, cannot be in doubt, and we appeal to all these to give every support to the effort the association is making to create order out of the welter of confusion in which the Industry is struggling.

## Income Tax (continued from page II.)

theless, deduct the "annual value"; or if you pay only a ground rent or a rent less than the annual value, then you may deduct the difference. If any obsolete plant or machinery has been replaced, some allowance will usually be claimable.

Having adjusted these points, the result will be your income as computed in accordance with the Revenue requirements. Having ascertained your income for each of the three necessary years, it is a simple matter to add the three years' profits together and divide by three to arrive at the average or statutory income.

### Doubtful Items.

In considering the permissible deductions you must bear in mind the fact emphasised last month that no drawings in any shape or form are deductible, whether they be called drawings, or salaries of partners, or wages of proprietor, or "living expenses," or otherwise. No item of maintenance of self or wife or family or of home may be deducted.

If your business premises are also used by you partly for residential purposes you may not deduct the whole rent, rates, etc., but only a portion. An amount up to two-thirds is generally allowed, according to the circumstances of the case; in some special cases a claim for even more may be equitable. The matter can be settled with your assessor or your inspector of taxes.

It is advisable carefully to classify all payments in the nature of interest and consult your assessor, for while most of such payments may not be deducted, certain kinds are permissible for deduction.

### Patents.

Patent royalties may not be deducted, but you are entitled to deduct tax from such royalties at the time of payment to the patentee, which, of course, recoups you.

There are various other outgoings which are disallowed, and though at first the reason may not be obvious, yet on reflection you will usually see why. Occasionally, of course, harsh rulings are made by the inspector, and it becomes a question whether or not to appeal to the Commissioners.

### Wear and Tear.

After having arrived at your average or statutory income, and not before, it remains to determine whether you can make any claim in respect of "wear and tear." This claim should be made in respect of any plant,

machinery, fixtures, fittings, furniture, motor-cars, typewriters, etc. etc., used in your business.

Note that it is the full amount of your statutory income that should be entered on the buff return of income, and that the claim for a wear and tear allowance is entered as a separate item lower down the page.

### Business Started within Three Years.

Supposing that you have not traded long enough to have three years' accounts available prior to the fiscal year, what is to be done? So far as the authorities are concerned the answer is simple: they must average as far as possible; that is, if only two completed years are available, the average of those two must be taken; and if only one completed year is available the profit for that year must be adopted as the statutory income.

And if the business has started *during* the fiscal year? The assessment will be on a basis to be approved by the Commissioners. In practice, a proportion of the profits when ascertained will commonly be accepted; that is, if you prove to have made a profit of £800 in your first year ended, say, July 5, 1925, your assessment for 1924-25 will be £600.

### Income Tax.

"**H**OW," a correspondent asks, "is assessable income arrived at?" and the question is one of such general interest that our tax practitioner has made it the subject of a special article. Owing to an oversight last month omission was made of the statement that these notes have been written with special application to wireless retailers. They will repay careful study, as some useful points are made, and the notes contain information not to be found in the ordinary text books.

### The "Wireless Times."

**W**E are interested to note the publication, in separate form, of the *Wireless Times*, hitherto, of course, appearing as a section of the *Sound Wave*. With its policy of safeguarding every aspect of wireless industrial activity devoted to the cause of better musical wireless transmissions everyone must be in sympathy. The trade will echo its motto of "a perfect musical receiver in every house in the country."

# ACCUMULATORS v. DRY BATTERIES

by J. F. Stanley, B.Sc., A.C.G.I.

FROM certain statements made recently in the Press it would appear that a dry battery is quite useless for heating the filaments of dull-emitter valves. In my view this statement, though true in certain cases, is misleading and requires further justification. It must be remembered that there are three distinct classes of dull-emitter valves available for use in receiving sets, and each class should be considered separately as regards the type of battery required for heating the filament.

In the first place there are what we may call high-consumption dull-emitter power amplifiers, such for example as the Marconi-Osram D.E.5; D.E.5b, and L.S.5. These valves take anything from 0.3 to 0.8 amps or even more, and are usually used when really large power is required to work one or more loud speakers in a large hall. These valves *must* be worked off an accumulator, it being quite impossible to obtain a dry cell of sufficient capacity to give a steady output at this high rate of discharge. It would, of course, be possible to put several large cells in parallel and thus build up a battery of sufficient capacity, but the cost of so doing would be much greater than running an accumulator, and, in fact, would be quite prohibitive. For this type of valve, therefore, there is no practicable alternative but to use an accumulator.

The second class of dull-emitter valve is the general-purpose valve, taking about 0.25 amp. at a voltage varying from about one to two volts. When this type of valve first appeared on the market it was rumoured abroad in all the advertisements that accumulators were now things of the past and that dry batteries would very soon be universally used with this class of valve. The introduction of these valves

has undoubtedly done a great deal of good in encouraging research into the manufacture of large capacity dry cells, but it cannot truthfully be said that dry batteries are entirely satisfactory when required to give a constant and more or less continuous discharge of a quarter of an ampere. In cases where the valves are only used for a period of about an hour a day it is quite possible to get satisfactory results provided not more than 3 valves are used. If more than three valves are used it will necessitate building up a large battery by putting several cells in parallel, and in the present state of the art of dry-cell manufacture it is inadvisable to run several cells in parallel, since owing to irregularities in the voltage of individual cells secondary reactions are liable to be set up when several cells are connected in parallel. Two cells of the same make and in the same state of discharge can safely be run in parallel; but it is not advisable to run more than two in parallel. It is far more satisfactory to try large cells than small ones, and a good rough guide to the size of battery to try is to allow 3 lbs. per volt per valve. Smaller cells than this should never be used for discharges of the order of 0.25 amps per valve. For more than 3 valves, however, I would advise an accumulator every time.

We now come to the third class of dull-emitter valve, the filament current now being reduced to the order of 60 milliamps; I say 60 milliamps rather than 0.06 amp. because the word "milliamp" immediately suggests dry batteries, and this type of valve is essentially a dry-battery valve. It will be seen that the filament current consumption is only a quarter of that of the second class, and consequently we can safely use 4 or 5 of these "super-dull-emitters" from dry

batteries. For one, two- or three-valve sets I would personally much prefer dry batteries than accumulators, because if one stands a dry battery on the piano there is not nearly so much fuss about it as there would be if one stood an accumulator on that piece of furniture. Not that a piano is ever used in these days of Paderewski broadcasts, but people still have a dislike for sulphuric acid. As is the case with the second class of valves, a useful guide to work on when purchasing dry batteries for this third class of valves is to allow 1 lb. per volt per valve. Buy larger batteries than this if you like, but it is not advisable to get anything smaller.

It is further advisable to get a 4½ volt battery with a tapping at 3 volts, the advantage of so doing being that the extra 1½ volts can be brought into play as soon as the first 3 volts start to show signs of distress. In this case, however, extra resistance must be inserted in the filament circuit by means of a filament rheostat, which should be at least 30 ohms resistance.

I think I need say no more on this matter than to state that on January 27, 1924, I installed a 3-valve loud-speaker set using Marconi-Osram D.E.3 valves and 2 Ever-Ready dry batteries (type L.T.3) in parallel. The batteries were not renewed until February 18, 1925, after having given good service practically every night during the 12½ months of their life. The batteries cost 7s. 6d. each, the total cost for filament current thus being about 15s. a year. Contrast this with another set I know of, a 2-valve set this time. The cost of recharging the accumulator is 2s. a week, or £5 a year! Many people refuse to believe that a 3-valve set can be run on fifteen shillings worth of filament juice a year, but I have proved that it can be done.

## THE WIRELESS RETAILERS' ASSOCIATION

Hon. Secretaries,

70, Finsbury Pavement,

London, E.C.2

TEL.: CLERKENWELL 1550

### FORM OF APPLICATION FOR MEMBERSHIP.

Sirs,

*I/we desire to join THE WIRELESS RETAILERS' ASSOCIATION, and shall be pleased if you will submit my/our name/s to the Committee for election at the next meeting.*

*Yours faithfully,*

Name \_\_\_\_\_

Address \_\_\_\_\_

Date \_\_\_\_\_

Particulars of Business \_\_\_\_\_

NOTE.—Subscriptions become payable upon election, and should be sent direct to the Hon. Treasurer, H. C. WILLARD, Esq., 48, London Wall, London, E.C.2 (whose receipt alone will be recognised).

# T. & H. JOYCE

## ELECTRICAL & WIRELESS FACTORS

'PHONE: GERRARD 671.

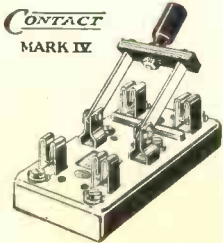

No. 525

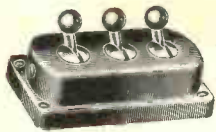

No. 533



No. 531

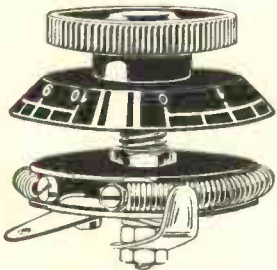

No. 200



No. 296



No. 270

### ENSURE REPEAT BUSINESS

**G**OODWILL is the life-blood of any business, and it can only be built up by offering the public goods that will give satisfaction at reasonable prices. All the Components illustrated here — and others shown in our Catalogue — are

### WRITE FOR OUR CATALOGUE TO-DAY

fully guaranteed  
relied upon to  
business and to  
In spite of their  
these Compo-  
reasonably



and may be  
bring repeat  
create goodwill.  
high quality all  
ments are most  
priced and  
therefore enable the trade to make a considerable margin of profit. We offer prompt deliveries and satisfactory service. It will be to your advantage to get in touch with us, if you are not already one of our many satisfied customers. Please send us your name in order that we may add it to our mailing list and forward you a Catalogue. We are confident that our service will be of assistance to you and our goods of interest to your customers.

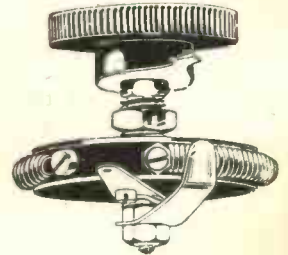

No. 215



No. 240

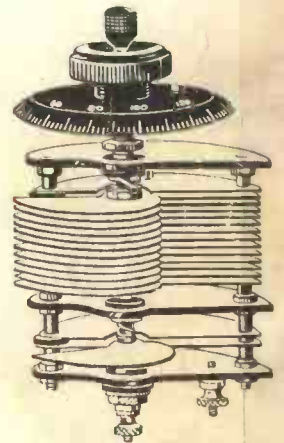

No. 441



No. 326

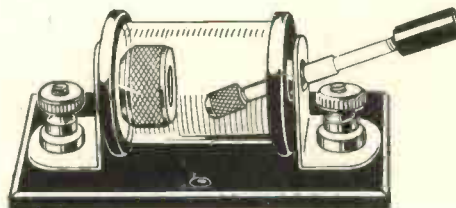

No. 228



No. 245



No. 504

210B, SHAFTESBURY AVENUE,  
LONDON, W.C.2

# LISSENIUM.

When your customers ask for LISSEN Parts—what do you say? \_\_\_\_\_

Suppose you heard a customer a few doors away asking for your shop, and you heard somebody recommending him to another shop—what would you say? When a customer asks for a LISSEN Part and you are out of stock, aren't you trying to send him to your competitor?

## BUILD UP YOUR TRADE WITH— THE AID OF THE BEST PARTS

### LISSEN Lines FOR INCREASING YOUR TRADE.

1. LISSENSTAT RESISTOR (size of a penny).—Can be attached to any rheostat—provides an adjustable minimum safety resistance for dull emitters. HAS A POTENTIAL SALE OF MILLIONS—think of the number of rheostats there must be in use, every one should be accompanied by the LISSENSTAT RESISTOR—neatest thing of its kind—and the price only . . . . . **1/3**
2. LISSEN 5-POINT SWITCH.—Here is a little switch which does the following things :
  - (a) Switches off one stage of L.F. without touching the filament control—a separate switch for each stage.
  - (b) Connects the telephones to the plate of whichever valve it is desired to use, and at the same time switches off the L.T. current from the unused valve.
  - (c) Cuts out a stage of H.F. in the same way as it does L.F. (we do not recommend any switching in H.F. circuits where it can be avoided, but if a switch is used this is the one).
  - (d) Will also disconnect both the H.T. and L.T. batteries and short the aerial to earth, so that the receiver can be left adjusted ready for switching *instantly* into commission next time.

LISSEN PUSH-PULL MOVEMENT—LISSEN ONE HOLE FIXING, OF COURSE **4/-**

3. YET ANOTHER LISSEN SWITCH—reaction reversing switch.—This little switch will be particularly useful when the LISSEN 5-point switch is used for cutting out one stage of H.F. when reaction is being taken off the aerial circuit. Can also be used to reverse connections of a battery, a coil, or a condenser, for instance. Very useful for comparative tests—LISSEN PUSH-PULL MOVEMENT—LISSEN ONE HOLE FIXING, OF COURSE **4/-**  
Also the LISSEN D.P.D.T. SWITCH . . . . . **4/-**

4. LISSEN CHOKE FOR L.F. AMPLIFICATION.—A good Choke coupling will give amplification of a quality comparable to the best Resistance Capacity coupling without the disadvantage of using a large H.T. voltage. This LISSEN CHOKE is different to any other Choke—THERE ARE NO SHARPLY DEFINED RESONANT PEAKS ANYWHERE IN THE BAND OF AUDIBLE FREQUENCIES **10/-**

#### OTHER LINES FOR YOUR STOCK ARE—

5. LISSENSTAT MINOR (patent pending).—Many thousands of rheostats are being discarded and replaced by this perfect little control. . . . . **3/6**
6. LISSENSTAT (patent pending).—Puts a fine edge on dull tuning . . . . . **7/6**
7. KNOWN TO GIVE CORRECT GRID POTENTIAL—LISSEN Variable Grid Leak (patent pending) . . . . . **2/6**  
(LISSEN Variable Anode Resistance—same outward appearance as the LISSEN Variable Grid Leak, 20,000 to 250,000 ohms, also **2/6**)  
YOU JUST GENTLY PUSH OR PULL.
8. LISSEN 2-way Switch . . . . . **2/9**
9. LISSEN Series Parallel Switch . . . . . **3/9**
10. A POPULAR TRANSFORMER.—LISSEN T3, the very best transformer value money can buy . . . . . **16/6**

TEXT BOOK OF LISSEN PARTS OUGHT TO BE IN EVERY DEALERS' HANDS—free to the trade.

## LISSEN LIMITED,

42-46, Woodger Road, Goldhawk Road,  
SHEPHERD'S BUSH, LONDON, W.12.

ANY SHOP IS A BETTER SHOP—WITH LISSEN PARTS.

