

The Journal of THE BRITISH INSTITUTION OF RADIO ENGINEERS

FOUNDED 1925

INCORPORATED 1932

*"To promote the advancement of radio, electronics and kindred subjects
by the exchange of information in these branches of engineering."*

VOLUME 20

JUNE 1960

NUMBER 6

JUSTIFYING THE COST OF RESEARCH

WHETHER or not to embark upon a research project is a most difficult decision to take, whether it be at board room or Government level. In both cases, the purpose is usually to obtain a reliable and usable end product or practical result which will justify the cost of the venture. The only exception to this purpose is long range and fundamental research such as is undertaken in universities and certain co-operative Research Institutes.

Current interest in space research has emphasized the magnitude and the cost of research. As an example, the Department of Scientific and Industrial Research has recently announced that the British Radio Research Station will in future be devoting one half of its total effort to space research. It cannot be emphasized too strongly that this programme is being materially helped by the techniques developed as a result of original research in the design and use of rockets and artificial satellites. It is an example of how new lines of thought and enquiry often provide means of development in fields other than that envisaged in the original programme.

In the case of the D.S.I.R. project, the knowledge obtained from rocket design will assist in the work of sounding the ionosphere from above. For many years the Radio Research Station has been measuring the height and density of the ionosphere from *below*. But the information obtained has been incomplete without measurement from *above* and with the aid of a transmitter in an artificial satellite the Radio Research Station will "*top sound*" the ionosphere by measuring the time it takes a radio impulse to travel from a satellite

into the upper layers of the ionosphere and back again. This will greatly increase knowledge of the ionosphere and will obviously influence meteorological research and especially the extension of radio communication. Moreover, it will give an opportunity of examining the possibility of using man-made satellites to provide more channels for inter-continental and international communication.

It is, however, important that, as stated in the Institution's proposal for the formation of a British Radio Research Institute* "progress reports describing the results of [such] work should be published at regular intervals and that no restriction be placed upon access to these reports or upon private, commercial or industrial employment of the information contained therein." It is only in this way that it will be possible to encourage industrial applications of the knowledge flowing from scientific research.

The problem of translating the results of research into development and production is tremendous. How best to assist it has been one of the tasks of a Government Committee recently appointed to examine the whole question of research. The Committee's report will be of considerable importance, not only in determining future research programmes, but also in securing a balanced and realistic assessment of the cost of research. In Great Britain there is now an expenditure of over £3 million a year on research, and three-quarters of that money is spent by the Government. There is a constant demand for more research and with rising costs the total bill is likely to increase rather than decrease. Justification for such expenditure is, inevitably, measured against the end result.

* *J. Brit.I.R.E.*, 4, page 37, 1944.

G. D. C.

INSTITUTION NOTICES

Birthday Honours List

The Council of the Institution has sent its congratulations to the following members whose appointments to the Most Excellent Order of the British Empire appear in the 1960 Birthday Honours List:

Squadron Leader Edwin Merch-Chammon, R.A.F. (Associate Member) as a Member of the Military Division of the Order.

Elected an Associate Member in 1952, Sqdn.-Ldr. Merch-Chammon is now with the Department of the Assistant Chief of the Air Staff (Signals).

Frank Henry Austen (Companion) on his appointment as a Member of the Civil Division of the Order.

Mr. Austen is general manager of Rediffusion (South East) Ltd. and was transferred to the grade of Companion in 1945.

Formation of Southern Section

A meeting of members in the Southampton area is to be held at the University of Southampton on Friday, 8th July, at 7.30 p.m. The meeting has been arranged to discuss the formation of a Southern Section of the Institution and to elect the first Section Committee.

The President and General Secretary will be attending and notices convening the meeting have been sent to all members resident in the area.

The Television Advisory Committee

The Television Advisory Committee set up by the Postmaster General under the chairmanship of Admiral Sir Charles Daniel, K.C.B., C.B.E., D.S.O., was asked in 1956 to report on the questions of changing the television line standards, on the utilization of Bands IV and V, and on the introduction of colour television. A digest of the Report appears on page 408 of this *Journal*.

The Committee has been advised by a Technical Sub-committee, which has included in its membership Messrs. P. Adorian and L. H. Bedford, both Past Presidents of the Institution, and Mr. V. J. Cooper (Member) who is chairman-designate of the Institution's Television Engineering Group Committee.

Medical and Biological Electronics Group

Since this specialist Group was founded in February 1959 there has been considerable discussion concerning its title. It was established as the Medical Electronics Group and members will recall that Professor A. V. Hill, in his inaugural address, pointed out that this title excluded the application of electronics to biology. The Group Committee has now recommended to Council that the title of the Group should be changed to the Medical and Biological Electronics Group.

Biological Engineering Society

A new society, the Biological Engineering Society, was inaugurated recently at a meeting held at the Royal College of Surgeons. The purpose of the Society is to bring together doctors, physiologists, electronics engineers, and physicists working in hospitals, research institutes and industry. The first president is Dr. R. Woolmer, Professor of Anaesthesia at the Royal College of Surgeons, Professor A. V. Hill, who gave the inaugural address to the Institution's Medical Electronics Group, and Mr. W. J. Perkins, Chairman of the Group, have been elected members of the first council.

The acting secretary of the Society, Dr. A. Nightingale of the Physics Laboratory, St. Thomas' Hospital, London, S.E.1, will be pleased to supply further information to interested members.

The Council of the Institution has already indicated that it welcomes the establishment of this new Society and will co-operate with it in all matters of common interest.

"How he got there"

The monthly review of training and education for industry, *Technology*, which is published by *The Times*, has for many months included short biographies of young engineers and scientists in a series entitled "How he got there." The June issue features Roger Towell, a Graduate Member of the Institution. He is now in charge of a group working on the development of basic techniques for semi-conductors and transistors for radar purposes with F.M.I. Electronics Ltd.

Radio — Its Impact on Shipping †

by

Captain J. D. F. ELVISH, C.B.E. ‡

An Address given at the Inaugural Meeting of the Radar and Navigational Aids Group in London on 28th October 1959.

In the Chair: The President, Professor E. E. Zepler.

Summary: Early experiments in radio afloat and the fitting of radio to ocean-going vessels commercially are described briefly. The progress and development of radio for the shipping industry is traced and the development of navigational aids, other than those used for communications, described. The effect of radio and complementary navigational aids on seafarers and the travelling public is discussed, and a forecast made of future trends. The influence of the two Wars on marine radar is mentioned. Finally, a résumé of the legislation directly caused by the advent of radio at sea is given, and the way in which the shipping industry handles its radio problems outlined.

The object of this address is to try and describe the story of radio at sea and the impact it has made on the shipping industry and on the men who man the ships, and those who travel in them.

Apart from the experimental work which was carried out sometimes between selected craft and the shore, and vice versa, the first actual commercial radio sets supplied to ships were those fitted on the German Norddeutsche-Lloyd vessel, *Kaiser Wilhelm du Gross*, and the Belgian R.M.S.P. *Princesse Clementine*. Marconi took out his first patents in England in 1896, and the first company formed to make commercial use of his work was formed in 1897 and these vessels were fitted with the new miracle in 1899. It was not till 1901 that a British vessel, the *Lake Champlain*, belonging to the Beaver Line (a company which is now extinct) was fitted with Marconi's apparatus. Her operator had already served in the *Princesse Clementine*. Naturally, his cabin and the wireless room had to be specially built and were little more than cupboards but on her first voy-

age with the new equipment it was in full use so far as its limitations of range permitted with stations at Holyhead and Rosslare. As no stations were then in being in North America she was the object of tremendous interest when she reached the other side of the Atlantic.

From then on radio stations were established on the large passenger ships, mainly in the North Atlantic trades, and inter-communication between these ships was used, apart from business and social messages, as a means of giving one another warnings of navigational hazards such as ice, and for gale warnings.

It was not till 1909, however, that the enormous strides made in this novel form of communication at sea were brought to the notice of the general public and, of course, as is so often the case, it was by means of a disaster. A White Star Liner, *Republic*, with some 1,000 passengers and crew aboard was in collision with an Italian vessel *Florida* carrying some 800 emigrants and crew. The operator of the *Republic*, Jack Binns, a name now well-known in the history of maritime disasters because of his devotion to duty and his skill with his set, brought aid to the scene with the result that no lives were lost. Without the aid of radio and the old distress call of CQD there would have undoubtedly been heavy loss of life.

† Manuscript received 28th October 1959. (Address No. 21.)

‡ Group Marine Superintendent, British and Commonwealth Shipping Company Ltd., London, E.C.3.
U.D.C. No. 621.396.932:656.6

The two most highly publicized items of news which really made the World "radio-at-sea" conscious were, of course, the finding and arrest of Dr. Crippen in 1910 on the *Montrose* and the loss of the *Titanic* in 1912. During this period the few ships usually fitted with radio were the large passenger ships but it was not until the first World War that the ships which constitute the great majority of sea-going tonnage—the cargo vessels—came into the picture. The author first went to sea at the end of 1911 and it was not until 1914-15 that any ship in which he served had radio.

About 1915 the U.S.A. made it obligatory for vessels above a certain tonnage to be fitted with radio if they regularly used American ports. At that time the author was on a ship running re-mounts from New Orleans to the United Kingdom for the British Army and it was then that his ship received her first radio set. It was very different from the sets of to-day and had a magnetic detector and an open spark-gap. As the ship had to keep continuous watch in American waters the one Marconi operator had to be supplemented by two wireless watchers who had to pass a simple test in Sound Morse to show ability to recognize an SOS signal which, by this time, had superseded CQD as the Official Distress Call.

By 1916, however, the wartime Defence Regulations made radio compulsory on all British ships of 3,000 gross registered tons and upwards and 1917 saw the tonnage limit reduced to 1,600 tons and also required two operators to be carried in ships so fitted. This caused considerable headaches concerning accommodation, as most cargo ships of the day had no spare cabins and many no power even for electric lighting. The wireless operator on a tramp steamer might find himself housed in some queer temporary erection placed anywhere a clear bit of deck could be found. This, of course, was all part of war-time conditions and the unrestricted submarine campaign and also of trying to fit something new into an existing ship. One of the amenities that the early radio sets conferred on the seafarer was, in many ships, the provision of electric lighting for the first time. The author was in a small ship about this period when she received her

first radio equipment—a ¼-kW set housed in a sort of roll-top desk which was part of the furniture of the operator's far from roomy cabin. We also received one electric globe per cabin, which was about the limit of the dynamo capacity. We also had the iniquitous wireless watcher system inflicted upon us which lasted until the development of the Auto Alarm device in about 1927. This device, by the way, had been suggested as long ago as the enquiry into the loss of the *Titanic* in 1912.

In 1919 the Merchant Shipping Wireless Telegraphy Act became law and laid down the watch-keeping and manning requirements for all classes of radio-equipped vessels. Roughly there were to be three radio officers in large passenger vessels of the deep-sea type, down to one radio officer and two wireless watchers for deep sea vessels carrying under 200 persons. 1920 saw the issue of the first of the Statutory Rules & Orders regarding radio, the first of many the shipmaster has received since.

During the War tremendous advances had been made in the development of radio, not the least being the introduction of shore-based d.f. stations. These were the means, not only of fixing ships' position accurately by taking bearings of her signals, but also of facilitating rescue work in times of peril.

The emphasis of the use of d.f. has changed from the early method whereby a ship transmitted a signal to shore-based station which sent the vessel her bearings, to a ship-borne instrument which picks up the signals of specially situated stations either ashore or on lightships and enables the ship to lay off her own bearings. In 1927 the British Chamber of Shipping was so impressed with the possibilities of this device that it recommended its fitting on all the ships belonging to its members.

Ships, of course, when so fitted could also "home" on a vessel in distress on the open ocean and find her without delay. Generally speaking today, the emphasis on direction finding is more as a safety device than a purely navigational one as the use of Radar and such devices as Decca Navigator, Dectra, Loran and Consol has made the d.f. stations less frequently used than formerly for position finding. Many

shipmasters do, however, check positions obtained by other means with their d.f. especially when approaching our home coasts.

One of the forgotten, or the least publicized of the benefits of radio was the provision of time signals as a means of checking ships' chronometers—still very important navigational instruments—in the open oceans. Prior to radio, ships carried three of these expensive instruments which were carefully regulated by qualified people ashore who supplied the ship with a daily gaining or losing rate. Long-term accuracy was hoped for by cross-checking the three chronometers to find out if changes occurred. The only other means of checking was by celestial observations taken from a known geographical position or by a time-ball which most major ports provided at set G.M.T. intervals. When one remembers that 4-seconds of error in time is one minute of error in longitude, it is obvious what a great boon regular and accurate radio time signals have been, not to mention the saving of cost in carrying fewer chronometers.

As time went on variants of radio were developed, each being a further aid to safe navigation. One of these which many navigators consider the most useful of all was the echo sounder, whereby the depth of the water under a ship can be measured by sound waves. The accuracy of these instruments is fantastic but it is a tribute to our early survey ships of the Royal Navy to find out what very small errors of depth the echo sounder reveals when compared with the wire and lead methods used by early navigators. These instruments came into our vessels in the early 1930's and the author first met such a device in 1934 when it had been developed from a purely visual signal to a self-recorder on paper. To-day its development is such that it is much used for the detection of shoals of fish by trawler men. It is a wonderful aid and if the author were told he could have only one of the many electronic devices now available in his ship he would plump for the echo sounder.

The foregoing items of radio equipment were all commonplace in British ships before the 1939-45 war. During this period practically all shipboard equipment was partially out of service owing to the necessity of maintaining radio

silence in areas frequented by submarine or surface raiders. In the meantime, however, another and extremely valuable electronic device had been developed firstly ashore and then in H.M. ships and finally in a small way during the War for certain selected merchant ships. This, of course, was radar. This device, if fitted to a merchant ship during the war, was operated and maintained by specialist Royal Navy ratings. As soon as hostilities ceased and radar came off the secret list, a round table Conference was held to draw up specifications for merchant ship radar.

Those who attended were representatives of the shipping industry, the Ministry of Transport and the manufacturers assisted by Admiralty experts. Eventually a specification was agreed which in the light of experience was probably a bit too severe and the first commercial sets started to appear on the market and were on the whole good, but expensive. As time went on competition and manufacturing methods and improved components brought the price down and the quality and reliability of the sets up.

When radar was first introduced, it was generally thought that the days of collisions at sea were numbered and that vessels would be able to proceed at full speed in all conditions of weather and visibility and make fast and safe passages. They were quickly disillusioned. Frankly, in the opinion of the author, propaganda for radar was completely overdone and it came to be regarded as a miracle worker instead of another "aid to navigation." After all there was nothing new in the mistaken ideas so widely held. When steam succeeded sail many otherwise sensible people thought that as ships would no longer be dependent on the elements they should be able to avoid running into one another. There is unfortunately nothing to control human fallibility and even to-day after numerous collisions between radar-equipped ships there are still people who regard radar as a means of making a fast—rather than a safe—passage. That unfortunate phrase "radar assisted collisions" tends to throw the onus on to the equipment rather than on to those who misuse a great and useful aid. However, it is only the foolish few who get into trouble. The vast majority of shipmasters use it with discretion and are well aware of its limitations.

Until recently there had been no compulsory system of radar training for ships' officers but now a young officer, before he can sit for his Second-mate's Examination, must take a Radar Observer's Course and pass an examination on what he has been taught. We should therefore see less of the unfortunate happenings which have tended to give radar a bad name.

We shall never cure the fools, as experience on our roads has shown, but we can teach them the results of folly. New and better radar is now being produced. The true motion sets now on the market are a great advance, especially when used with reflector plotters, and one day we may have radar vision when instead of seeing a blip on a screen we shall see the other ship herself and perhaps even the colour of her funnel!

Another war-time advance was, of course, the introduction of the various types of position finding devices such as Decca Navigator, Loran, and Consol. The first named is a commonplace now on ships using our home waters and its accuracy is uncanny.

The author was present at a meeting of the Honourable Company of Master Mariners in London in 1944 when Mr. H. F. Schwarz, a Member of this Institution, explained the system. I don't think many of us believed him at the time, but yesterday's mystery in this day and age becomes to-day's commonplace. One wonders what more can a ship need. She has a gyro compass to give accurate courses, untroubled by magnetism, radar to overcome bad visibility, a Decca Navigator to fix her position, and an echo sounder to give the depth of water plus d.f. stations as an overall check.

Our old friend radio telegraphy, is now seriously challenged by radio telephony. Port control by v.h.f. telephony is making great strides since the modulation argument has been settled and port after port adopted the International Hague Plan designed to standardize the service all over the world. Our own port of Southampton was the first in the World to provide a complete service of this kind. Add this to the other frequencies giving nearly world-wide coverage, makes one wonder whether telegraphy is on its way out in ships and in its place we shall have a telephone exchange on large ships and anyone who has a message to send

gets it through as is done ashore. Would this mean the disappearance of our old friend "Sparks?" I think it is about time something should be said about the men who came to us at sea with these new gadgets. Like most things new they had a mixed reception. Sailors had only just digested engineers when they had to accept a new rank. In some ships poor "Sparks" had an unhappy time but when it was discovered that he could sometimes get the football results his stock went up, only to slump badly when out of range of Poldhu. However, they gradually made a place for themselves and were accepted. The various disasters in which radio played such a vital part in saving life showed that the calibre of the young newcomers to the sea was as good as the rest of us and many a sailor has had "Sparks" to thank for his life whilst "Sparks" sacrificed himself to keep his set going. The two wars gave numerous examples of this and to-day the Radio Officer has a well-earned and well-deserved status and esteem amongst his shipmates.

As can be imagined the introduction of such a novel method of communication to ships and between ships had the effect of completely altering the relationship between the shipmaster and his head office. He is no longer isolated until he arrives in port and is now easily contacted and his orders, if necessary, changed en route. At the same time, if in trouble the advice of his employers is readily available. Added to this when radio was used for broadcasting entertainment most ships' people became the owners of receivers and were able to share one of the amenities of shore life. On the passenger liner the production of a daily newspaper with the latest news is made commonplace through radio.

Radio in ships brought with it a spate of new legislation. The first Wireless Telegraphy Act came into being in 1904 but it was not till 1905 that the Postmaster-General was given power to apply this Act to British ships and to foreign ships in our waters. From thence onwards legislation and rules and regulations came thick and fast. Some regulated the use of radio, others stated which ships should have radio and the number of operators, etc. Up to the start of World War I not many ships were fitted but when in 1916 under the Defence Regulations it became obligatory for all British Ships over

3,000 gross registered tons to be so fitted, and in 1917 this lower limit became 1,600 G.R.T., each ship to have two operators. After the War, in 1919 the Merchant Ship Wireless Telegraphy Act became law and laid down specific requirements for all ships using British waters. This laid down the operating manning scales in relation to the number of persons the ships carried and also to the length of voyage. As an example, a vessel carrying between 50 and 200 persons had to carry one Radio Officer and two Watchers if her voyage exceeded 48-hours, and one Radio Officer and one Watcher if her voyage was under 48-hours but exceeding 8-hours. The Watcher problem continued until the introduction of the Auto Alarm, as already mentioned. In due course "Statutory Rules & Orders, Amending Acts," and "Safety of Life at Sea Conventions" were introduced in which radio equipment played an increasingly important part. These Safety Conventions are held about every 10-years and there is to be one in 1960; an important Convention on Radio was held during the latter part of 1959 at Geneva. One of the shipowners' difficulties is to keep a fair balance between what is really necessary and the enthusiastic desires of the idealist. Like all new sciences, developments are fast and furious but frequent major changes in ships' equipment become an economic headache. We have to be constantly on the alert to protect our frequencies as broadcasting, television, and land mobile services which are all scrambling for space in the already overcrowded spectrum.

The Industry represented by the Chamber of Shipping of the United Kingdom and the Liverpool Steamship Owners' Association is advised on all radio matters by its Radio Committee which itself gets technical advice from its Radio Advisory Service, headed by Captain F. J. Wylie (a Member of the Brit.I.R.E.). The main Radio Committee is further advised by three sub-committees or panels dealing with Communication, Contracts, and Navigational Aids. The Communications' panel co-ordinates with the G.P.O., the Contracts' panels with the major manufacturing Companies, who also supply many shipping companies with Radio Officers. The Radio Aids to Navigation Panel, of which the author is chairman, needs no explanation. In addition there is representation on the Inter-

national Chamber of Shipping, and their Radio Committee which meets two or three times annually to agree on common policy. Representatives are also sent to various Governmental Committees which are more or less permanently sitting on all aspects of radio at sea. Through these organizations the industry has representatives on all similar international bodies both at industry and official levels. It is obvious that we must be satisfied that firstly a particular item of equipment is essential and secondly that we get value for money.

It will be realized that the shipping industry is covering every aspect of radio at sea most fully and competently. We appreciate too, the friendly relations we have built up with the Government Departments and the manufacturers who are concerned with us in providing efficient radio services and keeping our vessels in the fore-front of world shipping.

Speaking as a shipmaster, amongst the real boons that we do enjoy at sea nowadays is the ability to get medical advice if no doctor is carried, to receive weather and ice and other navigational warnings, and to take advantage of search and rescue in times of real trouble. Even our lifeboats are now equipped with a simple portable set which enables a searching vessel to home on them.

In this address an effort has been made to trace the development in the last fifty or sixty years of a great new science whose strides have been phenomenal and whose impact on those who go down to the sea in ships has been such as completely to change the monastic life which was previously lived. It has been the means of saving countless lives, of speeding up communications within the industry to its economic advantage and also of bringing one of the amenities of shore life to men who had little or no entertainment available. What of the future? To a great extent that is in the hands of the radio industry. Better radio, simpler circuits and cheaper equipment are in its province and as your good customers we wish you well.

The author would like to thank the Marconi International Marine Communications Co. Ltd. for permission to use their publication "Wireless at Sea—The First 50 Years" for checking dates and incidents, and for other documentary help willingly given.

THE FUTURE OF BRITISH TELEVISION

The Television Advisory Committee, in its 1960 Report to the Postmaster General*, expresses the view that, looking ahead, the 405-line standards now used in the United Kingdom with 5-Mc/s channel spacing will not be adequate for all purposes and that 625-line standards using 8-Mc/s channel spacing would give a worthwhile improvement in picture quality. Any change in line standards would need to be phased over a number of years to avoid premature obsolescence of 405-line receivers.

With 5 Mc/s channelling the television Bands I and III would give three 405-line programmes, two with 98 per cent. and one with 95 per cent. population coverage, and Bands IV and V would give three 405-line programmes with 98 per cent. coverage, or four of 95 per cent. and one of 70 per cent. With 8 Mc/s channelling Bands I and III would give two 625-line programmes with 95 per cent. coverage, which might be increased to 98 per cent., and on the same basis Bands IV and V would give two programmes each with over 98 per cent. coverage or three with about 95 per cent. coverage.

The Report, however, points out that it would be impracticable to adopt the 625-line standards if for any reason television is to be confined to Bands I and III only. There is still just sufficient frequency space left in Band III to accommodate a third 405-line programme with at least 95 per cent. population coverage. If more than three television programmes are envisaged for the future, Bands IV and V will have to be used.

The Report finds, on the evidence of a large-scale field trial, that an acceptable television service could be provided in Bands IV and V. The trials were conducted by the Technical Sub-Committee and the results showed that the overall assessment of Band V 625-line pictures was not significantly different from that of the Band V 405-line pictures, although in areas of comparatively high field strength the 625-line pictures generally received a slightly higher assessment. It is interesting to note that there was a significant difference, however, in the

visibility of the scanning lines which was not, however, reflected in the overall assessment of picture quality. The Sub-Committee felt however that this was due partly to the nature of the trials and partly to restriction of the video bandwidth of the 625-line system to 5 Mc/s, and that further development, using a 6 Mc/s video bandwidth and receivers with improved noise factors, would show a definite superiority. The Sub-Committee also considered there would be technical advantages and no loss in picture quality in restricting the video bandwidth to 5.5 Mc/s and increasing the width of the vestigial side-band from 0.75 Mc/s to 1.25 Mc/s.

The Committee believes that a higher line standard than the 625-line is undesirable because of the wider channel required; 625-lines with 8 Mc/s channelling is felt to represent the best compromise and the only one likely to be acceptable to the rest of Europe as a common standard in Bands IV and V.

If television is to be introduced into Bands IV and V (the ultra high frequencies), then this will be the last opportunity of changing to 625-line standards and in such circumstances it is recommended that this should be done. Television in Bands IV and V would, however, be more expensive in terms of capital cost, since use of these Bands would need four or five times the number of transmitter stations required in Bands I and III to give comparable coverage. Sets capable of receiving all four television bands will also cost more.

Discussing colour television the Report refers to the full-scale field trials which have been carried out in Band I by the B.B.C. using the N.T.S.C. system adapted to 405-line standards, and concludes that this system is probably the only one suitable for the present standards and probably also the most practicable for use with 625-line standards. Taking into account all the complexities of the technical details of colour television standards, and the view that it is unlikely that a colour receiver could be produced, at a sufficiently low price to command an adequate market, the Report suggests that it is not yet the time for a system to be brought into service.

* Report of the Television Advisory Committee, 1960. (H.M.S.O. 1s.)

A Historical Survey of Radio and Radar Aids to Aircraft Navigation †

by

Sir RAYMUND G. HART, K.B.E., C.B., M.C., A.R.C.S., MEMBER ‡

*An Address given at the Inaugural Meeting of the Radar and Navigational Aids Group
in London on 28th October 1959.*

In the Chair : The President, Professor E. E. Zepler.

Summary : The parallel evolution of the sciences of radio and of aeronautics in the same generation are traced in relation to applications of Radio to air navigation. This evolution was accelerated by radio techniques being deliberately applied to increasing the effectiveness of aircraft as weapons of war, and therefore the paper is in the main a review of the application of radio to navigation in the R.A.F.

1. Introduction

In 1864 James Clerk Maxwell gave demonstrations to the Royal Society which entitle him to be regarded as the "father" of Radio, and the Wright brothers gave birth to powered flight in 1903. Radio equipment was first used in the air in 1908, when the Army balloon "Pegasus" communicated successfully with the ground by wireless, but the first use of radio in heavier-than-air powered aircraft dates from 1912, when a 30 watt spark transmitter was used in a Royal Naval Air Service Short hydroplane S.41, called "H.M.S. *Amphibian*."

When the 1914-1918 war commenced both R.N.A.S. and the R.F.C. had several types of aircraft fitted with spark transmitters which were used primarily for control of gunfire. The author himself flew an R.E.8 fitted with a Sterling spark transmitter in an Army Co-operation squadron in France. The pilot had to operate a morse key to transmit messages from the air to the ground, and he received messages from the ground by looking over the side and reading coded ground strips or by picking up messages on a hook.

At this stage radio was no aid to navigation, but as soon as radio receivers were carried in aircraft the use of loop aerials carried in the fuselage or mounted in the wings was introduced, and in December 1917 the erection of four high power transmitting stations, operating on a wavelength of 2,650 metres was initiated to provide navigational assistance to the Handley-Page long distance night bomber aircraft. Each station in this beacon system transmitted for five minutes in every hour, and loop aerials were used in the aircraft. At this time the Germans had a revolving directional transmitter which was used in conjunction with a stop-watch. In this way the application of Radio to air navigation commenced.

As time passed and radio techniques and aircraft both developed, various navigational systems were introduced making use of continuous waves until, with the development of Radar from 1936 onwards, more sophisticated navigational systems were introduced based on pulsed transmissions, and making use of the cathode-ray tube, which was invented by Professor Braun in 1897, and was first applied to Cathode Ray Direction Finding in 1923.

2. Air Navigation Without Radio

Before it became possible to use radio in any way as an aid to navigation the pilot had to rely on his magnetic compass and a watch to do

† Manuscript received 14th September 1959.
(Address No. 22.)

‡ Director, Radio Industry Council, London. W.C.1; formerly Controller of Engineering and Equipment, Air Ministry.

U.D.C. No. 621.396.96

“dead reckoning” of his position relative to the ground, or rely on identification of landmarks on a map. There was a severe temptation in those days for a pilot to follow convenient railways rather than to perform either of the more tedious processes of dead reckoning or map reading of identifiable features on a direct straight track. This became known as navigation by “Bradshaw,” and was generally frowned upon but considerably adopted. The author’s experience at this stage led him to the conclusion that aircraft compasses were at that time more accurate than their reputation would lead one to believe. Pilots did not trust them as fully as they could have done, mainly because no simple and quick method of determining drift had been evolved; a compass course set and followed with care might not result in the correct track being made, despite the fact that both the compass and the pilot were doing their best. The fault often lay in an inaccurate estimation of the effect of the wind. The normal practice was to use a combination of dead reckoning and map reading, but this did not satisfy the needs of pilots crossing the sea or uncharted areas of land, and was difficult to apply at night and above cloud, there was, therefore, from the first a crying need for more sophisticated navigational systems.

3. The Philosophy of Navigation

Navigation of an aircraft involves determining continuously its position relative to points on the surface of the Earth while it is flying in an atmosphere which is moving relative to the Earth at velocities which are inconstant and which vary with height above the Earth. The ideal is that the crew should be presented continuously with a map on which the positions of the aircraft and of all other aircraft in the vicinity at the time are accurately displayed, and for reliable blind landing and collision warning systems to be available so as to ensure that a journey is completed safely.

The science of electronics is now reaching the stage where this ideal is practically realizable, although there are still limitations to its application. In the past navigation systems satisfying the full need only in part have been adopted, either because no better devices existed, or because more complicated systems were not

applicable to the types of aircraft involved, or the roles that they had to perform.

Important features of military applications are that they should not be usable by the enemy, and that the enemy should not be able to render them either misleading or unusable. Neither of these considerations applies to the systems employed by civilian aircraft. Astro-navigation is a good example of a system which cannot be confused by the enemy, whereas many electronic systems can be either jammed or rendered unreliable.

4. Early Aircraft Installations and Ground Based Aids

The “frame” aerial was the basis of all early radio direction finding systems. It consisted of a pair of open spaced aerials with a common earth lead and coupled and connected to form a “loop” or “frame” aerial. The loop is rotated about a vertical axis until the position of minimum signal strength is determined, when the source of transmission is on a line at right angles to the plane of the loop.

When these systems were in use the aerial was small compared with the wavelengths in use. The use of amplifiers added noise, and made it more difficult to determine a minimum, so there was a continuous tendency to use bigger and better frames. In aircraft this led to frames built in the wings, whilst on the ground it led Bellini and Tosi in 1907 to a method of using two large fixed frame aerials at right angles, the received signals in which were compared in a radio-goniometer. Ground stations of this type would naturally find two minima 180 degrees apart, so a sensing process was developed which involved adding the signal received on an open aerial to that received on the frame. In one direction the signals added and produced a maximum, whilst in the opposite direction they were in reverse, and produced a minimum.

The main errors in loop and frame aerial installations were “site” or “quadrantal” error and “night effect” or “diurnal variation.” Further causes were coastal refraction and polarization. Site errors in an aircraft loop system had to be cured by fixing a calibration chart to the loop scale. On the ground they could largely be eliminated by really careful siting relative to conductors in the vicinity.

Night effect on medium frequencies between dusk and dawn could give rise to large bearing errors, and was largely due to the reception on horizontal elements of the frame aerial of signals reflected at the ionosphere. This was greatly reduced by the use of Adcock aerials devised in 1919, in which the top horizontal limb of the frame did not exist. In an Adcock aerial voltages induced in horizontal conductors cause opposing currents to flow in the coil. These cancel each other (Fig. 1).

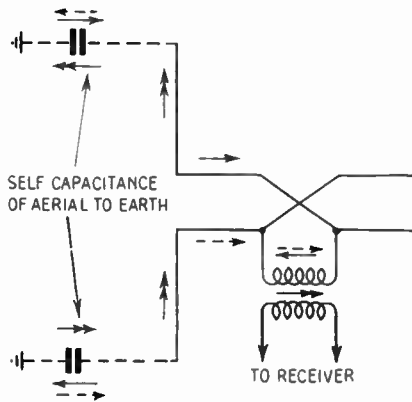

Fig. 1. Schematic representation of the Adcock direction-finding array.

By 1934 there were two civil aviation Bellini-Tosi stations at Manchester and Croydon, and two Marconi-Adcock stations at Pulham and Lympne, and there was a plan to provide twelve permanent and six mobile stations by 1938/1939.

When the War started in 1939 the only long range navigational aid that bomber aircraft could use was the medium frequency d.f. network. It was a common user system manned by civilian employees of the Air Ministry, and operated in the 300-400 kc/s band. Stations were laid out and grouped in such a way that bearings or fixes could be given on request all round the coast and inland. The accepted range on an aircraft flying at 7000-8000 feet was 350 miles. The order of accuracy at this range was ± 1 deg whereas a loop system in an aircraft could not be expected to give better than ± 2 deg at a range of 200 miles.

In 1934 the author was a night-bomber pilot in No. 9 Squadron, and became familiar with

this m.f. d.f. system. It was then a very useful check on dead reckoning, which was still the basis of all navigation. The accuracy of a fix depended on the individual skills of at least two operators on separate stations, so there was naturally a variation of accuracy of fixes passed to aircraft. On the whole the m.f. d.f. system was popular with bomber aircrews, but it became saturated if more than 100 aircraft were flying. A section of stations could pass 20 fixes an hour to aircraft requesting service provided the requests were spread over the hour. This satisfied requirements between 1939 and 1942 fairly well.

In addition to this m.f. d.f. service there were h.f. d.f. stations on Bomber Command airfields for homing and controlling aircraft. These operated in the 3-5 Mc/s band.

5. Standard Beam Approach

In 1939 steps were taken to provide Bomber Command with Standard Beam Approach, which was the version of the Lorenz system which had been developed by the Standard Telephones and Cables Co., Ltd. The system laid down a fixed lead in to an airfield, a "beam" being provided by aerial keying. There were two main lobes, 180 deg apart, and dots or dashes were radiated in intervening sectors. There were also two marker beacons, transmitting vertically, one of which was placed 2 miles from the airfield, the other being on its edge. The aircraft equipment consisted of twin channel reception apparatus with frequency selection on four channels. This system was never popular in Bomber Command as a landing aid, but in 1941 the S.B.A. receivers were put to use as long range navigational aids, and became more popular in that role. High-powered S.B.A. transmissions were beamed across the North Sea and the Channel, and bomber aircraft could follow the beams out and back for ranges of 350 miles. Marker beacons were installed at the transmitting stations so as to provide accurate pin-points. This system was known as "track guides" or "jay beams."

6. Navigation and Control of Fighters

While m.f. d.f. partly satisfied the needs of aircraft carrying radio-operators or navigators, it did not serve single seater fighters. The first

navigational system based on radio for fighter aircraft consisted of direction finding stations at Hornchurch, North Weald and Biggin Hill which were designed by Wing Commander C. K. Chandler, and which were able to take bearings on transmissions from T.R. 9 airborne equipment, operating in the 2000-7000 kc/s band. These radio-telephony d.f. stations were brought into use round about 1935, and were used extensively in the early development of interception techniques at Biggin Hill. The study of interception problems was initiated by Air Marshal Sir Philip Joubert de la Ferté before Radar came on the scene, so that the R.A.F. would be ready to make the best use of Radar when it became available. The Chandler-Adcock d.f. stations played a very important part in these experiments. The author was on the staff of Sir Philip when these trials commenced, and became well aware of the intricacies of interception before he was whisked away to Bawdsey to work on radar.

7. Ground-based Radar

The first radar equipment that was put into operational use was that in the coastal CH stations, which were wide cover "broadcast" stations, and provided the information on which was based the control of fighters in the daylight phase of the Battle of Britain. These stations gave accurate range measurement on high flying aircraft out to 100 miles and more, but angular measurement in azimuth was not sufficiently accurate. In consequence a filtering system which combined information from several stations had to be introduced to provide usable tracks on the tables in operations rooms. Height measurement was also provided, but this also had to undergo a process of assessment.

An important but later development in radar ground stations was the CHL which was a narrow beam station with a rotatable aerial working in the 200 Mc/s band. This was the progenitor of the GCI station, and from the plan position indicator an aircraft controller could direct a night fighter equipped with AI to a position relative to an enemy aircraft from which AI could take over. The CHL station was also the "father" of the ground-based element of the "Oboe" system which will be referred to later.

8. Airborne Radar

It is sometimes forgotten that, whereas the building of R.D.F. ground stations started in 1936, there was in fact an airborne radar equipment flying in a "Heyford" aircraft in 1937. Progress in the development of airborne radar, and of transmitters in particular, was hampered by a critical shortage of valves which could be used on sufficiently high frequencies. This

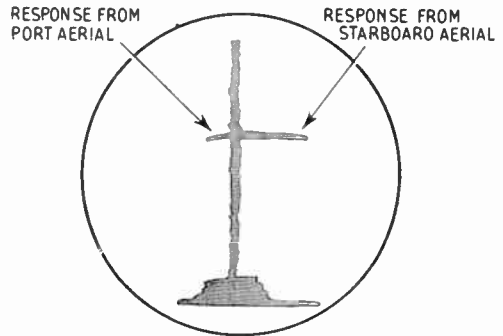

Fig. 2. Presentation of responses on the cathode-ray tube display of an airborne interception radar.

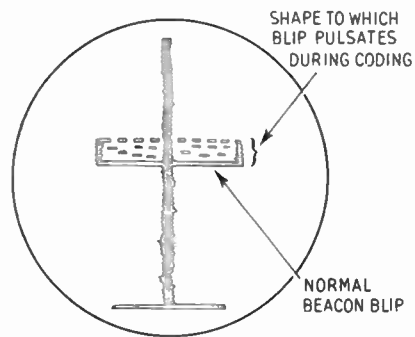

Fig. 3. Appearance of width coding of the time-base to identify beacon transmissions.

proved a very real handicap to the development of airborne interception equipment for fighters, and the first airborne radar was only able to locate coast-lines, ships at sea, and harbour installations. However, this was the first time that an airborne installation was able to give the aircrew the range and bearing of an object on the surface of the earth, and it was therefore an

important step forward in the history of navigation.

The author flew with Dr. E. G. Bowen in this "Heyford" on one of its earliest test flights, and was able to locate ships at sea after very limited training in the use of the apparatus. On this trip he was able to distinguish the position of the railway line in Harwich. This proved to be a fortunate incident in the long term, for in 1942, when the need for H2S was painfully evident, there was nobody else readily available to the Air Ministry who could confirm from experience that H2S was in fact a practical proposition. At that time Dr. Bowen was in America guiding the development of AI.

Thus the first operational application of airborne radar was the detection of ships from the air, and was called ASV ("air to surface vessel"). It was not until mid-January 1940 that the first twelve "Hudson" aircraft were fitted with ASV Mark I. ASV quickly became popular with Coastal Command aircrews, and the following report was written just a month after its introduction into operational use.

"ASV is of great assistance in reconnaissance at night and in bad visibility. The detection of landfall is extremely helpful."

In October of the same year it was reported that ASV equipment in flying boats had made it possible to do more work with convoys at night than had hitherto been regarded as practicable or safe. Not only had it been possible to locate the convoys and maintain a patrol in the area without the help of moonlight, but the assistance of ASV in making landfall gave pilots confidence and lessened the risk inherent in operating flying boats at night or in bad visibility.

Here we see the realization that ASV was a valuable navigational aid, a realization which was further strengthened when ASV beacons were introduced and were installed on suitable coastal sites. These beacons comprised a receiver which accepted the ASV signal, triggered a transmitter, and thereby sent out a strong response which also could be coded. The aircraft was able to obtain range and bearing for positioning or homing at considerable distances if flying reasonably high.

Figures 2 and 3 are a reminder of the type of

ASV display available to the aircrew, and the method of coding a beacon response.

9. Radar Beacons

Various applications of the radar beacon were used in the Second World War. Coastal Command aircraft could use their ASV to home on to reconnaissance aircraft shadowing enemy forces from considerable distances if the shadowing aircraft were fitted with "Rooster" beacons. A Rooster was a modified IFF set, and it was possible to modulate the signal transmitted so as to convey messages between the two aircraft concerned. In 1941 a Beam Approach Beacon System (BABS) was produced which combined the principles of the Lorenz beam and the radar responder beacon. An airborne interrogator transmitted pulse signals on receipt of which the responder beacon retransmitted dot and dash signals by means of two aerials to the right and left of the runway on an airfield, the power being switched alternately between the two aerials. The signals overlapped to form the beam, an equi-signal zone which was aligned along the middle of the runway to form the approach path.

The Rebecca/Eureka system was a combination of an airborne radar interrogator called Rebecca (she followed Abraham's servant into another country), and a ground based responder beacon called Eureka (I have found it), which enabled an aircraft to identify a target. An aircraft could home from 50 miles on to a Eureka beacon which could be carried in a suitcase. The "father" of Rebecca was ASV Mark II, and the "father" of Eureka was IFF. This combination was used to locate dropping points for supplies and agents, and to mark dropping zones for invasion from the air. In the invasion of Europe the airborne forces used Rebecca/Eureka at base airfields, at rendezvous points, and at dropping zones. From a navigational point of view each of these applications involved straightforward homing. In one case a Eureka beacon was mounted on a ship at sea to provide an accurate turning point for airborne invasion forces. Such interrogator/responder systems have many possible applications for the solution of special navigational problems, but, being primarily either identification or homing systems, they have their limitations.

10. Other Radar Devices

In the early phase of the war between 1939 and 1942 the m.f. d.f. organization provided fixes, bearings, an SOS service and identification of friendly bombers as they approached the coast and entered the area covered by coastal radar stations. As the war progressed and it became normal procedure for bombers to operate by night, and penetrate further into enemy territory in increasing numbers, the service provided by the m.f. d.f. organization became less and less satisfying. Mention has already been made of "jay" beams which reduced the load on the m.f. d.f. system, but it was evident some time before 1942 that higher capacity and longer range systems were needed. Two lines of development were pursued; firstly, the system known as "Gee" was brought into operational use in March 1942, and secondly, development of H2S was started in 1942 as a follow-up to experiments conducted by Professor P. I. Dee and Dr. A. C. B. Lovell on airborne surface search equipment in 1941.

10.1. "Gee"

The principle of "Gee" was conceived by Mr. R. Dippy working at Bawdsey in 1938, and it was accepted as an urgent operational requirement in Bomber Command in November 1940. The Gee system is closely related to such systems as Loran and Decca, and is therefore of considerable historical interest. Gee was invaluable as a navigational aid. It facilitated concentration of forces, helped navigators to determine wind, to maintain accurate tracks and to avoid defended areas, and also helped to solve the problem of homing and landing large numbers of bombers in a short time under all weather conditions. It was not, however, sufficiently accurate for blind bombing, and the accuracy of a fix fell off seriously at considerable ranges from the ground stations.

In Gee transmissions from the ground from a marker transmitter and two slaves are accepted by a receiver in the air, and displayed so that a navigator can readily determine the position of the aircraft relative to a grid composed of hyperbolic curves joining points of common time difference of reception of the marker and slave signals (Fig. 4).

Although the merits of Gee as a navigational

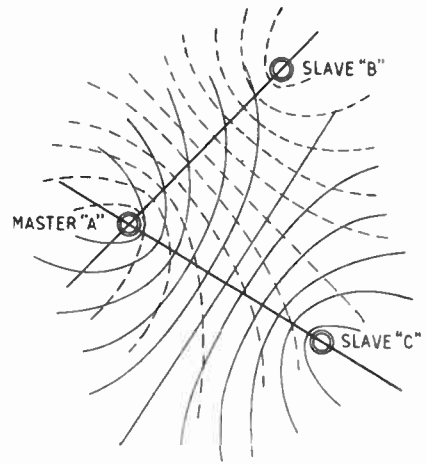

Fig. 4. Principle of Gee, showing the hyperbolic grid.

aid were well appreciated, so also were its shortcomings, and the need for a device to increase the accuracy of bomb-aiming or target marking under all weather conditions remained paramount. During the early part of 1942 development work was proceeding on three such devices—"Oboe," H2S and "Gee-H." The first of these to be used operationally was Oboe.

10.2. "Oboe"

"Oboe" was a system of blind bombing in which an aircraft was controlled by range measurements from two ground stations. Each ground station transmitted pulses on different pulse recurrence frequencies, and the aircraft carried a pulse repeater to provide adequate signal strength at the ground stations over great distances. The controlled aircraft flew at constant range measured by normal radar means from one station, called the "cat," such that the track took it directly over the target. At another station, called the "mouse" usually located about 100 miles from the cat, the range of the aircraft and the component of ground speed along the line joining the mouse with the target were measured. From this information, in conjunction with a knowledge of the ballistic characteristics of the bomb, the point at which the aircraft must release its bomb was determined, and a signal given to the aircraft accordingly. Signals were transmitted on the same radio-frequency channel as that used for

range measurement to assist the pilot to keep on track and to indicate to the bomb-aimer the moment of release.

This system achieved some remarkable successes during the precision bombing which took place in Normandy immediately before the invasion.

10.3. H2S

Oboe, which is a precision bombing equipment barely qualifies to be mentioned in an address on radio aids to navigation, but its successor, H2S, was fully qualified. It was an airborne primary radar equipment with a rotating aerial system which swept the surface of the Earth with a narrow beam, the radar picture being displayed on a plan position indicator. The interpretation of the picture that was obtainable on early marks of H2S, operating in the 9-cm waveband, was not easy, and particular targets, especially in a built-up area, were either very difficult to distinguish, or were not distinguishable. H2S was suitable for bombing a built-up area and was most useful for navigation, but once again the need for precision bombing equipment that could be used by a large force remained an unsatisfied requirement, despite the fact that excellent navigation facilities were available.

10.4. H Systems

Since the radar system of pulse transmissions could readily be used for measuring range to an accuracy of a few hundred feet or better, a precision much higher than that of measuring bearings, it was particularly suitable for providing navigation fixed by measurement of the distance to two different known positions. This

method of using radar in which airborne equipment was used to measure the distance from the aircraft to two ground radar beacons, was known as "H." The principal H systems used by the Royal Air Force during the war were Gee-H, Rebecca-H, and Shoran.

11. Conclusion

From a historical point of view it is interesting to note that Gee, Oboe, H2S and Gee-H all made their individual contributions to enabling R.A.F. aircraft to perform most complicated and precise movements in the air, and to achieve fantastically accurate bombing results in Operation "Overlord," the Invasion of Europe in 1944. It is no mean feat for a squadron of aircraft to fly in such a way as to appear to radar stations to be a slow moving convoy, neither is it a simple matter to navigate 99 aircraft so accurately that they can completely eliminate a target at the one moment that it must be eliminated, but both of these tasks were performed, together with many others.

Precise navigation is a war-time requirement, but it is a peace-time requirement also, and future systems must allow a congested air space to be used with impunity and complete safety by a large number of aircraft. Navigation must be so precise internationally that it is possible to bring down a V-bomber in trouble from above normal traffic lanes, through those lanes, and on to an airfield without danger to anybody.

12. Acknowledgment

The author is indebted to the Air Historical Branch of the Air Ministry for allowing him to have access to the History of Signals in the Royal Air Force so as to ensure the accuracy of the facts stated in this Address.

MEMBERS OF THE EDUCATION AND EXAMINATIONS COMMITTEES



Brigadier Leonard Henry Atkinson was born at Hale, Cheshire, and educated at Wellington College and University College, London, obtaining a B.Sc. degree in Engineering in 1932. In 1936 he obtained a commission in the Royal Army Ordnance Corps and during the War he held increasingly responsible appointments with Field and Command Workshops. During the Invasion of Europe, he was Commander of the Royal Electrical and Mechanical Engineers attached to the headquarters of the Guards Armoured Division. At the conclusion of the war in Europe, Colonel Atkinson was posted to India as Deputy Director of Mechanical Engineering with the Airborne Corps. From 1946-1947 he was responsible for technical supervision of Workshops in the Far East at the headquarters of the South East Asia Land Forces, Singapore. On his return

to the United Kingdom, Colonel Atkinson held staff appointments at the War Office and in England and Germany. From 1955 to 1958 he held appointments in the Directorate of Electrical and Mechanical Engineering in the War Office, latterly as Deputy Director.

Brigadier Atkinson is now Commandant of the R.E.M.E. Training Centre at Arborfield and is thus responsible for the technical training of R.E.M.E. officers and tradesmen.

He was appointed an Officer of the Most Excellent Order of the British Empire in 1945.

Elected to Full Membership of the Institution in 1957, Brigadier Atkinson has served on the Education Committee since it was established as a separate Committee last year.

Squadron Leader William Laurence Price, who has served on the Examinations Committee since 1955, is Officer Commanding the Electronics Division at the R.A.F. Technical College, Henlow. Born in Birmingham in 1923, Squadron Leader Price took a war-time Course in Radio Physics at Nottingham University College, returning after the war to obtain B.Sc. and M.Sc. degrees in Mathematics. During the War he was a Technical Officer in the R.A.F. concerned with ground radar, and after obtaining his B.Sc. returned to the Service in 1948 as an Instructor. In 1951-52 he took the post-graduate course for the Diploma in Electronics of Southampton University, and he received his present appointment in 1954. In the New Year Honours List of 1958 Squadron Leader Price was appointed an O.B.E.



Elected an Associate Member in 1952, Squadron Leader Price was appointed to the Council of the Institution in September of last year.



Born in Bromley, Kent, in 1912, **Kenneth Edward Everett** received his technical education at Woolwich Polytechnic where he secured National Certificates during his training as an apprentice factory engineer at Standard Telephones and Cables Ltd. From 1932-1936, he attended the City and Guilds Engineering College obtaining his B.Sc. degree with 1st Class Honours. He returned to S. T. & C. as a radio valve development and production engineer. In 1946 Mr. Everett was appointed lecturer in Electrical Engineering at Woolwich Polytechnic and two years later obtained his M.Sc. degree. In 1954 he became a Senior Lecturer at South East London Technical College, specializing in Industrial Electronics. He was appointed Head of the Department of Electrical Engineering and Applied Physics at Southampton Technical College in 1957.

Elected an Associate Member of the Institution in 1954, Mr. Everett was transferred to Full Member earlier this year. He was appointed to the Education and Examinations Committee in 1955, and he has been the Institution's Examiner in Advanced Radio and Electronic Engineering and in Applied Electronics for several years. He now serves on the Examinations Committee.

Future Trends of Radio and Radar Navigation †

by

CARADOC WILLIAMS, B.Sc. ‡

An Address given at the Inaugural Meeting of the Radar and Navigational Aids Group in London on 28th October, 1959.

In the chair: The President, Professor E. E. Zepler.

Summary: The paper compares the requirements for marine and aeronautical navigation. In radio navigation a knowledge of the path of the radio waves and the velocity of wave propagation along the path is essential. Distance-bearing navigation, hyperbolic navigation and radio Doppler navigation are considered. The new techniques of navigation discussed are inertial, mobile high stability sources, very low radio frequencies, radio telescopes and earth satellites. Systems for berthing ships and landing aircraft during bad visibility are described. The paper concludes with some proposals for automation in air traffic control.

1. Introduction

Ships and aircraft use Radio and Radar Navigation systems for defining and following economic transport routes in which movement is safe and unhindered by the presence of other craft or by terrestrial obstructions. The contribution which radio makes to navigation is by the measurement of distances and bearings. In the more usual applications of radio to navigation, distances are being measured from a few feet to several thousand miles and bearings are measured to a few minutes of arc. The radio frequency spectrum used for navigation extends from about 10 kc/s to 40 Gc/s.

2. Marine and Aeronautical Navigation Requirements

The mariners' needs have been largely satisfied by technological progress in marine and harbour radar, direction finding and off-shore position fixing systems. On the other hand, vast advances in aeronautical development have created many new problems of communications, navigation and movement control of a highly perplexing nature, such that the impact of progress in radio and electronics, although very

considerable, is being strained to meet the increasing demand for greater precision of movement control. One of the most urgent tasks of the present time is to solve the technological problems of safe movement control, particularly so in the case of aircraft, and to a lesser degree in the case of ships. No less important than the definition of routes over the earth's surface is the subject of collision warning and avoidance and it seems that more technological effort should be devoted to this subject.

Whereas the mariner is concerned with large craft moving at low speed in two dimensions, the air operator is concerned with smaller craft moving at high speed in three dimensions. These differences lead to a diversity of techniques to resolve the navigational requirements. These marine and aeronautical requirements are approximately indicated in Tables 1 and 2.

The mariner is interested in technical improvements to prevent collisions at sea, effective means of port control and systems for berthing ships during bad visibility. For berthing purposes and for the control of ship movements in busy waterways, marine and harbour radars of greater precision may be required. For some purposes radar information of ship size, aspect and speed may be needed.

The air operator is concerned with long and short distance aircraft navigation, safe movement in a complex traffic pattern, aircraft "let-down" through cloud and landing during bad

† Manuscript received 8th March 1960. (Address No. 23.)

‡ Ministry of Aviation, Royal Aircraft Establishment, Radio Department, Farnborough, Hants.

U.D.C. No. 621.396.96

visibility. With the rapidly expanding amount of air traffic and increased speed of flight, improved methods of navigation and movement control are vital to the future progress of air transport.

3. Basic Physical Principles of Radio Navigation

The main techniques of radio navigation are illustrated in Fig. 1. They make use of the assumption that radio waves are propagated in straight lines at constant velocity in the earth's atmosphere. Radio waves follow the great circle path around the earth's surface by diffraction, the degree of diffraction being dependent on the frequency. Whereas waves at very low frequencies follow the overground path with low attenuation in the diffraction region, waves at very high frequencies are rapidly attenuated in the diffraction region and in consequence are ineffective much beyond the optical horizon distance. For this reason low and medium frequencies are used by the mariner because the signals may be propagated to great distances beyond the optical horizon. Since aircraft fly at considerable altitude, the greater horizon distance permits very high frequencies to be used by direct wave propagation.

Whereas in radio communication the path by which the waves travel from transmitter to receiver is not usually of great importance, in

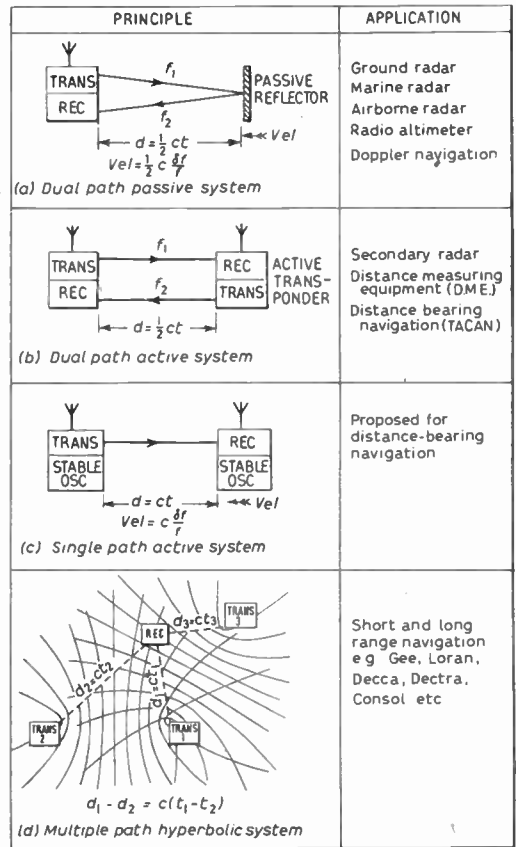

Fig. 1. Principles of radio navigation.

Table 1
Requirements for Marine Navigation

Function	Distance from nearest danger	Order of accuracy required	Order of time available to obtain a position
Aid to ocean navigation	Over 50 miles	± 1% of distance from danger	15 min
Aid to approaching land	Between 50 and 3 miles	± 1/2 mile to ± 200 yards	5 min to 1/2 min
Aid to coasting and general port approach			
Aid in harbours and entrances	Less than 3 miles	± 50 yards	Instantaneous position and track

radio navigation the path of the waves and their velocity along the path are matters of primary importance. Precise measurement of wave propagation time intervals and the direction of arrival of waves forms the basic process of all radio navigation methods. The radio wave is analogous to a measuring tape laid over the earth's surface. The length of the tape is the distance: $d = ct$ where c is the velocity of wave

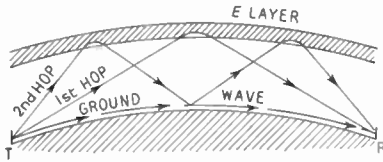

Fig. 2. Ionosphere reflected waves.

propagation and t is the time taken for the signal to reach the receiver. If the tape is not laid in a straight line, corrections have to be made to the measurement. Likewise, if the radio wave does not follow the great circle path, but is reflected by the ionosphere, for example, as shown in Fig. 2, then corrections have to be applied to the measurement of d to derive the true over-ground distance.

In the Dual Path Passive System in Fig. 1, pulse-modulated signals originating from a rotating narrow beam aerial are returned along the same path to the receiver by passive reflection from obstacles in the path of the waves. The distance is given by:

$$d = \frac{1}{2} ct$$

If the passive reflector has a radial velocity, a Doppler shift of the radio frequency occurs between the incident and reflected wave and the radial velocity is given by:

$$V = \frac{1}{2} \lambda \delta f = \frac{1}{2} c \frac{\delta f}{f}$$

where the Doppler shift $\delta f = f_1 - f_2$ and f is the radio frequency.

The time integral of V gives the radial distance moved by the craft.

In the Single Path Active System very stable frequency sources are used at the fixed ground source and in the craft. These have the same nominal frequency, but if the craft has a radial velocity a Doppler shift of the signal received in the craft can be measured with respect to its own frequency source. The radial velocity is given by:

$$V = \lambda \delta f = c \frac{\delta f}{f}$$

and as above, the time integral of V gives the radial distance moved by the craft.

The widely used hyperbolic systems of radio navigation are based upon simultaneous transmissions from two separated stations. A receiver in the craft which measures the phase or time difference between these two signals originating from the transmitters, defines its position on a hyperbola, where the difference in distance of the mobile receiver from the two transmitting stations is given by:

$$d_1 - d_2 = c(t_1 - t_2).$$

Table 2

Requirements for Air Navigation

Function	Order of accuracy required	Order of time available to obtain a position
Long Range Air Navigation	10 miles	5 min
Short Range Air Navigation	0.5 miles	5 sec
Airfield Approach	50 ft (plan position) 10 ft (height)	Instantaneous position and track
Aircraft Landing	15 ft (plan position) 2 ft (height)	Instantaneous position and track

By a similar measurement from a third co-phased transmitting station the position of the craft is uniquely defined at the intersection of two hyperbolae in the manner shown in Fig. 1. The transmissions may be either continuous wave as in the case of Decca, when the phase differences are measured or they may be pulse modulated as in the case of Gee or Loran, when pulse time intervals are measured.

Bearing measurement provided one of the earliest forms of navigation by direction finding using a magnetic loop or "Adcock" receiving aerial. When a unipole radiates signals, lines of constant phase are defined as concentric circles around the source. A magnetic loop or "Adcock" aerial will pick up these signals, and if the plane of the loop is orientated parallel to the phase front, the signal is at a minimum level and the normal line to the loop indicates the direction of arrival of the wave. These lines of constant phase may be disturbed by ground obstacles or by multiple path propagation such as occur at night by reflection from the ionosphere, and for minimum signal the loop will be in the disturbed phase front. The larger the loop or aerial aperture the less it is disturbed by these phase front perturbations and thus it is advantageous to use as large a loop as possible. This kind of direction finding is carried out by locating a signal minima and therefore the bearing is inaccurate under high radio noise conditions, but in radar practice on microwaves high gain narrow beam aeriels are used and direction finding is carried out by locating the signal maxima. To obtain these high gain narrow beam aeriels the aperture of the aeriels must be many wavelengths, the beamwidth relationship being given approximately by:

$$\theta = 60 \frac{\lambda}{D}$$

where λ/D is the aperture of the aerial in wavelengths.

Some of the most advanced radar technique has been achieved in Q band (37 Gc/s) but since signal attenuation in rain increases very greatly at the very high microwave frequencies, these highly accurate systems are liable to be completely blotted out during bad weather conditions.

A notable development derived initially from

airborne radar technique is radio Doppler navigation which is used to measure the ground speed and drift angle of an aircraft in flight. In the Doppler technique relative motion is measured by the Doppler shift of a radio frequency which occurs when a beamed signal initiated in the aircraft is reflected by the ground. As a result of the forward motion of the aircraft the return signal from the ground differs in frequency from the incident signal, the frequency difference δf being directly proportional to the speed of the craft. The practical applications of the Doppler technique will be dealt with in the next section.

4. Brief Survey of Existing Techniques

In techniques which measure bearing and radial distance, the dual path method (go and return signals) is used for primary radar, the signals being returned to the receiver by passive reflection from the obstacles illuminated by the rotating narrow beam aerial. Alternatively the passive reflector may be replaced by an active reflector called a transponder which serves to identify the origin of the return signals from all others originating from passive sources. In the marine field these transponders are called Racons and are used as radio lighthouses to give positive identity to land features or light vessels on the ship's radar display. In like manner transponders are sometimes carried in aircraft to give identity on the secondary ground radar display.

The advances in radar technique have mainly been to achieve a better degree of definition. This can only be realized by using narrower beam aeriels to give greater bearing discrimination and generating shorter pulses to improve range discrimination. For this purpose radars have been developed in Q band where it is more practical to design relatively small aeriels of large wavelength aperture. An interesting example of the high degree of definition which can be achieved in this radar band is shown on the Q band surface movement indicator at London Airport and Southampton Water, Figs. 3 and 4, where the definition given on the p.p.i. displays are compared with true aerial photographs.

The use of marine and airborne radar for collision warning and avoidance is a subject of

considerable interest. In the marine field there exists an opinion that collisions have not been materially reduced by the use of marine radar.

In the normal ship's radar display, the movements of a craft B as shown on the radar display of a craft A, are relative movements. It can be deduced from this relative display that a collision is inevitable if the relative bearing of B is maintained constant on the display of A, but the picture fails to reveal the positive action which is necessary to avoid a collision and a set of collision avoidance rules needs to be defined. A new form of display has been developed, known as "true motion radar." In this, the

Studies of this problem suggest that it is feasible to develop a new kind of display which remains fully interpretable when either one or both craft manoeuvre and this work could lead to some important contributions to help solve the problems of collision avoidance.

There are two classes of navigational system widely used: those which are fully contained within the craft and those which are provided from outside. In the first class are the dead reckoning devices which use compass heading, measured speed and drift to compute the track made good. These devices have been made largely automatic in nature, the position being

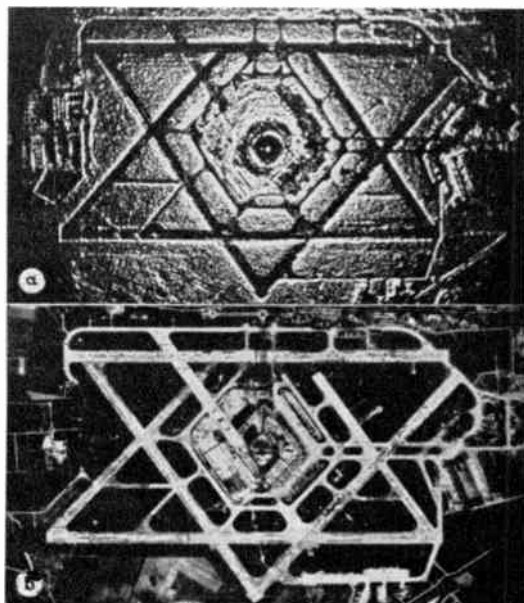

Fig. 3. London Airport.
 (a) Resolution of a Q band radar.
 (b) Aerial photograph at 40,000 ft.

vector components of the ship movement are applied electronically to move the origin of its own display vectorially and thus to reveal the true movements of other craft on the display. However, the serious shortcoming of both these displays is that they become more or less unintelligible immediately one or both of the craft start to manoeuvre. This is largely because information on ship aspect is missing in the display.

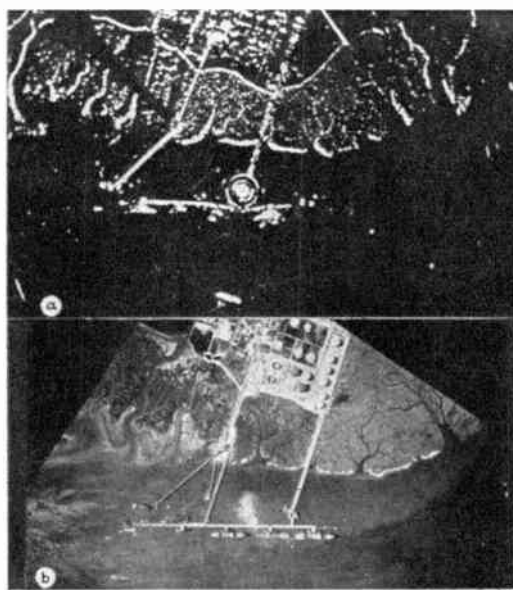

Fig. 4. Part of Southampton Water at Fawley.
 (a) Resolution of a Q band radar.
 (b) Aerial photograph at 10,000 ft.

given for example in the ground position indicator as latitude and longitude co-ordinates. The errors of these systems are integrated in time, that is they are cumulative and in consequence it is necessary to correct the instruments from time to time by reference to recognizable geographical features or to other navigational data. An advantage of the self-contained systems is that there are no geographical restrictions to their use, because no ground based

organization is required to support them. In consequence they may be used over oceans, deserts or in the polar regions.

With the large increase in aircraft speed and operating altitude the need for more accurate means of measuring ground speed and drift has been achieved by the use of Doppler navigation. In the Doppler technique, relative motion is measured by the Doppler shift of a radio frequency which takes place when a beamed signal initiated in the aircraft in flight is reflected by the ground. The practical way of measuring the

mately 9 kc/s. Ground speed is indicated from the measurement of Doppler frequency. Drift angle is measured by using two separate pairs of these depressed beams, which are disposed symmetrically about a vertical plane through the aircraft, each pair being directed to port and starboard respectively, thus receiving its own Doppler frequency; both Doppler signals are then mixed together to control a servo system which rotates the aerial beams in a horizontal plane until both pairs are orientated along the direction of motion of the craft. This

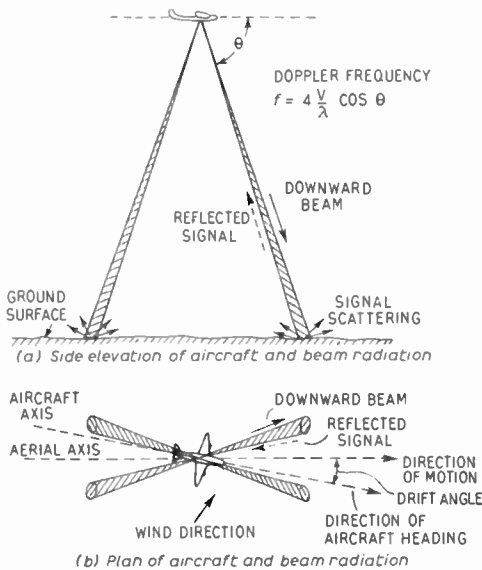

Fig. 5. Doppler navigation.

Doppler frequency shift is to direct one beam forward and downward and a second beam backwards and downward of the aircraft axis, (see Fig. 5) in which instance the reflected signals when mixed together give a beat frequency

$$\delta f = 4 \frac{v}{\lambda} \cos \theta$$

where v = aircraft velocity, m/sec,
 λ = wavelength, m,
 θ = depression angle of the beams with respect to the axis of the aircraft.

If $\theta = 60$ deg and $\lambda = 3.2$ cm, the Doppler frequency, δf , at a speed of 300 knots is approxi-

occurs when the two Doppler frequencies are equal. The drift angle is obtained by measuring the difference between the fore-and-aft axis of the aerial and the fore-and-aft axis of the aircraft.

These data, together with heading information derived from the gyromagnetic compass, are fed to a computer which shows the aircraft position in latitude and longitude or the distance flown and deviations from a preset track. Distance accuracy is obtained to within about 0.2 per cent. of the distance flown and the drift angle is measured to within about 0.2 deg. However, since the system is dependent on the aircraft compass, the overall accuracy is of the order of 1.0 per cent. of the distance flown.

As might be expected, this accuracy can be maintained during flight only provided that the attitude changes of the aircraft are fairly restricted. It is interesting that this complex method of measuring the distance flown in aircraft serves the same purpose as the ship's log at sea, which is the long-established method for measuring sailing distance. This complexity arises because the ground or sea beneath the aircraft is the nearest fixed datum against which direct measurements of movement can be made. In Doppler navigation, the relative tidal movements of the sea introduce errors similar to those which occur with the use of the ship's log.

The ground-based radio navigation systems can be separated into those which provide distance and bearing relative to a fixed beacon and those which define position with respect to three geographically separated stations by the intersection of position line hyperbolae. Both techniques are being extensively used, as for example the v.h.f. omnidirectional beacon is being used by civil aircraft in the U.S.A. and elsewhere. The ground beacon is a single-sited equipment operating at a fixed frequency in the 100 Mc/s frequency band which gives the bearing of the beacon to the air pilot. The range attainable depends upon the height of the aircraft. The beacon radiates two modulations on the same radio frequency carrier, one being a reference signal of fixed phase and the other having a phase delay which conveys the bearing information as the phase difference between the two modulations. Thus, by measurement of the relative phase of the two signals in the aircraft, the bearing of the aircraft relative to the beacon is indicated. Bearing information is given visually on a bearing indicator to within 5 deg and the pilot is able, by means of a bearing selector and a left/right steering indicator, to select and fly along any line which he chooses, radial to the beacon.

To provide a complete distance-bearing radio navigation service, a separate pulse system called DME (Distance Measuring Equipment) is used to measure distance along the radials. This service is provided by a transmitter-receiver in the aircraft radiating pulses which are received by a ground beacon, the pulses being transmitted back to the aircraft on another frequency. The total time for the pulses to be

propagated along the go and return path is related to the distance of the aircraft from the beacon and the information is presented to the pilot on a meter indicator.

The latest navigation system which provides the bearing and distance services together uses an airborne equipment called TACAN which operates in the 1,000 Mc/s band. Each aircraft carries an interrogating transmitter that radiates pulses at a fixed recurrence rate which are received on a ground beacon where they are transmitted back to the aircraft on another frequency, the time pulses take to traverse the go and return path being related to the distance between the aircraft and the beacon.

At the ground beacon the returning pulses are amplitude modulated with the bearing information before they are transmitted back to the aircraft. The beacon is able to reply to about 100 aircraft at a time and, as would be expected, all these pulse replies are mixed together, but those intended for a particular aircraft are identified from all the others because they are phase coherent with respect to the regular outgoing pulses. All the beacon reply pulses are used together to carry the bearing information by modulating their level sinusoidally, this being achieved by using a directional aerial which is continuously rotating, the speed of rotation defining the modulation frequency, and



Fig. 6. TACAN distance-bearing indicator.

phase of the modulation defining the bearing angle. With this system distance can be measured to an accuracy of about a quarter of a mile and bearing to $1\frac{1}{2}$ deg; the information is shown to the pilot on a meter instrument with a dial having a circular bearing scale and a window aperture in which the distance of the aircraft from the beacon is indicated (Fig. 6).

On the marine side the Decca hyperbolic system of navigation is extensively used. It is chosen because at low frequencies of the order of 100 kc/s, the signals are propagated far beyond the visual horizon, and are not attenuated or appreciably affected by rugged terrain which may be in the vicinity of the vessel using the service. The Decca Navigator has provided a unique solution to the mariners' requirements for coastal navigation. The position of a vessel can be determined quickly by reference to charts overprinted with the Decca co-ordinate lattice or instantaneously by means of a moving marker on an automatic map display.

As might be expected, a system which was developed primarily for marine use has extended its application into the aeronautical transport field, and here the automatic map display of aircraft position has proved itself to be capable of meeting the present requirements for continuous and up to date position indication. (Fig. 7.) Both British and some foreign airlines are using the Decca Navigator with the automatic map display for primary route navigation.

5. New Techniques of Radio Navigation

In this Section a number of new navigational techniques are mentioned which indicate the trend of development. Some of them are only proposals and the author does not claim to have special knowledge of them, but they are mentioned for the interest they will arouse among those concerned with radio navigational development.

5.1. Inertial Navigation

Inertial navigation may be defined as the determination of acceleration, velocity and position of a craft by instruments which are sensitive to motion. The basic instruments used are



Fig. 7. Decca Navigator flight log.

gyroscopes and accelerometers for detecting angular and linear motions respectively. A gyroscope is maintained vertical as the craft is moved by the application of controlling torques about two axes at right angles. If the wander rate of the gyroscope is sufficiently small the integral of the applied torques is proportional to the angle through which the gyroscope has been precessed and through which the vertical has been turned relative to the earth's axis and hence to the distance travelled by the craft over the surface of the earth.

One system uses two accelerometers which are sensitive to motion along orthogonal axes. They are corrected for the effects of gravitational acceleration and the axes must retain a fixed relationship to the earth's gravitational components and a gyroscope is used for holding this relationship. The first integral of the acceleration gives the velocity and the second integral the components of distance moved along the orthogonal axes. A very important requirement in this technique is exceptionally low wander rate of the gyroscopes. The particular characteristic of inertial navigation is that it provides a good short term accuracy at a high data rate. Thus inertial navigation has the characteristic that it can be used in conjunction with low data rate radio position-fixing such as

direction finders to provide accurate indication of craft movement between radio position fixes. In some parts of the world where radio position-fixing systems are widely separated, inertial navigation might well provide the intermediate position fixing facility.

There is a requirement for gyroscopes of very low wander rate, say not more than a few minutes of arc per hour for transpolar navigation. The magnetic compass can no longer provide a satisfactory magnetic heading indication in high latitudes and these gyroscopes may be used as part of the inertial system or alternatively they may be used with radio Doppler which measures speed and distance moved with respect to the gyroscope axes.

5.2. High Stability Frequency Sources

The advances in the development of mobile frequency sources of very high stability indicates that in the future these may be used for radio navigational purposes. It appears that mobile frequency sources with an order of stability of 1 part in 10^9 might now be realizable from quartz crystal resonators or by using the spectral lines of molecules such as ammonia and caesium for the control of stable frequency oscillators. If two sources of the same nominal frequency are located one on the ground operating a transmitter and the other in the craft, the signal in the craft will differ from the one on the ground as a result of the Doppler shift of frequency caused by relative motion of the craft. The radial velocity is given by:

$$v = \lambda (\delta f) = c \frac{\delta f}{f}$$

where δf is the Doppler frequency, f the radio frequency and λ the wavelength. The integral of this gives the radial distance moved by the craft. Errors in the system are caused by the finite difference in frequency between the craft and ground frequency sources and for a difference of 1 part in 10^{-9} , the cumulative error in 1 hour is of the order of 1 km.

5.3. V.L.F. Navigation

Global coverage radio navigation systems capable of providing a service for both marine and aeronautical use have from time to time

aroused great interest among those concerned with navigational development. For example, a hypothetical arrangement of two beacons which gave distance and bearing, one at the north pole and one at the south pole would provide a latitude-longitude co-ordinate system, lines of constant bearing being lines of longitude and lines of constant distance being lines of latitude. If the transmissions from the antipodes are phase locked then the earth's axis forms the baseline of a hyperbolic system and lines of latitude are lines of constant phase difference. The use of very low radio frequencies of the order of 10-15 kc/s have been proposed for global cover navigation systems because of the expected high order of phase stability of signals propagated by reflection from the ionosphere and the low attenuation of the signals in the diffraction region. A rather more practical system has been proposed which uses six v.l.f. transmitting stations suitably sited on the earth's surface to give global coverage with a fixing accuracy of the order of five nautical miles and a programme of research is being initiated to investigate the proposal.

5.4. Radio Astronomy and Satellites

The science of Radio Astronomy may provide techniques which are complementary to astromavigation and can be used when the stars are not visible. However, radio telescopes cannot be constructed with an aperture-to-wavelength ratio which approaches even remotely that of a conventional telescope using visible light. For example the Jodrell Bank 250 ft diameter steerable telescope has a beamwidth of about 1 deg at 1 metre wavelength. Radio sextants have been built for marine use which operate in Q band (8 mm) on solar radio emission. These would be far too large to be carried in aircraft, but a shorter wavelength version of smaller physical dimensions is contemplated. The operation of radio sextants is not necessarily confined to solar or lunar radiation and radio stars and artificial radiating earth satellites could be used for navigational purposes. Observations indicate that the path of satellites and the position along the path are accurately predictable. A radio sextant could be used to track the satellite, but much simpler radio direction-finding methods or Doppler methods appear to offer navigational facilities.

For example, if the orbit time of the satellite were 90 minutes, the path of the satellites relative to the ground would be displaced $22\frac{1}{2}$ degrees westward in longitude during each rotation and it would make 16 transits in 24 hours. If its height above the ground is 240 nautical miles, the true speed of the satellite is 15,200 knots and it will move 240 miles per minute as measured relative to the earth's surface.

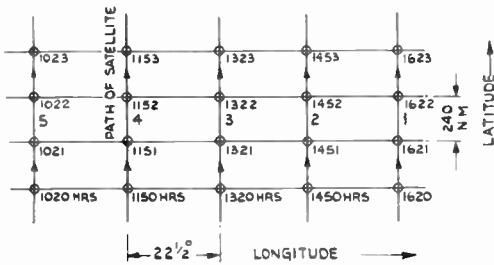

Fig. 8. (a) Meridian path of satellite showing transmitting positions.

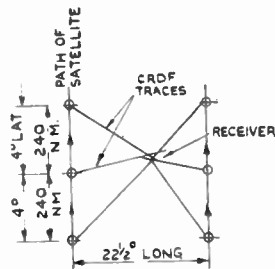

Fig. 8. (b) C.R.D.F. presentation of receiver position.

If the satellite radiates radio signals of duration about one second at one minute intervals, they may be received on a cathode-ray direction-finder on the craft and with a long persistence trace the bearing lines derived from the satellite transmissions will intersect at a point corresponding to the position of the receiver relative to the satellite orbit in the manner shown in Fig. 8.

5.5. Very Short Range Navigation

Some kinds of navigation require great precision over a limited area of coverage, for

example the movement of vessels along narrow channels, the berthing of ships and the landing of aircraft during bad visibility. These movements create hazards where the points of danger are imminent and the navigation aids must provide immediate and accurate information.

Ideally a shipborne radar should have a degree of resolution which is sufficient to carry out the berthing operation during fog. In practice, this is incompatible with longer range operation while the vessel is at sea and in any case the provision of a very high discrimination radar on each vessel would be most costly and uneconomic for use on the rare occasions when it is needed. A high resolution harbour radar would be suitable for this purpose, but it should be capable of showing ship aspect and ship movement to a few feet. This calls for beamwidths not greater than about 0.2 deg and pulse lengths of the order of 20 millimicroseconds. It is suggested that the harbour display is clearly processed by the technique of map matching to show all the vital features such as deep water channels, dock gates, the ship's berth allotted and other relevant data. This map in its complete form should be transmitted by a v.h.f. television link to the ship being berthed so as to place the ship's captain or pilot in full control of the berthing operation.

It may be suggested that similar methods could be applied to aircraft during the landing approach, but this case is rather different because ideally aircraft will follow a unique path to the airfield. The present practice is to use precision approach radar (p.a.r.) on the airfield which enables the aircraft to land under bad visibility by means of directional and descent instructions given by the airfield controller to the pilot on the v.h.f. radio telephony channel. The p.a.r. operates in the 3-cm band and radiates very narrow scanning beams in both the horizontal and vertical planes.

The future trend appears to be toward a completely automatic system of aircraft landing which uses a combination of ILS radio azimuth and glide path beams for the initial approach, which is replaced when the aircraft is near the ground by guidance in azimuth from a magnetic leader cable, and in descent by a high precision radio altimeter. The magnetic leader cable ground installation comprises two cables

situated 250 feet on either side of the runway centre line and extending to about 5,000 feet from the runway touchdown point. The magnetic fields of these two cables are separately modulated, being detected in the aircraft by a small rotating loop and their values compared, so that the centre line can be determined to less than five feet. The accurate measurement of height is made by a frequency modulated altimeter, which also measures the rate of change of height. This controls the flare out stage of the aircraft landing, the pitch attitude of the aircraft being controlled so as to make the rate of descent proportional to height. During the landing sequence, the control of the autopilot from the ILS azimuth and glide path beams continues down to approximately 300 feet when the aircraft enters the fields of the magnetic leader cable, which is then switched in place of the ILS azimuth guidance signal to control the autopilot azimuth channel. At 100 feet the ILS glide path signal is automatically switched out and the aircraft attitude kept constant down to a height of 60 feet when the radio altimeter is introduced to start the flare out to touchdown.

At a height of 15-20 feet, the final switching takes place to remove any drift and after touchdown the pilot disengages the automatic system and manually stops the aircraft. Automatic speed control in the form of a throttle servo is also employed to maintain constant speed during the approach and reduces power during the flare out and landing.

5.6. Automation in Air Traffic Control

The increase in the amount of air traffic is adding new difficulties to the task of air traffic control. When the aircraft movement density is small, there is ample time for the ground controller to communicate with the aircraft and to establish its position and identity on the ground radar display or with the aid of the c.r.d.f. fixing system. Altitude information will be available either from the aircraft flight report or from the radar height finder. When the data is correlated with the other aircraft movements, the Ground Controller can issue instructions for flight progress or for altitude descent, airfield approach and landing. It can be appreciated that a marked increase in air traffic and speed of movement quickly leads to situations when the

human mind is too overburdened to assess the whole air traffic position and in these circumstances an automatic electronic aircraft movement store and computer is required.

It is suggested that voice communications will eventually take only a subsidiary part in air traffic control, the main control being effected through high-speed digital signalling systems which would communicate to the ground automatically the aircraft identity, position and altitude; and from the ground to the aircraft a discrete address and aircraft movement instructions. Aircraft would display only those messages which are preceded by the discrete address.

The air-to-ground data would be fed automatically into an electronic store and computer, where aircraft movements are integrated in time and where incompatibilities of flight paths are brought to the immediate attention of the air traffic controllers. The controllers would process new flight data to the aircraft concerned, each aircraft receiving only the instructions which are prefixed by the discrete address. Likewise, it is suggested that new flight plans would be fed into the electronic computer, which would be accepted or rejected in the store by the state of their compatibility with other aircraft movements.

A digital communication system is very suitable for feeding its information into electronic data stores and flight movement computers. By using a time multiplex system for communications many aircraft can share the service between them on a single radio frequency channel.

The new system will take a long time to develop and bring into use, because long established practices of aircraft communication and navigation will have to be changed. Communications, navigation, identification, proximity warning and collision avoidance will need to be closely integrated if the full benefits offered by this automatic system are to be realized. It is considered that integration is technically feasible, but there are great difficulties ahead in reaching international agreement on the system details and its adoption.

The author considers that these proposals should be developed around an accurate system

of air-interpreted navigation. To meet this need, large area coverage systems based on hyperbolic technique or distance bearing systems would be suitable, but they must be free from ambiguity and give the pilot an up-to-date pictorial presentation in the aircraft, preferably in cartesian co-ordinates. This navigational data would also be available in digital form for automatic air-to-ground position reporting. When received, it would be correlated with position information received from a network of ground radar stations covering the control area, the radar data being transmitted to the control centre by microwave links and land lines. It is thought that an automatic system of this kind would give scope for a considerable increase in air traffic and provide greater safety without imposing a further burden upon the human controllers.

Many of the techniques mentioned in this paper inevitably lead to electronic equipments of increasing technical complexity and in consequence the subject of equipment reliability is one of great importance. Very high reliability and the use of fail-safe devices are required in the preparation of engineering designs of equipment if a high order of system infallibility is to be assured.

6. Bibliography

"A review of radio aids to aeronautical and marine navigation," Caradoc Williams. *Proc. Instn Elect. Engrs*, Paper No. 2582, **105**, Part B, Supplement No. 9, pp. 196-212, 1958.

"Some problems of secondary surveillance radar systems," K. E. Harris. *J. Brit.I.R.E.*, **16**, No. 7, pp. 355-382, July 1956.

"Blind landing," W. J. Charnley. *J. Inst. Navigation* **12**, No. 2, pp. 115-135, April 1959.

"Radio guidance in the automatic landing of aircraft," J. S. Shayler. Paper read before Brit.I.R.E., May 1960. (*To be published.*)

"Radio-astronomy and navigation," C. M. Cade. *J. Roy. Aero. Soc.*, **62**, pp. 805-828, November 1958.

"Inertia navigation systems," E. W. Anderson. *J. Inst. Navigation*, **11**, No. 7, pp. 231-258, July 1958.

"Doppler navigation," J. E. Clegg and T. G. Thorne. *Proc. Instn Elect. Engrs*, Paper No. 2568, (**105**, Part B, Supplement No. 9, pp. 235-247, 1958.)

"Factors in the design of airborne Doppler equipment," E. G. Walker. *J. Brit.I.R.E.*, **18**, No. 7, pp. 425-444, July 1958.

"The future of marine electronics," F. J. Wylie. *J. Inst. Navigation*, **10**, No. 1, pp. 50-57, January 1957.

"A high-definition general-purpose radar," J. W. Jenkins *et al.* *J. Brit.I.R.E.*, **14**, pp. 5-23, January 1954.

"Airfield surface movement indication," R. F. Hansford. *J. Inst. Navigation*, **8**, pp. 258-260, July 1955.

"Navigation and traffic control over the North Atlantic," D. O. Fraser. *J. Inst. Navigation*, **10**, No. 4, pp. 115-132, April 1957.

Avalanche Carrier Multiplication in Junction Transistors and its Implications in Circuit Design †

by

M. L. N. FORREST, M.A.‡

Summary: Theories of junction breakdown and transistor action necessary to account for the observed characteristics of avalanche carrier multiplication are surveyed. The implications of these characteristics in circuit design are discussed and certain special techniques for avoidance of anomalous operation in conventional circuits are described. Avalanche multiplication may be used to obtain useful device characteristics and circuits for exploitation of these are surveyed. Methods of measurement of avalanche characteristics are outlined.

PART 1 — THEORY OF THE EFFECT

1. The Reverse Characteristics of a Germanium p - n Junction

At voltages within the reverse rating of a *p-n* junction diode an approximately constant current flows. This reverse saturation or leakage current results principally from the thermal generation of electron-hole pairs in the region of the junction and their flow under the influence of the field existing across the junction. This field is of course caused by the reverse bias. The field region is generally referred to as the depletion layer.

As the reverse bias is increased it is observed that at some voltage the current commences to rise more or less rapidly, and at still higher voltages becomes very large indeed. This is the familiar reverse breakdown of a junction diode and is illustrated in Fig. 1.

The spectacular increase of current clearly results from the presence of carriers at the junction additional to those due to thermal electron-hole pair generation. Two mechanisms can generate the necessary carriers. The first is the phenomenon known as Zener breakdown. In this case the extra carriers are generated,

quite independently of the already-present thermal generation, by field emission from the lattice. The field in the depletion layer is tearing bound carriers from their parent atoms. The second mechanism is analogous to phenomena in a gas discharge. The carriers already present, forming the inherent saturation current, if accelerated by the field in the depletion layer

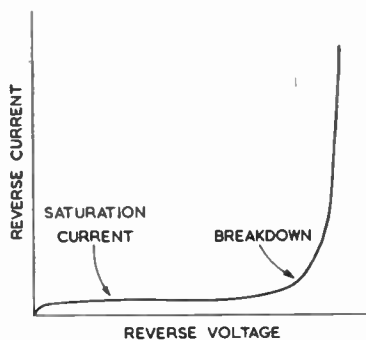

Fig. 1. Reverse characteristic of a *p-n* junction.

to sufficiently high velocity, can generate further carriers by impact ionization of the lattice atoms. Carriers of both polarities, i.e. electrons and holes, may produce the ionization, and an electron-hole pair will result from each atom ionized. The efficiency of ionization will increase with voltage. Because the new carriers may themselves produce further ionization

† Manuscript received 5th October 1959. (Paper No. 559.)

‡ International Computers and Tabulators Ltd., Electronics Branch, Gunnels Wood Road, Stevenage, Hertfordshire.

U.D.C. No. 621.382.333.34

before leaving the junction the yield will increase very rapidly at high voltages, and very large currents may flow. It is important however to note that, in contra-distinction to the gas-discharge phenomena the process cannot become regenerative although the resultant slope resistance can become very low indeed at high currents.

An empirical relation for the carrier multiplication factor M at voltage V may be quoted:

$$M = \frac{1}{1 - \left(\frac{V}{V_0}\right)^n} \dots\dots\dots(1)$$

where V_0 is the value of voltage at ultimate breakdown i.e. infinite current, and n is a constant of value about three for n -type germanium.

Which of the two phenomena described controls the breakdown of a particular diode depends mainly upon the resistivity of the material. In the junctions normally met with in relatively high voltage junction diodes and transistors the impact ionization rather than the Zener effect is operative. True Zener breakdown occurs in some so-called Zener reference diodes but even with these devices a transition from Zener to impact ionization breakdown occurs as the nominal voltage passes through the region of 6 volts. The impact ionization process is sometimes called avalanche multiplication, although in the opinion of the author this term is, as here, best reserved for the extension of the phenomenon to junction transistors.

2. Transistor Action in a p-n-p Junction Transistor

Before proceeding to consider the extension of this phenomenon to transistors it is appropriate to review normal transistor action. The current flowing in the forward biased emitter junction has two components: a flow of holes from emitter to base, and a flow of electrons from base to emitter. Only the first component is useful to transistor action, and the ratio of the hole to electron current is designated the emitter efficiency γ . The holes in crossing the emitter junction enter the base region. There they diffuse towards the collector junction. On the way some recombine with electrons. The fraction that reach the reverse biased collector junction are swept up there by the field in the

depletion layer and pass across to form the collector current. If the fraction of those injected which successfully diffuse across the base is δ , then the remainder $(1 - \delta)$ will have combined with electrons in transit. The electrons for this re-combination will have been drawn as a negative (often called forward) base current. The fraction of the emitter current which eventually appears as collector current will be the product of the emitter efficiency and the base transport efficiency, that is $\gamma\delta$. This is defined as the current gain α . Thus $\alpha = \gamma\delta$, and is less than unity since as defined γ and δ are both less than unity. The collector current $I_c = \alpha I_e$. The base current will contain two components, that supplying electrons for re-combination, and that forming the electron flow across the emitter junction. Thus the base current will be:

$$[(1 - \delta) \gamma + (1 - \gamma)] I_e$$

This may be seen to be $(1 - \alpha) I_e$ as is required by considerations of current continuity for the device as a whole. It will be seen that the base current constitutes a make-up current supplying to the base region electrons which are required to take part in the essential phenomena of transistor action.

To complete the picture of normal transistor action mention must be made of reverse leakage or saturation current in the collector junction. The electron-hole pairs generated by thermal agitation in or near the collector junction constitute this current as in a junction diode. The holes cross the junction to the collector and supplement the collector current, the electrons move to the base where they supplement the supply from the base lead. The effect of these carriers is excluded from the definition of α , but it is clear that for a given emitter current it will result in a collector current somewhat higher and a base current somewhat lower than expected. For the particular condition $I_e = 0$ the collector current flowing is called I_{c0} and the base current will be reversed and also of value I_{c0} . I_{c0} is excluded from the definition of α because it is uncontrolled by the emitter current. To take the leakage current into account we must write:

$$I_c = \alpha I_e + I_{c0} \dots\dots\dots(2)$$

and therefore $\alpha = \frac{I_c - I_{c0}}{I_e}$

and similarly $I_b = (1 - \alpha) I_e - I_{c0}$ (3)

The various carrier-flows in normal transistor operation are illustrated in Fig. 2.

3. Transistor Action when Junction Breakdown Mechanisms are present

The effect of true Zener breakdown will not be further considered because, as noted, it is not commonly encountered in transistor collector junctions. However, before proceeding to a consideration of the effect of impact ionization in the collector junction upon transistor action, which forms the main topic of this account, mention should be made of the phenomenon of punch-through. Punch-through occurs when the collector depletion layer widens under the influence of the applied collector voltage until it extends completely across the base and reaches the emitter junction. Transistor action then ceases and the device appears to have a conducting path between collector and emitter.

Depending upon the geometry and resistivity of the base material punch-through may or may not manifest itself at a lower collector voltage than that at which the effect of impact ionization becomes significant. It is assumed in what follows that the effect of impact ionization is not masked by the occurrence of punch-through at a lower voltage.

4. The Collector Voltage - Collector Current Characteristics of a p-n-p Junction Transistor at Constant Emitter Current

Since the condition of constant emitter current usually pertains when the device is operated in grounded base the considerations to be discussed in this section may be viewed as applying to that configuration.

For the case of zero emitter current the collector voltage-current characteristics will be similar to those shown in Fig. 1. Because $I_e = 0$ no transistor action takes place, and the characteristic is that of the reverse biased collector junction. For most transistors the breakdown characteristic of this junction will be controlled by impact ionization as described previously.

To proceed to a consideration of conditions pertaining when the emitter current is not zero it is necessary to combine the pictures of normal transistor operation and of the impact ionization process to define how a transistor will behave when such an ionization process is occurring in its collector depletion layer. It is important to realize that impact ionization is always occurring to some extent at the collector junction, as defined by eqn. (1), and that our picture of normal transistor operation is always to this extent incomplete. However at the low voltages of normal operation the effects may be negligible.

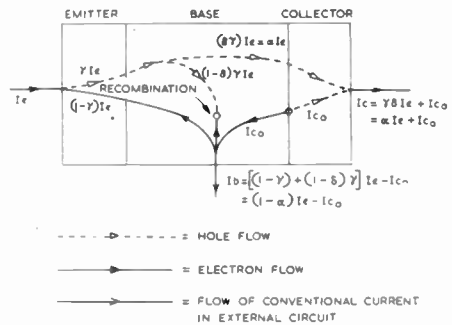

Fig. 2. Normal carrier flow in a p-n-p transistor.

We will ignore henceforth the effect of I_{c0} because in comparison with the multiplied currents we shall be considering it is of secondary importance. We are interested in a condition where the holes that diffuse across the base to form the collector current are accelerated in the collector depletion layer and then ionize atoms by impact. The product of this ionization will be electron-hole pairs. The new holes will cross with the original to the collector, the electrons will return to the base. In conformity with eqn. (1) M will be the total number of holes arriving at the collector for each original hole reaching the depletion layer from the base. The number of electrons returned to the base will be $(M - 1)$ times the number of original holes.

For a constant emitter current the collector current will be augmented by the original holes and we shall have:

$$I_c = \gamma \delta M I_e$$

If we define α_0 as the value of α at low collector

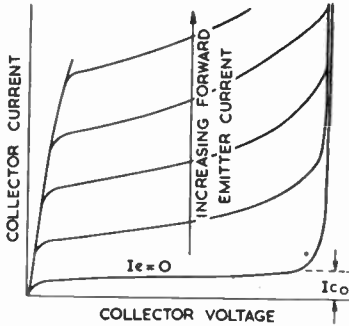

Fig. 3. Transistor characteristics at constant emitter current.

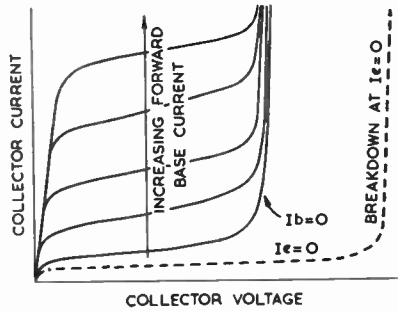

Fig. 4. Transistor characteristics at constant base current.

voltage and use α for the general parameter we have:

$$I_c = M\alpha_0 I_e$$

$$\alpha = M\alpha_0 \dots\dots(4)$$

M is by definition equal to or greater than unity. It increases with increasing voltage according to eqn. (1). Because α_0 is close to unity, α may become unity when M is only a little greater than unity. This may occur at a voltage no more than half the ultimate breakdown voltage. However, because of the influence of the power n in eqn. (1), M only increases rapidly to large values when the ultimate breakdown voltage is closely approached.

The effect of this on the low-voltage part of the collector current voltage characteristics at constant emitter current will be a slight increase in the spacing of the horizontal portion of the characteristics corresponding to the increase of α . Only very near the ultimate breakdown voltage will the current rise rapidly. In so doing it will follow the $I_e = 0$ characteristic. Such characteristics are illustrated in Fig. 3.

current as a make-up current, and is immediately deducible from eqns. (2) and (3) if I_{c0} is excluded from the definition of α .

We have noted that at voltages considerably lower than the ultimate turn-over voltage at constant emitter current the value of α may attain and exceed unity. The value of α' will tend to infinity as α approaches unity. The attainment of infinity by α' implies that the collector current will attain infinity for any forward or zero value of base current. (Forward base current corresponds, by the convention, to an outflow of conventional current from the base.) This means that for such forward and zero base currents there is effectively a turn-over voltage at the voltage at which α attains unity. We have seen that this voltage may be as low as half the ultimate breakdown voltage. The characteristics in Fig. 4 illustrate this. A representative characteristic for $I_e = 0$ is included for comparison.

5. The Collector Voltage-Current Characteristics of a p-n-p Junction Transistor at Constant Base Current

These characteristics correspond to operation in the grounded emitter configuration. The base to collector current gain α' is related to the emitter to collector current gain α by

$$\alpha' = \frac{\alpha}{1 - \alpha} \dots\dots(5)$$

This result follows from the role of the base

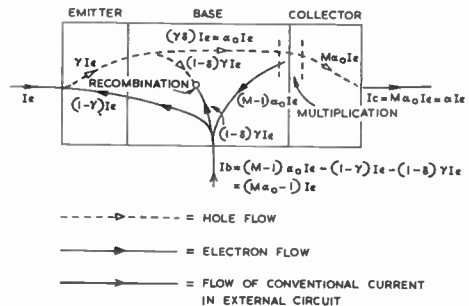

Fig. 5. Flow of carriers in a p-n-p transistor in which current multiplication is occurring.

Equation (5) does not help us to the right of the $I_b = 0$ characteristic. For this it is necessary to return to a consideration of the physical operation of the device. It was noted previously that the process of multiplication in the collector depletion layer produced holes and electrons in pairs. We have investigated the effects of the holes fairly fully. The electrons produced move into the base region where they are available to augment the supply of electrons down the base lead. The action is analogous to the effect of the electrons forming I_{c0} but for the fact that this new source of electrons is controlled by the emitter current. These extra electrons may be considered as either reducing the external base current required to support a given collector current, or alternatively increasing the collector current available at a given external base current. Because the extra electrons are derived from the relatively large collector current, but influence the relatively small base current, the factor M controlling their generation does not have to be large to have a profound effect upon the operation. It will be apparent that the effect we are describing is one and the same as that upon α and α' as defined by eqns. (4) and (5). From the latter it will be seen that small changes of α near unity cause very large changes in α' . However, this new physical view can tell us what happens as α becomes greater than unity. When α is exactly unity the electrons generated by ionization are sufficient to supply all the needs of the base and the external base current is zero. As α becomes greater than unity a reverse base current consisting of an outflow of the excess electrons can be drawn. Indeed it must be drawn if entry is to be obtained into the region between the $I_b = 0$ characteristic and the ultimate breakdown characteristic. The various carrier-flows when reverse base current is drawn are shown in Fig. 5. The mechanism producing I_{c0} is omitted for clarity.

We see therefore that we can enter the region between the $I_b = 0$ characteristic and the ultimate breakdown characteristic by drawing reverse base current. This region is commonly known as the avalanche region. It should be noted that if reverse base current as great as the collector current is drawn then the operating point will lie on the ultimate breakdown

characteristic because under these conditions $I_e = 0$. It is necessary now to investigate the form which the collector voltage-current characteristics takes in the avalanche region. It would be expected from the foregoing discussion that the characteristics would turn-up vertically at a voltage determined by the magnitude of the reverse base current being drawn. In fact it is found that they "peel off" at this voltage and then slope back in such a manner as to constitute a negative resistance characteristic. The form of this is shown in Fig. 6. The explanation of the negative resistance requires the invocation of an effect not so far mentioned. The

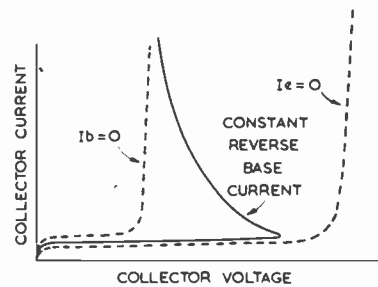

Fig. 6. Transistor characteristic in avalanche region.

emitter efficiency γ appears as a factor in the low voltage current gain α_0 as previously described. Through α_0 and eqns. (4) and (5) it will effect the collector voltage corresponding to particular pairs of values of collector current and reverse base current in the avalanche region. Now γ increases with increasing emitter current and at low currents its influence on α_0 is large and in most cases the increase of α_0 with current will be further enhanced by an increase of the base transport efficiency δ with current. Therefore for a given reverse base current the collector voltage as defined by the current multiplication effect will decrease with increasing emitter (and therefore collector) current. The decrease of collector voltage with increase of collector current constitutes a negative resistance at the collector terminal.

All the important mechanisms contributing to the effect generally referred to as avalanche have now been described. A representative set

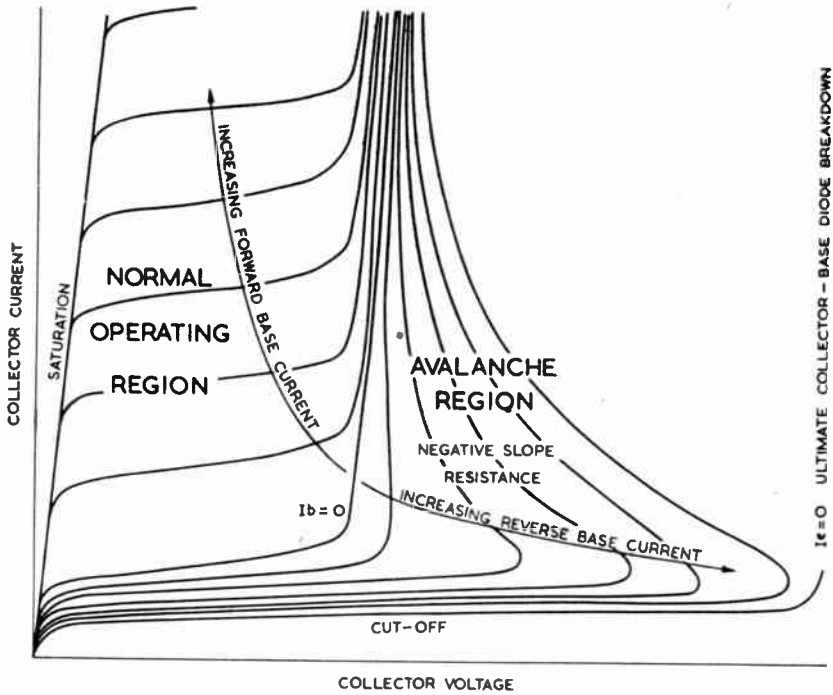

Fig. 7. Comprehensive transistor characteristics.

of collector voltage-current characteristics for constant base current is shown in Fig. 7, where a number of regions which have been described will be recognized. A short summary is given below before proceeding to a consideration of the circuit implications of the effect.

6. Summary of the Mechanisms comprising the Avalanche Effect

Ionization by impact may occur in a reverse biased *p-n* junction. This effect, occurring in the

collector junction of a transistor generates carriers of both polarity. These carriers augment both collector and base currents. The emitter to collector current gain is augmented, becoming a direct function of collector voltage. The base to collector current gain may become infinite and a reversal of base current then occurs. When operating with reverse base current a negative slope resistance appears at the collector terminal because of the increase of emitter efficiency with current.

PART 2 — SIGNIFICANCE OF THE AVALANCHE EFFECT IN CIRCUIT OPERATION

7. Implications in Conventional Circuit Operation

The presence of the avalanche region may prove an embarrassment to the circuit designer. It also provides a novel mode of operating the transistor, of which advantage can be taken in certain circumstances. We will consider first the disadvantages of the presence of avalanche multiplication from the viewpoint of conventional circuit operation.

Consider a transistor operated with a purely

resistive load. Two load lines are shown plotted on representative characteristics in Fig. 8. With a supply voltage V_{cc1} and a load resistance R_{L1} the transistor may be switched between points (1) and (2) by switching the base current from I_{b1} forward to I_{b2} reverse. The use as here of reverse base current to improve the cut-off performance is common. In its absence the switched-off point would lie at (3). Suppose however that an attempt is made to take advantage of the higher turn-over voltage at

point A resultant from the drawing of reverse base current. The attempt to switch from point (1) to point (4) will be frustrated at point (5) by the load line intersecting the avalanche characteristic for the base current I_{b2} . It will prove impossible to switch off the transistor. This will represent a failure of normal circuit operation; furthermore, because point (5) corresponds to a relatively high voltage-current product the transistor may be damaged by overdissipation.

Anomalous operation can occur even more easily if an inductive load is involved. Suppose

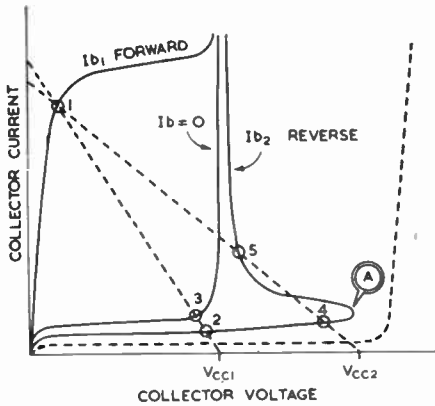

Fig. 8. Operation with resistive load.

the transistor to be operated in the circuit of Fig. 9. The load lines are plotted upon representative transistor characteristics in Fig. 10. Here it will be seen that the resistive component of the load line does not intersect the I_{b2} characteristic although advantage has been taken to use a high value of V_{cc} by drawing reverse base current. When switching-on rapidly from I_{b2} to I_{b1} the inductive line (5)-(1) will be followed. When switching off from I_{b1} to I_{b2} the inductance will cause the collector voltage to rise significantly before the current has fallen very much. The path initially followed will be (1)-(2). At (2) the avalanche characteristic will be intercepted. The effect will be the same as that of a catching diode returned to the voltage at (2). The fall of current will now be controlled by the time constant L/R , independently of the transistor's switching speed. The path (2)-(3) will be traced out until at point (3) the diode D conducts and the paths (3)-(4) and (4)-(5) are traversed rapidly. The anomalous operation

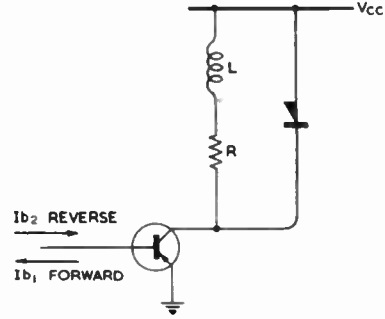

Fig. 9. Circuit with inductive load.

thus takes the form of the delay in switch-off resultant from the time to traverse (2)-(3) controlled by the time-constant L/R which will normally be very much greater than the switching time of the transistor itself. It should be noted that along the path (2)-(3) a voltage is still impressed upon the coil. Because points on this path correspond to high dissipations, and because the path is traversed relatively slowly, the resultant dissipation may damage the transistor.

8. Modification of Load-line to avoid Avalanche Breakdown

Little can be done if the resistive load-line intersects the avalanche characteristic for the maximum reverse base current which the driving source will supply. However, one or two of the palliatives set out below for the more important case of inductive load may be appropriate.

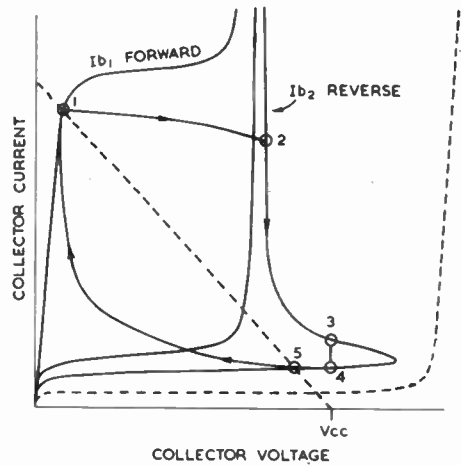

Fig. 10. Operation with inductive load.

Where difficulty arises solely because the presence of an inductive load causes the natural load-line to intersect the relevant avalanche characteristic some steps can be taken to modify the line to avoid such intersection. It is clearly desirable to make the load-line followed at switch-off concave in some such manner as is indicated in Fig. 11. Such a load line differs

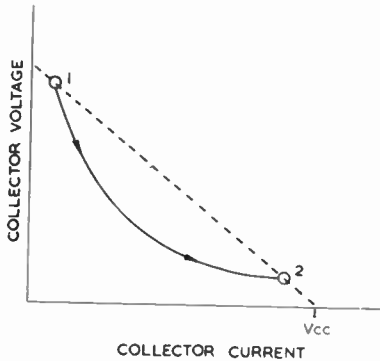

Fig. 11. Desirable load line at switch off.

from that in Fig. 10 in that the collector current has fallen before the collector voltage has risen significantly. Such a load line will be seen to be that corresponding to a capacitive load. It is necessary to consider fully the mechanisms controlling the rate of fall of collector current and of rise of collector voltage in order to see how the former may be speeded up or the latter delayed or both. The circuit of Fig. 12 will be considered, in which the capacitance C may be stray or an added component.

So long as avalanche is avoided the rate of fall of collector current will be determined by the rate of switch of the drive source, the value of reverse base current drawn and the cut-off frequency of the transistor. It is clearly desirable to make the rate of fall of collector current as great as possible, but once this has been done for a given transistor and source it must be considered as a constant. The rate of rise of collector voltage will be controlled by the rate of fall of collector current and by the values of resistance, inductance and capacitance in the load circuit. The values of resistance and inductance will not usually be alterable, having been fixed, in conjunction with the supply voltage to give the required performance from

the magnetic circuit. We are left only with the capacitance as controllable above a minimum fixed by strays. As the value of capacitance is increased the rate of rise of collector voltage is decreased. Varying C from zero to a large value will change the shape of the load-line from convex to concave. For a given inductance and resistance the degree of "concavity" of the load-line will vary directly with the ratio of the capacitance to the switching time of the transistor. This ratio should therefore be as great as possible to give the greatest immunity from the risk of avalanche breakdown.

The limit to the value of capacitance which may be used is set by two factors. Firstly it is set by the minimum rate of fall of current which is permissible in the inductance. However this is not usually a significant limitation because the rate of fall is only limited by the capacitance until the diode D conducts, thereafter the rate is limited by L/R . In spite of the requirement, if advantage is to accrue from the presence of capacitance, for the delay in

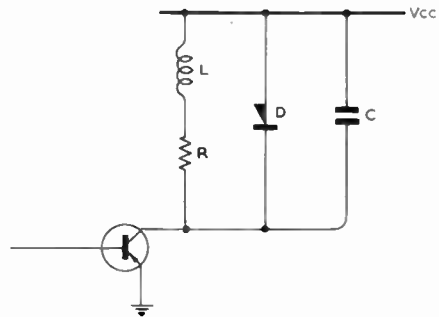

Fig. 12. Load circuit including capacitance.

voltage rise due to it to be long compared with the switching time of the transistor, it is nevertheless usual for the delay in coil current fall due to the capacitance to be insignificant compared with L/R . It may be noted here that if overswing is controlled other than by a diode connected to the supply line then operation will be more complicated and each such case will require investigation separately.

The second limit to the maximum value of capacitance is set by the magnitude of charging current of this capacitance at switch-on.

Such current will be proportional to the rate of switch-on of the transistor. The charging current will correspond to a convex load-line at switch-on and such a load line may give rise to avalanche. Independent control of the rate of

is operated with a predominantly inductive load, the back voltage across which is predominantly the cause of entry into the avalanche region.

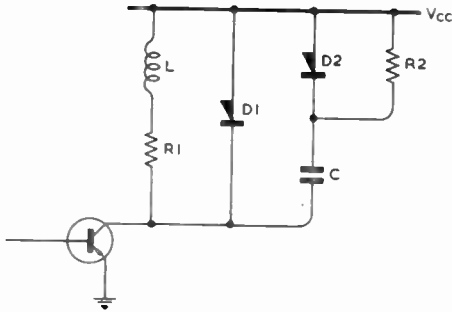

Fig. 13. Modified load circuit.

switch on and off will usually avoid this difficulty. Alternatively a further modification of the load circuit may be employed.

The modification involved is shown in Fig. 13. At switch-on R2 limits the charging current, the diode D2 being cut-off. At switch-off D2 immediately conducts and the capacitor C is brought immediately into play. A high value of R2 is desirable, the maximum being limited by the requirement for C to be fully charged by the end of the conduction period. Examples of current and voltage waveforms and load-lines for various of the circuit arrangements discussed are shown in Fig. 14. These examples are intended to illustrate normal circuit operation when avalanche breakdown has been avoided.

9. Summary of Implications in Conventional Circuits

The use of supply voltages which can cause a transistor to enter the avalanche region may result in anomalous circuit operation and also damage the transistor by excessive dissipation. Manipulation of the load-line by control of switching speeds and also by the use of additional components in the load circuit, in particular added capacitance, may allow avoidance of these effects whilst retaining the high supply voltage. These measures may most advantageously be employed where a transistor

10. Use of the Avalanche Region in Circuit Operation

When a significant degree of avalanche multiplication is taking place the low frequency α of the transistor becomes greater than unity. It is then possible to use the device in many of the ways that were developed to exploit similar properties in the point contact transistor for both large and small signal applications. However, as with that device, these uses, such as in bistable circuits with one active element, are of marginal advantage and tend to be not worthwhile in many instances. Similarly the negative resistance presented at the collector has proved to be of limited use. The fact that an avalanche transistor only shows such characteristics over

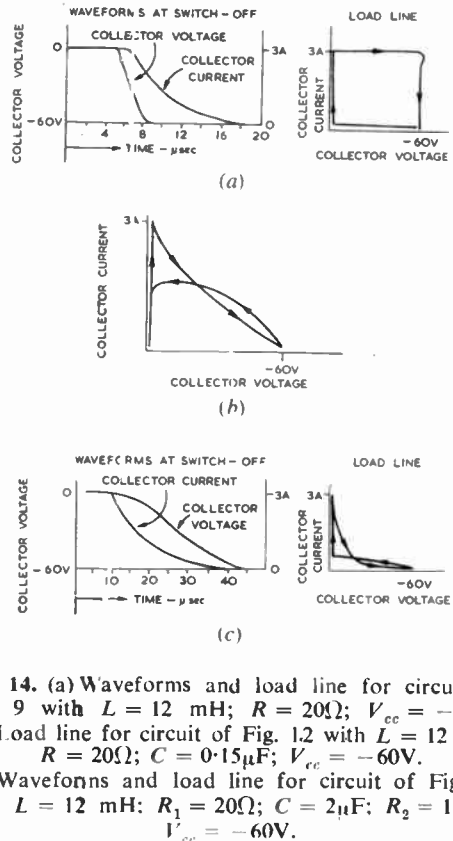

Fig. 14. (a) Waveforms and load line for circuit of Fig. 9 with $L = 12 \text{ mH}$; $R = 20\Omega$; $V_{cc} = -60\text{V}$. (b) Load line for circuit of Fig. 12 with $L = 12 \text{ mH}$; $R = 20\Omega$; $C = 0.15\mu\text{F}$; $V_{cc} = -60\text{V}$. (c) Waveforms and load line for circuit of Fig. 13 with $L = 12 \text{ mH}$; $R_1 = 20\Omega$; $C = 2\mu\text{F}$; $R_2 = 180\Omega$; $V_{cc} = -60\text{V}$.

a limited range of collector voltage further detracts from its usefulness.

One particular aspect of operation in the avalanche region which has attracted considerable attention cannot be predicted from the theory presented in this account. This is that switching in the avalanche region may occur faster, sometimes spectacularly faster, than would be expected from the normal current gain cut-off frequency of the device. A number of effects may contribute to this result, but one in particular may be quoted.

A transistor in the avalanche region has a high collector voltage and thus a wide depletion layer. This depletion layer extends into the base. The speed of response of a transistor is determined very largely by the transport time of carriers diffusing across the base region from the emitter junction to the collector junction. In this context the collector junction may be considered to lie at the edge of the depletion layer since the large field in the latter means that transport across it is very rapid. Thus a wide depletion layer reaching into the base results in a narrow effective base width and thus a short diffusion transport time. A transistor which is nearly but not quite punched-through when operated in the avalanche region may have a very narrow effective base and exhibit an effective cut-off frequency many times higher than that exhibited under normal conditions.

The high speeds of switching have been used, notably by Dr. G. B. B. Chaplin, to obtain pulses of small rise-time and high current from transistors incapable of such performance under normal conditions. The pulse widths and repetition frequencies obtainable are however limited by the nature of the phenomenon and the ratings of the transistors used. The usual mode of avalanche operation to produce fast positive pulses at the collector is shown in Fig. 15. The collector is supplied from a high negative voltage via a large resistor. The base is supplied with reverse current from a positive supply. The circuit is triggered by the application of a negative pulse to the base which causes the transistor to switch from the quiescent cut-off condition to a conducting condition through the avalanche region. The circuit has been shown by Chaplin to be capable of delivering, via the differentiating capacitor, pulses of hun-

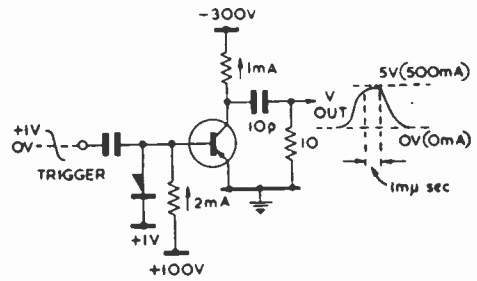

Fig. 15. Chaplin's circuit¹⁰ for producing 1 μ sec pulses.

dreds of milliamperes with durations of only a few millimicroseconds when using selected small r.f. alloy junction transistors.

The long-term importance of avalanche switching transistors is in doubt. No very significant efforts appear to have been made to produce a transistor with controlled avalanche characteristics. Furthermore it is doubtful whether the inflexibility of avalanche transistors would allow them to compete in the long run with the ever developing performance of normal transistors.

Although the avalanche transistor itself may have a restricted future many derived devices are being very actively pursued. These are known by such terms as thyristors and are all apparently attractive for particular applications, especially where high currents are involved.

11. A Further Effect

A new phenomenon, whose effect on the characteristics of a junction transistor is akin to avalanche has been observed. This effect, takes the form of a further breakback from the normal avalanche curve in the collector characteristics. This breakback occurs very suddenly at a relatively high value of current, and reduces the possible collector potential to a few volts only. Some transistors become damaged even when the condition is allowed to last less than 1 millisecc and the average dissipation in the device is kept very low. The effect occurs most readily in the majority of transistors when they are operated with base connected to emitter. A typical characteristic observed on an otherwise normal power transistor exhibiting this effect is shown in Fig. 16. Similar steps to those

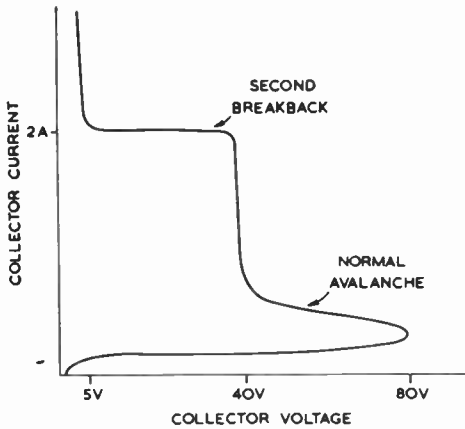

Fig. 16. Second breakback characteristic in a medium power transistor with base connected to emitter.

already described may be taken in circuit design to modify the load-line to avoid the effect.

12. Measurement of Characteristics

Because of the high dissipations corresponding to the collector voltages and currents in the avalanche region measurements of avalanche characteristics have to be performed under pulse conditions with very small mark-to-space ratios. For general purposes a 1 millisecc pulse repeating at 50 c/s is suitable. The characteristic may conveniently be scanned by applying a collector current having sawtooth form. A suitable current generator is formed by a valve with the transistor to be investigated connected as the anode load. The valve grid may be driven by a sawtooth voltage waveform derived from a Miller integrator. A resistor in the valve cathode converts the grid drive to a current sawtooth at the anode and also provides a point from which a voltage proportional to the transistor's collector current may be taken. (Fig. 17.)

13. Acknowledgments

The author acknowledges the work of his colleagues Messrs. B. J. Holmes and R. M. Lloyd who developed one of the methods of suppression of anomalous operation with inductive loads described here and who investigated the further effect described in Section 11.

The author wishes to thank the Directors of International Computers and Tabulators Ltd., for permission to publish this account.

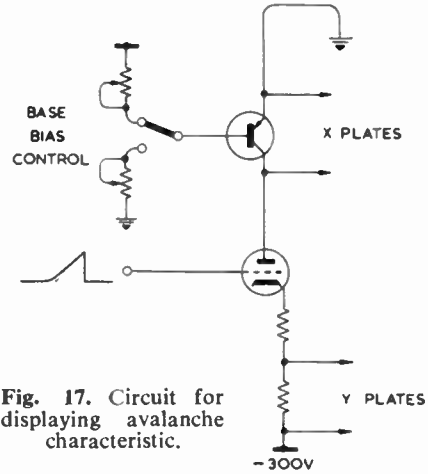

Fig. 17. Circuit for displaying avalanche characteristic.

14. Selected References

1. M. C. Kidd, W. Hasenberg, and W. M. Webster, "Delayed collection conduction, a new effect in junction transistors," *R.C.A. Review*, **16**, pp. 16-33, March 1955.
2. S. L. Miller, "Avalanche breakdown in germanium," *Physical Review*, **99**, pp. 1234-1241, 15th August 1955.
3. R. D. Knott, D. Colson, and M. R. P. Young, "Breakdown effect in p-n alloy germanium junctions," *Proc. Phys. Soc. (Lond.)*, **B68**, No. 3, pp. 182-185, March 1955.
4. J. R. A. Beale, W. L. Stephenson, and E. Wolfendale, "A study of high speed avalanche transistors," *Proc. Instn Elect. Engrs*, **104B**, pp. 394-402, July 1957.
5. F. J. Biondi (Ed.) "Transistor Technology," Vol. 2, pp. 135-165 and pp. 420-437, (Van Nostrand, Princeton, U.S.A., 1958).
6. E. Wolfendale (Ed.) "The Junction Transistor and its Applications," (Heywood, London, 1958).
7. A. F. Newell, "An introduction to the use of transistors in inductive circuits," *Mullard Tech. Commun.*, **4**, No. 35, November 1958.
8. B. J. Holmes, "Characteristics of transistors," *Electronic Engineering*, **31**, p. 233, April 1959.
9. C. G. Thornton and C. D. Simmons, "A new high current mode of transistor operation," *Trans Inst. Radio Engrs (Electron Devices)*, **ED-5**, No. 1, pp. 6-10, January 1959.
10. G. B. B. Chaplin, "A method of designing transistor avalanche circuits, with application to a sensitive transistor oscilloscope," *Proceedings, 1958 Transistor and Solid-state Circuits Conference*, pp. 21-23, (Winner, Philadelphia, 1958).
11. G. B. B. Chaplin and A. R. Owens, "A method of designing avalanche transistor trigger circuits," I.E.E. Paper No. 2944, May 1959 (*Proc. Instn Elect. Engrs*, **106B**, pp. 806-14, 1959).

OBITUARY

The Council has learned with regret of the deaths of the following members, and has sent messages of sympathy to their relatives.

Rupert Pollard Browne (Companion), who died on the 21st May, trained as a chemist and studied for his B.Sc. degree at University College, London. He joined the British Electrical Manufacturers' Association in 1919, and in 1924 was appointed assistant secretary to the then National Association of Radio Manufacturers. Two years later, on the formation of the Radio Manufacturers' Association, he became its assistant secretary, and in 1936 he was appointed secretary. In 1946 the Radio Industry Council was formed by the R.M.A. and other industry associations, and he was appointed secretary to the Council—a position he held until his retirement three years ago.

During the war Rupert Browne served as joint secretary of the Hankey Wireless Personnel Committee which played an important part in recruiting and training radio engineers for the Services and government establishments. His work in this field was recognized by his appointment as an Officer of the Most Excellent Order of the British Empire.

In his capacity as senior executive officer of the Radio Industry Council, Mr. Browne was closely concerned with the development of the organization of the radio industry, and he also took a special interest in the development of technical training in the industry. The organization of the Industry's shop window—the National Radio Show—was an important task which he also undertook.

Elected a Companion of the Institution in 1955, Mr. Browne was 62 years of age and died after a very lengthy illness.

The Reverend **Raphael Conesa**, Ph.D., M.A.(Ed.), S.J., died suddenly from heart failure on 20th November, 1959. Fr. Conesa was Director of St. Xavier's College Technical Institute, Bombay, a position he had held since 1949; he joined the College as Director of the Educational Department in 1944, and was subsequently an instructor in radio physics. This Institute is well known in India as a technical college specializing in radio and electronics, and for degree purposes is an internal college of Bombay University. Fr. Conesa, who was 51

years of age at the time of his death, registered as a Student with the Institution in 1949 and was transferred to Associateship in 1952.

Michael Norton Grenier Goldsmith died on the 19th January from injuries received in a car accident. He was 37 years of age, and had been an Associate Member of the Institution since 1954. After service in the R.A.F. as a Signals Officer, Mr. Goldsmith graduated in Natural Sciences at the University of Cambridge in 1948, and for five years was a senior scientist with the Mullard Research Laboratories. In 1954 he was appointed manager of the Research Division of Tickford Ltd. at Newport Pagnell, and subsequently became research manager of the associated company of Newport Instruments.

Donald Healis Harrison who died on 1st January last at the age of 57 had been concerned with marine communication throughout his career. His first appointment was with the Marconi International Marine Radio Company in 1919 as an installation engineer. In 1931 he transferred to the International Marine Radio Company and in 1936 he was appointed Radio Traffic Manager at the Company's London office, a position he held until shortly before his death. He regularly represented his Company at international meetings concerned with radio and safety at sea. Mr. Harrison was elected a Member of the Institution in 1942.

Wilfred Hartley Spencer, who died in January this year aged 60 years, was concerned for nearly all his professional career with wire broadcasting. He instituted and developed the relay service in Bootle and nearby areas, becoming General Manager and subsequently Technical Director of Wireless Services Limited, later Rediffusion (Merseyside) Ltd. Ill health led to his retirement in 1954. He served as chairman of the Relay Services Association of Great Britain, and on its post-war Planning Committee. Mr. Spencer was an active member of the Merseyside section of the Institution, holding the position of treasurer from 1948 to 1953. He was elected an Associate of the Institution in 1942 and was transferred to Associate Member in 1948.

Industrial Television : A Survey of History, Requirements and Applications †

by

J. E. H. BRACE, B.SC. ‡

A paper read on 1st July 1959 during the Institution's Convention in Cambridge.

Summary : Progress in the applications of television to fields other than entertainment has been much slower than was at first anticipated. From a survey of the history and requirements of the technique it is concluded that the initial approach was misguided and the results consequently discouraging. The economic basis of industrial television is then analysed and current and future trends in equipment design are briefly considered. A survey of some typical established applications is given which covers the four major fields, namely industry, commerce, science and education; applications are classified under four headings, respectively control and surveillance, data transmission, instructional and experimental. The paper concludes by postulating an eventual reversal of the present relative importance of the entertainment and utilitarian applications.

1. Introduction

The virtual impossibility of finding a satisfactory, all-embracing description of television applied to other purposes than entertainment is symptomatic of the difficulties with which its advocates are faced. The necessity of avoiding too close an association with a medium that is either amusing, or boring, or time-wasting, or frankly alarming, according to the personal viewpoint, has taxed the ingenuity of many people and has resulted in the various descriptions "industrial," "closed-circuit," "non-broadcast" and so on being employed. Whilst none of these is entirely adequate, the author prefers, for simplicity, the term Industrial Television which is thus considered, for the purposes of this paper, to embrace all such applications.

This new branch of television engineering was effectively legitimized roughly ten years ago. The forecasts for its future at that time are now seen to have been exceedingly optimistic and although the technique is now firmly established, progress has been much slower than expected. The author believes that an attempt to understand the reasons for this reveals an

object lesson which, in the light of the current evolution of the electronics industry, is of great importance.

2. History

The so-called high-definition television system had reached a state of development as long ago as 1936 sufficient to enable the introduction of regular public broadcasting. However, it is well known that the early equipment was costly, complex and extremely delicate and whilst such problems have never proved a serious deterrent in the world of entertainment, they are normally of inescapable relevance to scientific and industrial organizations.

Had there been any obvious and important military application for television, there is little doubt that considerable effort would have been devoted to its development during the war. As it happened, just sufficient was done in America to result in a vastly improved entertainment system almost immediately after the war but the operational problems remained. The major stumbling-block was the apparent incompatibility of simplicity and satisfactory performance in the camera pick-up tube and it was evident that further development of existing photo-emissive tubes was unlikely to overcome this. On the other hand, whilst it had long been realized that the principle of photo-conduction

† Manuscript received 1st June 1959. (Paper No. 560.)

‡ Marconi's Wireless Telegraph Company Ltd., Closed Circuit Television Division, Basildon, Essex.

U.D.C. No. 621.397:62

would lend itself well in theory to the conception of a simpler tube, a satisfactory photo-conductive material was not discovered until the late 1940's.

At about this time, an American manufacturer of water-tube boilers installed a television camera of original design in a thermal power-station for the remote observation of one of the drum water-level gauges. The camera was of simple conception and employed one of the earliest of all pick-up tubes, the image dissector, which is well suited to such applications in respect to its extremely long inherent life, but suffers the severe disadvantage of very poor sensitivity.

This installation and others of a similar nature which followed were undoubtedly the seed from which the idea of industrial television has grown and it is of great significance that it was sown by a company outside the electronics industry. However, the applications of such insensitive equipment were bound to be limited and it was not until the subsequent introduction of the vidicon photo-conductive pick-up tube that full exploitation of the technique was made possible.

This occurred at a time when the entertainment television industry was expanding rapidly and absorbing virtually all available skilled effort. Thus, whereas most other important developments in industrial mechanization have sprung from a clearly defined need, industrial television was merely a by-product of a well-established and prosperous entertainment business and its advocacy was initially based only on a vague and somewhat generalized idea. Indeed, little attempt was made to establish the validity of the idea itself and virtually none to discover whether the technical basis of the original technique was applicable to the new medium.

The result is well-known. Several designs of simplified, relatively low-priced equipment employing whenever possible domestic quality components, appeared on the market and were put to various uses. The seller understood little of the environmental conditions and the user almost nothing of the operational problems. The equipment was in many cases entirely unsuitable, was frequently abused and was

rapidly discredited on the grounds of poor reliability. It is, indeed, only within the last two years that, generally speaking, both manufacturers and users have attempted to understand each other's problems and to rectify the initial mistakes.

3. Justification of Industrial Television

Most of the material dealing with the subject of industrial television published during the past few years appears to assume that its benefits to industry are axiomatic and obvious but from a purely philosophical standpoint this assumption is most questionable. However, it is quite clear that the television system has a number of important attributes which, when taken together, are virtually unique. It combines the advantages of accurate pictorial reproduction,

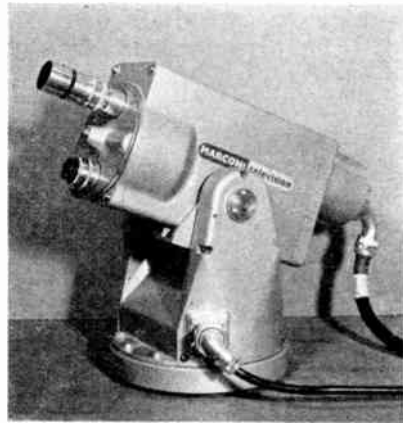

Fig. 1. An industrial vidicon camera equipped for remote control of focus, lens change, pan and tilt. This unit is completely sealed against ingress of dust and humidity.

rapid transmission over great distances and complex routes, great flexibility and ease of multiple observation, and thus constitutes a highly efficient means of visual communication.

In questioning whether such a system can contribute significantly to increasing efficiency in industry it must first be recognized that the current trend of technology is towards increased automation with the minimum of human intervention. However, in the foreseeable future there will always be a variety of operations in

which the human element is indispensable, for example the accurate manoeuvring and positioning of certain types of object and material, the control of processes for which a programme cannot be pre-determined and of which the parameters are not susceptible to easy measurement, the inspection of product or plant, the interpretation of certain types of documentary information and the general surveillance of plant or premises.

Throughout industry, examples of all such operations can be found where direct observation is impossible due to the size or layout of the plant, the hazard or discomfort involved for the observer and so on. When this situation arises an alternative to direct observation must be found such as the employment of an optical relay, increase of operational personnel, installation of an instrumentation or telemetry system or re-arrangement of the plant or process. To this list may now be added television.

Where more than one solution is possible, the correct choice is obviously that which achieves the desired object in the most economical manner and this must be assessed by consideration of the operating costs and capital depreciation of the system employed in relation to the increase in turnover achieved.

The five solutions postulated above are discussed in turn below.

3.1. *Optical Relay*

This has the advantages of being a passive device, frequently of low capital and recurrent cost, and enabling actual observation of the process. However, it is also inherently rigid and inflexible and can only operate satisfactorily over relatively simple routes and short distances, for which reasons it is frequently impracticable.

3.2. *Increase in Personnel*

Whilst this normally involves no capital outlay, recurrent costs are relatively high. Speed and accuracy of control are normally impaired and information is liable to misinterpretation. This solution is frequently impracticable for the same reasons (hazard, discomfort, layout, etc.) as direct observation.

3.3. *Instrumentation or Telemetry*

The capital and recurrent costs of such systems are extremely variable and may be almost negligible or very high. Flexibility and transmission speed are normally good but there is risk of an undetected fault resulting in misleading information. Simultaneous interpretation of a large number of parameters may be difficult and the use of such a system impracticable where such essentially visual characteristics as shape and "finish" are involved.

3.4. *Re-arrangement of Plant or Process*

This is usually impossible due to the nature of the process itself particularly where large-scale or hazardous operations are concerned. Even when practicable, the capital outlay and temporary loss of production involved are normally very high.

3.5. *Television*

The capital cost of a television system may be lower than an instrumentation system or plant re-arrangement. Recurrent cost is normally significantly less than the cost of one man and accuracy and speed of transmission are high. Moreover, the system is effectively self-monitoring for fault conditions so that there is no risk of false information being received. It is of great flexibility and is seldom impracticable except where insufficient subject illumination is available, the relative size of detail in the subject is too small or under certain extremely arduous environmental conditions.

Summarizing the above discussion, it can be shown that television might be the most economic solution to a given problem by reason of lower capital outlay; or lower recurrent cost; or greater speed, accuracy or reliability; or impracticability of other methods; or a combination of two or more of the above.

4. **System Requirements**

Justification of industrial television on theoretical grounds would obviously be quite pointless unless in practice suitable equipment can be produced. Unfortunately, even today, the technique is plagued by its association with the entertainment medium although, in fact, the differences are profound and fundamental.

It is of interest to consider these in some detail. On the one hand, there are obviously no absolute criteria of that elusive quality "entertainment value." To the unsophisticated, a mere travesty of the original subject may be vastly diverting as is evidenced by reactions to the first phonograph cylinders and the early cinema,



Fig. 2. A document viewing console, designed for transmission of bank statements, incorporating a vidicon camera. Camera controls and monitor selector switches are mounted in the top of the console.

the critical faculty being awakened only by successive improvements and experience. At any stage the criterion of acceptability is purely relative and is closely linked with aesthetic and emotional considerations. Thus it is most probable that the generally accepted quality of television pictures today will be regarded almost with derision in twenty years from now.

Furthermore, the dictates of fashion figure largely in any entertainment medium and in television specifically these are typified by such factors as the size and shape of receivers, the employment of certain types of special effect and even the introduction of colour. Finally, the subject matter is largely concerned with fantasy and deception.

With industrial television, on the other hand, we are concerned with an entirely functional medium for which precise and absolute performance criteria can be established on an intellectual or objective, as distinct from an emotional or subjective basis and these will remain valid

indefinitely. Fashion plays little or no part in the techniques employed and the subject matter is factual and truthful. It is thus clear that requirements for the two media might differ enormously and the assumption that the normal broadcast system is the most suitable for industrial applications might be entirely erroneous.

It should, however, be noted in passing that ultimately both techniques are dependent upon the same physiological factors, such as tolerance of brightness flicker, ability for recognition and perception of noise in the observer, and for this reason must be based on similar principles.

The most suitable system for a particular application is determined by the type of information to be transmitted, the distance between the subject and the observer, the speed of transmission necessary, the level of illumination obtainable on the subject and its nature (infrared, visible, ultra-violet) and the environmental conditions. These factors will influence the choice of pick-up device, the system bandwidth, the transmission system employed, the form of display and the general mechanical design and these in turn will affect the capital and operating costs and the problems of maintenance.

From these considerations, a clear requirement emerges of several types of equipment. Whilst complete classification is difficult, they can be roughly distinguished under the following application headings.

4.1. *Control and Surveillance*

For this type of application, medium or low definition is normally sufficient and instantaneous transmission over relatively short distances is required. Light levels are often low, demanding good sensitivity, and extreme environmental conditions may be unavoidable. The vidicon tube is generally the most suitable pick-up device, involving a conventional scanning system and orthodox circuitry of simple conception and moderate bandwidth. Transmission is normally over coaxial cable at video frequencies or occasionally as a modulated r.f. carrier and display by means of a conventional monitor using a direct view cathode-ray tube. For certain very simple applications, the Nipkow disc and photocell have been used as pick-up device which has the

advantage of lower operating costs but the serious limitation of severe image distortion when a cathode-ray tube display is utilized.

4.2. Data Transmission

The transmission of data frequently demands very high definition but some transmission delay is normally acceptable due to the static nature of the subject and limited bandwidths can therefore be employed. The distance of transmission may be very great and in such cases the ability to use normal telephone circuits becomes attractive for reasons of economy. However, pending further developments in the art of bandwidth compression, the speed of transmission of a high-definition picture over such circuits is only comparable with that of a good facsimile system and the display problems are difficult to resolve. For localized installations, conventional direct pick-up and flying-spot scanning systems are quite suitable for most applications and sensitivity is normally unimportant.

4.3. Instruction and Education

Applications of this type vary considerably and may utilize a wide range of equipment from the simplest vidicon camera to full-scale simultaneous colour system image orthicon equipment. The subject matter may include documents, photographic slides and film in addition to live subjects and frequently demands a high order of definition.

4.4. Experimental

Under this heading are included all applications where television is used as an adjunct to a scientific or technical investigation. Whilst for economic reasons an attempt is usually made to utilize or adapt standard equipment for such purposes, theoretical requirements are of such a wide variety as to defy any attempt at classification.

5. Equipment Design

It is not within the scope of the present paper to consider in any detail the specific electrical and mechanical features of any particular equipment. Some general remarks on basic design principles would, however, be appropriate.

To the industrial user, long-term reliability is of major importance and unless this can be achieved with television equipment it is likely to be of little real value. The idea that electronic devices are unreliable gadgets to be avoided at all costs is firmly established with most production engineers. It is, of course, unfortunately based on experience and has probably inhibited the widespread adoption of industrial television more than any other single factor.



Fig. 3. Industrial television in use at the Steel Company of Wales for the remote control of the ingot buggy and shuttle car feeding ingots into the slabbing mill. Fifteen cameras and monitors provide a continuous view of approximately 700 feet of track.

In the military and aeronautical spheres, considerable effort has been devoted during the past twenty years to the design of reliable electronic equipment but little of this experience seems to have been directly applied elsewhere. There appear to be two main reasons for this.

Firstly, the major source of business to the electronics industry outside the military field has been until recently for domestic equipment and this has generated a school of designers concerned primarily with considerations of price, performance and consumer appeal. In the same way, the components industry has tended to be dominated by the requirements of domestic receiver manufacturers.

Secondly, the average industrial buyer knows little or nothing of electronics and tends to buy on price considerations alone or at best as a

result of a short demonstration staged under ideal conditions. There is no industrial equivalent of the Joint Services Specifications and the conscientious manufacturer is therefore faced with a tedious process of education and a long period of unequal competition.

There are, however, recent indications of an improvement in this lamentable state of affairs. The current interest in electronic computers is stimulating the quantity production of reliable valves and components which are consequently less costly than hitherto. Moreover, many large industries are now employing production engineers with electronics experience and providing themselves with proper electronics maintenance facilities. Finally, the armed services are becoming important users of television and are encouraging the design of equipment to military standards.

From these developments, a better class of equipment is already emerging in which more attention is being paid to long-term reliability, performance stability and the problems of environment, such as temperature extremes, excessive humidity, vibration and so on. Considerable further progress is to be expected in this direction with the emphasis on pick-up tube

performance, completely automatic operation and general ruggedization.

6. Applications

A complete survey of established applications of industrial television throughout the world would involve very considerable research well beyond the capabilities of the present author. However, an impressive list is obtainable from readily available published material and this is given as an Appendix to indicate the present scope of the technique. The applications are grouped under the previous headings.

7. Conclusions

Television is an economic, practical and firmly established solution to many problems in science, education and industry. There is an increasing trend towards specialized equipment of entirely new conception which bears little resemblance to its broadcasting counterpart and this trend can be expected to accelerate in the future.

It is thus already possible to foresee a relative decline in importance of the entertainment medium until it becomes subsidiary to its own offshoot.

8. Appendix : Some Typical Industrial Applications of Television

1. Control and Surveillance

1.1. *Steel Industry*

Observation of hot-strip run-out tables.
Observation of reverse side of slabbing mills.
Detection of scarf on slabs.
Control of strip coiler.
Alignment of strip and bars for shearing.
Alignment of pipes for hot sawing.
Internal seam welding of pipes.
Remote control of ingot buggy and shuttle car.
Charging of blast furnaces.
Alignment of slabs in re-heat furnaces.
Observation of continuous casting.
Scrap handling.

1.2. *Electricity Generating Industry*

Furnace flame viewing.
Observation of water-level gauges.
Detection of chimney emission.

1.3. *Aviation Industry*

Static testing of rocket motors.
Static testing of gas turbine engines.

Rocket launching.

Observation of components during flight tests.
Dynamic testing of structures.

1.4. *Atomic Energy Industry*

Handling of dangerous materials.
Inspection of atomic pile interiors.
Fuel element manipulation.

1.5. *Explosives Industry*

Manufacture of nitroglycerine.
Loading of shells.
Explosives handling.

1.6. *Police*

Traffic control.
Prison supervision.

1.7. *Railways*

Wagon marshalling.
Traffic movements.

1.8. *Coal Industry*

Observation of conveyor crossovers.

1.9. *Medical*

Control of radiation therapy.
X-ray image intensification.

1.10. *Cable Industry*

High-voltage insulation testing.

2. **Data Transmission**

2.1. *Steel Industry*

Transmission of shearing instructions.

2.2. *Banking*

Transmission of cheques and statements.

2.3. *Stockbroking*

Transmission of price information.

2.4. *Aviation*

Transmission of meteorological maps and charts.
Observation of flight traffic control boards.
Re-transmission of radar displays.
Display of passenger information.

2.5. *Railways*

Transmission of seat booking information.
Relay of traffic movement information.

3. **Instruction and Education**

3.1. *Medical*

Group observation of surgical and clinical procedures.
Television microscope.
Psychological studies.

3.2. *Universities and Schools*

General instruction of large classes.
Group observation of small-scale experiments.
Observation of remote events.

3.3. *Technical Colleges*

Workshop instruction.

4. **Experimental**

4.1. *Motor Industry*

Vehicle transmission experiments.

4.2. *Physiology*

Study of human eye behaviour.
Study of human subjects under stress.

4.3. *Astronomy*

Observation of distant stars.
Brightness amplification for rapid photography of planets.

of current interest . . .

B.B.C. Engineering Appointments

Among recent senior appointments within the B.B.C. Engineering Division are those of Mr. W. E. C. Varley (Associate Member) as super-intendent engineer, transmitters, Mr. W. D. Hatcher, B.Sc.(Eng.) (Associate Member) as engineer-in-charge, London television studios, and Mr. W. L. Nicoll (Associate Member) as engineer-in-charge at Kirk o'Shotts television station.

Mr. Varley joined the Corporation in 1933; after the war he carried out a number of broadcasting surveys in Africa and elsewhere for H.M. Government and since 1947 he has been concerned with technical operation of B.B.C. sound and television transmitters.

Mr. Hatcher has been with the B.B.C. since 1931 and has been in the Television Service since it started in 1936, apart from the war period he was concerned with design of equipment of high power short-wave transmitting stations.

Mr. Nicoll joined the B.B.C. in 1937 and held appointments with the technical operations and maintenance department at transmitters at Burghead and Penrith; he was appointed assistant engineer-in-charge at Kirk o'Shotts when the station commenced operations in 1952.

University Scholarships and Student Apprenticeships

To encourage recruitment for engineering posts the British Post Office is launching a scheme under which it will guarantee university training or a diploma in technology course at a college of advanced technology to about 20 suitable students from schools who have passed G.C.E. at advanced level. Under the scheme the Post Office will pay all fees, and half the cost of essential textbooks will be met. During the student apprenticeship, including the time of attendance at university or college, salaries will be paid according to age and varying from £270 annum at 17 to £430 at 21 and over.

The electronics industry too is thinking and acting along rather similar lines. It has recently been announced that two University scholarships, are to be sponsored by Ultra Electronics Ltd.

One, a two-year research scholarship for an

honours graduate in Engineering, is available for the term commencing next Autumn. During the period of the scholarship the graduate will be paid a salary of £575 per annum.

The second scheme is an undergraduate sandwich course. This is open to students who pass advanced level G.C.E. this summer and who are accepted by a University for enrolment in the autumn of 1961.

Earlier this year Mr. Kenneth Thompson, M.P., Parliamentary Secretary to the Ministry of Education, said that the Government was anxiously watching to see whether industry will accept the challenge to increase the number of apprenticeships and learnerships as the number of school leavers grows.

The aim of doubling the number of students released from industry to technical colleges by the mid-1960's could only be done with the maximum interest and co-operation of all sections of industry.

Electronics in Road Research

Higher speeds, ever-increasing traffic, as well as the special problems of motorways and other modern roadworks, all call for large-scale practical road research facilities. To help in meeting this demand, a new road safety research track is being built at Crowthorne in Berkshire. By 1964, the site will also house the entire Road Research Laboratory of D.S.I.R.—at present occupying two different centres at Harmondsworth, Middlesex, and Langley, Bucks.

The track, a figure-of-eight, three miles long, will provide for experiments on the guidance and control of vehicles in fog. Wires laid below the surface will emit signals which can be detected by simple electronic devices in the vehicles. The ultimate objective of this work is to see whether drivers can be helped to steer a safe course through and round hazards even in the thickest fog. Similar electronic devices using energized wire loops in the track surface may also be used to warn vehicles of other vehicles ahead.

Reference to this work by the Road Research Laboratory was made by Dr. V. K. Zworykin in his Clerk Maxwell Memorial Lecture last year when he discussed similar techniques with which he was concerned in the United States.

Application of Television in Industry and Science in the U.S.S.R. †

by

V. I. SARDYKO ‡

A paper read on 4th July 1959 during the Institution's Convention in Cambridge.

Summary: A classification is given of various fields employing television in industry and science. Television sets developed in the Soviet Union for the purpose of remote checking and control are briefly described. Examples of the application of television in medicine, metallurgy and railway transport are considered. Some practical results of the application of television in the automation of manufacturing processes and in scientific investigations are also discussed. In conclusion, basic trends are outlined for further efforts which are planned in the Soviet Union.

1. Introduction

In recent years the application of television has gone well outside the field of broadcasting. Television equipment has found widespread use in solving problems put forward by industry, science and other branches of national economy of the Soviet Union.

Analysing the application of television in industry and science, one may distinguish three large groups:

- (1) Television as a new means of communication.
- (2) Television as a new aid to the automation of manufacturing processes.
- (3) Television as a new aid to scientific investigations.

This paper gives a brief account of each of these groups with examples illustrating the application of television in the national economy of the Soviet Union.

2. Television as a New Means of Communication

This group incorporates a great number of diverse examples of the application of television wherein the basic purpose is the remote vision and control of various processes. The nature of the functions performed involves the transmission of various data over a distance. In this

case television equipment is used in a similar way to other existing means of communication.

The distinguishing feature of these new communication facilities is the high information content and objectivity of transmitted data. In fact, no human presence is required at the transmitting point, which is highly desirable when one has to do with manufacturing and other processes associated with physically dangerous or with health-hazardous environments. Moreover the prospects of releasing man-power for more productive labour is of no less importance.

Television sets of several types have been developed for this purpose in the Soviet Union. In designing them special attention has been paid to versatility in order to facilitate their mass production and to cut down their cost as far as possible.

The most popular of these sets are those designated conventionally as ИТТ, namely ИТТ-0, ИТТ-2, ИТТ-3, ИТТ-5, as well as a colour medical set.

Types ИТТ-0, ИТТ-2 and ИТТ-3 are now in quantity production, which makes it possible to conduct experiments associated with the application of television in science and industry on a greater scale and to draw to this field a wider circle of specialists from different spheres of knowledge.

The ИТТ-0 type set is the simplest of all the above listed closed-circuit industrial sets. Figure 1 shows the experimental model and by

† Manuscript received 1st July 1959. (Paper No. 561.)

‡ State Committee for Radio Electronics, Moscow, U.D.C. No. 621.397:5/6(47)

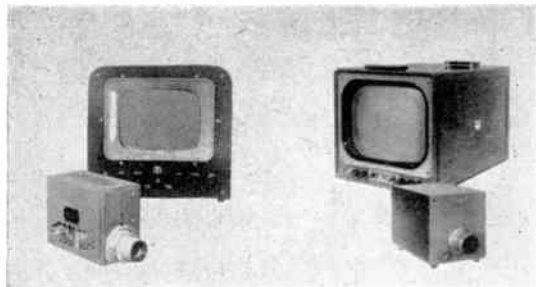

Fig. 1. IITY-0 type television set. Experimental model (left) and model in quantity production (right).

way of comparison the model which is now in quantity production. The set consists of a camera and a monitor display unit. The camera may be removed from the monitor display unit to a distance of up to 150 metres. The image is scanned progressively with 300 lines and 50 frames per second.

The IITY-2 type set is shown in Fig. 2. It consists of a camera and a monitor display unit almost identical to those of the IITY-0 type set as well as a signal shaping unit. The shaping unit comprises a synchronizing generator, camera sweep generators, an intermediate amplifier, a v.h.f. oscillator and a power-supply unit. The distance between the camera and the monitor display unit in the IITY-2 type set may be as great as 1,000 metres. Interlaced scanning of the image is employed with 625 lines and 25 frames per second.

Vidicon camera tubes are used in the IITY-0 and IITY-2 sets. These sets have cascode camera preamplifiers with low-noise tubes and aperture correction. For these reasons good light sensitivity is obtained without sacrificing definition. The quality of picture provided is quite satisfactory for industrial needs; the luminance of the object to be transmitted is 50-100 lux.

Several arrangements have been designed to extend the field of application of these sets. Some of these are shown in Fig. 3 namely:

(a) A television camera with optical head having a facility for remote focusing, diaphragm adjustment and replacement of two objectives.

(b) A camera with rotary gear for its remote rotation in horizontal and vertical planes.

- (c) A camera combined with a microscope
- (d) Control equipment connecting to five or eighteen cameras respectively.

During switching operations, the inoperative cameras are turned over to a stand-by low consumption condition in which the anode voltage is switched off and the filament voltage is reduced to 50-60 per cent. of nominal value. This precaution extends the life of the camera tube and of other electronic valves contained in the camera unit by 5 to 8 times. When the camera is switched on, the image appears almost instantaneously.

The IITY-3 type set is shown in Fig. 4. It comprises a camera tube of the image orthicon type, a signal shaping unit, a synchronizing generator, a camera control unit, monitor display units and a power-supply unit. The camera may be placed as far as 300 metres from the set. The set employs interlaced scanning of the image with 625 lines and 25 frames per second.

Figure 5 shows the IITY-5 type set. It consists of an image orthicon camera tube, a signal shaping unit with a display monitor, a power-supply unit and a remote monitor display unit. The distance between the camera and the set may amount to as much as 400 metres; this distance may be increased with some sacrifice to the picture quality. An interlaced scanning of the image is used with 625 lines and 25 frames per second.

An interesting feature of this set is the use of a sinusoidal line deflection voltage. As the

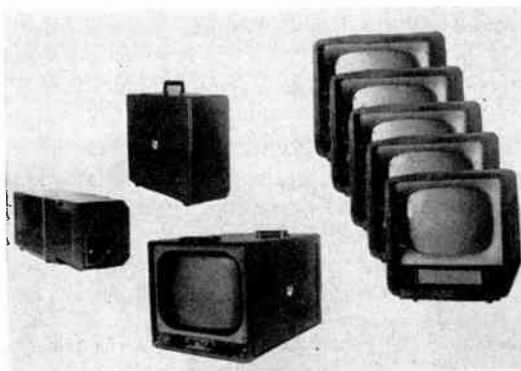

Fig. 2. IITY-2 type television set.

heater voltage of the camera tube is supplied from the line scanning transformer, the application of such scanning resulted in a substantial reduction of the dimension of the camera unit. Figure 5 illustrates the camera as enclosed in a hermetically-sealed casing and out of it. The

These sets have a vast field of application. They are used in such widely different fields as medicine and metallurgy, astronomical, submarine and subterranean observations. They are also applied in chemical industry, at electric power stations, in ports, for the observation of



Fig. 3. Various appliances extending the application field of the IITY-0 and IITY-2 television sets (camera with optical head, camera with rotary gear, camera with microscope, switching consoles for 5 and 18 cameras).

reduction of the camera dimensions is of great importance since it is used chiefly for underwater observation in diving operations.

A two-to-one change of picture scale by electronic means is provided in the set as well as a stand-by economical operating regime. The hermetic casing has a special lens for widening the camera angle of vision in water.

A number of other special sets have been developed in the Soviet Union of which the following examples may be listed:

(a) A colour television set for medical work which is described in detail later.

(b) A television set for the investigation of bore-holes.

(c) A set for the observation of underwater flora and fauna.

(d) A set giving a three-dimensional coloured picture in two additional colours, for instance azure blue and orange-red.

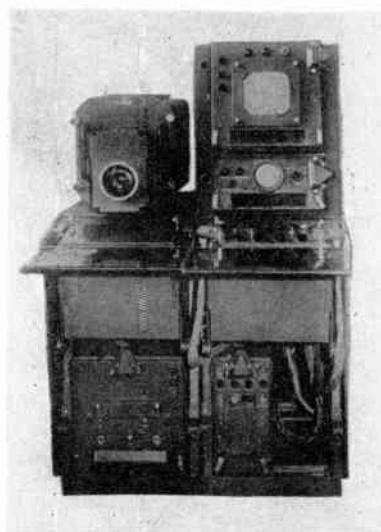

Fig. 4. IITY-3 type television set.

jet engine operation, for the observation of the behaviour of experimental models in wind tunnels, for non-destructive testing in conjunction with X-ray equipment, and for the observation of steam boiler gauge glasses. Further application of television is foreseen in many

use of television equipment. In this connection an experimental medical colour television set has been developed in the Soviet Union which has been installed in one of the clinics. The equipment shown in Fig. 6 comprises the following: a camera with a shadowless illumina-



Fig. 5. IITY-5 type television set.

projects of newly-designed enterprises and those under construction.

It is not possible to give in a single paper a comprehensive account of television applications in the national economy of the Soviet Union and so several cases of application in which some experience has been acquired will be described. The technical advantages resulting from the application of television may be evaluated on the basis of this experience.

2.1. Application in Medicine

In the last few years the surgeons of the Soviet Union have gained considerable experience in performing very complicated operations in the treatment of diseases in particular of heart operations. The training of surgeons in performing such complex operations required new demonstration methods.

The comparison of different methods of the demonstration of surgical operations has shown that the most promising method involves the

use of a camera control unit, commentator's board and several projection type monitors.

Basic operating parameters of the equipment have been determined in the course of its service. The camera position over the surgeon's table and the illuminator design have proved very convenient, causing no trouble to the surgeons and not affecting the usual routine.

The camera illuminators provide shadowless illumination of the operating table of 25000-lux which permits the observation of narrow surgical cuts to their entire depth. Owing to the application of special filters thermal radiation from the illuminators is negligible.

A system of sequential colour transmission is used in the set, with interlaced scanning of the image by 525 lines in three fields—red, green and blue; the number of frames per second is 25. This affords a satisfactory picture quality and viewers can easily see the boundaries of separate organs and the change of blood colour in the course of the operation.

The positioning of the television camera and the image scanning of 500 effective lines allow an operation zone of 300 mm diameter with 150 mm focusing depth to be transmitted. All principal details of the zone, including surgical needles and threads, are well defined.

operation to show the procedure of anesthetizing the patient and preparing the instruments, and in the course of the operation proper because of some gradual shift of the patient's position.

All the above-mentioned additional appliances are provided in the models produced at

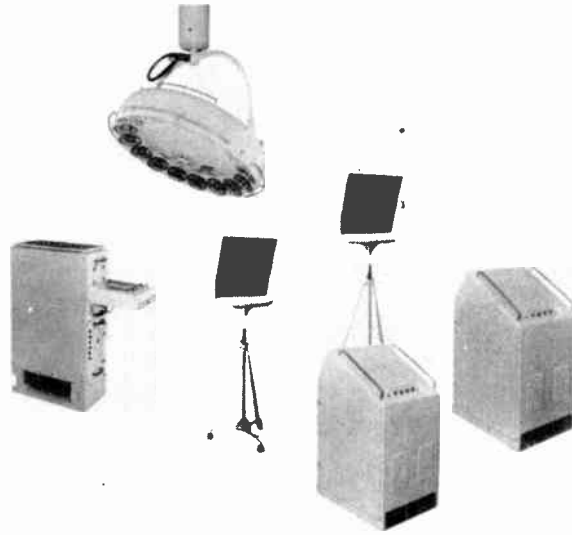

Fig. 6. Medical colour television set.

Two-way voice communication by means of loudspeakers is provided, which enables the demonstration of the operation to be accompanied by the surgeon's comments and the viewers to ask questions; a separate commentator's board is also provided in the operating room for an assistant surgeon.

The use of the set has shown that an arrangement should be introduced in the set which could draw attention by electrical means the most important details (the so-called "electronic pointer") and this takes the form of a moving bright spot. A remotely controlled photo-camera for photographing certain moments in the operation proved necessary as well. This is built into the television camera and has a remote drive and an automatic shift of film. A two-tone electronic change of scale is provided in the television camera. In addition, it has been found imperative to move the camera over the table both in the course of preparing for an

present. The serviceability and reliability of the system have proved to be quite satisfactory.

In a number of clinics in the Soviet Union use is made of less expensive monochrome (black and white) sets, of type IITY-0 or IITY-3, for relatively simple operations.

Now we shall consider briefly two more examples of television application for medical purposes. The demonstration of various microscopic objects in the auditorium for students is very important in teaching, especially when studying different biological phenomena. For this purpose use is made of micro-projectors but to ensure sufficient image illumination, light sources of high intensity are normally used in these projectors which cause rapid drying-up of the objects to be demonstrated. The application of the IITY-2 type of television equipment for this purpose has given good results since it has become possible to attain a hundredfold reduction of the object illumination without a

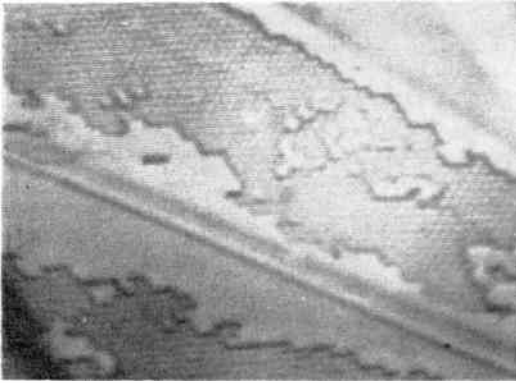

Fig. 7. Image of a diatom cut on the display monitor screen.

serious degradation of the picture. The resolving power of such a micro-projector, checked by inspecting the image of the diatom water-plant cut, has been recognized as entirely satisfactory. The picture of the diatom cut as it appeared on the display monitor screen is given in Fig. 7.

The observation of X-ray pictures may serve as another example of television application in medicine. Modern super-sensitive television camera tubes can solve this problem too.

2.2. *Application of Television in Railway Transport*

The experience gained in the use of television equipment for observing railway marshalling yards and for the supervision of shunting and side tracks has shown that television can improve the utilization of the technical resources of the railway station and reduce the inter-operation intervals.

This is corroborated to some extent by the comparison of figures for the transit of railway cars and the duration of their demurrage for equal periods of time before and after equipping the railway station with television. Thus, for example, the transit of cars has risen by 12-13 per cent. and demurrage went down by as much as 14 per cent. when television was installed.

The application of television in the railway transport simplifies a number of operations. For instance a railway station dispatcher may observe directly the proper disposition of long trains on the tracks of the departure yard without the need for additional personnel. The dis-

patcher can easily see without leaving his working place to what extent the train has occupied the tracks and whether the points are clear.

Television equipment can also contribute to the safety of railway traffic both when the trains are passed through the station and during shunting. Examples can be given of railway accidents being prevented.

2.3. *Application in Metallurgy*

During the last five years experimental work has been carried out at a number of metallurgical enterprises with the aim of discovering the most efficient methods of television application in this field.

The operation of Martin and rolling-mill shops depends on the functioning of the local transport which can be improved when television equipment is used for its control. For example, the installation of television equipment in the dispatcher's office controlling the preparation of trains with moulds resulted in a substantial improvement of their traffic with the effect that mean temperature of ingots delivered to the heating furnaces has been raised by 10 per cent. This gave greater economy of fuel and raised the productivity of rolling mills.

The workers controlling the process of vacuum pouring of steel are in the zone where there is danger from sparks of heated steel. The process of pouring steel into moulds and steel de-gassing is controlled by watching the character of the steel stream and the filling of the moulds through an inspection window in a sealed vessel. The application of television made possible the remote control of the steel pouring process while the working personnel could be transferred to a safe zone.

A television set with the camera tube of the image orthicon type is used for this purpose. A violet light filter consisting of two parts is placed over the photocathode. The part of the filter corresponding to the steel stream projection on the photo-cathode has the greater density.

Good results were obtained in an application of television for rolling mill control and especially for checking the position of heated ingots when they are taken out of the heating furnaces. Television technique has made possible the realization of the remote control

for the process of ingot delivery from furnaces.

In case of a metallurgical enterprise having an ore-supplying mine and an extensive group of ore-dressing and agglomerating factories, installation in the dispatcher's office of television monitors enables the continuous supervision of the ore-train traffic zone, thereby allowing the unloading of ore-laden trains into the bunkers of crushing machines in ore-dressing factories to be checked. Furthermore, the use of television at certain technological assemblies of ore-dressing, sulphide and agglomerating factories tends to improve their work. For example, the installation of television cameras for the supervision of crushing machines may prevent damage by large stones.

In case of power-producing plants television cameras are used for watching the water gauge glasses of steam boilers, for the inspection of unserviced rooms, for checking the operation of dust and smoke collectors, etc.

Television has now found a widespread use at a number of metallurgical enterprises in the country and firmly established itself in their system of communication. Figure 8 shows a typical communication centre equipped with television.

The major requirements of the workers in metallurgical enterprises for television are:

- (1) The increase of distance between the television camera and the receiving point up to 8-10 km and the simplification of cable links.
- (2) The automation of the television equipment operation under the conditions of varying illumination and temperature.

3. Television as an Aid to Automation of Production Processes and its Application in Scientific Investigations

The application of television for the automation of production processes and for scientific investigations is as yet in a stage of study and experimental work. However, it is certain that in the near future television in the Soviet Union will also play a leading role in these fields.

In any production process the role of man is determined by his ability to analyse the impressions he receives and to make a necessary decision. General statistical investigations have shown that over 80 per cent. of all the impressions of the outer world are obtained by man through eye-sight. It may be concluded, therefore, that television equipment in conjunction with some kind of computing device will replace man and release manpower for more productive labour in many processes of manufacture.

Investigations in this field made in the Soviet Union have pointed out two main trends of development:

- (1) Automatic counting and sorting of micro-particles.
- (2) Non-contact measurement of dimensions and sorting ready-made articles or automatic control of the machine producing the articles.

An example illustrating the first line of development is a television microscope which allows the process of counting blood corpuscles to be made automatic. Similar devices and their application have been described in literature.

As to the second line of development this is based on a comparison, made by television

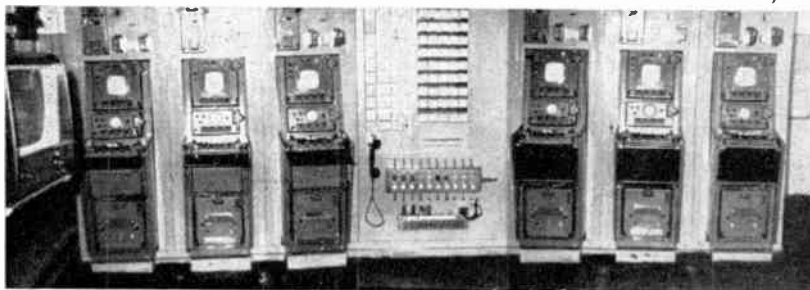

Fig. 8. Communication centre of a metallurgical enterprise having a television installation.

means, of a template profile with that obtained in the process of machining. Information obtained from the outer contour of the article is converted into a special code. After some transformations this information is further employed either for sorting out the articles produced or for the control of the machine producing them. Different modifications of such devices are now in the stage of various tests. It is, therefore, premature to discuss specific constructions. It is however known for certain that the efficiency of devices based on television principles for the purpose in question is much higher than of those employed at present. Moreover, they are not subjected to mechanical wear and tear peculiar to the similar devices with various contact transducers and pantographs which control cutters or abrasive discs.

As to the application of television in scientific investigations, the following two lines of effort are being pursued in the Soviet Union:

(1) The observation of physical and biological processes in the invisible parts of the light spectrum, for instance, in ultra-violet or infra-red.

(2) The utilization of storage effect and, in particular, the improvement in the process of photographing heavenly bodies.

Let us consider the latter application.

It is well known that photocells, in contrast to photosensitive emulsions, retain the linearity of their light characteristics down to very small luminances. In addition, the quantum output of photocathodes is on an average about a hundred times greater than the similar parameter of photoplates.

The research work carried out recently at one of the astronomical observatories has shown that the application of television equipment with a camera tube of the image orthicon type resulted in a decrease of the exposure time of 10-20 times in photographing heavenly bodies. In addition, an increase of the image size is obtained.

The decrease of the exposure time obtained in photographing heavenly bodies is of great importance both from the viewpoint of reducing distortions created by the turbulent flow of air and for the investigation of small stars. The latter are not amenable to observation by

optical instruments whereas their direct photographing is impossible due to the short duration of night time.

A detailed study of the subjects associated with the application of television for astronomical investigations shows that stereo-television equipment with high resolution will be of special value. Such equipment will make it possible to place the telescopes at considerable distances apart and to pick out the images of heavenly bodies among the distortions and interferences introduced by the atmosphere.

This field of television application presents its own particular requirements in techniques. The most important of these requirements are:

(a) Reduction of noise arising in the television channel.

(b) Development of sensitive camera tubes capable of storing images for a period of several hours.

4. Conclusions

Summarizing the foregoing discussion, it may be noted that television technique in the Soviet Union has firmly established itself in diverse branches of industry and science.

With a view to stimulating further developments in this field of television application, the radio and electronics engineers in the Soviet Union have set themselves the following major tasks:

(1) To increase the reliability and to reduce the cost of television sets for industrial application.

(2) To equip television sets with various appliances extending their field of application.

(3) To increase the distance between the camera and the receiving point up to 8-10 km, and at the same time to simplify and cheapen the cable communication lines; to automatize camera operation under the conditions when the illumination varies over a wide range.

(4) To design and produce complex arrangements combining television sets and computing devices for the automation of production processes.

(5) To study the subjects relating to the application of television as a new aid to scientific research and to create the technical and scientific basis required for this purpose.

Transportable Ground Receiving and Recording Equipment for 24-Channel Telemetry †

by

F. G. DIVER, M.B.E., MEMBER ‡

A paper read in a Symposium on Radio Telemetry held in London on 25th March 1959.

In the Chair : Mr. I. Maddock, O.B.E. (Member).

Summary : The equipment receives telemetered data in the form of an r.f. carrier in the 400-500 Mc/s range, amplitude-modulated by a frequency-modulated sub-carrier, using time-division multiplexing. The demodulated data is photographically recorded both in "histogram" form and as individually selected channel groups. The equipment is designed for operation as either a fixed or a self-contained transportable station. A mechanical selector switch using punched cards expedites selective recording of particular data channels.

1. Introduction

The equipment described is a recent addition to the series of 24-channel air-to-ground radio telemetry receiving and recording facilities commissioned by the Ministry of Aviation. It forms part of a system which is based on the principle of time-division multiplexing of a frequency-modulated sub-carrier, the resulting signals being caused to pulse modulate the main carrier.

The principal structural feature which distinguishes it from earlier equipments is its relative compactness which makes possible the housing of a complete ground terminal in a hut of dimensions compatible with the limitations of normal transport services. Detail improvements in technical design and an innovation to expedite operational use also are incorporated.

Only a brief outline of the basic characteristics of the overall system is given. A review of the factors influencing the choice of modulation system for this particular application of radio telemetry is to be found in "A comparison of telemetry systems" by A. Cowie.¹ Another paper by W. M. Rae on "The airborne sender for 24-channel telemetry"² describes the transmission system and equipment in detail.

† Manuscript received 9th April 1959. (Paper No. 562.)

‡ McMichael Radio Ltd., Slough, Bucks.
U.D.C. No. 621.398.

2. General Description

The equipment is designed to receive and record data signals transmitted on a radio-frequency carrier in the band from 400 to 500 Mc/s approximately. The equipment can accommodate up to 23 data channels plus one synchronizing channel, the transmission process having provided for the sampling of these in turn at a nominal recurrence rate of 85 per second. The incoming signals take the form of a carrier amplitude-modulated beyond 100 per cent.—that is, effectively pulsed—by a sub-carrier which in turn is frequency-modulated by the data and synchronizing signals. These are successively applied to the sub-carrier by means of a commutator-type switch referred to later as the sender switch. The modulation range of the sub-carrier is 130 to 180 kc/s; 130, 145 and 160 kc/s correspond to the minimum, mean and maximum amplitude levels respectively of the data signals and 180 kc/s to the synchronizing signals.

The transmitted information is presented by the receiving equipment in three forms, one of which is a comprehensive display on a cathode-ray tube for visual control purposes and referred to as the monitor. The other two forms are permanent records on photographic film of the data transmitted in the various channels. One of these is a 35 mm film record of the signals transmitted in all 24 channels, the

record having sufficient similarity to a histogram to justify this part of the equipment being named the Histogram Recorder. The second recording facility is the 16-Tube Recorder, described in a companion paper by F. F. Thomas,³ which provides on four 5½ in. films separate traces of any selected channels.

All the receiving, demodulating and demultiplexing units, the monitor unit, comprehensive system-testing facilities and their power supplies are contained in the three-bay enclosed rack assembly shown in Fig. 1. The fifteen units of which it is comprised will receive brief individual mention later. The complete cabinet is approximately 6 ft. wide by 5 ft. 6 in. high by 1 ft. 10 in. deep.

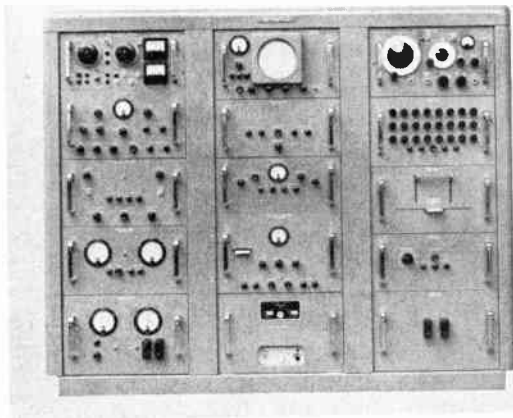

Fig. 1. Rack assembly containing all units of the receiving equipment other than the data recorders.

The Histogram Recorder is the separate cabinet assembly shown in Fig. 2. Its overall dimensions are 3 ft. 9 in. high by 2 ft. wide by 4 ft. deep approximately. A 35 mm continuous-running type camera is mounted on the top in front of a 5 in. double-beam cathode-ray tube.

The 16-Tube Recorder consists of sixteen 3½ in. cathode-ray tubes mounted in two units, each unit containing two vertical lines of four tubes and two 5½ in. continuous-running type cameras. Each of the latter records the spot positions of one vertical line of tubes.

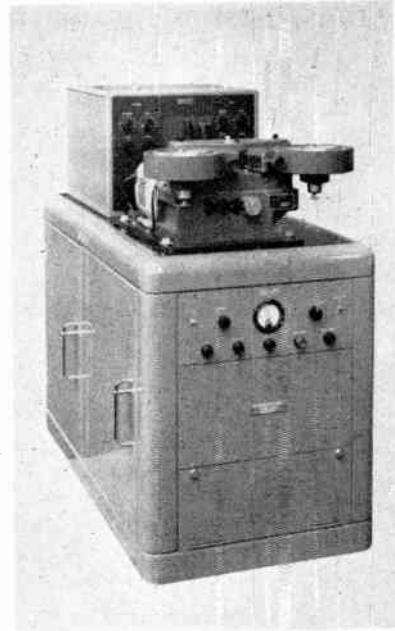

Fig. 2. The Histogram Recorder which provides a 35-mm film record of all data and synchronizing signals in consecutive order of transmission.

Figure 3 is a general view of the complete equipment assembly as installed in a transportable hut specially designed for field use in a wide range of climatic conditions. The equipment fastenings are specifically arranged to permit safe *in situ* transportation and the fully installed hut can be handled by normal transport services. The approximate dimensions of

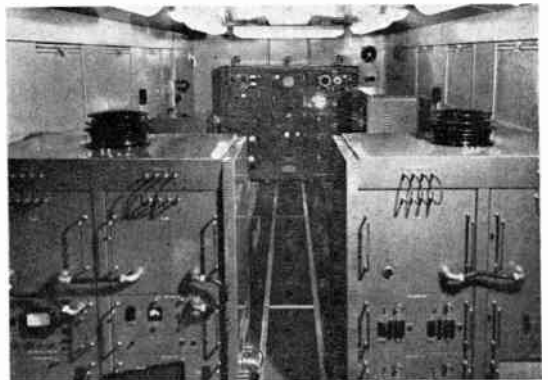

Fig. 3. General view of radio telemetry receiving and recording installation in a transportable hut.

the hut are 9 ft. 6 in. wide by 20 ft. 6 in. long by 8 ft. high.

3. Technical Description

The block diagram, Fig. 4, shows the relationships of the various units comprising the equipment.

Incoming u.h.f. telemetry signals are amplified and demodulated by the type TD 212A Receiver and passed to the discriminator and to the sync. separator as amplitude-limited sub-carrier pulse trains. The discriminator converts these into square-wave pulses of amplitude corresponding to the level of the original data signals for application to the deflector plates of all the cathode-ray tubes in the 16-Tube Recorder and, after further amplification, to the Histogram Recorder and to the monitor tube. The sync. separator selects the sync. sub-carrier pulses and converts them to square pulses for application to the time-base unit. This unit generates synchronized unstepped and stepped sawtooth waves having a high degree of linearity. It also provides a "memory" voltage or reference potential which varies with the time-base amplitude, that is, with the instantaneous sync. pulse repetition frequency which is a function of the sender switch speed. The

stepped sawtooth time-base waveform and the reference potential are applied to the strobe unit; the unstepped sawtooth waveform is applied to the monitor. The Strobe Unit produces 23 pulses—to provide ultimately bright-up pulses—whose times of incidence can be adjusted to correspond with those of the 23 data signal pulses. These bright-up strobe pulses are passed to the strobe selector switch, a mechanical matrix selector switch operating on the punched card principle. This switch enables any selected individual strobe pulses, up to the full number, to be connected to any of fifteen mixer circuits. The output of each of these fifteen mixers is fed to the control grid of a corresponding cathode-ray tube in the 16-Tube Recorder. It has already been mentioned that the composite waveform is applied to the deflector plates of the tubes. The level is arranged to be below that which is necessary to provide a record; the bright-up pulses produce a recordable intensity and they are coincident with the data signal channels. Their selective application to the 16-Tube Recorder by the mechanical selection facilities of the Strobe Selector Switch allows the recording of any selected data signals either singly or in combination.

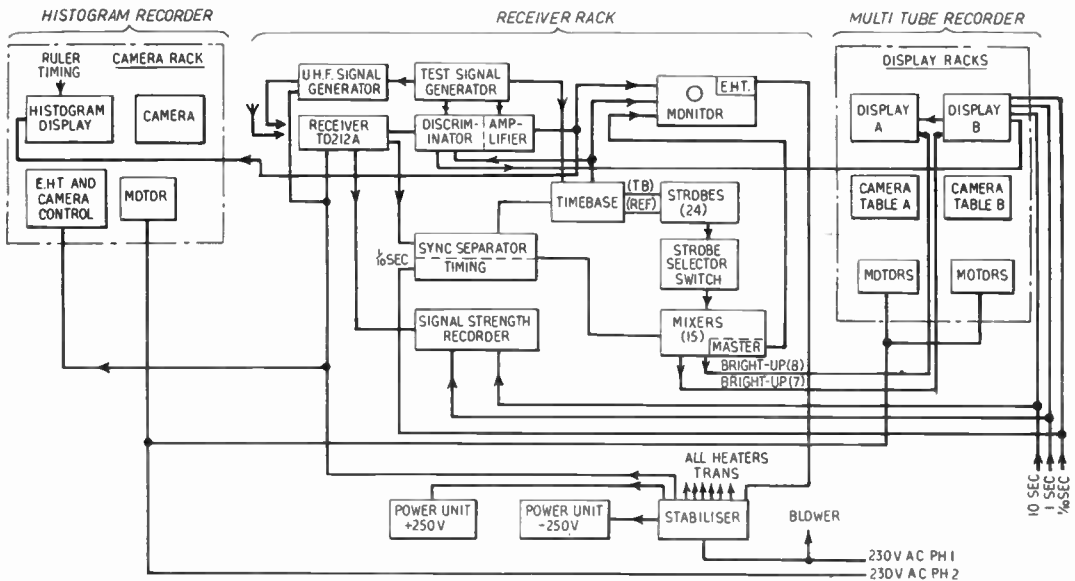

Fig. 4. Block diagram of the complete receiving and recording installation.

An additional mixer circuit is provided which handles all 23 bright-up pulses, these being applied to the monitor tube for facilitating the precise timing adjustment of all the individual strobe pulses.

The test-signal generator provides artificial square-wave sync. and signal pulses for application to the time-base unit and the amplifier in the discriminator respectively. It also provides sub-carrier pulse trains for application to the discriminator input, the sync. separator and, as modulation signals, to the u.h.f. signal generator. The u.h.f. signal generator modulated by the test-signal generator, applies artificial u.h.f. telemetry signals to the input of the u.h.f. receiver for testing purposes. In all cases the monitor is used to examine the signals from the various units and to facilitate adjustment. The signal strength recorder is fed from the a.g.c. circuit in the u.h.f. receiver and provides a chart recording of the u.h.f. signal strength at the receiver input. Externally generated timing signals are reshaped and applied through the mixer circuits to impress time markers on the records and are also applied to the signal strength recorder.

This paper does not deal with the aerial system which, in general, will be designed to suit the particular telemetry application.

The receiver equipment is driven from a single-phase 50 c/s supply, the permissible voltage range being 190–260V. A 3 kVA voltage regulator provides a 230V a.c. supply stabilized to within ± 0.2 per cent. This regulated supply is fed to valve-heater transformers in most of the units and also to the +250V, 1A and the -250V, 0.5A regulated supply units. A filtered blower unit circulates clean cooling air throughout the main rack.

The units in the main rack, except the a.c. voltage regulator, are mounted as chassis in trays fitted with runners and can be withdrawn forward to expose the complete unit. Quick-release catches and interconnecting harness enable the units to be readily withdrawn for examination while functioning. After drawing forward any of these units to its full extent and releasing the connecting harness, the unit can be removed as a whole from the cabinet.

4. Brief Technical Description of Individual Units

A description of the u.h.f. receiver is given elsewhere.³ The output signals to the sync. separator consist of discrete pulses of 130–180 kc/s energy, the pulse interval being about 490 microseconds, corresponding to a nominal and mean sender switch speed of 85 revolutions per second. The actual pulse length is about 400 microseconds. The output signals to the discriminator are similar but, through the inclusion of a 120–170 kc/s band-pass filter in the receiver, the sync. signals are almost entirely suppressed and the signal/noise ratio improved. The limiter circuits are designed to provide an output signal of approximately 1 V r.m.s.

The Discriminator and Amplifier accepts sub-carrier signals from the u.h.f. receiver, converts them into d.c. pulses varying in amplitude in accordance with the levels of the original sampled data signals and finally amplifies them sufficiently to provide a balanced output to the cathode-ray tube in the monitor and to the histogram recorder. An unbalanced output to the 16-Tube Recorder is also provided.

The Sync. Separator accepts limited sub-carrier signals from the u.h.f. receiver, and applies them to a sharply tuned 180 kc/s filter network which passes the sync. pulses and excludes the data signals. After rectification, smoothing and shaping, a d.c. restorer network ties the sync.-pulse base level to zero potential and prevents the drift in potential which would otherwise result from variation in the original pulse repetition frequency. A cathode-follower output stage produces square-topped pulses of constant amplitude and potential for application to the time-base unit. Other circuits in the sync. separator unit reshape externally supplied timing signals to a form suitable for application as bright-up pulses to the Mixer Unit.

The Time-base Unit generates unstepped and stepped sawtooth waveforms of a high order of linearity with a recurrence frequency set by that of the sync. pulses received from the sync. separator. The unstepped waveform provides a time-base for the monitor tube; the stepped waveform fires each strobe generator in the strobe unit in turn at its preset point. A fraction of the sawtooth voltage can be applied, through

the data signal amplifier in the discriminator unit, to the 16-Tube Recorder for facilitating testing. The time-base unit also includes a memory circuit which provides the strobe unit with a d.c. reference potential whose level is related to the peak value of the sawtooth and is capable of following rapid changes in that peak value so that the relative timing of the strobe generators does not vary. After generation of the sawtooth time-base in a conventional manner, circuits are employed to ensure that the potential at the sweep-zero point is maintained constant and that the forward waveform has a high order of linearity.

A flyback-limited sweep is applied to the strobe unit in which 23 pulses are produced at regular intervals over the sweep period. Since the time-base sweep is synchronized with the channel-sampling switch in the sender the strobe pulses can be made to appear in each data channel sampled by the switch. The strobe generators are, however, voltage-operated gates and hence any variation in the peak amplitude of the sweep can vary the strobe timing and possibly cause the strobos to wander outside their correct time interval. To prevent the possible ill effects on strobe timing, the strobe gates operate against a reference voltage which is a unidirectional voltage level proportional to the peak level of the sweep voltage. Hence variations in the sweep level are followed by the reference voltage and the gating time is not affected. The time-base unit supplies this necessary reference voltage to the strobe circuits.

The Strobe Unit accepts the time-base and reference voltages from the time-base unit and applies these voltages to 24 strobe generators to produce ultimately bright-up pulses at times corresponding to the 23 individual data channels. The 24th strobe generator is a spare.

The strobe generators each consist of a cathode-coupled double-triode flip-flop stage whose input grids are connected in common to the time-base sweep input. The grids of the second half of each stage are connected through an isolating resistor to the slider of a potentiometer which in turn is connected across the reference voltage. The point at which the second half of the double-triode conducts depends upon the setting of the potentiometer associated

with it, and therefore each strobe generator can be individually adjusted by means of its potentiometer until its output pulse coincides in time with the required point in its associated data signal channel. The point at which any strobe generator is triggered would vary with changes in the recurrence frequency (which change the peak sweep value) were it not for the fact that the potentiometers are fed, not from a constant voltage, but from the sweep reference voltage which rises and falls with the peak sweep value. The adjustment of the individual potentiometers is effected by observation of the monitor tube while the latter is driven from the test-signal generator.

The Strobe Selector Switch is a manually operated selective switching unit which enables any number of the strobe pulses associated with the 23 data signal channels to be routed to any of the 15 mixer channels. All connections are made through germanium diodes to reduce cross-talk.

In Fig. 5 is shown a top view of the switch assembly. Each individual switching element is a proprietary item which, in the main, previously has found widespread and successful use in universal valve testers. The complete

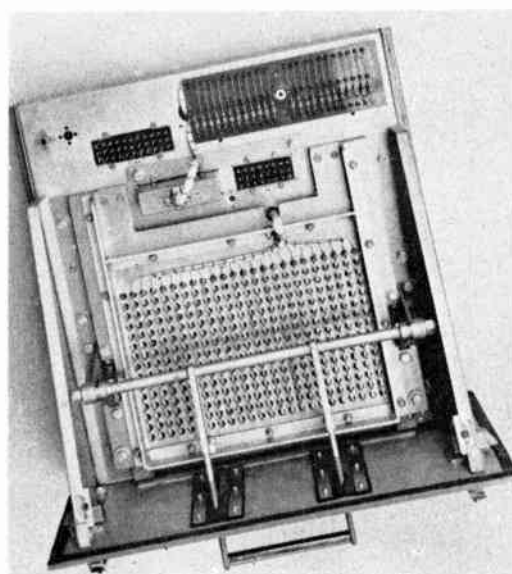

Fig. 5. Top view of strobe selector switch.

assembly has 360 top contacts mounted on a hinged panel with an operating handle projecting through the front panel and 360 corresponding contacts rigidly mounted. Each of the 23 active incoming leads pass to a series of 15 knife contacts. These are the top moving contacts. Each of the 15 outgoing leads is connected to 24 somewhat similar contacts which are the bottom fixed contacts. The rows of bottom contacts are electrically arranged transversely with respect to the rows of top contacts so forming a kind of matrix. All the contact blades have V-shaped knife edges and both top and bottom blades are spring-loaded but, whereas the spring-loading permits sideways movement only in the case of the bottom contacts, in the top contacts axial movement is also possible. The planes of the top and bottom blades are set normal to one another.

When the switch is closed by operation of the handle each top contact makes contact with its corresponding bottom contact—providing no barrier intervenes. By virtue of the sideways play and the V-shaped profile of the contact blades, each pair of knife blades registers at the apices of the V-grooves with contact pressure provided by the spring-loading in the top element.

Selection of specified contacts is effected by a form of punched-card technique, making use of thin synthetic resin bonded fabric “cards” which are inserted between the top and bottom set of contacts through a horizontal slit in the front panel. The cards, which measure 10 in. by $11\frac{3}{16}$ in., are punched with clearance holes at points corresponding to the contacts which it is intended should make. When the switch is closed, those top contacts which are opposite clearance holes pass through the holes and make contact with the bottom contacts; the others are held back by the intervening card.

This switching system very materially expedites the frequent changes which sometimes are necessary in the selective recording of data signals. Having punched a card to give one particular recording arrangement it is suitably marked and stored for repeated use whenever that arrangement is again required. Previously used selective routing methods such as individually operated switches or jumper wire cross-connections have obvious disadvantages in speed of execution and freedom from error as well as being cumbersome both constructionally and operationally.

The Mixer Unit embodies 16 basically similar circuits, each consisting of a voltage-amplifier

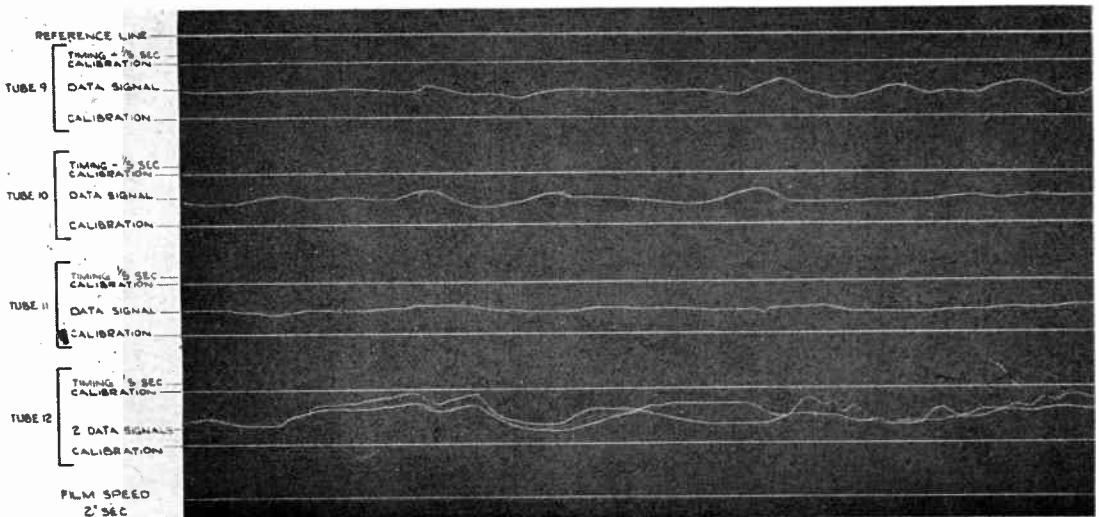

Fig. 6. A specimen of the “selected-channels” form of recording produced by one of the 5½-in. film cameras in the 16-Tube Recorder. (The traces on this illustration have been delineated for clarity of reproduction).

stage, a flip-flop stage and a cathode-follower output. Each of these 16 mixer circuits receives an input from the strobe selector switch and converts the appropriately routed strobe pulses into low-impedance positive-going voltage pulses of equal amplitude and duration. Timing pulses, derived from the timing circuits in the sync. separator unit, are inserted in each channel and are likewise converted into positive pulses of equal amplitude and duration to the strobe bright-up pulses. The 15 selectively-fed mixer circuits pass their output to the grid of a corresponding tube in the 16-Tube Recorder. A typical example of a four-tube record taken on one of the four cameras in the 16-Tube Recorder is shown in Fig. 6. The top three tubes each handled one of three particular data signals while another two data signals were handled by the bottom tube. In all cases relevant calibration signals have been transmitted on other channels and routed to the data display to which they refer. Each of the four records carry timing marks which in this instance are at intervals of 1/5th of a second. A pin-hole light source produced the solid reference line at the top of the film. The film speed was 2 in./sec. The sixteenth mixer, referred to as the master mixer, handles all the strobe bright-up pulses. A 16-way selector switch enables the output from either the master mixer or from any one of the 15 selectively-fed mixers to be connected to the monitor tube.

The Monitor embodies an electrostatic single-beam flat-faced cathode-ray tube for displaying the 23 individual data-signal levels, for setting the temporal positions of the strobe bright-up spots and for checking the operation of the equipment circuits. The horizontal centre line of the tube (which corresponds to a 145 kc/s sub-carrier signal) is indicated by two short marks at the left-hand and right-hand sides of the tube face. Two horizontal lines equally spaced above and below these reference marks correspond, with correct gain setting in the discriminator and amplifier, to 160 and 130 kc/s sub-carrier input-signal levels respectively. The brightness of the strobe spots and of the rest of the trace can be adjusted independently of one another.

The Test-signal Generator provides signals for checking purposes as follows :—

- (1) Sync. pulses for application to the time-base unit.
- (2) Constant-amplitude square-wave pulses of half the channel repetition frequency for application to the amplifier in the discriminator and thence to the monitor. Figure 7 shows the waveform on the monitor tube when driven from the test-signal generator and fed with strobe bright-up pulses. The effect is to synthesize maximum and minimum signals alternately on each successive channel.
- (3) Signal trains simulating the sub-carrier pulses from the u.h.f. receiver for application to the discriminator input or the sync. separator input.
- (4) Signal trains for application as external modulation of the u.h.f. signal generator.

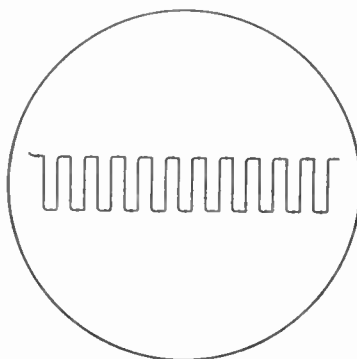

Fig. 7. The monitor tube display of alternate maximum and minimum level signals, with bright-up pulses, on successive channels as locally produced by the test-signal generator.

A local oscillator operating at 840, 1020 or 1200 c/s, corresponding to sender switch speeds of 70, 85 or 100 rev/sec, feeds shaping circuits to produce square pulses. The pulses drive counting-down circuits to provide sync. pulses at p.r.f.s of 70, 85 or 100 c/s. Crystal oscillators, of frequencies 180, 160, 145 and 130 kc/s, can be gated and switched in a variety of ways to provide sub-carrier signals for feeding the discriminator or sync. separator or for modulating the u.h.f. signal generator.

The U.H.F. Signal Generator is a standard proprietary instrument modified only to con-

form physically with the mounting and frontal presentation of the other units. It covers a frequency range of 400–700 Mc/s. It can be externally modulated from the test-signal generator with sub-carrier pulse trains and can be used to drive the u.h.f. receiver through either a coaxial feeder or through a radio link using appropriate aerials.

The Signal Strength Recorder provides a teledeltos paper record of the received signal strength together with timing marks. The chart may be set to run at either 0.25 or 1 cm/sec but can be reset for other speeds.

The Histogram Recorder incorporates a double-beam cathode-ray tube with its control panel, a camera and an e.h.t. and camera control unit. The camera is continuous-running and employs a 35-mm perforated cine-film. It runs at a speed ranging from 1 to 128 in./sec. The front panel of the tube display unit carries a detachable mask which in turn carries a "titling" display for registering the run number of the film. In the front cover above and below the mask are pin-holes behind which lamps are mounted. These lamps produce reference level lines at the top and bottom of the film within the lines of sprocket holes during recording.

Incoming square-wave signal pulses from the discriminator deflect vertically one of the two beams of the tube. Timing pulses, after suitable amplification, are caused to vertically deflect the other beam.

The section of a histogram recording shown in Fig. 8 was taken under test conditions in which only 15 of the 23 data channels were used. Four complete sampling cycles are shown; time progression is from left to right. The "pin-hole" reference lines are seen at top and bottom. The synchronizing signals are the top line of spots. Nine of the 15 activated channels are assigned a constant maximum level, three a constant mean level and three a constant

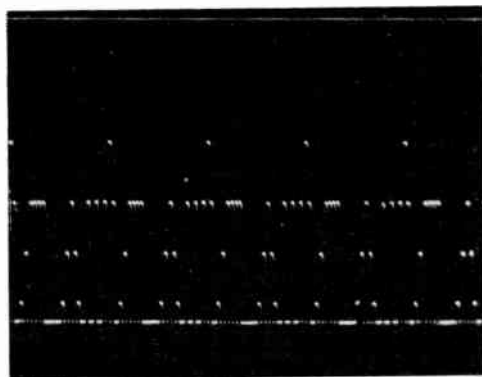

Fig. 8. A specimen of the "all-channels" form of recording produced by the Histogram Recorder on 35-mm film. A test run is shown in which only 15 of the full complement of 23 data channels are used.

minimum level. The unused channels and the intervals between successive channels combine to produce the dot and dash line below the minimum level. It conveys no significant information in this instance and if desired the sender and recorder conditions can be arranged to eliminate such a base line trace from the record.

5. Acknowledgment

The author expresses his thanks to the Ministry of Aviation and to the Directors of McMichael Radio Limited for permission to present this paper, and also to the several members of the Equipment Engineering Division of his Company on whose efforts it is based.

6. References

1. A. Cowie, "A comparison of telemetry systems", *J. Brit.I.R.E.*, 19, pp. 491-2, August 1959.
2. W. M. Rae, "The airborne sender for 24-channel telemetry", Radio Telemetry Symposium paper. (To be published.)
3. F. F. Thomas, "A 455 Mc/s telemetry ground equipment", Radio Telemetry Symposium paper. (To be published.)

A 600 Mc/s Pulse Telemetry System †

by

G. T. HARDWICK, STUDENT ‡

A paper read in a Symposium on Radio Telemetry held in London on 25th March 1959.

In the Chair : Mr. I. Maddock, O.B.E. (Member)

Summary : This paper is mainly concerned with the ground equipment for a telemetry system employing pulse-position modulation in which the information is conveyed by variations of the delay time between a wide datum pulse and up to twenty narrow pulses. In order to explain the nature of the signals with which the ground equipment has to deal, a brief description is given of the airborne equipment. This is followed by a description of the operational ground equipment and of the ancillary equipment for calibration and testing. Finally, details are given which illustrate some of the problems involved in the development of the ground equipment and methods used to meet certain design requirements.

1. Introduction

The 600 Mc/s Pulse Telemetry Ground Equipment was produced in conjunction with the Ministry of Supply to receive and record information transmitted from airborne vehicles using pulse position modulation in which the positions of pulses are related to voltages developed by transducers. The dependence upon voltage as the controlling parameter in the sender led to the use of the term "Voltage Telemetry" to describe the system and also to the use of the prefix "Voltage" in the titles of several units of the ground equipment. This nomenclature also helped to distinguish between these units and their counterparts in a subsidiary system which used a signal from the airborne equipment to determine the roll characteristics of the vehicle and which was known as "Roll Telemetry."

Continuous progress in the development of the airborne equipment and changes in the method of arrangement of the information pulses necessitated the development of ground equipment which was capable of handling signals from several differing versions of telemetry airborne sender.

Subsequent to the original work, parts of the ground equipment were considerably redesigned

and improved and new ancillary equipment was produced to facilitate calibration and testing. Also as part of this development programme an equipment was produced to align and calibrate the airborne sender independently of the main ground equipment and a low-speed recorder was produced which worked in conjunction with the main recording equipment and which enabled a multi-channel record to be taken on a single film.

The system now in use has a maximum capacity of twenty information channels with a frequency response of d.c. to 140 c/s allowing ten samples or "paints per cycle." A reduction in the number of channels employed allows an increase of maximum response to a limit of 320 c/s when only four channels are used. If however the information conveyed is of sine wave form, a further increase in frequency is possible since the number of samples necessary per cycle can be reduced.

The overall accuracy which can be achieved is of the order of 3 per cent., but this requires considerable care in initial setting up and calibration of both airborne and ground equipment.

2. Airborne Equipment

The sender generates a datum pulse, often referred to as the "sync. pulse," of approximately 60 microseconds duration and maximum pulse repetition period of 720 microseconds. The actual pulse repetition period used depends

† Manuscript first received 24th April 1959 and in final form on 1st October 1959. (Paper No. 563.)

‡ J. Langham Thompson Ltd., 11-12 Dalston Gardens, Stanmore, Middlesex.

U.D.C. No. 621.398:621.376.55

upon the number of channels in use and is kept substantially constant once the sender is set up for operation. In earlier versions of the pulse sender, this repetition period was allowed to vary and in some cases was arranged to convey information.

The trailing edge of the datum pulse is the reference point from which all times are measured, the interval between it and the leading edge of another pulse being referred to as the "delay time" to avoid confusion with "range timing" information. The latter refers to the time interval between the start of recording of telemetered information and subsequent occurrences in the airborne vehicle.

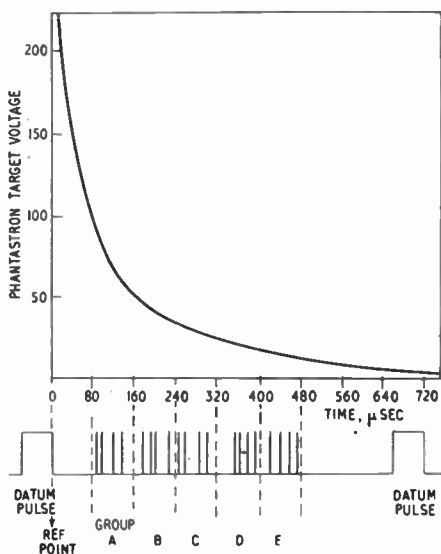

Fig. 1. Typical pulse train and graph showing relationship between target voltage and delay time.

The quantities to be measured are converted to voltages by means of transducers and these voltages are applied to networks which control the target potentials and hence the "run-down" times of up to twenty phantastrons. The "run-down" of all the phantastrons is initiated by the datum pulse, and a narrow pulse of the order of one microsecond duration is derived from the screen grid of each phantastron at the termination of "run-down." Thus the delay time between the datum pulse trailing edge and the

narrow pulse leading edge can be related to the original quantity. All the pulses produced are mixed and used to amplitude modulate a 600-Mc/s carrier produced by a power oscillator which provides the radio link with the ground equipment.

The narrow pulses are arranged to fall into groups, a maximum of four being available in each group with a maximum of five groups. A period of 80 microseconds is allocated to each group whose pulses will not, in normal circumstances, be allowed to fall outside their own period. The form of the pulse train is illustrated in Fig. 1.

In a phantastron, the law relating "run-down" time to target potential is basically hyperbolic, and this is also illustrated in Fig. 1. It will be seen that the sensitivity obtainable in the first period of 80 microseconds is very poor, a small change of delay time requiring a large change of voltage especially for times near zero. For this reason the first period zero to 80 microseconds is not used.

The interval between the last group of pulses and the next datum pulse allows time for the system to recover, for example, for all flyback to be completed.

3. Operational Ground Equipment

A block diagram of the units comprising the operational ground equipment is shown in Fig. 2. Demodulated signals from the Receiver are fed via the Voltage Circuit Box into five Voltage Time-base Units in parallel. Each of these is arranged to select and offer one group of narrow pulses to its associated Display Unit.

3.1. Receiving System

The receiving aerial consists of a tripole mounted adjacent to the focus of a parabolic dish and shielded from ground reflections by a circular disc.

The receiver itself uses conventional super-heterodyne technique with one stage of amplification at the input frequency and a separate oscillator. The gain of the intermediate frequency amplifier is controlled by variation of grid voltage, which is derived from the Voltage Circuit Box and is the means whereby automatic gain control is provided.

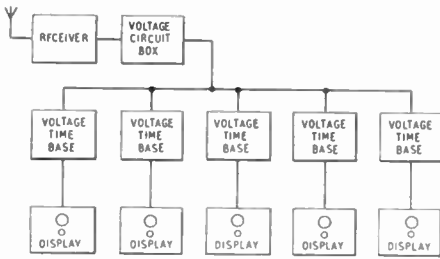

Fig. 2. Schematic diagram of operation—ground equipment.

The demodulated signal, which consists of positive-going pulses, is fed from the detector to the Voltage Circuit Box via an amplitude limiting circuit the purpose of which is discussed later.

3.2. Signal and Sweep System

The Voltage Circuit Box has four main functions as follows:—

- (a) To provide signals which represent the leading edges of the narrow pulses.
- (b) To provide trigger signals to initiate action of the circuitry in the sweep channel of the Voltage Time-base.
- (c) To provide trigger signals for ancillary equipment.
- (d) To provide a.g.c. voltage to control the gain of the intermediate amplifier in the receiver.

A simplified block diagram of the Voltage Circuit Box which shows voltage waveforms occurring at relevant points is given in Fig. 3.

The required outputs are obtained as follows:—

(a) *Signal Output.*—The incoming demodulated pulse train is amplified and a slice taken from it at approximately three-fifths of the height of the datum pulse. The resulting signal which is amplified further in the slicer stage is differentiated by a network having a very short time constant, any resulting negative-going pulses being removed by a germanium diode. The resulting pulses are fed to the signal channel of each Voltage Time-base Unit via a cathode follower using amplified feed back to enable it to handle the fast pulses when feeding the considerable cable capacitance involved.

(b) and (c) *Trigger Outputs.*—The slicer circuit produces a second output which is opposite in polarity to that used in (a) above to provide the signal output. This is fed to a Miller Integrator so arranged as to integrate only on negative-going edges, which are the leading edges of the signals which it receives. It is then only necessary to feed its output through an amplitude discriminator to produce a trigger signal free of narrow pulses, but having a trailing edge which has not been affected by integration. A cathode follower feeds this trigger pulse to the Voltage Time-base Units to give output (b) and an inverter stage gives output (c).

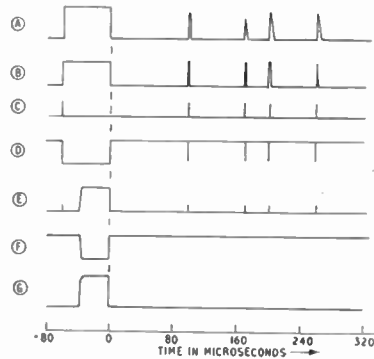
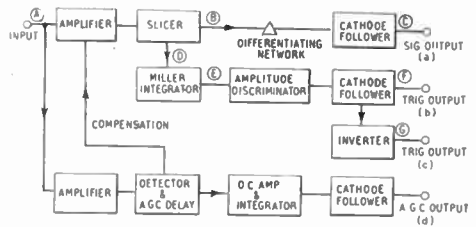

Fig. 3. Simplified waveforms and block diagram of voltage circuit box.

(d) *A.G.C. Voltage.*—The incoming demodulated pulse train is amplified in a feedback amplifier and rectified by a circuit which provides a d.c. voltage proportional to the peak to peak amplitude of the incoming datum pulse. This prevents the a.g.c. voltage level from being affected by changes in the pulse repetition period of the datum pulse. An a.g.c. delay circuit feeds a d.c. amplifier and integrator and a cathode follower feeds the a.g.c. voltage to the

receiver. This section of the unit also provides a compensation voltage which is applied to the amplifier and slicer circuit in order to maintain a constant slice level with variation of input amplitude.

The five Voltage Time-base Units are identical and are arranged to select the required portion of the signals fed to them by the setting of a range switch and the associated controls. Each unit contains two channels which accept inputs (a) and (b) from the Voltage Circuit Box. A simplified block diagram of a Voltage Time-base Unit and relevant waveforms is illustrated in Fig. 4.

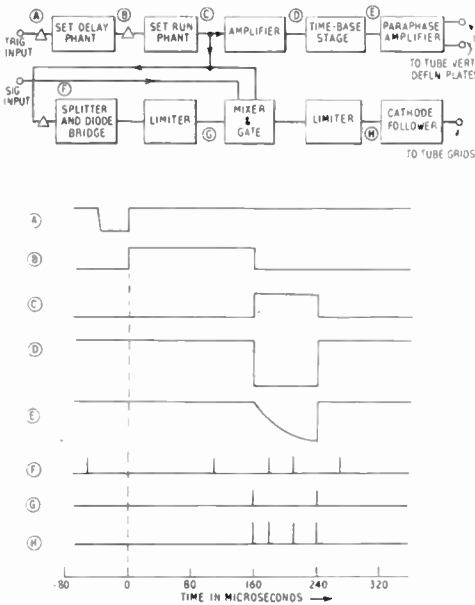

Fig. 4. Simplified waveforms and block diagram of voltage time-base unit.

The Sweep Channel generates a voltage of exponential form over a period of 80 microseconds, and this is used to provide the vertical axis deflection voltage for a cathode-ray tube of the associated Display Unit. The delay between the trigger signal and the start of the sweep period is an integral multiple of 80 microseconds and is determined by a cathode coupled, suppressor triggered, phantastron which is known as the "Set Delay Phant." This is followed by a cathode-coupled, anode-triggered,

phantastron which determines the sweep duration and is known as the "Set Run Phant." (See Section 5.3.)

The Signal and End Marker Channel also makes use of the output of this second phantastron. It is used as a gating waveform which removes all narrow pulses except those required on the display and also to produce the signal pulses known as End Markers which, as the name implies, mark the beginning and end of the sweep period.

One Display Unit is allocated to each Voltage Time-base Unit and contains two cathode-ray tubes and their associated controls. The larger of the two tubes is operated with negligible quiescent beam current, so that, by modulation of the beam current by the narrow pulses, spots are produced on the screen. Since the exponential form of the sweep approximates to the form of the corresponding section of the hyperbolic law of the original sender circuits, the position of a narrow pulse on the display bears a nominally linear relationship to the original quantity. The smaller tube is fed with range timing information which is displayed by upward deflection of the beam.

3.3. Recording System

Each pair of tubes is photographed by a 35 mm continuous film camera, the direction of film movement being horizontal. The form of a typical visual display and film record is shown in Fig. 5.

Each of the five cameras has a capacity of 200 feet of film and facilities exist for speed changing, camera control and braking and for titling. Cameras may be controlled individually or by local or remote master switches and provision is made for starting high-speed cameras first to enable them to reach full running speed before operational recording commences.

4. Ancillary Equipment for Calibration and Test

In the system as originally envisaged, the method of evaluation required that the form of the display should guarantee within known limits a linear relationship between spot position on the tube and original quantity. This involved an attempt to relate the law of the

sweep waveform accurately to that of the appropriate section of the hyperbolic law relating voltage to time in the sender.

A more satisfactory method is now employed in which the sender is calibrated by means of the Sender Alignment Equipment which relates voltage to delay time, an accurate delay time calibration being photographed on to the recording film at the end of a run. This latter calibration is provided by the Calibrator/Simulator Unit.

4.1. Calibrator/Simulator Unit

The output produced by this unit is equivalent to a demodulated telemetry signal which may, if required, be used to modulate an oscillator to produce a 600 Mc/s radio frequency signal. Either signal can be fed into the operational ground equipment to produce displays on the cathode ray tubes.

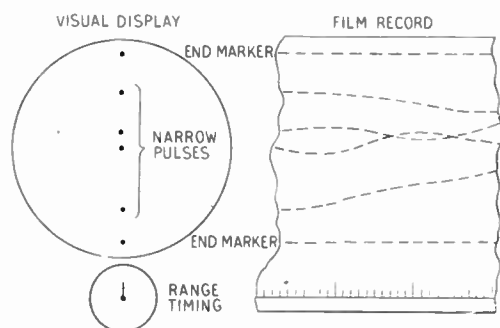

Fig. 5. Typical (static) visual display and (varying) film record.

The unit can, by means of a switch, be set to produce any one of three patterns of pulse train as follows:—

(a) Datum pulse and narrow pulses whose timing is controlled by a crystal oscillator, there being one narrow pulse every 10 microseconds after the reference point.

(b) Datum pulse and narrow pulses, crystal controlled as in (a) but with one narrow pulse every 80 microseconds.

(c) Datum pulse variable in amplitude, duration and pulse repetition period and two narrow pulses variable in amplitude and delay time relative to the datum pulse.

Pattern (a) is used for photographic calibration of the receiving equipment and the use of (b) permits accurate adjustment of Voltage Time-base Unit controls of delay and sweep run times. These patterns thus comprise the Calibrator function of the unit, the Simulator function being provided by pattern (c) which makes possible tests which simulate a wide variety of operating conditions.

Provision is also made to simulate a telemetry signal carrying information by modulation of the delay time between the datum and narrow pulses either by sine or sawtooth voltage waveforms obtained from another test unit, the Sweep Generator/Interpolator. This facility is also available for the datum pulse repetition period.

4.2. Sweep Generator/Interpolator Unit

This unit produces horizontal axis deflection voltages on the larger of the cathode-ray tubes for two alternative test purposes. The Sweep Generator section provides sawtooth voltages to simulate film movement and to permit visual examination to reveal faults which would otherwise require a film record to be taken in order to appreciate their nature. It also provides the sawtooth waveforms used to modulate the simulator pulses as mentioned in 4.1 above. The Interpolator produces a pulse accurately related in time to the reading of a calibrated dial. Fundamental calibration is obtained from the Calibrator/Simulator Unit and it is then possible to derive calibration data for any intermediate period from the Interpolator.

4.3. Sender Alignment Equipment

The Sender Alignment Equipment which is used to calibrate the airborne equipment consists of a twin cathode-ray tube display and can accept either the modulated 600 Mc/s signal or the demodulated pulse train.

On the larger of the two tubes, the telemetry pulses are displayed as upward deflections on a raster time base. Downward pulses are used to provide 1, 10 and 80 microsecond delay time calibration and are derived from oscillators which in turn are calibrated against a 100 kc/s crystal oscillator. Each line of the raster covers one eighty microsecond period and a facility exists for examination of the datum pulse.

The smaller tube can display any portion of the raster, the sweep duration being variable from 8-110 microseconds. The portion selected is indicated on the raster tube by a brightening pulse.

4.4. *Low-speed Recorder*

It is desirable to have a record which contains all the relevant information on one film, to avoid the necessity of examining five lengths of film run at high speed in order to locate any section which is of interest. This is achieved in the Low Speed Recorder by means of a single camera using 120 mm film which photographs five tubes carrying narrow pulse information plus a tube carrying timing information. The tubes are mounted one above the other and are fed with signal pulse information and sweep voltage from the appropriate Voltage Time-base Unit in the main rack.

5. Design Detail

It is obviously impossible in a paper of this type to describe the circuitry in detail and in any case considerable use is made of conventional circuits to which certain modifications have been made. This section is therefore confined to a discussion of certain aspects of the system which illustrate the type of design problem met in the ground equipment.

5.1. *Amplitude Limiting of Demodulated Input*

When operating with senders providing a considerable number of narrow pulses, it is found that the amplitude of the trigger output from the Voltage Circuit Box is liable to be insufficient for satisfactory operation of the Voltage Time-base. This is due to the fact that the frequency of the oscillator in the sender differs slightly for the long datum pulse and the narrow pulses. This means that, should there be any frequency drift, the amplitude of the demodulated narrow pulses can become much greater than that of the datum pulse which is maintained constant by a.g.c. action. When this signal is applied to the amplifier in the Voltage Circuit Box the d.c. restoration which is provided to clamp the positive excursion of the datum pulse is upset, since there is sufficient energy in the large number of narrow pulses to cause the clamp to be transferred to them to a

degree sufficient to cause loss of datum pulse output amplitude from the slicer.

This fault is corrected in the first place by including in the amplifier input a circuit which limits the amplitude of the narrow pulses to not greater than that of the datum pulse. This addition allows satisfactory operation for approximately double the frequency drift which is otherwise allowable. New designs of receiver and sender which are now used have much improved stability, and ease the situation still further.

5.2. *Voltage Circuit Box Slicer and Trigger Circuits*

Since the only information required from the airborne sender is the time interval between edges of pulses, design is directed towards producing outputs which are independent of the input signal in amplitude and slope of edges, and which are not affected by noise or by changes in the repetition period of the datum pulse which can occur in the sender. The methods adopted to meet these design requirements are illustrated by the following descriptions of the circuit operation of the signal and trigger channels.

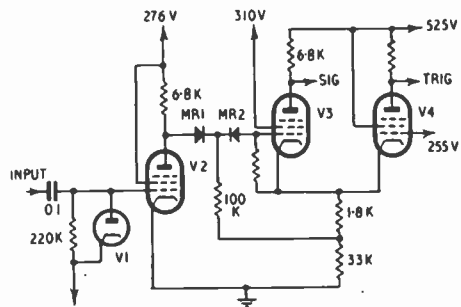

Fig. 6. Simplified amplifier and slicer circuit.

A simplified circuit diagram of the amplifier and slicer stages is shown in Fig. 6. The demodulated telemetry signal, which consists of positive going pulses of maximum amplitude 4½ volts, is applied to the input, and the grid potential of V2 equivalent to the positive excursion of the datum pulse is clamped by V1 to a negative potential determined by a manual control and a circuit which compensates for variations in amplitude of the input signal. This potential is

adjusted so that, during periods of quiescence when the input voltage is negative, the anode of V2 is sufficiently positive that MR2 is non-conductive. This reduces considerably the output due to noise input during these periods. When a positive pulse is applied to the input, the anode of V2 is driven negative, MR2 becomes conductive and the grid of V3 is carried negative reducing the anode current of V3 to zero. This provides at the anode, a positive voltage pulse, the amplitude of which is independent of that of the input and which is adjustable by controlling the V3 screen grid potential.

The amplification provided by V2 ensures that the rise rate of the voltage at the anode of V3 is dependent upon internal time constants to a considerably higher degree than it is on the rise rate of the input pulse. The signal output is obtained by differentiation of the voltage at the anode of V3 with the time constant substantially less than the duration of the narrow input pulse. Hence the amplitude and duration of the input pulse have little effect on those of the output pulse.

The anode current of V2 at which MR2 becomes conductive is affected by the voltage between the anode supply to V2 and the cathode of V3. To keep acceptable the variation of this voltage due to adjustment of the anode current of V3 and to avoid excessive loss of gain due to degeneration, the cathode of V3 is connected to that of V4. The grid to earth voltage of the latter valve is related to the anode supply voltage of V2.

At the end of a pulse the anode of V2 moves positive and may move fast enough to make MR2 non-conductive before the grid of V3 has reached the potential equivalent to quiescent anode current. If this happens the rate of movement of the grid will drop, and should the anode of V2 move negative again before the quiescent state is reached, the output at V3 anode will be reduced. The inclusion of MR1 reduces this effect by limiting the degree to which the grid goes negative since MR1 becomes non-conductive when V3 grid has been taken sufficiently negative to cut off its anode current.

It is desirable that, when two incoming narrow pulses begin to merge into each other, the output should produce two discrete pulses for as long as possible. This is achieved in the

slicing circuit as shown in Fig. 7. It is obvious that the degree to which this condition can be met depends upon the slice level—too low a level will worsen the situation and in addition will allow noise through when the signal/noise ratio drops. On the other hand, if the level is set too high, pulses may be lost if the narrow pulses fall in amplitude with respect to the datum pulse, the amplitude of which determines the slice level. A compromise has therefore to be accepted.

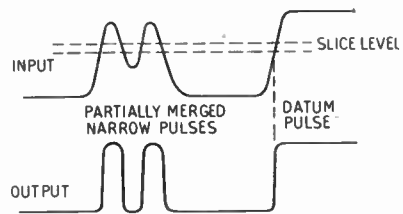

Fig. 7. Simplified slicer waveforms.

The action of the trigger channel is explained by reference to the simplified circuit diagram of Fig. 8. The signal voltage to operate this channel is obtained from the anode of V4 and is a.c. coupled to the grid circuit of the Miller integrator V7. The positive excursion of this voltage is clamped by V5 and the amplitude is arranged to give negligible current in V7 on the

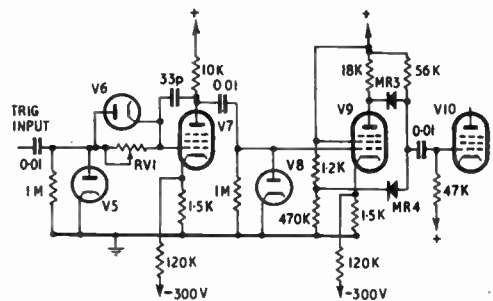

Fig. 8. Simplified trigger channel circuit.

negative excursions of input. The cathode of V7 is connected to the tap of the potential divider between earth and negative supply. This is equivalent to connecting V5 cathode to a positive point and reduces the effect of the valve characteristics of V7 on the stage.

During periods of quiescence, the cathode and anode of V4 and the grid of V7 are at their positive excursion and hence the anode of V7 and the grid of the amplitude discriminator V9 are negative. The circuit parameters and the clamping action of V5 and V8 ensure that the anode current of V9 is low enough that MR3 is non-conductive. Thus the voltage at the grid of the cathode follower V10 is positive during the period of run down of the delay phantastron in the Voltage Time-base and it is desirable to keep spurious output voltages to a minimum to avoid the possibility of errors in the delay time. This is ensured primarily by MR3 being non-conductive and MR4 conductive. The negligible anode current of V9 and MR2 being non-conductive are also of assistance.

During narrow pulse periods the anode of V4 moves negative but the rate of voltage change at the anode of V7 is so adjusted by means of RV1 that the anode current of V9 does not reach the value necessary to make MR3 conductive before the anode of V4 returns positive. Hence no output is obtained and these pulses are prevented from affecting the phantastron.

During datum pulse periods there is time for the anode of V7 to move sufficiently positive to produce the anode current in V9 necessary to make MR3 conductive and MR4 non-conductive thus making V10 grid negative. Spurious output voltages are reduced to a very low level by the negligible anode current of V7 and the fact that MR1 is non-conducting.

At the end of the datum pulse period, the anode of V4 moves positive and the grid of V7 moves rapidly without restraint by Miller action since V6 effectively shorts RV1. The anode of V9 moves positive quickly enough to make MR3 non-conductive without MR4 conducting and the grid of V10 then moves positive at a rate determined by the time constant of the grid resistor and the input capacity of V10 until MR4 becomes conductive. This prevents the output edge being affected by any spurious signals which may be present on the original edge.

The slight delay involved in the timing of this edge is compensated in the adjustment of the run time of the delay phantastron in the Voltage Time-base and hence is of no significance provided that it remains constant.

5.3. Voltage Time-base Unit Delay and Sweep Run Times

It is stated in the general description of the voltage Time-base Units that the delay between the trigger signal and the start of the sweep period is an integral multiple of eighty microseconds and that the sweep period is eighty microseconds. With the phantastron controls set to obtain these conditions, it is found that there is a marked degree of non-linearity between sweep voltage waveform on the cathode-ray tube and the exponential waveform generated by the time base stage. This is due to the inability of the paraphase amplifier which drives the tubes to respond immediately to the discontinuity which occurs in the input voltage waveform at the start of the sweep period and has the effect of making accurate interpolation impossible over the first 10 microsecond portion of the sweep.

The shape of the waveform generated on the tube is represented in Fig. 9. It will be seen that, if the first few microseconds of the sweep are not used in the functional trace, the effect of the non-linearity may be considerably reduced and therefore a change is made in the delay and run times to allow this to be done.

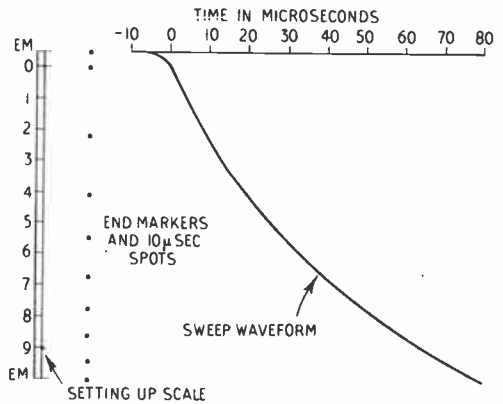

Fig. 9. Display sweep waveform and setting-up scale.

The "run-phantastron" is allowed to run a few microseconds longer than 80 microseconds and the run time of the "delay-phantastron" is reduced by exactly the same amount to compensate, the controls being set to match the positions of end-

markers and calibration spots to a specially marked scale on the face of the tube. The marking of this scale is also illustrated in Fig. 9.

5.4. Sweep Generator/Interpolator Precision Sanatrons

A point of interest in the design of the sanatrons used in the Interpolator section is the application of transitron action to reduce "turn-round" times. During development it was found that a serious discontinuity occurred in the calibration and this was found to be caused by transitron action due to stray capacitances which caused rapid "turn-round" over only part of the range. The principle was therefore adopted of deliberately inserting sufficient capacitance to ensure transitron action over the whole range.

6. Conclusions

The 600 Mc/s Pulse Telemetry System as a whole is capable of a reasonable degree of accuracy and flexibility, and eliminates rotary switches whose life is liable to be short. However it suffers in comparison with some other systems in that both the airborne modulator and the ground equipment is of considerable complexity and requires very careful setting up to achieve the maximum possible performance.

One great advantage of the system is that the sender employs delay circuits of the Miller type which have inherently high negative feedback and whose performance is thus not greatly affected by changes which are liable to occur in the mutual conductance of valves under conditions of high acceleration and shock. It is therefore possible to obtain telemetry records from the instant of launching and during similar arduous operational conditions.

Identification of channels is liable to be diffi-

cult under certain conditions when more than one narrow pulse is used in any one group unless some system such as half-speed triggering of particular channels is resorted to. This of course will reduce the maximum usable frequency.

The non-linearity of the system is also a disadvantage, but the design of delay circuits having a reliability equal to those employed plus a linear delay characteristic would, even if possible, involve a tremendous increase in the already considerable sender complexity.

It would probably be feasible to decrease the ratio of radiated power in the datum pulse to power in information pulses by a change in shape of the datum pulse or by shortening its duration, but it must be remembered that the power consumed in the sender is so great compared to the total radiated power that a significant saving in total power consumption is not to be achieved by this means. In addition it must not be possible for the reliability of results to be in question due to the possibility of confusion between a shortened or reshaped pulse and a group of information pulses which could follow each other so closely as to represent a continuous pulse of considerable duration.

The bandwidth required for normal operation is governed by the frequency drift in the airborne oscillator rather than by the theoretical bandwidth requirements and so the fact that these point to inefficiency in use of bandwidth is in practice of little significance.

7. Acknowledgments

The author wishes to thank the Ministry of Aviation and the Directors of J. Langham Thompson Ltd., for permission to publish this paper.

INSTRUMENTS, ELECTRONICS AND AUTOMATION IN 1960

This year's Instruments, Electronics and Automation Exhibition held in London from the 23rd to 28th May, presented an impressive view of the electronics, scientific instrument and industrial control industries. The total number of exhibitors—over 500—represented 100 per cent. increase over the 1957 Exhibition, and overseas exhibitors came from some fifteen countries. It is therefore not surprising that an attendance of over 75,000 visitors was recorded.

Industrial television at last seems to be coming into its own and to be fulfilling the promise discussed in papers read at last year's Institution Convention, two of which appear in this issue of the *Journal*. Stereoscopic television developed by Pye and by E.M.I. Electronics for use with remote handling equipment attracted much interest, and several exhibitors made use of closed circuit television to provide visitors with a better view of their demonstrations.

Differential analysers operate by reducing all computation to the single operation of integration and variables may be integrated with respect to quantities other than time, a facility which enables the computer to deal with non-linear problems. Digital integration is performed by the summation of rectangles in a step by step process, and electronic speeds of operation enable continuous quantities to be represented with great accuracy. In a transistorized digital differential analyser—CORSAIR—developed by the Royal Aircraft Establishment in collaboration with Semiconductors Ltd., integrators are interconnected by transmitting pulses which represent increments of the computed quantity. The state of each integrator is described by means of two numbers or words in binary code which are stored in a ferrite core matrix. These number pairs are read out sequentially and the integration process takes place in a central time sharing arithmetic unit.

The De Havilland process control computer, ANATROL, represents a new approach to the design of an on-line analogue computer system for the process industries. Its computing accuracy is stated to be compatible with present-day measurement accuracies, allowing it to be easily and efficiently integrated into existing control schemes. The minimum of computing amplifiers and multipliers are formed into an arithmetic unit which is used to provide a step-by-step solution of the process equations according to a pre-set programme. Up to a maximum of twenty-five steps is available, which gives the computer the potential of a machine employing at least seventy-five computing amplifiers and twenty-five multipliers. Semiconductor techniques are used exclusively with the

exception of some electro-mechanical switching elements.

A direct-viewing, bi-stable storage tube, now in the final stages of development, was shown by Mullard. Its chief application will be in specialized oscilloscopes designed to display transient phenomena: the display can be retained for as long as required and successive waveforms can be stored and displayed together for comparison. If permanent records are necessary, photography becomes a much easier task.

Basically, the tube comprises a phosphor screen, a storage mesh and a collector mesh, mounted in that order immediately behind the screen, and two electron guns. A third mesh is incorporated to prevent residual ions reaching the storage mesh. The storage mesh consists of a metallic backing mesh coated with a layer of insulating material which has a high secondary emission coefficient. As the storage layer is scanned by the "write" gun the areas struck by the electron beam acquire a positive charge, due to the emission of secondary electrons. The secondary electrons are prevented from returning to the storage mesh and destroying the charge by the presence of the secondary collector, which is held at a more positive potential. To display the stored information, the storage mesh is sprayed uniformly by low velocity electrons from the "flood" gun. The "flood" electrons pass through the mesh where it is positively charged, but are repelled by the areas uncharged. Those allowed to pass through are accelerated by the higher potential applied to the viewing screen, and in striking the phosphor produce a trace identical with that represented by the pattern of stored charges. Erasure of the information is achieved simply by adjusting the potential of the collector mesh, so that the secondary electrons return to the storage surface to neutralize the charges.

A new coil winding machine was exhibited by Avo which is claimed to be capable of winding almost perfect layer-wound coils without the use of any medium of interleaving. The normal mechanical coupling between the headstock and the traverse of the machine has been dispensed with and both are driven by independent motors, whose relative speeds are electronically controlled by a sensing head which monitors the wire feed angle to ensure that each turn is laid precisely beside the preceding turns. The greatly improved space factor of the coils produced by the machine ensures maximum electro-magnetic efficiency. Self-supporting coils, dispensing with the use of bobbins or formers can be wound. This offers a new form of coil of great interest to designers.

Sync.-signal Regeneration System for Low-power Translators †

by

P. K. KIRILLOFF ‡

A contribution given on 4th July 1959 during the Institution's Convention in Cambridge.

Summary : Noise-immune synchronization for fringe area television reception is discussed. The general lay-out of low-power translators used for expanding regular television reception areas is also considered with a special stress on the sync.-signal restoration circuit.

1. Introduction

The use of translators is one of the methods by which the regular television service area can be expanded. Such a translator consists of a low-power television transmitter and special receiving equipment.

Direct reception on domestic television receivers is quite reliable at distances up to 35-45 miles, while special receivers and high-gain aerials permit signals to be received at greater distances from 60 to 100 miles. When direct reception is impossible, the low-power transmitter of the translator together with cable or radio relay links can be used to bring the main station signals to remote small towns and communities.

It should be noted that when reception is achieved directly from the main station, we can only improve the receiving end of the communication channel by complicating the aerial system and by increasing the sync.-circuit noise immunity. To achieve stability and quality in the operation of special long-range receiving stations the equipment can be complicated to a very high degree but this method is not permissible as far as mass production television sets are concerned.

2. Synchronizing-signal Restoration

The main purpose of the special receiver incorporated in the translator is to minimize the noise signals in the video signal applied to

the transmitter modulator. As is well known sync. stability is first of all affected by noise signals. Consequently special measures are provided in the receiver for "cleaning" sync. signals to remove noise which might find its way into the sync. channel. In this case the sync. pulses can, for all practical purposes, be considered as restored.

To achieve this the receiver incorporates:

- (a) a separate sync. channel with a narrow-band i.f. amplifier.
- (b) a noise-immune clipper circuit.
- (c) a "comb" filter for horizontal sync. signal separation.

In addition the receiver possesses an amplified "keyed" a.g.c. system.

The receiver sensitivity is approximately 30-60 microvolts with a 20-db signal/noise ratio.

The complete sync. signal consists of the horizontal sync. pulses and the vertical group, which includes equalizing pulses and the serrated vertical sync. pulse. As a rule, horizontal synchronization is the first to be affected by noise with consequent deterioration of the picture, while vertical synchronization is more stable under the same conditions. Taking this into account and striving for technical simplicity in the design, it is advisable to separate the sync. mixture into two groups, the noise in each group being suppressed by different methods. The sync. mixture frequency spectrum can be considered as a function of time. The spectrum of the horizontal sync. pulses (considered as a continuous sequence) consists of horizontal frequency harmonics.

† Manuscript received 1st July 1959. (Contribution No. 27.)

‡ State Committee for Radio Electronics, Moscow. U.D.C. No. 621.397.61

The spectrum of both equalizing pulses and vertical serrations (again considered as a continuous sequence) consists of harmonics of twice the horizontal frequency. The sync. mixture includes both the vertical and horizontal groups, and its spectrum is more complicated.

second input. The functional diagram of the noise suppression unit for the sync. mixture is shown in Fig. 2.

When the vertical group is being transmitted the signal taken from the three tank circuits of the "comb" filter is noticeably weaker since most of the energy in the vertical group is concentrated in the even harmonics. Therefore it is possible to single out the vertical group at the output of the anti-coincidence circuit.

The cleaned horizontal group and singled-out vertical group are applied to a summing stage from the output of which the signal is fed to a shaper trigger. The "cleaned" sync. mixture to be inserted into the video signal is obtained at the trigger output.

In order to do this the video signal is limited to the blanking pulse level to remove the primary sync. mixture. This is accomplished with the aid of a diode limiter and a keyed circuit clamping the blank level. The tips of the blank pulses are kept at the limiting level by the keyed clamping circuit.

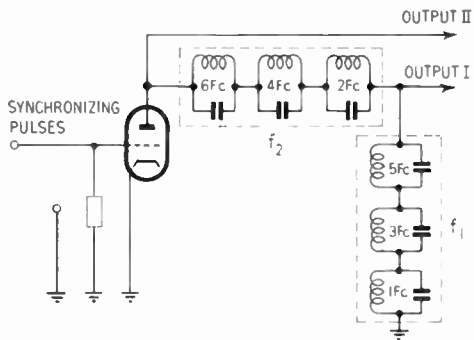

Fig. 1. Circuit diagram of amplifier with "comb" type frequency response.

Nevertheless the main energy is concentrated at frequencies (1) which are multiples of the horizontal frequency (when the horizontal sync. pulses are being transmitted), and (2), which are multiples of twice the horizontal frequency (when the vertical sync. pulses are being transmitted).

To decrease noise signals in the horizontal group "comb" filters may be used. They consist of series-connected tank circuits tuned to the horizontal frequency harmonics. This makes it possible to single out on each circuit the respective harmonic voltages and to obtain their sum (Fig. 1). Since the complete restoration of the vertical group is a difficult matter and is not absolutely necessary, the vertical sync. pulses may just be bilaterally clipped.

In order to mix the vertical group with the horizontal sync.-pulses which have already been cleaned with the aid of the "comb" filter it is necessary to single out this group from the primary (uncleaned) sync. mixture. Singling out of the vertical group is accomplished with an anti-coincidence circuit. In such a circuit the primary sync. mixture is applied to one of the inputs, while a signal from the three tank circuits tuned to odd harmonics of the "comb" filter or a special gate pulse is applied to the

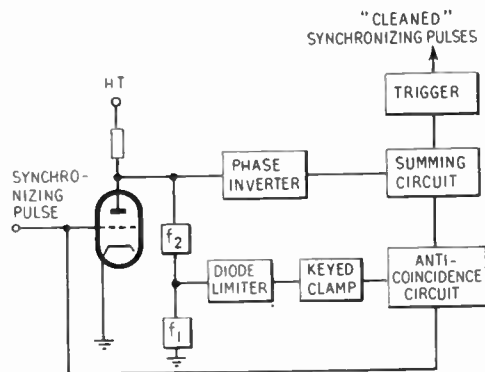

Fig. 2. Functional diagram of sync. mixture noise-suppression unit.

The limited video signal and the "cleaned" sync. mixture are applied to a summing stage at the output of which a complete video signal is obtained. Then this video signal is fed to the vision transmitter modulator.

The translator includes a vision transmitter and sound transmitter. At present in the U.S.S.R. both 20-watt and 100-watt translators are produced (power is indicated for the vision

transmitter). The transmitter of these translators operate in any chosen channel in the 48-100 Mc/s and in the 174-230 Mc/s bands. The vision transmitter bandwidth is approximately 4.5 Mc/s.

3. Automatic and Remote Operation of Translators

As the number of television stations put into service grows the need for translators also increases. Hence economical servicing of translators is a problem of great importance, and unattended translators have been introduced. Such translators are designed both for automatic operation and for remote control.

When automatically operated an unattended translator is switched on by the main station signal which actuates a "watching indicator" and is switched off when this signal disappears. The control system also prevents spurious operation which may be caused by interference signals or by momentary disappearance of the main station signal. All translator stations include complete reserve equipment. In case of failure the appropriate reserve unit is automatically switched on.

In the remote control version switching on and off and transition from active to reserve units is accomplished from a control panel located in a near-by communications office. The control panel may be a distance of six miles from the translator and is connected to it with two pairs of telephone wires. The translator can operate for a month without any servicing.

A 5-watt unattended translator with its special receiver unit is shown in Fig. 3.

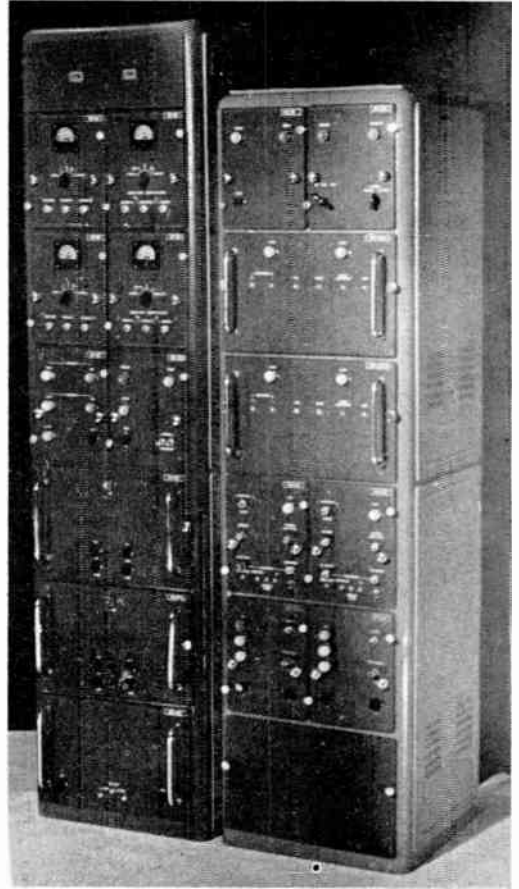

Fig. 3. Low-power unattended translator.

APPLICANTS FOR ELECTION AND TRANSFER

As a result of its May meeting the Membership Committee recommended to the Council the following elections and transfers.

In accordance with a resolution of Council, and in the absence of any objections, the election and transfer of the candidates to the class indicated will be confirmed fourteen days after the date of circulation of this list. Any objections or communications concerning these elections should be addressed to the General Secretary for submission to the Council.

Transfer from Associate Member to Member

BLAKEMAN, Eric Thomas, B.Sc.(Eng.), *Leyland, Lancs.*
NICOL, William Paul, *Gerrards Cross, Bucks.*
WOOD, Gp. Capt. Philip Harold Seymour, O.B.E., R.A.F. (Ret'd), *Bedford.*

Direct Election to Associate Member

BROWN, Lt. Cdr. Harry, R.N. *Purley, Surrey.*
BROWN, Kenneth Charles, B.Sc. *Ibadan, W. Nigeria.*
DOWNING, Thomas William Frederick, *London, S.E.9.*
FONSEKA, Swinburne Bertie, *Colombo, Ceylon.*
HALL, Cyril John, B.Sc. *Athls-Mons, France.*
OBERMAN, Alfred Horace George, *Alverstoke, Hampshire.*
WALL, Geoffrey Ernest, B.Sc.(Physics), *Wells, Somerset.*

Transfer from Associate to Associate Member

LEE, John, *Cheltenham, Glos.*

Transfer from Graduate to Associate Member

BRIGGS, Sqdn. Ldr. Eric Harold, R.A.F. *Dereham, Norfolk.*
CARTER, Arthur William H. *Richmond, Surrey.*
DESAI, Gajanan Vishnu, B.Sc.(Hons.), *Bombay.*
GRAY, Robert Frank, *Aden.*
GROSS, Michael Hubert, *Chelmsford, Essex.*
LONGLAND, David Arthur, B.Sc. *East Twickenham.*
MULLARD, John Eric, *Woodbridge, Suffolk.*
RICHARDS, Arthur Edwin, *Maldenhead, Berks.*
RICHES, William Henry, *Selsdon, Surrey.*
TREGEAR, Paul, *Weybridge, Surrey.*
WILMOT, Sqdn. Ldr. Alfred, R.A.F. *Mountain Ash, Glamorgan.*

Transfer from Student to Associate Member

HAMILTON, James Henry, *Dublin.*
KELLEHER, John, *Uxbridge, Middlesex.*

Direct Election to Associate

ARCHER, Kenneth, *Huddersfield, Yorkshire.*
POOLEY, Eric Kenneth, *Southend-on-Sea.*
WEENINK, Martinus Cornelis, *Curaçao, Dutch West Indies.*

Direct Election to Graduate

ASHDOWN, Michael Bryan, *Bromley, Kent.*
CHARLTON, Ian John Austin, *Romford, Essex.*
CLARKE, Leonard Harold, *Birmingham.*
CLAY, Plt. O.T. Michael Charles, R.A.F. *Bisley, Surrey.*
DATAR, Sudhakar, B.Sc. *London, S.W.19.*
DIGGLE, Geoffrey Edward, *London, N.19.*
HANCOCK, Flt. Lt. Raymond, R.A.F. *London, S.W.1.*
HANSON, Patrick Temple Gairdner, *St. Albans.*
HARRIS, Malcolm Frederick, *London, S.E.3.*
MEENS, Philip Henry, *London, W.5.*
OKUNRINBOYE, Olufolarin, *Welwyn Garden City.*
RAMANATHAN, Kaithakode Puthanvedu, *Kuala Lumpur.*
WINSLOW, Terence Raymond, *Wolverhampton.*

Transfer from Student to Graduate

AHMAD, Hafeeb, *Rainandgaon, India.*
SAVOOR, Krishna Rao, B.Sc. *London, E.4.*

STUDENTSHIP REGISTRATIONS

The following 71 students were registered at the March and April meetings of the Committee. The names of a further 62 students registered at the May meeting will be published later.

AGASS, Benjamin E. *Basingstoke, Hants.*
BILLINGTON, Paul S. *Bruton, Somerset.*
BROGAN, Gerard, *Laval West, Canada.*
BRUNSDON, Graham P. *Brentwood.*
BURTON, Geoffrey, *Abingdon, Berks.*
CARROLL, Richard F. *Washington, Co. Durham.*
CHALLIS, Anthony Frank, *Chelmsford.*
CHAN, Ronnie Ronald Swee Hoon, *Singapore.*
COBB, Ronald Arthur, *Basingstoke.*
D'CRUZ, Horace Leslie, B.Sc. *Northolt.*
DENHAM, Thomas Ernest, *Cambridge.*
DICKS, Jack L. *St. Johns, Newfoundland.*
DUFFY, Francis Fintain, *Covenry.*
EALLES, Sidney B. *Letchworth, Herts.*
ERLICH, Mordechai, *Hameuchad, Israel.*
EYLES, Frank W. *Nantwich, Cheshire.*
EZE, Victor Chukwuemeka, *London, N.7.*
EZIASHI, John, *London, N.19.*
FRAMPTON, Geoffrey A. *London, S.W.16.*
GIANNOPOULOS, Panayotis, *Athens.*
GOODWIN, Gerald, *Barrow-in-Furness.*
HANSOTT, John, *Wallasey, Cheshire.*
HAYES, Maurice George, *Malta, G.C.*
JEGEDE, Ayodele, *Ibadan, Nigeria.*
KAPONIDES, Aristides, *London, N.4.*
LEELA, Laxminarsima, Miss, B.Sc. *Westcliff-on-Sea.*

*LEVY, Yermiyahv, *Sutton Coldfield.*
LIM, Yoon Kooi, *Perak, Malaya.*
LINNEY, Peter John, *London, W.13.*
LOWE, Bernard Joseph, *Bedford.*
LOYNES, David Howard, *Liverpool.*
LUTER, Michael E. *East Cowes.*
MATHUR, Prabhat K., B.Sc. *Basingstoke.*
MENDIS, Martin, *Kuala Trengganu, Malaya.*
PING SHUE, Law, *Hong Kong.*
SANDERS, Thomas Gerald, *Malvern.*
SARGOOD, Alan Richard, *Southampton.*
SCOTT, Claude F., B.Sc. *London, S.W.11.*
SEENEY, Gordon W. *Reading, Berks.*
SMITCH, Francis G. *Bury St. Edmunds.*
SMITH, Gerald J. G. *Trowbridge.*
SOUTHWELL, Capt. Barry, R.E.M.E. *Gosport.*
STEVENS, John H. *Guildford, Surrey.*
STOKES, Roy, *Cambridge.*
TIFFIN, Allen James, *Tiptree, Essex.*

AHMED, Zobaer, *Rothsay, Isle of Bute.*
BAPLE, Clarence Percy, *Plymouth.*
BATES, Arthur Owen, *Slough.*
BLAIR, Desmond McGavock, *Larne.*
FERNANDEZ, Samuel N. *Johore Bahru, Malaya.*
HILL, John W. *Newport, Monmouthshire.*

IABLOVER, Alec, *Haifa, Israel.*
JALI, Muhammad Anwar, B.A. *Khartoum.*
KOPTEROS, George B. *Cambridge, U.S.A.*
KWAWUKUME, Oscar Aitsu, *London, S.W.2.*
LEE, Han Chi, B.Sc. *Hong Kong.*
LEWIS, John T. *Hayes, Middlesex.*
LING PING CHI, B.Sc.(Eng.), *Hong Kong.*
NICHOLSON, Harry, *Hartlepool, Co. Durham.*
PARASURAMAN, P. S., M.A. *Madras.*
PERRY, Edward H. *Enfield, Middlesex.*
PICKARD, John, *High Wycombe.*
PICKSTOCK, Barry T. *Chelmsford, Essex.*
PILLAI, Rajagopala, *Kera'a, India.*
RAMACHANDRA MURTHY, Kompella Gopala, B.Sc. *Kothapeta, India.*
ROBERTS, Douglas I. *Cranford.*
SANSOM, Walter A. *Hawick, Roxburghshire.*
SPURWAY, John L. *Sevenoaks, Kent.*
*SRINIVASAN, Peruvamba Krishna, *Bangalore.*
VEELABHADRAIAH, H. S. *New Delhi.*
WEST, Noland, *Poole, Dorset.*
† SAYAL, Nardev Pal, *Singapore.*

* Reinstatements.

† Omitted from the list of registrations at the June 1959 meeting which was published in the November *Journal*.

Radio Engineering Overseas . . .

The following abstracts are taken from Commonwealth, European and Asian journals received by the Institution's Library. Members who wish to consult any of these papers should apply to the Librarian, giving full bibliographical details, i.e. title, author, journal and date, of the paper required. All papers are in the language of the country of origin of the journal unless otherwise stated. The Institution regrets that translations cannot be supplied; information on translating services will be found in the publication "Library Services and Technical Information."

POLARIZATION OF SOLAR RADIATION

Work carried out at the Meudon Observatory in France on the polarization of solar radiation is reported in a recent Indian paper which describes a high resolution interferometer for 3 cm waves. The dimensions of polarized and unpolarized sources have been measured and it has been found that the main contribution to the polarization of the radiation emitted by a persistent source comes from the narrow and bright region (apparent diameter less than 1.5 min) of the source; the diffuse region of larger diameter does not contribute much to the polarization of the total radiation from the source. About 60% of the bursts observed on 3 cm waves have been found to be polarized. The probability of observing a polarized burst seems to be greater for the bursts of small diameter. Great bursts associated with metre-wave bursts of a particular type have been in most cases found to be polarized.

"On the polarization of sources of solar activity on 3 cm wavelength," M. R. Kundu and J. L. Steinburg. *Journal of the Institution of Telecommunication Engineers, New Delhi*, 6, pp. 23-30, December 1959.

STATISTICS OF RELIABILITY

If the average lives of the various kinds of structural elements of a system are known, and it is further assumed that the lives of each kind follow an exponential distribution, the life distribution of the system can be easily stated. A German paper shows how predictions can be made concerning the anticipated useful life of a system, if the average life of the structural element is not accurately known, but has merely been determined with the aid of more or less extensive samples.

"A statistical method for useful life predictions in communication systems," H. Stormer. *Archiv der Elektrischen Übertragung*, 14, pp. 217-24, May 1960.

VERY HIGH VALUE RESISTORS

In the measurement of extremely weak currents, very high value resistances ($10^7 - 10^{15}$ ohms), are necessary. A range of carbon layer resistors mounted in evacuated sealed glass tubes are described in a paper in a French journal. The manufacture of these resistors is discussed and their electrical properties described in some detail. Applications are then reviewed briefly, namely:

Measurement of very weak current (ionization chamber); measurement of insulation resistance; standardization of measurement apparatus.

"Operating characteristics of very high value resistances." R. Miclo and J. Tsoca. *L'Onde Electrique*, 40, pp. 249-51, March 1960.

TRANSISTORIZED RECEIVERS

Community receivers were introduced in India some fifteen years ago to make available to the rural areas facilities for listening to broadcasts from All-India Radio. These receivers have generally been operated from dry batteries, but the possibility of effecting economies in battery power consumption by using transistors has been investigated. A recent paper describes briefly a method of stabilization of the bandpass characteristics of the h.f. stages on application of a.g.c. The complexity of the circuit technique required for this purpose and the high cost of h.f. transistors lead to a prohibitive cost of the community receiver. A hybrid design, i.e. a design utilizing both valves and transistors, is then described and it is shown that at slight increased initial cost one can secure substantial economies in maintenance and battery replacement costs.

"Transistors in community receivers," M. V. Joshi and T. V. Ramamurti. *Journal of the Institution of Telecommunication Engineers, New Delhi*, 6, pp. 71-76, February 1960.

WIDE-BAND OMNIDIRECTIONAL RADIATORS

A recent German paper reports on measurements of input impedance and reflection coefficient of different types of omnidirectional radiators having extremely wide bandwidth and optimum shape. The paper goes on to describe the electrostatic field of these radiators as a basis for the calculation of the impedance at very low frequencies and an approximation for the lower cut-off frequency for matching. The optimum shape of a wide-band radiator is shown to be a cone with smooth rounded corners. The essential condition for wide-band characteristics of matching is a well-matched transition between feeder and radiator.

"Wide-band omnidirectional radiators of axial symmetry with high-pass matching characteristics." H. Meinke. *Nachrichtentechnische Zeitschrift*, 13, pp. 161-8, April 1961.

DIELECTRIC PLATE RADOME

A new type of radome employing metal mesh embedded in the dielectric plate to cancel reflections is discussed in a recent Japanese paper. Special regard is paid to the various fabrication errors likely to effect its electrical performance, and theoretical results are compared with experimental data on actual aerials. Radomes of this type are serving as anti-snow protectors to some of the aerials of a 4000-Mc/s multi-channel relay link in Japan. It is suggested in the paper that radomes of this type may find applications for airborne radar antennas.

"Metal-mesh embedded dielectric radome for antenna system." T. Kitsuregawa and F. Arita. *Mitsubishi Denki Laboratory Reports*, No. 1, pp. 27-50, January 1960. (In English.)

PARASITIC RESONANCES

A recent Dutch paper presents measurements on u.h.f. triodes which reveal that parasitic resonances of the cathode-heater system of electron tubes may very well lead to difficulties at ultra-high frequencies even though the geometrical dimensions are considerably smaller than a quarter wave-length. These parasitic resonances may give rise to unsatisfactory operation of oscillator tubes within a well-defined frequency range. Although the oscillatory condition is apparently satisfied, oscillation may become poor or even cease completely. To investigate the influence of the geometry of the tube components, admittance curves of various experimental electrode systems were plotted on Smith charts. (The paper contains a useful introduction to the use of the Smith chart.) The curves revealed the cause of these resonances and have led to constructional measures which eliminate this trouble. It is possible to suppress these resonances completely by terminating the transmission line, which is formed by the heater and cathode, by a resistance in the order of its characteristic impedance, but as a rule this method will not be practicable. A solution to this problem consists in incorporating a small inductance in the cathode lead, which results in the disturbances occurring at lower frequencies.

"Parasitic resonances in tubes at ultra-high frequencies," *Electronic Applications, Eindhoven*, 20, No. 1, pp. 24-40, 1960. (In English.)

MICROWAVE RADIO LINKS

Microwave radio-relay systems have played an increasingly important role in recent years in the provision of large quantities of high-grade communication circuits particularly in countries such as Canada where wide sparsely populated tracts of country have to be traversed. A paper discussing the problems and means for their solution was

presented at the recent annual meeting of the Engineering Institute of Canada in Winnipeg and the author began by first categorizing systems as "heavy route" or "light route" depending on circuit requirements and distances involved between terminal points. Careful route layout is required in order to use the minimum number of repeaters necessary to provide the desired performance and reliability.

The requirement for a system is created by the demand for more circuits or the improvement of existing circuits. Once a requirement has been established, the most suitable route must be determined. If the end points of the system are widely separated and intermediate requirements are not of major proportions, considerable savings can accrue with wise routing. An actual case was presented to demonstrate this approach to routing. Some special cases create the demand for a microwave system and a case was described in detail where a complete toll line had been replaced by a microwave system without circuit additions.

For a proposed system, the required performance must be established with consideration for the ultimate capacity of the route. The system must then be engineered to these requirements. Cost and propagation studies must be made and the technical and service features of available equipment investigated to determine the best means of meeting the requirements. The paper details the calculation and considerations for performance and reliability necessary to engineer a light route system for a typical case. Performance figures based on actual results are presented. Systems using both frequency and space diversity to maintain propagation reliability are described.

"Application of microwave radio links," R. W. Wilson. *Engineering Journal of Canada*, 43, pp. 98-102, April 1960.

SYNC. AND A.G.C. CIRCUITS FOR TELEVISION RECEIVERS

In a paper presented at the 1959 Convention of the Australian I.R.E. it is shown that the requirements of sync. and a.g.c. circuits are similar and can be satisfied by twin pentode valves having two control grids with sharp cut-off characteristics. A circuit using the twin pentode 6BU8 to provide a noise gated sync. clipper and keyed a.g.c. amplifier is described. A.g.c. level and noise gate controls are included in the circuit. Design considerations in connection with the valve characteristics and maximum ratings are also discussed.

"A new approach to sync. and a.g.c. circuitry," H. R. Wiltshire and J. Van Der Goot. *Proceedings of the Institution of Radio Engineers, Australia*, 21, pp. 211-24, April 1960.