

The Journal of

THE BRITISH INSTITUTION OF RADIO ENGINEERS

FOUNDED 1925

INCORPORATED 1932

*"To promote the advancement of radio, electronics and kindred subjects
by the exchange of information in these branches of engineering."*

VOLUME 19

DECEMBER 1959

NUMBER 12

REPORT OF THE 34th ANNUAL GENERAL MEETING

The Institution's Annual General Meeting, the twenty-sixth since Incorporation, was held at the London School of Hygiene and Tropical Medicine on Wednesday, 2nd December, 1959.

The Chair was taken by the President, Professor E. E. Zepler, Ph.D., who was supported by other officers of the Institution and members of the Council. When the meeting opened at 6.5 p.m., 52 corporate members had signed the Minute Book: in addition, a number of non-corporate members were present.

The Secretary, Mr. G. D. Clifford, read the notice convening the meeting, which had been circulated to members on 16th September, 1959, and subsequently published on page 593 of the October *Journal*.

1. To confirm the Minutes of the 33rd Annual General Meeting held on the 26th November, 1958

The Secretary stated that the report of the last Annual General Meeting was published on pages 693—695 of the December 1958 *Journal*. The President's proposal that these Minutes be signed as a correct record of the proceedings was approved unanimously.

2. To receive the Annual Report of the Council for the year ended 31st March, 1959

The President referred to the publication of the Annual Report in the October 1959 *Journal* and called upon Professor Emrys Williams, a Vice-President of the Institution, to present the Report.

Professor Williams said that the Annual Report laid stress on two very important aspects of the Institution's work—strengthening the relations between members of all countries, and establishing Specialized Groups.

The formation of further Sections, both at home and overseas, had been greatly welcomed by members and thanks must be expressed to the local Committees who did so much to organize the activities of those Sections.

In addition, three Specialized Groups were operating in London at the moment—the Computer Group, the Radar and Navigational Aids Group, and the Medical Electronics Group. It was the intention of the Council to form an Audio Frequency Engineering Group in the near future.

It was always the desire of the Council to co-operate with any recognized body whose work in a general sense might advance science and technology. Such opportunities for co-operation did arise through some of these Specialized Groups. It was, therefore, with considerable regret that the Council had to record failure to secure co-operation, in the national interests, in the Medical Electronics field. The Council believed that publication of its belief in the value of interchange of opinion between kindred bodies would ultimately overcome present inhibitions.

The sections of the Report dealing with Membership, Education and Examinations indicated the growing strength of the Institution. The three Committees concerned were very competent to handle these important facets of the Institution's activities, and were obviously interdependent Committees. The standard of the membership was indeed very largely dependent upon the work of the Examinations Committee: nor should it be forgotten that in promoting adequate training for the radio and electronics

engineer the Institution had not neglected its indirect responsibilities towards the mechanic and technician. It was nearly twenty years since the Institution promoted the idea of a Radio Trades Examination Board, whose examination was now accepted as a national standard and providing the technical schools with a nationally agreed syllabus.

Professor Williams particularly commended to members the work of the Technical Committee, the Library Committee, the Programme Committee and the Group Committees as being the means by which the Institution achieved one of its main objects—"to promote the advancement of radio and electronics by the exchange of information." In many ways the Technical Committee not only provided information but actually initiated the form of information. Its various Reports, participation in the work of standardization, and arrangement of visits, all contributed to encouraging good engineering practice and to facilitating access to information.

The work done by the Programme and Papers Committee was reflected in every *Journal* and in every meeting. Professor Williams personally had the greatest sympathy with the Committee in its constant endeavour to persuade the Council to finance more and larger *Journals*, and in trying to arrange more meetings. The work of the Groups posed further problems in this latter connection which would never really be overcome until the Institution acquired its own premises and Lecture Theatre.

Professor Williams concluded: "It has, Mr. President, become a feature in presenting our Annual Reports for the mover of the motion to express a vote of thanks to those members who give up their time to serve on the various Committees. It would be impossible to have an Annual Report to present were it not for the members who so ably assist the Council in this way. It is with a personal sense of gratitude to our Standing Committees, therefore, that I formally move the adoption of the 33rd Annual Report of the Institution."

The proposal was seconded by Mr. R. N. Lord (Associate Member) and the Report was adopted unanimously.

3. To elect the President

Mr. Thompson said that, on behalf of the Officers and Council of the Institution, it gave

him very much pleasure to propose the re-election of Professor Eric E. Zepler as President of the Institution. Mr. Thompson continued: "Professor Zepler has served the Institution in many ways; first as an examiner, later as Chairman of our Education and Examinations Committee, and then as a member of Council. His Presidential Address, dealing with the education and training of the radio engineer, achieved international quotation.

"In the past twelve months, however, we on the Council of the Institution have had much cause to appreciate the care with which our President has led our deliberations. It is because of our confidence in Professor Zepler's direction of the Institution's work, and his good relations with all who work in the interests of science, that on behalf of the Council I formally move that Professor Eric Zepler be invited to continue for a further period as President of the Institution."

The motion that Professor Zepler be re-elected President for a further year was carried with acclamation.

4. To re-elect the Vice-Presidents

Professor Zepler thanked the members for the way in which they had received the Council's proposal to re-elect him as President of the Institution for a further year. He then expressed his personal pleasure in proposing the re-election of the following Vice-Presidents:

John Langham Thompson.

Professor Emrys Williams, PH.D., B.ENG.

Air Vice-Marshal C. P. Brown, C.B., C.B.E., D.F.C.

Colonel G. W. Raby, C.B.E.

The proposal was approved unanimously.

5. To elect the Ordinary Members of Council

Professor Zepler stated that the Council had not received any opposing nominations to fill the vacancies arising for Ordinary Members of Council, and he declared the following members elected to Council for the year 1959-60:

Eric K. Cole, C.B.E. (*Honorary Member*); A. D. Booth, D.SC. (*Member*); Ieuan Maddock, O.B.E., B.Sc. (*Member*); D. L. Leete, B.Sc. (*Associate Member*); Squadron Leader W. L. Price, O.B.E., M.Sc. (*Associate Member*); A. H. Whiteley, M.B.E. (*Companion*).

It was with regret that he had to report that Air Marshal Sir Raymund Hart had reluctantly decided that his business commitments during

the coming year would make it impossible for him adequately to serve the Institution and membership as a member of the Council. Council had therefore decided, in accordance with Article 35 of the Institution's constitution, to co-opt Mr. F. G. Diver, M.B.E. (*Member*), who had previously served on the Council.

6. To elect the Honorary Treasurer

The President stated that he was sure members would agree, after having read the section of the Annual Report dealing with Finance, that Mr. George A. Taylor had earned their thanks for the way in which he supervised this important aspect of the Institution's work. He formally moved that Mr. Taylor be re-elected as Honorary Treasurer of the Institution, and the motion was carried unanimously.

7. To receive the Auditors' Report, Accounts and Balance Sheet for the year ended 31st March, 1959

Mr. G. A. Taylor expressed his appreciation of being re-elected and then moved the adoption of the year's accounts in the following terms:

"The Accounts which are before members show that during the year the Institution has kept within its income, but it is becoming increasingly difficult for the Council to continue with all the economies which have been effected for several years. Although the Council is pleased that increases in Administration expenses have been kept to a minimum commensurate with rising costs, it will not be possible always to maintain this effort. For example, it is incumbent upon the Council to give urgent consideration to the provision of adequate pension schemes, etc., for the staff."

Mr. Taylor referred to the possibility of an increase in subscription rates, as mentioned in the *Journal* and stated that the Council had been encouraged by the fact that no adverse comments had so far been received. He hoped that in the event of this proposal taking effect, every member would bear in mind the relief which had been extended by the Chancellor of the Exchequer in regard to subscriptions to professional bodies. The Institution, however, did not receive any concessions and was still having to meet many increases in costs.

Referring to the Building Appeal, Mr. Taylor thanked all members and industrial organizations who were giving support to the Institu-

tion's endeavours to secure its own building. Members would have seen in the Annual Report that the contributions so far received had warranted the Council now taking steps to secure a suitable building site.

The Balance Sheet showed a gradual building up of the Institution's Reserves and Mr. Taylor believed members would agree that the Accounts reflected the growing financial stability of the Institution.

Mr. Taylor concluded by paying tribute to the help which he had received from the members of the Finance Committee and then moved the adoption of the Accounts and Balance Sheet for the year ended 31st March, 1959.

The motion was approved unanimously.

8. & 9. To appoint Auditors and Solicitors, and to agree the Auditors' remuneration

The President stated that there were many ways in which the Institution's Auditors and Solicitors co-operated with each other in advising the Institution on financial and legal matters. He asked the meeting's permission, therefore, to take items 8 and 9 together so that members could signify their thanks to Messrs. Gladstone, Jenkins & Co., and to Messrs. Braund & Hill, for their co-ordination of opinion and advice, and for their help to the Institution, by re-appointing them as Auditors and Solicitors respectively.

Professor Zepler also formally moved that, in accordance with usual custom, the Auditors' remuneration be left to the discretion of the Council.

The motion was approved unanimously.

10. Awards to Premium and Prize Winners

Professor Zepler congratulated the recipients of Premiums and Examination Prizes for 1958 and presented the awards to the authors and successful examination candidates. He especially welcomed Dr. A. van Weel who received the Sir Louis Sterling Premium for the third year in succession. (A list of winners of Premiums was published in the July *Journal*, and Prize winners are given in the Annual Report.

11. Any other business

The Secretary confirmed that he had not received notice of any other business, and at 6.50 p.m. the President declared the 34th Annual General Meeting closed.

INSTITUTION NOTICES

Christopher Columbus Prize awarded to Members

Members will be interested to learn that the 1959 Christopher Columbus International Prize for Communications given by the City of Genoa has been awarded to Brigadier General David Sarnoff and Dr. Vladimir K. Zworykin, both Honorary Members of the Institution, and Dr. Elmer William Engstrom. The citation of the award refers to the contributions made by the recipients, who are all with the Radio Corporation of America, to the progress of information transmission and the advancement of electronics, especially in the field of black and white and colour television. The Christopher Columbus Prize, which has a value of 5,000,000 lire, is awarded for important work in the field of communications in the past four years. Each year one of the categories of maritime, air or land communication, or telecommunication is selected, and this year's award is, of course, in the latter category.

Students' Essay Competition

The Council has decided that, in view of the disappointing number of entries for last year's Students' Essay Competition, the subject—"The Future of Electronics in Industry"—will be repeated for 1960. The value of the prize for the most outstanding essay has been increased to £20, and there are now second and third prizes of £10 and £5 respectively; outstanding essays will be considered for publication in the *Journal*. Essays should be between 3,000 and 5,000 words in length, and the closing date for their submission will be the 31st March 1960. The competition is open to all registered Students and to Graduates who are under the age of 23 years at the closing date.

Completion of Volume

This issue completes Volume 19 of the *Journal*. An index to the Volume will be distributed with the January 1960 issue.

Members wishing to have their *Journals* bound by the Institution should send the complete set of issues and index to the Institution (See Cover II for details).

Technical Visit

A party of Institution members enjoyed the hospitality of the Mullard Organization in a visit to their transistor factory at Southampton on 3rd November. This visit was arranged by the Technical Committee. Films of the basic methods of transistor production and theory were shown before the visit, and opportunity given for discussion.

At the factory members were able to follow the complete process for three main types of transistor, from the purifying of the germanium to the testing of the finished products. Members were impressed with the scale of quality control exercised at all stages of manufacture.

The 1959 Physical Society Exhibition

The hours of opening of the Exhibition on Friday, 22nd January, will be 10 a.m. to 1 p.m. *not* 10 a.m. to 3 p.m. as previously announced; other details published in the November issue of the *Journal* (page 666) are correct as stated. Members who wish to take advantage of the Physical Society's offer of tickets for the "members' morning" or for other times should apply to the Institution without delay.

During the Exhibition, discourses (demonstration-lectures) will be given as follows:—

Monday, 18th January.

"Some Reactions of the Human Body to the Stresses of High Performance Flight" by Flt. Lt. J. Billingham (*R.A.F. Institute of Aviation Medicine*).

Tuesday, 19th January.

"Atomic Time" by Dr. L. Essen (*N.P.L.*).

Wednesday, 20th January.

"Recent Advances in Solid State Physics" by Dr. D. A. Wright (*Research Laboratories of the General Electric Company Ltd.*).

Special admission tickets are *not* needed for the discourses, which will start at 5.45 p.m.

Correction

A typographical error occurs in the report of the discussion on the paper by W. J. Morcom, "Gap Filling Transmitters and Translators" published in the October *Journal*.

On page 660, left hand column, fourth paragraph, the noise figure *should read* 4.6 db.

THE DRIFT OF ELECTRONICS†

by

Captain LUCIEN HIX, R.N., B.SC.(HONS.), MEMBER‡

The Chairman's Address to the South Western Section of the Institution

Delivered in Bristol on 7th October, 1959

Introduction

It was perhaps a little tempting for me to survey in this Address some technical subject with a naval bias which I could get from my daily duties. I have not done so and have instead tried to gather together many large aspects of Electronics and present them in a simple way to illustrate the very broad but basically unified pattern to which all who are concerned with Electronics are contributing in one way or another. This is of course "broad-brush" art which some might regard as a restatement of the obvious. However, there are occasions when the obvious is missed until restated and it is for you to judge whether this has been true of my Address at its conclusion.

For the title I chose the "Drift of Electronics" rather than the trend. There is no guiding hand to direct science and engineering in a particular way, nor a formula for discovering new principles. Drift in a d.c. amplifier is uncontrollable and its observation is important. The drift of Electronics is also uncontrollable and its observation may be important too.

What is Electronics ?

Let us examine first what the term "Electronics" is thought to mean. The following are definitions taken from leading authorities:

- (1) The science which deals with the behaviour of free electrons.
- (2) A branch of Physics dealing with elementary particles (protons, neutrons, etc.).
- (3) The science or practice of using electricity in devices similar to radio tubes

so as to get results not possible with ordinary electrical equipment.

- (4) That branch of science and Technology which deals with the study of phenomena of conduction of electricity in a vacuum, in a gas, and in semi-conductors, and with utilization of devices based on these phenomena.
- (5) Describes the wide uses of the radio valve and kindred devices: it is radio technique at work in new ways and in widely diverse fields.
- (6) A bag of tricks culled from radio, radar and electrical engineering, to which are added from time to time any likely new items from research in pure and applied physics.

One can go on adding to this list, but electronics engineers will recognize that the last one, flippant though it is, gets nearest the truth.

One's first thought is to shorten the word to "electron" and use that as a guide; but free electrons exist in the ionosphere, in the atmosphere around us, in an X-ray tube, a cyclotron, a copper wire. Conduction in gases is concerned with ions, not electrons, and these are used not only in a cold-cathode tube or a thyratron, but also in a mercury arc rectifier, a fluorescent lamp, an electric arc, or an electrostatic precipitator. Semi-conductors until recently have been more used for electrical power purposes than for electronics. Then too what about magnetic amplifiers, ferro-electric amplifiers, bang-bang (or switch) amplifiers, rotary amplifiers, metadynes, amplidyne? A study of the equivalent circuit of an ordinary thermionic valve, shows that it consists of a generator plus R's and C's; in other words there is no essential difference (apart from a surfeit of L, rather than R and C) between an electric generator and a thermionic valve. Also electric components

† Manuscript received 27th August 1959. (Address No. 18.)

‡ Admiralty Electrical Engineering Department; now with Admiralty Surface Weapons Establishment, U.D.C. No. 621.37/9

seem only to be electronic if they are small or used in a radio set. It took the electrical engineer some time to discover that electrical L's, R's and C's were just the same as the electronic ones, and the electronics engineer has had the same sort of inhibition.

The term "electronic" acquired its serious meaning shortly before the war to describe a technique which had grown from radio and was proving useful for non-radio purposes. It also described the type of component put on the market to satisfy the needs of that technique. There is in fact no more difference between electronic components and electrical components than there is between a coffee cup and a tea cup.

In advertising for an electronics engineer the industrial employer knows what he wants. He does not want a man who uses electrons, or controls the discharge through a gas, or shapes a piece of semi-conductor. He wants an engineer who can process electrical signals, signals from a microphone, a switch, a strain gauge, a radio aerial, and knows how to generate other kinds of signals if he needs to. The technique is focused on electrical signal processing with the word "signal" used comprehensively, by no means confined to telecommunications. This view could be made more precise by confining the signal processing circuit elements to static ones only, i.e., electrons and ions move, but the medium through which they travel does not move. However we are here getting down to finer distinctions and this Address is not meant to open up discussions on demarcation between electronic and electrical engineering. These have merged by the process of each borrowing ideas from the other, and it is wiser simply to confine our attention to the broad basis of the electronics engineer's job.

You will note too that I have omitted transducers even though an electronics engineer is expected to know all about them, at least if they have an electrical output or input. Although the electronics engineer may feel that he has proprietary rights in a loudspeaker, he would not claim these rights for, say, a thermocouple or a pressure switch which may be freely used in his circuits. Transducers as a class are the sensing elements which may make the electronics engineer move into optics, a furnace, a chemical

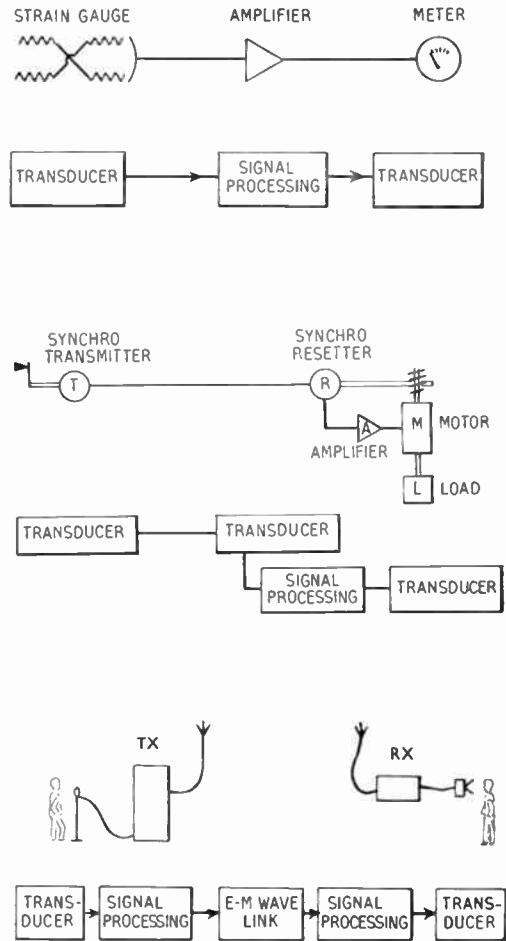

Fig. 1. Basic signal processing systems.

process, a patient's heart and so on, but he does not do such things on his own initiative. Also his outputs usually finish up in transducers such as an electric motor, a meter, a counter, loudspeaker, lamp and so on. The radio set and radar set are two of the few examples in which the electronics engineer has complete control over the input and output; for much of his time he must be content to receive a specified electrical input and to produce a specified electrical output, and only enter the transducer field when the inputs are not good enough or his outputs mishandled. Reference must also be made to electronic signal generation; but such generators too are in all but the

very simplest cases concerned with signal processing which is therefore much the largest part of what Electronics means today.

Man's Signal Processing

Man is a thinking, communicating and working animal and it will not be a cause for dispute if we assert that in these three respects he has abilities which are much beyond those of any other animal; this focuses on the point that he has a built-in signal processing system much superior to that of any other member of the animal kingdom. What other such attributes he has have been much debated, as also is the means by which the signals are processed. However, it is intended here to do no more than examine man's thinking, communicating and working in relation to Electronics and to see what conclusions may be drawn.

Some members of the audience may immediately call to mind Wiener's Cybernetics which is based on the view that all systems (of which man is one) can be regarded as information systems and feedback systems (or servos). While such considerations will inevitably intrude, it is not my purpose either to justify or oppose this generalization.

In choosing the three headings concerned with thinking, communicating and working, I assert that, while man wants to reduce his thinking and working, his keenness is to extend his faculty for communication. It may therefore be not surprising that electronics, which is capable of application to all three, was applied first to communication; and indeed it would be hard to visualize what progress would have been made in Electronics if man's urge to communicate over greater and greater distances and to more and more of his fellows had not been such a dominating desire.

Man as a Communicating Animal

Communication between man and man is a subject in which the electronics engineer is concerned with a small but very important part. All five of man's senses, sight, hearing, touch, smell and taste can be used for communication purposes, of which sight, hearing and touch are normally used, though it is as well to remind ourselves that smell and taste (especially smell)

are underdeveloped in man, but are of great importance to other animals. Sight and hearing are clearly the most important and have the advantage of giving almost instantaneous contact over a distance. Touch is vital to the blind and the deaf but for a normal man under normal conditions it is not an important medium for communication.

It was in the provision of aids first to hearing and then to sight that Electronics was born as a form of engineering and has up to today, made its biggest single contribution to progress. The electric telegraph had already provided a point-to-point communication system over the world. Wireless telegraphy extended this to mobile points (e.g. ships) and enabled many receiving stations to operate simultaneously. There was however, nothing radically new in this (except in technique) since it provided no more than a faster method of doing what was already being done by other means. The telephone could be used for point-to-point conversation over long distances but not one of these devices seriously changed the general pattern of man's everyday life.

There was no thunderclap, not even a spate of advertising, when the thermionic valve came to us (Fig. 2). It took more than ten years for the first glimmerings of broadcast transmission and reception of speech to appear. The thermionic valve made possible the combination of the advantages of the telegraph and the telephone, enabling one person to speak to anyone and everyone. This was something radically new and as you know has altered the pattern of our lives.

As you also know, the same principle has been extended to sight communication which, still with severe limitations, has added impetus to the social revolution caused by broadcasting. Broadcasting marks the point at which Electronics started its drift and sped on its way by pressure not so much from the technical services, the fighting services or industry, as from the public, the man in the street who saw in it a convenient and cheap means of getting entertainment and news—and has unwittingly provided others with a means of conditioning his mind by views, advertising and propaganda.

The fact that electronics started life geared to entertainment has left its mark today and no

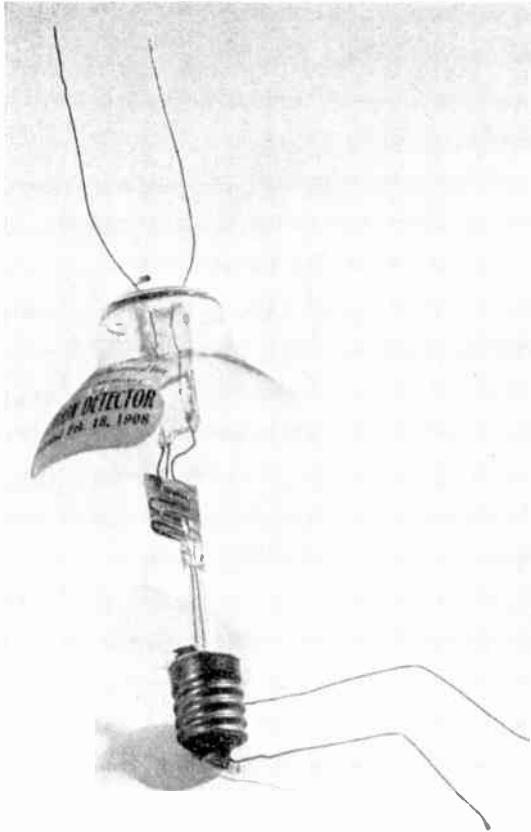

Fig. 2. The first Lee de Forest triode valve (The Audion).

doubt the repercussions will be slow to die. It is easy now to criticize the low standards of the electronics engineers, the poor components, the fashionable designs, the horrors of servicing, and so on. When the country was suffering an acute depression, radio industry thrived, run by amateur enthusiasts, scientists and financiers with serious minded engineers conspicuously few. The engineer was trained to shape his materials as he required: radio offered him only "tin-bashing." The engineer distrusted imprecise unmatched components; radio sets were full of them. The engineer expected to see how his equipment worked; radio sets had only a few simple moving parts which gave no indication of how they worked. The engineer was trained to apply fairly simple mathematics to fairly simple circuits with a high degree of

accuracy; radio presented him with complex mathematics applied to complicated circuits with large tolerances on component values and a final answer that might vary by an order of magnitude yet be quite satisfactory. It is therefore small wonder that engineers as a whole were not interested.

Fortunately we do not have to leave electronics there drifting in such a depressing state and while this part of my Address shows briefly how electronics was born out of man's desire to communicate with his fellows, it will soon be apparent that his desire to save himself from thinking and working has given the subject new interests with a more cogent meaning in terms of engineering and the chance to redeem its bad name for crude mechanical design and unreliability. It would be unfair though to move on without acknowledging the effort made by the radio industry itself to remedy the defects in its own past, and by the more professionally minded in the B.B.C. and the Post Office.

It is of interest to note why there was no alternative to the thermionic valve and the electronic circuit for broadcast radio, even though radio in the early wireless telegraphy days made good progress using only conventional electrical techniques. Figure 3 is the circuit diagram of a complete transmitter and receiver as used in the early days of "wireless" in which none of the components would today be regarded as electronic. One could visualize a broadcast transmitter and receiver based on electric arcs or even rotary amplifiers, but every economic factor is against them for such a

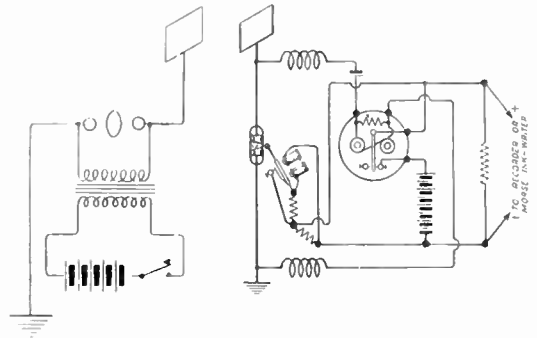

Fig. 3. Circuits of a spark transmitter and coherer receiver used by Marconi in early experiments.

purpose. For what it had to do in a broadcast system, the valve was cheap and efficient and everyone had good cause to believe that reliable valves were possible. But above all, the valve's superlative advantage lies in its use of electron movement only for its action. The electron with a mass of only about one two thousandth of the lightest known atom and carrying within itself the whole electric current-carrying capacity, has the least possible inertia for any purpose whatsoever. Speech frequencies are, in mechanical terms, very high and to deal with them by any electro-mechanical system would require speeds and accelerations beyond what the engineer would like to use. Any such system carries a huge dead-weight of useless atoms while the valve, operating on the almost inertialess stream of electrons has no such limitation. Such factors become even more obvious in considering the cathode-ray tube, and you may recall with a wry smile the strenuous efforts made before the war to make television systems based on electro-mechanical scanning. Thus man, in his craving for more and better means of communication stumbled on an extraordinarily useful device in the thermionic valve for the generating and processing of electrical signals which he pressed on with and developed at an astonishing rate in the face of many difficulties.

Man as a Working Animal

It is presumably partly because of his gregarious instinct that man wants to make others work for him. As a communicating animal he has the means at his disposal of making known what he wants done. His control of power in the form of other men or of animals has existed throughout known history and it is a recent advance for him to add to the power available to him by using machines.

When no other means are at hand man uses himself as a machine rated at about $\frac{1}{8}$ h.p. This gives him an inadequate amount of power to maintain a high standard of life. If he uses other men, he has an easy means of communication and control but he has to lower his fellow's standard of life in order to raise his own, so there is an advantage in turning say, to a horse. If he can control the horse, this raises his effective power to 1 h.p. and he uses his own $\frac{1}{8}$ h.p. only for control purposes.

His method of control is to give the horse instructions which include not only the application of power but also the means of correcting any errors which the horse may make, which must include himself as a signal processing device and he may train the horse sufficiently to do some signal processing for him. He and his horse together form a servo, the essential parts of which are shown in Fig. 4(a).

Now this is a fairly complicated servo since it has two signal processing stages and two error detectors. If we study a man working on his own we reduce this diagram to Fig. 4(b). This then contains the essential parts of any servo, in fact it is what we mean by a servo.

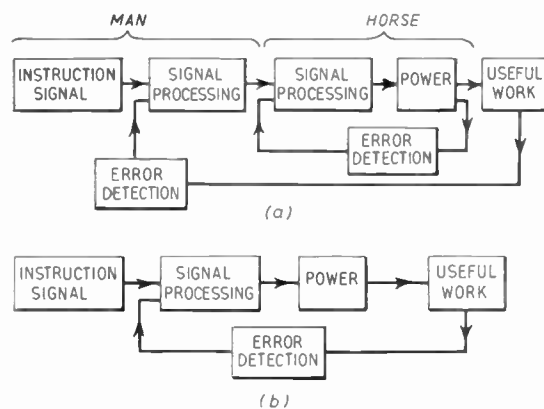

Fig. 4. Basic servo systems (a) representation of man and horse as a servo system; (b) representation of a man alone as a servo system.

I have elaborated a little on servos to make it clear that signal processing is essential to man as a working animal. The extension of my remarks about the horse to a machine such as a steam engine or electric motor, is obvious enough, but it will also be immediately apparent that the signal processing devices used on machines, the levers, valves, switches and controllers, are extremely crude and simple when compared with a man driving a horse, for instance a horse will avoid obstacles or even take you home when you are asleep. No car has been made that can do that.

It is only in certain narrowly defined ways that controlled power can be transmitted over a distance and as the distances increase so the

problem of control becomes greater. It is usually found to be far better to put the source of power at the point where it is wanted and to control it by means of signals which in themselves are not concerned with the transmission of the power, e.g. if a gun turret is to be kept in line with a gun director, it is not practicable to transmit the power from the director to the turret. Instead pointers were sited in the turret to indicate the director and turret's positions, and a man controlled the power to keep the pointers in line. To use a man as a signal processing device in this way was wasteful but no mechanical or electrical device could be made to do the job satisfactorily. This is of course but one illustration of many similar problems which had faced the fighting services and industry for a very long time, and was only nibbled at even as recently as the beginning of the late war. The problem was not one of transmitting the instructions or of smooth control of power, or of detecting the error; it was the apparent incompatibility of stability and accuracy, i.e. if the system was stable it was sluggish and inaccurate, and oscillated violently when it was stiffened up. It is not possible in the space of this Address to describe how the problem was solved, but the solution came through the combination of an attack on the theory of servos, and the introduction of electronic techniques for signal processing. Mechanical servos do not make high demands on speed, in fact many servos have a natural frequency of a few cycles per second only and no frequency met anywhere in the system would of itself demand the inertialess nature of the thermionic valve. The equivalents of L, C, R and amplification all exist in the mechanical world and in the absence of demands on speed, electronic circuits can be imitated if required. The mechanical engineer's trouble however, came from the fact that stability was dependent on such intangible quantities as friction in bearings, backlash in gears and the viscosity of oil. A mechanical signal processing device needed just the right component values, some of which were almost impossible to predict even approximately. Substituting a mechanical component could take hours or days, but the electronic component is replaced in a few seconds or minutes. Although electronic components have large tolerances, when in the circuit they remain

constant over narrow limits and for the most part follow predictable, mostly linear, laws. Their mechanical equivalents can be made to close dimensional tolerances but from there on, their behaviour is hard to predict.

Thus for remote control, electronic signal processing has excelled in combating the problem of stiffness versus stability though of course by no means all servos pose this problem and therefore require electronics. The real significance lies in the fact that electronics, has, through servos, been swept into the provinces of the mechanical and electrical engineer despite the reluctance shown when electronics existed only in the guise of radio engineering.

These remarks must seem far removed from my earlier references to the crudeness of electronic engineering, but it will be recognized that the versatility and simplicity of electronic equipment design, need not be equated to crudeness. There will be no other opportunity in this Address to mention the drift of Electronics from this point of view, but if you will study for yourself pre-war and post-war methods of assembly you will see how the influence of the professional engineer has come in and helped to place the technique on a much surer footing. Construction is no longer a matter of tin bashing and tags, and much is being designed today with the care previously lavished on a watch. New techniques now on the way go even further and if they succeed will make watchmaking look easy.

However, to return to my theme, the mechanical servo exists today as a means of fast and accurate control of machines and manufacturing processes of many kinds with electronics playing an irreplaceable part in the signal processing stage. But the story does not end there, since precisely the same problems are posed in say the control of the voltage, of a generator, concentration of a chemical, temperature of a furnace, power of a nuclear reactor and so on. In each of these the essential need is to make a setting at some pre-determined level and keep it there. For high accuracy this means balancing against an accurate reference; but the reference device may be a neon tube, a refractometer, a pyrometer, a neutron fluxmeter, which cannot of itself provide power for control, indeed its own signal

power output may be very small. To use a man to watch meters and correct the error, has for long been the only way, but this is often not economic, nor is a man's accuracy reliable. It is fast being recognized that in the large majority of cases, his presence is not necessary and an electronic device can take his place. To the electronics engineer this is rarely a serious problem, but the speed, accuracy and stability requirements commonly mean that the electronic solution is the only one. Thus the factory manager is faced with the decision to use the reputedly unreliable electronics in a vital part of his plant where a breakdown could mean rejects, loss of production, accidents or worse. The decision is not lightly taken as the electronics engineer and component manufacturer still have the stigma of the past to overcome, and the call for reliability at least as good as that of any associated mechanical or electrical equipment is only slowly being recognized. It is difficult for the conventional engineer to understand that this is not a matter of using larger components, thicker wires or robust watertight containers: meticulous attention to circuit design, component layout and environmental conditions have a way of being all-important.

Thus to summarize this section, man has found in electronics a means of imitating himself at work and controlling power with even greater precision than is possible to him unaided. His gains in increased leisure and a higher standard of living are already apparent even though he has only just begun to apply the technique. You will note however, that this drift of electronics is almost entirely towards light and heavy engineering industry. While the technique has also been extensively applied in the fighting services for weapon control and in the design of aircraft control systems, little or none appears in agriculture, land and sea transport, the hospital or the home, although Dr. Zworykin in his Clerk Maxwell lecture gives us a brief glimpse of such devices being used for the prevention of motor accidents.†

The grand view of large industrial plants working entirely automatically is open to us:

† *J. Brit.I.R.E.*, 19, No. 9, September 1959: see pp. 536-541.

but think again of man and a horse; we have some way to go yet before man has such a complete control over a machine.

Man as a Thinking Animal

It is plain enough that a man can drive a car and hold a detailed discussion at the same time, just as a woman can knit a complicated pattern and read a book at the same time. It is not my intention to try to analyse this or to suggest an electronic means of performing the same functions, though the facts suggest that man's working function and thinking function exist separately so to treat them separately in this Address is justified.

We are here considering the harder thinking which comes with say working out a mathematical problem, writing a Chairman's Address and so on.

Much of this kind of thinking follows an habitual pattern and one can be taught how to do it. If it can be taught and learnt, then the pupil could save himself trouble by building a machine programmed to do the thinking for him. Besides the obvious requirement for a means of feeding the question in and getting the answer out, the machine would need three essential parts, a memory (or store) in which the

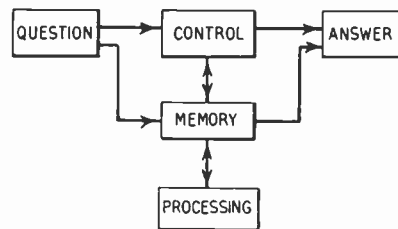

Fig. 5. The basis of a computer.

facts are kept ready for use, a group of devices for putting together and processing the facts and a control system which feeds instructions round the other two parts. Figure 5 illustrates the system which is of course the basis of a computer, and is a counterpart of man's brain. Such a device is by no means confined to mathematical computation. It can be used to replace any of the habitual actions of the brain, for instance translating a language, composing music or playing a game of cards, if we build

a big enough computer. It is not possible to programme it to include the emotional stimulus of the music or the psychic grand slam at a game of bridge, and it's all too easy to drive the analogy with a man's brain (in the fullest sense of the term), too far.

You will already be familiar with mechanical devices used for mathematical computation which include the slide rule, the cash register, the totalizer as well as the large sophisticated engines which earn the title of "computer," presumably because they are more versatile. Monumental mechanical digital computing engines were designed and made by Charles Babbage, but his work lay dormant for almost a century. The serious application of Babbage's methods reinforced with electronic logic circuits and stores in place of his mechanical ones, is a post-war development which has raced along at a most astonishing speed. Why this did not happen before the war is something of a mystery since such computers, either mechanical or electrical, were quite practicable with or without the aid of electronics. There was of course the problem of storage which was difficult electrically or electronically, but this problem was no more insoluble then than it was in Babbage's time. It may be that no one thought of it or perhaps no one would finance it, and it cannot be claimed that the use of electronic methods did more than add a bonus. However, it certainly is true that electronics has made these computing engines much faster and more flexible than they otherwise would have been; also the use of semi-conductors and ingenious storage methods is making them far more compact and efficient. Thus while electronics drifted into servos to solve an otherwise insoluble problem, it drifted into digital computers as a beneficial adjunct—this is a statement which may do something to dispel the idea that the "electronic brain" is some magical device born from electronics.

All this is equally true for analogue computers which have existed in very complex mechanical forms for many years. For most of its history in the Royal Navy it has been known as a predictor, calculator, or "fruit machine." The term "computer" is a comparatively recent innovation, and "analogue computer" even more recent.

Electronics came to be used in analogue computers through the use of electro-mechanical servos in lieu of cams, velodynes in lieu of potter's wheels, synchros and resolvers in lieu of rods and gears, and resistance adding in lieu of differentials.

However, the most recent versions of analogue computers have been made a great deal more versatile by the ingenious use of electrical circuits to simulate the laws of mechanics, hydraulics, pneumatics, etc. which, together with mathematical operations can thus be used to simulate the behaviour of any equipment, plant or process. Electronics is an indispensable part since non-linear laws cannot be simulated with linear components nor can signal levels be adjusted at will without the aid of amplifiers.

There is no calculation that a digital or analogue computer can do that man could not do with pencil and paper given enough time. It may take a long time to make a computer and to program it, but in the long run the saving of time is often big and not infrequently enormous. It may well be true that, but for this saving, guided missiles would still have been on the drawing board and satellites no more than a dream. The contribution of electronics has been to increase speed (inertialess electrons again) though we must keep in mind that computer designers have a long way to go before they can regard their engines as a fair imitation of a man's brain. For instance, what is meant in terms of time by say learning a language of 10,000 words, its parts of speech, the sounds, the gestures, the written symbols, and all the finer points which we use to string together words at the rate say 100 a minute in our ordinary conversation? This means sorting out millions of bits of information stored in the brain and arranging them in orderly fashion to make words, sentences and paragraphs. No computer has been made yet that will do it, though of course attempts at simple language learning and translation have been made.

Electronics and Digits

I have so far avoided mentioning the distinction between analogue and digital computers. It is doubtful whether there is any mathematical problem that could not be applied to either.

There are uses, limitations, advantages, and disadvantages for each type and the user can make his choice. There are however, points worth mentioning in the context of this Address, namely that our brains prefer mathematical answers in digital form, e.g. income tax codes are presented as a table and not a graph. Even if one uses a graph, it is never satisfying until the axes are marked off in digits which can be used for analogue-to-digital conversion. Whether this indicates that the brain works digitally is a matter of speculation and it may be sheer coincidence that there is an increasing tendency to use electronics digitally usually in the binary form, i.e. with the electronic device used simply as a two-state device or a switch. Now there is a highly practical reason for this. A switch is a device which has a low resistance, when it is "on," and a high resistance when it is "off." The power absorbed in the switch is the least in these two states rising to a maximum in between when its resistance equals the load impedance. The least power will therefore be dissipated in the switch if the changeover from "on" to "off" and vice versa is done in the least possible time. (This by the way is just as true for power switching as for electronics though of course the situation is apt to be complicated by inductive energy in the circuit and the point on an a.c. cycle at which the switching starts.) If the switch is replaced by a proportional device, this will for most purposes be used so that its resistance is of the same order as that of the load, i.e. it is consuming the maximum power. Now the absorption of energy in a valve or transistor is a serious nuisance to the electronic equipment designer; there is every advantage in reducing this energy to a minimum, and the switch does just that. Many electronics designers will recognize in this technique the fascinating prospect of using transistors, and diodes, in conjunction with digital techniques for many purposes in which proportional and sine wave techniques were previously used. Also, although I believe that the analogy should not be pushed too far, the similarity to natural methods of signal processing in the body and the brain seems oddly significant.

Interconnection

I would like now to turn to the problem of connecting together electronic equipments such

as the types already discussed, i.e. communications, servo amplifiers and electronic computers. You will have recognized the thread in this Address that the drift of electronics is towards imitating man. If men are replaced by machines doing various jobs, we must think too of the problem of connecting the machines together. The possible methods of interconnection are multitudinous and the choice is as often based on historical as on technical considerations. One is naturally tempted to do the transmitting in a form related to the output. However, even for mechanical outputs, there has been a trend towards using electrical methods of connection for short distances and of course these methods have become paramount for long distances. There are a vast number of different forms that electrical signals can take and electrical and electronics engineers are by no means agreed among themselves what method to use. While there is no urgency about standardizing machines, there should be some logic behind methods of interconnection since all machines must be compatible with the method of interconnection.

In many cases interconnection is a two-state problem, i.e. the connection is either made or broken. It is customary to use two-state devices to control the connection, i.e. switches, interlocks or relays. Now nature has the same problem in the animal body and solves it in the same way, i.e. using neurons which are two-state devices, but the power used in their operation is very low and they have no moving parts, in marked contrast to control systems based on relays and contactors.

The valve is a rather clumsy device to use for switching operations as it needs a heater supply and wastes power because of its high impedance; its merit for such a purpose lies in its speed which computer-designers need, but many others do not. The transistor however, is an efficient switch especially if designed for the purpose and the power needed to use and operate it is very small. It has the merit too of being versatile in the kinds of control signals used, the method of connection, and the signals it can pass. Also, and we may find even more important, it is easily made compatible with a machine with a transistor output, or requiring a transistor input.

Thus the semi-conductor is bidding fair to replacing the relay and contactor and it is of interest to note how much closer this brings us to Nature's way of interconnecting parts of the body. But is a semi-conductor device as reliable as a relay? Its use will depend on the answer, and we do not know the answer yet. Until we do, it will be confined to cases where fast operation, saving of power, or special circuit requirements, makes it essential.

The Future of Electronics

I have so far been discussing various aspects of electronics which lie in the past and present and deliberately left my references to digits and switching to the last. The earlier subjects all concerned well founded techniques which follow a recognizable pattern and enable one to forecast where they are likely to get to as the years go by. Solid-state physics (semi-conductors and so on) is not one of those subjects even though it has been with us since the early days of wireless telegraphy. As you know a breakthrough came with the invention of the transistor, and the discovery of its principles has started something like a gold rush in the laboratories. The silicon and germanium diodes and transistors may seem remarkable enough; but one has to remember that these diodes can act as extremely efficient and fast acting thyratrons with much more versatile characters, that they can also act as variable capacitors, that transistors can work both ways, that they can be built in an extraordinary number of multi-electrode forms, that magnetic and electrostatic fields can be used on them; also Hall effect, thermal effects, optical effects, X-ray effects, radioactivity and so on all play their part in some significant way. Germanium and silicon are only two of a bewildering array of intrinsic materials. If we restrict ourselves to the more likely elements of valency 3, 4 and 5, and the crystalline form of their compounds, we have an array of permutations that makes a football pool coupon look simple. There is unending cause for speculation on what might or might not be good lines to try, most of them bedevilled by the fantastically high purity and close control of crystalline structure which are essential to success, followed by the maddening problem of adapting

the laboratory process to the production line, and followed again by the risk that the component will be outmoded before the production line gets going, or turn out to be marketable only in small numbers. The quest for the new component may be such that it costs £1,000,000 to produce the first useful sample but such costs are being cheerfully counted.

Today the situation bears only the vaguest relationship to what we were thinking five years ago, and it would be idle to speculate on what it might be five years hence. The transistor alone has caused a revolution in Electronics. This, with the various forms of semi-conductor rectifier is beginning also to cause a revolution in electrical engineering. The transistor is, we think, as reliable as a modern reliable valve and may prove to be much more so, both for intrinsic reasons and also because of the new and closely controlled methods of making it. This in its turn is making us think again about the reliability of other components and time honoured methods of packaging and maintaining equipment. You will recall Mr. Manfield's description of the micro-miniaturization programme last January.† This is an off-shoot from semi-conductor development, the ultimate goal of which is the production of solid state circuits. The programme is an attack on the problem of size, and also, perhaps more important, of reliability for the solid state circuit, without wires, connections and components, should be intrinsically as reliable as a transistor.

I should not end this dissertation on solid-state physics without a reference to thermo-electric generation. This has been feasible since Seebeck discovered his effect, but today semi-conductors show signs of being useable for raising the efficiency sufficiently to make direct thermo-electric generation a practical proposition. Should this happen, we shall be faced with direct current at low voltage. Semi-conductors could be used to chop this into a supply of alternating current in square wave form. It would be wasteful and inefficient to filter this supply to make a sine-wave a.c. as my earlier remarks on switching will make clear. Now the electronics engineer would on the whole be happier with square wave supply

† See *J. Brit.I.R.E.*, 19, pp. 114-5, February 1959.

rather than a sine wave and the electrical engineer would no longer be faced with a peak voltage much greater than his mean voltage or cyclic heating of his conductors. The transformer manufacturer could make a rather better transformer. Switching can be done without moving masses of copper and suppressing arcs by using semi-conductors which can switch with precise timing at the current zero, or on any time scale required. Semi-conductors will suppress the surges (if any). It only remains for the electrical engineer to design a motor to accept square waves, which may not be as formidable as might at first be thought for semi-conductors can come to his rescue and help him design a brushless d.c. motor. It would seem therefore that we may be at the verge of another revolution, this time in power engineering in which electronics has played the part of foster father.

Conclusions and Epilogue

I have set out in this Address two broad aspects of Electronics which might for want of better words be termed the old and the new. In the old, I have made a case for comparing certain activities embodied in man and the embodiment of similar activities in certain types of electronic equipment. I have not included all of man's activities nor all types of electronic equipment but you may agree with me from what I have quoted that there are grounds for thinking that man is striving to imitate his own faculties and extend them with the aid of electronics. This then has been the major part of the drift of electronics, and it is not unreasonable to regard neurology as a subject to study in close conjunction with electronics.

I must however debunk any idea that Electronics makes the automaton or the robot look even a remote possibility. Think of the micro-miniaturized computer to replace your brain; consider the multitude of fast and accurate servos to replace your muscles; the television system to replace your eyes, the audio system for your ears. Then there is the interconnection problem and the power supply problem and the

many other parts that make a man which electronics has not even begun to imitate. People who think in terms of electronic robots are romancing and can only debase Electronics as a serious subject.

Concerning the new, I have drawn attention to the importance of switching techniques, two-state devices and the problem of interconnection. These are matters that both electronic and electrical engineers must get to grips with and other engineers might help themselves and the rest by studying them too. The electronics engineer may be able to contribute most because he is used to thinking in such terms, but they are not the perquisites of any one engineering profession. I have referred somewhat casually to micro-miniaturization and reliability. Both or either may well become matters of immense importance. The old electronics was not reliable enough; the new is much better but still looks hardly good enough; so which way do we go and how far can we go? The future of electronics depends very much on the answers and I cannot give them.

I last referred to solid state physics and ventured to forecast a revolution in electrical engineering, but went no further. Already much of the subject is concerned with transducers (which I earlier barred from the electronic engineer's province) and solid-state electronic circuits are part of it too. Does this mean that just as Electrical Engineering and Electronic Engineering were conceived in the Physics Laboratory, we are witnessing the conception of yet another form of engineering?

As a parting shot, may I refer again to the definition of electronics. There is a danger that the word itself will be discredited and cease to be used if the public, the employer and the etymologist cannot agree on what it means. Does it matter? It is for those who carry the title of electronics engineer at least to try and provide an answer. I have used the term "electrical signal processing" to describe the electronics engineers job. Does this help with the answer, or does it make confusion worse confounded?

APPLICANTS FOR ELECTION AND TRANSFER

As a result of its November meeting the Membership Committee recommended to the Council the following elections and transfers.

In accordance with a resolution of Council, and in the absence of any objections, the election and transfer of the candidates to the class indicated will be confirmed fourteen days after the date of circulation of this list. Any objections or communications concerning these elections should be addressed to the General Secretary for submission to the Council.

Direct Election to Full Member

GIBOIN, Rear Admiral Eugene, French Navy, Paris.

Transfer from Associate Member to Member

COOPER, George, B.Sc. Aldershot, Hants.

Direct Election to Associate Member

*ATKINS, John Percival, Penrith, Cumberland.
 DEAN, Peter, Zurich, Switzerland.
 EPSTEIN, Monty, Palmers Green, N.13.
 HARRISON, Anthony Frederick, Enfield, Middlesex.
 JACKSON, Flt. Lt. Roy, D.F.M., R.A.F. B.F.P.O. 31.
 JOYCE, Robert Henry, B.Sc. South Shields, Co. Durham.
 KITCHIN, Harry Donald, Bradford.
 MORISON, Peter Philip, Cambridge.
 POTTER, Michael James, Isleworth, Middlesex.
 STAYNOR, Derrick Vere, Berkhamsted, Herts.

Transfer from Associate to Associate Member

CUNNINGHAM, Albert Roy, London, N.9.
 LEICESTER, Edward James, Westerham Kent.

Transfer from Graduate to Associate Member

ASHMAN William George, St. Albans, Herts.
 CALLENDER, Donald Christopher, Welwyn Garden City, Herts.
 HOGGETT, George James, Reading, Berks.
 JACKSON, Flt. Lt. Alfred, M.B.E., R.A.F. London, S.E.18.
 KIRKHOPE, James, Glasgow, S.2.
 LINGLEY, Peter James, Morden, Surrey.
 PATWARDHAN, Prabhakar Keshava, M.Sc. Bombay
 RAYNER, Stuart Verrinder, London, N.22.
 RIESEL, Chaim Manfred, Tel-Aviv, Israel.
 SALMON, Lieut. Christopher Leonard, R.N. Cosham, Hants.
 SANHI, Pritam Singh, B.Sc. Patiala, India.
 SIPAHIMALANI, Bhagwan Kishinchand, London, W.1.
 SKINNER, Leonard Malcolm, B.Sc.(Hons.), South Ruislip.
 SKINNER, Sydney Lonsdale, Reading, Berks.
 TICEHURST, Roy Alfred, Reigate, Surrey.
 WALKER, Roderick William, Newcastle-on-Tyne.

Transfer from Student to Associate Member

BALCOMBE, Jack, Coulsdon, Surrey.
 BEN-DOR, Baruch, Haifa, Israel.
 CHATER, William Charles, Kampala, Uganda.
 REID, Keith Gordon, Montreal, Canada.
 WARIN, John William, Bedford.

Direct Election to Associate

ALLCOCK, Geoffrey Arnold, Southampton.
 BELL, Douglas Charles, Ilford, Essex.
 COOPER, Michael, B.Sc. Stockport, Cheshire.
 FAITHFUL, James Montague, Plymouth.
 ISLE, Desmond Eric Stuart, Thames Ditton, Surrey.
 KARPOVICH, Leo Nicholas, Hong Kong.
 REID, Terence Patrick, Ilford, Essex.
 STEPHENSON, Oswald Allen, Kampala, Uganda.
 YATES, Peter John, Twyford, Berks.

Direct Election to Graduate

*AKINDELE, Theophilus Olowole, London, W.8.
 ATTWOOD, Thomas Vincent, Liverpool.
 BAKER, Kenneth Alwyn, Worcester Park, Surrey.
 BELL, Capt. George Nelson, B.Sc.(Eng.), R. Sigs. Singapore.
 BLAIR, Peter Kenneth, Danbury, Essex.
 EASTERBROOK, John Edgar, Hailsham, Sussex.
 ELLIS, Norman, Madvern, Worcestershire.
 FELLOWS, Kenneth Gordon, Biggleswade, Bedfordshire.
 FRENCH, Richard Charles, Godstone, Surrey.
 HAWKINS, Arthur Goodwin, Letchworth, Hertfordshire.
 HOATH, William Daniel, Woburn Green, Bucks.
 HOPKINS, Robert Thomas, Wisbech, Cambs.
 JACKSON, Dennis Benjamin, Portsmouth, Hants.
 JORDAN, James Redmon, Twickenham, Middlesex.
 LAWRENCE, Barry Owen, Chelmsford, Essex.
 LEWIS, Raymond Brian, London, N.W.6.
 MEECH, John Norman, Bracknell, Berkshire.
 MORGAN, Charles Thomas, Liverpool.
 NEWTON, Robert Dorrick, Weymouth, Dorset.
 REFFOLD, Bryan Godfrey, Basingstoke, Hants.
 STOCKER, Norman, South Croxdon, Surrey.
 FOURNIER, John, High Wycombe, Bucks.
 WATTS, Bartley Leighton, Auckland, New Zealand.
 WHEELER, Eric Gilbert, Cheltenham, Glos.
 WISE, Joseph, Hlitchin, Hertfordshire.
 WOOD, Roger David, Bexleyheath, Kent.

Transfer from Student to Graduate

BALASUBRAMANYAM, T. R., B.Sc.(Hons.), Madras, India.
 CACHIA, Saviour, Hayes, Middlesex.
 CHAWLA, Bhupendra Nath, New Delhi.
 DAVIS, Eric Cambridge, Southampton.
 DOWLING, Patrick Joseph, Limerick, Eire.
 HINDLEY, Peter John, Hayes, Middlesex.
 MACGREGOR, Henry George, South Harrow, Middlesex.
 SAMEL, Shrinivas Shantaram, B.Sc. Bombay.
 STEYN, Marthinus Jacobus Dewald, South Africa.
 THOMAS, David Geoffrey, Cardiff.
 WALKER, William, Brodick, Isle of Arran.

STUDENTSHIP REGISTRATIONS

The following 37 students were registered at the September and October meetings of the Committee. The names of a further 92 students registered at the October and November meetings will be published later.

RUSSOM, Kenneth John Radcliffe, Salisbury, Southern Rhodesia.	WAHAB, D.S.A. Brunei.	CHAN, Peter Kiu, London, N.7.
SAINI, Babu Lal, Barrackpore.	WOLHUTER, Andreas Francois, Stellenbosch, South Africa.	CHAN, Tai-Yuen, London, N.5.
SAINI, Gur Charan, London, S.W.4.	YIP, Seck Weng, Singapore.	CHIDAMBARESWARA SARMA, Mahesa Karainagar, Ceylon.
SHARMA, Roshan Lal., B.Sc. Jullundur.		COOK, David Ernest, Beccles, Suffolk.
SOE-MYA, Frank, Feltham.		COWDRILL, Roy, Cheltenham, Glos.
SOUTHGATE, John William, Clislehurst.	ABRAHAM, Frederick, Ibadan, Nigeria.	DEAKIN, William John, Newport, Mon.
SWAIN, Anthony John Britton, Harrow.	AGARWAL, Anand Prakash, Bombay.	DUCKWORTH, John, Bournemouth, Hants.
TALUKDAR, Arun Kumar, Belfast.	ALAMAN, Mounal Mousa Ali, London, W.2.	DUTTA, Ajoy Kumar, London, S.E.3.
THOMAS, John Eryl, Gloucester.	ANDERSON, Edward Philip Talbot, Cardiff.	FAY, John William, London, W.14.
TIDSWELL, Anthony, B.Sc. Grays.	*ANTONY, O. A. Trivandrum 1, India.	GOPINATHAN, Thonnangamath, B.Sc. Trichur, India.
TREVELYAN, Bernard, London, S.W.15.	BAKER, Anthony Stuart, B.Sc.(Eng.), London, N.8.	GRAY, Reginald Edward, London, N.1.
TRIBBLE, Ian Noel, Waltham, New Zealand.	BARRATT, Peter Vincent, Lusaka, Northern Rhodesia.	GUNNINGHAM, Foster Gilbert Cole, Basingstoke, Hants.
TUPLING, Harry, Grimsby.		
TWIGGER, David John, Coventry.		
TWINING, Neville Percy, Heston.		

* Reinstatements

Transistors in Video Equipment†

by

P. B. HELSDON, ASSOCIATE MEMBER‡

A paper read on 3rd July 1959 during the Institution's Convention in Cambridge.

Summary : Principles involved in the design of video current amplifiers for television using transistors are discussed in terms of the hybrid-pi equivalent circuit. The importance of the current gain-bandwidth factor is emphasized and a design philosophy which exploits an unconventional concept of gain-bandwidth is presented. An investigation of noise with regard to camera head amplifier design gives the transistor parameters and circuit conditions necessary for maximum signal/noise ratio. Experimental confirmation shows transistors to be comparable with valves in this application.

List of Symbols

A	Ratio of f_{ab} to f_e .	f_t	Base "transit" frequency $1/(2\pi\tau)$.
α_b	Grounded base current gain.	g_m	Mutual conductance.
α_e	Grounded emitter current gain.	I_b	Base bias current.
$ \alpha_e $	Modulus of α_e at video frequencies.	I_c	Collector current.
A_e	Stage current gain.	I_{c0}	Collector current for zero emitter current.
$C_{b'e}$	Internal feedback capacitance.	I_{cs}	Collector saturation current.
$C_{b'e}$	Sum of C_{es} and C_{et} .	I_e	Emitter current.
C_{cs}	Collector storage capacitance.	I_{e0}	As I_{c0} but with emitter and collector interchanged.
C_{ct}	Collector transition capacitance.	I_{es}	Emitter saturation current.
C_e	Emitter circuit equalizing capacitor.	i_r	Vidicon signal current.
C_{es}	Emitter storage capacitance.	k	Boltzmann's constant = 1.38×10^{-23} joules per degree centigrade
C_{et}	Emitter transition capacitance.	L_e	Inductance in series with C_e .
C_k	Sum of C_{et} , C_{ct} and C_v .	L_s	Inductance in series with R_s .
C_m	Miller equivalent capacitance.	n	Ratio of f_p to f_{ae} .
C_s	Capacitance in shunt with L_s .	q	Electron charge = 1.6×10^{-19} coulombs
C_v	Vidicon signal electrode capacitance.	$r_{bb'}$	Extrinsic base resistance.
C_x	External circuit stray capacitance.	$r_{b'e}$	Internal feedback resistance.
$d\bar{i}^2$	Mean square noise current per unit bandwidth.	$r_{h'e}$	Internal base to emitter resistance.
$d\bar{v}^2$	Mean square noise voltage per unit bandwidth.	r_{ce}	Collector to emitter resistance.
f_{ab}	Grounded base cut-off frequency.	R_e	Emitter circuit feedback resistance.
f_{ae}	Grounded emitter cut-off frequency.	R_{eq}	Equivalent noise resistance.
f_e	Grounded emitter short circuit current gain-bandwidth product.	R_{in}	Input resistance.
F_e	Stage grounded emitter current gain-bandwidth product.	R_L	Load resistance.
f_{σ}	Product of $ \alpha_e $ at f_p and f_p .	R_s	Interstage shunt load resistance.
F_{σ}	Stage frequency-gain product.	R_v	Vidicon load resistance.
f_m	Frequency corresponding to $g_m/(2\pi C_m)$.	T	Absolute temperature.
f_p	Maximum video frequency.	V_c	Collector voltage.
		Z_{in}	Input impedance.
		Z_L	Load impedance.
		Δ	q/kT .
		τ	Base "transit time."
		μ	Internal voltage magnification factor.
		$\omega_e = 2\pi f_e$	$\omega_p = 2\pi f_p$
			$\omega_t = 2\pi f_t$

† Manuscript received 16th March 1959. (Paper No. 529.)

‡ Marconi's Wireless Telegraph Co., Ltd., Television Laboratories, Chelmsford.

U.D.C. No. 621.375.4:621.397.331.222

1. Introduction

Transistors and valves are fundamentally charge-controlled devices, but various imperfections demand a current and hence a voltage input.¹ With valves the input current is usually negligible (except in electrometer applications) but the high rate of electron-hole recombination within realizable transistors demands a base input current only one or two orders less in magnitude than the collector output. Consequently practical transistor amplifiers can be regarded as either voltage, current or power gain devices. The point of view to be adopted depends largely on the type of signal source and load, and the magnitudes of their impedances compared with those presented by the amplifier. In the case of a vidicon camera tube source and a coaxial cable load, a current amplifier is required. A load consisting of a cathode-ray tube control grid would however demand a voltage amplifier.² The principles involved in the design of the first type of amplifier form the subject of this paper.

The normal signal current from a vidicon is 0.3 microamperes peak-to-peak so that an overall current gain of 45,000 is necessary to give a 1 volt p-p. level into a 75-ohm cable. Voltage gain within each stage need only be considered with respect to Miller effect, which unfortunately reduces the current gain, especially at high frequencies.

2. Natural Response

Current gain from cascaded transistor stages is most conveniently obtained using the grounded emitter configuration. In this mode transistor parameters are usually expressed under constant signal input current and zero impedance load conditions. Low frequency current gain of a transistor (α_e) is usually in the range 20 to 200 times. At high frequencies the current gain falls³, so that two characteristic frequencies of the grounded emitter transistor can be defined. At the cut-off frequency f_{α_e} the modulus of the current gain falls to 0.707 of α_e , and at a much higher frequency f_e the modulus of the current gain becomes unity. The value of f_e is given by

$$f_e = f_{\alpha_e} \sqrt{(\alpha_e + 1) (\alpha_e - 1)} = f_{\alpha_e \cdot \alpha_e} \text{ approx.} \dots\dots\dots(1)$$

At normal current levels f_e is approximately equal to f_t which is one of the fundamental transistor parameters, whose corresponding angular frequency ω_t is the reciprocal of the "transit time" τ of current carriers through the effective base region between depletion layers. The frequency f_e is related to the grounded base cut-off frequency as $f_e = (f_{\alpha_b} \alpha_b) / A$, where A is a semi-constant theoretically equal to 1.22, but which has measured values ranging from 1 to nearly 3. It is to be regretted that f_{α_b} has acquired such wide currency as an alleged fundamental parameter.

Obviously to be useful as a video amplifier a transistor must have an f_e value well in excess of the required stage bandwidth f_p , since to a rough approximation the stage gain will be the ratio of f_e to f_p .

3. Hybrid- π Equivalent Circuit

The most useful equivalent circuit for video amplifier design is the grounded emitter hybrid- π representation by Johnson⁴ and Giacoletto⁵, shown in Fig. 1. This circuit can be

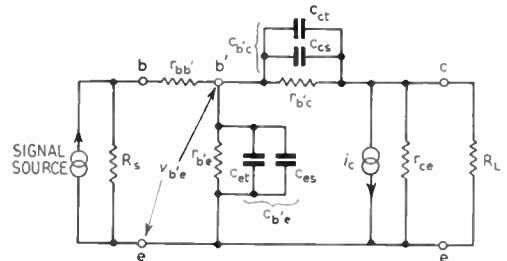

Fig. 1. Hybrid- π equivalent circuit.

used with reasonable accuracy up to about half the f_e frequency but applies only to alloy junction transistors. The grown junction transistor requires a complex impedance in place of the simple extrinsic base resistance $r_{bb'}$.

3.1. Extrinsic Base Resistance

In an alloy transistor the extrinsic base resistance $r_{bb'}$ is only slightly current sensitive and can be regarded as a fixed resistance (usually about 100 ohms in h.f. transistors) acting in series with the inaccessible internal base terminal b' .

3.2. Base-emitter Resistance

The base-emitter resistance $r_{b'e}$ is a function of emitter current and is given by

$$r_{b'e} = \alpha_e / g_m \dots\dots\dots(2)$$

where g_m is the internal mutual conductance given by

$$g_m = (i_b q I_c) / kT = \alpha_b \lambda I_e \cong 39 I_e \dots\dots\dots(3)$$

3.3. Base-emitter Capacitance

The base storage capacitance c_{es} and the emitter junction transition capacitance c_{et} act in parallel to give $c_{b'e}$.

$$c_{b'e} = c_{es} + c_{et} = g_m / (2\pi f_{\alpha e} \omega_e) = g_m / \omega_e \dots\dots\dots(4)$$

where $\omega_e = 2\pi f_e \dots\dots\dots(4a)$

and $c_{es} = g_m \tau = g_m / \omega_t \dots\dots\dots(5)$

The base storage capacitance c_{es} is a result of the charge stored in transit through the base region between the depletion layers, hence the relationship involving the base diffusion or "transit" time τ .

A transition capacitance is formed by the separation of depletion layer boundaries at a junction and is a function of junction voltage. The voltage concerned is the difference between the applied voltage and the barrier potential, which in the case of germanium is about 0.4 V. Since this is large compared with forward emitter bias at low currents the emitter transition capacitance c_{et} can be regarded as constant irrespective of emitter current. The storage capacitance c_{es} is of course a function of emitter current. At normal emitter current levels, say 1 mA and above, the storage capacitance c_{es} is usually much larger than c_{et} so that $\omega_e \rightarrow \omega_t$.

3.4. Active Generator

The active current generator delivers a current given by

$$i_c = v_{b'e} g_m \dots\dots\dots(6)$$

where $v_{b'e}$ is the voltage developed across the capacitance $c_{b'e}$. The variation of $v_{b'e}$ with frequency due to the reactance of $c_{b'e}$ is the main factor in the reduction of gain at high frequencies.

3.5. Feedback Capacitance

The capacitance $c_{b'c}$ consists of two parts, a collector transition capacitance c_{ct} and a storage capacitance c_{cs} which is normally smaller but

not negligible. The transition component is inversely proportional to the square root of the collector voltage.

The storage component is a result of the time delay involved in the change of charge in the base in response to a change in collector voltage. The charge involved is the one responsible for the base storage capacitance c_{cs} so the collector storage capacitance varies in the same manner as c_{cs} with emitter current but is also inversely proportional to the square root of the collector voltage.

The feedback capacitance $c_{b'c}$ is usually small (typically 1 to 10 pF for r.f. transistors) and is given by

$$c_{b'c} = c_{cs} + c_{ct} = g_m / (\omega_t \mu) + c_{ct} = (c_{cs} / \mu) + c_{ct} \dots\dots\dots(7)$$

where μ is the voltage magnification factor between the internal base and the collector. This definition of μ corresponds to conventional valve terminology, but some transistor authorities take the reciprocal definition.

3.6. Feedback and Output Resistances

The feedback resistance $r_{b'c}$ and collector resistance r_{ce} are both the result of the combined effect of leakage and base-width modulation⁶ and are given by

$$r_{ce} = \mu / g_m \dots\dots\dots(8)$$

$$r_{b'c} = \mu r_{b'e} \dots\dots\dots(9)$$

In practice the latter expression is a very poor approximation due to the leakage component and an over-idealized derivation.

These resistive components are large enough to be neglected in most video amplifier design, but are the cause of a slight extra loss in l.f. gain met with in some circuit arrangements.

4. Gain-Bandwidth Product

The concept of gain-bandwidth is a very useful device in the evaluation of transistors for video amplifier applications. Conventionally the definition of gain-bandwidth is the product of the low frequency gain and the frequency at which it has fallen 3 db. The grounded emitter short circuit current gain-bandwidth of a transistor is thus the product of α_e and $f_{\alpha e}$, which as we have seen, is equal to f_e to a close approximation.

4.1. *Cascade Loss*

Care should be taken in the use of gain-bandwidth symbols such as f_e , since these cannot be used as ordinary algebraic quantities in every context. For example, when considering the overall gain-bandwidth of cascaded stages, the gain and bandwidth of individual stages must be expressed separately. When identical stages having a simple R-C type response are cascaded, the overall gain increases but the bandwidth falls.

If the gain of individual stages is reduced to keep the overall bandwidth constant as the total number of stages is increased, the overall gain passes through a maximum for a finite number of stages. The overall gain obtainable is very limited when stages having low initial gains are used. For example⁷, with an initial gain per stage of ten times, maximum overall gain is reached with about twenty-five stages, which gives an overall gain of 408,000. But if the initial stage gain is only four times, maximum overall gain occurs for only four stages, which gives an overall gain of only eight times. This latter case is obviously inadequate for a vidicon head-amplifier.

It is possible of course to design stages which do not have a simple R-C type response. If the response of some stages is made to rise towards the higher frequencies and so compensate the middle frequency of other stages, the adverse effect of cascading can be reduced.

5. **Stage Gain-Bandwidth**

The intrinsic gain-bandwidth f_e is obtained when the transistor is driven from a constant current source and works into zero load. In a practical multi-stage amplifier these special conditions do not exist. Each transistor is fed from a source R_s and drives into a complex load Z_L . This greatly complicates matters, especially when the complex Miller feedback through $c_b'e$ and $r_b'e$ is considered. Miller effect is fairly easily dealt with in simple cases, such as an output stage feeding a purely resistive load. But at each stage back in the amplifier the problem becomes increasingly difficult. This is due to the growing complexity of the network needed to represent the Miller effect components acting in parallel with $c_b'e$, $r_b'e$ and the other elements.

The design method can be described most simply by considering examples with progressively complicated forms of Miller feedback.

5.1. *Case of Negligible Miller Effect*

In the first example, Miller effect is neglected. The situation is then similar to that in an amplifier using a pentode valve. With a pentode valve stage, gain can be exchanged for bandwidth simply by changing the anode load resistance, the product of gain and bandwidth remaining constant. This would also be true in this transistor example if it were not for the extrinsic base resistance r_{bb}' . The effect of r_{bb}' is to reduce the gain-bandwidth when the frequency response is extended by reduction of the shunt load resistor R_s . Determination of the frequency response by R_s is characteristic of this design method.⁸ It is assumed that the value of $r_b'e$ will be fixed by the amount of emitter bias current required to handle the maximum signal level without distortion. The value of R_s needed for a given ratio n is given by

$$R_s = \frac{r_b'e}{n-1} - r_{bb}' \dots\dots\dots(10)$$

where $n = f_p/f_{ae} \dots\dots\dots(10a)$

Obviously n cannot be made larger than

$$n_{max} = 1 + \frac{r_b'e}{r_{bb}'} \dots\dots\dots(11)$$

which corresponds to $R_s = 0$, or pure voltage drive. But with a finite value for R_s , the stage current gain at low frequencies (A_e) is

$$A_e = \frac{\alpha_e}{n} \left[1 - \frac{r_{bb}'(n-1)}{r_b'e} \right] = \frac{\alpha_e R_s}{r_b'e + r_{bb}' + R_s} \dots\dots\dots(12)$$

also as the bandwidth f_p is $n \cdot f_{ae}$ the stage gain-bandwidth product F_e becomes

$$F_e = A_e f_p = f_e \left(\frac{R_s}{R_s + r_{bb}'} \right) = f_e \left[1 - \frac{r_{bb}'(n-1)}{r_b'e} \right] \dots\dots\dots(13)$$

In a typical case $r_b'e$ might be ten times r_{bb}' , so that 90 per cent. of the available gain-bandwidth f_e can be obtained for n values up to two. This corresponds to $R_s = 0.9 r_b'e$. In practice it might prove difficult to increase R_s much above this, so in this example there is little point in using transistors having a grounded emitter cut-off frequency f_{ae} of more than about half the

required stage cut-off frequency f_p . In other words transistors with very large values of f_e are of no special value unless they also have a correspondingly high low-frequency current gain α_e . The importance of a low ratio of $r_{bb'}$ to $r_{b'e}$ is also apparent.

5.2. Resistive Load

When the collector load consists of a simple resistance R_L , Miller feedback reduces the gain. Loss in gain at low frequencies due to internal feedback through $r_{b'e}$ is usually small for normal video loads, but at high frequencies the loss is more serious. This is due to feedback through $c_{b'e}$, which gives an effective Miller capacitance c_m acting in parallel with $c_{b'e}$. The value of c_m is determined by the internal voltage gain between b' and the load R_L , so that c_m is

$$c_m = c_{b'e} (1 + g_m R_L) \cong c_{b'e} g_m R_L \dots\dots\dots(14)$$

The stage gain-bandwidth is reduced by the Miller feedback to

$$F_e = f_e \left(\frac{R_s}{R_s + r_{bb'}} \right) \left(\frac{1}{1 + \frac{f_e}{f_m}} \right) \dots\dots\dots(15)$$

where $f_m = g_m / (2\pi c_m) = 1 / (2\pi c_{b'e} R_L)$ (15a)

Expressed in terms of the frequency ratio n , this becomes

$$F_e = \frac{f_e}{1 + \frac{f_e}{f_m}} \left\{ 1 - \frac{r_{bb'}}{r_{b'e}} \left[n \left(1 + \frac{f_e}{f_m} \right) - 1 \right] \right\} \dots\dots\dots(16)$$

It will be seen that Miller effect reduces the gain-bandwidth in two ways: firstly by reduction of the effective value of f_e , and secondly by an increase in the adverse influence of $r_{bb'}$. The value of R_s required to maintain the same stage cut-off frequency f_p becomes

$$R_s = \frac{r_{b'e}}{n \left(1 + \frac{f_e}{f_m} \right) - 1} - r_{bb'} \dots\dots\dots(17)$$

where n is still the ratio of f_p to f_{ae} . Also the low frequency gain falls, due to the reduction in R_s , to

$$A_c = \frac{\alpha_e R_s}{r_{b'e} + r_{bb'} + R_s} \text{ approx. (neglecting } r_{b'e})$$

$$= \frac{\alpha_e}{n \left(1 + \frac{f_e}{f_m} \right)} \left\{ 1 - \frac{r_{bb'}}{r_{b'e}} \left[n \left(1 + \frac{f_e}{f_m} \right) - 1 \right] \right\} \dots\dots\dots(18)$$

So even this simple case of Miller feedback involves fairly complicated design equations. From these it will be seen that larger values for f_{ae} can be usefully employed where R_L and hence the Miller effect is increased. If R_L is not large compared with the reciprocal of g_m , Miller feedback can be neglected and the equations of the previous example used.

Care should be taken in the application of this design method to high level output stages, since the frequency response and hence the high frequency gain is a function of the instantaneous value of $r_{b'e}$. Heavy intermodulation distortion can result, especially when $R_s + r_{bb'}$ is of the same order as the mean value of $r_{b'e}$, as can be seen from the relationship between f_p and the instantaneous emitter current I_e

$$f_p = \frac{f_{ae}}{1 + \frac{f_e}{f_m}} \left(1 + \frac{r_{b'e}}{R_s + r_{bb'}} \right)$$

$$= \frac{f_e}{1 + \frac{f_e}{f_m}} \left(\frac{1}{\alpha_e} + \frac{1}{\Delta I_e (R_s + r_{bb'})} \right) \dots\dots\dots(19)$$

5.3. Simple Iteration

For the third example in this class the case of simple iteration is considered. Here properly the load on each stage consists of the network $R_s, r_{bb'}, c_{b'e}, r_{b'e}, c_m$ and other components due to the complex Miller feedback. This situation is much too complicated for tractable design expressions to be developed without drastic approximations. To simplify matters $c_{b'e}$ and the internal feedback components will be neglected when considering the effective load impedance on each stage. This load then consists only of the network $R_s, r_{bb'}$ and $r_{b'e}$. The result of this approximation will be to over estimate the effect of Miller feedback. The design equations reduce to those of the previous example, excepting that the effective load resistor R_L becomes

$$R_L = \frac{R_s (r_{bb'} + r_{b'e})}{R_s + r_{bb'} + r_{b'e}} \dots\dots\dots(20)$$

where these quantities are those of the next stage to the one under consideration.

5.4. Shunt and Series Inductive Compensation

Extra gain-bandwidth can be obtained by using shunt and series peaking coils⁹ as shown

in Fig. 2. The values required and performance obtained are best determined experimentally, since the presence of $r_{bb'}$, $r_{b'e}$ and $c_{b'e}$ invalidates the classical theory applicable to the pentode valve case. It should be remembered that an inductive load produces an effective negative resistance acting in parallel with $r_{b'e}$, so that oscillation is possible. A suitable damping

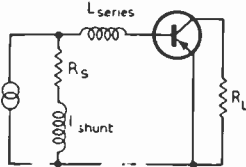

Fig. 2. Conventional shunt-series inductive compensation.

resistance across the series coil may be necessary to counteract this effect. Maximum gain-bandwidth is usually obtained when the series coil is connected between the collector and shunt load resistor as shown in Section 7.2 below.

6. Stage Frequency-Gain Product

In the basic conventional design method already described, the value of R_s is determined by the required frequency response. At the upper frequencies the signal current from the previous stage is divided between the shunt load resistor R_s and the input impedance of the transistor. When the video spectrum extends to frequencies more than two or three times $f_{\alpha e}$ only a small part of the signal current flows into the transistor, the rest is wasted in R_s .

This situation is avoided by a design philosophy in which the first object is to obtain all the intrinsic current gain available at the highest frequency of interest f_p . Current gain at lower frequencies is inherently larger and must be equalized by some method which does not reduce the gain at f_p .

6.1. Gain-bandwidth Redefined

The new method employs another definition for gain-bandwidth—the product of the modulus of the current gain at f_p and f_p itself. To differentiate between the definitions the new one will be called frequency-gain product and the conventional one gain-bandwidth product. Or, symbolically

$$f_g = |\alpha_e| \cdot f_p \text{ (Intrinsic frequency-gain product)} \dots\dots\dots(21)$$

$$f_e = \alpha_e \cdot f_{\alpha e} \text{ (Intrinsic gain-bandwidth product)} \dots\dots\dots(22)$$

The intrinsic high frequency current gain at f_p of a grounded emitter transistor working into zero load is

$$|\alpha_e| = \frac{\alpha_e}{(1+n^2)^{\frac{1}{2}}} \dots\dots\dots(23)$$

where n is still the ratio of f_p to $f_{\alpha e}$. The frequency f_p is then

$$f_p = n \cdot f_{\alpha e} \dots\dots\dots(24)$$

Thus the intrinsic current frequency-gain product is given by

$$f_g = f_e \left(1 - \frac{1}{1+n^2} \right)^{\frac{1}{2}} \dots\dots\dots(25)$$

Now this is within 90 per cent. of f_e when n is greater than two. In television application and with presently available transistors n is usually greater than two, so the intrinsic frequency-gain can be taken as equal to f_e .

6.2. Cascade Loss Eliminated

Another advantage of this design philosophy is that the cascade loss and the loss due to $r_{bb'}$ met with in the conventional approach are no longer encountered. This advantage greatly simplifies the design of a multi-stage amplifier. To a rough approximation the overall gain-bandwidth of a multi-stage amplifier using this technique is the product of all the individual stage gains at f_p times the frequency f_p . It will be seen that there is no inherent limit to the number of stages that can be used since stage gains do not have to be reduced on cascading, consequently a large number of inferior transistors can give the same overall gain-bandwidth as a smaller number of high-performance types. This situation does not necessarily hold for the conventional approach, as mentioned before.

6.3. Optimum Circuit Values

The first object in the design of a practical amplifier is to find the conditions necessary to obtain all the intrinsic high frequency current gain available at f_p .

It will be assumed that the coupling circuits do not provide any current gain at f_p in themselves, i.e. no transformers or equivalent networks. Each stage has a source resistance R_s and a load Z_L , which introduces Miller effect. As before, examples will be examined with

different types of load. Some cases have to be simplified owing to the complexity of the equivalent load impedance.

6.3.1. Simple iteration

When simple identical stages are cascaded, each stage has, as a source the shunt load resistor R_s , and as a load the next R_s shunted by the input impedance Z_{in} of the next stage. So far as the proportioning of R_s is concerned the input impedance can be assumed to be a pure resistance R_{in} . The internal voltage gain from b' to the collector will result in an effective Miller capacitance c_m acting in parallel with $c_{b'e}$.

$$c_m = c_{b'e} \left[1 + g_m \left(\frac{R_s R_{in}}{R_s + R_{in}} \right) \right] \cong c_{b'e} g_m \left(\frac{R_s R_{in}}{R_s + R_{in}} \right) \dots\dots\dots(26)$$

High frequency current gain at f_p when n is large is

$$|A_e| = \frac{g_m \left(\frac{R_s}{R_s + R_{in}} \right)}{\omega_p (c_{b'e} + c_m)} \text{ approx.} = \frac{1}{\omega_p \left[\frac{c_{b'e}}{g_m} \left(\frac{R_s + R_{in}}{R_s} \right) + c_{b'e} R_{in} \right]} \dots\dots\dots(27)$$

Therefore the stage frequency-gain F_o after simplification becomes

$$F_o = \frac{f_e \left(\frac{R_s}{R_s + R_{in}} \right)}{1 + \frac{f_e}{f_m}} \dots\dots\dots(28)$$

where $f_m = g_m / 2\pi c_m \dots\dots\dots(28a)$

By inspection, F_o is a maximum when R_s is much larger than R_{in} . So that, for example, when n is large the effective value of R_s at the frequency f_p must be made much larger than $r_{bb'}$. The available frequency-gain is then

$$F_o = f_e / (1 + f_e / f_m) \dots\dots\dots(29)$$

where

$$f_m = 1 / (2\pi c_{b'e} r_{bb'}) \dots\dots\dots(29a)$$

For large values of n this F_o is a property of the transistor alone, and is a useful parameter for the evaluation of transistors for video amplifier applications. The advantage in gain mentioned earlier arises from the signal current at f_p which now flows usefully into the transistor, instead of

being wasted in the shunt load resistor R_s , as in the conventional design.

In the intermediate range where n is not large the real part of Z_{in} gives a capacitive Miller component in shunt with $c_{b'e}$ as before, but the reactive part gives a resistive Miller component acting in shunt with $r_{b'e}$. An exact calculation of F_o in this situation is very complicated, but a rough approximation, when R_s is much larger than Z_{in} is given by

$$F_o = f_o \left/ \left(1 + \frac{f_o}{f_m} \right) \right. \dots\dots\dots(30)$$

where $f_o = f_e \left(1 - \frac{1}{1+n^2} \right)^{\frac{1}{2}} \dots\dots\dots(30a)$

and $f_m = \frac{1}{2\pi c_{b'e} \left[r_{bb'} + r_{b'e} \left(1 - \frac{n^2}{1+n^2} \right) \right]} \dots\dots\dots(30b)$

The quantities inside the square brackets refer to the next stage.

6.3.2. Low current operation

At low current levels the emitter storage capacitance falls so that the transition capacitances become important. Consequently f_o is also reduced and no longer approximately equals f_t .

$$f_e = \frac{f_t}{1 + \frac{1}{\mu} + \frac{\omega t}{g_m} (c_{et} + c_{ct})} \dots\dots\dots(31)$$

Also, stray capacitance in the external circuit can cause a further reduction so that the stage frequency-gain product (for large R_s) becomes

$$F_o = \frac{f_t}{1 + \frac{c_{et} + c_{b'e} + c_x}{c_{es}}} \dots\dots\dots(32)$$

(neglecting Miller effect)

where c_x is the circuit stray capacitance acting in parallel with $c_{b'e}$. At low currents the impedance of $r_{b'e}$ and $c_{b'e}$ will almost certainly be large compared with $r_{bb'}$, even at fairly large values of n ; but Miller effect does not change much, due to the complementary fall in g_m and $c_{b'e}$.

6.3.3. Resistance loaded stages

An output stage driving a resistive load R_L has, for large values of n , an effective frequency-gain F_o given by

$$F_{\sigma} = f_e \left(\frac{R_s}{R_s + R_{in}} \right) / (1 + f_e/f_m) \dots\dots\dots(33)$$

Again this is a maximum when R_s at the frequency f_p is much larger than R_{in} , so that F_{σ} becomes

$$F_{\sigma} = f_e / (1 + f_e/f_m) \dots\dots\dots(34)$$

where $f_m = g_m / 2\pi c_m = 1 / (2\pi c_b' c R_n) \dots\dots\dots(34a)$

The input impedance at f_p of high current stages is often not much more than r_{bb}' even at low values of n . It will be noticed with this new design technique that the stage high-frequency current gain is not a major function of instantaneous emitter current. Consequently in high level stages the intermodulation distortion can be much less than with the conventional design method.

6.3.4. Interstage shunt impedance

All these examples show that maximum stage frequency-gain is obtained when the effective value of the shunt load resistance R_s at the frequency f_p is made large compared with the input impedance of the transistor itself. There are two ways in which this can be achieved, one is simply to use a large resistance, the other is to use a lower resistance in series with a parallel tuned circuit resonant at f_p . This latter is an artifact which will be developed below. A low value of real resistance may be convenient for d.c. feed purposes, but a higher value gives less distortion. Flexibility in the choice of R_s is one of the advantages of this new method of design.

7. Equalization of Response

Low-frequency current gain is inherently larger than the value obtained at f_p and must be equalized by some method which does not reduce the gain at f_p . If the amplifier consists of only one or two stages, the low frequency gain per stage can be made either 3 or 1½ db respectively above the high frequency gain. But in a multistage amplifier it is better to make the low frequency stage gain A_e equal to the stage gain at f_p . This helps to avoid the cascade loss, and stage gains can be safely multiplied together to obtain the overall amplifier gain.

Two ways are shown in Fig. 3 by which the low frequency gain can be equalized. Figure

3(a) shows a lower value R_s used in conjunction with a resonant circuit. Here R_s is given by $R_s \cong A_e (r_{bb}' + r_{b'e}') / (u_e - A_c) \dots\dots\dots(35)$

The optimum values for L_s and C_s are best found experimentally, but the resonant frequency is usually just above f_p . No difficulty has been found in obtaining satisfactorily flat responses with this method. The capacitor C_s can often be removed with only a slight loss in frequency-gain, especially if the coil is designed to have a comparable self capacity. The circuit is then of course almost identical to the conventional one using a shunt peaking coil and the results can be no better, the advantage then lies only in the ease of design using the frequency-gain concept.

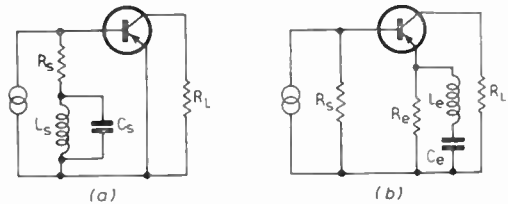

Fig. 3. (a) Equalization using a low value R_s ; (b) Equalization employing emitter circuit feedback.

7.1. Emitter Circuit Feedback

The most useful method of equalization uses an emitter feedback resistance R_e , shown in Fig. 3(b), with a large value R_s to maintain the frequency-gain at maximum. A series tuned circuit, again resonant at f_p or just above, is connected across R_e to restore the initial situation at f_p . The ratio of L_e to C_e is also best determined experimentally. The use of a large value R_s and emitter circuit feedback has other advantages. Distortion is reduced and nearly all the available frequency-gain product can be obtained without the use of peaking coils. If R_e is shunted by C_e alone, the frequency-gain falls only a small amount, perhaps 10 per cent. in a typical case. A maximally flat response¹⁰ can then be obtained when

$$C_e = 0.414 R_s / (\omega_e R_e^2) \dots\dots\dots(36)$$

(neglecting Miller effect)

A useful rule of thumb value, for a flat response, has been found to be

$$C_e = 1 / (\omega_p R_e) \quad (\text{empirical non-staggered}) \dots\dots\dots(36a)$$

Or

$$C_e = 1 \text{ to } (3/\omega_p R_e) \quad (\text{empirical staggered}) \dots\dots\dots(36b)$$

In a multi-stage amplifier the cascade loss can be almost completely eliminated by the use of graduated staggering.¹¹ This technique is used in the experimental low-noise amplifier described in Section 12 below.

The low frequency stage gain A_e required is obtained by making the emitter feedback resistance R_e equal to

$$R_e = (R_s/A_e) - (1/g_m) - ((R_s + r_{bb}')/\alpha_e) \text{ approx.} \dots\dots\dots(37)$$

Because of internal feedback through $r_{b'e}$ the resulting low frequency gain is usually less than the value corresponding to these expressions for R_s and R_e . In practice it is advisable to design for a stage gain A_e about 10 per cent. higher than required finally. The shunt load resistor R_s is of course the parallel combination of the previous collector load resistance and any base bias network.

7.2. Reactance Transformer Coupling

Extra current gain at high frequencies can be obtained by matching the high output impedance of one stage to the low input impedance of the next by some form of current transformer or its equivalent such as a reactance transformer. These circuits operate by developing more of the potential voltage gain, consequently Miller effect will be increased.

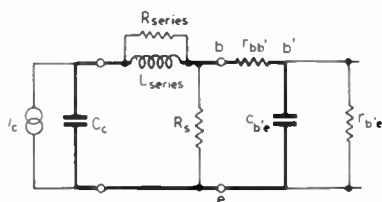

Fig. 4. Reactance transformer coupling.

High-frequency current gain can be obtained in a passive network by means of resonance. In Fig. 4 the inductance can resonate with the series combination of the collector output capacitance of the first stage and the input capacitance of the next stage. The circulating current in these capacitances exceeds the signal current from the active generator by the circuit magnification

which is a function of Q and frequency. By a proper choice of inductance and Q the overall frequency response can be extended while maintaining a reasonably flat response at medium frequencies.

8. L.F. Response

Maintenance of a good low-frequency response is basically similar in both transistor and valve amplifiers. The main difference is the much lower input impedance of transistor stages, which is often comparable with the previous interstage shunt load resistor. It is important to note that this interstage load resistance must be added to the effective input impedance when considering coupling time constants. The input impedance of a grounded emitter stage at l.f. is given by

$$R_{in} = r_{bb}' + \alpha_e \left(\frac{1}{g_m} + R_e \right) \dots\dots\dots(38)$$

This is reduced in practice by the base bias resistors which are effectively in parallel.

8.1. Emitter Circuit By-pass Capacitor

Stabilization of the working point in grounded emitter amplifiers is usually aided by means of a resistor in series with the emitter. In some cases at least part of this resistor has to be bypassed effectively at all signal frequencies by means of a large capacitor. From eqn. (37) it will be seen that the reactance of the capacitor must be small as given by

$$\frac{1}{\omega C_e} \ll \frac{R_s + r_{bb}'}{\alpha_e} + \frac{1}{g_m} + R_e \dots\dots\dots(39)$$

where R_e is the portion of the emitter circuit resistance remaining unby-passed at low frequencies.

8.2. Collector Circuit Compensation

As in valve amplifiers, some low-frequency compensation can be achieved by suitable choice of the decoupling network feeding the previous collector. To be useful in this respect the decoupling resistor must be large compared with the effective value of R_{in} at low frequencies. Taking the previous base bias feed from the same network can nullify the compensation, due to the l.f. negative feedback introduced, but at the same time this improves the d.c. stabilization.

9. Transistor Noise Sources

L. J. Giacoletto¹² has shown that four uncorrelated noise generators can represent the white noise sources active within a transistor. These are shown in Fig. 5.

The extrinsic base resistance produces simple thermal noise

$$\overline{dv_{bb'}^2} = 4 kT r_{bb'} df \quad \dots\dots(40)$$

Base current flow is a main source of noise, represented by a noise current generator in shunt with $r_{b'e}$

$$\overline{di_{b'e}^2} = 2 q(I_b + I_{cs} + 2 I_{es}) df \quad \dots\dots(41)$$

Between the internal base b' and the collector appears

$$\overline{di_{b'c}^2} = 2 q I_{cs} df \quad \dots\dots(42)$$

Collector current shot noise is represented by

$$\overline{di_{ce}^2} = 2 q (I_c - I_{cs}) df \quad \dots\dots(43)$$

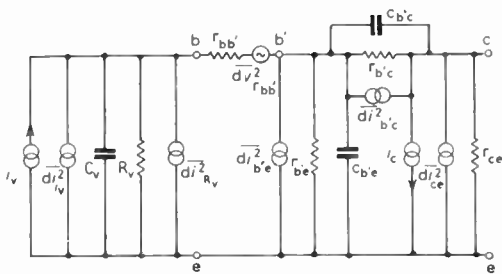

Fig. 5. First stage noise sources.

Also shown in Fig. 5 is a signal source i_v representing a vidicon camera tube with its internal stray capacitance C_v and the necessary load resistance R_v .

It should be noted that the transistor saturation currents (I_{cs} , I_{es}) used in these noise equations are not the usual cut-off currents (I_{e0} , I_{c0}) but are related to them. Neither of course, include leakage current in this context.

9.1. Excess Noise

Leakage and surface recombination effects within a transistor produce extra noise in addition to the white noise described above. This excess noise is characterized by a power spectrum which is inversely proportional to frequency.¹³ In a good modern transistor excess noise is small above the lower audio frequencies. Since a clamp can greatly reduce low frequency

errors, excess noise should be negligible in television applications.

10. Conditions for Maximum Signal/Noise

So that a direct comparison of signal and total noise currents can be made, it is convenient to refer each noise source back to the input of the amplifier. Miller effect can be ignored since it is only a form of negative feedback and reduces the noise and signal equally. This is true even for the collector circuit noise.

In a practical case $r_{bb'}$ is usually small compared with the reactance at f_p of either C_v or $C_{b'e}$, so these can be considered to act in parallel so far as the vidicon signal current and the referred noise currents are concerned. An exception is the noise generated by $r_{bb'}$ itself: the noise current circulating in the base circuit due to this source is a function of the loop impedance, the loop consisting of $r_{bb'}$, $C_{b'e}$ and C_v . Now the latter in practice has a larger reactance than $C_{b'e}$, so the elemental mean square noise current due to $r_{bb'}$ is at most

$$\overline{di_{bb'}^2} = (\omega C_v)^2 4 kT r_{bb'} df \quad \dots\dots(44)$$

Shot noise in the vidicon signal current contributes

$$\overline{di_v^2} = 2 q i_v df \quad \dots\dots(45)$$

Both these sources are small compared with the base current noise

$$\overline{di_{b'e}^2} = 2 q (I_b + I_{cs} + 2 I_{es}) df \quad \dots\dots(46)$$

which can be regarded as an equivalent noise resistance R_{eq}

$$\overline{di_{b'e}^2} = (4 kT / R_{eq}) df \quad \dots\dots(47)$$

from which

$$R_{eq} \cong 2 r_{b'e} \quad \dots\dots(47a)$$

Noise from the load resistor R_v can be made negligible by making R_v much greater than $2 r_{b'e}$. The input impedance of the second stage is such that the first stage can be considered to have zero load impedance. Consequently the transfer noise source can be simply added giving

$$\begin{aligned} \overline{di_{b'e}^2 + i_{b'c}^2} &= 2 q (I_b + 2 I_{cs} + 2 I_{es}) df \\ &\cong 2 q \left(\frac{I_c}{\alpha_e} + 2 I_{cs} + 2 I_{es} \right) df \quad \dots\dots(48) \end{aligned}$$

Second stage base current is usually small compared with the first stage collector current, so that the collector circuit noise has a value of

$$\begin{aligned} \overline{di_{ce}^2} &= 2 q (I_c - I_{cs}) df \\ &\cong 2 q I_e df \quad \dots\dots(49) \end{aligned}$$

this could have been produced by a $b'e$ voltage of

$$\overline{dv_{b'e}^2}(\text{ref}) = (2q I_e / g_m^2) df = 2q (1/\Lambda^2 I_e) df \quad \dots\dots(50)$$

which in the parallel combination of $r_{b'e}$ and C_{in} would result in an equivalent noise current

$$\overline{di_{b'e}^2}(\text{ref}) = \frac{2q}{\Lambda^2 I_e} \left(\frac{1 + \omega^2 C_{in}^2 r_{b'e}^2}{r_{b'e}^2} \right) df \quad \dots\dots(51)$$

where $C_{in} = C_v + c_{b'e} + c_{b'c}$ (51a)

Now C_{in} can be divided into a constant part $C_v + c_{et} + c_{ct} = C_k$

and a variable part $c_{cs} + c_{cs} \cong c_{cs}$

$$c_{cs} = \Lambda I_e / \omega_t \quad \text{from } \dots\dots(5)$$

By substituting for $r_{b'e}$ and C_{in} , the referred collector noise reduces to

$$\overline{di_{b'e}^2}(\text{ref}) = 2q \left(\frac{I_e}{\alpha_e^2} + \frac{\omega^2 C_k^2}{\Lambda^2 I_e} + \frac{\omega^2 I_e}{\omega_t^2} + \frac{2\omega^2 C_k}{\omega_t \Lambda} \right) df \quad \dots\dots(52)$$

Addition of the signal current, load resistor, $r_{bb'}$, and base current noises to this, results in a total $b'e$, equivalent mean square elemental noise current of

$$\begin{aligned} \overline{di_{b'e}^2}(\text{total}) &= 2q \left(i_v + \frac{2}{\Lambda R_v} + \frac{\omega^2 C_v^2 2r_{bb'}}{\Lambda} + \frac{I_e}{\alpha_e} + 2I_{cs} + 2I_{es} + \frac{I_e}{\alpha_e^2} + \frac{\omega^2 C_k^2}{\Lambda^2 I_e} + \frac{\omega^2 I_e}{\omega_t^2} + \frac{\omega^2 2C_k}{\omega_t \Lambda} \right) df \\ &= 2q \left[i_v + \frac{2}{\Lambda R_v} + \frac{\omega^2 C_v^2 2r_{bb'}}{\Lambda} + \frac{I_e}{\alpha_e} + 2(I_{cs} + I_{es}) + \left[\frac{\omega^2 C_k^2}{\Lambda^2 I_e} + \frac{\omega^2 I_e}{\omega_t^2} + \frac{\omega^2 2C_k}{\omega_t \Lambda} \right] \right] df \\ &\quad \text{approx. } \dots\dots(53) \end{aligned}$$

Integrated over a bandwidth f_p this becomes

$$\overline{i_{b'e}^2}(\text{total}) = 2q f_p \left[i_v + \frac{2}{\Lambda R_v} + \frac{\omega_p^2 C_v^2 2r_{bb'}}{3\Lambda} + \frac{I_e}{\alpha_e} + 2(I_{cs} + I_{es}) + \frac{\omega_p^2 C_k^2}{3\Lambda^2 I_e} + \frac{\omega_p^2 I_e}{3\omega_t^2} + \frac{\omega_p^2 2C_k}{3\omega_t \Lambda} \right] \quad \dots\dots(54)$$

10.1. Optimum Emitter Current

A minimum value for the total referred mean square noise is obtained when

$$\frac{I_e}{\alpha_e} + \frac{\omega_p^2 I_e}{3\omega_t^2} = \frac{\omega_p^2 C_k^2}{3\Lambda^2 I_e} \quad \dots\dots(55)$$

which gives an optimum emitter current

$$I_e = \frac{\omega_p C_k}{\Lambda \left(\frac{3}{\alpha_e} + \frac{f_p^2}{f_t^2} \right)^{\frac{1}{2}}} \quad \dots\dots(56)$$

Now when

$$f_p \gg f_t (3/\alpha_e)^{\frac{1}{2}} \quad \dots\dots(57)$$

the optimum condition corresponds to making

$c_{cs} = C_k$, but when

$$f_p \ll f_t (3/\alpha_e)^{\frac{1}{2}} \quad \dots\dots(58)$$

the optimum condition corresponds to making

$$R_{b'e} = \frac{(3\alpha_e)^{\frac{1}{2}}}{\omega_p C_k} \quad \dots\dots(59)$$

The latter relationship is more likely with presently available transistors suitable for this application, so the optimum emitter current required becomes

$$I_e = \omega_p C_k \left(\frac{\alpha_e}{3} \right)^{\frac{1}{2}} / \Lambda \quad \dots\dots(60)$$

Substituting this value into the expression for the total mean square noise gives the minimal value

$$\begin{aligned} \overline{i_{b'e}^2} \text{ min} &= 2q f_p \left[i_v + \frac{2}{\Lambda R_v} + \frac{\omega_p^2 C_v^2 2r_{bb'}}{3\Lambda} + \right. \\ &+ \frac{\omega_p C_k}{\Lambda (3\alpha_e)^{\frac{1}{2}}} + 2(I_{cs} + I_{es}) + \frac{\omega_p C_k}{\Lambda (3\alpha_e)^{\frac{1}{2}}} + \\ &\left. + \frac{\omega_p^3 C_k}{3\omega_t^2 \Lambda} \left(\frac{\alpha_e}{3} \right)^{\frac{1}{2}} + \frac{\omega_p^2 2C_k}{3\omega_t \Lambda} \right] \quad \dots\dots(61) \end{aligned}$$

10.2. Required Parameters

Evaluation of eqn. (61) term by term shows the importance of each factor. Clearly for maximum signal/noise ratio a transistor should be chosen which has small values for $r_{bb'}$, c_{et} , I_{cs} and I_{es} , but a large value for f_t . Also the circuit should be arranged to minimize C_k and have R_v large compared with $2r_{b'e}$. There would appear to be an optimum value for α_e , but this is well above normal values. In a typical example, doubling α_e from 50 to 100 only improved the signal/noise ratio by 1 db, whereas a fall of α_e to the low value of 10 reduced the signal/noise ratio by only 3 db. Transistors which

provide normal values of current gain α_c in the range 30 to 100 while operating at the required low emitter current are satisfactory.

For a given high frequency performance it would appear that silicon transistors with inherently lower saturation currents should be better than germanium types. But silicon transistors in general suffer a large fall in current gain at low currents.¹⁴ Apart from this, presently available silicon types have inferior high frequency performance and tend to have large extrinsic resistances which introduce extra thermal noise.

11. Measured Low Current Parameters

Samples of the 2N345 have proved to have excellent characteristics for this application. These are *p-n-p* germanium surface barrier units now in production in this country. Fifteen samples have been tested for major characteristics; and one has been completely analysed to determine the required low current equivalent circuit values. The latter are tabulated below with relevant figures for a vidicon tube. These measured results on one sample are of course not necessarily representative of the type in general.

12. Experimental Low-Noise Amplifier

An experimental amplifier, shown in Fig. 6, was designed with the object of obtaining confirmation of the signal/noise ratio predicted by the noise equations. The designed bandwidth of 5 Mc/s and overall current gain of 100,000 closely simulated a normal vidicon head-amplifier, while providing sufficient gain for accurate noise measurements.

The amplifier as a whole was of course only experimental, being designed to measure noise and not to act as a normal video amplifier. Low frequency response was restricted to 1 kc/s to eliminate the extreme low frequency part of the noise spectrum, which has a $1/f$ power distribution. In a practical amplifier this low frequency noise, if present, can be reduced by the usual clamp.

A total of six transistors were used, four type 2N345 gain stages and two type 2N393 connected as a single ended push-pull output stage.

12.1. First Stage Design

In designing the low-noise amplifier the first step was to determine from eqn. (56), the 1st stage optimum emitter current; the value obtained was 51.8 μ A. From noise considera-

Table 1
Low Current Equivalent Circuit Values for p-n-p Germanium Surface Barrier Transistor.

Base "transit" frequency ...	$f_t = 102$ Mc/s
Emitter transition capacitance ...	$c_{et} = 10.3$ pF
Collector transition capacitance ...	$c_{ct} = 1.4$ pF
Current gain ...	$\alpha_c = 45$
Extrinsic base resistance ...	$r_{bb'} = 320$ ohms
Collector saturation current at 22°C	$I_{cs} = 0.08$ μ A
Emitter saturation current at 22°C	$I_{es} = 0.06$ μ A
Vidicon signal plate capacitance ...	$C_r = 5.2$ pF
Vidicon load resistance ...	$R_v = 1.2$ M Ω

All the measurements were made at room temperature (22°C), a collector voltage of $V_c = -1$ V and the results are valid for emitter currents in the range 20 to 500 μ A. The value of f_t is a constant in this range, but above 500 μ A it rises, so that at 1 mA it becomes 126 Mc/s. This rise in f_t is due to a drift field resulting from the electron distribution within the base at high currents.¹⁵

tions the vidicon load resistor R_v must be made much larger than $2r_{b'e1}$. Now $r_{b'e1} = \alpha_c / (\Delta I_c) = 22,200$ ohms. The value of R_v determined by d.c. conditions was 1.2 megohms, which also satisfied the noise requirement.

A 1st stage collector voltage of -1 V was used to keep leakage current to a minimum, since at -5 V the leakage current would have been equal to the saturation current.

Frequency-gain for the input stage was

$$F_a = \frac{f_t}{1 + \frac{C_k}{c_{e2}}} = 16.1 \text{ Mc/s} \dots\dots\dots \text{from (32)}$$

At 5 Mc/s this corresponds to a theoretical 1st stage current gain of only 3.22 times.

12.2. *Second Stage Design*

For its noise to be negligible the 2nd stage base bias current must be small compared with the 1st stage collector current. Consequently I_{b2} was made only 5 μA which gave about 225 μA for I_{e2} , and 5700 ohms for $r_{b'e2}$.

Direct coupling between the 1st and 2nd stages conferred several advantages. Firstly, coupling capacitors and base bias resistors with their stray capacitances were eliminated, secondly, some d.c. and low-frequency negative feedback was obtained by returning the vidicon load resistor to the 2nd stage emitter. This method of stabilization requires a large d.c. voltage gain between the first base and the second emitter, hence the large resistance values in the 1st stage collector and the 2nd stage emitter circuits. The relatively small d.c. voltage gain obtainable from the 1st stage, limited operation of this circuit to 34°C. For tests up to 45°C the feedback loop was broken and a manual adjustment of bias introduced as also shown in Fig. 6.

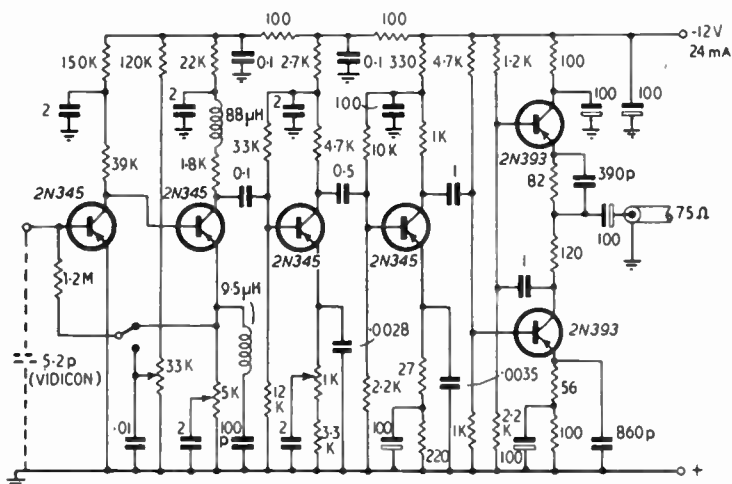

Fig. 6. Experimental low-noise amplifier.

Frequency-gain of the 2nd stage was

$$F_a = \frac{f_t}{1 + \frac{C_{e1} + C_{b'c}}{c_{e2}}} = 55 \text{ Mc/s} \dots\dots\dots \text{from (32)}$$

which implies a 2nd stage current gain at 5 Mc/s of eleven times. In both stage gain calculations stray circuit capacitances and Miller effects were neglected; measured 1st and 2nd stage gains were 2.5 and 9.4 respectively.

12.3. *D.C. Stabilization*

Thermal noise from the interstage load resistor was minimised by choosing a value (39 k ohms) which was large compared with twice the $r_{b'e2}$ value (5.7 k ohms) of the 2nd stage.

12.4. *L.F. Equalization*

Excess 1st stage low-frequency gain was equalized by means of the 2nd and 3rd stage emitter feedback networks. Equalization was deferred to the latter stages so that the amplified signal could over-ride thermal noise from these networks.

12.5. *Remaining Stages*

The rest of the experimental amplifier was designed using techniques outlined in earlier sections of this paper. Apart from the 1st stage it was found that maximum gain-bandwidth was obtained when the collector voltages were maintained at the maximum permissible. Overall gain-bandwidth measured was close to the value

predicted from simple considerations of individual stage frequency-gain products. This elimination of cascade loss was aided by staggering stage component values so that the later stages had progressively rising responses.

12.6. *Measured Signal/Noise Ratio*

Measured signal/noise ratio, assuming a vidicon signal current of 0.3 μA p-p was 43 db at 22° C and 42.5 db at 45° C. The first stage bias control was readjusted at the higher temperature to maintain the initial optimum emitter current. Only the first two stages were heated to 45° C, the rest remaining at room temperature since only the first two stages produced any measurable noise.

13. **Calculated Signal/Noise Ratio**

The theoretical value for the S/N ratio can be obtained by summation of all the terms in the noise eqn. (54). As with valve practice, the first term below, which arises from the vidicon signal current shot noise, will be neglected in arriving at the amplifier S/N ratio.

S/N ratio of 42.3 db. The measured value was 43 db. All of the transistor parameters can be expected to change at the higher temperature, so the calculated S/N ratio of 40.8 db at 45° C compares quite well with the measured value of 42.5 db at that temperature.

13.1. *Relative Importance of Noise Sources*

Examination of the individual noise terms shows that the noise generated by $r_{bb'}$ in this example is negligible, and that R_v could be made as little as 100 k ohms without increasing the total noise appreciably. Saturation current noise is also negligible at room temperature, but becomes dominant at 45° C. It should be noted that all the samples of 2N345 tested had saturation and leakage currents well below specification.

14. **Comparison with Valve Performance**

The noise current for a camera head amplifier using valves can be shown¹⁶ to be

$$\begin{aligned}
 2q f_p (i_v) &= 0.48 \times 10^{-18} \text{ A}^2 \text{ (vidicon shot noise)} \\
 2q f_p (2/\Delta R_v) &= 0.0684 \times 10^{-18} \text{ A}^2 \text{ (load resistor noise)} \\
 2q f_p (2 I_{cs} + 2 I_{es}) &= 0.448 \times 10^{-18} \text{ A}^2 \text{ (saturation current noise at 22° C.)} \\
 \text{or} &= 2.68 \times 10^{-18} \text{ A}^2 \text{ (saturation current noise at 45° C.)} \\
 2q f_p \left(\frac{\omega_p^2 C_v^2 2 r_{bb'}}{3\Lambda} \right) &= 0.233 \times 10^{-18} \text{ A}^2 \text{ (extrinsic base resistance noise)} \\
 2q f_p (I_e/\alpha_e) &= 1.84 \times 10^{-18} \text{ A}^2 \text{ (base current noise)} \\
 2q f_p \left(\frac{\omega_p^2 C_k^2}{3\Lambda^2 I_e} \right) &= 1.9 \times 10^{-18} \text{ A}^2 \\
 2q f_p \left(\frac{\omega_p^2 I_e}{3\omega_t^2} \right) &= 0.0663 \times 10^{-18} \text{ A}^2 \\
 2q f_p \left(\frac{\omega_p^2 2C_k}{3\omega_t \Lambda} \right) &= 0.71 \times 10^{-18} \text{ A}^2
 \end{aligned}
 \left. \begin{array}{l} \\ \\ \\ \\ \\ \\ \\ \end{array} \right\} \text{(referred collector current noise)}$$

$$\begin{aligned}
 \text{SUM} &= 5.266 \times 10^{-18} \text{ A}^2 \text{ at 22° C.} \\
 \text{or} &7.45 \times 10^{-18} \text{ A}^2 \text{ at 45° C.}
 \end{aligned}$$

The corresponding r.m.s. noise currents are 2.3×10^{-9} A at 22° C, or 2.74×10^{-9} A at 45° C. The latter figure was obtained by assuming that only the saturation currents changed with the increase in temperature (doubling every 9° C rise). Taking a vidicon signal current of 0.3 μA, the 22° C figure corresponds to a theoretical

$$\overline{i_n^2} = f_p \{ 2q i_v + 4kT [(1/R_v) + (R_{eq}/R_v^2) + (R_{eq}\omega_p^2 C_{in}^2)/3] \} \dots\dots\dots(62)$$

where $R_{eq} = 2.5/g_m$ for a triode valve, and C_{in} = total input capacitance. Inserting typical values for a 6BQ7A valve gives a calculated S/N ratio for $f_p = 5$ Mc/s of 44.5 db. The

corresponding measured value was 43 db, which is identical to the measured result using a 2N345 transistor at 22° C.

The well known Percival resonant input circuit gives about a 6 db improvement of S/N ratio in valve amplifiers and a similar result might be expected in the case of transistors.

14.1. Noise Spectrum

A well-designed valve amplifier has a triangular noise power spectrum. In the transistor case however the noise is uniform up to some middle frequency and changes to a triangular form at higher frequencies. The low-frequency part of the spectrum is modified by flicker effect in valves and by the excess noise in transistors. Both the effects give a $1/f$ power spectrum below the lower audio frequencies.

Valves can be microphonic and also pick up hum from their own heater supply; both these faults are of course absent in transistors.

14.2. Gain-bandwidth

The gain-bandwidth product of a 6BQ7A valve is 130 Mc/s, which is less than the measured figure of 146 Mc/s obtained for the sample 2N345 transistor operating at a collector voltage of -4 V and 1 mA emitter current. A valve of course does not lose gain-bandwidth while operating under low-noise conditions, in which the transistor figure fell to 21.7 Mc/s.

14.3. Power Supply Requirements

A typical valve head amplifier might consume 20 watts of h.t. power and $7\frac{1}{2}$ watts for the heaters; in contrast the experimental transistor amplifier worked with only 0.3 watts total power input.

15. Conclusions

It has been shown that with selected 2N345 transistors, it is possible to equal valve performance in respect of S/N ratio and gain-bandwidth.

A new design philosophy has been developed which gives greater gain-bandwidth per transistor than is obtained with conventional methods. Also the necessary conditions for maximum S/N ratio have been established and confirmed by experiment.

16. Acknowledgment

The author wishes to thank Mr. B. N. MacLarty, Engineer-in-chief of Marconi's Wireless Telegraph Co., Ltd., for permission to publish this paper, also Mr. V. J. Cooper at whose suggestion it was written.

17. References

1. R. Beaufoy and J. J. Sparkes, "The junction transistor as a charge-controlled device," *A.T.E. Journal*, **13**, pp. 310-327, October 1957.
2. R. G. Salaman, "Receiver video transistor amplifiers," *Trans Inst. Radio Engrs*, **BTR-4**, p. 68, September 1958.
3. R. L. Pritchard, "Frequency variations of current amplification factor of junction transistors," *Proc. Inst. Radio Engrs*, **40**, pp. 1476-1481, November 1952; also "Frequency variations of junction transistor parameters," *ibid*, **42**, pp. 787-789, May 1954.
4. H. Johnson, "Diffusion reactance of junction transistors," I.R.E.-A.I.E.E. Transistor Research Conference, Pennsylvania State College, July 1953.
5. L. J. Giacoletto, "Study of *pnp* alloy junction transistor from d.c. through medium frequencies," *R.C.A. Review*, **15**, pp. 506-562, December 1954.
6. J. M. Early, "Effects of space-charge layer widening in junction transistors," *Proc. Inst. Radio Engrs*, **40**, pp. 1401-1406, November 1952.
7. Miss G. Wagner, Private communication.
8. G. Meyer-Brötz and K. Felle, "Die Dimensionierung von transistor-breitbandverstärker," *Nachrichtentechnische Zeitschrift*, **9**, pp. 498-503, November 1956.
9. Yasushi Fujimura, "High frequency characteristics of transistor video amplifiers," *J. Inst. Elect. Commun. Engrs, Japan*, **41**, pp. 957-965, October 1958.
10. D. J. Brockington, Private Communication.
11. V. H. Grinch, "Stagger-tuned transistor video amplifiers," *Trans Inst. Radio Engrs*, **BTR-2**, pp. 53-56, October 1956.
12. L. J. Giacoletto, "The noise factor of junction transistors," pp. 296-308, in "Transistors I," (R.C.A. Laboratories, Princeton, 1956).
13. W. H. Fonger, "A determination of $1/f$ noise sources in semiconductor diodes and triodes," pp. 239-295, in "Transistors I," (R.C.A. Laboratories, Princeton, 1956).
14. Chih-tang Sah, R. N. Noyce and W. Shockley, "Carrier generation and recombination in *p-n* junctions and *p-n* junction characteristics," *Proc. Inst. Radio Engrs*, **45**, pp. 1228-1243, September 1957.
15. W. M. Webster, "On the variation of junction-emitter current amplification factor with emitter current," *Proc. Inst. Radio Engrs*, **42**, pp. 914-920, June 1954.
16. I. J. P. James, "Fluctuation noise in television-camera head amplifiers," *Proc. Instn Elect. Engrs*, **99**, pp. 796-803, May 1952.

DISCUSSION

A. J. Henk : Mr. Helsdon describes the early stages of a transistorized video frequency amplifier in his paper. Surely somewhere in the amplifying chain he is likely to have to face the problem of feeding the amplified information into a 75-ohms line. I would be interested to hear how he proposes to go about this problem.

I. F. Macdiarmid : Would Mr. Helsdon care to give us some more quantitative data on the performance of his video amplifier? The only actual figures given in the paper are for the noise performance. Can he give details of the response of the amplifier through the band, the power output, the linearity, and so on?

P. B. Helsdon (Associate Member) (in reply) : In answer to Mr. Henk, the problem of feeding video information at a standard level of 1 volt into 75 ohms. presents no great difficulty. The output stage shown in Fig. 6 will, in fact, do this. It is common practice, however, to make the output impedance also 75 ohms to give a

matched sending impedance. This condition was not required for the experimental low-noise amplifier since the measuring equipment was connected by only a short piece of cable. In a proper television distribution amplifier, however, one would match the sending impedance. Such an amplifier was described elsewhere†. That amplifier did, in fact, present an impedance of approximately 75 ohms up to 3 Mc/s.

Mr. Macdiarmid takes this question further. I must apologise if in section 12 of this Paper I did not make it sufficiently clear that the low-noise amplifier was not intended as a conventional video amplifier. As mentioned there "the amplifier as a whole was, of course, only experimental, being designed to measure noise and not to act as a normal video amplifier." The experimental amplifier mentioned in my reply to Mr. Henk would pass a standard 625-line high quality picture without any visual deterioration. Measured results in that case were as follows:

- Frequency response: ± 0.1 db to 6.5 Mc/s, -3 db at 8.7 Mc/s (small signal)
- L.f. tilt: 5% on 50 c/s squarewave
- Output impedance: 68 ohms to 3 Mc/s, 85 ohms at 3.5 Mc/s
- Input impedance: Same modulus as $5.6K\Omega$ shunted by 10 pF up to 7 Mc/s
- Voltage gain: +0.3 db
- Pulse rise time: 0.05 μ sec input, 0.08 μ sec output (1V p-p)
- Pulse overshoot: Not measurable
- Differential gain distortion (sine wave):

Percentage Distortion

	10 kc/s	500 kc/s	1 Mc/s	2.5 Mc/s	3.5 Mc/s	5 Mc/s	7 Mc/s
1.0V p-p output	—	0.25	0.25	0.25	0.55	0.95	4.25
1.5V p-p output	—	0.4	0.7	1.2	1.6	2.5	11
1.9V p-p output	2.3	2.5	3.2	3.6	5.5	7.7	20

† P. B. Helsdon. "Transistor video amplifiers." *Marconi Review*, 21, No. 129, pp. 56-72, 2nd quarter 1958.

A Rocket-Borne Magnetometer †

by

K. BURROWS, M.SC., ASSOCIATE MEMBER‡

Summary: The geophysical reasons for requiring magnetic measurements in the upper atmosphere and the general and instrumental considerations involved in using a Skylark rocket for the purpose are outlined. The principles of the measuring technique employing a proton precession magnetometer and the reasons for its selection are discussed. The application of these principles to the design, construction and testing of a practical instrument are described.

1. Introduction

The generally accepted basis for the explanation of the observed daily variations in the earth's magnetic field is to be found in the dynamo theory, first suggested by Balfour Stewart¹ and later elaborated by Schuster² and Chapman³. It is suggested that a system of horizontally stratified sheet currents is initiated and maintained in the ionosphere by the movement of charged particles across the lines of force of the earth's magnetic field through the action of atmospheric tides.

Whilst spherical harmonic analysis of the observed daily magnetic variations can yield a height integrated picture of the postulated current system, a detailed analysis, in particular of the vertical structure, is not possible from ground data alone. In 1947 Vestine and others⁴ first suggested the direct investigation of the ionospheric currents with rocket-borne magnetometers and some successful flights have been reported^{5, 6, 7}.

In 1957 it was proposed that a British rocket-borne magnetometer should be developed, under the auspices of the Gassiot Committee of the Royal Society, to be fired from the Woomera range in Skylark research rockets. The project would form part of the Royal Society's upper-atmospheric research programme, already commenced in connection with the International Geophysical Year⁸.

The Skylark⁹ is a single-stage uncontrolled rocket propelled by a Raven solid-fuel motor.

It can carry 150lb of payload to a height of approximately 150 km.

2. Design of Rocket Magnetometer

Since it is impractical, at present, to stabilize rocket-borne equipment within the accuracy required for useful three-component magnetic measurements, the scalar magnitude of the total geomagnetic force vector was selected for measurement.

2.1. Estimated Geomagnetic Effects

The observed magnetic variations at Watheroo Observatory yield an estimate¹⁰ of the maximum expected total force magnetic discontinuity observable in passing through the postulated current layers of only 10 gamma at Woomera, on a magnetically quiet day (1 gamma = 10^{-5} gauss). Hence to detect the currents the experimental errors must be less than this—though if this were not practicable, and only an upper limit could be assigned to any discontinuity present, the results would still be of considerable value in the further development of the dynamo theory, when considered in the light of observations taken in other parts of the world.

2.2. Measurement Repetition Rate

Since the Skylark rocket acquires a vertical velocity of up to 1 km per second through the ionosphere, measurements of the magnetic field are required at about one second intervals in order that any detailed structure may be resolved.

2.3. Rocket Magnetism

Measurements carried out on the mild steel Raven motor together with some scale-model experiments indicate that the magnetic field

† Manuscript received 29th June 1959. (Paper No. 530.)

‡ Department of Geophysics, Imperial College of Science and Technology, London, S.W.7.
U.D.C. No. 550.380:621.398:629.136.3

distortion due to the motor would be several orders of magnitude greater than that expected due to the ionospheric currents. It is essential therefore that the motor be separated from the measuring instruments by at least 60 ft. after "burn out" and before productive observations can be taken. This separation is achieved initially by a cutting charge positioned round the circumference of the rocket and is completed by the differential aero-dynamic drag forces acting on the nose-cone assembly and the motor⁹. To reduce heading errors still further the amount of magnetic material used in the construction of the nose-cone assembly is kept to a minimum and current loops are avoided, where possible, by the use of coaxial or twisted cables. The sensing head is, furthermore, mounted on a probe protruding four feet forward of the nose-cone in order to minimize the errors due to remaining unavoidable magnetic material in the round.

2.4. Instrumental considerations

Magnetometers using the conventional flux-gates as sensing heads suffer from some severe limitations, particularly when used in moving vehicles.

1. The information from a flux-gate element normally appears as a d.c. signal proportional

1. A strong polarizing magnetic field H_0 is created through the sample, preferably at a large angle to the earth's field F , by passing a direct current through a coil wound round the sample. This results in a magnetization parallel to H_0 of $M_z = \chi H_0 [(1 - \exp(-t/T_1))]$ where χ is the nuclear susceptibility and T_1 is the thermal relaxation time. ($H_0 \gg F$.)

2. The polarizing field H_0 is reduced to a value of the same order of magnitude as F , in a time short compared with T_1 and is then removed in a time short compared with $\tau_p/4$ where τ_p is the period of the precessional signal in the magnetic field present. If this condition is not fulfilled the polarization in the sample follows the direction of the resultant vector $H_0 + F$, the final orientation of M is therefore parallel to F and no coherent precession can ensue. This switching operation is performed conveniently, and simply, by the opening of a pair of relay contacts, since the final rapid removal of the polarizing current is achieved when the spark is extinguished. It is evident that the ringing frequency of the polarizing coil must be high compared with the expected precession frequency—a condition which sets certain limits to the design of the coil/cable combination.

Fig. 1. Decay envelope of precession signal from protons in paraffin (2.000 c/s unresolved).

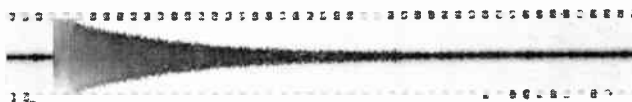

to the component of the measured field parallel to the axis. The instrument is therefore susceptible to drift problems and it requires frequent in-flight calibration.

2. It is very difficult to align three orthogonal flux-gates and to match their characteristics within the limits required to reduce heading errors to an acceptable magnitude.

For these reasons a magnetometer using the proton precession principle was developed.

3. Proton Precession Magnetometer

Packard¹¹ and Waters^{12, 13} were the first to report the successful detection of nuclear free precession. Three distinct operations are required to induce and detect coherent precession in a sample of a hydrogenous liquid.

3. The polarized protons in the sample now precess in phase, round the direction of F , at a frequency given by $f_p = \gamma F / 2\pi$, where γ is the gyromagnetic ratio of the proton, and the rotating resultant of the proton magnetic vectors induces an e.m.f. (of the order of a few microvolts) in a pick-up coil wound round the sample. When space is limited, as in the present application, it is convenient to use the same coil for detecting the precession signal as was used for polarizing. The signal finally decays exponentially as a result of the gradual loss of phase coherence in the precessing protons, caused by atomic interactions, any inhomogeneity in the magnetic field and absorption of energy by the pick-up coil (Fig. 1). Substituting the value of the latest determination of γ ($26753 \pm 0.6 \text{ sec}^{-1} \text{ gauss}^{-1}$) yields an expression

for the precession frequency of $f_p = 4257 \cdot 8F = 2478 \cdot 0$ c/s at Woomera (ground level) since the mean total field there is 0.582 gauss. Approximating the geomagnetic field to that of a dipole located at the centre of the earth the calculated frequency excursion during the rocket's upward flight is approximately -170 c/s. The expected frequency of the signal is therefore conveniently in the audio frequency spectrum and can be fed directly into a telemetry system for subsequent accurate measurement on the ground. Since the useful information is contained in the frequency of the signal, problems of changes in calibration due to slow drifts in the gain of the associated amplifier circuits are eliminated, a considerable advantage when the instrument is required for use in rockets.

Changes in the earth's field can thus be measured with an accuracy limited only by the time for which a usable precession signal can be detected. It is a simple matter to produce a signal lasting several seconds, by using pure water or benzene as the proton sample¹³, but a correspondingly long polarizing period is necessary; therefore a compromise has to be achieved between accuracy and resolution.

The one second available for each measurement of the geomagnetic field is divided into two approximately equal periods for polarizing and recording of the precession signal.

4. Design of the Sensing Head

Bloch¹⁴ showed that the signal voltage induced in a pick-up coil is given by:—

$$V_s = (4\pi/3) (j+1) \cdot j^{-1} \cdot [(a+b)^2 + d^2]^{-1/2} \cdot n \mu^2 \times (kT)^{-1} \omega H_0 \cdot N \cdot V \times 10^{-8} \text{ volts} \dots\dots\dots(1)$$

Furthermore the thermal noise voltage generated in the internal resistance of the coil is given by

$$V_n = (4kTBR)^{1/2} \dots\dots\dots(2)$$

In these expressions:

- j = spin quantum number,
- a = inside radius of coil,
- b = outside radius of coil,
- d = length of coil,
- n = number of protons per cm³,
- μ = magnetic moment of proton,
- k = Boltzman's constant,
- T = absolute temperature,
- ω = $2\pi \times$ precession frequency,

- H_0 = polarizing field,
- N = number of turns in sensing coil,
- V = volume of sample,
- B = noise bandwidth,
- R = resistance of coil.

From these equations the design for a sensing coil, which is required to perform the dual role of polarizing and detecting the precession signal, can readily be determined. The equations enable the optimum values to be determined of those parameters (wire gauge and ratio of internal to external diameters of coil) which are not immediately evident on a basis of physical reasoning.

The above equations lead to an expression for the signal/noise ratio of

$$\frac{V_s}{V_n} \propto H_0 N V R^{-1} [(a+b)^2 + d^2]^{-1/2} \dots\dots\dots(3)$$

since j , n , μ and T can, for the present purpose, be considered constant and the quantities ω and B are determined by other considerations.

Let the wire, used for the construction of the sensing coil, be of resistivity ρ and radius r . Equation (3) can then be written in terms of the geometrical configuration of the coil:

$$\frac{V_s}{V_n} \propto (b-a)^{1/2} \cdot [(a+b)^2 + d^2]^{-1/2} \cdot (a+b)^{-5/2} \cdot d^{3/2} \cdot a^2 \cdot r^2 \cdot \rho^{-1/2} \cdot V_p \dots\dots\dots(4)$$

where V_p is the polarizing voltage.

Equation (4) leads to the following conclusions:

1. The coil should be as long as practicable.
2. The polarizing voltage should be as large as practicable and the wire should be of heavy gauge and low resistivity. The practical limits to this requirement are determined by the power which can be dissipated in the coil.
3. When b is given a value of 3.2 cm (the maximum permissible, as determined by aerodynamic considerations) then the value of a which gives a maximum signal/noise ratio is approximately 2.1 cm. A slightly lower optimum value of a is obtained when the shot noise of the amplifier is taken into consideration, though the increase in V_s/V_n is less than 5 per cent. whereas the weight of the coil would be increased by approximately 20 per cent.

The principal considerations involved in the choice of proton sample are that the liquid is required to contain a high concentration of protons and to have relaxation times somewhat

longer than the $\frac{1}{2}$ second polarizing and precession periods. The optimum conditions are most readily found experimentally and, of the numerous samples which have been tested, paraffin gave the largest signal.

When the same coil is used both for polarizing and as the pick-up coil, the signal amplitude is proportional to $\sin^2\theta$ where θ is the angle between the coil axis and F , since the component of polarization normal to F and the induced signal for a given polarization are each proportional to $\sin\theta$. It therefore follows that there is a solid cone within which orientations of the coil axis will not give a detectable signal. For this reason (and to increase the reliability of the installation) two independent coils are used, mounted with their axes respectively along and perpendicular to the rocket axis. Aluminium is used for the axial coil because of its low specific gravity but the small diameter of the probe made it necessary to use copper for the transverse coil in order to obtain an adequate signal.

The coils are embedded in Araldite high temperature casting resin type F and mounted on a platform machined from duralumin (Fig. 2). The platform is attached to the nose cone by means of a 1 in. o.d., 18 S.W.G., austenitic stainless steel tube. (Stainless steel proved to be unsuitable for the platform since it was discovered that machining it resulted in an appreciable magnetization.) To minimize electromagnetic damping the axial coil is mounted forward of the transverse coil and two saw-cuts are made in the platform.

To protect the coils during the rocket's ascent through the atmosphere the coil assembly is enclosed in a fibreglass sheath with $\frac{1}{4}$ in. thick walls. (Durestos, which could more easily withstand the aerodynamic heating, was found to be slightly magnetic due to the asbestos used in its manufacture.)

During the six-minute rocket flight the temperature inside the probe will increase due to the electrical energy dissipated in polarizing the proton samples and due to conduction inwards of heat generated by aerodynamic friction at the outside surface of the fibreglass sheath. The internally generated temperature can readily be calculated from a knowledge of the mean power dissipated and the weights and specific

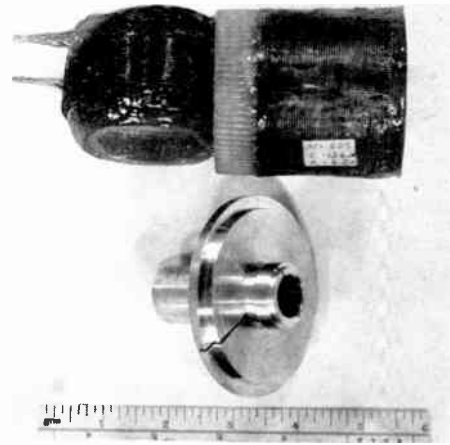

Fig. 2. Sensing coils and mounting platform.

heats of the various materials used in the construction of the probe. The calculated thermal capacity of the coils, proton samples, platform and the embedding Araldite is approximately 30 calories. The total electrical energy dissipated during the flight is 6480 joules (12V, 3A for half the time) which corresponds to a liberation of 1542 calories. Hence the temperature rise will be approximately $+52^{\circ}\text{C}$. The rise in temperature on the inside surface of the sheath due to aerodynamic heating has been computed by the Royal Aircraft Establishment, as being of the same order as that due to electrical heating derived above. This temperature rise, whilst it is appreciable, is within the limits at which trouble might be experienced from softening of the embedding resin or electrical breakdown of the high temperature enamel insulation of the copper wire, the oxide insulation of the aluminium wire or the p.t.f.e. insulation of the connecting cables.

5. Electronic Circuitry

The circuit diagram of the instrument is shown in Fig. 3 and a photograph of the complete equipment mounted on a Skylark bulk-head is shown in Fig. 4.

It is virtually two complete instruments, each with its own independent amplifier channel, the information from them being sampled alternately, at approximately ten times per second, by means of the switching diodes V10 and V11 with their associated multivibrator circuit. Whilst it would have been perfectly feasible to

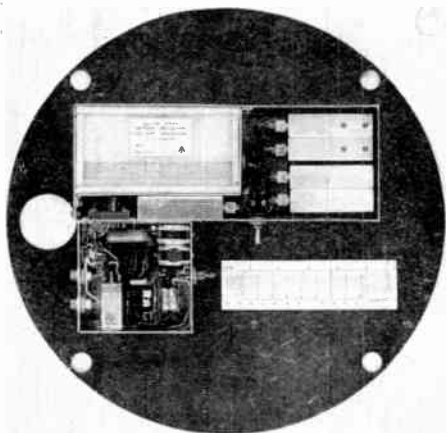

Fig. 4. Rocket-borne instrumentation mounted on a "Skylark" bulkhead.

perform the channel switching in the input circuit and to use a common amplifier, with resulting saving in weight and space, the present duplicated system is preferred as being inherently more reliable.

The cycling of the sensing coils L1 and L2 is performed by relays RLA and RLB. Contacts RLA1 and RLA2 alternately select polarizing current and switch the coils into their respective amplifiers, while RLB1 and RLB2 remove the polarizing fields as previously described. Since a current in one sensing coil would result in a severe field gradient across the other sensing coil, with consequent rapid loss of phase

coherence in the precessing protons, it is essential that the two polarizing currents are switched off simultaneously. There is thus a limit to the degree of independence, and hence increase in reliability, which can be achieved by the use of this double coil system, though this consideration is partially offset by the use of the two relays operating in parallel. The series-parallel arrangement of the contacts assists furthermore in the rapid breaking of the polarizing current and reduces the risk of contact welding. To ensure that the sensing coils are not connected to their respective tuning capacitors before the polarizing fields have been completely removed a capacitor is connected across relay RLA, thereby delaying its operation by a few milliseconds.

The coupling constants in each pair of resonant circuits, formed by the sensing coils and the grid coils with their respective tuning capacitors, can be adjusted by varying the number of turns in L3 and L4. This, together with the resonant L/C anode load in the first stage of each amplifier channel, enables an approximately rectangular frequency characteristic to be obtained, with the required bandwidth. The frequency of the anode loads is arranged to coincide with the minimum of the double hump frequency characteristics of the input circuits: all three resonant circuits in each channel are then tuned to a frequency of 2394 c/s which is the centre of the expected frequency excursion during the rocket flight. Electrostatic

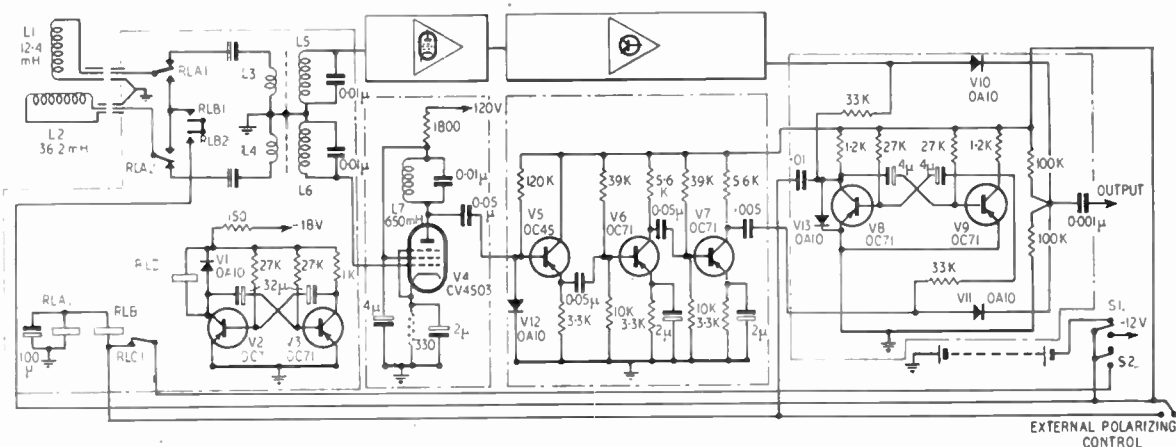

Fig. 3. Proton precession magnetometer circuit diagram.
Note: RLA and RLB are each duplicated to give greater reliability.

shields, in the form of earthed sheets of copper foil (0.001"), are incorporated between the primary and secondary windings of the input transformers.

A specially ruggedized sub-miniature low microphony pentode (CV4503) is used in the first stage of each amplifier in order to minimize loading of the input circuit and achieve the maximum signal/noise ratio consistent with adequate gain. This is followed by an emitter follower, to maintain the high Q of the pentode anode load, and two stages of standard transistor amplification. The voltage gain of each complete amplifier channel is 4×10^5 .

The switching circuit and the two sections of each amplifier channel are built as separate plug-in potted units (Fig. 5). A flexible polyester resin is used to reduce contraction pressure and to provide a slight degree of cushioning thereby minimizing the effects of severe transient accelerations. A thin glaze of epoxide resin is finally applied to seal the units against moisture penetration.

In the rocket installation the cycling of the magnetometer is controlled by means of an external switch operated by a programme motor. For test purposes, where the limited capacity of the 12V silver-zinc polarizing battery would restrict the time available, an external polarizing battery is used and the cycling can be controlled either manually, by S2, or automatically by the multivibrator (V2 and V3, with their associated components).

Figure 6 shows a record of the output beating with a standard local oscillator—a convenient method of counting the precession frequency. The channel with the best signal/noise ratio is selected and the number of missing cycles can then be interpolated. By counting the number of beats in the $\frac{1}{2}$ second precession period to an accuracy of $\pm 1/10$ cycle the recorded frequency is obtained with an accuracy of $\pm 1/5$ c/s.

The total weight of the magnetometer instrumentation is $6\frac{1}{2}$ lb - of which $1\frac{1}{2}$ lb is

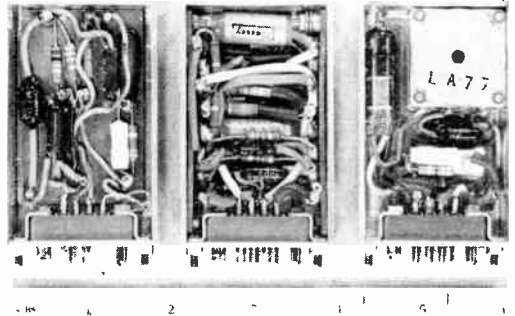

Fig. 5. Plug-in units. Transistor amplifier, electronic switch and valve amplifier.

accounted for by the two sensing coils and the remaining 5 lb by the electronic circuitry, including the internal battery.

In practice a signal/noise ratio of approximately 10 is achieved in the absence of any extraneous inductive pick-up. On the assumption that the maximum phase error φ introduced into a signal of amplitude V_s by an unwanted sinusoidal signal of amplitude V_n is given by $\tan \varphi = V_n/V_s$, it follows that the limiting accuracy of the instrument is approximately 0.03 c/s which corresponds to an error in the measured field of less than one gamma. The calculated temperature rise previously discussed will result in a reduction of signal (eqn. (1)) and an increase in noise (eqn. (2)). A rise in temperature from 300°K to 350°K will affect the signal/noise ratio available from the coil by a factor of $(3/3.5)^{3/2}$ (i.e. V_s/V_n will be reduced to a value of approximately 8) but the error in the magnetic field measurements will still be only one gamma approximately.

Further errors are introduced into the measurements by the Doppler effect on the telemetered precession frequency and by a combination of unbalanced d.c. current loops and magnetic material in the round. The Doppler correction is small (± 0.4 gamma at a radial velocity of ∓ 2 km/sec) and can readily be calculated from a knowledge of the rocket

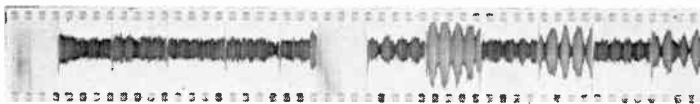

Fig. 6. Sample record of the output signal of a double coil magnetometer, beating with a local oscillator (Duration of record approx. 1 sec.).

trajectory. The magnetic effects of the rocket head assembly and its associated instrumentation are, on the other hand, less susceptible to calculation; the errors will vary from one round to another and, for any given round, will change during the flight due to the continual discharge of the batteries and to variations in temperature and ambient field. Measurements carried out on the two rotary converters which are used to provide h.t. in the round and which, it is anticipated, will be the two largest sources of heading errors in the majority of Skylark rounds, indicate that, when they are orientated in such a way that their external fields tend to cancel each other, the heading error attributable to this cause is of the order of ± 1 gamma. A non-magnetic platform, which will enable the assembled rocket head to be rotated in azimuth and elevation, is in process of construction in order that the heading errors of each magnetometer round can be measured and, if necessary, appropriate corrections can be applied to the recorded data.

The information from the magnetometer is telemetered by means of the standard R.A.E. 465 Mc/s airborne sender in current use in Skylark rockets¹⁵.

6. Flight Simulation Tests

To ensure as far as possible that the equipment can survive, though not necessarily function, during the initial part of the rocket flight, prototypes of each unit were subjected, whilst operating, to vibration tests covering the range

30-2000 c/s at maximum accelerations of 10g (+20% - 0%), the rate of frequency sweep being adjusted continuously, throughout the range, to permit the full build-up of any resonances present.

A theoretical investigation of the effects of rotations of the sensing coils reveals that when the rocket is rolling, precessing or tumbling, the precession signal, in addition to being amplitude modulated as discussed previously, will be frequency modulated. The instantaneous frequency deviation is, in the general case, a function of the coil orientation, and is given by $f_r \cdot \sin \alpha \cdot (\sin^2 \theta)^{-1}$ where f_r = frequency of rotation of the coil, α = angle between F and the plane of rotation of the coil and θ = angle between F and the coil axis¹⁶. In order to verify the fundamental assumptions made in the calculations and to investigate the performance of the magnetometer under the simulated conditions of a rotating rocket, the experiment illustrated in the block diagram of Fig. 7 was conducted. The single channel magnetometer, the transmitter and batteries were mounted on a platform which could be rotated manually at speeds in the range 0.4 revolutions per second. The precession frequency at any part of a revolution was measured by beating the received signal with a 2000 c/s standard sine wave and comparing the period of individual beats with 100 c/s brightening pulses derived from the same crystal oscillator. The corresponding orientation and rate of revolution of the coil were found from the cam-operated micro-switch.

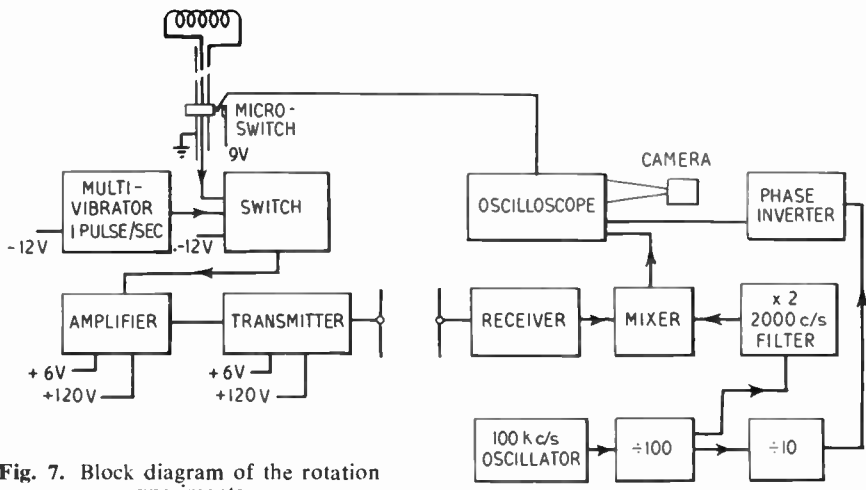

Fig. 7. Block diagram of the rotation experiments.

Several experiments were carried out at various values of α in the range $0-90^\circ$. The results of one experiment, at $\alpha = 24^\circ$, are presented in Fig. 8 which shows the normalized measured frequency deviations plotted against β , the angle between the coil axis and the projection of \mathbf{F} on the plane of revolution of the coil. The observations of this, and the other experiments carried out at different values of α , agree, within the limits of the experimental errors involved, with the theoretically derived curves and confirm that the precession signal is frequency modulated by rotating the coils.

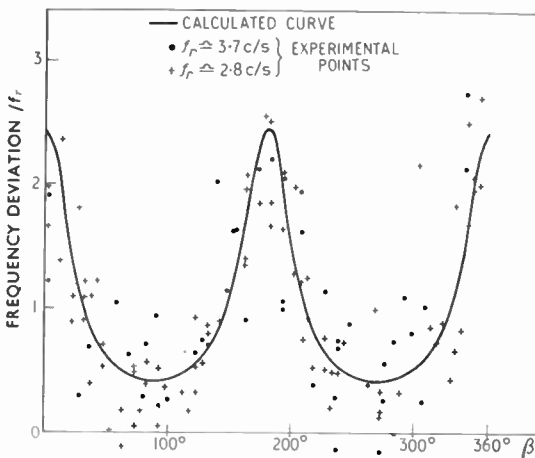

Fig. 8. Sample of the results of the rotation experiments.

Since the separation of the Raven motor will, in general, result in an unpredictable motion of the instrumented portion of the round it is therefore essential that corrections for the spin of the sensing coils can be applied to the measured frequency. For this purpose photocells and a three-element flux-gate magnetometer, developed by the Royal Aircraft Establishment, Farnborough, are included in the instrumentation of the round, the information from them being telemetered during each $\frac{1}{2}$ second polarizing period of the proton precession magnetometer.

The first firing of a Skylark round carrying a double-coil proton precession magnetometer is expected to take place shortly after mid-day during March, 1960.

7. Acknowledgments

The author wishes to acknowledge his indebtedness to the Royal Society who are financing the project, to Professor J. McG. Bruckshaw for his continued guidance and interest in the work, and to Dr. S. H. Hall, Mr. F. Gray and personnel of Venner Electronics Ltd., and the Royal Aircraft Establishment, Farnborough, for many interesting and valuable discussions in connection with the work.

8. References

1. Balfour Stewart, "Terrestrial Magnetism" (Encyclopaedia Britannica, 9th Ed., 1882).
2. A. Schuster, "The diurnal variation of terrestrial magnetism," *Phil. Trans. Roy. Soc. A*, **208**, pp. 163-204, 1908.
3. S. Chapman and J. Bartels, "Geomagnetism," Vol. 2, p. 1049 (Oxford University Press, 1940).
4. E. A. Vestine, L. La Porte, I. Lange and W. E. Scott, "The Geomagnetic Field, Its Description and Analysis," Carnegie Inst. Wash. Publ. 580, P363, 1947.
5. S. F. Singer, E. Maple and W. A. Bowen, "Evidence for ionospheric currents from rocket experiments near the geomagnetic equator," *J. Geophys. Research*, **56**, p. 265, 1951.
6. J. P. Heppner, J. D. Stolarik and L. H. Meredith, "The earth's magnetic field above W.S.P.G., New Mexico, from rocket measurements," *J. Geophys. Research*, **63**, p. 277, 1958.
7. L. J. Cahill, "Investigation of the equatorial electrojet by rocket magnetometer," *J. Geophys. Research*, **64**, p. 489, 1959.
8. H. S. W. Massey, "Rocket exploration of the upper atmosphere," *Nature*, **177**, pp. 643-645, 1956.
9. J. F. Hazell and E. B. Dorling, "Sounding Rockets," p. 243. (McGraw-Hill, New York, 1959.)
10. A. T. Price, Private communication.
11. M. Packard and R. Varian, "Free nuclear induction in the earth's magnetic field," *Phys. Rev.*, **93**, p. 941, 1954.
12. G. S. Waters and P. D. Francis, "A nuclear measuring the earth's magnetic field," *Geophysical Prospecting*, **4**, No. 1, 1956.
13. G. S. Waters and P. D. Francis, "A nuclear magnetometer," *J. Sci. Instrum.*, **35**, p. 88, 1958.
14. F. Bloch, "Nuclear induction," *Phys. Rev.*, **70**, p. 460, 1946.
15. W. M. Rae, "The airborne sender for 24-channel telemetry," Paper read at the Brit.I.R.E. Symposium on Radio Telemetry, 25th March, 1959.
16. S. H. Hall, Private communication.

The Testing and Operation of 4½-in. Image Orthicon Tubes†

by

D. C. BROTHERS, B.Sc.(ENG.)‡

A paper read on 3rd July 1959 during the Institution's Convention in Cambridge

Summary : The methods used by a broadcasting organization to check the performance of image orthicon tubes are described. Aspects dealt with include: the transfer characteristic; sensitivity; contrast handling ability; signal/noise ratio; picture sharpness; geometrical distortion and linearity; microphony; uniformity of picture background; freedom from spurious effects; lag, movement blur, sticking, etc.; colour response; freedom from drift; ease of adjustment. Some conclusions are drawn on particular aspects of operating these tubes.

1. Introduction

It is highly desirable that the quality of the pictures produced by cameras operated by broadcasting authorities for entertainment should be of consistent high quality for a wide variation of scene content, and that the operational effort required for each camera channel should be kept to a minimum. The basis of consistent camera picture quality is the camera tube, and therefore there is a need for adequate measurement and selection of tubes by the broadcasting authority.

Such tests are not intended to replace the testing done by the manufacturer, who has to perform special tests related to the manufacturing processes in use, but is an objective check to ensure that the tube has not deteriorated since leaving the factory and to show that the tube will meet the standards required under the particular conditions of use prevailing. The aim has been to avoid tests of a subjective nature since with such tests it is always a matter of opinion whether a borderline tube is acceptable or not and valuable time and effort can be wasted in deciding whether such a tube should be rejected.

Much work has already been done on measuring many of the parameters of the image orthicon^{1,2} but little of it refers specifically to

the 4½-in. image orthicon or, more particularly, to this tube operated in a "contrast-law corrected" condition. Some of the parameters which are important to the performance of the tube will be enumerated and relatively simple measurement techniques explained.

2. Parameters affecting Picture Quality

The principal parameters are:

- Sensitivity
- Contrast law
- Signal-to-noise ratio
- Sharpness of picture
- Geometrical distortion
- Microphony
- Uniformity of picture background (both white and black)
- Freedom from spurious effects
- Lag, sticking, movement blur etc.
- Colour response
- Ease of adjustment
- Freedom from drift

The order of the above parameters has no particular bearing on their relative importance. Unless any given tube can achieve a performance between certain limits in each of the parameters at the same time and at the same setting of the various controls of the camera, it can be said to be unable to produce a reliable picture of sufficient quality to be acceptable.

Each parameter will, therefore, be given a detailed examination and as a result of this examination, an attempt will be made to show how the tube may be set up and operated to

† Manuscript first received 14th April 1959 and in final form on 26th May 1959. (Paper No. 531.)

‡ The British Broadcasting Corporation, Planning and Installation Department, London, W.1.

U.D.C. No. 621.397.331.22:621.385.832.45

achieve a good compromise between the simultaneous requirements of the different parameters.

3. Basic Principles

The basic principles of the image orthicon have been very well covered in the literature³⁻⁸ and therefore only a brief recapitulation will be given here.

The operation of the image orthicon depends on the creation of a positive charge pattern on a thin glass membrane known as the target. This is achieved (see Figs. 1 and 2) by optically projecting an image of the scene on to a photo-emissive surface (photocathode) on which, at

The charge pattern having been created on the target, it is necessary to read it off in the form of an electrical signal. This is achieved from the other side of the target by means of the scanning beam. A beam of electrons is scanned over the target and the potentials are so arranged that it arrives there at approximately cathode potential. Here it is able, owing to conduction through the target, to neutralize the positive charges corresponding to illuminated areas in the image, and the target becomes stabilized at a potential just sufficiently negative to repel the scanning beam in the absence of light (approximately cathode potential). The repelled beam is accelerated back towards the cathode end of the tube and directed

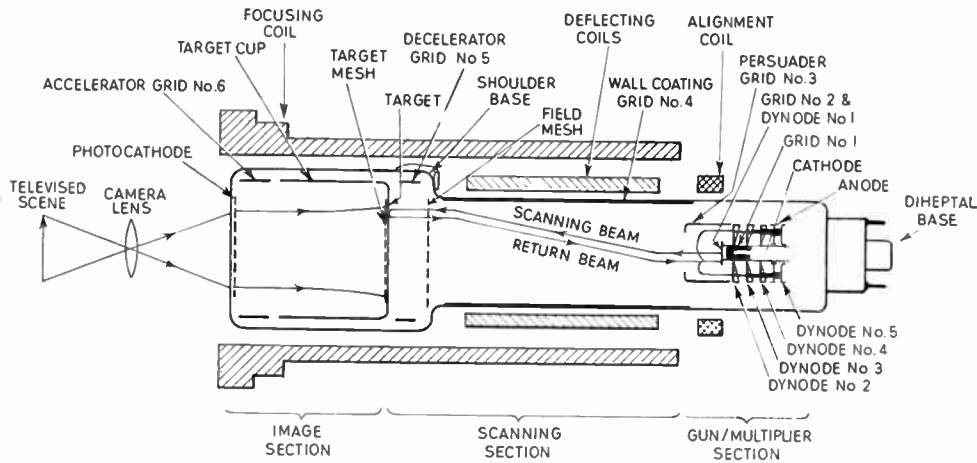

Fig. 1. Schematic arrangement of Type P811 4½" Image Orthicon.

any point, light causes the emission of a proportionate number of electrons. These (primary) electrons are accelerated towards and focused on to the target, where on landing they cause the emission of secondary electrons which are collected by the target mesh, which is held slightly positive with respect to the target. The conditions are so arranged that the secondary emission ratio at the target is greater than 1, so that the resulting charge image is positive. For various reasons, some of which are mentioned later in the paper, it is necessary to hold the mesh potential at from 1-5 volts positive with respect to the gun cathode. Thus the rise in potential of any portion of the target reaches a limiting value when the secondary electrons can no longer land on the mesh.

into an annular electron multiplier the output of which is fed into the head amplifier of the camera.

A fine mesh known as the field mesh is placed across the tube between the cathode and target to give a uniform decelerating field of high strength close to the target.

During line blanking a large negative potential is applied to the target, causing the repulsion of all electrons in the beam and the resultant pulse in the output is used as a black level reference in the camera clamping circuits.

The output of the electron multiplier is sufficiently great for head amplifier noise to be negligible in practice and the random fluctuation noise is entirely that due to the scanning beam

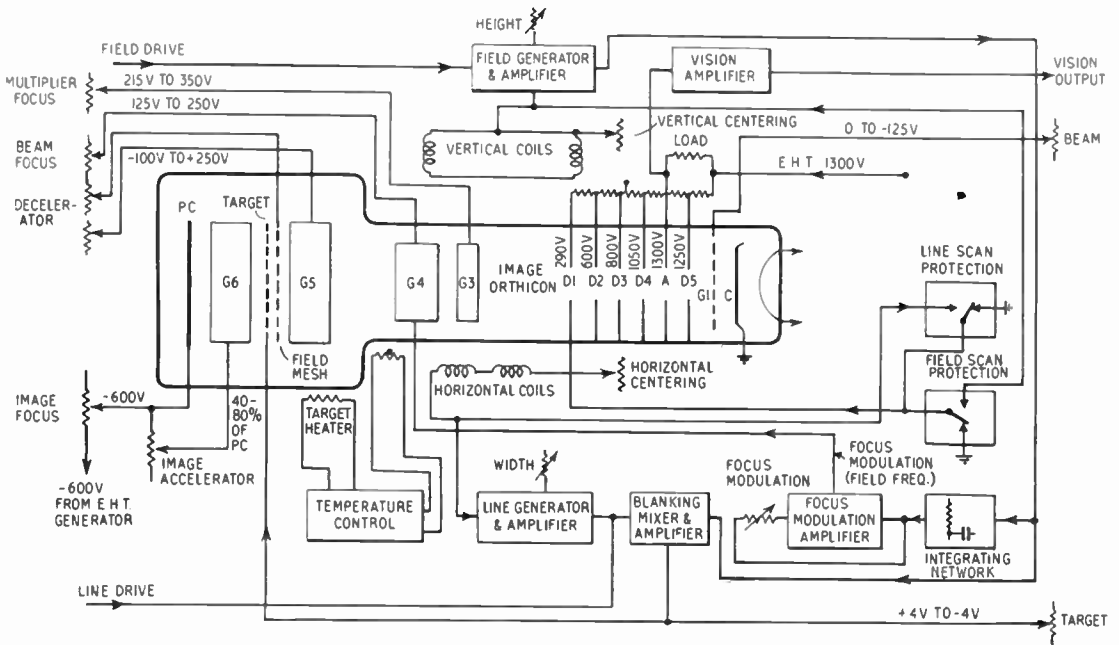

Fig. 2. Block diagram of P811 and associated control units.

(modified by the electron multiplier and partition noise through the field mesh).

The majority of this paper will deal with the ways in which the operation of the tube differs from the idealized summary given above, and the objective measurement of that departure.

4. The Transfer Characteristic

4.1. Definition

So far as this paper is concerned, the transfer characteristic of the tube may be defined as the relation between the photocathode illumination (L) and the signal current (i_s). If the signal current is fed into a resistive load R_L , then the signal voltage $V_s = R_L i_s$. It is often convenient to deal with V_s and this will therefore be used in this paper.

If the transfer characteristic is plotted with logarithmic scales, the gradient of the curve at any point is known as the point gamma. The point gamma (γ) may be defined as

$$\gamma = \frac{d(\log V_s)}{d(\log L)}$$

This definition is used as the basis of the following method of measuring the transfer characteristic of the image orthicon.

4.2. Measurement of Transfer Characteristic and Point Gamma

The block schematic of the arrangement is shown in Fig. 3. The camera is exposed to an illuminated transparency of the type required

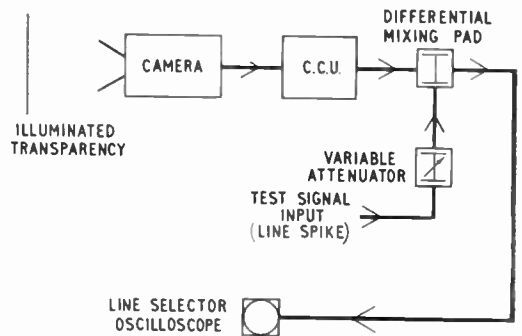

Fig. 3. Schematic of equipment for measuring transfer characteristics.

for the particular test being made. For this example consider a dark surround, dimensions approximately 9 in. by 12 in., with a small illuminated window approximately 0.4 in. square in the centre (see Fig. 4(b)).

The illumination in the window represents white and the camera exposure is set to the condition required for the test.

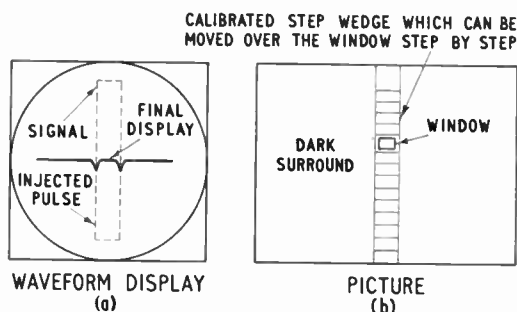

Fig. 4. Measurement of transfer characteristics—display of test object.

A line “spike” test waveform of approximately 2 microsec duration is mixed differentially with the output of the C.C.U., the camera is panned until the signals from the window and test waveform are overlapping in the waveform display, and the attenuator adjusted until the test waveform just cancels the signal in the output (see Fig. 4(a)).

A neutral light filter of known density is then placed in the window (see Fig. 4(b)) and the attenuator readjusted until the test waveform amplitude once again cancels that of the signal excursion in the display (Fig. 4(a)). Figures 5, 6 and 7 show photographs of the actual waveforms obtained in such a test.

The transfer characteristic can be obtained by plotting density against attenuator reading. Also if the attenuator reading in decibels is $Y = 20 \log_{10} V_s / V_{s(\max)}$ and density of light filter is $X = \log_{10} L_0 / L$ then

$$\dot{\gamma} = \frac{|Y|}{20|X|}$$

where V_s is the signal voltage after insertion of the neutral step, $V_{s(\max)}$ is the signal voltage before the insertion of the neutral step, L is the illumination after insertion of the neutral step, and L_0 is the illumination before insertion of the neutral step.

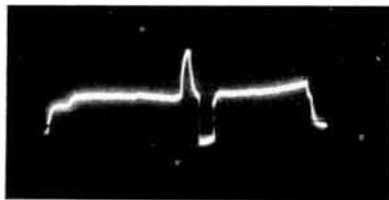

Fig. 5. Sensitivity and contrast law measurement. Electronic and camera pulse before superimposition.



Fig. 6. Sensitivity and contrast law measurement. Electronic and camera pulse after superimposition, before complete cancellation.

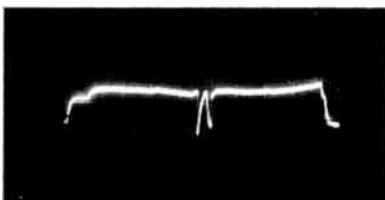

Fig. 7. Sensitivity and contrast law measurement. Electronic and camera pulse after complete cancellation.

The point gamma can be found at any value of illumination to any accuracy required by making the steps small enough. In practice density steps of 0.15 give a sufficiently accurate reading for most purposes. In this way it is possible to read either the point gamma around any given light value or to plot the complete transfer characteristic.

5. Sensitivity

For the purposes of sensitivity measurement, the usual definition of the “knee” of the transfer characteristic is not sufficiently precise, so an arbitrary but precise definition for the purposes of measuring tube sensitivity has been adopted, namely that the “knee” of a small illuminated area in a dark surround shall be defined as that point on the transfer characteristic at which the point gamma of the tube just drops to 0.5 on increasing the tube exposure.

The operating point can then be accurately defined in terms of increasing the exposure above or below the knee by a prescribed amount. Appendix I gives details of the particular operating point recommended for B.B.C. studios and the reasons for it.

In order to specify sensitivity of the tube alone, without involving the lens, highlight brightness on the photocathode is used. This is related to scene brightness by the formula

$$I_{pc} = \frac{BT}{4f^2(m+1)^2}$$

where

- B* = brightness of subject
- I_{pc}* = photocathode illumination
- T* = transmission of lens
- f* = relative aperture of lens
- m* = linear magnification from scene to photocathode.

If *B* is in foot-lamberts, *I* is in lumens per sq. ft. (foot-candles).

The sensitivity can then be given in terms of the highlight brightness required to reach the preferred operating point. This is preferable to giving sensitivity in terms of highlight brightness required to reach the knee, since the other tests have to be performed with the tube exposed to the operating point if they are to bear any relation to the results likely to be obtained in the studio.

Referring once more to Appendix I the highlight point in mode A would be at approximately ½ the light value to reach the "knee", whilst in mode B it is at the knee, mode C 1.5-2 times the value just to reach the knee and mode D about 4 times.

It follows from the above that the mode of operation has a very pronounced effect on the working sensitivity of the tube, and this is one more reason for selecting modes B/C rather than D.

Finally, it is perhaps worth mentioning that the working sensitivity measured in this way is a function of sensitivity of photocathode, secondary emission factor of the target, potential and capacity of target, transparency of target mesh and storage time. It may be seen that the single overall measurement of the function is a great deal quicker than measuring each factor separately and calculating the overall sensitivity

from them. Some typical results of sensitivity measurements are given in Table 1.

Table 1

	Target Volts above Cut-off	Sensitivity (Lumen, sq. ft. incident on photocathode)
Tube A	1	0.04
	2	0.04
	3	0.04
	4	0.04
	5	0.055
Tube B	1	0.1
	2	0.1
	3	0.1
	4	0.1
	5	0.125
Tube C	3	1.1 †
	3	0.125 ‡

† Image focus/target potential = 600.

‡ Image focus/target potential = 280.

Note.—At a lens magnification of ½, a highlight brightness of 25 ft. lamberts and lens aperture of 5.6 at 80 per cent. transmission factor, the photocathode illumination is 0.125 lumen/sq. ft.

The above tubes would all be satisfactory for use in studios, tubes B and C being just sufficiently sensitive for normal use, whilst tube A has about 1½ stops in hand.

These results are interesting in that they show that over a wide range, target potential does not affect the sensitivity. On the other hand, the highest image focus potential (i.e. the most negative) on which a focus can be obtained, gives an appreciable increase in sensitivity over the lower potentials (presumably owing to the greater energy of the primary electrons causing more secondary emission at the target).

6. Contrast Handling Ability

This is a subject that has sometimes been misunderstood in the past. The scenic contrast range which a camera can handle with reasonable faithfulness is a function of several parameters, namely:

- (1) Signal noise ratio
- (2) Background blemishes

- (3) Spurious effects
- (4) Limitations due to imperfections at the lower end of the transfer characteristic.

Limitations due to effects (1), (2) and (3) are discussed in this paper under those headings. This section is concerned with the measurement of effects under heading (4), the definition and importance of this parameter being discussed in detail in Appendix 2.

Limitations caused by the lower part of the transfer characteristic fall into two groups:—

- (1) Those which exist in small details in a dark surround.
- (2) Those which exist in details in a light surround.

6.1. *Small Details in a Dark Surround*

Reproduction of these is limited by an effect fully described in Appendix 2 and called "ultimate contrast range". As described in the appendix, this parameter can be measured by recording the change of point gamma at the lower end of the grey scale. However, any tube suffering from such a defect can be detected in the test for contrast handling of details in a Light Surround described below, so that it is not normally necessary to test for this alone.

6.2. *Details in Light Surround*

The case where a detail is surrounded by a background of a lighter tone is somewhat more complex and may best be considered in reference to Fig. 8.

6.2.1. *Small white square on black surround*

First consider Fig. 8(a), a picture of a small white square on a black surround. If the exposure of a tube regarding this object is gradually increased, starting from well below the knee, several changes take place.

- (a) Well below the knee, the behaviour of the tube is substantially as might be predicted from simple theory.
- (b) As the light is increased towards the knee, the signal from the background (A) increases very slightly owing to veiling glare in the optical system and equivalent effects in the tube. This increase is very small indeed and may be neglected for all practical purposes.

- (c) As the white area (D) is exposed above the knee, a defocused white halo of fairly large area appears around it (area B). This can be shown to take place on the image section side of the target and the area of it is affected by the image acceleration potential. Its mechanism has been described by Janes and Rotow⁷. It is caused by some of the secondary electrons having sufficient velocity to pass through the mesh and eventually return to the target with enough energy to cause the emission of other secondaries.

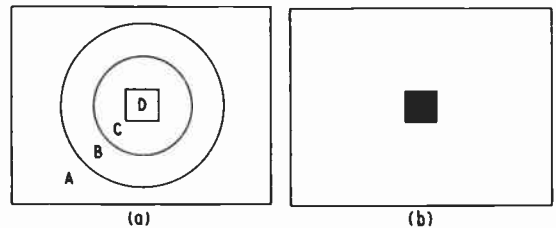

Fig. 8. Test object for examination of white and black halo.

- (d) If the target voltage is low, or if the tube has very large target/mesh spacing, an area of black halo, C, caused by slow secondary electrons from areas above the knee being repelled from the mesh and returning to the target, cancels the white halo near to the illuminated area. It is unfortunately not possible to use this cancellation to dispose of white and black halo at one stroke, since the white halo moves its position relative to the lighted patch according to the position of the illuminated square on the target, whilst the black halo is of smaller area and is always symmetrically dispersed around it.

6.2.2. *Dark detail on white surround*

If the above considerations are now applied to a dark detail on a white surround (Fig. 8(b)), the following is the sequence of occurrence.

- (a) When the surround is well below the knee, the behaviour is substantially as predicted by simple theory.
- (b) As the brightness of the surround increases towards the knee, there is a very slight increase in brightness of the

patch due to veiling glare. Although larger than in case 6.2.1, owing to the larger illuminated area, this is still generally small enough to be negligible.

- (c) On the surround reaching or exceeding the knee, there is a sharp increase in the brightness of the reproduction of the dark square, owing to white halo, which in this case covers the test patch completely and evenly.
- (d) On certain critical sizes of patch, it is possible to arrange for black halo just to cancel white halo if the tube is operated at a low target/mesh potential. This is more of academic than practical interest, since it only applies to small sizes of picture detail.
- (e) It is relevant to consider the transfer characteristic of the dark square under these conditions.
 - (i) In general, at all points where the surround is above the knee, a component B will have been added to the voltage. This gives a typical curve with decreasing point gamma towards black.
 - (ii) In order to understand the other effects, it is of interest to explore the transfer characteristic, ignoring the effect mentioned in (i) above. The method described in Section 4.2 can be used to do this, it being arranged that on cancellation of the pulses, the zero level on the detecting waveform monitor is that which would obtain on a small black square in place of the dark square. A transfer characteristic taken in this way for a 50 per cent white surround brightness is shown in Fig. 9 (the white in this graph is considerably brighter than normal in order to demonstrate the effects more clearly). It may be seen that it is substantially as for the black background case, except for an apparent decrease in sensitivity which is, in fact, caused by an evenly distributed black halo.

It follows from the above that tubes with a low value of ultimate contrast range will have a rather

worse behaviour than other tubes in areas affected by black halo, since the effect of the decrease in sensitivity is equivalent to a corresponding decrease in the ultimate contrast range.

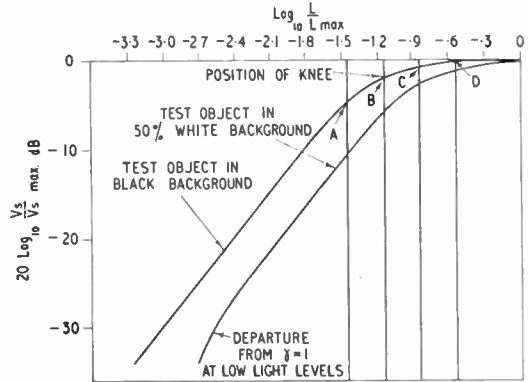

Fig. 9. Light transfer characteristics.

To sum up, the most sensitive test for the ability of a tube to handle scenes of large contrast range is that of a small dark square surrounded by a light background, the test consisting of two parts:

- (a) A measurement of the rise in black level caused by white halo and veiling glare.
- (b) A measurement of the point gamma at dark grey values disregarding the rise in black level mentioned in (a), to ensure that the ultimate contrast range is sufficiently great.

Figure 9 illustrates contrast laws that were plotted by the methods outlined in Section 4.2. These represent the normal tube. It will be seen that over a very large contrast range the point gamma below the knee remains at 1. Table 2 illustrates the behaviour of a tube that has a poor

Table 2

Density	Voltage Change (db)	
	Black Background	White Background
1.5	3.0	4
1.65	3.0	4
1.80	3.5	4
1.95	4.0	(not readable)
2.10		

contrast handling capacity. Density 0 represents white, set to the preferred operating point. The black level is set to zero for no light in.

This tube displays a limiting contrast range of approximately 250 : 1 under conditions of grey background and would be found rather unsatisfactory in service. It might be serviceable if used with a higher target/mesh voltage (these readings were taken with target/mesh=3.2 volts) and would certainly be completely unserviceable at lower target/mesh voltages.

7. Signal/Noise Ratio

One of the most important parameters in a television picture is the signal/noise ratio. For the purposes of this paper, signal/noise ratio will be taken to mean the peak signal voltage/r.m.s. random fluctuation voltage at the output of the camera chain. It is most important to measure the signal/noise ratio of a tube accurately and it is very useful to have an idea of the distribution of that noise throughout the frequency spectrum. In addition, in order to ensure that consistent results are obtained by different people, it is essential that an indicator is used giving a true r.m.s. reading of the noise voltage, since, in theory at any rate, the peak voltage of any random noise is infinite.

A method of calculating the signal/noise ratio by measuring all the contributing factors has been suggested by Pilz² and this avoids the difficulty of an actual signal/noise measurement. The formula used is

$$S = i_s \sqrt{\frac{m}{1-m}} \sqrt{\frac{1}{f_m \cdot 2e \cdot X}}$$

where

i_s = signal current

m = modulation depth of return beam

f_m = bandwidth of transmission channel

e = charge on an electron

X = factor expressing the increase in noise in the electron multiplier.

To this should be added a factor (which is usually small) for partition noise and noise caused by field mesh secondary emission in some tubes using a field mesh, so that it may be seen that this method involves a fairly large number of measurements and calculations.

In order to obviate the necessity for this a direct measurement method has been developed by Weaver¹⁰ which gives a reliable and consistent reading with an accuracy of repetition within less than 1 db.

The method consists of a narrow band-pass filter, the centre frequency of which can be placed accurately in the "dead" area between the signal harmonics of line frequency. (A communications type receiver may be used for this purpose.) The energy in these areas is the r.m.s. noise (all components caused by picture, shading, syncs, etc. being rejected) and by a simple comparison with a standard noise source, using an r.m.s. indicator, a value of the noise at any given frequency within the band can be obtained. Normally it is only necessary to check the noise on a known type of tube in a known channel at about two or three frequencies and, in fact, in the case of any given type of 4½-in. tube a check at, say, approximately 1 Mc/s gives a fairly accurate idea of the noise of the tube.

It is strongly recommended that the noise is not measured by the height of "grass" on an oscilloscope, as under differing conditions, widely differing results can be obtained by this method, since its accuracy depends on subjective assessment as well as objective observation of the oscilloscope.

Some results of signal/noise measurements on tubes set up in different ways are given in Table 3.

The results on tube D are interesting in that they show the way in which signal/noise ratio improves with increasing target volts. If the target/mesh potential is increased to more than 3.5 volts, it will be noticed that the improvement is quite small. However, between 1.5 and 3.5 volts the improvement is 3.5 db which is really worthwhile.

Similarly in tube A which has already been used as an example in the sensitivity tests, the improvement in signal/noise ratio on changing the target/mesh potential from 2 to 4 volts is about 3 db.

Tube E is an example of how the noise spectrum may be used to check the aperture correction in the C.C.U. Basically the frequency spectrum of electron beam noise is flat and any departure at

high frequencies must be due to inadequate or excessive correction in the camera or C.C.U. In the case of tube E it will be observed that there is ½ db of high-frequency tip-up in the C.C.U. at 3 Mc/s. This is an extremely reliable way of checking aperture correction and C.C.U. frequency response, since the measurement is performed with the tube in position *and working*.

The results on tube F illustrate the effect of G₃ potential on gain and noise. It is fairly clear from these results, which are quite typical, that there is an appreciable contribution to the noise from the multiplier since the signal/noise is better at positions of maximum gain. In addition, the signal/noise ratio is affected by the potential of G₃ and at two positions of equal multiplier gain signal/noise is best at the lower potential of G₃.

If the measurements are made without contrast law correction in the camera, when assessing the tube in terms of measurements on signal/noise ratio it is necessary to allow for the contrast correction which it is anticipated will be used when the tube is in service (this will increase the noise in the blacks). In the case in point, tubes D and A would appear rather noisy in the blacks if correction were added, whilst E would be reasonably satisfactory and F adequate. Apart from the objectionable nature of the noise itself, noise in the blacks tends to be rectified in the suppression mixer or c.r.t. and will distort the grey values of the lower tones by adding a small d.c. component to them. In this sense, signal/noise ratio may be said to limit the contrast handling ability of the tube.

Table 3

Tube	Exposure	Target	G ₃ Potential	Frequency	Relative Gain	Signal/Noise/ kc/s
D	Preferred	1.5	185	1.0 Mc/s	0	70
	„	2.5	185	1.0 Mc/s	+3.5	72
	„	3.5	185	1.0 Mc/s	+6.0	73.5
	„	4.5	185	1.0 Mc/s	+7.0	74
A	„	1	max. sig.	1.0 Mc/s		70
	„	2	„	1.0 Mc/s		72
	„	3	„	1.0 Mc/s		74.5
	„	4	„	1.0 Mc/s		75
	„	5	„	1.0 Mc/s		75.5
E	„	3	„	0.5 Mc/s		75
	„	3	„	1.0 Mc/s		75
	„	3	„	1.5 Mc/s		75
	„	3	„	2.0 Mc/s		75
	„	3	„	2.5 Mc/s		75
	„	3	„	3.0 Mc/s		74.5
F	„	3	155	1.0 Mc/s	+1.5	78
	„	3	185	1.0 Mc/s	+6.0	80
	„	3	237	1.0 Mc/s	+1.5	77
	„	3	272	1.0 Mc/s	+4.0	78
	„	3	320	1.0 Mc/s	+1.5	77
	„	3	335	1.0 Mc/s	0	75.5

Note.—In a rectangular noise spectrum of bandwidth 0–3 Mc/s a signal/noise ratio of 70 db/kc/s gives an overall ratio of 35 db.

8. Picture Sharpness

The ability of a camera tube to reproduce fine detail depends upon its horizontal and vertical resolution and other factors such as edge effect, which in turn depend upon redistribution. If a picture is sufficiently good in horizontal and vertical resolution, it is not necessary to resort to spurious responses in order to make a picture appear sharp. For example, a picture from a good 35 mm flying spot telecine is free of spurious responses and always appears sharp.

The main object of this section is to discuss the measurement of vertical and horizontal resolution. Spurious effects and redistribution are discussed in Section 12.

8.1. Horizontal Resolution

Television is a bandwidth limited system and good depth of modulation within the passband is the criterion rather than a very high limiting resolution. Horizontal resolution measurements on tubes are, therefore, confined to measuring the amplitude response of the tube to test patches of various frequencies within the passband and in particular to the response at the upper limit of the passband.

Several other considerations are of the utmost importance in measuring horizontal resolution.

- (a) In order that resolution measurements should not be confused with contrast law limitations in a tube, it is important that any resolution patterns should have a low contrast range and be placed in the upper middle part of the grey scale.
- (b) Comparatively large areas of low frequency (<100 kc/s) information of equal density range to the test frequency pattern should be situated immediately beside it.
- (c) All patterns of frequency $f_m/3$ or more, where f_m is the bandwidth of the system, should be of approximately sine distribution of transmission, in order that the subtraction of harmonics by the system (or tube) bandwidth limitation will not artificially boost the response to the fundamental. (The amplitude of the fundamental in a square wave is $4/\pi$ greater than the amplitude of the square wave.)

A special test transparency (B.B.C. Test Transparency No. 51)¹¹ to fill these and other requirements has been produced and has given consistent results in the measurement of horizontal resolution.

Once the channel has been set to its working condition, a reading of the horizontal resolution can be taken in the centre and corners by measuring the amplitude response on a line selector oscilloscope, in every case relative to the low frequency transition placed immediately beside (or astride) the test frequency patch.

Figures 10 and 11 show the waveforms obtained in a typical horizontal resolution measurement on a test chart 51.

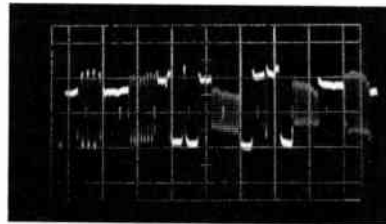

Fig. 10. Horizontal resolution, Test Card 51. Target/mesh potential 1.5 V. Preferred exposure.

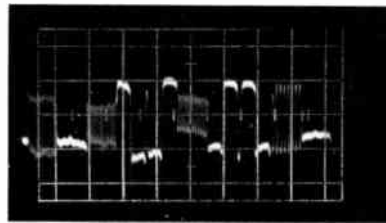

Fig. 11. Horizontal resolution, Test Card 51. Target/mesh potential 3.5 V. Preferred exposure.

It is interesting to examine the change of horizontal resolution with change of target/mesh potential. Table 4 shows these results.

Of the results in Table 4, tubes A and G are typical and B unusual in respect of change of resolution with change of target/mesh potential. It will be noticed that in tube A the loss of resolution is less than the gain in signal/noise and this result is also typical.

Tube G is an example of a tube with good resolution, and A and B are poor. The resolution at the junction of Zones II and III

should normally be not more than about 3 db worse than the centre resolution (Fig. 15).

Table 4

Tube	Target	Centre Resolution at 3 Mc/s. relative to black/white %
A	1	50
	2	53.6
	3	50
	4	44
	5	40
B	1	40
	2	50
	3	50
	4	50
	5	55
G	1	75
	2	75
	3†	72.5†
	4	68
	5	65

† Corner resolution at 3 Mc/s—%:—top left 56, top right 51.5, bottom left 46, bottom right 38.

8.2. Vertical Resolution

Of great importance in the rendering of detail in a television picture is the vertical resolution of the tube. Good vertical resolution in a picture gives it the property of “travelling well” since the sharpness of such a picture is not so badly affected by any loss of horizontal resolution as that of a picture which lacks vertical resolution.

The horizontal resolution of a tube is not necessarily a good measure of its vertical resolution. This may be due to straightforward astigmatism in the beam focus, but even when this is not present, the vertical resolution may be (and generally is) considerably worse than the horizontal. The reason for this is not fully understood by the writer but is believed due to the fact that in the horizontal direction most of the work is done by the leading edge of the spot, whilst in the vertical direction this does not apply to the same extent, probably owing to the ability of a charged portion of the target that has been partly discharged by an overlapping

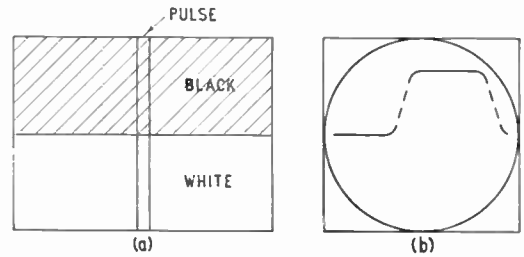

Fig. 12. Field strobe. Test object and waveform display for vertical resolution.

spot on another line to recharge whilst the spot is in a different part of that line.

A measurement of the vertical resolution of a tube can be made using an instrument showing a section of a picture in the vertical direction.

This method was used by Theile and Pilz¹ and is a very powerful tool for various measurements on the image orthicon. The instrument is very simple and its principle may be understood with reference to Fig. 12. A short pulse (say 2–8 microsec) is generated at the same point on each line and applied to the cathode of the display oscilloscope as a brightening pulse. The oscilloscope is run at field speed and the resulting display (which is actually composed of small dots) gives a vertical “slice” through the picture. By varying the width of the brightening pulse and its position in the line, it is possible to explore the properties of the picture in the vertical direction.

If such an instrument (sometimes referred to as a “field strobe” in distinction to the more usual “line strobe”) is used to observe the display of a sharp horizontal step from black to white (or vice versa) the vertical resolution of the tube can be measured in terms of the time of rise or fall (measured in lines or fractions thereof) on the display. If the test object is very slightly tilted it is possible, by moving the position of the “slice” along the line, to adjust the phase of the dots of which the display is composed in order to start the transition exactly on a given line.

Under these conditions, a “perfect” camera tube should not take more than 1 line (it cannot take less) to change from black to white. Practical camera tubes show anything from 2–3 lines down to just over 1 line and obviously

the difference in picture sharpness between such tubes is quite marked.

Finally, it must be mentioned that in all measurements of tube resolution, due allowance must be made for losses in the lens and in any filters that may be interposed in the optical system.



Fig. 13. Vertical resolution, edge effect and halo. Target/mesh potential 2.0 V. Below knee.

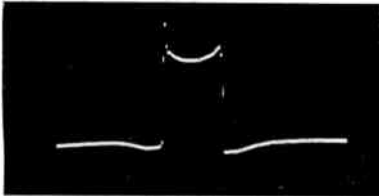

Fig. 14. Vertical resolution, edge effect and halo. Target/mesh potential 2.0 V. Above knee.

Figures 13 and 14 show vertical resolution oscillograms taken for various target/mesh potentials. It is quite usual for tubes to take more than 1 line to rise (and fall) on a sharp horizontal edge, and this is a feature of tube performance to which more attention should be paid, since sharpness is as much a factor of resolution in this direction as in the horizontal direction.

9. Geometrical Distortion and Linearity

Whilst most television engineers are familiar with the effects of geometrical and linearity distortion on pictures, most measurements used at present do not separate faults caused by the tube from those caused by faults in the yoke design or the scanning waveforms in the camera.

One obvious method of showing the difference from tube to tube is to measure them in the same camera, or in cameras calibrated in terms of a known standard, and this method is recommended as a basis for tube selection. In

order to select the mean value and limits, a large number of tubes has to be tested (specially constructed tubes can also be used to aid the result of these tests). As a result of a large number of measurements, all in the same yoke, it should be possible to distinguish any random differences between tubes from any consistent error on all, or most, of the tubes. Such a consistent error is either a basic constructional fault in the tube or incorrect yoke design and it is necessary to decide whether it is best eliminated by a change of yoke design or by an alteration within the tube.

In addition to separating errors caused by the tube from other errors, it is also important that the limits should be specified in a way most nearly connected with their subjective effect. Undesirable effects of geometrical distortion (including linearity distortion) in a picture can be analysed into the following components.

- (a) Certain areas of the picture are more critical than others.
- (b) Sharp changes of linearity are very objectionable, whilst a fairly large total error can be tolerated if it is evenly distributed.
- (c) To a first approximation, changes are equally objectionable in whatever direction they occur, i.e. the same "goodness" is desirable in every direction.

The above requirements suggest that geometrical errors should be measured in terms of the differential of the error, i.e. the change of error per unit distance in any direction on the picture. Furthermore, the picture may be divided into zones in which a different limit can be placed on the distortion allowed. Figure 15 shows the zones used by the B.B.C. in specifying tube performance for studio purposes.

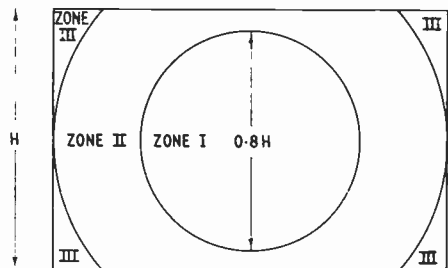

Fig. 15. Zones of interest in studio television picture.

It is fairly easy to see why a differential method of specification meets the requirements. Requirement (b) is satisfied since the maximum rate of change has been set. On the other hand, a maximum latitude for errors is given by relaxing the specification in zones of the picture where most receivers will not be showing the picture (e.g. Zone III). Furthermore, a larger total positional error can be allowed by this method than could be allowed in the traditional way of specifying geometry, for equal "spoiling" of the picture subjectively.

The actual method of measurement is simple. An electronic grille is injected into the output of the channel and the camera caused to observe a chart with a grille with similar number of squares to the electronic one drawn onto it

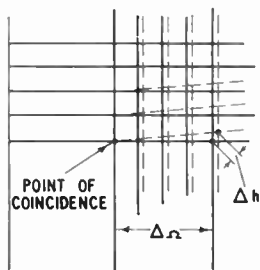

Fig. 16. Measurement of differential linearity.

(see Fig. 16). Then if the camera is so positioned that the image of a point on the test card coincides with the corresponding point in the grille pattern, the differential can be approximately calculated by measuring the positional error at any other point and dividing it by the distance δr from the point at which the pictures coincided. The limit of $\delta h/\delta r$ as h and $r \rightarrow 0$ is the differential. For most practical purposes, it is sufficiently accurate to use $\delta h/\delta r$ if h and r are small.

In other words, the method differs from the traditional method of specifying linearity only in that the error is divided by the distance over which it occurred, rather than by a fixed number such as the height or width of the picture.

In the 4½-in. image orthicon cameras in general use at present typical readings are a maximum differential error of 6 per cent at the corners (in Zone III) due to a type of barrel distortion. In Zones I and II the error is

normally less than this, and in some cases, too small for accurate measurement. (A typical reading is 2 per cent.)

As mentioned previously, more work is yet to be done in very carefully calibrating a yoke to be used as a standard.

10. Microphony

10.1. Theory

Owing to their construction, image orthicons are inherently liable to produce annoying amplitude modulation of the picture signal if disturbed by mechanical shock or acoustically induced vibration. In most cases the disturbance is caused by relative movement between the target and the mesh, and it is this type of microphony which will be discussed in this paper.

Because of their target and mesh, some versions of the 4½-in. tube have proved in the past to be more troublesome in respect of microphony than the 3-in. tube. In addition, the disturbance has tended to be aggravated as the distance between the target and mesh has been reduced.

The effect of the relative vibration of target and mesh on the signal is complex. The behaviour of the target/mesh to acoustic disturbance has some resemblance to that of a condenser microphone. For constant relative movement, the disturbance produced on the output signal is proportional to the charge between the target and mesh and the impedance of the circuit connected to it (i.e. principally the beam impedance).

Now when no light is landing on the target there is a considerable charge between the target and mesh, the exact magnitude of which depends on the potential to which the mesh has been set. In this condition, however, the beam does not land, so that the beam impedance is infinite and no microphonic effects are visible. When a very small amount of light falls on the target the charge is reduced, but the beam begins to land so that its impedance becomes finite but large, and a small disturbance becomes visible. This process continues until a compromise between beam impedance and charge is reached which gives a maximum disturbance. As the light is increased beyond this point the charge approaches zero, so that there is little disturbance although the beam impedance is now comparatively low. When the light is again increased the

charge begins to build up again, in opposite polarity, the beam impedance remains low and eventually another point of maximum disturbance occurs when the exposure is somewhat above the knee.

Although the disturbance of the picture appears as a series of horizontal bars running up or down the picture, or occasionally stationary, the basic disturbance is normally a time modulation of the signal. However, the beam does not land at any part of the picture on which no light is falling and at such a point there is no microphonic disturbance even when the remainder of the picture is illuminated. Furthermore, the impedance across the target is high and it is not easy for charge to travel across the target, so that the effect may well be more dependent on the charge at the point at which the beam is landing at any given moment than on the charge on the target as a whole.

The effects can be further complicated by the fact that the maximum vibration is probably in the centre of the target structure and the minimum at the edges. Modes can also be excited where more than one node occurs, but these are generally more difficult to excite and of less importance than the fundamental single node vibration.

10.2. Method of Test

In order to investigate the microphonic properties of the tube, the apparatus was set up as shown schematically in Fig. 17. A commercial vibrator unit was placed in contact with the spigot on the base of the tube via a metal bar. A constant output oscillator whose frequency could be varied between 400 and 2000 c/s was connected to the vibrator unit via a changeover

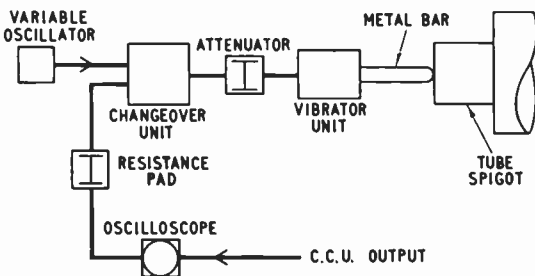

Fig. 17. Microphony test by variable oscillator.

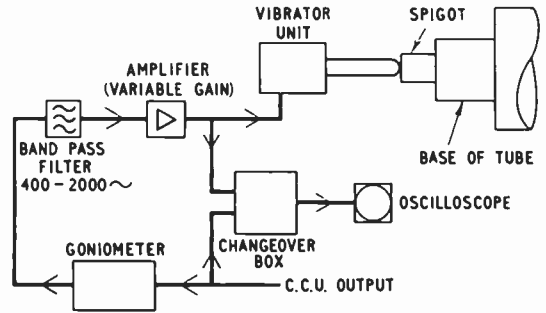

Fig. 18. Measurement of microphony by self excitation method.

unit. The changeover unit consisted of a switch which either fed the output of the oscillator to the vibrator unit via a calibrated attenuator, or through a resistance pad to the camera channel output, or to neither.

The resistance pad was so arranged that when the oscillator voltage was mixed into camera output through it, a known small percentage of sine wave from the oscillator appeared superimposed on the picture. A suitable amount was found in practice to be 3 per cent of white picture signal. This apparatus was tuned to the microphonic resonance of the tube and the excitation required just to reach 3 per cent excitation of the signal (checked by comparison with the standard 3 per cent in the changeover box) was measured. The excitation was then removed and the time taken for the microphony to die away was noted. This method proved quite effective and consistent in use, but suffered from the disadvantage that it was rather slow and tedious to use, since the mechanical *Q* factor of the resonance is very high indeed.

An improved method which has now displaced the earlier method is shown in Fig. 18. In this method the output of the channel is fed through a goniometer to a bandpass filter with its pass-band from 400-2000 c/s and thence to an amplifier with variable gain (or a fixed gain amplifier and variable attenuator in series) the output of the amplifier being fed to the input of the vibrator unit. An oscilloscope is arranged via a changeover box so that it can be used to measure the input to the vibrator unit or to monitor the signal. The goniometer is then adjusted to obtain a simple positive feedback loop which produces continuous microphony,

the loop gain being increased (or reduced) until continuous microphony of about 3 per cent of white signal can be obtained if the tube is lightly tapped to start the microphony. The excitation at the input to the vibrator is then measured on the oscilloscope. The loop is cut and the time taken for the microphony to die away is noted.

This method has proved very quick and simple to use in practice and the results check very well with those obtained by the method described in Fig. 17 and also correlate very well with the complaints of operational crews about the nuisance value of certain microphonic tubes.

Table 5 shows a typical result on a tube rejected by the studio.

Table 5

D.C. Sensitivity of Vibrator = 400 grams/ampere

Tube	Excitation (Vibrator current) decibels relative to 1 amp. (for modulation of 0.03 V. at C.C.U. output)	Die Away Time (seconds)
H	-61	3
K	-51	15
L	-55	10

Table 6 shows the variation of microphony with target/mesh potential and exposure on a tube rejected as microphonic.

Table 6

Target/Mesh Volts	Exposure Relative to knee	Excitation relative to 1 amp. decibels (for modulation of 0.03 V at C.C.U. output)
3.5	+3 stops	-69
3.5	-2 stops	-71
1.5	+3 stops	-69
1.5	-2 stops	-71

The reason for selecting exposures of +3 and -2 stops is that at these points maxima occurred as explained above. It may be of interest to note that the fundamental microphonic mode in most tubes is at approximately 800 c/s.

It is quite usual also for tubes to exhibit an increased sensitivity to microphony at high target/mesh potentials.

The target/mesh potential also has a bearing on the position and relative magnitude of the microphony maxima above and below the knee. This accords very well with the theory given above, since the potential to which the mesh is set will determine the charge between the target and mesh when no light is reaching it and also the maximum charge that the target can hold.

11. Uniformity of Picture Background

11.1. Uniformity of Dark Current

This is affected by the uniformity of response over the 1st dynode surface, and how far out of focus this surface is when the other conditions necessary for satisfactory operation of the tube are met. The uniformity of transmission of the field mesh is also involved, since the beam has to pass through this twice. Any secondary emission effects at the field mesh may also affect it.

11.2. Uniformity of Sensitivity up to the Knee

Primarily this is a function of variation of sensitivity of the photocathode, together with variation of secondary emission over the image side of the target (caused by impurities and/or "burning") and uniformity of transmission of the target mesh. Efficiency of transfer of charge through the target can affect this parameter, also variation of contact potential between different parts of the target³, so that an image previously "burnt" on a tube may be seen in negative if the tube observes a plain white background. Linearity of scan also plays a very important part in this and the next parameter and although this is really a camera rather than a tube function, it is clearly necessary that any camera used for this test should have a very high order of scan linearity.

11.3. Uniformity of Signal above the Knee

In the simple theoretical case, above the knee the output of the image orthicon is constant at all parts of the target for all light values. Practical tubes do not achieve this and there are several possible reasons for it. Lack of uniformity of target/mesh spacing over the picture area is one possible contributory cause. This has the very objectionable operational effect of causing the tube to act as a low capacitance tube in one part of the picture and

a higher capacitance tube in another part. Thus in one part of the picture area the knee occurs at a lower light level but there is a low signal output above the knee, whilst in another part the knee occurs at a high light level but there is a high signal output above the knee. Tubes of this sort cause the operators to make frequent adjustments as the object of interest traverses the picture area.

Due to beam landing errors, beam alignment also seems to affect the behaviour of a tube in this parameter and in many tubes alignment of the beam for evenness of target cut-off or minimum movement of the picture for change of beam focus does not produce the best white background above the knee. Misalignment and beam landing errors may well cause different parts of the target to be stabilized at different voltages and this may be used to counteract effects similar to uneven target/mesh spacing provided the misalignment is sufficiently small not to cause other harmful effects.

Linearity of scan, as previously mentioned, also affects background above the knee, also efficiency of transfer of charge through the target and variation of contact potential. (A "burnt on" image shows above as well as below the knee.)

11.4. Methods of Measurement of Background

Background variations of the above mentioned types can occur as large area blemishes or as "spots", and together constitute one of the most serious defects on the 4½-in. image orthicon to-day. The effects referred to under 11.1 and 11.3 are far more serious than those quoted in Section 11.2. Thus an objective method of measurement related to the subjective nuisance value has had to be devised.

Examination of the problem showed that, like scan linearity, the nuisance value of background defects varies according to the part of the picture in which it occurs and also the rate at which it changes. Once again, a differential measurement has been devised in order to get the closest possible correlation with subjective effects. This can be done by reasonably simple methods which will be described below.

11.4.1. Measurement of dark current variations

An illustration of a single line oscillogram of

the dark current of an image orthicon is shown in Fig. 19. The overall amplitude of the variation is simply the voltage excursion of the trace, whilst the rate of change is represented by the gradient or dv/ds (where v is the voltage excursion and s the linear distance across the picture).

If the X and Y scans of an oscilloscope are of known sensitivity, then it is a simple matter to inscribe a line (or lines) at a suitable angle to represent the limit permitted for dark current

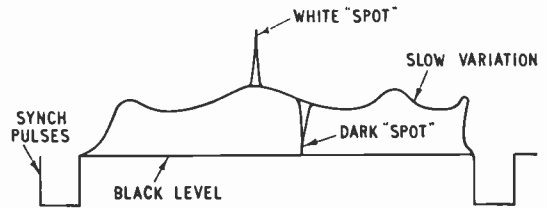

Fig. 19. Single line oscillogram of image orthicon dark current.

rate of change. By means of the line selector and field strobe (Figs. 14 and 15) it is then possible to examine the entire field of the tube to ensure that the limit is not exceeded. It is particularly important to note that in this test the tube should not be exposed to a chequer-board pattern. It is possible to be grossly deceived on the black background of the tube when using such a pattern since white ghost and black halo from the white areas may affect the signal from the black areas.

Figures 20 and 21 show dark current shading, the graticule line at 45° representing a differential rate of change of shading of 20 per cent. In fact, this tube only exceeded that figure in Zone III and is quite acceptable for studio use.

An alternative method of testing dark current variation is to use in front of an evenly illu-



Fig. 20. Dark current—line direction. Slope of 45° represents $\delta V/\delta H=0.2$.



Fig. 21. Dark current—frame direction. Slope of 45° represents $\delta V/\delta H=0.2$.

minated scene an opaque card with two small holes in it, one above the other, a known small fraction of the picture height apart, the holes being at the left hand edge of the picture. The oscilloscope is then set to trigger off the signals produced by the white spots instead of the synchronizing pulses, and the display is checked as previously described in the line direction. In the field direction the differential is within a given limit if the two lines on the oscilloscope are not displaced by more than $\delta V=L\delta S$ where L is the limit, and δS the distance apart of the two holes. In order to cover the whole picture area, the card may be

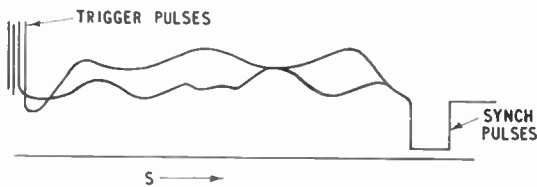

Fig. 22. Measurement of dark current—vertical direction.

moved and the check repeated as often as necessary. Figure 22 illustrates the type of display obtained in this method. Differential limits that are suitable for diffuse background effects are generally unreasonably tight for "spots" when they are not in the centre of the picture, and provided the linear dimensions are smaller than a certain specified size, spots are best measured by a simple amplitude check. Both the amplitude, number and distance apart of the spots must be specified.

11.4.2. Measurement of sensitivity variations below the knee

If the tube is exposed to a plain white background and the tube exposure adjusted so that all parts of the picture area are below the knee,

line or field oscillograms represent the sum of the background measured in 11.4.1 and the variation of signal caused by sensitivity variations. In order to measure the variation of sensitivity alone it is, therefore, necessary to find some means of subtracting the dark current variations automatically. A simple and effective means has been devised to achieve this.

Figure 23 shows diagrammatically a single line oscillogram of the signal produced by the

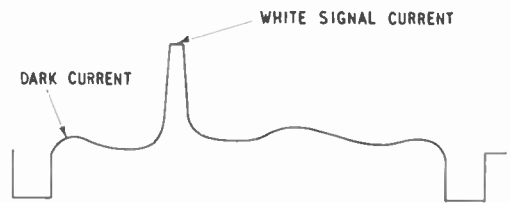

Fig. 23. Measurement of white background—waveform display (uncorrected).

tube if it is exposed to a white spot on a dark background. It will be seen that there is a sharp pulse caused by the white spot and a residuum of comparatively slow variation of the dark current.

If the camera output is delayed by a time slightly longer than the duration of the white pulse and this is fed to one input of a differential oscilloscope, the undelayed signal being fed to the other input, the delayed signal will effectively cancel the low frequency variations, but not the pulse; the oscillogram will then appear as in Fig. 24.

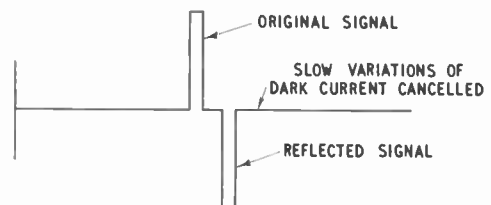

Fig. 24. Measurement of white background—waveform display (corrected).

It may be seen that the dark current variations have been effectively subtracted. If the camera is exposed to a card with a diagonal slot such as is shown in Fig. 25 a white pulse occurs on

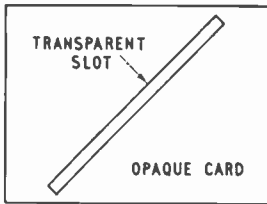

Fig. 25. Measurement of white background—test object.

each line and the resulting positive signal peaks from an oscilloscope whose time base is running repetitively at line frequency, will effectively draw the contour of the sensitivity along the diagonal. A simple cursor line whose angle determines the limit of white background variation permitted may be used on the oscilloscope as a check. The diagonal slot can be moved across the picture, the card reversed, turning the angle of the slot through 90 deg, and the procedure repeated to cover the whole picture in two directions at 90 deg. The light source may be masked in order to check for the different limits in the different picture zones.

Figures 26 and 27 show white shading when the tube is exposed below the knee, firstly with

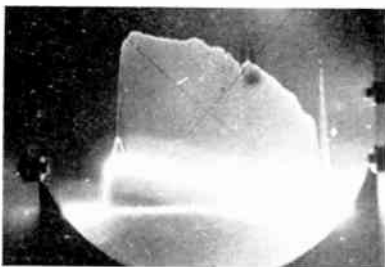

Fig. 26. Sensitivity variations (below knee). Before cancellation of dark current (shown by thick line at base).

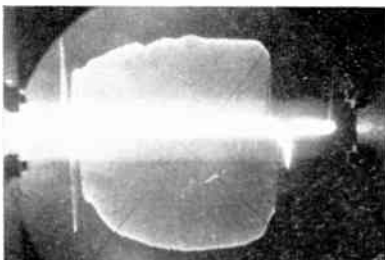

Fig. 27. Sensitivity variations shown in Fig. 26 after cancellation of dark current.

black shading also present, and secondly with black shading eliminated by the delay line method. The 45 deg line here represents 40 per cent differential shading, a reasonable acceptance figure for sensitivity variations below the knee.

11.4.3. Measurement of signal variations above the knee

The method used in 11.4.2 will effectively work for variations above the knee if the exposure of the tube is increased so that all parts of the transparent slot are above the knee on all parts of the target.

The limits specified for this parameter should be somewhat more stringent than those measured under 11.4.2 (e.g. 20 per cent instead of 40 per cent) because of the much greater operational nuisance value of defects above the knee. As in 11.4.1, so in 11.4.2 and 11.4.3 it is better to deal with the “spots” separately, since differential methods of specification virtually eliminate any picture disturbances that occur suddenly. However, the size, amplitude, number and distance apart of such spots, if permitted, should be carefully specified.

12. Freedom from Spurious Effects

The main spurious effects in the image orthicon, other than those already dealt with, are edge effect and halo.

According to the literature^{1, 3}, edge effect is the resultant of two other effects. One is the apparent increase in capacitance which takes place above the knee around the edge of a charged portion of a target. The second is the attraction of the beam towards the charged object—generally known as “beam pulling” or “beam bending.” The apparent increase in capacitance around the edge of charged areas is a function of the ratio of transverse to through capacitance. It is in this respect in particular that the 4½-in. image orthicon is superior to the 3-in. type.

Attraction of the beam towards a charged portion of the target is a function of the potential of the charged portion and the strength of the decelerating field. In this respect the influence of the field mesh is very important, as shown by Theilæ and Pitzl¹.

Black halo is caused by the collection by surrounding areas of the target of slow secondary electrons emitted by an area above the knee which is already fully charged and therefore unable to accept further electrons.

Both edge effect and black halo are reduced as the target/mesh potential is increased, owing to the greater efficiency of collection of secondary electrons by the stronger field. It is possible with tubes of reasonably high capacity to reduce black halo to negligible proportions by this means.

12.1. *Measurement of Edge Effect*

Edge effect is best measured in the field direction, since in this direction it is greater than across the line. A sharp horizontal black/white transition exposed for the preferred operating conditions makes a suitable test object. The field strobe may be used to measure overshoot at the leading and trailing edges of the test object. As this measurement is in the field direction it is insensitive to the amplifier frequency and phase response.

12.2. *Measurement of Black Halo*

The same white object surrounded by a grey tone of 3 per cent white, is suitable for the measurement of halo. There should be no measurable darkening of the grey surround close to the white test object when the white is just exposed to the preferred operating point.

These tests may also be used as an indication of the target/mesh spacing and potential.

13. Lag, Movement Blur, Sticking etc.

These effects may be divided into three:—

- (a) Build-up time of charge image.
 - (b) Failure of beam erasure.
 - (c) Image retention.
- } These effects are sometimes called capacitance lag.

In a low velocity tube, effects (a) and (b) have been shown by Meltzer and Holmes¹² to be due to the low velocity beam acceptance mechanism. An idea for reducing its effects by means of biasing the target was suggested by the same authors but this is not easily applicable to the image orthicon as constructed at present and the necessity does not exist except in tubes of very

close target/mesh spacing since redistribution usually reduces lag to negligible proportions.

Image retention is a function of the inability of the target to transfer charge from one side to the other. The target suffers a change of contact potential and conductivity in places where charge has passed through it. This fatigue effect becomes important when too much charge has passed through the target, or when the target temperature has been too low when the charge passed through it. Thus, when a portion of the target suffering from fatigue is exposed, chiefly owing to the change in contact potential, a negative image of a scene previously “burnt on” will appear when the camera observes a plain white background.

13.1. *Measurement of Build-up and Erasure Time*

Figure 28 shows the schematic of apparatus used for measuring the lag of pick-up tubes. It consists of a shutter which is synchronized with field pulses but with variable delay so that it can be set to operate at any part of the field

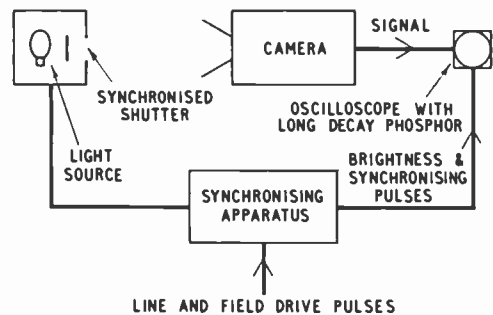

Fig. 28. Measurement of lag.

period. An oscilloscope with a slow speed time base is also triggered by the same apparatus. There is also a variable delay in the oscilloscope trigger. In addition, a brightening pulse is fed to the oscilloscope so that only that part of the picture in which the shuttered light appears is displayed on the oscilloscope.

A display of the sort shown in Fig. 29 is obtained. Both the build-up and decay can be registered by this method. In order to obtain consistent measurements, it is usual to adjust the phasing of the shutter so that the last completely bright signal is just equal to the

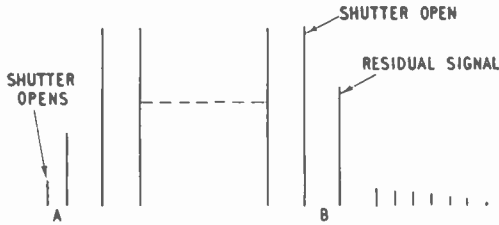

Fig. 29. Oscilloscope display of lag test.

exposed amplitude, i.e. any further advance of the shutter opening begins to reduce the last completely bright signal. As an additional check, a light sensitive cell is mounted outside the shutter, so that an electrical signal showing the opening time of the shutter is available if required.

The lamp brightness and iris are adjusted until the tube just reaches the preferred operating point on the image of the light source when it is exposed to it continuously.

It is reasonably easy to show that all except the super-high-capacitance tubes (e.g. P 812) have lag values that are acceptable for all normal purposes, when exposed to the preferred operating point.

Where lag is troublesome, it is of interest to note that an increase of target voltage greatly improves the signal/lag ratio. This may be due in part to the tube behaving as though it has a small bias on the target, as discussed by Meltzer and Holmes¹².

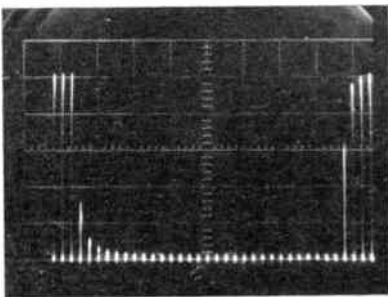

Fig. 30. Lag. Decay and build-up time below knee. Target/mesh potential 4.5 V.

Figure 30 shows the build-up and decay lag in a tube with high target voltage, exposed with highlights below the knee. It will be noticed

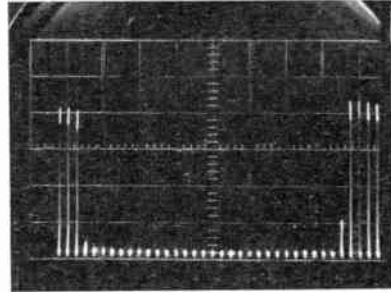

Fig. 31. Lag. Decay and build-up time above knee. Target/mesh potential 1.5 V.

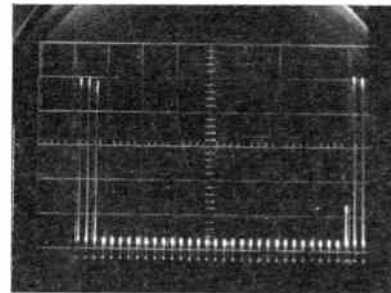

Fig. 32. Lag. Decay and build-up time above knee. Target/mesh potential 4.0V.

from Figs. 31 and 32, which show the same tube exposed to the preferred operating point, that the decay is appreciably slower at low target. The lag is still negligible in this tube under these conditions.

13.2. Image Retention

One method of image retention measurement has already been mentioned in Section 11 (under the measurement of sensitivity variations above and below the knee). In this measurement it is readily distinguished from the other types of sensitivity variation in that it is not affected by whether exposure is above or below the knee. However, although this is a possible quantitative method of checking the "burn-in" it does not indicate the ease or otherwise with which the tube became burnt.

A more usual test is to expose the tube to a standard test scene for a measured period (say 30 seconds) and then check that any resultant "burn-in" after removal of the scene clears within a time of, say, 10 seconds.

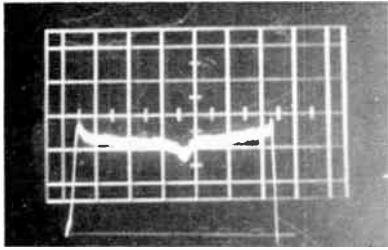

Fig. 33. Image retention—burnt-in image after removal of test object.

In this connection, the effect of target voltage on the life of the target is an interesting subject which is frequently raised.

It is sometimes assumed that the "burn-in" is an increase of resistivity of the target. However, the signal produced by the "burn" does not seem to be proportional to the signal current, but to be a constant. This supports the statement that "burn-in" is a change of contact potential³ rather than resistivity. If this is the case, it is obviously an advantage to keep the signal through the target as large as possible in order to keep a maximum ratio of signal/burn-in (i.e. by keeping the target/mesh potential high).

The liability of the target to become permanently affected is a function of quantity of charge passing through the target. However, the efficiency of collection of secondary electrons is also a function of target voltage, as is the total charge that can be stored by the target. It is believed by the writer that, provided the tube continues to be used at a high target/mesh voltage, this increase of signal balances the additional "burn-in" effect. Naturally, if a tube is used at a high target voltage which is later reduced, the additional burn-in will then appear. Thus, as the tube gets older, the target voltage should, if anything, be increased in order to minimize the effect on the background of previous burns.

Figure 33 shows burnt image shown against a white ground, 15 seconds after removal of a test object to which the tube had been exposed for one minute. This tube is quite acceptable for use, but many tubes are much less liable to burn-in than this.

14. Colour Response

Until recently, it has been the custom to check the colour response of camera tubes by comparing

the response of the tube to a coloured surround with that to a calibrated neutral density strip inset in the colour. One chart of this type, with three coloured portions each with its neutral density strip, is B.B.C. Test Chart 50¹¹.

However, more recently Warren¹⁴ has introduced a method which the writer considers superior and which has yielded very valuable practical results.

Figure 34 shows a schematic of the method. A diffraction grating slit spectroscope is adjusted to produce a spectrum of a tungsten lamp of known colour temperature on the tube face. A displaced display of the spectrum of a calibrating source such as a helium lamp, is also produced on the tube face.

The camera is exposed so that the image of the spectrum is below the knee and it is also necessary that the sensitivity and dark current shading over the area used for the display should be negligible. By means of a line selector oscilloscope a display of the amplitude response of the camera to the spectrum is obtained. The spectroscope deviation is such that there is a nearly linear relation between the wave-length of the light and position across the picture. By selecting for display on the oscilloscope the portion of the picture on which the image of the calibrating source is displayed, lines of accurately known wave-length may be used to obtain a complete calibration of the X axis of the oscilloscope in relation to the wave-length of the light. Thus a complete calibration of the tube can be obtained from about 3500-8000 Å which is the working range of most of the tubes in use at present.

A suitable allowance can be made for the known colour response of the lamp if it is desired to obtain the equal energy response of the tube.

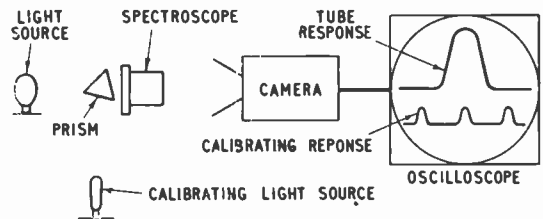

Fig. 34. Spectroscopy method of measuring colour response.

The response of most tubes is continuous, so that an accurate check of the amplitude response at 2 or 3 points is all that is required. In particular, the response of the tube in the region 5500-7000 Å should be very close to the photopic curve if satisfactory results are to be

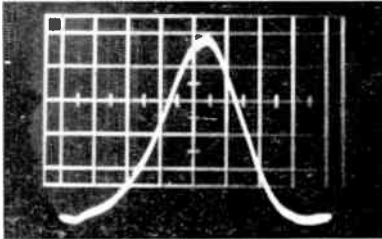

Fig. 35. Colour response—normal tube, light source of colour temperature 2900°K.

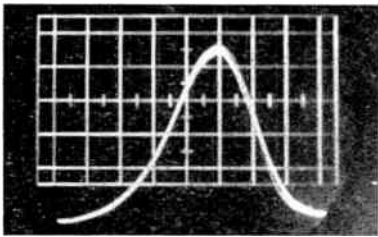

Fig. 36. Colour response—tube with excessive red response. Illumination as in Fig. 35.

obtained on studio productions. Figures 35 and 36 show two tubes which differ in this region, that in Fig. 36 being too sensitive in the red for reliable results in the studio.

Curiously, the excessive response at 4500 Å shown by most tubes seems to have very little subjective effect on studio pictures, presumably owing to the rarity of saturated blue tones in most scenes.

15. Freedom from Drift

It is of the greatest importance that a tube, once correctly set up, should not drift with time. Although, for obvious reasons, it is not possible to test every tube for long term stability, one should occasionally be selected for such a check. In most cases, drift is a function of the C.C.U. (e.g. change of the potentials fed to the tube, amplifier gain etc.), but some tubes do exhibit changes of characteristic after they have

been in use for a considerable number of hours.

Checks should be made on resolution, sensitivity, background, microphony etc. after a period of several hours running at maximum temperature, in order that any change may be detected. Tubes exhibiting drift in their characteristic generally cause a great deal of trouble operationally since the transmission is often at the end of a day's rehearsal, and such tubes, if set up during rehearsal, give poor pictures on transmission.

16. Ease of Adjustment

Various defects in a tube can cause great difficulty in the setting-up process although it may be able to meet the test limits when critically adjusted. It is very hard to outline such effects in a paper such as the present one, but one example will be given.

In some tubes, if the potential of G₁ is advanced beyond the point at which the whites are just discharged, the beam current apparently decreases and the whites cease to discharge. Such a tube is known as a "Beam Dip" tube. These tubes are normally rejected by the manufacturer before leaving the factory and rarely appear in the studios. Other tubes may have insufficient or excessive dynode gain, awkward pulses in the blanking period which upset the clamps in the C.C.U., heater-cathode leaks that cause difficulty in asynchronous operation and so on. Such faults are rare, but any new tube type and a few samples of normal production should be examined from time to time for these and any new factors in behaviour that may have occurred.

17. Mechanical

It is, of course, necessary that tubes should be checked dimensionally to ensure that they will fit into the cameras in the studios. If a special camera is used for testing tubes, a convenient way to do this is to make the yoke in the test camera on the lower limit, so that any tube which can be fitted into this is sure to fit any camera which is itself within tolerance. An occasional check of orthogonality of face-plate and optical flatness is also a good thing.

18. Conclusions

Some details of various methods of testing the performance of 4½-in. image orthicon tubes

have been given in the preceding sections, as well as a small number of examples selected to illustrate various points. From these and other tests which have been made on a number of tubes it is possible to draw some conclusions on the setting up and operation of the tubes.

Before proceeding to this, however, it is worthwhile summarizing those tests which are necessary for every tube, together with the time taken to perform each test in a suitable camera, with test gear to hand.

<i>Test</i>	<i>Time (Minutes)</i>	<i>Ref. Para.</i>
Preliminary examination	10	6.2
Contrast handling	3	6.2
Signal/noise	5	7
Horizontal resolution	3	8.1
Vertical resolution	3	8.2
Geometrical distortion	5	9
Microphony	5	10.2
Uniformity of dark current	5	11.4.1
Uniformity of signal below knee	5	11.4.2
Uniformity of signal above knee	5	11.4.3
Edge effect, halo etc.	5	12
Image retention	5	13.2
Colour response	5	14
—		
<i>Total</i> <u>64</u> minutes		

Thus, the total time taken to test a tube is approximately one hour. It may be possible to reduce this time somewhat with a special test camera with appropriate metering etc. built in.

It will be seen that this is no longer than the time taken to perform some of the much less objective tests which are currently in use.

The other tests described in the paper can be made as occasional checks, or as required.

18.1. *Setting Up*

The writer recommends that tubes should be set up at a target/mesh voltage in the region of 3.5-4.0 V. The exact voltage will vary a little from tube to tube and could be recorded during its initial test. Factors militating against high target/mesh potentials are beam flutter, loss of resolution and in some tubes, increased microphony. Factors in favour are lower

noise, vastly improved contrast handling and reduced spurious effects.

In this connection it is worth mentioning that with other types of image orthicon without field meshes, beam pulling at high target is also a limitation. With the current types of 4½-in. image orthicon, careful tests of the type suggested by Theile¹ have revealed that there is a negligible increase in beam pulling even at large target and highlight values.

The multiplier focus should be set to the lowest potential at which a gain maximum is obtained, in order to get maximum signal/noise ratio.

Alignment is set for minimum rotation of image with change of beam focus. Image focus (potential between photocathode and target) should be set to the position of maximum voltage for focus as at this potential there is a minimum number of focus loops, and the electron trajectory is less affected by residual fields from the scanning side of the target, so that better resolution is obtained.

Image accelerator is set as near to photocathode potential as possible to reduce white halo and ghost, the limit being where the S distortion becomes objectionable.

Beam focus is generally best used at the highest potential on G₄ that will give reasonable geometry in most yokes about 140 to 210 volts. It is of great advantage if the camera control unit is arranged so that only the relevant nodes of focus for image and beam are obtained. This gives a much finer control of focus.

It is also a great advantage if the multiplier gain can be adjusted, in its later stages, so that the tube can be set to a standard signal current at its preferred operating point. In this way the video amplifiers under normal conditions are worked at constant gain and tests made for pick-up, hum etc. on one tube will remain valid for other tubes. It is most important to keep the gain of the first dynode as high as possible in order to prevent the multiplier from increasing the noise.

The setting of beam current is very important. This should be set so that the beam is just able to discharge a white about 1.4 times greater than a white at the preferred operating point. This will allow for all likely contingencies in use. In

practice the beam current is sometimes set even higher than this, and this adds about 2–3 db to the noise.

Shading should, of course, be set to a minimum with the tube capped.

Lastly, the method of exposing the tube just over the knee, and adding a small amount of additional amplification to the blacks is very highly recommended. The reasons for this are twofold—firstly a considerable saving in light compared with operation with highlights 1–2 stops over the knee, and secondly in order to achieve a constant black level and reduce spurious effects in the white and light grey regions to negligible proportions. Under these conditions a high capacitance (e.g. English Electric Type P822 JEDEC No. 7389) $4\frac{1}{2}$ -in. image orthicon tube has an excellent contrast handling capacity and grey scale reproduction.

18.2. Operation

When tubes are selected as adequate in all the parameters discussed in this paper and are then set-up in the way mentioned above (parameters not mentioned being assumed to be set up in the traditional manner), operation may be regarded somewhat more scientifically than has sometimes been thought in the past.

If the supplies to the tube and the electronics of the camera and C.C.U. are made stable, then there remain only two parameters of the tube that it is necessary to vary from scene to scene:—

- (a) Light input.
- (b) Contrast Law in the broadest sense, including “lift” and gain.

18.2.1. Light input

It is obviously necessary to vary the light input to the channel so that the relevant highlights in a scene can be placed at the preferred operating point. Experience has shown that this is achieved better by a remotely controlled iris than by a variable neutral density filter. This is because if the iris is fixed, it must be fixed at the value required by the darkest scene and minimum depth of field. In order to be able to continuously adjust the neutral filter, it is never possible to operate it at its lowest density, since then there is nothing “in hand”. In this way about 1–2 stops of sensitivity tend to be lost. Remotely controlled iris systems, however,

merely exchange depth of field for light input, so that automatically the maximum depth of field for the brightness available is obtained. On those comparatively rare occasions when it is desirable to limit the depth of field, this can be done either by reducing the light on the scene or by putting a fixed neutral density filter in the camera.

18.2.2. Contrast law

This is a broad subject sufficiently large for a paper in its own right and it is only possible to mention it somewhat briefly here.

Any given contrast law, over any given contrast range (measured from white downwards), can be achieved to a very close approximation by more than one combination of lift, gain and black stretch. There is, however, one combination of these components which will achieve the most evenly distributed and hence least objectionable, signal/noise ratio.

This combination for optimum signal/noise ratio is most unlikely to be obtained by continual variation of three continuous controls whilst observing a monitor. If the tube exposure can also be varied, thus altering the camera tube law as well, it is not unreasonable to state that on any given scene, for any given effect, it is only by luck that optimum signal/noise can be obtained by empirically varying the controls and observing a monitor.

On the other hand, it is essential that it should be possible to change the contrast law from time to time in order to denote changes of mood, night to day, interior to exterior and so forth, some of which can be achieved by the lighting, but a part of which must be done by the camera if, once again, optimum signal/noise ratio is to be obtained.

In the writer’s opinion this situation is best met in the following way:

The operator is provided with a light input control (preferably remote iris), a very fine “lift” control (for trimming out glare, flare and similar effects) and a selector switch at each position of which is a preset combination of lift, gain and black stretch, carefully set for optimum signal/noise ratio for the particular contrast law required.

18.2.3. General

Other than these controls, the tube itself does not require any other adjustments operationally. In many cases unnecessary operational controls are left on channels for reasons of tradition, or because the design of the channels themselves has not been as good as could be desired and it is necessary to compensate continuously for variations in supplies to the tube or even for amplifier gain or black level drift. With care, these and other sources of unnecessary variation can be eliminated, and indeed, in fairness to the operator, should be eliminated.

Finally, a word on picture "matching". The necessity to "match" one picture to the next when they are to be transmitted in sequence is obvious. It is hardly necessary to add that if the above mentioned procedures are followed and the lighting on the scene and tube exposure critically adjusted, tubes do match each other. Matching is certainly not improved by continuously varying shading controls (which of course should always be set up with no light admitted to the tube), target/mesh potential, multifocus, beam current etc. The ideal arrangement of operators seems to be a team of vision control and lighting staff working in collaboration directed by a lighting engineer and vision control supervisor who work together.

Ways of achieving this collaboration and the best method of controlling a number of cameras to obtain a good match between their pictures are beyond the scope of this paper and will no doubt be dealt with elsewhere.

Summing up, it may be said that the foundation of better pictures, more logical vision control methods and, in particular, predictable, consistent results, is adequate testing of camera tubes to ensure that a sufficiently good standard is achieved and maintained.

19. Acknowledgments

The writer is indebted to the Director of Engineering of the B.B.C. for permission to publish this paper. In addition he would like to thank many friends and colleagues in the Corporation and in industry for helpful discussion and advice. In particular, Mr. J. Kelleher who devised many of the testing methods described in the paper; Mr. H. G. Anstey and

Mr. A. B. Palmer of the Operations and Maintenance Department; Mr. C. R. Messenger of the Planning and Installation Department; Mr. S. N. Watson, Mr. T. Worswick and Mr. L. E. Weaver of the Designs Department, Mr. A. G. Warren of Operations and Maintenance Department for information on testing colour response; Dr. R. D. A. Maurice and Mr. C. B. B. Wood of Research Department; Mr. W. E. Turk and Mr. E. Hendry of the English Electric Valve Co.; and the Management of the English Electric Valve Co. for permission to use Figs. 1 and 2 from one of their publications; Dr. H. G. Lubszynski of E.M.I. Research Laboratories for advice on measurement of build-up and decay time.

He would also like to thank the Superintendent Engineer Television (London Studios) and Engineer-in-Charge of the B.B.C.'s London Studios for the loan of facilities for investigations and tests and Mr. C. H. Colborn of the B.B.C.'s Planning and Installation Department for much helpful advice and encouragement.

20. References

1. R. Theile and F. Pilz, "Conversion errors in super orthicon camera tubes," *Arch. Elektr. Uebertragung*, **11**, pp 17-32, January 1957.
2. F. Pilz, "Test and measurement methods for image, orthicon camera tubes," *Rundfunktech. Mitt.*, **1** No. 4, pp 125-138, August 1957.
3. R. B. Janes, R. E. Johnson and R. S. Moore, "Development and performance of television camera tubes," *R.C.A. Review*, **10**, No. 2, pp. 191-223, June 1949.
4. R. B. Janes, R. E. Johnson and R. R. Handel, "A new image orthicon," *R.C.A. Review*, **10**, No. 4, pp. 586-592, December 1949.
5. O. H. Schade, "Electro-Optical Characteristics of Television Systems." Books 1-4 (R.C.A., Princeton).
6. G. Baldwin Banks, K. Frank and E. O. Hendry, "Image orthicon camera tubes," *J. Television Soc.* **7**, pp. 92-104, 1953.
7. R. B. Janes and A. A. Rotow, "Light-transfer characteristics of image orthicons," *R.C.A. Review* **11**, No. 3, pp. 364-376, September 1950.
8. S. W. Amos, D. C. Birkinshaw and J. L. Bliss, "Television Engineering," Vol. 1 (Hilffe, London, 1957).
9. W. F. Niklas, "The current characteristic of television picture tubes," *J. Television Soc.*, **12**, pp. 512-515, 1958.
10. L. E. Weaver, "The Measurement of Random Noise in the Presence of a Television Signal." B.B.C. Engineering Monograph No. 24, March 1959.

11. G. Hersee and J. R. T. Royle, "Two New B.B.C. Transparencies for Testing Camera Channels." B.B.C. Engineering Monograph No. 21, November 1958.
12. B. Meltzer and P. L. Holmes, "Beam temperature, discharge lag and target biasing in some television pick-up tubes," *Brit. J. Appl. Phys.*, 9, pp. 139-143, April 1958.
13. A. A. Rotow, "Image orthicon for pick-up at low light levels," *R.C.A. Review*, 17, pp. 425-435, September, 1956.
14. A. G. Warren, "A new method of testing television camera tubes for colour response." *Electronic Engineering*, 32, 1960. (To be published.)

21. Appendix 1:

Operating Point of the Tube

There are many different ways of operating the $4\frac{1}{2}$ in. image orthicon so some space will be given to explain the particular way preferred in B.B.C. studios, since every parameter of the tube tends to behave somewhat differently in the different regions of its characteristic.

Using the method detailed in Section 4.2, transfer characteristics can be plotted for different exposure conditions and a graph of the type shown in Fig. 9 will be obtained. One of the typical features of such a graph is a bend towards white where the target becomes fully charged. This point of departure from linearity in the white regions has been called the "knee"⁷ and this term has become accepted into general use. In Section 5 the question of measuring the position of the knee has been dealt with.

The behaviour of the tube is quite different if the highlights are exposed in different ways as shown at points A, B, C and D on Fig. 9. In condition A the characteristic of the tube is linear, storage at the target is taking place during the entire cycle from the time the beam leaves a given place until it reaches that place again, and there is a negligible number of excess electrons to cause spurious effects. The transfer characteristic being linear, it is necessary (owing to the contrast law of the reproducing cathode-ray tube⁹) to apply contrast law correction to achieve reasonable reproduction of normal scenes, and this correction amplifies the voltage representing black and reduces the voltage representing white. Unfortunately, the signal/noise ratio of tubes at present in use, together with the background and spurious effects in the dark tones, normally prevent the tube being used in this manner.

Points B and C show the transfer characteristic when the exposure is increased by 1 and 2 stops respectively. It will be seen that the point gamma in the region of white has dropped to approximately 0.5 or just below, whilst the majority of the characteristic is still linear.

Good reproduction of a wide range of scenes can be obtained if a small amount of contrast law correction is applied, amplifying those regions representing the darker portions of the scene. The amount is considerably less than that required for operation in condition A.

Operating in this manner, a reasonable proportion of tubes have a signal/noise ratio that is acceptable (both in dark and light tones) and also a reasonable proportion have acceptable backgrounds. This is the mode of operation preferred in the B.B.C. studios at present.

In mode B/C and also in the next mode of operation D, which are both generally known as operating with the highlights at or above the "knee", there is another great operational advantage. Should the highlight brightness of the image change somewhat (on panning around a scene for example, or on changing from one scene to the next) there is a tendency for the peak signal voltage of the camera to remain reasonably stable owing to the reduced gain in the white regions. This stability of output voltage helps the operators not to become too "jumpy" for small changes of scene highlight brightness but, of course, does not remove the necessity to adjust iris or variable light filter on appreciable changes of scene brightness, since the grey tones would otherwise suffer distortion.

A third method of operating the tube is shown at point D. Here the highlights are located about 2 stops over the "knee", the point gamma in the highlight regions is reduced to a low value, and no contrast correction is applied in the camera amplifiers. The omission of contrast correction has the advantage of realizing the best signal/noise ratio from the tube and of reducing dark current effects to a minimum. It has, however, several disadvantages. Redistribution effects such as "black halo" and "white edge effect" cause distortion of the picture and, owing to "white halo"⁷, the voltage level corresponding to black at any point is liable to vary according to the content of the remainder of the scene. In this condition

operational adjustments to the channel are required more frequently and at best the pictures have a kind of spurious quality that has tended to give the image orthicon tube (quite unjustifiably in the case of the 4½-in. version) a reputation for poor reproduction of the grey scale. However, it must also be said that in certain conditions of poor reception such as fringe areas or areas of heavy interference, the exaggerated edges and black halo tend to help the picture to be recognizable, and such pictures have therefore gained a reputation for "traveling" well.

22. Appendix 2:

Contrast Law and Contrast Ratio

To explain the reason for some of the measurements made in Section 6, it is necessary to discuss some basic principles of contrast laws.

Consider two representations of the same imaginary transfer characteristic. Figure 37(a) shows the linear representation and Fig. 37(b) shows a logarithmic representation. From Fig. 37(a) it may be seen that this transfer characteristic is a straightforward linear relation between light input and signal voltage, except that the tube produces no signal until the light reaches a value A. The same characteristic plotted on logarithmic co-ordinates gives a line whose gradient (i.e. point gamma) varies from point to point but which is asymptotic to $\dot{\gamma}=1$ for large values of light below the knee and asymptotic to $\dot{\gamma}=\infty$ at A.

Analytically, the following equations may be used to represent these graphs:—

In Fig. 37(a)

$$v = m(l - A)$$

$$\frac{dv}{dl} = m = \frac{v}{l - A} \quad \dots\dots(1)$$

In Fig. 37(b)

$$\dot{\gamma} = \frac{d(\log v)}{d(\log l)}$$

$$= \frac{\frac{1}{v} \frac{dv}{dl}}{\frac{1}{l}} = \frac{l}{v} \frac{dv}{dl} \quad \dots\dots(2)$$

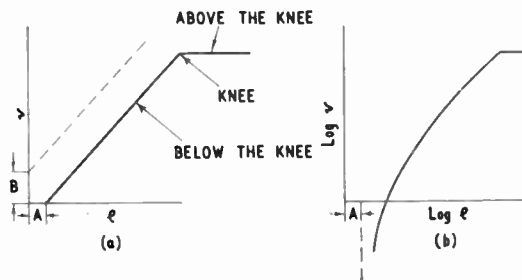

Fig. 37. Idealized transfer characteristic of contrast limited picture source.

Substitute (1) in (2) and

$$\dot{\gamma} = \frac{l}{v} \frac{v}{l - A} = \frac{l}{l - A} \quad \dots\dots(3)$$

In the more general case of light transfer characteristic of camera tubes,

$$v = m(l - A)^x$$

and

$$\frac{dv}{dl} = mx(l - A)^{x-1} = \frac{xv}{l - A}$$

and

$$\dot{\gamma} = \frac{l}{v} \frac{dv}{dl} = \frac{l}{v} \frac{xv}{l - A} = x \frac{l}{l - A} \quad \dots\dots(4)$$

To a first approximation the image orthicon, when exposed over the knee, has a transfer characteristic that may be treated as two straight lines (Fig. 37(a)) and the relationship shown in eqn. (3) applies to that part of the curve below the knee.

Therefore, if a transfer characteristic shows an increasing point gamma for decreasing values of l, the value of A can be calculated.

The contrast range represented by l/A will be defined for the purposes of this paper as the *Ultimate Contrast Range* of the tube.

In practice, a certain percentage of camera tubes, measured under most carefully controlled conditions, exhibit this increasing point gamma at low light values and it may, in these cases, be used to calculate the ultimate contrast range of the tube. Equation (4) also expresses the effect of subtracting "sit" from a picture or decreasing the black level. For example:

Tube A gives a point gamma of 1.5 at a density of 1.6 (where white is represented by density 0). Using relation 3

above, such a tube has an ultimate contrast range of 120 : 1.

Tube B gives a point gamma of 1.2 at a density of 2. The ultimate contrast range is, therefore, 600 : 1.

Of course, using exactly the same method, a tube with $\gamma < 1$ in the low light regions may be shown to have a value of A that is negative, which in fact means that the transfer characteristic intercepts the Y axis at a point $B = mA$, since it is impossible to have negative values of light! This is one way of expressing the effect of adding "sit" to a picture or increasing the black level. Similarly it shows the effect of origin shift if there is any error in the measuring equipment used for taking transfer characteristics.

22.1. Effect of Ultimate Contrast Range on Picture Quality

In any given tube, if $A = 0$ or is completely negligible, it may be seen that black level can be accurately set by removing all light from the tube and adjusting the output voltage to zero. A curve of the correct shape will then be obtained for any form of contrast law correction that may be required and grey areas in scenes of any contrast range will fall into the correct relation to each other.

Now consider a tube which has an ultimate contrast range of 100 : 1, worked in the purely linear condition. Figure 38(a) shows the curve obtained if black is set to zero voltage

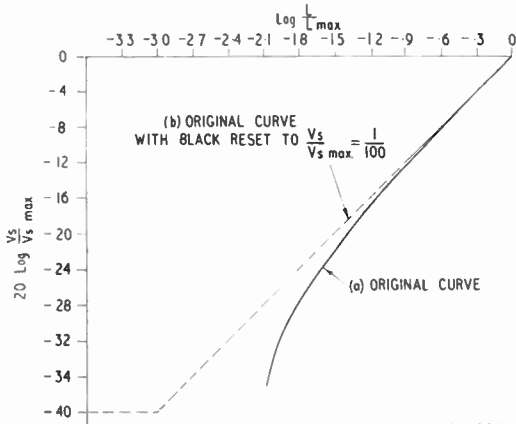

Fig. 38. Theoretical curve. Tube with linear response and contrast range limited to 100 : 1.

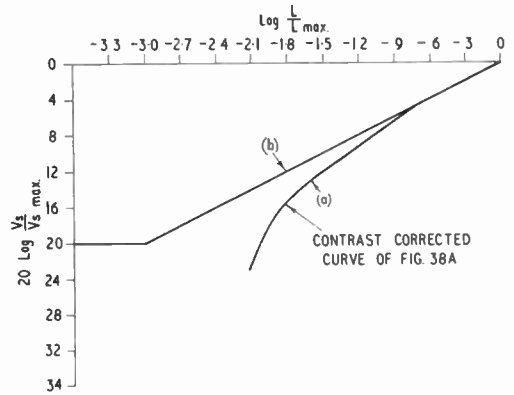

Fig. 39. (a) Curve of Fig. 38 after passing through a gamma=0.5 corrector. (b) Curve of (a) with blacks set correctly.

and Fig. 39(a) the result when this signal is passed through a contrast law corrector which would convert a $\gamma = 1$ law to $\gamma = 0.5$. It may be seen that severe black crushing results and that the curve is unsatisfactory in that the steeply increasing γ in the blacks leads to small changes of grey in the original scene giving exaggerated changes of grey in the reproduced image.

There is, however, another way of setting up such a tube. If a test pattern with a grey tone known to be well within the ultimate contrast range of the tube is used, the signal voltage resulting from this tone can be set to be on the correct part of the desired curve. This results in transfer characteristics of the type shown in Figs. 38(b) and 39(b) and gives satisfactory results on grey values down to 100 : 1 on the example given.

Present practice, however, is either to set tubes so that the signal voltage is 0 for no light input, or to set the black subjectively by an operator being available to adjust it all the time it is in use. It is the writer's personal opinion that much of this continuous adjustment is necessitated by the presence in the system of a certain number of tubes which, for various reasons of operation or imperfection, have too high a value of A . Tests on a fairly large number of tubes show that, with reasonable target/mesh spacing, and operated with sufficient target volts (> 2.5 V above cut-off), such tubes are rare, but if the target voltage is too low (< 2.0 V above cut-off) it is quite usual for tubes to exhibit this

effect. Similarly, tubes with large target/mesh spacing or operated too far below the knee also exhibit this effect. For reasons already mentioned, tubes operated too far above the knee also exhibit undesirable effects of a different type.

22.2. Contrast Handling Capacity of Picture Monitors

It will probably be asked why a tube need be capable of dealing with scenes of high contrast ratio, and in order to answer this question it is necessary to consider the behaviour of a picture monitor in respect of varying contrast range in the signal.

The transfer characteristic of the cathode-ray tube is basically a power law with an exponent between 2 and 3, depending on the design of the tube and the way in which it is operated⁹. In any practical picture, two other components modify the characteristic, namely a general veiling glare, which is an evenly dispersed brightness component proportional to the integrated scene brightness, and a "flare" or white halation surrounding each white point in the scene and proportional to its brightness.

The contrast ratio which the monitor can usefully reproduce is therefore a function of the contents of a scene, and it is fairly simple to verify that a monitor can reproduce scenes consisting of a few fairly small details on a dark surround having a ratio of several hundred to one, whilst it will only reproduce small dark details on a white ground with a ratio of ten or fifteen to one or even less.

Subjectively, it is frequently the case that pictures appear best when they are so arranged that the contrast range presented to the monitor is as great as it can handle on that subject. If this is so, the camera (including the camera

channel) should be capable of handling a signal that will produce a very large contrast ratio on the monitor screen on suitable subjects. Fortunately, the type of subject which requires the longest contrast range on the monitor screen is also the type in which the camera reproduces its longest contrast range.

There are two alternative methods of producing a television picture of given contrast range and law. The original scene may have a contrast range lower than that required for the monitor and the camera may artificially increase the contrast in the signal to give a suitable effect. Alternatively the camera may be made capable of handling scenes of wide contrast range and the original scene can be designed and lit to give the required result visually, the overall process from studio to c.r.t. screen being linear.

In practice a compromise between the two alternatives is found to be the best solution. There can be only a limited control over costumes, scenery etc. and the scenic artists and actors only work at their best if the scene in the studio bears some relation to a real scene. Studio contrast ranges may be as low as 5 or 10 : 1 for say, interviews or talks, and may be as high as 80 or 100 : 1 for certain light entertainment shows.

On many of the scenes, therefore, the contrast law of the overall signal has an exponent averaging somewhat more than 1, and the precise value is in general arrived at by subjective assessment on the monitors in the studio. It may be seen, however, that it is impractical and probably undesirable to reduce the contrast ratio of all scenes to 20 : 1 or even 30 : 1, figures that tend to be quoted as limiting values of contrast range in studio productions. With modern camera tubes, correctly operated, it is unnecessary.

News from the Sections . . .

Montreal Section

With the encouragement of the Canadian Advisory Committee members of the Institution in the Montreal area met on 24th September last and elected a local committee to organize future activities in Montreal. Mr. T. A. Cross (*Member*), was elected Chairman and Mr. G. Zelinger (*Member*), Vice-Chairman. The Offices of Honorary Secretary and Treasurer will be combined by Mr. K. N. Coppack (*Associate*). A useful discussion followed in which members made suggestions for subjects of papers to be read at meetings, and for visits to factories and other similar organizations.

On 23rd October the first visit by members of the Section was made to the McConnell Engineering Building of McGill University on the occasion of the "McGill Open House." This Building, which was opened earlier this year, houses the Electrical Engineering Department and the School of Architecture. Members were conducted over the building by Professor T. J. F. Pavlasek and the Dean, Professor G. L. d'Ombain, formerly of Battersea Polytechnic, London. Amongst many interesting items, they saw the acoustic chamber, shielded rooms for investigations on radio measurements, microwave apparatus designed for double side-band suppressed carrier transmission and reception, an analogue computer, which was being used to produce an instantaneous power measurement curve on an oscilloscope, and the digital computer room. An antenna laboratory is to be installed on the roof, from which signals could be fed via coaxial cables to lecture theatres.

Details of future activities of the Section will be circulated to members by the Secretary whose address is 5757 Decarie Boulevard, Decarie Towers, Apt. 31, Snowdon, Montreal.

K. N. C.

Scottish Section

In his paper to the Section on 22nd October, first given in Glasgow and repeated in Edinburgh on the following evening, Mr. J. H. Beattie discussed the subject of "True Motion Radar." He began by describing the types of modern radar at present in use and their particular applications, and dealt with the main factors which lead to strandings and collisions at sea. He gave figures to show that in the

period 1953-57 there was an estimated reduction in these incidents of 81 per cent. as compared with the period 1934-38, due largely to the widespread use of marine radar.

After describing the various types of display, Mr. Beattie stressed the importance of afterglow on the tube which would show the direction in which a particular ship was heading. He demonstrated, with the aid of tables, the information available to the mariner in clear weather, and compared it with what radar can provide in both a "true presentation" and a "relative presentation." The advantages and uses of these presentations were discussed and the author then dealt with the problem of stabilization of the display relative to land or sea, and explained when each type of display should be used. Finally, the various facilities achieved in a typical installation were described in broad terms.

The discussion was very lively and the matter of reliability of radar equipment and the steps which were being taken to improve it was of particular interest. Questions were also asked on types of display tubes and Mr. Beattie pointed out that so far no really satisfactory daylight viewing tube was available.

W. R. E.

South Midlands Section

The 22nd Section Meeting at Malvern, on the 27th October 1959, when Mrs. L. M. Roberts, M.A., gave her paper on "Superconducting Computer Components" was the first time that a woman had presented a paper before the Section.

Mrs. Roberts gave a brief introduction to digital computers to indicate the function and requirements of a memory or store. Factors affecting the speed of operation of such stores were discussed and this led to the possibilities of using superconducting storage elements of very high speeds. The physics of superconductivity and the effect of magnetic fields in influencing the critical temperature were described and it was explained how the necessary low temperatures (only a few degrees above absolute zero) were achieved.

The stage was now set for a description of two superconducting devices—the cryotron, and

the persistent current element. The cryotron is a two-state device consisting basically of a tantalum "gate" wire, round which is wound a niobium control wire whose critical temperature is above that of tantalum. Small currents in the control wire can control larger currents in the gate wire, current gains of around seven being possible. Factors affecting the resolving time of the device were discussed, and the strip cryotron with improved resolving times was described.

The lecturer then dealt with one type of persistent current element—the Crowe cell—in which currents were set up by 10 millimicrosecond operating pulses. This cell did not give a current gain and one of the problems associated with it was the design of suitable control circuits. The speed of operation was so fast, however, that the length of the control wires became important due to the time taken for the pulses to travel down them.

The brisk discussion which followed ranged over such points as: the physical sizes of the helium liquefier and associated apparatus; types of external amplifier suitable for use with the Crowe cell (*p-n* junction diode, cryosar, and tunnel diode were described); the superconducting store in relation to servicing and maintenance in a computer. In this last connection Mrs. Roberts suggested that it would not be any harder to maintain than any other form. Power supplies required were also discussed and other topics included the selection of 2" wires with *n* switches, and the production of short pulses by transistors and mercury wetted relays.

In proposing the vote of thanks Mr. Langley Morris paid particular tribute to the excellence of Mrs. Roberts' presentation of the subject.

A. H. M.

West Midlands Section

The opening meeting of the session on 14th October was particularly notable in that it showed how the intricacies of operation of a digital computer can be taught to technical college students. The paper was entitled "The Design and Programming of a Digital Computer" and was read by Mr. C. E. Ramsbottom (Associate Member).

In his introduction Mr. Ramsbottom covered the general principles of computer circuitry and

arithmetic methods with particular reference to the use of Dekatron tubes. Comparison was made between these and the circuitry of more modern machines, it being stressed that whilst Dekatrons are basically slower, the advantage of storing numbers in decimal form made them particularly suitable for the teaching of computer principles. Mr. Ramsbottom then continued with a detailed description of "WITCH" (Wolverhampton Instrument for Teaching Computation from Harwell).

The name of this computer requires some comment; it was designed and built at the Atomic Energy Research Establishment, Harwell, as a reliable machine to do routine and repetitive calculations normally done by operators with desk machines. It was completed in 1950 and replaced by a faster and more modern machine in 1956; the original machine was then presented to the Wolverhampton & Staffordshire College of Technology.

The machine uses 827 Dekatron tubes in arithmetic stores and circuits, thus avoiding translation to binary code. 141 other valves are used in pulse generation, switching, etc. The action and store selection is carried out by about 400 P.O.-type relays. These are primarily responsible for the slow action, though this is offset by reliability and initial economy in design. Orders can be stored, but are normally obeyed as soon as read from an input tape. Input is by six tape readers which can carry orders or numbers on standard 5-hole tape.

The design of the machine provides for self-analysis under fault conditions, the fault alarm being capable of giving immediate or delayed warning. When set in the latter condition, the machine makes three attempts at the programme before shutting down.

Certain features of the design make WITCH without equal as a teaching aid, the most important being that it can be stopped at any intermediate stage in a programme and the numbers in the stores read out visually through perspex windows. Numbers and orders can then be memorized in a few minutes.

Mr. Ramsbottom concluded by mentioning of some of the applications to local industry in which the machine had proved most useful, and then demonstrated the computer in action on a programme of successive squaring. R. A. L.

Radio Engineering Overseas . . .

The following abstracts are taken from European and Commonwealth journals received in the Library of the Institution. Members who wish to borrow any of these journals should apply to the Librarian, stating full bibliographical details, i.e. title, author, journal and date, of the paper required. All papers are in the language of the country of origin of the journal unless otherwise stated. The Institution regrets that translations cannot be supplied.

SOLAR RADIATION

The accuracy of radiometer readings of the Sun taken at the Goth Hill (Ottawa) Observatory of the Radio and Electrical Engineering Division of the National Research Council has recently been assessed. Analysis of 815 simultaneous readings of the 10.7 cm solar flux obtained from two independent radiometers shows that the relative basic probable error of a single reading is ± 1 per cent. for a single radiometer. This must be increased to ± 2 per cent., or even ± 3 per cent., to include errors in the recording meters and in the variable transmission of the weatherproof dipole. The total relative probable error to be applied to the monthly means of the series of observations which commenced in 1947 has the same value.

"Internal precision of the daily radio flux observations at 10.7 centimetres." A. E. Covington. *The Journal of the Royal Astronomical Society of Canada*, 53, pp. 156-161, August 1959.

POWER LINE INTERFERENCE

A method is described in a recent German paper for simulating power influence on communications cables. It consists in inducing at the hypothetical centre of the section exposed to natural interference, for instance at the centre of a cable section, longitudinal voltages of equal magnitude with the aid of a toroidal or frame core coil both in the layers and in the metallic sheath of the cable, which in particular may also be insulated. For proving the efficiency of this method the equations of the voltages and currents that are effective between the group of wires, cable sheath, and ground are set up and intercompared, for the natural and the artificial case of interference. Finally, the methods are stated for measuring the resultant shielding factors, the sensitivity factor, and the grounding factor with the new method of artificial interference. Here the large influence of the load resistors connected at the ends of the cable between the metallic sheath and ground comes distinctly into evidence. Theoretical considerations are verified by measurements on an experimental cable.

"A method for simulating power interference on communications cables in particular with isolating metal sheaths." E. Widl. *Archiv der Elektrischen Übertragung*, 13, pp. 363-372, September 1959.

N.T.S.C. COLOUR TECHNIQUES

The superimposition of the colour subcarrier and the luminance signal according to the N.T.S.C. principle causes, besides a string-of-pearls disturbance, a desaturation of certain hues due to rectification by the picture tube characteristic. A colour subcarrier attenuation must therefore be provided for in the luminance channel of the receiver. A paper by a German television research laboratory describes experimental studies which show the extent to which the luminance signal is affected by the variations in the frequency response of the amplitude that are required and possible for this purpose. For the case of generating a narrow depression of the frequency response curve by means of wave traps the envelope curves of the carrier-frequency transient are calculated for the colour subcarrier wave, in order to investigate the appearance of brightness contour strips with use of such a circuit.

"Colour subcarrier attenuation with colour television on the N.T.S.C. system." H. Schonfelder. *Archiv der Elektrischen Übertragung*, 13, pp. 383-392, September 1959.

MEDICAL COLOUR TELEVISION

A closed-circuit colour-television system has recently been installed in the Department of Medicine at the University of Marseilles for demonstrating surgical operations to audiences up to 300. The camera in the operating theatre contains three photoconductive camera tubes and a zoom lens system whose focus, focal length and aperture can be remotely controlled. The lecture theatre is equipped with a colour-television projector, in which the three primary-colour pictures are brought into superposition on the screen by mechanical and electrical means. The picture on the screen measures 2.70 x 3.60m and has a maximum luminance of approx. 14 cd/m². Sound installations are installed for the commentary and for intercommunication.

"Colour television in medical teaching." W. A. Holm and F. H. J. van der Poel. *Philips Technical Review*, 20, No. 11, pp. 327-330, 1958/59.

A subject index to the 120 abstracts published during 1959 will be included in the Index to the Volume which will be circulated with the January 1960 *Journal*.

SUBJECT INDEX

Papers and major articles are denoted by printing the page number in bold type.

	Page	Page
Abstracts (<i>see</i> Radio Engineering Overseas and Synopses of Convention papers).		
"Abstracts of Brit.I.R.E. Papers, 1946-58" ...	606	
Advanced Courses in Science and Technology	437	
Advisory Committees, Representation ...	4, 613	
AERIALS:		
Calculated Radiation Resistance of an Elliptical Loop Antenna with Constant Current	89	
Multiplicative Receiving Arrays	369	
Transmitting Aerials for Television Broadcasting	389	
Mesny array at Mendlesham I.T.A. station	661	
Alborne technique for propagation studies ...	303	
Annual General Meeting of the Institution:		
Notice and Agenda	593	
Report	737	
Annual Report of the Council	594	
Annual Report of the Trustees of the Brit.I.R.E. Benevolent Fund	722	
Applicants for Election and Transfer 72, 116, 164, 210, 322, 346, 508, 647, 680,	752	
Application of Magnetic Resonance to Solid State Electronics	357	
Appointments Register	599	
Aslib Electronics Group	484	
Assessment of X-Radiation from Television Receivers	469	
Discussion	703	
Associated Television Grants	614	
Asymmetric Information Channels	305	
Audio Frequency Selective Amplifiers (Discussion)	436	
Automatic landing of aircraft	648	
Automatic Standing-wave Indicator for the 3-cm Waveband	253	
Benevolent Fund:		
Accounts	724	
Annual General Meeting Notice	722	
Report of Trustees	723	
Trustees	2	
Biology and Electronics	78	
British Conference on Automation and Computation	596	
British Standards Institution, Representation on Technical Committees	603, 613	
British United Provident Association, Institution Group	79, 614	
Calculated Radiation Resistance of an Elliptical Loop Antenna with Constant Current	89	
Careers Forum	679	
Cathode-ray oscilloscopes: Recommendations for expressing characteristics (Technical Committee report)	29	
Cathode-ray Tubes in Industrial and Low Scanning Speed Display Systems, Phosphors for	485	
Centenary of A. S. Popov	678	
Ceramic, Dielectric Flame-sprayed, for Transducers	699	
Chinese Scientific Literature	236	
Christopher Columbus Prize	606, 740	
CIRCUIT TECHNIQUES:		
Some Aspects of Permeability Tuning ...	47	
Coupling Coefficients of Ladder Networks with Maximally Flat Amplitude Response	63	
Microwave Ferrite Modulators for High Signal Frequencies	117	
Cold-cathode Voltage-transfer Circuits	149	
Negative Resistance for D.C. Computers	411	
Switching Circuits using Bi-directional Non-linear Impedances	571	
Clerk Maxwell Memorial Lecture "The Human Aspect of Engineering Progress"	529	
Coast Radio Jubilee	679	
Cold-cathode Voltage-transfer Circuits ...	149	
Commonwealth Technical Training Weeks ...	526	
Communications in Independent Television	545	
COMMUNICATIONS:		
Signal/Noise Ratio in Pulse Code Modulation Systems—Use of the "Ideal Observer" Criterion	183	
Installation for Port of London	400	
Mobile radio channels	490	
Communication in Independent Television	545	
Radio Show 1959	554	
Fifty years of G.P.O. Coast Radio ...	679	
Comparison between Pulse and Frequency-modulation Echo-ranging Systems ...	105	
Comparison of Telemetry Systems	491	
Committees, Members of:		
Local Sections	3	
Standing	2	
Specialized Groups	2	
(<i>See also</i> under individual committees)		
Computer Group Committee:		
Members	2	
Report	607	
COMPUTERS:		
Digital Techniques for Small Computations	37	
Ferroelectrics and Computer Storage ...	93	
Computers—the Next Ten Years ...	199	
Negative Resistance for D.C. Computers	401	
CONFERENCES:		
Administrative Radio	661	
Dielectric Devices and Network Theory	273	
Local Section Chairmen	605	
Potted Circuit Techniques	289	

SUBJECT INDEX

CONVENTION:		Flame-sprayed Ceramic Dielectric for Trans-	
Convention Committee	2	ducers	699
Brit.I.R.E. Convention (article)	4	Gap Filling Translators and Transmitters ...	649
Value of Conventions (editorial)	133	Gating Circuit for Single-gun Colour Tele-	
Planning the Convention (editorial)	197	vision Tubes	667
Attending the 1959 Convention	209	GRACE	45
Hospitality in Cambridge (editorial)	265	Graduateship Examination:	
Timetable	266	Pass Lists—November 1958	104
Synopses of papers	268, 326	May 1959	520
Convention background (editorial)	325	Number of Candidates	73
Convention Diary	387, 455, 527	Closing dates	73, 272
Corrections	134, 272, 388, 740	Group Provident Scheme	79, 614
Council, 1959	1	Higher Technological Award	236
Dinner of Council and Committees	78, 134, 288	Honorary Members:	
Annual Report of Council	594	Election of Mr. Eric K. Cole	73, 454
Nominated for Election	624	Bestowal of Honorary membership at Con-	
Coupling Coefficients of Ladder Networks		vention	386
with Maximally Flat Amplitude Response	63	Election of Dr. V. K. Zworykin	528
Courses:		Honours List	333, 598
M.Sc. in Information Theory	198	Image Amplifier, X-ray, using Image Orthicon	
Transistor Theory	334	Camera Tube	615
Current and Field Stabilization of the 9 kW		Indian Advisory Committee:	
Electromagnet of the A.E.I. Magnetic		Members	4
Spectrograph	309	Promotion for Chairman	92
Current Interest	92, 236, 303, 368, 400, 490, 661	Information Engineering, M.Sc. Course	198
D.S.I.R. Technical Digests	484	Insignia Award in Technology	198
Design of Dual-standard Television Receivers		INSTITUTION:	
for the French and C.C.I.R. Systems	457	Annual General Meeting, Notice	456, 593
Detectors for Low Energy X-radiation	273	Report	737
Digital Techniques for Small Computations	37	Building Appeal	596, 609
Diploma in Technology	236, 303	Convention (<i>see</i> Convention)	
Drift of Electronics	741	General Account	611
Editorials:		Investments	610
Qualification <i>and</i> Ability	77	Tie	614
The value of Conventions	133	Institution Meetings in London	198, 605, 666
Planning the Convention	197	Institution Notices	
Hospitality in Cambridge	265	73, 78, 135, 198, 272, 333, 388, 456, 526, 614, 666, 740	
Convention background	325	Institution of Production Engineers	236
Immediately afterwards	385	Institution of Radio Engineers Australia:	
Meeting different needs	453	Visit of President to England	333
The Syllabus of National Certificate Exami-		Co-operation	606
nations	525	Hayes Memorial Medal	679
A Minister for Science	665	International Geophysical Year	88
Education Committee:		Inventions, Development	437
Formation, members and terms of reference	599	<i>Journal</i> :	
Electro-Diagnostic Stimulators, Constant		Back copies	78, 198
Voltage	245	Circulation	134
Electronic measuring instruments. Recom-		Advertisements	334
mended method of expressing charac-		Readership	526
teristics; 2. Cathode-ray Oscilloscopes	29	Annual Report	606
Electronic telephone exchanges	45, 726	Library Committee:	
Electronics in the Universities	92	Members	2
Examination entries	600	Report	604
Examination prizewinners	602	"Library Services and Technical Information	
Examinations Committee:		for the Radio and Electronics Engineer"	604
Members	2	Linear Accelerator	661
Report	599	List of Members	272, 598, 666
Exemptions	600	Local Sections:	
Ferroelectrics and Computer Storage	93	Members of Committees	3
Film on "Photo-emission"	368	Conferences of Chairmen	188, 605
Finance Committee:		Annual Report	605
Members	2	Low-drain Distress Beacon for a Crash	
Report	608	Position Indicator	135

Measurement of Time Delay of Ultrasonic Delay Lines	237	Practical Examinations for the Technician and Mechanic	189
Mechanical Speech Recognition, Theoretical Aspects	211	Premiums:	
Mechanical Speech Recognizer at University College London, Design and Operation	219	New Institution Premiums	134, 606
Medical Electronics:		Awards for 1958	388, 606
International Conference	251, 483	Pre-pulse Techniques in High Speed Oscillography	439
Institution co-operation with I.F.M.E. ...	596	President of the Institution (Professor E. E. Zepler):	
Medical Electronics Group:		Presidential Address	5
Members of Committee	2	Visit to America	388
Inaugural Address	79	Problems of Reliability and Maintenance in very large Electronic Systems for Shipboard Use	625
Report	607	Professional Engineer	13
Membership Committee:		Professional Institutions	490
Members	2	Professional Purposes Committee:	
Report	597	Members	2
Merseyside Section:		Report	595
Members of Committee	3	Programme and Papers Committee:	
News	188	Members	2
Microwave Ferrite Modulators for High Signal Frequencies	117	Report	605
M.I.T. Electronic Systems Laboratory ...	661	RADAR AND NAVIGATIONAL AIDS:	
Mobile Radio Channel Spacing	490	Comparison between Pulse and Frequency Modulation Echo-ranging Systems ...	105
Mode Spectra of Cylindrical Waveguides containing Gyromagnetic Media, Theory ...	347	A Low-drain Distress Beacon for a Crash Position Indicator	135
Montefiore Award	334	Installation for Port of London	400
Multiplicative Receiving Arrays	369	Radar and Navigational Aids Group:	
National Certificates	62, 601	Members of Committee	456
Syllabus of Examinations (editorial) ...	525	Report	608
National Lending Library for Science and Technology	92	Radio Engineering Overseas 74, 130, 195, 263, 323, 383, 450, 524, 592, 662, 735, 808	
Negative Resistance for D.C. Computers ...	401	Radio Industry Council:	
New British Standards	235, 484	Appointment of new Director	92
News from the Sections	61, 114, 187, 252, 304, 438, 734, 806	Specifications	484
North Eastern Section:		Radio Show	553
Members of Committee	3	Radio Trades Examination Board:	
News	114	Change of radio and television examinations	272
North Western Section:		Electronics technicians' examinations ...	272
Members of Committee	3	Institution representation	4, 602
News	187, 252, 304, 438, 734	"Trainer-tester"	189
Obituary Notices:		Random Noise in Television, Theoretical and Experimental Characteristics	335
Crossman, J. D.	148	Recommendations for Medical Electronic Instrumentation: 1. Constant Voltage Electro-diagnostic Stimulators	245
Gee, W. C.	148	Reed's School, Visit by H.M. The Queen Mother	666
Oberai, H. S.	148	Benevolent Fund Bursaries	725
Rangachari, T. S.	334	R.E.C.M.F. Council and Officers	236
Sinclair, W.	334	R.E.M.E./Brit.I.R.E. Working Party	602
Sullivan, R. J.	148	Reliability and Maintenance in Very Large Electronic Systems for Shipboard Use ...	625
Overseas Sections:		Representation on other bodies	4
Toronto	198	Research at Birmingham University	678
Canadian Advisory Committee	333	Rocket-borne Magnetometer	769
Wellington New Zealand Committee	526	Royal Society Tercentenary	236
Annual Report	595	S.B.A.C. Exhibition	648
Montreal	806	Scottish Section:	
Parliamentary and Scientific Committee		Members of Committee	3
Conversazione	436	News	61, 114, 806
Permeability Tuning, Some Aspects of ...	47		
Phosphors for Cathode-ray Tubes in Industrial Low Scanning Speed Display Systems	485		
Photo-electric Image Techniques in Astronomy	417		
Potted and Printed Circuits, Recent Advances	289		
Policy in Education	5		

SUBJECT INDEX

Section Activity (Annual Report) (See also News from the Sections)	605	Assessment of X-radiation from Television Receivers	469
Signal/Noise Ratio in Pulse-code Modulation Systems—Use of the "Ideal Observer" Criterion	183	Phosphors for Cathode-ray Tubes in Industrial and Low Scanning Speed Display Systems	485
Six-channel High-frequency Telemetry System	493	Some Aspects of Television Transmission over Long Distance Cable Links ...	509
Small Television Station, Some Aspects of the design	705	Television Receiver Production in the U.S.S.R.	521
South Midlands Section:		Communications in Independent Television	545
Members of Committee	3	Radio Show 1959	553
News	188, 252, 734, 806	Television for the Microscopical Examination of Radioactive Metals ...	555
South-East London Technical College ...	333	System Design Criteria for Space Television	561
South Wales Section:		X-ray Image Amplifier using an Image Orthicon Camera Tube	615
Members of Committee	3	Gap Filling Transmitters and Translators	649
News	62, 115, 304, 734	Television and sound developments in eastern England	661
South Western Section:		Gating Circuit for Single-gun Colour Television Tubes	667
Members of Committee	3	Some Aspects of the Design of a Small Television Station	705
News	61, 114, 188, 438	Some Aspects of Television Reception on Band V	727
Space Television, System Design Criteria ...	561	Transistors in Video Equipment	753
Standard industrial classification	368	Testing and Operation of 4½-in. Image Orthicon Tubes	777
Statistical Methods in the Manufacture of Radio and Television Receivers	15	Television Transmission over Long Distance Cable Links	509
Students' Essay Competition	73, 78, 272, 740	Testing and Operation of 4½-in. Image Orthicon Tubes	777
Subscriber trunk dialling in the British Post Office	45	Thermo-electric generator for operation in outer space	400
Subscriptions:		Time assignment speech interpolation (on submarine telephone cables)	490
Payment by Members overseas	73, 456	"Trainer-Tester"	189
Switching Circuits using Bi-directional Non-linear Impedances	571	Training of Radio Apprentices:	
System Design Criteria for Space Television	561	South-Western Section Symposium	456, 526
Teaching methods	8	Trans-Atlantic telephone cable	303, 490
Technical Committee:		Transistors in Video Equipment	753
Members	2	Translation Services	604
Report	602	Transmitting Aerials for Television Broadcasting in the United Kingdom	389
Technical reports	602	Discussion	697
Visits	73, 78, 304, 438, 740	Ultraharmonic and Subharmonic Resonance in an Oscillator	411
Technical Education	490	Underwater Echo-ranging with Electronic Sector Scanning: Sea Trials on R.R.S. <i>Discovery II</i>	681
Telemetry Symposium	78	V.A.S.C.A.	678
Papers presented	491, 493	Vidicon Camera for Industrial Colour Television	165
Telemetry (at S.B.A.C. Exhibition)	648	West Midlands Section:	
TELEVISION:		Members of Committee	3
New B.B.C. Stations in Orkneys and Caithness	103	News	114, 188, 252, 304, 807
Translator at Folkestone	103	Whitworth Foundation Scheme	368
A Vidicon Camera for Industrial Colour Television	165	X-Ray Image Amplifier using an Image Orthicon Camera Tube	615
Synopses of papers to be presented at the Convention (<i>For titles see Index to Abstracts</i>)	268		
Theoretical and Experimental Characteristics of Random Noise in Television	335		
Closed circuit television in Barclays Bank	345		
Facsimile transmission of a newspaper	345		
Extension of I.T.A. service to Northern Ireland	345		
Transmitting Aerials for Television Broadcasting	389		
Photo-electric Image Techniques in Astronomy	417		
Future of Television Broadcasting	437		
Design of Dual-standard Television Receivers for the French and C.C.I.R. Television Systems	457		

INDEX OF ABSTRACTS

This index classifies under subject headings the abstracts published through the year in Radio Engineering Overseas, synopses of papers read at the Institution's 1959 Convention on "Television Engineering in Science, Industry and Broadcasting", and reports of papers read before Local Sections.

	<i>Page</i>		<i>Page</i>
Education		Reliability	
The teaching of electronics. R. E. Aitchison and C. T. Murray	74	The problems of reliability and maintenance in very large electronic systems for ship-board use. G. C. F. Whitaker	132
The use of demonstration equipment in basic radio theory. H. Henderson	734	Component Design	
Radio Astronomy		The solution of the problem of heat conduction in electrical technique by means of a unidimensional Laplace transform. R. Hofmann	74
Recent astronomical research using radio waves. H. P. Palmer	187	Design and construction of precision toroidal potentiometers for data transmission. H. J. Arnott	114
Development of highly directive aerials in radio astronomy. W. N. Christiansen ...	662	Recent advances in printed and potted circuit techniques. H. G. Manfield	114
Internal precision of the daily radio flux observation at 10.7 centimetres. A. E. Covington	808	Micro-miniaturization. G. W. A. Dummer	252
Physics		Ferrites	
Electro-optical measurement of distance. B. Sokolik	131	A fast method of reading magnetic-core memories. H. J. Heijn and N. C. de Troye	264
Signal transmission with light pulses. F. Frungel and G. Hands	323	Temperature coefficients of permeability of Mn-Zn ferrites. A. Braginski, J. Kulikowski and S. Makolagwa	384
The high-order-mode interferometer. J. I. Caicoya	450	Coil Design	
Geophysics		Dependence of mass of choke coils on Q. M. M. Brezinscak	130
On the electron production rate in the F2-region of the ionosphere. S. Datta ...	74	Materials for Microwaves	
Automatic Control		Some absorbent materials at s.h.f. H. G. Stubbs	130
Stability of equipment arranged for automatic control. P.-L. Dubois-Violette	195	Measurements	
Nuclear Engineering		A broadband microwave calorimeter for high powers. T. Jaeger and M. V. Schneider ...	263
Some aspects of the control of nuclear reactors. L. W. J. Newman	252	A mechanical method for the automatic regulation of sensitivity of field intensity recorders. J. Karpinsky	451
Papers on the Saclay Proton Synchrotron ...	664	An automatic time signal recording device for automatic recorders. G. C. Choudhury ...	664
Transducers		Transmission Lines	
Electronic transducers. G. F. N. Knewstub	61	Measurement of the properties of a strip line and its transition junction. F. Norman ...	130
Production Techniques		Radiation and reception properties of a wide slot in a parallel-plate transmission line. R. F. Millar	323
The cooling of p.v.c.-coated conductors during the production process. B. Buhmann ...	75	Surface wave transmission line composed of dielectric membrane. M. Sugi and T. Nakahara	735
Continuous measurements of the capacitance of coaxial cables during manufacture. D. Wolff	130	Network Analysis	
An apparatus for testing the solderability of wire. J. A. ten Duis	132	Application of resistance potential networks in passive linear network engineering. J. Virant	263
Printed wiring in development and small batch production of video equipment. E. Davies	327		
The production of service electronic equipment. H. I. Millar	383		

INDEX OF ABSTRACTS

Attenuators	
Calibration of microwave attenuators by means of thermistor bridges. J. Hosek ...	662
Crystal Filters	
Quartz filters for the frequency range 7-30 Mc/s. R. Bechmann ...	263
Waveguides	
Syntheses of bent waveguides with continuous curvature. M. G. Andraesen ...	75
Reflections at waveguide flange connections. U. von Kienlin and A. Kurzl ...	75
Investigations of the disk-loaded and helical waveguide. Bengt T. Henoch ...	130
Q-value measurements by means of a standing wave indicator on cavity resonators connected with transmission lines. Hans W. Urbarz ...	131
A long slot directional coupler with H-waves. H. Pascher ...	263
A variable high power microwave divider. K. Varecha ...	450
New isolators for radio links. J. Deutsch, W. Haken and C. von Haza-Radlitz ...	524
Oscillators	
Frequency stable oscillators as current or voltage sources. W. Herzog ...	195
On the frequency modulation of tuned circuit and relaxation oscillators. Ernst Kettel ...	383
A contribution to stabilizing the pulse duration in monostable multivibrators. T. Hornak ...	735
Amplifiers	
A new method of microwave amplification. S. K. Chatterjee ...	74
Recovery of amplifiers after overload. A. N. Thiele ...	384
General energy relations for parametric amplifying devices. S. Duinker ...	735
D.C. Amplifiers	
The measurement of weak direct currents by direct coupled amplifiers. G. Friedling ...	450
Pulse Amplifiers	
The design of pulse amplifiers. R. C. Ganguli ...	662
Circuit Techniques	
A new wideband discriminator. N. B. Chakraborti ...	263
Theory of parallel circuit diode reactance amplifiers. W. Dahlke, R. Maurer and J. Schubert ...	662
Transistor Amplifiers	
Neutralization of transistor low-frequency amplifiers. Jan Mikula ...	195
Calculations and measurements for an optimum design of a low noise transistor amplifier. K. Spindler ...	450
Non-linear distortions and cross-modulation in h.f. transistors. M. Akgun and M. J. O. Strutt ...	
	663
Transistor high frequency amplifiers. L. E. Jansson ...	
	734
Transistor Circuits	
Design of d.c. push-pull transistor converters. T. Konopinski and M. Politowski ...	131
The junction transistor as a network element at low frequencies: III. Stabilization of the operating point, in particular with regard to temperature changes. J. P. Beijersbergen, M. Beun and J. te Winkel ...	195
Transistor circuitry. B. R. A. Bettridge ...	304
Transistors in video equipment. P. B. Helsdon	328
Pulse modulators using transistors and switching reactors. B. F. C. Cooper and W. J. Payten ...	383
Design of a junction type transistor divider chain and indication of its state. V. Spany	524
A new, approximate approach to the design of a junction transistor blocking oscillator. V. Spany ...	663
Photocells	
Photoelectric curve follower. J. Tomasek ...	74
Semiconductor Devices	
The electrical properties of a storing switch transistor. W. von Munch ...	131
Double diffusion germanium npn transistors. R. Deschamps ...	263
A method of measuring the resistivity and Hall coefficient on lamellae of arbitrary shape. L. J. van der Pauw ...	323
The static current amplification factor as a function of emitter current for transistors with diffused and homogeneous base region. Peter Kaufmann ...	450
Measurement of the high frequency characteristics of transistors. S. Vojtasek, F. Zajic and M. Stanek ...	524
Applications for the storing and switching transistor. W. von Munch and H. Salow ...	592
On the frequency characteristics of Hall generators. F. Kuhrt, H.-J. Lippmann and K. Wiehl ...	663
The measurement of semi-conductor conductivity in the microwave range. B. Kvasil and V. Husa ...	735
Valve Technology	
Study and assessment of oxide cathodes by means of a test electron tube. G. Landauer and W. Veith ...	451
Electron emission of materials for electron tubes. G. A. Esperson and J. W. Rogers ...	451
V.H.F. Valves	
The reason for differences between the theoretical and practical values of the shot noise in high gain v.h.f. triodes. R. Thielert ...	324

Transit-time Devices			
Vacuum tube with magnetic-field control. J. Katscher	76	Transmitting aerials for television broadcasting in the United Kingdom. A. Brown	332
The limits of gain in travelling-wave tubes for radio links. W. Klein	592	An anechoic antenna for comparison of losses in microwave antenna systems. K. A. Steele	383
A backward-wave oscillator with periodic slow-wave structure for the frequency range 27-48 kMc/s. F. Gross	663	The dimensions of a horn parabola antenna. F. Stranak	735
		Systems for guiding waves on end-firing radiators. G. Trentini	736
Scintillation Counters		Noise	
Signal-to-noise ratio and dead time of a scintillation counter. J. A. W. van der Does de Bye	384	Radio interference from fluorescent lamps. H. J. J. van Boort, M. Klerk and A. A. Kruihof	75
Communication Theory		The deduction of data for a television noise evaluation filter. J. Muller and E. Demus	324
Tests relating to the improvement of the intelligibility of speech in the presence of noise. O. Brosze, K. O. Schmidt and A. Schmoltd	592	Radio noise testing of high voltage line equipment. A. S. Denholm	452
		Interference due to parasitic signals on television pictures. L. Goussot	452
Telegraph Equipment		A method for simulating power interference on communications cables in particular with isolating metal sheaths. E. Widl	808
Teleprinter signal regenerator equipped with transistors. F. Obst and F. Ohmann	196	Power Supplies	
Electro-Acoustics		Theory of a new current stabilizer based on the transducer principle. J. Krusek and B. Dudas	323
A small portable noise-level analyser for the measurement of sound spectra. Chr. Peekel	196	A transducer regulator for stabilized power supplies. A. N. Heightman	328
A non-linearity test unit for broadcast music circuits. E. A. Pavel and M. Bidlingmaier	452	The wind driven power supply for the s.h.f. radio relay station Schoneberg (Eifel). G. Rosseler	524
Transmission of speech with the aid of an ear microphone. J. Naujoks	664	Large area earthing in telecommunication installations. O. Warners and A. Ziegler	736
Loudspeakers. F. H. Brittain	734		
Propagation		Broadcasting	
Propagation conditions between Europe and North America in the frequency band 40 to 52 Mc/s during a maximum of sun-spot activity. H. Wisbar	76	Common channel common programme operation of medium-wave broadcasting stations. S. F. Brownless	76
Tropospheric scatter propagation and equipment. J. Fieguth	196		
Quebec-Labrador tropospheric scatter radio system. D. J. McDonald and C. E. Frost	452	Radar	
The frequency dependence of the effect of solar flares on long wave coverage. H. Volland	736	High resolution airfield control and ground surveillance radar. P. H. Walker	114
Unusual propagation conditions for ultra short waves. J. Ortner and A. Egeland	736	An electronic line storage device for bandwidth compression of periodically repeated signals, particularly for radar p.p.i. displays. K. Lange	131
		The statistical properties, the frequency spectrum and the suppression of low frequencies in signals for radar p.p.i. displays. H. Groll and E. Vollrath	132
Radio Communication		The storage of radar pictures with bandwidth compression. H. Groll and E. Vollrath	324
On the considerations for future developments in communications techniques. K. O. Schmidt	75	Storage processes for improving the signal-to-noise ratio of approximately periodical signals with particular reference to radar. H. Meinke and K. Rihaczek	324
A high stability pilot: the synchrocompteur. L. Berman	451	Long distance transmission of the angular informations from a shaft rotating with an average uniform speed. K. Dinter	736
		True motion radar. J. H. Beattie	806
Aerials			
The horizontal radiation patterns of rhombic antennas for receivers in short wave-links. H. Bohnenstengel, W. Kronjager and K. Vogt	132		

Television—General		The combined television-radio receiver and its problems. R. S. Hildersley	327
Reduction of television bandwidth by frequency-interlace. E. A. Howson and D. A. Bell	268	Some aspects of television reception on Band V. H. N. Gant	327
Design techniques for space television. A. J. Viterbi	271	Good practice techniques in television scanning circuits. K. E. Martin	328
Technical considerations of television in the international field. T. Kilvington	326	Television field scan linearization. H. D. Kitchin	328
A common carrier multi-channel television wire broadcasting system. K. A. Russell and F. Sanchez	326	The synthesis of black and white television images from coloured picture tube phosphors. C. H. Laurence	664
Subception. N. F. Dixon	326		
Photo-electric image techniques in astronomy. B. V. Somes-Charlton	331	Television Broadcasting	
Television Camera Tubes		ABN television transmitter. F. M. Shepherd. The ATN television centre. M. H. Stevenson. The studio procedures of Finland's television. P. Pesari	324 384
Signal distortion in the supericonoscope. W. Dillenburger	264	Colour Television	
The testing and operation of the 4½ in. image orthicon tube. D. C. Brothers	269	Experiments concerning the adaptation of the N.T.S.C. colour television system to the European 625-line standards. J. Davidge	76
Some aspects of vidicon performance. H. G. Lubszynski, J. Wardley and S. Taylor	328	Transmission failure in the N.T.S.C. system. H. Schonfelder	264
Delay effects in camera tubes of the vidicon type. W. Heimann	451	Methods of performance measurement on colour television receivers. A. J. Biggs and E. Ribchester	270
Television Transmission		The development and progress of medical colour television. R. D. Ambrose and A. R. Stanley	330
Some aspects of the design of a small television station. Aubrey Harris	268	A gating circuit for single-gun colour television tubes. K. G. Freeman	330
Communications in independent television. L. F. Mathews	270	Colour television in medical teaching. W. A. Holm and F. H. J. van der Poel	808
Waveform distortion in television links. I. F. Macdiarmid	271	Colour subcarrier attenuation with colour television on the N.T.S.C. system. H. Schonfelder	808
Gap filling translators and transmitters. W. J. Morcom	271		
A television master switcher. B. Marsden	329	Industrial Television	
Automation of television programme switching. G. E. Partington	329	Industrial and underwater television. B. V. Somes-Charlton	188
Microwave television mobile relay for outside broadcasting. J. P. Polonsky	332	Closed circuit television equipment. R. E. Blythe	252
Some aspects of television transmission over long distance cable links. H. Mumford	332	An X-ray image amplifier using an image orthicon camera tube. E. Garthwaite and D. G. Haley	270
Television re-transmitters (translators). M. Boxberger	452	Industrial television: a survey of history requirements and applications. J. E. H. Brace	326
Television re-transmitters (translators) of 300 milliwatts and 3 watts. M. Nadeau	452	The use of television for the microscopical examination of radioactive metals. E. C. Sykes	330
Precision offset of television transmitters with varying field frequency. R. Busi	664	A high-grade industrial television channel with reference to infra-red operation. J. H. Taylor	330
Television Recording		The application of closed-circuit television in the nuclear industry. J. Barratt and I. M. Waters	331
Recent developments in video tape recording. C. P. Ginsburg	270	Phosphors for cathode-ray tubes in industrial and low scanning speed display systems. M. D. Dudley	331
Operational facilities in the R.C.A. colour television tape recorder. A. H. Lind	329		
A mobile television camera and recording vehicle. Aubrey Harris	329		
Television Receivers			
Assessment of X-radiation from television receivers. A. Ciuciura	269		
Design of dual-standard television receivers for the French. C. J. Hall	269		
Time-base synchronization and associated problems. P. L. Mothersole	269		

Telemetry			
A six-channel h.f. telemetry system. T. C. R. S. Fowler	188	The development of an electronic detector of flaws in paper. M. P. MacMartin and N. L. Kusters	592
Remote control equipment for telecommunication systems, the transmission of signals and supervision. G. Pietzik	196	Computers	
Variable audio frequency tele-voltmeter. H. R. Harant	524	Computers and logic circuits using cold cathode thyratrons. R. Arronsohn ...	76
Industrial Electronics		The parametron digital computer MUSASINO-I. I. System and logical design. S. Muroga and K. Takashima. II. Engineering description. K. Takashima. S. Muroga and K. Nishida. III. Magnetic core memory. S. Yamada, T. Bessho and T. Koshiba ...	264
Electronic pin-hole detector for tinplate inspection. D. Goodwin	61	Superconducting computer components. (Mrs.) L. M. Roberts	806
Electronic engine indicator. G. F. Norman	61	The design and programming of a digital computer. C. E. Ramsbottom	807
A multi-purpose electronic tachometer. S. M. Zoha	132	Human Engineering	
High-speed electronic welding control. C. R. Bates	188	Human information processing. K. Kupfmüller	196
The application of microwave energy in industry. W. Schmidt	195		

JOURNALS FROM WHICH ABSTRACTS HAVE BEEN TAKEN DURING 1959

<i>Archiv der Elektrischen Übertragung</i> (Germany)	<i>L'Onde Electrique</i> (France)
<i>Canadian Journal of Physics</i>	<i>Nachrichtentechnische Zeitschrift</i> (Germany)
<i>Elektrotehniski Vestnik</i> (Yugoslavia)	<i>Philips Technical Review</i> (Holland)
<i>Engineering Journal of Canada</i>	<i>Prace Instytutu Tele-I-Radiotechnicznego</i> (Poland)
<i>European Broadcasting Union Review</i>	<i>Proceedings of the Institution of Radio Engineers Australia</i>
<i>Indian Journal of Physics</i>	<i>Slaboproudy Obzor</i> (Czechoslovakia)
<i>Journal of Technology, Bengal</i>	<i>Teknillinen Aikakaulehti</i> (Finland)
<i>Journal of the Institute of Electrical Communication Engineers of Japan</i>	<i>Tijdschrift van het Nederlands Radiogenootschap</i>
<i>Journal of the Institution of Engineers Australia</i>	<i>Transactions of the Engineering Institute of Canada</i>
<i>Journal of the Institution of Engineers (India)</i>	<i>Transactions of the Royal Institute of Technology (Sweden)</i>
<i>Journal of the Royal Astronomical Society of Canada</i>	

INDEX OF PERSONS

Names of authors of papers published in this volume are indicated by bold numerals for the page reference.

Authors of Brit.I.R.E. papers which are given in abstract form are noted by A.

Contributors to discussions are indicated by D. Biographical references are indicated by italic numerals.

	<i>Page</i>		<i>Page</i>		<i>Page</i>
Adorian, P. ...	388	Dixon, N. F. ...	326 A	Hives, Lord ...	303
Ambrose, R. D. ...	330 A	d'Ombraïn, G. L. ...	806	Hix, L. ...	741
Anderson, W. N. ...	659D, 720D	Dorling, Vice-Admiral J. W. S. ...	92	Horlock, R. J. ...	438
Arnott, H. J. ...	114 A	Dudley, M. D. ...	331 A, 485	Howe, G. W. O. ...	386
Ashbridge, Sir Noel... ..	386	Dummer, G. W. A. ...	252 A	Howson, E. A. ...	268 A
Bailey, R. ...	309	Edinburgh, H.R.H. The Duke		Huggins, P. ...	115 A
Bakhshi, N. S. ...	605	of ...	526	Hughes, J. R. ...	161 D
Banerji, R. B. ...	305	Elizabeth, H.M. The Queen		Hughes, N. ...	621 D
Barratt, P. ...	331 A	Mother ...	666	Hutchins, R. ...	436D
Bates, C. R. ...	188 A	Engstrom, E. W. ...	740	Indiresan, P. V. ...	401
Beattie, J. H. ...	806 A	Essen, L. ...	678, 740	Ingram, D. J. E. ...	357
Beech, T. H. ...	27 D	Fatehchand, R. ...	230 D, 335	Ivall, T. E. ...	622D
Beesley, J. H. ...	149	Fellows, E. C. ...	309	James, I. J. P. ...	165
Bell, D. A. ...	198, 268 A	Fison, Rev. Canon F. J. ...	527	Jamieson, E. ...	697D
Benham, C. M. ...	236	Foster, A. ...	699	Jansson, L. E. ...	734 A
Benson, D. L. ...	162 D	Foster, K. ...	388	Kapur, B. D. ...	92
Berkley, C. ...	483	Fowler, T. C. R. S. ...	188 A, 493	Kay, G. ...	720 D
Bettridge, B. R. A. ...	304 A, 438	Freeman, K. G. ...	330 A, 667	Kay, L. ...	105, 681
Biggs, A. J. ...	270 A	Friedlaender, E. R. ...	28 D	Keays, S. K. ...	135
Billingham, J. ...	740	Fry, D. B. ...	211	Kell, R. C. ...	102 D
Binney, H. A. R. ...	666	Gabor, D. ...	198	Kendell, R. ...	388
Blythe, R. E. ...	252 A	Gant, H. N. ...	327 A, 727	Kilvington, T. ...	326 A
Booth, A. D. ...	199, 230 D	Garland, D. J. ...	526	Kitchin, H. D. ...	328 A
Booth, C. F. ...	661	Garrard, C. C. ...	678	Knewstub, G. F. N. ...	61 A
Brace, J. E. H. ...	326 A	Garthwaite, E. ...	270 A, 615, 622 D	Lamping, C. T. ...	62 D
Bratebart, A. Y. ...	521	Gee, W. C. ...	748	Lampitt, R. A. ...	304
Brennand, R. ...	245	Germany, L. W. ...	181 D	Laverick, E. ...	253
Brickwood, R. ...	333	Ginsburg, C. P. ...	270 A	Lawrence, G. F. ...	62 D
Brittain, F. H. ...	734 A	Godfrey, A. I. ...	15, 28 D	Leak, H. J. ...	134
Brothers, D. C. ...	269 A, 777	Goodhew, E. G. ...	703 D	Lea-Wilson, C. P. ...	198
Brown, A. ...	332 A, 389, 697 D	Goodwin, D. ...	61 A	Lee, E. M. ...	236
Bulgin, A. F. ...	236	Gordon, D. ...	61 D	Lee, J. K. V. ...	28 D
Burfoot, J. C. ...	102 D	Goult, I. F. H. ...	602	Leete, D. L. ...	624
Burrows, K. ...	769	Gower, H. J. C. ...	721 D	Lind, A. H. ...	329 A
Butler, B. C. ...	288	Green, K. H. ...	602	Loh, S. C. ...	89
Butler, F. ...	198	Griffiths, J. W. R. ...	183	Long, A. ...	273
Campbell, D. S. ...	102 D	Hailsham, Rt. Hon. Viscount	665	Lord, R. N. ...	738
Chippendale, R. A. ...	623 D	Hale, H. C. A. ...	526	Lubszynski, H. G. ...	181 D, 328 A
Ciuciura, A. ...	269 A, 469, 703 D	Haley, D. G. ...	270 A, 615	Lundh, Y. ...	37
Clarke, Rear Admiral Sir Philip	288, 454	Hall, C. J. ...	269 A, 457	McCall, D. R. ...	457, 526
Clifford, G. D. ...	737	Hall, G. G. ...	333	Macdiarmid, I. F. ...	271 A, 768 D
Cole, E. K. ...	73, 386, 454, 455, 598	Hamburger, G. L. ...	233 D	McMichael, L. ...	386
Cole, W. ...	387	Hann, A. ...	162 D	Makow, D. M. ...	135
Cooper, V. J. ...	209, 455, 527, 605	Harris, A. ...	268 A, 329A, 705, 720 D	Mallory, E. T. ...	605
Cooper, Air Commodore W. C. ...	193	Harris, K. E. ...	456	Manfield, H. G. ...	114 A, 289, 302
Copeland, K. ...	483	Hart, Air Marshal Sir R. ...	92, 624, 738	Marchal, M. ...	483
Coppack, K. N. ...	806	Heightman, A. N. ...	328 A	Marples, E. ...	45
Cotterell, J. ...	62 D	Heightman, D.W. ...	181 D	Marriott, G. A. ...	78, 134, 198, 288, 333, 527, 595, 679
Cowie, A. ...	491	Helsdon, P. B. ...	328 A, 753, 768 D	Marsden, B. ...	329 A
Cox, M. H. ...	623 D	Henderson, H. ...	734 A	Martin, K. E. ...	328 A
Cross, T. A. ...	806	Henderson, J. G. ...	681	Mason, M. T. ...	605
Crossman, Capt. J. D. ...	748	Hendley, D. A. ...	388	Mathews, L. F. ...	270 A, 545
Crowe, G. ...	455, 679	Henk, A. J. ...	768 D	Meewezen, W. D. ...	47, 606
Davies, D. E. N. ...	388	Hersee, G. ...	29	Metcalfe, G. R. F. ...	697 D
Davies, E. ...	327 A	Hildersley, R. S. ...	327 A	Meyer, L. W. ...	604
Denes, P. ...	219	Hill, A. V. ...	79	Miller, C. W. ...	233 D
Diver, F. G. ...	604, 739	Hinshelwood, Sir C. ...	87, 236	Miller, W. E. ...	388
Dixon, J. C. ...	115 A				

Mitra, S. K. ...	133, 209, 333	Rao, B. R. ...	388	Tomlinson, T. B.	162D, 232D, 571
Monk, A. J. ...	198	Rao, M. S. ...	388	Treharne, R. F. ...	679
Monnier, A. M. ...	483	Ratcliffe, J. A. ...	666	Tucker, D. G.	369, 388, 678, 681
Morcom, W. J. ...	271 A, 649, 659 D, 740	Ray, S. N. ...	334	Tucker, M. J. ...	681
Morris, A. L. ...	117, 807D	Real, R. R. ...	135	Turner, R. J. A. ...	333
Mothersole, P. L. ...	269 A	Reddy, C. A. ...	388	Tyler, L. N., Major Gen. ...	602
Mott, N. F. ...	455, 527	Remond, A. ...	483	Ungoed-Thomas, Sir Lynn ...	288
Mountbatten, Admiral of the Fleet The Earl ...	288	Ribchester, E. ...	270 A	Viterbi, A. J. ...	271 A, 561
Mumford, H. ...	332 A, 509	Robb, A. J. ...	526	van Weel, A. ...	388
Nag, B. R. ...	411	Roberts, (Mrs.) L. M. ...	806 A	Waldron, R. A.	63, 231 D, 347
Newman, L. W. J. ...	252 A	Rosen, E. E. ...	553	Walker, P. H. ...	114 A
Newson, W. K. ...	605	Ross, I. M. ...	198	Wardley, J. ...	328 A
Nightingale, A. ...	483	Russell, K. A. ...	326 A	Waters, I. M. ...	331 A
Norman, G. F. ...	61 A	Sanchez, F. ...	326 A	Watson, S. N. ...	660 D
Oberai, H. S. ...	148	Saraga, W. ...	233 D	Welsby, V. G. ...	369, 388, 681
Ogden, H. ...	115 A	Sarnoff, Brig. General D. ...	740	Welsh, J. ...	253
Osborne, B. W. ...	704 D	Scott-Farnie, G. R. ...	333	Wender, E. J. ...	233 D
Osmaston, M. F. ...	623 D	Sears, J. ...	237	West, W. R. ...	679
Paddle, L. H. ...	333, 595	Shackel, B. ...	483	Whitaker, G. C. F. ...	625
Palmer, H. P. ...	187 A	Shipton, H. W. ...	483	Whiteway, F. E. ...	439
Part, A. A. ...	437	Sims, H. V. ...	660 D, 698 D	Wilkins, S. R. ...	333
Partington, G. E. ...	329 A	Sinclair, W. ...	334	Willby, S. G. ...	604
Pavlasek, T. J. F. ...	806	Skinner, D. G. ...	602	Williams, E. ...	62 D, 737
Perkins, W. J. ...	251, 483	Smyth, C. B. ...	483	Williams, R. C. G. ...	483
Philippart, H. A. ...	721 D	Smyth, H. R. ...	135	Wise, F. H. ...	698 D
Piddington, V. H. ...	26 D	Somes-Charlton, B. V. ...	188 A, 331 A, 417	Wong, J. Y. ...	89
Planer, G. V. ...	699	Stanley, A. R. ...	330 A	Wolf, M. ...	388
Plant, G. R. G. ...	232 D	Stanley, C. O. ...	387, 455	Woolmer, R. ...	483
Polonsky, J. P. ...	332 A	Stanley, P. S. ...	697 D	Wright, D. A. ...	740
Popov, A. S. ...	678	Stubbs, A. R. ...	681	Wright, G. T. ...	666, 678
Powell, C. ...	388	Sullivan, R. J. ...	148	Wylie, F. J. ...	661
Prince, M. B. ...	388	Sykes, E. C. ...	330 A, 555	Young, R. E. ...	660 D
Prutton, M. ...	93	Taylor, G. A. ...	739	Zelinger, G. ...	806
Punnett, S. W. ...	436 D	Taylor, J. H. ...	330 A	Zepler, E. E. 5, 92, 288, 386, 387, 388, 454, 455, 526, 528, 666, 737	
Ramsbottom, C. E. ...	807 A	Taylor, S. ...	328 A	Zworykin, V. K. 14, 133, 209, 333, 386, 483, 528, 529, 740	
Rangachari, T. S. ...	334	Thompson, J. L. ...	528, 738		
		Thomson, A. F. H. ...	198		
		Thomson, F. P. ...	231 D		
		Tilsley, D. N. ...	334		

(Note : Authors of papers abstracted from other journals are not included here.)