

The Journal of THE BRITISH INSTITUTION OF RADIO ENGINEERS

FOUNDED 1925

INCORPORATED 1932

*"To promote the advancement of radio, electronics and kindred subjects
by the exchange of information in these branches of engineering."*

VOLUME 18

FEBRUARY 1958

NUMBER 2

WASTAGE OF STUDENTS

STIMULATED by recent reports and publications, the Minister of Education has now asked the Central Advisory Council for Education to carry out a special enquiry into the failure of students to complete technical college courses.

Trade union control over apprenticeship schemes is suggested by Professor Lady Williams¹ as being so inflexible as to prove a major deterrent in the recruitment of apprentices. The suggestion that skilled workers who have not completed a prescribed apprenticeship are regarded by trade unions as a "lower order" needs urgent investigation. Depending upon general education, a craft technical training course can be completed in three years. Trade union insistence upon a five-year apprenticeship seems, therefore, to ignore better standards of entry, as well as improved facilities in trade schools.

Discouraged, therefore, to take up work for which they may be especially suited, many students may embark upon other courses. In a recent article,² Dr. E. C. Venables, of the University of Birmingham, provides interesting facts to prove the contention that many students are not suited to the courses for which they enrol. Her evidence includes an analysis of the results of a five-year survey among 1,000 first-year engineering students.

Only 8% succeeded in passing the Ordinary National Certificate examination in the minimum time of three years, although five years study, 13% eventually obtained the Certificate. 55.5% of all students left college with, at the best, only a pass in the first year examination.

Dr. Venables states that whilst it takes an average student at least five years to gain the Higher National Certificate, many students take eight or nine years. Bearing in mind school leaving ages and eligibility for admission to a National Certificate course, a student may be 23 or 24 years of age before gaining the Higher Certificate. The craft apprentice may also be 22 or 23 years of age before being admitted to membership of his union.

Mr. A. A. Part, Under-Secretary of the Ministry of Education, has stated that too many students with inadequate ability in mathematics and science are being admitted to National Certificate courses. Similar comment has been made in these columns, coupled with the viewpoint that maintaining the interest of the student is an essential factor.³ Some modifications in the Higher National Certificate scheme have admitted new subjects such as radio, and any replanning of the scheme should provide for maintaining the interest of the student in his chosen vocation or profession.

Mr. Part has also stated that it is necessary that practical training in industry should be satisfactory. From the student engineer's viewpoint, this is rather more difficult to control if the student is not employed in an organization giving all-round training in, say, radio and electronics. Smaller companies might well consider joining with each other in order to give craft or student apprentices wider opportunity for practical experience.⁴ The lack of technicians, and the shortage of engineers in our own field of radio-electronics, make all the more appalling the wastage of educational effort. The ultimate report of the Central Advisory Council will arouse wide interest.

¹ Professor Lady Williams, "Recruitment to Skilled Trades" (Routledge and Keegan Paul Ltd.) and also "Training of Craftsmen," *The Engineer*, 102, page 165, Jan. 31, 1958.

² "Technology," page 392, January, 1958.

³ "The Future of National Certificates," *J.Brit.I.R.E.*, 16, page 353, July 1956.

⁴ "Industrial apprenticeship," *J.Brit.I.R.E.*, 15, page 129, March 1955.

INSTITUTION NOTICES

OBITUARY

It is with particular regret that the Council records the sudden death of Frederick Henry Robinson (Companion) on January 31st.

A radio operator in the 1914-18 war, F. H. Robinson afterwards became the first Editor of "The Broadcaster" when only 20 years of age. "The Broadcaster" became a trade paper and in 1929 F. H. Robinson assisted in founding "Electrical Trading." Both these journals are continued in the present Odhams publication "Electrical and Radio Trading."

F. H. Robinson was very well known throughout the British radio and electronics industry and, indeed, to radio journals throughout the world by reason of his freelance writing. He was a founder of the Radio Industry Golfing Society and had this year been elected President of the Society. He had also been prominently associated with the Radio Industries Club for very many years.

Elected to Companionship of the Institution in 1947, Mr. Robinson had assisted the Institution in several ways, especially as Public Relations Officer during the course of some of the Institution's Conventions.

* * *

Whilst it is not customary in these columns to make personal references other than to members, countless members of the Institution will regret to learn of the death of John Hytch.

Held in high esteem throughout the radio industry, John Hytch was one of the original staff of the British Broadcasting Company, and for some years prior to his retirement from the B.B.C. was Chief Publicity Officer. He was also associated with a number of radio industry organizations and committees, and through these and other ways had been of very considerable help to the Institution.

John Hytch was 59 years of age when he died on February 10 last after an operation.

Visit to Western Germany

The Institution has decided that its sponsorship of the proposed visit to radio and electronics establishments in Western Germany can be more appropriately undertaken by a specialist organization. Details of the new arrangements appear on page (xiv) of this issue.

Institution Dinner

Admiral of the Fleet, the Earl Mountbatten of Burma, K.G., P.C., G.C.B., G.C.S.I., G.C.I.E., G.C.V.O., D.S.O. (Vice-Patron and Past President) will preside at the Institution Dinner to be held on Thursday, May 1, at the Savoy Hotel, London.

A form of application for tickets is enclosed with this *Journal*. It must be appreciated that accommodation is limited and, as there will be a considerable demand for tickets, members are asked to apply as soon as possible, more especially if they wish to bring guests. It may be necessary to limit the number of guests an individual member may invite, as first preference will be given to members who have applied for tickets by March 25.

The cost of tickets will be £2 10s. each and evening dress and decorations, or dinner jacket will be worn.

1958 Physical Society Exhibition

The Physical Society Exhibition of Scientific Instruments and Apparatus takes place from Monday, 24th, to Thursday, 27th March, inclusive, at the Halls of the Royal Horticultural Society in Westminster, London. The opening ceremony will be performed by Professor N. F. Mott, F.R.S.

The Physical Society has kindly provided special admission tickets to enable Institution members to visit the Exhibition on the Physical Society's Members' morning, Monday, 24th March, from 10.30 a.m. to 2 p.m., when the Exhibition is not so crowded. These special tickets, which may be obtained on application to the Institution, are valid for admission throughout the whole of Monday. General tickets, available for use on Monday from 2 p.m. to 7 p.m. or on any other day, can also be supplied.

Electrical Engineers Exhibition

The Seventh Electrical Engineers Exhibition, to be opened by the President of the Board of Trade, the Rt. Hon. Sir David Eccles, K.C.V.O., M.P., will take place during March 25th—29th, 1958, at Earls Court, London, S.W.5 and will be open 10 a.m. to 7 p.m. (Wednesday 10 a.m.—9 p.m.). Tickets may be obtained from the Institution.

TOROIDAL TRANSFORMERS FOR AN ANALOGUE SYSTEM OF MACHINE TOOL CONTROL*

by

D. A. Alexander, M.A. †

Based on a paper presented at the Convention on "Electronics in Automation" in Cambridge on 28th June 1957. In the chair: Mr. E. E. Webster (Member).

SUMMARY

The use of toroidal transformers makes possible analogue computing circuits with an accuracy of a few parts in a million. Among many applications the use of such circuits has proved of great value in the control of machine tools. Some details are given of the transformers and of design procedure, and the simulation of mathematical operations, such as multiplication and interpolation, is shown. A discussion follows of the design of the analogue circuits in a unit used to convert digital information to an analogue signal. Finally some results are quoted of accuracy tests on a system for a skin milling control, showing that during 1,184 readings taken under a wide variety of conditions of temperature and electrical supplies the total error on a 540 in. (13·7 m) axis only exceeded 0·001 in. (0·025 mm) on 0·42 per cent. of the measurements.

1. Introduction

The shape of a workpiece being cut on a machine tool is determined by the successive relative positions of the cutting tool and the workpiece. On a milling machine, for instance, the position of the head, which carries the cutter on its spindle, is varied relative to that of the table which carries the workpiece. Normally the positions are measured in terms of standard geometrical coordinates, either cartesian (two-dimensional, x and y ; or three-dimensional, x , y and z) or polar (r and θ).

In numerical control systems any relative position is defined by a set of numbers, which is fed automatically to the machine in an arithmetic form. The control circuits themselves may be digital or analogue. In a digital system all measurements are made as counts in a fixed unit, which might be, for example, 0·0002 in. for a machine tool control.

In analogue systems the measure of a property or a quantity on which interest is focused is represented by the magnitude of

some other physical quantity. This magnitude is infinitely variable and can be changed by minute increments. As a common example, the position of the needle of a speedometer is an analogue of the speed of the car.

The use of analogue systems is often desirable when one of the parameters is real time, and this is so for the control of continuous cutting machine tools where movement along the different axes has to be synchronized and where travel is usually required at a definite speed. The complete command and feedback signals are continuously present, which eases the design of the servo-mechanisms. In addition, interpolation between given positions is a convenient operation, as will be shown. Networks housed next to the machine have been used to interpolate accurately between widely spaced data positions, up to 30 in. apart. Since these positions form the input information, it follows that a minimum of input information is required.

It is common in electrical work to use voltages as the analogues. There are many direct current analogue computers using the voltages developed across resistors, potentiometers and capacitors. They suffer from the disadvantages that the accuracy and stability of

* Manuscript first received 28th June 1957, and in final form on 2nd September 1957. (Paper No. 437.)

† Formerly with E.M.I. Electronics Ltd., Hayes, Middx.; now Associated Industrial Consultants Ltd., London.

U.D.C. No. 621.314.236:621.9:681.142

the components rarely approach 0.1 per cent. In addition successive networks cause loading errors on previous ones and these can only be overcome by the use of expensive drift-free buffer amplifiers.

Similar systems exist using alternating current. Because of the impedances involved buffer amplifiers are still required, but they are less of a problem as they are not so subject to drift. However, phase angle shifts are troublesome and component difficulties are worse. The position is a little improved if ordinary transformers are employed.

A radical improvement can be effected by using transformers with toroidal cores. Two important advantages are gained. Firstly, extremely high off-load accuracies can be obtained. Secondly, the ratio of input to output impedance is very high. It follows that the loading errors of one such transformer on another can be made very small, and therefore, that several computing operations in succession can be carried out on the input information without much loss in accuracy and, incidentally, without buffer amplifiers.

2. Toroidal Transformers

2.1. Physical Details

2.1.1. Cores

The transformer cores, which are in the shape of toroidal rings, are made as spirals of magnetic strip. High permeability, low loss materials such as mumetal, permalloy and supermalloy are required and strip thicknesses from 0.001 to 0.005 in. (0.025 to 0.125 mm) have been used. A typical core has an internal diameter of 2 in. and a cross section of $\frac{3}{8}$ in. \times $\frac{3}{8}$ in. The core is partly or fully enclosed in a case for protection.

Figure 1 shows a core, a core case with a core in it, an unfinished single-layer autotransformer, and a double-wound transformer with tape covering.

2.1.2. Windings

Enamelled copper wire of size from 16 to 28 s.w.g. is normally used for the windings, though much finer wire is occasionally employed.

Any wire passing through the plane of the core forms a single turn winding, and in fact this technique ("lacing") is sometimes used. For most windings the wire is taken close round the core with the turns evenly distributed and wound consecutively. In some applications multifilar windings are employed. For these, several wires, each being used as a separate winding, are held as a group and the whole group wound normally round the core. Thus every n th wire in a layer will belong to the same winding of n -filar design, and the n windings will be interspersed.

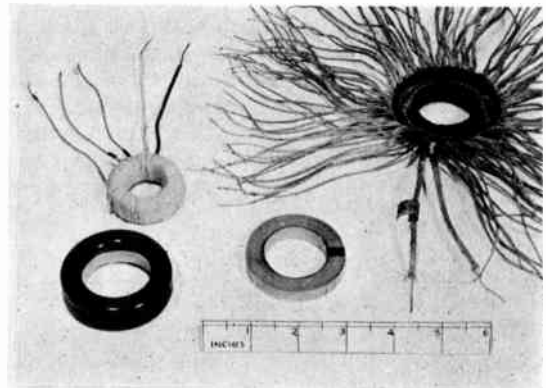

Fig. 1. Typical toroidal transformers. Bottom centre, a core. Bottom left, a core inside a protective case. Top right, an unfinished single-layer autotransformer with 127 taps. Top left, a double-wound transformer with one tap, in its tape covering.

Tables have been made for each gauge of wire of the number of turns that can be accommodated on each layer on the different cores. These calculated figures require sample checks and allowances are made for variations in wire diameter, etc. The presence of taps may also affect the results obtainable in practice.

2.2. Design Parameters

2.2.1. Excitation

It is convenient to plot graphs of the form shown in Fig. 2 for the various cores. These curves were taken on windings of 100 turns at a particular frequency, 1,000 c/s. The best frequency to use for a system should be found by a theoretical assessment of impedances based on families of these curves. It will be

seen that above a certain excitation level the input impedance drops rapidly, i.e. the transformer becomes saturated. In practice it is best not to exceed a maximum excitation level of about 70 per cent. of that corresponding to the peak of the graph, in order that there shall be no distortion of the waveform due to harmonics.

2.2.2. Input impedance

The parallel input resistance and reactance are convenient measures of the input impedance. Their value for a particular design in a given circuit is obtained by taking from the graph in Fig. 2 the values for a 100 turn winding at the appropriate level of excitation and multiplying them by $n^2/100^2$, where n is the number of turns on the winding.

2.2.3. Output impedance

The series output resistance can be calculated and then tabulated. The series output reactance presents a more difficult problem. Its value is usually several times that of the resistance and the expression for it is normally of the form $k \times n^2$. However k varies over an extremely wide range of values depending on the configuration of the winding, and it is only practicable to measure certain common cases. Theoretical calculation is very complex.

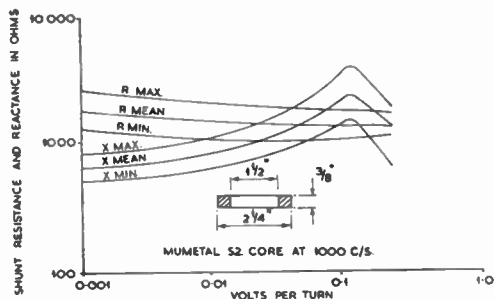

Fig. 2. Input impedances for typical cores. Values of X and R are referred to a 100-turn winding. The curves are based on 50 cores manufactured in July 1955.

The output reactance of a multifilar winding is much less than that of a normal winding. In particular that of a winding formed by connecting ten multifilar windings in series, has a value $k_2 \times n^{0.6}$, which for a typical example gives a final value 1/30th of that for the simple winding.

2.3. Accuracy

The accuracy of a transformation ratio obtained depends very much on the windings employed. The best results are obtained when symmetry is fully maintained, and this often entails the use of multifilar windings. In addition it may be necessary to make use of only one or two layers and to fill completely the layers used.

Autotransformers have higher accuracies than double-wound transformers. In a specially designed example with nine equally spaced taps the error in voltage on the taps is less than 0.5 in 10^7 of the applied voltage.

Double-wound transformers suffer from two disadvantages. The primary and secondary windings do not occupy the same physical space and the IZ potential drop in the primary winding is reflected as a transformation ratio error. However, the off-load errors can be kept below 1 in 10^5 . If this order of accuracy is required on load, it is necessary to use multifilar windings to avoid errors due to distortions of the magnetic field.

2.4. Reliability and Stability

These toroidal transformers have all been used in low voltage circuits. Although severe mechanical shock might affect the core, causing an increase in the magnetizing current, no troubles of any sort have been experienced with the thousand or more in service, and they can be regarded as completely reliable. They are also completely stable.

3. Advantages of Circuits using Toroidal Transformers

The attraction of using toroidal transformers for computing circuits lies mainly in the two electrical properties:

- (1) that transformation ratios can be maintained in circuit with extremely high accuracy and
- (2) that the ratio of input impedance to output impedance is very high.

In the computing circuits used the final voltage obtained is either measured by setting up a similar voltage on a measuring unit or compared with that developed by some feedback unit. From this it follows, as in most

analogue systems, that variations in the voltage of the reference supply are unimportant, since both the measured and the measuring circuits suffer the same drop in voltage. It is also true that the circuits are unaffected by normal variations in frequency.

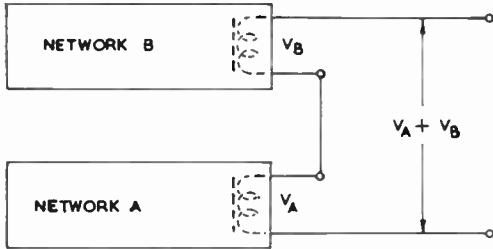

Fig. 3. Addition of two isolated voltages.

In order that only the in-phase components of voltage are compared, the detector amplifiers contain phase-sensitive detectors. Under these conditions the regulation on the input side of an autotransformer is $R_1/R_2 + X_1/X_2$ where R_1 and X_1 are the series output resistance and reactance of the input circuit and R_2 and X_2 the parallel input resistance and reactance of the transformer.

A comparison between a centre-tapped toroidal autotransformer and a centre-tapped resistive potentiometer, both used to give a voltage step-down of 2:1, illustrates the different orders of impedance ratios obtainable. In a typical design the ratio of the parallel input resistance to the series output resistance of the transformer is $3 \times 10^4:1$. Depending on the method of winding chosen the ratio of the reactive components can be much greater. The equivalent (resistive) ratio for the potentiometer is 4:1.

In addition to the two advantages just stated, the following factors may influence the designer and lead him to make use of toroidal transformers:

- (1) their performance is not critically dependent upon frequency,
- (2) their actual design is a comparatively quick and simple process,
- (3) they are reliable, and
- (4) they are stable.

4. Simulation of Mathematical Operations

General computation is effected by carrying out a series of basic arithmetical steps, such as additions and multiplications. It is therefore necessary to investigate how these may be performed in circuits with toroidal transformers.

4.1. Addition

The addition of the voltage occurring across two terminals of a network to another such voltage is achieved by connecting together two of the terminals so that the two voltages appear in series. This is illustrated in Fig. 3.

However, if a common base or "earth" is to be maintained, which means in effect that the two networks are not isolated from each other, then an isolating transformer is required. This is illustrated in Fig. 4.

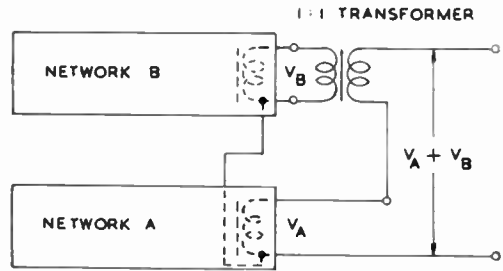

Fig. 4. Addition of two voltages with a common base.

4.2. Subtraction

Subtraction of a voltage V is performed by adding a voltage $-V$. $-V$ is obtained by interchanging the appropriate two terminals, as shown in Fig. 5.

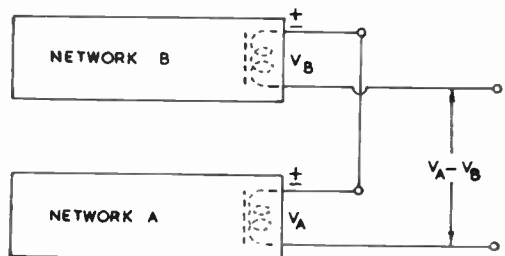

Fig. 5. Subtraction of two isolated voltages.

4.3. Multiplication

When one number is multiplied by another, the answer obtained is the required proportion of the first number. The appropriate circuit is a transformer with the correct ratio between the numbers of turns on the primary and secondary windings.

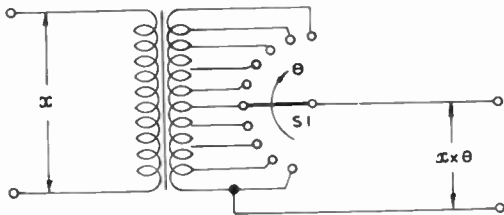

Fig. 6. Multiplication. θ represents the angular position of the brush of the mechanical switch S1.

This arrangement gives multiplication by a fixed number. The number can, however, be varied by changing from one secondary winding to others or by changing from the one tap to others on the secondary winding. The selection can be accomplished by a mechanical selector switch, in which case the position of the selector arm is an analogue of the multiplier. Fig. 6 shows this diagrammatically.

The switch may be a multi-position switch, a uniselector, or, most usefully, a rotary switch. Fig. 7 shows an example of a specially designed rotary switch, with two fixed rows of 64 studs

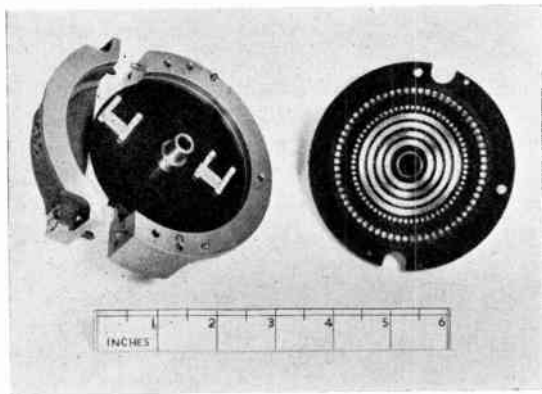

Fig. 7. A rotary switch.

and four fixed rings, only two of which are being used. The rotor plate carrying the brushes is attached to a mechanical shaft whose rotational position is controlled to represent the multiplier.

4.4. Division

Division is accomplished as multiplication by the inverse of the divisor. It may be possible to instrument the inverse of the divisor and multiply it by the dividend. Alternatively the mechanical shaft position must represent the inverse of the divisor, a condition which causes no theoretical difficulty. Both methods may make the actual design problem more difficult because the inverse number is not a linear function of the original number.

4.5. General Functions

Since the taps may be placed at any positions on the secondary windings and may be connected to any switch studs, the output obtained as the mechanical switch is rotated can be made to vary in any arbitrary manner. Thus any expression of the form $x.F(\theta)$ can be instrumented with x as the input voltage applied to a transformer and θ as the position of the shaft of a mechanical switch whose studs are connected to the transformer taps.

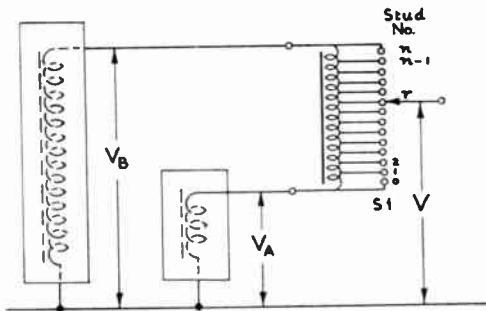

Fig. 8. Linear interpolation. Voltage V on stud r is
$$\frac{rV_B + (n-r)V_A}{n}$$

S1 may be any type of switch.

$F(\theta)$ may be a function of almost any form. In particular, polynomial, trigonometric and empiric functions have been instrumented, but it is necessary only that the function should be pre-determined, since its values are built into the design.

4.6. Interpolation

In a system where all voltages are measured with respect to a common wire, interpolation between the voltages at two terminals can be obtained by connecting an autotransformer between them. The voltage at any point on the transformer will lie between those at its ends, i.e. those on the two terminals. Taps spaced evenly will provide a series of voltages with equal increments, and any number of values can thus be interpolated between two given voltages. A circuit is drawn in Fig. 8.

The interpolation shown is linear or, in mathematical terms, first order. By a similar but more complicated procedure using two transformers it is possible to interpolate between three voltages using the necessary linear and quadratic terms, i.e. to provide second order interpolation.

It should be noted that the interpolation provided is implicit. No knowledge of how the input voltages are obtained is required nor is any equation linking the values derived. The interpolation is a direct operation.

4.7. Differentiation and Integration

General purpose circuits for differentiation and integration cannot be readily designed with these transformers, though approximate methods corresponding to numerical differentiation and integration are possible. When these operations are to be applied to known functions of a variable, the integral or differential can be instrumented directly as another known function of the original variable. For example, the differential of $\sin \theta$ can be obtained directly as $\cos \theta$. This process may involve two operations, because it will be necessary to obtain the variable as a mechanical shaft position if it does not already exist.

5. Sub-Division and On-Load Switching

5.1. Sub-Division

One difficulty in the use of toroidal transformers arises from the fact that only a limited number of turns and taps can be put on a core and that taps can only be placed at spacings of an integral number of turns. In practice it is unprofitable to place more than about 100 taps on a transformer.

However, voltages between those on the taps on a transformer can be obtained by adding to one of them stepped-down contributions from other transformers. Since only the same absolute accuracy is required from the contribution as from the tap itself, the small value of the contributions means that they can be made with low inherent accuracy.

5.2. Off-Load Switching

Off-load switching of these contributions creates no problems other than the choice of reliable switches with low contact resistance. The resistances are required not to exceed about 25 milliohms in very low voltage circuits in which currents of only a few milliamperes are flowing.

5.3. On-Load Switching

Frequently on-load switching is required. This is so when the circuit forms part of a servo system such as occurs in machine tool control, where continuous signals are needed and open- or short-circuits cannot be tolerated. The requirement is that the brushes of the mechanical switches should have a make-before-break action in passing from one stud to another and that any studs being bridged should be at equal potentials.

The adjustment of the voltages on the switch studs is achieved by adding in (or "injecting") between the taps of the main transformer and the studs voltages derived from auxiliary circuits. These voltages must normally vary cyclically as the switch is rotated from stud to stud. This is because when one stud is shorted to another connected to a tap of lower voltage the injected voltage must be negative, whereas when the same stud is shorted to the one on its other side connected to a higher voltage tap the injected voltage must be positive. If the switch is acting as a linear multiplier the main taps will be equally spaced, and the voltages at shorted switch studs will be mid-way between those on the taps. The injected voltage will rise as the switch brush is rotated from minus half the tap voltage interval when the stud is shorted to the one before it, to zero when the brush is central on the study to plus half the tap voltage when the stud is shorted to the next one. A suitable circuit is shown in Fig. 9, where the auxiliary circuit is shown for sim-

plicity as an inductive potentiometer. The shaft of the potentiometer is mechanically geared to that of the switch.

Since the shorting action of the brush may not occur at precisely the correct position of the shaft and in any case covers a small band of angular positions, the two studs must be kept at the equal potentials for some distance on either side of the nominal changeover point. This is accomplished by arranging for the injected voltage to reach values a little more than half the tap voltage intervals. In Fig. 9 the inductive potentiometer windings are therefore carried beyond the nominal feed points, giving the desired "overhang."

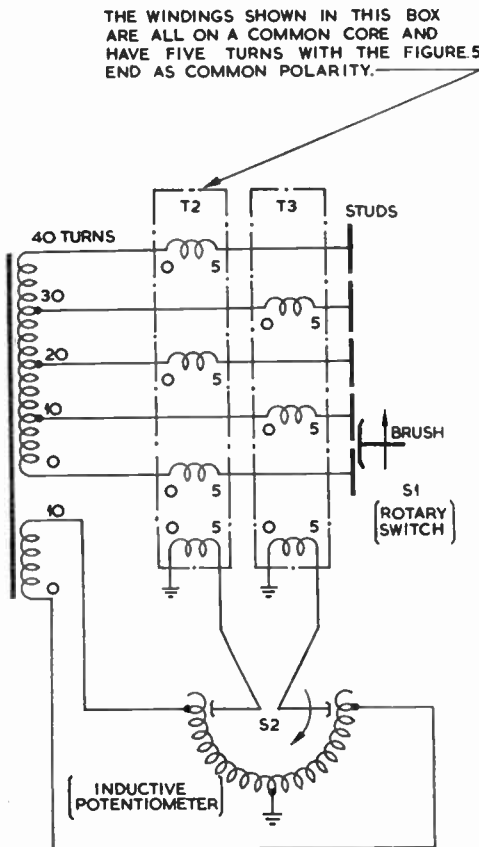

Fig. 9. A simple on-load switching circuit. Switches S1 and S2 are geared together so that S2 performs 1 revolution when S1 moves a distance of 2 studs.

5.4. The Fine Element

The auxiliary circuits themselves may employ the same "stepless switching" technique.

The final element in the chain producing voltages may be a finely graded transformer-switch combination, a wire-wound potentiometer, an inductive potentiometer or a device called a linear synchro. Built on a standard synchro frame, it resembles a sine-cosine resolver. However, its two outputs vary linearly with angle of rotation over ranges of almost -90 deg. to $+90$ deg. about their null points, which are spaced physically 90 deg. apart. Their characteristic is shown in Fig. 10.

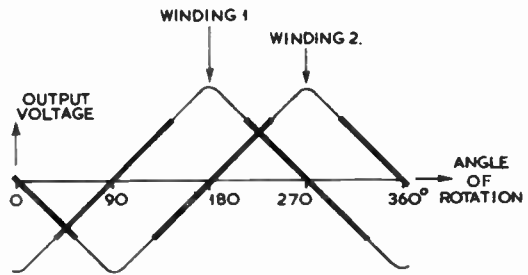

Fig. 10. Characteristic of a linear synchro. The portions of the characteristic used in circuit are shown by thick lines.

They are used in circuit over the ranges -45 deg. to $+45$ deg. plus overhang. Their outputs are injected into a coarser circuit rather as shown in Fig. 9, but the sense of alternate secondaries is reversed and the linear synchro is made to perform one revolution while the switch brush traverses four studs. They produce completely smooth switching.

Linear synchros have been built with an accuracy of ± 0.2 per cent. over the range -45 deg. to $+45$ deg. Others are commercially available in this country with an accuracy of ± 0.5 per cent. over that range.

6. Units in a Machine Tool Control

There are seven essential electrical elements in a complete machine tool control system. Four of them do not merit discussion in this

paper. They are the power supplies, the reader (which converts the numerical information on the punched tape or cards or magnetic tape into electrical signals), the servo amplifiers, and the drive motors or hydraulic valves that drive parts of the machine tool. The other three, the Store Units, the Interpolator and the Table Position Analogue Units, are mentioned briefly below.

6.1. *The Store Units*

These units convert the digital input information received as pulses from the reader into analogue signals which are held until fresh information is received. The analogue signals are selected by relays or uniselectors. The relays have latch-in circuits and the uniselectors necessarily stay put until their control circuits are re-energized.

Five of these units are required for each fully controlled dimension. At any time three are in active use and two are being set ready for future use, with off-load switching.

6.2. *The Interpolator*

The Interpolator is a common unit for all controlled dimensions, so that movement in the different dimensions is synchronized by mechanically gearing the switching in the different analogue circuits.

More than twenty points are obtained by second order interpolation of distance as a function of shaft position between sets of three information points. The voltages representing the latter are fed from three Store Units. In terms of two-dimensional machine tool positions, the interpolated points therefore all lie on a particular parabola. Between these points linear interpolation is performed.

The mechanical switches in the interpolation circuits are driven at pre-determined speeds, so that a definite position-time relationship is held.

6.3. *Table Position Analogue Units*

These act as the feedback units in the servo loops and measure the table positions. The analogue output voltage must vary linearly with the position of the table, which is geared through either a rack or the leadscrew to the rotary switches, etc., that provide the on-load switching.

6.4. *Block Diagram*

Figure 11 shows a block diagram for the control in a single dimension of the position of a machine table.

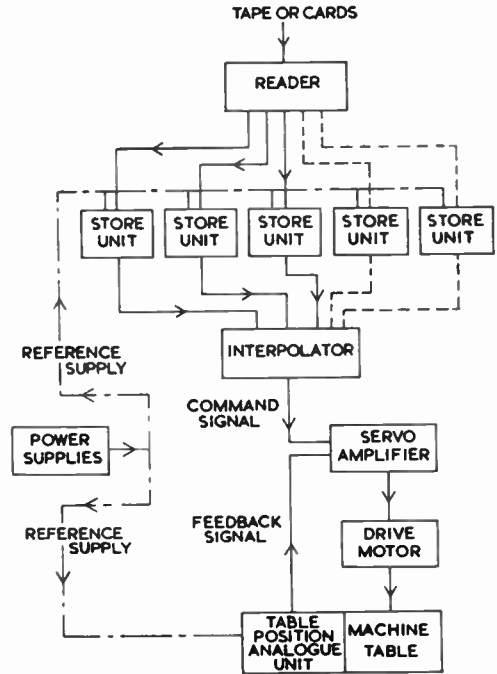

Fig. 11. Block diagram for the control of one dimension of a machine tool.

Numerical information representing “programmed” positions is taken from the tape or punched cards by the reader and transmitted as direct current signals to operate the store units’ relays. The analogue outputs from three of these units are fed to the Interpolator, thus determining its output at each position of its switches, which are rotating at a pre-determined speed. The Interpolator output signal is compared at the servo-amplifier with the analogue signal given by the Table Position Analogue Unit to show the position of the table. If the two differ, the amplifier energizes the motor until the table has been driven to the position required—this part of the circuit is a normal position servo.

The sequencing circuits that connect the

output wires of the reader to each Store Unit in turn, and those that connect each of the Interpolator input terminals to the correct Store Unit, have been omitted from the diagram. They are controlled by rotary switches in the Interpolator. In addition the Interpolator triggers the reader at the appropriate times so that new batches of positional information are read when required.

From the diagram it can be seen again that variations in the voltage and frequency of the reference supply will have very little effect, since it is the balance of two analogue signals derived from the same reference source that controls the table movement.

7. Design Considerations for a Store Unit

In order to give an indication of some of the considerations involved in the design of an analogue unit using toroidal transformers, some of the major steps are shown in the design of a particular unit, the Store Unit.

7.1. Specification of Unit

The specification for the Store Unit, whose purpose was discussed in Section 6.1, was that it should cover the range 0 to 60 in. (1.5 m) with an accuracy appreciably better than 5×10^{-4} in. (0.012 mm). The decimal digital input information would be in units of one thousandth of an inch. The input impedance of the unit was to be at least 1,000 ohms and the output impedance not more than 50 milliohms.

7.2. Switching

The input information is received from a card reader which energizes one out of ten wires for each decade. Uniselectors were chosen for the switching because they are reliable, cheap and compact. Although comparatively slow in operation, they are fast enough because information for all the different digits of two points is fed simultaneously and in parallel for at least 200 milliseconds. The input wires are connected to studs on one bank of the uniselectors. Another bank switches the analogue circuit, and is made with gold-plated contacts with a reliable contact resistance of about 15 milliohms with the extremely light currents carried.

7.3. Decade Formation

Since the input information is in decimal form, the analogue signal synthesis must be of decimal form. It is desirable to use as few transformers as possible, because this tends both to keep the total magnetizing current to a minimum and to minimize costs. It was, therefore, decided to use a base transformer providing a tapped range of 100:1 to supply the digital steps, and to use a step down transformer to reduce the voltages appropriately for the lowest actual digits. This also confines the switching to circuits feeding into high impedances, without placing many contacts in series with the output.

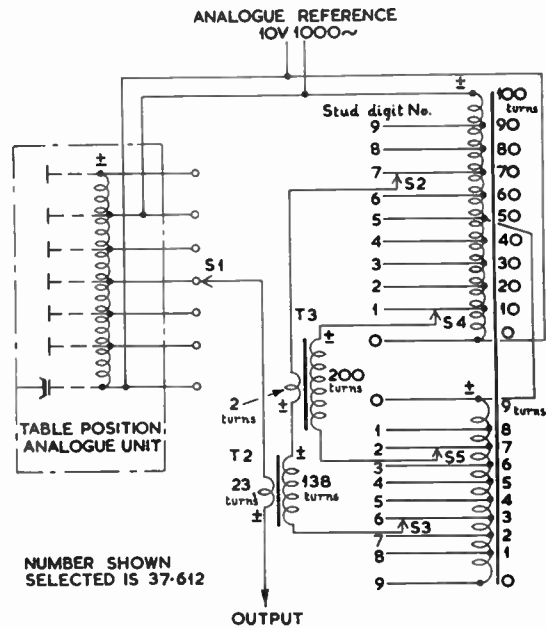

Fig. 12. Analogue circuit diagram for a Store Unit.

- Notes:—
- (1) S1 etc. are uniselectors. The arrow represents the wiper arm and the horizontal lines the stationary contacts.
 - (2) Like polarities on the transformers are shown by the ± sign and are not necessarily shown at the same physical end.

Advantage was taken of the fact that the output, after passing through the Interpolator, is eventually balanced against the signal from the Table Position Analogue Unit. This latter requires on-loading switching but its circuit was

designed so that the taps on the main transformer occur at intervals equivalent to 10 in. These taps were then utilized also as accurate sub-references for the Stores Unit, whose output voltage is built up by selecting the appropriate ten-inch sub-reference and adding to it amounts representing the lower decades. Any error in these sub-reference voltages can then cause only a second order effect on system accuracy, since normally both the command and feed back signals will have this error in common. At worst the two sub-references will be separated by only one ten-inch interval, and this can only introduce small errors.

The analogue circuit is shown in Fig. 12, but the uniselector coil circuits have been omitted. Uniselector S1 selects the decade tap on the Table Position Analogue Unit that corresponds to the 10 in. digit on the punched card. Uniselector S2 picks off an analogue contribution corresponding to the inch digit. This contribution (after all the other contributions have been added to it) is transformed down in the ratio of 6:1 by transformer T2, so that its value is correct on the main analogue scale of 10 volts equivalent to 60 in. Similarly S5 picks a contribution which represents the thousandths-of-an-inch digit and which is added directly to the hundredth-of-an-inch voltage. T3 transforms down these two voltages by 100:1 and they then undergo the further transformation by T2.

The base transformer T1 should have a very low output impedance and highly accurate transformation ratio. Since it has to carry unbalanced load currents and since one section acts as a normal secondary, it is wound as eleven multifilar windings. In order to give the necessary transformation ratios the number of primary turns must be a multiple of 100. 100 turns are sufficient to support the applied reference potential of 10 volts on one of the smaller cores in the range used, giving an input impedance of over 2,000 ohms. Since for accuracy a single layer winding was to be used, the selection of a larger core would have necessitated inconveniently thick wire and hardly reduced the output impedance.

7.4. Adding Transformers

The transformer T2 adds to the sub-reference voltage the contribution from all the other digits. Since it must be double wound and of

high accuracy, it causes the main design problem. In order to ease the problem the contribution it must handle is reduced to approximately ± 5 in. instead of 0 to 10 in. In practice, inspection of the diagram will show that in order to avoid complexity in the circuit the contribution varies from -5.050 to $+4.949$ in. It follows that the Store Unit adds a permanent bias voltage to its output, which is equivalent to a zero displacement of -5.050 in. of the Table Position Analogue Unit.

To obtain the highest ratio of input to output impedance the largest core in the range ($2\frac{1}{2}$ in. internal diameter with a cross-section of $\frac{1}{2}$ in. \times $\frac{1}{2}$ in.) was used. This reasoning is correct even though the core would not be used at the level of excitation giving the highest input impedance. Accuracy demands that multifilar windings are used, but in order to obtain a high input impedance double-layer windings are necessary and do not upset the accuracy too much. For a circuit with a double-wound toroidal transformer whose windings occupy a definite number of layers, minimum regulation occurs when the output impedance of the primary winding is just under twice that of the network feeding it. To improve the accuracy and to cut down the output impedance two secondary windings were used in parallel. These considerations led to a convenient arrangement of eight multifilar sections with 12 turns each on the first layer and 11 each on the second. Six sections were connected in series to form the primary, and the remaining two, which were not adjacent, were connected in parallel to form the secondary.

All the transformers built to this design have an off-load transformation ratio more accurate than 1 in 10^5 , and the load in service is comparatively light.

Transformer T3 does not need great accuracy since the final value of its contribution is small. A high input impedance is desirable to reduce the loading effect on T1. The primary was chosen to fill the first layer and is machine wound. It was necessary to take the precaution of winding the secondary as three equally spaced windings in parallel to avoid load distortions.

7.5. Accuracy

Measurements taken on a series of ten units built to this design showed no errors greater than 2.5×10^{-4} in. (0.006 mm).

Testing is only strictly necessary at one or two of the worst positions such as 39.999 in. An analysis of the errors at this position showed that there were three main components each causing about one quarter of the final total. These were the inaccuracies and regulation in T2, the *IZ* voltage drop in the section of T1 with taps at single turn intervals, and inaccuracies due to unbalanced load currents in the upper half of the primary winding of T1. There were in addition other measurable errors including voltage drops in connecting wires.

7.6. Improvements

The achieved results are in fact satisfactory, and no changes have been made to the production units. Experiments showed, however, that a number of small improvements could be made. The main one was to wind T1 as a ten-filar transformer with the section between the 50-turn tap and the 40-turn tap tapped every turn and used instead of the secondary (marked in Fig. 12 as Section B) to provide the lower decade of voltages. Further improvement would be obtained by using heavier wire than that actually employed, which was equivalent to 18 s.w.g.

Other types of circuit which had been thought of were not investigated, because they all used more transformers. One of them should have given greater accuracy. This was a cascade circuit, the principle of which is that each decade is obtained from an autotransformer connected across two adjacent digit taps on the transformer for the previous decade. No double-wound transformers are used and the output passes through each transformer in series.

8. Tests on an Analogue Control

A prolonged series of tests was carried out on a system for controlling the long dimension of a 540 in. \times 144 in. \times 20 in. (13.7 m \times 3.8 m \times 0.5 m) gantry type skin miller. In this system the Table Position Analogue Unit is not mechanically attached to the machine but transmits its position to the machine by a

synchro link. The Unit is driven by an electro-hydraulic servo. For the tests the Interpolator was omitted, though its loading effect was artificially simulated. The Store Units already described were used as the fine part of a coarse-fine system.

The readings were taken over the course of a month with varying thermal conditions (oil temperatures varied from 27°C to 60°C). Normal electrical mains supplies were used. No adjustments were made to the analogue system during the tests.

The position of the Analogue Unit dials was compared with that coded on the punched card. The error only exceeded 0.0005 in. on 20.61 per cent. of the 1,184 measurements taken. Only 0.42 per cent. of the readings showed an error greater than 0.0001 in. (0.025 mm). The greatest recorded error was one of 0.002 in.

9. Conclusions

Analogue circuits using toroidal transformers are suitable for most types of calculation except, in general, integration and differentiation. Even these can be performed under certain conditions.

Toroidal transformers are essential to an analogue system if it is required to be accurate to better than a few parts in a thousand. The use of the transformers can lead to an improvement of accuracy of at least 100:1, giving overall errors of only a very parts in 10^5 , and sometimes of only a few parts in 10^6 .

Such systems are robust and reliable and require negligible maintenance. Experience has shown that they are particularly useful in the control of machine tools, where continuous interpolation is required.

10. Acknowledgments

The author wishes to thank Messrs. E.M.I. Electronics Ltd. for permission to publish this paper. He also wishes to acknowledge that many colleagues have played parts in the development of toroidal transformers, and to mention in particular Messrs. R. E. Spencer, G. H. Stephenson and R. H. Booth, who did most of the original development, and Mr. F. W. Hartley, who has carried out much of the recent work on the toroidal transformers themselves.

THE SCOTTISH SECTION

The growth of the Scottish Section of the Institution was well reflected at the Annual Dinner of the Section held at St. Enoch Hotel, Glasgow, on January 31st.

A near capacity attendance of members and their guests was received by the President and Mrs. G. A. Marriott. Principal guests included Major General S. W. Joslin, C.B., C.B.E., M.A., Professor N. Feather, F.R.S., Mr. J. S. Pickles, Mr. J. N. Toothill, C.B.E., and the General Secretary of the Institution.

Describing the present era as "The Atomic Age," Major General S. W. Joslin stated that his last ten years in the Army were spent in the Royal Electrical and Mechanical Engineers, the Corps responsible for the repair and maintenance of all the wireless and radar equipment of the Army. He continued:

"We owed a great debt to your industry for the robustness and reliability of that equipment. For the past few years I have been with the Atomic Energy Establishment at Dounreay. Here we are dealing with ionising radiations whose existence can only be detected by instruments and which unless properly controlled can present a health hazard. Until the advent of nuclear reactors one gram of radium seemed a large and particularly hazardous amount of radio-active material, but chemical plants are now in continuous operation in Britain and America processing material with radio-activity equivalent to that of millions of grams of radium.

"Much of the instrumentation in the atomic energy projects is electronic and our nuclear instrumentation is adding much to the scope and value of your industry. Nuclear instruments are used in almost every phase of atomic work, not only for assessing the health hazard, but also for the purpose of assay, plant control, etc. For example, nuclear instruments are used for prospecting for nuclear fuels, uranium and thorium, for assay and monitoring in uranium and thorium mines and their associated extraction plants, for the control and safe operation of nuclear reactors and their associated fuel element chemical processing plants, for making measurements in research, for purposes of defence against atomic weapons (by assessing the magnitude of the health hazard from radio-active 'fall-out') and for the detection and measurement purposes in the many and varied uses of radio-isotopes in medicine, agriculture and industry.

"The importance of adequate instrumentation was stressed in the recent technical report on the incident at Windscale. Instruments are required

in reactors for three main purposes—control circuits, alarm circuits and safety circuits. It is necessary to ensure not only that the machine is under complete control, but that enough is known of what is going on inside in the way of temperature rises, pressures, flows, liquid levels, etc. to feel confident that nothing abnormal is taking place in any one part of it. It is also essential to ensure that staff working in the vicinity of the reactor are safe from radiation hazards, in particular gamma radiations and neutrons. For this purpose alone on the materials testing reactors at Dounreay there are 25 health monitors in addition to portable instruments. Each involves ion chambers or scintillation counters with the associated amplifying equipment and indicators or recorders. The fast reactor has something like 700 units of electronic instruments, the materials testing reactors about 300. With the large numbers of complicated electronic equipments for counting, monitors, measurings, etc. in the chemical plants, the laboratory, the health physics department, the surgery, etc., there is a total of something like 3,500 pieces of electronic equipment to be installed or maintained.

"May I finally, speaking as a member of the older engineering institutions and not without experience of the running of such organizations, say that I have seen and heard something of the efforts of your Council to build up a first class professional institution for electronics engineers. I admire the great progress which you have made in the relatively few years of your existence."

Professor N. Feather, F.R.S. (University of Edinburgh), supported the toast of "The Atomic Age" and suggested that Lord Rutherford might have been a radio engineer had he not met Roentgen and subsequently been appointed Cavendish Professor at Cambridge.

Tracing the development of Rutherford's original work, Professor Feather outlined how, from an original hypothesis the various scientific workers succeeded in obtaining the disintegrated

tion of nitrogen, discovered the neutron, and finally made possible the discovery of fission.

Professor Feather then recalled some of the other discoveries in fundamental physics which had led to the achievement of Calder Hall and the promise of the ZETA project. "A. W. Bickerton's work on molecular attraction has proved especially important and it is interesting to note comments made by Professor O. W. Richardson in an address to the British Association meeting in Edinburgh in 1921 which were still topical 'If they (nuclear effects) can be both intensive and controlled then we shall have at our disposal an almost illimitable supply of power which will entirely transcend anything known. . . . It may well be that we are at the beginning of a new age which will be referred to as the age of sub-atomic power.' Remember that was said in 1921!"

Concluding, Professor Feather said that the future development of atomic energy should provide a rich harvest for the radio and electronics engineer, especially in the field of instrumentation.

The toast of the Institution was formally proposed by **Mr. J. S. Pickles** (Chairman of the South of Scotland Electricity Board). Emphasizing the new opportunities for engineers of all specializations, Mr. Pickles made particular reference to the future work of his Board. When

the atomic power station at Hunterston was finished in 1963, its output would be 300 MW—about a quarter of the estimated requirements of the area at that date. Approximately 100 tonnes of the total charge of uranium fuel rods would be expended each year. This irradiated fuel would be returned to the Atomic Energy Authority for processing and production of by-products. (100 tonnes of uranium was equivalent to the burning of approximately one million tons of coal in a conventional station.)

The President of the Institution, **Mr. G. A. Marriott**, thanked the previous speakers for the generous way in which they had proposed the toast of the Institution. The Institution took pride in the fact that it had initiated the first meetings on problems of electronic instrumentation in nuclear energy projects at its 1951 Convention. A great amount of original research work was being done in all the Universities, including Edinburgh and Glasgow, but Mr. Marriott felt that it was misleading to suggest that all was well for scientific developments in Great Britain.

"There is no doubt that America indirectly subsidizes development and scientific work in electronic engineering. I think we are second to none in this country in producing the original ideas. I suggest, though, that we are second to America in bringing these ideas into practical use, and this is largely due to the lack of engineers."

Mr. Marriott stated that there were only about 200 Honours Degree students from all Universities in Great Britain taking electrical engineering and electronics, and that it was not disclosed how many of these specialized in electronics. The Institution was fully aware of its responsibilities in making a contribution to the improvement of facilities in technical education and had already done much to stimulate new thought in this direction.

The health of the guests was proposed by **Mr. Graham D. Clifford** and a most witty response was given by **Mr. J. N. Toothill** (General Manager, Ferranti Ltd., Edinburgh).



A Group at the Dinner.

Left to right: Mr. C. W. N. Reece (Scottish Section Chairman); The General Secretary; The President; Mr. J. S. Pickles; Major-General S. W. Joslin; Mr. J. N. Toothill; Professor N. Feather.

INCREASING INDUSTRIAL SUPPORT FOR THE INSTITUTION

Much has been publicly stated on the need to encourage the development of scientific bodies, and there is general agreement that such encouragement should take practical form.

In general, the present level of taxation has eliminated the help enjoyed in the past by many of the older professional institutions by way of endowments from individuals and from their respective industries.

Our own Institution has not had those advantages, and it is agreed that nowadays few learned societies can adequately serve their members and industry, as well as provide for future development, solely from the income received by way of membership subscriptions.

It is moreover true, as stated in *The Times*, that "These societies cannot raise money as easily as coal prices and railway fares are raised, for their members find it increasingly hard to keep their heads above the spring tide of the cost of living. Subscriptions may go up modestly, some economies are possible, although to a diminishing degree . . ."

It is hardly necessary to add that such economies as are possible never compensate entirely for the continually increasing costs of paper and printing—which are unavoidable charges in publishing the Journal and other reports. Without exception, all Institutions have found that increased postal charges have been a severe blow to the efforts to balance income with expenditure.

It is, therefore, with particular appreciation, that the Council of the Institution reports that more companies in and associated with the radio and electronics industry, are giving practical expression to their support of the objects of the Institution. Those contributions to the general fund will enable the Institution to acquire working capital—thus materially helping to finance the normal yearly work of the Institution, as well as expenditure on new activities.

Encouraged, therefore, by the practical support given by so many companies, the

Council has decided that a special appeal be made to other firms. Relatively small contributions, if given by a large number of organizations, will achieve the aim of enabling the Institution to acquire a strong financial position.

In support of this project, the following companies have already contributed most generously:—

Acoustical Manufacturing Company Ltd.
Avo Ltd.
British Tabulating Machine Company Ltd.
Clarke, Chapman & Company Ltd.
Dawe Instruments Ltd.
E. K. Cole Ltd.
General Electric Company Ltd.
Hinchley Engineering Company Ltd.
H. J. Leak & Company Ltd.
Plessey Company Ltd.
Reslosound Ltd.
Roberts Radio Company Ltd.
Siemens Edison Swan Ltd.
Telegraph Condenser Company Ltd.
J. Langham Thompson Ltd.
Thorn Electrical Industries Ltd.
Truvox Ltd.
Ultra Electric Ltd.
Vacuum Reflex Ltd.
Vitavox Ltd.
Walter Instruments Ltd.
Wharfedale Wireless Works Ltd.
Wingrove & Rogers Ltd.

Some companies have kindly undertaken to make an annual contribution, and others are donating under deeds of covenant.

Several members of the Institution have already undertaken to approach their organizations with a view to obtaining support. The Secretary will be pleased to send further information regarding the appeal and details of a deed of covenant to any member who is able to assist.

A NUCLEAR POWER PLANT TRAINING SIMULATOR FOR USE AT CALDER HALL*

by

I. Wilson, B.Sc. (Eng.)† and L. A. J. Lawrence †

A paper presented at the Convention on "Electronics in Automation" in Cambridge on 29th June 1957. In the Chair : Professor D. G. Tucker (Member)

SUMMARY

Problems peculiar to nuclear reactor and heat exchanger simulation are outlined and techniques are described which deal satisfactorily with these problems. A description is given of a machine which gives a reasonable accurate simulation of the behaviour of stations of the Calder Hall type without being too complex in design.

LIST OF SYMBOLS

α = fractional rotation of reactivity potentiometer.	S = neutron source (neutrons/sec).
β = total fraction of delayed neutrons.	Q = electrical charge.
β_i = fraction of delayed neutrons in i th delay group.	I = current.
λ_i = decay rate of i th delayed neutron emitter.	V = voltage.
K = effective neutron multiplication factor.	R = resistance.
δK = small increment in K .	C = capacitance.
l^* = mean neutron lifetime.	T_{ci} = coolant inlet temperature to reactor.
n = neutron concentration.	T_{co} = coolant outlet temperature from reactor.
r_i = concentration of delayed neutrons emitted from i th group.	T_u = uranium temperature.
	T_g = graphite temperature.
	x = scaling factor of dimensions neutrons/volt.

1. Introduction

Training simulators have been used successfully in several fields, particularly in air transport.¹ The idea of using a simulator for training nuclear power plant operators is attractive and unique. Any nuclear power plant is well protected against maloperation by a comprehensive fault detection system which will return the plant to a safe condition in the event of any misdemeanor being committed by the operator. Nevertheless it is desirable, if only from economic reasons, to prevent such occurrences, and a suitable training simulator would enable operators to be trained to an adequate level of proficiency before being allowed to control the actual plant.

* Manuscript received 29th June 1957. (Paper No. 438.)

† Atomic Energy Research Establishment, Harwell, Didcot, Berkshire.

U.D.C. No. 681.142:621.039

2. Approach to the Problems of System Simulation

Realism is essential in any training device, but unfortunately it is often difficult and expensive to achieve. In designing this reactor plant simulator the policy adopted has been to achieve realism where possible by reproducing the kinetic processes in various parts of the plant. Where this would have been too involved the system performance has been synthesized from a knowledge of actual plant behaviour. Some essential features of the system are shown in block diagram form in Fig. 1.

The production of nuclear power in the reactor can be represented with reasonable accuracy by a set of first-order differential equations. These are amenable to solutions using conventional analogue computer techniques. The main difficulty arises when one

attempts to compute neutron flux over a wide dynamic range. One of the most unusual features of a nuclear reactor is the wide variation in power during start-up. A reactor delivering hundreds of megawatts at full power may occasionally be started up from a power level of a few watts. This operation is one in which the operator must receive considerable

The nuclear reactor safety features have been simulated by constructing small mechanisms which alter the reactivity of the neutron flux computing circuits. These mechanisms reproduce the action of the reactor control mechanisms in the correct time scale. The release of these safety devices is initiated in the reactor by de-energizing magnetic clutches

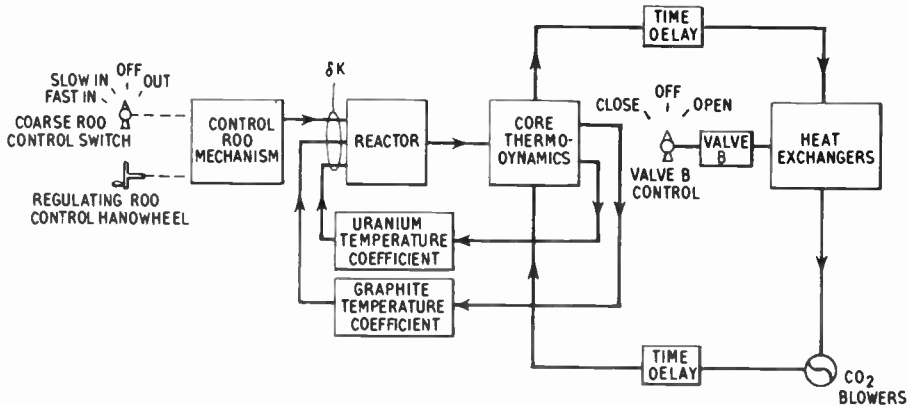

Fig. 1. Simple representation of system to be simulated.

training and so it is essential that a wide dynamic range is covered by the simulator.

Heat transfer processes taking place in the reactor can be adequately represented by a simple set of first-order equations. The chief complication lies in the number of coefficients which are functions of coolant flow. A multigang potentiometer bank can be employed in this instance to perform the necessary multiplication in the relevant equations, this potentiometer being hand operated in a manner similar to the "blower speed" control in the reactor control desk.

The performance of the heat exchanger, which has high and low pressure sections, is not adequately represented by a simple set of equations. In the case of this part of the plant the performance has been synthesized. Since heat exchanger conditions change comparatively slowly during operation of the plant it has been possible to construct what is virtually a function generator, this delivers a coolant outlet temperature from the heat exchanger which varies in the appropriate manner as coolant inlet temperature, coolant flow and steam flow conditions are varied.

which release neutron absorbers into the reactor core. A similar technique has been adopted in the simulator since this has facilitated the reproduction on the simulator of actual safety and guard circuits used on the reactor. The release of these safety devices is initiated by

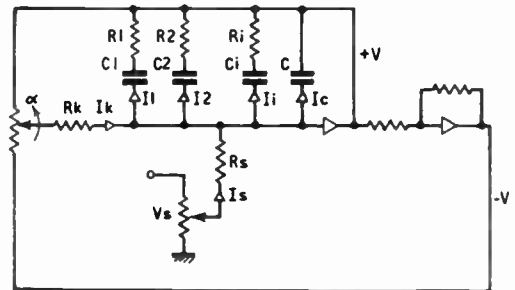

Fig. 2. Basic circuit of reactor analogue.

signals from measuring instruments in the plant. Whenever a suitable analogue signal has been available this has been employed, via trigger circuits or via a recorder fitted with alarm contacts, to initiate release of the safety mechanisms. Other fault conditions can be set

into the simulator by the instructor in order to test the reactions of the operator. The appropriate warning bells and annunciator panel displays have been provided.

3. Characteristics of the System Components and Method of Simulation

3.1. Neutron Kinetics

The neutron kinetic equations of a reactor are discussed in Appendix 1. Briefly, the rate of change of neutron population may be described in terms of reactor parameters as follows:—

$$\frac{dn}{dt} = \frac{\delta K}{l^*} n - \sum_i \frac{dr_i}{dt} + S \dots\dots(1)$$

The rate of change of output voltage of the circuit of Fig. 2 is related to the circuit parameters in such a way that its performance can be described by an equation similar to (1) above. It is shown in Appendix 2 that by introducing a scaling factor,

$$x = \frac{\text{neutron population}}{\text{amplifier voltage}}$$

the terms in the circuit equation can be related to terms in eqn. (1). From this, the values of circuit components can be calculated in order that the simulator equation may be identical with the reactor equation.

The circuit of the neutron kinetics simulator is shown in its practical form in Fig. 3. Design details are discussed below.

Some of the essential elements in the control of the reactor² are the measuring devices indicating

- (i) Reactor neutron flux and power.
- (ii) Reactor power deviation (difference between reactor power and required power).
- (iii) Reactor period.

In the reactor (i) and (ii) are measured by means of ionization chambers, or ¹⁰BF₃ proportional counters (as appropriate) suitably

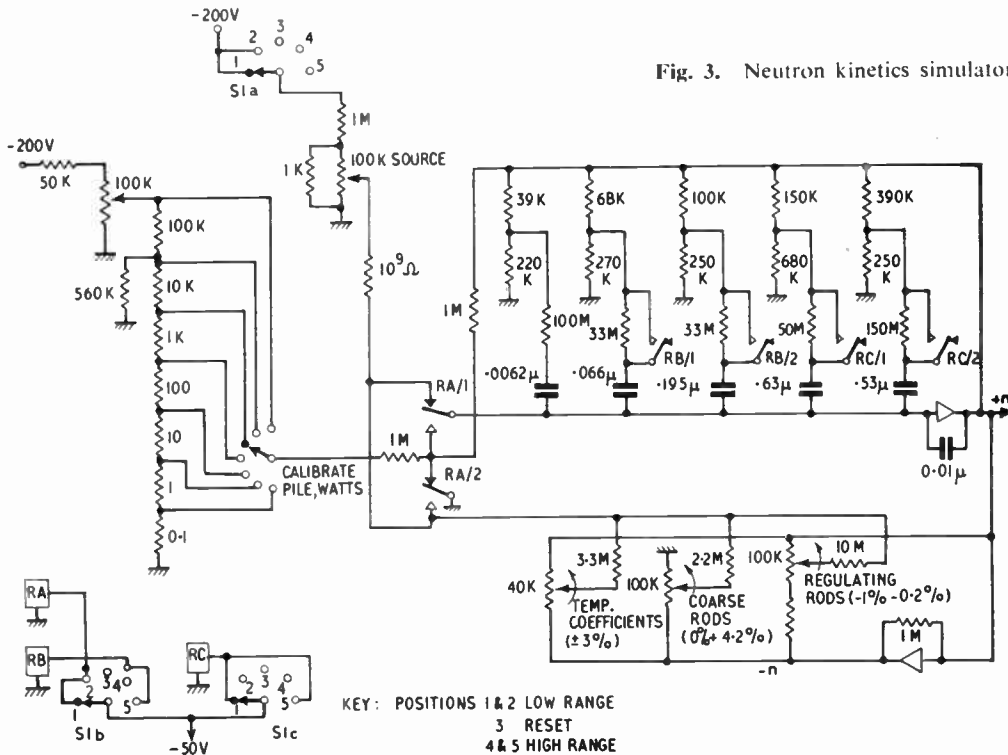

Fig. 3. Neutron kinetics simulator.

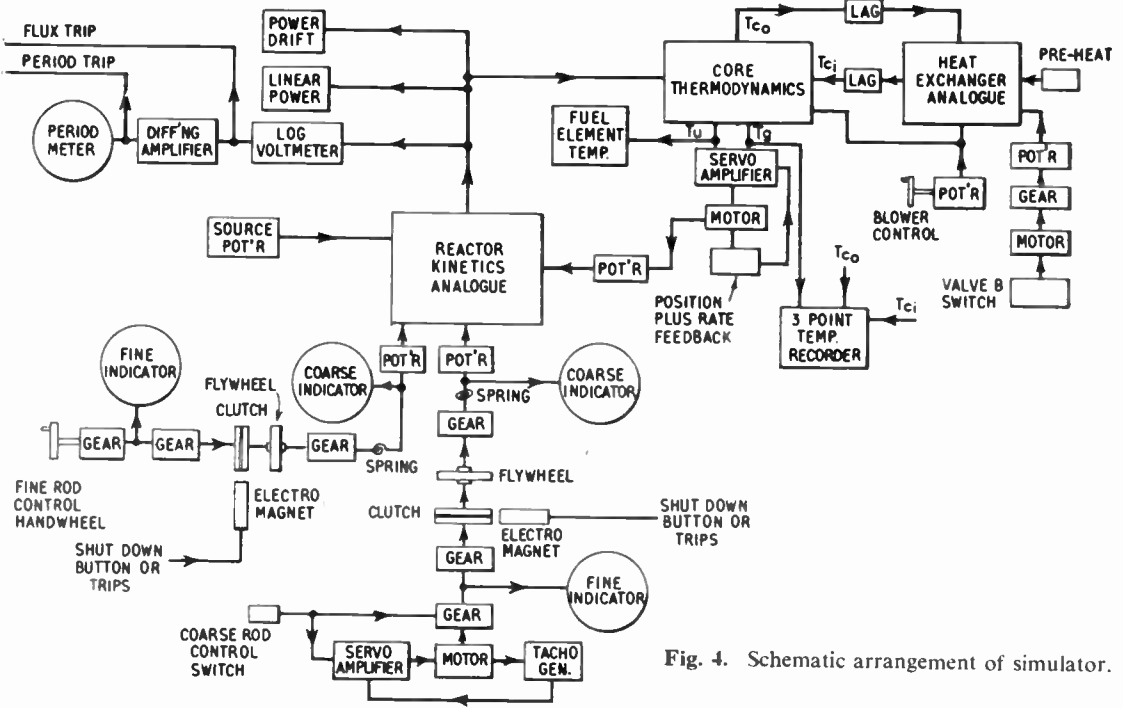

Fig. 4. Schematic arrangement of simulator.

disposed about the reactor and feeding the indicating or recording instruments.

(iii) is derived from a logarithmic neutron flux measuring channel whose output when differentiated gives a signal proportional to the reciprocal of reactor period. This signal is fed to a meter which is calibrated in reactor doubling time.³

Since the quantities fed to the measuring instruments associated with the control of the reactor are normally electrical in form, the application of an appropriate amount of simulator output to the instruments will produce the desired indications. A logarithmic amplifier⁴ and differentiating circuit basically similar to those employed in the reactor are used. (See Fig. 4.)

Operating at full power, the reactor produces approximately 200 megawatts: under shut-down conditions the power, due to the presence of a neutron source, is assumed for convenience to be some 8 decades lower. Since the simulator is required to cover this range, difficulties arise in the design of both the computing amplifiers and the logarithmic voltmeter. These difficulties

have been overcome by changing the scaling factor x at the simulated output. The output, then, is presented in two alternative ranges, either range being selected by means of a range selector switch:—

Low range: 2.2 watts — 2.2 megawatts

High range: 220 watts — 220 megawatts

The range to be covered in each case is 10^6 . This dynamic range can be achieved in the computing amplifiers and the logarithmic voltmeter by employing drift correction techniques.

In order to set up initial conditions in the computing circuits the range selection switch is provided with a "reset" position. Since time-constants as long as 80 seconds are used in simulating delayed neutron production, a number of relays are employed to reduce the value of the longer time-constants so that initial conditions can be set up quickly. The value of initial power set up with the range selection switch in the "reset" position is determined by the setting of "Calibrate Pile, Watts," switch. This switch is associated with an accurate resistor chain which also permits calibration of the logarithmic voltmeter.

3.2. Control Rods

3.2.1. Reactor

Two sets of control rods are provided in the reactor: 38 coarse rods and 2 fine or regulating rods.

The coarse rods are motor driven and may be operated by the coarse rod control switch (see Fig. 5) as follows:

- (a) Out: 0.5 in/min
- (b) Slow in: 5 in/min
- (c) Fast in: 50 in/min
- (d) Shut Down: Rods fall under gravity to all-in position in approximately 5 seconds.

The regulating rods are manually operated by two respective hand-wheels (see Fig. 5).

An excess reactivity of approximately 5 per cent. is controlled by rods: 4.2 per cent. by the coarse rods, 0.8 per cent. by the regulating rods.

Coarse and regulating rod positions are indicated on the control desk (Fig. 5) by means of a magstrip transmitter/receiver system. A total of six indicators are used:—

- (i) Coarse Rods Position—Coarse Indicator.
- (ii) Coarse Rods Position—Fine Indicator.
- (iii) First Regulating Rod position—Coarse Indicator.
- (iv) First Regulating Rod position—Fine Indicator.
- (v) Second Regulating Rod position—Coarse Indicator.

- (vi) Second Regulating Rod position—Fine Indicator.

Additional information is provided by warning lights indicating “control rods fully down” and “slack cable condition,” the latter indicating loss of tension in the cables supporting the control rods.

3.2.2. Simulator

Simulation of control rod motion, and hence change of reactivity is obtained by rotation of the input potentiometer or potentiometers in the neutron kinetics simulation circuits. The equations are discussed in Appendix 2.

Coarse rod motion is simulated by driving the shaft of the “coarse rods” potentiometer by a velodyne acting through a reduction gear. The variations in speed corresponding to (a) and (c) in 3.2.1 are obtained by either changing the reduction by means of an electro-magnetic gear-changing mechanism, or by changing the input voltage to the velodyne. In either case the change is initiated by the normal coarse rod control switch.

For convenience, one regulating rod only is simulated. Motion is controlled by manual operation of the normal handwheel. This operates the “regulating rods” potentiometer through a flexible drive and reduction gear.

Reactor shut-down, initiated either manually or by one of the automatic devices indicated in Section 2, is simulated by the operation of an

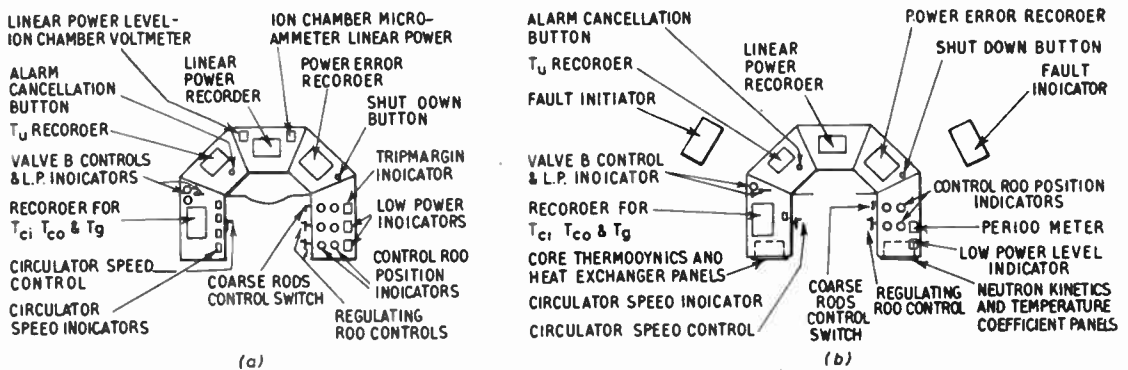

Fig. 5. (a) Plan view of reactor control desk. (b) Plan view of simulator control desk and fault panels.

electro-magnetic clutch releasing the drive mechanisms from both the reactivity potentiometers mentioned above. By means of a clock-spring acting against a flywheel of appropriate moment of inertia, the potentiometers are returned to the positions corresponding to shut-down in a manner corresponding to that of the reactor mechanisms.

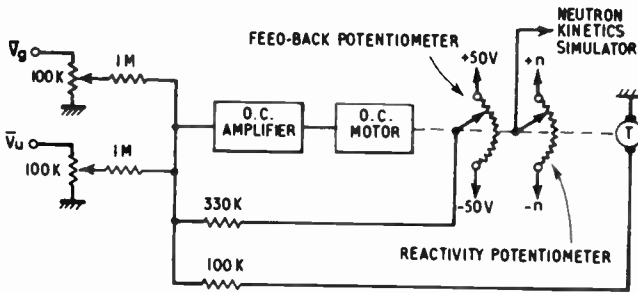

Fig. 6. Temperature coefficient servo.

The arrangement of the potentiometer control devices is shown diagrammatically in Fig. 4.

3.3. Temperature Coefficients in the Reactor

Increase in fuel temperature and/or moderator temperature will, in general, produce a reduction in pile reactivity, i.e. the pile has a negative temperature coefficient.

Simulation of reactivity change with temperature is effected by rotation of the appropriate reactivity potentiometer shown in Fig. 3. This is controlled by a position control servo actuated by voltages representing the mean temperatures of uranium and graphite respectively.

Some details of the servo are given in Fig. 6.

3.4. Reactor Heat Transfer

Reactor coolant inlet and outlet temperatures can be related to reactor power and coolant flow by a set of three first order equations. These equations together with a network suitable for their simulation are described in a companion paper.⁵ A multigang potentiometer is employed to convey the effects of coolant flow changes to the network. This potentiometer is mechanically coupled to a handwheel which represents the "blower speed" control on the reactor control desk.

3.5. Heat Exchanger Performance

Heat is extracted from the reactor coolant as it passes through the heat exchangers, the rate of extraction of energy being proportional to the mass flow rate and the temperature drop. The design of the heat exchanger is such that an increase in the inlet gas temperature to the exchanger results in an increased rate of extraction of energy, hence, within certain limits the gas outlet temperature tends to remain constant. Some adjustment to this temperature can be effected by a regulating valve (valve B) in the low pressure steam section which has the effect of altering the surface temperature of the tubes in the l.p. section.

A detailed analysis of the heat exchanger characteristics was found to be complex and unnecessary. Satisfactory performance was obtained from a simple analogue which was derived by synthesizing the actual performance of the exchanger from operating data.

Steam from an external source may be injected into the drum heaters of the heat exchangers. Thus, by running the gas circulator the whole system may be maintained at an even temperature (140°C) under shut-down conditions.

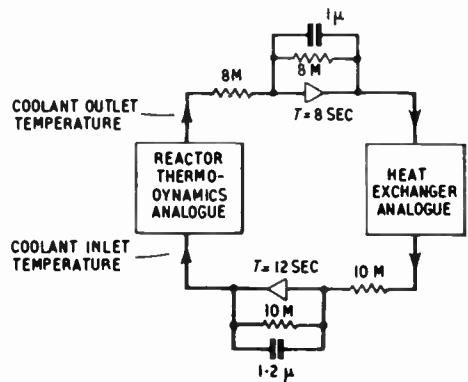

Fig. 7. Heat exchanger analogue.

The analogue shown in Fig. 7 has been designed to incorporate the following features: —

- (i) Pre-heat: A bias is introduced so that points in the circuit representing fuel, graphite and coolant temperatures respectively reach a voltage equivalent to 140°C in the steady-state. This is normally put into effect with the simulator in the condition representing reactor shut-down.
- (ii) "Break Temperature": The amplifier in the analogue is arranged so that for voltage inputs equivalent to less than 200°C no increase in amplifier output voltage (coolant outlet temperature) is obtained.
- (iii) "Slope": A potentiometer provides a means of applying a fine adjustment to the rate of increase of output voltage compared with input voltage (i.e. coolant outlet temperature compared with coolant inlet temperature) when the "Break Temperature" has been exceeded.
- (iv) "Valve B Control": A voltage is injected into the amplifier input when a potentiometer is rotated. This voltage is in such a sense as to offset the effect of rising

3.6. Coolant Transport Lags

The passage of coolant gas from reactor core to heat exchanger and from heat exchanger, via the gas circulator to core, is naturally subject to some time delay, the delay being determined by the gas velocity and piping length. No appreciable loss of temperature is experienced in transit.

Simulation of a pure time delay is possible by means of a revolving drum⁵ or by an electrical analogue⁶. In this case, however, it was found permissible to use a simple active network with transfer function $1/(1 + \tau p)$.

The circuit arrangement is shown in Fig. 8.

4. General Arrangement of the Simulator

A photograph of the simulator is given in Fig. 9.

A comparison of the respective plan views of the reactor control desk and simulator control desk is given in Fig. 5. It will be noted that some instruments have been omitted on the simulator desk; this has been done in order to simplify the presentation, thus enabling the trainee to concentrate on the more essential features of control of the reactor.

With the exception of the above simplification, the reactor control desk and simulator control desk are identical, the same controls and indicating instruments being used.

All the electronic equipment involved in the simulator is housed in the control desk, including power supplies. The interconnecting diagram is shown in Fig. 4.

Those parts of the equipment requiring manual adjustment, e.g. Range-Switch, are mounted on the end panels of the control desk (see Figs. 5 and 9).

5. Conclusions

The essential characteristics of the Calder Hall Reactor have been reproduced by a simulator housed in a duplicate reactor control desk. Thus, many of the operations performed on the reactor can be practised on the simulator, thereby enabling operational experience to be gained more quickly.

The approach to the simulation of various parts of the plant seems to have been satisfactory. It is the opinion of the authors that an alternative approach to the wide range

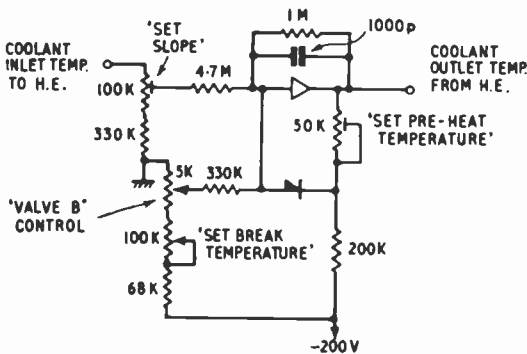

Fig. 8. Simulation of coolant transport lags.

coolant temperature. The potentiometer is motor driven through a reduction gear at a constant velocity, the velocity being such as to produce a rate of change of voltage equivalent to the rate of change of temperature experienced in the reactor. The motor is driven by 50 c/s a.c. and is controlled by the normal valve B control switch (see Fig. 5).

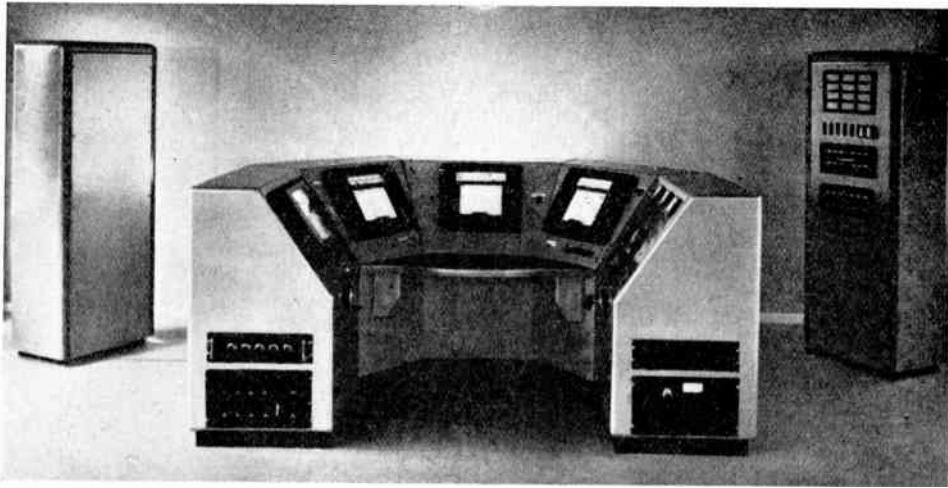

Fig. 9. Photograph of simulator.

computation of neutron flux by computing log flux⁵ should be considered in future projects of this kind. A linear flux signal could then be derived with sufficient accuracy to feed desk recorders and the heat transfer analogue.

Since the simulator has been in use for only a few months it is not possible to assess its behaviour from the training point of view. However, early comments from the training staff indicate that the simulator is proving to be satisfactory in service and is fulfilling an important role in the training of nuclear plant operating staff.

6. Acknowledgments

The simulator described in this paper was designed and constructed at A.E.R.E. Harwell. Thanks are due to Mr. K. R. Sandiford and Mr. V. Koller of U.K.A.E.A. Industrial Group, Risley, who gave valuable assistance in providing data on the reactor and provisioning some of the control desk components. Acknowledgment is also due to Mr. K. Frost of the Reactor Operators' School, Calder Hall, for his advice on the simulator design from the training aspect.

7. References

1. A. E. Cutler, "An analogue computer for aircrew training," *J. Brit.I.R.E.*, **14**, pp. 351-360, August 1954.
2. Symposium on "The Calder Works Nuclear Power Plant." *Journal of the British*

Nuclear Energy Conference, **2**, p. 2, April 1957.

3. R. J. Cox and J. Walker, "The control of nuclear reactors," *Proc. Instn Elect. Engrs*, Paper No. 2068M (**103**, Part B, pp. 577-589, 1956).
4. I. Wilson and R. J. Cox, "Improvements in and Relating to Voltmeters." British Patent Application No. 27468.
5. I. Wilson and R. Potter, "Analogue computers and their use in reactor safety studies," *J. Brit.I.R.E.*, **18**, pp. 95-100, 1958.
6. R. L. Hovious, C. D. Morrill and N. P. Tomlinson, "Industrial uses of analog computers," *Instruments and Automation*, **28**, p. 4, April 1955.

8. Appendix 1: Derivation of Reactor Kinetic Equations

Consider the core of a reactor in which a source of S neutrons appear per second due to radio-active decay. When a neutron is captured by a uranium nucleus, fission may take place, provided the neutron has sufficient energy. In the event of fission, two or three neutrons are released. Thus source neutrons, plus those neutrons born in fission may either

- (1) Escape from the reactor entirely,
- (2) Be absorbed by some non-fissionable material, or
- (3) Be captured by uranium nuclei to cause further fission and hence produce further neutrons.

If, on the average, K neutrons are produced for every neutron lost due to causes 1 to 3, then a chain reaction will be maintained if K is equal to or greater than unity.

If the mean neutron life-time is l^* and there are n neutrons at any particular time then the rate of neutron loss is n/l^* and the rate of neutron gain is nK/l^* .

While most neutrons are produced virtually instantaneously (prompt neutrons), a small fraction β (0.75% for uranium 235) of the nK neutrons are not immediately emitted, but are emitted in accordance with an exponential decay law. These are called delayed neutrons and are identifiable in several distinct groups, the percentage number per the i th group being denoted by $\beta_i\%$ and the corresponding decay constant $\lambda_i \text{ sec}^{-1}$. Furthermore, if there are r_i delayed neutron emitters at a given time then the contribution from this group to the neutron population of the core is $\lambda_i r_i$ neutrons per second.

The rate of increase of prompt neutrons is

$$\left[(1 - \beta)K - 1 \right] \frac{n}{l^*}$$

and the rate of arrival of delayed neutrons is $\sum_i \lambda_i r_i$.

Thus bearing in mind the source contribution and writing excess reactivity $\delta K = (K - 1)$, the rate of growth of neutrons may be written

$$\frac{dn}{dt} = \left[\delta K - \beta K \right] \frac{n}{l^*} + \sum_i \lambda_i r_i + S \quad \dots\dots(2)$$

The rate of growth of the delayed neutron emitter group may be written

$$\frac{dr_i}{dt} = \beta_i K \frac{n}{l^*} - \lambda_i r_i \quad \dots\dots(3)$$

In reactor operations where δK is small, K is approximately equal to unity, thus we may re-write equations (2) and (3) in simpler form

$$\frac{dn}{dt} = (\delta K - \beta) \frac{n}{l^*} + \sum_i \lambda_i r_i + S \quad \dots\dots(4)$$

$$\frac{dr_i}{dt} = \beta_i \frac{n}{l^*} - \lambda_i r_i \quad \dots\dots(5)$$

By combining (4) and (5) we have

$$\frac{dn}{dt} = \frac{\delta K n}{l^*} - \sum_i \frac{dr_i}{dt} + S \quad \dots\dots(6)$$

9. Appendix 2: Derivation of Analogue Equations

An analysis of the circuit of Fig. 2 shows that the amplifier output voltage and the rotation of the input potentiometer slider are related by equations similar in form to equations (4) and (5) derived in Appendix I.

The amplifier may be considered to draw negligible current, thus the sum of the currents flowing towards the amplifier input may be equated to zero and the circuit equations may be derived as follows

$$I_c = I_k - \sum_i I_i + I_s \quad \dots\dots(7)$$

$$\text{Now } I_c = C dV/dt \quad \dots\dots(8)$$

$$\text{and } I_k = \alpha V/R_k \quad \dots\dots(9)$$

where $\alpha = I_k/I_{k \text{ max}}$

The $\sum_i I_i$ term may be determined by considering the delay network equations and writing $n = xV$.

$$\text{We have } \frac{n}{x} = \frac{Q_i}{C_i} + R_i \frac{dQ_i}{dt} \quad \dots\dots(10)$$

Re-arranging equation (5)

$$n = \frac{l^*}{\beta_i} \lambda_i r_i + \frac{1}{\beta_i} \frac{dC_i}{dt} \quad \dots\dots(11)$$

Comparing terms in equations (10) and (11)

$$Q_i = \frac{l^* r_i}{x \beta_i R_i} \text{ and } R_i C_i = \frac{1}{\lambda_i} \quad \dots\dots(12) \text{ and } (13)$$

$$I_i = \frac{dQ_i}{dt} = \frac{l^*}{x \beta_i R_i} \frac{dr_i}{dt} \quad \dots\dots(14)$$

$$\text{Therefore, } \sum_i I_i = \frac{l^*}{x \beta_i R_i} \sum_i \frac{dr_i}{dt} \quad \dots\dots(15)$$

Finally, $I_s = R_s/V_s$

Substituting in equation (7)

$$\frac{CdV}{dt} = \frac{\alpha V}{R_k} - \frac{l^*}{x \beta_i R_i} \sum_i \frac{dr_i}{dt} + \frac{V_s}{R_s} \quad \dots(17)$$

Writing $n = xV$

$$\frac{dn}{dt} = \frac{\alpha n}{CR_k} - \frac{l^*}{\beta_i R_i C} \sum_i \frac{dr_i}{dt} + \frac{xV_s}{CR_s} \quad \dots\dots(18)$$

Thus, for eqns. (18) and (6) to become identical

$$\frac{\alpha}{CR_k} = \frac{\delta K}{l^*} \quad \dots\dots(19)$$

$$\frac{l^*}{\beta_i R_i C} = \frac{\delta K}{\alpha} \frac{R_k}{\beta_i R_i} = 1 \quad \dots\dots(20)$$

$$\frac{xV_s}{CR_s} = S \quad \dots\dots(21)$$

of current interest . . .

Silver Jubilee of the Institution of Radio Engineers, Australia

All members will join with the President and Council in sending greetings to the Institution of Radio Engineers, Australia, on the occasion of the 25th Anniversary of its foundation. The occasion has been marked by a Silver Jubilee issue of the "Proceedings of the Institution of Radio Engineers, Australia," which contains a number of notable papers, as well as more general articles on research and management.

The Australian Institution held its 1957 Convention in October last at which 58 papers were read in the course of 20 lecture sessions.

Members of Frequency Allocation Committee

Since the announcement in the January issue of the *Journal* that Sir Lawrence Bragg, F.R.S., would be Chairman of the new Frequency Allocation Committee set up by the Postmaster-General, the names have been published of the members of the Committee.

It is understood that professional institutions will not be directly represented, and that the members will be representative of both users and manufacturers. Two Members of the Institution have, however, been nominated to the Committee—Mr. J. R. Brinkley, technical director of Pye Telecommunications Ltd., and Captain F. J. Wylie, R.N. (Rtd.), director of the Radio Advisory Service as representative of marine users.

University Extension Lectures

The Department of Extra-Mural Studies of London University has arranged a series of lectures on "Britain in the Second Half of the 20th Century," which will be held at the Beveridge Hall, Senate House, Malet Street, London, W.C.1. The following will be of interest to members:—

February 27th: "Britain and her Scientific Potential: What might be done in the next ten years." Professor P. M. S. Blackett, F.R.S.

March 6th: "Britain's Basic Fuel Needs." Professor A. R. Ubbelohde, F.R.S.

March 20th: "The Needs of the Rising Generation." Admiral Sir Denis Boyd, K.C.B., C.B.E., D.S.C.

Lectures start at 6.30 p.m. Single tickets, obtainable at the door, cost 2s. each.

Appointment of Delegate for the European Organisation for Nuclear Research

Her Majesty's Government have appointed Dr. H. W. Melville, F.R.S., Secretary of the Department of Scientific and Industrial Research, to succeed Sir Ben Lockspeiser, K.C.B., F.R.S., as one of their delegates to the Council of the European Organisation for Nuclear Research (C.E.R.N.).

Sir Ben Lockspeiser retired from public service in March 1956, and has now asked to be relieved of his responsibilities as a Council member.

Progress in Atomic Power

The United Kingdom Atomic Energy Authority announces that it will hold a Conference at Harwell on Wednesday, 11th June, 1958, at which recent developments in nuclear reactor technology will be discussed with representatives of British industry.

Accommodation will be available for about two hundred representatives from industry. Because of the limited accommodation available it will probably be necessary to restrict the number of representatives from each firm. Requests for further details and for reservations should be made to: The Director, (Industrial Liaison Office), Building 329, Atomic Energy Establishment, Harwell, Didcot, Berks., not later than the 15th March, 1958.

The first Conference with British industry on the Authority's programme of research on advance types of nuclear power reactor systems was held in November 1956. The Conference now announced will inform industry of the progress achieved over the last eighteen months.

Courses in Reactor Technology

The Reactor School at Harwell is to increase the number of courses to be held each year, introducing four Standard Courses instead of three, of sixteen weeks duration, and two courses for Senior Technical Executives, of nine days' duration. The starting dates are as follows:—Standard Courses: 14th April, 1st September, 27th October. Executives' Courses: 12th May, 22nd September.

Further details may be obtained from: The Principal, Reactor School, Atomic Energy Research Establishment, Harwell.

ANALOGUE COMPUTERS AND THEIR USE IN NUCLEAR REACTOR SAFETY STUDIES*

by

I. Wilson, B.Sc. (Eng.)† and R. Potter, B.Sc.†

A paper presented at the Convention on "Electronics in Automation" in Cambridge on 29th June 1957. In the Chair: Professor D. G. Tucker (Member)

SUMMARY

Computational and circuit techniques are described which have been used successfully to study the various aspects of nuclear plant kinetics which are relevant to reactor safety. These include an examination of the overall stability of the system, the effects of coolant pump failure, burst steam lines and control rod maloperation. Particular reference is made to a revolving capacitance storage drum which simulates transport lags in coolant circuits.

LIST OF SYMBOLS

- n = neutron density.
 K = effective neutron multiplication factor.
 $\delta K = K - 1$.
 l^* = mean neutron lifetime within the reactor.
 r_i = concentration of i th group of delayed neutron emitters.
 β_i = fraction of fission neutrons which come from i th group of delayed neutron emitters.
 β = total fraction of fission neutrons which are delayed.
 λ_i = decay constant of i th group of delayed neutron emitters.
 m_f, m_c, m_m = masses per unit length of core, of fuel, coolant, moderator respectively.
 C_f, C_c, C_m = specific heats of fuel, coolant, moderator.
 h_1, h_2 = heat transfer coefficients per unit length of core.
 T_f, T_c, T_m = mean temperatures of fuel, coolant, moderator.
 $T_{c\text{in}}$ = coolant inlet temperature to reactor = $T_{c\text{out}}$ delayed.
 $T_{c\text{out}}$ = coolant outlet temperature from reactor.
 H = mean power output from fuel.
 u = coolant flow speed through core.
 l = length of core coolant channel.
 m_p, m_s = masses of primary coolant and secondary coolant per unit length of heat exchanger.
 h = heat transfer coefficient per unit length of heat exchanger.
 u_1 = primary coolant flow speed through heat exchanger.
 l_1 = length of primary coolant tubes in heat exchanger.
 T_p, T_s = mean temperatures of primary and secondary coolants in heat exchanger.
 $T_{p\text{in}}$ = inlet temperature of primary coolant to heat exchanger.
= $T_{c\text{out}}$ delayed.
 $T_{p\text{out}}$ = outlet temperature of primary coolant from heat exchanger.
 C_s = specific heat of secondary coolant.
 q = latent heat of secondary coolant.
 M = mass of secondary coolant vapourized per unit time.
 R = resistance.
 C = capacitance.
 φ_n, φ_m = temperatures at n th and m th points.
 K_1 = thermal conductivity.
 k_1, k_2 = thermometric resistances.
 Q = rate of heat release per unit volume.
 s_1, s_2 = mesh lengths.
 i_n = current fed into n th point.
 t = time.
 x = space co-ordinate.

* Manuscript received 29th June, 1957. (Paper No. 439.)

† Atomic Energy Research Establishment, Harwell, Didcot, Berkshire.

U.D.C. No. 681.142:621.039

1. Introduction

The development of nuclear power reactors necessitates the close examination of their kinetic response since individual types of reactor differ widely in this respect. During the early development of any new reactor it is necessary to assess its kinetic behaviour under a variety of conditions. Only when this has been done can instrumentation and operational procedures be considered in any detail. Important in this is the study of the effects of faulty operation of the reactor or its auxiliaries. It is with this particular category of transient analysis, sometimes referred to as safety studies, that this paper is concerned.

For most cases of practical interest the differential equations which represent the transient behaviour of a reactor plant are intractable analytically. Some form of computational aid is therefore required. Frequently it is necessary to consider the effect of forcing a system simultaneously in several ways. It may also be desirable to consider a large number of possible combinations of major plant variables in order to optimize a design. The electronic analogue computer has become established as a convenient and flexible tool with which to perform these operations, techniques having been developed for reducing the equations to a form in which they can readily be handled on this type of computer.

2. The Nature of the Problem

A nuclear power plant consists of a nuclear reactor, in which energy is released, a heat transfer medium, in either liquid or gaseous form and some suitable device such as a heat exchanger in which the heat output of the reactor is transferred to the working fluid of the generating machinery. The rate at which the reactor produces nuclear energy depends principally on its reactivity. The reactivity is in turn affected by the temperature of the reactor components, the presence of reactor poisons and the configuration of the control elements which form the principal external means of varying the reactivity. Reactor temperatures and poison concentration are closely related to nuclear power level whilst temperatures throughout the system are also a function of coolant flows and station load. Analysis of the system is therefore complicated

by the existence of several feedback loops. Many of the relationships in the system are non-linear and fairly large analogue computers are necessary to handle problems in sufficient detail. However once a satisfactory model has been derived it is then possible to make a very wide investigation into transient effects. Analogue computers have the desirable feature that preset variations in the coefficients of equations can easily be made. The effect of changes in plant variables can thus be investigated with ease.

Each reactor plant will be susceptible to sets of conditions which represent all likely forms of maloperation peculiar to a plant of that type. The more commonly encountered transients will be mentioned in order to indicate the scope of reactor safety studies.

In general the transients are of two types; those in which the reactivity of the reactor changes directly, for example as a result of incorrect operation of the reactor control system, and those resulting from disturbances in the heat transfer processes.

An example of the former type is the start-up fault in which reactivity is added to the reactor at a fixed rate and for a sufficiently long time for the reactor power to rise to a high value. The temperature of the reactor core components will rise, causing a corresponding loss in reactivity which will offset that added by the reactor control mechanism. The system will tend to reach equilibrium conditions of power and temperature but the peak values attained during the transient are of interest since they enable an assessment to be made of the ability of the system to withstand these conditions without suffering mechanical damage.

Complete or partial failure of the reactor coolant flow when the reactor is at power is typical of the second type of transient. In this case the effect of coolant flow reduction is to cause reactor core temperatures to rise. This reduces the reactivity with the result that reactor power is reduced to a level which in spite of the reduced cooling will sustain steady temperatures roughly similar to those existing initially. Although equilibrium conditions are reached ultimately as a result of the stabilizing effects of reactivity feedback in the system, the

transient conditions may represent undesirably large excursions in critical plant parameters.

Since the main reactor coolant system is generally a closed circuit it is easy to visualize other conditions, such as sudden increases in steam demand, which could conceivably result in reactor temperature (and hence power) surges. In general the amplitude of these surges is markedly affected by the speed with which the disturbing influence becomes effective. For any particular restrictions which apply in the reactor or associated plant it is possible to predict rates of change of externally applied reactivity, coolant flow or steam demand which must not be exceeded. These maximum rates having been established the reactor and plant designers can take steps to prevent them being exceeded in practice, the object being to reduce the possibility of damage to expensive plant due to malfunctioning of the auxiliaries.

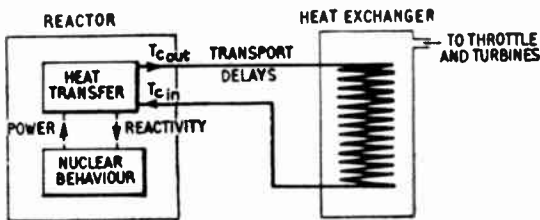

Fig. 1. Schematic of Calder Hall type reactor.

3. System Simulation

The general procedure for simulating a reactor system can be illustrated by considering the Calder Hall type of reactor.

The system can be considered in three distinct parts with a number of interdependencies. This is illustrated in Fig. 1. It is necessary to formulate sets of equations to represent the behaviour of each part. Representative sets would be as follows. (Symbols are as defined on page 95.)

3.1. Nuclear Behaviour

$$\frac{dn}{dt} = \frac{(\delta K - \beta)n}{l^*} + \sum_{i=1}^m \lambda_i r_i$$

$$\frac{dr_i}{dt} = \frac{\beta_i \cdot n}{l^*} - \lambda_i r_i \text{ for } i=1, 2, \dots, m.$$

3.2. Heat Transfer in Reactor

$$m_f c_f \frac{dT_f}{dt} = H - h_1(T_f - T_c)$$

$$m_c c_c \left(\frac{dT_c}{dt} + \frac{2u}{l} (T_c - T_{c \text{ in}}) \right) = h_1(T_f - T_c) + h_2(T_m - T_c)$$

$$m_m c_m \frac{dT_m}{dt} = h_2(T_c - T_m); T_{c \text{ out}} = 2T_c - T_{c \text{ in}}$$

3.3. Heat Transfer in Heat Exchanger

$$m_g c_g \left(\frac{dT_g}{dt} + \frac{2u_g}{l_g} (T_g - T_{g \text{ in}}) \right) = h(T_s - T_g)$$

$$T_{g \text{ out}} = 2T_g - T_{g \text{ in}}$$

$$m_s c_s \frac{dT_s}{dt} = h(T_g - T_s) - q \cdot M$$

and a further equation relating *M* to throttle opening.

A circuit to simulate the first set of equations is given by Wilson and Lawrence in a companion paper¹. The second and third sets are similar to each other and a circuit for the second set is shown in Fig. 2. This is designed so that the coefficients which are dependant upon coolant flow speed can all be simultaneously modified in a manner representing a pump failure.

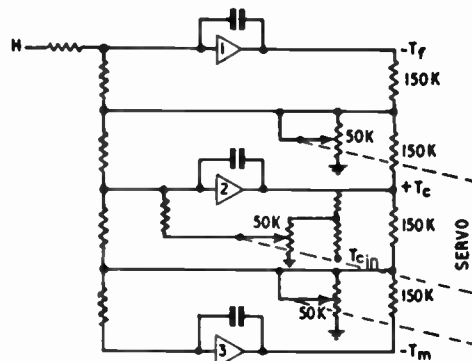

Fig. 2. Circuit for simulating the equations for heat transfer in a reactor.

These equations are based on the assumption that it is adequate to work with mean values over the reactor core. In many cases this is not justified and it becomes necessary to solve partial differential equations. It is possible to combine the network technique developed by Liebmann,² with the unit amplifier methods in order to solve some of the cases of practical importance.

For example, if there is an appreciable amount of material cladding the fuel element, it has a significant effect during rapid transients. This problem can be studied as follows, where for simplicity a flat plate type of fuel element is considered, as shown in Fig. 3.

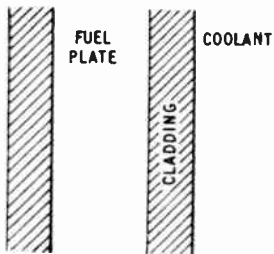

Fig. 3. Illustrating the cladding of a fuel plate. (Diagrammatic.)

The heat conduction equation to be simulated is:

$$\frac{\partial^2 q}{\partial x^2} + \frac{Q}{K_1} = k_1 \frac{\partial q}{\partial t} \text{ in the fuel}$$

$$\frac{\partial^2 q}{\partial x^2} = k_2 \frac{\partial q}{\partial t} \text{ in the cladding}$$

The finite difference form of these equations is:

$$\frac{q_{n-1} + q_{n+1} - 2q_n}{S_1^2} + \frac{Q_n}{K_1} = k_1 \left(\frac{dq}{dt} \right)_n$$

$$\frac{q_{m-1} + q_{m+1} - 2q_m}{S_2^2} = k_2 \left(\frac{dq}{dt} \right)_n$$

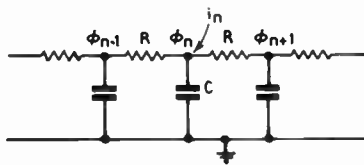

Fig. 4. Network simulating the temperatures of a fuel plate with cladding.

If we consider the network shown in Fig. 4, the sum of currents at the n th point gives

$$\frac{q_{n-1} - q_n}{R} + \frac{q_{n+1} - q_n}{R} + i_n = C \left(\frac{dq}{dt} \right)_n$$

so that the potentials on the network are analogous to the temperatures in the fuel plate if

$$\frac{R}{S_1^2} = \frac{Q_n}{K_1 i_n} = \frac{k_1}{c}$$

and to the temperatures in the cladding if

$$\frac{R}{S_2^2} = \frac{k_2}{c}; i_n = 0.$$

The conditions at the boundaries require special attention on the lines suggested in Ref. 2.

Another important feature in the simulation of a system is the representation of the transport delay of the coolant, since this affects the overall stability. Time delays of between one and several hundred seconds may be encountered in practice and ways of simulating these transport lags are discussed later (Sect. 4).

The reactor power level rarely varies over a range of greater than 10 to 1 during normal operation on load. During start up and certain other transients the reactor power level may however change by 10^4 or more. The computation of reactor power over this range presents a novel problem which is discussed in the next section. It is possible, however, to rearrange the equations given in section 3.1 in terms of $\log n$ and r_i/n so that an analogue voltage proportional to $\log n$ can be generated in suitable networks. This approach facilitates the wide range computation of flux " n " but introduces other inconveniences which may or may not be considered acceptable for specific applications. A knowledge of the rate of change of $\log n$ is often desirable in reactor control system study, although the generation of $\log n$ from a voltage proportional to n over a wide dynamic range is not easy. The subsequent conversion from $\log n$ to n is rather easier than the reverse. A normal n signal is of course necessary when the additional heat transfer mechanisms are being considered.

4. The Nature of Equipment Required

An analogue computer for reactor plant studies would not differ significantly from any general purpose analogue computer which might be suitable for the study of process control. Of all the reactor transient analyses, the field of safety studies calls for the most complicated computer. This is brought about by the need to consider wide excursions in plant variables with the resulting requirement for function generators and multipliers. In other fields, for example in servo control study, smaller excursions are generally considered and simplifications are possible in setting up a model of the system.

The wide dynamic range encountered in neutron flux computation is handled in two ways. First, the circuits involved in these processes are arranged so that computation can be started and stopped at any time. (Often referred to as "clamping.") Means are provided for reading out the values of all relevant quantities at the instant of stopping the computation and for inserting initial conditions of these quantities which are separately adjustable. Computation of a transient covering a wide dynamic range can thus be stopped when analogue voltages become too large or too small and the scaling factors changed by a suitable amount. Computation can then proceed until a further halt is necessary or until the transient effects have ceased to be of further interest.

In order to reduce the necessity for changing scale factors in this way the second desirable feature is for the flux computing circuits to have as wide a dynamic operational range as possible. Techniques described in a comparison paper permit a dynamic range of 10^5 to 1 (100 db) to be used whilst retaining the facility for "clamping" the flux computing circuits¹.

In a reactor start-up transient it is usually the last part of the excursion which is of interest. Nevertheless the computation of all the transient must be carried out in order to derive the correct approach to its final stages. Quite often it is desirable to consider changes in plant parameters only whilst keeping the nuclear reactor start-up conditions the same. In these circumstances one can avoid repeating the wide range flux transient computation and

can start the transient at some convenient point where temperature effects are still insignificant. The provision of suitable clamping and initial condition resetting circuits enables this to be carried out easily.

Although it is rarely necessary to record or measure the value of neutron flux during the initial stages of a reactor start-up transient for the reasons just given, it is nevertheless convenient to derive the log of neutron flux. A wide range logarithmic voltmeter which is discussed elsewhere^{1,3} has been developed. This enables $\log n$ and rate of change of $\log n$ to be computed with sufficient accuracy over an analogue voltage range from 10^{-3} to 10^2 volts (another way of generating a $\log n$ signal has been discussed at the end of the previous section.)

In order to permit circuit "clamping" to be satisfactorily achieved the effective input current of d.c. amplifier should be kept below 10^{-11} amps. This is not difficult to achieve with currently available circuit techniques and components.

Transport lags in coolant circuits can be simulated in several ways. A technique which has been used successfully is the capacitor storage system. This is shown in Fig. 5 and makes use of a large number of high grade capacitors mounted on a rotating drum.

Input signals charge successive capacitors to an appropriate voltage which would be scaled to a coolant temperature. The capacitor then leaves the charging point and proceeds to the measuring point where the impressed voltage appears at the output of the measuring

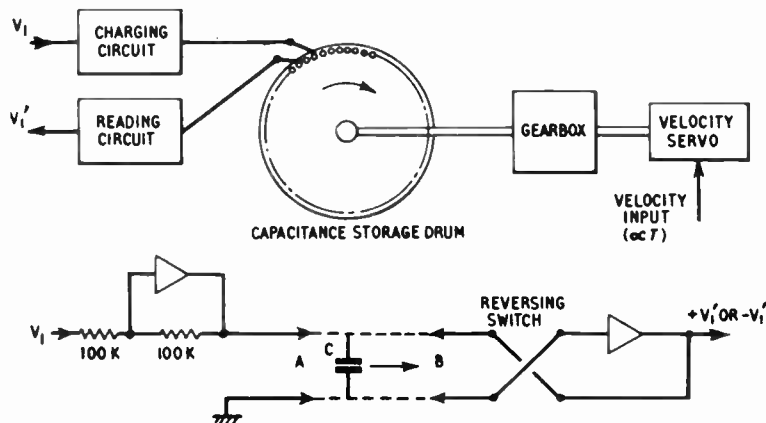

Fig. 5. Capacitance storage drum and its delay line analogue. Used to simulate transport lags in coolant circuits.

amplifier. The capacitors then move on to be impressed with a new voltage. The time delay is almost the time for one revolution of the drum. This can be varied by means of a velocity servo drive and auxiliary gear ratios from one to several hundred seconds. The output signal will change in a series of steps if the input is changing. With 100 capacitors on the drum the granularity of the output is satisfactorily smoothed by the inertia of the system. This method of transport lag simulation has the desirable property that the time delay can be varied easily by altering the speed of the drum. This is essential when the effects of coolant flow changes are being considered since delay time is a function of coolant flow.

Conventional multigang servo multipliers have been found to be satisfactory for the majority of the system when a "real" time scale is used. In the case of the "reactivity" multiplier (equations in section 3.1) in the reactor flux computation, an electronic multiplier does not permit a wide dynamic range to be used since its zero errors are not as low as those of the remainder of the flux computing circuits. On the other hand a servo multiplier, though suitable for wide range operation if the flux signal is applied across the potentiometer winding, is sometimes found to give poor results due to its limited resolution. It should be borne in mind that in reactor flux computation very small changes in reactivity can significantly affect the value of neutron flux. A resolution of better than 10^{-4} is sometimes desirable. A fast electronic multiplier has been developed which is capable of very low phase shift up to 100 c/s and which has zero errors of the order of 0.02 per cent.⁴

A computer for reactor studies should include several function generators since plant and reactor parameters will frequently vary with power level or temperature. Other non-linear effects can occur and may need to be simulated with reasonable accuracy if conditions during an excursion are to be represented with sufficient accuracy. For example, thermal

radiation can be simulated by use of a suitable "Metrosil."

Operational d.c. amplifiers can be of conventional design provided that their input current is sufficiently small to permit "clamping" to be carried out where necessary. Time constants of up to 10^3 seconds are sometimes encountered and a low input current permits this to be achieved, without using unusually large values of capacitor. Zero drift correction is essential in the neutron flux computing amplifiers of a computer and is most desirable in the remaining amplifiers in the interests of accuracy.

5. Conclusions

Analogue computers have proved to be eminently suitable for reactor kinetic studies of various types. In particular they have been found capable of handling the more elaborate wide range excursions encountered in safety studies. Such is the current state of the electronic art that many problems appear to lie in the overall engineering of a computer rather than in the design of individual units.

The difficulty of satisfactorily constructing a kinetic analogue of a distributed system is a serious problem. The development of suitable techniques is progressing but further effort in this field is necessary if some of the present complications of analogues are to be overcome.

6. References

1. I. Wilson and L. J. Lawrence, "A nuclear power plant training simulator for use at Calder Hall," *J.Brit.I.R.E.*, **18**, pp. 85-93, February 1958.
2. C. Liebmann, *Journées Internationales du Calcul Analogique, Actes*, p. 346, Brussels, September 1955.
3. I. Wilson and R. J. Cox, "Improvements in and relating to voltmeters." British Patent Application No. 27468.
4. S. Sternberg, "An accurate electronic multiplier," *R.C.A. Review*, **16**, No. 4, pp. 618-634, December 1955.

A CORRELATION BETWEEN THE TRANSIENT AND FREQUENCY RESPONSES IN SERVOMECHANISMS*

by

Z. J. Jelonek, Dipl.Ing.† and G. I. Boomer, A.R.T.C.‡

SUMMARY

The need is stressed for simple correlation between the time and frequency responses in servomechanisms in order to rationalize synthesis procedures. Some existing methods of correlating features of the unit step response with frequency response parameters are examined and their shortcomings noted. Statistical evidence, obtained from the responses of a large number of servo systems of various types, is employed to set up empirical relations between selected parameters of the time and frequency responses, i.e. delay time, rise time, overshoot, settling time, and period of oscillation on the one hand, and 6 db bandwidth, peak magnification, etc., on the other. A new theoretical relation for the delay time is also obtained. These relations make it possible to sketch the step response with reasonable accuracy, when the open-loop frequency response is given. In some cases, in which the closed-loop amplitude response departs considerably from the more typical form, the step response is shown to consist of two sub-transients, each of which can be determined separately.

1. Introduction

Despite the fact that great importance attaches to the dynamic behaviour of feedback control systems, it was found more expedient to carry out system synthesis in terms of the known steady state sinusoidal transmission properties of the elements. Using either "vector multiplication" or logarithmic gain-frequency response techniques, synthesis can proceed logically towards a system having a stable loop transmission characteristic, from which the closed loop frequency characteristic may be obtained.

Servomechanism performance specifications, however, go well beyond the obvious requirement that the system should be stable, in so far as they place limits on the error-versus-time curve, as the system responds to some standard input disturbance, for example a unit step function.

In attempting to realize a particular form of response in the time domain, the designer is faced with formidable difficulties, since the

determination of transient behaviour of feedback systems by analytical methods involves processes which are lengthy and tedious in all but the simplest cases; also, in arriving at the result, no straightforward cause and effect pattern, such as is apparent in sinusoidal analyses, is in evidence. That is to say, it is difficult to assess the contributions of the various parts of the system to the transient and, should the response be unsatisfactory, it is not immediately clear what steps should be taken to modify it.

The above difficulties prompted the designer to adopt the root-locus method in which, from the knowledge of the roots, directly associated with the elements of the system, information is obtained about the frequency and time responses by a more or less laborious procedure.

The general purpose of the present work is to provide simple and yet sufficiently detailed and accurate relations between the frequency and time responses to make the design in the frequency domain attractive and economical, even if the specification relates to the time domain.

The Fourier Integral provides a link between the time and frequency domains, thus enabling the response of a linear system to any aperiodic

* Manuscript received 29th June 1957. (Paper No. 440.)

† Department of Electrical Engineering, The Royal College of Science and Technology, Glasgow.

‡ Harland Drives, Ltd., formerly at the Royal College of Science and Technology, Glasgow.
U.D.C. No. 621-52

time function to be determined from a knowledge of the overall frequency characteristic of the system and the frequency spectrum of the input function.

Having regard to the amenability of sinusoidal methods, and recognizing that a particular form of frequency response uniquely determines transient behaviour, it would appear most desirable to interpret time domain specifications as limitations on the shape of the frequency characteristic. A frequency response of prescribed shape would then be the object of synthesis. Although the Fourier Integral, as a tool of synthesis, is unattractive, its existence provides a basis for seeking more specific correlations, an example of which is discussed in the following section.

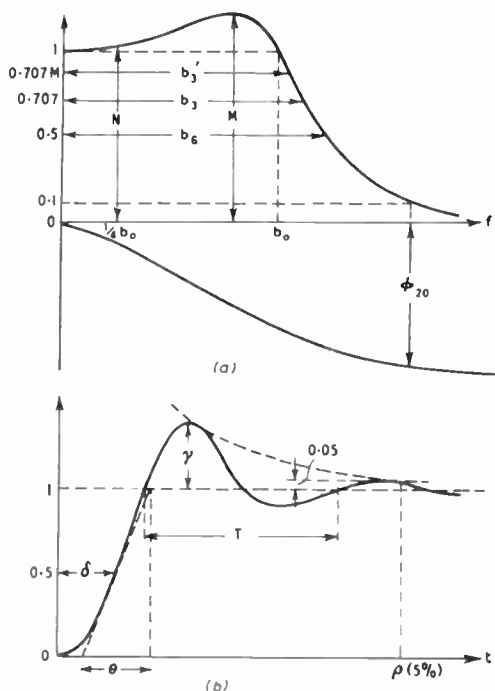

Fig. 1. Designation of parameters of
 (a) frequency response.
 (b) transient response.

When a step response of a system is specified, the specification may not refer to the complete waveform but to some of its features, or parameters, only, e.g. overshoot γ , rise time θ , delay time δ , settling time $\rho(5\%)$, as indicated in Fig. 1(b). Simple relations between one of

the parameters and those of the frequency response (Fig. 1(a)) could be found for a particular system. For example, it can be shown that, in the case of a simple second-order servomechanism, the following relation holds for $M > 1$:—

$$\gamma = \exp \pi [\sqrt{(M^2 - 1)} - M] \dots\dots\dots(1)$$

It expresses the maximum fractional overshoot γ of the step response in terms of the peak magnification M of the frequency response. When applied to the responses of more complex systems, the formula gives moderate accuracy in many cases, but with others large errors are incurred, indicating that factors other than peak magnification have an important influence on overshoot.

Another relation, given by Cunningham¹, between the overshoot and some other parameter of the frequency response also proves unsatisfactory when applied to some systems. This shows that one parameter of the frequency response cannot give a reliable and general indication of the value of the overshoot.

Even simpler design criteria are commonly used, e.g. the 30 deg. phase margin of the open loop response and the 1.4 limit of M in the closed loop response, which are supposed to ensure satisfactory transient behaviour. Those criteria may be taken as a statistical result of numerous trials. Even less accuracy and generality can be expected in applying them than in the case of previously discussed relations.

Evidently, two independent parameters of the frequency response can provide more information than one. It is not simple to derive a relation between the overshoot and two parameters of the frequency response and, even if such relation were found for a particular system, its accuracy would have to be checked, when applied to a great number of different systems.

As an alternative procedure, one may try to guess the analytical form of such a relation and elicit numerical factors statistically from a large collection of data. In this way Jaworski² and Demczynski³ have found reasonably accurate relationships between the overshoot and settling time on the one hand and two parameters of the amplitude–frequency response on the other,

in the field of communication networks.

The specific purpose of the present work is to find in the above way a sufficient number of simple relationships, and to devise a method of sketching with a reasonable accuracy the whole step function response of a servomechanism, when the open-loop frequency response is known.

By its nature, a statistical line of approach requires a considerable amount of correlation data. This has been obtained through the use of an electronic servo simulator which was constructed to facilitate the investigation. It should be noted that a statistical result will depend on the choice of samples. In this work approximately equal weight was given to each of the eight systems examined.

The investigation is limited mainly to systems with amplitude-frequency responses possessing one maximum. The resemblance of this type of response to that of the simple second-order servomechanism does not by any means limit the application of the results to simple systems. Indeed, they should be applicable to systems possessing a great number of nearly equally significant roots, yet having a frequency response of this type.

In addition to the above type of frequency response, whose parameters were found to be very simply related to those of the corresponding time response, the investigation extends to systems with two maxima in the amplitude-frequency response, one being at zero frequency. In the latter case the relationships obtained are somewhat more complicated.

2. A Review of Correlating Techniques

In order to provide a background against which the findings of this investigation may be set, it is proposed here to acknowledge and examine some existing ways of correlating transient and sinusoidal behaviour. Approximate methods of evaluating the Fourier Integral^{4,5} and Laplace Transform of the time response⁶ are excluded from this discussion.

2.1. General Relationships

Elmore⁷ and Moss⁸ have developed relationships, some of which will be briefly discussed. The exact relation between the co-ordinate of

the centroid t_c of the impulse response and the slope of the phase response at zero frequency can be interpreted as an approximate relation for the delay time of the step response:

$$\delta \cong t_c = - \left. \frac{d\varphi}{d\omega} \right|_{\omega=0} \quad * \dots\dots(2)$$

Similarly, the exact relation between the second moment of the impulse response in respect to t_c and the second derivative of the amplitude $A(\omega)$ at zero frequency can lead to an approximate formula for the rise time of the step response:

$$\theta \cong \sqrt{\left(-2\pi \cdot \left. \frac{d^2a}{d\omega^2} \right|_{\omega=0} \right)} \quad * \dots\dots(3)$$

where $a = \ln A/A_0$, and $A = A_0$ at $\omega = 0$.

A reasonable degree of accuracy can be expected from the above formulae only in the case of monotonic step responses. They are not at all reliable, when applied to responses with an overshoot, which are most prevalent in servomechanisms. This is because in those cases the impulse response has negative parts, which shift the position of the centroid towards zero time, at which the impulse is applied, and in some cases beyond zero, to negative values of time. Thus, the value of δ obtained from (2) may differ considerably from the actual value of the delay time as given by the position of the half-amplitude point of the step response.

To illustrate the failure of these formulae when applied to the responses of servos, an elementary servo, having the characteristic equation

$$Jp^2 + Dp + G = 0$$

will be considered. It can be shown that a zero frequency phase derivative is given by

$$\left. \frac{d\varphi}{d\omega} \right|_{\omega=0} = -D/G$$

where D is the damping force coefficient and G the loop gain constant. Thus, the delay of the step function response, according to (2), should be independent of J , the inertia loading

* This relation holds also in the case of band-pass systems with a frequency response symmetrical with respect to the centre frequency, driven by a carrier step at that frequency. The response refers then to the carrier amplitude and the derivative is taken at the centre frequency.

of the servo. Purely physical reasoning shows this result to be absurd.

2.2. *Overshoot and Poles and Zeroes of the Transfer Function*

Mulligan⁹ derived a relation between the overshoot of the step response of a system and the co-ordinates in the *p*-plane of poles and zeroes of its transfer function. In it, he neglected oscillatory modes with the exception of the dominant one, the amplitude of which, however, was affected by the presence of the other modes. The relation appears to be tractable only in the case of simple systems. Moreover, it could be applied only when the transfer function of the system is known in an analytical form.

2.3. *West and Potts' Method*¹⁰

It may be of considerable importance to know how long transient oscillations persist in a step response. West and Potts describe a method which extends the phase margin concept of the open loop frequency response in order to extract quantitative information regarding the oscillations of the closed loop transient response. Approximate formulae are given for the frequency and attenuation constant of the principal oscillatory mode.

In all but the simplest cases, which do not merit attention, the step function response contains more than one transient mode. Often a single oscillatory mode predominates over several simple exponential modes. The method described does not provide any information as to the initial amplitude of the principal mode relative to the input step and it neglects other modes.

Having emphasized the shortcomings of the method, it is fair to acknowledge the authors' statement that a wide tolerance could be allowed on estimated values and they would still be a useful guide to the designer. It is also as well to remember that the order of accuracy to be expected from a practical frequency response measurement is such as not to reward over-fastidious methods of extending the results.

2.4. *Statistical Methods*

The correlation technique used by Jaworski² and Demczynski³ constitutes a departure from

the others in so far as the relations set up between the time and frequency domains have no analytical justification, but draw their support from statistical evidence. This approach enjoys the advantage of allowing complete freedom of choice in the selection of correlating parameters and, since shape is a primary consideration, these may be as numerous as is required to permit an adequate description of the features of both time and frequency responses. Parameters are chosen similar to those shown in Fig. 1, which describe the most salient features of both responses.

A large amount of correlation data was collected from a representative group of communications networks, and the required relations were extracted by plotting graphs of various combinations of time and frequency parameters, recognizing tendencies in the distribution of the plots, and setting up empirical formulae to account for these tendencies by a process which minimizes the mean square error of the distribution.

The empirical relations obtained, with their estimated accuracies, are:

rise time $\theta = 1/2b_6$; average error of 4% ... (4)

percentage overshoot $\gamma\% = 58F - 39$;

average relative error of 14% (5)

settling time (measured from the half-amplitude time) $\rho_1(1\%) = (7F - 3)/2b_6$;

r.m.s. relative error of 19% (6)

where $F = Mb_3/b_6$.

It appears that this method, although deficient of analytical support, yields more accurate and general relations than the other methods discussed.

3. *Servomechanisms and their Responses*

A transient response of a linear network is a function of both the amplitude- and phase-frequency responses. In minimum-phase-shift networks, however, the two latter responses are strictly interrelated and so, one of them, say, the amplitude response, contains all the information required to determine the transient response. Therefore, the following investigation,¹¹ which makes use almost exclusively of the amplitude response, is confined to systems

having the minimum-phase-shift property. For example, servomechanisms containing a time delay in the loop do not fall into this category and are excluded from the investigation.

3.1. Selection of Samples

In any statistical survey care must be taken to avoid placing undue weight on a particular

section of the samples if the result is to be a representative one. In this investigation the sample correlation data have been extracted from responses obtained from a variety of servo systems, these being classified according to the order of their characteristic equation, and also according to whether or not they are zero velocity-error systems. Type 1 servos have zero position-error and type 2 servos have, in addition, zero velocity-error. A particular system may, therefore, be specified as follows:

“Third order type 2” or “Fifth order type 1.” Almost equal weight is here given to them by employing an approximately equal number of responses from each system.

The electronic simulator on which the systems to be examined were set up¹² followed the pattern of that described by Williams and Ritson¹³ in so far as it provided for such mathematical operations as integration and summation and made use of isolated passive networks for simple lag terms, i.e. $1/(1+pT)$. The circuitry of the operational amplifier was, however, different and the transient solution was repetitively displayed on an oscilloscope.

In order to obtain terms of the form $(1+pT)/p$, the signal was fed in parallel to an integrator and to a reversing amplifier, and the two outputs added. Thus

$$-T - 1/p = -(1+pT)/p$$

Figure 2 summarizes the types of system examined. Seven or eight pairs of responses were obtained from each set-up by using a phase-sensitive voltmeter to measure the frequency response and by photographing the transient response.

The responses from a particular set-up were varied by changing the loop gain and/or by altering lag time constants.

It is clear that in higher order servos the choice of settings is very

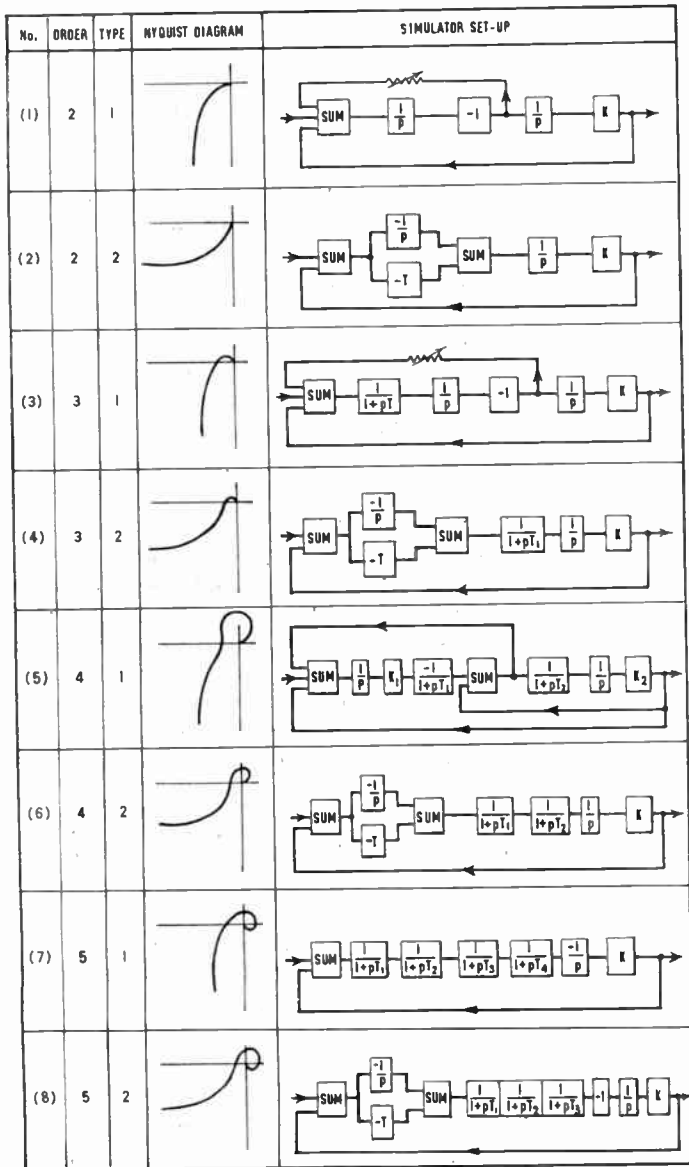

Fig. 2. Types of systems examined and the simulator set-up.

wide. When several simple lags were involved, it was made a rule to ensure that each had a significant effect on the transient in order to extract what were thought to be the most useful responses. That is to say, instead of having one large time-constant and the rest very small, their magnitudes were all of the same order. In this way the roots of the open-loop response were spread at random in a limited range of the complex plane.

their ratio the phase angle was extracted; this latter information was required in order to determine the delay δ of the step response.

An accuracy of between 5 and 10 per cent. might be claimed for the parameters of the transient response obtained from oscillograms, and of less than 5 per cent. for the parameters of the frequency responses. These inaccuracies can, to some extent, be overlooked on the grounds that the derived results are statistical ones.

3.2. *The Significance of Shape*

It will be useful here to consider the response of a servomechanism to a succession of positive- and negative-going unit step functions, whose repetition rate is such that the transients they generate have time to die out. The periodic input function then has a discrete frequency spectrum with amplitudes which are real, finite and inversely proportional to frequency. This imposes less effort on the imagination than the spectrum of unit step function which, according to the Fourier Integral, is given by $g(\omega) = 1/j\omega$.

Experience has shown that there are several distinctive types of transient response which have, in correspondence, a recognizable form of frequency characteristic. This makes possible a broad appraisal of transient behaviour when only the frequency characteristic is known. To illustrate this, the corresponding forms shown in Fig. 1(a) and (b), associated with a system having a dominant oscillatory mode, are taken as a basis and the significance considered of the various departures in shape indicated in Fig. 3(a).

It is found that, as a result of departures (1) and (2), overshoot is increased and the transient in general becomes more oscillatory. In order to appreciate why this should be so, one may ponder the effect of omitting higher harmonics or of stressing a particular harmonic in the Fourier series for a square wave, and conclude from this loose analogy that rapid attenuation of upper frequencies or magnification in a narrow band of frequencies both should have a de-smoothing effect on the transient.

Attenuation of d.c. and very low frequency components of the spectrum, exemplified by departure (3), should slowly reduce the

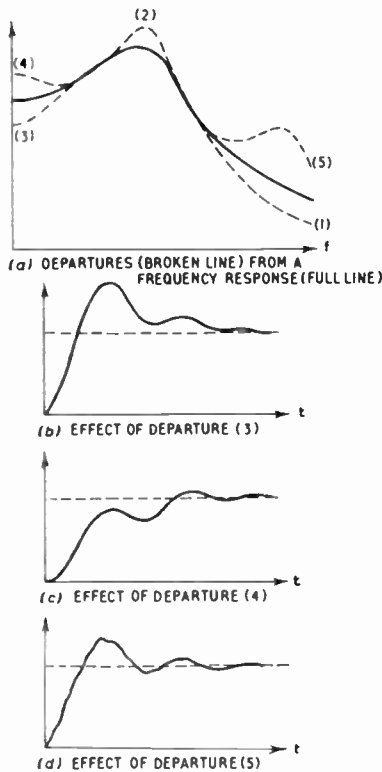

Fig. 3. Effect of departures from a frequency response.

- (a) Departures (broken line) from a frequency response (full line).
- (b) Effect of departure (3).
- (c) Effect of departure (4).
- (d) Effect of departure (5).

Graphs of frequency responses were obtained by plotting the readings from the phase-sensitive voltmeter. The amplitude characteristic was then obtained by vector addition of in-phase and quadrature components. From

steady-state level, as indicated in Fig. 3(b). Conversely, magnification of those components (departure 4) should raise the level, as in Fig. 3(c). The transient response (Fig. 3(d)), associated with a frequency characteristic exhibiting a secondary resonance peak (departure 5) is seen to contain two oscillatory modes.

The examples, which have been considered, represent types of response which may occur in servo systems. This, of course, is not to suggest that these responses are in any way desirable. Indeed, the reverse is the case. The examples have been chosen deliberately to emphasize the interdependence of the time and frequency domains, and to indicate the manner in which some of the chosen shape parameters vary in relation to one another.

In the next sections these qualitative notions will be extended to obtain correlation formulae which apply to responses not showing departures (3), (4) and (5), and which will be subsequently termed "normal." Methods of dealing with responses showing departures (3) and (4) are considered later.

4. Results of Statistical Investigations

4.1. Rise Time

The step function response of an ideal low pass filter, that is, one having a rectangular amplitude characteristic and a linear phase function, has a maximum slope, at the half amplitude, which is twice the "cut off" frequency. This fact suggests at once a definition for rise time and a correlation between the responses of physically realizable systems. Thus, one definition of rise time gives it as the reciprocal of the slope at the half amplitude, and there have been several proposals as to its relationship to other bandwidth (see, for example, references 1, 14 and 15). Jaworski's investigation² showed that more consistent results appeared to be obtained by relating rise time θ to b_6 than to b_3 .

In Fig. 4, θb_6 is plotted against the overshoot $\gamma\%$ for the purpose of spacing the results, for the eight systems examined, the numbers corresponding to those in Fig. 2. A reasonably good consistency of results is seen, although a slight tendency for θb_6 to drop with increasing overshoot can be noticed.

By averaging the products θb_6 , a formula for θ is obtained

$$\theta = 0.45 / b_6 \text{ sec} \dots\dots\dots(7)$$

where b_6 is expressed in c/s. The average error in this selection of samples is 9 per cent.

4.2. Overshoot

Overshoot γ is usually defined as a fraction of the final value of the transient. It has already been indicated that the peak magnification M and the cut-off slope of the frequency characteristic are significantly connected with it. In reference 2, these parameters were combined to give the "form parameter,"

$$F = M b_3 / b_6 \dots\dots\dots(8)$$

the ratio b_3 / b_6 representing the slope of the characteristic. The linear relation (5) between γ and F has been tested for a variety of servo systems and found to give quite good results.

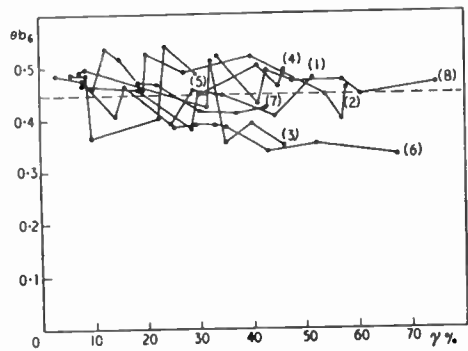

Fig. 4. Distribution of the product θb_6 .

However, for larger values of overshoot than those considered by Jaworski, a divergence became apparent, and it was subsequently found¹⁵ that, by using the logarithm of F , linearity was better maintained. A plot of $\gamma\%$ against $\ln F$ is shown in Fig. 5.

The formula derived from this distribution, by minimum mean squared error methods, is

$$\gamma\% = 42 \ln F + 18 \dots\dots\dots(8a)$$

which is represented in Fig. 5 by the dotted line. It indicates that zero overshoot should be obtained when $\ln F$ has a value below -0.43 ($F < 0.65$). This is corroborated by analysis of a simple servo (No. 1), which shows that no overshoot appears when $\ln F < -0.44$.

4.3. Settling Time

Settling time ρ is defined as the time taken for the envelope of transient oscillation to settle to a prescribed percentage of the final value of

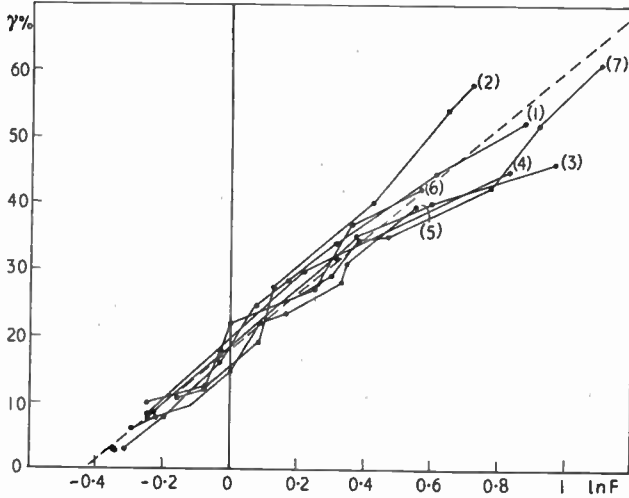

Fig. 5. Correlation between the overshoot and the parameter F .

the transient. Equation (6), obtained by Demczynski³, shows that the same form parameter F and b_6 are well correlated with the settling time $\rho_1(1\%)$. Even better correlation has been found in this investigation (Fig. 6) between F and b_6 on the one hand and $\rho(5\%)$ on the other. Responses, which exhibit an overshoot but no subsequent oscillation have not been included in this plot, which otherwise would not show such close dispersion about a straight line.* The formula obtained

* This remarkably small dispersion at greater values of F could be explained in the following way. Very high values of F , M and γ occur when feedback is close to the critical value for instability. In this case, one pair of simple roots in the closed-loop transfer function becomes dominating and the system characteristics approach those of the simple second-order system. It is not so in some multi-stage communication networks, which may have only one pair of multiple roots, giving high values of F , M and γ . In the latter case the shape of the amplitude-frequency response in the vicinity of its peak may differ from that in the second-order system, resulting in a different attenuation of the transient oscillation. This, presumably, is why the values of ρ_1 , given in reference 3, have much greater dispersion.

from this distribution is:

$$\rho(5\%) = (2.16F - 0.4) / b_6 \text{ sec} \dots\dots\dots(9)$$

The choice of 5% was directed partly by the method of obtaining results, which did not permit smaller amplitudes to be measured with good accuracy, and partly in recognition of the fact that in many servomechanisms non-linear friction and backlash do not permit the transient to settle much closer to the theoretical level.

4.4. Delay Time

The delay of the transient response δ is defined here as the time taken for the transient to reach the level of half final value. This specification is one of considerable importance in control systems, since it indicates how soon significant action appears after an input disturbance.

Apart from the analytical relation (2), which was shown to have very limited application, the

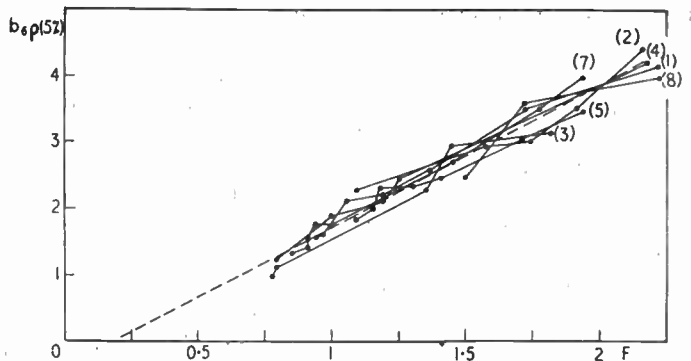

Fig. 6. Correlation between the settling time ρ and the form parameter F .

existence of any other formula for delay time was unknown to the authors. It was therefore felt that the empirical formula presented here would be quite useful in the prediction of time delay in linear systems. In order to justify the formula, some analysis will be carried out.

An assumption is first made that the initial part of the transient can be approximated by a law of the form:

$$X = At^n \dots\dots\dots(10)$$

Referring to Fig. 7, the slope of the tangent at $t=t_1$ is

$$\begin{aligned} \dot{X} &= Ant_1^{n-1} \\ \text{therefore } a &= bAnt_1^{n-1} = At_1^n \\ \text{thus } t_1 &= nb \end{aligned}$$

If t_1 is measured at the half amplitude of the transient, then:

$$\delta = \frac{1}{2}n\theta \quad \dots\dots\dots(11)$$

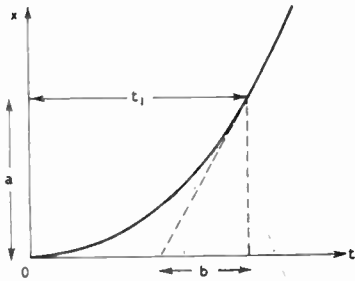

Fig. 7. The initial part of the step response.

It is already known that θ can be expressed in terms of b_6 . Therefore, the manner in which n can be determined from the frequency response remains to be found.

Use will be made of expansions of the time function $x(t)$ and its Laplace transform $\bar{x}(p)$, proved in reference 17:

$$\begin{aligned} \bar{x}(p) &= \frac{a_r}{p^r} + \frac{a_{r+1}}{p^{r+1}} + \dots \quad (r \gg 1) \\ x(t) &= \frac{a_r}{(r-1)!} t^{r-1} + \frac{a_{r+1}}{r!} t^r + \dots \end{aligned}$$

When p is very large, $\bar{x}(p) \cong a_r/p^r$, and when t is very small, $x(t) \cong a_r t^{r-1}/(r-1)!$

If $x(t)$ is the response of a system to a unit step, then $\bar{x}(p)$ is the system transfer function $K(p)$ divided by p . Hence, in the above circumstances, putting $r=n+1$,

$$K(p) = p\bar{x}(p) \cong \frac{a_{n+1}}{p^n}; \quad x(t) \cong \frac{a_{n+1}}{n!} t^n$$

A factor p in a transfer function advances the phase response by $\frac{1}{2}\pi$. Therefore, the phase response of the above system at $\omega = \infty$ is $-\frac{1}{2}n\pi$, and so, the exponent n in (10) and (11) can be found from the frequency response as

$$n = \varphi_\infty / \frac{1}{2}\pi$$

where φ_∞ is the absolute value of the phase shift of the system at $\omega = \infty$. Hence, from (11) and (7),

$$\begin{aligned} \delta &= \theta\varphi_\infty / \pi \quad \dots\dots\dots(12) \\ &= 0.144\varphi_\infty / b_6 \quad \dots\dots\dots(12a) \end{aligned}$$

A transfer function may contain terms which have an insignificant effect on the transient response, like those introduced by an exponential delay with a very small time-constant, which nevertheless produce a large phase shift at very high frequencies. It is a common practice to ignore such terms. This suggests that the phase shift in (12a) should not be taken at an infinite frequency, but at some other, in the range where the amplitude response becomes appreciable. In other words, one may consider that very small components of the spectrum of the output waveform, found at very high frequencies, have a negligible effect on the waveform, whatever phase they have.

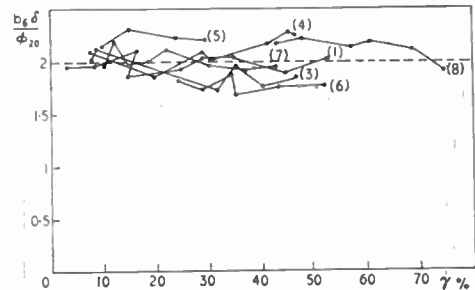

Fig. 8. Distribution of $b_6 \delta / \varphi_{20}$.

A 20 db level was taken as a limit of the effective part of the amplitude response and the phase shift φ_{20} was measured at the corresponding frequency. In Fig. 8, $\delta b_6 / \varphi_{20}$ is plotted against the spacing parameter $\gamma\%$, φ_{20} being expressed in degrees. The distribution is a surprisingly close one and shows little tendency to vary with overshoot. The formula obtained from this plot is:

$$\delta = 2\varphi_{20} / b_6 \text{ millisecc} \quad \dots\dots\dots(13)$$

giving an average error of 7%.

If φ_{20} were taken in radians and δ expressed in seconds, the coefficient in (13) would be 0.114, which differs only by 20% from that in

(12a). The agreement is closer than was expected, considering the fact that in the derivation of (13) not only was $q \infty$ replaced by $q_{f_{20}}$ and θ expressed by b_6 , but also higher terms in the power expansion of the transient were neglected. The latter, negligible at $t \cong 0$, could reach significant values before a half-final level is attained by the transient.

4.5. *Period of Oscillation*

A pronounced peak in the amplitude response suggests the presence of a strong oscillation in the transient response at a frequency close to that at which the peak occurs. This gives a simple way of finding the period of oscillation T . It cannot be applied, however, to systems in which the peak occurs at zero frequency, and yet oscillations may be present in the transient. In this case an analogy can be drawn from the "ideal" system with a rectangular amplitude response, in which the frequency of oscillations is that of the bandwidth. This suggests a correlation of T with a bandwidth at a certain level of attenuation.

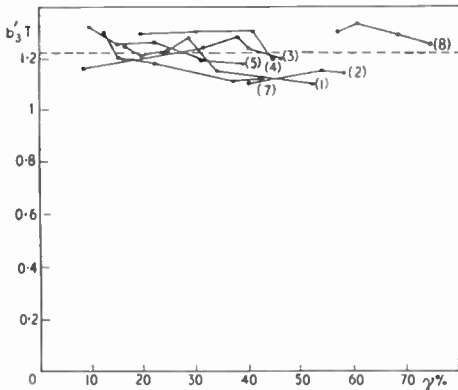

Fig. 9. Distribution of $b_3^1 T$.

In both cases, the best correlation found was with a frequency b_3^1 at a level 3 db below the peak. The product $b_3^1 T$ is plotted in Fig. 9 against a spacing parameter $\gamma\%$. Cases, in which the oscillation was not pronounced enough to enable a reasonably accurate measurement of T , are not included. From the plot a simple relation is obtained:

$$T = \frac{1.22}{b_3^1} \dots\dots\dots(14)$$

with the average error of 5%.

It should be noted that the cross-over points of the oscillation with the final level are not always evenly spaced, but the unevenness is rarely pronounced in "normal" responses.

5. *Methods of Sketching the Transient*

5.1. "Normal" Responses

The formulae which have been given make it possible to sketch in some detail the transient response of a system when the frequency response is known. Moreover, since the parameters required are available from "M"

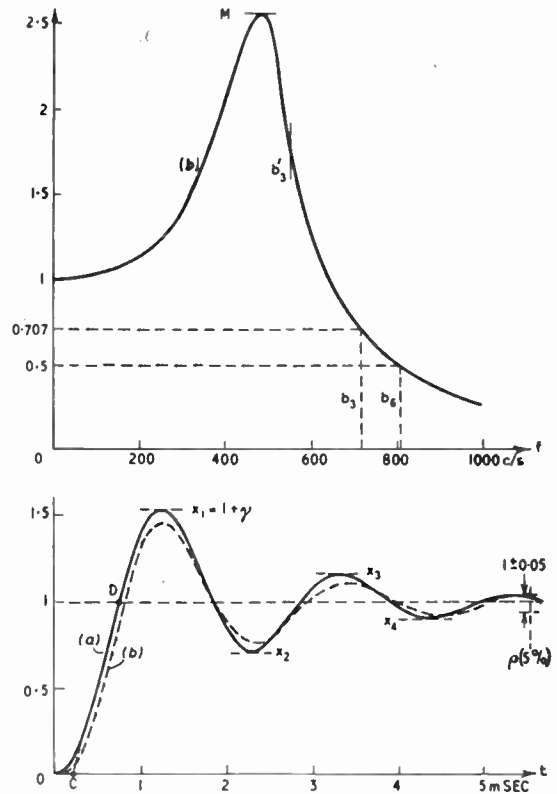

Fig. 10. Examples of transient and frequency responses of normal shape (No. 4). (a) Computed. (b) Experimental.

and "N" circles on a Nyquist diagram⁴, or from contours on a decibel-phase-angle diagram¹⁸, the information can be obtained at an early stage of design in order to indicate desirable modification of the system.

The procedure will be described and illustrated by an example of responses, shown in Fig. 10, of a system No. 4 (3rd order, type 2). In the example, parameters b_3 , b_6 , b_3^1 and M are taken from the measured amplitude response of the closed-loop system, while φ_{20} is obtained from the phase response (not shown in Fig. 10).

First, δ and θ are evaluated by using relations (13) and (7) respectively. Points C and D are then marked on the graph (Fig. 10(b)) at the moments $\delta - \frac{1}{2}\theta$ and $\delta + \frac{1}{2}\theta$, respectively, and joined by a straight line. Then, γ is found with the help of formula (8a) and a level of the first peak $x_1 = 1 + \gamma$ is marked. Cross-over points of the response are marked on the unit level at distances of $\frac{1}{2}T$, T , $\frac{3}{2}T$, etc. from point D, T being obtained from (14). The settling time $\rho(5\%)$ is found from (9) and is used to evaluate the levels of subsequent peaks and troughs of the responses, as follows:

Assume that the oscillation is attenuated exponentially,* and that the curve joining the peaks passes through a point at a level of x_1 , half way between the first two cross-over points, and through another point at a level of 1.05, at the moment ρ . It can be shown that the time constant of attenuation τ is then

$$\tau = \frac{\rho - (\delta + \frac{1}{2}\theta + \frac{1}{4}T)}{\ln 0.2\gamma\%}$$

The ratio α between the values of the subsequent peaks of oscillation, distant by $\frac{1}{2}T$ from one another, is

$$\alpha = \exp \left[- \frac{T}{2\tau} \right]$$

Hence, the levels of the consecutive peaks and troughs of the response can be evaluated and marked on the graph between the appropriate cross-over points:

$$x_1 = 1 + \gamma$$

* This assumption implies that the system is of second order. It was explained in the footnote in section 4.3 that, when γ is large, the system characteristics approach those of second order. This, no doubt, is the case in the present example. If γ is small, however, and a greater number of roots are significant, the oscillation will not attenuate exponentially and the assumption will lead to a somewhat different shape of the transient response. Nevertheless, the difference will be small, as compared with the steady-state level, since the whole transient oscillation is then small.

$$\begin{aligned} x_2 &= 1 - \alpha\gamma \\ x_3 &= 1 + \alpha^2\gamma \\ x_4 &= 1 - \alpha^3\gamma \end{aligned}$$

It is possible now to sketch the response within this framework, as has been done in Fig. 10(b) (full line). This is compared with the subsequently drawn measured response (broken line).

5.2. Responses Showing Departure from the "Normal" Shape

The method described in the previous section is liable to incur large errors, when applied to responses of the type shown in Fig. 3(b) and (c). Furthermore, much of the character of the transient would be lost.

It is possible to deal with these responses by considering the frequency characteristic as being the superposition of two characteristics, as shown in Fig. 11(a) and (b), one of them being "normally" shaped, the other corresponding to an RC low-pass network. For simplicity, it is assumed that the phase difference of the

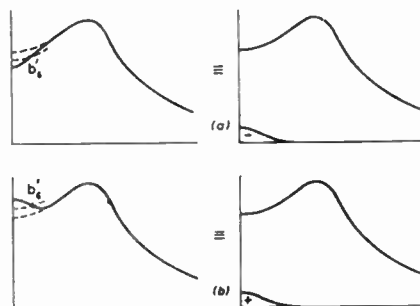

Fig. 11. Illustration of compound amplitude responses.

- (a) Subtracted responses.
- (b) Added responses.

responses is slight over the important range of frequencies, which permits them to be added algebraically. This assumption, although not well justified, is not expected to introduce unduly large errors. The empirical formulae are now applied to the "normal" response and its transient evaluated.

The additional response, assumed to correspond to an RC network, gives an exponential transient response with a time constant,

$$\tau' = \sqrt{3/2\pi} b'_e \cong 0.28/b'_e \dots\dots\dots(15)$$

where b_s' is found by tracing a parallel to the base of the response (broken line in Fig. 11) through a point at a half of its zero-frequency amplitude. The exponential response with a time constant τ' is traced, and the complete transient is then obtained as the algebraic sum of the two sub-transients.

It is difficult to recognize how the normal shapes in Fig. 11 should be traced. To aid the procedure, a family of normal shapes on log-scale, taken for a simple servo of the 2nd order, is given in Fig. 12. The actual amplitude response can now be plotted on tracing paper placed over Fig. 12. The graph can then be shifted, while maintaining the orientation of the co-ordinates, until its peak

Two examples of these compound responses are dealt with in Figs. 13 and 14. The responses in Fig. 13 were obtained from a 5th order type 2 servo system, and those in Fig. 14 from a 3rd order type 1 system having velocity feedback.

In Fig. 13 the frequency characteristic has been modified to give a normal shape; the additional shape is inverted which signifies that its transient should be subtracted from that of the former. In Fig. 14 modification to the frequency characteristic produces two positive shapes, so that their transient responses should be added.

A technique, similar to that described above, could be adopted in the case of departure 5

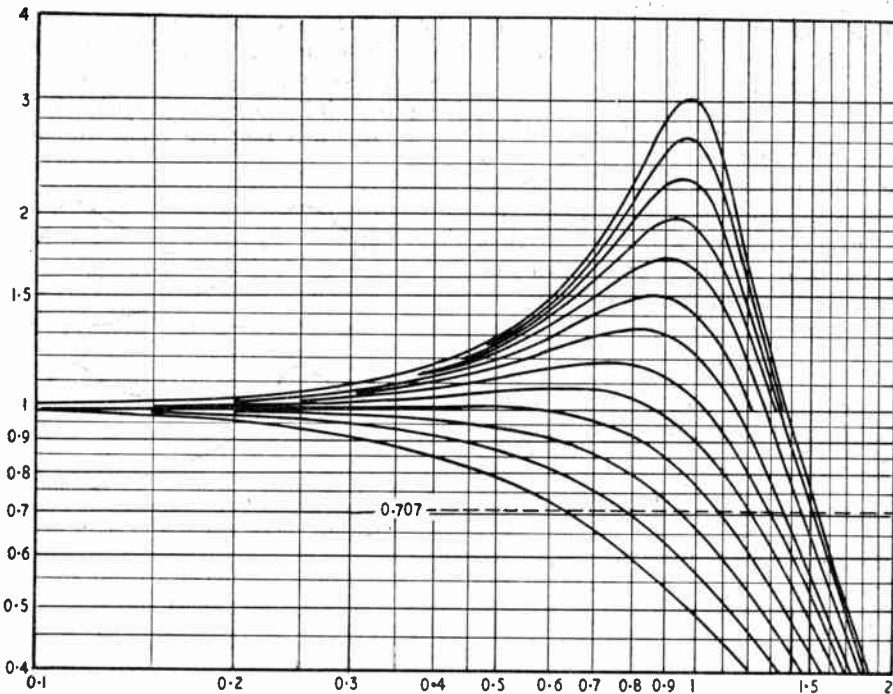

Fig. 12. Normal shape of amplitude responses.

response matches as closely as possible one of the normal shapes. In some cases interpolation between the normal shapes may be necessary. Finally, the normal shape is transferred to the tracing paper and the required parameters of both responses are found.

(see Fig. 3(a) and (d)). In this case, the additional response could be treated as that of a resonance circuit. Since the spectrum of the step input is nearly uniform within the band of the additional amplitude response, it can be assumed that the resonance circuit is driven by an impulse at the moment of application of the

step input. Hence, the initial amplitude and phase, frequency, and the attenuation constant of the additional transient response could be evaluated, the latter plotted and added to the "normal" transient response. This case was not examined in detail, however.

5.3. General Formula for Overshoot

The method of arriving at the transient response of systems with compound frequency characteristics, described in the previous subsection, although practicable, departs considerably from the simplicity of dealing with normal frequency responses. Also, the normal component of a compound (closed-loop) frequency characteristic is not readily determined from the open loop frequency response.

Whereas the rise time and delay, both confined to the initial part of the time response, are little affected by the shape of the lower part of the frequency response, the settling time,

overshoot and period of oscillation depend on that part to a great extent. Owing to the

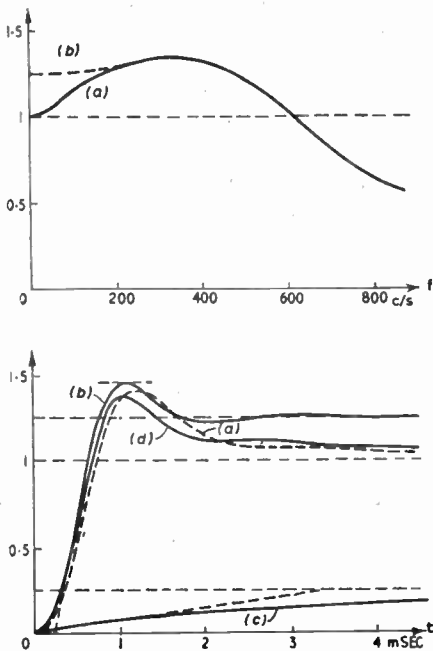

Fig. 13. Example of transient and frequency responses departing from normal shape (departure 3).
 (a) Experimental response.
 (b) Normal response.
 (c) Effect of departure.
 (d) Resultant response.

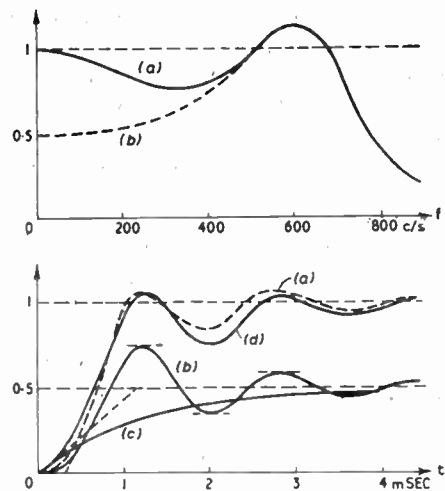

Fig. 14. Example of transient and frequency responses departing from normal shape (departure 4).
 (a) Experimental response.
 (b) Normal response.
 (c) Effect of departure.
 (d) Resultant response.

importance of the overshoot in the application and design of servomechanisms, an attempt has been made to obtain a formula for overshoot applicable in all cases.

A parameter N , defined in Fig. 1(a), is effective in lending weight to the form parameter of those responses having a broad resonance peak, and it also attenuates the form parameter of responses exhibiting a dip between resonance and zero frequency. For normal responses, N is approximately unity and in the case of an elementary servo it can never exceed 1.13.

$\gamma\%$ was plotted against $\ln NF$ for all the responses taken. The distribution obtained was rather open, but it was a considerable improvement on that obtained without the use of the correction factor N . The formula extracted from this plot, containing now three shape parameters, M , N , and b_3/b_6 , is

$$\gamma\% = 41 \ln NF + 17 \dots\dots\dots(16)$$

which is seen to be quite similar to the normal overshoot formula (8a).

6. Acknowledgment

Acknowledgment is due to Mr. J. Jardine, B.Sc., for permission to include in this work some results of his investigation, described in reference 16, in particular the use of the logarithm of the form parameter, and to Professor F. M. Bruce, for providing facilities for carrying out the research at the Royal College of Science and Technology, Glasgow.

7. References

1. W. J. Cunningham, "Simple relations for calculating certain transient responses," *Journal of Applied Physics*, **19**, p. 251, 1948.
2. Z. E. Jaworski, "Empirical transient Formulae," *Electronic Engineering*, **26**, p. 396, 1954.
3. S. Demczynski, "The correlation between decay time and amplitude response," *Proc. Instn Elect. Engrs*, Monograph No. 139, July 1955.
4. G. Brown and D. Campbell, "Principles of Servomechanisms." (Chapman and Hall, London, 1953.)
5. H. H. Rosenbrock, "An approximate method for obtaining transient response from frequency response," *Proc. Instn Elect. Engrs*, Paper No. 1907M, November 1955 (**102**, Part B, p. 744). Also "Approximate relations between transient and frequency response," *J. Brit. I.R.E.*, **18**, p. 57, January 1958.
6. H. Harris, M. J. Kirby and E. F. von Arx, "Servomechanism transient performance from decibel-log frequency plot," *Trans. Amer. Inst. Elect Engrs*, **70**, Part II, p. 1452, 1951.
7. W. C. Elmore, "The transient response of damped linear networks with particular regard to wideband amplifiers," *Journal of Applied Physics*, **19**, p. 55, 1948,
8. S. H. Moss, "Pulse distortion," *Proc. Instn Elect. Engrs*, Monograph No. 5, October 1951 (**98**, Part IV, p. 37).
9. J. H. Mulligan, "Effect of pole and zero location on transient response," *Proc. Inst. Radio Engrs*, **37**, p. 516, 1949.
10. J. C. West and J. Potts, "A simple connection between closed-loop transient response and open-loop frequency response," *Proc. Instn Elect. Engrs*, Paper No. 1378, June 1953 (**100**, Part II, p. 201).
11. G. I. Boomer, "A Statistical Correlation of the Transient and Frequency Response of Servomechanisms," Post-Graduate Diploma Thesis, The Royal Technical College, Glasgow, 1955.
12. G. I. Boomer, "An Electronic Analogue of a Linear Servomechanism," Associateship Thesis, The Royal Technical College, Glasgow, 1954.
13. F. C. Williams and F. J. V. Ritson, "Electronic servo simulators," *J. Instn Elect. Engrs*, **94**, Part IIA, p. 112, 1947.
14. D. G. Tucker, "Bandwidth and speed of build-up as performance criteria for pulse and television amplifiers," *J. Instn Elect. Engrs*, **94**, Part III, p. 218, 1947.
15. C. Cherry, "Pulses and Transients in Communication Circuits, p. 167. (Chapman and Hall, London, 1949.)
16. J. Jardine. "An Investigation of the Relation Between Frequency and Transient Responses of Servomechanisms," Post-Graduate Diploma Thesis, The Royal Technical College, Glasgow, 1954.
17. H. S. Carslaw and J. C. Jaeger, "Operational Methods in Applied Mathematics," 2nd edition, p. 271. (Oxford University Press, 1949.)
18. H. M. James, N. B. Nichols and R. S. Phillips, "Theory of Servomechanisms," p. 179. (McGraw-Hill, New York, 1947.)

APPLICANTS FOR ELECTION AND TRANSFER

As a result of its January meeting the Membership Committee recommended the following elections and transfers to the Council.

In accordance with a resolution of Council and in the absence of any objections, the election or transfer of the candidates to the class indicated will be confirmed fourteen days after the date of circulation of this list. Any objections or communications concerning these elections should be addressed to the General Secretary for submission to the Council.

Direct Election to Member

FLETCHER, Lt.-Col. Roy Carruthers, R.A. *Fleet, Hants.*
HARRIES, John Henry Owen. *Bermuda.*

Transfer Associate Member to Member

SIMPSON, Arthur Ian Forbes, M.B.E. *Bushy, Herts.*
WEST, Ralph Leighton, B.Sc. *London, N.11.*

Direct Election to Associate Member

BROWN, Cyril William, B.A.(Cantab.) *Morden.*
DUMERT, Victor. *London, N.2.*
GARGINI, Eric John. *West Drayton.*
GILLETT, William Francis Herbert. *Chile.*
MALONE, George. *Rochdale.*
MASON, Martin Thomas. *London, S.W.15.*
SAMPSON, Herbert Owen. *Sunbury-on-Thames.*

Transfer Associate to Associate Member

PERRY, Wiliam Edward. *Surrey.*
WALLER, Major Richard De Warrene, R.E.M.E. *Ascot, Berks.*

Transfer Graduate to Associate Member

ROZENSTEIN, Solomon. *Tel Aviv.*

Transfer Student to Associate Member

FOOT, George Owen. *Hertford.*
ROWLES, Arthur Leonard, B.Sc. *Danbury, Essex.*

Direct Election to Associate

AKEHURST, Lieut.-Com. John Basil, R.N. *Portsmouth.*
BIRD, Gordon Alfred. *Croydon.*
BROWNE, Graham Roy. *St. Albans.*
COOPER, Capt. Bertram Norman, R.E.M.E. *Nairobi.*
GORE, William George. *Basingstoke, Hants.*
MOORE, Wilfrid Henry. *Windermere.*

Direct Election to Graduate

ALVANIS, Elpidoforos Nicholas. *Nicosia.*
BRADFELD, Derek William, B.Sc. *Ilford.*
BULL, Harold Thomas, B.Sc.(Hons.). *Ashby-de-la-Zouch.*
COX, Maurice Edward. *Sunbury-on-Thames.*
GARNETT, Christopher Howard, B.Sc. *Wirral, Cheshire.*
HOLMES, Maurice David. *Rainham.*
MONCRIEFF, Alexander William. *Boreham Wood.*
WILTSHIRE, Cecil Arthur. *Brighton 6.*

Transfer Student to Graduate

BINKS, John Kenneth. *Coventry.*
CHOPRA, Janak Kumar. *Delhi.*
EDIRISINGHE, Don Francis. *London, W.2.*
HSU, Wei Kung. *London, S.W.11.*
MYCROFT, George Herbert, B.Sc. *Corby.*
NAQVI, Sayid Masrur Ali, B.Sc. *Karachi.*
SAWNEY, Mohan Singh. *New Delhi.*
SEKHRI, Guatam Dev. *Kanpur, India.*
WHITE, Nigel John. *Wells, Somerset.*
WOOD, Capt. Leslie Gilbert, R.E.M.E. *Larkhill.*

STUDENTSHIP REGISTRATIONS

AGGARWAL, Govind Saroop. *India.*
ATKINS, Peter Brian. *London, W.4.*
AVTAR SINGH, Sandhu, B.Sc. *Roorkee India.*
AYUB, Mohammed. *E. Pakistan.*
BAILEY, Paul. *Kettering.*
BARRETT, John Albert, B.Sc. *Maidenhead.*
BLANCHETTE, Roy George. *Singapore.*
BRYANT, Victor Charles. *Southall.*
CARPENTER, Robert Frank. *Arborfield, Berks.*
DAWSON, Patrick Ignatius. *Feltham, Middx.*
DICKINSON, Ernest. *London, N.W.10.*
DONDEERS, Leendert Petrus. *Nijmegen, Netherlands.*
DOXSEY, John Alfred. *Swansea.*
FAI, Loke Mun. *Singapore.*
GARRAD, Terence Victor. *London, N.W.1.*
GLAZIER, Richard Eric George. *Bracknell.*
HARIDAS, Krishnan, M.Sc., B.Sc. *Birmingham.*
HODSON, Derrick Frank. *Stevenage.*
HOPE, William John. *Hong Kong.*
HUTCHINSON, David Norman. *Montreal.*
JONES, Neil. *Rhiwbina, Nr. Cardiff.*

LANGSTONE, Peter George. *West Drayton.*
LANGTON, Maurice Eric. *Gainsborough.*
LAVENDER, Derek Charles. *Nuneaton.*
LOH WING SIEW. *Singapore.*
MacKINNON, Albert. *Cleethorpes.*
MARRIOTT, Geoffrey Ward, B.Sc. *Chilwell.*
MODY, Eruch Rustomji. *Bombay.*
MOORE, John Keith. *St. Albans.*
O'KANE, William. *Glasgow.*
QUINE, Robin Brian. *Wolverhampton.*
RAGOOWANSI, Nandlal Lakhoomal, B.Sc. *Bombay.*
RAMA MURTHY, Mangipudy. *India.*
ROESENER, Werner. *Toronto.*
SACHIDANANDA KAMATH, N., B.Sc. *Alwaw, India.*
SETHURAMAN, Kiliyanallur, Srengaraja. *Tiruchirappalli.*
SMALE, Phillip Herbert. *Hitchin, Herts.*
TAMHANKAR, Hari Vyankatesh. *Bombay.*
THOMAS, David Price. *Rhondda, Glam.*
TUCKER, John Drew. *Old Coulsdon.**
WEECH, William Donald. *Newport.*
WILLIAMSON, Peter John. *Sheffield.*
WILLIAMSON, Peter Noel. *Southampton.*

* Reinstatement.

TELEVISION LINKS ON CABLE

The British Post Office has recently given some technical details of the way in which the Scottish independent television transmitter at Blackhill has been linked with the Glasgow studios of the programme company and all the main I.T.A. studios in England by a bothway link routed on coaxial cables. This follows the general direction of the west-coast railway route; the cable length from Manchester to Glasgow is 215 miles, and from Glasgow to Blackhill a further 22 miles.

The vision circuits are carried on two coaxial pairs; and, within the same cables, there are other coaxial pairs and audio pairs carrying telephone circuits. From Carlisle, there are four coaxial pairs in the northward direction and six in the southward. Between Telephone House, Manchester and the Post Office Repeater Station at Kirk o'Shotts the vision signals are transmitted in the frequency band 0.5—4.0 Mc/s, using the vestigial sideband mode, with a high-level carrier located at 1.056 Mc/s. At the sending end of each section of the main link the video waveform is applied to a modulator which, by means of a double frequency-changing process, translates the signal into the frequency band to be transmitted to line. An inverse frequency-changing process is applied at the receiving end. At each switching centre the vision signals appear in the standard video waveform, fully corrected at the standard switching level of 1 volt peak-to-peak across an impedance of 75 ohms unbalanced to earth. Vision signals from studio circuits appear in similar condition, thereby enabling full flexibility of routing.

The main line amplifier system, which conveys the vision signals in the frequency band 0.5—4.0 Mc/s, is the most recently developed broadband line system to be used by the Post Office. The system can be used, without alteration, to serve either a single 405-line vision circuit or a super-group of 960 trunk telephone circuits. At intervals of approximately six miles throughout the whole cable route, wayside repeater stations are provided, which contain separate amplifiers for each direction of transmission. Each amplifier is of three valve stages, and most components are provided in duplicate to minimize fault-liability.

Changes in loss/frequency characteristics of the coaxial pairs, which arise from temperature variations, are compensated by varying the gain/frequency responses of the line amplifiers. This is done automatically by means of networks controlled by thermistors connected in the negative-feedback portions of each amplifier. The heater voltage applied to each thermistor is governed by the level of a pilot frequency of 4.092 Mc/s supplied from the sending terminal station. The power for operating the amplifiers at the small intermediate stations is supplied from power-feeding intermediate stations which are generally located in the larger towns on the route. These power-feeding stations may be as much as 70 miles apart, and power is fed from them at 1,000 volts balanced to earth.

Each section of main link terminating at any of the switching centres requires accurate alignment to be closely maintained. This is made possible by use of an echo-waveform corrector at the receiving end, and adjustment is made on a waveform basis. Test signals for this purpose are sent from a sine-squared pulse-and-bar generator, and the results are observed on a cathode-ray oscilloscope.

The main link is extended from Kirk o'Shotts to Blackhill (3 miles), and from the network switching centre at Glasgow to the Theatre Royal (1 mile), by coaxial cable sections on which unbalanced video transmission is used. In each of these short coaxial sections the level of 50-c/s hum and other low-frequency interference is satisfactorily reduced by insertion of longitudinal chokes. These sections are also aligned on a waveform basis; but, because the accumulated distortion is very small as compared with that of the long main link, adequate correction is afforded by simple passive-type waveform corrector networks.

South of Manchester there is a bothway coaxial cable link between the switching centres at Birmingham and Manchester, and a 900 Mc/s bothway radio link between London and Birmingham. There is also a single-way 2,000 Mc/s radio vision channel from London to Birmingham and a second channel, on coaxial cable, from Birmingham to Manchester.

AUTOMATIC CONTROL IN STEEL STRIP MANUFACTURE*

by

G. Syke, Dipl.Ing.†

A paper presented at the Convention on "Electronics in Automation" in Cambridge on 28th June 1957. In the Chair: Mr. E. E. Webster (Member).

SUMMARY

The paper discusses thickness gauges on strip rolling mills and their use for automatic screw control, measurement and control of extension on skin-pass or temper mills, and automatic sorting of steel sheet and tin-plate on cut-up lines.

1. Introduction

The relevant mechanical plant involved in producing steel strip from hot slabs (Fig. 1) consists of the following:

- (1) Hot strip mill;
- (2) Cold strip mill;
- (3) Temper mill;
- (4) Cut-up line;
- (5) Tinning line.

Instrumentation can be used at various stages either to effect control or to perform continuous inspection.

Perhaps the most important variable, which requires continuous measurement and control on hot and cold strip mills, is the *strip thickness*. It is usual to have a thickness gauge on the exit side of the mill, so arranged that it gives a continuous indication of thickness error, i.e. deviation of actual strip thickness from the specified value. This information is used to make appropriate adjustments to the spacing of the work rolls or to strip tension, both of which affect the strip thickness.

On hot mills the temperature of the slab affects the pliability of the metal, and thus the resulting strip thickness; the information obtained from the thickness gauge can thus also be used to correct temperature distribution in the preheating furnace or to regulate the water

spray, provided on some hot strip mills for correcting temperature distribution.

On hot mills the *strip width* also lends itself to continuous control; narrow strip mills usually have adjustable edging rolls between the reducing stands, whilst wide strip mills are preceded by a slabbing mill which can adjust the width and height of the slabs to obtain correct strip width.

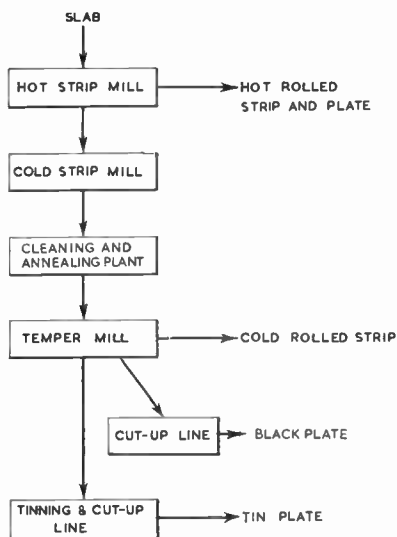

Fig. 1. Steel strip, plate and sheet manufacture.

After cold rolling the strip is too hard for most applications; it is thus put through an annealing furnace where it becomes quite soft. The required hardness is obtained by a controlled amount of cold work on the temper

* Manuscript received 7th May 1957. (Paper No. 441.)

† Baldwin Instrument Co. Ltd., Dartford.
U.D.C. No. 621.387.46:621.771.

mill. The reduction in strip thickness at this stage is quite small—0.5 to 3 per cent. is the usual range for motor car body steel and tin plate; it may be as high as 6 to 9 per cent. for silicon steel used in electrical machinery. In temper rolling it is the extension and not the finished thickness by itself that matters. *Extension* can be controlled by adjusting roll spacing or tension.

Coils leaving the temper mill may be cut into sheets on a cut up line which is usually equipped with a thickness gauge to inspect thickness. The output signal of the thickness gauge is used to control a sorting gate, which passes sheets within specified thickness limits onto a main conveyor, diverting off gauge sheets to a separate conveyor.

In tin plate manufacture the trend is towards continuous electrolytic tinning followed by automatic inspection for *total thickness* and *pin-holes*. Off-gauge sheets and those containing pin-holes are rejected and passed to secondary conveyors, whilst prime sheets, which are within specified thickness limits and free from pin-holes are deposited on the main conveyor. The tinning line may also contain instruments for continuously monitoring the thickness of *tin coating* on both sides of the strip.

The object of this paper is to describe briefly the present state of art in measuring, controlling and sorting techniques available for the applications listed above.

2. Measuring Instruments

2.1. Strip Thickness Gauges

Electromechanical gauges—"flying mikes"—consist of two hardened steel rolls spring tensioned against the strip. Displacement of one roll relative to the other due to variations in strip thickness is converted into an electrical signal. The use of such contact type thickness gauges is confined to measuring the edge of cold strip.

In recent years X-ray and radioactive non-contact thickness gauges have come into use; they are applicable to hot and cold strip at any speed and can measure almost anywhere across the width of the strip.

The X-ray gauge consists of an evacuated thermionic X-ray tube (with 50 kV to 200 kV

high tension supply) and a radiation sensitive detector (fluorescent screen and photomultiplier tube) on opposite sides of the strip. The X-rays emitted by the tube are attenuated in passing through the strip and the amount of radiation reaching the detector is a measure of strip thickness.

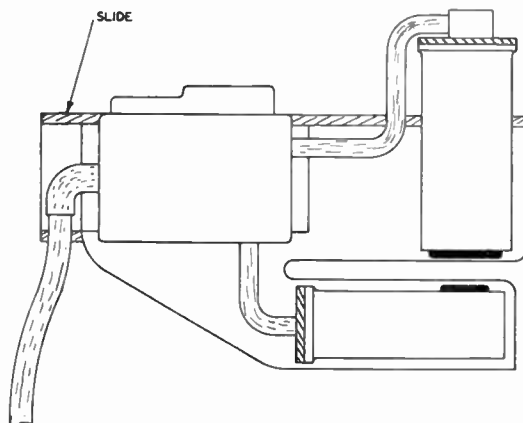

Fig. 2. Measuring head of radioactive cold strip thickness gauge.

In radioactive thickness gauges the X-ray tube, with stabilized high tension supply, is replaced by a radioactive source. Beta particles originating from a suitably prepared, sealed source of strontium 90 are used for measuring steel strip thickness up to about 0.02 in. thickness (Fig. 2). Until recently, however, there was no radioactive source available, which had all features needed for the thickness range of 0.02 in. to 0.4 in. This range embraces practically all hot, and much of the cold, strip and plate rolling. The author and his colleagues have succeeded in developing a technique, which appears to meet all practical requirements. The prime radioactive source is again strontium 90 but the beta rays are not used for the measurement as such; they impinge on a suitable target, where they give rise to secondary electromagnetic radiation (X-rays), consisting mainly of continuous spectrum ("white") radiation, known as *Bremsstrahlung*.

Such sources have the right radiation spectrum for measuring steel strip over the entire range of about 0.004 in. to 0.4 in. thickness, they have a very long half life

(approximately 25 years) and can be produced with sufficient activity (strength) to satisfy most applications encountered in hot and cold rolling. A typical hot strip gauge for instance measures strip of 0.03 in. to 0.25 in. thickness, to 1 per cent. accuracy with a time-constant of about 0.2 seconds, at a clearance of 12 in. between source and detector housings. By using a stronger source—now readily obtainable—it is possible to shorten still further the time-constant or increase the source-detector distance.

Radiation backscatter techniques for measuring strip thickness from one side only, are in an advanced stage of development; these are based on the principle that the amount of radiation diffusely reflected or backscattered from steel strip varies with its thickness.

A fundamentally different approach to measuring strip thickness was put forward by Hessenburg and Sims; in their scheme the rolling mill itself is in effect used as a micrometer; strip thickness is here computed as the sum of initial roll separation under no load S_0 (derived from the rotation of the loading screw) and increase in roll spacing due to elastic deformation of the mill under load (KF , where K is a constant of the mill and F is the screw load, as measured by load gauges between screws and bearings).

This measuring system avoids the time lag inevitably associated with conventional contact or non-contact thickness gauges, i.e. the time it takes for the strip to travel the distance—usually about 2 ft. to 5 ft.—from the roll nip to the gauge. A limitation is however, that errors in the nature of zero drift arise due to thermal deformation of mill stands and rolls, as well as due to roll wear. It therefore cannot replace or supersede the gauge, which measures strip thickness directly, though it may form a useful supplement for coping with sudden thickness changes.

2.2. Strip Width Gauge

A strip width gauge presents optical images of the two edges of the strip to photoelectric cells; servo motors are used to keep the edge images in coincidence with datum lines on the photocell assemblies by moving the photocells or by deflecting shutters so that their edge follows the optical image of the edge of

the strip. The linear displacement of the photocell assemblies and shutters is a measure of strip width. The red and near infra-red radiation of the hot strip itself is used as a light source.

2.3. Extension Gauge

Two different systems for extension gauges are in use, depending on the construction of the temper mill.

Many temper mills are fitted with tensioning rolls on entry and exit side, which can be relied on to follow the strip under normal operating conditions without slipping. The measuring system here consists of some means of accurately determining the speed ratio of exit and entry side tensioning roll shafts. A preset correction is applied, if the diameters of the two relevant tensioning rolls are not equal.

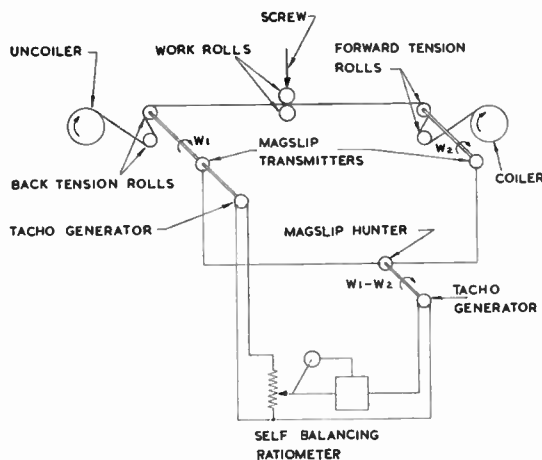

Fig. 3. Differential extension gauge.

If the angular velocity of the entry side tensioning roll shaft is ω_1 , that on the exit side ω_2 , then the extension (assuming equal roll diameters) is $\frac{\omega_2 - \omega_1}{\omega_1} \times 100\%$. Fig. 3 shows the general layout of such a measuring system, using mag slip elements and a self-balancing potentiometer.

If the mill does not contain rolls which can be relied on to follow the strip without slipping, a different technique is adopted (Fig. 4). This essentially consists of four thin U shaped wound iron cores under the pass line. Two of these—the print coils—are energized by short duration pulses to create localized magnetic poles in

that section of the strip which was just above the pole faces of the print coil unit at the moment of applying a pulse. The repetition frequency of the printing pulses is made proportional to mill speed, in order to obtain a magnetic pattern of substantially constant wave length on the strip.

The two print signals are derived from a common oscillator by frequency division and the exit side print signal is displaced by exactly one quarter-wave in time relative to the entry side print signal.

When the magnetic poles imprinted on the strip pass over the pick-up coil, they induce electrical signals in the latter. These signals are amplified and their phase relationship is measured.

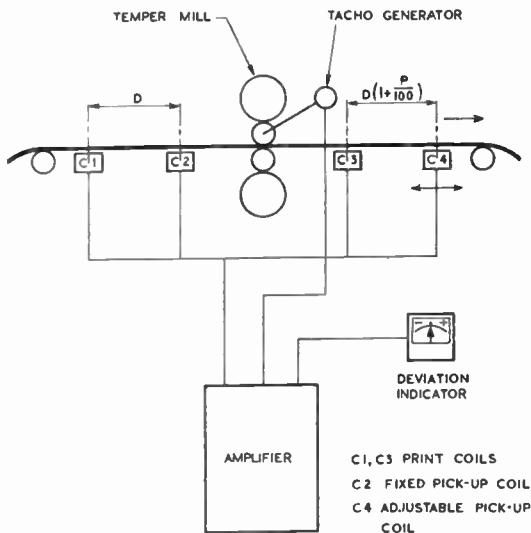

Fig. 4. Magnetic extension gauge.

If it is for instance required to roll with p per cent. extension and the distance between print and pick-up units on the entry side is D inches, one would adjust the distance between print and pick-up units on the exit side to $D \cdot \left(1 + \frac{p}{100}\right)$ inches. As long as the actual extension is correct, i.e. exactly $p\%$, the phase displacement in time between the two pick-up signals will be the same as between the two print signals, i.e. 90 degrees. Any error in extension will advance or retard the exit side

pick-up signal relative to the entry side pick-up signal.

One of the four coil units is adjustable and its setting screw is calibrated in percentage extension. A centre zero indicator and recorder display the error, that is, the deviation of actual from the required, preset extension.

2.4. Pin-hole Detector

Very small pin-holes occur at times in tin plate and it is necessary to detect and eliminate sheets containing these defects.

The detector consists of a strong light source on one side of the strip and a row of photomultipliers on the other. The light source is usually modulated at a frequency of several hundred cycles per second to eliminate the effect of stray light from other sources reaching the photomultipliers. One of the practical difficulties is to inspect the strip over the entire width, right up to the edges, without allowing modulated light to get round the edges to the detector.

The output signal is used either to mark the strip with a solenoid-operated punch wherever a pinhole is detected, or to actuate a sorting gate farther along the line.

2.5. Tin Coating Thickness Gauge

The total amount of tin deposited in unit time along the whole electrolytic tinning line is measured in first instance by an ammeter in series with the plating electrodes. Dividing this by line speed gives the amount of tin deposited per unit length. A self-balancing ratiometer is used to obtain this ratio, which is a measure of average tin coating thickness.

Spot checks are usually made by cutting out samples of accurately controlled size, dissolving the tin and determining its quantity by chemical (e.g. titration) methods.

To obtain continuous monitoring of coating thickness and distribution on both sides of the strip, backscatter radiation gauges are used. These work on the principle that the scatter of ionizing radiation varies considerably with the atomic number of the scattering medium. The atomic number of tin (50) is much higher than that of iron (26).

X-ray backscatter gauges for this application exist in the U.S.A. and radioactive gauges are being developed in this country.

3. Control Systems

3.1. Single Stand Cold Strip Mills

The control system consists of a contact or preferably non-contact thickness gauge on the exit side of the mill, in combination with a controller acting on the screw motor contactors.

The simplest form of controller consists of a discriminator which defines a dead zone, followed by a timer to provide intermittent on-off action. The "on" period is chosen to apply a correction corresponding to half of the dead zone. The "off" period is chosen to cover the time interval required by the strip to travel from the nip to the gauging point at the lowest mill speed, at which the automatic control is operative; it also covers time delays incurred in the measuring system and screw drive mechanism.

A limitation of this system is, that it takes a long time to correct sudden errors which are very large compared with the dead zone.

An improved control system applicable to contactor operated, fixed speed screw motors applies in case of a small error an immediate small correction, followed by a dead time ("off" period). In case of a large error however it

decreased to such value, that the over-run of the motors due to time lag (including transit time of the strip) and inertia will just bring the strip thickness to the central region of the dead zone. This action is followed by a dead time, as in the case of a small error.

The coiler side of a single stand cold strip mill, employing such a control system, is shown in Fig. 5. The measuring head of the radioactive thickness gauge (2.1) is seen at the left.

The operator presets the required thickness on a dial (top right); as soon as the strip is tensioned, he slides the measuring head onto the strip and accelerates the mill. Automatic control is brought into action at a predetermined threshold speed; it is terminated by a limit switch on the entry side, when the tail of the strip approaches. At the same time the head is withdrawn from the strip by means of a pneumatic cylinder. Automatic standardization takes place during the waiting period.

If the operator alters coiler tension during the pass, to improve the shape (flatness) of the strip, the resulting thickness change is immediately corrected by the automatic control.

The gauging point is about 18 inches after the pinch of the work rolls. This distance is traversed by the strip in 0.3 second at a rolling speed of 300 feet per minute; the transit time is proportionately less at higher speed. Delay in the control system due to this cause is thus of similar order or less than that due to contactor operating time and screw motor inertia.

3.2. Cold Tandem Mill

This plant usually consists of three to five stands, each of which reducing the strip thickness by some 20 to 40 per cent., so that the total reduction may be by a factor of 10 in one pass.

Many cold tandem mills have contactor-operated fixed speed screw motors; on the most modern plants however the screw motors are actuated by Ward-Leonard or other variable speed systems, incorporating rotary or magnetic amplifiers. Such plant lends itself to faster and more accurate gauge control by means of a multi-term, continuously acting servo system.

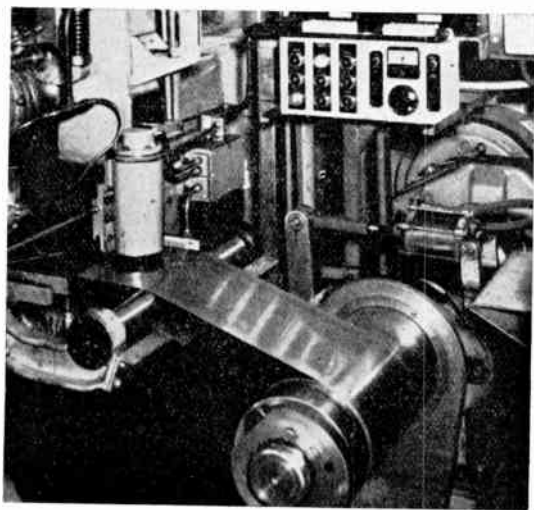

Fig. 5. Cold strip mill with automatic gauge control.

keeps the screw motors continuously energized until the error at the controller input has

On a five-stand mill several variables are in principle available to the control engineer for applying corrective action, for instance screw setting on each of the five stands and the four interstand tensions. It is usual to preset all but one or two of these to fixed values, maintain them individually constant and include thickness gauges in the closed loop control of the remaining one or two variables.

A scheme in use in the U.S.A., for instance, consists of a radiation gauge after the first stand to control the screws of this stand and a second radiation thickness gauge after the last stand to control the last interstand tension.

3.3. Hot Tandem Mill

As far as the author is aware no automatic closed loop strip thickness control schemes on hot tandem mills have yet been reported. With the advent of non-contact radiation thickness gauges and photo-electric width gauges the field is now open for the development of automatic thickness and width control schemes. The control engineer however must look to the mill manufacturers to design mills which are suited for such automatic control.

The prime variables to use for automatic thickness control are again the loading screws, particularly those of the last stand. This might be supplemented by means for improving temperature distribution of the ingoing hot strip or slab; in such a scheme however the information obtained from the strip just rolled can at best benefit subsequent strips by being applied to the furnace or to the water spray preceding the mill.

3.4. Temper Mill

No automatic control schemes have yet been reported for maintaining constant extension. The use of extension gauges is a relatively recent development and the author does not foresee any fundamental difficulty in applying the error signal of the extension gauge to the automatic control of screws or tension, provided at least one of these is independently available for this purpose.

It should be noted that surface finish and flatness of the outgoing strip are also relevant. It is with an eye on these that the operator uses his judgment to decide what combination of screw and tension settings will give the best

overall rolling result. It is not easy to forecast just how this particular faculty of judgment can best be supplemented or replaced by instrumental aids. It is possible that automatic screw control to maintain constant extension, in combination with manual tension control, might give improved mill performance and ease the task of the operator.

3.5. Cut-up Line

The practice is to measure strip thickness before the cutter and use the error signal to actuate a sorting gate after the cutter. The distance between measuring head and sorting gate may be 10 to 20 ft., i.e. the length of several sheets. To ensure that all off-gauge sheets and only the off-gauge sheets are ejected, a synchronized storage device is used, which receives information from the measuring instrument at the time of the measurement and presents it to the sorting gate with a time-delay, inversely proportional to line speed.

The length of the sheet must also be taken into consideration, since the sorting gate is only operative when the leading edge of a sheet passes it; in the case of long sheets the gate should operate earlier than in case of short ones.

Solenoid-operated pin wheel type storage devices are in general use, but there is scope for electronic storage and synchronization to meet the requirements of modern, high speed cut-up lines.

3.6. Tinning Line

This is usually combined with a cut-up line. The prime variable to be controlled is tin coating thickness. Continuous inspection and automatic sorting in respect of total thickness and pinholes are also required.

Control of coating thickness is usually applied by regulating the current through the electrolytic tanks. Since electrolytic tinning is a relatively stable process, free from random short term fluctuations, there is little urge to control automatically from the error signals of coating thickness gauges. Means for maintaining constant the ratio of current in the tanks to strip speed are usually considered adequate.

The problems associated with automatic sorting by means of thickness gauge and pin-hole detector are substantially the same as on the self-contained cut-up line although the

number of cuts per minute is usually much greater.

3.7. Safeguards

When entrusting the control of a plant to automatic devices, adequate safeguards are needed in respect of the possible consequences of a failure in the measuring and control equipment. Even the most reliable equipment may fail on rare occasions; if however this happens, it should be immediately disclosed. Damage to the plant or the continued production of reject material must not arise.

Failure in an automatic inspection and sorting device must not result in off-gauge material being wrongfully accepted; the amount of on-gauge material wrongfully rejected—the lesser of the two evils—should be a minimum.

The following are a few examples of simple safety measures applicable to automatic screw control by means of radioactive thickness gauges.

- (a) Automatic control is muted by a load gauge when the screw load exceeds a safe limit.
- (b) The maximum correction allowed for the automatic control is limited.
- (c) "Self-check" or "automatic standardization" is applied; during the waiting period between consecutive coils the gauge checks and if necessary corrects itself with reference to standard samples incorporated in the measuring head.
- (d) Failure cut-out is incorporated to mute the automatic control and give alarm if some relevant current or voltage in the equipment—for instance the error signal at the end of the self-check period—is outside specified limits.
- (e) Two independent thickness gauges are combined in such a way that one normally controls, whilst the other inspects. In case of a failure in either, the remaining gauge continues to perform the control task.

Another way of achieving safety is by combining three or more measuring and control channels; in the case of conflicting control instructions that of the majority prevails. The probability of simultaneous failure in two out of three or three out of five channels is considerably smaller than that of a single channel.

The decision of how far such safety measures should be carried is largely a matter of experience and economics; given adequate basic facts on costs and probabilities, the optimum might be calculated or at least estimated.

4. Conclusions

Instruments for the continuous measurement of the relevant variables—strip thickness, width, extension, tension and screw load—have only in recent years reached adequate accuracy and reliability to allow their use for automatic control.

On rolling mills and similar plant friction, backlash, slack, eccentricity or other mechanical imperfections account for some of the variations found in the finished product; the reproducibility of the effect (e.g. thickness change) brought about by a given control action (say, one revolution of the screw drive motor) is also limited by such mechanical imperfections. These are the concern of the plant designer and maintenance engineer; they set a limit to the accuracy and sensitivity of control attainable with instrumentation and automatic control aids.

On the other hand variations in the finished product due to variations in the ingoing material, drift in plant parameters such as varying thermal deformation of the mill stand and rolls and gradual roll wear can be greatly reduced, even substantially eliminated by such means.

The task of the control engineer is to approach the optimum performance of which the plant is intrinsically capable in respect of product uniformity and quantitative output without imposing undue strain on the continuous alertness, speed of reaction and judgment of the human operators.

The development of measuring instruments to provide error signals—usually of an electrical nature—has made great strides in recent times; the use of such error signals to bring about automatic control is the predominant subject of current development. Electronics no doubt has an important part to play in this endeavour, though thermionics must in many instances give way to transistor, saturable reactor (magnetic amplifier) and other (pneumatic and hydraulic) amplifier and controller techniques.

DISCUSSION

D. F. Nettell: The display system for indicating the gauge of steel strip is an admirable one, and I understood that the indications provided by the five digits showing on gauge and degrees of deviation either plus or minus are also recorded on teleprinter tape. Have the tapes so produced been used to analyse statistically the quality of strip rolled and does this give any indication of the performance of the gauge control system?

I have carried out some trials myself in which the gauge of strip was recorded on teleprinter tape. The gauge measurement was in that case measured by a "flying mike," and the intervals were every two feet of cold strip. The immense amount of data collected was reduced automatically and gave valuable information on the quality of the strip.

Dr. D. A. Bell: Although I agree that operating personnel have a strong preference for the simple micrometer, and sometimes distrust even the mechanical flying micrometer, there are some measurements which simply cannot be made with the simple hand micrometer. It will not measure the thickness at the centre of a wide strip; and it requires the mill to be stopped, which may in itself change the thickness of the emerging strip. Therefore I believe there are occasions when electronic instruments must be trusted because there is no other means of obtaining those particular measurements.

With regard to the dependence of strip thickness and quality on strip tension and on screw-down of the mill jointly, I have heard of some work in Russia on the design of automatic controls for systems in which there are several mutually coupled closed loops. I think it should be possible to design a system so that if it is desired to change the tension in order to improve the quality of the rolled strip, there will simultaneously be applied a first-order correction to screw-down so as to maintain constant thickness. A servo loop might be used for final adjustment of screw-down to secure exactly the desired thickness.

J. H. Batchelor: Could Mr. Syke state

whether the method using magstrips has been found to be satisfactory?

R. O. R. Chisholm (Graduate): I should be interested to know about any special techniques employed in testing a servo in which one of the lags is related to the distance between the rollers and the thickness sensing head, and the speed of transit of a fast moving steel strip.

G. Syke (in reply): The hot strip gauge with lamp board display* and Teleprinter recording referred to by Mr. Nettell types out the measurement results in terms of the symbols
 $+ 0 - =$. Each horizontal line represents one coil. A paper strip 8 in. wide by 2 ft. long thus contains the record of more than 100 coils, with a resolution of about 20 to 48 digits per coil.

For statistical analysis one can connect five Veeder-Root counters across the discriminator output; this has so far not been done on this particular installation.

I fully agree with Dr. Bell's remarks on the capabilities of electronic measuring techniques compared with the hand micrometer.

The small transient thickness error resulting from a manual alteration of tension on a rolling mill with automatic screw control could perhaps be still further reduced by the method Dr Bell suggests; it should be remembered however, that the function relating thickness to tension also contains many other variables.

In reply to Mr. Batchelor's question I would say, that the Magslip instrument measures percentage extension on temper mills, not absolute strip thickness. It is giving satisfactory service as an aid to manual control and also in studying plant characteristics.

Replying to Mr. Chisholm, I think that the technique of injecting a step-function error, rather than small amplitude variable frequency sinusoidal error, is applicable in this case. The latter would probably be more affected by friction and backlash in the mill loading screws.

* See G. Syke, "A gamma ray thickness gauge for hot steel strips and tubes," *J. Brit. I.R.E.*, 14, pp. 419-426.

A DECIMAL PRODUCT ACCUMULATOR*

by

Robert R. Hoge, M.Sc.†

A paper presented at the Convention on "Electronics in Automation" in Cambridge on 27th June 1957. In the Chair: Dr. A. D. Booth (Member)

SUMMARY

As a step towards a digital correlator, a machine has been built which accumulates the sum of products of pairs of numbers. This device can determine the correlation between two series of numbers, provided all terms in the series are positive. The arithmetic operations are performed by dekatrons. To minimize multiplication time each product is formed in an asynchronous cycle whose duration is governed by the value of the digits in the multiplier factor. The speed of the present model is limited by relays which control the programming cycle. Given pairs of numbers having two decimal digits each, the machine accumulates 100 products per minute.

Symbols Used to Represent Numbers

p_i = decimal number (normally two-digit) representing a sample of the input function.

q_i = ditto for the delayed input function (used in determining auto-correlation).

p' = tens digit in a number p_i .

p'' = units digit in a number p_i .

q' = tens digit in a number q_i .

q'' = units digit in a number q_i .

1. Introduction

A digital product accumulator machine has been built to facilitate the numerical evaluation of correlation functions. This special-purpose apparatus operates entirely in the decimal number system. Dekatrons and hard valve circuits are used for computing and temporary storage elements, while telephone-type relays perform the switching operations necessary for programme sequence control.

Product factors are represented by two digits between 00 and 99, inclusive. Data is inserted into the multiplication unit simultaneously at two inputs on separate five-hole teleprinter tapes. This data is presented in decimal notation using a self-checking two-out-of-five-hole code‡ to represent the digits 0 to 9. Code combinations of other than two holes are detected as errors, causing the machine to stop. A diode-tree decoding matrix translates the

punched data into chains of 1 to 9 pulses during data read-in operations.

The method of forming the product of two numbers, one from each tape, is similar to the method employed in mechanical desk calculators. That is, the multiplicand is repeatedly added into the accumulator under the control of the multiplier digits.

Circuit arrangements are such that a summation of the successive products is formed in the accumulator until a STOP signal is detected on a data-input tape. Product accumulation is achieved in asynchronous computing cycles consisting of a variable number of subcycles. Each subcycle consists of a chain of ten dekatron drive pulses derived from a 1 kc/s oscillator. Data is read into the multiplication unit in four subcycles, i.e. one per digit for both two-digit factors. The number of subcycles required for the actual multiplication operation (multiple addition) is equal to $q' + q''$, where q' and q'' are the two digits of the multiplier factor in each particular product. The limiting case in which the digits of the multiplier factor are 00 requires no multiplication subcycles. It is not possible to quote a fixed computing time for one product because of the asynchronous operation. In practice one hundred products are accumulated in about one minute, and between 75 and 85 per cent. of this time is lost waiting for the relays to operate.

* Manuscript first received 23rd May 1957 and in final form on 9th November 1957. (Paper No. 442.)

† Formerly of the Electrical Engineering Department, University of Birmingham; now with Bendix Aviation Corporation, Research Laboratories Division, Southfield, Michigan.

U.D.C. No. 621.374.32:681.142

‡ W. Keister, A. E. Ritchie and S. H. Washburn, "The Design of Switching Circuits," p. 280. (Van Nostrand Company, Princeton, New Jersey, 1951.)

The accumulator portion of this apparatus, designed by Mr. J. C. Cluley, is a six-digit dekatron counter with input terminals at the *units, tens, and hundreds* dekatrons. Drive pulses from the multiplication unit are always applied to two of these terminals at once. In order that the propagation of carry pulses between orders in the counter may not coincide and interfere with input pulses from the multiplier, two interleaved 1 kc/s pulse trains govern these operations. Thus input pulses occur in phase with one pulse train while carry pulses are propagated by the interleaved pulses.

2. Background of the Problem

Although numerical analysis by means of digital computers is becoming fairly commonplace, universal electronic digital computers are sufficiently complex and costly to limit their ownership to large industrial and academic research organizations whose work load can justify the capital expenditure. This unhappy fact leaves many potential users of computers with nothing better than the key-and-crank desk calculator as a tool for performing simple but repetitive operations on mountains of data. Research personnel are often reluctant to attack long problems with calculators because the process is slow, tedious, and prone to human error.

A dilemma of this sort regarding the evaluation of correlation coefficients was the motivation for the design and construction of the apparatus described here. The analytic form of the function to be evaluated, i.e., the autocorrelation function, is

$$\varphi_{11}(\tau) = \lim_{T \rightarrow \infty} \frac{1}{2T} \int_{-T}^T f_1(t) f_1(t + \tau) dt \dots\dots(1)$$

where $f_1(t)$ is in general a random aperiodic function. Detailed discussions of the properties and uses of correlation functions can be found in the literature.*

With the intent of designing a device to facilitate evaluation of correlation functions, the relative merits of analogue and digital computing techniques were compared, keeping in mind the general nature of the raw data to be

correlated. In this instance material for existing and prospective correlation problems originated as statistical data or as relatively "slow" time functions representing the response of human operators. Using analogue techniques, it is necessary to present the functions to be correlated in a special graphical form. The essential computer components required are two curve followers (photoformers), an analogue multiplier, and an integrator. If reasonably accurate results are required, say within one per cent., this equipment must include many precision and high stability components, and special measures must be taken to make the apparatus essentially drift-free over the period of a computation. Using automatic digital techniques, one must also specially prepare the data, usually as a table of numbers written in "machine language." However, evaluation of correlation functions by numerical methods can yield results with accuracy comparable to that of analogue methods, using a minimum of precision equipment. The numerical accuracy is limited only by the original data and by the number of significant digits used to represent it. The potentiality for high predictable accuracy without high-stability equipment was decisive in choosing numerical analysis in this instance.

Equation (1) may be evaluated numerically by machine calculation if the time function $f_1(t)$ is sampled at time $t_1, t_2, t_3, \dots t_n$, leading to a set of ordinates $p_1, p_2, p_3, \dots p_n$. The ordinates represent the values of the function at the corresponding sampling times. The function $f_1(t)$ is similarly sampled τ seconds later (at $u_1, u_2, u_3, \dots u_n$) leading to a second set of ordinates $q_1, q_2, q_3, \dots q_n$. If the number of samples n is made sufficiently large, the autocorrelation function (1) will be

$$\varphi_{11}(\tau) = \frac{1}{n} \sum_{i=1}^n p_i q_i \dots\dots(2)$$

Thus, the problem of correlation is reduced to the summation of a series of products. It is usually required to plot $\varphi_{11}(\tau)$ for many values of τ , say m values, so that m summations consisting of $(m \times n)$ products must be performed. This can lead to a tremendous amount of work on a desk calculator.

* N. Wiener, "The Extrapolation, Interpolation, and Smoothing of Stationary Time Series" (John Wiley and Sons, Inc., New York, 1948).
 J. Truxal, "Control System Synthesis," pp. 410-499 (McGraw-Hill Book Co., Inc., New York, 1955).

A machine capable of rapidly computing

$$\sum_{i=1}^n p_i q_i \dots\dots\dots(3)$$

can significantly facilitate a complete evaluation of eq. (2). This machine will be especially useful if it can accept the ordinates p_i and q_i as separately tabulated sets on suitable input media such as punched paper tapes. The tables of ordinates p_i and q_i may then in fact be identical, since p_i and q_i are merely samples of the same data separated in time by a delay τ . Introduction of the delay or displacement τ is achieved by actually displacing one table of ordinates q_i from the other table p_i by the number of sampling intervals equivalent to the delay τ . Changes in τ are thus simply changes in this displacement of the tables of ordinates.

The simplest conceivable automatic machine for rapidly evaluating eq. (3) is capable of accumulating positive products only. One may assure positive values for samples p_i and q_i by intentionally weighting $f_i(t)$ so that it is always greater than zero. For example, if $f_i(t)$ is a curve on a pen-recorded chart, it is only necessary to measure the samples P_i and Q_i with respect to a margin of the chart rather than with respect to the centre of the chart, even if the zero points of the function are in the centre. This method increases the value of the sum of products by $h(\bar{P} + \bar{Q} - h)$, where \bar{P} and \bar{Q} are mean values of the samples measured from the margin or reference axis and h is the displacement of the reference axis from the zero axis of $f_i(t)$. If one is restricted to a machine which will accumulate positive products only, it is (sometimes) necessary to use the weighted samples P_i and Q_i and also to compute \bar{P} and \bar{Q} , so that the corrected correlation function

$$\varphi_{11}(\tau) = \frac{1}{n} \left[\sum_{i=1}^n P_i Q_i \right] - h(\bar{P} + \bar{Q} - h) \dots\dots\dots(4)$$

may be evaluated.

Another related measure of correlation is the so-called product moment correlation coefficient*, which is defined as

$$r = \frac{\frac{1}{n} \sum_{i=1}^n p_i q_i - \bar{p} \bar{q}}{\sigma_p \sigma_q} \dots\dots\dots(5)$$

where σ_p and σ_q are the standard deviations of p and q , respectively. That is

$$\sigma_p = \sqrt{\left(\frac{1}{n} \sum_{i=1}^n p_i^2 - (\bar{p})^2 \right)}$$

$$\text{and } \sigma_q = \sqrt{\left(\frac{1}{n} \sum_{i=1}^n q_i^2 - (\bar{q})^2 \right)} \dots\dots\dots(6)$$

The tedious part of evaluating eq. (4) or (5) can be done with a machine capable of computing summations of the following forms:

$$\sum_{i=1}^n p_i q_i \quad \sum_{i=1}^n p_i^2 \quad \sum_{i=1}^n p_i$$

With the preceding considerations in mind, it was decided to design an electronic machine capable of evaluating the above summations. The source of the raw data for $f_i(t)$ is usually an ink-line graph on paper recording tape, which can scarcely be read or sampled with an accuracy better than 1 per cent. Therefore the input ordinates p_i and q_i are supplied to the machine as numbers between 00 and 99. Ordinates p_i are tabulated consecutively and inserted at one input, while ordinates q_i are tabulated and inserted at a second input. For a specific value of τ , one part of the evaluation of eq. (3) is complete after p_i and q_i are read into the machine, their product is formed, and the result is stored in the accumulator. Similarly, the second part consists of reading p_2 and q_2 into the machine and adding the product $p_2 \times q_2$ to the sum already in the accumulator. The process continues in this manner until all the products from $p_1 q_1$ to $p_n q_n$ have been added into the accumulator. Division of eq. (3) by n yields eq. (2), or by using the summations of p_i and p_i^2 one can evaluate eq. (4) or (5).

The machine briefly outlined above is a very considerable improvement over the mechanical desk calculator for the intended purpose. Yet, at best, it is a very modest machine as electronic computers go. The few machine instructions constituting the computation programme are

* The autocorrelation function defined by eq. (1) may have any magnitude, depending on the magnitude of $f(t)$; but the correlation coefficient is normalized by dividing by the standard deviations and has a value between -1 and +1.

built into the circuits, with only three possible routines. Since the total or sum in the accumulator must be visually noted and manually recorded after the end of each summation, the read-out time constitutes a significant part of the total computation time. It is intended that facilities for automatic read-out of results will be added to the existing apparatus at a later date. The manual recording of totals could be eliminated by adding to the accumulator a printing system such as has been applied to some commercial dekatron counters.*

3. The Product Accumulator

The main components of the product accumulator are shown in Fig. 1, a simplified block diagram. Data on standard five-hole perforated teletypewriter tape is read into the multiplier by the two photoelectric tape readers. The multiplicand register, the multiplier

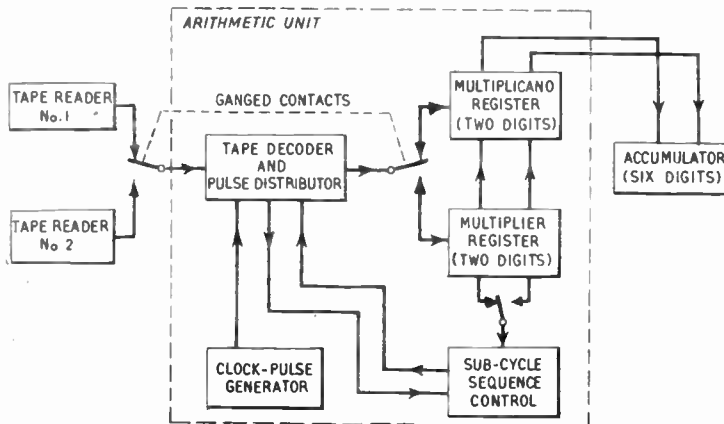

Fig. 1. Simplified block diagram of multiplier.

register, and the accumulator consist of dekatrons, one for each digit. Selector dekatrons are also used in the tape decoder and pulse distributor and in the subcycle sequence control unit. Chains of one to nine pulses in succession are transmitted to the registers as

* E.g., the printing counter described in the Convention paper by C. C. H. Washtell, "Automatic Counting Techniques applied to Comparison Measurement," *J. Brit. I.R.E.*, 17, pp. 397-402, July 1957.

M. Graham, W. A. Higinbotham and S. Rankiwitz, "Dekatron drive circuit and application," *Rev. Sci. Instrum.*, 27, p. 1059, December 1956.

required by the code on the tape. In turn, pulses are sent from the multiplicand register to the accumulator to form the product of the numbers in the registers. The sequence of events and the number of pulses involved in each multiplication are controlled by the subcycle sequence control unit.

Calculation of the product of two two-digit numbers, $p'p''$ and $q'q''$, is accomplished in six steps, as follows:

- (1) Read p' from the tape reader No. 1 and insert it into the tens position of the multiplicand register.
- (2) Read p'' from the tape reader No. 1 into the units position of the multiplicand register.
- (3) Read q' from reader No. 2 into the multiplier register.
- (4) Read q'' from reader No. 2 into the multiplier register.
- (5) Add the multiplicand $p'p''$ into the accumulator q' times.
- (6) Shift the accumulator one digit to the left and add $p'p''$ into the accumulator q'' times. Return to step 1 and repeat for new values of $p'p''$ and $q'q''$.

Thus, formation of the product ($p'p''$) ($q'q''$) is accomplished in much the same manner as one does it with pencil and paper.

Each one of the above steps is completed in one or more subcycles, where one subcycle consists of ten pulses from the clock-pulse generator. Steps

1, 2, 3, and 4 require one subcycle each. Step 5 requires q' subcycles and step 6 requires q'' subcycles. The time required for the completion of a product is variable, dependent upon ($q' + q''$), so that a series of products is completed in an asynchronous rhythm.

Relay switching occurs after each step of a calculation, in order to set up the circuits for the next step. These relays are controlled by the subcycle sequence control unit and some of the relays are included in the control unit. The sequence control circuits actually comprise

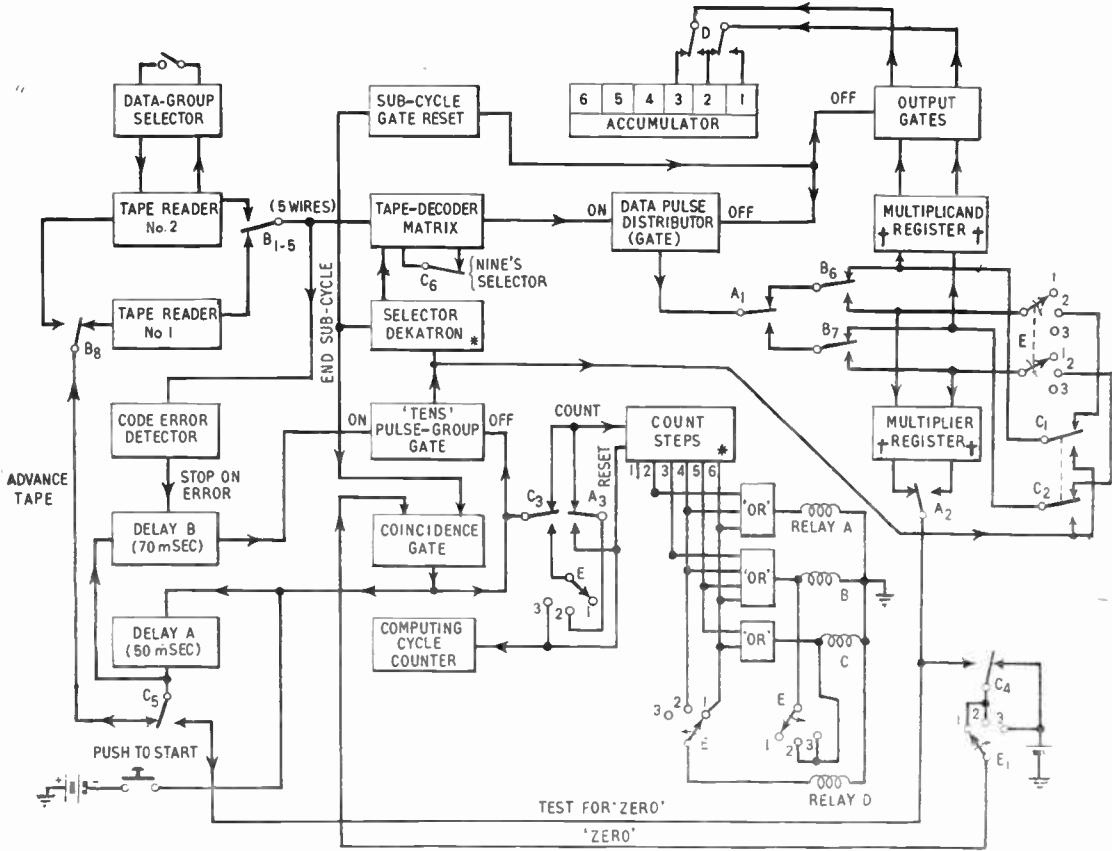

NOTES:—

- (i) All relay contacts shown in the normal non-energized position.
- (ii) All sections of switch "E" ganged together.

- (iii) Symbol * for GS10D dekatron (selector).
Symbol † for GC10D counter dekatron.
- (iv) Programme set by switch "E" as follows:
1. $\sum p_i q_i$; 2. $\sum (p_i)^2$; 3. $\sum p_i$

Fig. 2. Block diagram showing logical design of multiplier.

a larger proportion of the total circuitry than Fig. 1 implies.

Figure 2 is a complete diagram showing the logical design of the multiplier. Component blocks shown in Fig. 1 appear in about the same relative position in Fig. 2, with many accessory blocks added. All relay contacts have been shown. It will be noted that the entire lower-half of the diagram represents the subcycle sequence control unit.

Three different computing routines or sub-cycle sequences have been built into the digital multiplier. The routine in use is selected by means of multiple-deck switch E, giving the

following results:

Routine 1:
$$\sum_{i=1}^{i=n} p_i q_i$$

Routine 2:
$$\sum_{i=1}^{i=n} (p_i)^2$$

Routine 3:
$$\sum_{i=1}^{i=n} p_i$$

Data is drawn from two tape readers in routine number 1 and from tape reader number 1 only in routines 2 and 3.

Routine No. 1, $\Sigma p_i q_i$

The sequence of events described earlier in section 3 will now be examined in more detail to explain the functions of the circuits which control the subcycle sequence. Steps 1 to 6 previously described are actually counted by a selector dekatron in the count-steps block. Cathodes two to six inclusive of the selector dekatron are connected to a germanium diode OR matrix which controls the operation of relays A, B, C, and D as shown in Table 1. This table is valid when selector switch E is in position 1, which causes the function $\Sigma p_i q_i$ to be calculated.

Table 1

Step No.	Relay Coils Energized
1	None
2	A
3	B
4	A and B
5	B and C
6	A, B, and C

If we assume that we are starting a problem and that we have inserted the data tapes in the readers, we may consider the six steps in order.

Step 1: The operator pushes the START button. After delay A (50 milliseconds) a pulse is transmitted to tape reader No. 1, advancing the tape one position to the first digit, p' , on the tape. After delay B (70 milliseconds) the tens pulse-group gate is triggered ON, causing drive pulses to be applied to the selector dekatron. The tape-decoder matrix similarly triggers the data-pulse distributor to ON after the $(10 - p')$ th dekatron drive pulse, thereby routing p' dekatron drive pulses through contacts A1 and B6 to the tens dekatron of the multiplicand register. Step 1, consisting of one subcycle (ten pulses), is complete when the glow in the selector dekatron arrives again at the "0" cathode and causes an end-of-subcycle pulse to be generated. This pulse causes the data-pulse distributor to be reset to OFF and also causes the coincidence circuit to

- (a) reset the tens pulse-group gate to OFF,
- (b) advance the count steps circuit to "2" via relay contact C3, and

(c) initiate delay A (50 milliseconds).

Step 2: This step really begins with the end of step 1, when the two delay circuits are triggered. In step 2 the second digit, p'' , of the multiplicand is read from tape reader No. 1. Since relay A is energized, p'' drive pulses are routed to the units dekatron of the multiplicand register. In other respects step 2 is like step 1. The pulse marking the end of step 2 switches the pulse gates to OFF, advances the count to "3", and again initiates delay A (50 msec).

Step 3 and Step 4: The same operations as in steps 1 and 2 take place, but relay B is energized, so that $q'q''$ from tape reader No. 2 is placed into the multiplier register.

Step 5: On the count of 5 relay C is energized. Contacts C1 and C2 connect both dekatrons of the multiplicand register to the tens pulse-group gate. Contact C4 connects the "0" cathode circuit of the multiplier register to the coincidence gate. Contact C5 completes the test-for-zero circuit and contact C6 causes the decoder matrix to select chains of nine pulses. When delay B switches the tens pulse-group gate to ON, drive pulses are simultaneously applied to the multiplicand register. However, for every ten pulses applied to the multiplicand register, only nine pulses are applied to the tens dekatron of the multiplier register. Therefore after $10(q')$ multiplicand drive pulses the tens multiplier glow will return to the zero cathode in coincidence with the end of a subcycle, and step 5 is completed.

It will be recalled that pulses are applied to the multiplicand register in multiples of ten pulses called subcycles. In each subcycle the cathode glow in each dekatron makes one complete revolution, starting and ending on p' (tens digit) and p'' (units digit). An output gate is triggered ON when the glow in its associated dekatron passes zero and the gate is reset to OFF at the end of each subcycle. Thus in each subcycle the tens output gate transmits p' pulses to the accumulator and the units output gate transmits p'' pulses to the accumulator. Since these gates feed into corresponding tens and units inputs to the accumulator, the number $p'p''$ is added into the accumulator in each subcycle of step 5, thereby increasing the

total in the accumulator by $10(q')(p'p'')$ at the end of q' .

In the event that $q'=0$ it is necessary for the count-steps dekatron to skip quickly through step 5 to step 6 in order to observe the rule for multiplication by zero. This transfer from the end of step 4 to the beginning of step 6 must take place during the 120 msec delay separating steps. When $q'=0$ the glow in the multiplier tens register is already at the "0" cathode and this condition is detected with the help of a negative test-for-zero pulse which is transmitted through contact C5 50 msec after the end of step 4. If the glow already invests the "0" cathode, the rising edge at the end of the test-for-zero pulse passes through the coincidence gate, thereby advancing the count steps dekatron to "6" and re-initiating delay A.

Step 6: On the count of six relay D is energized, switching the output circuits from the multiplicand register one digit to the right (or shifting the accumulator one digit to the left). Relay A is also energized, thereby making the duration of step 6 dependent upon the magnitude of q'' .

The arithmetic operation in step 6 is similar to that of step 5, i.e., multiple addition of $p'p''$ into the accumulator. The accumulator total is increased by $q''(p'p'')$. Step 6 is complete when the multiplier units register arrives at zero in coincidence with the end of a subcycle. As before, all of the pulse gates are reset to OFF and the delays are initiated. The count-steps dekatron is reset to "1" through relay contacts C3 and A3, causing all relays to be de-energized. At this point tape reader No. 1 is again caused to advance one position to a new value of p' and a new computing cycle is started.

The test-for-zero circuit is also operative in step 6. Therefore if $q''=0$ the count steps dekatron will reset to "1" 50 msec after arriving at "6".

Routine No. 2,
$$\sum_{i=1}^{i=n} (p_i)^2$$

This routine is completed in four steps, corresponding to steps 1, 2, 5, and 6 of routine No. 1. Since data is required from only one source per computing cycle, data are placed in the multiplicand and multiplier registers

simultaneously in two steps rather than four. Therefore relay C is energized and multiplication begins in the third computing step, and the count steps dekatron is reset to "1" after the fourth step.

Routine No. 3,
$$\sum_{i=1}^{i=n} p_i$$

This routine is completed in three steps. In steps one and two values of $p'p''$ are transferred into the multiplicand register exactly as described under routine No. 1. Step No. 3 consists of one subcycle in which $(p'p'')$ is added into the accumulator once. Termination of step 3 in one subcycle is achieved by means of switch E, which in routine No. 3 permanently connects the zero circuit to a positive source.

4. Accessory Circuits

The component blocks of Fig. 2 described in the following paragraphs are accessories to the computing circuits.

4.1. Code Error Detector

Decimal digits 0 to 9 on the input data tapes are represented by two-out-of-five hole combinations in the punched tape. Since only ten different two-hole combinations are possible, any number of holes other than two constitutes an error. When an invalid code combination appears at a tape reader, the error detector interrupts the computing cycle by holding or inhibiting the output of delay B (70 milliseconds), thereby preventing the tens pulse-group gate from being triggered ON. Thus, a code error stops the apparatus at the beginning of a subcycle before any pulse-handling gate is opened.

4.2. Data-group Selector

The circuits contained in this block permit certain two-digit data groups to be selected from a prepared data tape, with the exclusion of all other groups.

Data group selection is achieved by means of a preset counter circuit and a gate controlled by the counter. The counter circuit can be preset to open the gate at any number M from 1 to 100. When an advance tape pulse starts the tape drive mechanism in tape reader No. 2, the photoelectric reader produces a marker pulse as each line of data reaches the reading

position. These pulses advance the counter one position for every two-digit group passing the reading photocells. On the second digit of the $(M - 1)$ th data group the gate is opened, so that the marker pulse for the first digit of the M th data group is transmitted through the gate, causing the tape-drive mechanism to stop. Thereafter, the tape-drive mechanism advances one line (digit) per pulse calling for advance tape until the counter is reset to (01).

Automatic or manual resetting of the counter in the data-group selector is optional. If manual resetting is employed, the counting and selecting routine takes place only once at the beginning of a calculation. That is, the selector causes tape reader No. 2 to begin with the digits of the M th data group and to read each consecutive data group thereafter. This mode of operation permits an automatic shift or displacement between data tapes one and two, thereby effecting the displacement in time (τ) which is necessary in autocorrelation and crosscorrelation computation.

When the data-group selector is set to be automatically self-resetting, this circuit selects only every M th data group from tape No. 2, skipping all others. This feature is particularly useful in computing coefficients for Fourier Series representation of a periodic function $f(x)$. If $f(x)$ is periodic of period T , then $f(x)$ has the Fourier series expansion

$$f(x) = \frac{a_0}{2} + \sum_{m=1}^{\infty} \left(a_m \cos \frac{2m\pi}{T} x + b_m \sin \frac{2m\pi}{T} x \right) \quad \dots\dots(7)$$

where

$$a_m = \frac{2}{T} \int_{-\frac{T}{2}}^{\frac{T}{2}} f(x) \cos \frac{2m\pi}{T} x \, dx, \quad m=1, 2 \quad \dots\dots(8)$$

and

$$b_m = \frac{2}{T} \int_{-\frac{T}{2}}^{\frac{T}{2}} f(x) \sin \frac{2m\pi}{T} x \, dx, \quad m=1, 2 \quad \dots\dots(9)$$

Equation (8) for the coefficient a_m consists of a product of two functions under the integral, just as in eq. (1) for the correlation function. Hence, the previously described basic method for numerical evaluation of the integral is again applicable. As before, the function $f(x)$ is sampled at regular intervals $x_1, x_2, x_3 \dots x_n$,

leading to a set of ordinates $p_1, p_2, p_3, \dots p_n$. Similarly, a cosine wave of period T is sampled at the same regular intervals x_1 leading to a second set of ordinates $q_1, q_2, q_3, \dots q_n$. The coefficient a_1 is then given by

$$a_1 = 2 \sum_{n=1}^n p_i q_i \quad \dots\dots(10)$$

which can be readily evaluated using computing routine No. 1. The same procedure is followed for evaluating coefficient a_2 , except that one uses a new set of ordinates $r_1, r_2, r_3, \dots r_n$ of a cosine wave of period $T/2$ in place of the ordinates q_1 . Rather than prepare a new set of ordinates r_1 , it is convenient to:

- (a) make an endless loop by connecting the beginning and end of the tape bearing the ordinates q_1 ,
- (b) select every second data-group from the tape, and
- (c) traverse the tape twice.

If the data-group selector is set to $M=2$ (self-resetting), parts (b) and (c) of this procedure are automatically achieved.

Coefficients $a_3 \dots a_m$ may be evaluated in the same manner by performing the summation with the data-group selector preset to select every M th ordinate, where $M=3 \dots m$. Similarly, coefficients b_m may be evaluated using the same tapes for p_i and q_i , except that the q_1 tape is started $n/4$ ordinates from the joining point on the cosine tape. The latter displacement corresponds to the $\pi/2$ lag between the sine and cosine curves.

4.3. Computing Cycle Counter

This circuit counts the number of multiplication cycles (or separate products) which contribute to the sum in the accumulator. The counter advances one position for every time the count steps dekatron is reset to "1".

5. Bibliography

The author's thesis on this subject for the degree of M.Sc., which includes detailed circuit information, is deposited in the Library of Birmingham University.

6. Acknowledgment

The author is indebted to Dr. D. A. Bell for his guidance during the course of the project and to Messrs. J. C. Cluley and J. W. R. Griffiths for helpful suggestions.

DISCUSSION

Dr. J. H. Westcott*: In view of the order of accuracy that Mr. Hoge requires from his device I wonder whether the hundred subdivision in the amplitude of signals was really justified. In measuring correlation functions one takes the mean. It seems not to be generally realized just how crude the assessment of the individual product may be in order to give quite tolerable engineering accuracies in the final result.† I think it would be true to say that four amplitude levels would have been quite adequate for Mr. Hoge's correlator application.

R. R. Hoge (in reply): It must be admitted that the specifications for the product accumulator were formulated in relation to the feasible degree of elaboration of the equipment rather than to the requirements of particular classes of problem. But although a coarse quantization suffices for the type of work considered by Widrow, there are several reasons for desiring an even greater accuracy than the two decimal digits so far provided.

(1) Unless one undertakes the labour of scaling the initial data, one is liable to find the variable ranging say between 10 and 50, so that more than half the available range 0—100 is wasted.

(2) The machine does not accept negative values, so that one cannot subtract the mean

value from the initial data. One subtracts instead sufficient to bring the least value near zero. One must then evaluate a cross-correlation from a difference of the form $\Sigma xy - \bar{x}\bar{y}$, and the presence of a difference exaggerates the effect of rounding errors in the individual terms.

(3) The use of Sheppard's corrections for grouped data, as recommended by Widrow requires that (a) the sample contains many elements and (b) the distribution function be not only continuous but also rather slowly asymptotic to zero for large departures from the mean.

(4) Only if the variables do not change in general level over the range to be correlated can one be sure that the available digits will be *significant* digits throughout.

In evaluating the correlation between experimental series, e.g. series of economic indices, or small-sample input/output relationships in closed-loop systems, the number of items in a complete series may be in the range 10 to 100. This is too few to provide satisfactory smoothing of rounding errors.‡

In using the auto-correlation as an intermediate step between time function and power spectrum, e.g. to determine the power spectrum over a wide range of frequency of a relaxation process of which the decay law is not a simple analytic function, one wishes to form products of ordinates which may decrease by several powers of ten between the beginning and end of the sequence.

I therefore anticipate that all the available accuracy of the apparatus will be of service at one time or another.

* Imperial College of Science and Technology, London.

† B. Widrow, "A study of rough amplitude quantization by means of Nyquist sampling theory," *Trans. Inst. Radio Engrs (Circuit Theory Group)*, CT-3, No. 4, p. 266, December 1956.

‡ R. S. Burington and D. C. May, "Handbook of Probability and Statistics" p. 59. (Handbook Publishers, Inc., Sandusky, 1953.)

GRADUATESHIP EXAMINATION—NOVEMBER 1957—PASS LISTS

These lists contain results for *all* successful candidates in the November Examination. A total of 389 candidates entered for the examination which was held at 58 centres. This number includes 117 candidates attempting parts of the examination in order to complete qualification for election to Graduateship or Associate Membership of the Institution.

LIST I

The following candidates having completed the requirements of the Graduateship Examination, are eligible for transfer or election to Graduateship or higher grade of membership.

Candidates in Great Britain

FULTON, Edward Ian Whittenham. *London*.
 GALLIVER, Geoffrey Edward Lewis. (S) *London*.
 GEORGE, Julian. (S) *London*.
 HALTON, Dennis Lewin. (S) *London*.
 HORN, Peter Jack. (S) *London*.
 KONIECZNY, Gustaw. (S) *London*.
 LUFF, William. (S) *London*.
 NEWMAN, Henry John. *London*.
 NICHOLS, Basil Hopes. (S) *Newcastle*.
 PREEDY, John. (S) *London*.
 REIDY, Kevin John. (S) *London*.
 SNASHALL, Gerald Herbert. (S) *London*.
 SPENCER, Godfrey Stanley Gibson. (S) *London*.
 SYMONDS, Robert Frank. *Bristol*.
 TURNER, Dennis John. (S) *London*.

Overseas Candidates

CAMPBELL, Gordon Jarvis. *Oslo*.
 EXARCHOS, Vladimir. (S) *Athens*.
 GURDIAL, Singh Khillon. (S) *Kuala Lumpur*.
 HOLTZHAUSEN, Petrus Johannes. (S) *Johannesburg*.
 ISLAM, Sayed Sultan-ul. (S) *Rawalpindi*.
 JAIN, Gian Chandra. (S) *Delhi*.
 KAMAL, Jit Singh. (S) *Delhi*.
 LAKSHMANAN, Krishna. *New Delhi*.
 LAKSHMINARAYANAN, Thirunillai Mahadevan. (S) *Hyderabad*.
 LUND, Hugh Forsyth. (S) *Durban*.
 NARASIMHACHAR, Mandayan Kannannan. (S) *Calcutta*.
 SIMHI, Menashe. (S) *Tel-Aviv*.
 SMIT, Cornelis. (S) *Delhi*.
 SRINIVASAN, Ramachandran. (S) *Bangalore*.
 WASSENAAR, Dirk Jan. *Delft*.

LIST 2

The following candidates were successful in the parts indicated

Candidates in Great Britain

ADAMS, William Edward. (3) (S) *London*.
 BACON, Roy Harold. (1) (S) *London*.
 BEALE, Stanley George. (3) (S) *H.M.S. Collingwood*.
 COLLINS, Cyril Raymond. (1) (S) *Glasgow*.
 CRIDLAND, William Wyndham. (4) (S) *Manchester*.
 DUNNETT, Paul Wesley. (1, 2, 3) (S) *Bristol*.
 GRICE, William Henry. (1) (S) *London*.
 HELSZAJN, Josef. (1) (S) *London*.
 HISCOCK, David John. (2) (S) *Birmingham*.
 HOPKINS, Roland Michael Terrence. (3) (S) *London*.
 HORE, John Reginald. (1, 2) (S) *London*.
 HOWARD, Alwyn George. (1) *Birmingham*.
 HOWES, Bentley Arthur. (3) (S) *London*.
 KEMP, Paul Courtney. (1) (S) *Plymouth*.
 LARGE, Douglas Blake. (4) (S) *London*.
 NEWNHAM, Neville Jack. (2) (S) *London*.
 O'CONNOR, Joseph Francis. (3) *Manchester*.
 OSBORN, James Philip. (2, 3) (S) *London*.
 PANTHAKY, Jal-Khurshed. (4) (S) *London*.
 RICE, Mathew Joseph. (4) (S) *Dublin*.
 RINTOUL, Donald Alexander. (1) (S) *London*.
 SHIPGOOD, Frederick John. (3) (S) *London*.
 THOMAS, Philip Robinson. (2, 3) (S) *London*.
 WHITEMAN, John. (4) (S) *Birmingham*.

JONES, K. P. (4) (S) *Bangalore*.
 KAPOR, Onkar Nath. (3) (S) *Lucknow*.
 KHAMBADKNOR, Murlidhar Ramrao. (2) (S) *Bombay*.
 KHATRI, Dindayal Tahltam (2) (S) *Bangalore*.
 KOHLI, Suraj Parkash. (1) (S) *Delhi*.
 LEE CHING CHIN. (1, 2, 3) (S) *Hong Kong*.
 LEVI MINZI, Gad. (3) (S) *Tel-Aviv*.
 LOBO, James Joseph. (2, 3) (S) *Bombay*.
 MALHOTRA, Madan Mohan. (4) (S) *Delhi*.
 MANJE GOWDA, N. S. (4) (S) *Bangalore*.
 MARATHE, Yashvant. (4) (S) *Bangalore*.
 MARIOUW, Rudi Gijbert Ferdinand. (4) (S) *Delft*.
 MASHIAH, Baruch Elic. (1) (S) *Tel-Aviv*.
 MEHTA, Ardash Kumar. (1) (S) *Bangalore*.
 MEYER, Leighton Francis. (3) (S) *Wellington*.
 MITRA, Gobinda Lal. (2) (S) *Kanpur*.
 MOORJANI, Motiram Issarsing. (2) (S) *Bombay*.
 MUTHURAGHAVAN, Navaneetham (4) (S) *Bangalore*.
 NARISIMHAN, Villiambakkam Venkatachari. (2, 3) *Delhi*.
 NARAYANMURTHY, Kalamber Veeraraghavan. (2) (S) *Madras*.
 NICE, Richard Keith. (4) (S) *Essen*.
 NURTON, George. (2) (S) *Zomba*.
 OBERAI, Harbans Singh. (1) (S) *Bangalore*.
 PAL, Ranendra Nath. (3) (S) *Calcutta*.
 PANCHAPADESAN, Ramachandra. (4) (S) *Madras*.
 PARAMESWAREN NAMBUDIRI, K. S. (3) (S) *Madras*.
 PARDASANI, Roche Ramchand. (3) (S) *Bombay*.
 PULLAPERUMA, Don Gilman. (3) (S) *Colombo*.
 PUNIA, Atma Singh. (3) (S) *Agra*.
 RAJAGOPAL, A. (4) (S) *Bangalore*.
 ROY, Biman Bihari. (4) (S) *Calcutta*.
 RUBEN, Moshe. (4) (S) *Tel-Aviv*.
 SADASIVA DASS. (2) (S) *Delhi*.
 SAUNDERSON, John Joseph. (1) (S) *Woomera*.
 SAYWELL, John Stephen. (1) (S) *H.M.A.S. Albatross*.
 SCHUITEMAKER, Jozef Johannes. (2) (S) *Delft*.
 SHAH, Ramesh Chandra Paramanadas. (4) (S) *Bombay*.
 SHARMA, Kamal Kishore. (1) (S) *Kanpur*.
 SHUKLA, Ratan Prakash. (2) (S) *Delhi*.
 SOOD, Omkar Nath. (4) (S) *Dehra Dun*.
 SUJAN, Chander Sobhraj. (3) (S) *Bombay*.
 TALWAR, Satish Kumar. (2) (S) *Delhi*.
 TARLOCHAN SINGH. (4) (S) *Agra*.
 TEMBE, Shivram Ramchandra. (3) (S) *Bombay*.
 TERZOPoulos, Christos. (3) (S) *Athens*.
 THADANI, Hiro K. (4) *Delhi*.
 TOEG, Haim. (2) (S) *Tel-Aviv*.
 VASUDEVAN, V. (4) (S) *Bangalore*.
 VIRINDER SINGH. (2) (S) *Bangalore*.
 VIRDI, Harbas Singh. (4) (S) *Lucknow*.
 WRIGHT, Frank William. (1) *Kirkuk*.

Overseas Candidates

AHMAD, Habeeb. (1) (S) *Bombay*.
 ANAND, Sham Lal. (3) *Delhi*.
 ANANTHANARAYANAN, Subramanya. (4) (S) *Madras*.
 ASLAM, Mohammad. (3) (S) *Rawalpindi*.
 BALASUBRAMANIAN, Venkatram. (4) (S) *Calcutta*.
 BEN DOR, Baruch. (4) (S) *Tel Aviv*.
 BHATTACHARYA, Dilip Kumar. (4) (S) *Delhi*.
 BHOGENDRA KRISHNA, V. K. (2) (S) *Bangalore*.
 BHOWMIK, Sital Chandra. (2, 3) (S) *Delhi*.
 CHANDRASEKHARAN, Chempath. (1, 3) (S) *Madras*.
 CHATTERJEE, Jatindra Mohan (2) (S) *Kanpur*.
 DEEKSHITULU, R. S. V. Y. (1) (S) *Bangalore*.
 DONENFOLD, Adolp. (1, 2, 3) (S) *Israel*.
 DUGGAL, Didar Singh. (2) (S) *Agra*.
 FONG YAN, Alick. (4) *Hong Kong*.
 GURCHARAN SINGH SURIE. (4) (S) *Bangalore*.
 HANDA, Jagdish Rai. (4) (S) *Delhi*.
 HANS RAH SINGH SIWACH. (4) (S) *Delhi*.

(S) denotes a Registered Student

DEVELOPMENTS IN COMPONENT DESIGN

A further selection of papers read at the International Symposium on Electronic Components, Malvern, September 1957.

Some Recent Developments in Magnetic Alloys

C. E. Richards*

Mr. Richards introduced the subject by saying that the realization that magnetic materials having comparatively low coercivity and yet with an almost ideal rectangular hysteresis loop can be made is of relatively recent origin. It was used by Keppelman in 1941 in the development of a mechanical rectifier.

Rectangular loop materials can be made in at least three ways: Grain orientation brought about by heavy cold rolling, domain orientation by annealing in a magnetic field, and the production of ultra-thin strip.

Mr. Richards then described the manufacture of 50/50 nickel iron alloys and stressed the importance of the annealing temperature. He discussed domain orientation of material and suggested that alloys containing 65–68% nickel with the balance iron can give very good rectangular hysteresis material. Increased resistivity can be provided by including small amounts of

molybdenum or tungsten. He gave tables of the effects of coercivity on remanence ratio and B_{max} by additions to the basic 65/35 nickel-iron alloys.

High permeability materials were discussed at some length and their uses in a shift register or matrix stores given. Mr. Richards mentioned thin films on which work was being done in the U.S.A. and in this country. It has been found that the switching time of films less than three microns thick is almost independent of thickness. He discussed high permeability alloys and some recent introductions, emphasizing the different meanings of certain trade names which are internationally accepted. He stressed the importance of composition in these alloys and said that an error of not more than 0.02% in the nickel content caused the fall of about 1/6 of the permeability obtainable under given conditions. He referred to the recent British Government Advance Specification DEF.5192 for high permeability magnetically soft alloy which is believed to be the most advanced of its kind in that it prescribes the exact heat treatment to be given to a sample, the method of measurement and the result to be expected.

* G.P.O. Research Laboratories, Dollis Hill, London, N.W.2.
U.D.C. No. 621.318.1

Magnetic Pulse Generators

D. W. R. Sewell*

The paper describes a new magnetic technique for the production of recurrent pulses for such purposes as radar modulation, nuclear particle acceleration, impulse testing and sub-modulators for arc initiation in ignitrons, etc. The technique eliminates the need for unreliable discharge devices such as thyratrons and spark gaps, in many applications.

This magnetic technique exploits the properties of "rectangular hysteresis loop" magnetic core materials. Such cores, suitably wound, possess certain switching properties and are the main circuit elements. They are known as "pulsactors" and have been defined as "saturable reactors"

having properties which suit them for the functions of a discharge device.

A description was given of the mode of action of an elementary pulsactor circuit. This was followed by a description of the "Melville line," this being the circuit arrangement of a number of elementary pulsactor stages connected in cascade to give the desired short pulse width. Generated pulses can be unidirectional or bi-phase, squared or "unformed", and examples were given of some Melville line applications.

Some of the latest developments in pulsactor circuitry were mentioned, in particular the transformer-pulsactor connection which has practical advantages in high voltage circuits. The paper concluded with a note on desirable qualities for pulsactor core materials.

* The British Thomson-Houston Co., Ltd., Rugby.
U.D.C. No. 621.373.443.

Design of Magnetic Amplifying Circuits

B. W. Glover and D. A. Ramsay*

The elementary principles of the auto half-wave Ramey magnetic amplifier were first discussed. Waveforms of the output show that it is essentially the half-wave rectified a.c. supply voltage. The power gain is affected by the size and design of the transductor element, but an upper limit is set by the properties of the core material. In practice, power gains of 50 have been attained with a 2400 c/s supply. This amplifier is called a half-cycle response or high-speed amplifier to differentiate it from the conventional type of amplifier which has a response time of the order of 10 cycles of the supply frequency. Mention was made of the former circuit using a transistor control element in which the signal and power amplifying properties of the transistor are cascaded with those of the magnetic amplifier.

As regards components for these amplifiers, maximum gain and linearity are obtained by using the best B/H square loop core materials; silicon junction diodes are of particular importance

* The General Electric Co. Ltd., Stanmore, Middlesex.

U.D.C. No. 621.375.3; 621.375.4

because of their very low reverse currents; transistors of the silicon type are preferred as then the whole unit may operate in ambients of 150°C; the tantalum electrolytic is important in this application as capacitors of a high value are required. An application of the transistor controlled Ramey amplifier in the form of a stabilised power pack was then described.

The authors then gave details of the conventional bridge auto-self-excited amplifier which has a slower response than the Ramey type but higher power gains (e.g. 10^6), and good zero stability. This was followed by a conventional push-pull amplifier but with high impedance input and therefore suitable to be preceded with a transistor stage.

Descriptions of other circuits were given which basically are the normal self-excited type but have been modified by the methods of Maine and Ramey to produce half-cycle response. In a full-wave system power gains of 200 per stage at 400 c/s have been obtained.

These circuits show the trend is to obtain a very fast response but with higher gains, suitable for use in all closed loop servo systems.

A Short Time-Constant Switching Mechanism and its Application to Communication Techniques

Dr. H. Salow and Dr. Walderman von Munch*

There is no doubt that semiconductor devices will play an important role in telecommunication as well as in digital computer techniques. Apart from elements used for amplification, there is need for semiconductor devices suitable to serve as electronic switches. Diodes and transistors may be used for this purpose, but they have no memory, i.e. a permanent signal must be fed to them as long as a certain switching state—off or on—is to be maintained. Some semiconductor devices are already known, which can be operated in bi-stable circuits, e.g. the point contact transistor, the hook transistor and the double base diode. Such an element should have a response time less than one micro-second, it should stand a high power dissipation, and—last but not least—low production costs are desired. A method was described which results in a semiconductor

switching device to meet these conditions.

Dr. von Munch then gave a description of a new type of transistor switching device, in which an n-p-n transistor was used. In this device a "whisker" was inserted through the barrier between the conduction layers in the germanium so providing positive feed-back from the collector to the base electrode. As a result the unit can operate in either of two bi-stable positions and on receipt of a tracker impulse will pass exceedingly rapidly from one state to the other. This provides the essential feature of a switching mechanism of very small current and power consumption which can be used as a basis for a number of circuit applications, of which examples were given, a feature which the lecturer considered, in reply to questions, could be attributed to the establishment of a very strong field in the base. As a result the performance could normally be made fully comparable with the best which can be obtained from more conventional units in special circuits.

* Bundes Institut für Fernmeldungs-technik, Darmstadt, Germany.

U.D.C. No. 621.382.3

Recent Developments in Electrolytic Capacitor Design

G. C. Gaut*

Mr. Gaut reviewed first the history of electrolytic capacitor design. Progress in aluminium capacitors had been mainly in the purification of the materials used in their manufacture and further developments must depend on the ready availability of aluminium of 99.999% purity. He emphasized the difficulties arising in spacers in normal aluminium electrolytic capacitors. Electron micrograph slides were shown of the mechanism of film formation in aluminium, showing that during the process of anodisation the film is covered with a number of craters uniformly distributed so as to give a honeycomb-like appearance through which the oxide in a soluble form is believed to diffuse before it is finally solidified into a fully resistive crystalline structure.

Further progress was being made by the use of tantalum as a metal for anodisation. This could be prepared as a sintered spongy mass permitting the use of solid anodes and dispensing with

* Head of Research Laboratories, The Plessey Company, Caswell.
U.D.C. No. 621.319.45

the need for spacers; this allowed the use of concentrated sulphuric acid as an electrolyte. In this way units could be constructed capable of operating to much higher temperatures than had hitherto been the case whilst ensuring incidentally very low leakage at ordinary temperatures. The present units are of relatively low voltage and work is still in progress to produce a tantalum capacitor capable of operating to voltages as high as can be obtained by using aluminium.

Mr. Gaut then described solid electrolytic capacitors in which the operating electrolyte is replaced by a semiconductor. The anode consists of a porous pellet of tantalum powder sintered on to a tantalum wire. The oxide dielectric is formed by anodisation in boric acid and then covered by a layer of manganese dioxide produced by thermal deposition of manganese nitrate solution; a graphite coating is added and connection made between this and the negative terminal. This allows the unit to be potted in resin, and avoids the problem of loss of electrolyte with time.

Development of Plastic Dielectric Capacitors

J. H. Cozens†

Only one or two special plastics were discussed in this paper. In general, plastic materials are attractive alternatives to paper since they can be cast in very thin films and roughly the volume of a capacitor of a given capacitance is proportional to the square of the thickness. The construction of plastic capacitors is similar to a paper capacitor, either metallized film or foil construction being used. The most important film is polystyrene which is available in thicknesses down to 10 microns but, owing to the low permittivity of the material, the capacitor is large compared to that obtainable by using paper. Suitable heat treatment can stabilize the capacitance, giving a negative temperature coefficient of some 150 parts per million per degree centigrade. The loss tangent is very low and virtually independent of frequency, and the insulation resistance is very high, making these capacitors suitable for application in long time constant circuits and the like. There is a definite time of electrification corresponding to a very small charge of current which may persist up to any length of time provided that suitably sensitive

measuring instruments are adopted. The chief disadvantages of polystyrene is its low melting temperature, but attempts are being made to overcome this by formation of co-polymers. The polythene capacitor has generally similar properties, but the available films are not so thin and the resulting stability is less satisfactory.

The P.T.F.E. capacitor has been recently developed; it has many of the properties of polystyrene but the temperature range is much higher, reaching 200°C. It is prepared in thin films by casting or by slicing off a block, the latter giving the higher dielectric strength. Films down to 6 microns thick are available, but the permittivity is low, as is the breakdown strength, so that the capacitors tend to be bulky. Again, capacitance is independent of frequency, having a negative temperature coefficient of some 200 parts per million up to 120°C and then changing more rapidly. Losses are very low and persist low up to the highest frequencies. Dielectric absorption is similar to that found in polystyrene. Insulation resistance again is very high, but manufacturing difficulties limit the value which can be obtained. Further work aims at improving the dielectric strength and uniformity of the film.

† The Telegraph Condenser Co. Ltd., London.
U.D.C. No. 621.319.4

A Survey of Ferrites and their Applications

Dr. Ir. A. A. Th. M. van Trier*

Dr. van Trier confined his paper to a discussion of the magnetic properties of the low loss ferrites, having a composition $MO Fe_2O_3$ where M referred to such elements as manganese, zinc, or even a mixture of manganese and zinc†. These materials are magnetic but their saturation is much lower than is obtained with metallic material; thus the saturation of ferrites usually ranges from 500 to 5000 gauss, compared with some 20,000 for iron. This makes them unsuitable for power transformers and applications, where maximum energy must be achieved, but in certain other applications such as cabling and transformers in communication circuits (where low losses provide excellent compensating features, in particular at higher frequencies), the high conductivity of iron results in a strongly pronounced "screen effect" so that the flux can hardly penetrate the material. The relatively high resistance of ferrites permits a large penetration so that large volumes can be magnetised, even if to lower intensity.

The next point which Dr. van Trier brought out was that materials of high permeability at low frequencies have a relatively low frequency cut-off. The magnetic losses due to so-called ferro-

magnetic resonance are closely connected with a relatively high permeability at low frequencies. At microwave frequencies ferrites have found application because, owing to their high resistivity, they are capable of low losses under these conditions, while the magnetic effects causing loss at lower frequencies are no longer operative.‡ These microwave properties are connected with the so-called gyrotory precession of the electrons in a magnetic field, which gives rise to the different velocities of propagation for the left- and right-handed circularly polarized waves. By using this differential propagation it is possible to produce gyrators, differential attenuators and differential phase shifters. Very briefly, the characteristics of the medium for these purposes vary according to its principal states of magnetization at low fields—below saturation the loss is variable.

There follows a region between saturation and the so-called resonance field at which the precessional velocity of the electrons is of the same frequency as the microwave field applied. In this region, losses are low and it is particularly suitable for phase shifting applications. At gyro resonance one component of the wave can be completely eliminated. Above this strength frequency again differential propagation results are found.

Finally, Dr. van Trier referred to the existence of so-called square loop ferrite materials, in which the remanence is very high but which are readily brought to a state of saturation by triggering impulses of very short duration. These find application in computer circuitry.

* Formerly N. V. Philips, Eindhoven, now Professor of Electrical Engineering, Technische Hogeschool te Eindhoven, Holland.

† See also J. Salpeter, "Developments in sintered magnetic materials," *J.Brit.I.R.E.*, 13, page 499, October 1953.

‡ See also G. H. B. Thompson, "Ferrites in waveguides," *J.Brit.I.R.E.*, 17, page 311, June 1956.

U.D.C. No. 621.318.1

A Survey of Dielectric Materials

G. C. Garton*

The author limited his paper to just three special problems. First he referred to the effect of continued discharge on various materials. He emphasized in particular, that for a material approaching the limit of safe working, the essential feature would be the number of cycles of a.c. with their corresponding intermittent discharges which would have to be endured.

Secondly, he discussed the dependence of leakage properties on temperature, showing how materials ranged from bakelite, with its very poor insulation and large temperature coefficient, to

such materials as polythene which, subject to its tendency to melt, showed vastly increased performance not only in high resistance but also in its temperature dependence. Beyond this group, particular attention should be given to the behaviour of P.T.F.E., not only for its high intrinsic resistance at normal temperature, but on account also of its relative slow fall even up to 200–250°C, indicating the existence of special resistance mechanisms.

Finally Mr. Garton discussed the effect of silver migration in any materials in which normal conduction was possible as a major factor in producing rapid break-down.

* Head of Materials Division, Electrical Research Association, Leatherhead.

U.D.C. No. 621.315.616

. . . Radio Engineering Overseas

537.311.62
Research on the high-frequency surface discharge. TOSHIO HONDA. *Memoirs of the Faculty of Engineering, Kumamoto University, Japan*, 4, pp. 1-12, March 1957.

In practice, the behaviour of an h.f. surface discharge under an undamped field may be more important than that in the damped field. The author has studied the mechanism of the h.f. surface discharge with the aid of Lichtengerg's figures, and found that the progress of building up the h.f. surface discharge occurs in three principal stages in a successive sequence, namely discharges of types A, B and C. These three types may occur under the favourable conditions on the basis of current density in a streamer or a discharge path: the type A occurs under a high current density, the type C under a low, and the type B in the transition stage between them. These phenomena are similar to that of h.f. glow discharge in air under low pressure. The investigations are qualitative rather than quantitative owing to the extreme complication of the phenomena, and the difficulty of the exact experiment.

621.317.75.015.1
A recurrent surge oscillograph for surge-voltage distribution measurements on transformers. F. C. HAWES. *Proceedings of the Institution of Radio Engineers, Australia*, 18, pp. 462-467, December 1957.

The apparatus comprises a thyratron surge generator combined with a c.r.t. display unit. The generator supplies the transformer with test pulses which rise to a maximum of 450V in 1 microsec and decay to one half this value in 50 microsec ("1/50 microsec wave") at a repetition of 50 per sec. The display unit, consisting of a measuring probe, a variable capacitance attenuator, video amplifier and double-beam cathode-ray tube, provides simultaneous comparison of the waveshape at any point along a winding with the applied voltage wave or with a timing wave. Means are provided for measuring the voltages on taps of windings as a percentage of the applied voltage. The instrument features simple design and construction from readily available components.

621.317.77:621.372.5
An accurate phasemeter for four-terminal networks. B. CHATTERJEE. *Indian Journal of Physics*, 31, pp. 541-552, November 1957.

This paper is a continuation of a previous one (1956) in which the principle of working of an accurate phasemeter for four-terminal networks was discussed. The present paper gives the details of measurement with such a phase meter at audio and radio frequencies. Arrangements for both balanced and unbalanced types of networks are explained and the circuit diagrams are also given. The absolute accuracy of measurement is about 1 deg and a small change in phase can be measured with an accuracy of about 0.1 deg. Modifications necessary for making different types of measurement as well as the high-frequency limit of the meter are also discussed.

621.372.2
Wave diagrams in waveguides with diaphragms or corrugations. G. PIEFKE. *Archiv der Elektrischen Uebertragung*, 12, pp. 26-34, January 1958.

The influence of corrugations or diaphragms at periodical intervals in a circular lossless waveguide is theoretically investigated. The spacing of the

A selection of abstracts from European and Commonwealth journals received in the Library of the Institution. Members may borrow these journals under the usual conditions. All papers are in the language of the country of origin of the journal unless otherwise stated. The Institution regrets that translations cannot be supplied.

corrugations or diaphragms, i.e., the thickness of the diaphragms plus their interval, is assumed to be far smaller than the guide wavelength. For the H_{0n} and E_{0n} modes formulas for calculating the propagation constant are given and explained by reference to curves. With the H_{0n} modes the corrugations or diaphragms have no effect but they have great influence with the E_{0n} modes. At a certain frequency the phase velocity of the E_{0n} modes can sometimes be higher as well as lower than the velocity of light. In the latter case a delay line with very narrow pass bands is obtained. If the depth of the corrugations or diaphragms is $\frac{1}{4}$ of the wavelength in free space, the E_{0n} mode has the same phase velocity as the H_{01} mode. The impedance for coupling to an electron beam is calculated.

621.373.5
Construction and characteristics of high quality quartz crystals. G. BECKER. *Archiv der Elektrischen Uebertragung*, 12, pp. 15-25, January 1958.

Design details are given concerning shape, processing, supporting, binding, and electrode configuration of the control crystals in the new crystal clocks of Physikalisch-Technische Bundesanstalt. Measured results are given for oscillating performance, parameters of the equivalent circuit, dependence on amplitude of the frequency, mechanical stability, influences of electrode shape on frequency, and influence of the vacuum on frequency and Q-factor. Further information relates to temperature coefficient, frequency trimming, frequency aging, frequency stability, and the method of frequency control of the crystal resonators.

621.375.1
A transformerless class B power amplifier with identical transistors. M. FEDOROWSKI. *Prace Instytutu Tele- i Radiotechnicznego*, 1, no. 3, 1957.

A single-ended push-pull a.f. power amplifier (output stage) with transistors of the same conductivity type is analysed. After a short discussion on merits of a.f. power amplifiers of different types, the advantages of the transformerless output stages are given. The analysis of circuit operation contains the method of calculation of the load resistance value which is optimal from the standpoint of maximum power output at predetermined d.c. main voltage, peak collector current and power dissipation ratings on the transistor, as well as the method of determination of input impedance and driving power from the characteristics of a transistor.

621.376.5
Theoretical considerations concerning the frequency compression of periodically recurring processes. R. A. KAENEL. *Nachrichtentechnische Zeitschrift*, 10, pp. 618-626, December 1957.

The frequency band compression of periodically

recurring processes is investigated theoretically on the basis of the sampling theorem. The requirements resulting from this, as far as the sampling frequency and the spectrum of the sampling pulse train are concerned, are quoted with a view to a practical realization of such a compression equipment (sampling circuit).

621.385.16

The focal length of a diaphragm of finite aperture for electron fields with finite space charge. K. POSCHL and W. VEITH. *Archiv der Elektrischen Übertragung*, 12, pp. 45-48, January 1958.

The paper deduces an improved formula for the focal length of an apertured diaphragm through which a cylindrical stream of electrons is sent. The formula takes into consideration the focal-length reducing effects of the finite aperture of the diaphragm on the one hand and of space charge on the other. Also given is an extension of the formula which contains the influence on to the focal length of a longitudinal magnetic field serving for guiding the beam.

621.387.424:535.215

Photoionization versus photoelectric effect for discharge spread and output pulse measurements in G-M counters. P. S. GILL and S. P. PURI. *Indian Journal of Physics*, 31, pp. 564-571, November 1957.

The probability of discharge spread versus overvoltage has been measured in a multicathode, single-anode counter by keeping dead the space across which the discharge spreads. The pulse size versus voltage curves for the externally coated counters, reveal that the operation of soft glass type is analogous to that of the conventional counter, whereas in case of pyrex counter, the deposition of the positive ions across the inner glass surface develops an opposing e.m.f., which varies linearly with the overvoltage. Discharge spread probability has also been studied as a function of overvoltage in a multi-cathode, segmented counter, using beads sealed on to the wire. The beads suppress the photoionization contribution by reducing the field around them, thus eliminating altogether the photoionization near the immediate vicinity of the wire, which, in normal operation, contributes to the stepwise discharge spread. The photoelectric effect responsible for discharge spread remains negligibly feeble but constant over an overvoltage of about 400 volts in the case of present counter with the rare gas-organic vapour admixture.

621.396.62:621.382

A high-quality transistor receiver. A. E. PEPPERCORN. *Proceedings of the Institution of Radio Engineers, Australia*, 18, pp. 457-462, December 1957.

An a.m. superheterodyne receiver using ten junction transistors is described. The frequency range is 750 to 2,750 kc/s. Normal tuning capacitors are used without band-switching. The set is capable of delivering one watt of high-quality audio output from a power supply consisting of two 4½ volt batteries. Provision is made for heterodyne reception of c.w.

621.396.65.029.634:621.396.11

Microwave Links. *L'Onde Electrique*, 37, November 1957. A Special Issue containing the following papers: **The TH 949 medium range tropospheric scatter link.** (400-500 Mc/s). J. ILTIN and P. CHAVANCE. (pp. 1036-1044).

Diversity systems and reliability in tropospheric scatter links. P. CHAVANCE. (pp. 1045-1048).

Principles of radio climatology. F. DU CASTEL and P. MISMÉ. (pp. 1049-1052).

The use of ultra short waves for long distance telephone links in Africa.—F. DU CASTEL. (pp. 1025-1035).

Special problems in the production of the GDH 103 equipment. (70 Mc/s). Messrs. DORBEC and LEVY and Messrs. DELON, KOREICHO and FRANCOIS. (pp. 964-975).

Some aspects of the GDH 103 radio link equipment. M. CHAUX and DENIS. (pp. 976-984).

Large capacity radio links in the 7,000 Mc/s band. J. POLONSKY and E. SAFA. (pp. 985-1003).

The FHT 4003 radio link equipment (3,800-4,200 Mc/s). A. LAURENS and J. D. KOENIG. (pp. 1004-1017).

The FHT 4003 remote control equipment for radio links. M. RASTELLO. (pp. 1018-1021).

Six-channel frequency modulated links (for FHT 4003). J. D. KOENIG. (pp. 1022-1024).

Radio links in 1957. R. SUEUR. (pp. 915-918).

New radio link systems of the Administration des P.T.T. (3,800-4,200 Mc/s). L. J. LIBOIS and M. THUE. (pp. 919-936).

Radio links of Radiodiffusion Television Française. (3,800-4,200 Mc/s). Y. ANGEL. (pp. 937-947).

New time division multiplex systems. F. D. DAYONNET. (pp. 948-963).

621.396.662:621.396.933

The power level control in transmitters for the instrument landing system (ILS). K. MAY. *Nachrichten-technische Zeitschrift*, 10, pp. 612-616, December 1957.

The transmitters for the instrument landing system, the approach course and glide path transmitters are fitted with power level controls which permit the adjustment of the energy for the centre aerials (carrier and sidebands) of the approach course transmitter and for the side aerials of the glide path transmitter. In practical applications it has been found that level changes in the approach course transmitter have produced unwanted phase shifts which did not occur during level changes in the glide path transmitter. The construction is described and the principles as well as the properties of the level control are determined as far as they result from changes of the control adjustment.

621.397.335

On the behaviour of synchronization circuits in television broadcast receivers in the presence of interference. EDUARD LUDICKE. *Archiv der Elektrischen Übertragung*, 12, pp. 8-14, January 1958.

The paper discusses methods by which the susceptibility to noise of the horizontal and vertical sweep control system in simple television receivers can be considerably reduced. These methods are:

- (1) Selection of the sync. pulses from the composite video signal by amplifiers of distinct saturation properties and predetermined time constant, or
- (2) separation of the horizontal and vertical sync. signals by integrating networks. Guiding rules are also developed for,
- (3) suitable tuning and proportioning of the self-controlled relaxation oscillators for control of the sawtooth sweep of the electron beam.