

No. 2

BERNARDS RADIO SERIES

1/-

HAM NOTES

FOR THE HOME CONSTRUCTOR

CONTENTS

THE R-9'ER

PERFORMANCE CHARACTERISTICS
CIRCUIT DETAILS
CONSTRUCTIONAL DETAILS
OPERATING ADJUSTMENTS

Complete with Photographs and Diagrams

GADGETS

AUDIO OSCILLATOR
CIRCUIT DETAILS
CONSTRUCTION
TESTING

VOLT-OHMMETER

OHMMETER CALCULATIONS
VOLTAGE CALCULATIONS
CONSTRUCTION
CALIBRATION

Complete with Photographs and Diagrams

Messrs. Bernards 'Ham Notes' series is based on the General Electric 'Ham News' and R.C.A. 'Ham Tips' of America.

BERNARDS (PUBLISHERS) LIMITED
LONDON

THE R-9'ER

One-Tube Preamplicr Automatically Matches Antenna ELECTRICAL CIRCUIT

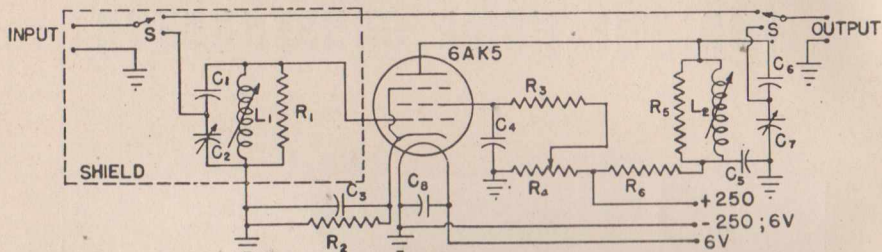

Fig. 1—Circuit Diagram of the R-9'er

COMPONENTS

C_1, C_6	—5 mmf fixed ceramic	R_1, R_5	—7,000 ohm, $\frac{1}{2}$ watt
C_2, C_7	—100 mmf variable (Cardwell ZU-100-AS)	R_2	—200 ohm, 1 watt
C_3, C_4, C_5, C_8	—500 mmf 400 volt mica	R_3	—15,000 ohm, $\frac{1}{2}$ watt
* L_1, L_2	—Slug-tuned ceramic form (Millen No. 69041)	R_4	—25,000 ohm, 4 watt potentiometer (Mallory M25MP)
	10 metres—16 turns No. 25 enam. close wound	R_6	—10,000 ohm, 1 watt
		S	—D.P.D.T. wafer switch (Mallory 3222)

* **NOTE:** Constructors in Great Britain should use "Neosid" coil formers, Type Drg 450 and cores Type Drg. 400, Ref. 900. Winding data as follows, 10 metres, 11 turns 24 S.W.G. close wound, and 20 metres, 29 turns 24 S.W.G. close wound. Available from Neosid Ltd., 23/25 Hyde Way, Welwyn Garden City.

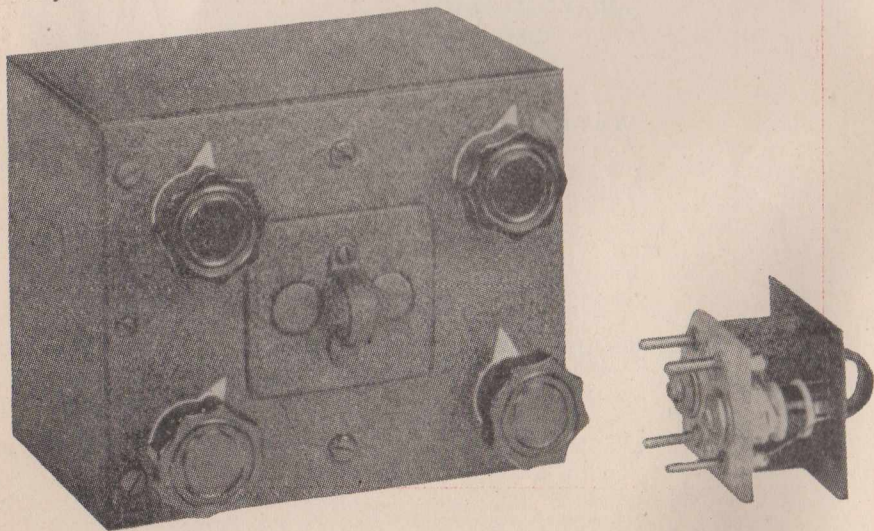

Fig. 2—Front View of R-9'er and Plug-in Coil

ARE you having trouble picking those weak dx signals out of the noise? The R-9'er, using a single General Electric 6AK5 miniature tube, is designed to do exactly that. The R-9'er is an electronic impedance-matching device and a broad-band pre-amplifier, designed to work primarily on the 10 metre band. (For the benefit of Constructors in Great Britain, Messrs. Ferranti will shortly be producing Type 6AK5.)

PERFORMANCE CHARACTERISTICS

The gain which can be achieved by this unit depends upon how well your antenna is matched to your receiver, but the minimum gain which may be expected is 30 decibels—about 5 R's! This gain comes about in two ways. The R-9'er, once it is tuned, automatically matches your receiving antenna to your receiver. In the usual ham shack this problem is not given much consideration, but a tremendous gain can be obtained by a proper match. The problem is doubly important on the 10 metre band, as at this frequency the input impedance of the receiver may vary widely from its stated value. For example, a widely known communication receiver, stated to have an input impedance of 250 ohms, actually had an input impedance of 1,500 ohms on 10 metres. Tests made recently show that the average gain experienced, merely by properly matching the receiving antenna, is from several db to as high as 30 db.

In addition to this gain, the 6AK5 miniature tube acts as a broad-band r-f amplifier stage, giving an additional gain of approximately 30 db. This tremendous gain is possible only because of the electrical characteristics of the 6AK5. This tube has a transconductance of 5,000 micromhos, which means that a voltage gain of approximately 35 can be achieved with a plate load of 7,000 ohms, as used in the R-9'er. This amount of gain has been available only by former tubes at narrow band widths and with higher noise levels. The General Electric 6AK5 has been designed to give these high gains at wider band widths and at lower noise levels.

Here then is what the R-9'er will do for you—60 decibels gain (or more) if your present receiving antenna is not matched, or, assuming it is perfectly matched, a 30 decibel gain. In tests conducted at W2RDL's shack, the R-9'er brought in signals which could not ordinarily be heard even with the use of the BFO!

CIRCUIT DETAILS

Referring to Fig. 1, the circuit consists essentially of a broad-tuned grid and broad-tuned plate circuit, a standard cathode bias system, and an adjustable screen supply. The grid and plate circuits are identical except that capacitor C_5 is employed as a plate blocking capacitor so that the plate tuning capacitor may be grounded.

In the grid circuit, capacitors C_1 and C_2 form the impedance matching network. A regular two-wire transmission line from the receiving antenna is brought to the input terminals, or a single wire antenna may be used and connected to the input lead which connects to the junction of C_1 and C_2 . Inductance L_1 must be tunable so that resonance may be achieved after C_2 has been adjusted to match the antenna. Once C_2 and L_1 , as well as C_3 and L_2 have been set, no further tuning is required for operation on that particular band.

With the constants shown, the R-9'er will match any input and output between 16 ohms and 2,700 ohms. This may be calculated:

$$\text{Impedance} = \frac{7,000}{\left(\frac{C_1 + C_2}{C_1}\right)^2}$$

The same formula may be applied to the plate side by substituting C_6 for C_1 and C_7 for C_2 .

All constants given must be strictly adhered to in duplicating the R-9'er, as even the values of the by-pass capacitors are important. R_1 and R_5 must be 7,000 ohms, as the band-width will be altered and the impedance formula changed if different values are used.

The band-width of the R-9'er with the constants as shown is approximately two megacycles on ten metres (28-30 Mc), dropping off only one or two db at each end of the band when it is peaked in the centre of that band-width.

The plate voltage is not critical, and any voltage available in your receiver will operate the 6AK5 satisfactorily.

CONSTRUCTIONAL DETAILS

The R-9'er is built in a 3 by 4 by 5 inch box, with all component parts mounted on the front panel. Figs. 3 and 4 show the essential details of construction. The switch, S, and the potentiometer, R₄, are the two controls on the upper part of the front panel with capacitors C₂ and C₇ being mounted directly beneath.

The coil box occupies the central portion of the box, and is so arranged that the main support on the coil form, a piece of $\frac{3}{8}$ inch by $1\frac{1}{2}$ inch aluminium, $\frac{1}{4}$ inch thick, just fits into the central shield on the box, which is also made of $\frac{1}{4}$ inch thick aluminium. With the coil plugged into the R-9'er, a solid shield is thus formed which completely isolates the grid section from the rest of the circuit. It is very important to have complete shielding between grid and plate. The polystyrene base on the coil is $1\frac{3}{4}$ inch by $1\frac{1}{2}$ inch, and the aluminium front of the coil measures 2 inches by $1\frac{3}{4}$ inches. One corner is cut on the polystyrene base in order to provide a method of keying the coils for proper insertion. The cutout in the panel is similarly keyed. The coil forms are mounted on a thin piece of aluminium (see Fig. 2 of page 2) so that the centre of the grounding strip contacts a grounding spring mounted on the $\frac{1}{4}$ inch aluminium shield. This grounding spring is identical to the one shown in Fig. 3 which is mounted on the rear of the shield. The purpose of the latter spring is to contact the inside of the box, in the rear, for good grounding.

The pins on the coil are Millen No. 10029, which fit into two crystal sockets (Millen No. 33002), although any good quality pin and socket will be found suitable. These sockets are mounted on the $\frac{1}{4}$ inch wide aluminium shield, as may be seen in Fig. 4.

The G-E 6AK5 tube is mounted horizontally. Fig. 3 and 4 show how the grid pin on the tube socket projects on the one side of the shield with the remainder of the pins on the other side of the shield. Switch, S, is mounted on this shield. The input connection is mounted on a third shield which cuts through the centre of switch, S, shielding the input and output circuits.

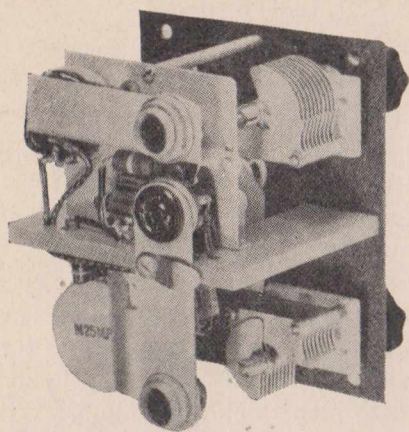

Fig. 3—Rear View of R-9'er Showing Constructional Features

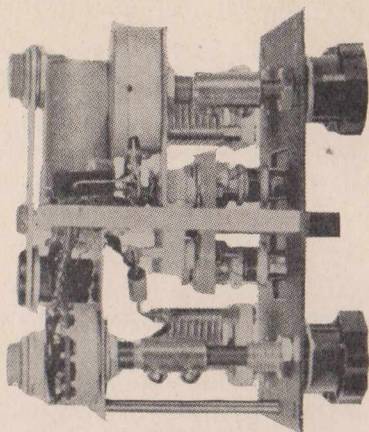

Fig. 4—Side View of R-9'er with Cover Removed

Placement of parts is not too critical if adequate shielding is maintained. Lack of shielding may cause unwanted regeneration and possible spurious oscillations.

OPERATING ADJUSTMENTS.

Input and output connections should be made to R-9'er with well insulated wire, preferably coaxial cable. Switch S should be set so that the amplifier is cut out, and the receiver tuned to a signal in the approximate centre of the band. A local signal is preferable. The amplifier should then be cut in by the switch, the screen potentiometer adjusted to give maximum voltage, and the grid condenser (C_2) tuned together with L_1 until the signal is heard. The signal should then be peaked with an R-meter or an output meter by tuning L_1 , adjusting C_2 , retuning L_1 , readjusting C_2 , etc. till the signal is maximum. This process should be repeated with the plate circuit C_7 and L_2 .

If C_1 is found to be at full maximum or minimum capacity, the length of the antenna feeder must be altered. Conversely, the length of the line between the R-9'er and the receiver must be altered if C_7 does not tune near its middle capacitance. To correct this situation, add a quarter-wave length to the line and prune this line until the capacitor peaks the signal at approximately centre scale.

After the entire unit has been peaked, the screen potentiometer (R_4) should be adjusted for maximum output, keeping the voltage on the 6AK5 screen as low as possible, with output as high as possible. Once all adjustments are made, it is only necessary to peak capacitors C_2 and C_7 when changing bands, as the coils remain at resonance after once being adjusted.

The coils are the most important part of the preamplifier. Unless the coils are of a sufficiently high Q very little gain may be achieved. This is because the band-width of the R-9'er is jointly dependent upon the Q of the coil, the resistance across the coil and the distributed capacitance in the circuit. It is desirable to have a coil with a sufficiently high Q that the band-width is effectively dependent only upon the resistance across the coils and the distributed capacitance. (R_1 and R_5 , referring to the original diagram.)

Coils wound with a large diameter wire which is poorly insulated will have a low Q . Similarly, the Q will be lowered if it is necessary to overwind the coil, that is, if more than one layer of wire is used. High Q coils will be achieved if the wire is of a diameter which will allow the proper number of turns to fit exactly onto the coil form of one layer. It is very important also that the wire be well insulated. Silk-covered wire would be preferable. Avoid enamelled wire if the enamel seems the least bit cracked or worn.

The R-9'er will work on 20 metres but it will be necessary to make several minor changes if optimum performance is to be realized. The first change should be to remove R_1 and R_5 from the circuit. These should be replaced in duplicate on the ten metre plug-in coils and wired directly across L_1 and L_2 . In other words, L_1 and L_2 on the ten meter coil should each have a 7,000 ohm resistor added in parallel to them.

It is necessary to make this change as the 20 metre coils will require a different resistance in parallel and it is necessary to remove the internal resistance in order that the proper resistance will be added to the circuit automatically when coils are changed.

The 20 metre coil should be wound with 25 turns of very small wire. As explained before, this wire should be small enough to allow all 25 turns to be placed in one layer. The resistance to be added across the coil will now depend upon the Q of the coil in the circuit. For example, if the coil Q is 100, the resistance to be added across both coils should be 25,000 ohms. For a Q of 75, 36,000 ohms should be added. For a Q of 50, the resistance should be omitted entirely.

Inasmuch as very few of us will be able to measure the actual Q , it is suggested that the resistance be omitted entirely on the 20 metre coils. If the R-9'er then seems to be too sharp and covers too narrow a band, resistors should be added across L_1 and L_2 on the 20 meter coil until the band-width is approximately one megacycle. The band-width can be judged roughly by tuning the receiver across the band and listening for the slight amount of background noise which indicates that amplification is being achieved. When the increased background noise covers approximately one megacycle on the dial the band-width may be considered to be approximately one megacycle. After resistors have been added which broaden out the band-width to this value, the coils should be properly adjusted.

Another change that is suggested for operation on 20 metres is to make C_1 and C_6 10 mmf instead of 5 mmf. This change will give added sensitivity on 20 and will not affect operation on 10 metres appreciably.

With changes made as described above the R-9'er will give appreciable gain on the 20 metre band, although it will not be as great as that obtained on ten metres.

6AK5

BASING DIAGRAMS—PIN CONNECTIONS

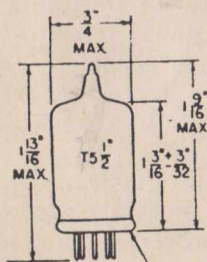

MINIATURE BUTTON
7-PIN

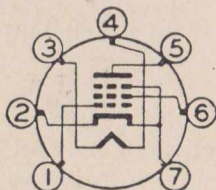

- Pin 1—Grid Number 1
- Pin 2—Cathode and
Grid Number 3
- Pin 3—Heater
- Pin 4—Heater
- Pin 5—Plate
- Pin 6—Grid Number 2
- Pin 7—Grid Number 3

GADGETS

Three Useful Accessories for the Shack

AUDIO OSCILLATOR

AN audio oscillator can be very useful, but very few ham shacks can boast of one. The reason for this is understandable, as many types of audio oscillators are complicated and difficult to construct. The type to be described here is not only easy to build, but it also is easy to get working properly.

By reference to the circuit diagram in Fig. 2 it will be seen that a 6SK7 is used in a transitron oscillator circuit. This type of oscillator may be made to oscillate over a very wide frequency range, from tenths of cycles per second to megacycles per second. If the oscillations are confined to the audio spectrum it is possible to design it so that the entire audio range may be covered by a variable grid resistor.

Several of the uses which suggest themselves for a gadget of this sort are: (1) Code practice oscillator; (2) Oscillator for ICW operation; (3) Source of continuous audio voltage for use while testing a speech amplifier and modulator.

The transitron oscillator puts out an audio wave which is essentially a sawtooth wave. Inasmuch as this waveform is difficult to interpret on an oscilloscope this oscillator is not recommended for use in running audio response curves on audio amplifiers. For work of this sort it is advisable to use an oscillator with sine wave or square wave output.

CIRCUIT DETAILS

A power supply is incorporated in the unit so that the audio oscillator would be self-contained. Two filament transformers are

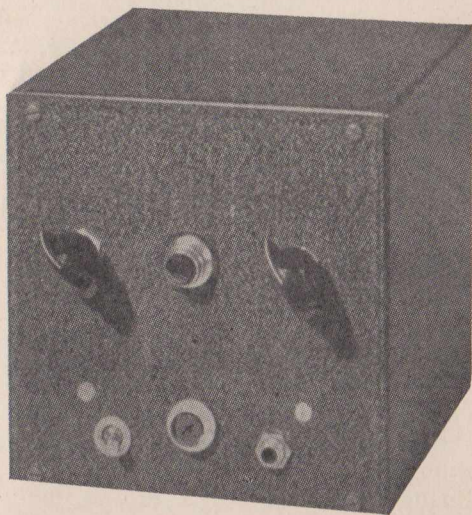

Fig. 1. Front View of Audio Oscillator

employed in this connection. One transformer supplies filament voltage to the 6SK7 and the other one is used as the power transformer. The selenium rectifier, X, rectifies the 115 volts. Resistor R_5 is a protective resistor and resistor R_6 with condensers C_6 and C_7 forms the filter circuit.

Resistor R_1 is the frequency control potentiometer, seen on the left in the photograph, and R_3 is the output gain control, which is on the righthand side of the panel. Other components on the panel are the pilot light in the centre, with the output jack directly below. The on-off switch and the keying jack are on each side of the output jack.

Two output arrangements are shown, A and B. When the output of the audio oscillator is used to modulate a transmitter, for test purposes, or for ICW use, it will be necessary to use the setup shown at A. Resistor R_7 and C_8 form a filter which tends to cut off all high frequency overtones so that wide sidebands are not present. When this circuit is being used the audio frequency should be between 500 and 1,000 cycles.

The setup shown at B indicates that a pair of earphones may be placed directly across the output. This would be the case when the oscillator were used for code practice work. Keying is done in the cathode circuit.

CONSTRUCTION

The entire unit is built in a 6 by 6 by 6 inch box. For convenience in wiring a small sub-chassis was bent out of aluminium sheet. The photograph, Fig. 3, indicates how this is made. The tube is mounted near the front panel, with the two filament transformers in line to the rear. A dual 40 mf. electrolytic condenser occupies the other side.

The under-chassis view, Fig. 4, shows the layout of the rest of the components. The selenium rectifier is attached directly to the rear of the chassis. This is done so that the heat generated by the rectifier does not affect the other components, and also so that the chassis itself can carry away some of the heat. No critical layout is required, and no special precautions need be taken with the wiring.

The Publishers invite the submission of original manuscripts for inclusion in this series dealing with Amateur Radio and Television. Manuscripts should be limited to about 2,500 words and should be submitted to the Technical Dept., Messrs. Bernards (Publishers) Ltd., The Grampians, Western Gate, London, W.6.

ELECTRICAL CIRCUIT

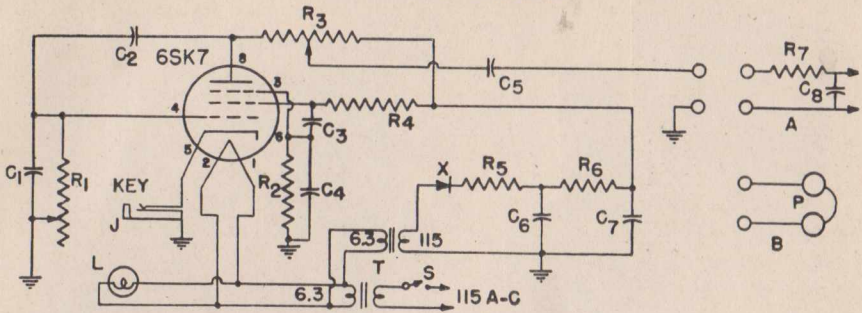

Fig. 2. Circuit Diagram of Audio Oscillator

COMPONENTS

C_1, C_7 —500 mmf mica
 C_2 —200 mmf mica
 C_3 —0.1 mf paper
 C_4 —0.005 mf mica
 C_6, C_7 —40 mf electrolytic
 C_8 —0.001 mf mica
 J —Closed-circuit jack
 R_1 —3 megohm potentiometer
 R_2, R_4 —0.47 meg. $\frac{1}{2}$ watt

R_3 —0.5 megohm potentiometer
 R_5 —25 ohm $\frac{1}{2}$ watt
 R_6 —4,700 ohm 2 watt
 R_7 —1 megohm $\frac{1}{2}$ watt
 S —SPST toggle switch
 T —6.3 volt filament transformer
 X —Selenium rectifier
 P —Earphones
 L —6.3 volt pilot light

It is suggested that readers in Great Britain use a single mains transformer of the following specification. Pri. to suit mains. Sec. 6.3 v. 1 amp. 115 v. 30 m/a.

TESTING

After the unit is completed, the first step is to check the audio frequency range. This may be done easily by monitoring with a pair of earphones. If accurate measurements are desired, another calibrated audio oscillator can be compared with this one by means of an oscilloscope. The output of one oscillator is fed into the vertical plates of the 'scope and the output of the second oscillator is fed into the horizontal plates. By means of Lissajous' figures, the two frequencies can be compared.

If the audio frequency range is not wide enough or does not cover the desired range, several adjustments may be made. Reducing the value of C_2 will raise the maximum frequency of oscillation. Varying the value of the screen resistor, R_4 , and the capacitor C_3 , will also affect the frequency range covered. When adjusted properly, the frequency control should be capable of producing a continuous audio range from below audibility at low frequencies to above audibility at the high frequencies.

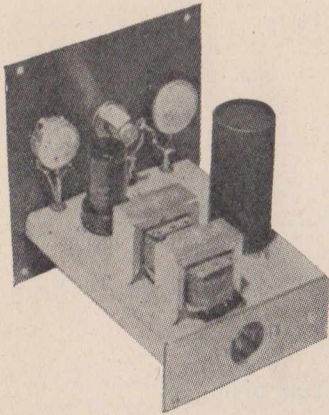

Fig. 3. Rear View of Audio Oscillator

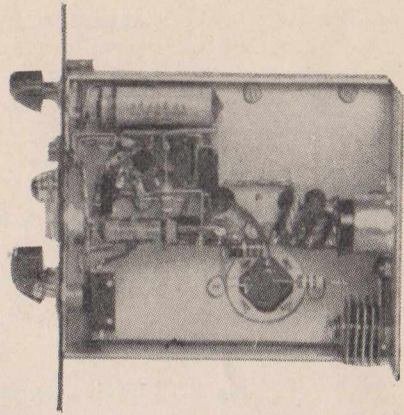

Fig. 4. Under-chassis View of Audio Oscillator

VOLT-OHMMETER

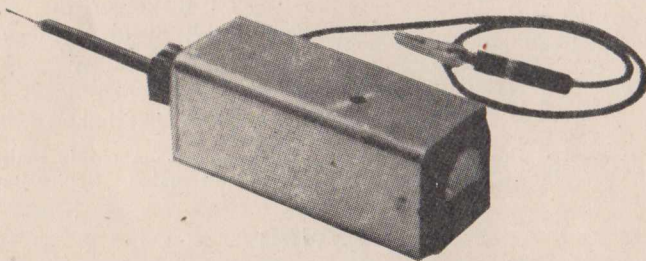

Fig. 5. Miniature Volt-Ohmmeter

No ham shack is complete without a volt-ohmmeter of some sort. Their biggest use is in checking continuity, and reading a-c and d-c voltages. An instrument of this sort need not be elaborate, nor is extreme accuracy required.

Fig. 7 shows the circuit for a volt-ohmmeter which will measure 0-10, 0-100 and 0-1,000 volts a-c (switch positions 3, 2, and 1 respectively); 0-100 and 0-1,000 volts d-c (positions 5 and 4) and 0-100,000 ohms (position 6). These ranges can be added to quite easily, as later data will show, but they represent ranges which are used most.

Practically any type of constructional arrangement can be followed, but a little effort will produce a very handy device. Fig. 5 shows how the entire volt-ohmmeter may be placed in a shield

can, with a small $1\frac{1}{2}$ inch meter on one end and the probe and range switch on the other end. In use the device may be held in one hand much like a probe. The wire with the clip is the negative lead, with the probe proper being the positive lead.

OHMMETER CALCULATIONS

In deciding what resistance scale can be obtained, it is first necessary to determine how much battery voltage you wish to provide. This, together with the meter, determines the resistance scale. In the ohmmeter shown it was not practical to use more than three volts. Full scale on a 1 m/A. meter, with three volts in series, requires a series resistance of 3,000 ohms. The ohmmeter will therefore read 3,000 ohms at mid-scale. (Mid-scale reading is always the same as the total circuit resistance.)

This 3,000 ohms series resistance is made up of the resistance of the meter (100 ohms), R_2 of 2,000 ohms and 900 ohms in R_1 . To calculate the resistance values indicated by various meter readings, use the formula

$$R = \frac{BR_s}{M} - R_s$$

where R is the resistance to be read, B is the battery voltage (3 volts in this case), R_s is the series resistance (3,000 ohms) and M is the voltage read by the meter. This latter voltage is determined from the ratio of meter reading to battery voltage. Full scale is three volts, half-scale (0.5 m/A.) is 1.5 volts, etc.

Carrying these calculations through for this particular ohmmeter we find the following resistance readings for each 0.1 m/A. scale division—starting from 1.0, 0.9, 0.8 etc.: 0, 333, 750, 1,285, 2,000, 3,000, 4,500, 7,000, 12,000 and 27,000. The last value is for a meter reading of 0.1 m/A. Inasmuch as 0.025 m/A. may be read, the highest value of resistance which may be read is 117,000 ohms. If desired, values may be calculated for each meter division, and a chart made up which may be pasted to the ohmmeter case.

To design an ohmmeter to read higher values of resistance, it would be necessary to use more batteries, and then calculate the series resistance by dividing the battery voltage in volts by the full-scale meter reading in amperes. The formula given above will then permit you to calculate the resistance range which can be covered.

VOLTAGE CALCULATIONS

D.C. voltage calculations are very simple. Start with the lowest range (0-100 in this case). The resistance to use in series with

a 1 ma. meter to read 100 volts is merely the voltage divided by the current, or 100,000 ohms. The next scale of 0-1,000 volts gives a resistance of 1 megohm. Since these two resistors are in series, the resistor for the 1,000 volt range would be 1 megohm less 0.1 megohm, or 0.9 megohm. The resistance of the meter is so small that it may be neglected.

In designing a voltmeter to read above a thousand volts take care that adequate insulation is used with the leads, and also that not more than 1,000 volts appears across any one resistor used as a multiplier.

The voltmeter shown has a sensitivity of 1,000 ohms per volt on both d-c ranges. A more sensitive voltmeter can be made only if a more sensitive meter, such as a microammeter, is employed.

For measurements of a-c voltages, a rectifier is required. The rectifier shown in Fig. 7 consists of two germanium crystal diodes.

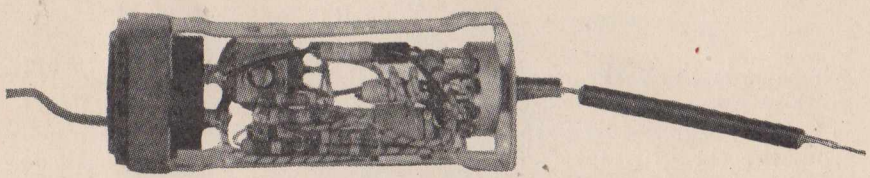

Fig. 6. Internal Construction of Volt-Ohmmeter

ELECTRICAL CIRCUIT

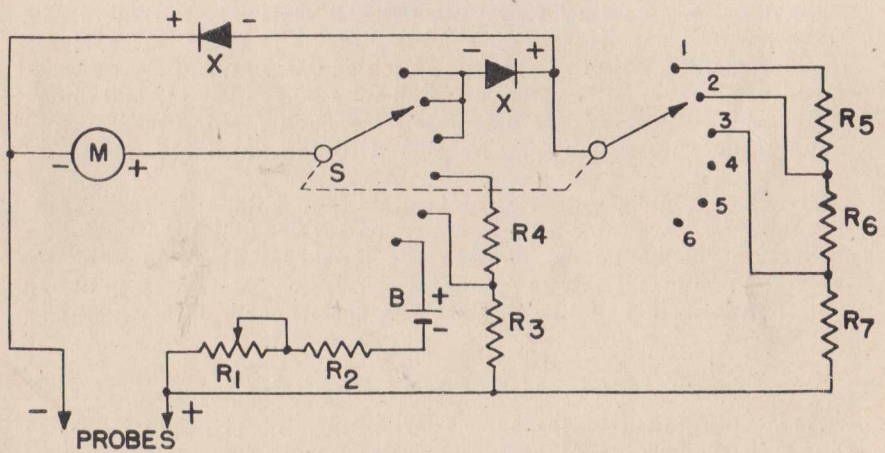

Fig. 7. Circuit Diagram of Volt Ohmmeter

COMPONENTS

B—Two 1.5 volt penlite cells in series	R ₆ —0.04 meg $\frac{1}{4}$ watt
R ₁ —1,000 ohm wire-wound rheostat	R ₇ —4,100 ohm $\frac{1}{4}$ watt
R ₂ —2,000 ohm $\frac{1}{4}$ watt	S—Double pole six position switch (Mallory 3226 J)
R ₃ —0.1 meg $\frac{1}{4}$ watt	M—0.1 m/A meter (G.E. 411X92)
R ₄ —0.9 meg 1 watt	X—Germanium crystal (1N34 or equivalent)
R ₅ —0.4 meg $\frac{1}{2}$ watt	

One acts as the rectifier proper while the other passes current in the opposite direction on the other half-wave so that a high voltage is not built up across the first diode. The action is that of a half-wave rectifier. Because of this, and because the meter will read the average value of voltage, a multiplying factor of .45 must be used to calculate resistance.

In other words, if 10 volts is applied to the voltmeter circuit, the meter would only read 4.5 volts. In order to make the meter read full scale on 10 volts we therefore calculate on the basis of 4.5 volts. The series resistance to use is therefore 4.5 volts divided by 0.001 ampere or 4,500 ohms. Similarly for 100 volts a total resistance of 45,000 ohms is required and for 1,000 volts .45 megohms is required. Doing the proper subtraction, because the resistors are in series, shows us that we need 4,500 ohms, 40,500 ohms and 405,500 ohms. The values need not be that exact, and those specified will be close enough.

CONSTRUCTION

The circuit of Fig. 7 may be used to build a volt-ohmmeter using any size meter in any style of box desirable. However, if a small meter is used a much handier device will result. The volt-ohmmeter pictured in Figs 5 and 6 was built into a 2 by 2 by $4\frac{1}{8}$ inch shield can (Millen No. 80005). No special tools are required. Referring to Fig. 6, the meter fits into a piece of $\frac{1}{2}$ inch thick bakelite. The bakelite is cut 2 inches square and the corners rounded with a file.

The inner case is made by bending a piece of $\frac{1}{32}$ in. aluminium to the shape shown. Before bending the piece is $1\frac{1}{8}$ inch wide and $11\frac{1}{4}$ inches long. The two ends which meet on the bakelite piece are filed out to fit around the meter and the entire aluminium bracket is held to the bakelite piece by the meter mounting screws.

A square angle bracket is made to support R and the two small batteries are held by another clamp made of aluminium. It is also necessary to drill a hole in the end of the inner case to support the rotary switch.

In order to bring the connection from the positive probe into the case it is necessary to drill a hole axially through the switch shaft. This is not a difficult task if the switch is held firmly in a vice and moderate care taken to keep the drill straight.

The next step is to procure a probe which has the same diameter as the shaft on the switch. This is necessary because the switch knob must be capable of sliding off over the probe. Finally the knob must be drilled and tapped so that the probe can be held into the knob by the setscrews in the knob.

When this work has been done the parts may be assembled on the inner case and the wiring completed. The lead which goes through the switch shaft from the probe should be left slack and formed into a loop so that the switch is free to turn. Finally, holes should be drilled in the outer case for the probe, negative lead, and adjustment of R_1 . The bakelite piece is drilled and tapped to hold the outer case

To assemble the unit, remove the switch knob and feed the probe into the hole on the end of the case. Push the unit in at the same time as the negative lead is pushed through its hole. When the unit is together slide the knob over the probe and tighten the setscrews which hold the knob to the shaft and the probe to the knob. Fastening the case to the bakelite completes the assembly.

CALIBRATION

After the volt-ohmmeter is completed it is desirable to check its accuracy. To do this easily, locate another voltmeter that you can trust and check the two together. Some juggling of resistance values may be necessary for extreme accuracy, although the unit described was within three per cent without changing resistor values.

For the ohmmeter circuit, short the two probes and adjust R_1 so that full-scale deflection of the meter is obtained. While it is now possible to calibrate the meter, for most uses this will be unnecessary. However, you may wish to check some known values of resistance against the calculated meter readings that you have made.

As the battery voltage drops it will be necessary to readjust R_1 for full-scale meter deflection.

Acknowledgments

The information contained in the article(s) "*The R-9'er & Gadgets*" has been reprinted by kind permission of "General Electric Ham News" from their Vol. 1—No. 4 and Vol. 3—No. 2 issues.