

No. 1

BERNARDS RADIO SERIES

1/-

HAM NOTES

FOR THE HOME CONSTRUCTOR

CONTENTS

A COMPREHENSIVE CRYSTAL CALIBRATOR

by R. W. ADAMS

Complete with Diagrams and Photographs

RIG-BUILDER'S CIRCUIT GUIDE

TRIODE, BUFFER OR FINAL

TETRODE PENTODE & BEAM POWER

PUSH-PULL TRIODE

PUSH-PULL TETRODE, PENTODE & BEAM POWER

CLASS B MODULATORS

CLASS AB2 MODULATORS

SOCKET CONNECTIONS

Complete with Diagrams and Tables

Messrs. Bernards 'Ham Notes' series is based on the General Electric 'Ham News' and R.C.A. 'Ham Tips' of America.

BERNARDS (PUBLISHERS) LIMITED
LONDON

A COMPREHENSIVE CRYSTAL CALIBRATOR

By R. W. ADAMS

THE conditions governing the issue of the amateur transmitting licence to-day are far more rigid than was the case before the last war and this is especially true in the matter of the station operator's ability accurately to check his operating frequency. The increasing popularity of the variable frequency oscillator coupled with ever narrowing frequency bands and the increasing number of stations using them has made some form of frequency standard an absolute necessity in the amateur station instead of the luxury it was so often regarded in past years.

In the following paragraphs will be described an instrument which has been developed specifically for such work, being capable of a very high degree of accuracy whilst, at the same time, its construction does not involve the major problems associated with a frequency meter. Since it is intended that it shall be used during actual operation of the station, some care has been taken to make its employment as simple as possible after the initial setting-up process has been completed. This simplification in no way detracts from its use for more involved calibrations so that it can be regarded as the frequency standard for the entire station.

The instrument consists of two separate crystal oscillators, a harmonic amplifier, modulator, multivibrator; a stabilized power supply is also built on to the same chassis. The first oscillator is a relatively simple Pierce circuit into which crystals having fundamental frequencies of 7 Mc, 1 Mc or 500 Kc can be switched at will with the additional advantage that, if required, the 7 Mc crystal may be removed to allow any of the transmitter crystals to be inserted for checking. The second oscillator is somewhat more elaborate and is devoted, solely, to a 100 Kc bar on which the final accuracy of the instrument depends and provision has been made for its frequency to be varied by a few cycles so that it may be referred to a known standard such as the B.B.C. at Droitwich on 200 Kc or the NPL standard frequency transmission on 2 Mc. The 100 Kc oscillator is also made to control a multi-vibrator running at 10 Kc and in this manner a series of known marker signals is obtained which, with their higher order harmonics, provide accurate reference points throughout a wide frequency spectrum. The harmonic amplifier enables the marker signals to be used up to 30 Mc and higher and, when the modulator is switched in, each marker signal is easily identified by a superimposed 400 cycle tone. The accuracy of the 10 Kc multi-vibrator is of the same order as that of the 100 Kc bar and further subdivision of the 10 Kc signal intervals is unnecessary and might even be confusing at higher frequencies, it being found adequate to use simple interpolation in conjunction with the station receiver for the determination of spot frequencies. All the valves, with the exception of the rectifier and voltage control tubes, are of the same type, namely, EF-50, some of which are connected as triodes. Their use for all purposes simplifies the replacement problem by avoiding a multiplicity of valve types.

If reference is made to the circuit diagram, it will be seen that the 100 Kc. oscillator (V_1) is a conventional arrangement which balances out the crystal capacity so that the trimmer condenser C_3 can be used to give a variation of a few cycles in the crystal frequency. Coil L_2 is a two section RF choke with an inductance of 17.9 mH., C_3 being mounted directly on the chassis with its spindle grounded and arranged for screwdriver adjustment. A low value of HT is used for this stage and, as a rule, no difficulty will be found in getting the bar to oscillate. If difficulty is found in this connection the resistors R_3 and R_4 may be lowered in value slightly, but care must be taken to ensure that the output from the stage does not tend to overload the following amplifier; C_5 being kept small, consistent with good output from V_4 . The 10 Kc. multi-vibrator (V_5 and V_6) will next be considered, since it is most intimately connected with the 100 Kc. oscillator. It will be seen that the EF-50's are connected as triodes and the circuit values have been found to give good locking at 10 Kcs. with R_5 at mid-travel. This variable resistance will usually allow of operation at 9, 10, 11 and, occasionally, 12 Kc. but once set, has been found to remain locked on frequency. If a different circuit layout is adopted it may be found necessary to alter, slightly, the values of R_6 and R_8 to compensate for varying circuit capacities etc.; but best operation will be found to occur when the values of R_6 plus $\frac{1}{2}R_8$ are equal to R_8 . The locking signal is obtained via C_7 and C_9 which, in series, comprise a small, but sufficient capacity for the purpose and, in fact, can often be omitted altogether without losing locking, but it will be seen that they perform another function besides this, acting as coupling condensers to the harmonic amplifier (V_4). V_2 is the oscillator for the remaining three crystals which are switched into circuit as required by one section of switch S_1 . The circuit is a normal one except for the condensers shunted across the RF choke in the anode circuit and which have been found a help in starting the two lower frequency crystals. Some constructors may prefer to simplify this design somewhat by the omission of the 500 Kc. and 7 Mc. crystals, and this may be accomplished by very small modifications to the switching. In practice, it has been found that the 500 Kc. bar is more of a luxury when operation is confined to the amateur bands, but it is useful when the range of application is wider. The use to which the 7 Mc. crystal can be put, however, will be realised especially when the receiver to be calibrated only covers the amateur bands and the band edge has to be set before further calibration is carried out.

Choice of output frequency is obtained by means of the switch S_1 which is a rotary six-bank wafer type and is marked at each step to show the frequency interval between the output signals (i.e. 10 Kc., 100 Kc., 500 Kc., 1Mc., 7 Mc.). Its action is to select the appropriate crystal in the case of the Pierce circuit, put HT to the oscillator in use and also to the multi-vibrator when required so that there is no ambiguity and no operating time need be wasted in setting up. In the 7 Mc. position, the HT to the oscillator is reduced by the inclusion of R_{11} in the HT feed as the output is too great when the full value is used and the harmonic amplifier would be over-driven.

The harmonic amplifier has signals fed to its grid via the small variable condensers C_5 , C_9 and C_{10} , these being adjusted so that the harmonic output from the amplifier is at maximum. In the anode circuit, as will be seen from the diagram, one of a number of coils may be selected at will to cover any part of the spectrum from 100 Kc. to 60 Mc. or higher; the switch in question being S_2 . Each coil has a link coupling coil interwound with it so that it can be matched into a co-axial line of any convenient length, but on the lowest frequency range this was not found practicable so that a straightforward capacity output is used in conjunction with the RF choke shown. The tuning condenser C_{10} is left in circuit continuously, even in the first position across the choke.

The last stage to be described is the modulator which is connected as a triode in a Meissner circuit. The transformer is an ordinary audio intervalve component such as most amateurs will possess. The modulator output is fed to the anode of the amplifier, which is modulated by the 400 cycle tone produced by tuning the grid winding of the transformer with condenser C_{21} . The value of this condenser may be varied to produce a note of the required frequency. The negative feedback control R_{17} is mounted on the chassis close

to V_3 , and when the instrument is set up R_{17} should be adjusted to give a clean note free of harmonics, once set it should require no further adjustment. The modulator is controlled from the panel by its own switch, S_3 , so that it can be brought into use at will when it is required to identify any one marker point.

The power supply for the instrument is conventional with the addition of a pair of VR 150/30 stabiliser tubes which hold the HT line voltage to a figure of 300 volts, thus ensuring that the final measurements are not made inaccurate either by mains voltage fluctuations or HT variation when the modulator is brought into use. Indicator lamps associated with the mains on/off and HT switches are provided but for clarity are not shown on the circuit diagram. The mains voltage selector panel is located on the rear apron of the chassis.

A few words, in conclusion, on the correct use of the crystal calibrator will, no doubt, be of some interest to those who have not had the experience of using one and, although the remarks which follow are intended to refer specifically to the calibrator described, they can, from the point of view of actual operation, be applied equally well to a number of instruments available to-day.

The crystals, other than the 100 Kc. bar, are used only as guides to the final frequency and, therefore, it is important to ensure that the accuracy of this bar is as high as possible. We are fortunate in this country, in having an excellent frequency standard of convenient value in the B.B.C.'s. Droitwich long-wave station on 200 Kc. whose accuracy is within very fine limits. If, therefore, the calibrator be fed into a receiver tuned to this station it is possible to detect, either by ear or by means of a tuning indicator, the beat note between Droitwich and the second harmonic of the 100 Kc. oscillator in the calibrator. If now condenser C_3 be adjusted it should be possible to zero beat the two signals or, at worst, produce a frequency difference of a few beats per second and, this having been accomplished, it should not need re-checking unless the instrument has been in transit or had a change of valve.

The check receiver is next switched to the medium wave-band and two adjacent harmonics of the 100 Kc. oscillator identified (the modulator should be used to ensure that the signals chosen are not confused with carriers from broadcast stations). Next, the 10 Kc. position of S_1 is chosen when the intervening space between the two chosen signals should be divided into a number of equal spaces by similar signals and these should be counted carefully to find out into how many divisions the multi-vibrator is separating the 100 Kc. range. For correct operation there should be nine signals between the two original ones, thus making ten equal divisions of 10 Kc. each. In practice, it will most probably be found that either 8, 10, 11 or 12 signals are counted and, therefore, it will be necessary to adjust R_2 until the correct sub-division is obtained. This done, the instrument is ready for use and the following procedure is suggested as being the quickest method of finding the frequency of an unknown signal. If the receiver, in conjunction with which the calibrator is to be used, has little or no calibration, it will be necessary to determine one or two fixed points of reference in its spectrum and, for this purpose, the 7 Mc. crystal is provided as it also acts as a very good band-edge marker for some of the main amateur bands. It should be possible, with its aid, to locate 7, 14, 21, 28 Mc. on the receiver dial and care should be taken to see that the real and not the image signal is logged; any receiver having an RF stage should discriminate between these two unless the injected signal is very strong. This done, the intervening megacycle points can be found by switching to the 1 Mc. crystal. Similarly, further sub-divisions are made so that, in the end, the unknown frequency is 'bracketed' by two points 10 Kc. apart whose frequency is accurately known. For many purposes this will be sufficient, but if an exact figure is needed it is found by simple interpolation which is best illustrated by a numerical example:—

It is required to find the exact frequency of a point on the receiver dial whose frequency, for example is 14,395 Kcs. The adjacent points which have been found are 14,390 Kc. = 436 deg., and 14,400 Kc = 450 degs. We know that 14 degs. of dial (450—436) = 10 Kc. (14,400—14,390), therefore:—

$$1 \text{ Kc.} = 1.4 \text{ deg. (dial).}$$

Therefore, 14,395 Kc. = $436 + (5 \times 1.4)$ deg:

$$= 436 + 7 = 443 \text{ degs. dial}$$

The only assumption in the above is that the receiver dial is linear over the small range of 10 Kc. between the last last marker points and this may usually be assumed as the range is comparatively small.

Finally, if care be taken with the construction and setting-up procedure, the calibrator will be found to give consistent service and gives the station operator the confidence of knowing that his VFO and receiver are subject to constant check so that he need have no fear of off frequency working when operating near the edges of the allotted bands.

COMPONENTS

Resistors.

- R₁—1 megohm
- R₂—390 ohms
- R₃—470 K ohm
- R₄—470 K ohm
- R₅—5 K ohm var.
- R₆—11 K ohm
- R₇—490 ohm
- R₈—12 K ohm
- R₉—2.7 K ohm
- R₁₀—2.7 K ohm
- R₁₁—160 K ohm
- R₁₂—82 K ohm
- R₁₃—390 ohm
- R₁₄—39 K ohm
- R₁₅—Adjust to give 15 m/a through through V₈ and V₉ (approx 1,000 ohms).
- R₁₆—220 ohms
- R₁₇—10 K ohm var.
- R₁₈—470 ohm
- R₁₉—82 K ohm
- R₂₀—100 K ohm

Condensers.

- C₁—8 mfd
- C₂—16 mfd
- C₃—20 pf. var.
- C₄—15 pf.
- C₅—2.9 pf. var.
- C₆—.1 mfd
- C₇—.01 mfd
- C₈—.01 mfd
- C₉—2.9 pf. var.
- C₁₀—2.9 pf. var.
- C₁₁—.002 mfd
- C₁₂—.002 mfd
- C₁₃—.0002 mfd
- C₁₄—.00047 mfd
- C₁₅—.001 mfd
- C₁₆—.0001 mfd
- C₁₇—.001 mfd
- C₁₈—.002 mfd
- C₁₉—.0005 mfd. var.
- C₂₀—.0001 mfd
- C₂₁—.002 mfd
- C₂₂—.002 mfd

- C₂₃—.002 mfd
- C₂₄—.0005 mfd

Valves.

- V₁—V₆—EF50 (Mullard)
- V₇—AZ31 (Mullard)
- V₈ and V₉—VR150/30 (U.S.A.)

Coils.

- RFC1
- RFC2 Edystone SW Chokes
Cat. 1010.
- L₂—17.9 mH
- L₃—4 turns 16 s.w.g. self supporting winding length 1 inch
- L_{3d}—1 turn 18 D.C.C. Inserted at cold end of L₃ and cemented into position with coil dope.
- L₄—8 turns 18 D.C.C. winding length 1 inch.
- L_{4c}—3 turns 18 D.C.C. close wound spaced ¼ inch from cold end L₄.
- L₅—30 turns 18 D.C.C. close wound
- L_{5b}—5 turns 18 D.C.C. close wound spaced ¼ inch from cold end of L₅.
- L₆—50 turns 18 D.C.C. close wound.
- L_{6a}—8 turns 18 D.C.C. close wound spaced ¼ inch from cold end of L₆.
- L₄—L₆ together with their couplings are all wound on ¾ inch diameter formers.

- L₁—20H 80 m/a
- T₁—PRI 200/250 V (or to suit mains voltage)
SEC 350—0—350 V. 80 m/a
6.3 v 4 a.
4 v 2 a.
- T₂—Audio Intervalve Transformer
- S₁—D.P.S.T. toggle
- S₂—2 bank 5 way wafer switch
- S₃—2 bank 2 way wafer switch
- S₄—6 bank 5 way wafer switch
- S₅—D.P.S.T. toggle
- 6 B9G valve holders
- 3 Int. Octal holders
- Instrument knobs.
- Crystals and Holders as required.

The Publishers invite the submission of original manuscripts for inclusion in this series dealing with Amateur Radio and Television. Manuscripts should be limited to about 2,500 words and should be submitted to the Technical Dept., Messrs. Bernards (Publishers) Ltd., The Grampians, Western Gate, London, W.6.

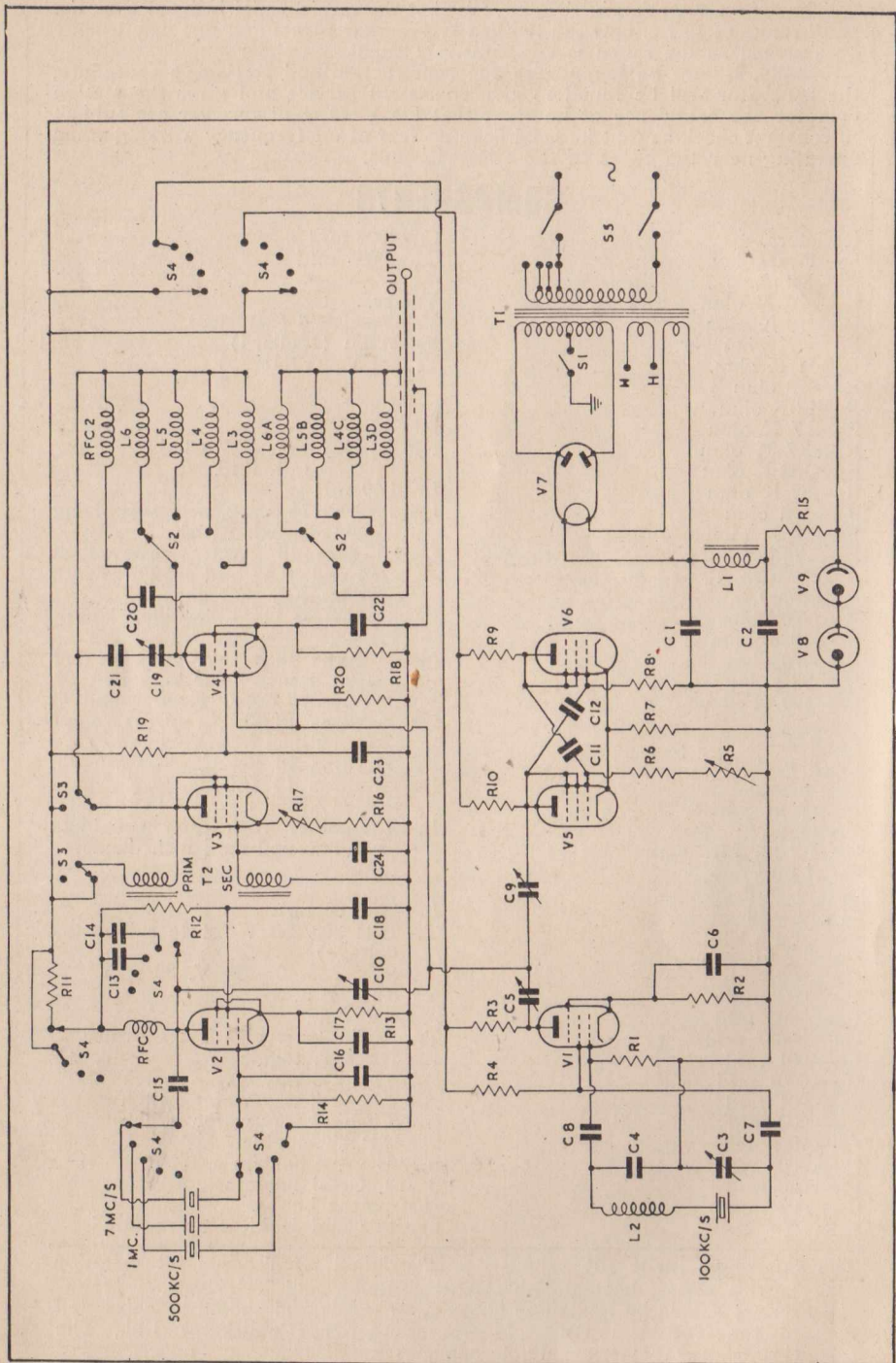

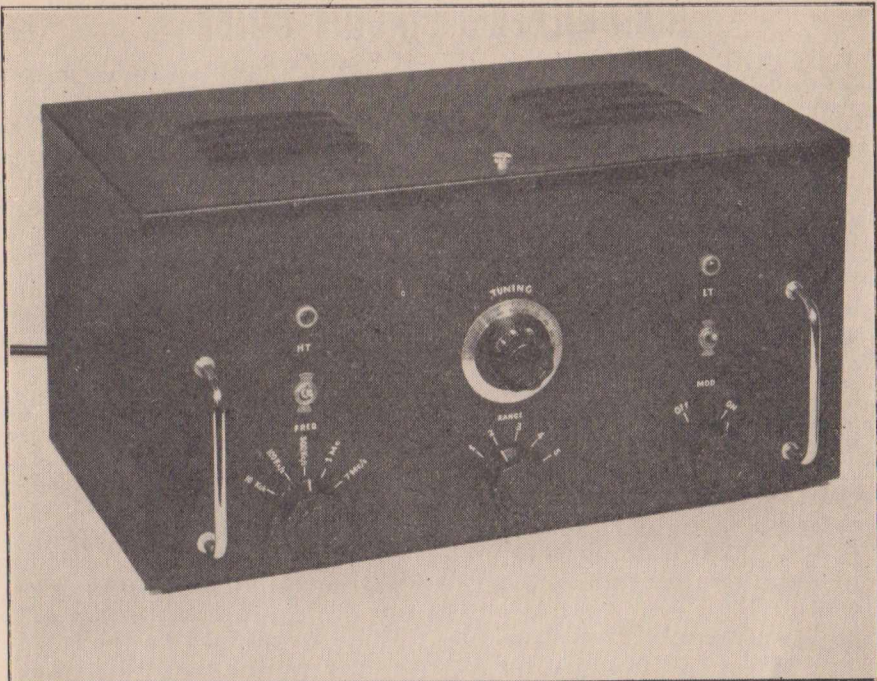

RIG-BUILDER'S CIRCUIT GUIDE

RECOGNISING the fact that most R-F and audio circuits change very little from tube to tube, this issue presents six standard circuits. With each circuit are listed the types of tubes which will operate in that circuit, together with the circuit constants which must vary from tube to tube. These six standard circuits are therefore the equivalent of eighty-nine separate circuits.

The single tube circuits (circuits A and B) may be employed as either buffer or final circuits. An untuned grid circuit is shown in order to keep the diagram as simple as possible. Circuits C and D are push-pull circuits and would normally be used as circuits for final amplifiers, although low power tubes in these circuits will allow their use as buffer amplifiers. Circuit E is a class B audio modulator circuit and circuit F is a class AB₂ modulator circuit.

The tube operating conditions given in the tables are, in most cases, the conditions for maximum input. It is important that these limits are not exceeded. The bias voltage given in circuits A, B, C and D is designed to protect the tubes in case of excitation failure, or in case the crystal or VFO circuit is keyed. In the case of these four circuits bias is obtained by a combination of grid resistance bias and fixed bias. These values may be changed if desired. For example the grid resistor can be omitted if the fixed bias is increased. This increase in fixed bias should be equal to the amount of bias that was obtained from the grid resistor due to the grid current (I_g). Conversely the fixed bias can be removed and the grid resistor increased to give the proper bias. This is not recommended unless the stage is protected by an overload relay in the plate circuit.

Values for grid and plate coils and condensers are not specified. Manufactured assemblies may be used, or homemade coils employed. The table gives the airgap necessary for the plate condenser. In the case of split-stator condensers, the airgap given is still valid for each section. This value of spacing allows a 100 per cent factor of safety.

Neutralizing condensers (NC) should have an airgap 50 per cent greater than that of the plate condenser. Maximum usable capacity of the neutralizing condenser should be somewhat greater than the grid to plate capacitance of the tube it is used with.

The wattage of the various resistors is not given. This is easily computed by I^2R , where I is the current through the resistor (grid current or screen current). Use a wattage rating which is approximately double the computed value, as a safety factor.

CIRCUIT A

The filament bypass condensers may be of the 600 volt paper type. The 0.001 mf plate bypass condenser should have a voltage rating of twice the d-c voltage for c-w operation and three to four times the d-c voltage for phone operation. The RF choke should be of the all-band type and be capable of handling the d-c plate current.

CIRCUIT B

The circuit as shown is for phone operation only. If c-w operation is desired, omit resistor R_2 , and use a separate source of voltage on the screen grid as indicated in the table. Circuit B is used for tetrodes, beam power tubes, and pentodes. If the beam-forming plates of the beam tubes are brought out to a pin connection, they should be connected to the centre-tap of the filament transformer. If the tube has a cathode connection, it should be connected to ground. The suppressor grid in pentodes should also be grounded, unless the table indicates that a positive voltage is required. In the latter case a well-regulated source such as a battery should be used.

The filament bypass condensers may be of the 600 volt paper type. The 0.002 mf plate bypass condenser should have a working voltage of twice the d-c voltage for c-w operation and three to four times the d-c voltage for phone operation. The screen bypass condenser (0.005 mf) should be rated at twice the screen voltage for c-w work and three to four times the screen voltage for phone operation.

CIRCUIT C

This circuit is the push-pull version of circuit A. The same comments apply regarding bypass condensers. In addition, the 0.01 mf grid circuit bypass condenser may be a 600 volt paper condenser for most circuits, unless the bias voltage is very high, in which case a 1,250 or 2,500 volt mica is preferable.

CIRCUIT D

Push-pull tetrodes, beam power tubes or pentodes may be used in this circuit. As in the case with circuit B, the diagram shown is for phone operation only. For c-w operation remove R_2 and supply screen voltage from a separate source. All remarks regarding beam-forming plates, cathodes and suppressor grids pertaining to circuit B also apply to circuit D. Similarly, the comments on bypass condensers also apply.

CIRCUIT E

This class B modulator circuit is quite straightforward. The table gives complete operating data, including output impedance, plate-to-plate. Grid bias requirements are small, so that batteries may be used in most cases. Two tubes, the GL-811 and the GL-838, are zero bias tubes. In this case the C— and C+ terminals may be tied together.

CIRCUIT F

Tetrodes, beam tubes or pentodes may be used as class AB₂ modulators in this circuit. Both transmitting tubes and receiving tubes are included in the table. Beam tubes with an external connection for the beam-forming plates should be used with the beam-forming plates tied to the centre tap of the filament transformer. Tubes with cathodes should have the cathode grounded, and pentodes should have their suppressor grid grounded unless the table indicates otherwise.

It is necessary to use a well-regulated source of voltage for the screen-grid supply (+SG). For this reason a separate power supply is recommended. It is possible to use a voltage divider circuit, but the screen current varies so much in operation that the divider must draw a current equal to the screen-grid current. The divider is thus not economical.

TRIODE BUFFER OR FINAL

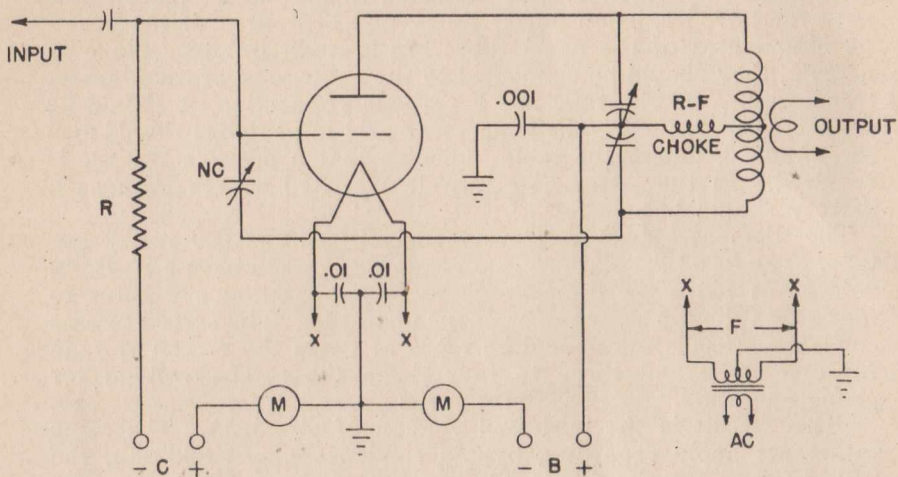

Tube Type	Input Watts		B		C		I_p ma		R ohms	F volts	Airgap (inches)	
	CW	PH	CW	PH	CW	PH	CW	PH			CW	PH
GL-35T	250	168	2000	2000	45	105	45	23	2,000	5.0	.100	.250
GL-100TH	495	366	3000	3000	75	215	51	26	2,500	5.0	.200	.500
GL-203A	188	150	1250	1000	80	45	25	50	1,800	10.0	.070	.100
GL-211	188	150	1250	1000	135	90	18	35	5,000	10.0	.070	.100
GL-592	600	395	2600	2500	90	200	45	45	3,500	10.0	.175	.375
GL-805	300	200	1500	1250	45	70	40	60	1,500	10.0	.078	.144
GL-806	990	585	3300	3000	250	440	40	27	8,750	5.0	.250	.500
GL-810	620	450	2250	1800	45	45	40	50	3,000	10.0	.150	.225
GL-811	225	156	1500	1250	45	25	35	50	2,000	6.3	.078	.144
GL-812	225	156	1500	1250	95	45	25	25	3,200	6.3	.078	.144
GL-838	188	150	1250	1000	45	45	30	60	1,500	10.0	.070	.100
GL-1623	100	75	1000	750	45	75	20	20	2,500	6.3	.070	.084
GL-8000	750	500	2500	2000	135	275	40	37	2,500	10.0	.175	.250
GL-8005	300	238	1500	1250	90	160	32	28	1,250	10.0	.078	.144

TETRODE, PENTODE & BEAM POWER BUFFER OR FINAL

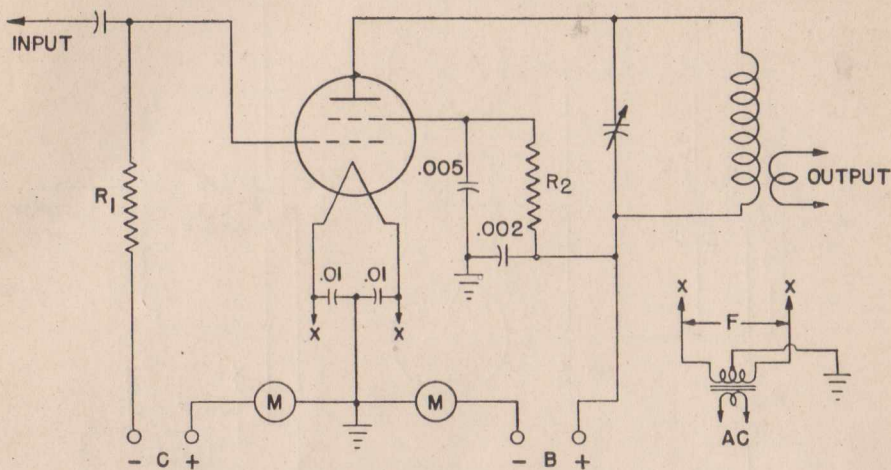

CIRCUIT B

Tube Type	Input watts		B		C		I_k ma		R_1 ohms	R_2 ohms PH*	E_{sg} volts		Airgap (inches)	
	CW	PH	CW	PH	CW	PH	CW	PH			CW	PH	CW	PH
GL-2E24	40	27	600	500	20	15	3	3	10,000	40,000	195	180	.050	.070
GL-2E26	40	27	600	500	15	20	3	3	10,000	35,000	185	180	.050	.070
GL-4D21	500	375	3000	2500	90	150	9	9	7,000	71,500	350	350	.200	.375
GL-802**	33	20	600	500	45	.0	2	2	27,000	17,000	250	245	.050	.070
GL-803†	320	240	2000	1600	45	0	12	20	37,500	20,000	500	500	.100	.200
GL-807	75	60	750	600	20	60	4	4	7,000	50,000	250	275	.050	.070
GL-813	360	240	2000	1600	45	70	3	4	15,000	60,000	400	400	.100	.200
GL-814	225	180	1500	1250	45	60	10	10	4,500	43,000	300	300	.078	.144
GL-828‡	270	200	1500	1250	45	85	12	12	4,500	30,000	400	400	.078	.144
GL-837**	30	18	500	400	45	0	4	5	7,500	13,000	200	140	.050	.050
GL-1613	18	12	350	275	0	0	4	4	10,000	7,500	200	200	.030	.030
GL-1614	30	23	375	325	0	0	2	2	20,000	10,000	250	245	.030	.030
GL-1619	30	20	400	325	0	20	5	3	11,000	5,000	300	285	.030	.030
GL-1624	54	38	600	500	45	45	5	3	3,000	25,000	300	275	.050	.070
GL-1625	75	60	750	600	20	60	4	4	7,000	50,000	250	275	.050	.070

*Phone only; see text.

**Suppressor grid voltage = +40 volts.

†Suppressor voltage of +40 for CW and +100 for phone.

‡Suppressor voltage = +75 volts.

PUSH-PULL TRIODE BUFFER OR FINAL

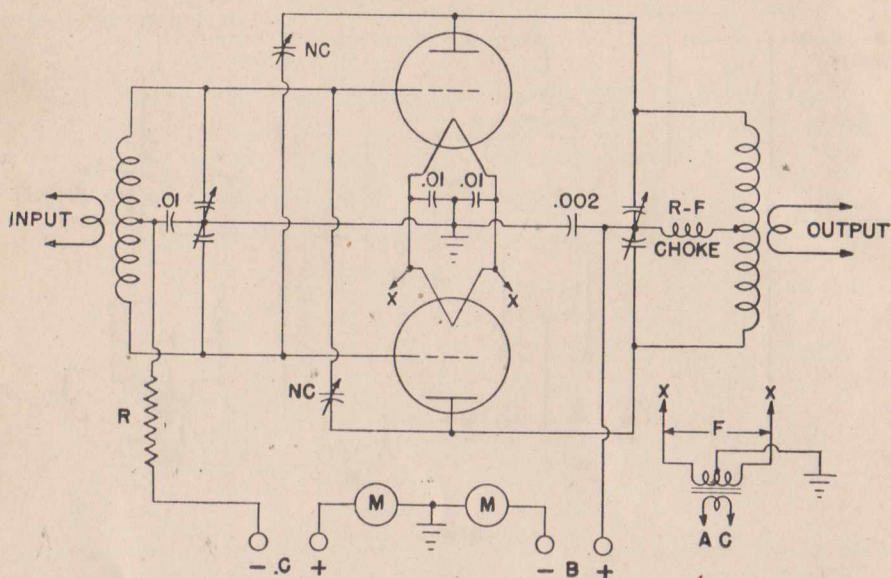

CIRCUIT C

Tube Type	Input watts		B		C		I_p ma		R ohms	F volts	Airgap (inches)	
	CW	P.A	CW	PH	CW	PH	CW	PH			CW	PH
GL-35T	500	336	2000	2000	45	105	90	46	1,000	5.0	.100	.250
GL-100TH	990	732	3000	3000	75	215	102	52	1,250	5.0	.200	.500
GL-203A	376	300	1250	1000	80	45	50	100	900	10.0	.070	.100
GL-211	376	300	1250	1000	135	90	36	70	2,500	10.0	.070	.100
GL-592	1000	790	2500	2500	80	200	90	90	1,750	10.0	.175	.375
GL-805	600	400	1500	1250	45	70	80	120	750	10.0	.078	.144
GL-806	1000	1000	2500	2500	250	200	50	80	5,000	5.0	.175	.375
GL-810	1000	900	2000	1800	45	45	80	100	1,500	10.0	.100	.225
GL-811	450	312	1500	1250	45	25	70	100	1,000	6.3	.078	.144
GL-812	450	312	1500	1250	95	45	50	50	1,500	6.3	.078	.144
GL-826	250	150	1000	800	35	65	70	70	500	7.5	.070	.084
GL-838	376	300	1250	1000	45	45	60	120	750	10.0	.070	.100
GL-1623	200	150	1000	750	45	75	40	40	1,250	6.3	.070	.084
GL-8000	1000	1000	2000	2000	135	275	50	75	1,250	10.0	.100	.250
GL-8005	600	476	1500	1250	90	160	64	56	625	10.0	.078	.144

All values are for two tubes.

CLASS AB₂ MODULATORS

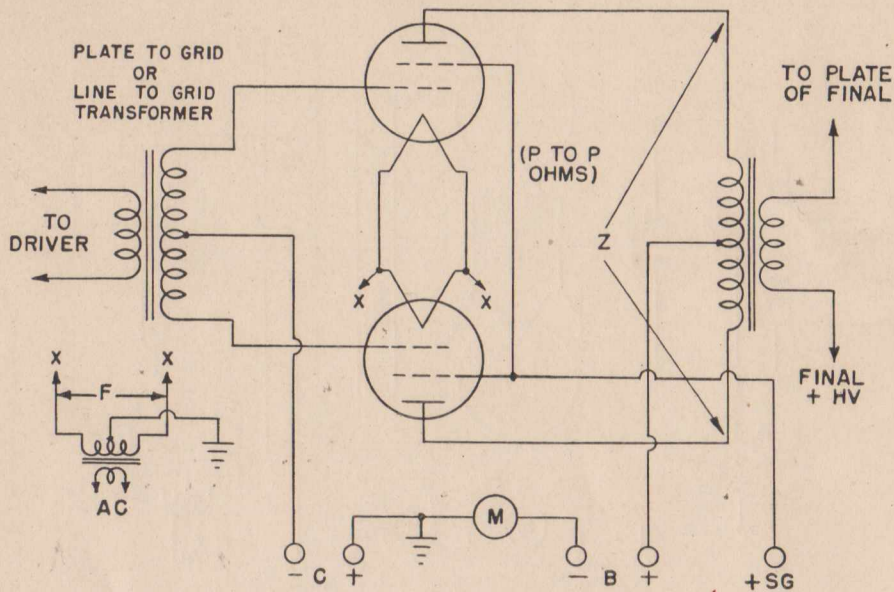

CIRCUIT F

Tube Type	F volts	Audio output watts	Peak grid power watts	B	C	SG	Max. sig. I_p ma	Max. sig. I_g ma	Z ohms
GL-2E26	6.3	54	0.36	500	15	125	150	32	8,000
GL-4D21	5.0	520	2.5	3000	51	350	260	3.5	27,700
GL-807*	6.3	120	0.5	750	32	300	240	10	6,960
GL-813	10.0	515	0.1	2250	90	750	315	58	18,500
GL-815†	6.3	54	0.36	500	15	125	150	32	8,000
GL-828‡	10.0	385	2000	120	750	270	60	18,500
GL-1619	2.5	36	0.4	400	16	300	150	11.5	6,000
GL-1624	2.5	72	1.2	600	25	300	180	15	7,500
GL-1625	12.6	120	0.5	750	32	300	240	10	6,960
2A5	2.5	18.5	375	26	250	82	19.5	10,000
42	6.3	18.5	375	26	250	82	19.5	10,000
6F6	6.3	18.5	375	26	250	82	19.5	10,000
6L6	6.3	31	360	18	225	142	11	6,000
6V6*	6.3	10	250	15	250	79	13	10,000

*Class AB₁ †Single tube operation.

‡Suppressor voltage = +60 volts.

All values are for two tubes.

SOCKET CONNECTIONS

(Bottom View)

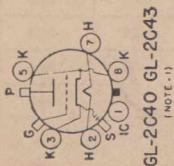

GL-2C40 (NOTE 1)

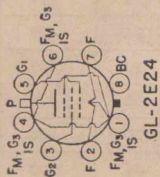

GL-2E24

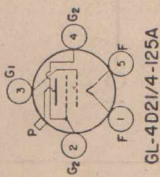

GL-5024

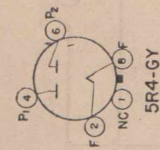

5R4-GY

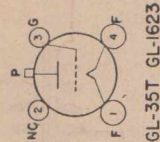

GL-35T

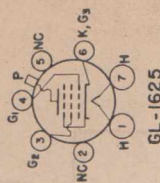

GL-1625

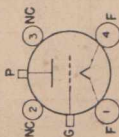

GL-100TH

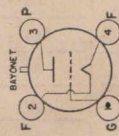

GL-203A

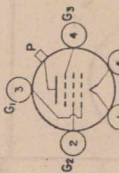

GL-803

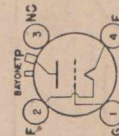

GL-805

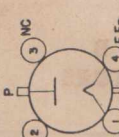

GL-8008

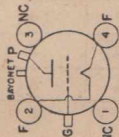

GL-806

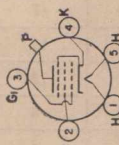

GL-807

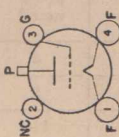

GL-811

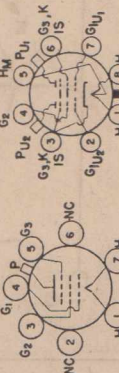

GL-815

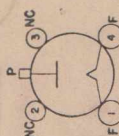

GL-816



GL-802A (NOTE 1)

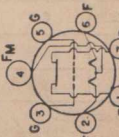

GL-826

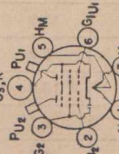

GL-829B

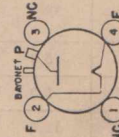

GL-872A

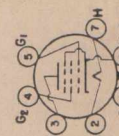

GL-1613

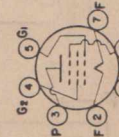

GL-1619

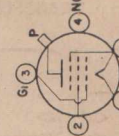

GL-1624

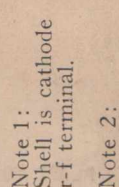

Note 1:
Shell is cathode r-f terminal.

Note 2:
Plate oaps are those farthest from base.

Key: BC—Base Sleeve; F—Filament; F_M—Filament centre-tap; G—Grid; H—Heater; H_M—Heater centre-tap; IC—Internal connection (do not use); IS—Internal shield; K—Cathode; NC—No connection; P—Plate; S—Shield; U—Unit.

Acknowledgments

The information contained in the article(s) "Rig-Builders Circuit Guide" has been reprinted by kind permission of "General Electric Ham News" from their Vol. 3—No. 1 issue.