

RADIO ANTI-INTERFERENCE MANUAL

2/6



by Edwin N. Bradley

No 76

**RADIO
ANTI-INTERFERENCE
MANUAL**

by

EDWIN N. BRADLEY, A.I.P.R.E.

LASKY'S RADIO
370 HARROW ROAD,
PADDDINGTON, LONDON, W.9.

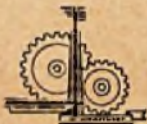

**BERNARDS (PUBLISHERS) LTD.
LONDON**

First Published 1948

CONTENTS

- Chapter 1. INTERFERENCE: ITS SYMPTOMS AND SOURCES - Page 5
- Chapter 2. MAINS BORNE INTERFERENCE. PART 1 Suppression at the source—Suppression on D.C. operated motors and equipment—Universal motors and A.C./D.C. converters—D.C. circuits other than motor circuits, lamp and sign circuits—Vibratory devices—Arc lamps—D.C. operated power supplies for special purposes—Suppression on A.C. operated motors and equipment—A.C. circuits other than motor circuits—Switches and vibratory circuits—PART 2 Suppression at the receiver - Page 9
- Chapter 3. R.F. INTERFERENCE. PART 1 R.F. interference due to motors and mains gear—PART 2 Ignition interference—PART 3 R.F. Interference from neighbouring receivers, transmitters, overhead lines, etc.—PART 4 Amateur transmitter interference - Page 32
- Chapter 4. INTERFERENCE WITHIN THE RECEIVER - - - - Page 40
- Chapter 5. ANTI-INTERFERENCE AERIALS - - - - Page 45
- Chapter 6. TELEVISION INTERFERENCE - - - - Page 52

RADIO ANTI-INTERFERENCE MANUAL

CHAPTER I.

INTERFERENCE : ITS SYMPTOMS AND SOURCES

Modern radio—using the term in its broadest sense, may be taken to include television reception, amateur transmission and experimental work as well as the reception of programmes from broadcasting stations—is still the most intimate of entertainments, bringing, as it can, the whole world in miniature into the home. Yet this wide and diverse source of pleasure is, perhaps, the most easily ruined, for it is open to interference from a great number of sources, both natural and man-made.

In the title of this Manual "Interference" is given the broadest possible meaning, for it is intended to deal with radio disturbances and parasitics arising not only from electrical machines and apparatus and from the weather and location of the receiver, but also with those effects arising within the receiver itself, either by failings in its design or faults in its installation or aerial system. It is therefore immediately necessary to classify the various types of interference which may give trouble.

The first broad classification is as follows:

1. Mains Borne Interference. Under this heading come the noises introduced to the receiver via the mains circuit itself; clicks as lights are switched on and off, crackling and buzzing from fans, refrigerators, mixers and other motor driven gear, and noise produced by poor or heavily-loaded contacts, best described as "Frying."

It must be understood that apparatus which causes mains borne interference also almost invariably causes R.F. interference at the same time. The R.F. interference takes the form of a heavily damped wave covering a wide frequency range and is received as R.F. interference over a relatively small area surrounding the source. The mains borne interference appears both within and outside this area.

2. R.F. Interference. Whilst mains borne interference is often allied with R.F. interference, depending on the source of the noise, much R.F. interference has no connection with mains driven gear. R.F. interference consists of signals, generally staccato in nature, received at the aerial of the installation and amplified throughout the receiver. It is sometimes tunable to a degree, but this effect is only found on a wide frequency range receiver; for example, ignition interference from automobiles is usually troublesome only at the higher frequencies, the intensity of the noise rising throughout the short wave bands until, at television frequencies, ignition interference is probably the most serious external source of trouble.

Nevertheless, ignition interference is present on all wave ranges on a car radio.

Other examples of R.F. interference are the noises obtained from house circuits where long leads to battery driven gear such as door bells and signal bells act as aerials to the bell's R.F. output caused by sparking at the contacts; the very serious interference which can be caused by neon

lighting displays: diathermy sets and, more recently, radio heating installations in factories, although little trouble should arise from this type of gear since its screening and filtering for the prevention of interference is one of the most important features of its construction.

R.F. interference also covers the transmission of signals from other radio equipment, the best known example of such an effect being the howl or whistle caused in one receiver when a second oscillating receiver is tuned through the same frequency.

3. Natural Interference. Natural interference is also R.F. interference since the resulting noise is received at the aerial of the installation and amplified in the receiver, but this type of interference is classified separately in order that it shall be distinguished from man-made R.F. interference. The controlling factors are weather, location, and the frequency range on which the interference is observed, and it is obvious that any preventive measures must be taken at the point where the noise is introduced to the receiver, that is, at the aerial.

The only natural interference observed by the great majority of listeners is that due to thunderstorms, but it is of interest to note that for some time radio amateurs have been observing the effect on beamed transmissions caused by meteors whilst inter-continental communications are regularly affected by "Magnetic Storms" or Aurora displays.

Most natural interference occurs as crashes or crackles of sound in the output of the set, but "Rain Static" or "Precipitation Static" gives rise to a hissing sound, or, alternatively, as a regular "popping" caused by the build up on the aerial of electric charges until a corona discharge is set up. "Rain Static" is not actually dependent on rainy or thundery weather, but most usually occurs at such times, and is to be expected chiefly on high ground, exposed positions or at cliff locations near the sea.

It is sometimes experienced by the users of television receivers where the efficient aerial offers greater chances for the build up of static charges, and in one case, known to the present writer, a television aerial (on low ground and shielded by buildings) became charged during thunder rain to such an extent that a rapid discharge ensued between the two halves of the dipole within the central supporting insulator. Earthing the aerial affords only temporary relief, for the charges rapidly build up once more to recommence the discharge, but the effect is not common. Messrs. Belling and Lee, the aerial specialists, announce that their engineers have seen the effects of rain static only on the blank raster of a television receiver, and have been unable to make observations of the effect, if any, on the reception of a television signal.

It must not be supposed that special aerials or anti-interference devices attached to aerials can prevent the reception of interference or static. What can be done is to improve the efficiency of the aerial so far as the required signal is concerned, thus discriminating against the reception of noise and interference. Man-made interference, for example, is often received by the downlead of an aerial which passes within the interference field, in this case the introduction of noise can be greatly reduced by the use of a screened downlead.

When interference is to be combated at the aerial all that can be done is to make the system efficient, and to position it so that it is as far as possible out of the affected area.

4. Receiver Interference. It is often not realised how many interference effects can occur within the receiver itself. In general, the more complicated the receiving circuit the more chances are there for receiver interference, although such a statement can be no more than a generalisation. Nevertheless the superheterodyne receiver is open to far more interference trouble than is the T.R.F. receiver, whilst the communications receiver, unless excellently designed and suited to the purpose for which it is used, can develop more interference effects than the ordinary superhet.

Receiver interference usually occurs as a result of interaction between two signals in one or other of the tuned circuits, or as a result of a signal's breaking through into the I.F. system of the receiver, although there are several other causes. Also classified as receiver interference may be the relatively rare cases of the reception of spurious signals from land lines or "wired wireless" cables, for here the interference is not picked up by the aerial nor is it tuned by the receiver, since the source of the trouble is working at audio frequencies. This type of interference, and also interference from amateur transmitting stations, is often caused by the audio stages of the receiver responding to a slight inductive pickup, or, in the case of transmitter interference, responding non-linearly to a modulated wave with resulting detection and amplification.

These, then, are the broad classifications which cover most of the sources of interference, each section capable of being subdivided to a considerable degree.

Some of the symptoms of interference have already been noted, and it is upon the noise or sound produced that the first steps towards the elimination of the trouble must be based. Discovering whether interference is mains borne or R.F. interference, or a combination of the two is of course simple, for it is only necessary to remove the aerial contact from the set, leaving the receiver working without touching the controls. If the interference ceases along with the signals from the station then obviously it is R.F. interference. If the volume of the interference remains level—it may even rise, with the aerial disconnected and no station tuned, due to an increase in receiver sensitivity as the A.V.C. line automatically goes out of action—the interference is mains borne. But if the volume of interference is reduced, the type or sound or quality of the interference possibly undergoing a slight change at the same time, then the interference is both R.F. and mains borne.

These tests refer chiefly to the crackly, or crashing, or hissing types of interference arising from electrical machinery and from other man-made sources. Natural interference or static occurs at random, and at irregular intervals, but machine or man-made interference is almost always detectable by reason of its very regularity, and even by the time of day. Neon lights, for example, will be switched on at dusk, fans will be working in hot weather, refrigerators and, in the case of country dwellers, electric pumps, come into operation automatically and at reasonably regular intervals, all therefore advertising the fact that this type of interference is caused mechanically.

Interference arising within the receiver itself is also immediately obvious, since it generally consists of whistles or heterodyne notes. Or it takes the form of a second programme as a background to the required programme or as a flutter or growl or even as inverted speech or "monkey chatter."

At least one of these forms of interference, however, can also be created externally to the receiver. A second programme as a background to the desired programme—the Cross Modulation Effect—can be caused in overhead lines for power or telephones or in metal structures isolated from earth. Signals are received and detected in the lines perhaps by a poor joint or a point of resistance across which rectification of the signal takes place, the two or even more signals then combining and being re-radiated from the lines and picked up by the receiver's aerial. Cross Modulation external to the receiver is not a common fault, but where it occurs it is difficult to trace and rectify. At least one instance is on record where bad cross modulation was due to a rain-guttering on the side of a house. When at last the source of the trouble was detected and the guttering earthed the trouble ceased.

Wherever possible, interference should be dealt with at its source. The great majority of interference effects are due to electrical machinery, and legislation to ensure that all electrical devices are fitted with proven suppressors is long overdue. Where offending machinery is the property of a third party, it is obvious that the only step which can be taken for the complete elimination of the interference is a courteous request that the apparatus be fitted with suppressors, and if this should fail it then becomes necessary to introduce the suppression devices, so far as is possible, at the receiver. It is often found that many users of electrical equipment fail to provide suppression through a mistaken idea that the cost of current consumption will rise or that the equipment will become unsafe, whilst motorists in particular have greatly exaggerated ideas of the loss of efficiency consequent upon the use of ignition interference suppressors.

It should be simple to demonstrate the fallacy of the first misconception whilst the adamant motorist can at least be informed that a great number of trucks, cars and other vehicles used during the war were fitted with suppressors as a matter of course. Actual reports on the effect of fitting suppressors to ordinary cars have been published from time to time and show that the loss of efficiency, if it exists at all, is slight, especially when weighed against the benefit obtained by the users of communications and television receivers.

Apart from these considerations there still remain many instances where interference cannot be treated. The source may be impossible to determine or, once found, treatment may be impracticable, whilst even the most vigorous campaign on the part of a communications or television set user will result in no abatement of the ignition nuisance. In such instances all the preventive measures must be taken at the receiver.

The radio enthusiast can, however, play his part by ensuring that all of his own equipment, radio and electrical, is not contributing to the sad state of affairs.

The G.P.O. has a special department dealing with the problems of radio interference which will assist in tracing causes of interference, give advice on the best suppression methods and their official backing is often useful in dealing with owners of equipment causing interference. No charge is made. Requests should be made on a form obtainable at any Post Office.

CHAPTER 2.

MAINS BORNE INTERFERENCE

PART 1.

Suppression at the Source

Mains borne interference, traced by the fact that the removal of the aerial lead from the receiver causes no abatement of the interfering noise, can be dealt with either at its source or at the receiver.

The interference consists, usually, of R.F. waves carried along the mains wiring. The waves are set up by sparking at intermittent or moving contacts, the spark acting as a generator of highly damped oscillations, and electric motors of various types are generally the worst offenders, especially brush and commutator motors. Apart from the fitting of suppression devices motors should always be kept clean and in good running order. Greasy or dirty commutators cause bad sparking, as do worn and chipped or otherwise badly-fitting brushes, and as sparking increases so does commutator wear.

All brushes on electric motors should be bedded down so that the carbon face of the brush fits the arc of the commutator perfectly, and new brushes should be bedded by placing between the brush and commutator a slip of very fine abrasive paper, this being drawn back and forth to cut the brush to the correct curve. The method is shown diagrammatically in Fig. 1.

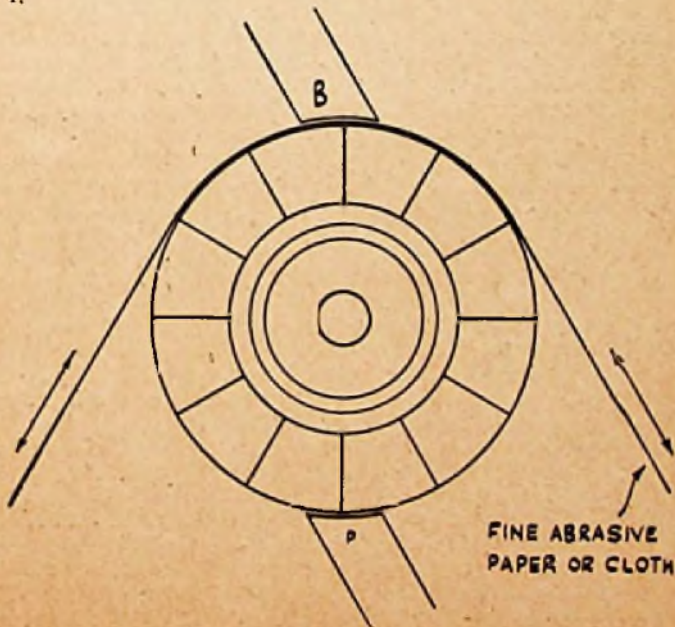

Fig. 1. Bedding a brush to a commutator

Brushes working on slip rings should be treated in the same manner, and should be adjusted with no less care.

The commutator is open to considerable wear, and its life is reduced by sparking which causes serious pitting of the surfaces of the bars. As the commutator ages and the bar surfaces wear down the mica insulators between the bars tend to protrude or at least to become level with the bar surfaces, this condition leading to brush chatter. As the commutator wears, therefore, it becomes necessary to undercut the mica separators, although this operation should be a very infrequent one on a properly run motor. Undercutting should be carried out by an expert with the correct tools for the work.

The components used for interference suppression on motors are capacitors and, on occasion, chokes. Non-inductive resistors are also sometimes used in collaboration with capacitors to swamp out current surges.

Suppression on D.C. and A.C. circuits is made in different ways.

Suppression on D.C. Operated Motors and Equipment

Whatever the type of motor to which suppression gear is to be fitted, the frame of the motor should be earthed, a precaution which should in any case have been made when the machine was installed. At the same time the existing earthing circuit of the motor may be unsuitable for use as a suppression earth, especially if the earth return is made via the supply conduit or the sheathing of the supply cables. This type of earthing circuit is perfectly satisfactory as a safety measure to protect the user from shock, or in the event of a breakdown in the internal insulation of the machine, so long as the conduit or sheath is itself properly earthed. But a suppression earth, which is used to ground the R.F. disturbances set up by sparking, must be direct and as short as possible.

Note, therefore, that when a suppression device has been fitted to a machine and the existing earth has been used, poor results will probably be greatly improved by the fitting of a new and direct earth line.

When running a new earth line care should be taken to see that it conforms to the regulations laid down by the local Supply Authorities.

The suppression circuit can take one of several forms, and the various circuits are shown in Figs. 2 to 5.

In Fig. 2 is the simplest suppression system. A pair of capacitors are connected across the supply leads at the point of entry to the motor—i.e., at the motor terminals—and the central point of the capacitive circuit is connected to the motor frame. An earth connection from this point may or may not be necessary; this is determined by trial.

Almost all suppression of interference is a matter of trial and error, for there is little point in going to considerable expense in the purchasing of special gear if a pair of capacitors can perform the suppression satisfactorily. This circuit, therefore, is the first which should be tried out when motor interference is to be checked, using 2 mfd. capacitors.

This large capacitance value must only be used on D.C. circuits.

All capacitors used for suppression must be rated for high voltage working. Motors contain inductive circuits, and there is always the possibility of a high Back E.M.F. being set up across the suppression unit. For this reason 500 v.w. or, preferably, 1,000 v.w. capacitors must be used, and

COLOURS = LEAD COLOURS ON
COMMERCIAL SUPPRESSION UNITS.

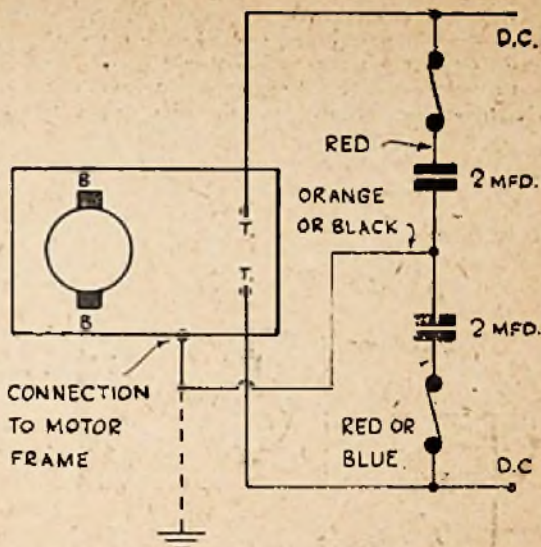

Fig. 2. D.C. Suppression Circuit No. 1.

paper or oil-filled components chosen. Electrolytic capacitors are not suitable for this work, for although they may be connected up in the correct polarity they will in all probability be mounted on or beside the motor itself, thus being subjected to conditions of heat and, perhaps, mechanical shock, whilst there is always the chance of seepage of lubrication oil or grease.

Suppressing capacitors may be obtained commercially, and are usually rated for D.C. or A.C. working. Messrs. Bulgin make their Unit A30 or A31 for D.C. apparatus, and whilst this unit, like those of other manufacturers, consists of no more than a pair of capacitors with a central connection the capacitors are made to suit the work and are protected by a suitable case.

When commercial units are used the colour coding of the wiring must be observed, and this is shown in the circuit diagrams. Since some units use red and black wiring, and the Bulgin unit uses blue, red and orange wiring, two colours are shown against two of the three connections.

Note that fuses are inserted in the capacitor leads. This is a precaution which should always be taken in fitting suppression to electrical apparatus. For all capacitances up to 2 mfd. the fuse in each branch should have a breaking value of 1 amp, whilst for capacitances above 2 mfd. 2 amp fuses must be used. The charging current, on a D.C. circuit, is only

momentary but rises to quite a high value, which must be passed by the fuse.

If the simple circuit of Fig. 2 proves inadequate, the same two capacitors may be reconnected directly across the motor brushes as shown in Fig. 3. This suppression circuit is of especial value when used on series wound motors, the most common type of small motor, and it will be seen that in this case the central point is taken both to the motor frame and to earth.

The earth line, as already explained, must be short and direct, and it

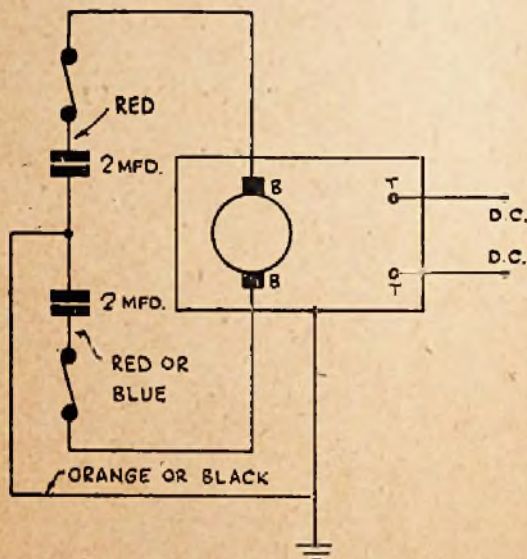

Fig. 3. D.C. Suppression Circuit No. 2.

is also of great importance to make the leads from the capacitors to the brushes, via the fuses, as short as possible. Sufficient energy could be transmitted from these leads to a nearby receiver to cause trouble.

The connections are again colour coded to suit standard and Bulgin D.C. suppression units.

This type of circuit may give relief so far as R.F. or transmitted interference goes, yet still permit of some mains borne interference, or may result in a lessening degree of interference. In this case two chokes must be added in the supply lines as in Fig. 4 and the chokes must be chosen with care for not only must they permit of the full load current flowing—not forgetting the heavy current surge as the motor is switched on—but, for best results, they should be shielded in earthed conducting casings.

Common choke inductances range between 2 and 10 millihenrys, the

choke being air-cored and wound on a suitable former. Below is given the design of a choke the inductance of which is 5 millihenrys, wound to carry a steady current of 3 amps.

The chokes are each wound on a paxolin tube former 1" in diameter, the tubes being furnished with end cheeks cut from paxolin sheet, the cheek diameters being $3\frac{1}{8}$ " and spaced by $2\frac{1}{4}$ ". The former is shown in Fig. 6, on this are wound evenly, in layers, 480 turns of 16 S.W.G. D.S.C. wire, and if the full number of turns are to be laid on, the winding must be made carefully and kinks in the wire, which consume a considerable part of the winding space when heavy gauge material is used, must be avoided. Each completed layer may be well brushed with good shellac varnish, and the winding continued, until the former is full.

Each choke requires about $3\frac{1}{2}$ pounds of wire and the starting and finishing turns should have soldered to them heavy flexible conductors. The choke, after the last winding is in place, is given another coat of varnish and set aside to dry naturally, or baked dry in an oven at about 100° F. When the varnish has hardened, the whole winding should be covered with a layer of Empire cloth or similar material.

Screening these heavy duty chokes is not a simple matter since unless the screen is to be very close to the winding it will require to be of very large diameter, so that the effect of the unscreened chokes may first be tested.

Each choke has a resistance of approximately 0.63 ohms so that at the full load of 3 amps the energy dissipated in the winding is less than 2 watts. It can immediately be seen that such chokes are expensive to make,

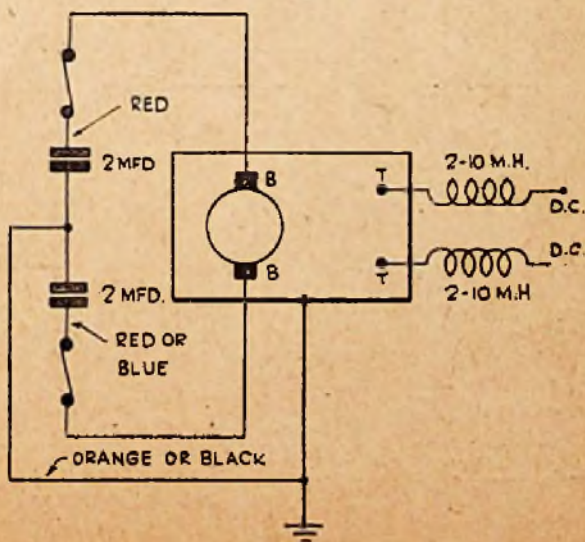

Fig. 4. D.C. Suppression Circuit No. 3.

as well as difficult to build (bearing in mind the wire size), but details have been included here in order that users of heavy apparatus and large motors may have the design to hand. For small motors perfectly suitable chokes may be purchased, and the Bulgin double choke, H.F. 11, which carries up to 0.25 amp in each winding will serve for motors of powers up to $\frac{1}{8}$ horse-power, assuming an efficiency of 80%, covering many small motors such as mixers, small fans, etc.

For intermediate motor powers a range of skeleton chokes is made by Messrs. Belling & Lee. The chokes, which are uncased, are wound for currents of 0.5, 1, 2, 5, 15 and 30 amps, the prices ranging from 17s. 6d. to £2 15s. The same manufacturers also make complete Industrial Suppression units for lifts and similar heavy duty machinery.

In a stubborn case of interference, suppression may not be complete even with chokes in the supply lines to the motor. In this case further capacitors must be added to the circuit as shown in Fig. 5, by-passing each side of the choke in either line to earth. Once again 2 mfd. capacitances are used together with 1 amp fuses.

In all circuits where such fuses are to be included a small neat fuse box, holding the cartridge type of fuse, is an advantage over other forms. A suitable component may be obtained from either Messrs. Belling & Lee or Messrs. Bulgin, from whom replacement fuses may also be obtained. The Belling-Lee box is priced at 6s.

Also worthy of mention is the T.C.C. Type 1a Suppressor Unit, which contains a pair of 1 mfd. capacitors with associated fuses within a moulded case, priced at 25s. Such a unit is suitable for easily suppressed apparatus where the circuits of Fig. 2 or Fig. 3 are found satisfactory.

Where some interference is present even after suppression as thorough as that given by the circuit of Fig. 5 the motor supply lines should be run

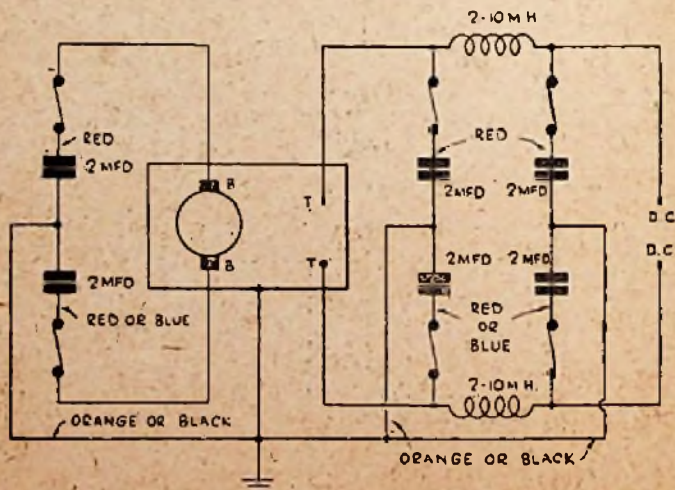

Fig. 5. D.C. Suppression Circuit No. 4.

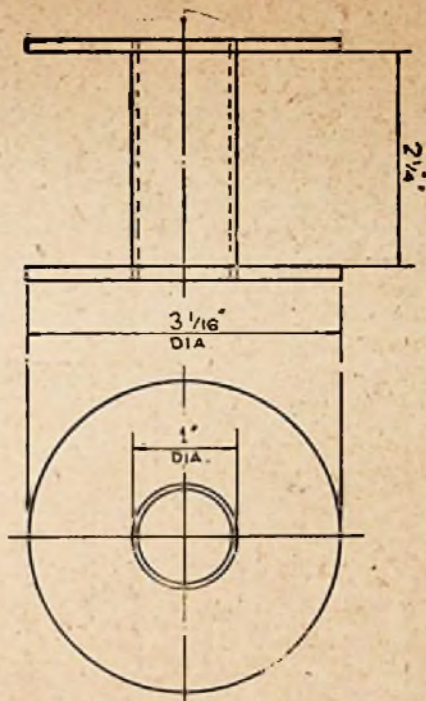

Fig. 6. Former details for 5 millihenry, 3 amp., choke.

through an earthed conduit for as great a part of their length as possible, and this is, in any case, a wise measure to undertake whenever possible. Nevertheless, when dealing with larger motors, a combination of inductive and capacitive filter circuits may be found insufficient—indeed it is possible for interference to become worse as the capacitors are connected into circuit—and in this case resistors should be connected across the capacitors to act as a discharging path. For shunt wound motors a double filter is advisable giving suppression both at the power input terminals and across the brushes, whilst for series wound or compound motors brush suppression alone is usually satisfactory.

The two circuits are shown in Figs. 7 and 8. In Fig. 7 the supply line inductances can be reduced in value as the motor size increases, common inductance values being between 0.5 and 3 millihenrys.

In both circuits the capacitance values should be .5 mfd. with 5,000 ohms resistances as the shunts across the capacitors. An increase in motor size generally means an increase in the circuit inductance and so also an increase in the Back E.M.F.'s produced at the commutator by the sudden reversals and starting and stopping of the current flow, so that high working voltage capacitors are essential. The T.C.C. Type 131 .5 mfd. capacitor

can be recommended, its working voltages being rated at 2,000 volts at 60°C.

The resistors used should be rated at 10 watts or higher, and must be non-inductive.

Where motors are incorporated with automatic gear and are controlled by relays or by mechanical switches, the making and breaking contacts may also require interference suppression. Again a capacitive-resistance circuit is used, the more common type of connection being the series circuit as shown in Fig. 9. Here a 2 mfd. capacitor is placed in series with a 50 ohms non-inductive resistor, the resistance rating being about 2 watts. At the

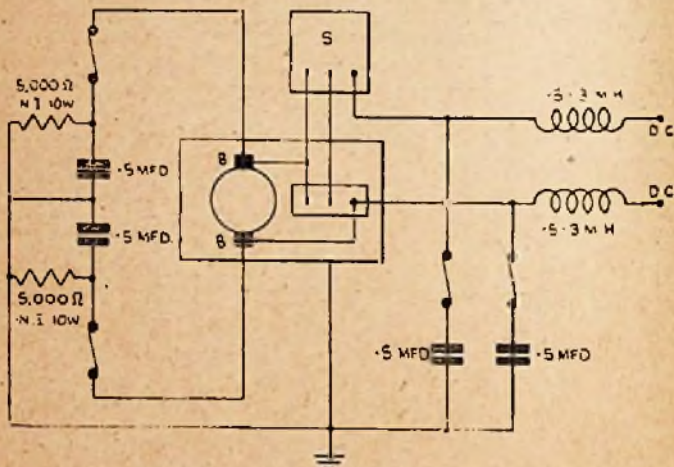

Fig. 7. Suppression Circuit for large D.C. shunt-wound motor (with starter).

same time the series resistance, used to damp the circuit, reduces the capacitive effect and on occasion it may be found more effective to use a shunt resistor as in Fig. 10. Obviously the resistance value must be considerably increased and there is the disadvantage that a current will be flowing through the resistor at all times. For 250 volt supplies the resistance value should not be below 10,000 ohms, and the rating not below 10 watts. By reason of its several disadvantages the circuit is not often used.

Universal Motors and A.C./D.C. Converters

Universal motors are treated for suppression as D.C. motors when used on D.C. mains and as A.C. motors when used on A.C. mains.

Rotary converters, however, require special treatment, the suppression on either side of the machine being suitable for D.C. and A.C. respectively according to the input and output circuits. These machines are dealt with in the section devoted to A.C. suppression.

D.C. Circuits other than Motor Circuits Lamp and Sign Circuits

Interference caused by switching in resistive circuits is usually caused by arcing at the switching contacts, and one example of such interference

is that noticed when ordinary household lighting circuits are switched on. Since there is very little, if any, inductance in the circuit the spark or arc is not caused by induced E.M.F.'s and the only way in which the spark or arc can be reduced is to fit new switches with good contacts and quick make-and-break characteristics, the arc in such a switch being very rapidly extinguished by the swift separation of the contacts.

Interference suppression on household circuits is hardly necessary, for the effect is only momentary and occurs only at the moment of switching on or off, an infrequent process, but where lamps are arranged in a flashing

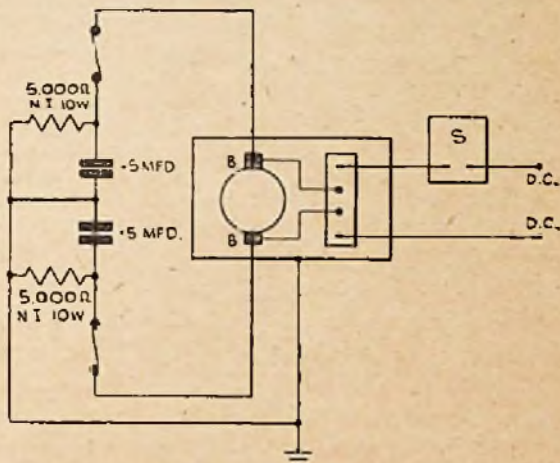

Fig. 8. Suppression Circuit for large D.C. series-wound motor (with starter).

sign and are constantly being switched in and out of circuit either by a temperature controlled switch or a mechanical rotary switch suppression is needed. Examples of such circuits are small advertising displays in shop windows, where the switching often is mechanical, and arrays such as "Christmas Tree" festoons where the switching is thermally controlled by the bending of a heated metal bar or by a similar device.

Once again the degree of suppression required is a matter for experiment. If the switch is rotary, driven by a small motor, the motor suppression circuit will be separate from the light suppression circuit.

The simpler of the two suppression circuits available, shown in Fig. 11, is identical with the relay suppression already mentioned, consisting of a 2 mfd. capacitance in series with a 50 ohms 2 watt resistance. In Fig. 12 is shown the more effective circuit which must be used if the simpler circuit affords insufficient relief. 2 mfd. capacitances and line chokes of between 2 and 5 millihenrys must be used, the centre point of the capacitor system being earthed or connected with the frame of the contactor device.

The chokes described and shown in Fig. 6 will not be overloaded by passing the current to an 800 watts total consumption load of say, 8 x 100 watt lamps; but for greater displays heavier chokes will be required.

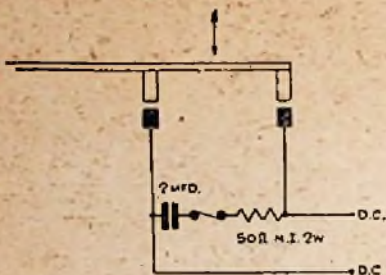

Fig. 9. Series Suppressor across relay or mechanical contactor contacts.

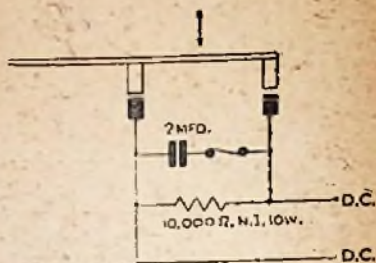

Fig. 10. Shunt Suppressor across relay or mechanical contactor contacts.

In general, however, it will be found that the simpler suppression circuit connected across the display switch will be all that is required, but whichever filter is used it must be connected into circuit as close to the switch as possible, and if the inter-lamp wiring is shrouded, with the lead or metal shroud connected to earth, this will also materially assist in the suppression of interference.

Vibratory Devices

Few vibratory devices work from the D.C. mains, but some bells and also some medical apparatus may possibly be causing interference. The suppression circuits on such apparatus are suitable both for mains and battery gear.

Bells are usually suppressed for interference by a capacitance-resistance filter across the vibrating contacts, although large bells and, perhaps, electric clock mechanisms, may require a more comprehensive filter. The two circuits are shown in Fig. 13, 1 mfd. capacitors and 50 ohms non-inductive resistances being suitable values throughout. The resistance ratings need be no greater than 1 watt.

Medical apparatus is suppressed at the point of entry of the supply line, not across the vibrator, and the circuit is shown in Fig. 14, using 2 mfd. capacitors and a choke in each line. Since such apparatus usually requires only a small current, a double choke such as the Bulgin H.F.11 should prove suitable for currents below 0.25 amp.

Arc Lamps

When it is remembered that at one time arc lamps were radio transmitters in their own right it can easily be seen that they are likely to give rise to a considerable amount of interference, producing, as they do, only 'lightly' damped waves. A suitable filter for a D.C. arc lamp is shown in Fig. 15, using 2 mfd. capacitances on either side of a 2 millihenry choke. The lamp frame, as well as the lamp housing or projector casing within which the lamp is contained, is earthed by a short and direct earth lead.

Arc lamps draw high currents so that the chokes will need to carry in most cases about 30 amps but in some cases even higher currents will be met and commercially made chokes are advisable. Nevertheless, most arc lamp circuits are fitted with chokes or choke-solenoid devices, and before

further chokes are added to the circuit it might be possible to investigate the filtering obtained by adding capacitances to the existing choke circuit.

D.C. Operated Power Supplies for Special Purposes

Under the heading of D.C. gear must come motor-generator and vibratory power supplies as used for transportable and car radio equipment. The interference generated by such equipment can be both of the R.F. and the mains borne types, for the interference may be carried to the receiver along the leads from the energising battery, these leads therefore being exactly equivalent to mains leads. The interference is, moreover, carried very efficiently, for the leads are generally as short and direct as possible.

The input and output filtering on a motor-generator set—sometimes known as a D.C. or Rotary Transformer since up to 400 volts output, at a low current, is obtained from a 6, 12 or 24 volt input, at a relatively high current—is shown in Fig. 16. On the input side the filtering is in the negative or earth line, which is common to both L.T. and H.T. circuits and serves as the battery return line, whilst in the H.T. circuit the filtering is in the positive line.

The input choke requires to carry a high current and must have a very low resistance, for the whole of the battery potential is needed across the motor, and so this choke, usually termed a "hash" choke, is wound using 60 turns of 14 S.W.G. enamelled copper wire on a wooden dowelling former 1" in diameter, and 7" long, the turns touching.

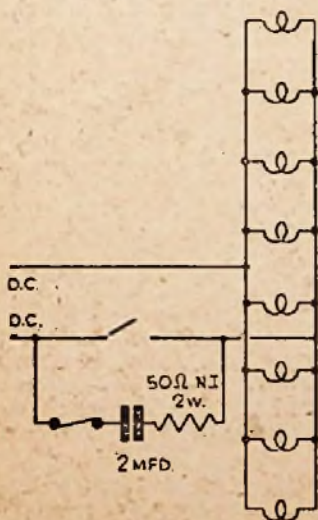

Fig. 11. Simple D.C. lighting circuit suppression.

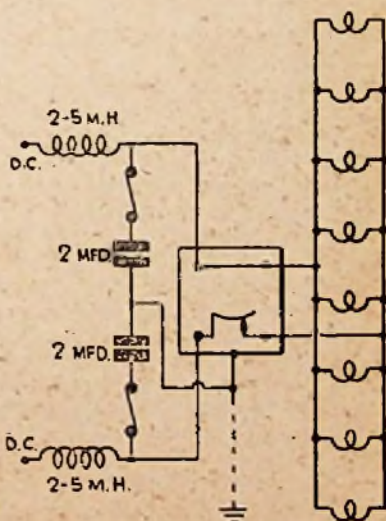

Fig. 12. Suppression on D.C. thermally or mechanically switched lighting circuit.

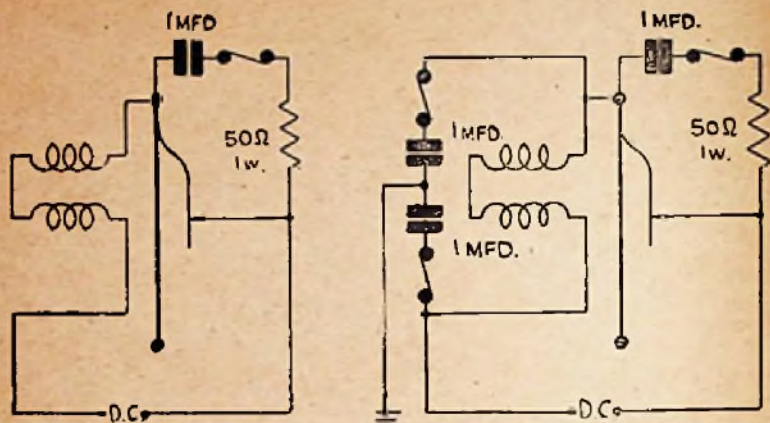

Fig. 13. The suppression of bell and similar vibratory circuits.

The low frequency hum or whine, in the output circuit, is smoothed out by the 10 Henrys choke and its associated 0.5 mfd. capacitors, but there is still the chance that R.F. will be present, in the form of interference, generated by sparking at the brushes. This is dealt with by an R.F. choke and a 0.0005 mfd. capacitor. The 0.5 mfd. components should be rated at 1,000 volts working, whilst the 0.0005 mfd. component should be of the mica type.

The R.F. choke should cover a wide band of frequencies and must also be able to handle the full H.T. current drawn from the generator by the receiver. The Eddystone Transmitting Choke, No. 1022, which covers the range of 60-1.5 mcs., and can carry up to 250 mAs., is suitable.

A vibratory power pack circuit is shown in Fig. 17. This type of power pack can cause very serious interference in the set which it supplies with H.T. although the number of receivers using such a power pack prove that suppression is not difficult if due care is taken over the work.

A synchronous vibrator power supply circuit is shown in Fig. 17, and the smoothing and filtering arrangements will apply also to valve rectified vibrator supplies where the chances of interference are somewhat smaller. The vibrator makes and breaks a heavy current into an inductive load, so far as the input side is concerned, the output from another inductance being switched from either end of the inductance to earth. There is thus a likelihood of serious sparking at the vibrator contacts, with a consequent generation of damped waves.

The contact sparking must be quenched not only to prevent interference but also to maintain the contacts in good condition. A poorly quenched (or "buffered") vibrator has a short life and may eventually stick, when a heavy current will flow through the sticking contacts and one-half of the transformer primary. For this reason the vibrator power pack must be fused on its input side, a common fuse rating being 10 amps,

Nominal values are shown in Fig. 17 for C1, C2, C3, the primary and secondary buffering capacitors, but these values may require adjustment to suit some vibrators.

A hash choke is used in the positive supply line from the battery, made to the same dimensions as that described for the motor-generator pack.

It is possible, in the synchronous rectification circuit, to obtain an incorrect polarity on the output side. For this reason the electrolytic smoothing capacitors must not be connected until a check with a voltmeter shows that the output polarity is correct, otherwise the capacitors will break down.

Note the working voltages shown against the capacitors.

General Note

In the majority of suppression circuits shown thus far, the capacitances have been given as of 2 mfd. values, a size found by experience to be the most satisfactory. Nevertheless it may be found in some instances that smaller capacitances will give adequate suppression, or that rather larger capacitances are required, and in such cases the capacitance may be changed to a different value. On D.C. circuits in particular the capacitor size is not critical, but there is an obvious saving of expense if the component sizes are reduced when possible.

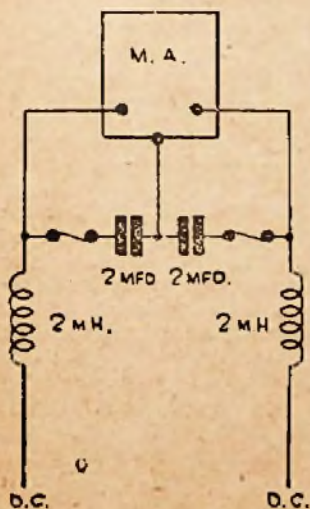

Fig. 14. Suppression of medical apparatus, D.C. operated.

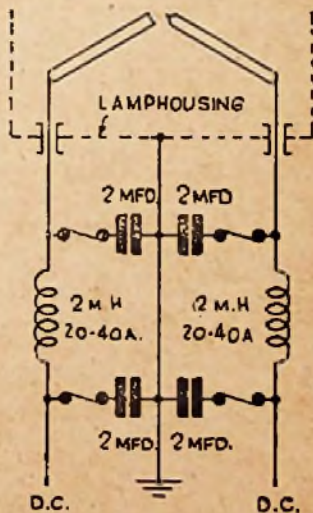

Fig. 15. Arc lamp suppression.

Suppression on A.C. Operated Motors and Equipment

Quite a considerable number of A.C. motors cause no radio interference and require no suppression. Inductive and synchronous motors of small powers, using neither commutators nor sliprings and thus having no brushes, cannot cause interference since the field of such a motor is connected directly to the main supply and the circuit is broken only when switched off. If such motors are, for any reason, controlled by relays or mechanical contactors, then the relay or contactor points may require suppression.

A number of small motors used on A.C. supplies are fitted with commutators, however, whilst larger motors may be fitted with sliprings and

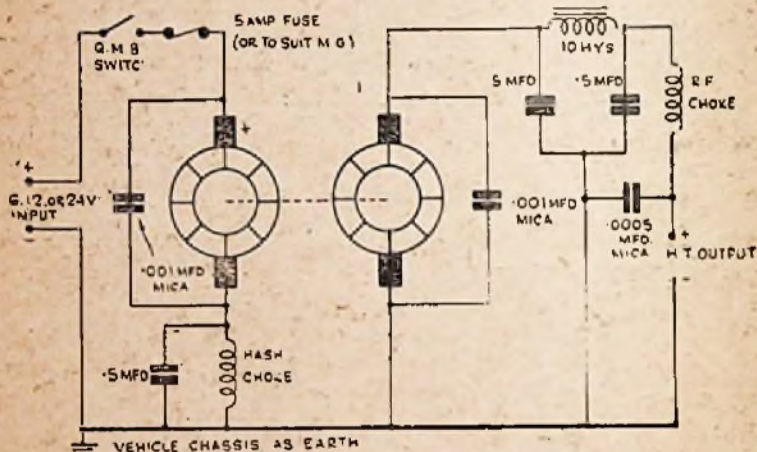

Fig. 16. Motor-generator (Radio H.T.) suppression.

brushes. In some cases the slipring and brushgear are brought into use only when the motor is started up, the rotor being finally short-circuited to act as an inductively energised armature, but wherever A.C. motors have commutating or slipring attachments they may be suppressed for interference in much the same manner as a D.C. motor is suppressed.

Nevertheless it must be realised that capacitors are to be connected either across live and neutral wires or across these wires and earth, so that the capacitor will act as an impedance of greater or smaller value according to its capacitance. The resistance of a good component, on a D.C. circuit, should, to all intents and purposes, be infinite, so that no current flows through the capacitor apart from that due to the alternating or oscillating interference voltages. On A.C. however, the capacitor will pass an alternating current flow, besides the interference currents.

This current flow must not, of course, be confused with leakage current, which would flow on D.C. circuits also, and must be extremely small in any case. The alternating current flow is due to the reactance of the capacitor to A.C.

Providing that the capacitor has a low power factor (or is a "good" component) the current which flows through the capacitive branch of the circuit will be practically wattless, for resistance, as distinct from impedance, must enter the circuit before power is consumed, and little or no power is used up in the capacitor itself. At the same time the flow of wattless current must be reduced as far as possible, and therefore the capacitances used in the suppression of interference from A.C. operated gear are generally much smaller in value than those used on D.C. circuits. When chokes are used in the supply lines these are also generally reduced in inductance values, for whilst a choke presents only its ohmic resistance to the passage of direct current, it too has an impedance to alternating current whilst its

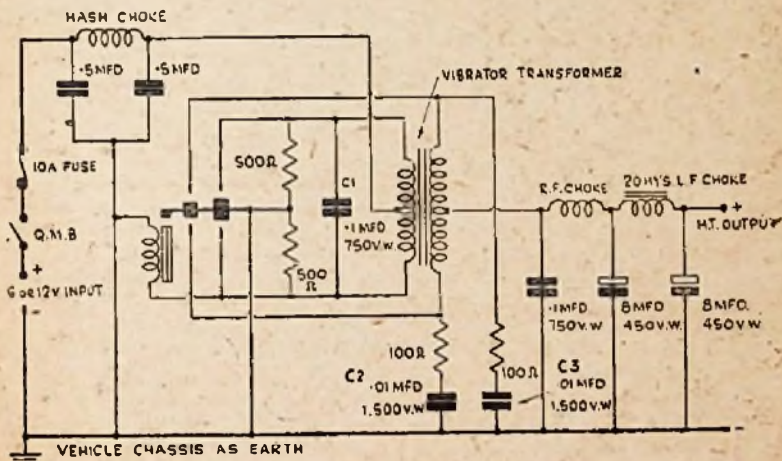

Fig. 17. Vibrator power pack suppression.

use will result in a degree of phase-shift with a consequent effect on the power factor of the whole circuit.

A typical suppression circuit for a small A.C. motor is shown in Fig. 18. Note that 0.1 mfd. capacitances are used in contrast to the 2 mfd. capacitances recommended for the D.C. suppression circuits, and note, also, that the supply lines are coded for their correct connections, being shown as "Line" and "Neutral." Particular attention must be paid to this point when fitting suppressors to A.C. gear, and the neutral line, if not coded at the gear itself, must be traced from the switchboard. Alternatively the live line may be discovered by connecting each line to earth, in succession, via a *high resistance* A.C. voltmeter. An indication will be shown on the scale when the live line is connected in, but no reading will be obtained with the neutral line earthed.

The capacitors used must be rated for high working voltages and although it is less usual to fit fuses in the suppressor circuit when dealing with A.C. gear, and when smaller capacitances are concerned, their use is strongly recommended. 1 amp. fuses are satisfactory.

The simple circuit of Fig. 18 often gives complete suppression, even with capacitances of only 0.01 mfd. values, but a more common circuit is shown in Fig. 19 where three capacitances are used. Common values are 0.1 plus 0.1 plus 0.01 mfd. or 0.02 plus 0.02 plus 0.005 mfd. and various manufacturers market triple capacitors in a single can ready for instant connection. Two types made by Messrs. T.C.C. are especially worthy of note.

Type S1736, tested at 5,000 volts D.C., contains a pair of 0.02 mfd. capacitances connected into a 0.005 mfd. capacitance. Type S2342, tested at 2,250 volts D.C., has a pair of 0.1 mfd. capacitances connected into a 0.01 mfd. capacitance. These triple capacitors have colour coded leads, this coding being shown in Fig. 19.

The triple capacitor suppression circuit is most suitable for small motors of fractional horsepowers, such as are found operating most home devices; sewing machines, vacuum cleaners, refrigerators and fans, etc. when the third or black wire is connected, as in Fig. 19, to the motor frame. The frame should then be earthed itself, by a direct and short earth when possible or through a three-core cable when the gear is portable, as in the case of a vacuum cleaner.

When it is inconvenient to earth the motor frame, or when a poor earth is all that can be provided, the circuit of Fig. 20 may be tested. This circuit can also be used for motors operating on D.C. and it thus lends itself ideally to apparatus such as a small cinema projector which, being portable, might be used on either A.C. or D.C. The capacitors are connected solely to the brush gear, each brush being by-passed to the motor frame through a 0.01 mfd. capacitance with 0.5 mfd. across the brushes.

Where capacitors alone do not provide sufficient suppression, chokes must be included in the supply lines, as in Fig. 21. Suitable inductances are from 0.5 to 5 millihenrys, the choke size increasing, generally, with motor power, an average value of 1 or 2 millihenrys usually proving satisfactory.

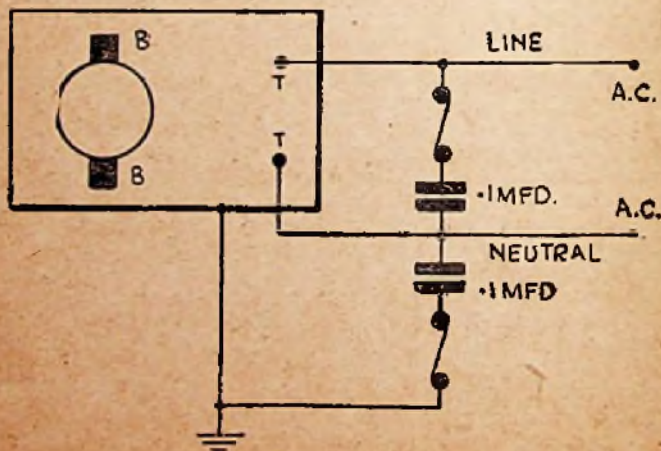

Fig. 18. Simple suppression Circuit for small A.C. motor.

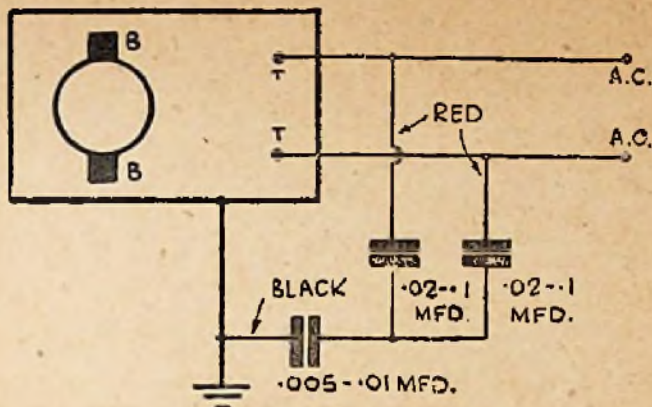

Fig. 19. Triple capacitor suppression.

Rotary converters provide a special instance since one side of the machine must be suppressed for D.C. and the other for A.C., and a comprehensive suppression circuit is shown in Fig. 22. Note that the commutator capacitors are shunted by damping resistors, each of 5,000 ohms resistance and rated at 10 watts.

Larger motors with rotors connected via sliprings to a starter or starter-controller are suppressed as shown in Fig. 23, the slipring—brush contact being by-passed to earth through a capacitor-resistor combination. The need for further suppression in the supply lines to the field must be determined by trial, for the motor may have a switched energising winding or special connections by means of which interference is introduced into the mains. If suppression in the power lines is required, it may be provided by the circuit of Fig. 21.

Three-phase motors, with three power lines instead of two, are dealt with in the same manner as a two-line, single-phase motor, the third line having a capacitor connected between it and the neutral together with an inductance, if these are provided for the other two lines.

A.C. Circuits other than Motor Circuits

A considerable amount of gear is operated from A.C. supplies via transformers, which, naturally, cause no interference on their own account. One branch of transformer fed apparatus can cause considerable interference, however; this is the high voltage discharge tube such as neon and mercury vapour tubes used for advertising displays.

Tube lighting runs at a voltage of about 15,000 volts, so that there are many possibilities of spark discharges and corona effects, especially at the electrode contacts. The display or sign must be properly installed and should be overhauled periodically in order that contacts may be kept clean

and in good condition, but even without sparking the high voltage discharge tube can create interference of itself.

The interference may be combated in several different ways, and whilst the final suppression circuit will depend to some extent on the original wiring and circuitry of the equipment, some, if not all, of the following points will apply.

The supply lines to the transformer primary should run through an earthed conduit for their whole length from the supply or meter point.

The transformer core and casing, should be earthed.

If the transformer secondary is centre tapped, this point should also be earthed by as short and direct a route as possible.

The transformer primary should be suppressed by a suitable capacitive circuit, shown in Fig. 24.

The discharge tubes should be connected in circuit through a 10,000 ohms resistance, suitably rated for the current drawn by the display which may be as high as 100 mAs, the resistor being well protected from the weather and shielded by an insulated screen earthed to the transformer core or casing.

The high voltage lines from the transformer secondary to the tubes should run through earthed conduits. This means that highly insulated cable must be used, especially if the secondary has an earthed centre tap.

Each electrode connection on the tubes should be shrouded by an earthed metal cap of a size sufficient to prevent sparking or discharges between the electrode and the cap.

In a poorly maintained neon or gaseous lighting circuit the inclusion of all these measures will not prevent interference from a fluctuating or flickering tube. Fluctuation may be caused by a drop in H.T. from the transformer, possibly caused by an internal short circuit over part of the windings with consequent arcing and strong interference, or may be caused simply by the tube ageing. In either case the whole lighting array should be overhauled and the defect corrected. Neon signs employ very high voltages indeed and for this reason any alterations to neon installations should only be undertaken by experienced electricians.

Allied to gaseous discharge tubes is the mercury vapour rectifier, which can also cause serious interference, one of the reasons accounting for the

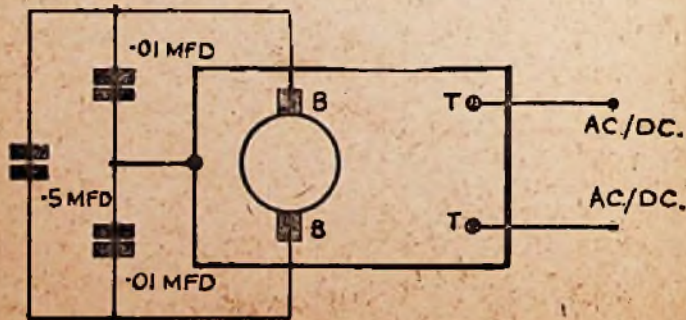

Fig. 20: Brush suppression for small A.C. and A.C./D.C. motors.

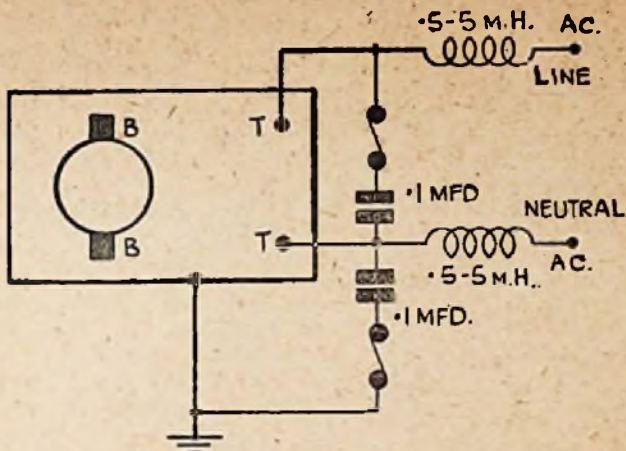

Fig. 21. Capacitive-inductive suppression for A.C. motors.

fact that even small mercury rectifiers are seldom found in receiving equipment. When used by the amateur for supplying rectified power to transmitters and audio equipment, a mercury vapour rectifier must be enclosed completely within a stout shielding case or cabinet, and be fitted with a suppressing circuit similar to that shown in Fig. 25.

This circuit is shown connected to a large mercury vapour rectifier but will serve for smaller models. Each anode, as well as the cathode, is by-passed to earth through a damped capacitive-resistive circuit, the capacitances having a value of 0.1 mfd. with as high a working voltage as can conveniently be provided, the rating rising with an increase of applied voltage. The resistances should each have a value of 10,000 ohms and be rated at 10 watts for 250 volt circuits, the resistance and wattage rating rising, once again, with an increase in the applied potential.

The suppression circuits must each be fused with 1 amp fuses, or, on a small installation with a well-loaded transformer, smaller fuses may be used down to 0.5 or even 0.25 amp.

Multi-anode mercury vapour rectifiers such as are found on large power or multi-phase circuits are suppressed for interference in exactly the same way, each anode being by-passed to earth.

The earth connections from the anode by-pass circuits and also from the shield enclosing the rectifier must be stout and well bonded to keep the effectiveness of the system high, and the earth lead proper should be short, direct and stout.

The inductance in the positive output line from the rectifier should have a value of 1 or 2 millihenrys. For small rectifiers as used for amateur transmitters the Eddystone Transmitting Choke No. 1022 will be suitable for currents up to 250 mAs, but for power rectifiers with a high-current output a commercial choke wound to suit the current must be obtained.

Ordinary L.F. smoothing, if desired, is connected in following the choke.

Medical Apparatus

Professional medical equipment working at high voltages should be thoroughly screened and suppressed as it is installed, and therefore it is only mentioned here as a matter of interest. Medical equipment includes such apparatus as X-ray and Ultra Violet Ray machines, and such devices should be used only in a completely and thoroughly screened compartment. The apparatus itself is also screened.

The screening prevents the radiation of interference in the form of R.F. signals, leaving the mains borne interference to be suppressed at the point of entry of the supply lines to the shielded compartment. The usual suppression circuit for this purpose is shown in Fig. 26. Line chokes of 2 or 3 millihenrys inductance are by-passed on either side to earth through 0.1 mfd. high voltage capacitances.

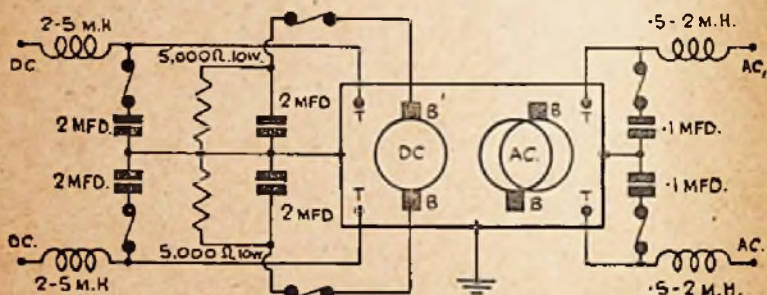

Fig. 22. Rotary Converter suppression.

Arc Lamps

A.C. operated arc lamps are suppressed in a similar manner to that used for D.C. arc lamps. The circuit is shown in Fig. 27, where 0.1 mfd. capacitances are used to by-pass line chokes of 2 millihenrys inductance, although, once again, the chokes incidental to the arc lamp circuit may first be by-passed as a trial.

Switches and Vibratory Circuits

The suppression of switches on A.C. circuits follows D.C. practice except for the fact that a smaller capacitance is used. The circuit of Fig. 11, with the 2mfd. capacitance replaced by a 0.1 mfd. capacitance, is used for straight-forward switching whilst thermally or mechanically operated switch gear may be suppressed by a circuit as shown in Fig. 28, this being similar to a motor suppression circuit. Again 0.1 mfd. capacitances and 2 millihenry chokes are used, although the capacitances alone may prove sufficiently effective.

Vibratory circuits, operated from A.C. supplies, very often have no making and breaking contacts. An electric bell, for example, may consist only of a pivoted armature carrying the striker, the armature trembling in the alternating field. Such devices obviously require no suppression and create no interference.

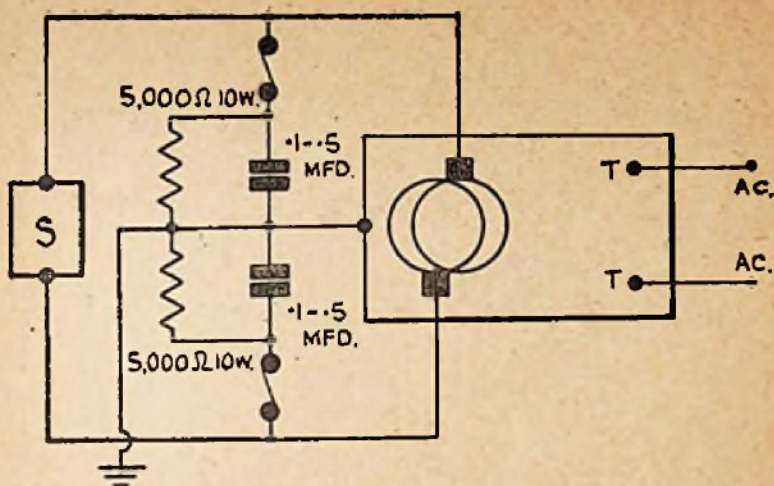

Fig. 23. Suppression circuit for inductive motors with rotor control.

On the other hand ordinary bells are often used, driven via a small transformer from the A.C. mains. In this case the suppression across the bell contacts is still required, and since only a low voltage is applied from the transformer secondary, the suppression circuit may be identical with that used on D.C. bells, as shown in Fig. 13. Interference is then suppressed directly at the source, and only rarely will any mains borne interference result by induction between the secondary and primary transformer windings. If a trace of interference remains, a 0.01 mfd. capacitance connected directly across the transformer primary should effect a cure.

PART 2.

Suppression at the Receiver

So far the suppression circuits shown have been designed to operate at the source of the suppression, and naturally they prevent not only mains borne but also R.F. interference arising from the machine or apparatus to which they are connected. In very many cases, however, mains borne interference will be present to a degree sufficient to ruin radio reception, yet treatment at the source will be impossible for various reasons. It may be that the source cannot be traced or that the owner of the apparatus will refuse to have the interference suppressed.

In this case the suppression must take place at the receiver. Suppressing circuits could be connected to the power lines at the point of entry to the home, but in this event the chokes used would need to be large and expensive and a small suppression circuit for the receiver only is much simpler to make and fit, and can often be accommodated within the receiver cabinet. This is the ideal location, for then the receiver can be used on any power point, the suppression gear moving with the receiver.

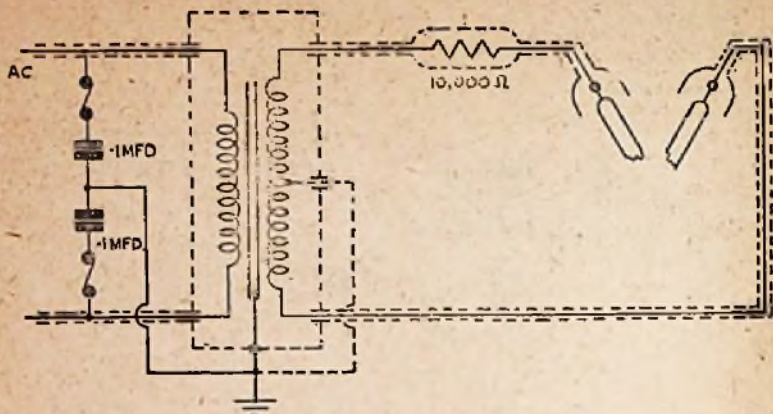

Fig. 24. Neon sign suppression.

Where the characteristic sound of the interference is hissing or rushing noise, capacitors may effect a cure, but where the interference includes crackling and crashing, chokes will be necessary as well. To prepare for all eventualities in a noisy reception area, where it is likely that interference will become worse instead of better, a complete capacitive-inductive filter is advised.

The standard circuit is as shown in Fig. 29, this arrangement suiting both D.C. and A.C. circuits although the capacitances for A.C. mains will be smaller in value than those for D.C. supplies. If the interference is very

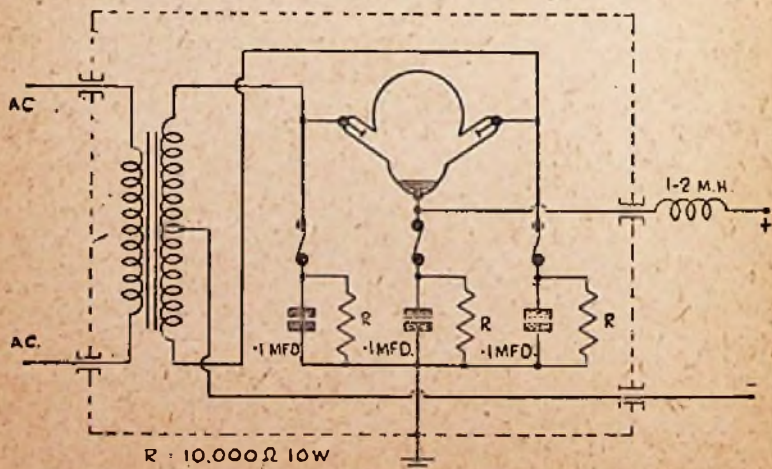

Fig. 25. Mercury vapour rectifier suppression.

bad, a second pair of capacitors may prove necessary, shown in Fig. 29 by dotted lines, their values being equal to the capacitances already fitted. As in most cases of interference suppression, however, these capacitors should be included only after trial and error working has shown the necessity for them.

For many receivers a double choke, obtainable commercially, will be perfectly suitable. The Bulgin H.F.11, already mentioned, is ideal for this suppressor circuit, and since it passes a current of 0.25 amp. its rating should be satisfactory for most A.C. receivers.

For D.C. operation the two capacitances should be of 2 mfd. values each, and for A.C. operation 0.1 mfd. with 1,000 volt working voltage ratings or better. The fuses are so placed that they afford protection both to the filter and to the receiver.

Where capacitive suppression proves satisfactory by itself, a double capacitor may be used in one of the many forms available. The Bulgin P50 for A.C. or D.C. working plugs directly into any two-pin 5 amp. socket, the receiver plugging into the unit via a fuse plug, P25. An earth line must be provided to the P50 unit.

The earth to any receiver suppressor must be good. If the suppressor is earthed to the receiver earth line, and a high resistance or otherwise poor earth is provided, the interference may become worse rather than be reduced. A good earth must, therefore, be installed when both receiver and suppressor have to use the same line.

If, to save space or for any other reason, it is desirable to avoid the use of a double choke, a pair of Eddytone 1022 transmitting chokes might be tested in the circuit.

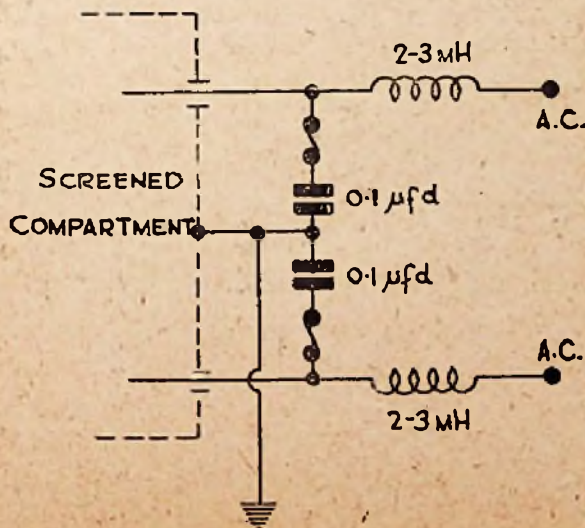

Fig. 26. Suppression of supply lines to X-ray equipment, etc.

CHAPTER 3.
R.F. INTERFERENCE

As specified in Chapter 1, R.F. interference may be due either to electrical apparatus such as motors, neon lighting, vapour rectifiers, etc., where mains borne interference is also generated (and is usually more troublesome than the purely transmitted interference which is generally effective only in a very small area) or due to ignition systems or—as another form of interference—due to re-transmission of signals from neighbouring receivers or to oscillating receivers or similar causes.

The broad classification may now be split into its sub-classifications, and each treated separately.

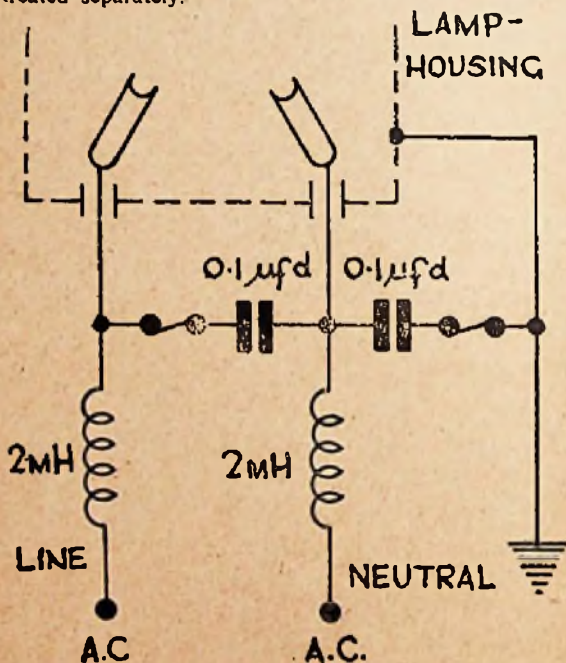

Fig. 27. A.C. Arc lamp suppression.

PART I.

R.F. Interference due to Motors and Mains Gear

If the interference from motors and other mains driven apparatus is to be suppressed at its source, the previous chapter should be referred to, for the method of suppression is exactly similar to that used for the suppression of mains borne interference. As the two forms of interference are due to the same cause—an electrical discharge or a spark between

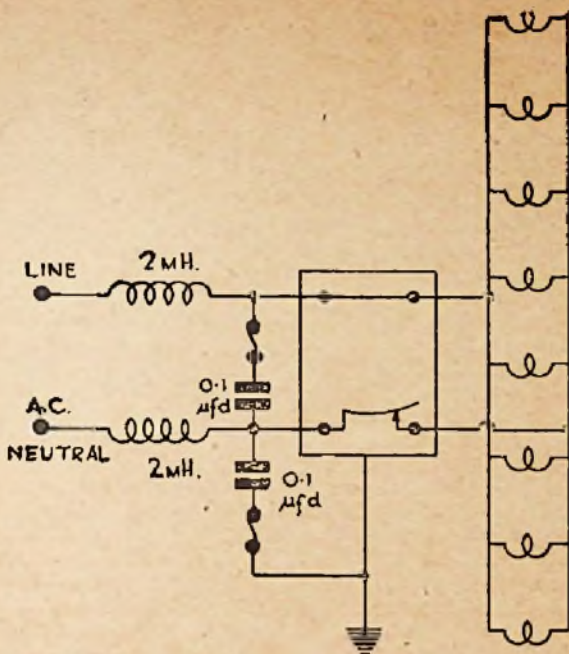

Fig. 28 Suppression on A.C. operated thermal or mechanically switched circuit.

moving or rubbing contacts—curing one will also cure the other, provided that the suppressor is connected directly across or at the seat of the trouble. Fitting a receiver suppressor will, obviously, have no effect whatsoever on R.F. interference generated by a motor or contactor.

When the interference cannot be suppressed at the source, and the mains borne interference is dealt with by a receiver suppressor, any noise still received along with the desired programme will be due to R.F. interference, and this interference can then only be combated by adapting the aerial system to receive the required signals whilst discriminating against the interference signal. Such an anti-interference aerial requires separate discussion, and is dealt with in Chapter 5.

PART 2.

Ignition Interference

Ignition interference may be dealt with in two ways; by fitting suppressors to the engine to prevent the interference or by including a noise limiter in the circuit of the receiver prone to interference from ignition sources. Any radio enthusiast who is also a car owner will feel it a duty to take the first step, and the second remedy may be employed by users of communications receivers and V.H.F. equipment.

Ignition suppression is carried out on a vehicle by fitting resistors to the main lead to the distributor head and, should this prove only partially successful, further resistors at each sparking plug. Properly-made ignition suppressing resistors should be obtained and ordinary carbon resistors should not be used, for the components are subject to a certain amount of mechanical shock, heat and an oily atmosphere.

The resistor for the main distributor lead should be of about 10,000 ohms resistance, fitted with screw ends. Cut the main lead to the distributor as close to the head as possible, screwing the resistor home between the cut cable ends. If the distributor lead is at all long or follows a circuitous route shortening it may prove an advantage.

The spark plug resistors should be of about 15,000 ohms resistance, and should be fitted with a lug at one end, this lug fitting directly onto the sparking plug terminal, a binding post at the other end of the resistor taking the lead from the head.

The effect of fitting the suppressors should be tested by running the engine in the proximity of a good high frequency or communications receiver, or possibly a television receiver. The bonnet should be closed for the test.

Several noise silencing circuits are in use in various receivers, but the simplest to build and fit is the diode noise limiter. The audio signal from the detector is passed to the first amplifying stage via a diode which is biased from the receiver H.T. line. Noise due to ignition interference consists of peaks of sound of short duration but of much greater amplitude than the audio signal being received, and the diode may be biased to the point where the maximum audio sound is passed. A noise peak of greater amplitude blocks the signal for an instant, the peak sound thus being clipped off to the predetermined level of the rest of the signals. The interference is therefore not completely cut out, but is reduced to a point where the

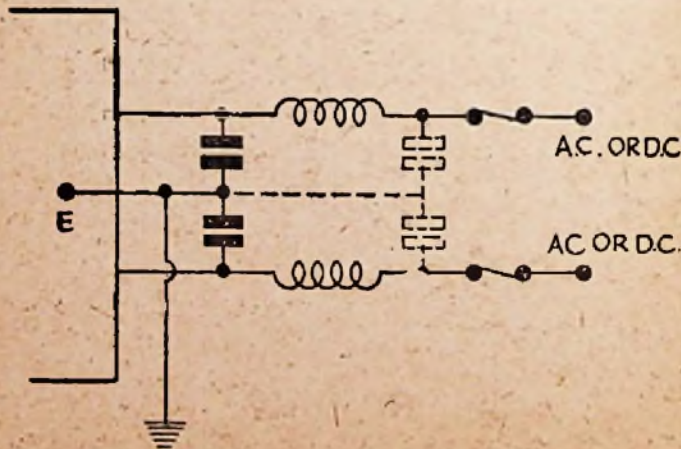

Fig. 29. Suppression at the receiver. For A.C./D.C. values, see text.

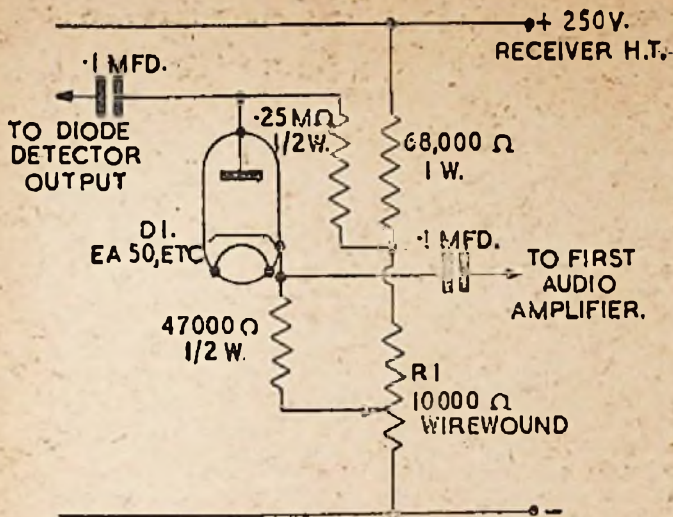

Fig. 30. Diode ignition noise silencer.

required signal can be copied through ignition noise with considerably more ease and comfort.

The noise limiter circuit is shown in Fig. 30, where R1 is the bias adjuster and is set to pass the required audio signal by turning the control until distortion is heard, backing the control off to just clear the distortion. The limiter control should be brought out to the receiver panel, since a new setting will be necessary on a signal of different strength.

PART 3.

R.F. Interference from Neighbouring Receivers, Transmitters, Overhead Lines, etc.

Interference from neighbouring receivers is experienced chiefly in country districts where battery sets are still widely used. Such a receiver, unless of a modern type, often includes in its circuit an oscillating detector, energy being radiated when the reaction control is advanced too far. Another receiver tuned to the same station or frequency will receive some of the radiated energy with the result that a heterodyne whistle is heard.

The only real cure is to train the user of the receiver to keep the reaction control retarded. Fitting an H.F. stage to a receiver where an oscillating detector acts as the first or input stage gives a degree of isolation between the troublesome portion of the set and the aerial, but is often insufficient to prevent some re-radiation of energy. Fortunately the trouble is usually of short duration, for with the station once tuned the reaction control must be retarded if the signal is to be heard properly. Probably the effect is most noticeable on the short-wave bands where a T.R.F. receiver is set at the oscillating point for station hunting.

It is not always realised that superheterodynes can cause mutual interference, especially when they are used on a single aerial as might be the case in a home furnished with more than one receiver. The effect depends on the type of input circuit of the set, and the interference is caused by one or both of the receivers radiating some energy from the local oscillator. The effect can also be caused by a superhet receiver at some little distance.

The radiation of energy from the oscillator stage within the receiver is fortunately a rare occurrence, depending as it does, either on a very powerful oscillator stage, an unusual receiver coupling in the frequency converter circuit, an aerial tuned, by chance, to the oscillator frequency or a harmonic frequency, or to a poorly filtered and smoothed receiver power supply which passes oscillator energy into the mains supply.

An example of a frequency converter circuit very prone to cause oscillator interference is the autodyne frequency changer, where the oscillator may build up across the first R.F. tuned circuit quite a considerable voltage at the oscillator frequency, which then couples directly into the aerial for radiation.

Oscillator interference is identified by a whistle, probably on the local station, which appears and changes frequency at random. A receiver which is known to radiate oscillator frequency energy should be shielded, and the oscillator grid leak reduced if the radiation is due to a powerful oscillator stage, or, if the radiation is through the frequency converter, as in the autodyne circuit, an R.F. stage should be fitted to isolate the aerial from the mixer. At the same time a suppression circuit should be fitted to the mains lead to prevent radiation of interference as mains borne interference.

Generally, however, the effect is observed as due to another unidentified receiver, when the effect must be eliminated at the home receiver. In the first place it is difficult to assess whether or not the interference is mains borne, for if the aerial is removed from the set the trouble almost certainly will cease simply because the incoming signal also ceases. In some cases, however, the whistle might still be heard faintly, when a mains filter is indicated. The mains filter for this purpose should take the form described and pictured in Fig. 29. In cases of doubt it is as well to include the mains filter in any case. The effect of such a filter should certainly be tested, unless the interference can be traced as obviously arriving via the aerial.

An anti-interference aerial may assist in reducing or eliminating the trouble, but as a last resort the I.F. of the home receiver must be altered. A signal generator must of course be used, and the I.F. reduced or increased in frequency by one or two kcs. With the I.F. stages at the new frequency, the padders and trimmers on the R.F. and oscillator circuits must then be re-adjusted to bring the set once again into alignment.

It may be noted that when such interference is radiated via the mains, the energy being passed into the mains lines by the receiver, the receiver causing the trouble very possibly has a full or half wave metal rectifier connected directly across the supply. Alternatively, users of receivers with such power supplies should ascertain that their receivers are not causing interference by connecting between each mains lead and the centre point of the metal rectifier a 0.001 mfd. mica capacitance.

The same precaution should be taken with T.R.F. receivers which can cause strong mains borne interference when fitted with metal rectifiers.

Oscillator interference is most commonly found in built-up areas, where receivers are in close proximity.

Receivers in the locality of powerful transmitters, either commercial or programme stations, are liable to forms of interference not experienced in other areas. A common type of such interference is I.F. "break through" where a transmission, usually of morse, imposes itself on the station required. Tuning the receiver has no effect on the interference which can be very strong indeed and blot out completely even the local station, whilst even switching through the various wavebands of the receiver has no effect on the interfering transmission.

The effect is most pronounced in coastal areas where radio stations are transmitting to shipping on a fairly low frequency, the frequency being close to or identical with the I.F. of the receiver. Such interference is found only with superhets, obviously, though a strong and nearby station may also cause a lesser form of interference on a T.R.F. receiver, the interfering signal growing in strength as the receiver is tuned from the high towards the low frequency end of the medium wave band.

One remedy is to fit an I.F. filter in the aerial lead-in at the aerial socket of the receiver, although experience shows that unless this filter has a narrow selectivity curve and is tuned to the exact I.F. of the set the long wave sensitivity of the receiver suffers.

Since the chief causes, which allow the signal to break through the first tuned circuits to enter the I.F. amplifier, are either an aerial which is naturally tuned to a low frequency and thus giving a relatively high input voltage to the receiver from the unwanted signal, or a receiver which has rather poor selectivity in its tuned circuits between the aerial and I.F. system, a better remedy is to fit an R.F. stage to the receiver, at the same time changing the type of aerial used.

This, however, is a big step to take, and the writer has found that a very satisfactory measure affording considerable relief is to change the I.F. of the receiver. In an actual case the I.F. of a superhet was changed from 465 kcs. to 470 kcs. with remarkable success, the receiver being re-aligned to suit the new intermediate frequency, but it cannot of course be guaranteed that the same results will always be obtained. Some receivers, moreover, suffer a great drop in efficiency with an I.F. alteration, even though the whole receiver is most carefully re-trimmed and padded, and in such a case reliance must be placed on an I.F. trap or a new aerial.

I.F. traps can be obtained commercially and it is sound practice to buy such a filter rather than to make it up from scrap parts, although for testing purposes an old I.F. coil and trimmer capacitor might be tried out in the aerial circuit of the receiver. If room can be found on the set chassis for the trap, so much the better. The usual combination is to use the coil and capacitor as a parallel tuned circuit connected in series between the receiver aerial socket and the lead-in.

The new aerial may be an anti-interference aerial, or, if the interference is very powerful, a frame or loop aerial might be used, so directed that it receives required stations as efficiently as possible whilst discriminating against the unwanted signal.

Another interference effect obtained in the neighbourhood of a powerful station is observed when the station frequency is twice the I.F. of the receiver. When the receiver is tuned through a frequency which is a harmonic of the I.F. a heterodyne whistle is heard, caused by a harmonic of the strong transmitter combining with the local oscillator frequency. The effect is unusual and may be eliminated by re-trimming the I.F. transformers for sharp response or by a simple wave trap at the receiver's aerial socket, the trap being a parallel tuned coil-capacitor combination set to the frequency of the local station causing the trouble.

Image response, on superheterodynes, occurs as a whistle or a second programme on certain stations only. The effect is due to a strong signal situated at twice the I.F. above the required station and such interference is most easily eliminated by a wave trap tuned, once again, to the interfering station. The reception of image response indicates that the receiver selectivity tends to be poor. If the wave trap fails to clear the interference the aerial is probably suited to the frequency of the interfering station and a change of aerial will possibly cure the defect. As a last resort, the I.F. of the receiver may be changed very slightly and the set re-aligned.

An effect which may at first be confused with I.F. "break-through" is the reception of Morse or speech signals in the medium wave band. Tuning the receiver round the band will cause the signals to disappear and reappear, however, unlike I.F. "break-through" which is present all round the dial. The trouble is most probably due to short-wave signals combining with oscillator harmonics to produce spurious I.F. signals, and is very unusual. This type of interference is generally caused by a local or powerful short-wave transmitter, so that a wave trap in the aerial lead-in should stop the trouble, if the trap is tuned to the frequency of the interfering station. Alternatively the grid leak of the local oscillator within the set may be reduced in value to cut down the oscillator output, for this interference indicates an over-powered or poorly shielded oscillator the excitation of which may well be reduced.

A heterodyne whistle or second programme on practically every station tuned is due to two powerful signals separated by the intermediate frequency of the receiver. The effect is therefore likely only in a few restricted areas and on little-used wavebands, for the chances of two powerful signals separated by the required frequency are slight. Where it does occur this type of interference may be stopped by a wave trap tuned to one of the powerful signals, by improving the selectivity of the receiver, or by trimming the first tuned circuits to improve their efficiency if possible, or by a very slight change in the I.F. of the receiver.

Single channel beat is identified as a low-pitched growl or flutter. It may occur in T.R.F. receivers as well as in superhets, but only in sensitive sets. The effect is caused by two stations working on the same frequency with one station very slightly separated in tune from the other. A directional aerial aligned on the required station is the most effective cure, although reducing the sensitivity of the receiver or reducing the bass response of the receiver also causes the interference to vanish.

Adjacent channel beat has a similar origin to single channel beat, but is caused by stations close in frequency—say, within 9 kcs.—as distinct from stations working on the same frequency, and the effect is to give a high-pitched whistle when either station is tuned. Generally speaking, it is

caused by the adjacent signal being strong, and so the interference appears most obviously on the weaker signal.

If a wave trap is used it will require very sharp tuning in order that the strong signal may be suppressed to some degree whilst the weaker signal is unaffected. A simpler but often effective method of reducing the interference is to re-align the set and to correct any circuits which are off trim. It may also be possible to effect a cure simply by manipulation of the tone control, cutting the high frequency response of the receiver until the whistle disappears.

Monkey chatter may be said to be the result of aggravated adjacent channel interference, where the two stations overlap in frequency to the extent of combining their sidebands. As with adjacent channel interference the effect may be observed either on T.R.F. or superheterodyne receivers. This type of interference can only be combated by the methods already specified for curing adjacent channel interference: the set must be re-trimmed or the high frequency audio response reduced.

As a last resort in either of the last two types of interference, a directional aerial aligned on the required station must be used.

As has already been said, cross modulation external to the receiver is difficult to diagnose and troublesome to cure. The effect given is that of a second programme as a background to the required station, and the trouble, when extant, will occur on all types of receivers. This, therefore, gives the key to whether the interference is external to the receiver or not, for any set, tried in the same position, will reproduce the fault.

External cross modulation usually occurs only in the neighbourhood of a powerful transmitter, and is due, most probably, to detection of signals in power lines and other overhead cables. All that the set user can do is to ensure that the earthing system on his own house wiring is in good condition, whilst, if the trouble is serious, he may test any metallic structures about the house, ensuring that these are well earthed. If the trouble persists the only cure, and even then it is one which cannot guarantee results, is the use of either an anti-interference aerial or a directional aerial placed experimentally to discriminate against the interference.

Induction interference from wired wireless or telephone lines would appear to be rare, but was once encountered by the writer as an effect in a T.R.F. short-wave receiver. Placing the set totally within an aluminium cabinet—a foil lined wooden cabinet gives sufficient screening—cured the trouble.

PART 4.

Amateur Transmitter Interference

Interference resulting from the activities of amateur transmitters is separately headed and described, for the correct course of action is always to notify the transmitter concerned or, if the transmitter cannot be located, an unlikely event in view of the fact that self-evident transmitting aeri-als will probably be visible, the Radio Society of Great Britain, 28, Little Russell Street, W.C.1.

Amateur transmission interference may take the form of code or telephony, but it usually consists of rapid rhythmical clicks caused by the keying of the transmitter.

Preventive measures may be taken at both the transmitter and the affected receiver, although it is only correct to say that the fault actually lies in the receiver in the vast majority of cases. Transmitter interference becomes most troublesome at the higher frequencies, where the transmitter is working in the 10 metre band or on shorter wavelengths, and in this case the interference is often apparent as a non-tunable signal.

The cause, in this case, is pick up of R.F. energy on the grid of the first audio amplifying stage of the receiver, the signal being rectified and amplified along with the required programme. By including a grid stopping resistance in the grid circuit of this valve, locating the resistor directly at the grid terminal or cap, the interference is usually suppressed.

The interference may, however, be introduced to the receiver through the mains lines, when it will be most apparent on universal sets. In this case an effective cure is to by-pass the heater of the first audio valve, usually also the detector, to earth by a 0.001 mfd. mica capacitance. If this results in an incomplete cure, the mains leads to the receiver must be by-passed by similar capacitors, one from each line to the receiver chassis, whilst the grid of the detector-first audio amplifier may also be by-passed to earth by a 0.0002 mfd. capacitance. The grid leak in this case must be reduced to no more than 1 megohm in value, should the original value be higher.

In cases where amateur transmitter interference is caused by the transmitting aerial being close to the aerial of the affected receiver it may be necessary to change the receiver aerial to a doublet, or to provide a screened downlead, or to fit chokes or tuned circuits into the aerial feeders or lead-in, but this work should always be undertaken by the amateur, who should himself investigate the type of trouble caused by his station and be capable of suppressing the interference.

The last form of R.F. interference to mention is that caused by weather conditions. This, where serious, can only be partially controlled by a special aerial, as set forth in Chapter 5.

CHAPTER 4.

INTERFERENCE WITHIN THE RECEIVER

It may at first appear that interference arising within the receiver itself is closely allied to, if not identical with, R.F. interference, but actually there is a clear and definite difference. For the purpose of this manual R.F. interference has been identified as an effect due to external causes, and although the cures for such interference must often be made by a receiver re-adjustment the set itself is usually not at fault.

One quite common example of interference arising within the receiver is modulation hum, appearing, usually on the more powerful or the local stations, as a hum which is tuned in with the signal to remain as an annoying background. In point of fact modulation hum can be introduced into the receiver from an external source, such as a badly filtered set, as mains borne interference, but it arises more often within the receiver itself from a variety of causes.

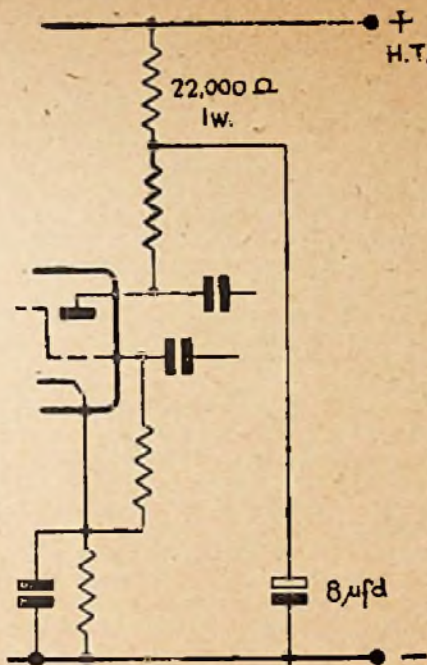

Fig. 31. Decoupling the oscillator.

Modulation hum in the receiver may arise from:—

Heater to cathode leakage in the frequency converter or an R.F. amplifying valve.

Poor smoothing and filtering between the power pack and the R.F. stages of the receiver.

A poor earth or lack of an earth connection.

To cure modulation hum the following measures may be tried, in the order in which they are given here.

Ensure that the conduit carrying the mains supplies to the receiver's plug point, or the cable sheathing, if conduit is not used, is well earthed.

Earth the receiver to a good earth by a short and direct route. If an actual earth rod connection is impossible, use a water pipe earth, preferably on a rising main. Do NOT earth to gaspipes, the mains conduit, or sheathing, etc.

By-pass each of the two mains leads, at the point of entry into the receiver, with capacitors between the leads and the receiver chassis. If the receiver is a Universal set, only one capacitor between the live and the neutral wire will be required. The actual capacitance needed should be found by trial, commencing with 0.001 mfd. values, increasing these to 0.01 mfd. if necessary. Good components must of course be used, mica capacitors whenever possible, whilst not lower than a 500 volts rating and

preferably a 1,000 volts rating should apply. This by-passing may be ineffective if the chassis itself is not earthed. Universal receivers must, of course, be earthed only through a 0.1 or 0.01 mfd. capacitance which should be integral with the receiver when bought.

If these measures prove useless, the oscillator anode supply, in a super-heterodyne, may be suspected, and if the anode circuit has no decoupling this should be added. Break the anode circuit at its junction with the H.T. line and insert a 22,000 ohms resistance, by-passing the connection between this resistance and the anode circuit by an 8 mfd. capacitance to the chassis, as in Fig. 31.

The extra resistance should have no effect on the oscillator working, except as a stabilising and smoothing device.

If the hum still persists, the frequency converter valve may be replaced by a new valve, to ensure that no heater-cathode leakage is taking place. An R.F. valve, if fitted, may also be replaced by a new valve to make the similar trial for this stage.

Finally, the heaters of both R.F. and converter valves should be by-passed to earth, even if one side of the heater is already earthed to the chassis. If this is so a capacitor should be taken from the "live" side of the heater to earth, but otherwise two capacitors will be needed to each valve, one from each side of the heater to earth. Values of 0.01 and 0.1 mfd. should be tried.

Hum in a high gain receiver (or amplifier) which occurs over the whole tuning range may be due to a poorly smoothed power pack but, with single ended valves, may also be due to capacitive coupling between the grid and heater sockets of the valveholder. The best cure is to use a humdinger across the heater lines, taking the moving arm contact direct to the chassis, the contact being adjusted to eliminate the trouble. The humdinger resistance should be 100 ohms.

Hum can also be caused by working high gain valves in the field from a poorly shielded mains transformer, or by the use of L.F. transformers in such a field. Good shielding and, in the case of transformers, orienting the component to minimise the induction effect, are the usual cures.

Cross modulation within the receiver, as distinct from that type of cross modulation described in the last chapter, is really a borderline case, for it is caused by a powerful signal from a neighbouring transmitter. Nevertheless, the receiver must be apportioned much of the blame, for the final effect, that of a second programme as a background to the required programme, is due either to poor selectivity in the tuned circuits or to pick up of the R.F. signal on exposed grid wiring in the audio amplifying stages of the set.

Internal cross modulation may be traced by noting whether or not the effect varies with weather conditions: external cross modulation will vary but internal cross modulation will not.

If possible try, as a check, another receiver at the same position working from the same aerial, and note whether the effect is less pronounced, or eliminated.

Possibly the simplest cure for internal cross modulation is to fit a wave-trap in the aerial lead-in as close as possible to the aerial socket of the receiver, but the set should be inspected and exposed grid wiring carefully shielded in the audio stages.

When internal cross modulation occurs within T.R.F. receivers and superhets with a first R.F. stage, the first stage in each case containing a straight R.F. pentode, a cure is sometimes effected by changing the valve and such stage components as necessary to variable- μ working, but since the alterations required will vary widely from set to set no details can be given here.

As an alternative an anti-interference aerial may be installed, or an aerial arranged to discriminate against the powerful signal which is causing the trouble with the receiver.

Ordinary commercial receivers used in normal reception areas should be and are free from most self-introduced interference effects, but one common fault may be mentioned, *i.e.*, second channel reception on the short-wave bands in all-wave superheterodynes.

Second channel reception may be classed as interference for stations on the high frequency end of the band are received twice—that is, at two points on the tuning dial—and one of these points may lie on the frequency of a desired station.

Second channel reception often comes more into evidence as the receiver ages, and the tuned circuits tend to fall out of trim.

The effect is due to a lack of selectivity natural to tuned circuits at the higher frequencies. The tuned circuit is increasingly heavily loaded by its associated valve as the frequency rises, so that the Q and therefore the selectivity of the tuned circuit falls, whilst at the same time there is a natural fall in the circuit efficiency with a frequency increase. As a result the selectivity curve of the receiver as a whole is flattened and second channel reception becomes possible.

Theoretically, second channel reception is possible at any frequency. Presume that a station is working on a frequency of 10 mcs., *i.e.*, 30 metres. Then the receiver's local oscillator would be working at 10,465,000 cycles per second, or 10.465 mcs. to suit the usual intermediate frequency of 465 kcs.

At the same time, however, the oscillator would also beat with the signal situated at 10 mcs. when the oscillator was working on 9,535 mcs. for the frequency difference is still 465 kcs, under these conditions. Normally, the selectivity of the signal tuning circuit would prevent the signals being passed to the frequency converter when the oscillator was tuned to 9,535 mcs. because the first tuned circuit would then be set to receive stations on a frequency of 9.070 mcs. But with the poorer selectivity of the first tuned circuit at the high frequencies, the 10 mcs. station may not be completely cut off. The station, especially if the carrier is strong, will thus be received rather poorly at the 9.070 mcs. point on the tuning dial and correctly at the 10 mcs. tuning point.

Even on a receiver with no R.F. stage the effect should not be noticeable on frequencies lower than about 15 mcs (wavelength above about 20 metres), but beyond that point the ordinary superhet, which has as its input stage the frequency converter valve, is almost powerless to prevent a certain degree of second channel reception.

Adding an R.F. stage to the receiver gives great improvement for, the extra selectivity will then permit of tuning up to about 25 mcs. at which point further selectivity is required to prevent the reception of the signal "image," as the unwanted signal is called.

For very high frequency working, therefore, it is desirable to use receivers with high intermediate frequencies, for the higher the I.F. is made, the greater is the separation between the signal and its image. Converters for the reception of 10 and 5 metres signals may be used with ordinary receivers, for then double frequency conversion is obtained. The Converter works into the receiver at an I.F. of perhaps 5 or 10 mcs. and the receiver's own mixer stage reconverts this signal to the 465 kcs. I.F. signal for further amplification, high selectivity thus being obtained with high gain.

As may be expected, home constructed receivers, particularly superhets, are liable to include faults or misalignments which show their presence as interference of one form or another. One most likely fault in broadcast or high frequency communications receivers is oscillator squegging, indicated by "birdies"—whistles as the receiver is tuned over the band—or a hiss. Squegging is the effect obtained when an oscillator is driven too hard, so that it oscillates simultaneously on high and low frequencies. An example of an oscillator deliberately made to squegger is a super-regenerative very high frequency receiver.

Squegging in broadcast receivers is usually caused by too much feedback between the grid and anode oscillator coils, which are closely coupled to suit all types of circuits and valves with which they may be used. The fault may be cured, in this case, by tuning the anode coil and inserting between the grid coil and the grid capacitor a small resistance, the value of which—found by experiment—will lie between the approximate limits of 50 and 500 ohms.

Oscillator squegging may also be caused by a too high voltage on the oscillator anode or screen, or a too high grid leak resistance, so that these points may also require attention.

Another quite common defect in home built superhets, especially communications receivers where two or three I.F. stages are used, is feedback over the I.F. stage or stages to the point of oscillation. In the comprehensive receiver some I.F. regeneration is of extreme use, but it must always be under close control and kept below the oscillation point.

I.F. oscillation is observed as a harsh distortion of signals in the ordinary receiver, whilst in the communications receiver it is identified by switching on the beat oscillator, when a shrill whistle will result. Poorly run wiring is often the cause, allowing capacitive feedback between anode and grid of the I.F. stage, but too high a screen voltage on the valve or insufficient or faulty decoupling components can also cause the trouble. Another possibility is that the metal coating of a metallised valve has become isolated from its base connection, and is therefore not brought to earth potential. The defect must be cured by checking all these points, providing extra screening to the stage if the wiring is short, direct and neat and the stage components in good order and correctly chosen and wired.

Oscillation through the instability of an R.F. stage gives rise to "birdies" and whistles as the set is tuned, whilst it is possible for the A.V.C. system to be so heavily loaded that the receiver gain is cut drastically and no signals are heard. The points requiring attention are those enumerated for I.F. oscillation interference; poor wiring, feedback over the stage by anode-grid capacitive coupling, poor decoupling, faulty screening or a too high screen voltage.

ANTI-INTERFERENCE AERIALS

Where, after suppression at the receiver has been introduced, R.F. interference is still prevalent, collected by the aerial, a change of antenna is indicated in order that the efficiency of the system shall be enhanced, if possible, for signal reception and lowered so far as interference reception is concerned.

It must be realised that an anti-interference aerial, whatever its type, cannot prevent the reception of weather interference. Indeed, the more efficient the aerial is made, the more likelihood is there of reception of—fortunately rare—interferences like rain static, aerial corona, etc. A good aerial should be fitted with a static discharger which will prevent the accumulation of high charges.

An anti-interference aerial is designed to overcome radiated man-made R.F. interference arising from electrical machinery and apparatus.

Modern receivers are so sensitive that they are often used with a very poor aerial, sometimes with no aerial at all, whilst a very great number of indoor aerials are in use. In each case the reception of interference is made more likely.

A receiver working without an aerial or with a poor aerial must be run at full gain, for the signal input is low. Interference, in this case, may set up input voltages as great and perhaps even greater than the signal voltages across the first tuned circuit, whereas from a well designed aerial the interference input would be reduced whilst the signal input would be much enhanced. It is only necessary to erect the aerial in such a manner that the interference signals are not picked up, or are received poorly.

Similarly an indoor aerial can introduce a great deal of interference into the receiver. The aerial may be perfectly adequate as far as station carrier pick up is concerned, and provide a good input signal to the receiver, but by its very nature it is ideally situated for the reception of interference as well, for it is close to the house wiring and to any electrical apparatus within the house—fans, refrigerators, vacuum cleaners, etc.

An outdoor aerial, erected in the open, will nearly always make the extra work worth while in better results, but the ordinary flat-top, lead-in aerial can be improved in several ways with little expense. Interference is nearly always more strongly received by the lead-in or downlead than in the aerial proper, and so a screened downlead should be used. The best material for the purpose is co-axial cable, the outer conductor acting as the screen which should be earthed. The downlead then becomes a non-receiving feeder.

The downlead tends to receive interference since, like the indoor aerial, it comes into close proximity of house wiring and house apparatus. In the great number of cases where aerials are erected behind the house, it is also the part of the aerial closest to the street, where there may be power lines, tramways, trolleybus wires and similar sources of interference. Screening the downlead, therefore, is often an effective measure whenever slight interference is obtained from a good outside aerial.

Where the house does front on to a busy street or a route followed by electrical vehicles, an excellent aerial may be erected by placing the antenna at the far end of the garden to the rear of the house, the wire

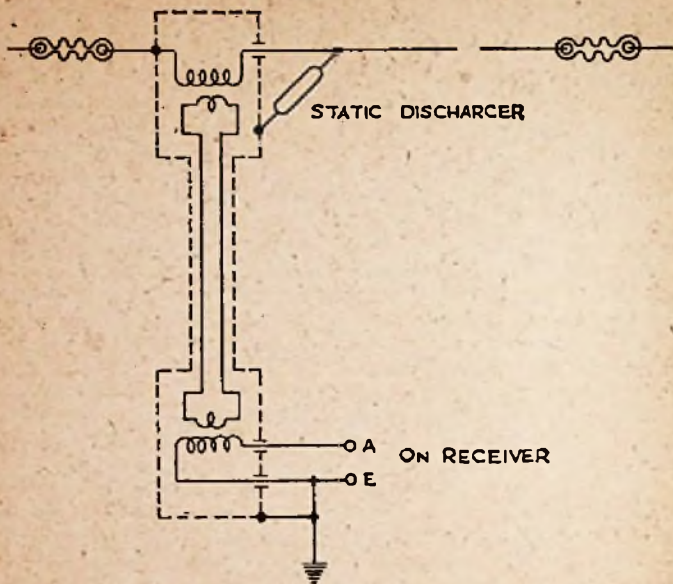

Fig. 32. The commercial anti-interference aerial.

being perpendicular to the street. The screened downlead is then brought to the receiver by as direct a route as possible, since there is an unavoidable loss with length in a co-axial downlead.

In the case of commercial anti-interference aerials, where a low impedance twin feeder connects the aerial to the receiver, the feeder may be brought from the matching transformer at the end of the aerial farthest from the interference source and actually run underground to the house, thus preventing a very considerable amount of interference reception.

Wherever R.F. interference is bad the use of a commercial anti-interference aerial is strongly recommended, an excellent example being the Belling-Lee "Eliminoise" aerial.

A flat top wire is transformer coupled to a screened twin feeder of low impedance, which is then transformer coupled to the input sockets of the receiver, the whole system being as shown in Fig. 32.

The aerial is purchased as a kit under the catalogue number L.308/K, and is priced at £6 6s. 0d.

The static discharger, shown in the diagram, is of the carbon block type, static collecting on the aerial being conducted to ground whilst signals are unaffected. Other static dischargers are in use, one well known type consisting of two electrodes in a small tube of inert gas, the gas ionising and conducting away any charge sufficiently strong to energise the tube.

"Eliminoise" transformers may also be used with vertical aerials, and since a considerable amount of interference, especially from tram and

trolleybus wires, is horizontally polarised, such aeri-als can be recommended for noisy reception areas. Several makes are obtainable, but most worthy of mention are the Belling-Lee "Winrod," a small vertical aerial for good reception areas, the 12' "Skyrod" and the larger 18' "Skyrod," both types of "Skyrod" aerial being fitted with transformers and low impedance twin downlead if required.

The amateur is not advised to wind his own R.F. transformers for aerial-downlead and downlead-receiver matching, for a really good instrument is necessary, capable of matching over a wide frequency range.

An excellent vertical aerial can, however, be home produced, and, with a shielded downlead and static discharger, together with a mains suppression filter at the receiver, will provide an overall efficient anti-interference system. The aerial is shown diagrammatically in Fig. 33.

The aerial proper, supported on strong insulators, is made from metal tubing, and some trouble must be taken to make the structure strong yet of light weight. The material used should therefore be chosen with a view to weather conditions at the receiving point, for whilst aluminium tubing would be perfectly suitable in sheltered positions or inland, coastal conditions and wind forces make a hard copper type of tubing desirable.

The weight of the aerial must be kept down, and its wind-resistance also maintained at a low level since it is to be bolted to a chimney stack or to the gable end of a roof, or to a similar structure sufficiently strong to take the extra weight and strain.

In cases of doubt the aerial should be supported on a well guyed mast and not mounted on the house fabric at all.

The aerial is formed of three sections of tubing, and in view of the present supply difficulties a final tubing size is not specified. The material should be chosen so that the sections fit one into the other, the joints thus being firm and rigid. The second section is set into the first for a distance of 6", secured by two long 4 B.A. bolts passed right through the sections, one bolt being at right angles to the other, and separated by 4", the detail being given in Fig. 34. The top section, which might well be a whip rod, is set for 6" into the second section, and 6 B.A. bolts used to secure the joint.

The bottom section of the aerial is held by two strong stand-off insulators to a beam of hard wood 30" x 8" x 1" when the antenna is to be supported on a chimney or a wall, or mounted directly on a mast top by stand-off insulators.

The overall length of the aerial should be about 9' when the bottom section is 4' long, the second section is 3' 6" long and the top section or whip rod is 2' 6" long, the extra 6" in each of the upper two sections allowing for the joint overlap.

At the foot of the aerial a small conical shelter, cut from sheet zinc or galvanised iron, provides a weather screen for the static discharger, safety choke and downlead joint, together with the lightning gap. To support the lightning gap, shunted by the static discharger, a small bar is sweated or screwed to the foot of the aerial, supporting, via two cylindrical stand-off insulators, a second bar. The lightning gap is tapped and screwed across the two bars, the second or lower of which has a direct connection to a good earth.

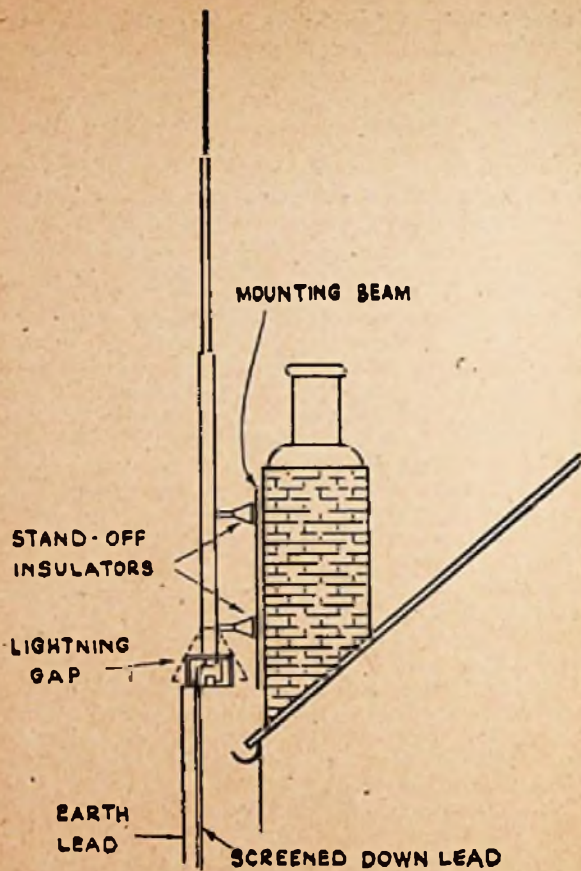

Fig. 33. The home-made vertical aerial.

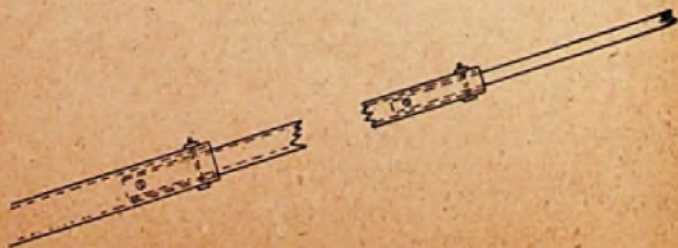
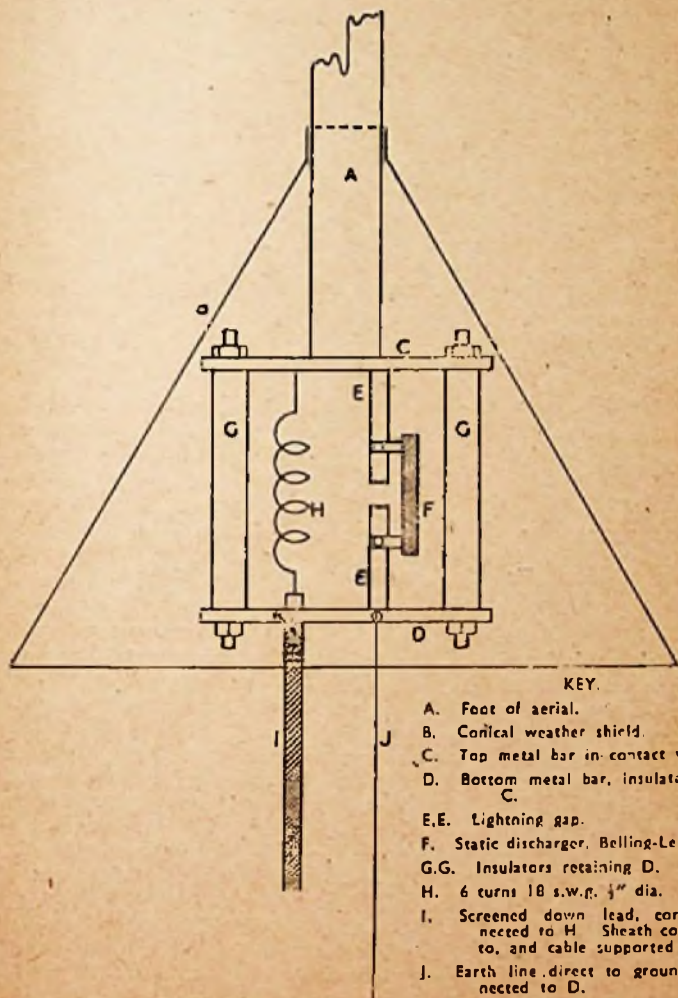

Fig. 34. Detail of section joints.

The downlead is connected to the aerial through the 6 turns of 18 S.W.G. copper wire which form the self supporting helix with sufficient inductance to ensure that a sudden charge would pass across the gap, rather than be conducted to the receiver.

The lightning gap combs may be taken from an old lightning switch, or cut from sheet metal. The gap should be no broader than one thirty-second of an inch, the detail being shown in Fig 35.



KEY.

- A. Foot of aerial.
- B. Conical weather shield.
- C. Top metal bar in contact with A.
- D. Bottom metal bar, insulated from C.
- E.E. Lightning gap.
- F. Static discharger, Belling-Lee L350.
- G.G. Insulators retaining D.
- H. 6 turns 18 s.w.g. $\frac{1}{8}$ " dia.
- I. Screened down lead, core connected to H. Sheath connected to, and cable supported by, D.
- J. Earth line direct to ground, connected to D.

Fig. 35. Detail of lightning gap, etc.

A co-axial downlead is used, the outer conductor or screen being bonded to the earth lead from the aerial, and also to the receiver's earth lead which may join the aerial earth lead by the most direct route.

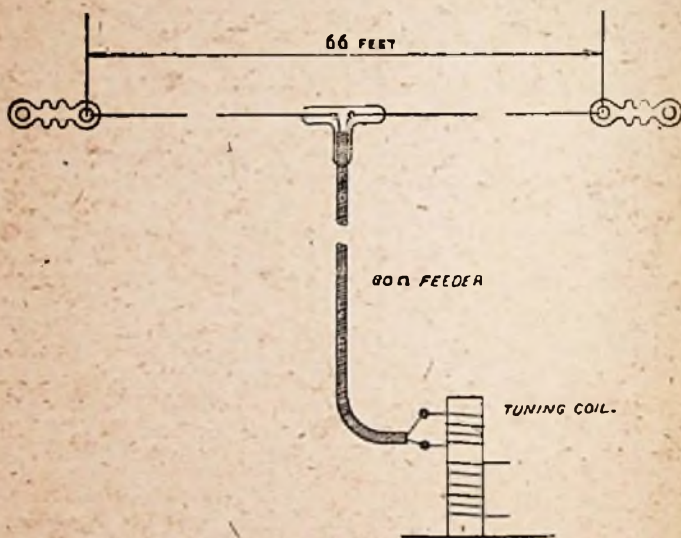

Fig. 36. The 40 metre Doublet aerial.

This vertical aerial will prove of value to set users in any normal reception area, but probably will give insufficient pick up in a really poor reception area whilst, at the same time, it will hardly suit the short wave listener.

For the receiver in a poor reception area a conventional flat top aerial, transformer and feeder coupled to the set, can hardly be bettered, so that a commercial aerial kit should be obtained. The short wave listener can, however, build his own aerial, and since his chief interest will probably lie in the amateur bands the aerial can be of the resonant doublet type. Such an aerial is actually best suited for the one band to which it is tuned, and for transmission is usually only used for that band, but the doublet aerial, used for reception, generally gives very satisfactory results on all the amateur bands.

The doublet aerial is generally cut to resonate at the 40 metre band, so that the overall aerial length is a half wave, or 20 metres, since a length of wire is resonant, or naturally tuned, to a wavelength twice the length of the wire.

A half wave aerial receives most efficiently from the side direction, that is along a line at right angles to the aerial wire, so that whenever possible the aerial must be erected along a line which will favour reception from the most desired direction. In Britain an aerial running N.N.E. to S.S.W. favours reception from America in the one hand and Italy, North Africa and India on the other hand. The directivity of the aerial undergoes some changes when used on bands other than the resonant, but a directed aerial is of assistance on all bands.

The aerial length is slightly affected by "end effects," due to the capacitance of insulators, stays and masts, etc., and is made slightly shorter than the indicated length. Thus a half wave aerial for the 40 metre band is given an overall length of 66 feet.

An aerial has a radiation resistance which must not be confused with the ohmic resistance of the wire itself, and the radiation resistance at the centre of a half wave aerial, no matter for what band it is resonated, is between 70 and 75 ohms. A feeder line also has a characteristic impedance which is not related to the ohmic resistance of the wire, the characteristic impedance being that impedance or resistivity offered by the feeder to a travelling charge. For the most efficient and simple transmission of the aerial currents to the receiver the radiation resistance at the centre of the half wave aerial must be related or matched to the characteristic impedance of the feeder line, and since 80 ohms feeder can be obtained commercially, this may be used to provide an excellent match into the 75 ohms or so of the aerial.

The feeder, Belling-Lee L336, contains two wires. The aerial is cut at its exactly central point, so that the two wires may be brought into circuit, and the joint may be made strong and efficient by using a Belling-Lee "T" strain insulator.

At the receiver the 80 ohms feeder must be matched for the best energy transfer, and the feeder line is not, therefore, plugged into the A and E sockets. Round the short wave tuning coil of the first tuned circuit should be made a winding of about 6 turns of insulated wire, and it is to either end of this winding that the feeder line is connected.

Depending on the size and characteristics of the tuning coil the winding may be made smaller or larger, but this is a case for experiment in each individual set.

The feeder line may be of any length, but naturally should be kept as short as possible in order that the inevitable line losses do not assume too great proportions.

The aerial system is outlined in the diagram of Fig. 36.

Note that the system is not earthed at any point, and is symmetrical.

TELEVISION INTERFERENCE

By "television interference" is chiefly meant the forms of interference which affect television receivers, spoiling both the high fidelity sound reproduction and the picture quality, but the term may also be applied to one very different trouble.

Users of ordinary broadcast receivers situated near to the Alexandra Palace transmitter found that the television programmes were sometimes received as a background to the ordinary medium and long wave programmes for which their sets were designed, the interference being an aerial-introduced type of R.F. interference.

With new transmitters, soon to be built in other centres of population, the cure for television interference of this sort will require to be more widely known, and so the details are given here.

In the great majority of cases a simple choke in the aerial lead to the set is sufficient to stop the interference. The choke should be connected in at the aerial terminal or socket of the receiver, and since it is effective only on the ultra short wave band, it has no effect on the reception of other signals, whether short, medium or long wave.

The choke is wound on a $\frac{1}{4}$ " diameter former, paxolin tube or ebonite rod being suitable materials, and consists of 110 turns of 36 S.W.G. enamelled wire, wound with the turns touching to occupy a winding length of $\frac{1}{4}$ ". The sizes and number of turns are of some importance since the design of the choke is such that its inductance is tuned by or resonates with its capacitance to make the choke appear as a very high impedance at the required frequency.

If the inclusion in the aerial lead of such a choke does not prevent the television interference on a normal receiver, the set should be inspected for poor shielding, or for exposed grid wiring in either the R.F. or audio stages, and shielding applied where necessary.

As regards television interference proper, the forms of interference to which television receivers are prone, ignition interference is undoubtedly the most troublesome type and most often experienced.

Some manufacturers now make their television receivers with noise limiting systems already incorporated, the limiter circuit being derived from the diode limiter of Fig. 30. The television sound receiver can, of course, have such a limiter fitted exactly as shown, some care being taken in the initial adjustment of the diode bias to prevent any distortion on the quality sound. In Fig. 37 is shown a vision "noise" limiter, again using a diode acting as a biased shunt between the modulator and cathode of a cathode ray tube. A somewhat similar circuit is sometimes used in cathode ray oscilloscopes for the blacking out of flyback traces.

The circuit and values shown in Fig. 37 are designed to suit the author's T.R.F. Television Receiver shown and described in the "Television Constructor's Manual," No. 59, on Messrs. Bernard's List.

It must be realised, however, that in the case of commercial receivers the modulation is applied to the tube in different ways whilst the tube power supplies also vary widely in their arrangements. "Noise" eliminators may

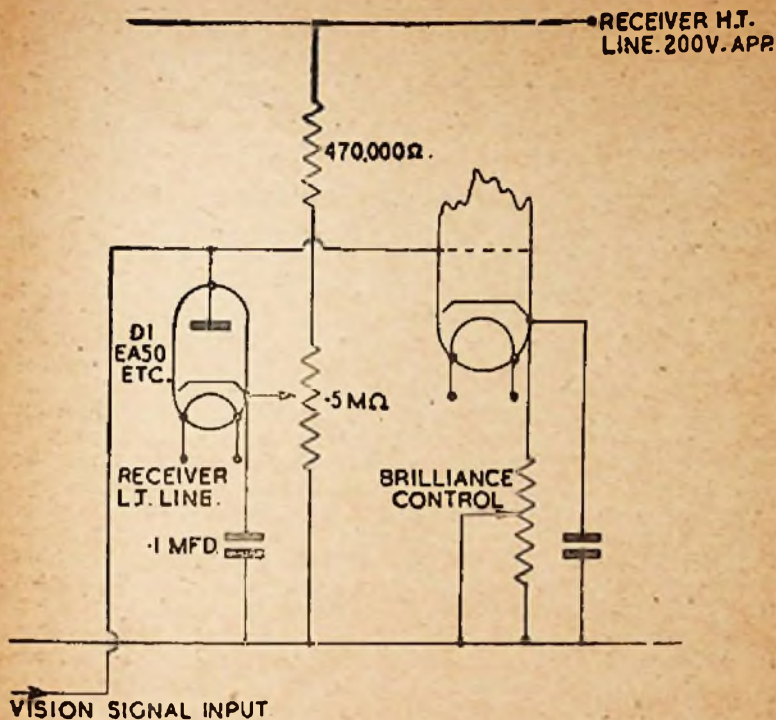

Fig. 37. Vision interference eliminator for the T.R.F. Television receiver (Bernards' Television Constructor's Manual).

therefore be fitted to commercial television receivers only by expert engineers.

The limiter is adjusted in much the same way as that used on sound receivers. The control is brought to the point where the whites of a picture or test pattern are just dimmed, then backed off until the whites return to their natural brilliance.

Note that whereas the ordinary diode limiter is a series circuit, the diode being biased to pass current under normal conditions (Fig. 30), the limiter for vision signals is a shunt circuit and is normally non-conducting since the cathode is made positive with respect to the anode. Ignition interference, which causes peaks of extra-positive polarity on the tube grid, will render the diode anode positive with respect to the cathode whilst the interference lasts so that the diode becomes conducting and passes the momentary signal to earth via the capacitor.

Apart from ignition interference various other forms of interference are possible with a television receiver. Interference from other transmitters is only likely when the receiver is used in the neighbourhood of an

amateur transmitting station, when the amateur should be contacted. Oscillating detector receivers can cause trouble when operating on the television frequencies, as can also a super regenerative receiver used in the neighbourhood for the reception of television sound or for experimental purposes. In each case the trouble lies with the external gear, not the television set, and little can be done apart from contacting the user of the offending apparatus.

"Ghost" images, a fainter secondary picture usually misplaced to the right on the true picture, are caused either by a form of interference at the aerial, or by serious mismatching of the receiver to the aerial by the feeder line. The first cause is the more common.

"The ghost" is the result of receiving the television signal twice, once directly and once as a signal which has been reflected from some large natural or artificial object, the second signal thus having travelled over a greater distance so that it appears after the true synchronised scan has started. Receivers used near to large steel framed buildings or gasometers are those most likely to exhibit the effect, although in some cases the ghost image is caused by a signal travelling over a quite long reflected path.

The remedy, where such a reflected signal is being received, must be applied to the aerial. Reflected signals often occur as quite sharply defined beams and in several cases shifting the aerial a few feet has resulted in a cure. The aerial should also be fitted with a reflector on the side remote from the transmitter, not only to make the aerial give a greater output but to reduce by a considerable amount the chance of signal pick up from the rear of the aerial, the direction in which reflected beams might well come.

The reflector is a single rod or tube of metal, not cut at its centre as is the dipole aerial, and either equal in length to the aerial or about 5 per cent longer. Thus the reflector length may vary between approximately 10' 4" and 10' 10". The reflector should be approximately 0.2 of a wavelength behind the aerial proper, and has no electrical connection with the aerial or receiver.

"Ghosts" caused by mismatching are often multiple. Signals flowing down the feeder to the receiver are fed into a mismatched input stage with the result that the available energy is not used, some being reflected and flowing back to the aerial whilst further picture signals are flowing down to the receiver. The "waste" energy is reflected at the aerial and flows again to the receiver's input causing a "ghost" image, yet even so the "waste" energy may not be totally absorbed and further reflections may cause another "ghost" after the first, with even another "ghost" following the second, the "ghosts" being misplaced by a very small amount at each occurrence. The remedy is obviously to correct the matching at the receiver, and it may be said that this trouble is only likely either where a commercial receiver is fed from an unsuitable aerial or a homebuilt receiver has an incorrectly made input coil, the signal, in each case, being strong.

Inverted "ghosts" sometimes occur on home built receivers and one or two cases have been met with by builders of the T.R.F. receiver in the Television Constructors Manual. The "ghost" is not a true "ghost," but a fly-back picture, being a portion only of the true picture inverted, left to right, and enlarged laterally. This is due to a slightly incorrect setting of the line time base, so that the fly-back is not blacked out on the

sync pulse and, as it returns, takes up a portion of the picture period, showing that portion of the picture as a reversed and enlarged image. The time base used has a rather long fly-back time, but correct setting of the controls wipes out the effect and no picture content is lost.

Interference due to weather or static conditions, the aerial becoming charged, is unlikely, but if it occurs little can be done. The peculiar effect, sometimes observed, of the aerial becoming charged in such a manner that one half of the dipole discharges into the other half can be overcome by a static discharger between the two halves, but this is far from necessary. A gap can be arranged between the dipole rods and earth to act as a lightning gap if desired, but this, again, is a precaution not always observed. Commercial television aerials are often protected, however, whilst the aerials marketed by Messrs. Belling-Lee have insurance coverage against lightning.

A form of interference which should not be observed on a commercial receiver but which may occur with a homebuilt receiver is sound "break-through." The tuning circuits of the vision receiver must be broad in their response so that the set is extremely unselective; this is necessary in order that the very wide band of frequencies taken up by the vision signal might be passed without attenuation to provide a detailed picture. As the pass band of the tuned circuits is narrowed so does the picture lose detail.

At the same time this poor selectivity means that a signal near in frequency to the television signal may be received, so that the picture will be blotted out, or at least affected in some way. The sound programme accompanying the picture is the nearest transmission to the picture frequency (vision, 45 mcs., sound 41.5 mcs.), and sound break-through means that the vision receiver is also receiving the sound transmission, at least in part. The effect, as seen by the writer, is easily identified since a peculiar shimmer or waver, to one side of the picture, varied in exact accordance with the sound issuing from the loudspeaker, whilst the waver was strongest on music, where the sidebands of the sound carrier were extending more nearly to the television carrier, and almost non-existent for voices with their narrower frequency range.

Several means exist whereby the sound programme can be prevented from interfering with the picture carrier, and the simplest is a wave trap, as shown in Fig. 38, interposed between the feeder and the coupling coil to the input stage of the vision receiver.

This system cannot be used with the ordinary commercial set where the first stage amplifies and accepts both sound and vision carriers, but with a home built receiver, where the two sections of the set are separate, it is often usable.

The trap, which is actually double, with a section in each feeder, consists of a pair of coils, each wound with 4 turns of 18 S.W.G. spaced out by its own diameter on a $\frac{1}{2}$ " diameter former, each coil being tuned by a 3—30 mmfds. trimmer, the trimmers being set experimentally to absorb the sound carrier in the parallel tuned circuits.

When the first stage of the receiver is built to tune in both carriers, however, the trap must appear later in the vision circuit. For example, a tuned circuit can be connected into the cathode line of the first vision R.F. amplifier, or a wave trap may also be inductively coupled to one of the tuned circuits, wound on the same former as a tuning coil.

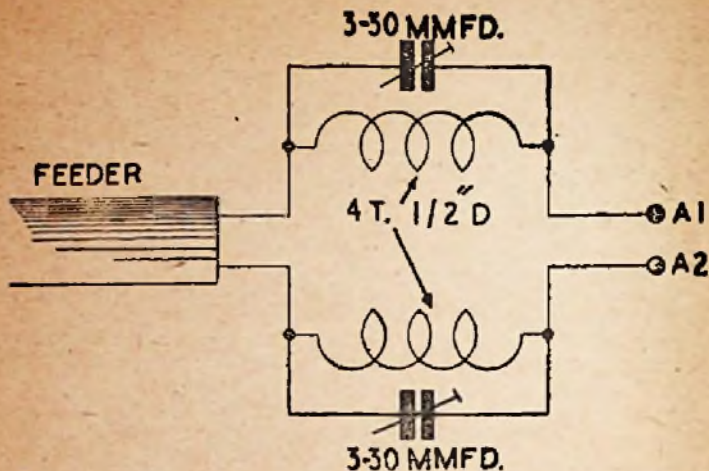

Fig. 38. Sound wave trap in television aerial feeder.

I.F. break-through may occur with television superhets, just as with broadcast receivers. The I.F. is chosen to be clear of the short wave broadcasting bands, and is necessarily high in frequency in order that the I.F. amplifier may accommodate the wide band of vision signals, whilst the transformers are well screened, but if I.F. break-through does occur the picture can easily be ruined. A strong harmonic of a nearby transmitter or amateur station can be sufficient to cause the effect.

I.F. break-through may be identified as a random type of interference, occurring at times, and the effect on the picture will depend to a great extent on the type of signal causing the trouble.

Extra screening of the receiver, or a suitable double trap in the feeder lines tuned to the I.F. of the receiver may cure the interference, but the advice and service of an experienced engineer is advisable.

Whilst not a form of interference, an effect akin to interference is sometimes experienced by viewers who endeavour to work their receivers from an aerial not correctly cut to size or mounted. The input circuits of many sets are adjusted so that they operate correctly only when properly loaded by the aerial, a bad loading causing the vision to be received well with poor or fluctuating sound, and vice-versa, whilst tuning the receiver allows either sound or vision to be received well but not both at once.

In this case the cure is to fit a true dipole aerial and 80 ohms feeder, so that the first stage is properly loaded.

OPPORTUNITIES IN RADIO

Get this FREE Book!

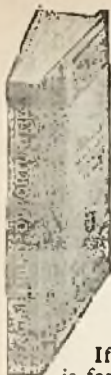

"ENGINEERING OPPORTUNITIES" reveals how you can become technically-qualified at home for a highly-paid key-appointment in the vast Radio and Television Industry. In 108 pages of intensely interesting matter it includes full details of our up-to-the-minute home-study courses in all branches of RADIO AND TELEVISION, A.M.Brit. I.R.E., A.M.I.E.E., City and Guilds, Special Television, Servicing, Sound Film Projection, Short Wave, High Frequency, and General Wireless Courses.

We definitely guarantee

"NO PASS—NO FEE"

If you're earning less than £10 a week this enlightening book is for you. Write for your copy today. It will be sent FREE and without obligation.

BRITISH INSTITUTE OF ENGINEERING TECHNOLOGY

503 SHAKESPEARE HOUSE, 17, STRATFORD PLACE, LONDON, W.1.

ADVERTISE

in

Bernards Radio Books

The large readership enjoyed by Bernards Radio Books assures that advertisers reach an interested public.

For advertising rates, etc., apply

BERNARDS (PUBLISHERS) LTD.

Advertising Dept.

The Grampians,

Western Gate - London, W.6.

RUCO MAINS NOISE SUPPRESSOR

Eliminates or Reduces
Mains Borne Interference

*Easily fitted to supply leads of
any radio.*

Where used at source of interference, e.g., small motors, &c, the RUCO will be found very effective.

The unit measures only 3" x 3" x 1½" is completely safe, contains capacitors and chokes for both leads and a neat terminal block for connection.

Simple instructions supplied with each unit.

LIST PRICE 16/6

RUCO PRODUCTS,
667, FULHAM ROAD, S.W.6.
Telephone: RENown 4043.

BERNARDS RADIO BOOKS

FOR THE HOME & AMATEUR CONSTRUCTOR

3.	SERVICES SIGNALLING MANUAL	1/-
4.	RADIO POCKET BOOK	1/-
6.	ELECTRICAL ENGINEERS HANDBOOK	1/-
22.	MANUAL OF RADIO CIRCUITS	2/-
30.	RADIO VALVE MANUAL	3/6
37.	MANUAL OF DIRECT DISC RECORDING	2/-
41.	WIRELESS AMPLIFIER MANUAL	2/-
42.	SHORTWAVE RADIO HANDBOOK	2/-
43.	MODERN RADIO TEST GEAR CONSTRUCTION	1/6
44.	RADIO SERVICE MANUAL	2/6
45.	RADIO REFERENCE HANDBOOK	12/6
48.	RADIO COIL AND TRANSFORMER MANUAL	2/-
50.	INTERNATIONAL SHORTWAVE RADIO STATION LIST	1/-
51.	CATHODE RAY OSCILLOSCOPE MANUAL	2/-
52.	RADIO TUNER UNIT MANUAL	2/6
53.	RADIO CONSTRUCTORS' MANUAL	3/-
54.	RADIO RESISTOR CHART	1/-
55.	HANDBOOK OF RADIO CIRCUITS NO. 2	2/6
56.	RADIO AERIAL HANDBOOK	2/6
57.	ULTRA SHORTWAVE HANDBOOK	2/6
58.	RADIO HINTS MANUAL	2/6
59.	TELEVISION CONSTRUCTION MANUAL	3/6
60.	RADIO REPAIRS MANUAL	2/6
61.	AMATEUR TRANSMITTERS' CONSTRUCTION MANUAL	2/6
62.	CAR AND PORTABLE RADIO CONSTRUCTORS' MANUAL	2/6
63.	RADIO CALCULATIONS MANUAL	3/6
64.	SOUND EQUIPMENT MANUAL	2/6
65.	RADIO DESIGNS MANUAL	2/6
66.	COMMUNICATIONS RECEIVERS' MANUAL	2/6
67.	RADIO VALVE EQUIVALENTS MANUAL	2/6
68.	FREQUENCY MODULATION RECEIVERS' MANUAL	2/6
69.	RADIO INDUCTANCE MANUAL	2/6
70.	LOUDSPEAKER MANUAL	2/6
71.	MODERN BATTERY RECEIVERS' MANUAL	2/6
72.	EXPERIMENTAL CIRCUITS MANUAL	2/6
73.	RADIO TEST EQUIPMENT MANUAL	2/6

Other Titles in Preparation

74.	RADIO VALVE APPLICATIONS MANUAL
76.	RADIO ANTI-INTERFERENCE MANUAL
77.	WALKIE-TALKIE CONSTRUCTION MANUAL
78.	RADIO AND TELEVISION LABORATORY MANUAL
79.	MODERNISING OLD RADIOS
80.	TELEVISION SERVICING MANUAL