

[www.vintage-radio.com](http://www.vintage-radio.com)

# RADIO and TELEVISION POCKET BOOK



2/6

Compiled by B. BABANI  
BERNARDS RADIO SERIES No. 120

## BRITISH AND U.S.A. RESISTANCE COLOUR CODE.

Colour code shall consist of four bands of colour which may be adjacent to each other or be slightly separated from each other as desired. They shall be placed on the resistor towards one end of it and the significance of the colour bands shall be read from the band nearest to one end and in the order of the bands as follows:—

Band	Indicates
1st	First significant figure of the resistance value.
2nd	Second significant figure of the resistance value.
3rd	Decimal multiplier applicable to the first two significant figures.
4th	% Tolerance.

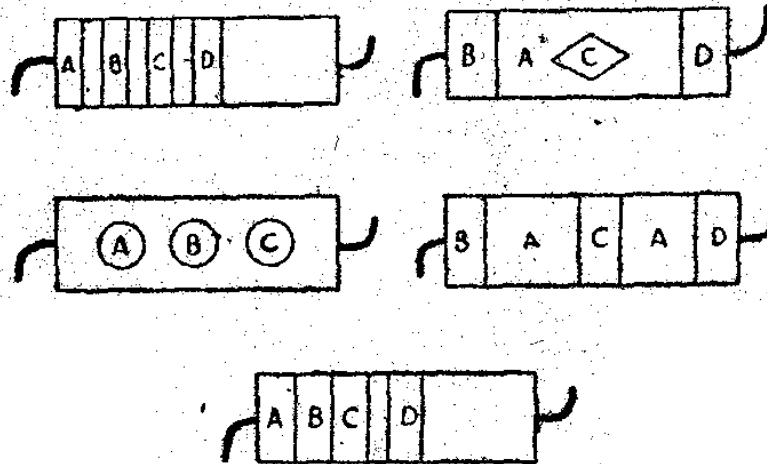

The meaning assigned to the various colours are set out in the Table below:—

Colour	Shade	Significant Figures	Decimal Multiplier	Tolerance
Black	—	0	1	—
Brown	No. 13	1	10	—
Red	No. 38	2	100	—
Orange	No. 57	3	1,000	—
Yellow	No. 55	4	10,000	—
Green	No. 26	5	100,000	—
Blue	No. 5	6	1,000,000	—
Violet	*	7	10,000,000	—
Grey	No. 31	8	100,000,000	—
White	—	9	1,000,000,000	—
Gold (metallic)	*	—	0.1	5%
Silver (metallic)	*	—	0.01	10%
No additional colour	—	—	—	20%

\* No suitable shade is included in the B.S. Specification.  
The violet shall be a dark violet.

NOTE.—The shade colours specified are those referred to in B.S.S. No. 381C—1931.

The above information supplied by courtesy of Dubilier Condenser Co. (1925) Ltd.

# BRITISH AND U.S.A. COLOUR CODES FOR FIXED MICA CONDENSERS.

<i>Colour Mark</i>	<i>1 First Figure</i>	<i>2 Second Figure</i>	<i>3 Third Figure</i>	<i>4 Multiplier Value</i>	<i>5 Direct Current Voltage Best Rating</i>	<i>6 Percentage Tolerance Plus or Minus</i>
Black ...	0	0	0	Nil	—	—
Brown ...	1	1	1	× 10	100	1%
Red ...	2	2	2	× 100	200	2%
Orange ...	3	3	3	× 1,000	300	3%
Yellow ...	4	4	4	× 10,000	400	4%
Green ...	5	5	5	× 100,000	500	5%
Blue ...	6	6	6	× 1,000,000	600	6%
Violet ...	7	7	7	× 10,000,000	700	7%
Grey ...	8	8	8	× 100,000,000	800	8%
White ...	9	9	9	× 1,000,000,000	900	9%
Gold ...	—	—	—	÷ 10	1,000	5%
Silver ...	—	—	—	÷ 100	2,000	10%
No Colour	—	—	—	—	500	20%

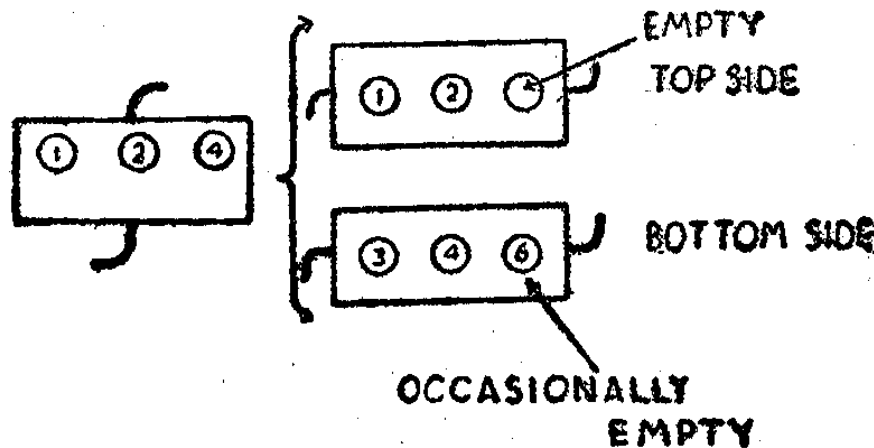
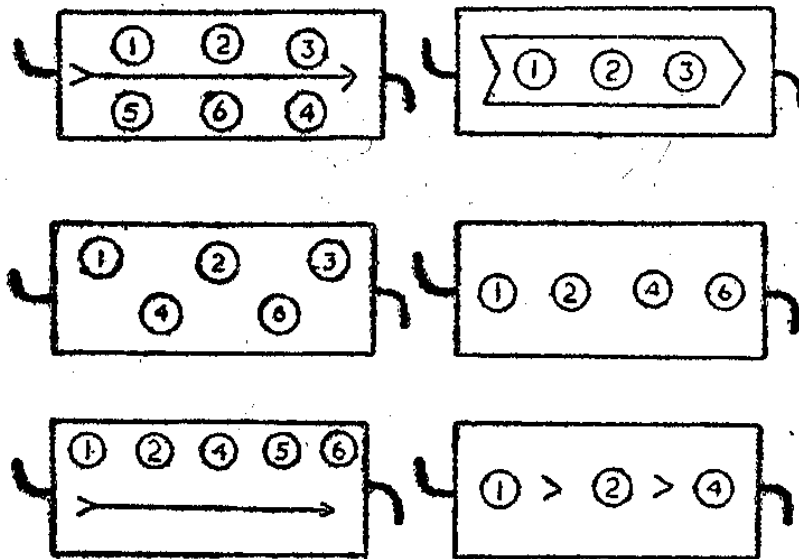

# BRITISH AND U.S.A. COLOUR CODES FOR RADIO COMPONENTS.

## FUSES.

<i>Colour :</i>	<i>Value :</i>	<i>Colour :</i>	<i>Value :</i>
Black ...	.060 Amp.	Dark Blue ...	1 Amp.
Grey ...	.100 Amp.	Light Blue ...	1.5 Amp.
Red... ...	.150 Amp.	Purple ...	2 Amp.
Brown ...	.250 Amp.	White ...	3 Amp.
Yellow ...	.500 Amp.	Black and White	5 Amp.
Green ...	.750 Amp.		

## FIXED CONDENSER LEADS.

<i>Value :</i>	<i>Colour :</i>
Centre lead of Voltage doubler Condensers	White
Principal Negative Lead	Black
2nd Negative "	Brown
3rd " "	Grey
5th highest Capacity +	Violet
4th " " +	Blue
3rd " " +	Green
2nd " " +	Yellow
Highest Capacity +	Red

When 2 capacities are of the same value, the one of the higher voltage rating has the higher colour in the table.

Series connections are marked  $\pm$   
 Common Positive junctions are marked +  
 Unconnected sections are marked &  
 Common Negative junctions are marked —

Examples :—

- 6  $\pm$  6 = A series voltage doubler connection.
- 2 + 2 = Two 2 $\mu$ F condensers with common positive lead.
- 4 & 4 = Two isolated 4 $\mu$ F condensers.
- 8 — 8 = Two 8 $\mu$ F condensers with common negative lead.

## WANDER PLUGS.

<i>Value :</i>	<i>Colour :</i>
Highest + H.T.	Red
2nd highest + H.T.	Yellow
3rd highest + H.T.	Green
4th highest + H.T.	Blue
L.T. Positive	Pink
L.T. —	Black
H.T. —	Black
G.B. +	Black
Highest G.B. —	Brown
2nd highest G.B. —	Grey
3rd highest G.B. —	White

Any additional battery lead is Violet, and any centre tap is White.

# BRITISH AND U.S.A. COLOUR CODES.

## U.S.A. COLOUR CODES FOR LOUDSPEAKER LEADS AND PLUG CONNECTORS.

A = Blue lead. B = Brown lead. C = Red lead. D = Black and Red striped lead. E = Slate and Red striped lead. F = Yellow and Red striped lead. G = Black lead. H = Green lead. J = Black and Green striped lead. K = Yellow and Green striped lead. P = Primary. S = Secondary.

Sketch A.

Plugs shown with Pins facing the reader.

Sketch B.

Plugs shown with Pins facing the reader.

Sketch C.

Plugs shown with Pins facing the reader.

Sketch D.

Plugs shown with Pins facing the reader.

Sketch E.

Plugs shown with Pins facing the reader.

Sketch F.

Plugs shown with Pins facing the reader.

**OUTPUT TRANSFORMER**

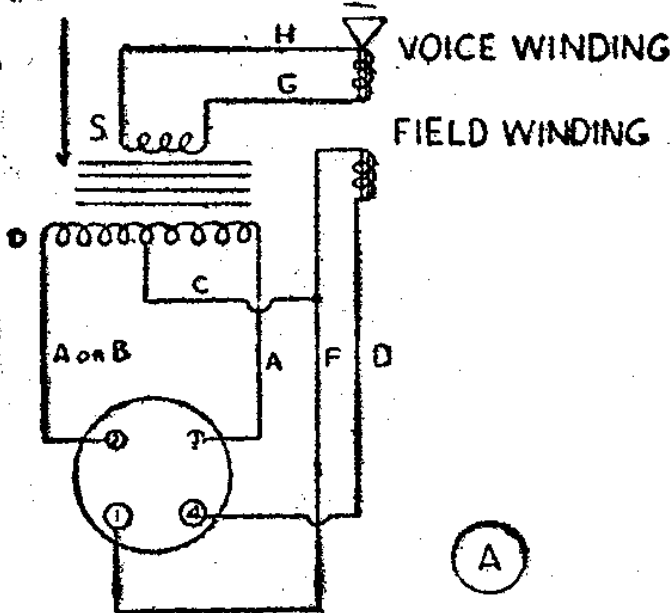

**OUTPUT TRANSFORMER**

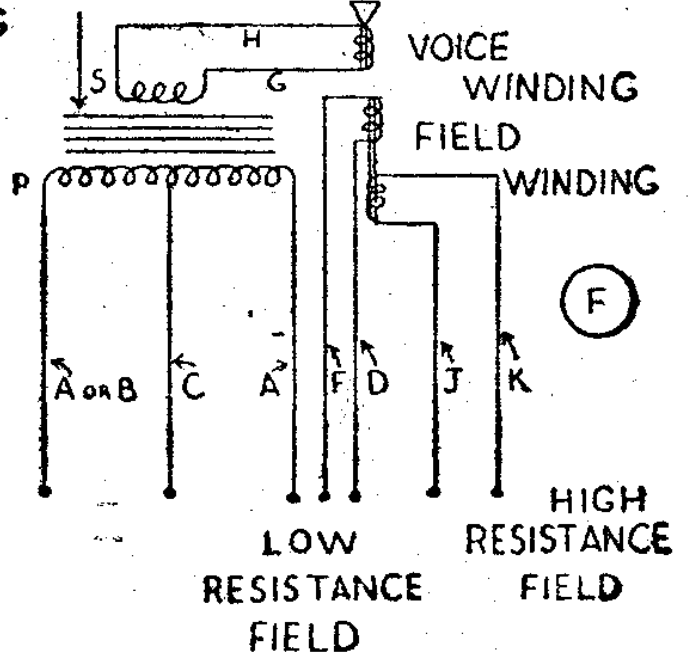

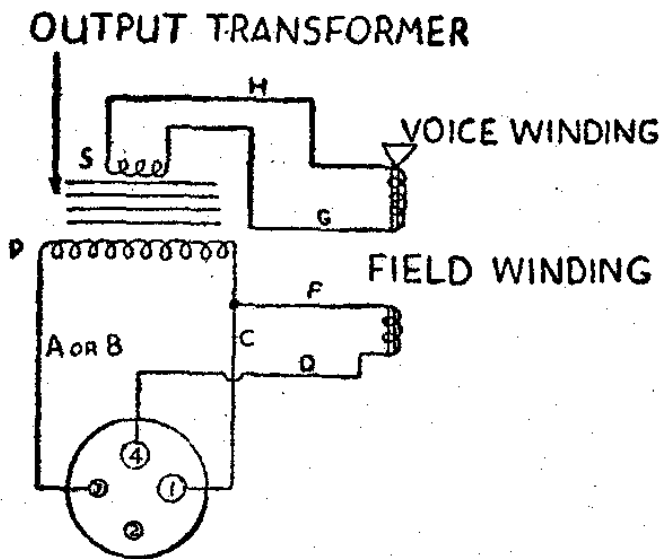

(B)

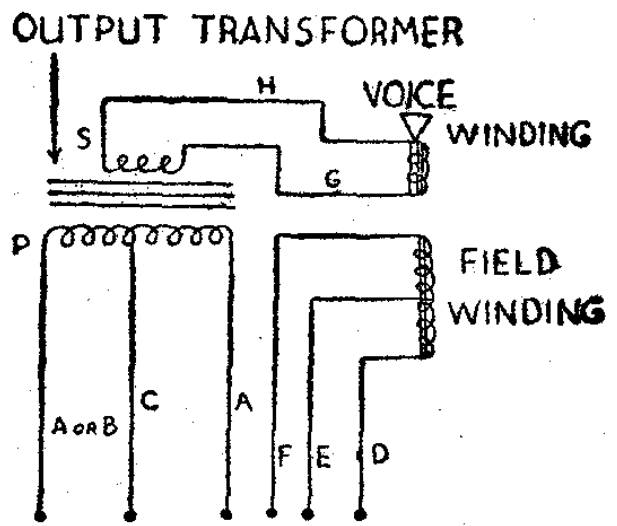

(E)

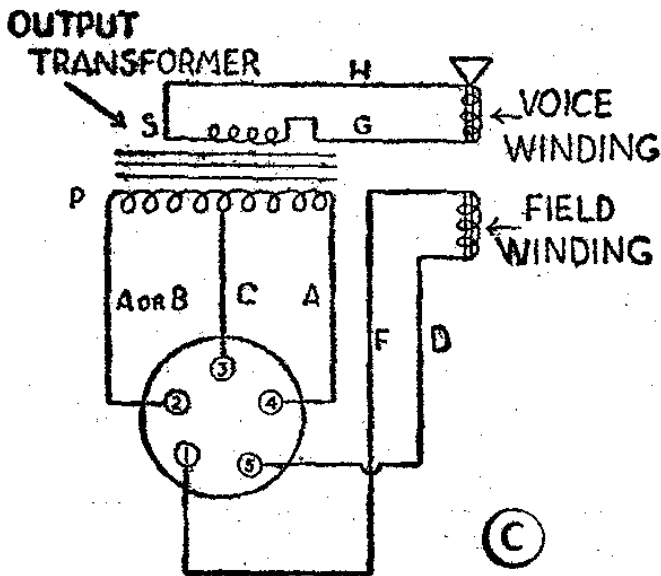

(C)

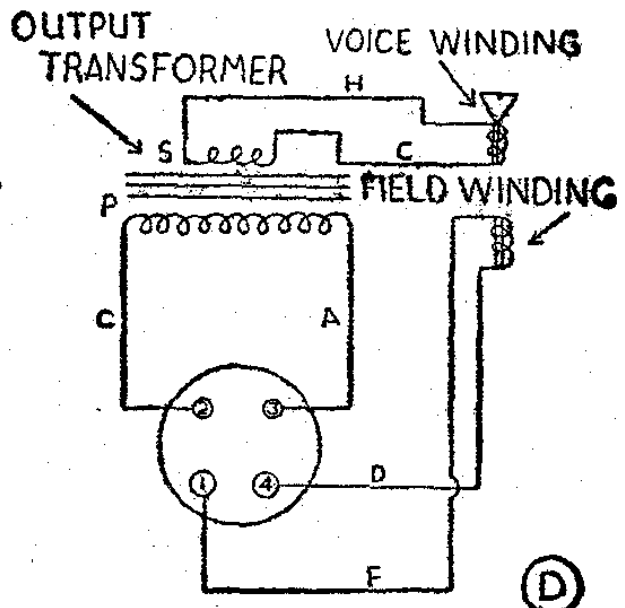

(D)

**BRITISH AND U.S.A. COLOUR CODES.**

**BRITISH COLOUR CODE FOR BATTERY CORDS.**

<i>Colour.</i>	<i>Purpose.</i>
Maroon	3rd Positive Voltage.
Maroon and Red	2nd Positive Voltage.
Red	Highest Positive Voltage.
Black and Green	2nd Negative Bias.
Black with Green Tracer	Maximum Negative Bias.
Green	Positive Bias Voltage.
Black with Yellow Tracer	Negative L.T. Voltage.
Yellow	Positive L.T. Voltage.
Black with Red Tracer	Negative H.T.
Black with Brown Tracer	Loud-speaker Connections.
High Potential, Brown	Loud-speaker Connections.

## U.S.A. COLOUR CODE FOR

### A.F. Transformers.

*Blue* = plate (finish) lead of primary.

*Red* = B + lead (this applies whether the primary is plain or centre-tapped).

*Brown* = plate (start) lead on centre-tapped primaries. (Blue may be used for this lead if polarity is not important).

*Green* = grid (finish) lead to secondary.

*Black* = grid return (this applies whether the secondary is plain or centre-tapped).

*Yellow* = grid (start) lead on centre-tapped secondaries. (Green may be used for this lead if polarity is not important).

NOTE.—These markings apply also to line-to-grid and tube-to-line transformers.

### Loudspeaker Voice Coils.

*Green* = finish.

*Black* = start.

### Loudspeaker Field Coils.

*Black and Red* = start.

*Yellow and Red* = finish.

*Slate and Red* = tap (if any).

### Power Transformers.

1. Primary Leads	...	...	...	...	...	...	<i>Black</i>
If tapped :							
Common	...	...	...	...	...	...	<i>Black</i>
Tap	...	...	...	...	...	...	<i>Black and Yellow Striped</i>
Finish	...	...	...	...	...	...	<i>Black and Red Striped</i>
2. High-Voltage Plate Winding	...	...	...	...	...	...	<i>Red</i>
Centre-Tap	...	...	...	...	...	...	<i>Red and Yellow Striped</i>
3. Rectifier Fil. Winding	...	...	...	...	...	...	<i>Yellow</i>
Centre-Tap	...	...	...	...	...	...	<i>Yellow and Blue Striped</i>
4. Fil. Winding No. 1	...	...	...	...	...	...	<i>Green</i>
Centre-Tap	...	...	...	...	...	...	<i>Green and Yellow Striped</i>
5. Fil. Winding No. 2	...	...	...	...	...	...	<i>Brown</i>
Centre-Tap	...	...	...	...	...	...	<i>Brown and Yellow Striped</i>
6. Fil. Winding No. 3	...	...	...	...	...	...	<i>Slate</i>
Centre-Tap	...	...	...	...	...	...	<i>Slate and Yellow Striped</i>

## RADIO GRAMOPHONE ELECTRIC MOTORS. COLOUR CODE FOR FREQUENCY.

White dot = 25 cycles.

Green dot = 50 "

No mark = 60 "

## U.S.A. COLOUR CODE FOR MULTIPLE BATTERY CABLES.

Blue	=	H.T. + highest.
White	=	H.T. + medium.
Yellow	=	H.T. —
Red	=	L.T. +
Black	=	L.T. —
Brown	=	G.B. +
Green	=	G.B. — highest.
Orange	=	G.B. — medium.

## BRITISH MAINS TRANSFORMER LEADS.

Primary Winding	{	10 volt tapping	<i>Colour.</i> Black and Green.
		210 volt "	Black and Yellow.
		230 volt "	Black and Red.
		250 volt "	Black and Brown.
		Zero tapping	Black.
Secondary Winding	{	High tension ends	<i>Colour.</i> Red.
		" " centre tap	Red and Yellow.
		Rectifier heater ends	Green.
		" " centre tap	Green and Yellow.
		Valve heater ends	Brown.
		" " centre tap	Brown and Yellow.
		Additional L.T. winding ends	Blue
" " centre tap	Blue and Yellow.		
Earthing Lead		Bare Wire	

## G.E.C. Wiring Colour Code.

White	...	...	High-potential connections to aerial and first section of band-pass circuits, also non-earth side of special coil.
Green	...	...	Other high potential signal circuits, including grid circuits.
Blue	...	...	Screening grid circuits.
Pink	...	...	Cathode connections.
Orange	...	...	Anode connections.
Black	...	...	Earth connections.
Slate	...	...	H.T. negative, when not earthed.
Red	...	...	Smoothed H.T. positive.
Red/White	...	...	Unsmoothed H.T. positive.
Green/White	...	...	A.V.C. and grid de-coupling.
Black/Red	...	}	Heaters.
Black/White	...		
Black/Red	...	...	L.T. positive (in battery sets).



## BRITISH MOVING COIL SPEAKER—COLOUR CODE.

<i>Colour.</i>	<i>Purpose.</i>
Green (outer end)	Output Transformer—Primary ends of winding.
Brown (inner end)	„ „ Primary ends of winding.
Red	„ „ Primary centre tap.
Maroon	„ „ Secondary end—inside.
White	„ „ „ „ outside.
Yellow	Field Winding—Outside end.
Black	„ „ Inside end.

### LF. Transformers.

*Blue* = plate lead.

*Red* = B + lead.

*Green* = grid (or diode) lead.

*Black* = grid (or diode) return.

NOTE.—If the secondary of the i.f.t. is centre-tapped, the second diode plate lead is green-and-black striped, and black is used for the centre-tap lead.

### REACTANCE FORMULAS.

Reactance is measured in ohms and is defined as the resistance against the flow of an A.C. in any component due to its capacity or inductance. Amongst other factors it is variable due to the frequency of the A.C.

Reactance in ohms of a condenser is equal to 1 divided by  $(6.283 \times \text{frequency of A.C. in cycles per second} \times \text{capacity of condenser in farads})$ .

Reactance of a coil is equal to  $(6.283 \times \text{frequency of A.C. in cycles per second} \times \text{inductance of coil in henries})$ .

Reactance of a condenser and a coil in series is equal to the reactance of the coil on its own minus the reactance of the condenser.

### RESONANT FREQUENCY.

This is the condition when a condenser and coil in a tuning circuit are so adjusted as to produce resonance. The formula for this condition is as follows :—

Frequency of resonance =  $1 \div [6.283 \text{ (square root of the coil inductance in henries multiplied by the condenser capacity in farads)}]$



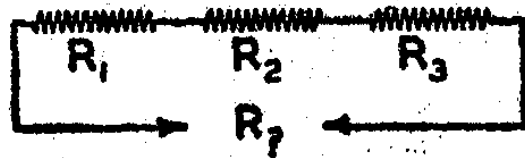

Capacity in farads of a condenser in a resonant circuit =  $1 \div [39.478 \times (\text{resonant frequency})^2 \times \text{inductance of the coil in circuit in henries}]$

Inductance in henries of a coil in a resonant circuit =  $1 \div [39.478 \times (\text{resonant frequency})^2 \times \text{capacity of the condenser in circuit in farads}]$ .

OHMS LAW FOR D.C.	RESISTANCES IN PARALLEL
<p><b>AMPERES</b> = Volts ÷ Resistance.</p> <p>" = Watts ÷ Volts.</p> <p>" = <math>\sqrt{\text{Watts} \div \text{Resistance}}</math>.</p> <p><b>VOLTS</b> = Resistance x Amperes.</p> <p>" = Watts ÷ Amperes.</p> <p>" = <math>\sqrt{\text{Watts} \times \text{Resistance}}</math>.</p> <p><b>WATTS</b> = [Amperes]<sup>2</sup> x Resistance.</p> <p>" = [Volts]<sup>2</sup> ÷ Resistance.</p> <p>" = Amperes x Volts.</p>	 $R = \frac{1}{\frac{1}{R_1} + \frac{1}{R_2} + \frac{1}{R_3} + \frac{1}{R_4} + \text{etc.}}$ <p><b>2 PARALLEL RESISTANCES</b></p> $R = [R_1 \times R_2] \div [R_1 + R_2]$ <p><b>3 PARALLEL RESISTANCES</b></p> $R = \frac{R_1 \times R_2 \times R_3}{[R_1 \times R_2] + [R_2 \times R_3] + [R_3 \times R_1]}$ <p><b>4 PARALLEL RESISTANCES</b></p> $R = \frac{R_1 \times R_2 \times R_3 \times R_4}{[R_1 \times R_2] + [R_2 \times R_3] + [R_3 \times R_4] + [R_4 \times R_1]}$
<p><b>RESISTANCE</b> = Volts ÷ Amperes.</p> <p>" = [Volts]<sup>2</sup> ÷ Watts.</p> <p>" = Watts ÷ [Amperes]<sup>2</sup></p>	<p style="text-align: center;"><b>RESISTANCES IN SERIES</b></p>  $R = R_1 + R_2 + R_3 + \text{etc}$

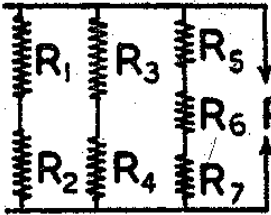
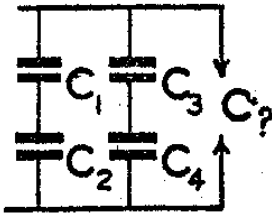
### OHMS. LAW FOR A.C.

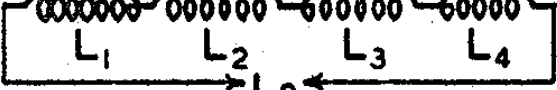
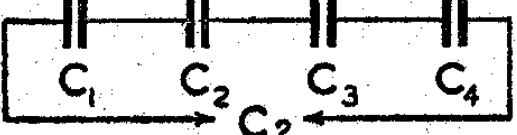
- Where I = current in amperes.  
 Z = impedance in ohms.  
 E = voltage across Z.  
 P = wattage.  
 X = degrees of phase angle.  
 E =  $P \div (I \cos X)$ .  
 =  $\sqrt{PZ} \div \cos X$ .  
 = IZ.  
 Z =  $P \div (I^2 \cos X)$ .  
 =  $E \div I$ .  
 =  $(E^2 \cos X) \div P$ .  
 P = IE cos X.  
 =  $(E^2 \cos X) \div Z$ .  
 =  $I^2 Z \cos X$ .  
 I =  $P \div (E \cos X)$ .  
 =  $E \div Z$ .  
 =  $\sqrt{P \div (Z \cos X)}$ .

RESISTANCES IN SERIES-PARALLEL	CONDENSERS IN SERIES-PARALLEL
 $R = \frac{1}{\frac{1}{R_1+R_2} + \frac{1}{R_3+R_4} + \frac{1}{R_5+R_6+R_7}}$	 $C = \frac{1}{\frac{1}{C_1} + \frac{1}{C_2}} + \frac{1}{\frac{1}{C_3} + \frac{1}{C_4}}$
CONDENSERS IN PARALLEL	INDUCTANCES IN SERIES
 $C = C_1 + C_2 + C_3 + C_4 + \text{etc.}$	 <p>WHERE THERE IS NO MUTUAL INDUCTANCE</p> $L = L_1 + L_2 + L_3 + L_4 + \text{etc.}$
CONDENSERS IN SERIES	INDUCTANCES IN PARALLEL
 $C = \frac{1}{\frac{1}{C_1} + \frac{1}{C_2} + \frac{1}{C_3} + \frac{1}{C_4} + \text{etc.}}$	 $L = \frac{1}{\frac{1}{L_1} + \frac{1}{L_2} + \frac{1}{L_3} + \frac{1}{L_4} + \text{etc.}}$

### WAVELENGTH AND FREQUENCY TABLE.

This table enables all calculations for wavelength and frequency to be arrived at. Although the table only covers a limited scale it is quite easy to cover any range required by the following method: If the figure in column A is multiplied by 10 the answer in column B must be divided by 10, or if the figure in column A is divided by 100 the answer in column B must be multiplied by 100. If column A is used to denote wavelength, then the answer in column B will be in Megacycles, or if column A is used for Frequency in Megacycles, the answer in column B will denote the equivalent wavelength in metres. This table is based on the fact that the frequency in kilocycles is equal to  $299,820 \div$  by the wavelength in metres, whilst the wavelength in metres is equal to  $299,820 \div$  by the frequency in kilocycles.

# FREQUENCY AND WAVELENGTH TABLE

A	B	A	B	A	B	A	B	A	B
299.8	1000	315.6	950	333.1	900	352.7	850	374.8	800
300.1	999	315.9	949	333.5	899	353.1	849	375.2	799
300.4	998	316.2	948	333.9	898	353.6	848	375.7	798
300.7	997	316.6	947	334.2	897	354.0	847	376.2	797
301.0	996	316.9	946	334.6	896	354.4	846	376.7	796
301.3	995	317.3	945	335.0	895	354.8	845	377.1	795
301.6	994	317.6	944	335.4	894	355.2	844	377.6	794
301.9	993	317.9	943	335.7	893	355.6	843	378.2	793
302.2	992	318.3	942	336.1	892	356.1	842	378.6	792
302.5	991	318.6	941	336.5	891	356.5	841	379.0	791
302.8	990	319.0	940	336.9	890	356.9	840	379.5	790
303.1	989	319.3	939	337.3	889	357.4	839	380.0	789
303.5	988	319.6	938	337.6	888	357.8	838	380.5	788
303.8	987	319.9	937	338.0	887	358.2	837	381.0	787
304.1	986	320.3	936	338.4	886	358.6	836	381.4	786
304.4	985	320.7	935	338.8	885	359.0	835	381.9	785
304.7	984	321.0	934	339.2	884	359.5	834	382.4	784
305.0	983	321.4	933	339.5	883	359.9	833	382.9	783
305.3	982	321.7	932	339.8	882	360.4	832	383.4	782
305.6	981	322.0	931	340.3	881	360.8	831	383.9	781
305.9	980	322.3	930	340.7	880	361.2	830	384.4	780
306.3	979	322.7	929	341.1	879	361.6	829	384.9	779
306.6	978	323.1	928	341.5	878	362.1	828	385.4	778
306.9	977	323.4	927	341.9	877	362.5	827	385.9	777
307.2	976	323.8	926	342.3	876	363.0	826	386.4	776
307.5	975	324.1	925	342.7	875	363.4	825	386.9	775
307.8	974	324.5	924	343.0	874	363.9	824	387.4	774
308.1	973	324.8	923	343.4	873	364.3	823	387.9	773
308.4	972	325.2	922	343.8	872	364.7	822	388.4	772
308.8	971	325.5	921	344.2	871	365.2	821	388.9	771
309.1	970	325.9	920	344.6	870	365.7	820	389.4	770
309.4	969	326.2	919	345.0	869	366.1	819	389.9	769
309.8	968	326.6	918	345.4	868	366.5	818	390.4	768
310.1	967	327.0	917	345.8	867	367.0	817	390.9	767
310.4	966	327.3	916	346.2	866	367.4	816	391.4	766
310.8	965	327.7	915	346.6	865	367.9	815	391.9	765
311.0	964	328.0	914	347.0	864	368.3	814	392.4	764
311.3	963	328.4	913	347.4	863	368.8	813	392.9	763
311.7	962	328.8	912	347.8	862	369.2	812	393.4	762
312.0	961	329.1	911	348.2	861	369.6	811	394.0	761
312.3	960	329.5	910	348.6	860	370.1	810	394.5	760
312.7	959	329.9	909	349.0	859	370.6	809	395.0	759
313.0	958	330.2	908	349.4	858	371.1	808	395.5	758
313.3	957	330.6	907	349.8	857	371.5	807	396.0	757
313.6	956	330.9	906	350.2	856	372.0	806	396.6	756
314.0	955	331.3	905	350.7	855	372.4	805	397.1	755
314.3	954	331.7	904	351.1	854	372.9	804	397.6	754
314.6	953	332.1	903	351.5	853	373.4	803	398.2	753
314.9	952	332.4	902	351.9	852	373.8	802	398.7	752
315.3	951	332.8	901	352.3	851	374.3	801	399.2	751

# FREQUENCY AND WAVELENGTH TABLE

A	B	A	B	A	B	A	B	A	B
399.8	750	428.3	700	461.3	650	499.7	600	545.1	550
400.3	749	428.9	699	462.0	649	500.5	599	546.1	549
400.8	748	429.5	698	462.7	648	501.4	598	547.1	548
401.4	747	430.1	697	463.4	647	502.2	597	548.1	547
401.9	746	430.8	696	464.1	646	503.1	596	549.1	546
402.4	745	431.4	695	464.8	645	503.9	595	550.1	545
402.9	744	432.1	694	465.6	644	504.7	594	551.1	544
403.5	743	432.6	693	466.4	643	505.6	593	552.2	543
404.1	742	433.3	692	467.0	642	506.5	592	553.2	542
404.6	741	433.9	691	467.7	641	507.3	591	554.2	541
405.2	740	434.5	690	468.5	640	508.2	590	555.2	540
405.7	739	435.1	689	469.2	639	509.0	589	556.3	539
406.3	738	435.8	688	469.9	638	509.9	588	557.3	538
406.8	737	436.4	687	470.7	637	510.8	587	558.3	537
407.4	736	437.1	686	471.4	636	511.6	586	559.4	536
407.9	735	437.7	685	472.1	635	512.5	585	560.4	535
408.5	734	438.3	684	472.9	634	513.4	584	561.5	534
409.0	733	439.0	683	473.6	633	514.3	583	562.5	533
409.6	732	439.6	682	474.4	632	515.2	582	563.6	532
410.2	731	440.3	681	475.2	631	516.0	581	564.6	531
410.7	730	440.9	680	475.9	630	516.8	580	565.7	530
411.3	729	441.6	679	476.7	629	517.7	579	566.8	529
411.8	728	442.3	678	477.4	628	518.7	578	567.8	528
412.4	727	442.9	677	478.2	627	519.6	577	568.9	527
413.0	726	443.5	676	478.9	626	520.5	576	570.1	526
413.6	725	444.2	675	479.7	625	521.4	575	571.1	525
414.1	724	444.8	674	480.5	624	522.3	574	572.2	524
414.7	723	445.5	673	481.3	623	523.2	573	573.3	523
415.3	722	446.2	672	482.0	622	524.2	572	574.4	522
415.8	721	446.8	671	482.8	621	525.1	571	575.5	521
416.4	720	447.6	670	483.6	620	526.0	570	576.6	520
417.0	719	448.2	669	484.4	619	526.9	569	577.7	519
417.6	718	448.8	668	485.1	618	527.9	568	578.8	518
418.2	717	449.5	667	485.9	617	528.8	567	579.9	517
418.8	716	450.2	666	486.7	616	529.7	566	581.1	516
419.3	715	450.9	665	487.5	615	530.7	565	582.2	515
419.9	714	451.5	664	488.3	614	531.6	564	583.3	514
420.5	713	452.2	663	489.1	613	532.5	563	584.4	513
421.1	712	452.9	662	489.9	612	533.5	562	585.5	512
421.7	711	453.6	661	490.7	611	534.5	561	586.6	511
422.3	710	454.3	660	491.5	610	535.4	560	587.8	510
422.9	709	455.1	659	492.4	609	536.4	559	588.9	509
423.5	708	455.7	658	493.1	608	537.3	558	590.2	508
424.1	707	456.3	657	493.9	607	538.3	557	591.3	507
424.7	706	457.0	656	494.8	606	539.2	556	592.5	506
425.3	705	457.7	655	495.7	605	540.2	555	593.7	505
425.9	704	458.4	654	496.5	604	541.2	554	594.9	504
426.5	703	459.1	653	497.3	603	542.2	553	596.1	503
427.1	702	459.8	652	498.0	602	543.2	552	597.3	502
427.7	701	460.5	651	498.9	601	544.1	551	598.4	501

# FREQUENCY AND WAVELENGTH TABLE

A	B	A	B	A	B	A	B	A	B
599.6	500	666.3	450	749.4	400	856.5	350	999.4	300
600.8	499	667.8	449	751.3	399	859.1	349	1003.	299
602.1	498	669.2	448	753.2	398	861.6	348	1006.	298
603.3	497	670.7	447	755.1	397	864.1	347	1009.	297
604.5	496	672.2	446	757.1	396	866.5	346	1013.	296
605.7	495	673.8	445	759.1	395	869.1	345	1016.	295
606.9	494	675.3	444	761.0	394	871.6	344	1020.	294
608.2	493	676.9	443	762.8	393	874.2	343	1024.	293
609.4	492	678.3	442	764.8	392	876.7	342	1027.	292
610.6	491	679.9	441	766.7	391	879.2	341	1030.	291
611.9	490	681.4	440	768.7	390	881.8	340	1034.	290
613.1	489	683.0	439	770.7	389	884.4	339	1037.	289
614.4	488	684.6	438	772.7	388	887.1	338	1041.	288
615.6	487	686.1	437	774.7	387	889.7	337	1045.	287
616.9	486	687.7	436	776.8	386	892.3	336	1048.	286
618.2	485	689.2	435	778.8	385	895.1	335	1052.	285
619.5	484	690.8	434	780.8	384	897.7	334	1056.	284
620.7	483	692.4	433	782.8	383	900.3	333	1059.	283
622.1	482	694.0	432	784.8	382	903.1	332	1063.	282
623.3	481	695.6	431	786.9	381	905.8	331	1066.	281
624.6	480	697.3	430	789.0	380	908.6	330	1070.	280
625.9	479	698.9	429	791.1	379	911.3	329	1074.	279
627.3	478	700.6	428	793.2	378	914.1	328	1078.	278
628.6	477	702.2	427	795.3	377	916.9	327	1082.	277
629.9	476	703.8	426	797.4	376	919.7	326	1086.	276
631.2	475	705.5	425	799.5	375	922.5	325	1090.	275
632.5	474	707.1	424	801.7	374	925.4	324	1094.	274
633.9	473	708.8	423	803.8	373	928.2	323	1098.	273
635.2	472	710.5	422	805.9	372	931.1	322	1102.	272
636.6	471	712.2	421	808.1	371	934.1	321	1106.	271
637.9	470	713.9	420	810.3	370	936.9	320	1110.	270
639.3	469	715.6	419	812.5	369	939.8	319	1115.	269
640.6	468	717.3	418	814.7	368	942.8	318	1119.	268
642.1	467	719.1	417	817.1	367	945.8	317	1123.	267
643.4	466	720.7	416	819.2	366	948.8	316	1127.	266
644.8	465	722.5	415	821.4	365	951.8	315	1131.	265
646.2	464	724.2	414	823.8	364	954.8	314	1136.	264
647.6	463	725.9	413	826.1	363	957.9	313	1141.	263
649.1	462	727.7	412	828.3	362	961.1	312	1145.	262
650.4	461	729.5	411	830.4	361	964.1	311	1149.	261
651.8	460	731.3	410	832.8	360	967.2	310	1153.	260
653.2	459	733.1	409	835.2	359	970.3	309	1158.	259
654.6	458	734.9	408	837.5	358	973.4	308	1162.	258
656.1	457	736.7	407	839.8	357	976.7	307	1167.	257
657.5	456	738.5	406	842.2	356	979.8	306	1171.	256
658.9	455	740.3	405	844.6	355	983.1	305	1176.	255
660.4	454	742.1	404	847.1	354	986.2	304	1180.	254
661.9	453	744.1	403	849.4	353	989.4	303	1185.	253
663.3	452	745.8	402	851.8	352	992.8	302	1190.	252
664.8	451	747.7	401	854.2	351	996.2	301	1195.	251

## FREQUENCY AND WAVELENGTH TABLE

A	B	A	B	A	B	A	B	A	B
1199	250	1362	220	1578	190	1873	160	2306	130
1204	249	1369	219	1587	189	1885	159	2323	129
1209	248	1375	218	1595	188	1898	158	2342	128
1214	247	1381	217	1603	187	1910	157	2361	127
1219	246	1388	216	1612	186	1923	156	2380	126
1224	245	1395	215	1620	185	1934	155	2399	125
1229	244	1401	214	1629	184	1947	154	2417	124
1234	243	1407	213	1638	183	1960	153	2438	123
1239	242	1414	212	1647	182	1973	152	2458	122
1244	241	1421	211	1656	181	1986	151	2478	121
1249	240	1428	210	1665	180	2000	150	2498	120
1255	239	1435	209	1675	179	2012	149	2521	119
1260	238	1442	208	1684	178	2025	148	2541	118
1265	237	1448	207	1694	177	2040	147	2563	117
1270	236	1454	206	1703	176	2053	146	2585	116
1276	235	1463	205	1713	175	2067	145	2607	115
1281	234	1470	204	1723	174	2082	144	2630	114
1287	233	1477	203	1733	173	2097	143	2653	113
1293	232	1484	202	1743	172	2110	142	2677	112
1298	231	1492	201	1753	171	2127	141	2701	111
1303	230	1499	200	1763	170	2142	140	2726	110
1309	229	1507	199	1774	169	2157	139	2751	109
1315	228	1514	198	1784	168	2173	138	2776	108
1321	227	1523	197	1794	167	2188	137	2808	107
1327	226	1531	196	1806	166	2204	136	2828	106
1333	225	1538	195	1817	165	2221	135	2855	105
1338	224	1545	194	1828	164	2237	134	2883	104
1344	223	1553	193	1839	163	2254	133	2911	103
1351	222	1562	192	1851	162	2272	132	2939	102
1357	221	1570	191	1862	161	2289	131	2969	101
								2998	100

### CALCULATION OF CORRECT RESISTOR FOR SELF BIAS.

From Ohms. law :—

$$\text{Grid Bias Voltage} \times 1,000.$$

$$R = \frac{\text{Total Cathode Current in Ma} \times \text{number of Valves involved.}}{\text{Grid Bias Voltage} \times 1,000}$$

For Triodes total cathode current = plate current.

For Pentodes and Tetrodes, total cathode current = plate plus screen currents.

For Pentagrids, total cathode current = plate plus screen plus oscillator plate currents.

**Example.**—Find Bias Resistor for two 6K6 Valves operating in push pull with 315 volts on the plates.

The following data is obtained from valve characteristics for the 6K6 from Bernards "Radio Valve Manual, No. 30," price 3/6.

Grid Bias = 21 volts.

Screen Current = 4 Ma.

Plate Current = 25.5 Ma. ∴ Total Cathode Current = 29.5 Ma.

$$\text{Therefore, } R = \frac{21 \times 1,000}{29.5 \times 2} = \frac{21,000}{59} = 355 \text{ ohms. approximately.}$$

When over biased operation is used the advised bias resistor value will be shewn under Ratings and current applications for the type of Valve involved in Bernard's "Radio Valve Manual."

# POWER RATINGS OF FIXED RESISTANCES

Wattage Rating ↓	OHMS →	50	100	250	500	750	1000	2000	3000	4000	5000
0.5 Watt	Amps	.1	.07	.045	.032	.025	.022	.016	.013	.011	.010
	Volts	5	7	11	16	20	22	32	39.5	45	50
1.0 Watt	Amps	.141	.10	.063	.045	.036	.032	.022	.018	.016	.014
	Volts	7	10	16	22	27	32	45	55	62.5	71
2.0 Watts	Amps	.2	.141	.089	.061	.051	.045	.032	.026	.022	.020
	Volts	10	14.1	23.1	32.5	39	45	62	77	89	100
3.0 Watts	Amps	.25	.173	.108	.076	.062	.055	.040	.032	.027	.025
	Volts	12.2	17.3	27.2	39	49	55	77	95	110	121
5.0 Watts	Amps	.32	.224	.141	.100	.083	.071	.050	.041	.035	.032
	Volts	15.8	22.4	35.5	50	60	71	100	124	141	159
Wattage Rating ↓	OHMS →	6000	7000	8000	9000	10000	15000	20000	25000	30000	
0.5 Watt	Amps	.009	.008	.008	.0075	.007	.0058	.0055	.0045	.004	
	Volts	55	59	63	67	71	86	100	110	124	
1.0 Watt	Amps	.013	.012	.011	.0105	.010	.008	.007	.0063	.0058	
	Volts	77	84	89	95	100	121	141	158	174	
2.0 Watts	Amps	.018	.017	.016	.015	.014	.011	.010	.009	.0082	
	Volts	110	118	125	135	141	172	200	225	244	
3.0 Watts	Amps	.022	.021	.020	.018	.017	.014	.012	.011	.010	
	Volts	135	145	154	164	172	213	245	272	300	
5.0 Watts	Amps	.029	.027	.025	.023	.022	.018	.016	.014	.013	
	Volts	173	188	200	212	225	265	315	355	389	
Wattage Rating ↓	OHMS →	40000	50000	75000	100000	200000	250000	500000	750000	1000000	
0.5 Watt	Amps	.0035	.003	.0025	.0021	.0015	.0014	.001	.0008	.0007	
	Volts	140	159	194	220	321	350	500	612	709	
1.0 Watt	Amps	.005	.0043	.0036	.003	.0023	.002	.0014	.0012	.001	
	Volts	200	225	275	309	441	500	700	866	1000	
2.0 Watts	Amps	.0071	.0063	.0052	.0044	.0032	.0028	.002	.0016	.0014	
	Volts	282	317	387	440	631	700	1000	1224	1410	
3.0 Watts	Amps	.0087	.0077	.0062	.0055	.004	.0035	.0025	.002	.0017	
	Volts	344	386	475	550	770	861	1200	1500	1720	
5.0 Watts	Amps	.011	.010	.008	.007	.005	.0045	.003	.0026	.0022	
	Volts	448	500	613	707	1000	1120	1581	1937	2250	



# S.W.G. Tables

S W G	DIA IN INS.	AREA CIRCULAR MILS.	OHMS PER 1000 YDS	OHMS PER POUND (lb)	YARDS PER lb	lbs. PER 1000 YDS	TURNS PER INCH CLOSE WOUND			
							ENAMEL	SINGLE SILK	DOUBLE SILK	SINGLE COTTON
7/0	500	250000	12227	000053	440	2271				
6/0	464	215296	14202	000073	511	1955				
5/0	432	186624	16379	000096	589	1695				
4/0	400	160000	19110	000132	688	1453				
3/0	372	138384	2209	000175	797	1257				
2/0	348	121104	2526	000229	910	1100				
1/0	324	104976	2912	000305	1049	953				
1	300	105000	3396	000415	1228	818				
2	276	76176	4013	000580	1446	692				
3	252	63504	4815	000834	1733	577				
4	232	53824	5679	001162	2046	489				
5	212	44944	6804	001666	2449	408				
6	192	36864	8292	002476	2987	335				
7	176	30976	9870	003507	355	281				
8	160	25600	1194	005135	430	232				
9	144	20736	1474	007827	531	188				
10	128	16384	1866	012537	672	149	7.8			7.3
1	116	13456	2272	018587	818	122	8.3			8.1
2	104	10816	2826	02877	10	98.2	9.3			8.9
3	092	8464	3612	04698	13	76.9	10.4			10
4	080	6400	4776	08216	17	58.1	11.9			11.4
5	072	5184	5897	12520	21	47.1	13.2			12.7
6	064	4096	6611	2006	27	37.2	14.8	14.9	14.7	14.1
7	056	3136	9747	3422	35	28.5	16.9	16.9	16.6	15.9
8	048	2304	1327	6340	48	20.9	19.7	20	19.6	18.2
9	04	1600	1911	1315	69	14.5	23.5	23.8	23.3	21.3
20	036	1296	2359	2004	85	11.8	26.0	26.3	25.7	23.8
1	032	1024	2985	3209	108	9.30	29.2	29.4	28.6	26.3
2	028	784	3899	5475	140	7.12	33	33.3	32.3	29.4
3	024	576	5307	1014	191	5.23	38.3	38.5	37.1	34.5
4	022	484	6316	1437	228	4.40	42.4	42.6	40	37.1
5	020	400	7642	2103	275	3.63	46.5	46.5	43.5	40
6	018	324	9435	3206	339	2.94	51.5	51.8	48.5	43.5
7	0164	268.96	113.6	46.52	410	2.44	56.5	56.5	52.9	46.7
8	0148	219.04	139.6	70.14	503	1.99	62.5	62.1	57.8	50.5
9	0136	184.96	165.3	98.37	595	1.68	67.6	67.1	62.1	53.8
30	0124	153.76	198.8	142.4	716	1.40	74.6	73	67.1	57.5
1	0116	134.56	227.2	185.9	818	1.22	79.4	77.5	70.9	60.3
2	0108	116.64	262.1	247.4	944	1.06	85.7	82.6	75.2	63.3
3	010	100.0	305.7	336.5	1101	.908	91.7	88.5	80.1	66.7
4	0092	84.64	361.2	469.8	1300	.769	100	95.2	85.5	70.4
5	0084	70.56	433.2	676.0	1564	.641	109	103	92	80.6
6	0076	57.76	529.2	1009	1906	.525	120	112	99	86.2
7	0068	46.24	661.1	1574	2381	.420	135	123	107	99.2
8	0060	36	849.1	2596	3058	.327	151	137	118	100
9	0052	27.04	1130	4603	4070	.246	175	154	130	109
40	0048	23.04	1327	6340	4777	.209	189	164	137	114
1	0044	19.36	1579	8979	5687	.176	208	179	151	
2	004	16.0	1911	13146	6880	.145	227	192	161	
3	0036	12.96	2359	20040	8493	.118	256	208	172	
4	0032	10.24	2985	32090	10753	.093	285	227	185	
5	0028	7.84	3899	54750	14040	.071	322	250	200	
6	0024	5.76	5307	101400	19113	.052	377	278	217	
7	002	4.00	7642	210300	27527	.036	444	312	238	
8	0016	2.56	11941	513500	43000	.023				
9	0012	1.44	21230	1623000	76466	.013				
50	001	1.00	30570	3365000	101000	.009				

TPI CL. WD.	TURNS PER SQUARE INCH					CURRENT AT 1000 AMPS PER SQUARE INCH.	SECTIONAL AREA OF WIRE IN SQUARE INCHES.	LENGTH PER OHM. OF WIRE IN YARDS
	ENAMEL	SINGLE SILK	DOUBLE SILK	SINGLE COTTON	DOUBLE COTTON			
						196	.1963	8179
						169	.1691	7042
						147	.1466	6105
						126	.1257	5233
						109	.1090	4531
						95.1	.0951	3961
						82.5	.0825	3434
						70.7	.0707	2945
						59.9	.0598	2491
						49.9	.0499	2077
						42.3	.0423	1761
						35.3	.0353	1469
						28.9	.0289	1206
						24.3	.0243	1013
						20.1	.0201	837
						16.3	.0163	678
7.1	58				49	12.9	.0129	536
7.7	69				59	10.6	.0106	440.1
8.5	86				72	8.50	.00849	354.1
9.4	108				89	6.65	.00665	276.9
10.6	141				113	5.03	.00503	209.9
11.9	175				141	4.07	.00467	169.9
13.2	219	216	210	193	169	3.22	.00322	151.3
14.7	285	279	272	246	216	2.46	.00246	102.6
16.9	388	392	376	324	285	1.81	.00181	75.36
19.6	550	552	529	441	384	1.26	.00126	52.33
21.3	676	676	640	552	451	1.02	.00102	42.37
23.3	852	847	800	681	540	.804	.00080	33.51
25.6	1089	1089	1017	846	655	.616	.00062	25.64
29.4	1513	1568	1350	1169	860	.452	.00045	18.85
31.2	1789	1800	1590	1346	971	.380	.00038	15.84
33.3	2070	2160	1860	1568	1105	.314	.00031	13.09
35.7	2650	2600	2300	1850	1270	.255	.00025	10.608
37.9	3190	3170	2750	2100	1430	.211	.00021	8.803
40.3	3900	3800	3300	2500	1620	.172	.00017	7.163
42.4	4550	4450	3800	2800	1790	.145	.00014	6.050
44.6	5550	5300	4450	3250	1980	.121	.00012	5.030
46.3	6300	6000	5000	3550	2140	.106	.00011	4.405
48.1	7300	6800	5600	3950	2340	.092	.000092	3.817
50.1	8400	7800	6400	4350	2500	.078	.000078	3.271
52.1	10000	9000	7300	4850	2700	.066	.000066	2.770
57.5	12000	10000	8400	6400	2300	.055	.000055	2.309
60.2	14500	12500	9750	7370	3600	.045	.000045	1.890
63.3	18200	15000	11000	9650	4000	.036	.000036	1.513
66.7	22900	18500	13500	9900	4400	.028	.000028	1.178
70.4	30600	23500	16500	11500	4900	.021	.000021	.885
72.5	35600	26500	18500	12600	5200	.018	.000018	.750
	43000	32000	22000			.015	.000015	.633
	51000	36500	25500			.012	.000012	.520
	65000	43000	29000			.010	.00001	.424
	81000	51200	34000			.008		.336
	104000	62000	39500			.0061		.256
	142000	72000	46500			.0045		.188
	197000	97000	56000			.0031		.131
						.0021		.048
						.0011		.047
						.0007		.033

**PROPERTIES AND CHARACTERISTICS OF  
RESISTANCE MATERIALS**

MATERIAL	Resistance relative to COPPER	Resistance in ohms per circular Mil-Foot.	Temperature Coefficient of Resistivity per °C	Resistance in Microhms per cubic Centimetre	Resistance in ohms per square Mil-Foot	Resistance in Microhms per cubic Inch
Copper.	1.0	10.3	+ .0039	1.724	8.0	0.68
Steel.	6.4	67.4	+ .0043	11.2	53.0	4.41
Aluminium.	1.7	16.9	+ .0038	2.82	13.0	1.11
Pure Iron.	5.8	60.2	+ .005	10.0	47.0	3.94
Silver.	0.9	9.5	+ .0037	1.59	7.5	0.63
Gold.	1.3	14.6	+ .0035	2.43	11.0	0.94
Platinum.	5.8	60.2	+ .0031	10.0	47.0	3.94
Tin.	6.6	67.5	+ .0043	11.4	54.0	4.49
Zinc.	3.3	33.8	+ .0036	5.7	27.0	2.25
Lead.	12.7	133.0	+ .0039	21.9	104.0	8.63
Nickel.	6.0	61.4	+ .0059	10.2	48.0	4.02
Advance.	28.4	295.0	+ .000014	49.0	232.0	19.31
Eureka.	28.4	295.0	+ .000014	49.0	232.0	19.31
Glowray.	58.0	602.0	+ .00001	100.0	473.0	39.4
Climax.	50.4	524.0	+ .00069	87.0	412.0	34.28
Constantan.	28.4	295.0	+ .000014	49.0	232.0	19.31
Excello.	52.8	547.0	+ .00017	91.0	430.0	35.86
Ideal.	28.0	295.0	+ .000014	49.0	232.0	19.31
Manganin.	25.5	265.0	+ .000014	44.0	208.0	17.33
Platinoid.	24.3	253.0	+ .0003	42.0	199.0	16.55
la.-la.	29.6	307.0	- .000024	51.0	241.0	20.1
Tungsten.	3.3	33.8	+ .0044	5.7	27.0	2.25
Monel.	24.3	253.0	+ .0021	42.0	199.0	16.55
Alumel.	19.1	199.0	+ .0011	33.0	156.0	13.10
Chromel.	44.0	458.0	+ .00007	76.0	360.0	29.94
Copel.	28.4	295.0	+ .000001	49.0	232.0	19.31
Carbon.	2030.0	21070.0	- .0005	3500.0	16555.0	1379.0
Brightway.	58.0	602.0	+ .00019	100.0	473.0	39.4
Dullray.	50.4	525.0	+ .0007	87.0	412.0	29.94
Cupro.	15.0	157.0	+ .0003	26.0	123.0	10.24
No-Mag.	81.8	848.0	+ .00091	141.0	667.0	55.55
Nicrome 5%	52.8	547.0	+ .00105	91.0	430.0	35.86
Nicrome 15%	63.8	662.0	+ .0002	110.0	520.0	43.34
" 80% 20%	63.2	656.0	+ .0001	109.0	515.0	42.95
Corronil.	29.0	301.0	+ .00065	50.0	236.0	19.7
Redray.	53.9	559.0	+ .00026	93.0	440.0	36.65
Mangonic.	8.6	90.2	+ .0035	14.95	74.0	5.87
B.B.	23.2	241.0	+ .00021	40.0	189.0	15.76
Ferry.	27.8	289.0	+ .00002	48.0	227.0	18.91
Zodiac.	20.9	217.0	+ .00023	36.0	170.0	14.19
Tarnac.	22.6	235.0	+ .000017	39.0	184.0	15.36
Ferrozoid.	48.8	506.0	+ .00076	84.0	398.0	33.09
Cromaloy. 2	63.8	662.0	+ .00013	110.0	520.0	43.34
" 3	53.9	559.0	+ .00013	93.0	440.0	36.65
" 4	58.0	602.0	+ .00008	100.0	473.0	39.4
Nickel-Silver. 1	18.0	187.0	+ .00027	31.0	147.0	12.22
" " 4	12.2	127.0	+ .00047	21.0	100.0	8.28
Platinum-Iridium.	18.0	187.0	+ .00082	31.0	147.0	12.22
" Silver.	18.2	190.0	+ .00028	31.4	148.0	12.38
Kromore.	52.2	542.0	+ .0002	90.0	426.0	35.46

## RESISTANCE WIRE DATA

S. W. C.	NICKEL SILVER WIRE				MANGANIN WIRE				PLATINOID WIRE				Dia. in INCHES
	RESISTANCE		Amperage required for temperature rise of		RESISTANCE		Amperage required for temperature rise of		RESISTANCE		Amperage required for temperature rise of		
	Ohms per 1000 ft. approx.	Ohms per Ounce approx.	200°C	100°C	Ohms per 1000 ft. approx.	Ohms per Ounce approx.	200°C	100°C	Ohms per 1000 ft. approx.	Ohms per Ounce approx.	200°C	100°C	
8	—	—	—	—	9.6	·008	61	39	9.5	·008	—	—	·160
10	—	—	—	—	15.0	·018	39	27	14.9	·018	—	—	·128
12	—	—	—	—	22.7	·042	28	21	22.7	·042	—	—	·104
14	—	—	—	—	38.3	·12	17.5	11.7	38.4	·12	—	—	·080
16	34	·17	14.2	8.1	59.6	·30	10.1	7.2	59.7	·31	—	—	·064
18	59	·53	9.4	6.1	107	·95	7.6	5.1	108	·95	—	—	·048
20	109	1.7	6.3	4.1	190	2.9	5.1	3.6	189	2.9	—	—	·036
21	—	—	—	—	241	4.9	—	—	—	—	—	—	·032
22	180	5.04	4.2	3.1	315	8.8	3.8	2.6	316	8.7	—	—	·028
23	—	—	—	—	428	15	—	—	—	—	—	—	·024
24	292	12.25	—	—	510	21	—	—	509	22	—	—	·022
25	—	—	—	—	617	32	—	—	—	—	—	—	·020
26	437	27.56	—	—	763	48	—	—	764	48	—	—	·018
27	—	—	—	—	918	70	—	—	—	—	—	—	·0164
28	669	64.37	—	—	1166	112	—	—	1165	112	—	—	·0148
30	917	121	—	—	1600	211	—	—	1601	212	—	—	·0124
32	—	—	—	—	2105	367	—	—	2104	367	—	—	·0108
34	—	—	—	—	2935	704	—	—	2933	705	—	—	·0092
36	—	—	—	—	4303	1520	—	—	4305	1520	—	—	·0076
38	—	—	—	—	6918	3900	—	—	6917	3901	—	—	·006
40	—	—	—	—	10762	9530	—	—	10764	9531	—	—	·0048
42	—	—	—	—	15413	19500	—	—	15416	19500	—	—	·004
44	—	—	—	—	24083	48000	—	—	24087	48000	—	—	·0032
46	—	—	—	—	42816	152000	—	—	48819	152000	—	—	·0024

The above data supplied by courtesy of London Electric Wire Co. & Smiths Ltd. [LEWCOS].

# FUSE WIRE TABLES

Figures are approximate and for commercial use only

Fusing Current in Amperes.	DIAMETER IN INCHES.				
	Copper.	Aluminium.	Tin.	Allo-Tin.	Lead.
1	.0020	.0028	.0076	.0084	.0084
2	.0036	.0040	.0116	.0136	.0124
3	.0044	.0052	.0148	.018	.0164
4	.0052	.0068	.018	.022	.020
5	.0060	.0076	.022	.024	.024
10	.0100	.0124	.036	.040	.036
15	.0124	.0164	.044	.048	.048
20	.0156	.0180	.052	.064	.060
25	.018	.0220	.064	.072	.072
30	.020	.024	.072	.080	.078
35	.023	.028	.076	.092	.084
40	.024	.030	.084	.096	.096
45	.026	.032	.092	.104	.104
50	.028	.036	.096	.116	.108
60	.032	.040	.110	.128	.124
70	.036	.044	.122	.144	.136
80	.040	.048	.134	.160	.150
90	.044	.052	.144	.168	.162
100	.048	.056	.152	.180	.174
120	.052	.064	.176	.202	.196

## EUREKA RESISTANCE WIRE

(REGD.)  
CURRENT NECESSARY TO MAINTAIN GIVEN TEMPERATURE RISE. WIRE HELD STRAIGHT AND HORIZONTAL IN AIR WITH FREE RADIATION.

Size S.W.O.	Diam. Inch.	M/m.	Amperes for a Temperature rise of			Resistance per 1,000 yards at 15.5° C. Ohms.	Weight per 1,000 yards, lbs.
			100° C.	200° C.	300° C.		
8	.160	4.06	29.0	44.5	57.9	34.5	233.6
9	.144	3.65	24.0	37.2	48.7	42.6	189.0
10	.128	3.25	20.1	30.8	40.0	34.0	149.2
11	.116	2.94	18.6	28.1	36.4	31.7	122.8
12	.104	2.64	14.8	22.4	29.0	24.8	98.6
13	.092	2.33	12.6	18.8	24.5	20.4	77.1
14	.080	2.03	10.5	15.5	20.1	16.8	62.4
15	.072	1.82	9.3	13.4	17.4	14.6	53.3
16	.064	1.62	8.1	11.5	15.1	12.9	45.4
17	.056	1.42	7.0	9.8	13.0	11.4	38.6
18	.048	1.21	6.75	8.2	11.0	9.8	32.0
19	.040	1.01	4.6	6.7	9.2	8.2	26.4
20	.036	.91	4.1	6.0	8.3	7.2	22.8
21	.032	.81	3.6	5.4	7.4	6.4	19.8
22	.028	.71	3.1	4.6	6.5	5.6	17.0
23	.024	.60	2.7	4.00	5.5	4.8	14.4
24	.022	.55	2.4	3.55	5.0	4.4	13.0
25	.020	.50	2.18	3.20	4.6	4.0	11.8
26	.018	.45	2.00	2.90	3.60	3.6	10.6
27	.0164	.41	1.82	2.68	3.21	3.28	9.6
28	.0148	.37	1.66	2.42	2.85	2.92	8.8
29	.0136	.34	1.54	2.22	2.58	2.68	8.1
30	.0124	.31	1.40	2.00	2.30	2.40	7.4
31	.0116	.29	1.30	1.81	2.13	2.20	6.8
32	.0108	.27	1.20	1.64	1.94	2.00	6.3
33	.0100	.25	1.08	1.46	1.77	1.84	5.8
34	.0092	.23	.98	1.30	1.60	1.68	5.4
35	.0084	.21	.85	1.13	1.42	1.50	5.0
36	.0076	.19	.75	.98	1.26	1.34	4.6
37	.0068	.17	.66	.83	1.09	1.18	4.2
38	.0060	.15	.58	.70	.93	1.00	3.8
39	.0052	.13	.50	.58	.78	.84	3.4
40	.0048	.12	.46	.52	.70	.76	3.1
41	.0044	.11					
42	.0040	.10					
43	.0036	.09				68070	.118
44	.0032	.08				86370	.093
45	.0028	.07				112800	.072
46	.0024	.06				153500	.053
47	.0020	.05				221000	.036
48	.0016	.040				345400	.023
49	.0012	.030				614000	.013
50	.0010	.025				884200	.009

The resistance values given above are standard and are subject to the tolerances given in B.S.I. Specification No. 115 of 1933  
Approximate Characteristics

Temperature Co-efficient .. 0.000014. Specific Resistance .. 49 microhms per cm cube Comparative Resistance Copper—Unity 28 Specific Gravity .. 8.92	Thermo E.M.F. against Copper (20° to 200° C.) .. 0.8 millivolts per ° C Melting Point .. 1,250° C. Tensile Strength .. 36 tons per square inch
---	---

The above information supplied by courtesy of Lawcos Ltd.

## ELECTRICAL CABLE SIZES

NOMINAL AREA Sq. Inch.	OLD STANDARD No. S.W.G.	NEW STANDARD No./Inch.	Dia. In Inches	WEIGHT per 1000 yds. In lbs.	MAXIMUM RESISTANCE per 1000 yds. in OHMS.	LENGTH of CIRCUIT per Volt drop In feet.	CAPACITY of single cables in AMPS.
.001	1/20	1/.036	0.036	11.76	24.29	30	4.1
.0015		1/.044	0.044	17.58	16.26	30	6.1
.002		3/.029	0.062	23.37	12.61	30	7.8
.003	3/20	3/.036	0.078	36.02	8.180	29	12.0
.003	1/16	1/.064	0.064	37.20	7.688	29	12.9
.0045		7/.029	0.087	54.39	5.387	28	18.2
.007	7/20	7/.036	0.108	83.81	3.496	33	24.0
.01		7/.044	0.132	125.4	2.340	39	31.0
.0145		7/.052	0.156	174.9	1.675	45	37.0
.0225	7/16	7/.064	0.192	264.9	1.106	56	46.0
.03		19/.044	0.220	340.4	0.9637	61	53.0
.04	19/17	19/.052	0.260	475.8	0.6184	71	64.0
.06	19/16	19/.064	0.320	720.3	0.4085	83	83.0
.075	19/15	19/.072	—	911.6	0.3229	90	97.0
.10		19/.083	0.415	1212.0	0.2427	98	119.0
.12	37/16	37/.064	—	1403.0	0.2097	104	130.0
.15	37/15	37/.072	0.504	1776.0	0.1657	112	152.0
.20		37/.083	0.581	2360.0	0.1247	123	185.0
.25		37/.093	—	2983.0	0.09933	132	214.0
.30		37/.103	0.721	3635.0	0.08089	145	240.0
.40		61/.093	0.837	4666.0	0.06026	162	288.0
.50		61/.103	0.927	5994.0	0.04913	173	332.0
.60		91/.093	—	7290.0	0.04040	181	384.0
.75		91/.103	1.133	8942.0	0.03294	185	463.0
.85		127/.093	—	10175.0	0.02895	190	512.0
1.00		127/.103	1.339	12481.0	0.02360	200	595.0

## FLEXIBLE CORDS

SIZE	AREA In Sq. Inches	CURRENT RATING In Amps.	RESISTANCE per 1000 yards single core ...	MAXIMUM WEIGHT In lbs.	YARDS PER POUND WEIGHT FOR TWIN SILK (twisted)
14/.0076	.0006	2	39.7	3	17.6
23/.0076	.0010	3	24.2	5	13.3
40/.0076	.0017	5	13.8	10	9.75
70/.0076	.0030	10	7.94	10	6.55
110/.0076	.0048	15	5.05	10	4.65
162/.0076	.0070	20	3.43	10	3.33

## MAXIMUM CURRENT RATING OF CABLES

SIZE	Rating in AMPERES A.C. & Voltage drop per 100 feet				SIZE	Rating in AMPERES A.C. & Voltage drop per 100 feet			
	Cores in one sheath					Cores in one sheath			
	UP TO 4		UP TO 8			UP TO 2		UP TO 4	
	AMPS.	VOLTS	AMPS.	VOLTS		AMPS.	VOLTS	AMPS.	VOLTS
1/.044	5	2.8	5	2.8	19/.052	78	1.75	62	1.4
3/.029	5	2.1	5	2.1	19/.064	102	1.55	82	1.19
3/.036	10	2.8	8	2.4	19/.083	147	1.35	119	1.04
7/.029	15	2.9	12	2.4	37/.072	190	1.28	151	0.98
					37/.083	229	1.26	183	0.98
					37/.103	298	1.28	238	0.98
7/.036	29	3.4	23	2.9	61/.093	358	1.38	286	1.04
7/.044	38	3.1	30	2.4	61/.103	413	1.50	330	1.15
7/.052	45	2.7	36	2.2	91/.103	530	1.80	—	—
7/.064	56	2.1	46	1.75	127/.103	648	2.10	—	—
19/.044	65	2.0	52	1.6					

## CAPACITY OF FUSES IN AMPERES

FUSE RATING In Amps.	TINNED COPPER WIRE		STANDARD ALLOY WIRE		FUSE RATING In Amps.	TINNED COPPER WIRE		STANDARD ALLOY WIRE	
	Dia.	S.W.G.	Dia.	S.W.G.		Dia.	S.W.G.	Dia.	S.W.G.
1.5	—	—	.0164	27	30	.032	21	—	—
3	.006	38	.024	23	37	.04	19	—	—
5	.0084	35	.032	21	46	.048	18	—	—
8.5	.0124	30	—	—	53	.048	18	—	—
10	.0136	29	—	—	60	.056	17	—	—
15	.02	25	—	—	64	.056	17	—	—
17	.022	24	—	—	83	.072	15	—	—
20	.024	23	—	—	100	.08	14	—	—
24	.028	22	—	—					

**COMPARISON BETWEEN  
BRITISH & U.S.A. WIRE GAUGES**  
DIAMETERS IN INCHES

SIZE	4/0	3/0	2/0	0	1	2	3	4	5	6	7
S.W.G.	.400	.372	.348	.324	.300	.276	.252	.232	.212	.192	.176
B.W.G.	.454	.425	.380	.340	.300	.284	.259	.238	.220	.203	.180
B.&S.	.460	.4096	.3648	.3249	.2893	.2576	.2294	.2043	.1819	.1620	.1443
SIZE	8	9	10	11	12	13	14	15	16	17	18
S.W.G.	.160	.144	.128	.116	.104	.092	.080	.072	.064	.056	.048
B.W.G.	.165	.148	.134	.120	.109	.095	.083	.072	.065	.058	.049
B.&S.	.1285	.1144	.1019	.0907	.0808	.072	.0641	.0571	.0508	.0453	.0403
SIZE	19	20	21	22	23	24	25	26	27	28	29
S.W.G.	.040	.036	.032	.028	.024	.022	.020	.018	.0164	.0148	.0136
B.W.G.	.042	.035	.032	.028	.025	.022	.020	.018	.016	.014	.013
B.&S.	.0359	.032	.0285	.0253	.0226	.0201	.0179	.0159	.0142	.0126	.0113
SIZE	30	31	32	33	34	35	36	37	38	39	40
S.W.G.	.0124	.0116	.0108	.010	.0092	.0084	.0076	.0068	.006	.0052	.0048
B.W.G.	.012	.010	.009	.008	.007	.005	.004	—	—	—	—
B.&S.	.0100	.0089	.0079	.0071	.0063	.0056	.005	.0045	.004	.0035	.0031
SIZE	41	42	43	44	45	46	47	48	49	50	
S.W.G.	.0044	.0040	.0036	.0032	.0028	.0024	.002	.0016	.0012	.001	
B.W.G.	—	—	—	—	—	—	—	—	—	—	
B.&S.	.0028	.0025	.0022	.002	.0018	—	—	—	—	—	

The above data supplied by courtesy of LEWCOS LTD.

**RADIO SOLDER COMPOSITION AND MELTING POINTS**

Composition	Percentage	Melting at °F	Composition	Percentage	Melting at °F
LEAD TIN	100 —	452	LEAD TIN	40 60	462
LEAD TIN	90 10	411	LEAD TIN	30 70	494
LEAD TIN	80 20	381	LEAD TIN	20 80	551
LEAD TIN	70 30	366	LEAD TIN	10 90	566
LEAD TIN	60 40	373	LEAD TIN	— 100	617
LEAD TIN	50 50	411			

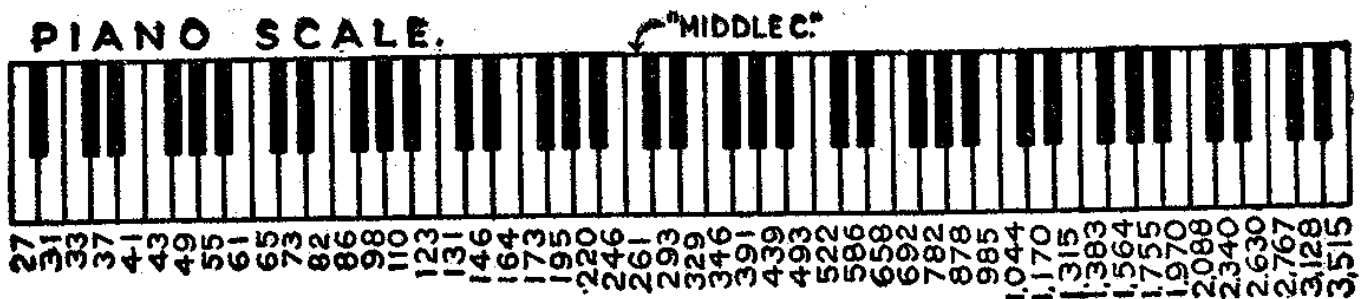

FREQUENCY (c/s)

Piano scale showing the frequencies to which the keys are usually tuned, which is to a slightly different pitch from that used by physicists, based on Middle C = 256 c/s., and such scales are apt to be misleading. Frequencies of black keys can be obtained by multiplying the frequency of the white key below it by 1.05946. This scale is useful for the approximate calibration of oscillators and rough determination of resonant frequencies, etc.

**VIBRATIONS AND THE MUSICAL SCALE.**

Ratio of vibrations of 1 octave in any part of the Musical Scale :—

Note	...	...	C.	D.	E.	F.	G.	A.	B.	C.
Ratio	...	...	1	9/8	5/4	4/3	3/2	5/3	15/8	2
Decimal Ratio	...	...	1	1.125	1.25	1.33	1.5	1.66	1.875	2
Tonic Sol Fa Scale	Doh	Ray	Me	Fah	Soh	Lah	Te	Doh		

**\* STROBOSCOPE TABLE.**

FREQUENCY of Supply (c/s.)	15	25	33	40	50	60	80	90	100	
RECORD SPEED r.p.m.	78	23	38	51	62	77	92	123	139	154

To find the number of black spokes required for any speed and a.c. mains-frequency, the formula is :—

$$N \dots = \frac{120.f}{r}$$

- where N = number of black spokes.
- f = mains supply frequency.
- r = speed of record required.

N.B.—180 black spokes are required at 33½ r.p.m. for 50 c/s. mains.



# FORMULAS FOR AERIALS CUT TO RESONATE AT ANY DESIRED FREQUENCY

## LONG WIRE MULTIBAND ZEPPELIN AERIAL CUT FOR MOST FREQUENT BAND USED

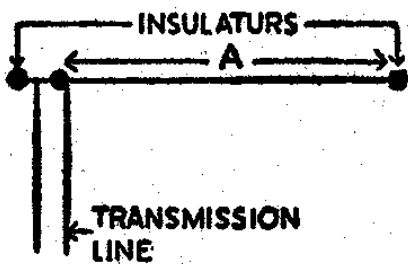

$$A = \left[ \left( 164 \left( \text{NUMBER OF HALF WAVES ON THE AERIAL REQUIRED, MINUS } 0.5 \right) \right) \div \left( \text{FREQUENCY IN MEGACYCLES OF MOST USED BAND} \right) \right] \text{ YDS.}$$

## DIRECTOR AND REFLECTOR HALF WAVE AERIAL

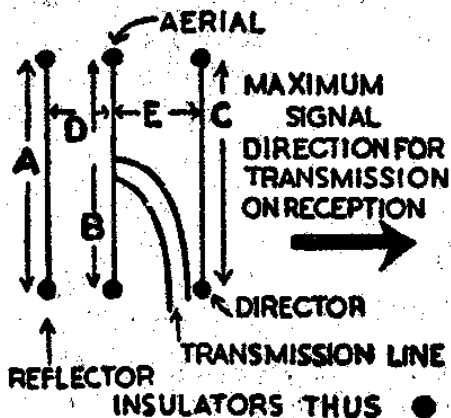

$$A = \left\{ 164 \div \left( \text{FREQUENCY IN MEGACYCLES} \right) \right\} \text{ YDS.}$$

$$B = \left\{ 156 \div \left( \text{FREQUENCY IN MEGACYCLES} \right) \right\} \text{ YDS.}$$

$$C = \left\{ 150 \div \left( \text{FREQUENCY IN MEGACYCLES} \right) \right\} \text{ YDS.}$$

$$D = \left\{ \left( \text{WAVELENGTH IN METRES} \times 1.25 \right) \times 1.094 \right\} \text{ YDS.}$$

$$E = \left\{ \left( \text{WAVELENGTH IN METRES} \times 1 \right) \times 1.094 \right\} \text{ YDS.}$$

## J TYPE AERIAL FOR VERY HIGH FREQUENCIES

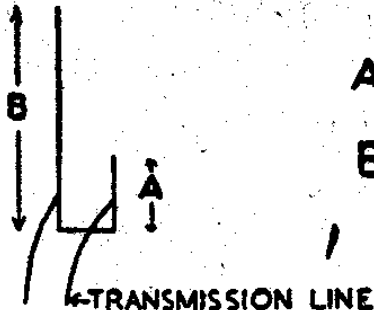

$$A = \left\{ \left( \text{WAVELENGTH IN METRES} \div 4 \right) \times 1.094 \right\} \text{ YDS.}$$

$$B = \left\{ \left( \text{WAVELENGTH IN METRES} \times 0.75 \right) \times 1.094 \right\} \text{ YDS.}$$

## MARCONI TYPE 1/4 WAVE AERIAL

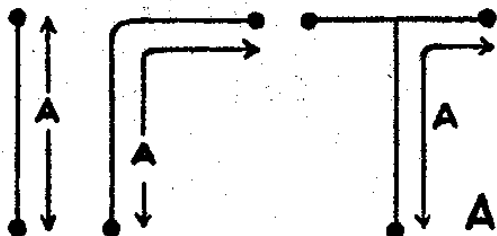

$$A = \left\{ \left( \text{WAVELENGTH IN METRES} \div 4 \right) \times 1.094 \right\} \text{ YARDS}$$

A HERE INCLUDES LENGTH OF LEAD IN

## HALF WAVE AERIAL

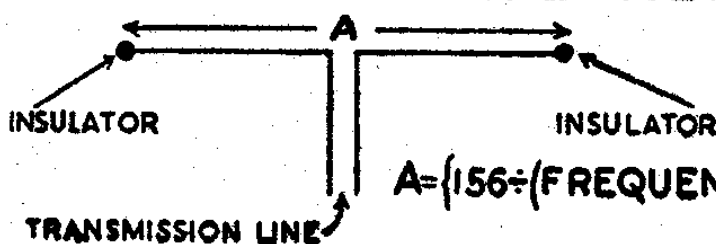

$$A = \left\{ 156 \div \left( \text{FREQUENCY IN MEGACYCLES} \right) \right\} \text{ YDS.}$$

# HALF WAVE Q MATCHED AERIAL

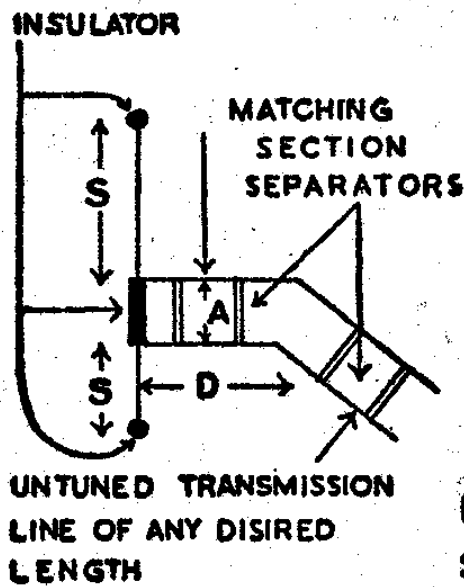

THE DIMENSION **A** DEPENDS UPON THE AERIAL IMPEDANCE AND THE IMPEDANCE OF THE TRANSMISSION LINE AND THE IMPEDANCE IN OHMS OF THE MATCHING SECTION IS EQUAL TO

$$\sqrt{\frac{\text{AERIAL IMPEDANCE IN OHMS} \times \text{TRANSMISSION LINE IMPEDANCE IN OHMS}}{\text{IMPEDANCE IN OHMS}}}$$

THEREFORE DIMENSION **A** IS OBTAINED BY REFERENCE TO THE SECTION DEALING WITH TRANSMISSION LINE FORMULAS ONCE THE IMPEDANCE OF THE MATCHING SECTION IS OBTAINED

$$D = \left\{ \frac{78}{\text{FREQUENCY IN MEGACYCLES}} \right\} \text{ YDS.}$$

$$S = \left\{ \frac{78}{\text{FREQUENCY IN MEGACYCLES}} \right\} \text{ YDS.}$$

# ZEPPELIN AERIAL

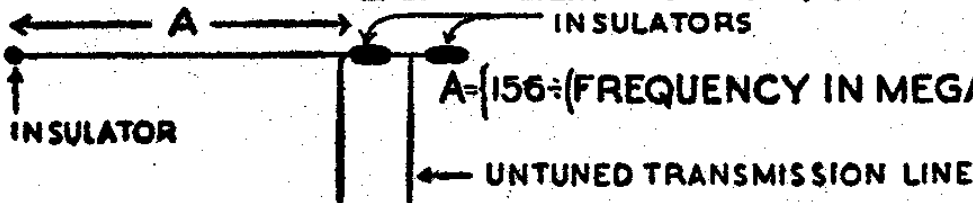

$$A = \left\{ \frac{156}{\text{FREQUENCY IN MEGACYCLES}} \right\} \text{ YDS}$$

# HALF WAVE DELTA MATCHED AERIAL

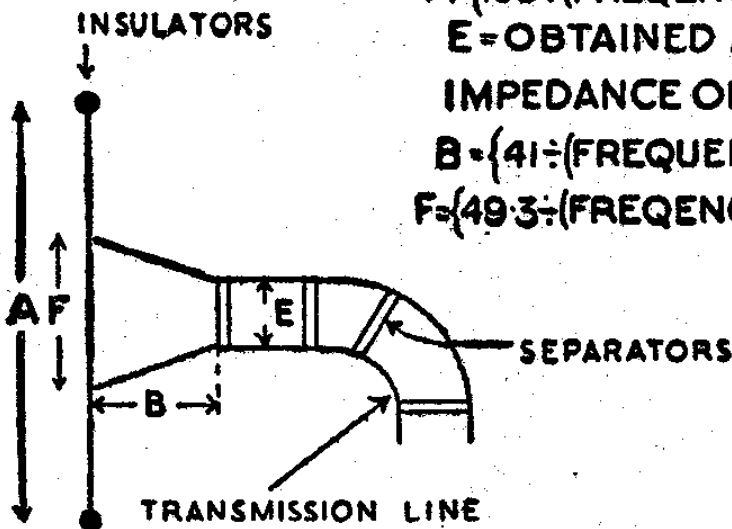

$$A = \left\{ \frac{156}{\text{FREQUENCY IN MEGACYCLES}} \right\} \text{ YDS.}$$

**E** = OBTAINED ACCORDING TO THE

IMPEDANCE OF THE TRANSMISSION LINE

$$B = \left\{ \frac{41}{\text{FREQUENCY IN MEGACYCLES}} \right\} \text{ YDS.}$$

$$F = \left\{ \frac{49.3}{\text{FREQUENCY IN MEGACYCLES}} \right\} \text{ YDS.}$$

# LONG WAVE AERIAL

ANY NUMBER OF HALF WAVES IN LENGTH

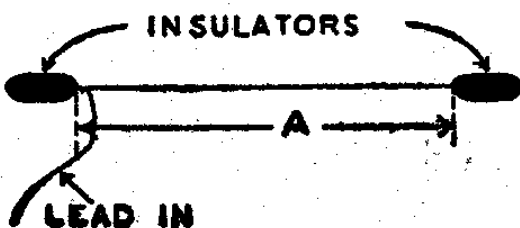

$$A = \left\{ \frac{164 (\text{NUMBER OF HALF WAVES ON THE AERIAL MINUS } 0.5)}{\text{FREQUENCY IN MEGACYCLES}} \right\} \text{ YDS.}$$

## TRANSMISSION AND FEEDER LINE FORMULAS.

### Two Wire Line.

Let A = Wire centre spacing in inches.

B = Wire diameters in inches.

C = Line impedance in ohms.

D = Capacity of twin line feeder in mmf. per foot.

E = Inductance of twin line feeder in millihenries per foot.

$$C = 276.36 \left\{ \log (2A \div B) \right\}. \quad D = 3.679 \div \left\{ \log (2A \div B) \right\}.$$

$$E = .2812 \left\{ \log (2A \div B) \right\}.$$

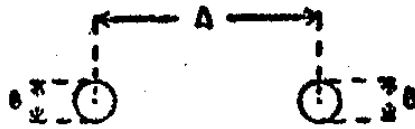

### Concentric Line.

A and B are given in inches.

$$C = 138.18 \left\{ \log (B \div A) \right\} \text{ ohms.}$$

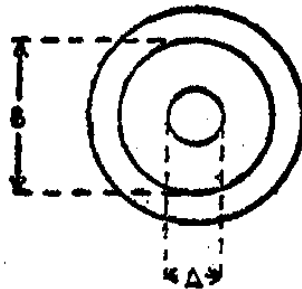

### Double Twin Line.

A and B are given in inches.

$$C = 138.18 \left\{ \log (1.41421 B \div A) \right\} \text{ ohms.}$$

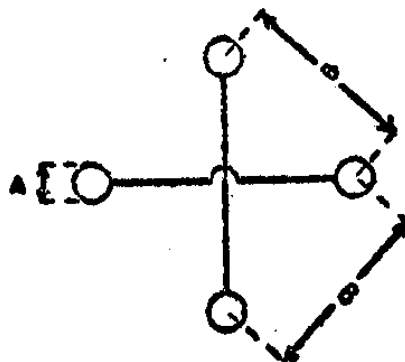

### Shielded Twin Line.

A, B and F are given in inches.

$$C = 276.36 \log \frac{2B}{A} \left\{ \left( 1 - (B \div 2F)^2 \right) \div \left( 1 + (B \div 2F)^2 \right) \right\} \text{ ohms.}$$

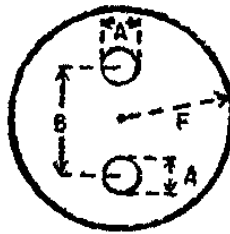

**Twin Single Line.**

A and B are given in inches.

$$C = 207.3 \left\{ \log (1.587401A \div B) \right\} \text{ ohms.}$$

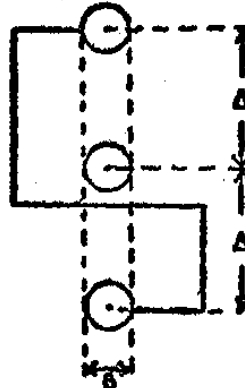

**Square Concentric Line.**

A and B are given in inches.

$$C = 171.71 \left\{ \log (1.148 B \div A) \right\} \text{ ohms.}$$

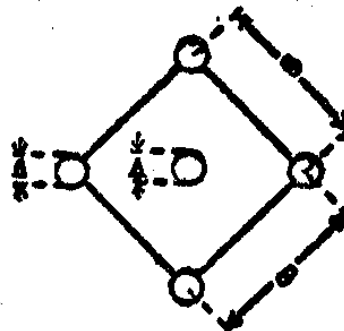

**Single Wire Line.**

A and B are given in inches.

$$C = 138.18 \left\{ \log (4 A \div B) \right\} \text{ ohms.}$$

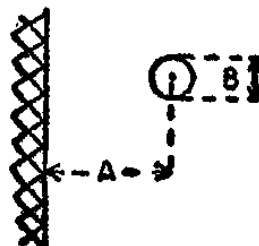

### Parallel Thin Strip Foil Line.

A and B are given in inches.

$$C = 1188 \div \left[ 1 + 2.3 \log \left\{ 2.3 \log \left( \frac{1 + 3.142B}{A} \right) + \frac{3.142B}{A} + 1 \right\} + \frac{3.142B}{A} \right]$$

The formula for this type of line is only true when B is much greater than A.



### METER FORMULAS FOR DIRECT CURRENT MEASUREMENTS.

(a) To find the ohms. per volt resistance of a voltmeter. This value is equal to :—

$1 \div$  full scale current in amperes.

(b) To increase range of meter for voltage reading by any desired multiplier.

Let B = multiplier resistance value in ohms.

A = Total meter resistance in ohms.

Then  $B =$  (Required full scale reading in volts  $\div$  by the full scale meter current in amperes).

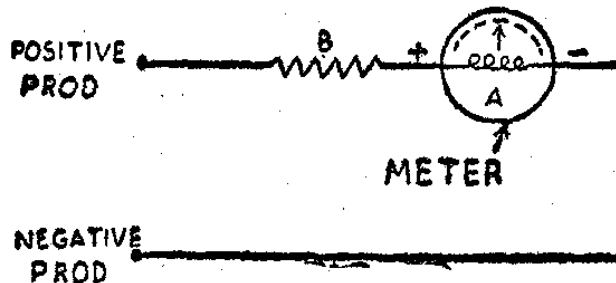

(c) To increase range of milliammeter for current reading by any desired multiplier.

Let C = Required multiplying factor.

B = Shunt resistance value in ohms.

A = Total meter resistance in ohms.

Then  $B = A \div (C - 1)$ .

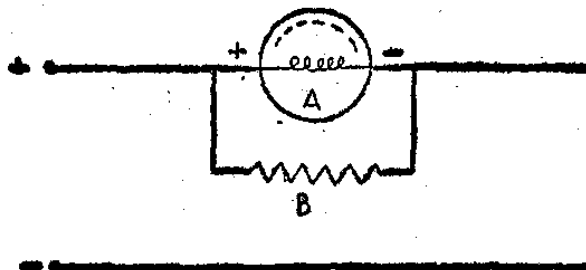

(d) To find ohmage value of unknown resistance by using a voltmeter and battery.

Let B = value of unknown resistance.

A = resistance of voltmeter in ohms.

Then  $B = A \left\{ \left( \text{Reading of voltmeter with closed switch} \div \text{Reading of voltmeter with open switch} \right) - 1 \right\}$

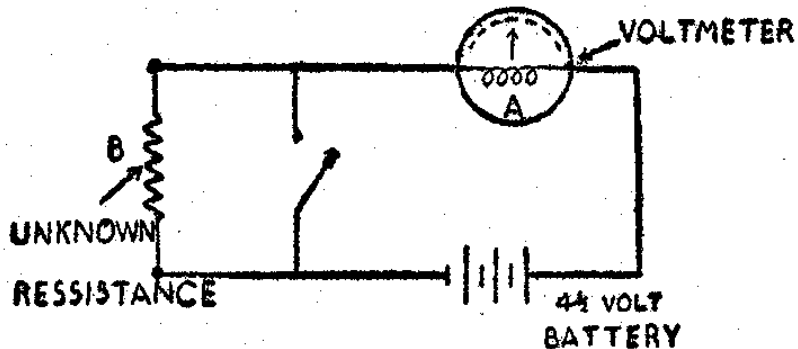

(e) To find value of universal current shunts.

Let D = required multiplier factor.

C + B = total resistance in ohms. for lowest shunted current range required.

A = meter resistance in ohms.

$$B = (A + B + C) \div D.$$

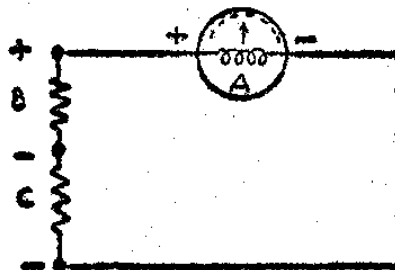

(f) To find ohmage value of unknown resistance by means of milliammeter and battery.

Let C = series resistor for limiting battery current so as to give a reading on the meter scale when switch is open.

B = unknown resistance.

A = resistance of milliammeter in ohms.

Then  $B = \left\{ \text{Switch closed meter current reading} \div \left( \text{switch open meter current reading} \text{ minus switch closed meter current reading} \right) \right\}$ .

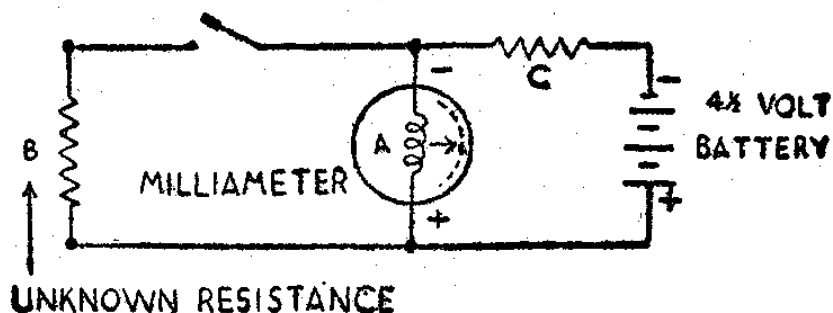

(g) To find ohmage value of unknown resistance by means of milliammeter, battery and any known resistor.

Let C = known resistance value in ohms.

B = unknown resistance value in ohms.

A = Meter resistance in ohms.

Then  $B = \left\{ C + A \right\} \left\{ \text{(Meter current reading with closed switch minus meter current reading with open switch)} \div \text{current meter reading with open switch} \right\}$ .

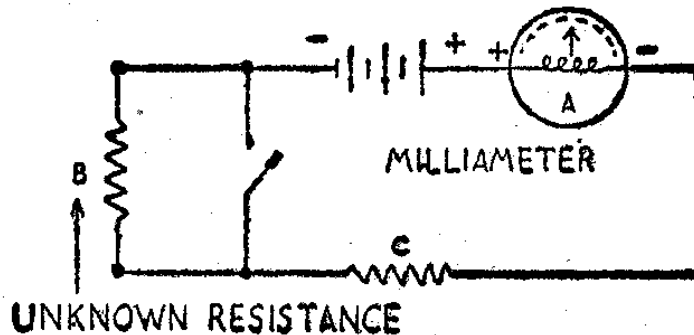

(h) To find the direct current resistance in ohms. of an unidentified voltmeter or milliammeter.

Let C and B = Variable resistors.

A = unknown meter resistance.

Then connect circuit as shown in diagram with resistor C only being used in circuit, whilst B is disconnected by switch being open. With switch open vary C for full scale meter reading, then bring resistor B into circuit by closing switch, and vary B until the meter reading returns to half scale. Then, if the value of resistance B at this setting is checked by an ohmmeter, the reading shown is equal to the resistance of A. It is vital that resistance C is of sufficiently high value to prevent an off the scale meter reading. If the full scale current of the meter is known, it is easy to calculate value of C by the following formula :—

$C = (1,000 \text{ times testing battery voltage used}) \div (\text{meter full scale current in milliamperes}).$

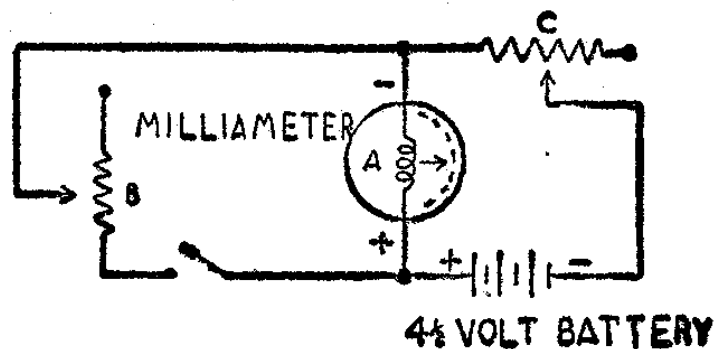

## SPEAKER OUTPUT TRANSFORMERS FORMULAS.

Ascertain output valve load resistance from "Bernards Valve Manual" No. 30, price 3/6, or from manufacturers data sheets and also speaker speech coil impedance in ohms. NOTE.—When two valves operate in Push-Pull, reckon the output load resistance to be twice that of a single valve, and when two valves are operating in parallel reckon output load resistance to be half that of a single valve.

The speaker output transformer ratio is equal to :—

$$\text{Square root of } \left\{ (\text{Optimum valve load resistance}) \div (\text{speaker speech coil impedance in ohms}) \right\}.$$

When extension speakers are required to be used with the same speech coil impedance as that used in the normal internal speaker, the output transformer ratio is equal to :—

$$\text{Square root of } \left[ \text{Number of speakers} \times \left\{ (\text{optimum valve load resistance}) \div (\text{single speaker speech coil impedance in ohms.}) \right\} \right]$$

Output transformer ratio for extra speakers with different speech coil impedances. In this case it is necessary for each speaker to have its own output transformer.

The output transformer ratio of each speaker is equal to :—

$$\text{Square root of } \left[ \text{Number of speakers} \times \left\{ (\text{Optimum valve load resistance}) \div (\text{Impedance in ohms. of speech coil of speaker being used}) \right\} \right]$$

## OUTPUT TRANSFORMERS TABLE OF RATIOS

VALVE LOAD (PLATE TO PLATE FOR P.P. OPERATION)	SPEECH COIL IMPEDANCES								
	2 Ω	3 Ω	5 Ω	8 Ω	10 Ω	15 Ω	20 Ω	25 Ω	
4000	44.7	36.5	28.3	22.4	20	16.4	14.1	12.6	
5000	50	40.8	31.6	25	22.4	18.3	15.8	14.1	
6000	54.8	44.7	34.6	27.4	24.5	20	17.3	15.5	
8000	63.3	51.6	40	31.6	28.3	23	20	17.9	
10000	70.7	57.7	44.7	35.3	31.6	25.8	22.4	20	
12000	77.5	63.3	49	38.7	34.6	28.3	24.5	22	
14000	83.7	68.3	53	41.8	37.4	30.6	26.5	23.7	
16000	89.4	73	56.6	44.7	40	32.8	28.3	25.3	
20000	100	81.6	63.2	50	44.7	36.5	31.6	28.3	
25000	111.8	91.3	70.7	55.9	50	40.8	35.3	31.6	



## WAVELENGTH FREQUENCY AND L.O. FACTOR TABLES.

To use these tables which give inductance capacity values for Radio Frequencies the following examples are shown :—

1. Given a tuned circuit total capacity .0005 mfd. and inductance 245 microhenries, what is the natural wavelength and frequency? Answer : the L.C. constant is  $.0005 \times 245 = .1225$ ; therefore, wavelength is 660 metres and frequency 454.3 Kilocycles.

2. What inductance is needed to tune a .0005 mfd. condenser to 1,900 metres. Answer : L.C. for 1,900 metres = 1.016; therefore, inductance is 1.016 divided by .0005 which equals 2.032 microhenries.

3. A circuit with a natural frequency of 1,250 Kc. is required, the tuning coil inductance being 81 microhenries. What capacity should be connected across the coil? Answer : L.C. for 1,250 Kc. = .01624; hence capacity is  $.01622 \div$  by 81 which equals .0002 microfarads.

### MULTIPLYING FACTORS FOR OTHER RANGES OUTSIDE THIS TABLE.

- (A) If column 1 is multiplied by 10 then read column 2 multiplied by 100, and column 3 divided by 10.
- (B) If column 1 is divided by 10, then read column 2 divided by 100 and column 3 multiplied by 10.
- (C) If column 2 is multiplied by 10 then column 1 is multiplied by  $\sqrt{10}$  and column 3 is divided by  $\sqrt{10}$ .
- (D) If column 2 is divided by 10 then column 1 is divided by  $\sqrt{10}$  and column 3 is multiplied by  $\sqrt{10}$ .
- (E) If column 3 is multiplied by 10 then column 1 is divided by 10 and column 2 is divided by 100.
- (F) If column 3 is divided by 10 then column 1 is multiplied by 10, and column 2 is multiplied by 100.

W/length Metres.	L. × C. Factor m.f. and m.h.	Frequency Kilocycles.	W/length Metres.	L. × C. Factor m.f. and m.h.	Frequency Kilocycles
1	.00000028	299820.0	55	.0008521	5451.0
2	.00000112	149910.0	60	.001014	4997.0
3	.00000253	99940.0	65	.001188	4613.0
4	.00000451	74955.0	70	.001379	4283.0
5	.00000704	59964.0	75	.001583	3998.0
6	.00001014	49970.0	80	.001801	3748.0
7	.00001383	42831.4	85	.002034	3527.0
8	.00001801	37477.5	90	.002280	3331.0
9	.00002282	33313.3	95	.002541	3156.0
10	.00002816	29982.0	100	.002816	2998.0
15	.0000635	19990.0	105	.003101	2855.0
20	.0001129	14991.0	110	.003404	2726.0
25	.0001754	11990.0	115	.003721	2607.0
30	.0002531	9994.0	120	.004052	2498.0
35	.0003445	8566.0	125	.004402	2399.0
40	.0004503	7495.5	130	.004757	2306.0
45	.0005702	6663.0	135	.005132	2221.0
50	.0007039	5996.4	140	.005518	2142.0

W/length Metres.	L. x C. Factor m.f. and m.h.	Frequency Kilocycles	W/length Metres.	L. x C. Factor m.f. and m.h.	Frequency Kilocycles
145	.005923	2067.0	395	.04392	759.1
150	.006335	1999.0	400	.04503	749.4
155	.006764	1934.0	405	.04617	740.3
160	.007204	1873.0	410	.04733	731.3
165	.007661	1817.0	415	.04851	722.5
170	.008134	1763.0	420	.04968	713.9
175	.008622	1713.0	425	.05084	705.5
180	.009120	1665.0	430	.05198	697.3
185	.009631	1620.0	435	.05323	689.2
190	.01016	1578.0	440	.05446	681.4
195	.01070	1539.0	445	.05573	673.8
200	.01129	1499.0	450	.05700	666.3
205	.01182	1463.0	455	.05830	658.9
210	.01239	1428.0	460	.05960	651.8
215	.01301	1395.0	465	.06092	644.8
220	.01362	1362.0	470	.06225	637.9
225	.01425	1333.0	475	.06356	631.2
230	.01490	1308.0	480	.06485	624.6
235	.01554	1276.0	485	.06624	618.2
240	.01624	1249.0	490	.06757	611.9
245	.01689	1224.0	495	.06898	605.7
250	.01755	1199.0	500	.07039	599.6
255	.01830	1176.0	505	.07184	593.7
260	.01902	1153.0	510	.07327	587.8
265	.01977	1131.0	515	.07468	582.2
270	.02052	1110.0	520	.07606	576.6
275	.02125	1090.0	525	.07757	571.1
280	.02209	1070.0	530	.07903	565.7
285	.02285	1052.0	535	.08055	560.4
290	.02372	1034.0	540	.08208	555.2
295	.02451	1016.0	545	.08363	550.1
300	.02530	999.4	550	.08518	545.1
305	.02621	983.1	555	.08677	540.2
310	.02704	967.2	560	.08836	535.4
315	.02795	951.8	565	.08986	530.7
320	.02884	936.9	570	.09141	526.0
325	.02975	922.5	575	.09304	521.4
330	.03069	908.6	580	.09467	516.8
335	.03161	895.1	585	.09630	512.5
340	.03250	881.8	590	.09803	508.2
345	.03351	869.1	595	.09973	503.9
350	.03446	856.5	600	.1014	499.7
355	.03552	844.6	605	.1031	495.7
360	.03648	832.8	610	.1047	491.5
365	.03753	821.4	615	.1064	487.5
370	.03856	810.3	620	.1082	483.6
375	.03962	799.5	625	.1099	479.7
380	.04070	789.0	630	.1117	475.9
385	.04173	778.8	635	.1136	472.1
390	.04277	768.7	640	.1154	468.5

W/length Metres.	L. × C. Factor m.f. and m.h.	Frequency Kilocycles.	W/length Metres.	L. × C. Factor m.f. and m.h.	Frequency Kilocycles
645	.1171	464.8	895	.2254	335.0
650	.1188	461.3	900	.2280	333.1
655	.1205	457.7	905	.2306	331.3
660	.1225	454.3	910	.2332	329.5
665	.1244	450.9	915	.2357	327.7
670	.1263	447.6	920	.2381	325.9
675	.1282	444.2	925	.2407	324.1
680	.1302	440.9	930	.2434	322.3
685	.1322	437.7	935	.2461	320.7
690	.1341	434.5	940	.2487	319.0
695	.1360	431.4	945	.2514	317.3
700	.1378	428.3	950	.2541	315.6
705	.1398	425.3	955	.2568	314.0
710	.1419	422.3	960	.2595	312.3
715	.1439	419.3	965	.2621	310.7
720	.1459	416.4	970	.2647	309.1
725	.1479	413.6	975	.2676	307.5
730	.1501	410.7	980	.2704	305.9
735	.1520	407.9	985	.2731	304.4
740	.1540	405.2	990	.2759	302.8
745	.1561	402.4	995	.2788	301.3
750	.1583	399.8	1,000	.2816	299.8
755	.1604	397.1	1,010	.2879	296.9
760	.1625	394.5	1,020	.2927	293.9
765	.1646	391.9	1,030	.2986	291.1
770	.1668	389.4	1,040	.3045	288.3
775	.1691	386.9	1,050	.3105	285.5
780	.1714	384.4	1,060	.3161	282.8
785	.1735	381.9	1,070	.3222	280.2
790	.1756	379.5	1,080	.3283	277.6
795	.1778	377.1	1,090	.3344	275.1
800	.1801	374.8	1,100	.3404	272.6
805	.1824	372.4	1,110	.3468	270.1
810	.1847	370.1	1,120	.3531	267.7
815	.1870	367.9	1,130	.3595	265.3
820	.1893	365.7	1,140	.3660	263.0
825	.1917	363.4	1,150	.3721	260.7
830	.1941	361.2	1,160	.3786	258.5
835	.1963	359.0	1,170	.3853	256.3
840	.1985	356.9	1,180	.3921	254.1
845	.2009	354.8	1,190	.3988	252.1
850	.2034	352.7	1,200	.4052	249.8
855	.2057	350.7	1,220	.4191	245.8
860	.2081	348.6	1,240	.4326	241.7
865	.2106	346.6	1,260	.4470	238.0
870	.2132	344.6	1,280	.4609	234.2
875	.2156	342.7	1,300	.4757	230.6
880	.2179	340.7	1,320	.4905	227.2
885	.2204	338.8	1,340	.5053	223.7
890	.2229	336.9	1,360	.5208	220.4

W/length Metres.	L. × C. Factor m.f. and m.h.	Frequency Kilocycles.	W/length Metres.	L. × C. Factor m.f. and m.h.	Frequency Kilocycles
1,380	.5359	217.3	2,500	1.7597	119.9
1,400	.5517	214.2	2,600	1.9027	115.3
1,420	.5675	211.0	2,700	2.0521	111.0
1,440	.5837	208.2	2,800	2.2071	107.0
1,460	.5999	205.3	2,900	2.3662	103.4
1,480	.6165	202.5	3,000	2.5331	99.9
1,500	.6334	199.9	3,100	2.7052	96.7
1,520	.6502	197.3	3,200	2.8831	93.7
1,540	.6671	194.7	3,300	3.0849	90.9
1,560	.6849	192.3	3,400	3.2552	88.2
1,580	.7028	189.8	3,500	3.4479	85.6
1,600	.7206	187.3	3,600	3.6478	83.3
1,620	.7388	185.1	3,700	3.8539	81.0
1,640	.7573	182.8	3,800	4.0648	78.9
1,660	.7756	180.6	3,900	4.2811	76.9
1,680	.7946	178.4	4,000	4.5007	74.9
1,700	.8135	176.3	4,100	4.7322	73.1
1,720	.8329	174.3	4,200	4.9657	71.4
1,740	.8520	172.3	4,300	5.2061	69.7
1,760	.8720	170.3	4,400	5.4512	68.1
1,780	.8917	168.4	4,500	5.6999	66.6
1,800	.9121	166.5	4,600	5.9561	65.2
1,820	.9327	164.7	4,700	6.2188	63.8
1,840	.9531	162.9	4,800	6.4861	62.5
1,860	.9742	161.2	4,900	6.7592	61.2
1,880	.9949	159.5	5,000	7.038	59.9
1,900	1.0165	157.8	5,100	7.321	58.8
1,920	1.0375	156.2	5,200	7.609	57.7
1,940	1.0598	154.5	5,300	7.911	56.6
1,960	1.0811	153.1	5,400	8.212	55.5
1,980	1.1036	151.4	5,500	8.508	54.5
2,000	1.1257	149.9	5,600	8.829	53.5
2,100	1.2413	142.8	5,700	9.151	52.6
2,200	1.3624	136.2	5,800	9.472	51.7
2,300	1.4894	130.3	5,900	9.809	50.8
2,400	1.6218	124.9	6,000	10.11	49.9

### THE CIRCULAR MIL.

The circular mil. is a modern and facile method of calculating area of wire cross sections and is equal to the square of the wire diameter given in mils., which are the one thousandth part of an inch. Example : 26 S.W.G. wire is equal to .018" diameter ; the circular mil. area of this size wire is calculated thus,  $18 \times 18 = 324$ . Therefore, the circular mil. area is equal to 324 mils.

The circular mil. foot is a piece of wire one foot in length by one circular mil. in area.

## " Q " SIGNALS.

The signals are intended as advice when no question mark follows them.

This code was originally used by wireless telegraphy operators at sea, but it has now become the standard code for use in all forms of Wireless Telegraphic Service.

It should be noted that, in a number of Aeronautical Services the words " True Bearing " and " True Course " are called " Geographical Bearing " and " Geographical Course."

- QRA ... What is the name of your station ?  
QRB ... How far approximately are you from my station ?  
QRC ... What Company (or Government) settles the accounts for your station ?  
QRD ... Where are you bound for and where are you from ?  
QRG ... Will you tell me my exact frequency (wavelength) in kc/s. (or metres) ?  
QRH ... Does my frequency (wavelength) vary ?  
QRI ... Is my note good ?  
QRJ ... Do you receive me badly ? Are my signals weak ?  
QRK ... What is the legibility of my signals (1 to 5) ?  
QRL ... Are you busy ?  
QRM ... Are you being interfered with ?  
QRN ... Are you troubled by atmospherics ?  
QRO ... Shall I increase power ?  
QRP ... Shall I decrease power ?  
QRQ ... Shall I send faster ?  
QRS ... Shall I send slower ?  
QRT ... Shall I stop sending ?  
QRU ... Have you anything for me ?  
QRV ... Are you ready ?  
QRW ... Shall I tell.....that you are calling him on.....  
kc/s. (or.....metres) ?  
QRX ... Shall I wait. When will you call me again ?  
QRY ... What is my turn ?  
QRZ ... Who is calling me ?  
QSA ... What is the strength of my signals (1 to 5).  
QSB ... Does the strength of my signals vary ?  
QSD ... Is my keying correct ? Are my signals distinct ?  
QSG ... Shall I send.....Telegrams (or one telegram) at a time ?  
QSJ ... What is the charge per word for.....including your internal telegraph charge ?  
QSK ... Shall I continue with the transmission of all my traffic ? I can hear you through my signals.  
QSL ... Can you give me acknowledgment of receipt ?  
QSM ... Shall I repeat the last telegram I sent you ?  
QSO ... Can you communicate with.....direct (or through the medium of.....) ?  
QSP ... Will you re-transmit to.....free of charge ?  
QSR ... Has the distress call received from.....been cleared ?  
QST ... General call preceding message addressed to all amateurs.  
QSU ... Shall I send (or reply) on.....kc/s. (or metres) and/or on waves of Type A1, A2, A3 or B ?  
QSV ... Shall I send a series of VVV..... ?  
QSW ... Will you send on.....kc/s. (or.....metres), and/or on waves of Type A1, A2, A3, or B ?

**" Q " SIGNALS—continued.**

- Q SX ... Will you listen for.....(call sign) on.....kc/s.  
(or.....metres) ?
- Q SY ... Shall I change to transmission on .....kc/s. (or  
.....metres) without changing the type of wave. or  
shall I change to transmission on another wave ?
- Q SZ ... Shall I send each word or group twice ?
- Q TA ... Shall I cancel telegram No..... as if it had not been  
sent ?
- Q TB ... Do you agree with my number of words ?
- Q TC ... How many telegrams have you to send ?
- Q TE ... What is my true bearing in relation to you ? or  
What is my true bearing in relation to.....(call sign) ?  
What is the true bearing of.....(call sign) in relation to  
.....(call sign) ?
- Q TF ... Will you give me the position of my station according to the  
bearings taken by the direction finding stations which you  
control ?
- Q TG ... Will you send your call sign for fifty seconds followed by a  
dash of ten seconds on .....kc/s. (or.....metres)  
in order that I may take your bearing ?
- Q TH ... What is your position in latitude and longitude (or by any  
other way of showing it) ?
- Q TI ... What is your true course ?
- Q TJ ... What is your speed ?
- Q TM ... Send Radio-electric signals and submarine sound signals to  
enable me to fix my bearing and my distance.
- Q TO ... Have you left dock (or port) ?
- Q TP ... Are you going to enter dock (or port) ?
- Q TQ ... Can you communicate with my station by means of the  
International code of Signals ?
- Q TR ... What is the exact time ?
- Q TU ... What are the hours during which your station is open ?
- Q UA ... Have you news of.....(call sign of the mobile  
station) ?
- Q UB ... Can you give me in this order information concerning  
visibility, height of clouds, ground wind for.....  
(place of observation) ?
- Q UC ... What is the last message received by you from.....  
(call sign of the mobile station) ?
- Q UD ... Have you received the urgency signal sent by.....  
(call sign of the mobile station) ?
- Q UF ... Have you received the distress signal sent by.....  
(call sign of the mobile station) ?
- Q UG ... Are you being forced to alight in the sea (or to land) ?
- Q UH ... Will you indicate the present barometric pressure at sea  
level ?
- Q UJ ... Will you indicate the true course for me to follow, with no  
wind, to make for you ?
- Q UK ... Can you tell me the condition of the sea observed at.....  
(place or co-ordinates) ?
- Q UL ... Can you tell me the swell observed at.....(place or  
co-ordinates) ?
- Q UM ... Is the distress traffic ended ?

**SIGNAL STRENGTH REPORTS.**  
**THE "QSA-R" SYSTEM.**

**"Q" Readability System.**

- QSA1—Barely perceptible ; unreadable.
- QSA2—Weak ; readable only now and then.
- QSA3—Fairly good ; readable with difficulty.
- QSA4—Good readable signals.
- QSA5—Very good signals ; perfectly readable.

**"R" Audibility System.**

- R1—Very weak signals ; hardly readable.
- R2—Weak signals ; barely readable.
- R3—Weak signals ; but can be read.
- R4—Fair signals ; easily readable.
- R5—Fairly strong signals.
- R6—Good signals.
- R7—Good strong signals, that come through QRM and QRN.
- R8—Very strong signals ; heard several feet from the phones.
- R9—Extremely strong signals.

**"T" Tone System.**

- T1—(" T3, R6 ") very rough 25 or 60 cycle A.C. tone.)
- T2—Rough 60 cycle A.C. tone.
- T3—Poor A.C. tone. Sounds like no filter.
- T4—Fair A.C., small filter.
- T5—Nearly pure D.C. tone, good filter, but has key thumps, or back wave, etc.
- T6—Nearly pure D.C. tone. Very good filter ; keying perfect.
- T7—Pure D.C. tone, but has key thumps, back wave, etc.
- T8—Pure D.C.
- T9—Pure crystal controlled D.C. tone.

**Readability. THE "RST" SYSTEM.**

- R1—Unreadable.
- R2—Barely readable—very few words distinguishable.
- R3—Readable with some difficulty.
- R4—Readable with practically no difficulty.
- R5—Perfectly readable.

**Signal Strength.**

- S1—Faint—signals barely perceptible.
- S2—Extremely weak signals.
- S3—Weak signals.
- S4—Fair signals.
- S5—Fairly good signals.
- S6—Good signals.
- S7—Fairly strong signals.
- S8—Strong signals.
- S9—Extremely strong signals.

**Tone.**

- T1—Extremely rough, hissing note.
- T2—Very rough A.C. note—no trace of musicality.
- T3—Rough, low-pitched A.C. note—slightly musical.
- T4—Rather rough A.C. note—moderately musical.
- T5—Musically modulated note.
- T6—Modulated note—slight trace of whistle.
- T7—New D.C. note—smooth ripple.
- T8—Good D.C. note—minute trace of ripple.
- T9—Purest D.C. note.

If the note appears to be crystal controlled, add X following the appropriate number.

## AMATEUR OR "HAM" ABBREVIATIONS USUALLY USED IN NON-COMMERCIAL WIRELESS TRAFFIC.

ABT ...	About	IC ...	I see
AGN ...	Again	ICW ...	Interrupted Continuous Wave
AHD ...	Ahead	K ...	Go ahead
AHR ...	Another	LID ...	Poor Operator
ANI ...	Any	LIL ...	Little
APRX ...	Approximate— Approximately	LFT ...	Left
BC ...	Broadcast	LST ...	Last— Listen
BD ...	Bad	LTR ...	Letter
B4 ...	Before	MG ...	Motor Generator
BK ...	Break	MI ...	My
BN ...	Been	MK ...	Make
BND ...	Band	MO ...	More
BCUZ ...	Because	MSG ...	Message
BTWN ...	Between	MT ...	Empty
BIZ ...	Business	N ...	No
C ...	See, Yes.	ND ...	Nothing Doing
CLR ...	Clear	NG ...	No good
CN ...	Can	Nil ...	Nothing
CNT ...	Cant	NM ...	No more
CK ...	Check	NR ...	Number
CKT ...	Circuit	NW ...	Now
CMG ...	Coming	OB ...	Old Boy
CUD ...	Could	OL ...	Old Lady
CW ...	Continuous Wave	OM ...	Old Man
CUL ...	See you later	OP ...	Operator
CUAGN ...	See you again	OT ...	Old Top-Timer
DA ...	Day	OW ...	Old Woman
DE ...	From	PLS ...	Please
DH ...	Deadhead	PSE ...	Please
DINT ...	Did not	PX ...	Press
DNT ...	Don't	R ...	OK
DX ...	Long distance	RCD ...	Received
ES ...	And	RCVR ...	Receiver
EZ ...	Easy	RI ...	Radio Inspector
FB ...	Fine business	SA ...	Say
FM ...	From	SEZ ...	Says
FR ...	For	SM ...	Some
FRQ ...	Frequency	SW ...	Short Wave
GA ...	Go ahead	SIG ...	Signal
GB ...	Good Bye	SKED ...	Schedule
GM ...	Good Morning	TFC ...	Traffic
GN ...	Good Night	TMW ...	To-morrow
GG ...	Going	TR ...	There
GT ...	Got Get	TT ...	That
GND ...	Ground	TK ...	Take
HA or HI ...	Laughter	TKS ...	Thanks
HM ...	Him	TNK ...	Think
HR ...	Here—Hear	TNX ...	Thanks
HV ...	Have	U ...	You
HW ...	How	UD ...	You would



## AMATEUR ABBREVIATIONS—continued.

<p>UL ... You will          UR ... Your          VT ... Vacuum Tube (Valve)          VY ... Very          WA ... Word after          WB ... Word before          WD ... Would          WF ... Word following          WK ... Work          WL ... Will—would          WN ... When</p>	<p>WT ... What          WX ... Weather          X ... Interference          XMTR ... Transmitter          XTAL... Crystal          YF ... Wife          YL ... Young Lady          YR ... Your          30 ... Finish—end          73 ... Best regards          88 ... Love and Kisses</p>
---	--

### SOLUTION OF RIGHT ANGLE TRIANGLES

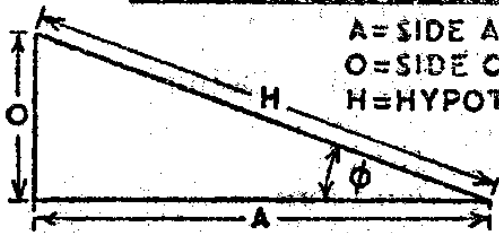

A=SIDE ADJACENT TO  $\phi$   
 O=SIDE OPPOSITE TO  $\phi$   
 H=HYPOTENUSE

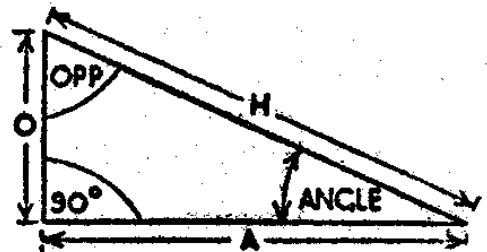

SINE  $\phi = \frac{O}{H}$     TANGENT  $\phi = \frac{O}{A}$     SECANT  $\phi = \frac{H}{A}$

COSINE  $\phi = \frac{A}{H}$     COTANGENT  $\phi = \frac{A}{O}$     COSECANT  $\phi = \frac{H}{O}$

PARTS GIVEN	PARTS TO BE FOUND				
	HYP	ADJ SIDE	OPP SIDE	ANGLE	OPP ANGLE
HYPOTENUSE AND ADJACENT	—	—	$\sqrt{HYP^2 - ADJ^2}$	$COSINE = \frac{ADJ}{HYP}$	$SINE = \frac{ADJ}{HYP}$
HYPOTENUSE AND OPPOSITE	—	$\sqrt{HYP^2 - OPP^2}$	—	$SINE = \frac{OPP}{HYP}$	$COSINE = \frac{OPP}{HYP}$
HYPOTENUSE AND ANGLE	—	HYP X COSINE	HYP X SINE	—	90°—ANGLE
ADJACENT AND OPPOSITE	$\sqrt{ADJ^2 + OPP^2}$	—	—	$TAN = \frac{OPP}{ADJ}$	$COTAN = \frac{OPP}{ADJ}$
ADJACENT AND ANGLE	$\frac{ADJ}{COSINE}$	—	ADJ X TANGENT	—	90°—ANGLE
OPPOSITE AND ANGLE	$\frac{OPP}{SINE}$	OPP X COTAN	—	—	90°—ANGLE

### B.A. TAPPING DRILLS

B.A. No	DRILL SIZE	B.A. No	DRILL SIZE	B.A. No	DRILL SIZE	B.A. No	DRILL SIZE
0	No 12	5	No 40	10	No 56	15	No 72
1	No 19	6	No 44	11	No 58	16	No 74
2	No 26	7	No 48	12	No 63	17	No 76
3	No 30	8	No 51	13	No 65	18	No 77
4	No 34	9	No 53	14	No 70	19	No 79

### B.A. CLEARANCE DRILLS

B.A. No	DRILL SIZE	B.A. No	DRILL SIZE	B.A. No	DRILL SIZE
0	"C"	6	No 32	12	No 54
1	No 3	7	No 37	13	No 54
2	No 11	8	No 42	14	3/64
3	No 19	9	No 46	15	No 60
4	No 26	10	No 49		
5	No 29	11	No 51		

# BRITISH ASSOCIATION THREADS (B.A.)

# METRIC TO DECIMAL EQUIVALENTS

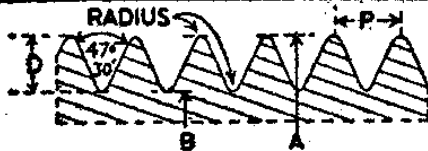

B.A. No	THRDS PER INCH	OUTSIDE DIA "A"	CORE DIA "B"	PITCH "P"	DEPTH "D"	RADIUS "R"
0	25.38	.2362	.1890	.0394	.0236	.0072
1	28.25	.2087	.1663	.0354	.0212	.0064
2	31.35	.1850	.1468	.0319	.0191	.0058
3	34.84	.1614	.1272	.0287	.0172	.0052
4	38.46	.1417	.1105	.0260	.0156	.0047
5	43.10	.1260	.0980	.0232	.0139	.0042
6	47.85	.1102	.0852	.0209	.0125	.0038
7	52.91	.0984	.0758	.0189	.0113	.0034
8	59.17	.0866	.0664	.0169	.0101	.0031
9	64.94	.0748	.0564	.0154	.0092	.0028
10	72.46	.0669	.0503	.0138	.0083	.0025
11	81.97	.0591	.0445	.0122	.0073	.0022
12	90.91	.0511	.0375	.0110	.0066	.0020
13	102.0	.0472	.0354	.0098	.0059	.0018
14	109.9	.0394	.0284	.0091	.0055	.0016
15	120.5	.0354	.0254	.0083	.0050	.0015
16	133.3	.0311	.0221	.0075	.0045	.0014
17	149.3	.0276	.0196	.0067	.0040	.0012
18	169.5	.0244	.0174	.0059	.0035	.0011
19	181.8	.0213	.0147	.0055	.0033	.0010
20	212.8	.0189	.0133	.0047	.0028	.0009
21	232.6	.0165	.0113	.0043	.0026	.0008
22	256.4	.0146	.0100	.0039	.0023	.0007
23	285.7	.0130	.0088	.0035	.0021	.0006
24	323.6	.0114	.0076	.0031	.0019	.0006

M/M	INCH	M/M	INCH	M/M	INCH
.01	.0004	.43	.0169	.85	.0335
.02	.0008	.44	.0173	.86	.0339
.03	.0012	.45	.0177	.87	.0343
.04	.0016	.46	.0181	.88	.0347
.05	.0020	.47	.0185	.89	.0350
.06	.0024	.48	.0189	.90	.0354
.07	.0028	.49	.0193	.91	.0358
.08	.0032	.50	.0197	.92	.0362
.09	.0036	.51	.0201	.93	.0366
.10	.004	.52	.0205	.94	.0370
.11	.0043	.53	.0209	.95	.0374
.12	.0047	.54	.0213	.96	.0378
.13	.0051	.55	.0217	.97	.0382
.14	.0055	.56	.0221	.98	.0386
.15	.0059	.57	.0225	.99	.0389
.16	.0063	.58	.0228	1	.0394
.17	.0067	.59	.0232	2	.0787
.18	.0071	.60	.0236	3	.1181
.19	.0075	.61	.0240	4	.1575
.20	.0079	.62	.0244	5	.1968
.21	.0083	.63	.0248	6	.2362
.22	.0087	.64	.0252	7	.2756
.23	.0091	.65	.0256	8	.315
.24	.0095	.66	.026	9	.3543
.25	.0099	.67	.0264	10	.3937
.26	.0103	.68	.0268	11	.4331
.27	.0106	.69	.0272	12	.4724
.28	.0110	.70	.0276	13	.5118
.29	.0114	.71	.0279	14	.5512
.30	.0118	.72	.0283	15	.5905
.31	.0122	.73	.0287	16	.6299
.32	.0126	.74	.0291	17	.6693
.33	.013	.75	.0295	18	.7082
.34	.0134	.76	.0299	19	.748
.35	.0138	.77	.0303	20	.7874
.36	.0142	.78	.0307	21	.8268
.37	.0146	.79	.0311	22	.8661
.38	.0150	.80	.0315	23	.9055
.39	.0154	.81	.0319	24	.9449
.40	.0158	.82	.0323	25	.9842
.41	.0162	.83	.0327		
.42	.0166	.84	.0331		

# BRITISH STANDARD FINE THREADS (B.S.F.)

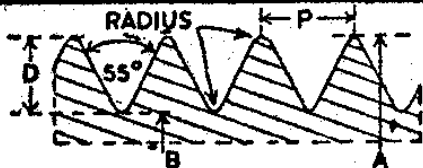

DIA	OUTSIDE DIA "A"	CORE DIA "B"	THRDS PER INCH	PITCH "P"	DEPTH "D"	RADIUS "R"
7/32	.21875	.1731	28	.03571	.0229	.0049
1/4	.250	.2007	26	.0385	.0246	.0053
9/32	.28125	.2320	26	.0385	.0246	.0053
5/16	.3125	.2543	22	.0454	.0291	.0062
3/8	.375	.3110	20	.050	.0320	.0069
7/16	.4375	.3664	18	.0556	.0358	.0076
1/2	.500	.420	16	.0625	.040	.0086
9/16	.5625	.4825	16	.0625	.040	.0086
5/8	.625	.5335	14	.0714	.0457	.0098
11/16	.6875	.596	14	.0714	.0457	.0098
3/4	.750	.6433	12	.0833	.0534	.0114
13/16	.8125	.7058	12	.0833	.0534	.0114
7/8	.875	.7586	11	.09091	.0582	.0125
1"	1.000	.8719	10	.1000	.064	.0137
1 1/8	1.125	.9827	9	.1111	.0711	.0153
1 1/4	1.250	1.1077	9	.1111	.0711	.0153
1 3/8	1.375	1.2149	8	.1250	.080	.0172
1 1/2	1.500	1.3399	8	.1250	.080	.0172
1 5/8	1.625	1.4649	8	.1250	.080	.0172
1 3/4	1.750	1.567	7	.1428	.0915	.0196
2	2.000	1.817	7	.1428	.0915	.0196
2 1/4	2.250	2.0366	6	.1667	.1067	.0229
2 1/2	2.500	2.2866	6	.1667	.1067	.0229
2 3/4	2.750	2.5366	6	.1667	.1067	.0229
3	3.000	2.7439	5	.2000	.1281	.0275

# B.S.F. TAPPING DRILLS

DIA	DRILL SIZE	DIA	DRILL SIZE	DIA	DRILL SIZE	DIA	DRILL SIZE
1/4	13/64	7/16	"U"	1 1/8	39/64	1"	7/8
1/4	No 7	1/2	27/64	3/4	21/32	1 1/8	63/64
5/16	"F"	9/16	31/64	13/16	23/32	1 1/4	17/64
3/8	"O"	5/8	35/64	7/8	49/64		

# B.S.F. CLEARANCE DRILLS

DIA	DRILL SIZE	DIA	DRILL SIZE	DIA	DRILL SIZE	DIA	DRILL SIZE
1/4	17/64	3/8	"V"	1 1/8	45/64	1 1/8	9/64
1/4	"F"	7/16	29/64	3/4	49/64	1 1/4	17/64
5/16	21/64	1/2	33/64	13/16	53/64	1 3/8	25/64
5/16	"O"	9/16	37/64	7/8	57/64	1 1/2	33/64
3/8	25/64	5/8	41/64	1"	11/64	1 5/8	41/64

# MATHEMATICAL SYMBOLS

$\gg$	Is much greater than.	$\therefore$	Therefore.
$>$	Is greater than.	$\Delta$	Increment or Decrement.
$\equiv$	Identity.	$\parallel$	Parallel to.
$\approx$	Is approximately equal to.	$-$	Negative. Minus. Subtract.
$\neq$	Does not equal.	$\times$ or $\cdot$	Multiplied by.
$\leq$	Less than or equal to.	$+$	Positive. Plus. Add.
$\geq$	Greater than or equal to.	$\mp$	Negative or positive. Minus or Plus.
$\ll$	Is much less than.	$\pm$	Positive or Negative. Plus or Minus.
$<$	Is less than.	$\div$ or $:$	Divided by.
$ n $	Absolute value of n.	$=$ or $\therefore$	Equals
$\perp$	Perpendicular to.		
$\sphericalangle$	Angle		

## UNITS

<p><b>A</b> Ampere</p> <p><b>Ah</b> Ampere-hour</p> <p><b>C</b> Coulomb</p> <p><b>F</b> Farad</p> <p><b>H</b> Henry</p> <p><b>db</b> Decibel</p>	<p><b>V</b> Volt</p> <p><b>W</b> Watt</p> <p><b>Wh</b> Watt-hour</p> <p><b><math>\Omega</math></b> Ohm</p> <p><b>C/S</b> Cycles per Second</p>
--	--

## *Examples:—*

$M\Omega$	$=$	Megohm [meg.]
$kW$	$=$	Kilowatt
$mA$	$=$	Milliamp
$\mu V$	$=$	Microvolt
$\mu\mu F$	$=$	Micro-Microfarad
$Mc/s$	$=$	Megacycles per second.
$kc/s$	$=$	Kilocycles per second.
$mH$	$=$	Millihenry
$\mu F$	$=$	Microfarad
$pF$	$=$	Pico-farad

## MULTIPLES AND SUBMULTIPLES

<b>M</b> Mega. $= 10^6$	<b><math>\mu</math></b> Micro $= 10^{-6}$	
<b>k</b> Kilo. $= 10^3$	<b><math>\mu\mu</math></b> Micro-micro. $\left. \vphantom{\mu\mu} \right\} = 10^{-12}$	
<b>m</b> Milli. $= 10^{-3}$	<b>p</b> Pico.	

# SYMBOLS

NORMALLY IN COMMON USE  
IN RADIO AND ELECTRICAL FORMULAE

<b>B</b>	Magnetic Flux Density.	<b>R</b>	Resistance .
<b>C</b>	Capacity.	<b>R<sub>a</sub></b>	A.C. Anode Resistance of Valve.
<b>E</b>	Electromotive Force [E.M.F.].	<b>R<sub>d</sub></b>	Dynamic Resistance of Tuned Circuit = $L/CR$ .
<b>i</b>	Instantaneous E.M.F.	<b>S</b>	Magnetic Reluctance .
<b>f</b>	Frequency.	<b>t</b>	Time
<b>G</b>	Magneto-Motive-Force [M.M.F.].	<b>V</b>	Potential Difference
<b>G</b>	Conductance.	<b>W</b>	Energy.
<b>g</b> or <b>g<sub>m</sub></b>	Mutual Conductance of Valve.	<b>X</b>	Reactance.
<b>H</b>	Magnetic Field Strength.	<b>Z</b>	Impedance.
<b>I</b>	Current.	<b>λ</b>	Wavelength.
<b>i</b>	Instantaneous Current.	<b>μ</b>	Valve Amplification Factor
<b>K</b>	Specific Inductive Capacity.	<b>μ</b>	Magnetic Permeability
<b>L</b>	Self Inductance.	<b>π</b>	Ratio of Circumference to Diameter of Circle = 3.14 [approx.]
<b>M</b>	Mutual Inductance.	<b>ρ</b>	Specific Resistance
<b>m</b> or <b>μ</b>	Amplification Factor of Valve.	<b>Φ</b>	Magnetic Flux .
<b>P</b>	Power	<b>φ</b>	Phase Angle.
<b>Q</b>	Quantity of Electricity.	<b>ω</b>	Angular Velocity

## CONVERSION TABLES.

<i>To change</i>	<i>Into</i>	<i>Multiply by</i>	<i>To obtain converse multiply by</i>
Cubic Centimetres	Cubic Inches	0.06102	16.39
Calories	Kilogrammetres	427.0	0.00234
Dynes	Grammes weight	0.001019	980.39
Cubic Yards	Cubic Metres	0.7646	1.308
Cubic Inches	Litres	0.0164	61.0
B.Th.U.	Watt-hours	0.2931	3.41
Atmospheres	Lb./sq. in.	14.70	0.068
B.Th.U.	Calories	0.252	3.97
B.Th.U.	Foot Pounds	777.4	0.001285
Centimetres	Inches	0.3937	2.54
Cubic Feet	Cubic Metres	0.0283	35.31
Dynes	Poundals	0.000072	13825.52
Feet	Metres	0.305	3.281
Ergs	Foot-lb.	$7.373 \times 10^{-8}$	$1.36 \times 10^7$
Foot-lb.	Kilogrammetres	0.1384	7.23
Feet/sec.	Miles/hr.	0.68182	1.467
Feet/min.	Miles/hr.	0.01137	88.0
Feet/sec.	Metres/min.	18.288	0.0547
Grains	Grammes	0.0648	15.432
Gallons	Litres	4.546	0.2205
Foot-lb./sec.	Horse-power	0.0018	55.0
Feet/min.	Metres/sec.	0.00508	196.8
Horse-power	B.Th.U./min.	42.41	0.0236
Grammes/c.c	Lb./cu. in.	0.03613	27.68
Gallons	Cubic Feet	0.161	6.211
Grammes	Ounces	0.03527	28.35
Grammes/sq. m	Ounces/sq. yd.	0.0295	33.9
Inches	Millimetres	25.4	0.03937
Horse-power	Kilogrammetres/sec.	76.04	0.01315
Horse-power	Watts	746.0	0.00134
Joules	Watt-seconds	1.0	1.0
Inches	Feet	0.0833	12.0
Imperial Gallons	U.S. Gallons	1.205	0.830
Kilocalories/Kilogramme	B.Th.U./lb.	1.80	0.55
Joules	Ergs	$10^7$	$10^{-7}$
Inches of Mercury	Lb./sq. in.	0.4902	2.04
Inches	Metres	0.0254	39.37
Inches	Yards	0.0277	36.0
Kilocalories	B.Th.U	3968.0	0.000251
Kg./P.S.	Lb./h.p.	2.235	0.4475
K.Cal./cm. <sup>2</sup> /cm./hr. C°	B.Th.U./in./hr./F°	5.598	0.180
Kilogrammes	Lb.	2.205	0.454
Metres	Yards	1.094	0.914
Kilowatt Hours	Joules	$36 \times 10^6$	$27 \times 10^{-7}$
Kilogrammes/sq. cm.	Lb./sq. in.	14.22	0.0703
Kilogrammes	Tons	0.000891	1016.2
Kilometres	Miles	0.621	1.609
Poundals	Lb. weight	0.03107	32.15
Knots	m.p.h.	1.151	0.868
Kilowatts	Horse-power	1.3406	0.746
Litres	Pints	1.76	0.568
Metres/sec.	m.p.h.	2.24	0.447
Square Metres	Square Yards	1.197	0.8361
Square Centimetres	Square Inches	0.155	6.4516
Tonnes	Tons	0.9842	-1.016

# TELEVISION AERIAL ATTENUATORS

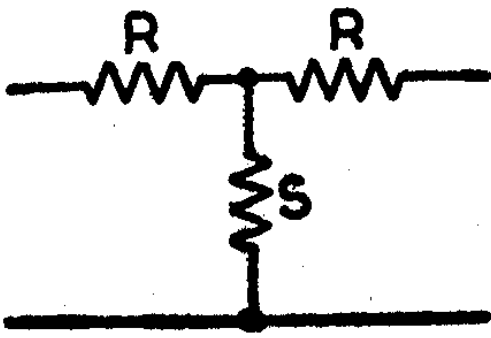

75 ohm Feeder—"T" Section

5 db	R — 22 ohms.	S — 120 ohms.
6 db	R — 25 ohms.	S — 100 ohms.
7 db	R — 29 ohms.	S — 84 ohms.
8 db	R — 32 ohms.	S — 71 ohms.
9 db	R — 36 ohms.	S — 61 ohms.
10 db	R — 38 ohms.	S — 56 ohms.
11 db	R — 42 ohms.	S — 46 ohms.
12 db	R — 45 ohms.	S — 39 ohms.
13 db	R — 48 ohms.	S — 35 ohms.
14 db	R — 50 ohms.	S — 31 ohms.
15 db	R — 52 ohms.	S — 26 ohms.
16 db	R — 54 ohms.	S — 22 ohms.
17 db	R — 57 ohms.	S — 19 ohms.
18 db	R — 58 ohms.	S — 17 ohms.
19 db	R — 59 ohms.	S — 16 ohms.
20 db	R — 61 ohms.	S — 15 ohms.

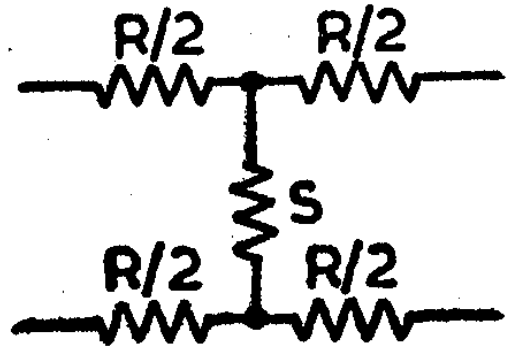

50 ohm Feeder—"H" Section

5 db	R — 14 ohms.	S — 82 ohms.
6 db	R — 17 ohms.	S — 67 ohms.
7 db	R — 19 ohms.	S — 59 ohms.
8 db	R — 22 ohms.	S — 47 ohms.
9 db	R — 24 ohms.	S — 41 ohms.
10 db	R — 26 ohms.	S — 35 ohms.
11 db	R — 28 ohms.	S — 31 ohms.
12 db	R — 30 ohms.	S — 27 ohms.
13 db	R — 32 ohms.	S — 24 ohms.
14 db	R — 33 ohms.	S — 21 ohms.
15 db	R — 35 ohms.	S — 18 ohms.
16 db	R — 37 ohms.	S — 16 ohms.
17 db	R — 37 ohms.	S — 14 ohms.
18 db	R — 38 ohms.	S — 13 ohms.
19 db	R — 38 ohms.	S — 11 ohms.
20 db	R — 50 ohms.	S — 10 ohms.

## π SECTIONS

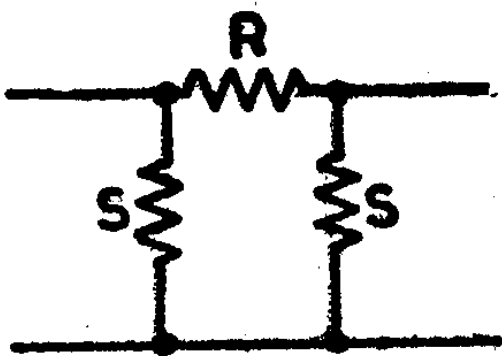

75 ohm Feeder

25 db	R — 664 ohms.	S — 83 ohms.
25 db	R — 1,195 ohms.	S — 80 ohms.
35 db	R — 2,100 ohms.	S — 78 ohms.
40 db	R — 3,750 ohms.	S — 76 ohms.
45 db	R — 6,670 ohms.	S — 76 ohms.
50 db	R — 11,850 ohms.	S — 75 ohms.
60 db	R — 37,500 ohms.	S — 75 ohms.

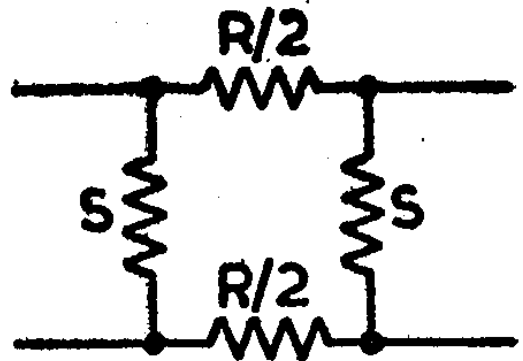

50 ohm Feeder

25 db	R — 443 ohms.	S — 56 ohms.
30 db	R — 790 ohms.	S — 53 ohms.
35 db	R — 1,400 ohms.	S — 52 ohms.
40 db	R — 2,500 ohms.	S — 51 ohms.
45 db	R — 4,500 ohms.	S — 50 ohms.

# TELEVISION AERIAL DIMENSIONS

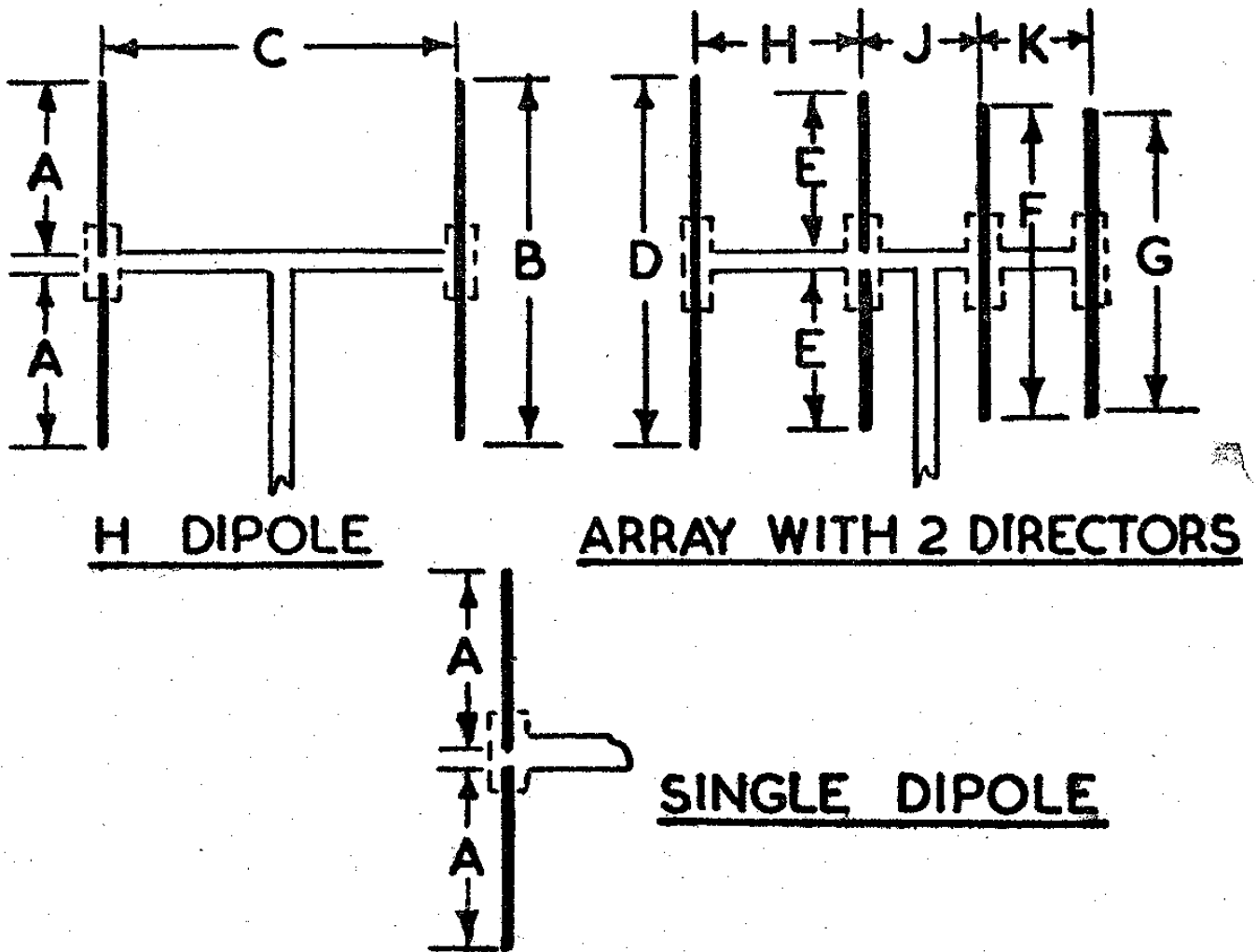

	A	B	C	D	E	F	G	H	J	K
Alexandra Palace	5' 3"	11' 6"	2' 10"	11' 2"	5' 5"	10' 5"	10' 0"	3' 5"	2' 2½"	2' 2½"
Holme Moss	4' 8"	10' 2"	2' 6"	9' 8"	4' 8"	9' 0"	8' 8"	2' 10"	1' 11"	1' 11"
Kirk o' Shotts	4' 2"	9' 4"	2' 4"	8' 10"	4' 3"	8' 2"	7' 11"	2' 8"	1' 9"	1' 9"
Sutton Coldfield	3' 10"	8' 4"	2' 1½"	8' 0½"	3' 10½"	7' 5½"	7' 2½"	2' 5"	1' 7"	1' 7"
Wenvoe	3' 6½"	7' 8"	1' 11½"	7' 5½"	3' 7½"	6' 11½"	6' 9"	2' 1½"	1' 5"	1' 5"

"H" AERIAL MEASUREMENTS ARE REPRODUCED BY  
COURTESY OF ANTI-FERRENCE LTD.

# INTERNATIONAL AMATEUR CALL SIGN PREFIXES

AC3 .....	Sikkim	HR .....	Honduras
AC4 .....	Tibet	HS .....	Siam
AG2 .....	(See I)	HV .....	Vatican City
AP .....	Pakistan	HZ .....	Saudi Arabia (Hedjaz & Nejd)
AR8 .....	Lebanon	I .....	Italy
C (unofficial) .....	China	I, AG2, MF2 .....	Trieste
C3 .....	Formosa	I5, MD4, MS4 ...	Italian Somaliland
C9 .....	Manchuria	I6, MD3, MI3 .....	Eritrea
CE .....	Chile	IS .....	Sardinia
CM, CO .....	Cuba	J .....	Japan
CN .....	French Morocco	JAø .....	Bonin & Volcano Islands
CP .....	Bolivia	K .....	(See W)
CR4 .....	Cape Verde Islands	KB6 ...	Baker Howland & American Phoenix Islands
CR5 .....	Portuguese Guinea	KC6 .....	Caroline Islands
CR5 .....	Principe, Sao Thome	KC6 .....	Palau Islands
CR6 .....	Angola	KG4 .....	Guantanamo Bay
CR7 .....	Mozambique	KG6 .....	Mariana Islands
CR8 .....	Goa (Portuguese India)	KH6 .....	Hawaiian Islands
CR9 .....	Macau	KJ6 .....	Johnston Island
CR10 .....	Portuguese Timor	KL7 .....	Alaska
CT1 .....	Portugal	KM6 .....	Midway Islands
CT2 .....	Azores Islands	KP4 .....	Puerto Rico
CT3 .....	Madeira Islands	KP6 .....	Palmyra Group, Jarvis Island
CX .....	Uruguay	KR6 .....	Ryukyu Islands (e.g., Okinawa)
DL .....	Germany	KS4 .....	Swan Island
DU .....	Philippine Islands	KS6 .....	American Samoa
EA .....	Spain	KV4 .....	Virgin Islands
EA6 .....	Balearic Islands	KW6 .....	Wake Island
EA8 .....	Canary Islands	KX6 .....	Marshall Islands
EA9 .....	Spanish Morocco	KZ5 .....	Canal Zone
EI .....	Eire (Irish Free State)	LA .....	Norway
EK .....	Tangier Zone	LA .....	Svalbard (Spitzbergen)
EL .....	Liberia	LI, MC1, 2, MD1, 2, MT1, 2 ...	Libya
EP, EQ .....	Iran (Persia)	LU .....	Argentina
ET .....	Ethiopia	LX .....	Luxembourg
F .....	France	LZ .....	Bulgaria
FA .....	Algeria	M1 .....	San Marino
FBS .....	Amsterdam & St. Paul Islands	MB9 .....	(See OE)
FB8 .....	Kerguelen Islands	MC1, 2 .....	(See LI)
FB8 .....	Madagascar	MD1, 2 .....	(See LI)
FC .....	Corsica	MD3 .....	(See I6)
FDS .....	French Togoland	MD4 .....	(See I5)
FES .....	French Cameroons	MD5 .....	(See SU)
FF8 .....	French West Africa	MD6 .....	(See YI)
FG8 .....	Guadeloupe	MF2 .....	(See I)
FI8 .....	French Indo-China	MI3 .....	(See I6)
FK8 .....	New Caledonia	MP4 .....	(See VU7)
FL8 .....	French Somaliland	MP4 .....	Kuwait
FMS .....	Martinique	MP4 .....	Oman
FN .....	French India	MS4 .....	(See I5)
FO8 ...	French Oceania (e.g., Tahiti)	MTI, 2 .....	(See LI)
FP8 .....	St. Pierre & Miquelon Islands	OA .....	Peru
FQ8 .....	French Equatorial Africa	OE, MB9 .....	Austria
FR8 .....	Reunion Island	OH .....	Finland
FU8, YJ .....	New Hebrides	OK .....	Czechoslovakia
FY8 .....	French Guiana & Inini	ON .....	Belgium
G .....	England	OQ .....	Belgian Congo
GC .....	Channel Islands	OX .....	Greenland
GD .....	Isle of Man	OY .....	Faeroes
GI .....	Northern Ireland	OZ .....	Denmark
GM .....	Scotland	PA .....	Netherlands
GW .....	Wales	PJ .....	Netherlands West Indies
HA .....	Hungary	PK1, 2, 3 .....	Java
HB .....	Switzerland	PK4 .....	Sumatra
HC .....	Ecuador	PK5 .....	Netherlands Borneo
HE .....	Liechtenstein	PK6 ...	Celebes & Molucca Islands
HH .....	Haiti	PK6, 7 ...	Netherlands New Guinea
HI .....	Dominican Republic	PX .....	Andorra
HK .....	Colombia	PY .....	Brazil
HL .....	Korea	PZ .....	Netherlands Guiana
HP .....	Panama		



# INTERNATIONAL AMATEUR CALL SIGN PREFIXES—cont.

SM .....	Sweden	VR1 .....	Gilbert & Ellice Islands & Ocean Island
SP .....	Poland	VR1 .....	British Phoenix Islands
ST .....	Anglo-Egyptian Sudan	VR2 .....	Fiji Islands
SU, MD5 .....	Egypt	VR3 .....	Fanning Island (Christmas Island)
SV .....	Greece	VR4 .....	Solomon Islands
SV .....	Crete	VR5 .....	Tonga (Friendly) Islands
SV5 .....	Dodecanese (e.g., Rhodes)	VR6 .....	Pitcairn Island
TA .....	Turkey	VS1, 2 .....	Malaya
TF .....	Iceland	VS4 .....	British North Borneo
TG .....	Guatemala	VS5 .....	Brunei
TI .....	Costa Rica	VS5 .....	Sarawak
TI .....	Cocos Island	VS6 .....	Hong Kong
UA1, 3, 4, 6 .....	European Russian Socialist Federated Soviet Republic	VS7 .....	Ceylon
UA9, ø .....	Asiatic Russian S.F.S.R.	VS9 .....	Aden & Socotra
UB5 .....	Ukraine	VS9 .....	Maldive Islands
UC2 .....	White Russian Soviet Socialist Republic	VU .....	India
UD6 .....	Azerbaijan	VU4 .....	Laccadive Islands
UF6 .....	Georgia	VU7, MP4 .....	Bahrein Island
UG6 .....	Armenia	W, K .....	U.S.A.
UH8 .....	Turkoman	XE .....	Mexico
UI8 .....	Uzbek	XZ .....	Burma
UJ8 .....	Tadzhik	YA .....	Afghanistan
UL7 .....	Kazakh	YI, MD6 .....	Iraq
UM8 .....	Kirghiz	YJ .....	(See FU8)
UN1 .....	Karelo-Finnish Republic	YK .....	Syria
UO5 .....	Moldavia	YN .....	Nicaragua
UP2 .....	Lithuania	YO, YR .....	Roumania
UQ2 .....	Latvia	YS .....	Salvador
UR2 .....	Estonia	YT, YU .....	Jugoslavia
VE, VO .....	Canada	YV .....	Venezuela
VK .....	Australia (including Tasmania)	ZA .....	Albania
VK1 .....	Heard Island	ZB1 .....	Malta
VK1 .....	Macquarie Island	ZB2 .....	Gibraltar
VK9 .....	Papua Territory	ZC1 .....	Transjordan
VK9 .....	Territory of New Guinea	ZC2 .....	Cocos Islands
VK9 .....	Norfolk Island	ZC3 .....	Christmas Island
VO .....	(see VE)	ZC4 .....	Cyprus
VP1 .....	British Honduras	ZC6 .....	Palestine
VP2 .....	Leeward Islands	ZD1 .....	Sierra Leone
VP2 .....	Windward Islands	ZD2 .....	Nigeria
VP3 .....	British Guiana	ZD3 .....	Gambia
VP4 .....	Trinidad & Tobago	ZD4 .....	Gold Coast, Togoland
VP5 .....	Cayman Islands	ZD6 .....	Nyasaland
VP5 .....	Jamaica	ZD7 .....	St. Helena
VP5 .....	Turks & Caicos Islands	ZD8 .....	Ascension Island
VP6 .....	Barbados	ZD9 .....	Tristan da Cunha & Gough Island
VP7 .....	Bahama Islands	ZE .....	Southern Rhodesia
VP8 .....	Falkland Islands	ZK1 .....	Cook Islands
VP8 .....	South Georgia	ZK2 .....	Niue
VP8 .....	South Orkney Islands	ZL .....	New Zealand
VP8 .....	South Sandwich Islands	ZM .....	British Samoa
VP8 .....	South Shetland Islands	ZP .....	Paraguay
VP9 .....	Bermuda Islands	ZS1, 2, 4, 5, 6 .....	Union of South Africa
VQ1 .....	Zanzibar	ZS3 .....	South-west Africa
VQ2 .....	Northern Rhodesia	ZS7 .....	Swaziland
VQ3 .....	Tanganyika Territory	ZS8 .....	Basutoland
VQ4 .....	Kenya	ZS9 .....	Bechuanaland
VQ5 .....	Uganda	3A1, 2 .....	Monaco
VQ6 .....	British Somaliland	3V8 .....	Tunisia
VQ8 .....	Chagos Islands	4X4 .....	Israel
VQ8 .....	Mauritius	9S4 .....	Saar
VQ9 .....	Seychelles		

## INTERNATIONAL COMMERCIAL RADIO STATION PREFIXES

AAA-ALZ	U.S.A.	AXA-AXZ	Australia
AMA-AOZ	Spain	AYA-AZZ	Argentine Republic
APA-ASZ	Pakistan	CAA-CEZ	Chile
ATA-AWZ	India	CFA-CKZ	Canada

# INTERNATIONAL COMMERCIAL RADIO STATION PREFIXES—cont.

CLA-CMZ	Cuba	TDA-TDZ	Guatemala
CNA-CNZ	Morocco	TEA-TEZ	Costa Rica
COA-COZ	Cuba	TFA-TFZ	Iceland
CPA-CPZ	Bolivia	TGA-TGZ	Guatemala
CQA-CRZ	Portuguese Colonies	THA-THZ	France and Colonies
CSA-CUZ	Portugal	TIA-TIZ	Costa Rica
CVA-CXZ	Uruguay	TJA-TZZ	France and Colonies
CYA-CZZ	Canada	UAA-UQZ	U.S.S.R.
DAA-DMZ	Germany	URA-UTZ	Ukranian Republic
DNA-DQZ	Belgian Congo	UUA-UZZ	U.S.S.R.
DRA-DTZ	Bielorussia	VAA-VGZ	Canada
DUA-DZZ	Philippines	VHA-VNZ	Australia
EAA-EHZ	Spain	VOA-VOZ	Newfoundland
EIA-EJZ	Ireland	VPA-VSZ	British Colonies
EKA-EKZ	U.S.S.R.	VTA-VWZ	India
ELA-ELZ	Liberia	VXA-VYZ	Canada
EMA-EOZ	U.S.S.R.	VZA-VZZ	Australia
EPA-EQZ	Iran	WAA-WZZ	U.S.A.
ERA-ERZ	U.S.S.R.	XAA-XIZ	Mexico
ESA-ESZ	Estonia	XJA-XOZ	Canada
ETA-ETZ	Ethiopia	XPA-XPZ	Denmark
EUA-EZZ	U.S.S.R.	XQA-XRZ	Chile
FAA-FZZ	France and Colonies	XSA-XSZ	China
GAA-GZZ	Great Britain	XTA-XWZ	France and Colonies
HAA-HAZ	Hungary	XXA-XXZ	Portuguese Colonies
HBA-HBZ	Switzerland	XYA-XZZ	Burma
HCA-HDZ	Ecuador	YAA-YAZ	Afghanistan
HEA-HEZ	Switzerland	YBA-YHZ	Netherlands Indies
HFA-HFZ	Poland	YIA-YIZ	Iraq
HGA-HGZ	Hungary	YJA-YJZ	New Hebrides
HHA-HHZ	Haiti	YKA-YKZ	Syria
HIA-HIZ	Dominican Republic	YLA-YLZ	Latvia
HJA-HKZ	Republic of Colombia	YMA-YMZ	Turkey
HLA-HMZ	Korea	YNA-YNZ	Nicaragua
HNA-HNZ	Iraq	YOA-YRZ	Roumania
HOA-HPZ	Panama	YSA-YSZ	El Salvador
HQA-HRZ	Honduras	YTA-YUZ	Jugoslavia
HSA-HSZ	Siam	YVA-YYZ	Venezuela
HTA-HTZ	Nicaragua	YZA-YZZ	Jugoslavia
HUA-HUZ	Republic of El Salvador	ZAA-ZAZ	Albania
HVA-HVZ	Vatican City	ZBA-ZJZ	British Colonies
HWA-HYZ	France and Colonies	ZKA-ZMZ	New Zealand
HZA-HZZ	Saudi Arabia	ZNA-ZOZ	British Colonies
IAA-IZZ	Italy and Colonies	ZPA-ZPZ	Paraguay
JAA-JSZ	Japan	ZQA-ZQZ	British Colonies
JTA-JVZ	Mongolian Republic	ZRA-ZUZ	Union of South Africa
JWA-JXZ	Norway	ZVA-ZZZ	Brazil
JYA-JYZ	Jordan	2AA-2ZZ	Great Britain
JZA-JZZ	Netherlands New Guinea	3AA-3AZ	Principality of Monaco
KAA-KZZ	U.S.A.	3BA-3FZ	Canada
LAA-LNZ	Norway	3GA-3GZ	Chile
LOA-LWZ	Argentina	3HA-3UZ	China
LXA-LXZ	Luxembourg	3VA-3VZ	France and Colonies
LYA-LYZ	Lithuania	3WA-3WZ	Viet-Nam
LZA-LZZ	Bulgaria	3YA-3YZ	Norway
MAA-MZZ	Great Britain	3ZA-3ZZ	Poland
NAA-NZZ	U.S.A.	4AA-4CZ	Mexico
OAA-OCZ	Peru	4DA-4IZ	Philippines
ODA-ODZ	Lebanon	4JA-4LZ	U.S.S.R.
OEA-OEZ	Austria	4MA-4MZ	Venezuela
OFA-OJZ	Finland	4NA-4OZ	Jugoslavia
OKA-OMZ	Czechoslovakia	4PA-4SZ	British Colonies
ONA-OTZ	Belgium and Colonies	4TA-4TZ	Peru
OUA-OZZ	Denmark	4UA-4UZ	United Nations
PAA-PIZ	Netherlands	4VA-4VZ	Haiti
PJA-PJZ	Curacao	4WA-4WZ	Yemen
PKA-POZ	Netherlands Indies	4XA-4XZ	Israel
PPA-PYZ	Brazil	4YA-4YZ	International Civil
PZA-PZZ	Surinam	5CA-5CZ	Aviation organization
QAA-QZZ	(Service abbreviations)	6AA-6ZZ	French Morocco
RAA-RZZ	U.S.S.R.	7AA-7ZZ	(Not allocated)
SAA-SMZ	Sweden	8AA-8ZZ	(Not allocated)
SNA-SRZ	Poland	9AA-9AZ	(Not allocated)
SSA-SUZ	Egypt	9NA-9NZ	San Marino
SVA-SZZ	Greece	9SA-9SZ	Nepal
TAA-TCZ	Turkey		Saar

# U.S.A. AMATEUR W PREFIXES BY STATES

Alabama .....	W4
Arizona .....	W7
Arkansas .....	W5
California .....	W6
Colorado .....	Wø
Connecticut .....	W1
Delaware .....	W3
District of Columbia .....	W3
Florida .....	W4
Georgia .....	W4
Idaho .....	W7
Illinois .....	W9
Indiana .....	W9
Iowa .....	Wø
Kansas .....	Wø
Kentucky .....	W4
Louisiana .....	W5
Maine .....	W1
Maryland .....	W3
Massachusetts .....	W1
Michigan .....	W8
Minnesota .....	Wø
Mississippi .....	W5
Missouri .....	Wø
Montana .....	W7
Nebraska .....	Wø
Nevada .....	W7
New Hampshire .....	W1
New Jersey .....	W2
New Mexico .....	W5
New York .....	W2
North Carolina .....	W4
North Dakota .....	Wø
Ohio .....	W8
Oklahoma .....	W5
Oregon .....	W7
Pennsylvania .....	W3
Rhode Island .....	W1
South Carolina .....	W4
South Dakota .....	Wø
Tennessee .....	W4
Texas .....	W5
Utah .....	W7
Vermont .....	W1
Virginia .....	W4
Washington .....	W7
West Virginia .....	W8
Wisconsin .....	W9
Wyoming .....	W7

# FRACTION TO DECIMAL INCH EQUIVALENTS

FRAC- TION	DECIMAL
$\frac{1}{64}$	.0156
$\frac{1}{32}$	.03125
$\frac{3}{64}$	.04687
$\frac{1}{16}$	.0625
$\frac{5}{64}$	.07812
$\frac{3}{32}$	.09375
$\frac{7}{64}$	.10937
$\frac{1}{8}$	.125
$\frac{9}{64}$	.14062
$\frac{5}{32}$	.15625
$\frac{11}{64}$	.17187
$\frac{3}{16}$	.1875
$\frac{13}{64}$	.2031
$\frac{7}{32}$	.2187
$\frac{15}{64}$	.2344
$\frac{1}{4}$	.250
$\frac{17}{64}$	.26562
$\frac{9}{32}$	.28125
$\frac{19}{64}$	.29687
$\frac{5}{16}$	.3125
$\frac{21}{64}$	.32812
$\frac{11}{32}$	.34375
$\frac{23}{64}$	.35937
$\frac{3}{8}$	.375
$\frac{25}{64}$	.3906
$\frac{13}{32}$	.4062
$\frac{27}{64}$	.4219
$\frac{7}{16}$	.4375
$\frac{29}{64}$	.4531
$\frac{15}{32}$	.4687
$\frac{31}{64}$	.4844
$\frac{1}{2}$	.500
$\frac{33}{64}$	.5156
$\frac{17}{32}$	.5312
$\frac{35}{64}$	.5469
$\frac{9}{16}$	.5625
$\frac{37}{64}$	.5781
$\frac{19}{32}$	.5937
$\frac{39}{64}$	.6094
$\frac{5}{8}$	.625
$\frac{41}{64}$	.6406
$\frac{21}{32}$	.6562
$\frac{43}{64}$	.6719
$\frac{11}{16}$	.6875
$\frac{45}{64}$	.7031
$\frac{23}{32}$	.7187
$\frac{47}{64}$	.7344
$\frac{3}{4}$	.750
$\frac{49}{64}$	.76562
$\frac{25}{32}$	.78125
$\frac{51}{64}$	.79687
$\frac{13}{16}$	.8125
$\frac{53}{64}$	.82812
$\frac{27}{32}$	.84375
$\frac{55}{64}$	.85937
$\frac{7}{8}$	.875
$\frac{57}{64}$	.89062
$\frac{29}{32}$	.90625
$\frac{59}{64}$	.92187
$\frac{15}{16}$	.9375
$\frac{61}{64}$	.95312
$\frac{31}{32}$	.96875
$\frac{63}{64}$	.98437
1	1.000

# METRIC TO DECIMAL INCH EQUIVALENTS

M/M	INCH	M/M	INCH	M/M	INCH	M/M	INCH
.01	.0004	.32	.0126	.63	.0248	.94	.03701
.02	.0008	.33	.013	.64	.0252	.95	.0374
.03	.0012	.34	.0134	.65	.0256	.96	.0378
.04	.0016	.35	.0138	.66	.026	.97	.0382
.05	.0020	.36	.0142	.67	.0264	.98	.0386
.06	.0024	.37	.0146	.68	.0268	.99	.03898
.07	.0028	.38	.0150	.69	.0272	1	.0394
.08	.0032	.39	.0154	.70	.0276	2	.0787
.09	.0036	.40	.0158	.71	.0279	3	.1181
.10	.004	.41	.0162	.72	.0283	4	.1575
.11	.0043	.42	.0166	.73	.0287	5	.1968
.12	.0047	.43	.0169	.74	.0291	6	.2362
.13	.0051	.44	.0173	.75	.0295	7	.2756
.14	.0055	.45	.0177	.76	.0299	8	.315
.15	.0059	.46	.0181	.77	.0303	9	.3543
.16	.0063	.47	.0185	.78	.0307	10	.3937
.17	.0067	.48	.0189	.79	.0311	11	.4331
.18	.0071	.49	.0193	.80	.0315	12	.4724
.19	.0075	.50	.0197	.81	.0319	13	.5118
.20	.0079	.51	.0201	.82	.0323	14	.5512
.21	.0083	.52	.0205	.83	.0327	15	.5905
.22	.0087	.53	.0209	.84	.0331	16	.6299
.23	.0091	.54	.0213	.85	.0335	17	.6693
.24	.0095	.55	.0217	.86	.0339	18	.7082
.25	.0099	.56	.0221	.87	.0343	19	.748
.26	.0103	.57	.0225	.88	.0347	20	.7874
.27	.0106	.58	.0228	.89	.0350	21	.8268
.28	.0110	.59	.0232	.90	.0354	22	.8661
.29	.0114	.60	.0236	.91	.0358	23	.9055
.30	.0118	.61	.0240	.92	.0362	24	.9449
.31	.0122	.62	.0244	.93	.0366	25	.9842