

# **2<sup>ND</sup> BOOK OF HI-FI LOUDSPEAKER ENCLOSURES**

**BY BERNARD B. BABANI**

**R**

**7**

de Historie v/d Ra

**No.204 BERNARDS(publishers)LTD 60p**

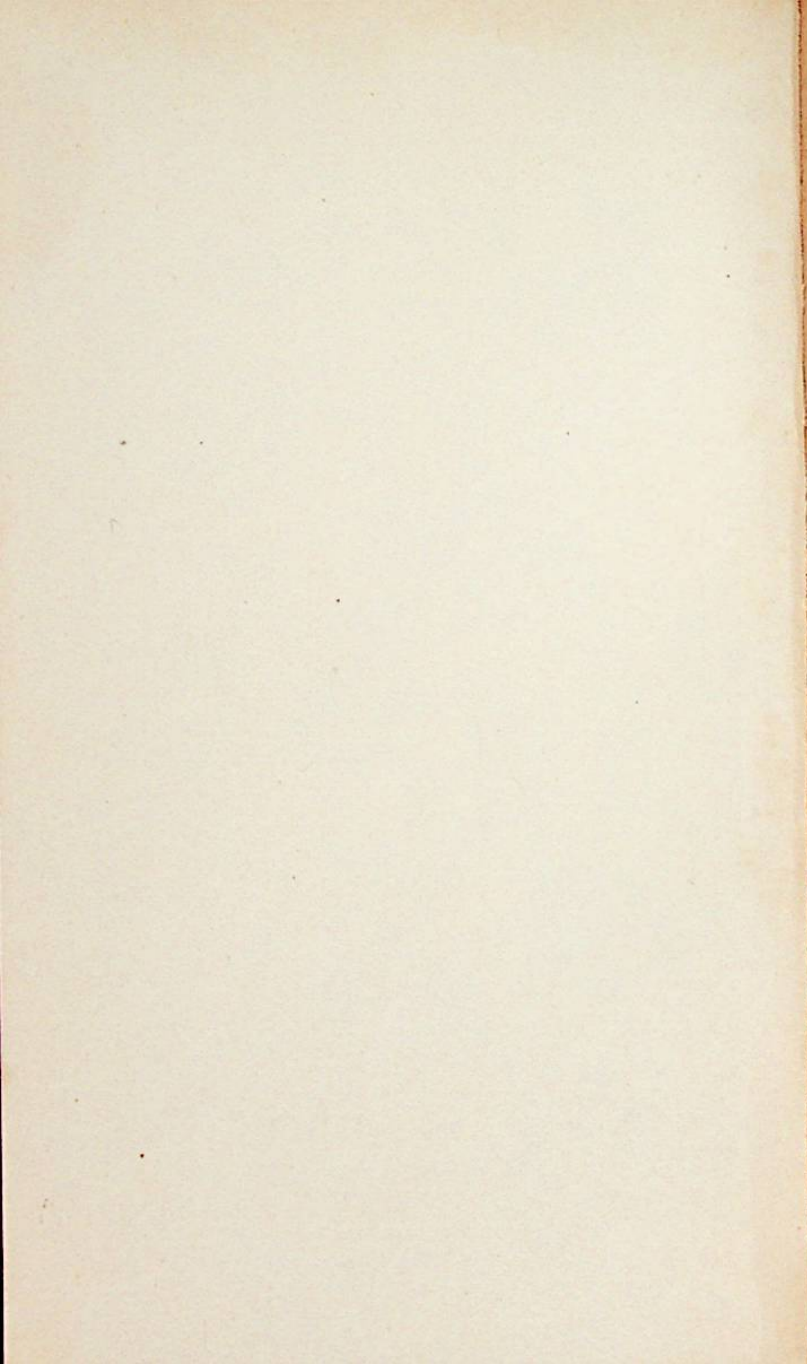

**2<sup>ND</sup> BOOK OF  
HI-FI LOUDSPEAKER  
ENCLOSURES**

**BY**

**BIBLIOTHEEK  
N.V.H.R.**

**B. B. BABANI**

**BERNARDS (publishers) LTD**

**The Gramplains  
Shepherds Bush Road  
London W6 7NF**

Although every care is taken with the preparation of this book the publishers will not be responsible for any errors that might occur

The compiler of this book wishes to express his most sincere thanks to 'ELECTRONICS AUSTRALIA' the leading radio, T.V. and electronics magazine published in that continent, and to Syndication International Ltd., their agents, for permission to use much of the material in this book which appeared originally as articles in that magazine.

© 1974 by Bernard B. Babani

I.S.B.N. 0 900162 37 6

First Published January 1974  
Reprinted October 1975

Printed and Manufactured in Great Britain  
by C. Nicholls & Company Ltd., Manchester M11 4AU

## CONTENTS

Horn Loaded Loudspeaker System	5
Rotating System Loudspeakers (Leslie Principles)	12
"Easy to Build" Enclosures for Halls and Churches	21
Sound in the Round	24
"Playmaster - Point Four"	29
A Column Speaker	32
Loudspeakers for Stereo	43
Powered Loudspeaker for Portable Recorders	51
Economy Loudspeaker System	59
Omnidirectional Speaker System	63
Compact Sealed Enclosures for 6", 8", 10", 12" and 15" Speakers	69
Loudspeaker Systems for Electric Guitars	79
"Playmaster" Book Shelf Loudspeaker Unit	87

**TO HELP OUR EUROPEAN AND AMERICAN READERS  
WE INCLUDE HEREWITH A FULL EQUIVALENTS AND  
INTERCHANGEABILITY LIST OF THE SOLID STATE  
DEVICES USED IN THE CIRCUITS SHOWN IN THIS BOOK.**

**2N3636-4889-5401.**

**AC187-175.RS276-2001.**

**AC188.NK211.2N1176-1384-2000-3427.SK3004.RS276-2005.**

**BC109.AM253.BC149-169-209-319.MPS6521.RS276-2009.SK3020.ZTX109.**

**BZZ17.OAZ225.**

**If readers experience any difficulty in obtaining the  
components or speakers mentioned in the text of this  
book, they should be guided by their Radio Parts  
Dealer who will recommend the best make to use as  
an alternative.**

## A HORN-LOADED LOUDSPEAKER SYSTEM

Horn-loaded loudspeaker systems are at present not as popular as sealed or reflex systems, but there is no doubt that they will always have dedicated adherents. The author of this article is very enthusiastic about the system he has developed, which is the product of many years of experiment.

A good loudspeaker system requires the least imagination on the part of the listener. In this article, it is intended to show the main problems and deficiencies of loudspeakers, and details will be given which if closely followed will give superb results.

The requirements in order of importance are:

- a. Low distortion.
- b. Freedom from serious peaks and dips in the frequency response.
- c. Reasonably wide frequency response.

Let us look at the mechanics of a cone loudspeaker. The paper cone is driven at its apex by a voice coil, and in turn the cone drives the air, i.e., if instantaneously the cone moves forward, the pressure at the front is high and at the back it is low.

As the cone is not absolutely rigid, it does not exactly follow the driving force from the voice coil over the whole surface of the cone, and furthermore resonances within the cone are excited over its whole surface.

The result is that much of the energy now supplied to the air is in the form of frequency components which were not supplied by the voice coil.

This is most severe on transients, and leads to "edgy" reproduction. Let us delve a little deeper. The paper cone of a loudspeaker has a high mechanical impedance, i.e., press it with your fingers—it is relatively hard to push. Now the air it is trying to couple to, has a low mechanical impedance, i.e., it is easy to push. The result is that they are sadly mismatched to each other. If we were to introduce an acoustic impedance transformer to match the high impedance of the speaker cone to the low impedance of the air, we would receive many benefits.

1. A great improvement in the efficiency of converting the electrical signal in the voice coil to acoustic output.
2. By matching the cone more accurately to the air, i.e., presenting the cone with a high mechanical impedance load, the development of spurious resonances over the surface of the cone will be discouraged, and much cleaner reproduction will result.
3. A further gain which will result is that due to the overall increase in efficiency, less input is now required for the same acoustic output, resulting in a further reduction of distortion.

A correctly designed exponential horn is a mechanical impedance transformer.

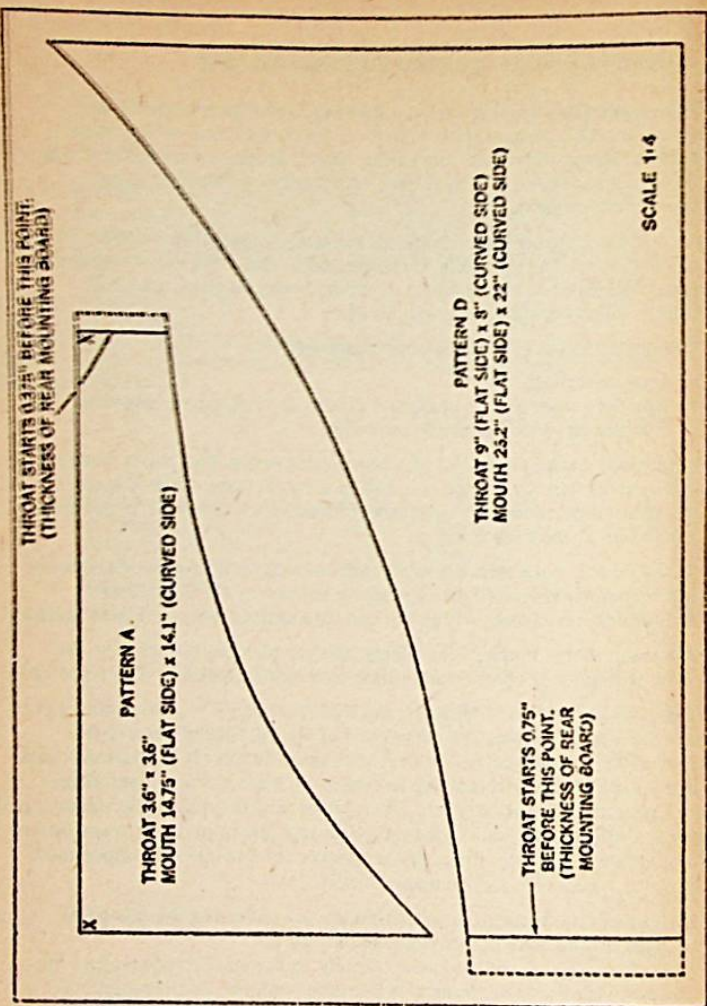

*Templates for the mid-range and bass horns. Both are for only half of a top or bottom, and must be turned over to produce the full outline. They are reproduced here one-quarter actual size. Pattern A is for the mid-range horn, and pattern D for the bass unit.*



As most of the information we hear, and of which we are the most critical, occurs in the mid-range, this is where we should start. Therefore the problem is to design a mid-range horn which must have no "character" of its own. It must be completely neutral.

Looking at the overall requirements, 400Hz or cycles has been chosen as the most suitable crossover point from the bass speaker. The mid-range horn has therefore been designed for a mouth cut-off of 300Hz or cycles which allows ample overlap.

A total of 21 different mid-range horns were built, the one to be described giving subjectively the best results. It can be truly stated that this unit is quite uncoloured and very clean on all types of program.

Having chosen this as the best design, a duplicate was made, and arranged to switch from one to the other. In this way, one could be compared with the other using different speakers as drivers.

Dozens of types of speakers were available for test, and the final choice is a Rola oval speaker. The fact that this is a very inexpensive speaker is irrelevant. It has been chosen on its merits.

One problem was that the high frequency range of the speaker became restricted when put in the horn, and on listening tests left a gap between the top of the mid-range horn and the bottom range of the treble unit.

As this appeared to be a cancellation problem in the throat of the horn at high frequencies, a series of phasing plugs were tried in the throat and compared with the other horn.

With the phasing plug shown, the problem was entirely cleared.

Frequency response measurements made on this horn show fairly bumpy results—nothing to indicate why it sounds musically so much better and cleaner than a variety of mid-range direct radiators, some of these units giving a smoother frequency response.

After months of listening, I can only conclude that of all the qualities we can talk about regarding loudspeakers, frequency response is NOT the most important.

It becomes increasingly obvious that a low distortion is the first requirement, and while difficult to prove this point scientifically, the audible improvement with the horn is obvious.

What came as a quite unexpected side effect was a very noticeable reduction in the intensity of clicks and plops from the surface of discs. This helps to support the theory that the increase in the mechanical impedance of the air load offered to the cone by the horn, discourages spurious cone resonances.

Construction of the horn and rear compression chamber is from 3/8" flakeboard. A sheet 6' x 3' will make a pair. Opposite sides of the horn are identical. From pattern A, make a cardboard template. When put

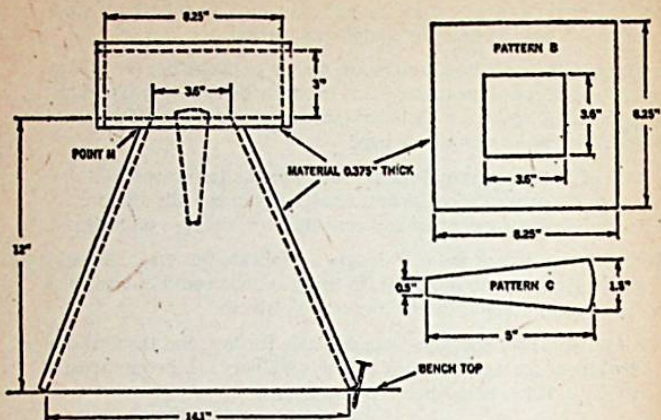

Figure 1: Dimensions of the various parts used to make up the mid-range horns. The diagram on the left is in effect a vertical cross-section through the horn. Pattern "C" is for the HF phasing plug.

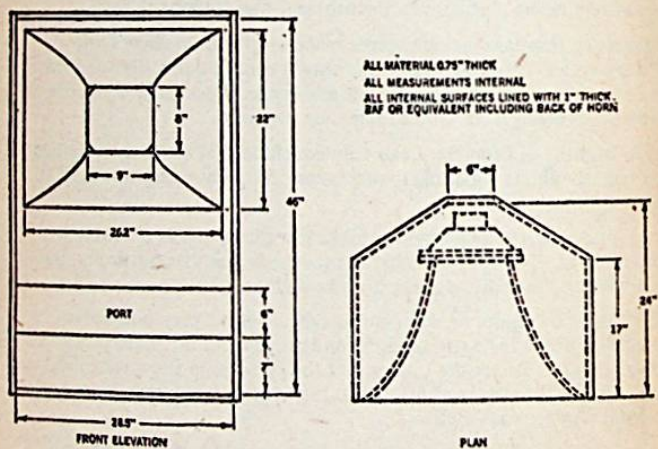

Figure 2: Details of the bass enclosure, which uses horn loading down to 150Hz, and becomes a reflex system below this frequency. Note the "chamfered" cabinet back, important for its tuning.

on the flakeboard and a pencil run around the template, this will give half a top. The template must now be turned over so that the same edge lines up with the line along x-x, and the pencil run around again.

Repeat this operation three times for two tops and two bottoms. Cut two pieces according to pattern B. These are the rear mounting boards.

Top and bottom and rear mounting board are glued together as in figure 1. A pair of nails driven into the bench top each side of the top and bottom will locate them while the glue dries. These locating nails must be placed so that the internal space between the top and bottom is 14.1".

It will be necessary to adjust the angle of mating surfaces at points M.

When dry, the sides can be built up. These curve all the way and are made from strips of the same material cut 1" wide and glued and bradded. The angles of adjoining surfaces should be adjusted to fit each other and each face should be flooded with Aquadhere cement and pressed together and a brad driven in each end.

When completed and dried, use a coarse sandpaper to round the curved sides of the inside of the horn. All cracks should then be filled with water putty, which when cut back will give a smooth surface ready for finishing.

Build the box onto the rear mounting plate with internal measurements of  $8\frac{1}{4}$ " x  $8\frac{1}{4}$ " x 3". A removable back is screwed onto the back of the box and lined with 1" absorbent. The speaker is mounted with the long dimension vertical.

The phasing plug which is of square section, is made to pattern C and centrally mounted with about  $1/8$ " clearance from the centre of the loudspeaker cone. The wide end of the phasing plug is nearest the cone.

All surfaces should be undercoated before finishing coats are applied.

Construction of the bass horn is the same in principle as the mid-range horn, this time using pattern D.

The diagrams give all measurements for construction of the main cabinet. Three quarter inch flakeboard is used for both the horn and cabinet. All parts of the cabinet are glued and nailed together, the only removable part being the horn itself. The part which is  $6$ " x  $28\frac{1}{2}$ " is left open. All internal surfaces must be lined with 1 inch absorbent such as bonded acetate fibre.

The internal volume of the cabinet is about 15 cu.ft. This is necessary to obtain high efficiency in the low bass range in keeping with the high efficiency of the upper bass range due to the horn loading.

Sweeping down from 400Hz or cycles with a signal generator, the response is smooth, and full efficiency is maintained to 32Hz or cycles, below which frequency doubling starts.

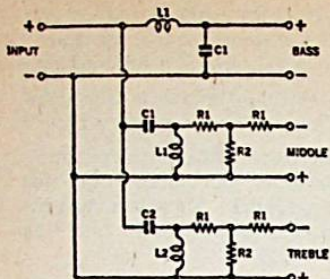

	8 OHM	15 OHM
L1	4.3mH	8.5mH
L2	0.36mH	0.67mH
C1	32 $\mu$ F	16 $\mu$ F
C2	3 $\mu$ F	1.5 $\mu$ F

dB	8 OHM SYSTEM		15 OHM SYSTEM	
	R1	R2	R1	R2
2	0.92	34.4	1.73	64.5
4	1.8	16.8	3.4	31.5
6	2.6	10.7	5	20
8	3.5	7.5	6.5	14.2
10	4.2	5.6	7.8	11

ALL VALUES IN OHMS

All coils 18 SWG Enamelled wire

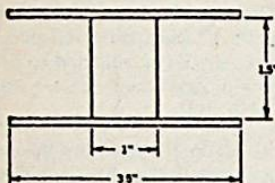

4.3mH = 460 TURNS 8.5mH = 600 TURNS

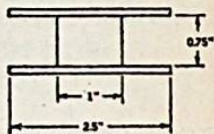

0.36mH = 120 TURNS 0.67mH = 160 TURNS

Figure 3: Details of the crossover network for the system, including resistor values for the equalising attenuators.

No internal bracing is required. The shape of the cabinet gives ample strength. Furthermore, instantaneous pressures are not high due to the large cabinet volume.

Do not attempt to simplify construction by making the back of the cabinet straight. This is a refinement on an earlier model to reduce the average depth front to back and improve tuning.

There is no tendency at all for male voices to be boomy. At the same time, when there is low frequency energy in the program results are smooth and full. I cannot imagine any conditions ever needing bass boost. If the condition did arise I would suspect the amplifier or pickup. Wonderful definition is heard in the bass instruments on good records—alas, not all records are good.

Regarding bass speakers, most suitable types will have resonances between 45 and 60Hz or cycles as a generalisation.

The long throw, very low resonance types are quite unsuitable.

Best results in order of preference were from the following types. They are all 12 inch units. Elac 12z, MSP 12UA, Rola 12PEG or 12PX. However, these are only mentioned as a guide. Other types may be found equally suitable.

Many high frequency horns were tried, and in my opinion the Goodmans Trebax 100 is the most suitable. It is interesting to note that this same

unit can sound completely foreign in a direct radiator system. In this all horn system the overall blend is very good.

Crossover between each speaker is at 400Hz and 5000Hz or cycles, and the slope rate is 12 dB/octave.

All capacitors in the crossover network must be non polarised, with preference for paper dielectric. Good non-polarised electrolytic capacitors may be used for C1, but not for C2. This item should be paper or plastic dielectric. The use of back to back electrolytic capacitors is not recommended.

All coils are air wound on formers made from 1 inch broomstick with plywood ends. Dimensions must not be changed and wire should be 18 SWG enamel or a little heavier if on hand.

Glue the cheeks to the 1 inch dowel and secure with a brass screw.

Normal steel screws must not be used. Layout is not critical but coils should be spaced by not less than 3 inches.

As the high frequency range of the mid-range horn does not extend beyond 5KHz or kilocycles, no restriction on the HF range is necessary in the crossover network.

The values of L1, C1, L2 and C2 are selected from the chart according to your choice of 8 or 15 ohm speakers.

In case of the use of a Trebax 100 HF horn which is only available in 15 ohms, it is quite in order to place a 16 ohm resistor in parallel with it and treat it as being 8 ohms from the point of view of crossover design and bearing in mind that this has reduced its sensitivity by approximately 3dB.

In the crossover circuit, 3 resistors appear in the mid-range circuit and the same in the treble circuit.

These form an attenuator of constant resistance, and from the chart the appropriate resistor values are chosen for the degree of attenuation required at the impedance you have used.

Although exact values of resistors are shown, it is not implied that this degree of accuracy is required. Ten percent variations are quite permissible. Many of the values will not be available as such and will need to be made up from combinations. Use resistors of 1 watt rating or higher.

Regarding values of capacitors C1 and C2, 20 percent tolerance is in order.

In the case of the prototype, 6dB attenuation is used on the mid-range and 4dB on the treble.

However, if your bass speaker is of a different sensitivity, the attenuation of the mid-range and treble will need to be altered.

Room absorption can have a marked effect so only regard the suggested attenuation figures as a guide.

As a further guide, assume you are building an all 8 ohm system. You will be making 4 coils of 4-3mH and 2 coils of .36mH.

When connecting speakers to the cross-over network observe the polarities.

It will be noticed on the crossover circuit the opposite connections to the bass speaker compared to the mid-range and treble. Due to phase shift in the crossover network this is necessary so that they are acoustically in phase at the crossover point.

## ROTATING SYSTEM LOUDSPEAKERS

This article explains the principles behind Leslie type loudspeakers and goes on to describe the construction of a generously proportioned system intended for use with a home constructed electronic organ. The article could provide the starting point from which individual readers could build up a rotating loudspeaker system to suit their own particular requirements.

The most obvious and the routine method of radiating sound from an electronic organ is by means of one or more loudspeakers, suitably and conveniently baffled. In a single-unit instrument, the loudspeaker(s) are mounted behind cutouts, usually in the front panel below the keyboard and above the pedal clavier.

While compact and convenient, this arrangement usually suffers some limitation in the effectiveness of the baffling, which can be provided and the efficiency with which the sound can be propagated.

A logical "next step" in improving the performance of an electronic organ is to associate with it a generously designed remote loudspeaker system, which can provide good fundamental bass output and which can propagate the sound from a position in the building where it will be heard to advantage, and enrich itself with natural reverberation.

Where the basic organ makes available its different voices from two or more channels, additional remote loudspeakers may be used, with or without supplementary amplifiers, to obtain a dispersion of sound sources, more akin to what occurs naturally with a pipe instrument.

Despite such measures, a charge levelled against electronic organs is that, while large amplifiers and elaborate loudspeakers can make them loud, the basic tone structure is too simple and too rigid, particularly where the tone generator system employs a sequence of frequency-locked dividers. Lacking is the acoustic "interest" which is present when the sound is being built up from a large number of dispersed and independent pipes, which are nominally in tune but not phase locked.

The problem has been countered in electronic organs by the use of separate oscillators in a limited number of designs, by the free use of variable-speed variable-depth vibrato and/or tremolo, and by the use

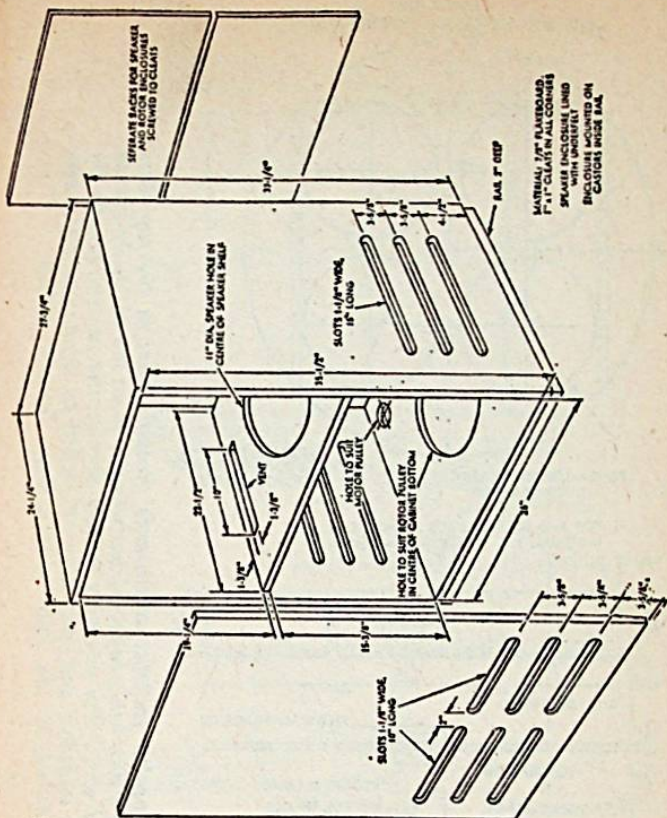

*Dimensional plans for the home-constructed rotational loudspeaker system pictured at the head of the article.*

of synthesised echo (reverberation). With such resources, good design and good playing technique, electronic organs can produce music which is appealing enough to have ensured their very wide acceptance in home, entertainment, and church situations.

However, over and above these largely electronic measures to add variety and interest to electronic organ sound, there has been wide adoption of the principle of feeding part of the sound to a loudspeaker system whose sound dispersion pattern is constantly being changed by actual physical rotation of the sound source.

One such system, which received a lot of early publicity, was the "Gyro" loudspeaker unit marketed by the Allen Organ Company. Externally, a typical Gyro cabinet appeared to be a fairly conventional

ROTOR PLAN  
TOP AND BOTTOM BEARINGS NOT SHOWN

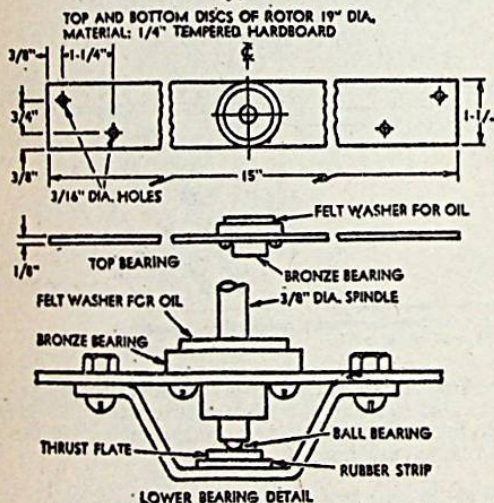
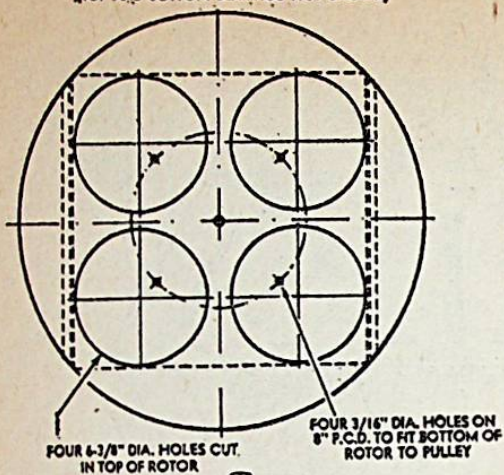

*The loudspeaker radiates downwards through holes in the top disc, the sound waves being reflected horizontally from the obliquely placed card-board vane. The assembly is held firm to the central spindle by a suitable adhesive and may also be locked to advantage by a set-screw at the hub of the large bottom pulley.*

open-backed unit, with loudspeakers radiating through a front fret. Behind the fret, however, a large circular flat baffle was arranged to spin on a stout supporting spindle. Mounted on the baffle, 180 degrees apart and carefully balanced were (or are) two 8-inch loudspeakers, receiving drive from the amplifier through a pair of slip rings. A motor inside the cabinet drives the spindle through suitably proportioned pulleys so that the loudspeakers can be spun as they radiate the organ sound.



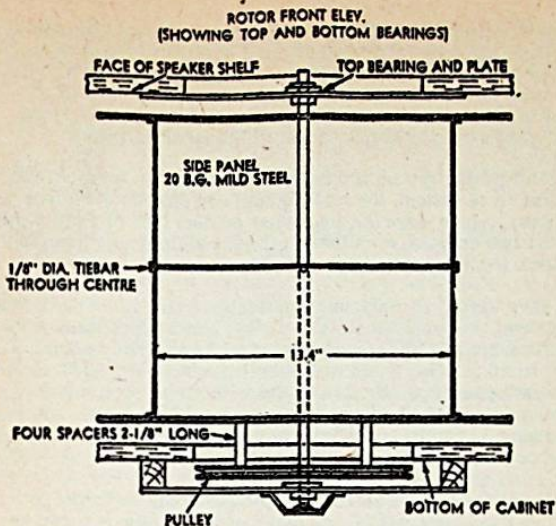

*The pulley system beneath the cabinet. The larger pulley is bolted to the lower circle of composition board, a clearance hole in the bottom of the cabinet allowing the pulley to drop through.*

In spinning they introduce "Doppler" effects which cause the sound as heard to be periodically raised and lowered in pitch as the cones alternately and periodically vary the respective distances to the listeners' ears. The same effect modulates the intensity and frequency of all natural echoes in the building so that the unit adds markedly to the complexity and potential aural interest of the radiated sound.

If such a loudspeaker system is used in addition to, but remote from a conventional fixed system, the rotating unit can provide the effect of an organ "chorus", since there is a somewhat random lack of relationship between the two outputs, even though the signals may originate, in the first instance, from the same basic tone generators.

While we have elected to make initial reference to the Allen Gyro loudspeaker system, the name which is nowadays almost universally associated with "position modulated" sound sources is "Leslie" and organs are freely advertised as being fitted with inbuilt Leslie loudspeaker. Separate extension loudspeaker cabinets, with and without supplementary power amplifiers, and using the Leslie principle are marketed for use with existing organs. The units are either made by, or presumably manufactured under licence to the Electro Music Company.

Whether or not the originators of the principle would be happy to acknowledge them, commercial and amateur-built Leslie systems, so called, have taken many forms in recent years. To mention a few:

- A single, often smallish loudspeaker, with a minimum of baffling, supported between two vertical spindles and projecting sound from both faces of its cone as it spins.
- One or more loudspeakers in a dynamically balanced enclosure, again spinning on pivots at top and bottom.
- A fixed conventional loudspeaker facing upwards or downwards, with the rear of the cone within a baffle housing and with the face radiating into a spinning, moulded horn, which sweeps the sound in a full horizontal circle.
- Similar to the above but using a flat or curved reflector plate to deflect the sound as the plate spins.
- A pressure transducer mounted vertically and feeding its output through a gland into a pair of back-to-back exponential horns, which sweep the sound through a full circle as they spin.
- A conventional fixed loudspeaker mounted vertically and able to radiate a certain amount of sound directly from the rear of its cone. A spinning moulded horn directs the sound from the front of the cone through a full vertical circle, creating a random interference pattern between the two sources.

Loudspeakers which actually spin are very effective in creating the desired result but they present problems in achieving dynamic balance; air pressure may distort the cone and slip-ring contacts carrying the audio drive

current present a further potential reliability hazard. Mercury dip contacts have been used with some success but they must obviously be designed not to spill if the system is accidentally upended.

Because of these problems, preference appears to have gravitated towards the fixed loudspeakers with rotating deflectors but even these call for very careful design and construction, particularly if they are to be used in a quiet domestic or church situation.

• The drive motor, belt and support bearings of the rotating system must be notably free from noise and rumble.

• The rotating system must be designed so that the adjacent air rotates with it. If the rotating system behaves instead as a paddle, it will create disturbing noise as it puffs the air in and out of the enclosure openings. In addition, air loading on the rotating system will upset any pre-arranged dynamic balance.

The modulation rate most commonly sought is about 7Hz, the same nominal figure as for electronic vibrato and tremolo. With single rotating loudspeakers or paddles, the system needs simply to be stepped down by pulleys to operate at between 6 and 7 revolutions per second, or about 400 rpm. In a few cases having symmetrical outlets 180 degrees out of phase, the required speed might be nearer half this figure.

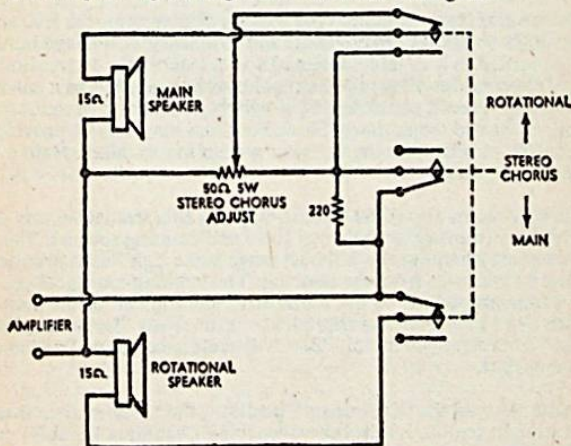

*The loudspeaker switching arrangement. It uses a key type switch, the contacts being drawn as they would rest in the centre position for "Stereo Chorus".*

Since a Leslie type system in itself achieves a vibrato-cum-tremolo effect, caution is necessary in using it with electronic vibrato or tremolo provided in the organ circuits. If the two are synchronised, the result may well be an excessive total effect; if they are not synchronised, the result may well be an excessive total effect; if they are not synchronised, a vibrato-on vibrato effect will be produced which may be more spectacular than pleasant to the listeners! In short, vibrato with Leslie is a technique that should be used cautiously—and sparingly.

An interesting possibility is to run a rotating system at a much slower rate, typically at, or slightly above, one revolution per second, using it to supplement the main loudspeaker system. While having less immediate impact than operation at the higher speed, the contribution can be subtle and agreeable and with greater freedom in the use of in-built vibrato.

Irrespective of rotational speed, however, an important aspect of all Leslie type systems is the proportion of the total output which is fed through them.

First reaction might be to construct a full-range rotating system and to feed through it the total output of the instrument—bass, middles and treble. In practice, the overwhelming auditory effect of so doing is to produce extremely deep vibrato-cum-tremolo, which may well be more immediately apparent than its other qualities. It may appeal to those who like deep vibrato and tremolo but certainly not to many others.

The genius of a rotating system is for it to be heard in conjunction with a fixed sound source, the two interacting to produce ever-changing sound interference patterns. The control facilities may well allow for a variation in the proportion of the output fed to the rotating system, without going to the extreme of cutting the fixed system altogether.

In the more usual form of Leslie type loudspeaker system, the frequencies below a 300Hz to 800Hz crossover are fed to a heavy duty fixed loudspeaker, mounted in a suitably designed and substantially conventional enclosure. Frequencies above the nominal crossover are fed to a much lighter rotating system, controlled by a switch giving as its functions: Stationary, Fast and (sometimes) Slow. Facilities may also be provided on the console to select the loudspeaker system in use: Main, Main + Leslie and Leslie only.

The significant point about the "Leslie only" in this arrangement is that it provides its own interplay between fixed and rotating sources. The fixed loudspeaker handles the full bass range and a significant proportion of the chord structures from the manuals. The rotating loudspeaker handles a large proportion of the sound from the top end of the manuals, along with overtones from lower-pitched chords. Thus "Leslie only" does not mean "Rotating System only" but a discrete mixture of fixed and rotational output.

At the same time, in the "Stationary" position, the Leslie system is available as a straight remote loudspeaker, capable of handling the full range of the organ.

Since the loudspeaker is mounted in a vented enclosure, it is capable of producing a solid bass output, only vaguely "rotated", the vent and its output being clear of the rotating mechanism. The system will take the full output of a spinet organ, with and without electronic vibrato, for extreme "popular" effects. Normally, however, it is used in partnership with the console loudspeaker as a "Stereo Chorus", with facilities to cut the rotating system altogether, or to use it as the major source, with a minor contribution from the fixed system.

Alternatively, a fully baffled system like this can be used with a larger multi-channel installation to take the full output of flutes and tibias, as distinct from other voices, with control facilities for "Stationary", "Slow" and "Fast".

The enclosure, as illustrated, is a large rectangular unit, built from 7/8-inch flakeboard and mounted on hidden castors for mobility. The front, sides, top and bottom are permanently glued and screwed together, with frets cut in front and sides to provide an outlet for the sound.

Above the level of the frets, screwed firmly in place, is a horizontal shelf, which serves as a baffle for the loudspeaker, mounted cone downwards. Preparatory work on the shelf should be completed before it is fixed in position.

Access to the cabinet for fitting out is through the back, which takes the form of two removable panels screwed to cleats around all edges. One panel seals off the loudspeaker enclosure; the other gives access to the rotating mechanism. A single panel could be used if desired.

Basis of the rotating mechanism is a pair of 19-inch circles scribed and cut from 1/4-inch thick tempered composition board. A pattern of holes in the top board allows sound waves from the loudspeaker cone to pass down to the rotating assembly. The bottom board carries the drive pulley on its underside, attached by bolts and stand-off pillars.

Between these two boards is mounted two side panels made from 20 or 22-gauge mild steel sheet, with a lip turned outward at each end to permit them to be bolted to the circles of composition board just mentioned. The edges are tied together by a couple of thin traversing rods, to prevent any distortion or movement later, when the assembly is rotating.

The vane, which deflects the output of the loudspeaker, was made from 1/32-inch cardboard, screwed and cemented by its two ends to the circles of composition board. The vane forms an oblique angle with the rest of the assembly and, as it rotates, tends to deflect the sound waves from the loudspeaker cone through a full horizontal circle. While the panel may seem to be of unduly light material, it is in fact adequate for the purpose and, with a total weight of about 4 1/2 oz, it does not detract much from the dynamic balance of the assembly. Even so, individual constructors may elect to offset any residual unbalance by attaching something like a 1/2 to 3/4 oz weight to each circle on the opposite side to the end of the cardboard vane.

The whole assembly described thus far must be provided with a central spindle, which, needless to say, must pass through the exact centre of the two composition board circles. If the assembly is symmetrical, as it should be, the spindle will be exactly equi-distant from the metal checks and it will also pass through the exact centre of the cardboard vane.

A 3/8-inch diameter mild-steel spindle is suggested and the holes through the assembly should be drilled or filed to a tight push-fit. Where the spindle passes through the cardboard vane, it is suggested that a thin aluminium washer be prepared which will also grip the

spindle and lie flat against the vane. Cement the whole assembly together with Araldite, or other similar preparation and, when complete, paint with dull black synthetic enamel. This prevents the rotating system from being visible through the vents or cloth and also seals the surfaces against the effects of moisture.

At the top, the spindle runs in a bearing attached to the loudspeaker baffle and on the centre line of the cone.

Another bearing, directly beneath the top bearing and hung from the floor of the cabinet, carries the spindle on the underside. In the original system, permanently lubricated bronze bearings were used, with a ball thrust arrangement at the bottom to take the vertical weight. The system has operated reliably for several months and should be adequate for a lengthy period of use in the home.

Ball bearings could be used instead, with some advantage, but precautions may need to be taken against the introduction of rumble. Rubber insulated bearings suggest themselves as a good choice.

The motor used in the original system was a capacitance start unit, actually salvaged from a worn-out electric typewriter. It measures 4in in diameter and 6in long and is rated at 35MH, 0.6A, 1425 r.p.m. It was complete with rubber mounting provisions, which would have been essential, anyway, to prevent vibration from being propagated via the cabinet panels. Smaller motors, from fans, etc., are not likely to be adequate for a system such as the one under discussion, since they have insufficient starting torque. However a powerful tape recorder electric motor could be used.

The motor drives the rotating assembly through a belt and pulley system on the underside of the cabinet. It is virtually essential to use a round section belt for the purpose, the engaging noise of a V-section belt making it far too noisy for this kind of work, by virtue of its propagation through the light rotating assembly.

To minimise the amount of air movement when the assembly is rotating, it is a good idea to slip a tube of light cloth over the rotating assembly using draw strings at top and bottom to hold it in position.

In the particular combination of units in the system, the acoustic efficiency of the loudspeaker in the rotating system was noticeably lower than that of the loudspeaker in the console. This was due both to the nature of the loudspeakers and by the somewhat restricted radiation path through the rotating system. To achieve optimum balance with both loudspeakers on, it was necessary to reduce the level from the main console loudspeaker.

Accordingly, a key switch was fitted to the console, together with a 50-ohm 5W potentiometer. These were wired as shown in the accompanying circuit so that it was possible to select the rotating system only; or "Stereo Chorus", involving both loudspeakers but with the facility for cutting back the loudspeaker in the console; and "Main", the console loudspeaker only, with the limiting potentiometer out of circuit.

## EASY TO BUILD ENCLOSURES FOR HALLS AND CHURCHES

Described here are a couple of simple loudspeaker systems which were devised by the author for a suburban church. Involving a minimum of fuss and expense, they have one important thing in their favour—they do the job required of them very effectively.

The buildings in which the enclosures were installed included a church and a church hall sharing a common entrance foyer. To minimise cost and provide for later flexibility, it was decided to install a single amplifier and turntable in the foyer, with microphone and loudspeaker lines running back under the floor to the central amplifier position.

A church officer, from the foyer, could thus control the sound level in whichever building was being used and could, if necessary, relay the proceedings into the second building. It remained to devise and install suitable loudspeakers, hopefully with a minimum of outlay.

The church is of modest dimensions and designed to seat about 150 people. The main role of the amplifier would be to assist those among the congregation who were hard of hearing, and in respect to ministers with a soft voice. High level reinforcement would obviously not be called for.

The pulpit is centrally placed at one extreme end of the building and a loudspeaker could not be located anywhere near it by reason both of appearance and the likelihood of acoustic feedback. In fact, there seemed to be only one place where a loudspeaker could go—on one side wall above the organ console, directed diagonally across the church and above the heads of the congregation.

There was no place for a second loudspeaker on the opposite wall and it was appreciated that the sound would be coming from one side rather than the pulpit area.

It was fairly obvious that the most pleasing style of loudspeaker would be a "line source" configuration with (say) four loudspeakers mounted one above the other in a vertical line. This results in a tall, slender enclosure which can usually be merged much more easily into the lines of a building than a more cubical shape, as would be necessary to house a single 12-inch loudspeaker.

A second major advantage of a line source system is that it tends to concentrate its radiation in a flat fan-shape. If placed above head height, the lobe tends to pass above the heads of those nearest to the loudspeaker, so that they are not subjected to an excessive sound level.

At this point of time, a search around the clearance houses revealed some keenly priced 8-inch loudspeakers fitted with 8-ohm voice coils. Four of these would do just fine; and by connecting their voice coils in series-parallel, the net impedance would remain at 8 ohms.

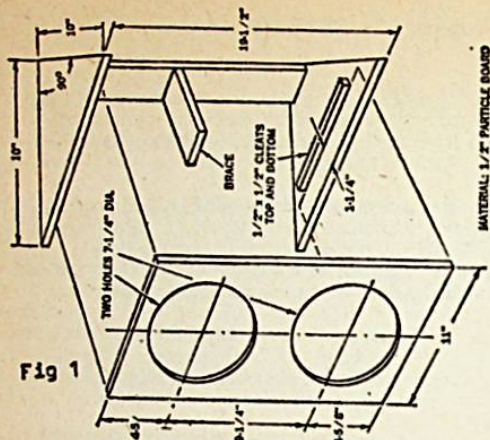

Fig 1

MATERIAL: 1/2" PARTICLE BOARD

Construction of the enclosure is fairly straightforward, as can be seen from these exploded drawings. The finish used is up to the individual constructor. In the prototype two loudspeakers the finish was satin enamel to match the adjacent walls. To ensure a good fit against the wall and to prevent rattles the edges of top and bottom panels should be covered with felt or foam tape.

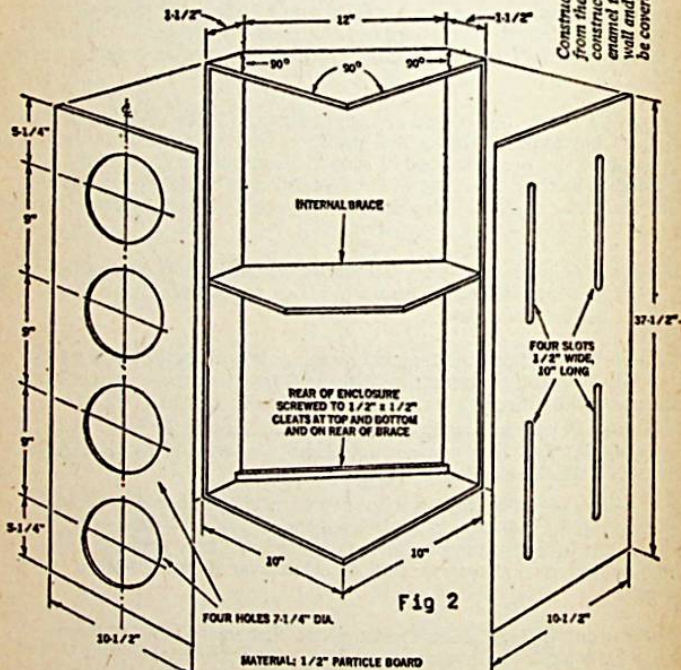

Fig 2

MATERIAL: 1/2" PARTICLE BOARD

The exposed timber surfaces of the four loudspeaker unit were covered with iron-veneer, such as "Thermo-Veneer". The moulding around the edge of the grille cloth, known as glazing bead, is obtainable at most timber yards.



The conventional next step should have been to construct a tall enclosure of rectangular base plan and bracket it to the wall so that it would face diagonally across the congregation. But, while utilitarian, a loudspeaker so arranged generally manages to look what it really is—a rather bulky afterthought.

Why not construct an enclosure of predominantly triangular section, which could mount flush against the wall? The exposed faces could then be covered with a suitable cloth to blend with the wall. And that's the way the enclosure was constructed, as shown on these pages.

It was convenient in this case to make the major angles 90-degrees so that the loudspeakers' cones would face across the auditorium at 45 degrees. With this arrangement, the enclosure can be modified to suit either wall by simply interchanging the baffle and the slotted panel.

Fairly obviously, however, the dimensions could be changed to meet particular requirements.

It will be evident that the dimensions of the enclosure are such as to accommodate no more than comfortably the four loudspeakers on the baffle face. Increasing the size would have been good for bass response but bad from the viewpoint of appearance.

To minimise the risk of the loudspeakers exhibiting a prominent bass resonance in the box, pressure relief slots are specified in the second outward facing panel. In addition, it is suggested that a layer of 16oz Innerbond or Bonded Courtelle be pinned around the rear of the loudspeakers.

The loudspeakers used in the original were a clearance line having a single curvilinear cone. Other loudspeakers could be substituted, however. The more sensitive they are, the less drive power you will need to produce a given sound level. If they have a low cone resonance, the bass end will sound fuller. If they have a tweeter cone, the top end will be brighter.

In practice, most ordinary loudspeakers as used in radio or television receivers will do the job quite effectively.

So much for the single system in the church.

The church hall provided a quite different situation, with a modest stage and proscenium and an almost automatic requirement to locate a loudspeaker system on either side in the corner formed by the proscenium and the side wall.

But it is not a large building and two 4-speaker columns would have been too costly and too cumbersome for the corners that were available for them.

In consequence, two smaller enclosures were made up, as per Fig. 1, each mounting two 8-inch loudspeakers of the same type as before.

The smaller enclosure is virtually a skeleton triangle intended to mount hard into the corner with the baffle facing inwards at 45 degrees. Note however, that the baffle does not seal against the adjacent walls but leaves a narrow slot to relieve the internal air pressure.

The baffle can be dressed with a suitable cloth in front while, behind it, the loudspeakers should again be encircled by a layer of sound absorbent Innerbond or Courtelle.

In these smaller enclosures, the loudspeakers were simply connected in series to produce a nett impedance for each system of 16 ohms. At the amplifier, the two were connected in parallel to bring them back to 8 ohms total.

## SOUND IN THE ROUND

### A new omnidirectional loudspeaker system

Details of an easily constructed loudspeaker enclosure which has a very smooth frequency response and an almost perfect omnidirectional character. Using two new low-cost Plessey loudspeakers, it is ideal for either two-channel or four-channel stereo systems.

Recently, Rola designed and released two new complementary loudspeakers. One is the X30 dome tweeter, which has excellent polar distribution together with a high frequency response extending well above the threshold of hearing. The other speaker is the C10-0, a 10-inch unit with low primary resonance and a curvilinear cone made using the new controlled fibre length (CFL) technology. Electrically the two speakers may be combined very simply, using a 3uF fixed capacitor in series with the tweeter for an 8-ohm voice coil impedance.

It was decided to combine these two compatible and outstanding loudspeakers to make an efficient and compact enclosure with a 360 degree radiation pattern which would handle, with reserve, the maximum output from a 20 watt amplifier.

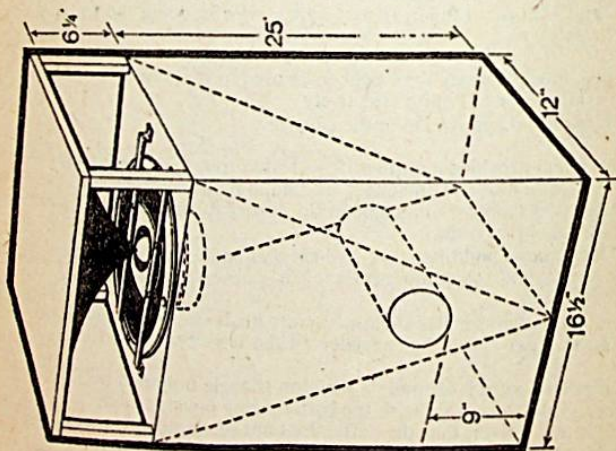

*A 'see-through' look at the new enclosure.*

The first question asked was why make it omni-directional? Well, from those working in the field of auditory perspective it is known that two channel stereo from two separated point sources is inadequate. With the exception of a special seating position, there is always a "hole in the middle" or inadequate breadth—an unnatural situation.

Omni-directional speakers help to eliminate this and produce in addition a wider sound field with increased realism. Also it is unnecessary to have a critical placement for the enclosures, a distinct advantage from the point of view of room arrangement.

The enclosure, although it had to provide 360 degree radiation, needed to be simple to construct with a low final cost. We decided to look at the middle and high frequency dispersion first, then follow up with the bass end.

The approach we decided to adopt was the fairly logical one, where the loudspeakers are mounted on the top of the enclosure proper, facing vertically upward. The tweeter is mounted co-axially within the cone of the larger unit, and above both is positioned a diffuser to deflect the middle and high frequency radiation into the horizontal plane.

A size was chosen for the basic enclosure, bearing in mind the need for a compact system and the requirements of the C10-0 for good performance at low frequencies. The dimensions we selected were 12 x 16½ x 25in (d x w x h) external, giving an internal working volume of about 2 cubic ft.

The parameters for a diffuser were readily worked out, knowing the case dimensions. A conical exponential shape was chosen as closest to ideal. Sound radiation below approximately 550Hz is omni-directional therefore we could concentrate above that frequency. A height of 6 inches was chosen as this is close to a quarter wavelength at 550Hz, the lowest frequency to be considered by the diffuser. Thus with diameter, height, and flare chosen it was simple to apply the exponential equation and work out a final shape.

A diffuser was turned out of wood and the experiments commenced, using one, two, and four tweeters. In fact we found one tweeter co-axially mounted to be adequate if the apex of the diffuser was close to the centre of the dome tweeter. A clearance of 1/16" to 3/32" was found to be optimum (one must be careful not to dent the tweeter dome). Considerable loading is experienced in the 10kHz to 20kHz region and this lift is required to increase the high frequency output, so that it is compatible with the remainder of the system over 360 degrees.

The wooden diffuser when tested came close to design, but produced a pronounced peak around 550Hz, which we reasoned to be caused by the dimensions and their symmetry. At about this time the question arose "how is the enthusiast going to manufacture a diffuser?" If one had a large enough lathe and was an experienced metal spinner

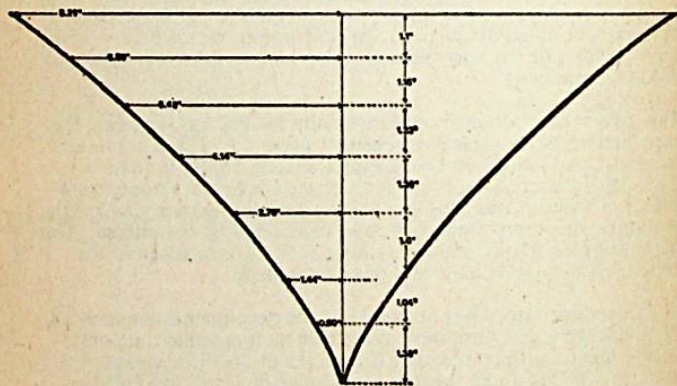
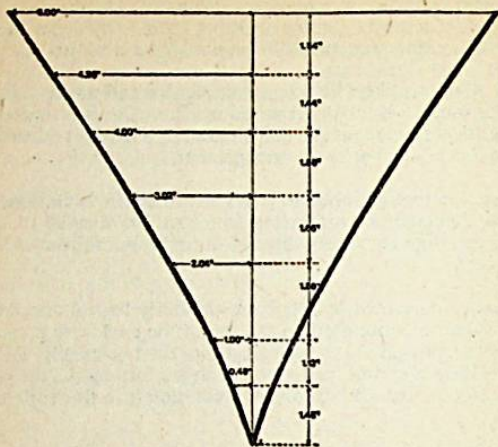

*These are the contours used to make the mould for the rectangular diffuser.*

or such it would be no problem, but this would not normally be the case. So that the problem became how to make it asymmetrical and also produce a simple form to manufacture.

It was decided to experiment with a prism still having exponential faces but with a rectangular cross-section. The main requirement for the diffuser is that it be rigid and non-resonant, and we could no doubt have fashioned a solid block of wood into the desired shape. However this would not have been easy, so we elected to try a different approach: casting the diffuser using a foaming polyurethane resin.

A mould for casting the resin was made in the following way. Two large sides and two small sides were cut from cardboard in the shapes shown in the diagrams. A piece of 3/16in thick tempered hardboard 20 x 16in was then taken and a rectangular hole 16 x 11½in cut in it to form a frame. A further rectangle 16½in x 12in was then drawn on the frame outside the hole, to make the base of the cardboard sides.

The four cardboard sides were taken, and one at a time, taped along the pencilled line. They were then pressed into the pyramid shape and the four edges where the cardboard faces met were taped into position. The exponential rectangular pyramid thus formed was untaped from the masonite frame and a fillet of lacquer adhesive was run inside along the four cardboard seams. The pyramid was again taped back onto the masonite frame and allowed to dry for 24 hours to form the completed mould.

The two-part polyurethane foaming resin we used was obtained through a marine supplier, but is also available through hardware stores handling fibreglass and similar materials. A one pound pack is sufficient to cast two diffusers.

A small quantity of the two components were mixed accurately according to the directions, making about half a cup of mixture. This was stirred well for about 30 seconds, and then poured through the frame into the inverted pyramid mould. The resin foamed and rose, and partially filled the mould, slowing down after about 2 minutes. A second small quantity was then mixed and poured around the sides to even up the fill. These operations were then repeated until the mould was evenly filled, using a stick to level off the top when the last addition rose above the frame level. Finally the casting and mould were left for about two hours to harden.

When the hardening appeared complete the frame was removed and the corners of the casting cut to clear the four support pillars. The pyramid was then glued and screwed to the top panel using PVA adhesive (which does not interact with the polyurethane—other adhesives do!). When dry the diffuser and underside of the top panel were lightly sandpapered (the cardboard is left on) and painted with flat black paint so that they would not be visible through the cloth ultimately added to the outside of the enclosure.

On test we found as calculated that the peak at around 550Hz had gone, and the radiation pattern was good. We had in fact produced a better diffuser than the original exponential conical design.

Since making the diffuser in the above manner, we are inclined to think that an easier approach would be to cut the sides of the mould from tinplate, folding them in the same manner and soldering the joins. The resulting tinplate mould could then be used to produce as many diffusers as required, using a moulding material such as "Spackle" or "Polyfilla". We have not actually tried this approach, but it would be somewhat easier than the polyurethane resin and should give results just as good.

When omni-directional enclosures there is generally a loss in bass because of decreased radiation resistance resulting from the mounting position of the loud-speaker. During our work on the diffuser we used a totally enclosed box which did exhibit these properties. Experimentally we overcame the lack of bass by using a second 10in speaker at the bottom of the cabinet facing the floor with the cabinet raised 3½in on legs. A 550Hz crossover network was incorporated and an expensive cross over network. The next experiment was to design and construct an open ended labyrinth or if you like transmission line and terminate it at the cabinet base with the cabinet still raised 3½in on legs.

The transmission line gave a clean bass, which many people liked, but it did require bass lift from the amplifier due mainly to the relatively small cross sectional area of the transmission line, which was limited because of the required final size of the enclosure. The need for bass lift in the amplifier was thought to be a disadvantage, so we went "back to the drawing board" once again.

At low frequencies where the wavelength is longer than 2 feet (at 550Hz), sound radiation is omni-directional. Theory thus suggests that it is possible to use a two speaker system with a correctly designed enclosure and obtain a simple compact system with omni-directional characteristics and a wide frequency response.

For our final experiment we designed a vented enclosure with the vent on one side close to the floor and tuned with a tunnel to 38Hz. A "v" shaped curtain of Innerbond is arranged as shown in the illustration. It gave a good base response which matched the rest of the system and was chosen as the best practical solution.

The frequency response was taken by supplying pink noise to the speaker system situated in a furnished listening room 20 x 14 x 9ft. The system was placed centrally 9ft from the rear wall. The ½in condenser microphone was fixed at a distance of 1 metre from the top opening. Pink noise was used because it has a 3dB per octave attenuation with increase in frequency, which makes it compatible with the B & K spectrum analyser that has a constant percentage band width. It can be seen that both the frequency response and polar curves are very impressive.

On listening tests it is always best for the individual to make up his own mind, but a lot of people have heard this unit and we think it is the best we have heard for a unit of this size. With the omni-directional facility we believe it makes tremendous value using two low cost speakers and a simple flake-board enclosure.

In concluding the author would like to thank all the members of the engineering team at the Plessey Central Engineering Laboratory, for their help in developing this project.

## THE PLAYMASTER "POINT FOUR"

Here is a new, compact bookshelf loudspeaker system of low cubic content and small in frontal dimensions, it gives a performance and should appeal automatically to those to whom room-space is a first consideration.

The thinking behind this latest enclosure is not by any means new. At the time, we were seeking a basic loudspeaker which could be operated in a compact, fully-sealed and filled enclosure; it needed to be a high-quality design, with as much cone area as practicable and with a natural free-air cone response at the lowest possible frequency.

To complete the picture, we specified the use of a high-frequency tweeter with sealed rear housing and a simple cross-over network centred at either 2.5 or 5KHz, depending on the particular tweeter selected.

Recently the Philips organisation brought to our attention a 6½-inch low frequency loudspeaker, newly added to their range, which had been expressly designed for the job we have in mind. Carrying the type number 2422/257/37701, it is intended for "woofer" service, having a large magnet, long-travel voice coil system and a ring of butyl-rubber to support the cone edge. The power rating is a generous 20 watts, provided the loudspeaker is housed in a suitable enclosure of not more than 30 litres or 1 cu.ft. approx.; impedance at 400Hz is 8 ohms, cone resonance in free air 28Hz, total magnetic flux 45,000Mx and flux density 9600Gs.

At the time of writing, the loudspeaker is available only with an 8-ohm voice coil, a figure that seems to be emerging as a new "standard" since the swing towards solid-state amplifiers. As such, it will suit most new transistor amplifiers directly, along with those valve amplifiers having output secondaries tapped for this order of load. In fact, having in mind the rather nebulous impedance characteristic of most practical loudspeakers, we would not hesitate to use such a speaker with amplifiers intended for 15-ohm loads, should the necessity arise.

Philips may make the AD3703 available later, in other impedances, according to demand.

Its natural cone resonance in free air is stated as 28Hz but, in the samples to hand, it was so non-apparent to ear, eye and instruments that we would have put it, if anywhere, below 20Hz.

Application data for the loudspeaker illustrates its use and performance in a fully sealed enclosure of about 0.33 cu.ft. Under these conditions, the bass resonance is shown as 60Hz and the frequency range, when associated with a suitable tweeter and cross-over network, as 50-18,000Hz.

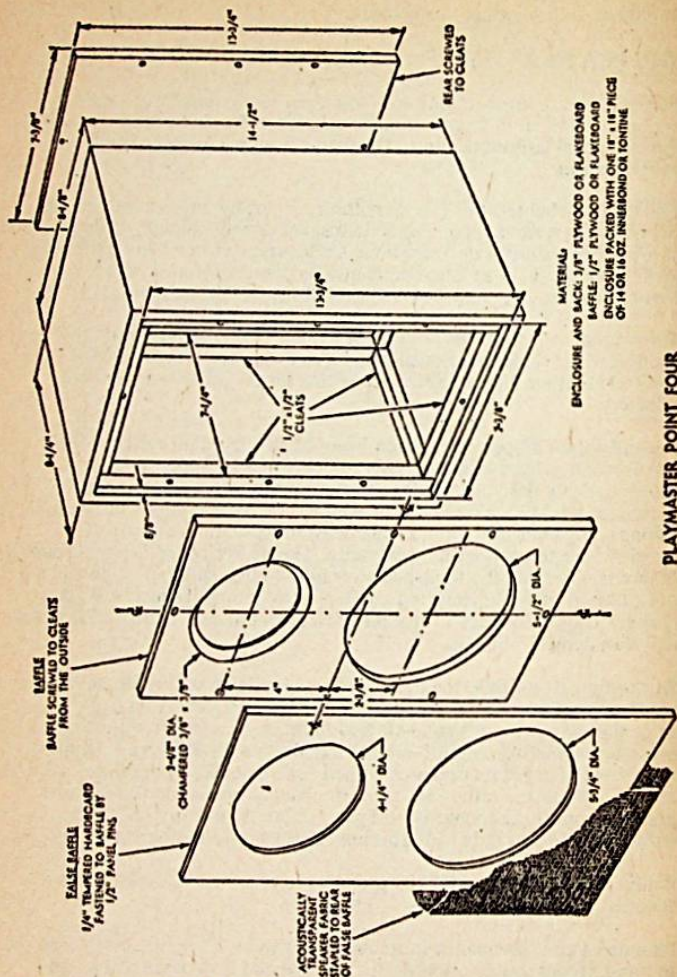

PLAYMASTER POINT FOUR

Constructional details of the enclosure for the "Point Four" loudspeaker system. Dimensions differ in a few details from the original Mullard drawings but relate closely to the commercial versions that are actually being sold. As mentioned in the text, however, we had to modify such an enclosure to achieve an airtight fit to baffle and rear panel.



Our first job, therefore, was to complete the line of cleats around the inside front of the cabinet and then to make up a new baffle from 1/2-inch flakedboard. While the new baffle appeared to fit nearly against the cleats and against the inside surfaces of the cabinet, we ultimately made sure of the seal by providing a washer of thin felt between baffle and cleats, and by a pellet of caulking compound in each of the corners.

The Philips loudspeaker, by the way, requires a cut-out of diameter 140mm, equal to 5 1/2 inches.

For the tweeter, we decided against the suggested type from the Philips range because of its conventional open-backed design. Whatever its merits in other directions, the need to provide an airtight enclosure for it is a very serious disadvantage.

We have specified a simple 1/4-section network crossing over at 5KHz and with values appropriate to 8-ohm loudspeakers. Details of the network are given in the accompanying diagram. It performs the necessary function of diverting low frequency energy to the woofer and high frequency energy to the tweeter. The necessity for the inductor is perhaps debatable because the impedance of the woofer is so high at the higher frequencies and its ability to absorb power so limited that inclusion of the inductor is somewhat academic. How-

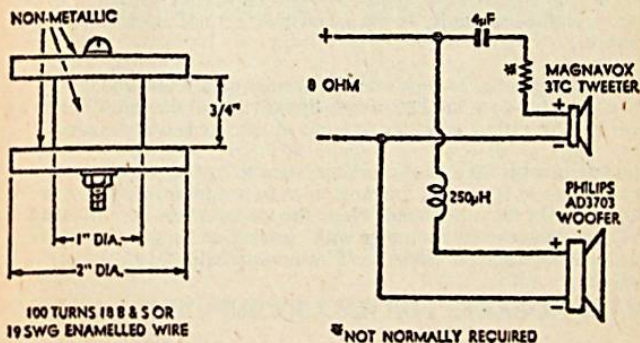

*Details of the cross-over network. It is shown for an 8-ohm system only and crossing over at 5KHz — the only combination which is practical at the moment.*

ever, it is not a costly component and we are recommending it as a standard fitment for the "Point Four" against the day when other woofer loudspeakers may become available, requiring the inclusion of the inductor for best results.

The enclosure does not need to be lined or padded internally but it should be filled with one of the currently available bonded fillings intended for the purpose. The appropriate method is to obtain a strip of the material as wide as the internal height of the cabinet, to roll it into a flattened pad without compressing it and to stand it on end on the cabinet. It should be pushed forward to either side of the loudspeakers and should roughly occupy the airspace within the cabinet, without being compressed significantly when the back is screwed on.

Care should be taken to see that the back seals as tightly as the front, the leads being brought out through holes of just the right size or through airtight connectors. This insistence on the enclosure being airtight is not a fetish; quite apart from the need to provide air loading on the cone, the air will hiss through any holes, creating spurious sound energy.

On test, the new "Point Four" sounded much like our reference "Playmaster Bookshelf" system, operating from a 10 + 10 watt amplifier and with about half-bass boost. There was some discussion among staff members about the sound of each on different types of programme material but all in quite vague terms. The general verdict was that there was a marked similarity in the sound and that both were highly satisfactory.

In a stereo set-up in the average suburban living-room there would be little to choose between the Playmaster Bookshelf and the Point Four, the most notable difference being in terms of the size and appearance.

If the requirement is for a loud-speaker system to rest on a shelf then, in contradiction to the name, the most suitable would probably be the "Point Four". On the other hand, where the loudspeakers have to stand on the floor against a wall, or merge with curtains, or hang on a wall like a picture, the slimmer "Bookshelf" would probably be the most practical shape.

## A COLUMN SPEAKER FOR HALLS, CHURCHES

*The following article discusses the design and likely uses for sound column type speaker systems and suggests a typical example. The unit, as described, would be well suited for use in churches, halls, and situations where a long, narrow enclosure can more readily be blended into its surroundings than a more cubical shape.*

First and foremost it is necessary to define exactly what we mean when referring to column loudspeaker systems.

There are columns and columns, the two varieties having very little in common. In fact, they are almost diametrically opposed in purpose and operation.

The kind of column with which we are NOT concerned is that currently finding favour for modest, though still good home amplifier systems. Prompted largely by interest in stereo sound reproduction, a need has arisen for loudspeaker units which occupy a minimum of floor space and which can even stand in corners behind lounge furniture, etc.

To satisfy this particular need, loudspeaker units have been contrived in which the basic speaker (generally about 8 inch) is mounted face up in the top of a hollow column, some three to four feet high and of cross section just large enough to contain the speaker cone. "Columns" which have been pressed into service, include concrete or earthenware pipes, wooden structures and tubes of thick cardboard/cum papier mache.

### **Bottom Vent**

Treatment involves supporting them off the floor slightly to create a bottom vent, lining the interior with padding and/or supplementary tubes and placing a reflector above the loudspeaker cone to disperse the sound in a horizontal direction. And, of course, the exterior normally needs to be hand painted or covered in wallpaper to give it some air of domesticity.

In short, this kind of column is yet another approach to the hi-fi-in-a-small-space problem which is so familiar these days. As we said before, it is the type of column with which we are NOT concerned here, although the foregoing remarks may well trigger off a reaction which will oblige us to do something about them before we are much older.

The type of column with which we ARE concerned is the one which has been used in one form or another for many years, for public address installations. Coverage and speech clarity are the major requirements, with fidelity frequently taking second place.

The public address type sound column involves (usually) four or more loudspeakers mounted in a vertical line up the face of a tall, column-like enclosure.

The voice coils are interconnected to ensure in-phase operation of the cones, so that they all move inwards together and outwards together under the influence of the driving signal. They simulate, in fact, a single elongated cone, no wider than any one speaker but as long as the overall stack.

Sound tends to be radiated in an arc, forward and sideways from the column but not steeply upwards or downwards. Reason for this is that the cones tend to be additive in the effect on air ahead of the loudspeakers but to cancel at oblique angles in the vertical plane.

This can confer a big advantage in buildings with high ceilings, in that echo is likely to be less of a problem if the original sound can be concentrated towards the audience and away from the ceiling zone.

Such directivity can also be put to good use in limiting acoustic feedback, particularly if augmented by the discreet choice and placement of microphone.

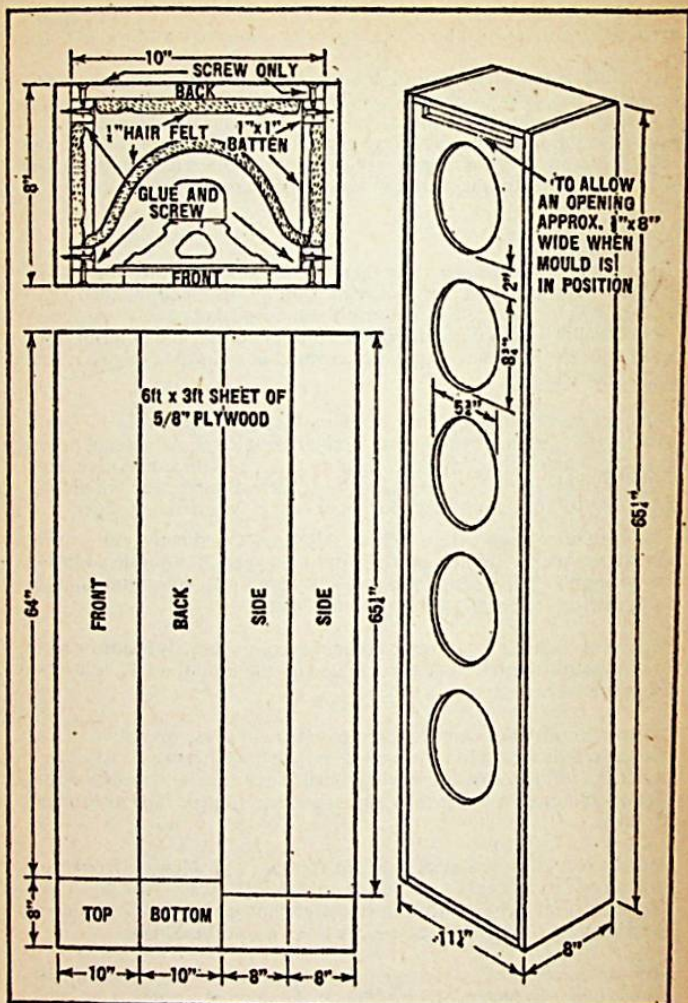

*These sketch plans indicate how the plywood sheet should be cut and how the panels are assembled. Note the use of 1 x 1-inch internal cleats to strengthen all corners and the use of internal padding to damp stray middle frequency resonances.*

Again, by using a column or columns above the front of the audience, but angled slightly towards the rear, the latter can be served without creating an intolerable level close to the speakers.

To be sure, these effects can be obtained with horns of one type or another but horns are famous neither for their frequency response, nor their aesthetic appeal. Sound columns, on the other hand, can often be attached to pillars, merged into architectural features, decorated in various ways or even build into stage and proscenium arrangements.

In practice, they come in sizes ranging from a few square inches in cross sections and two or three feet high, to square feet in cross section and many feet in overall height. They use anything from half a dozen three or four-inch speakers to an imposing array of twelve-inchers!

The performance varies to much the same degree. Some of the very small columns, often employed in hotels, etc. for paging and background music have no more to offer in the way of fidelity than a mantel radio set. At the other extreme, the huge columns built into the Sydney Town Hall can boast the response and power handling capacity necessary to stimulate a grand organ. In between are a variety of types with equally "in between" characteristics.

The plain fact is that almost any column loudspeaker will exhibit the kind of sound radiation pattern that one would expect—at middle frequencies. But, at the ends of the range, the problems of a column are not basically different from other systems. The high frequency response is still limited by the capabilities of the individual speakers, while the bass response is a function of cone resonance, enclosure volume and the various manipulations which can be attempted in this region.

these manipulations can modify the result a good deal, it is nevertheless not too far from the truth to accept the premise "the bigger the box, the bigger the bass". And it is certainly true that the smallest columns have no bass output to speak of, however good they may be in other respects.

While, as we said earlier, extreme fidelity may not be the prime objective in a public address installation, it is natural to seek the most favourable possible compromise with the conflicting factors of cost and bulk. But, even allowing for fairly generous ideas in regard to enclosure volume, bass response is likely to pose a serious problem.

A typical column of medium size may use a number of 8-inch or 9 x 6 inch speakers, having a cone resonance of about 85 c.p.s. Used in an open-backed cabinet, such speakers exhibit reasonably smooth response down to this frequency, the output tapering off sharply below it. Reproduction is not notably "coloured" though lacking in the lower bass register.

## **Resonance Rises**

If the rear of such a speaker is boxed in, however, to eliminate random rear radiation, cone resonance rises quite markedly. Furthermore, if several such speakers share the one sealed enclosure, the rise in resonance can be considerable, because each cone behaves more as if it is contained in a box, having only an equivalent fraction of the total volume.

In practice, the cone resonance may easily rise from 80 c.p.s. to nearly double the figure, producing a colouration which some have described as a "wooden" or "boxy" kind of bass response.

The situation could be relieved by using speakers with a much lower natural cone resonance, but with difficulties in other directions. Such speakers are likely to be special or imported units and considerably higher in price—which becomes a major factor when using at least four of them per enclosure.

The lower cone resonance means longer voice coil travel; this necessitates a longer voice coil and a possible loss of sensitivity or else the expense of a bigger magnet structure to maintain sensitivity at an acceptable level. In short the problems encountered are as outlined in our article "Big Bass From Small Enclosures".

## **Different Standard?**

Significantly, however, one may choose to apply quite different standards and therefore a different order of compromise to something intended primarily for public address, as compared with something for home hi-fi listening.

A further possibility has to do with the use of internal padding in the enclosure and the provision of vents or ports.

Padding is desirable to absorb internal reflections in the middle and lower register but it cannot obviate the rise in cone resonance, as mentioned earlier.

The use of a simple vent or port is likely to be disappointing too, in a long, narrow column structure. It would appear from observation that the port serves well enough the speaker closest to it but is progressively less effective for those further away. The most remote speaker (or speakers) still exhibit an artificially high cone resonance, with excessive acoustic output at the resonant frequency.

This objection can be overcome to a degree by using a principle featured in the so-called J-J enclosure. This involves mounting the speakers on a supplementary baffle, which is supported away from the front panel proper by a critically adjusted distance. The rear space between baffle and cabinet front along the total length of the column.

While not ruling it out as a possible approach, objections to the scheme include the extra material and woodworking involved, the sharpness of the resonance peaks so produced and the critical nature of the adjustments involved if the benefits of the scheme are to be fully realised.

An alternative scheme, which is strongly favoured in some quarters, is to create a distributed vent effect by drilling a line of holes (about 3/16-inch) down one side of the front baffle from top to bottom of the enclosure.

### **Acoustic Resistance**

This provides the necessary distributed vent to serve all speakers equally, while automatically producing high acoustic resistance and a broadening of the relevant peaks. The number of holes involved, determining the total effective vent area, is dependent on the enclosure volume and the fundamental speaker cone resonance.

It so happens that a recent brochure released by the Rola Company features several column-type enclosures, intended for 6-inch, 8-inch and 9 x 6-inch ovals, using four speakers in each case. The oval speaker arrangement is attractive in that the cones can be placed end to end to obtain a large effective overall length with restricted column width.

The enclosure is about 5 feet high, just under 1 foot across the face and about 10 inches deep. It is padded internally but completely sealed.

A tantalising feature, from the home-builder's point of view, is that it will not quite cut from a single 6 x 3 ft sheet of plywood. We reckoned that a considerable saving in cost would be possible, with little change in performance, by re-scaling to cut from a single sheet and using 5/8-in plywood for the basic structure.

We determined also to experiment with simple vent arrangements, in the hope of extending the bass response.

The cabinet was therefore proportioned to be as large as possible from a single plywood sheet, the joints being arranged to present unbroken surfaces at the sides for subsequent polishing. The top, rear and bottom will not usually be seen while the front will normally be finished with beading and plastic cloth.

### **Parallel Connection**

The slim, vertical line of the resulting cabinet is not only pleasing in itself but is adaptable to a variety of speaker arrangements. It would be possible, for example, to accommodate six 8-inch round speakers down the face, with a pattern of holes, as already mentioned, acting as a distributed port.

In fact, there is room for six 9 x 6-inch ovals, mounted end to end, though curving the holes would call for care, so as not to fracture the plywood left between the holes.

While some may, in fact, want to use six speakers, we imagine that others will be more than satisfied with five and most with a group of four.

On this assumption, and with the further idea of leaving two inches of plywood between adjacent holes, we cut five oval holes of the appropriate dimensions in the front panel. We had in mind primarily to use four of the holes for speakers, retaining the fifth for subsequent treatment as a vent, a port or acoustic resistance.

Alternatively, it could take a fifth speaker, with some other form of venting, though prime attention was given to the four-speaker arrangement.

The initial and natural step was to put the speakers in line in the top four holes with the bottom hole vacant. However, as mentioned earlier, it soon became evident that the vent was too remote from the top speaker to serve much useful purpose, allowing its cone resonance to be too high and too prominent for best overall results.

It subsequently became evident that an almost endless variety of minor impedance peaks could be created by "doctoring" the main port, by creating other ports or mounting the speakers back from the baffle to provide minor venting beneath the pad ring. However, while these modifications provided interesting observation on test instruments they looked far too chancy to recommend as an approach for home-builders.

A further complication also threatened. Rola engineers had expressed to us the desirability of operating all voice coils in a column in parallel, in order to ensure, as far as possible, in-phase operation of the individual cones. Contrariwise, we would have preferred a series arrangement of low-resistance voice coils, to give something like a 15 ohms impedance without need for a supplementary auto transformer.

It soon became evident, however, that fiddling with individual speaker mountings produced a basic dissimilarity in impedance behaviour, which made the possibility of anything but strict parallel connection even more remote.

Again this general background, and to cut a long story short, we finally mounted two of the speakers in the lower holes, leaving the centre hole to serve as a vent. A small supplementary vent was provided at the top as shown.

Measurement now showed two distinct impedance peaks, one either side of the speakers' natural cone resonance, at about 50 cps and 140 cps.

After listening tests, we decided to place a form of acoustic resistance across the vent, mainly to limit radiation from it of random middle-frequency sound, likely to prejudice the frontal pattern from the cones. This increased slightly the amplitude of the higher peak and flattened the lower peak till it was barely perceptible.

### **Serves All Speakers**

The "acoustic resistance" used for the purpose was merely a scrap of half-inch-thick caneite screwed over the vacant speaker position and drilled with a pattern of 1/4-inch holes spaced one inch apart.

On listening tests, and in this form, the column showed a fairly level output down to the 140-cycle region, where there was a slight prominence but not enough to colour reproduction objectionably. Below 150 cps the level is lower but output is available to well below 50 cps. This means that, if desired, discreet amplifier boosting can be used in the lower bass register to produce useful acoustic output.



At the high frequency end, the response is largely a function of the particular speakers. If routine frequency range only is required, ordinary 9 x 6-inch single-cone speakers can be used, preferably with the largest possible magnets, in the interests of sensitivity.

In our prototype enclosure, we used speakers newly released by the Rola organisation, namely type 9-6LX, fitted with centre tweeter cones and 15-ohm voice coils. These have basically the same sensitivity and bass characteristics as the normal 9-6L type, but maintain output to above 12Kc.

Using these speakers, musical reproduction from the column is excellent, with only a lightness in the extreme bass register to distinguish it from one's normal concept of hi-fi sound. However, the behaviour of the column, as described, allows boosting to be used in the lower register with gratifying results.

### Readily Adaptable

As mentioned earlier, and according to Rola engineers, the voice coils should ideally be connected in parallel and, of course, correctly phased so that the cones all move in the same direction at any instant.

Thus four 3.5-ohm voice coils in parallel would present a 0.9-ohm load, while four 15-ohm coils would produce 3.75 ohms. This may necessitate, in turn the use of a matching or auto transformer to allow the column to be fed conveniently from a fairly long line.

Using four 15-ohm speakers, as described, we found it practicable to connect them in series-parallel to produce a convenient total impedance of 15-ohms. At this impedance it is quite practicable to feed the column from a 15-ohm output transformer via a quite considerable length of plastic lamp cord, without line resistance causing any noticeable drop in efficiency.

The two upper speakers are connected in series, likewise the two lower ones, the leads being then connected in parallel across the line. Thus two speakers in series represent 30 ohms, and 30 ohms in parallel with 30 ohms gives a resultant of 15.

As before, it is essential to see that the speakers are correctly phased. Nowadays manufacturers are normally careful to see that all speakers of the one type are symmetrical in terms of magnet voice coil polarity, so that correct phasing can usually be obtained by proper interconnection of the voice coil lugs.

However, phasing can be checked very simply by touching the input line across a 1.5-volt torch cell and noting that all the cones move in the same direction for a given polarity of input voltage.

If one or more happen to be the wrong way around, simply reverse the leads to the voice coil.

At this juncture it may be as well to set out a few practical hints about the actual woodworking involved.

The most suitable material for the cabinet, consistent with cost and rigidity, appears to be 5/8-in plywood and, as already mentioned, we planned the design so that it could be cut from the popular 6ft by 3ft size sheet. To provide an attractive finish we selected a maple veneer.

### Marking Out

The marking and cutting out of the sheet is straightforward, providing that the drawing is followed and the saw, whether power or hand, is kept on the line. Some sheets, depending upon the manufacturer, are a little over-size and this can be distributed over the four sides, ensuring a minimum of waste material.

Having cut the sheet, opposite sides of the cabinet can be clamped together using G-clamps, veneered side inwards, and the edges planed straight and square. Remember to work from both ends to prevent chipping at the corners.

Some difficulty may be encountered in obtaining a good straight edge on the long sides but this can be checked by removing the G-clamps and butting the two corresponding edges together. Any high spots will be indicated by the amount of daylight visible between them. These can be marked with pencil and the sides reclamped and planed a little more.

Next the front panel can be marked out, the first step being a centre line running from top to bottom. Assuming the use of four elliptical speakers and five holes, as already suggested, the openings may be spaced two inches apart, with three inches from the top of the panel to the first opening. The latter space is to accommodate the vent, which should be 5/8-in deep, after allowing for whatever decorative moulding is selected.

The baffle opening for a typical 6 inch by 9 inch elliptical speaker is  $8\frac{3}{4}$  inches along the major axis and  $5\frac{3}{4}$  inches along the minor axis. The method used to obtain these ellipses was to insert a pin at each of the two focal points and, using a suitably adjusted loop of string and a pencil, describing a regular ellipse.

With the aid of a compass, these focal points can be obtained by first bisecting the major axis and drawing a perpendicular along which the minor axis is measured. Then with the compass opened up to half the major axis and the point on one end of the minor axis, describe an arc; the two points at which the major axis is cut being the focal points. Some time could be saved by using a cardboard template cutout.

The speaker cutouts were started by first drilling a series of small holes along the waste side of the outline and cutting out with a compass or keyhole saw. Rough edges can be cleaned up with a wood rasp and then sanded.

To ensure rigid construction, we decided to use 1 inch by 1 inch dressed batten in the four vertical corners and along the sides at both top and bottom. As soon from the plan drawing, this batten will be screwed and glued in all corners except to the back panel, which is screwed only.

### **Screwing Up**

The battens are screwed to the sides from the inside and can be prepared by drilling and countersinking clearance holes along one edge approximately 12½ inches apart. The back and front are screwed from the outside and they may be prepared by drilling and countersinking a similar series of holes about half an inch from each edge. Make sure these are suitable staggered so that the screws will not clash.

The job is now ready for glueing and screwing, and it is a good idea to keep the square handy and use it frequently. Once the glue sets there is little chance of correcting mistakes.

Casein-glue is a logical choice for this job. It has the advantage of cold mixing, a long setting time which permits unhurried assembly, and excellent strength when dry. The screws used were 1¼in, No.8 gauge, countersunk head.

With one side placed on a flat surface, two main vertical battens are glued and screwed in position allowing a margin around all four edges equal to the thickness of the plywood. Two small pieces of batten then join the ends of these as shown in the drawings. Tightening the screws will provide sufficient pressure to the glued surfaces. The same routine is followed for the other side.

Next, both the top and bottom of the cabinet can be glued and screwed to the sides, the screws passing first through the clearance holes in the top and bottom battens and then into the top and bottom respectively.

### **Keeping Square**

To ensure that the cabinet will remain square whilst drying, the front panel can be glued and screwed in position and the back screwed on. The cabinet should then be left overnight to allow the joints to dry and set thoroughly.

Finally, the edges can be planed level with corresponding faces and the whole cabinet sandpapered.

The back panel may now be removed and the speakers mounted in position.

All inside surfaces with the exception of the front panel are then covered with ½-in hair felt, more commonly known as carpet underfelt. A baffle curtain is also draped loosely around the rear of the speakers and tacked in position as shown on the plan drawing.

We planned to cover the front panel with fabric and, to prevent the pattern of the speaker cones being visible through this, the entire panel was given a coat of flat black paint. A dark stain probably would have served the same purpose had it been on hand, but a small tin of black-board paint proved an economical solution to the problem.

The fabric selected was one of the "Tygan" variety of woven plastic, made by Colan Industries. This material has virtually no adverse effect on the radiated sound, being acoustically transparent to a high degree.

Unfortunately, the length of the column makes it difficult to provide a single strip of material without incurring a lot of waste. However, a few designs are made in 64-in wide rolls and we were able to purchase a 1ft-wide strip from one of these. This is just long enough to do the job if handled carefully.

The fabric may be fastened to the panel either by stapling (an office stapling machine does an excellent job) or by gouging. We chose staples, mainly because we felt it might be necessary to remove the fabric if further experiments were warranted.

If it is to be glued the makers recommend a PVC type glue which dries colourless and is slow enough to allow the fabric to be straightened and adjusted after it is fitted.

If a single 64in strip cannot be obtained, two 3ft lengths will have to be employed, with the centre join masked by an extra strip of moulding as used for the edges.

The moulding chosen for the edges is supplied with a gold bead which is fitted to a centre groove. It was attached by using 1½-inch panel pins nailed into this groove, the heads driven home, using a piece of sheet metal as a punch.

The gold bead was then mitred, using a fine file, and temporarily placed in this groove, concealing the nails. A more permanent job can be made after staining.

After a fine sanding the cabinet can be stained and polished. Because of the light shade of the fabric used, it was decided that the inside half of the moulding remain the natural wood colour, being close to that of the fabric, and the outside half of the moulding stained to blend with the darker shade of the veneered plywood. Thus the gold bead provides the break between the two shades.

In conclusion, here's a brief note for those who may want to use five oval speakers. Rola 9 x 6 LX speakers are assumed with a cone resonance in the 85-cycle region.

Provide the vent at the top as specified for the four-speaker arrangement. Draw pencil lines, one down either side of the front baffle and along the bottom, just clear of the speaker frames. Mark off and drill 3/16 holes at 1-inch intervals along these lines, making about 120 holes in all. This provides the necessary extra venting. With five speakers, a series-parallel voice coil system becomes less attractive, though it would be possible to parallel the outer speakers and connect them in series with the centre one; the other two, in series, could connect across this.

The preferred system, however, would be to connect the voice coils in parallel, using an auto transformer to suitably raise the impedance.

## LOUDSPEAKERS FOR STEREO

*This is the story of a loudspeaker system which started out as a rather novel line-source unit for public address and finished up with specifications which put it into the category of a higher-powered version of our highly successful "Bookshelf" system.*

The general concept of this new loudspeaker system was mentioned in an article on the "Stereo Public Address Amplifier" but, at the time, we had not completed our developmental work on the system, nor realised how completely successful it would be.

To start at the beginning, the new system had its roots in the 36-inch tall line-source enclosure for use with indoor public address systems. We tended to think of them as "column" speakers, but the term invited too much confusion with the quite unrelated idea of mounting domestic hi-fi speakers in drain pipes or other columnar structures.

A line source system is one in which, typically, four or more loudspeakers are mounted fairly close together and in a vertical line. The cones face the area to be served with sound, the rear of the loudspeakers usually being enclosed.

Provided the loudspeakers are connected so that the cones move in phase, they tend to project a beam of sound which has a fairly wide coverage in the horizontal plane, but a fairly narrow beam in the vertical plane.

The unit is normally mounted in an auditorium so that it is above the heads of people seated in the front rows and aimed toward those at the rear. People at the front of the auditorium receive only a limited proportion of the sound, because the beam tends to pass above them, while those at the rear, who most need it, receive the full benefit of the reinforcement.

The system has the additional advantage that the main beam of sound is kept out of the ceiling area in lofty auditoriums, thus inhibiting the generation of strong echoes from this area.

The original line source enclosure was arranged to be 36 inches tall, mainly because this is a convenient figure for home carpenters working with a standard sheet of plywood. The remaining dimensions represented a compromise between an enclosure which would not be unduly bulky, and one which would not generate a too prominent peak in the upper bass register, because of an unduly small enclosed volume.

In an effort to relieve and utilise back pressure from the cones, we suggested drilling a pattern of small holes down both sides of the baffle, forming what is commonly referred to as a "distributed port".

For the loudspeakers we suggested four Magnavox 6WR twin-cone units, normally connected in series-parallel to give the same impedance as a

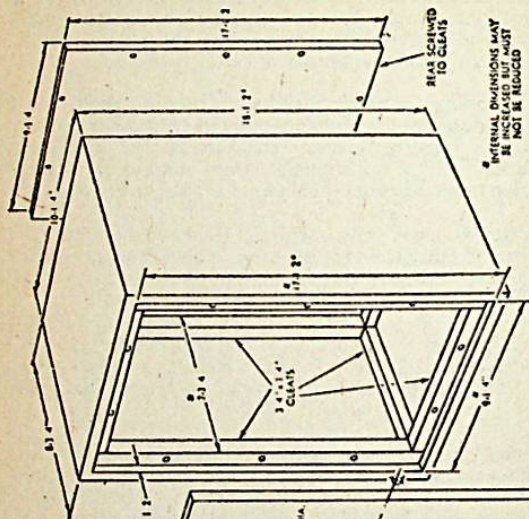

1 3/4" Baffle  
 FINISH EDGE TO ALLOW FOR  
 THICKNESS OF SPEAKER FABRIC.  
 BAFFLE SCREWED TO CLEATS  
 FROM THE INSIDE.

1 1/4" FOAM PLASTIC,  
 BLACK OR PRAYED WITH  
 FLAT BLACK PAINT, AND  
 GLUED TO FRONT OF BAFFLE  
 (OPTIONAL)

ACOUSTICALLY  
 SPRAYED FABRIC  
 STAPLED TO  
 REAR OF BAFFLE

ENCLOSURE PACKED WITH  
 1 1/2" FOAM PLASTIC  
 1 1/2" OR 100% "MINUSION".

The exploded diagram shows the construction of the new enclosure, together with essential internal dimensions. These can be varied slightly provided internal volume is not reduced. Minimum wall thickness is 1/8-in and all joints should be airtight. The foam overlay for the baffle is purely for styling and was not fitted to the prototype cabinets.

single unit. For those who might have been deterred by the price of the 6WR we suggested using its "smaller muscled" brother, the 6PIX. In fact, other 6-inch loudspeakers have since made their appearance on the market, with a sufficiently low bass resonance (50 to 60Hz) and adequate power handling and frequency response to do a similar job.

While a line source loudspeaker system along these general lines remains as good a proposition as ever for indoor public address, we were deterred by the thought that few would be prepared to provide two such systems for our proposed Stereo Public Address amplifier. We had to find a more appealing answer.

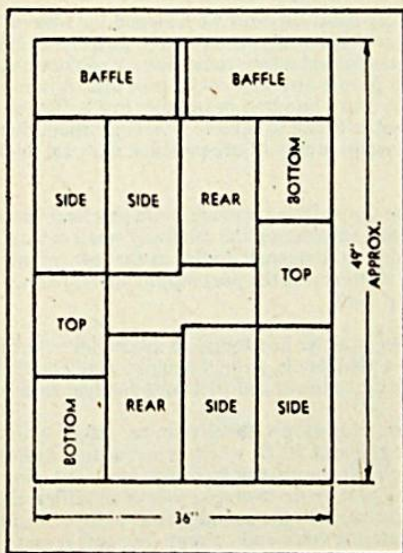

*For those working with plywood sheets, the cabinets can be cut out as shown, for minimum wastage.*

This led to the idea of making two enclosures, each about 18 inches tall and each containing two 6-inch loudspeakers. Where the situation demanded a line source system, for its vertical directivity, the enclosures could simply be stood one on top of the other, to produce a 36-inch 4-speaker column very similar to the original.

However, where the opportunity occurred, the enclosures could be separated, typically one to either side of a stage, to provide stereo music and well dispersed speech from the microphone channel. Each would have some vertical directivity, by reason of the two vertically aligned cones. The idea fitted the need so well that to think of it was to adopt it!

When we began to examine the proposition more closely, it became apparent that the proposed twin enclosures had the potential of being more than just the two halves of a public address line source. They would be of such a shape and size that they might very well be expected to double as compact enclosures for a high quality domestic stereo set-up. In planning them, therefore, we took a critical look at dimensions and volume, at the possibility of retaining our original distributed port idea, at the mailing-tube type of port and at the possibility of providing room for a tweeter and even a cross-over network!

Why design an enclosure for just one job, we reasoned, if we could make it readily adaptable for several?

To cut a long story short, first-off we dropped the idea of the distributed port. Whatever advantages the scheme might have, it is quite unsuitable for economical mass production by cabinetmakers—remembering that most people now buy cabinets or kits. A home carpenter may find time to drill a hundred or so holes in a baffle, but not a cabinet or kit maker trying to achieve a certain production rate. Nor could we find a ready supply of pre-punched material thick enough for a baffle.

The mailing-tube type of vent is much more practical but we were not happy with results, considering the relatively small cabinet volume. The system tended to frequency double at the low end more than we liked, while the cloth across the port mouth added its own considerable quota of flap and buzz.

So we reverted to what we had found so successful with the Playmaster Bookshelf unit: a completely airtight enclosure substantially filled with Innerbond material, to lower and to dampen the system resonance.

With the dimensions as shown, the system resonance with 6WR loudspeakers, occurs at about 90Hz, which is just a trifle higher than the original Bookshelf. However, thanks to the heavy damping provided by the Innerbond and by the average modern amplifier, there is virtually no sign of the resonance in the sound pressure curve; actually, we kept track of it by metering voice coil current. The actual pressure curve taken with the enclosure at floor level, is well-sustained to about 70Hz, where the bass roll-off becomes evident.

Not having to provide for port area cleared the way for possible addition of a 3-inch (or smaller) tweeter, the 6-inch loudspeakers being moved to one side just enough to create room for it.

We therefore set about a series of listening and evaluation tests on the basis of a sealed enclosure, to be packed with an amount of Innerbond yet to be verified; and with room to mount a tweeter and cross-over network, should these be considered worthwhile.

In accordance with the advice of Magnavox engineers, the 6WR loudspeakers in the new cabinet were two 33-ohm units wired in parallel to give near enough to the usual 15 ohms impedance. The parallel



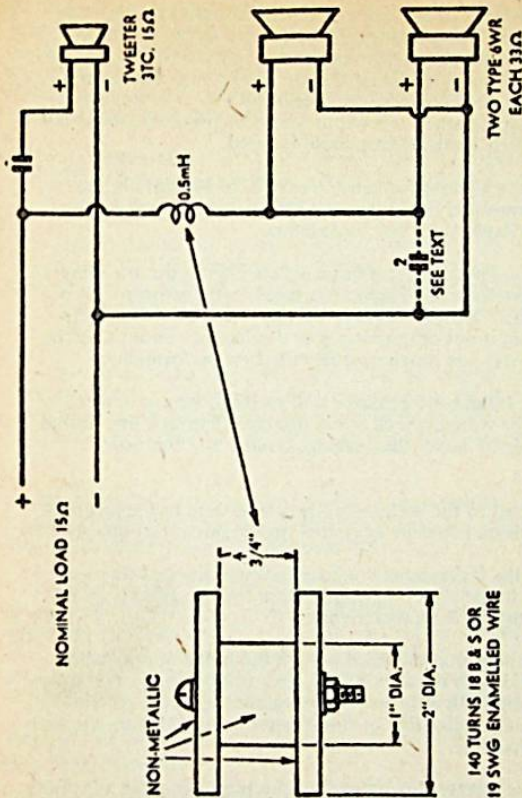

*The diagram at the right shows how the system is wired internally and, at left, winding details of the inductor. A suitable inductor may be made available commercially. The extra 2uF capacitor shown dotted improved the response contour around 5KHz. Without it, the system has a slightly more "middy" sound, which some may actually prefer.*

connection puts each loudspeaker directly across the amplifier, independently of other speakers. With any kind of a series arrangement, inevitable variations in the impedance of one speaker affect the drive to the other and, of course, the electrical damping.

Our advice, therefore is to plan for the loudspeakers to be connected in parallel and to order units which will give the requisite total impedance.

Our first observations were made with just the two 6WR loudspeakers in the enclosure, and with the tweeter cutout blocked off. As some kind of a reference, we set it up alongside one of our prototype Playmaster "Bookshelf" units, for which we had measured curves, with a changeover switch to select one or the other.

With just the two 6WR's in operation, the general sound quality was good and certainly well above average by any kind of public address standards. The bass had a good "fundamental" sound about it and we have no hesitation in recommending the use of two such enclosures, as originally envisaged, each containing a pair of 6WR's. For the loss of about 2dB in sensitivity and a somewhat lower maximum acoustic output, the cheaper 6PIX loudspeakers could be used.

Other low resonance high-performance loudspeakers might also be considered as alternatives for this general role, provided they can be obtained with a suitable voice coil impedance.

As for the Innerbond packing, it is quite practicable to use the same size piece as suggested for the Playmaster Bookshelf enclosure (14 or 16oz, 36 x 18 inches) loosely rolled to occupy the space behind the speakers. If the cost is not deterrent, up to double this amount can be used, though not with too much audible effect on performance.

Objective number 1 had been achieved and verified. We could recommend a loudspeaker system which could double either as a line source unit or a stereo pair of better than average quality for domestic listening.

Then we surrendered to the seemingly irresistible urge to see just how far this same enclosure could be exploited, in the pursuit of quality.

Comparison with the Playmaster Bookshelf system showed the new unit to be lacking in the upper register, judged by high fidelity standards; this despite the 6WR's tweeter cone.

At this stage, we uncovered the third hole in the baffle and installed the Magnavox 3TC3-inch tweeter. Taking care to observe correct polarity, one side was wired directly to the equivalent lug of the parallel connected 6WR's, the other side of the tweeter being fed from the active input via a 2uF capacitor.

Introduction of the tweeter brightened up the response quite a lot but, remembering the lessons learned from the Bookshelf system, we decided not to jeopardise results by leaving out the inductor necessary to constitute a proper cross-over network. A 0.5mH coil was then added, providing a cross-over at 5KHz, to suit the small tweeter.

Now on listening test, the system sounded quite impressive and, at loud volume, there could be no doubt about the value of having two 6WR speakers to share the heavy work up to 5KHz. Listening and measured tests indicated, also, the desirability of completely filling the enclosure with Innerbond, amounting to two pieces of 14 or 16oz material, each 36 x 18 inches rolled together to tuck fairly tightly around the speakers.

Under these conditions and with about half bass boost from a twin 12-watt amplifier, the bass response assumed a heavy non-resonant quality, that seemed completely free of doubling or distress or any kind.

Overall, the sound had a slightly middle-heavy quality, so favoured by some for its "presence" and so "safe" by reason of its discrimination against any slight "edge", whether present in the original music or produced by less than perfect record and replay. But most observers in the E.A. lab still expressed a preference for the somewhat brighted sound of the Bookshelf unit.

Pressure curves taken subsequently indicated the reason clearly enough. While the tweeter was doing its duty high up, the 6WR's were letting down a little in the 5KHz region by comparison with the level elsewhere.

The answer turned out to be delightfully simple: Add a further 2uF capacitor, this time wired across the 6WR's. By turning this half of the filter into a quarter-section, it would lift the output from the 6WR's near the cross-over region, dropping it away more sharply where the tweeter took up.

The modification left no doubt, either in the response configuration or listener verdict: The new system sounded every bit as good as the Bookshelf in terms of balance and remained clean at higher power levels where the Bookshelf, with its single bass speaker, was showing signs of distress.

In short, having started out to develop a public address unit, we had ended up with a loudspeaker system which we are quite happy to identify as the Playmaster "Super Bookshelf".

The "Super" is not intended to supersede the original Bookshelf unit and the performance of the two will leave little to choose at ordinary domestic listening levels. But, if you want higher power handling capacity and are prepared to meet the extra outlay for the additional bass speaker, the extra capacitor and the extra Innerbond, a Super Bookshelf will take a lot of beating, both in terms of performance and value.

And, of course, a pair can still be treated as the two halves of a superb line source system!

Having explained at such length how the new unit came into being, we must not overlook the few paragraphs necessary to discuss construction.

The exploded diagram herewith gives the essential inside dimensions and suggests a typical arrangement of internal cleats to hold it all firmly together. The dimensions can be varied somewhat to suit individual needs provided the internal volume is not decreased. It may be increased but NOT decreased.

With the relatively small panel sizes involved in the enclosure, half-inch thick material is adequate. It may be made thicker but NOT thinner.

Home carpenters may prefer to work with plywood but those mass-producing cabinets, these days, seem to prefer flake board of one type or another. This is quite satisfactory, provided you don't expect to wind screws in and out the same holes too many times. The original cabinets

were actually made for us out of flake board, surface finished in oiled teak veneer. As such, their appearance was much more appropriate to a modern lounge room than a P.A. situation, where a plastic cloth or laminate would probably be more the thing.

A basic requirement of sealed enclosures is that they should, in fact, be airtight, in the acoustic sense of the term. Joints at the four corners should be snugly glued, and all cleats accurately fitted and glued in position. If the front baffle and back are dressed to a snug push-fit, a pattern of screws around the cleats should hold them firmly in place.

And don't spoil all the good work by just passing the leads out through oversized holes. Fit connectors or plug the holes with a non-hardening compound.

The connection of the loudspeakers and details of the inductor are given in the accompanying diagrams. Note that, with the 3-inch or other small equivalent tweeter, the cross over **MUST** be in the vicinity of 5KHz and not 5.5KHz, as preferred in the original Bookshelf unit, with 5-inch tweeter. The inductor therefore must **NOT** be a 1.0mH unit but one having 0.7 the number of turns and half the inductance.

The 2uF capacitors are not critical as regards type or specification, as long as they are paper types and somewhere near the requisite value, as checked on an R/C bridge. The voltage rating is unimportant.

The unit, as described, is based on a nominal 15-ohm impedance, which will meet most requirements.

To construct a nominal 8-ohm version of the unit, it would be necessary to use two parallel connected 15-ohm 6WR loudspeakers and to associate them with an 8-ohm tweeter. The capacitor value would have to be increased to 4uF and the inductor reduced to 0.25mH, having about 0.7 the number of turns of the 0.5mH inductor.

Perhaps we can forestall another question: If the new enclosure appeals, with its somewhat more "dumpy" shap, can it be used to house a Bookshelf system?

Yes, we thought of that one too. Its internal volume is higher than that of the Bookshelf and a single 6WR operating in it would acquire a slightly lower system resonance, which is all to the good. Mount one 6WR at the bottom, fit a masonite or plywood patch over the two remaining holes and mount the tweeter of your choice on it so that it radiates out through the upper hole. Keep the whole system airtight, and use a single 36 x 18-inch piece of Innerbond, as for the Bookshelf unit.

If your choice is for a 5-inch tweeter, provide a 2.5KHz crossover; if it is a smaller type, provide a 5KHz crossover.

## POWERED LOUDSPEAKER FOR PORTABLE RECORDERS

This article discusses several ideas for those who wish to improve the sound quality from cassette recorders or portable transistor radios. It describes the use of a larger speaker enclosure in place of the internal speaker, the construction of a power amplifier to provide still more boost, and a mains power supply to save battery costs.

Practically everyone who owns a portable radio or miniature tape recorder has wished, at some time or other, to connect an external loudspeaker to improve the quality of the reproduction. After all, one cannot expect a wide range sound from a small loudspeaker with little or no baffling. An external speaker of even average quality will improve the sound from just about any small set, provided the amplifier is not so badly designed that the internal loudspeaker is actually masking a lot of inherent distortion. The external loudspeaker, by virtue of its greater cone area, larger magnet, and improved baffling, will usually be far more efficient than the set's internal speaker and will allow the amplifier to operate at a lower, more distortion-free level.

Besides using the set with an external loudspeaker it is usually desirable to have a mains supply to conserve the batteries. The quality of reproduction from any amplifier depends to a large extent on the regulation of the power supply. While new batteries provide a portable power supply with good voltage regulation, this tends to deteriorate long before they have reached the end of their service life. This deterioration is caused by the gradual depletion of the chemical components of the battery. Poor regulation and reduced voltage causes an increase in the level of distortion, a decrease in the sensitivity of portable radios, and a general fall-off in power capability of the amplifier.

Since this kind of deterioration would largely offset the advantage of a more efficient speaker system, with or without its own amplifier, a power supply becomes almost essential if lengthy periods of operation are envisaged. There is also the straight-out economic aspect to be considered, as it is surprising just how expensive battery power becomes when batteries have to be replaced every few weeks.

The need for a separate power amplifier to drive the speaker is dictated by the limitations of most portable units. Their power output is usually limited to a few hundred milliwatts and, while even this will sound a whole lot better when applied to a large efficient speaker system, it is not really sufficient in many applications.

What is desired then, is a loud-speaker-cum-amplifier with a power of, say, 3 watts, with the mains supply for the amplifier arranged to do double duty by supplying the power requirements of the cassette

player or portable radio. As further icing on the cake, the amplifier would be suitable for direct connection to a ceramic cartridge; an arrangement which could perform sterling service at parties and so on.

The speaker system used should be one of the more efficient types — a bass reflex type would be ideal — to obtain the best performance with the proposed amplifier. The small bookshelf enclosures are seldom efficient enough to be driven to an adequate level with a 3-watt amplifier.

The amplifier is based on a 3-plus-3 Stereo Amplifier. The sensitivity has been increased to 150mV for full output, partly as a result of dispensing with the balance and tone controls, and partly at the expense of lower input impedance, which is now of the order of 500K. A ceramic cartridge such as the BSR CI will drive the amplifier into clipping, even on lightly recorded discs. The volume control at the input enables the amplifier to handle a wide range of signals without being overloaded.

A value of 500K is somewhat less than ideal as a load for a ceramic cartridge, and will result in some loss of bass response. However, it is not as serious in practice as might be imagined, particularly in the kind of casual listening application for which this equipment is intended. If it should transpire that the particular cartridge has output to spare, then it would be advantageous to add as much resistance as possible in series with it; i.e., at the "top" of the volume control. This will reduce its output but improve the bass response.

The power supply for the amplifier consists of a small power transformer with a multi-tapped secondary winding, the 12.5V tap feeding a bridge rectifier. The D.C. output from the rectifier is filtered by 4,000uF of capacitance. Part of the DC output is fed to a zener diode network which supplies the DC requirements of the signal source; tape recorder, radio, etc. A 6, 7.5, or 9-volt zener diode may be used depending on the voltage required. For simplicity we have only shown a 7.5 volt zener on the circuit diagram. If a 6-volt zener diode is used the series resistor may be increased from 39-ohms to 47-ohms to avoid unnecessary current drain.

With the 7.5 volt zener in circuit the standing current is around 250mA which is the main reason for the large amount of filter capacitance. Some signal sources, such as a record changer, will not require low voltage DC and to avoid unnecessary power wastage when the DC is not required we have arranged for the zener diode network to be disconnected from the circuit when not in use. We have used a four-pin plug and socket for the DC output. The plug is wired with a link, as shown on the circuit diagram, and this serves the purpose of a switch.

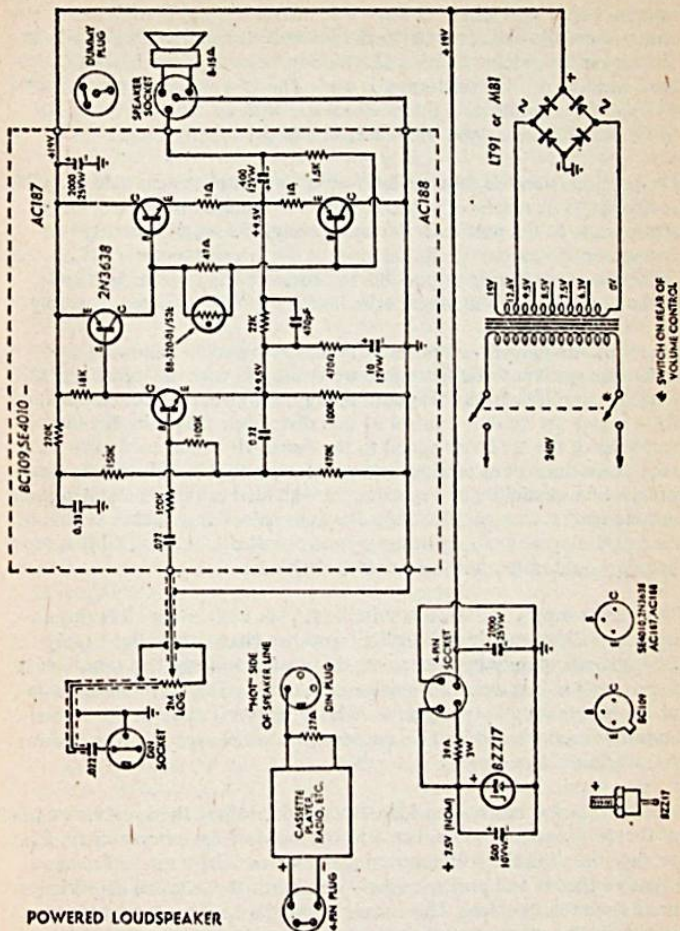

When the plug is removed no power is supplied to the zener diode network.

The maximum power available from the amplifier will depend on whether the zener diode network is in circuit or not. With it out the power output into an 8-ohm load will be 3 watts continuous, dropping to 2 watts continuous with the zener network in circuit. A similar order of power output can be obtained with a 15-ohm loudspeaker if the 15-volt secondary winding of the transformer is used. The 15-volt winding must not be used if the amplifier is intended for use with an 8-ohm speaker, to avoid running the output transistors in excess of their ratings.

Connection from the four-pin DC output socket to the cassette, portable radio etc., is by means of a "patch cord" terminated with a connector appropriate to the particular device. Usually, the act of inserting this connector will automatically disconnect the internal batteries. If no such provision exists it may be possible to provide a change-over jack and socket, and modify the player or radio for use with an external supply.

Most cassette players and portable radios have a socket allowing an extension speaker to be fitted and we elected to take the signal for the external amplifier from this point. Ideally, the signal should be taken from across the volume control so that distortion caused by the internal amplifier of the set is not added to the signal. However, to do this would require modifications to most sets and these would be difficult because of lack of accessibility and space to run shielded cable and install an output socket. One could modify the external speaker socket so that it carried the signal from the volume control instead, but we feel that most people would rather not tamper with their sets.

The power supply as shown is suitable for use with either NPN (negative chassis, positive supply rail) or PNP (positive chassis, negative supply rail) systems, simply by connecting its positive and negative terminals to the corresponding input terminals of the device. The fact that one side of the power supply, the negative side, is "earthy" as far as the external amplifier is concerned is of no consequence while ever this is the only connection to the device.

However, as soon as we consider the situation where the speaker terminals of the device are to be connected to the input of the external amplifier, we face the possibility of conflicting polarities. Where the device has a negative chassis and positive supply rail, as for the external amplifier, there is no real problem. The chassis of the device can connect to the chassis of the external amplifier without complications.

On the other hand, a device with a positive chassis and a negative supply rail presents the problem that the two chassis must not be connected



together, at least in the DC sense. For this reason, only one lead, the "hot" lead, is provided to convey the audio signal from the speaker circuit of the device to the input of the amplifier. The return circuit for the signal is provided, in the case of a negative chassis device, via the negative DC supply lead. In the case of the positive chassis device it will be via the positive supply lead and the 500uF capacitor to the chassis of the amplifier. Thus the system is suitable for use with a device of either polarity, simply by ensuring that DC power terminals are connected correctly.

For correct operation the internal amplifier's output should be correctly loaded. In this application the load can, with advantage, be higher than the impedance value of the internal speaker. This will give a lower current drain and, usually, a slight reduction in distortion. We used a value of 27 ohms, and this appears to be a good compromise.

Originally, we thought to connect this resistor across the input socket of the external amplifier, but we realised that this would create a permanent low impedance input and prevent the use of other signal sources, such as a ceramic pickup. We solved the problem by wiring the resistor inside the three-pin DIN input plug for the external amplifier. The other end of the cable attached to this plug is fitted with a plug appropriate to the player or radio involved.

Motor noise superimposed on the amplifier signal can be a problem with some cassette players. The 500uF capacitor across the zener diode reduces this to a level that is not noticeable on normal programme material. It can also be minimised by operating the external amplifier with its volume control set at a low level while the volume control on the cassette player is set at a fairly high level, but well short of overload.

The prototype amplifier was constructed in a small metal box measuring 7 x 4 x 4 inches and fitted with a biscuit tin lid. The box has a volume of 112 cubic inches, and this means it can be installed in speaker enclosures of more than about three quarters of a cubic foot with little effect on the performance of the speaker. The box could be installed in smaller enclosures without the biscuit tin lid fitted so that it occupied less volume in the enclosure. The use of the metal box is a much better way of accommodating the circuit components than mounting them on the rear panel, inside the enclosure.

The layout is such that the volume control, the four-pin DC output socket, the three-pin DIN input socket, and the grommeted hole for the power cable are all fitted to holes in the bottom of the box. A cut-out is provided in the back of the speaker enclosure measuring approximately 5¼in x 3in and the bottom of the box is mounted against this from the inside. The box is secured by four wood screws, one in each corner, and

an airtight seal provided by means of a thin felt gasket.

The only other fitting on the speaker box is a miniature four-pin speaker socket mounted directly on the wooden back. The purpose of this socket is to provide a convenient means of connecting the speaker to either the amplifier inside the speaker box, or an external amplifier, such as part of the domestic stereo system. A dummy plug is used to connect the speaker to its own internal amplifier, while external signals may be fed directly into the socket. Note that this four-pin socket has a different pin configuration to that used for the DC output socket, for obvious reasons.

The presence of these various sockets in the back of the cabinet will inevitably result in some air leakage in the enclosure, mainly via the holes in the four-pin sockets, the DIN socket being essentially airtight. While this is theoretically undesirable, it must be realised that the amount of leakage is quite small; nothing like the kind of leakage which can occur when an ill fitting back can leave a gap along one complete side. As far as any application involving tape players, portable radios etc., are concerned, the effect on performance would be negligible.

Where higher quality signal sources are concerned, such as a stereo channel, some users may feel that even this is undesirable. Most of the leakage, such as it is, will be prevented if there is a plug in the socket and it would be worthwhile fitting a dummy plug in any otherwise unused socket. The alternative is to use a completely different system of connections, possibly based on terminals mounted directly on the wooden back of the box.

Use good quality components for the amplifier. The resistors should be carbon film types for best results, rather than carbon composition types. The latter tend to increase their value after a period of service and this can play havoc with the amplifier's performance. The author recently had real cause for regret when he had to trace a fault in a high-power direct coupled amplifier. The fault was caused by three carbon resistors which had gone high. All the other resistors were carbon film types!

All the components within the dotted line on the circuit diagram are mounted on a printed circuit board. This board is actually one half of that for the 3-plus-3 Stereo Amplifier referred to above. The board is coded and is available from most kitset suppliers. Mounting the components on the board is straightforward and requires little comment except for a caution to avoid overheating the components when soldering.

The need to provide half a standard printed board warrants some comment. It is not clear at the time of writing whether any of the supply houses will be able to supply half boards, or whether, if they

do. that the saving will be worthwhile. We suggest that the constructor should be prepared to buy a complete board and divide it himself. It may be possible for two constructors to share such an arrangement.

The most satisfactory way of dividing the board appears to be by scoring and breaking. An ideal scoring tool is a Laminex knife, available from most hardware stores. Score the board neatly down the centre, then clamp one half firmly between two pieces of board with their edges flush with the score mark. The board should then break cleanly.

The board is mounted by means of  $\frac{1}{2}$ -in long 1-8in Whitworth screws and nuts or shorter screws and spacers.

The output transistors, which have a TO-1 metal case, are wired directly into the amplifier board, leaving a lead length of about 1 inch. The leads should be insulated with spaghetti sleeving to minimise the risk of short circuits. The transistors are fitted with flag heatsinks which are normally supplied with each complementary pair. These metal flags are firmly secured to the case, as shown in the photograph, by means of  $\frac{1}{2}$ -in screws and nuts. The flags should be secured individually to the case to ensure the best heat transfer. — not two flags by one screw. If the box has been painted, the area to which the flag heatsinks are attached should be stripped to the bare metal to ensure efficient heat transfer. This is not to say that the transistors are dissipating a lot of power but it is desirable to keep the temperature as low as possible.

The speaker leads are brought out through a grommited hole in the side of the case and run down to the four-pin speaker socket. The filter capacitors and the zener diode network can be seen in the photograph. The zener diode is soldered directly to a tag strip and requires no auxiliary heat-sink.

The mains cord should be anchored by a clamp as shown in the photograph. When terminating the mains cord the earth lead should be left longer than the active leads so that if the cord is strained to the limit the earth lead will be the last to break.

The bridge rectifier we used was a selenium type, Westinghouse LT91,

Assembly will be made easier if a suitable order is followed. First mount the power transformer and bridge rectifier. Then mount the tagstrip, input and output sockets and volume control. Wire the components into the tagstrip and connect the wires to the DC output socket. Wire the mains cord to the switch on the rear of the volume control, and connect the shielded cable from the volume control to the small tagstrip which accommodates the .022uF capacitor and chassis terminations. Lastly, the board is mounted and connected into circuit.

At no signal the amplifier should have a current drain of 8 to 10mA. If this is not the case, the quiescent current should be adjusted by varying the 47-ohm resistor. Increasing the resistor will increase the current and vice versa. For maximum power output at the point of clipping, the DC voltage at the positive connection of the 400uF output capacitor should be slightly less than half the supply voltage. Normally there should be no need to adjust this but it can be set by varying the bias resistors for the input stage.

The final step is to put the lid on the case, reinstall the back panel of the enclosure and connect up your cassette recorder, or other programme source.

## PARTS LIST

- 1 case and lid, inside dimensions, 7 x 4 x 4 inches.
- 1 loudspeaker system.
- 1 vero board.
- 1 2M (log) potentiometer with power switch.
- 1 3-pin DIN plug and socket.
- 2 4-pin plug and socket (different pin patterns).
- 1 power transformer, with secondary tapped at 6.3, 7.5, 8.5, 9.5, 12.6 and 15 volts AC at 1 amp DC.

### SEMICONDUCTORS

- 1 AC188/187 complementary germanium pair (with flag heat-sinks).
- 1 BC109, or similar, high-gain, silicon NPN transistor.
- 1 2N3638 or similar, high-gain, silicon PNP transistor.
- 1 LT91 selenium bridge rectifier or MBI silicon bridge rectifier.
- 1 B8-320-01/50E thermistor.
- 1 BZZ15 or BZZ17 or BZZ19 zener diode for 6, 7.5 or 9 volt supply, respectively.

### RESISTORS

( $\frac{1}{4}$  or  $\frac{1}{2}$  watt unless specified)

- 1 x 470K, 1 x 270K, 1 x 150K, 3 x 100K, 1 x 22K, 1 x 18K, 1 x 1.5K, 1 x 470 ohms, 1 x 47 ohms/ $\frac{1}{2}$ W, 1 x 39 ohms/3W, 1 x 27 ohms/ $\frac{1}{2}$ W, 2 x 1 ohm/ $\frac{1}{2}$ W.

### CAPACITORS

(Higher voltage ratings may be used).

- 2 x 2000uF/25VW electrolytic.
- 1 x 500uF/10VW electrolytic.
- 1 x 400uF/12VW electrolytic.
- 1 x 10uF/12VW electrolytic.
- 1 x 0.33uF/25VW ceramic or metallised polyester.
- 1 x 0.22uF/25VW ceramic or metallised polyester.
- 2 x 0.022uF ceramic or polyester.
- 1 x 470pF polystyrene or ceramic.

### SUNDRIES

- 1 knob, spacers, screws, nuts, mains cord and plug, mains cord clamp,
- 2 grommets, shielded cable, 1 8-terminal tagstrip, spaghetti sleeving, hook-up wire, solder.

## ECONOMY LOUDSPEAKER SYSTEM

*Here is a low cost high efficiency loudspeaker system expressly designed to give good results at relatively modest power levels. It uses an 8-inch twin-cone loudspeaker, and would be ideal as a means of upgrading the reproduction from low power amplifiers, tape recorders and receivers.*

While many of the loudspeaker systems we have published in the past have been quite suitable for use in low power applications, it is undeniable that in many cases they have been designed with the emphasis on quality of reproduction rather than high efficiency. In recent years most of the designs published have employed a sealed enclosure, and have been "two-way" systems employing a separate high frequency speaker or "tweeter" together with an associated frequency division network.

Although this type of speaker system is capable of providing excellent performance combined with compact physical size, it tends to be relatively low in efficiency, and also tends to have a smooth but steady bass roll-off. Thus it tends to be best suited for use with amplifiers having at least a moderate power output, and preferably with facilities for the provision of a modest degree of electrical bass boost. The loudspeaker units employed in compact sealed enclosure systems also tend to be relatively costly units with long-throw voice coils.

Undoubtedly there are many applications where the standard of reproduction provided by this type of enclosure is not required. Many of these same applications also involve economy low power amplifier systems whose capabilities are not really adequate for driving such enclosures.

For example, the person who owns a small record player with a very small internal loudspeaker may be unwise to couple it with a high-quality loudspeaker system—he may find that the internal speaker was hiding a whole host of faults such as peakiness in the cartridge, harmonic and intermodulation distortion in the amplifier and extraneous noise such as rumble and commutator hash from the motor. This is often the case with small record players. Nevertheless, the owner may still wish to improve the sound quality, particularly at the bass end.

In a similar position is the person with a low power amplifier such as the microcircuit stereo amplifier featured in an earlier article, or perhaps the "3-plus-3" stereo amplifier which we have also described. This latter amplifier is typical of many simple low power amplifiers and receivers in that it lacks any facilities for bass or treble boosting.

It seems clear from a consideration of the requirements that an economy loudspeaker system for low power use should possess two main characteristics: high efficiency, to enable it to provide an acceptable sound level from a modest electrical input, and an inherently good bass response, to obviate the need for reliance upon electrical bass boost in the driving amplifier.

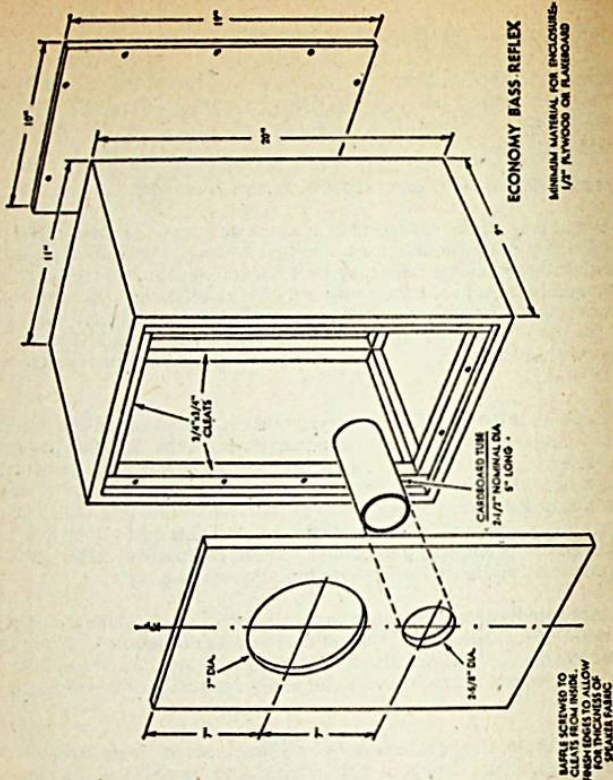

*An exploded diagram of the enclosure of the new system, showing all dimensions. Using this diagram, construction should present no problems even for the inexperienced.*

Really the only type of loudspeaker system capable of satisfying these requirements is one based on the familiar "bass reflex" type of enclosure. The efficiency of this type of enclosure is significantly higher than the sealed enclosures now in widespread use, both because of the type of speaker employed, and because of the reduced acoustic damping employed.

In terms of sheer quality alone the bass response of the reflex enclosure also tends to be greater, due to lower damping of system resonance, although of course the penalty paid for this is lack of smoothness and increased distortion.

Although conventional bass reflex enclosures have tended to be rather bulky, the use of an internal cardboard mailing tube pipe for enclosure tuning can result in an overall enclosure size which is significantly smaller than with a conventional vent, and not greatly larger than a well-designed sealed enclosure. Hence the use of a bass reflex design need not conflict with requirements regarding portability.

For the present project we have therefore selected the bass reflex approach, incorporating the cardboard pipe tuning principle. The particular loudspeaker we have used is the economical MSP uni type 8/TACX/15, an 8-inch 15 ohm twin-cone type with a useable frequency response up to 12KHz. The performance of this speaker is typical of general-purpose modest cost twin cone loudspeakers, of the sort one would commonly find in medium-quality stereograms.

Loudspeakers from other manufacturers could also be used, such as the Rola C8MX or Magnovox 8PIX. The impedance of the loudspeaker should of course suit the amplifier or receiver, and this should be checked before the speaker is purchased. If you have a transistor amplifier which may be suitable for several different load impedances, such as 4, 8 and 16 ohms, use 8-ohm loudspeakers. In general, most transistor amplifiers are designed to give optimum performance at this load impedance.

It is important that all joints in the cabinet, apart from the baffle and rear panel should be close-fitting and glued. This is to ensure that the cabinet is structurally rigid and also that the joints are airtight. If this is not the case, then the tuning of the enclosure will be to no avail. Similarly, the baffle and rear panel should be dressed to a close fit and held with a pattern of 10 screws, as seen from the photograph of the rear of the enclosure.

Do not spoil the job by merely passing the speaker lead out through an oversize hole in the rear of the cabinet. Either fit connectors or screw terminals, or plug the hole with non-hardening compound. If you are building a pair of these speakers for stereo use, it will be desirable to ensure that the leads are coded in some way to ensure correct phasing. Perhaps the easiest way of maintaining correct phasing is to use polarised plugs and sockets on the output of the amplifier.

While manufacturers generally code one or other of the loudspeaker terminals with a red dot or plus sign, phasing can be checked simply by connecting a torch cell briefly across the voice coil and noting that each speaker cone moves in the same direction for a given polarity of input voltage.

It is a good idea to record the loudspeaker type, impedance and lead polarity on the rear of the enclosure for future reference.

The finish of the enclosure is up to the builder. Natural wood veneers may be used or the more durable plastic laminates with simulated wood grain. On the other hand if the enclosures are to be carried around in a car, perhaps the best covering material is vinyl or something similar.

The sharp corners on plastic laminated cabinets tend to scratch upholstery and chip paint at the slightest bump, while wood veneers tend to deteriorate rapidly due to the inevitable bumping and abrasion.

We recommend that the completed enclosure have some acoustic absorbent material placed in it to remove some of the "boxiness" in the sound, which is almost inevitable with a compact enclosure. Material such as Innerbond, Bonded Courtelle or Tontine is ideal, but carpet-underfelt is not recommended. One piece of 16oz material approximately 18 x 10 inches tacked lightly over the rear of the loudspeaker and baffle should be sufficient. The material should not be placed in or over the cardboard tube.

The exploded diagram shown gives all the essential dimensions and shows details of cleats to hold it firmly together. The dimensions can be varied somewhat to suit individual needs but the internal volume should remain the same and the depth of the enclosure from front to back, should not be reduced.

All the panels of the enclosure should be made of 1/2-inch or thicker material otherwise the panels will tend to introduce spurious resonances. If thicker material is used, the internal dimensions of the enclosure must still remain the same.

Plywood or particle board may be used for the panels but the cleats should preferably be made from ordinary timber, as screw holes in particle board tend to become enlarged if the screws are wound in and out a few times.

When making the baffle, make sure to allow for the thickness of the decorative fabric on all edges, otherwise it will not fit. Bevel the corners slightly, on the rear of the baffle, to accommodate the folds of the fabric. The front of the baffle and the edge of the speaker hole should ideally be painted black so that the loudspeaker cone does not show through the fabric.

For the prototype we mounted the baffle so that it was slightly protruding, as can be seen from the photograph. However some readers may wish to recess the baffle slightly so that the possibility of damage to the fabric is lessened when the unit is in transit.

The hole for the cardboard tube should be cut to suit the tube. We found that tubing with a nominal diameter of 2 1/2 inches required a cut-out of 2-5/8 inches for a close fit. We used a hole saw for this job. These are available from most hardware stores at a reasonable price and greatly simplify the job.

The cardboard tube can be glued and/or tacked in place. We sealed off any leaks around the outside of the tube with a layer of non-hardening sealer compound.



## OMNIDIRECTIONAL SPEAKER SYSTEM IS EASY TO BUILD

Here is another vertically styled loudspeaker system which should appeal to hi-fi enthusiasts who face a furnishing problem. It occupies a minimum of floor space, can be covered with furnishing fabrics and produces omnidirectional sound from ear level. Construction is simple and the cost is very modest.

From the viewpoint of bass response, most loudspeaker systems can be divided into two categories. The first uses the acoustic suspension (or infinite baffle) principle; the second uses the bass reflex principle.

The acoustic suspension (or infinite baffle) principle is most appropriate with a loudspeaker having a resonant frequency of the order of 15Hz to 30Hz. When the loudspeaker is mounted in a suitable closed cabinet the resonant frequency of the loudspeaker increases to a value usually between 40Hz and 70Hz.

I consider that no locally manufactured loudspeakers are ideal for the home constructor who wants to build his own acoustic suspension loudspeaker system.

By contrast, the bass reflex principle can conveniently use a loudspeaker with a resonant frequency of the order of 35Hz to 45Hz. This is mounted in a cabinet which is acoustically tuned by a vent or duct to a frequency similar to the resonant frequency of the loudspeaker. For best results, the loudspeaker has to be carefully designed and the flux density, total magnetic flux, cone mass, spider compliance and cone rim compliance have to be optimised.

If the parameters mentioned have not been optimised to suit a tuned cabinet, the ultimate low frequency response will be non-level and the result such as to invoke the familiar description of "boom box".

One of the better local designs for a bass reflex loudspeaker system is the Magnavox 8-30 loudspeaker in a 1.6 cubic foot cabinet.

Both the acoustic suspension and bass reflex loudspeaker systems can exhibit the following four limitations:

- (1) If the internal volume is reduced for the sake of compactness (say one cubic foot) the internal depth of the enclosure may diminish to about six inches. This results in an internal air pressure resonance at about 1100Hz, assuming a sound velocity of 1100ft/sec in air. Such a resonance usually has a high Q and the acoustic result is evident through the cone of the loudspeaker. Other air resonances will be present due to the length and width of the cabinet, but they are usually of a lower frequency and smaller Q. Even so, all such resonances, if not adequately damped, will cause peaks in the frequency response and degrade the transient response of the system to a greater or lesser extent.

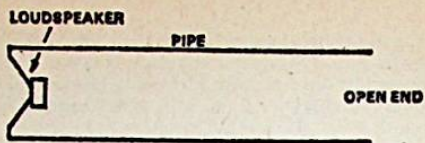

FIG. 1

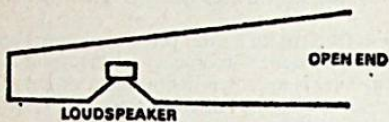

FIG. 2

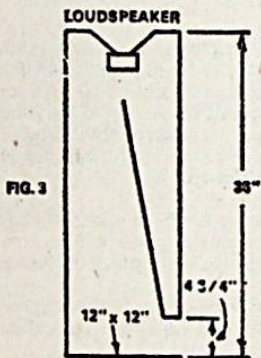

FIG. 3

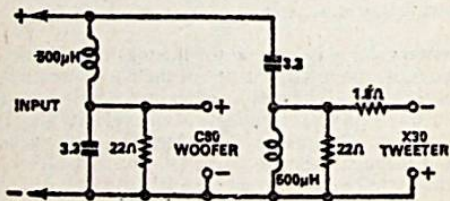

FIG. 4

- (2) When excited by low frequency energy, the walls of the cabinet tend to resonate. To minimise such resonance effects the walls must be heavy. In general, the wall thickness for cabinets with an enclosed volume of more than one cubic foot should be not less than  $\frac{3}{4}$  inch. Large panels need, even then, to be braced.
- (3) Most of the presently available loudspeaker systems radiate sound directly from the front, with the result that the sound source is often no more than 18 inches from the floor. I may represent a minority view but I prefer indirect sound with the apparent height of the sound source about four feet from the floor.
- (4) Because of the implications for driver design, the acoustic efficiency of highly compact loudspeaker systems is usually less than that of the larger systems. For a given level of sound input, the cost saving of the compact systems tends to be offset by the extra cost of the power amplifier necessary to drive them. Efficiency should not be sacrificed lightly.

In this different approach to the construction of a loudspeaker system, I have evolved a design which largely avoids the foregoing disadvantages.

I have also considered three other criteria in the design, namely: the floor space occupied should be no more than about one square foot; the external finish on the cabinet should match the room decor; the total cost should be less than 40 dollars per unit.

The acoustic principle used in the present approach is basically that of pipe loading. If the pipe were to be straight, as shown in Fig 1 the response would be non-level and would give output peaks at odd harmonics of the fundamental frequency of the pipe.

To damp out the harmonic response, the pipe can be tapered and the loudspeaker mounted on third of the distance from the closed end as shown in Fig 2.

To make such a system a practical proposition, the pipe can be folded and the loudspeaker mounted on the top of the resulting cabinet. Tapering the pipe raises the resonant frequency, but partially blocking the mouth of the enclosure has the effect of increasing the effective length of the pipe, tending to lower its resonance.

Fig 3 shows the outline of a practical enclosure. The low frequency resonance occurs at 55Hz and, using a loudspeaker with a nominal resonance of 45Hz, audio output was obtained down to 30Hz without frequency doubling or tripling being apparent.

The basic principles used in this approach are not new. In fact, they are the work of P.G.A. Voigt, a pioneer of loudspeaker enclosure design in the nineteen twenties and thirties.

Lacking a single loudspeaker with a smooth response up to 20KHz, I decided to use two loudspeakers to cover the frequency range from 30KHz to 20KHz. The woofer and midrange unit is an 8-inch loudspeaker, the Plessey C80 with a nominal 20-watt rating. The tweeter

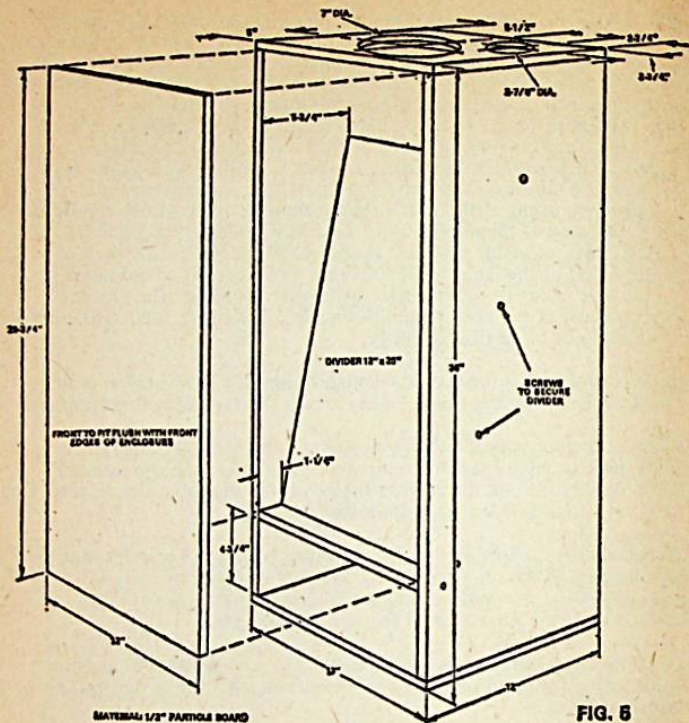

is a dome tweeter, the Plessey X30, with a claimed frequency response from 3KHz to 30KHz.

Faced with the need to build or buy a crossover unit for the C80 and X30, I eventually decided to use a commercial 12dB per octave unit with a crossover frequency of 4KHz. The objective was to obtain a smooth frequency response and to prevent low frequency overloading of the dome tweeter.

At a frequency of 4KHz, the impedance of the C80 is not 8 ohms as marked and measurement of the response through the crossover network indicated that a 22 ohm resistor should be connected in parallel with the voice coil of the C80 to give the required 3dB attenuation at the crossover frequency.

Similarly, a 22 ohm resistor is required across the dome tweeter, while a 1.8 ohm resistor is required in series with its voice coil to equalise the acoustic outputs of woofer and tweeter.

A full circuit diagram of the crossover is shown in Fig 4. Note that, due to the phase shift in the crossover network, the connections to the X30 tweeter must be as shown in Fig 4 to obtain a smooth response near the crossover frequency.

A detailed drawing of the cabinet is shown in Fig 5. The material that I used comes under the trade name of "Trudek". The cabinet is held together with screws and a wood adhesive. In my case I used Posidriv screws and Aquadhere.

Due to the shape of the cabinet and the sloping internal partition, all the air resonances are of low amplitude and frequency compared with those to be expected from a more conventional bookshelf enclosure.

However, further to discourage resonances, a piece of "innerbond" measuring 36 inches by 18 inches is placed in the position shown in Fig 6.

If the 36 inch height is too great for smaller rooms, it can be reduced to 30 inches by reducing the height of the mouth of the pipe to 4 inches and the length of the internal partition from 25 inches to 19 inches. There will be a slight degradation of the low frequency response, but performance will nevertheless be very satisfying.

The finish of the cabinet is up to the individual, but I suggest covering the four sides of the cabinet with a material which matches the individual room decor. Being attached only to the sides of the enclosure, it does not need to have any special acoustic properties.

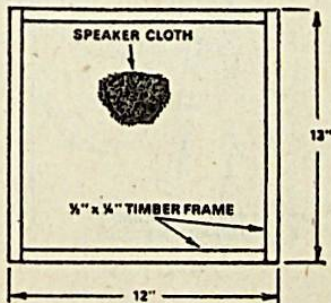

FIG. 7

*The cones must be protected. Grille cloth over a frame will suffice provided the family can be "educated." Otherwise a metal mesh may be necessary.*

The grille cloth is stapled to a 13 x 12 x ¼ inch wooden frame.

### Why all the interest in omnidirectional systems?

When measuring the response of a loudspeaker system, it is normal to locate the microphone in front of the cones and, preferably on the axis of the tweeter. This has reinforced the convention of building systems with the loudspeakers facing the listening position and projecting a frequency response as per the calibrated curve.

Conventionally designed loudspeakers can also create a well defined stereo image but many listeners have come to the opinion that both these considerations have been over-emphasised; that sound is more pleasant and less obviously being produced from boxes if the sources are more diffused.

Diffused sound can be achieved in a variety of ways. Most of them involve directing sound so that it is reflected into the room from walls and ceiling. The frequency response becomes more sensitive to room acoustics but there is a growing conviction that diffused sound is more acceptable than that from sharply defined sources.

The quadraphonic idea has tended to reinforce this thinking and has produced another important consideration: multiple loudspeakers can be merged more easily into the decor if they don't have to be located with fronts facing diagonally into the centre of the room.

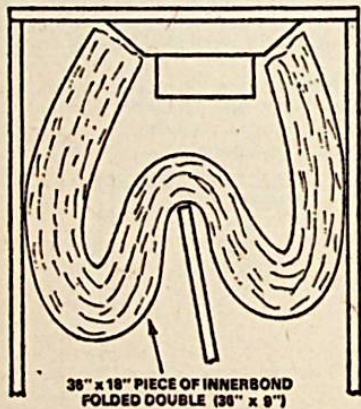

FIG. 6

### What You Will Need:

- 1 Plessey C80 loudspeaker 8 ohm
- 1 Plessey X30 tweeter 8 ohm
- 1 4KHz, 8 ohm, 12dB/Octave crossover unit
- 2 22 ohm, 2 watt 10pc resistors (or use 2 x 47 ohm 1 watt in parallel for each 22 ohm resistor)

1 1.8 ohm, 1 watt, 10pc resistor  
5 pieces particle board size 4ft x 1ft x ½inch  
40 wood screws 1 inch x No 8 countersunk  
10 woodscrews 5/8-inch x No 8 roundhead (for loudspeaker and crossover unit mounting)

Wood adhesive

Plastic wood

1 piece of wood 49 x ½ x ¼ inch for top of cover

1 piece of "Innerbond" 36 x 18 inches

1 piece of grille cloth 18 x 18 inches

Staples

4 x 4ft fabric to suit home decor

The approximate cost, less the 4 x 4ft fabric is £14

## COMPACT, SEALED ENCLOSURES FOR 6, 8, 10, 12 & 15-inch LOUDSPEAKERS

This article discusses the question of mounting larger diameter loudspeakers in fully sealed enclosures.

In evolving and presenting the "Bookshelf" loudspeaker system, we had a particular objective in view—to assist those readers desiring high fidelity reproduction but unable to accommodate, in their homes, anything more than very small loudspeaker enclosures.

Our objective was not to make a case for small enclosures against larger ones but simply to develop the theme that, if circumstances compelled the use of small enclosures, here was a recommended method of approach.

Our "prescription" involved the use, for each channel, of a basic loudspeaker having a nominal overall diameter of 6 inches and a natural cone resonance of not higher than 50cps, when measured in free air and driven from a low impedance source.

We recommended, further, that the loudspeaker be housed in a rigid, fully sealed enclosure, of effective internal volume not less than 0.5 cu.ft. and lightly filled with either of two materials: (1) a 36 x 18in piece of 16oz Innerbond or (2) a 20 x 30in batt of type A Fibertex.

These specifications looked after the bass end very well, but as a precaution against intermodulation, we advised the use of a tweeter (Rola SFX or Magnavox HF5S1C) and a simple L/C dividing network crossing over, for preference, at 2.5KC.

As verified by sound pressure tests, the Bookshelf system, as recommended, had a remarkably even response from at least 16KC down to 70cps. Below this figure, it tapered at the expected rate of 12dB per octave but sufficiently free from doubling effects to permit modest use of bass boost and a practical extension of the range to about 40cps.

The success of the project is now history and literally thousands of the units have been built up by readers or bought as complete units from one or other advertisers. Nor is there any reason why its popularity should diminish. The original 15-ohm versions are still selling well, while the 7.5-ohm version, is meeting a more limited but still definite demand.

It may be recalled that reference was made to the possibility of using the same technique for larger speakers—mounting them in sealed enclosures filled with the kind of packing suggested for the Bookshelf units. Not surprisingly the thought has intrigued quite a few readers but, due to pressure of other work, we have only just recently been able to give the matter our attention.

In considering the proposition it is necessary to appreciate that the motivation differs from that of the Bookshelf project. In that case, we were faced with a specific need and we came up with a specific answer—an enclosure of a certain minimum size, a stated amount and type of acoustic packing and a combination of loudspeakers and cross-over network selected for the job.

As far as a scaled-up system is concerned, it would appear that a major interest is from readers who already have one or more larger loudspeakers on hand and who face the compulsion to house them in something smaller than the conventional vented enclosure. The problem therefore starts with a variety of 8, 10 and 12-inch diameter loudspeakers and ends with the question "how do we house them?"

At the outset, it may be wise to stress that, here again, the purpose of this article is not to make a case for small enclosures against larger ones. As a general rule, for a given order of design merit, baffling can be made more effective as the number of cubic feet available multiplies. It certainly becomes less critical!

The purpose of the article rather is to show that, where space is at a premium, very acceptable results can be obtained from small enclosures by following the right procedures. In fact, results from an "optimum" small system may well be better than from an enclosure loudspeaker combination which is more bulky but less discreetly chosen.

It may also be wise to stress that an enclosure affects mainly the behaviour of a loudspeaker over the bass region below about 250cps. Provided the front of the cone can radiate freely into the listening area, what is heard above about 250cps relates substantially to the inherent characteristics of the loudspeaker (or loudspeakers).

If there are frequency regions where the output is prominent or suppressed, then the reproduction will be coloured thereby. If the high frequency response (or the separate tweeter) is dominant or inadequate, the overall balance will be affected accordingly—and so on.

In short, any enclosure details we might suggest from here on can vitally affect the bass end and have second order effects in the



NOMINAL SPEAKER DIMENSIONS	EFFECTIVE ENCLOSURE VOLUME	INTERNAL DIMENSIONS			EXTERNAL DIMENSIONS		
		a	b	c	a	b	c
6"	0.54cu.ft.	16"	10"	6"	17½"	11½"	7½"
8"	1cu.ft.	20"	12½"	7"	21½"	13½"	8"
10"	1.5cu.ft.	24"	15"	7½"	25½"	16½"	8½"
12"	2.2cu.ft.	26"	16½"	9½"	27½"	17½"	10½"
15"	3.5cu.ft.	30"	18½"	11"	31½"	20½"	12½"

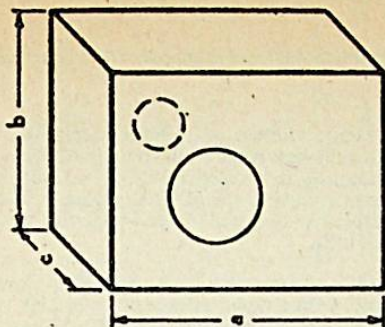

*This table suggests figures for minimum internal volume for sealed enclosures for use with 50-cycle loudspeakers. The suggested internal dimensions provide an acceptable average shape and allow for space taken up by tweeter and cleats. The proportion for a 6-inch loudspeaker system differs slightly from the original Bookshelf unit but the internal volume is substantially the same.*

middle register; beyond that, whether the sound is clear or muddled, peaky or smooth is a function of the loudspeaker which you have in mind to use.

This much is over to the individual enthusiast—and the capacity of his purse!

### Basic Requirement

We can start out, however, with one quite definite premise. For satisfactory performance in the bass register, the only loudspeakers which lend themselves to mounting in a sealed, compact enclosure are those having a natural cone resonance in the 50-cycle region, or below. This is as true of larger loudspeakers as it was of the 6-inch unit specified for the original Bookshelf unit.

Loudspeakers having a cone resonance from about 60cps upward have been designed primarily with a view to use in open-backed 'gram cabinets, where their cone resonance gives an obvious, if synthetic, boost to the bass response. However, this very quality prejudices their use for high fidelity application and a critically tuned reflex enclosure, designed to cancel the resonance and/or introduce a new, lower-frequency peak is probably the best course to follow, if such loudspeakers must be used.

Incidentally, completely sealed enclosures are sometimes referred to in audio circles as "infinite baffles"—to the mind of this author a misnomer. The term presumably arises from the idea that there is complete isolation between the front and the back waves. What is more to the point, the dimensions of any likely sealed enclosure are strictly finite, in terms of sonic dimensions, and they consequently modify the behaviour of the associated loudspeaker. The term "infinite baffle" could more fairly be applied to the situation where a loudspeaker is mounted through an otherwise unbroken wall.

The resonance figure for a particular loudspeaker may be quoted by the manufacturer, but should ideally be verified, as we did with the various units involved in our tests.

(Our method was to rest the loudspeaker on its back on the bench, without any form of baffle. It was driven from a low impedance amplifier [a typical "Playmaster" unit with feedback] with a resistor in series with the "earthy" voice coil lead. We used a 1-ohm resistor with 15-ohm voice coils, but it should be proportionately smaller with voice coils of lower impedance. The voltage across this resistor was monitored with an AC millivoltmeter, while the loudspeaker was driven across the bass end of the range. The frequency at which the voltage dips represents the natural resonance of the cone system when connected across a low impedance drive source. It should be noted that the frequency will normally be lower by perhaps 10cps than the resonance without electrical damping, this latter being an unreal condition for most applications.)

When a loudspeaker is placed in a completely sealed enclosure, the "springiness" of the air trapped behind the cone tends to raise the resonant frequency of the moving system.

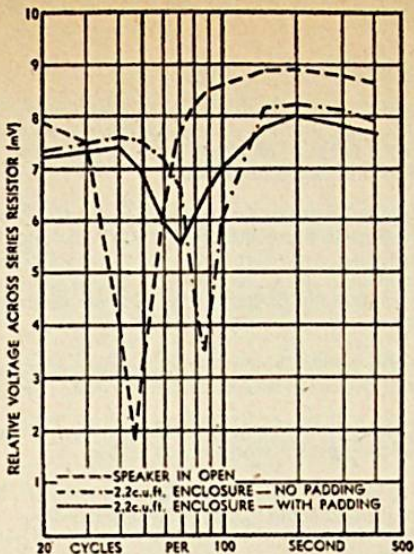

**A typical set of curves, taken during our tests, showing the shift in resonance and impedance, when mounted in a 2.2 cu. ft. enclosure.**

In the case of the Bookshelf unit, our basic idea was to start with a loudspeaker having a natural cone resonance of 50cps, put it in an enclosure which would raise the figure to not more than 100cps, then rely on acoustic filling to damp it back to about 85cps, producing the overall response curve already mentioned.

### Similar Objective

On the basis of the wide acceptance which the system has won, it was reasoned that these figures could serve as a guide to minimum enclosure volume for scaled-up systems using larger loudspeakers; that, other things being equal, such a scaled-up system should sound very like the Bookshelf, but having somewhat higher sensitivity and the increased power handling capacity expected of larger loudspeakers.

A point which is fairly self-evident is that the effect of any given volume of entrapped air will be greater on a larger cone than on a smaller one. Therefore, for a given effect on resonance, larger diameter speakers must be housed in larger enclosures. There is simply no possibility of housing larger 50-cycle loudspeakers in an enclosure of similar volume to the Bookshelf unit—and retaining an adequate performance at the bass end.

As a rule of thumb, we expected to find that enclosure volume would multiply in proportion to active cone area and therefore as the square of the cone diameter.

In fact, things worked out almost exactly so.

For the Bookshelf system, with dimensions dictated somewhat by timber cutting sizes, the internal volume, taking into account a few cubic inches for the tweeter and cleats, is about 0.54 cu.ft. This is for a nominal 6-inch diameter loudspeaker.

For 50-cycle 12-inch loudspeakers, an enclosure of  $4 \times .54 = 2.16$  cu.ft. gave results very close to those anticipated. While the middle and upper register remained a product of the individual loudspeaker, the general weight and character of the bass end, at comparable sound pressure levels, was broadly similar to that of a reference Bookshelf unit.

The performance of typical 8-inch 50-cycle loudspeakers, in a suitably proportioned enclosure also cross-checked quite closely.

On this general basis, the recommended minimum enclosure volume for a 50-cycle 8-inch loudspeaker works out at 0.96 cu.ft.

For a 50-cycle 10-inch loudspeaker, the figure is 1.5 cu.ft. For a 50-cycle 12-inch loudspeaker, the figure, as already mentioned, is 2.16 cu.ft. By a spot of projection, the figure for a 50-cycle 15-inch speaker would be 3.4 cu.ft.

Actual figures obtained for typical popular 12-inch loudspeakers in a 2.16 cu.ft enclosure (Innerbond filled) are as follows:

Magnavox 12WR Mark III—natural resonance 45cps; in enclosure 70cps.

MPS 12PQB—natural resonance 55cps; in enclosure 75cps.

Rola 12UX—natural resonance 58cps; in enclosure 80cps.

These figures indicate a clear trend and the kind of results to be expected at the bass end.

The 12WR Mark III starts off with a 45-cycle rather than a 50-cycle resonance, which rises to 70cps in the enclosure. In the sound pressure curve this shows up as a modest peak at 70cps, compared with 85 for the Bookshelf, and with a few dB advantage in the 40 to 50-cycle region.

The MSP 12PQB and the Rola 12UX move from something above 50cps to about 80cps, still retaining a slight advantage over the Bookshelf figures.

It emerged, from subsequent discussion with Rola representatives, that the 12UX we had on hand was from an early run and outside the present specification of 50cps plus or minus 5cps. However, we retained the figure as a useful guide to the upper limit condition. In all fairness, it must be stated that the 58-cycle 12UX sounded quite impressive.

However, the present situation is that all three of Rola's wide-range 12-inch loudspeakers now have 50-cycle cones, as does also the normal wide-range version of their 8MX.

The Magnavox "WR" series, including 6-inch, 8-inch and 12-inch models, have a cone resonance in the 45-50 cycle region.

The MSP 12PQB also qualifies and it is understood that other 50-cycle units will be added to the MSP range in the near future.

In addition, quite a few imported high-fidelity loudspeakers have cone resonance figures which would qualify them for use in fully sealed enclosures.

As a matter of interest, we ran a set of figures on the special version of the Magnavox 12WR, which was released some time ago for use with electronic organs. The supplementary organ loudspeaker used the same sealed enclosure technique as under discussion here, but without the Innerbond or Fibertex filling.

Starting with a free-air resonance of 30cps, the modified 12WR also moved up to 70cps in the enclosure, presumably indicating that the cone movement was being dominated more by the air and filling in the enclosure than by the suspension system.

Going to the other extreme, we also checked the behaviour of a couple of typical loudspeakers having a natural cone resonance in the 80-cycle region—the type commonly used for public address applications for mounting in open-backed radiogram cabinets, as already mentioned.

In a small, sealed enclosure, the resonance rose to the 100-cycle mark, producing a prominent peak at this frequency and a strong impression of "one note" bass.

At this point, we may with advantage summarise our conclusions:

- (1) "High fidelity" 12-inch loudspeakers, with a natural cone resonance of between 40 and 60cps perform satisfactorily in a sealed and filled enclosure of minimum cubic content of 2.16 cubic feet—say 2.2 cubic feet in round figures.
- (2) "High fidelity" 12-inch loudspeakers with a cone resonance of less than 40cps will tolerate a slight reduction on 2.2 cu.ft. to say 2.0 cu.ft.
- (3) 12-inch loudspeakers with cone resonance figures of above 60cps become progressively less suitable for mounting in sealed enclosures because of the rise in system resonance. Other systems of baffling may be more easily justified.
- (4) The remarks, as above, apply equally for loudspeakers of other diameters, in relation to the minimum enclosure sizes quoted earlier in the article—say 1.0 cu.ft. for 8-inch units, 1.5 cu.ft. for 10-inch units, and 3.5 cu.ft. for 15-inch units. Results should be satisfactory for loudspeakers having a natural cone resonance of below 60cps, but progressively less so for cone resonance figures above 60cps.

(5) The figures quoted for enclosure volume represent a recommended minimum for acceptable results and assume the use of a small amount of bass boost from the amplifier for substantially level response. Any increase in enclosure volume will be beneficial so that, other qualities being equal, argument can be advanced for using an 8-inch loudspeaker in an enclosure originally intended for a 10-inch or 12-inch unit, and so on.

(6) The notable exception to the above is in the case of special free-suspension loudspeakers which rely on the volume of the enclosed air to control and limit cone movement. Such loudspeakers should be used strictly in accordance with maker's instructions. The loudspeakers envisaged in the article are not of this type, being "general purpose" high-fidelity types, with conventional cone suspension.

(7) Though many wide-range loudspeakers do not require the use of a supplementary tweeter on the basis of frequency response, cleaner sound in terms of intermodulation is commonly obtained when the loudspeakers are used in conjunction with a high-performance tweeter and an L/C crossover network. With loudspeakers larger than 6-inch serving as the "woofer", there is an advantage in putting the crossover point in the 4 to 5KC region and suggested constants are shown in the accompanying diagram.

Note that the two speakers in each enclosure should be phased. Suggested procedure is to check each with an ordinary 1.5v torch cell and discover which way round the cell has to be connected so that it drives the cone forward in the housing. Mark the speaker plus and minus, to correspond with the battery and wire the speaker as shown in the circuit.

Coming now to the physical aspect of sealed enclosures, it may be wise to stress the relationship between enclosure size and the thickness of timber used in their construction.

For the Bookshelf unit, we were quite happy with 1/2-inch timber, experience indicating that, with the panel sizes involved, the enclosure was sufficiently rigid and free from panel "drumming". The same 1/2-inch timber would probably serve for a 1 cu.ft. enclosure but, for anything larger, 5/8-in or even 3/4-in ply should be used.

The choice depends, to some extent, on the proportions of the enclosure, a "cube" shape, for example, not having the large flat panels which characterise the "slim" variety.

In other respects, the shape of a fully sealed enclosure is not critical except, perhaps, where it is so distorted that it begins to look less like an enclosure and more like a stopped organ pipe. However, this is an unlikely extreme.

By and large, the proportions of the enclosure can be a matter for individual choice.

This is an important freedom for constructors who may wish to build their enclosures into fixed shelving, fixed cupboards or such like.

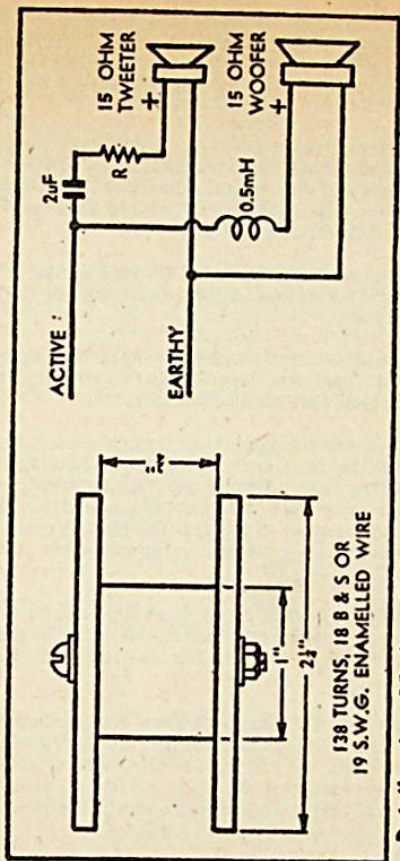

For those who prefer separate enclosures, proportions are important in terms of appearance and a height/width ratio which is commonly recommended is about 1.6:1. The depth of the cabinet can be dictated by "local" requirements, but it should, if possible, be notably smaller than the width.

A diagram showing typically proportioned cabinets is given herewith. It is for internal dimensions only and makes typical allowance for the displacement of tweeter speaker and cleats, but not for the "woofer", which has been regarded throughout as part of the whole.

Finishing details have been left for the individual constructor or cabinet-maker.

Cabinets intended to hang on the wall may need to be finished all round, but will need no special protection around their lower surfaces. Those which stand on the floor may need such protection, either as an external beading, "kickboard" treatment or stubby legs of one type or another.

Whatever the constructional methods, however, the enclosures must be rigid, must be free from drumming and must be airtight. The requirement is much more strict than for an ordinary vented box where, for all practical purposes, minor leaks merely add to the area of the vent—probably with no discernible effect.

In a sealed enclosure any leak becomes THE vent and vacant screw holes, over-sized lead egress holes or other air leaks can markedly modify the impedance curve.

Watch all corners and the way in which the baffle beds down, being particularly careful where extra layers of fret material under the corners may lift the baffle elsewhere clear of its cleats.

All told, however, the weakest point of many cabinets is the method of fitting the removable back. One common method adopted by "furniture" as distinct from acoustic enclosure manufacturers, is to rout about half the thickness of the sides, top and bottom and to fit the back panel into the space so created. The holding screws are limited to the very tenuous grip they can gain in the edge-grain of half a thickness of ply!

Our recommendation is a set of cleats glued and screwed to the inner faces and providing a seat against which the back can be solidly anchored—no matter how many times it has to come off at the hands of the avid experimenter.

A factor which may exercise the mind of anyone building larger enclosures is the amount of filling material which becomes necessary. In the original Bookshelf units, the half-yard of Innerbond required by each unit adds very little to the cost. We suggested its use, without apprehension, on the basis that it worked well and was the approach favoured by overseas manufacturers of compact loudspeakers.

However, with larger enclosures, the amount of filling required does multiply rather alarmingly and, as a guide, something like a yard of 16 oz Innerbond is needed for a 1 cu.ft. enclosure, 1½ yards for a 1.5 cu.ft. enclosure and 2 yards for 2.2 cu.ft.

The Innerbond should be folded and/or rolled fairly loosely into a shape that can be pushed lightly in behind and around the loudspeaker, substantially occupying the air space in the cabinet. It has sufficient body to retain its position when the back is screwed on.

If Fibertex battes are used, make sure to get the least dense material but in the maximum obtainable thickness. Trim the battes so that they will stand on edge around and behind the speaker, again occupying most of the free air-space.



Whichever material is used, the greater quantity will involve greater outlay, though not out of proportion to the total outlay on a complete loudspeaker system. We have retained the idea of lightly filling the entire enclosure on the supposition that it is, all told, the most effective method, since it damps the system in the bass region and suppresses cabinet standing waves at other frequencies.

However, it must be recognised that loudspeaker manufacturers have suggested other ideas—(1) tacking a material such as Innerbond to the baffle and covering the rear of the loudspeaker and (2) fitting the loudspeaker frame itself with an acoustic filter.

One final point, which applies to all enclosures: Do not cover the face of the enclosure with some heavy tapestry, simply because it matches the lounge or the carpet. Use only one of the acoustic cloths that are now available from parts dealers. These have been devised with an eye to acoustic transparency and are much to be preferred to other fabrics.

## LOUDSPEAKER SYSTEMS FOR ELECTRIC GUITARS

*In our series on guitar amplifier systems, and following the description of a "Fuzz Box", we have something to say about loudspeaker systems for electric guitars. The article outlines the broad requirements and discusses typically suitable loudspeakers on the market and the types of enclosure which are recommended by their manufacturers.*

Those who have never had occasion to give much thought to the subject are as likely as not to equate loudspeaker systems for guitars with those used for electronic organs and ambitious hi-fi systems. In fact, the requirements for all three are quite distinct.

In the case of a hi-fi system, for reproducing disc or tape records, the emphasis is on satisfying (though not necessarily smooth) bass, extended treble response and a curve, in between, which is as free as possible from notably prominent or depressed areas. Minimal harmonic and intermodulation distortion is another basic requirement.

While the owners of domestic high fidelity reproducing systems have a reputation for liking loud volume, in fact their inclinations seldom pose any great hazard for the loudspeakers involved. Such systems are normally operated within the confines of a home and within the tolerance of occupants and neighbours. In addition, the average hi-fi enthusiast is usually solicitous of his prized loudspeakers and the first to notice if they show any sign of acoustic overload.

As much as anything, moderately large loudspeakers, used in the average high-fidelity music situation, perform well because they are only moderately stressed and, for the same reason, give many years of trouble-free service.

Loudspeaker systems used for electronic organs have to satisfy a quite different set of requirements. First and foremost, they must exhibit a bass response which is not merely "satisfying" but is actually smooth, particularly over the range of pedal notes. It is most disturbing to organist and audience alike, if certain notes in the pedal octave(s) stand

out prominently above others; the organist has to put up with the effect, for there is little he can do in practice to counter it. Resonance effects in organ loudspeaker systems therefore either have to be strongly suppressed or else deliberately guided into some part of the frequency range where they will cause least embarrassment.

As far as treble response is concerned, the requirements for an organ loudspeaker are relatively modest. In fact, a loudspeaker which rolls off smoothly beyond 6- or 7KHz may be preferred for its "rounder", "more organ-like" tone and its reduced sensitivity to unwanted hiss and key-clicks.

The power handling capacity required of an organ loudspeaker system varies with the situation but organ amplifiers typically deliver from about 20 to 60 RMS watts. Remembering that organ installations are more usually permanent rather than portable, the tendency is to use large and/or multiple loudspeakers, generously baffled to obtain the requisite bass characteristics, and not too heavily stressed.

A basic reason for using organ loudspeakers well within their power handling capacity is to ensure a minimum of intermodulation distortion. This can become very evident in the sustained and complex chords which are possible on a modern electronic instrument and to audiences which, for the most part, are quiet and attentive.

Loudspeaker systems for electric guitars have to satisfy yet another set of requirements, the two most pressing ones probably being (1) Ability to produce a very high level of sound and (2) To be no more cumbersome than strictly necessary. In general, this means that the baffle systems for guitar loudspeakers are very much a compromise and that loudspeakers themselves are heavily stressed, with the result that bass response, distortion level and loudspeaker life expectancy all fall somewhat short of what is expected in either high fidelity or organ service.

Recent correspondence with the Rola Company serves to emphasise the problems involved. We quote:

"The development of suitable loudspeakers for a guitar system imposes certain unique problems on the design engineer and it was because of this that Rola developed the 'EG' or Electric Guitar series in both 12P and 12U models. A typical problem encountered with loudspeakers of this type is the rapid and severe rise in voice coil temperature. Guitar loudspeakers must be capable of operating with voice coil temperatures of 200 degrees F without loss of bonding. Extreme cone excursion causes extensive flexing of the voice coil pigtails and all Rola 'EG' series are equipped with high fatigue resistance.

"Viscous doping of the cone corrugations eliminates the danger of rim splitting and allows the combination of high compliance and maximum power handling. These and other features incorporated in these loudspeakers ensure long life under heavy-duty operating conditions.

"It is essential for optimum performance that the loudspeakers be enclosed in properly designed cabinets to ensure correct loading. Failure

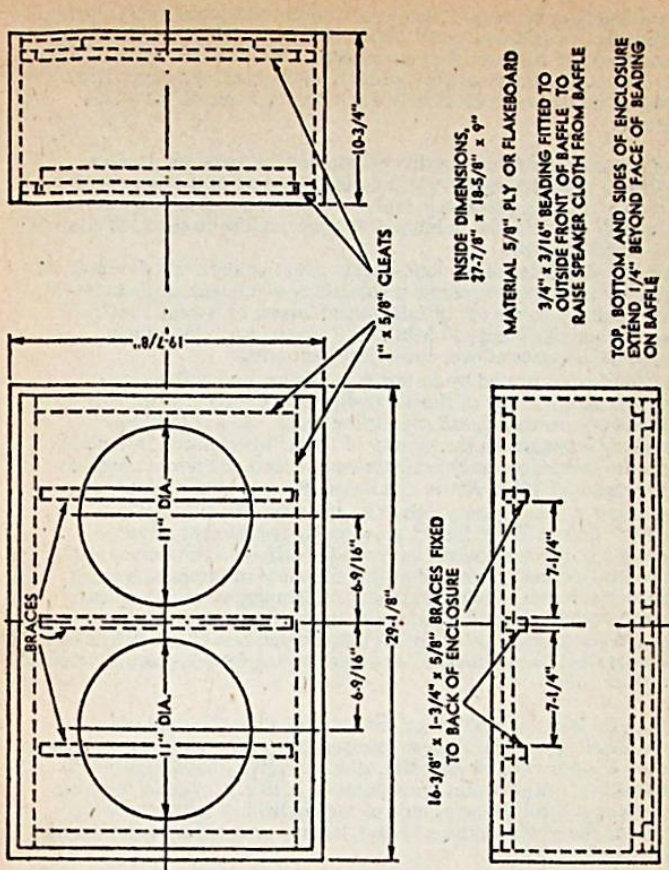

to do this can result in a substantial reduction in the amount of power the loudspeakers can handle without physical damage. Designs for suitable loudspeaker enclosures are available from Rola."

In recent years, guitarists' ideas of what constitutes a practical loudspeaker system have undergone considerable change and some of the systems in current use involve enclosures of one type or another, which are more easily carried by two men than one!

A proportion of these are open-backed or fitted with variously vented or slotted backs which actually impose very little air loading on the cones at low frequencies. Their users like them because the open back allows sound from the rear of the cone to bounce around the stage

area, broadening the apparent source. They are successful only if the loudspeaker's "unloaded cone" rating is high enough to cope with the power involved and/or if the player keeps away from damagingly heavy bass chords. For the most part, guitar manufacturers are wary about selling such enclosures because of the potential abuse of the loudspeakers.

They much prefer to standardise on completely sealed or, at most, cautiously vented designs which do load the rear of the cones with a cushion of air. The problem is that, for all their size, such enclosures are usually quite limited in internal volume, relative to the total area of the cone(s) involved.

From the viewpoint of the loudspeaker manufacturer, this practical limitation in enclosure volume is something of a bonus, in that it leads fairly naturally to the use of fully sealed boxes, with a sufficiently small volume of air trapped behind the cone(s) to cushion them against the excesses of over-enthusiastic guitarists.

Most loudspeakers used by guitarists in conjunction with higher-powered amplifiers are of the heavy-duty 12-inch type, with fairly substantial cone, surround, and supporting spider and a natural low-frequency resonance in the vicinity of 50Hz. When placed in a sealed enclosure dimensions as typically recommended, the resonance rises to the region of 80Hz. Above this figure, the response is relatively flat; below it, the response falls at an effective rate of between 6 and 12dB per octave. These figures are strongly reminiscent of sealed "bookshelf" type enclosures but with the difference that many such guitar loudspeaker systems employ a minimum of internal damping. One consideration is that the amount of damping material required would be quite substantial but, more to the point, guitarists do not appear to be averse to a somewhat less damped bass characteristic and to colouration from "bounce" at other frequencies being audible through the paper cone.

In fact, for lead and rhythm guitars, in particular, this kind of bass curve is quite practical. The lowest open string on the instrument produces a frequency of about 70Hz, which is not all that far from the nominal bass roll-off point. Furthermore, unlike an organist, a guitar player can control the amplitude of each individual note by the way he plucks the relevant string. In fact, he may even relish a bit of boom over the lower frets!

Bass guitars pose an additional problem in that they have an extra octave extending to about 35Hz and involve proportionately greater cone excursion for a suitably high level of sound. However, for practical reasons, bass guitarists often have to be satisfied with the same general class of loudspeaker system as other players and with developing high acoustic output by heavily driving loudspeakers in sealed enclosures at frequencies below the natural system resonance. Here again, the general thinking runs a close parallel to "bookshelf" techniques where output at the lowest frequencies is deliberately augmented by the use of bass boost. Naturally, this technique increases the stress on the loudspeakers and bass guitarists often have to "go easy" or put up with reduced loudspeaker life or discover, the hard way, those makes and models which will stand up to the punishment better than others.

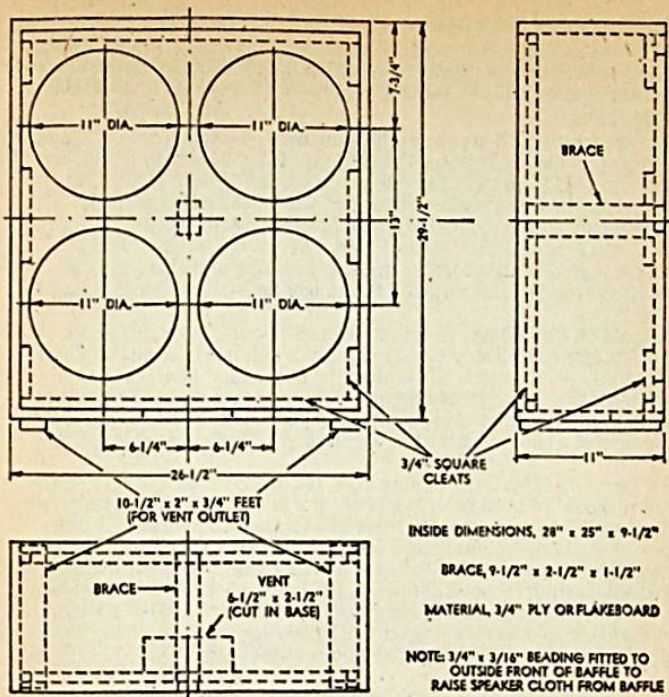

Not surprisingly, this situation has focused considerable attention on the use of larger loudspeakers for bass service—15 in and upwards—or loudspeakers with moulded plastic cones, very large and/or vented enclosures and so on. Such techniques can pay dividends in terms of louder and more trouble-free bass but they may also involve much higher initial expense and enclosures which are even less conveniently transportable than the more usual variety.

At the other end of the range, guitar loudspeakers and organ loudspeakers have a good deal in common. An upper limit of 5 to 6 KHz will satisfy most players, though some may like the extra bit of "edge" which a twin-cone loudspeaker can give.

In terms of intermodulation and harmonic distortion, the requirements of guitar loudspeaker systems are not as stringent as those for organs. Chords, on the whole, are less complex, audiences less attentive to the finer points of sound reproduction and more responsive to sound that gains sonic impact by an abundance of lower order overtones. In fact, "Fuzz Boxes", are expressly designed to generate distortion in a particular way and it is not unknown for guitarists to be rather partial to an amplifier or loudspeaker system, which can contribute a degree of "free" fuzz by running into nonlinearity at a convenient level.

The point in saying all this is not to suggest that frequency response and distortion level does not matter in a guitar loudspeaker system. Rather is it to stress that the standards by which their performance must be judged are those which apply for guitars—not for organs or high-fidelity systems!

Loudspeakers which are currently being used in Australian-made guitar systems include the Philips AD-5200, the MSP 12UA15 and 12PQ and the Rola 12PEG and 12UEG—all of these being 12-inch heavy-duty types. Also brought to our notice were some relatively new loudspeakers manufactured by Lafayette Electronic Industries, who have a range of 12- and 15-inch loudspeakers suitable for guitar and organ service. Again, distributors for overseas manufacturers have in their catalogues loudspeakers which are strongly favoured by some guitarists.

It would be a monumental task to list and test all the loudspeakers which might conceivably be considered for guitar service and to relate their likely performance and limitations in the kind of enclosures which are typically in use. Instead, we have chosen to make particular mention of three typical loudspeaker systems, with the idea that these can serve as a guide to the form which such systems can take.

For their AD-5200 series loudspeaker, the Philips organisation suggests that it should be used in a completely sealed and airtight enclosure on the basis of not more than 40 litres of enclosure volume per 12-inch speaker (i.e. 2,440 cubic inches or 1.4 cubic feet). They further recommend that airspace in the enclosure be substantially occupied with a light filling (Innerbond, Tontine 75, etc.). Provided the box is rigidly constructed and absolutely airtight, they will rate the AD-5200 series loudspeaker to operate at 25 watts RMS, which is substantially above the power rating under other conditions of baffling.

Figure 1 shows the photograph of a single-loudspeaker enclosure constructed to these basic requirements. External dimensions are 20 x 16 x 8 inches and, allowing for half-inch timber, the nominal internal dimensions of 19 x 15 x 7 give an enclosure volume of 1,995 cubic inches or 1.15 cubic feet. This is well under the maximum figure just quoted and gives a system resonance of 95Hz, as compared with 45Hz for the speaker in free air. The Miniwatt Division of Philips Electrical Industries have tested the speaker under these conditions and consider it to be an entirely practical design for lead and rhythm guitars in particular.

However, as a single loudspeaker unit, it is capable of working only with an amplifier of 25 watts maximum output power and the system would need to be scaled up to cope with more powerful amplifiers. Two AD-5200 loudspeakers operating in parallel in an 80 litre (2.6 cu.ft.) sealed enclosure should cope with 50 watts and so on. An important point is that larger enclosures will need to be constructed from thicker material (normally 1-inch) to maintain the requisite rigidity, and the larger panels may need to be internally braced.

Proper arrangements will also need to be made in regard to impedance. The loudspeakers should ideally be connected in parallel and two AD-5200PM loudspeakers, each 15 ohms, connected in parallel, would

give a total impedance of 7.5 ohms. Two AD-5200M loudspeakers, each 7 ohms, connected in parallel, would give a net impedance of 3.5 ohms. With three loudspeakers in parallel, 15-ohm (-PM) units would probably be preferred to give 5 ohms impedance—a rather odd value which could conceivably be fed from a 3.5-ohm or 7-ohm tapping on an amplifier, depending on which gave the best results. With four loudspeakers, it is generally most convenient to connect them in series-parallel to retain the same impedance as a single unit. Thus four 15-ohm loudspeakers connected in series-parallel, would give a nominal impedance of 15 ohms; likewise for other impedances.

It should be stressed that the performance figures quoted in connection with figure 1 are based primarily on the Philips Ad-5200 loudspeaker and, while we would expect other comparable heavy-duty loudspeakers to behave in a similar manner, they may or may not have a comparable power rating. This would be up to their manufacturers to say.

Figure 2 is a photograph of a two-loudspeaker system currently being marketed. It is constructed of flake board 5/8in thick, covered with good-quality plastic cloth and fitted with chrome-plated corners, rubber feet and tilt-back legs. It is available from the manufacturer with or without loudspeakers.

Fitted with MSP or Rola loudspeakers, the enclosure is normally sold as a 40-watt system, recommended particularly for lead and rhythm guitars. However, its internal volume of 2.6 cubic feet would qualify it to take two Philips AD-5200 loudspeakers and would presumably gain the blessing of the Philips organisation as a 50-watt unit. In fact, we gather that this type of enclosure, fitted with the Philips loudspeakers, is finding some application with bass guitars and amplifiers of the 40-watt class.

For those who may wish to build their own enclosure along these general lines, figure 3 gives the essential dimensions. Note that it should be constructed from material not less than 5/8in thick and that all joints should be accurately finished, then glued and screwed as necessary. The rear lid must also make a virtually airtight fit and be fastened in place with at least four screws along each of the longer edges and three screws at the ends. The original design provides for the fret cloth to be supported in front of the actual face of the baffle to minimise the risk of it flapping under the influence of large low-frequency cone excursion.

Pictured in figures 4 and 5 is a prototype enclosure which has been developed by Manufacturers Special Products to mount for twelve-inch loudspeakers. As shown, it contains four 12UA15 units and is rated to handle 60 watts as, for example, from our Playmaster 117 Guitar Amplifier. For heavier duty service or for use with bass guitars, the company suggests a particular version of the MSP type 12PQ (part no. 50226) rated at 20 watts per loudspeaker.

Of particular interest is the fact that the MSP enclosure design provides for a small vent in one surface which would normally be placed so that it is at the bottom, and exposed by tilting the enclosure backwards. The idea behind this is that tilting the enclosure will get the middle and upper frequencies out over the audience and away from people, furnishings and carpets. Having a vent feeding into a V-slot formed by the bottom of the cabinet and the floor is presumably intended to improve bass efficiency somewhat, as compared with a conventionally vented or a non-vented enclosure of the same general size.

The design provides for an internal volume of about 3.5 cubic feet, which is considerably short of the figures quoted earlier as being adequate for a sealed enclosure. It would, therefore, appear that MSP engineers have tried to come up with the smallest practical enclosure which would house four 12 inch loudspeakers, resorting to a vent in an effort to offset the very limited internal volume. While the presence of the vent will remove some of the protection from the cones at very low frequencies, they should not be unduly distressed, provided the 60-watt rating is observed. One would expect other comparable loudspeakers to perform in a similar manner to the 12UA15 units and this would include the Phillips AD-2000 series; Phillips have emphasised that the 25-watt rating per unit, mentioned earlier applies ONLY with sealed enclosures not exceeding the stated maximum volume.

On a listening test with an audio generator, the effect of the abbreviated enclosure was apparent as a reinforcement of the output in the region of 150Hz, with a considerable drop in level below about 130Hz indicating that the contribution being made by the vent was of a minor order. It would suggest that guitarists using such an enclosure may have to reinforce the lowest notes by appropriate playing techniques and the use of bass boost - assuming that this latter does not aggravate the already over-generous output at 140 - 160 Hz.

In discussions with MSP engineers, they indicate that practical tests by guitarists have shown that this kind of response presents no insuperable difficulties and that a compact four-loudspeaker enclosure has a strong utilitarian appeal. This view is strengthened by a prototype enclosure which arrived at our laboratory, quite late in the proceedings. Styled as a portable enclosure, somewhat like the Moody enclosure illustrated, it accommodates four 12-inch loudspeakers and has an internal volume very similar to that of the MSP enclosure - but without a vent port.

Figure 6 gives the main dimensions of the MSP enclosure. Note that material not less than  $\frac{3}{4}$ " thick should be used, with a centre pillar to stiffen the front and back panels. In the Electronics Kits enclosure, just mentioned, this centre pillar is replaced by a complete horizontal shelf which effectively divides the enclosure into two. This would not materially alter the resonance of the loudspeakers but it would certainly stiffen all faces and, as a bonus, make it easier to install internal padding if this were required.



For those who may be disturbed by the rather high resonance of these four loudspeaker systems, a possible alternative would be to install three loudspeakers only, eliminating any vent and filling the enclosure with Innerbond or Tontine 75 or further broaden and lower the resonance.

Alternatively, if four loudspeakers must be used, for their higher power handling capacity, consideration could be given to increasing the internal dimensions to about 5 cubic feet (with 5.6 as a maximum) again without the use of a vent but with internal padding.

For the Playmaster 117 60 watt amplifier, the Rola company suggests that four of their 12PEG loudspeakers could be used in a suitable enclosure, or four 12PX loudspeakers if the player is seeking the additional brightness which can be contributed by a tweeter cone. However, to give a margin of power handling capacity, particularly for bass work, 12UEG loudspeakers are recommended having a nominal power handling capacity of 80 watts. Again, where brighter sound may be sought, the 12UX could be substituted.

#### THE PLAYMASTER BOOKSHELF LOUDSPEAKER UNIT

Its not very often that we run to superlatives but this is one occasion when we're letting our heads go. The Playmaster "Bookshelf" loudspeaker is only a small unit but we think that it's going to be a pacesetter for the hi-fi industry. Why? Because it gives good fundamental bass to below 50cps, yet extends smoothly to 20KC. This, with clean, well defined sound and a remarkable freedom from boxiness. And the price, complete? Less than one third of what you would pay for manufactured counterparts.

#### ABOUT THE PLAYMASTER BOOKSHELF UNIT :

1. It is designed expressly for a 6 inch bass speaker having a low resonance cone. Use of a larger speaker or one with a higher cone resonance will, in most cases, produce an unacceptable bass characteristic.
2. The enclosure must be airtight, without accidental cracks or deliberate ports. Full power should be fed to the bass speaker only when the back is in position.
3. The tweeter has a sealed back to protect it against internal air pressure. Open-backed tweeters are not suitable and, in any case, most of the earlier types leave much to be desired in terms of high frequency response.
4. Use the recommended packing or its equivalent. Carpet underfelt or other dense materials will prejudice results.
5. The tweeter has a margin of level over the bass speaker. Do not run it full on unless you are quite certain that you want it that way. Conversely, be realistic about bass boost - about half on for normal listening volume. Use heavier boost only for low level listening or when the program material is deficient in the bass register.

The new Playmaster bookshelf unit isn't just a loudspeaker mounted in a small

The new Playmaster bookshelf unit isn't just a loudspeaker mounted in a small box, dressed up to look the part. Such a proposition would present little difficulty - and little reward.

Rather is our new speaker the result of intensive effort, during the past few weeks, to see whether we would get genuine wide-range sound from a combination of a do-it-yourself cabinet kit one or more loudspeakers, free from all the cost loadings of the manufactured article.

It started out as a rather vague hope and finished with the realisation that we have a winner on our hands.

In the laboratory, we had the pleasure of seeing it turn up with a curve on the Bruel and Kjaer equipment, which looked agreeably flat, considering all the problems of sound pressure testing and the kind of curve which so often emerges. And, in listening tests, in our own workshop, it was highly commended over and over again by people in the audio industry.

They were amazed at the hard transients and the deep fundamental bass - and the lack of artificial colouration. They were even more amazed to realise that this was coming from a couple of loudspeakers which could be bought for a few pounds from any radio supplier.

But enough of the trumpet blowing. What is the story behind this new loudspeaker system? To date, the accepted approach to obtaining 30-cycle bass and powerful wide-range reproduction has been to start off with a generously proportioned loudspeaker (usually 12 in diameter) and to mount it in an equally generous and stout enclosure (6 cu. ft. or more) variously vented or ported to hold up the extreme bass response where it might otherwise taper off. This combination is then fed from a suitable amplifier, it being a matter of pride and principle that the speaker must sound "right" with the variable bass and treble controls set to the strictly "level" position.

The coming of stereo and the implied need for not one but two of the costly bulky monsters in every hi-fi listening room has triggered an almost universal revolt on the domestic front. The ladies just wouldn't have them, so there! Little wonder that every second hi-fi enthusiast has been pondering the vexed problem of how to get big bass from small enclosures.

Perhaps it should be emphasised here that it is in the bass region where the problem concentrates. By nature, high frequency cones and tweeters can make all the noise they need to, with quite small dimensions. Even the middle frequencies aren't too demanding in this respect. But good bass response involves "pumping" lots of air slowly back and forth and this means either big cone areas or big cone movements, or a measure of both.

It also means controlling the pressure waves produced behind the cone, so that they won't cancel those generated by the face of the cone. This leads into the problems of loudspeaker "baffling", cabinets, enclosures and so on.

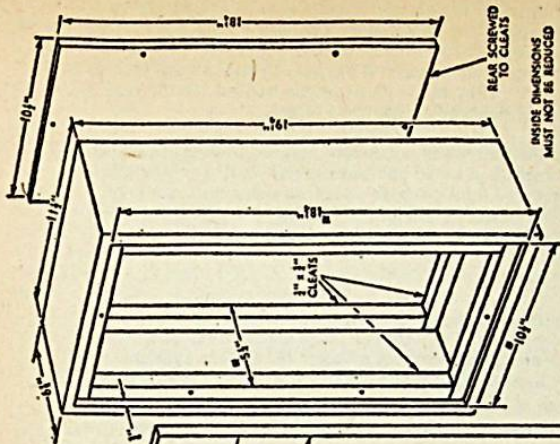

ENCLOSURE PACKED WITH  
30" x 18" x 14 OR 16mm  
"THINEBOND"

**PLAYMASTER 109 BOOKSHELF LOUDSPEAKER UNIT**

1" BAFFLE.  
FINISH EDGE TO ALLOW FOR  
THICKNESS OF SPEAKER FABRIC.  
BAFFLE SCREWED TO CLEATS FROM  
THE INSIDE

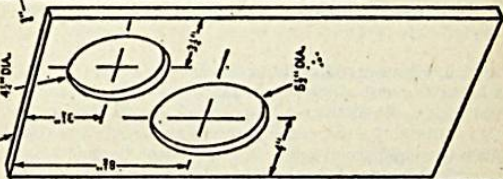

1" FOAM PLASTIC,  
BLACK OR SPRAYED WITH  
FLAT BLACK PAINT AND GLUED  
TO FRONT OF BAFFLE

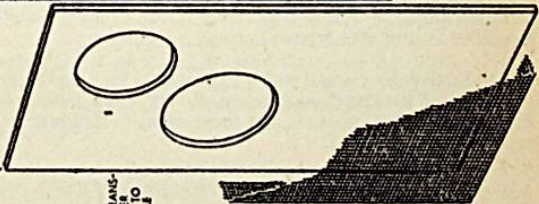

ACOUSTICALLY TRANS-  
PARENT SPEAKER  
FABRIC STAPLED TO  
REAR OF BAFFLE

As we've already said, the classic answer of large speakers in large enclosures has been rejected on a wide front and there have been numerous attempts to make do with small enclosures, their sponsors resorting to all manner of shapes, holes, ports, fillings and what have you. They mightn't sound too bad but, to the discriminating ear, they don't sound too good either.

The basic reasons for this is not in any failure, to date, to select the right combination of holes and imensons. It lies rather, in the fact that large general purpose speakers react unfavourably to small enclosures and no amount of fiddling with dimensions and details can alter the basic physical laws which relate the two.

### NOT REALLY NEW

None of this is really new, of course, and the audio industry abounds with examples of traditional large enclosures, dubious abbreviated versions and compact speaker / enclosure systems which have obviously been designed with a full knowledge of the factors involved. Some of these latter are very good indeed, even though most high fidelity enthusiasts have tended to be suspicious of their small size.

As far as we are concerned, it is probably true to say that the Goodman's was the unit which really made the audio industry sit up and take notice. Fantastic as it appeared, there was no denying the fact that these tiny units could produce amazingly well balanced sound, given the right conditions. It drove home the need for specialised speakers and the logic of using smooth bass boost from the amplifier rather than trying to win a bumpy substitute from any other kind of abbreviated loudspeaker system.

From the tiny Goodman it was a logical step back up to the "KEF Celeste" and the "Radford Bookshelf", which just happened upon the market at the time. It was no surprise to find in them the commendable qualities.

There is no secret about the fact that loudspeaker systems of this general type succeed because they start off with a bass loudspeaker unit having an extremely low frequency fundamental cone resonance and a cone area no larger than it need be for the power to be handled. When subsequently mounted in a small enclosure, air loading forces the resonance much higher in frequency but the aim is always to keep it well below 100cps.

The resonance curve in a small enclosure tends also to grove in amplitude, indicating a higher "Q" but this can be controlled by a discreet amount - not too little, not too much - of absorbent filling in the enclosure.

With this general design philosophy it is also common practice to make the enclosure absolutely airtight on the assumption that any kind of a port can only cause embarrassment.

Consultation with engineers brought to light the need of a 6" diameter Woofer with a cone resonance at 50cps or below and enough power handling capacity to cope with all likely demands of a stereo pair in a domestic listening situation.

As a next step, we made up a box which conformed to the general "book-shelf" concept and with dimensions which would allow it to be cut conveniently from standard plywood sheet. In it we mounted the 6" speaker, initially without internal padding of any kind.

We then explored the bass region with an audio generator and a low impedance source amplifier, observing voice coil current with a small value series resistor and a millivoltmeter. The resonant peak showed up in the 90 - 95 cps region with a calculated voice coil impedance of about 100 ohms. At least it was under 100cps which was something.

Then we tried packing the enclosure with the material that happened to be nearest to hand - a length of ordinary carpet underfelt. We found that we could flatten the impedance curve almost at will, while dragging the resonance down to 80cps or slightly below. Running over the range with an audio-tone source indicated output smoother to the ear than we had dared to expect and extending without obvious frequency doubling to around 40cps. It was beginning to look promising.

About this time, and quite fortuitously, the Rola Company sent along a sample of their new 5" tweeter and, modest price notwithstanding, it turned out to be one of the best tweeters we have ever handled.

So we cut another hole in the enclosure for the Rola tweeter, put in a single section crossover network and proceeded to some preliminary listening tests.

Because the tweeter tended to dominate the Woofer, we had to put in a small 100 ohm slider resistor to balance up the overall response. This done, the unit sounded quite impressive, to the point where we were beginning to generate real enthusiasm. But it still had a slight "woody" quality.

What about the packing? While carpet underfelt is cheap, available and suitable enough for walking on, we had no illusions about its limitations for acoustic purposes. Enquiries brought to light a suitable material, a bonded cellulose acetate fibre. The 16oz material is a nominal 1/4" thick, and weighs 11b per square yard.

One square yard, cut in two, provides two pieces 18" x 36" and, loosely rolled, these substantially filled two stereo enclosures, one roll to each.

#### MODEST COST

Even at the retail price, the cost of filling added up to less than £1.00 with the advantage that the material is completely clean to handle, involving no supplementary dustproofing of the speakers, no fixing arrangements and no extra padding of the enclosure walls. There may well be other absorbent materials available which would do the job.

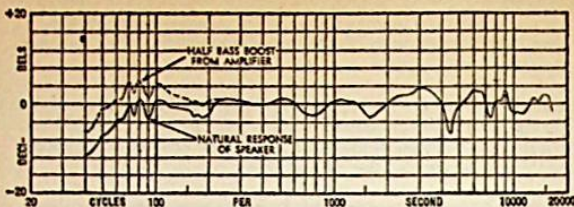

Shown above is the response curve of the Playmaster Bookshelf loudspeaker taken with the microphone on the axis of the tweeter and 18 inches from the fret cloth. For the test, the tweeter was fed through a simple 7-ohm series resistor. The dotted curve represents the response to be expected with a typical amplifier set for about half bass boost.

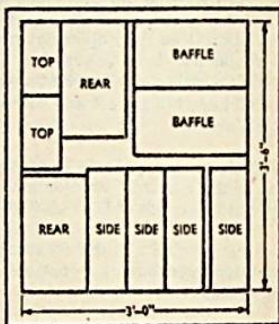
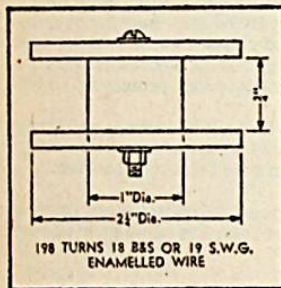

Cut like this, everything for two cabinets, other than two bottoms, can be cut from half a 7 x 3ft sheet of ply. Using a 6 x 3ft sheet, there will be material to spare.

The inductor can be wound on a non-metallic bobbin, hand-made to the dimensions above. At right is shown the interconnection of filter, speakers and tweeter level slider, which can well be preset before installation. See text re loudspeaker phasing.

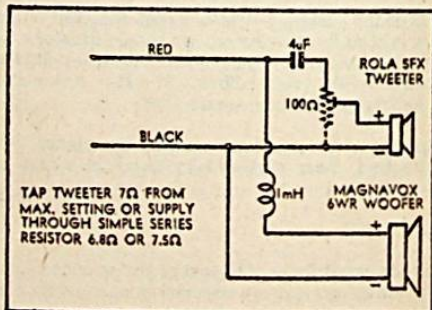

Listening tests indicated that the "woodiness" had completely disappeared and the sound quality from a stereo pair was now really impressive.

It was at this stage we sought the assistance of the laboratory to have them plot the actual acoustic output from the unit on their automatic curve tracing equipment. A slight touch up of the tweeter level and, as we said earlier, we found ourselves with a curve which was wide in its frequency coverage and substantially free from plateau effects which can so readily colour the sound, as heard.

The bass end was tapered as we expected, being an almost exact replica of commercial bookshelf speakers and well able to be built up by a few decibels of bass boost.

Of course, frequency response is not everything and no less attention must be paid to possible intermodulation and distortion effects. This was highlighted by some work which we did in relation to the cross-over frequency between woofer and tweeter.

We had proceeded on the assumption that we would use nothing but a proper L/C cross-over network, in order to divide the spectrum in a positive fashion. Further that the best crossover region would be about 5KC, so as to avoid the irregularities which appear in many tweeters in the 3KC region.

However, as part of our investigation, we substituted a 2.5KC cross-over network.

The difference was not great but most of the time, most of the listeners preferred it as "slightly cleaner" and with "a trifle better definition" this, in spite of the fact that the natural characteristic of the tweeter showed up as a prominence at 3-4KC, followed by a dip at 4.5KC. However, the listener reaction was clear enough.

The explanation, we feel is that:

- (1) The tweeter is better able to handle the middle register than the woofer, when the latter is heavily loaded up with lower frequency signal.
- (2) Most listeners react favourably to a slight prominence in the 3KC region.

Since the whole purpose of a loudspeaker system is to entertain the ear rather than the eye, we settled for the arrangement which, by majority judgment, sounded the better of the two.

Reproduction herewith is the curve for the loudspeaker, as fitted up ready for photographing, with woofer and tweeter, a crossover network for 2.5KC and  $\frac{1}{2}$ lb of packing.

The solid line is the curve of the system overall, with the tweeter tapped across 80 ohms of the 100 ohm slider resistor and obviously a trifle below "level". With this adjustment, it sounded fine in the laboratory, which has mainly hard reflecting surfaces.

Prior to taking the curve, we had used a few spot readings to set the level of the tweeter, subsequent measurement then showing that it was tapped 7 ohms away from "full on". Actual plots indicated that the result was virtually identical with the tweeter fed from the slider in this fashion or through a simple 7 ohm series resistor.

In fact, the curve as shown is for the simple 7 ohm series resistor. and, if you're not intent on being able to make rather fussy adjustments, you may as well instal a fixed resistor, in series with the tweeter, in the range 6.8 to 7.5 ohms and preferably rated at 1 watt minimum.

At the bass end also, the curve has to be taken with some reservation, because it is difficult to know exactly how much of the curve belongs to the speaker and how much to the standing wave pattern in the test room. While too much notice should therefore not be taken of local peaks and troughs, the general contour of the curve corresponded with listening tests in other situations.

The system does taper gradually below about 70cps but not so steeply that it sounds inadequate.

However, it performs to best advantage with about 5dB of bass boost, represented by the bass control of a typical amplifier set for about half boost. This raises the curve to the general contour, as shown dotted.

In this position, most of those who heard the system expressed amazement not only of the bass response from such compact enclosures but for the bass response - full stop! Runs of organ pedal notes emerged without obvious lumps, without apparent doubling and with little discernible intermodulation with higher frequency sounds.

Over all, we rated it as the kind of sound which is very easy to live with and, the more we listened, the more the feeling grew.

If all this is true, why bother about bigger magnets, foam cones and all the exotica of various imported speakers? This is a fair question.

The most obvious difference is that 6" is rated only as a 6-watt unit. This is a pretty general figure, of course, which would be augmented by mounting the speaker in a sealed and damped enclosure but diminished again by the likely use of bass boost. It also has to be interpreted in relation to the kind of sound to be fed through it, whether the listener is a fan of Segovia or German!

Considering the sensitivity of the system and, in the light of our own experience with a 12 + 12 RMS watt amplifier, we have no hesitation in stating that it will meet all likely requirements with any kind of music in a large lounge room.

But if you live in a furnished town hall and/or insist on playing everything at maximum volume with full bass boost, then a 6 RMS watt woofer isn't for you. You'll simply have to take out your cheque book and buy one of the manufactured units with a 15 to 25 watt rating.



As to comparisons at ordinary room volumes, this is something that the individual must judge for himself.

### FIXING THE BAFFLE

Coming on to the constructional side, the Playmaster Bookshelf prototypes were built up with  $\frac{1}{2}$ " sides, bottom and top of natural timber and with front and back panels of  $\frac{1}{2}$ " ply. In an enclosure of these dimensions  $\frac{1}{2}$ " material is permissible because the panel areas are limited.

We see no good reason why individual constructors should not use solid timber, plywood or one or other of the composition boards, as they choose, provided the panels are not less than  $\frac{1}{2}$ " thick. Yes, they could be thicker but not thinner.

The actual constructional method will vary with the material used, as also with the ideas and skill of the constructor.

The prime requirement is to build a short, rigid "tube", as formed by the sides, top and bottom and to the inside dimensions shown in the accompanying sketch. Thicker material will involve adding to the external dimensions; IN NO CIRCUMSTANCES should the enclosed volume be reduced.

If special circumstances force you to reduce any one dimension or to reduce internal volume by extra cleats, due compensation should be made elsewhere. A slight increase in volume may be all to the good; a decrease will push the speaker resonance up in both frequency and amplitude and ruin results.

With plywood, a popular jointing method for amateurs is to cut the top and bottom panels about  $\frac{1}{2}$ " shorter than the overall width of the cabinet, fixing them in place with internal cleats so that the edges are set in by about  $\frac{1}{4}$ ". A slightly oversize  $\frac{1}{4}$ " x  $\frac{1}{2}$ " sliver is then glued into the four recesses. Later it can be carefully planed and sanded flush with the surface veneers, effectively hiding the end grain of the top and bottom panels. The face can be dressed with strips of veneer filled and lacquered to a suitable shade of fawn or brown.

On the other hand, if suitable facilities are available, panels can be mitred at 45 degrees, then glued and screwed directly together, leaving only a hairline, which requires little disguising. This is not a practical method for the handyman, however, unless you are a much better craftsman than average.

Incidentally, if the cabinets are to stand on end, the sides can be carried to the floor and the bottom inset, obviating the need to hide end grain.

With this arrangement it is also possible to cut two complete cabinets out of a 36" x 42" sheet, as indicated, using scrap for the bottom which will not be seen.

If the cabinet is to be finished all round, it will be necessary to cut into a standard 36" x 72" sheet or work from a 36" x 42" and purchase an extra oddment for one of the baffles. Either way, it is not an expensive proposition considering that the yield is a pair of stereo cabinets.

With composition board, convenience and strength can take precedence over finish. The surface can then be finished with veneer. Inside the "tube" a set of  $\frac{3}{4}$ " x  $\frac{3}{4}$ " cleats has to be glued and screwed to support the front baffle and rear panel.

Those at the rear can be set in by the depth of the panel so that it will be flush with the edge of the "tube". It should be a snug fit, making a virtually airtight seal and be drilled for at least 6 screws, driven through the panel into the cleats.

The fret cloth should be one of the Tygan lines or something similar, intended to be acoustically transparent.

### CONSTRUCTION

Before screwing the loudspeakers in place, it may be wise to check their polarity. Most likely they will be marked already, but polarity can be double-checked by connecting a 1.5V torch cell across the voice coil. The convention is to observe which polarity causes the cone to move FORWARD when the circuit is CLOSED. The voice coil terminal connecting to the positive pole of the battery is then considered POSITIVE.

Having mounted the two loudspeakers, the divider network can be installed.

The components forming the network can be attached to the inside face of the front baffle and wired as per the accompanying circuit diagram.

If you elect to use a slider in place of a fixed resistor, you will have to choose whether to mount it inside, where it is inaccessible but protected, or outside where it is accessible but prone to damage.

If expense is no object, it could be replaced by a 100 ohm wire-wound potentiometer, with the spindle brought out through a snugly fitting hole.

BIBLIOTHEEK  
N.V.H.R.

BERNARDS & BABANI PRESS RADIO AND ELECTRONICS BOOKS

BP1	First Book of Transistor Equivalents and Substitutes	40p
BP2	Handbook of Radio, TV and Ind. & Transmitting Tube & Valve Equivalents	60p
BP3	Handbook of Tested Transistor Circuits	40p
BP4	World's Short, Medium & Long Wave, FM & TV Broadcasting Stations Listing (International Edition)	60p
BP5	Handbook of Simple Transistor Circuits	35p
BP6	Engineers and Machinists Reference Tables	30p
BP7	Radio and Electronic Colour Codes and Data Chart	15p
BP8	Sound and Loudspeaker Manual	50p
BP9	38 Practical Tested Diode Circuits for the Home Constructor	35p
BP10	Modern Crystal and Transistor Set Circuits for Beginners	35p
BP11	Practical Transistor Novelty Circuits	40p
BP12	Hi-Fi, P.A., Guitar & Discotheque Amplifier Design Handbook	75p
BP13	Electronic Novelties for the Motorist	50p
BP14	Second Book of Transistor Equivalents	95p
BP15	Constructors Manual of Electronic Circuits for the Home	50p
BP16	Handbook of Electronic Circuits for the Amateur Photographer	60p
BP17	Radio Receiver Construction Handbook using IC's and Transistors	60p
BP18	Boys & Beginners Book of Practical Radio & Electronics	60p
BP22	79 Electronic Novelty Circuits	75p
BP23	First Book of Practical Electronic Projects	75p
BP24	52 Projects using IC741 (or Equivalents)	75p
BP25	How to Build Your Own Electronic and Quartz Controlled Watches & Clocks	85p
100	A Comprehensive Radio Valve Guide - Book 1	40p
121	A Comprehensive Radio Valve Guide - Book 2	40p
126	Boys Book of Crystal Sets	25p
129	Universal Gram-Motor Speed Indicator (Combined 50 & 60 <sup>00</sup> model)	10p
138	How to make Aerials for TV (Band 1-2-3)	25p
143	A Comprehensive Radio Valve Guide - Book 3	40p
150	Practical Radio Inside Out	40p
157	A Comprehensive Radio Valve Guide - Book 4	40p
160	Coil Design and Construction Manual	50p
161	Radio, TV and Electronics Data Book	60p
170	Transistor Circuits for Radio Controlled Models	40p
177	Modern Transistor Circuits for Beginners	40p
178	A Comprehensive Radio Valve Guide - Book 5	40p
183	How to Receive Foreign TV Programmes on your Set by Simple Modifications	35p
195	High Fidelity 14 Watt Amplifier Design Chart	15p
196	AF-RF Reactance-Frequency Chart for Constructors	15p
197	Inexpensive Push-Pull Amplifier Construction Chart	15p
200	Handbook of Practical Electronic Musical Novelties	50p
201	Practical Transistorised Novelties for Hi-Fi Enthusiasts	35p
202	Handbook of Integrated Circuits (IC's) Equivalents and Substitutes	75p
203	IC's and Transistor Gadgets Construction Handbook	60p
204	Second Book of Hi-Fi Loudspeaker Enclosures	60p
205	First Book of Hi-Fi Loudspeaker Enclosures	60p
206	Practical Transistor Circuits for Modern Test Equipment	75p
207	Practical Electronic Science Projects	75p
208	Practical Stereo and Quadraphony Handbook	75p
209	Modern Tape Recording Handbook	75p
210	The Complete Car Radio Manual	75p
211	First Book of Diode Characteristics Equivalents and Substitutes	65p
215	Shortwave Circuits and Gear for Experimenters and Radio Hobbies	85p
216	Electronic Gadgets and Games	85p
RCC	Resistor Colour Code Disc Calculator	10p

BABANI PRESS & BERNARDS (PUBLISHERS) LIMITED

The Grampians, Shepherds Bush Road, London W6 7NF

Telephone Number: 01-603 2581/7296

Bibliotheek Ned. Ver.