



75p

**79 ELECTRONIC  
NOVELTY  
CIRCUITS**

**BY**

**B. B. BABANI**

R

de Historie v/d Radio

**BABANI PRESS**

**No. 22**

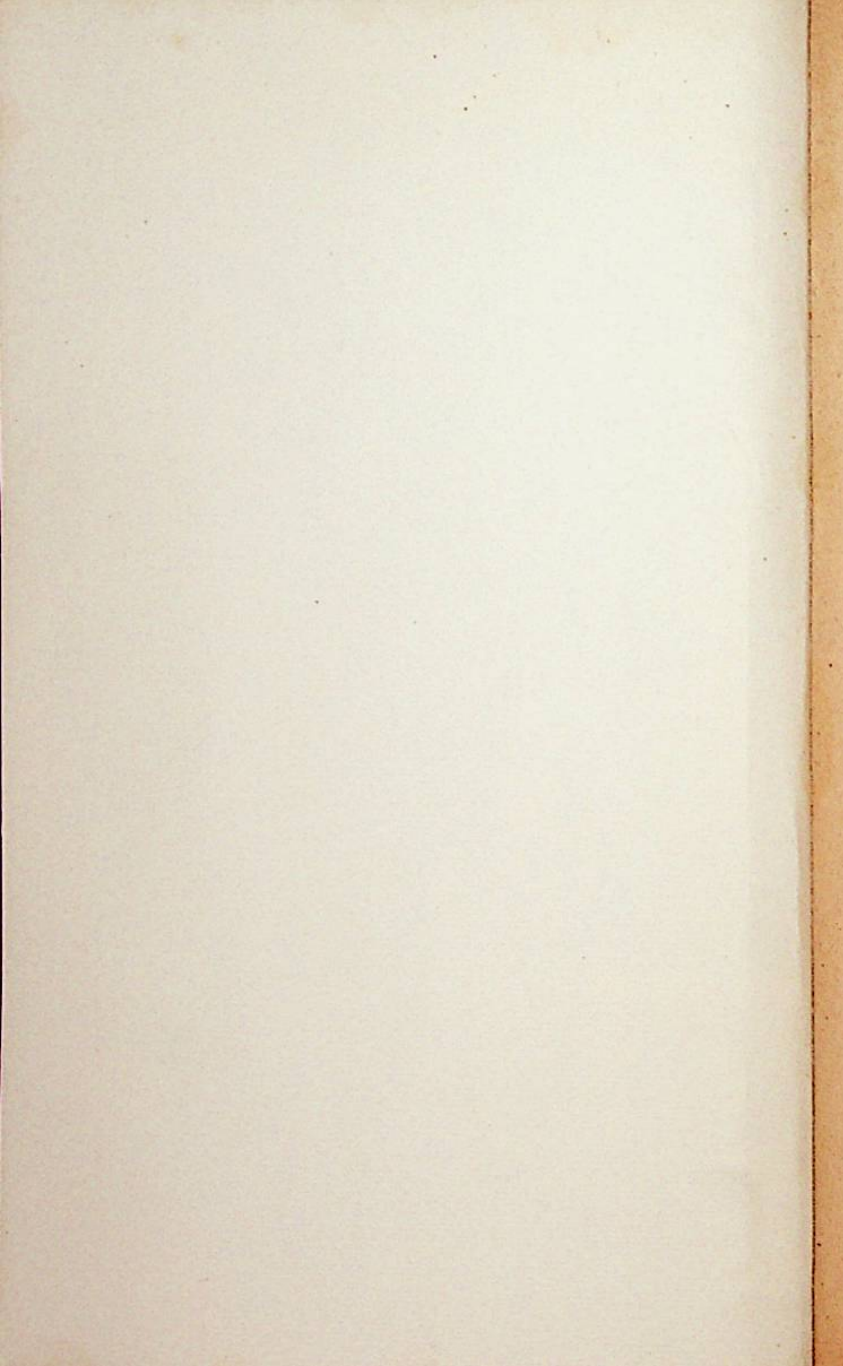

**79 ELECTRONIC**

**NOVELTY**

BIBLIOTHEEK

N.V.H.B.

**CIRCUITS**

**BY**

**B. B. BABANI**

**BABANI PRESS**

The Publishing Division of  
Babani Trading and Finance Co Limited  
The Grampians  
Shepherds Bush Road  
London W6 7NF

Although every care is taken with the preparation of this book the publishers will not be responsible for any errors that might occur.

© 1975 by Bernard B. Babani

I. S. B. N. 0 85934 021 X

First Published February 1975

Reprinted July 1976

Made and printed in Great Britain by  
C. Nicholls & Company Ltd, Manchester



## C O N T E N T S

Circuit		Page No.
1	Reduction of Hum in Hi-Fi Equipment	7
2	Intercom Privacy	9
3	Economical Burglar Alarm	9
4	Audio Sentry Siren	11
5	Magnetic Preamplifier Equaliser	11
6	More on Road Safety	12
7	Simple Capacitance Tester	12
8	Novel Broadcast Test Oscillator	13
9	Solid State AGC Circuit	13
10	Multiple Switching for Lighting Circuits	13
11	Low Frequency Function Generator	13
12	Regulated Power Supply	15
13	Wide Range Frequency Doubler	15
14	Operational Amplifier	17
15	Constant Impedance Potentiometer	17
16	Drilling Jig	17
17	Linear Sawtooth Oscillator	17
18	An Oscilloscope Calibrator	20
19	Temperature Sensitive Capacitor	20
20	Economical 455KHz Block Filter	21
21	Temperature Sensitive Capacitor	22
22	Testing Unknown Zener Diodes	24
23	Simple Signalling Device	24
24	Sawtooth Oscillator	24
25	Moving Target Range	26
26	Automotive Voltage Regulator	26
27	Transistor Repair	28
28	Checking Pick Up Tracking Error	28
29	A 50Hz Hum Eliminator	29
30	Reaction Testing Game	29
31	Temperature Operated Switch	29
32	Car Burglar Alarm	31
33	High Performance Amplifier	31
34	Centre Woofer Crossover Network	33
35	Burglar Alarm	35
36	F. E. T. Pick Up Preamplifier	35
37	Light Operated Transistor Alarm	37
38	Ultra Sensitive Ohmmeter/Light Meter	37
39	Light Beam Intruder Alarm	40
40	Low Voltage Solid State Regulated Power Supply	40

41	Improvements to a Logic Probe	42
42	Battery Protector	42
43	Inexpensive Alarm Device	42
44	Regulated Power Supply	44
45	Capacitor Tester	44
46	Trailer Flasher Unit	48
47	Bell and Buzzer Warning Circuits	48
48	Draws the Curtains at Sunrise!	50
49	Shorted Turns Tester	52
50	Simple Intercom	52
51	Inertia Operated Switch	54
52	Transistor Regulator for Alternator	54
53	Water Level Alarm	54
54	Power Supply for Car Radios	55
55	Simple Transistor Tester	57
56	False Neon Indications	59
57	Transistorized Resonance Meter	59
58	Transistor 2 Meter Convertor	60
59	Reflex Portable Receiver	60
60	Continuity and Polarity Indicators	62
61	Low Cost Regulated Power Supply	62
62	Thermistor Measures Temperature	64
63	Flasher for 240V Lamps	66
64	Pulse Control of 2 Speed Windscreen Wipers	66
65	Expanded Scale Voltmeter	68
66	Transistor Oscillator and Frequency Multipliers	70
67	Direct Reading Capacitance Meter	72
68	Multimeter	74
69	3 Transistor Millivoltmeter	74
70	A 144-Mc Antenna Matching Preamplifier	78
71	Audio Oscillator	78
72	Power Supply Unit for Transistors	78
73	Capacitance Meter	82
74	Low Noise Preamplifier	82
75	Road Safety Role for the Diode	85
76	Flood Warning Alarm	85
77	One Transistor P. A. System	87
78	Model Train Chuffer	87
79	Turn on Almost Anything with a Sensor Switch	88



TO HELP OUR AMERICAN AND EUROPEAN READERS WE  
 INCLUDE HEREWITH A FULL EQUIVALENTS AND INTER-  
 CHANGEABILITY LIST OF THE SOLID STATE DEVICES  
 USED IN THE CIRCUITS SHOWN IN THIS BOOK.

BIBLIOTHEEK  
 N.V.H.B.

Original	Tandy-Archer, USA or Pro-Electron Type
AC125	RS276-2005, OC71-81-303, AC122-126-151-163.
AC126	RS276-2004, OC71-303-304, AC122-151-163.
AC127	RS276-2001, 2N403-611-726-1221-1280.
AD140	RS276-2006, AD149, 2N2836-1022.
AF114	RS276-2003, AF134-135-194, 2N346-2495, 2SA116.
AF115	RS276-2003, AF136-185, 2N1110, 2SA156.
AF118	RS276-2003, 2N2207, 2SA76.
AY1101	RS276-1102, BB103, BAY11.
BA100	RS276-1102, BAY11.
BA102	RS276-1102, BB103.
BC107	RS276-2031, BC147-167-207-317, 2N2921-3568, 2SC458.
BC107B	RS276-2031, BC171-182-207-237-547-582.
BC108	RS276-2009, BC172-183-208-238-548-583.
BC109	RS276-2031, BC173-184-209-239-548-584.
BC177	RS276-2024, BC204-212-261-307-512-557, 2SA565.
BFY50	RS276-2009, BSX46, 2N2193-2222-2297-3110, 2SC708A, BSY46, BFR22, BFY55.
BY126/400	RS276-1144.
BYX20-200	RS276-1042, BYX46-200.
BYX28-400	2 x RS276-1042, BYX28-600.
BYZ13	RS276-1062, BYX38-300, BYX48-300.
BZY88C4V3	RS276-620.
BZY88C8V2	RS276-622.
BZY94C12	RS276-623
D13T1	2N6027, BSV58(A/B)
EM401	RS276-1139, BA219, BY126/100, 1N4002.
EM404	RS276-1103/1139, BY113-116-127-134-143, 1N4004.
FuL9914	RS276-015
LDR	RS276-116, ORP12, LDR03, RPY25
OA90	RS276-1101/1102, AA112-116-121-123-137-138-143-160, 1N60-618.
OA91	RS276-1102/1136, AA117-118-132-144, 1N38-55-63-617.
OA150	RS276-1102/1136, AA117-118-132-144, 1N38-55-618.
OA202	RS276-1102, BA148, BAX16-17, BAY21-45-88.
OA210	RS276-1114, BY126-127, 1N540-3194.
OA605	RS276-1104.
OC35	RS276-2006, ASZ18, 2N1073-2870.
OC45	RS276-2003, AF132-172-185-187, 2N2411-2635-3324.
OC70	RS276-2004, AC121-126, ASY27, 2N1375-1384-2429.
OC71	RS276-2004, AC122-125-131-162, 2N1384-1991-2431.
OC72	RS276-2005, AC122-131-152, 2N1371-2431.
OC74	RS276-2005, AC125-180-192, 2N2431-2613.
OC81	RS276-2005, AC153-184, 2N2613.
OC171	RS276-2003, AF172-178, 2N2635-2873.
ORP12	RS276-116, LDR03, RPY25.
SE1001	RS276-2013, BF118-173-241, 2N3693.
SN7493	FLJ181, FJJ211.
TT801	RS276-2018, 2N4921, BD131, TIP29, 2SC496.

u A709	TS276-017/1739. TAA521.
u A709c	RS276-017/1739.
u A741	RS276-038. TBA221.
u A748	uA735.
u A777	uA735-740. SN52770-72770.
1N914	RS276-1102. BAY38. BA127-209. BAX16. 1N4148.
1N1345B	2 x RS276-1144.
1N1613	2 x RS276-1062. BYY22.
1N1615	2 x RS276-1149. BYY24. BYX42/900.
1N3754	RS276-1114/1105. BA104. BY127. 1N4002.
1N4004	RS276-1103/1114. 1105/1138. BY127. 1S103.
2G302	RS276-2003. AF185. 2N1305-1307.
2N301	RS276-2006. AD131-138/50. 2N2869-3611.
2N647	RS276-2002. 2N1306. ASY29. AC127.
2N2147	RS276-2006. AD149-167. 2N1907.
2N2175	RS276-2005. 2N2944/5.
2N2646	RS276-2029. TIS43.
2N2708	RS276-2011. BFX62. BFY88-90.
2N2925	RS276-2009. BC108-172-238.
2N3054	RS276-2017. BDY13. BUY38-46.
2N3055	RS276-2023. BD130. BDY39. BDX10.
2N3337	RS276-2016. BFY79.
2N3390	RS276-2013. BC168-173-183.
2N3565	RS276-2031. BC172-183-208-238.
2N3638A	RS276-2021. TIS50.
2N3642	RS276-2009. 2N2219. BC337. 2N2222A
2N3643	RS276-2033. BFR41.
2N3665	RS276-2014. BFY56. 2N2297-3110-3252.
2N3671	RS276-2021. BFY64.
2N4250	RS276-2024. BC214.
2N4360	RS276-2028. 2N4343.
2SB324	RS276-2005.
3N142	40486
40235	RS276-2015.
40236	RS276-2015.
40237	RS276-2015.
40250	RS276-2019. BD131. BDX24.



## REDUCTION OF HUM IN HIFI EQUIPMENT Cir. 1

Nowadays it is generally agreed that an audio amplifier with frequency near perfect, as far as human hearing can tell, presents a comparatively simple design problem. For this reason it is usually the strongest link in the audio chain.

Assuming that a choice of high-grade turntable, pickup and speaker has been made, it is quite possible to hear, at normal volume, no sound whatever other than that which the disc has recorded. This desirable state of affairs is not always attained, however, and often the drama of the quiet phrases of music and opera is spoiled by a steady hum or other spurious noise which soon becomes a major irritant.

Now it is an easy matter to filter and smooth out the rectified alternating current so that the anodes of the valves are fed with direct current, as smooth and as ripple-free as from a battery supply, but hum can still be fed into the circuit in other ways.

Often the worst offender is the power transformer. The alternating magnetic field of the transformer can induce audible hum into a magnetic pickup at a distance of two feet or more. One can check the extent of this field by listening with headphones connected across an iron-core inductor, such as a small filter choke or speaker transformer. The inductor is moved around at various angles and distances from the energised power transformer.

For reasons of convenience of handling and compactness, the power transformer of most amplifiers is mounted on the amplifier chassis where, although carefully positioned, there may still be an irreducible amount of electro-magnetic and electrostatic coupling to wiring and other components; this means hum. Furthermore, because it is desirable to have short connections between pickup and amplifier the power transformer may be close enough to the pickup to induce a hefty hum. The shielding of power and audio transformers is difficult, because it would take up to an inch or so of steel or iron to act as an effective shield.

The logical thing to do, if hum from the power transformer is suspected, is to remove the transformer from the amplifier chassis and install it on its own separate small chassis, fitted with an octal socket. A multi-conductor cable, four or five feet long, with octal plug can then feed power from the transformer to a tag-strip on the amplifier chassis. The transformer may then be placed in an inconspicuous position well away from the rest of the gear.

Another advantage with this arrangement is the fact that mechanical vibration from the transformer is not transmitted through the equipment cabinet to the pickup stylus - a common cause of hum or rumble, especially with stereo pickups.

Hum also is often collected by magnetic pickups from the turntable motor and a satisfactory reduction of this trouble is not at all a difficult job. Firstly we can reduce the power input to the motor and thereby reduce the intensity of the magnetic (hum) field radiated. Most motors have ample power reserve to accept reduction of power input without interference to speed regulation.

The motor used by the writer is specified to operate on a voltage of from two hundred to two hundred and fifty volts. This motor is now running quite steadily with a two thousand ohm. wire wound resistor connected in series with the power plug.

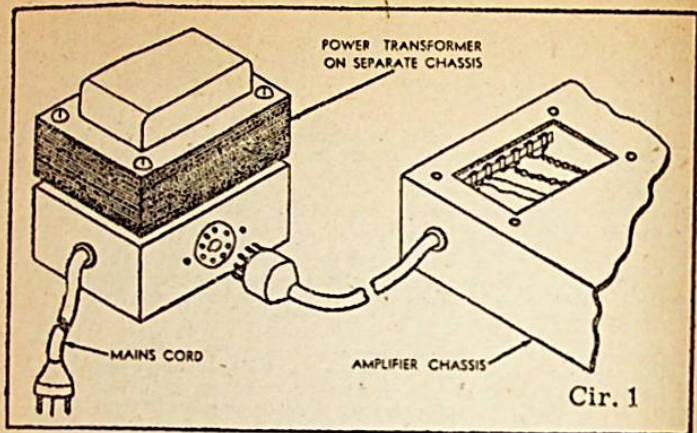

The power supply separated from amplifier chassis.

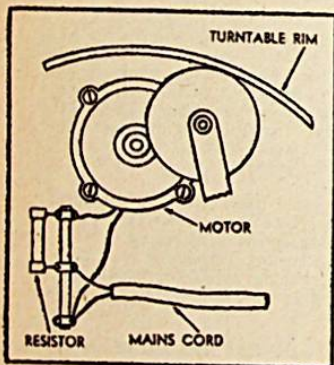

Reduction of motor hum.

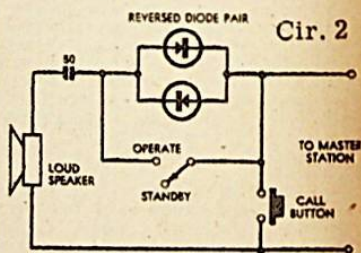

Cir. 2

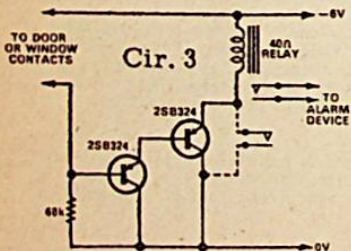

Cir. 3

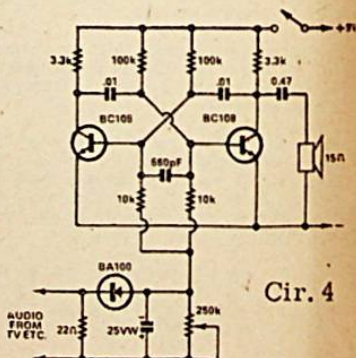

Cir. 4



It is a good idea also to place an additional rubber mat (such are available) on the turntable. This will lift the pickup further away from the motor (even a fraction of an inch is worthwhile) and, what is more, the steel or iron turntable will have less effect on the playing weight of magnetic pickups, while the risk of rumble is also reduced. If you do this don't forget to reset the stylus angle.

#### INTERCOM PRIVACY Cir. 2

An engineer mentioned the problem that the slave station of a simple intercom has no privacy. I have an intercom similar in operation to the "Edison" unit featured and use it in a situation where complete privacy is desirable.

To solve the problem, I installed a Standby-Operate switch and a 2-way semiconductor device in series with the slave loudspeaker as shown in the accompanying schematic.

With the switch in the Standby position, normal call tone signals and voice (though somewhat distorted) can be received by the slave unit, but the small signals generated by the slave loudspeaker acting as a microphone will be blocked because they are below the voltage level at which a diode will conduct.

With the switch in the Operate position, the intercom works as it was originally designed.

The semiconductor I used was of the type normally used to protect meter movements.

(If readers have trouble finding the semiconductor device, a pair of BA100 diodes - or similar types - wired in parallel with their polarities reversed will probably be satisfactory.)

#### ECONOMICAL BURGLAR ALARM Cir. 3

Here is a suggestion for a very economical burglar alarm. I used Japanese transistors salvaged from old radio sets. The transistors used may be either the 2SB prefix (PNP), or the 2SD prefix (NPN). Also, 2SA (PNP) or 2SC (NPN) types could be tried, if the relay coil you are using is not sufficient to overload them. The circuit will be used as shown for the PNP types but the battery polarity will have to be reversed for the NPN types.

As this circuit is activated by breaking the contacts circuit, it is suitable for application to door and window connections. If a break in the window or door contacts is remade, the relay will revert to its unoperated position. To avoid this, the relay can be made self-latching by using the dotted wiring.

In the passive state, with the transistors shown, the current is of the order of 0.3mA. In the operated state, 100mA or so is drawn. The 2SB324 transistors shown in the circuit are approximately equal to the AC128. A suggested setup would be to use a lantern battery as a power supply and the low current should give the battery a very long life. The alarm device can be left to the ideas of each individual.

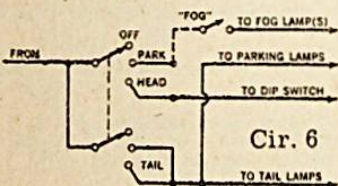
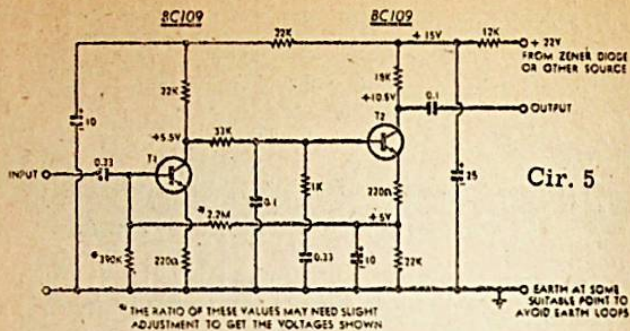

## A Simple Capacitance Tester

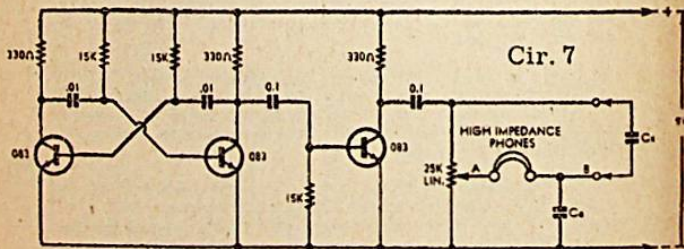



#### AUDIO SENTRY SIREN Cir. 4

A problem encountered in TV and audio servicing is intermittent sound. This can be a difficult fault to locate, as the unit has to be run for long periods with the volume turned up. Another person may turn the volume down and so the problem is compounded. Clearly, the need is for an alarm to attract attention when the audio fails. This circuit will meet that requirement.

Output of the audio amplifier for test is taken via two clip leads. A 22 ohm resistor across the input is to maintain a load for the amplifier under test. The audio is rectified and a negative charge appears across the 640uF capacitor, the discharge rate of which is determined by the setting of the 250k potentiometer. The voltage is fed to the base of each transistor via the 10k resistors, thereby holding the astable multivibrator at cut off and there will be no output. If the audio stops or falls to a low level the voltage across the 640uF capacitor will fall and so allow the multivibrator to function. The audio tone produced is fed to a small 15ohm speaker.

The unit is powered by a 9V transistor radio battery which should give a long life as the cut-off state current is only 20uA rising to 4mA when conducting. The maximum delay time is about 35 seconds and this is ample for most breaks between programs, etc. By progressively reducing the value of the 250k potentiometer the delay can be reduced to under 1 second. The audio tone may be altered by changing the value of the two .01uF feedback capacitors. The 560pF capacitor is additional feedback to ensure reliable starting. Although the drive to the speaker is small, it seems to be adequate.

I built my unit into an old remote control handset from a TV set, using the existing speaker and switch combination. This device is valuable in tracing intermittent faults in the audio systems in TV sets, radio sets, record players, etc.

#### MAGNETIC PREAMPLIFIER, EQUALISER Cir. 5

This circuit of a magnetic pickup pre-amplifier, which I have developed and built, is a result of a search for a circuit with better equalisation and signal-to-noise ratio than those I have previously built.

The circuit is quite straightforward, comprising T1 as a common emitter amplifying and impedance matching stage; a passive RIAA attenuator; and T2 which raises the signal level to about 200mV output from a 5mV cartridge. This signal is then suitable for feeding into high level (crystal or ceramic pickup) inputs on the main amplifier.

Input impedance at T1 is not less than 5Kohms which is suitable for the great majority of cartridges. This is due to the 220 ohm emitter resistor, which also provides a fair amount of negative feedback.

I have used a passive equaliser because a simple network gives a predictable 6dB per octave and it is easy to set up. The available compensation is not limited by amplifier gain, as may be the case with feedback type compensation.

The pre-amp has been used to drive the Unit Playmaster No.4 and it gives very pleasing results. Output will drive this amplifier to full power output with most recordings. For higher gain a 12AX7 may be substituted in the main amplifier.

Pre-amplifier noise level at full gain (listening about one foot away from the speaker) is just perceptibly higher than with the Playmaster input shorted.

EDITORIAL NOTE: The curve produced by this circuit follows the RIAA curve very closely, except that it does not provide the recommended roll-off at the bass end which should limit the bass boost to about 19dB at 20Hz, at which point the curve is substantially flat. This roll-off can be provided by reducing the size of the input capacitor (0.33uF) and output capacitor (0.1uF). In fact, by judicious selection of values the response could be made to fall below 20Hz; a useful feature where turntable rumble and/or acoustic feedback may be a problem.

#### MORE ON ROAD SAFETY Cir. 6

I was interested in an idea to ensure that the parking lights are still on when the head lights have been switched on. An alternate idea, which I believe is simpler and perhaps cheaper, is to identify the parking light wire at the light switch and connect it to the tail light terminal of the switch.

By doing this, the parking lights will be on with the switch in either the "park" or "head" position. An extra possible facility arising from this, is that the now vacant parking light terminal may be used via an extra switch for fog lights. This method of connecting the fog lights ensures that the fog lights are off when the headlights are on and vice versa.

#### SIMPLE CAPACITANCE TESTER Cir. 7

This is the circuit for a capacitance tester which I have made from some computer board components.

The first two transistors function as a pair in an astable multivibrator, at a frequency of about 5KHz. The output from the multivibrator is amplified by the third transistor. The output from the amplifier, via a 0.1uF blocking capacitor, appears across a 25K linear potentiometer. The same output is also impressed across two capacitors in series.

Although the capacitor  $C_a$  should have a nominal capacitance of .01uF, it need not be accurate but a good stable unit is most desirable. The unknown capacitor  $C_x$ , with the capacitance of  $C_a$ , form a voltage divider and the voltage appearing at point B will be determined by the ratio of the two capacitances.

A pair of high impedance headphones is connected between points A and B. The voltage at B is already established by the two capacitors and when the rotor of the potentiometer is adjusted so that the voltage at A equals that at B, sound which was audible in the headphones, will go through a "null" at this point.

Before this arrangement can be made use of a dial scale attached to the rotor of the potentiometer will have to be calibrated in terms of capacitance. To do this, several capacitors, giving a wide range of known values, are required. As each capacitor is connected into the position for  $C_x$ , the potentiometer is adjusted for the null and this point is a calibration corresponding to the value at  $C_x$ . A sufficient number of points must be provided on the scale to complete the calibration.



More than likely, the transistor type used by the author will not be available to readers. However, we can see no reason why many of the NPN small signal silicon types readily available, should not be satisfactory.

#### NOVEL BROADCAST TEST OSCILLATOR Cir. 8

This is a simple RF test oscillator, suitable for broadcast receiver alignment. The time constant consisting of the 330K resistor and .047 $\mu$ F capacitor gives a repetition rate of about 10 per second. Each pulse shocks the tuned circuit into oscillation, the frequency of the latter being determined by the LC constants. The resultant signal is heard as a strong tone in the receiver. The coil may be an old broadcast coil or a ferrite rod, 8in x 3/4in, with about 80 turns of 32 B & S enamel wire.

#### SOLID STATE AGC CIRCUIT Cir. 9

Recently I came across a rather novel AGC circuit. In essence it is yet another application of the capacitance of a reverse biased diode. Under no signal conditions D1 is lightly conducting and any weak signals will pass through unimpeded. The AGC amplifier is cut off and the AGC rail voltage will be low as the bleed current through R1, D1, R3 and R4 is quite small. As the AGC amplifier conducts on a stronger signal, the AGC voltage cuts off D1 and it progressively presents a higher impedance. R1 and R2 form a high resistance voltage divider and the voltage at the junction determines the threshold.

The circuit is very effective. Most receivers employing it that I have seen typically show less than 2dB variation in output for more than 100dB input change. Two of these circuits in a receiver seem to be adequate. The circuit has the further advantage of presenting a fairly high impedance at all times hence minimising loading problems of the associated tuned circuits. However, the input is best fed from an emitter follower, if located at the low level front end of a receiver.

#### MULTIPLE SWITCHING FOR LIGHTING CIRCUITS Cir. 10

Two-way lighting circuits are quite common but the facility of operating room lights, etc., from three or more points is not often considered. However, there are some situations where it would be convenient and even highly desirable to provide three or more switching points. Here is a circuit which provides for any number of switching points. It will be noted that two of the switches will be SPDT but the rest DPDT.

#### LOW FREQUENCY FUNCTION GENERATOR Cir. 11

Here is a very simple circuit which generates three different staircase waveforms, UP, DOWN, or UP-DOWN. This circuit is easily added to an existing sine/square oscillator. Functionally, the idea is to use an exclusive-OR gate as a "programmable" gate. That is, depending on the level at one input, the signal from the other input is transmitted with or without inversion.

A unity duty factor clock drives a binary counter whose individual outputs are fed to a set of DTL EX-OR gates. The first two positions of a 3-position switch control the sign of the stair-

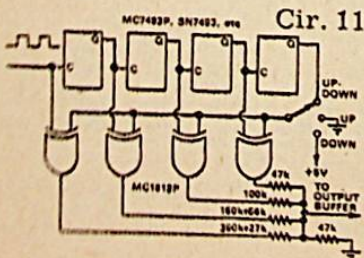
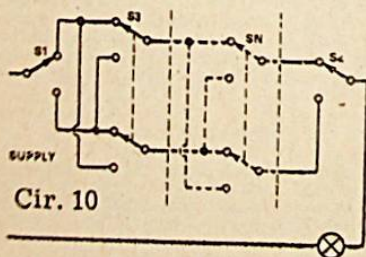
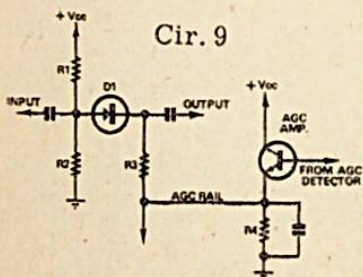
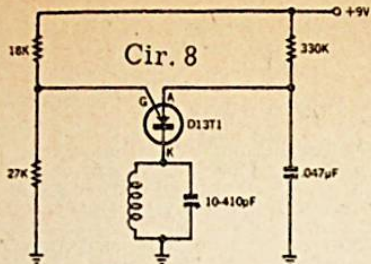



case increments. The third position, in conjunction with the last stage of the binary chain, sequentially selects the UP or DOWN control every 16 pulses. A binary weighted resistor ladder at the EX-OR outputs adds up the binary counts. The choice of ladder resistor values are such that they are standard values with consideration given to the internal 6k (nominal) output resistor. That is, total resistance per bit is 53k, 106k, 212k, 424k. The circuit has no low frequency limitation.

#### REGULATED POWER SUPPLY Cir. 12

Here is a circuit for a regulated power supply capable of 0-30V at 3A. Three 2N3055 transistors in parallel are used as a series regulator. An AY8139 senses the voltage drop across a 0.68 ohm resistor and whatever resistor is connected in series with the output and by so doing, protects the unit against overload.

A type 748 or 777IC and an AY8171 emitter follower functions as the error amplifier for the regulator circuit. Output voltage is adjusted with the 10k potentiometer at the input to the IC. A supply of -3.9V for the IC is provided by a small separate supply from a low current 6.3V winding.

In practice, a selector switch is used to determine the maximum current which can be drawn from the supply, according to requirements of the load. It may also be desirable to provide means of measuring output voltage and current. Mechanical arrangements may be adopted to suit individual needs. The 2N3055 transistors should have adequate heat sinking.

#### WIDE RANGE FREQUENCY DOUBLER Cir. 13

This is a frequency doubling circuit capable of wide band operation. No tuning is necessary and its frequency range is limited only by the transistor parameters used. The circuit makes use of the fact that smooth doubling occurs if the V-I characteristic of the emitter feedback element included in an amplifier approximates a parabola at the biasing point. The design procedure is simple and uses RC components only.

A tunnel diode exhibits a V-I characteristic closely approximating a parabola in the region of the peak current point and could be incorporated in the proposed circuit. However, for ease of biasing network design of the amplifier and good circuit stability, a non linear element having a controllable V-I characteristic is desirable. Therefore, the circuit shown which involves TR1 and TR2 has been adopted. Beta of TR1 and TR2 is 45 and 80, respectively. Transistors TR3 and TR4 make up a two stage amplifier of which the design procedure is standard.

The transistor types quoted are listed by Fairchild but we imagine that any small signal types for TR1 and TR2, should suffice, provided the beta values are within reasonable limits. Also for TR3 and TR4, types such as BC108 and 2N3638A should be suitable. Applications for this circuit are limited only by the imagination. However, as this circuit has properties similar to a mixers, any complex waveforms will be distorted, the amount of distortion depending upon the degree of complexity of the waveform.

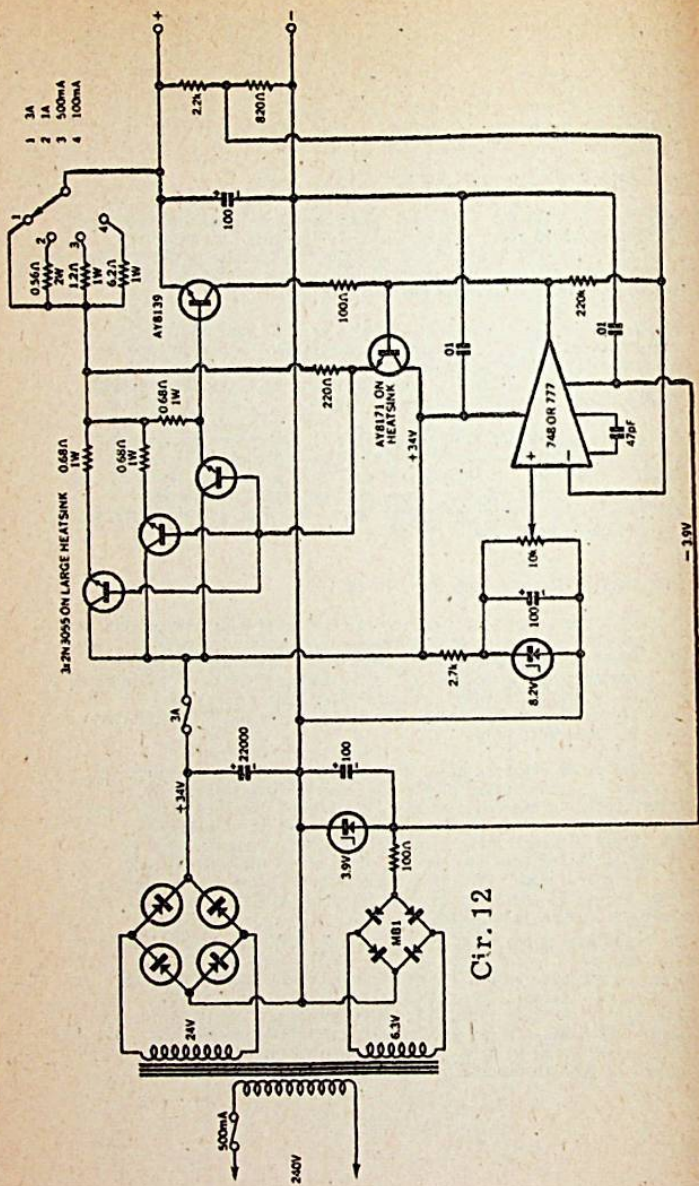

Cir. 12



#### OPERATIONAL AMPLIFIER Cir. 14

A new high power monolithic op amp from Fairchild designated the uA791 has high current driving ability. 1A at  $\pm 12V$  supply. It also features automatic circuit protection.

It is intended for use in a wide variety of applications, including audio amplifiers, servo amplifiers, magnetic deflection circuits and power supplies. The high gain and high output capability provide excellent performance, wherever an operational amplifier power booster combination is required. The uA791 is thermal and short circuit protected.

The foregoing characteristics permit very simple design for a bi-directional DC servo motor drive, as shown, and it can also be used in bridge type servo applications.

#### CONSTANT IMPEDANCE POTENTIOMETER Cir. 15

The circuit is shown herewith. All potentiometers are linear and of equal value. They are ganged together and regardless of the shaft position, the impedance across the line remains the same.

#### DRILLING JIG Cir. 16

When drilling printed wiring boards, a common problem is to hold them securely while drilling. They need to be held vertically, but cannot be held this way in a vice, as it would require too much pressure to hold them firmly enough. A vertical drill stand is handy, but not always available.

The simple jig to be described will hold the board firmly in a horizontal position.

The main part is a flat baseboard as wide as the largest wiring board likely to be used. This has two parallel slots cut in it, running lengthwise along the board, their length being determined by the narrowest wiring board likely to be used. The width of the slots is determined by the diameter of the bolts to be used with them.

A narrow strip of wood is used as a sliding clamp and is drilled with two holes to coincide with the slots in the baseboard. The clamp is held by two bolts passing through the slots to the underside of the baseboard.

A fixed clamp is attached to the other end of the board, again using nuts and bolts.

In use, the wiring board to be drilled is held by its edges underneath the two clamps. If the baseboard is held firmly, possibly by clamping or screwing to the bench, both hands will be free to handle the drill.

#### LINEAR SAWTOOTH OSCILLATOR Cir. 17

Here is the circuit of a saw tooth oscillator which produces an extremely linear ramp at frequencies from about 0.1Hz to in excess of 100KHz. The circuit is an OP-amp integrator plus a PUT to discharge the feedback capacitor. R1 & C determine frequency, R2 sets output zero, R3 sets PUT gate voltage and hence the breakdown voltage of the PUT and thus sets amplitude of sawtooth. The circuit of a suggested power supply is also given.

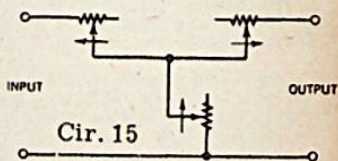
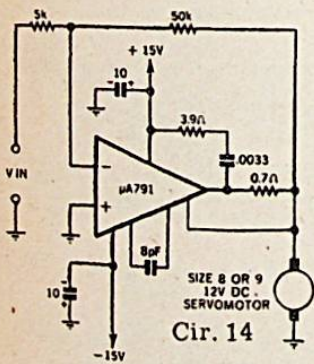
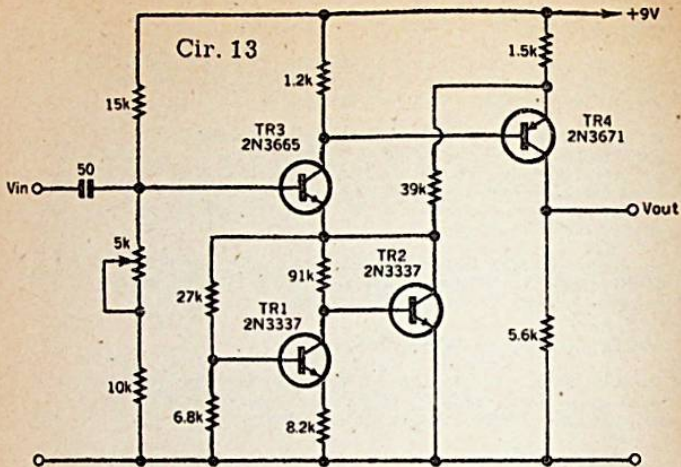



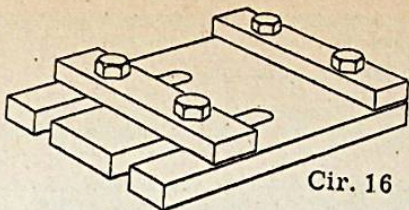

Cir. 16

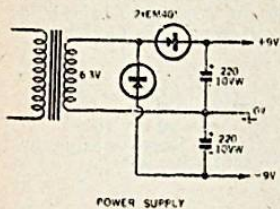

Cir. 17

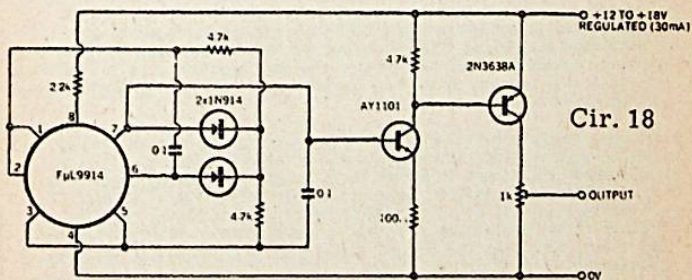
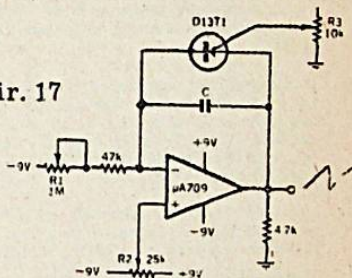

Cir. 18

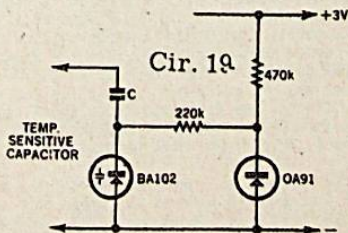

Cir. 19

I have used this oscillator as a CRO timebase with excellent results. Other uses will suggest themselves.

#### AN OSCILLOSCOPE CALIBRATOR Cir. 18

The calibrator illustrated generates a 10V P-P square wave of approximately 1KHz. The rise time is less than 1 $\mu$ S when working into the normal 1M, 50PF input of an oscilloscope.

This device may be of use to those who own an oscilloscope without a calibrator, or those who wish to upgrade the 50Hz, 100 $\mu$ S rise time calibrator common to many instruments. It is possible to use this calibrator for the adjustment of attenuators, up to the 10V/cm position.

An interesting feature of the circuit is the use of the FuL9914 for the astable multivibrator section of the calibrator. Good performance is obtained by using this device, provided a stable resistor is included to drop the supply voltage to approximately 3.6V required for the IC. If desired, discrete transistors could be used in place of the IC.

This unit could be used both as a frequency and voltage calibrator, provided that it is fed with a stabilised supply and that access could be obtained to a means of initial calibration.

#### TEMPERATURE SENSITIVE CAPACITOR Cir. 19

Recently the writer has been carrying out some private work on a crystal oscillator where high stability is of prime importance. Apart from care being taken with the type of circuit used and good quality components and construction the next problem to be solved is that of frequency change due to temperature variations under normal environmental conditions.

With a crystal exhibiting temperature characteristics such that an increase in temperature causes an increase in frequency, it seems reasonable to attempt to offset this frequency change by means of a capacitor with positive temperature coefficient. While such capacitors are listed in catalogues, they are not always easy to obtain. Also, the amount of positive temperature coefficient may not be enough to offset the crystal temperature characteristic in some instances.

After a certain amount of research into the problem, thought turned to the possibility of using a silicon diode variable capacitor, in a circuit which was temperature conscious. The possibility of incorporating a thermistor seemed to show promise, also the reverse resistance of a small signal germanium diode would be worth investigating. While the former was not ruled out, a check on the reverse resistance characteristics of the germanium diode showed such a dramatic change in resistance for quite a reasonable temperature change, it was decided to investigate this possibility further.

As may be seen from the circuit, the germanium diode is part of a voltage divider, with a stable resistor as the other part of the divider. The voltage at the divider junction is fed via a 220k isolating resistor to the silicon diode variable capacitor. It may also be seen that the silicon diode is reverse biased by the voltage at the divider junction and variation in bias voltage changes the effective capacitance of the diode.



If the ambient temperature increases, the reverse resistance of the germanium diode will be reduced, the voltage at the junction of the divider will fall and the capacitance of the silicon diode will increase. In short we have achieved, albeit by devious means, a positive temperature coefficient capacitor. It is also worth noting that simply by reversing the positions of the resistor and germanium diode in the divider, a negative temperature coefficient may be achieved.

The circuit shown may be considered as typical but components and parameters may be varied considerably to vary the amount of capacitance change to suit the particular situation. The capacitor C may only be needed for DC blocking purposes, in which case it will be a high value compared with the capacitance of the silicon diode. Alternatively, C may be made smaller so that it restricts the effect of the silicon diode. The 220k isolating resistor is not critical provided it does not affect the Q of the circuit. This value is a safe minimum.

The OA91 used had a reverse resistance of the order of 1M. This may vary quite a bit, particularly if a different type or brand is used. The BA102 under the circuit conditions had a capacitance of 36pF. Again, this can vary over quite wide limits, due to production spreads, etc.

While we were not able to make any accurate temperature versus capacitance measurements, several pF changes could be effected with only a few degrees Celsius variation.

The foregoing details are given as a starting point for readers who may wish to experiment and develop the circuit to suit individual needs.

#### ECONOMICAL 455kHz BLOCK FILTER Cir. 20

Thoughts along the lines of producing a simple radio receiver, using an integrated circuit as the IF amplifier and detector system, raised the question as to what would be the best way to get IF selectivity. A mixer and oscillator would precede the IF system as usual and so the logical place to fit the circuits giving the IF selectivity would be between the output for the mixer and the input of the IC.

Dictated by the high output impedance of the mixer and a low input impedance of the IC, it seemed logical to use a standard transistor type of IF transformer which meets these requirements. The desirability of getting a high degree of selectivity meant that more than just one IF transformer would be needed. Two could be placed back-to-back. Better still, two transformers back-to-back could possibly be coupled together with a two-section ceramic filter

This seemed to be the answer. Of course, the input and output impedances of the ceramic filter being low, must be matched into the transformers. This could be achieved by capacitively tapping across each winding. After some doodling on the part of the writer, this is the circuit which came out of it.

Preliminary checks indicate that with the components as shown, the top of the curve is slightly double-humped and the total band width at 40dB down is about 8KHz. This is adequate for many purposes. However, at this stage no claim is made that all values are optimum. Indeed, the circuit is wide open for further development and no doubt the characteristics may be varied to suit different needs.



Some points which come to mind at this stage are firstly, that the 68pF capacitor could be reduced for even sharper selectivity, or it could be increased up to about 150pF for a wider band width. Shunting this capacitor with a resistor can also change the characteristic of the top of the curve. The value of the resistor may best be obtained experimentally for the desired result.

#### TEMPERATURE SENSITIVE CAPACITOR Cir. 21

Previously I described a Temperature Sensitive Capacitor, based on the changing reverse resistance of a germanium diode with temperature, in conjunction with the variable capacitance of a silicon diode with a change in the applied reverse voltage. This works well in practice. There is a limit to the amount of change in capacitance available for a given temperature change.

If this arrangement is not adequate for the particular application, then a worthwhile increase may be obtained by using two germanium diodes in a bridge circuit. The two diodes assist each other and the change in voltage available across the bridge, with a given temperature change, is greater than that available with the simpler circuit. This extra voltage change, when applied to the varicap diode, results in a greater change in effective capacitance.

Reference to the circuit will reveal how this comes about. Under normal temperature conditions, we can reasonably assume a reverse resistance of the germanium diodes of about 1M. Assuming a resistance of 220k between point "A" and the negative line, the potential between "A" and this line will be in the vicinity of +0.5V. Also the potential between the negative line and point "B" will be in the vicinity of +2.5V. The difference of 2V is applied in the form of a reverse voltage across the varicap diode, thus setting its capacitance. With an increase in temperature, the effective resistance of the two germanium diodes will become less. The voltage divider effect will result in the voltage difference between points "A" and "B" being reduced. This reduced voltage applied to the varicap results in an increase in capacitance.

The 470k potentiometer is added as a refinement to allow the difference in potential between points "A" and "B" to be varied. This gives a measure of control over the sensitivity of the system. If this is not required, then the potentiometer may be replaced with a 220k resistor.

Capacitors C1 and C2 in series with the varicap are added primarily for blocking purposes, the whole being applied to the circuit requiring the temperature sensitive capacitor. If the compensating effect is more than needed, the right amount may be arrived at by reducing either C1 or C2, or both. Should more compensation be required, above that available from the system as shown, it may be increased by adding one or more varicap diodes in parallel.

The system described has a positive characteristic - capacitance increases with an increase in temperature. The circuit may be converted to a negative one by reversing the positions of the diodes and resistors of the bridge. The resistor values will also have to be increased to a value above the reverse resistance of the diodes, possibly to 2 M or higher.

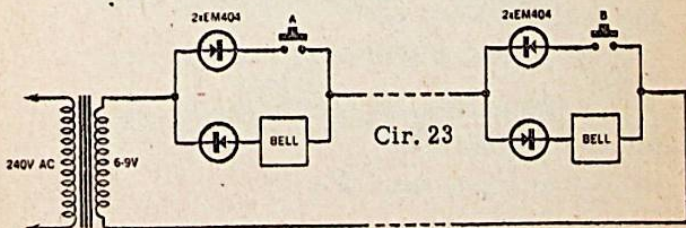
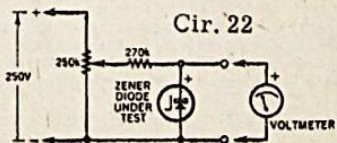
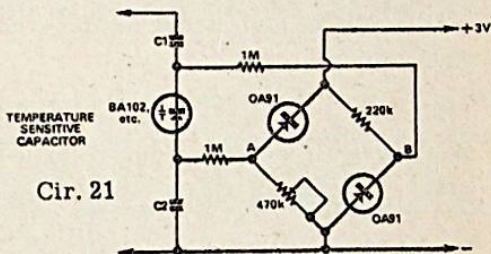
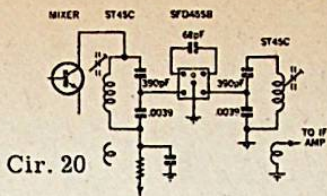



#### TESTING UNKNOWN ZENER DIODES Cir. 22

We show an easy method for determining the zener point of unknown zener diodes. All that is needed is VOM or VTVM, two  $\frac{1}{2}$  watt resistors and a high voltage, low current supply near 250 volts DC. If a variable power supply is on hand which can supply a voltage from 0-250 volts, it can be used in place of the fixed supply and the 250k pot. The 250k pot is used as a voltage divider and the 270k resistor serves the function of a current limiter.

The diode is placed in the circuit with the cathode to the positive side. The voltage is adjusted upward until the meter shows no further increase in voltage. This is the zener breakdown voltage of the device under test. If the meter reads zero, the zener is shorted and if it reads the supply voltage, the zener is open.

#### SIMPLE SIGNALLING DEVICE Cir. 23

This circuit was set up between workshop and kitchen so that a signal could be given to indicate that tea was ready, etc. Since the signal could sometimes be drowned out by the noise of machine tools, the two-way facility was needed to allow the person in the workshop to indicate that he had heard the summons. Advantages of the circuit are that it requires only two conductors between stations, needs a power supply at one station only and is very inexpensive.

The diodes are arranged so that normally no current flows. When push-button "A" is closed, the positive half-cycles from the transformer can pass to bell "B" and cause it to ring. When push-button "B" is closed, the negative half-cycles cause bell "A" to ring.

#### SAWTOOTH OSCILLATOR Cir. 24

"The simplicity of the design can be seen by the circuit, one from an English magazine. In the original, the transistors were: Tr1 MAT101; Tr2 MAT120. In my unit I used two OC71s, because they were two I had on hand. Almost any audio PNP transistors may be used, and suitable ones could be found by experiment.

"The oscillator is suitable for providing musical tones and sound effects. Colouring of the tone can be altered by using suitable filter networks in the output.

"With minor alternations to the circuit, this unit can be converted to a metronome. The following modifications will be necessary.

(a) Remove C3 and insert in its place a 8uF capacitor with the positive end to the base of Tr1.

(b) C1 and R1 may be omitted altogether, and only Output 2 is required.

"Using a crystal earpiece or audio amplifier connected to Output 2, a regular beat will be heard. The frequency or time interval between beats can be controlled by VR1.

"The oscillator is quite inexpensive to build,



Cir 24

Right: a simple square wave and sawtooth oscillator with many applications.

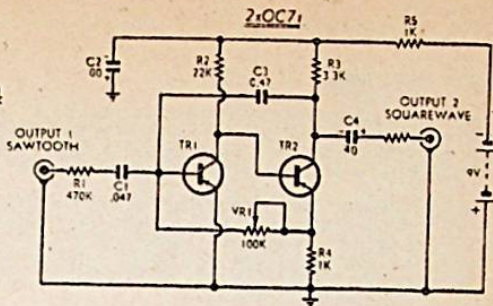

Right: Circuit of the moving target "receiver" (top) and the machine gun "transmitter" (lower) forming the complete shooting range. Addition of a speaker in the gun circuit adds realism.

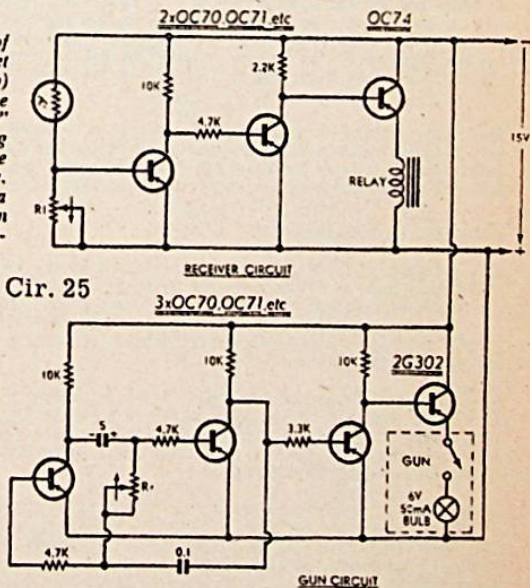

## MOVING TARGET RANGE

"Here is the circuit for a version of an 'Electronic Pistol Range', modified to make it suitable for moving targets. By using an oscillator to switch on the light in the gun, I achieved a machine-gun effect, which is almost essential because of the accuracy required.

"The multivibrator oscillator followed by an inverter gives a series of short pulses separated by a time interval whose length is determined by the setting of R2. I used a 1M pot, but this gives a lot of unnecessary space, and so a smaller value would probably be of more use. The pulses switch is a 2G302 transistor (Texas Instruments), which has the gun in its emitter.

In the receiver, an LDR forms half of a voltage divider. The pot which forms the other half controls sensitivity, and a value of 10K seems to be about right. On both pots the arrow shows clockwise rotation. When light strikes the LDR, the potential at the base of the first OC70 increases. This is amplified, and the relay operates.

The relay which I used was a P.M.G. one having a resistance of 1K. I connected a couple of red pilot lights and a filament transformer to it, but have not shown these, because almost anything could be used. The LDR was mounted inside a tube of black paper, to keep down ambient light, and this was mounted inside a wooden box, open at the front, which also houses the target moving mechanism. The two red lights are also in here, placed so that they do not affect the LDR. When they light up, it looks as if the target has blown up.

The gun is a piece of metal tubing attached to a wooden handle. The switch is inside the handle, and the globe inside the tube. A lens salvaged from an old camera fits on the end of the tube. To add realism, I connected a speaker in series with the gun.

## AUTOMOTIVE VOLTAGE REGULATOR Cir. 26

This voltage regulator was built to replace a faulty one of the single relay type as fitted to a car using a Bosch alternator. The new regulator has been in use for about seven months and during this time the preset potentiometer has not had to be touched. The voltage reading at 650rpm with headlights on is 13.8V and at maximum rpm with no load, it is 14.2V.

Regulation is fast and continuously variable, depending on load. Unlike the regulator it replaces or many electronic regulators, no suppression components are required, as the regulator uses a higher power field control transistor and it does not rely on switching to reduce dissipation.

I feel that it has some advantages to offer: (1)No thermistor is fitted as correction has been noted to be rapid and accurate under all conditions. (2)The voltage adjusting potentiometer is a readily available and is a cheap item. The use of this preset potentiometer became possible by using a Darlington pair, thus reducing the current through the zener diode/potentiometer network. (3)Only 10 components are required.

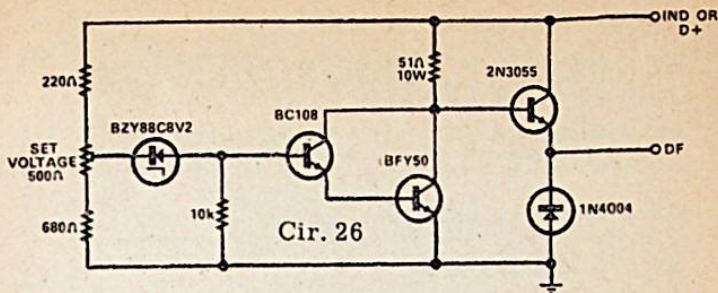

-12V NEGATIVE CHASSIS REGULATOR

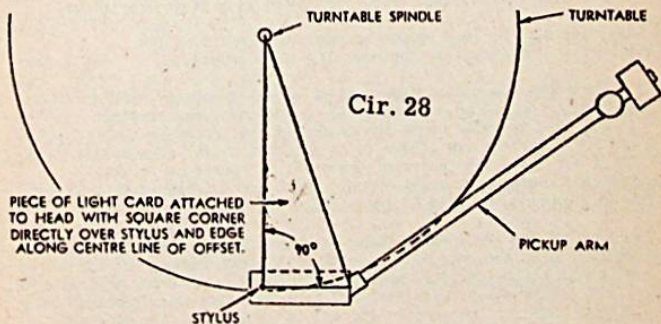
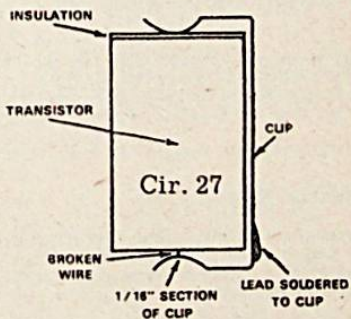



## TRANSISTOR REPAIR Cir. 27

Here is another idea. We must emphasise that the long term reliability of such a repair may be doubtful, but may be fully justified at an experimental level.

When transistor leads break off flush with the bottom of the transistor, they can usually be repaired by means of a small clip, made from a piece of tinplate.

With a pair of tinsnips cut a small strip from the lid of an empty food can. Cut it about 3mm wide and 25mm long, depending on the height of the transistor. Trim the last couple of millimetres down to about 1mm or 1.5mm wide.

Bend the strip of tinplate as shown in the diagram, starting from the thin end which presses onto the broken lead. The other end may need to be shaped to suit transistors with curved tops. Cut off surplus tinplate.

It may be necessary to insulate the clip from the body in the case of metal cased transistors. This can be done with a single layer of insulation tape.

A lead is soldered to the clip and the clip fitted. Finally, glue may be applied to the top and bottom of the clip. This makes the repair quite sturdy. More than one clip may be fitted if necessary, providing they are insulated from each other.

Although the transistor is less compact, it is still suitable for experimental work.

## CHECKING PICKUP TRACKING ERROR Cir. 28

"During some experiments involving pickup arm offset I evolved a trial and error method of determining optimum offset angle. This method can also be used to locate the base position for a pickup if the manufacturer's template is missing.

"All that is required is a triangle of light cardboard having one corner a rightangle and with one of the adjacent sides short and one long. The short side is carefully attached to the pickup head with the 90 degree corner exactly above the stylus point and the edge of the card perfectly aligned along the centre line of the cartridge.

The long side must be long enough to reach the centre of the turntable with the pickup at the edge of a 12in record.

"Then by swinging the pickup from outside to inside of the record the tracking error can be checked by the position of the straight edge of the card in relation to the centre of the turntable spindle. For a perfect arm (there is no such thing) the edge of the card would not leave the centre of the shaft. In practice it will move from the centre by a small amount, which can be reduced to a minimum by juggling the base of the pickup.

"In the case of the arm I was working on when I devised this system, I was able to keep the edge of the card within the diameter of the spindle, which was better than any commercial arm I had tried at that time. I still have the original arm and have made some measurements from it. The angle of the head to the arm is 35 degrees, the overhang 13/16ths in, and it is 8-11/16ths in from stylus point to pivot.

"The tracking error varies from -2.5 degrees at the outside of a 12in record, through +1 degree halfway across, to -2.5 degrees again at a distance of 2½" from the centre."

#### A 50Hz HUM ELIMINATOR Cir. 29

Whenever 50Hz hum is a problem in the laboratory, I have found the hum eliminator which is shown in the diagram to be very useful. There is really nothing new in the circuit. It uses a twin-T network which is a narrow band elimination filter centred on 50Hz, and which gives infinite attenuation at 50Hz. To ensure correct operation, the resistors and capacitors in the twin-T network are selected as close as possible to the wanted values from a handful of components. On the other hand close tolerance 1% resistors and 5% capacitors may be used. Q1 is an emitter follower with high input impedance and a voltage gain of slightly less than unity. Q2 is a series current feedback amplifier. The feedback is determined by the unbypassed resistor in the emitter circuit of Q2. The circuit operates from a 12V source.

The hum eliminator may be mounted in a small instrument case and provided with terminals. Terminals 1 and 2 are the input, 3 and 2 the output, with 2 and 4 the DC power supply. The voltage gain of this circuit may be adjusted by feeding a 400Hz signal of known amplitude, say 1 volt, at the terminals 1 and 2 and adjusting the 5k pot to give a signal of say 2 volts at terminals 3 and 2, thus giving a voltage gain of 2. The voltage gain could be set anywhere between about 2 and 10.

#### REACTION TESTING GAME Cir. 30

Here is a game which is a competition between two players. Construction is simple and straightforward. The three lamps and the "result" switch S4, are mounted on the front panel. The switch S3, for a third person is concealed and each player has a switch S1 or S2 in front of him.

The procedure is for the operator to close S3. Each player then attempts to be the first to operate his switch. Provided the difference in reflexes is greater than the relay pick-up time, then one will operate, extinguishing L3. On operation of the result switch S4, the lamp which is in parallel with the operative relay is lit, indicating the winner. If the players' reaction times are very close, the lamp L3 will remain on, indicating a draw.

#### TEMPERATURE OPERATED SWITCH Cir. 31

This simple circuit for a temperature switch may be used in many applications. The temperature sensing device is a small signal germanium diode operating under reverse bias conditions. The leakage current across the diode junction is temperature dependent and increases with temperature. This current is amplified by a high gain transistor.

When the voltage on the gate electrode of the SCR becomes great enough, the SCR is triggered into conduction and energy is applied to the load. The SCR continues to conduct until the unit is turned off. The temperature at which triggering occurs is determined by the setting of the 1k pot. In the original unit, the SCR is rated at 30V 2A, but devices with different ratings may be substituted depending on the type of load.



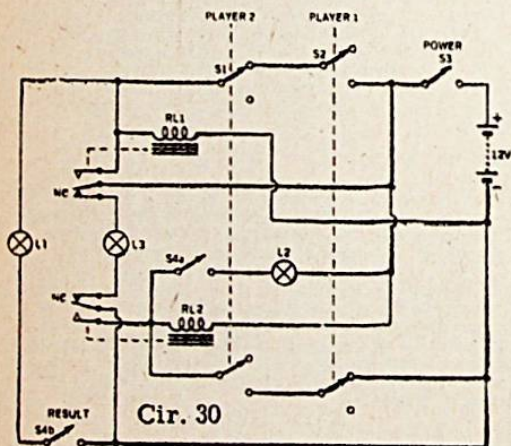
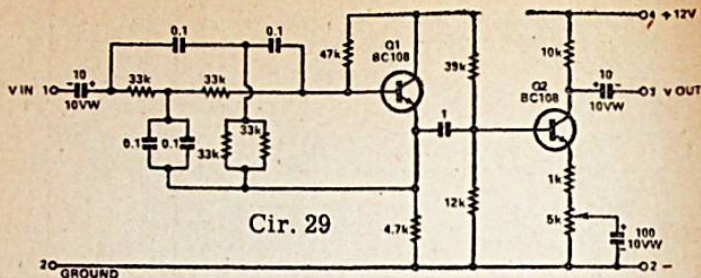

The unit is powered by a suitable 12V battery and the main components include two 12V relays, each with a set of changeover contacts. Switches include two DPDT toggle type and one each of DPST and SPST slider, etc. The lamps may be rated at 12V or 6V, with a suitable value of series dropping resistor.

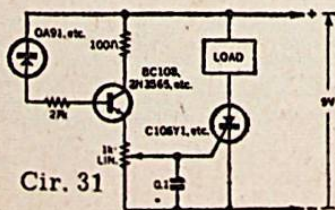



Instead of battery operation, if the unit is powered from a transformer of 240V to 6.3V or so, a slight modification will alter the mode of operation. 9V DC is supplied to the diode and transistor from a suitable rectifier and filter network, with 6.3V AC supplied to the load SCR combination. The 0.1uF capacitor is deleted from the SCR gate and a 1000uF electrolytic is added across the load.

When triggered, the SCR conducts on positive half-cycles and turns off on negative half-cycles. Therefore the SCR must be triggered on every positive half-cycle to remain conducting. This means that the SCR conducts when the temperature is above the specified value and turns off automatically when the temperature falls below this value.

The original unit was used to monitor the temperature of valve-operated equipment on hot days. Anyone who built the Simple Moisture Alarm has a ready made unit if a germanium diode substituted for the existing sensor.

#### CAR BURGLAR ALARM Cir. 32

Here is a simple and inexpensive burglar alarm which may be fitted to any vehicle which has an interior light operated by either of the front doors.

After being set, this alarm will operate the horn of the vehicle until turned off by the reset switch, which is mounted in some accessible, but inconspicuous position on the exterior of the car. Positions for this will suggest themselves to readers studying the construction of their own car. When either of the front doors is opened, a relay pulls in a set of heavy duty contacts which operate the horn. This relay should be of a type to match the voltage of the particular vehicle. The horn contacts must be heavy-duty types, as some horns draw large currents - 10 amps or more in some cases. A second set of relay contacts are required to provide a latching circuit whereby the horn is kept in operation once started. The current carried by these latter is quite modest.

The unit should be wired with fairly thick wire, again for the reason of high current. If the wiring is exposed (e.g., that to the exterior switch) it should be adequately waterproofed. The same applies to the switch itself.

The original unit was installed in a Volkswagen, and has performed with very satisfactory results.

While we have described a number of burglar alarms, some suitable for cars, this design may appeal to readers by reason of its simplicity and economy. One point, however, should be noted; the horn operates until turned off at the reset switch. In the event of the owner being absent for any length of time, and the alarm being tripped, he would return to find a flat battery. Although a car with a flat battery is preferable to a stolen one, readers may care to incorporate some type of time delay switch to turn off the device after a set period.

#### HIGH PERFORMANCE AMPLIFIER Cir. 33

WITH THE INTRODUCTION OF LOW COST, HIGH PERFORMANCE MONOLITHIC LINEAR AMPLIFIERS IT IS POSSIBLE TO DESIGN AUDIO EQUIPMENT AROUND THEM HAVING HIGH ORDERS OF PERFORMANCE. AN AMPLIFIER EMPLOYING THESE PRINCIPLES IS DESCRIBED HERE.





Using a good quality pickup, preamp. and speaker system I have found it impossible to fault the amplifier under any conditions. In fact, results have been so convincing that some people who have heard it are now changing the power amplifier sections of their commercial units to this or a similar design.

It would appear that there may be a risk of damage to the driver transistors in the event that either one is "cut-off", since both transistors have absolute maximum collector-emitter ratings of 50 volts. In view of this, constructors may wish to substitute higher rated driver transistors or reduce the supply voltage below 50 volts. 2N5322 or 2N3645 can be substituted for BC177 and 40408, 2N2102 or 2N3568 can be substituted for BC107.

#### CENTRE WOOFER CROSSOVER NETWORK Cir. 34

A loudspeaker system for external use with an electric organ was recently constructed and it has emerged that this unit has applications outside the field for which it was originally intended. As such, there may be a number of readers who would like to try this system, possibly for use with a stereo system where high fidelity and power handling ability are required.

The original need was for a speaker system which could handle a relatively high power level in the bass region and where a stereophonic effect was required for the middle and upper registers. The latter is necessary to cope with the particular type of vibrato system used on the organ in question. The organ makers actually used three amplifier channels, one for the bass and one each for the right and left middle and upper frequencies. As the writer had a good stereo amplifier, it was decided to make use of it if possible.

If the bass frequencies could be combined from both channels and fed into the bass speaker, while retaining the middle and upper registers such that each channel feeds into its own speaker(s), the original arrangement could be simulated. This was quite readily achieved as may be seen from the diagram. The crossover frequencies selected were 200Hz and 5KHz. The 6.4mH inductors from each channel, feed the woofer giving the requisite attenuation at 200Hz. While this method may be open to some criticism, as there is little isolation between the outputs of the two channels, it works out quite well in practice.

From each channel, again, the two mid-range speakers are each fed via a 100uF capacitor so taking over at 200Hz. Each tweeter is fed from its mid-range speaker by the simple method of capacitive coupling via a 4uF capacitor. This is possible due to the natural roll-off of high frequency response of the midrange speakers.

It may be seen that the circuit includes two 2200uF electrolytic capacitors back to back in the common line. This is introduced simply as a precautionary measure in cases where transistor amplifiers may not have a common earth for both channels. The capacitors may be omitted if it is safe to do so.

It will also be seen that two sets of 200uF electrolytics back-to-back have been used, to get the requisite non-polarised 100uF. While this is not considered to be the best practice, there is little alternative from an economics point of view and it works quite well in practice.



An important point about this amplifier is that, because of the large open loop gain (approx.  $10^5$ ) and thus the large amount of negative feedback employed, any mismatch in the output transistor pair is immaterial. In fact, to minimise cost in this design a silicon NPN transistor is used with a germanium PNP transistor of similar output rating, each being relatively inexpensive.

Because of the large degree of feedback and good supply rejection of the integrated circuit a simple power supply, as shown, may be used, contributing still further to overall cost reduction. The supply voltage is not critical. Any transformer capable of delivering 15 to 30 volts at 1A after rectification may be used, the 5 ohm collector resistors and 1.5K dropping resistors being changed as necessary.

However, the low cost does not imply a sacrifice in performance. The amplifier will deliver 10W into an 8 ohm load, has a low frequency response equal to DC and an upper limit (at the 3dB down point) of about 120KHz. When driven with 500 Hz, 1KHz, and 10KHz signals, the amplifier shows no measurable harmonic distortion on measuring equipment capable of resolving 0.1%.

When fed with a 10KHz square wave and operating into an 8 ohm resistive load shunted with a 0.1uF capacitor the amplifier showed no observable sign of ringing or ultrasonic instability. Increasing the capacitor to 1uF resulted in ringing over about 50% of the half cycle, but there was still no ultrasonic instability. There is also a total lack of crossover distortion at low power levels; an essential feature in any high quality amplifier.

The voltage gain of the unit as it stands is 11 but this could be increased with little loss in performance.

The only constructional notes which should be observed are as follows:

(a) The diode "D" should be mounted on the power transistor heat sink to provide stability against thermal runaway.

(b) The value of resistor "R" should be selected to give minimum quiescent current consistent with no crossover distortion. (Once set up the quiescent current, will be quite small, but the exact value will depend on the output transistors used.

(c) If the integrated circuit has a large input offset voltage, (there is a liberal allowance in the specifications) clipping at full power may not be symmetrical. This can be compensated for with the additional circuitry shown. This can also be used to hold the output at a certain quiescent current if a centre tapped power supply is not used. The 100K pot is adjusted to hold the output at a potential midway between the supply rails.

(d) It is advisable to limit the supply voltage to the integrated circuit with 15 volt zener diodes to protect it from excessive voltages which could cause damage.

(e) The 0.1uF decoupling capacitors should be connected to the rails as near to the integrated circuit as possible to minimise any chance of high frequency oscillation.

The inductors in speaker crossover networks are usually air-cored and wound with a heavy gauge of wire. It was felt that this rather cumbersome item could be reduced in size by winding it on a ferrite aerial rod. In this case, a  $\frac{1}{8}$  in diameter ferrite rod was cut in halves, each half being about 4 in long. Each winding consists of 360 turns of 22 B & S enamel wire, to give 6.4mH. It would be wise to check the inductance when any attempt is made to duplicate this, as the grade of ferrite will affect the final inductance.

The speakers used were all made by Magnavox. These were one C15W, two 6Ws and two 3UCs. These or equivalents, may be set up with the woofer in a centre enclosure and a 6W and 3UC in a suitable enclosure on each side.

The crossover network values given are for 8-ohm speakers. For 15-ohm systems, the inductor should be 12.8mH and the capacitors 50uF and 2uF. For 4-ohm voice coils, the inductors should be 3.2mH and the capacitors 200uF and 8uF.

#### BURGLAR ALARM Cir. 35

A rather novel suggestion for a burglar alarm. The basic idea is capable of many variations, according to the needs and ingenuity of the individual.

"The following circuit is a closed-circuit burglar alarm. It is basically a multi-vibrator with a direct coupled amplifier. Negative bias for TR1 is derived from the negative line via the 22K resistor providing the switch is open. With S2 closed, the base is connected directly to the emitter and the first half of the multi-vibrator is cut off. When S2 is opened, the base of TR1 returns to normal bias and oscillations begin.

"In my experiments I found that a strip of tin foil fixed to the window served the purpose of S2. When the window is opened or broken the foil is broken, S2 is opened, thus allowing the multi-vibrator to work.

#### FET PICKUP PRE-AMPLIFIER Cir. 36

A circuit for a pickup pre-amplifier with moderate gain.

There are times when it is desired to modify an inexpensive commercial record player for use with a better modern cartridge having a higher compliance. Since such record players seldom have much gain to spare, the lower output usually associated with better quality cartridges may necessitate some form of pre-amplifier being added.

What is needed is a low gain (say, 5 times) amplifier with a high input impedance suitable for ceramic cartridges. Both valve and transistor circuits have their problems in this situation, the valves requiring heater power which may not be available and transistors an inherent low impedance input which is undesirable.

The accompanying circuit using an FET is a cheap and simple way to achieve the required results. Because of the high impedance, some Miller effect is noticeable, resulting in high frequency loss. The small by-pass capacitor (.001-.01uF) shown dotted will boost the high frequencies to compensate.

Power may be derived from the heater supply line, using the voltage doubler circuit shown. The side of the filament winding that is earthed must be connected to terminal "B" as shown.

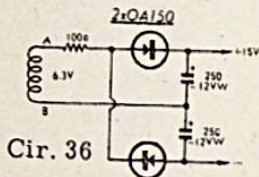
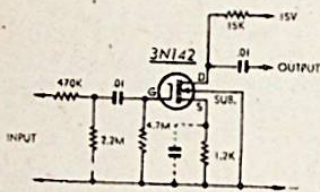
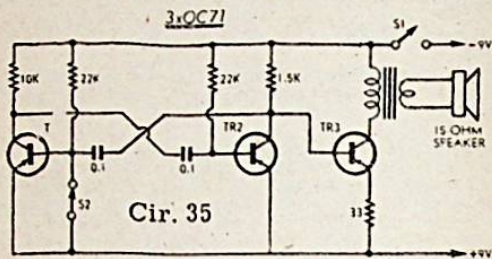
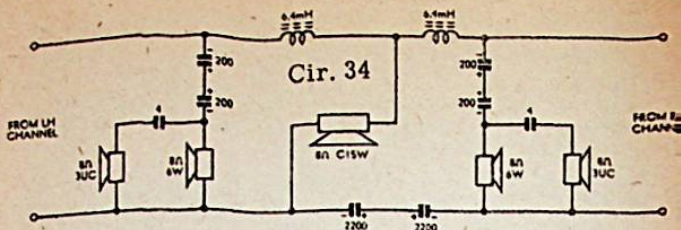

*Circuit of the F.E.T. preamplifier with suggested power supply. Other power supplies could be used.*



The FET terminals MUST be kept shorted until soldered in place, to avoid damage.

There would appear to be no justification for the two resistors, 2.2M and 4.7M, in the input circuit. The 4.7M could be omitted, and replaced by the 2.2M, leaving the remainder of the circuit as is.

#### LIGHT OPERATED TRANSISTOR ALARM Cir. 37

"I was approached recently by a local business man concerning the problem of detecting customers entering the shop while he was elsewhere. He had installed a mirror to enable him to see into the shop but it was only partially effective and not very convenient so he asked me about building some form of audio alarm.

"The following device is the outcome of my experiments. The alarm consists of a photoelectrically controlled multivibrator. The light-sensing device is an OC71 transistor of glass construction from which the black paint and the collector lead have been removed.

"The device is mounted on a tagstrip at about the focal point of a convex lens. The light source is a 6.3-volt dial lamp mounted in a similar way.

"When light falls on the emitter-base junction of the OC71, it becomes photoconductive and biases the 2N217S into conduction, with the result that its collector and thus the base of the OC74 are near earth potential. The OC74 is then near cutoff.

"When the light is cut off, the 2N217S ceases to conduct, the bias on the OC74 becomes more negative and it conducts, enabling the two OC72s in the multivibrator configuration to oscillate. This produces a buzz from the loudspeaker.

"In setting up the light system, two old octal valve cans were used and everything soldered to them.

"The distance between the bulb and its lens should be adjusted to produce an image of the bulb filament approximately 5ft to 7ft from the unit. The light beam should fall on the receiving lens and be focused on to the OC71 emitter-base junction. The position of the OC71 can be varied simply by bending the two leads.

"As a quick check on the optical system connect a DC voltmeter across the OC71 leads (negative to base) and a reading from .05 to 0.1 volts should be obtained with the light on.

"Although the unit was built from a junk-box of components, it has proved very successful during the few months it has been in operation and I am sure that anyone who duplicates it will be very pleased with the end result.

#### ULTRA-SENSITIVE OHMMETER-LIGHTMETER Cir. 38

To build a portable ultra-sensitive Ohmmeter-Lightmeter, battery-operated (4.5V), the sensitivity being more important than the accuracy; no adjustments, and no battery consumption when not in use, even if the switch remains in the "ON" position.

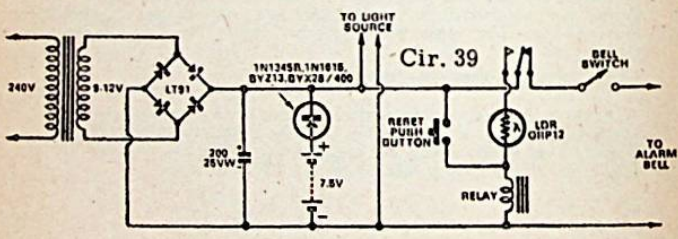
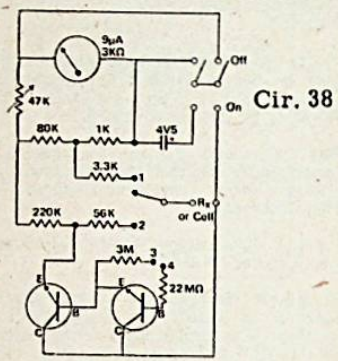
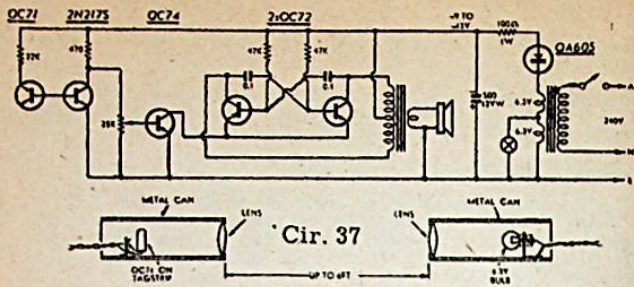





The meter has four ranges, it uses a d.c. amplifier with two transistors in Darlington configuration for two amplified ranges and has two ranges without amplification. High-gain NPN silicon transistors are used (e.g. 2N2925, 2N3390, BC109). An ON-OFF switch is included to short-circuit the galvanometer for transport (magnetic blocking).

A less sensitive micro-ammeter can be used, if the values of resistors are changed. A ceramic switch should be used for range changing. The meter scale can be guaranteed by Ohm's law calculation or by comparison with standard resistors.

The instrument described allows resistance measurements from 100 ohms to about 20,000 megohms, in four ranges: range 1, 100 megohms to 100 kilohms; range 2, 10 kilohms to 10 megohms; range 3, 1 megohm to 1,000 megohms and range 4, 50 megohms to 20,000 megohms. The instrument offers the means of testing silicon transistors, capacitor package currents, quartz insulation resistance and by adding a photocell, measurement of very low levels of illumination.

#### LIGHT BEAM INTRUDER ALARM Cir. 39

No doubt burglar alarms using door and window switches are very effective but equipping and wiring them takes many hours of work. The main feature of this circuit is that a locking facility is used, which transfers the operation of the relay to the reset circuit. The LDR does not participate in pulling in the relay, but merely holds it operated. The aim was to work over about 15m, possibly across two rooms and a hallway, so there would be a good chance the beam would be broken by an intruder.

Using 82mm diameter lenses of 76mm focal length, a 4000 ohm relay, a 6.3V pilot lamp operated from a 1.5V cell and a 15V DC supply to the relay, the system worked reliably over 10m. The pilot lamp gave a dull glow that would be scarcely visible. Using full voltage on the pilot lamp, the system worked over a distance of 24m. An infra-red filter may be used as detailed in Electronics Australia for February 1963

Set up the lenses, LDR and light for the distance over which it is intended to be used. Adjust the light so that the distant lens is just covered with light. Adjust the LDR so that it is just covered with light. Measure the resistance of the LDR. Obtain a relay with a coil resistance as close as possible to this value. Care must be exercised to avoid exceeding the LDR rating of 200mW.

To set up the system press the reset button and then close the bell switch. If the beam is interrupted the bell will ring until the reset button is pressed again, or the bell switch is turned off.

A spherical reflector behind the lamp may be used to increase sensitivity. If the lenses used are plano-convex, the plane side should face the LDR or light source.

#### LOW VOLTAGE SOLID STATE REGULATED POWER SUPPLY. Cir. 40

In the amateur journals and in electronic textbooks, there are many circuits for transistor-regulated power supplies. Most of these, however, are unsuitable for the delivery of output voltages below about six volts. Those circuits capable of giving low output

voltages are almost always rather complex - often requiring a separate negative supply or do not give very good regulation.

While there is nothing original in the circuit presented, it employs a couple of ideas that may not be widely known. The circuit is simple, uses readily available parts, and is capable of quite good performance. The output voltage drops less than 30mV for a full 500mA load. Hum and noise are well below 20mV. The supply is protected against overload or accidental short circuit of the output. The output voltage may be varied between about 2 and 4 volts making the supply very suitable for Fairchild microcircuits which require  $3.6V \pm 10\%$ .

As in all regulated supplies, the output voltage is sampled and compared with a reference voltage (the voltage of the 6V zener diode). Any difference, or "error," between the two is amplified by transistor Q1 and presented to the series regulating transistor Q2 and Q3 - in a Darlington configuration - in such a way that the "error" is corrected.

In conventional supplies, NPN transistors are often used throughout with the zener voltage less than the output voltage. Since zener diodes are not very satisfactory below about 6V (they are also hard to get), another approach is needed. In order to use a 6V zener diode, a PNP transistor is used for Q1 and NPN transistors for Q2 and Q3. The collector of Q1 is at about 3.8V and its emitter at 6V. Hence the collector is 2.2V negative with respect to its emitter. The base of Q1 is set at about 0.6V negative with respect to the emitter. Thus Q1 amplifies in a perfectly normal way.

The base current for Q2 is derived from the collector of Q1. With no load on the output of the supply, the entire collector current of Q1 passes through the 6.8K resistor. As current is drawn from the supply, more collector current passes into the base of Q2 - this is in addition to the constant current through the 6.8K resistor. This system is capable of good regulation because the comparator amplifier Q1 is supplied with its operating voltage from a regulated source.

Another unusual idea incorporated into the supply is the use of a field effect transistor Q4 in series with the zener diode. Q4 acts as a "constant-current diode" and supplies a constant current of about 5mA to the zener diode regardless of supply voltage variations. Since the zener voltage of a particular diode depends primarily on the current through it, the zener voltage is held more constant than is usually possible with a resistive feed from an unregulated source.

Because of production spreads in the 2N4360 FET, it may be necessary to alter the source resistor somewhat in order to set the current through the zener diode at about 5mA. The current must not be too large, or Q4 may overheat.

The protection circuit employs only one transistor, one resistor and one potentiometer. In view of its simplicity and usefulness, it should not be omitted. As the current drawn from the supply increases, the voltage developed across the 6.3 ohm resistor increases. The base-emitter voltage of Q5 reaches about 0.6V, the transistor starts to conduct and progressively it shunts the zener diode. This reduces the reference voltage and hence the output voltage.



As the output current increases above the threshold of protection - set by the 50 ohm potentiometer - the output voltage falls, eventually reaching zero. If the control is set to give a threshold of 500mA, the short circuit current is less than 600mA.

Editorial note: It should be possible to use a normal bi-polar transistor instead of the field effect transistor as a constant-current device. The production spread will be less, and the design more economical.

#### IMPROVEMENTS TO A LOGIC PROBE Cir. 41

Recently I built a logic probe. It worked very well but I consider that the over-voltage protection was inadequate and the input current required to drive the probe to logic 1 was excessive. Several circuit values have been changed and loading has been improved. The new values are shown on the circuit herewith.

Some of the input currents have been reduced by a factor of 30. The modified circuit gives good input protection. At 20 volts the input current is only 1.6mA. If R1 is a 1/4W resistor, the probe is protected against overload by more than 35 volts. The values of resistors R1, R2, R3 and R4 are quite critical as they determine logic 1 and logic 0 trigger levels. Resistors of 5% tolerance should be used.

R1 determines over a narrow range, the minimum input voltage for logic 1. R3 determines over a narrow range, the maximum input voltage for logic 0.

The modified circuit requires only 300-400uA to drive it to logic 1. This is within the limits of the normal TTL output stage. When the input circuit is open, none of the LEDs will light. Current consumption at 5 volts is 40mA with open circuit inputs, 74mA with one LED on and 60mA with a pulse train.

#### BATTERY PROTECTOR Cir. 42

Have you ever turned your portable radio volume control right down, then left it running for long periods because you forgot to turn it off? If you have, you probably flattened the batteries, or at least wasted a significant portion of their life.

A simple protection against this risk is to fit a small amount of resistance in series with the common end of the volume control. This allows the volume to be turned to a low level, but never right off. The minimum level should be kept as high as possible, to make the idea effective, but not so high as to be inconvenient in quiet listening situations. Values between 2% and 3% of the volume control value generally work out satisfactorily, but this can be varied on a trial and error basis.

#### INEXPENSIVE ALARM DEVICE Cir. 43

Here is a circuit for a novel alarm device which can be very compact and cheaper than similar commercial items. It consists of a unijunction oscillator stage TR1, of which B1 output pulses turn on transistor TR2, which has an 8 ohm or 15 ohm loudspeaker as its collector load.

The turn-on pulses have a duration of only 20-30us, so that the average power dissipation in TR2 for a frequency around 1kHz is less than one watt, thus eliminating the need for a heatsink. The original application was for automotive parking light reminder and adequate output was achieved with a miniature 2in diameter loudspeaker.



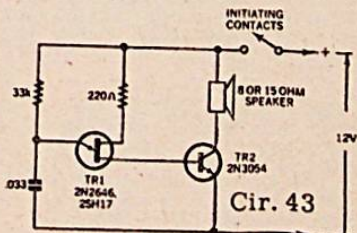
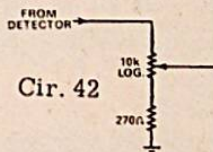
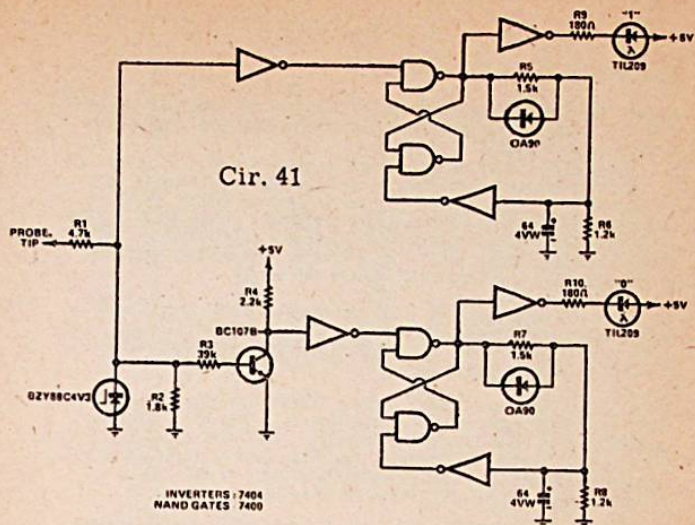

#### A REGULATED POWER SUPPLY Cir. 44

We describe a regulated power supply suitable for experimental bench work. It is completely protected against any degree of overload, including short circuit.

This power supply will deliver a well regulated supply of DC up to 12V at 200mA. It is completely overload proof and thus is very suitable for use as a general purpose lower power bench supply. I have found it suitable for testing experimental circuits- an application in which overload protection is particularly valuable. This form of overload protection is so effective that neither momentary or prolonged short circuit will damage the supply.

The source of unfiltered DC is up to the individual constructor. I used a full wave voltage doubler with 1000uF electrolytic capacitors. This gives about 12V at 200-250mA load from a standard 6.3 volt filament transformer.

The AC127 or 2N647 transistor must be fitted with a good heat sink, and a flag type bolted to the chassis is suitable. Although the 2N3642 gets warm it does not require a heat sink as it is operated well inside its ratings. The diode used as a reference voltage source is not critical. Almost any silicon diode with an average current rating of 30-40mA could be used.

The supply is variable from about 2V to 15V (under light load) and will deliver 350mA into a short circuit (after an initial surge due to the 1000uF capacitor discharging). The value of the short circuit current can be varied by adjusting R1. At low levels of current (up to 50mA) the filament of the 6 volt, 250mA lamp has a fairly low resistance (about 5ohms) but when the load current increases the filament gets hotter and the resistance increases. At normal current levels the globe is either dimly lit or not lit at all, but when the supply is overloaded it lights up brightly. The globe is mounted on the front panel and acts as an overload warning.

#### CAPACITOR TESTER Cir. 45

We describe a direct reading capacitance meter suitable for capacitors with values from 10pF to 1000uF.

In order to overcome the problem of the unmarked or suspect open circuit capacitor - particularly those of small value - I have constructed a direct reading capacitance meter. Admittedly, an RC bridge will do a similar job, but there is nothing quite like a linear voltmeter-like scale which is read directly as so many microfarads. It is sufficiently encouraging to cause the operator to happily run through two dozen capacitors, in search of a specific value, in one minute flat.

The instrument will read from about 10pF to 1000uF. It would not be difficult to add another range to cover even larger values, but I had no need of such. In addition, polarising facilities are provided for electrolytics. The original instrument has DC polarisation for 6, 12, 25 and 250V. However, I have deliberately deleted the 250 volt provision in the circuit enclosed as, in the hands of casual constructors, this could be dangerous. The capacitance of a high voltage electrolytic is reasonably accurately measured at 25V polarisation.



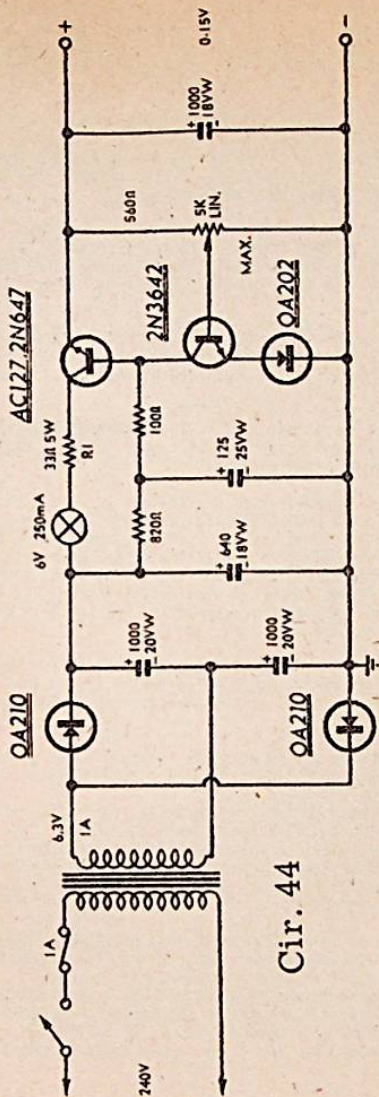

Cir. 44

*Circuit of the regulated power supply. The layout would not be critical and may be arranged to suit what ever cabinet or box which is available. The main power supply — transformer and rectifier — can be varied to suit requirements or available components.*

In order to retain as much versatility as possible, I have shown the leakage measurement circuit with a built-in current limiting resistor. Even so quite a large "bite" can be delivered by the capacitor itself, particularly when a large, high voltage electrolytic is involved.

The circuit uses valves, largely because the power supply necessary to test the full range of electrolytics is suitable for valves, and because they are rather more self protecting in the event of heavy-handed operation with charged capacitors. I also suspect they would be cheaper in this application than semiconductors.

The principle used is the measurement of capacitive reactance in terms of the resultant current from a fixed voltage source, at suitable fixed frequencies. For the larger values the AC heater winding at 6.3V 50Hz is used, with the meter shunted to provide higher value multipliers.

The other frequencies used are 40KHz, 4KHz, and 400Hz. These frequencies are supplied by a 6CG7 Wein bridge oscillator, with two arms of the bridge switched. This drives a 6AM5 cathode follower which provides low impedance source.

The polarising voltage for electrolytics is provided by a relatively high current voltage divider across the HT supply, using a 15W 240V lamp as the main resistive element.

A very large capacitor is required to provide the AC return path for testing electrolytics. The 6000uF electrolytic (25V DCW) shown is made up of three parallel 2000uF units. Strictly, this limits the accuracy of the highest scale to 600uF at 10% error. However, as it errs on the side of underrating large electrolytics, this is not considered serious. In fact, once the electrolytic under test is fully polarised the positive side can be returned to chassis for a short time and an accurate reading obtained.

By adding an extra shunt to the meter - provided the switch contacts will stand it, since the current will be approximately 1A for a 1000uF capacitor - larger values can be measured, up to the limit of the detector diode.

A 1000 ohm, 5W resistor is fitted as shown in the circuit to discharge the capacitors, rather than "splash" them on a screwdriver.

The switching circuit uses part of the rectifier for meter protection. Even so, since charged capacitors can produce exceedingly high currents, it is a sound rule not to change switch positions with a charged electrolytic connected to the test terminals. Also, one should always commence testing on a high capacity, low voltage setting, and progress towards the optimum setting.

The meter value shown is 0.5mA, 150 ohms. This happened to be an odd one on hand. There would be no objection to using (say) a 250uA meter, providing the shunt resistors were selected to match. Alternatively, a 1mA meter might be used, but may create some difficulty in calibrating the smallest range scale. The scales provided for in the circuit are: 0-.0005uF, 0-.005uF, 0-.05uF, 0-.5uF, 0-5uF, 0-50uF, 0-500uF, 0-1000uF. The last five ranges are provided with polarising facilities.





For the three lower ranges, where an oscillator is used in place of the relatively steady 50Hz mains signal used on the other ranges, a calibrating button and an adjustment pot. are fitted. For these, the best three capacitors obtainable (checked by a bridge preferably) should be used, as all future measurements will be referred to these values.

#### TRAILER FLASHER UNIT Cir. 46

Having had some problems in obtaining a suitable commercial flasher unit to fit to my trailer, I decided to make one up myself. In addition to the fundamental requirements for such an installation, regulations require that some means be provided to indicate to the driver that the added flashers are in fact working correctly. The unit to be described meets all these requirements.

The circuit is quite simple and there seems to be no reason to describe its operation in any detail. The left and right trailer indicating lamps form a return circuit for each of the pilot lamps when the ignition is switched on. The pilot lamps must be of a low wattage rating so as not to make the trailer indicating lamps glow. The trailer lamps should be about 20 watts each. A rheostat may be connected in series with the pilot lamps to reduce their brilliance for night driving.

Both pilot lamps will light up when the trailer plug is connected. When either direction is indicated, the appropriate lamp will flash. If an indicating lamp is open circuit the pilot lamp will go out, with or without the direction indicator being on.

The assembled unit, which may be on a printed board, may be mounted under the dash and the wires connected to the outgoing side of the indicator switch. For systems using a positive frame connection PNP transistors must be used, otherwise the circuit remains the same.

(Editorial Note: Since preparing the material for this item, the author has advised us that in cases where trailer lamp power runs towards 100 watts, the two 470 ohm resistors may be reduced or even eliminated altogether.)

#### BELL AND BUZZER WARNING CIRCUIT Cir. 47

"Every boy is interested in electric bells and the following circuit will show how to put a bell and buzzer to practical use in the home.

"If a warning device is required for only one entrance, the bell should be wired as shown in Fig 1.

"For those who desire to install an alarm on both back and front door, the circuit of Fig. 2 should be used. The advantage of this unit is that both bell and buzzer operate from the one power source.

"A buzzer works on the same principle as an electric bell but makes a buzzing sound when contact is made at the push button, thus the sound distinguishes it from the front door bell. For those who wish to install a transformer in lieu of a battery as a power source, make sure you buy one that reduces the voltage to suit the bell and buzzer ( $4\frac{1}{2}$  volts).

## Trailer flasher unit

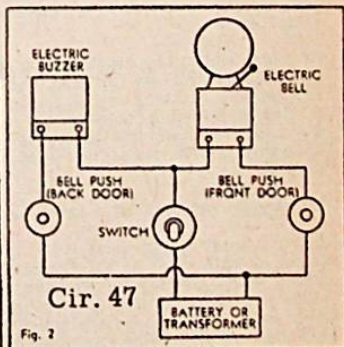
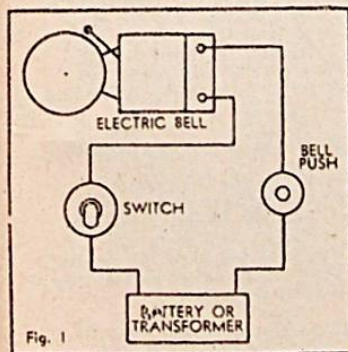
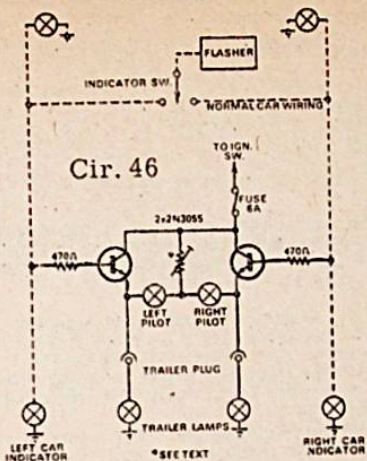

The circuit at the left is for a front door alarm only while that above will give a distinctive alarm on both front and back door.



"If you use a transformer, install it handy to the power source and use only standard electric flex to connect the transformer to the power point; bell wire should not be used to carry the full voltage from the power point."

#### Parts list

1 small electric bell  
1 single pole switch  
2 bell push switches  
1 4½ volt battery  
1 small buzzer  
Quantity of bell wire and staples to fix wire.

**DRAWS THE CURTAINS AT SUNDOWN!** THIS NOVEL LIGHT-OPERATED DEVICE IS DESIGNED TO AUTOMATICALLY CLOSE CURTAINS OR VENETIAN BLINDS WHEN DAYLIGHT FALLS BELOW A PREDETERMINED LEVEL. IT CAN ALSO SWITCH ON INTERNAL LIGHTS. Cir. 48

The light sensitive element is an LDR (Light Dependent Resistor), and this operates in conjunction with a two stage direct coupled amplifier and a relay. The characteristic of the LDR is that it has a very high resistance (typically several megohms) under conditions of no light and a very low resistance (a few hundred ohms) under bright light conditions.

As shown in the circuit it forms one arm of a voltage divider, in conjunction with the 10K potentiometer, supplying base bias to the OC71. Under bright light conditions the resistance of the LDR is relatively low and little forward bias is applied to the base. Under these conditions very little collector current flows through the OC 71.

As the light level on the LDR decreases its resistance increases, thereby increasing the forward bias on the base and increasing the collector current. This collector current, in turn, provides forward bias for the OC81, thereby increasing its collector current also. When this collector current reaches a large enough value the relay is pulled in.

The relay may be any sensitive 12V type with two sets of make contacts and two sets of break contacts. During daylight conditions the relay is open but, as night approaches, and at a level determined by the setting of the 10K potentiometer, the relay will close and operate the motor. The motor may be any toy motor, such as one from a slot car. It should be capable of being reversed by reversal of the applied voltage.

The size of the motor will really depend on the size of the curtains.

When the motor operates, it pulls the cord to close the curtains. As the curtains meet in the Centre a magnet, fastened to the moving switch (RS1), causing the motor to stop. When the return of daylight causes the relay to drop out, reverse voltage is applied to the motor which then runs in the opposite direction and opens the curtains. When the curtains reach the full open position the magnet in the curtain operates a second reed switch (RS2) and stops the motor.

Most reed switches are "normally" open" devices which will close in the presence of a magnet. To make them "normally closed" it will be necessary to bias these with a fixed magnet mounted at a suitable distance from the reed, and with its north and south poles



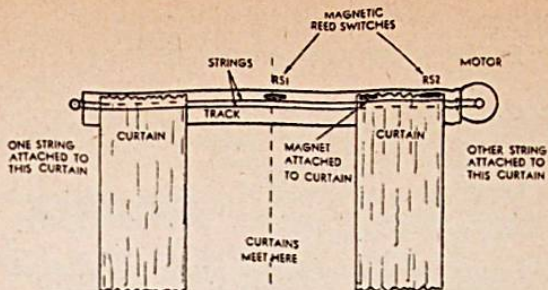

The layout of the complete curtain system, showing location of the motor, reed switches, and magnet. **Cir. 48**

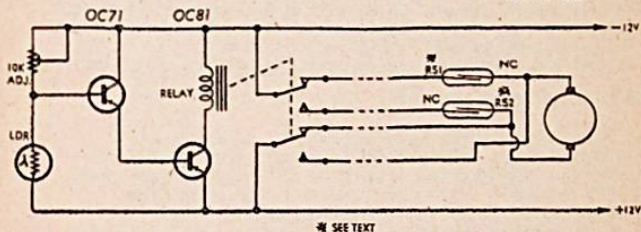

Circuit diagram for the curtain control system. Note the wiring of the changeover relay contacts in conjunction with the reed switches. The latter must function as "normally closed" types.

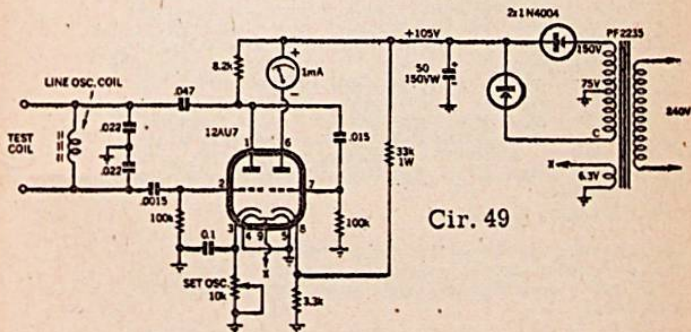

**Cir. 49**

suitably oriented. Presence of the moving magnet will now cancel the effect of the bias magnet and allow the reed to open. An alternative arrangement is to use a "change-over" type reed, which may be wired for either function.

More than one set of curtains could be operated by this unit by repeating the motor circuit shown in the dotted box. If desired, additional reed switches may be added to switch on (and/or off) inside lights when the curtains are closed or opened.

The LDR is located outside the building, preferably in the open shade rather than direct sunlight, and where it will not be affected by street or window lights at night.

The original unit was built and tested with complete success. It was fitted in a microbus converted to a caravan and operated from the car battery. If it is to be operated from the mains, a suitable power supply will have to be provided. The exact size of the power supply will depend on the size of motor used to draw the curtains, which will depend, in turn, on the size of the curtains. It may be possible to use a mains-operated motor, but the requirement that it be reversible must be kept in mind. Brush-type motors, AC or DC, can normally be reversed by reversing the connections to the brushes.

#### SHORTED TURNS TESTER Cir. 49

Inspired by the Simple Shorted-Turns Tester, I decided to build one. However, as I had many valves and other components in my junk box, I decided that I would use the valve approach, still retaining the basic design, as may be seen from the circuit.

Components appear not to be critical and the high tension may be within the range of 100-150V. If another twin triode is used, some variation in the 3.3k cathode resistor may be necessary. For a high  $\mu$  triode the resistor may be more suitably 1-1.5k. A suggested power supply circuit is given. Other power supplies will suggest themselves, according to the components on hand.

As with the original solid state unit no doubt, some operator experience is desirable before launching into testing various coils. A good idea is to test odd coils which happen to be handy. With a coil under test, place a shorted turn on it and observe the effect indicated by the instrument. It works very well on coils where the magnetic energy is reasonably well retained by the ferrite core, less well in larger air cored coils. I had some success with speaker transformers but the leakage reactance of a defective coil was sufficient to allow oscillation to continue. It then becomes a matter of interpreting the reduction in meter reading, also comparing the reduction at different oscillator activity levels.

#### SIMPLE INTERCOM Cir. 50

Most experimenters have a need for an intercom system of one time or another, such as between house and the workshop. The simple set-up described here would be all that was needed in many cases.

Here is a circuit of a simple intercom set-up. A small loudspeaker at each end of the system acts as both speaker and microphone, depending on the direction in which the amplifier is working. Both ends of the system require a function switch to allow the other station to be called and a buzzer to allow the station itself to be called. The switch is a three-position, single-pole type, preferably with a spring-loaded action in the "Ring" position.

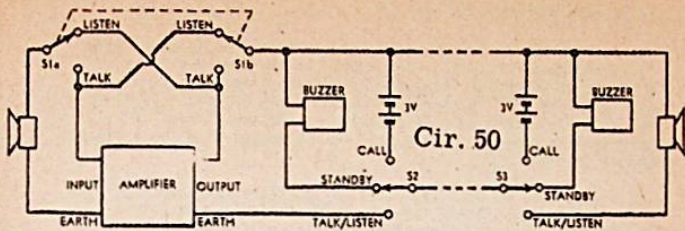

*Simplicity is the main feature of this intercom, which nevertheless offers most of the features needed in any two-station system.*

Direction of motion of vehicle

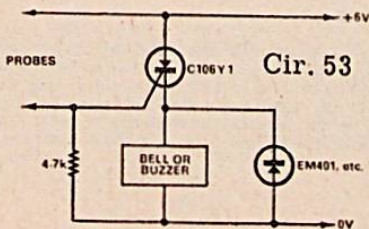
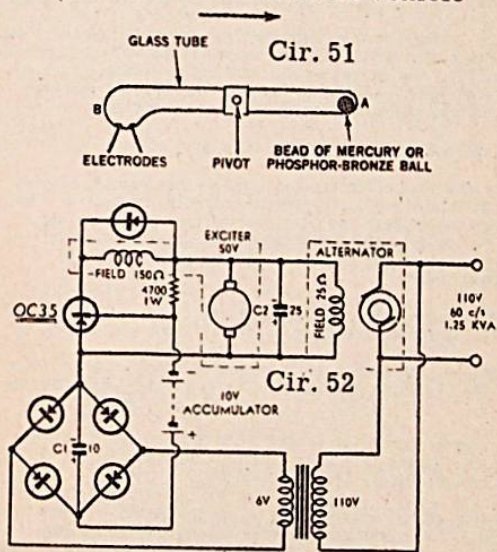



### INERTIA OPERATED SWITCH Cir. 51

Here is an idea for an inertia-operated device which could find an application in foiling car thefts. In its simplest form, it consists of a tube of insulating material, glass perhaps would be the best. The tube is shaped as shown in the diagram, sealed at the ends and with a pair of contacts at one end. A bead of mercury or a phosphor bronze ball is introduced into the assembly before sealing.

The assembly is pivoted in such a way that the tube can be tilted forwards towards "A" and the tube is installed so that its length lies along the direction of motion of the vehicle. The electrodes at "B" are so connected that a circuit can disable the ignition system or sound the horn when the contacts are closed. In order to accommodate all angles at which the vehicle is likely to be parked, the pivot bearings are set so that they bind slightly. This enables the owner to set the device for each particular situation but still avoid accidental tripping due to steep slope.

When set and in the event of unauthorised use of the vehicle, due to acceleration, the ball will move up the slope and short out the contacts at "E", thus actuating the warning or disabling system. This little device is easy to set and may be rendered inactive simply by tilting the tube into the vertical position.

### TRANSISTOR REGULATOR FOR ALTERNATOR Cir. 52

The circuit shows an effective and trouble-free regulator for a small alternator. The OC35 transistor controls the exciter field current, working to keep the DC output voltage of the bridge rectifier (which is proportional to the AC output voltage of the alternator) equal to the reference voltage supplied by the 10-volt accumulator.

The accumulator could be replaced by a small zener diode and parallel electrolytic condenser, carrying a few milliamps of current.

The loop gain of the system is increased by using a larger value capacitor for C1, which reduces the ripple voltage of the bridge output.

The diode across the exciter field is to protect the transistor from inductive surges if the base current is suddenly cut off. Capacitor C2 reduces ripple from the exciter.

Output voltage of the system could be controlled by a potentiometer between the six-volt transformer winding and the bridge rectifier.

No heat sink is required on the transistor.

### WATER LEVEL ALARM Cir. 53

Here is a water level alarm which was developed to cope with a situation in my home. The lady of the house has a semi-automatic washing machine and from time to time she would go away when water was running to fill the machine and the inevitable spillage would occur, thus flooding the laundry and environs. I built this little device which works well and has given no trouble over the last 8 or 9 months.

The circuit is very simple but the alarm mechanism must be a bell or buzzer or something which employs a constantly make and break arrangement. If this is not done, an on-off switch or reset button must be used.

I built mine in a metal case but other ideas could be used. The probe used was a 2-pin mains type plug.

The probe is arranged so that the pins are pointing downwards and at the top level of water required. When the water reaches the probe tips the alarm sounds. The alarm stops automatically as soon as the probe is removed from the water.

#### POWER SUPPLY FOR CAR RADIOS ETC. Cir. 54

"Here is a description of a high current low voltage power supply intended for use as a bench supply in the workshop. It is suitable for driving the older vibrator type car radios, of which there are still a number in use.

"I decided to build this because I was sick of continually charging a battery under the bench, which was usually flat after each use. No doubt other technicians have experienced this trouble.

"Since building it I have found other uses for it, such as battery charging, for testing small car refrigerators and small transistor radios. In these and other general workshop uses it has proved itself after nearly a year of operation, in use almost every day.

"Construction and operation is as follows:

"Power passes via an ON-OFF switch to power transformer T1. This came from an old radio, and has taps from 110V to 250V. It is used as a variac to supply T2. A 6.3V winding in the same transformer is used to supply a panel indicator lamp.

"Transformer T2 was wound for the job, using the core and primary windings of an old TV transformer. All windings other than the primary should be removed, the number of turns of the lower voltage secondaries being checked in the process to arrive at the 'turns per volt' design figure for the transformer. Thus, a 6.3V winding which consisted of about 33 turns would suggest a '5 turns per volt' design. The new winding should supply 12V centre tapped.

"Current rating is about 8A and this determines the gauge of wire required. One authority suggests 1200 circular mils of cross sectional area per amp or, for 8A, about 10,000 circular mils. This would correspond to approximately 10 B & S or 12SWG. This figure probably errs on the conservative side. In any case, the largest gauge that can be used will depend on the available 'window' space inside the core.

"This transformer feeds a bridge type rectifier consisting of four heavy duty diodes, type BYX20/200, mounted two each to two heat sinks. These provide sufficient cooling under maximum load.

"The filter capacitors must be at least 4200uF each to permit testing hybrid and all-transistor type car radios. The choke which I used was a speaker transformer with a 15 ohm/3.5 ohm secondary, the whole secondary winding being used. Anything smaller will not handle a heavy load without overheating.



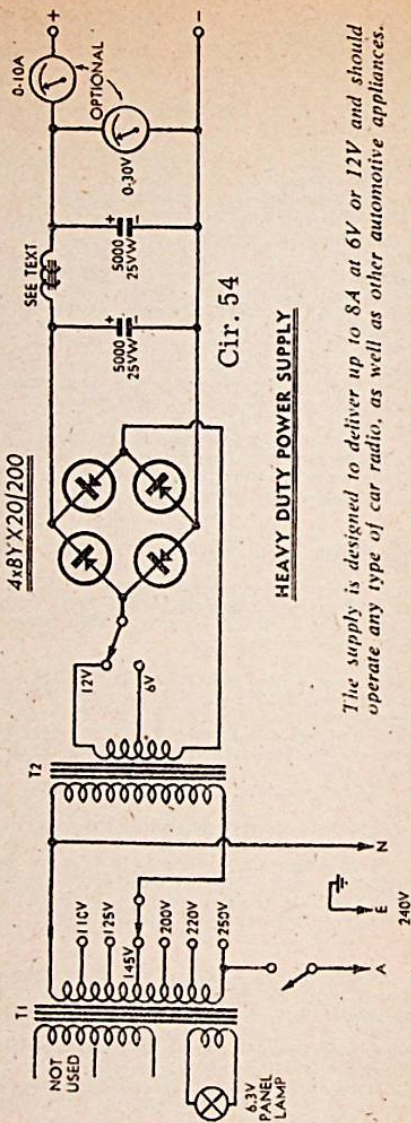

HEAVY DUTY POWER SUPPLY

*The supply is designed to deliver up to 8A at 6V or 12V and should operate any type of car radio, as well as other automotive appliances.*



"An oscilloscope test with the supply delivering 6A showed it to be near enough to pure DC. Only a slight ripple was apparent. This supply could, of course, be regulated but I have found this unnecessary as the voltage remains fairly stable even under considerable drain. Metering of the supply is optional.

Editor's note: There are some points to be considered by anyone likely to build a unit of this kind, but who may not be able to copy the published design exactly.

One concern is possible overload of and damage to the rectifiers in the event of a short circuit across the output - as from a faulty vibrator in a car radio. In the circuit as published the resistance of the choke is probably sufficient to protect the diodes, but this may be lost if one attempts to fit a bigger and better choke.

Secondly, while it is natural to fit as much "C" as possible in the filter circuit, in the interest of better filtering, there is a definite limit to what may be used for the first filter, directly after the rectifier. In its discharged state this represents a short circuit, leaving only the impedance of the transformer to limit the rectifier current to a safe value. Again, it is probable that the transformer used in the original has a high enough value, but this may not be automatically so for other units. Unless the situation is known precisely, additional "C" should be added to the second filter only.

Finally, an RF by-pass in parallel with the second filter may prove beneficial, particularly when the electrolytic begins to age a little. This should be a non-electrolytic capacitor of about 1 $\mu$ F, or larger if this can be provided economically. The need for such a capacitor would be indicated by any tendency to RF instability in a receiver, particularly if this was absent on battery operation.

#### SIMPLE TRANSISTOR TESTER Cir. 55

Designed to be compact, reliable, and inexpensive, the portable transistor checker shown in this chapter was designed by Westinghouse for use by their field-service personnel. The only other piece of equipment required is a conventional v.o.m or v.t.v.m.

While not producing any numerical values for the transistor being tested, the unit will show if the transistor is operating properly as its base potential is varied. This tester can also be used to indicate shorts and opens between the transistor elements, and is capable of testing diodes, NPN or PNP, NPNP or PNP, unijunction, and gate transistors.

In principle, the tester uses the transistor in a voltage-divider circuit and because negligible current flow is involved, the transistor under test cannot be damaged by incorrect connections or a short.

The unit is housed in a small chassis box 3 $\frac{1}{2}$ " by 2 $\frac{1}{2}$ " by 1 $\frac{1}{2}$ " in size. A double-pole, double-throw switch changes potential for testing NPN or PNP types. The external v.o.m. or v.t.c.m. should be set to measure about 1 to 2 volts d.c.

A voltage divider network tests transistor for conductance.  
TO BATTERY REVERSING SWITCH

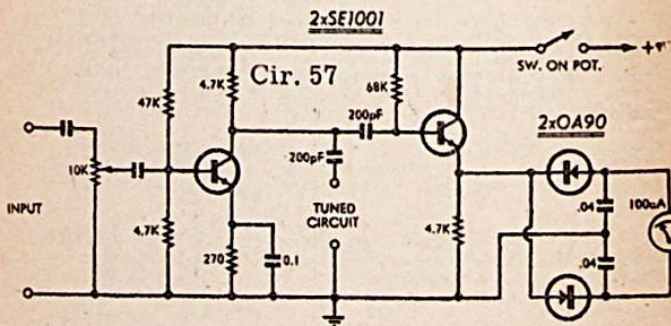
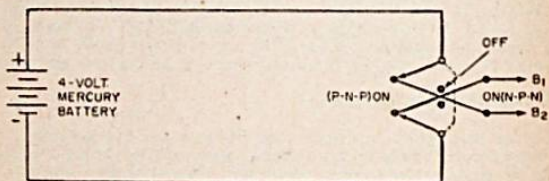
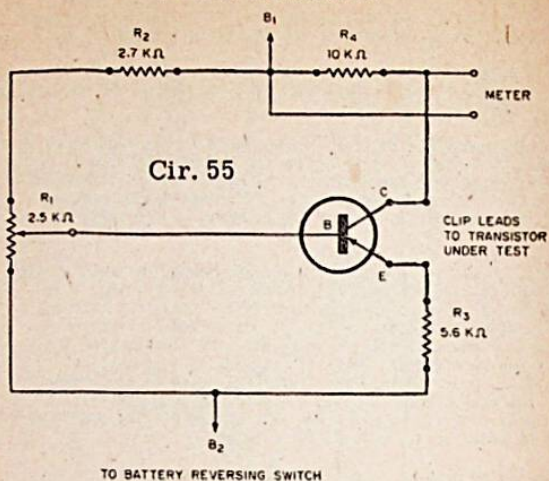



Resistor R3 (see diagram) prevents excess emitter current while R2 limits forward bias to the base. Potentiometer R1 provides the reverse-to forward base bias. Resistor R4 limits the transistor load, stabilizes the readings, and provides the voltage that is read out by the external voltmeter. Resistors R1 and R2 make up a voltage divider. With the circuit shown, any change in conductivity between the transistor collector and emitter will then show up as a reading on the external voltmeter.

If the transistor under test has an open collector circuit, the meter will indicate zero. If the emitter circuit is open, the meter reading will remain unchanged when the emitter test lead is disconnected. Short circuits between transistor elements are indicated by high meter readings.

A good transistor will produce a reading somewhat less than the short circuit value when only the collector and emitter leads are hooked up. This value will increase when the base lead is connected and potentiometer R1 is rotated towards the R2 end.

#### FALSE NEON INDICATIONS Cir. 56 no sketch

Because of their very low current consumption, 240V neon indicating lamps will often glow or flicker even though the associated circuit is switched off. This problem generally arises from cable to cable capacitance when neons are used for remote indication.

An effective solution is to bypass the lamp with a 100k resistor (1W for 240V). This provides an effective path for the leakage current but will not affect normal operation.

We have used this method widely with 100% success. In 415V applications it is more expedient to use a 220k resistor, allowing a 1W type to be fitted.

#### TRANSISTORISED RESONANCE METER Cir. 57

"Here are details of a transistorised version of a 'Resonance Meter'; a light compact meter that is very easy to use. It serves two purposes; as an RF indicator, and to check the resonance of tuned circuits and crystals. I have found the meter invaluable when, without a CRO, I have had to check and adjust the level of an oscillator or IF stage.

"No attempt has been made to make the scale linear with frequency, or to temperature stabilise the circuit. These are complicating factors, and my aim was simplicity with maximum usefulness.

With a signal generator at the input, and a tuned circuit or crystal at the 'tuned circuit' terminals, the resonance point is found by watching for a dip or peak. This is only an approximate reading, because the unit has some capacitance (about 5pF) which will affect the circuit with low capacitance, say 50pF or less.

"The original used a 100uA meter from an exposure meter. Any movement up to 500uA could be used by changing the voltage doubler capacitors. To measure the resonance of high Q circuits, a sharp acting movement is necessary, or the dip or peak may not be noticed even when using the vernier on the signal generator. It should be possible to use other transistors by altering the bias resistors, although I have not tried this.



"My unit gave good performance over the range 100KHz to 10MHz. The gain fell off after that, but it was still quite useful at 30Mhz. The circuit was assembled on a piece of "Veroboard," and the unit was built into a small box not much larger than a multimeter, making it compact and handy to use. The circuit draws only 1mA and is very economical on battery power.

#### TRANSISTOR 2 METER CONVERTER COURTESY RCA Cir. 58

- |   |   |
|---|---|
| C1 - 0.5-5 pF tubular trimmer   | L1 - 5 turns, N. 16 bare wire<br>1/8 in diameter (spaced wire<br>diameter), tap one turn up<br>from bottom. |
| C2 - 10 pF ceramic tubular  | L2, L3 - 4 turns, No 26<br>enamelled wire, close wound<br>on 1/8 in diameter ceramic slug<br>tuned form.    |
| C3, C9, C11 - 500 pF silver button.   | L4 - 11 turns, No. 26 enamelled<br>wire, close wound on 1/8 inch<br>diameter slug tuned form.               |
| C4 - 4.7 pF ceramic tubular.  |   |
| C5, C12, C14 - 3.3 pF ceramic tubular.  |   |
| C6 - 2.2 pF ceramic tubular   |   |
| C7 - 25 pF silver button.   |   |
| C8, C15 - 500 pF ceramic disc.  |   |
| C10, C13 - 30 pF ceramic tubular  |   |
| J1, J2 - coaxial jack.  |   |
| L5 - 3 turns, insulated wire, close wound link.   |   |
| L6 - 5 turns, No. 26 enamelled wire, close wound<br>on 1/8 inch diameter slug tuned form.         |   |
| L7 - 7 turns, No. 26 enamelled wire, close wound<br>on 1/8 inch diameter ceramic slug tuned form. |   |

- R1 - 27,000 ohms, 1/2 watt  
R2 - 3,900 ohms, 1/2 watt  
R3, R7 - 470 ohms, 1/2 watt  
R4, R9 - 820 ohms, 1/2 watt.  
R5 - 18,000 ohms, 1/2 watt  
R6 - 2,700 ohms, 1/2 watt  
R8 - 5,100 ohms, 1/2 watt  
R10 - 0.1 megohm, 1/2 watt  
R11 - 8,200 ohms, 1/2 watt  
R12 - 1,000 ohms, 1/2 watt.

Miscellaneous - 2 standoff solder terminals- one power socket, one crystal, 39.33 Mc/s overtone. 3 transistor sockets; one crystal socket, one brass plate 4 by 4 by 1/32 inches.

#### REFLEX PORTABLE Cir. 59

From a reader, comes this circuit for a simple reflex set.

"The set performs very well with the ferrite rod aerial on the local stations, and receives other stations if a short aerial is attached.

"The coil is wound on a 4 1/2 in piece of ferrite rod with 30 B and S wire, and consists of 52 turns with a tap 7 turns from the earth end. I used OA90's but any germanium diode may be employed. Although high impedance phones are shown, a crystal earpiece may be substituted with the primary of an output transformer in parallel.

"The current consumption is low so the battery should last a few months. An XA101 transistor will give higher gain than the OC45 and is also cheaper. The original circuit was built on a piece of "Veroboard," and housed in a wood case 4 1/2 in x 2 1/2 in x 1 1/2 in, with plywood panel and lid."

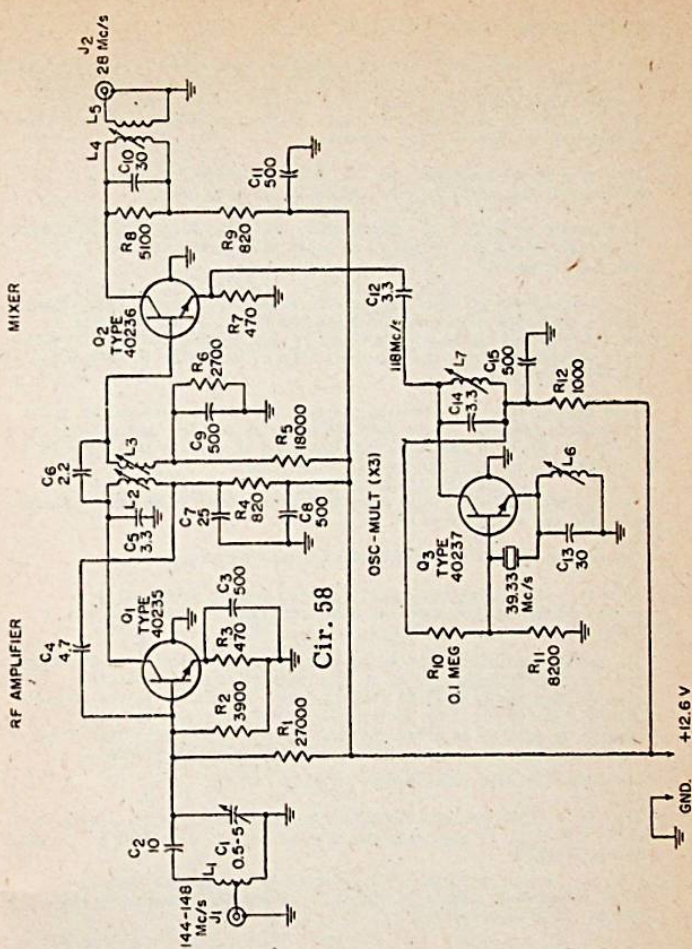



## CONTINUITY AND POLARITY INDICATORS Cir. 60

Here are two ideas submitted by different readers, for simple continuity and polarity testers. Considering the care necessary to ensure that certain solid state devices are not connected with wrong polarity, one or other of these would be handy on any experimenter's bench. The simpler of the two is described first.

Here is a handy instrument for the home experimenter. It is a polarity tester which is very simple and easy to make.

It consists of an OA81 germanium diode and a 6V, O32A bulb connected in series. These are fitted in an empty ball point pen tube (the ink tube removed).

Two short pieces of stiff copper wire are soldered to the diode leads. (Use a heat sink when soldering.) The one connected to the anode is pushed into the top of the tube and out the writing end. Secure this with insulation tape, leaving about 10mm of bare wire to form the positive terminal.

Trim the cathode wire close to the top of the tube and solder it to the bottom terminal of the bulb. Solder a third wire to the outer casing of the bulb and fit a suitable plug or clip to the other end. Finally tape the bulb to the top of the tube.

In use, the bulb will light when the pen terminal is on the positive wire and the flying lead on the negative.

The second idea is a little more elaborate and versatile.

This is a continuity and polarity tester using a light emitting diode. It can be housed in any container large enough to hold a small 9V battery, two switches, a LED, a diode and a resistor.

The tester indicates polarity of a DC voltage, indicates an AC voltage, and responds to pulses of AC or DC. It may be used on voltages greater than three and less than 100. As a continuity tester it gives a faint glow with a 100k resistor in circuit. It does not load a circuit as much as an ordinary test lamp and covers a voltage range with would require a selection of several conventional lamps.

## LOW COST REGULATED POWER SUPPLY Cir. 61

This is a design for a variable low voltage power supply, delivering up to 12 volts. It uses only two transistors and a handful of inexpensive components.

Despite its simplicity it is extremely useful where a low power regulated supply is needed for breadboards and microcircuit experiments.

The transformer and rectifier are from an electronics kit. The transformer is rated at nine or 12 volts, centre tapped, at 500 mA. If desired a larger transformer and rectifier could be used.

The rectifier and first filter capacitor deliver about 18 volts to the 2N301/AC125 Darlington pair. A reference voltage is derived from the divider network consisting of the 1K resistor, zener diode, 10K pot, and 1000uF electrolytic capacitor. The moving arm of the pot picks off a voltage which is always the same for a given degree of rotation of the control shaft. This voltage is fed to the Darlington input. The emitter follower action of the amplifier reproduces this voltage at the output.

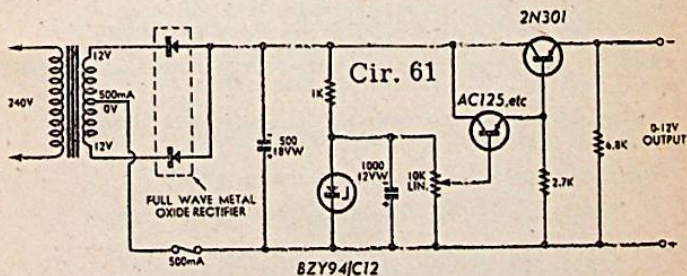
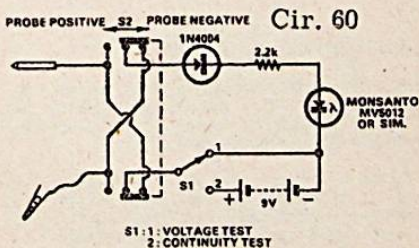
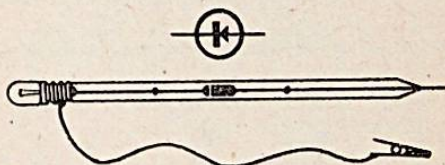
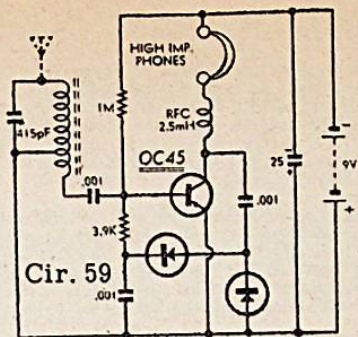

The circuit uses few components, many of which may already be available from the junk box.



The 2N301 is amply rated for this application, but the AC125 has less to spare, particularly the maximum collector-emitter voltage of 20.

Some variation may be necessary in regard to the zener divider network component values, to suit individual requirements. With the zener diode disconnected the voltage at the junction of the pot and the 1K resistor must always exceed 12 volts (the breakdown voltage of the zener) at the greatest current likely to be required. The 1K resistor was suitable for the current values I required, but can be reduced to about 800 ohms if desired.

Due to the collector/base leakage there will be some voltage present at the output even when the wiper of the 10K pot is connected to the common rail. The 2.7K resistor from the 2N301 base to the common rail reduces this to about 0.3V, which is negligible. The 6.8K resistor across the output terminals provides a nominal load for the system, so that voltage readings can be taken before the actual load is connected.

A voltmeter can be added as a permanent part of the supply, if desired, but the regulation is good enough to permit direct calibration of the control pot.

Performance of the unit is as follows; being the voltage at various loads:

NO LOAD	5K LOAD	500 OHM LOAD	50 OHM LOAD
12	12	12	12
9	9	8.9	8.8
5	5	4.9	4.8
3.6	3.6	3.5	3.4

#### THERMISTOR MEASURES TEMPERATURE Cir. 62

"Measuring temperatures with an ordinary glass thermometer is not always a convenient procedure. With this thought in mind, I set out to find a simple and inexpensive means of making a temperature measuring device which would read out the temperature on a meter.

"While measuring the resistance of a small thermistor of the glass enclosed variety I noticed that the resistance varied quite considerably with a small change in temperature; e.g., holding the glass stem between the fingers causes a sudden drop in resistance.

"Here are some of the resistance measurements in ohms at various temperatures: 40 deg. F - 500,000; 60 deg. F - 300,000; 100deg. F - 150,000; 400 deg. F approx - 400 (on my meter only!) The important thing was that the relationship of temperature to current was substantially linear, as far as the meter was concerned!

"Connecting the thermistor in a simple circuit as shown allowed me to measure temperatures successfully down to 20 deg. F.

"The setting-up procedure can be summarised as follows:

1. Immerse the 1AN into a liquid at a temperature of 40 deg. F.
2. Adjust the variable resistance R1 until the meter reads exactly 20uA. Call this reading 40 deg. F (20uA x 2)



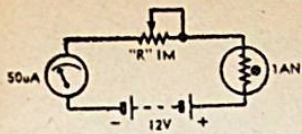

Cir. 62

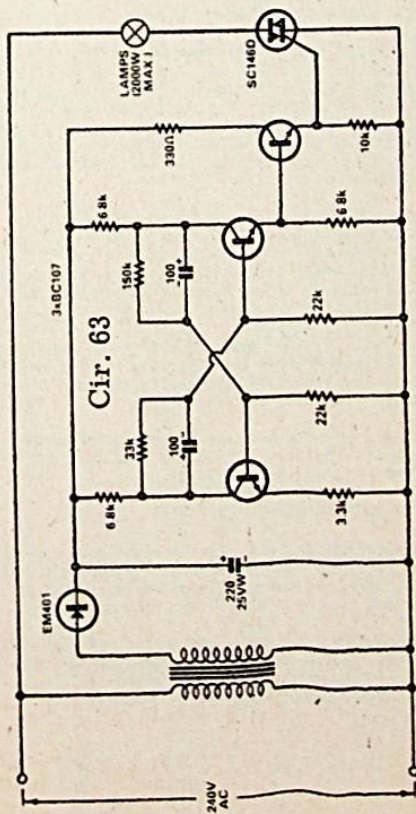
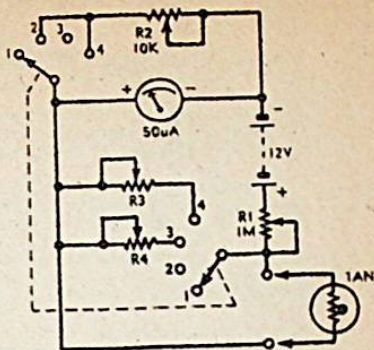
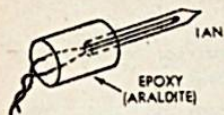

3. Raise the temperature of the liquid to 60 deg. F; the meter should now read 30uA.
4. Increase the temperature of the liquid to 100 deg. F; the meter should now read 50uA.
5. Shunt the meter with a 10K pot and with the liquid temperature unchanged, adjust the pot so that the meter reads 25uA. The full-scale reading will be 200 deg. F.
6. By adding extra switch positions, drawn as 3 and 4, and introducing extra resistors drawn as R3 and R4, the meter can be made to read other temperature ranges.

"Here are a few suggestions for its use: Measuring the temperature from various locations at a central point; monitoring the temperature of electronic equipment, while in use; fire alarms.

"To judge by the small amount of information about thermistors given in text books, one would think they had just been invented! The meter I used is a 4in square imported type.

#### FLASHER FOR 240V INCANDESCENT LAMPS Cir. 63

This solid state lamp flasher will handle tungsten lamp loads to 2000 watts or resistive loads to 2400 watts and it is ideal for flashing safety lamps in test bays or on danger signs. With the values of the multivibrator timing capacitors and resistors shown in the circuit diagram, the "on" period is 2.5 seconds and the "off" time is 2 seconds. Both these periods may be altered by changing the parallel resistor-electrolytic capacitor combinations, thereby altering the multivibrator switching sequence.

A power transformer with a 12V secondary winding feeding an EM401 or similar diode, provides about 15V DC for the multivibrator and switching transistor which controls the gate of the SC146D triac. Although very little power is dissipated in the triac (about 15 watts with a 2000 watt load) it should be mounted on a heatsink. It is essential to insulate the triac or better still, the heatsink, as the tab of the triac carries 240 volts. Avoid short circuits in the load circuit as these will destroy the triac. If small lamp loads (under 200 watts) are envisaged, then the triac may be operated without a heatsink and a 1A fuse could be inserted in the load circuit to help protect the triac from short circuits.

It may be necessary in some cases to fit RF interference suppression components to this circuit, to prevent it feeding regular "clicks" into nearby radio sets and audio systems.

#### PULSE CONTROL OF 2 SPEED WINDSCREEN WIPERS Cir. 64

A contributor suggested a method whereby windscreen wipers could be made automatically to describe a single sweep about ever five seconds, thereby avoiding the problem of having the wipers operating too much or too little in very light rain conditions.

Another reader suggested a solid-state version of the device which allowed an ordinary single-speed wiper system to perform single-wipe operations at intervals of 1, 4, or 8 seconds, according to the prevailing weather conditions.



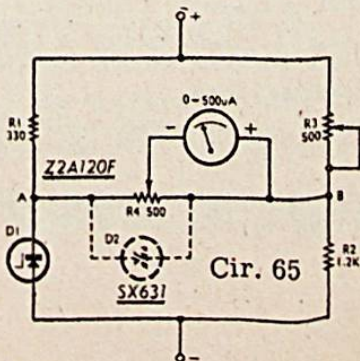
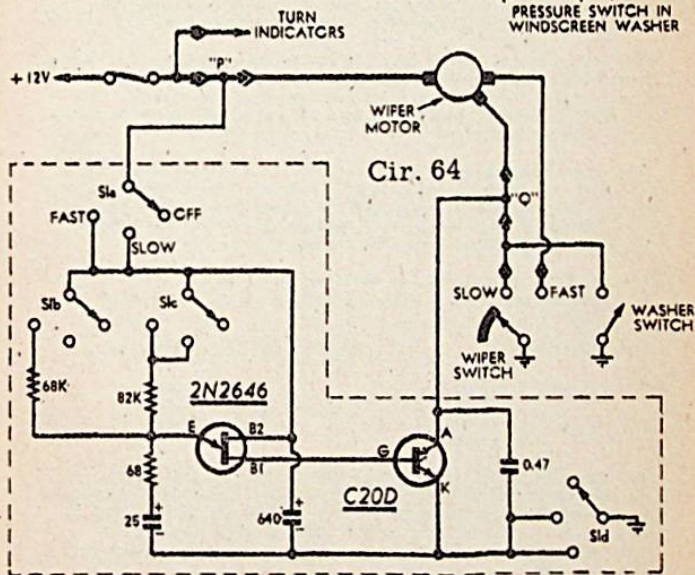
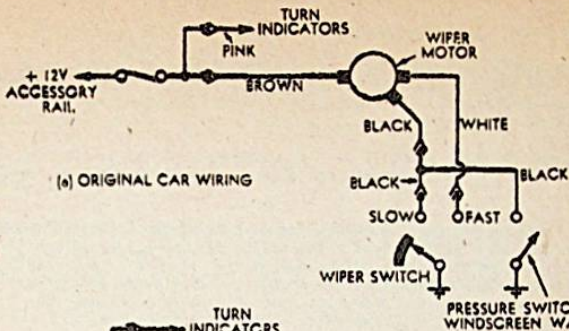

Now comes a letter on the same subject:

"The particular vehicle I installed the unit in is a Holden. As you may know, this model has two-speed windscreen wipers, controlled as in circuit (a). For simplicity, I have not shown the self-parking switch contacts.

"As the car will possibly be sold quite soon, I had to make the unit of a 'bolt-on' nature, and make it 'transferable' to a future car.

"I fabricated a small aluminium bracket to mount the switch under the dashboard as near as I could to the existing wiper switch. Thus the car now has two wiper switches - both rotary and reading 'Off-Slow-Fast' clockwise. The components within the dotted box in (b) are on the sub-assembly, most of them being mounted on a tagstrip attached to the bolts at the rear of the switch.

"The lavish use of switch poles is due to the fact that the smallest 3-position switch in the 8-amp range has 4 poles. The 8-amp switch is necessary; lighter duty types are too prone to 'cook up' under the load. I removed one clicker to make the switch easier to turn under driving conditions.

"The connections marked P and Q are made from quick-connect connectors. I soldered and crimped a male and female together to make the analogue of a 'piggy-back' power plug, so the only signs remaining when the unit is removed will be two mysterious  $\frac{1}{2}$ in holes out of sight under the dashboard.

"As predicted, experiment was necessary with the timing RC circuit. As I have the unit set up now, the periods of the four sweeps are as follows:

Switch setting	Time for one complete sweep
Original switch - slow:	1.7 seconds
.. .. - fast:	1.2 seconds
Delay box - slow:	7.1 seconds
.. .. - fast:	3.0 seconds

"No damage is caused by any combination of switch positions, and all components run well within their ratings. The major difference (excluding switching methods) between the two circuits is that I have bypassed the +12V rail with a 640uF electro. Until I did this, the wipers were most unsure as to how many sweeps were required of them.

"I tracked the trouble down to a large 'spike' as the self-parking switch opened. This was measureable as a 2V pulse on a well-damped multimeter, so I shudder to think what the real magnitude is! This may perhaps be curable by changing the 0.47uF to some more suitable value, or a series RC network, or some such. (Damping diodes, perhaps?)

#### EXPANDED SCALE VOLTMETER Cir. 65

"An advantage of this circuit is that most of the required components can be found in a well-stocked spare parts shop. The operation is as follows:

"Assume R3 to be set at 100 ohms. A variable DC supply is connected to the input terminals and slowly turned up from zero. The voltage



at 'A' rises positively with respect to the negative terminal, just below the applied voltage at the positive terminal. There is a small voltage drop across R1 since a small current flows through R4 and R2.

"The potential at 'B' rises positively according to

$$\frac{R2}{R2 + R3} \times E \text{ applied}$$

"The meter will be observed to deflect downward to begin with, since the voltage at A rises more readily than at B. At 12V input, the zener diode begins to conduct and, as the input is increased further, point A remains at +12V, while the voltage at B continues to increase.

"At 13V input, the potential at A is + 12V and at B is

$$\frac{1200}{1200 + 100} \times 13 = 12V$$

"Thus there is no voltage across R4 and the meter reads zero. Thus, we have a balanced bridge condition, with a zero meter reading at 13V input.

"Full-scale deflection will depend upon the sensitivity of the meter and the setting of R4. For a full-scale deflection at 15V input for example, using a 0-500uA movement, it was found that R4 was set so that 39 ohms was shunted across the meter and approximately 460 ohms in series.

"Diode D2 is included if necessary to limit the reverse deflection when the input voltage drops below the zener voltage. This diode should have a low forward resistance, where the voltage required for zero reading is somewhat higher than the zener voltage.

"It is obvious from the foregoing that, within limits, any desired minimum and maximum voltage can be selected at will, merely by adjusting R3 and R4 or by switching in suitable fixed resistors.

"Zener diode D1 is the heart of the circuit and while almost any type will suffice, a 4% tolerance is recommended for reasonable accuracy. Higher or lower voltage ratings can be used as well, depending on the required minimum voltage to be measured.

"Power rating is relatively unimportant, since the value of R1, the current limiting resistor, can be selected to suit, for example, a 9.1V diode rated at 260mA (0AZ207) can be used up to a maximum zener current

$$I = P/E = .26/9.1$$

or 29mA approximately.

"If the maximum voltage to be measured is 15V, then

$$R1 = E/I = 15/.029 = 516.$$

"A 560 ohm resistor is a good choice in this case, since it allows a safety factor for the diode, but is not high enough to affect regulation.

"It is interesting to note that when  $R_3 = 0$ , the meter starts to indicate at the zener voltage. In this case, no backward movement occurs, since the voltages at points A and B rise at the same rate. The bottom of the scale is slightly non-linear, however, and, if  $R_3$  is set so that zero meter-indication occurs at 0.5V or more above the zener voltage, the entire scale will be almost perfectly linear.

"This means that calibration is simply a matter of checking zero and full-scale readings and interpolating the intermediate points on a linear basis.

"The prototype was calibrated against a VTVM of known accuracy and having a 7in scale. This allowed as much readout accuracy as is necessary for practical purposes.

"The meter movement can be any moving coil type from 50uA to several milliamps FSD, thus allowing the use of cheap but rugged surplus types.

"All components were mounted on a printed circuit board, which bolted on to the meter terminals, making a very compact assembly. However, wiring is not at all critical.

"For stability  $R_3$  and  $R_4$  should be replaced by fixed resistors. To obtain the correct values, start with standard values slightly higher than required and pad down with much higher values in parallel. In this way, good accuracy can be achieved using junk-box parts.

#### TRANSISTOR OSCILLATOR, FREQUENCY MULTIPLIER Cir. 66

The purpose of this section is to introduce the reader to an efficient single transistor oscillator, capable of frequency multiplication

Consider figures 1a and 1b. If  $L_1 C_1$  is tuned to the low frequency side of  $F_p$ , it can introduce sufficient capacitive reactance to make the resistive part of the resultant parallel impedance  $Z$ , as seen across the crystal terminals, negative.

Hence oscillation can occur at the parallel resonant frequency of the crystal  $F_p$ .

Figure 2 shows that a parallel resonant circuit  $L_2 C_2$ , tuned to some harmonic  $nF_p$  of the crystal frequency, has been inserted in series with the collector or  $TR_1$ . The circuit, as it stands, is not a practical proposition as a harmonic generator. It suffers both from poor harmonic efficiency and "leak through" of the fundamental.

The latter can be overcome by minimising the inductive reactance of  $L_2 C_2$  at  $F_p$ . This is best accomplished by tapping the collector of  $TR_1$  close to the cold end of  $L_2$ . However, harmonic amplification will be reduced if this tap is too "earthy".

As far as efficiency is concerned, the tuned circuit  $L_1 C_1$  shows considerable capacitive reactance at the harmonic frequency  $nF_p$ . Its resultant impedance is this reactance in parallel with the relatively high effective loss shunt resistance of  $L_1$ . This loss resistance introduces considerable emitter negative feedback at  $nF_p$ , reducing the gain of  $TR_1$  and severely limiting the available harmonic output.



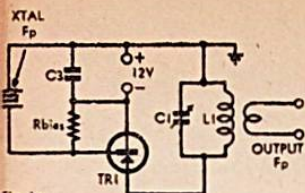

Fig. 1a

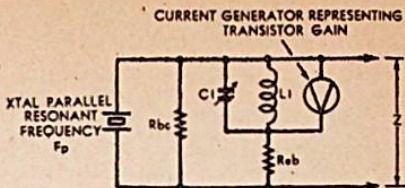
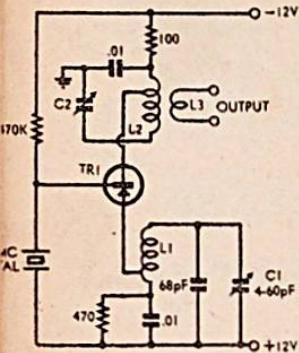

Fig. 1b

$R_{bc}$  = BASE-COLLECTOR RESISTANCE OF TR1  
 $R_{be}$  = EMITTER-BASE RESISTANCE OF TR1



TR1 = OC171, AF118, AF115N, AF114N, etc.

Fig. 3

Cir. 66

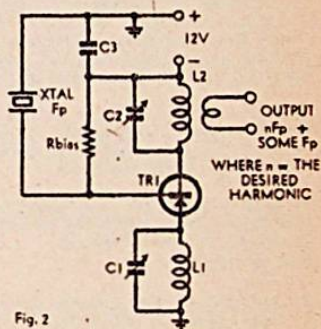
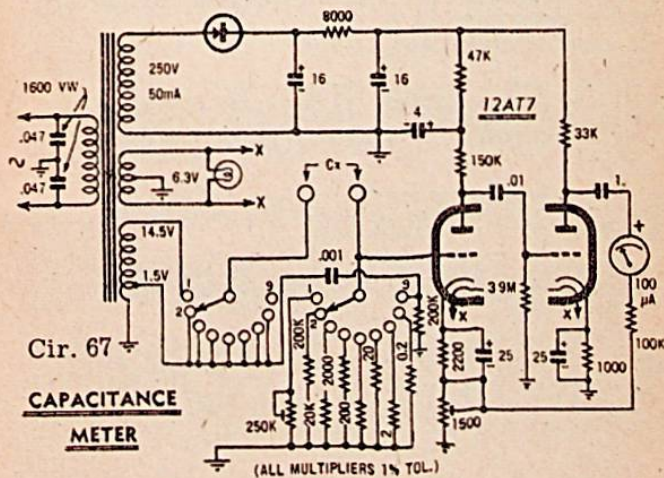

Fig. 2



**Cir. 67**  
**CAPACITANCE**  
**METER**



To correct this, a reasonably low L1/C1 ratio should be used and the emitter tapped towards the grounded end of L1. Again, this tap cannot be made too "earthy" as fundamental oscillation would cease.

A circuit, incorporating the ideas discussed, is shown in figure 3. The crystal oscillates in a common collector negative resistance configuration. Harmonic generation occurs by non-linear action in the base-emitter junction of TR1 and the common emitter amplified harmonic appears in the collector circuit, the 470 ohm emitter resistor limits the collector current of TR1. It is by-passed so as not to introduce unwanted degeneration.

This resistor must be sufficiently large to limit the collector current of the OC171 to 18 milliamps with C1 at maximum capacitance.

The adjustment procedure is as follows: With L1 C1 slightly on the low frequency side of resonance, C2 is peaked for maximum output of the desired harmonic. A sizeable dip in collector current will be noticed, indicating resonance. Then C1 is re-peaked for maximum output consistent with reliable oscillation.

An output of 80 milliwatts on 14MC and 30 to 40 milliwatts on 21 MC can be obtained, with careful adjustment, using a 7MC crystal. This is more than that required to drive another OC171 as a class C amplifier on these two bands.

No trouble should be experienced in picking off 5th, 6th or possibly even higher order harmonics of sufficient amplitude for mixer injection in crystal-locked converters.

Coil details:

All coils wound with B and S wire on  $\frac{3}{8}$ in diameter poly. formers. L1 35T, 24 gauge. Tap 4T from cold end.

L2 14MC 25T Tap 5T: 21MC 20T. Tap 4T from cold end. 22 gauge.

Link L3 3 to 6T wound over earthy end of L2. The exact number depending on the load impedance.

#### DIRECT READING CAPACITANCE METER. Cir. 67

"The following article describes a wide range, direct reading capacity meter. It measures static and electrolytic capacitors with an accuracy of 1% to 1.5%, if close tolerance resistors are used. The tolerance of the series resistors should be within 0.5% to 1%.

"The principle of this instrument is as follows: A standard voltage of 1.5 volts, 50 cycles is supplied to a series circuit of the unknown capacitor and fixed resistor.

"Because the supplied voltage and its frequency are known, the voltage across the resistor can be used to indicate the value of the unknown capacitor.

"In fact, the capacitance will be equal to the value of the resistor multiplied by the difference between the supply voltage (1.5 volts) and the resistor voltage, and divided by the resistor voltage times 314. The last term represents the reactance multiplying factor,  $2\pi f$ .

"Thus a meter measuring the resistor voltage may be calibrated directly in terms of capacitance. In this case, however, the voltage is too weak to work a meter movement. The heart of the instrument is thus an amplifier, which needs approx. 5mV. for the full output of 10 volts.

"The circuit is a simple audio amplifier employing a double triode as preamplifier and output stage. The amplification is variable by adjusting the cathode resistor in the first stage. The meter is connected to this cathode and the plate of the output stage through a 1uF paper capacitor.

"Two standard voltages are used, 1.5 volts for the 1,000pF to 1,000uF ranges and 13 volts plus the 1.5 volts in series for the 100pF range. The higher voltage for the 100pF range is necessary, because a relatively low variable resistor of 250K is used.

"By keeping the 1.5 volts for all ranges, a high value resistor must be employed for the 100pF range. This would increase the hum sensitivity badly, which would mean a loss of stability of the instrument.

"The range selector is a 9 position, 2 section ceramic switch. The last position, "Test", is for calibration of the 1,000pF to 1,000uF ranges.

"For the calibration two capacitors are necessary. A 1,000pF 1% Mica or a similar precision capacitor for the 1,000pF to 1,000uF ranges, and a 100pF 1% Mica or a similar precision capacitor for the 100pF range.

"Calibration procedure: 1,000pF to 1,000uF ranges. After the instrument has warmed up, set range selector to "Test" position. The terminals are now bridged by the inbuilt 1,000pF capacitor. Adjust the cathode resistor for full deflection of the meter.

"Calibration procedure: 100pF range. When the instrument has been calibrated as above, the 100pF range can be adjusted. Set range selector to the 100pF range. A 100pF 1% capacitor must be connected to the terminals. Adjust the 250K pot for full deflection.

"The mechanical set-up is an easy one. The chassis is made of 1/16th inch half-hard aluminium. The transformer, fuse and rectifier, a (Siemens selenium element), are on the right of the chassis; the valve, the 2 x 16uF electrolytic and the 4uF capacitor on the left.

In place of the selenium rectifier shown, a silicon diode may be used.

"The 1.5K potentiometer is on the rear right of the chassis, and the 250K unit in the centre. Two 0.047uF capacitors are used to balance the mains supply with respect to the chassis.

The meter is at the top of the front panel. The terminals are on the lower right and the on-off switch and the pilot light on the lower left.

"The 0.2 ohm resistor for the 1,000uF range can be made winding thin copper wire around a small ceramic former. The length



required is given by 0.2 times the wire cross-sectional area, divided by the material resistivity (for copper, this is 0.0178 ohm-cm)

"This instrument has been in use for a year and has not developed any faults. Calibration is required about every six months, depending on the time the meter has been in use. For static measurements on electrolytics, no D.C. is necessary. However, ordinary static condensers should be checked for insulation before being connected to the instrument.

"The meter is a DC movement with an inbuilt full-wave rectifier. The scale is marked "10V. 10,000 ohms/volt," the scale law showing the normal order of non-linearity one would expect of such a scale adjacent to the zero position.

"The voltage calibrations can be read directly in terms of capacitance, provided the full-scale deflection is properly set.

"For those who may wish to compare operation of an instrument against the prototype, the following voltages apply:

Output Stage:	Amplifier Stage
Pin 1 Plate 230V	Pin 6 Plate 130 V.
Pin 2 Grid 0V	Pin 7 Grid 0V.
Pin 3 Cathode 3.3V.	Pin 8 Cathode 2.3V.
	Pin 9 AC Htr. 6.3V.
	Pin 4, 5 AC Htr. 0V.

"The DC readings above were taken with a VT voltmeter and would be lower if read on a meter having lower internal resistance.

#### MULTIMETER Cir. 68

This simple multimeter for measuring voltage and resistance is a good project for younger readers. It can be built into a small wooden or plastic box with a hinged metal cover as shown in the drawing. Any 50 microamp meter movement with 2K internal resistance can be used, but it is helpful if the scale is already marked from 0 to 10. Any arrangement of batteries adding to 13.5V may be used for the 13.5V supply.

(If the 2M and 20M resistors are hard to find, two 1M, 1W resistors could be substituted for the 2M, 3W value, and two 10M, 2W resistors could be substituted for the 20M, 5W value. Unless high accuracy is desired, we would recommend good quality 5% tolerance resistors. They are more economical and easier to obtain than more accurate ones and are usually much closer than  $\pm 5\%$  of the nominal value.

#### 3 TRANSISTOR MILLIVOLTMETER Cir. 69

The following article describing a transistorised volt-ohm meter which has been constructed around a movement taken from an old multimeter. The voltmeter ranges have a sensitivity of 230K per volt.

"The diagram shows the circuit of the unit.

"The input transistor is direct coupled to the base of one of the output transistors. Sufficient negative bias is applied to the first to keep the output one in a nearly cut-off condition. The second output one is balanced to the same collector current by the balancing pot, so the meter reads zero.

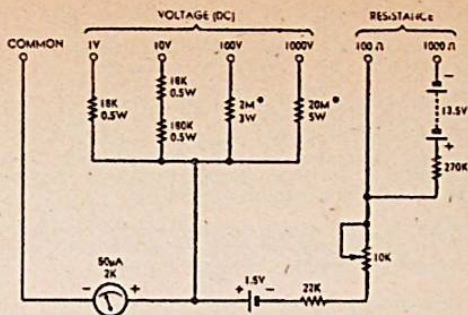

\* SEE TEXT

Cir. 68

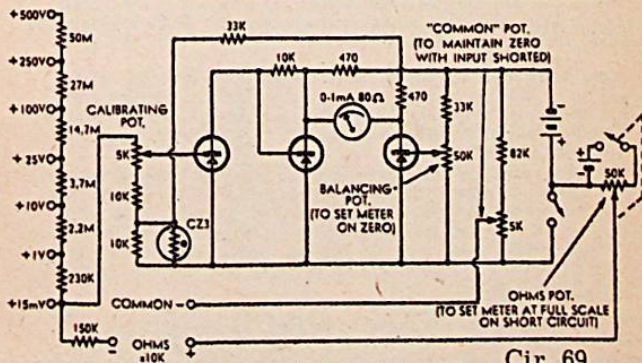
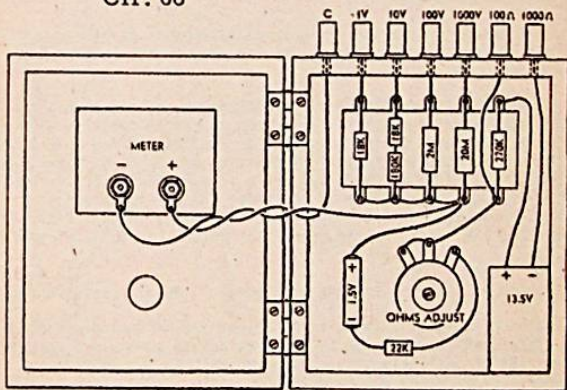

**TRANSISTORISED VOLT-OHM METER**

Cir. 69



"Any positive voltage applied to the input transistor unbiases it by that amount, causing its resistance to increase and so allow more negative to reach the base of the output one to increase its current so that the unbalance gives a reading on the meter.

"The negative on the base of the first transistor is of the order of 0.1 volt. This necessitates a current flow of a few microamps in the base circuit. The bias is derived from the potential divider consisting of a 33K res. to negative line and a CZ3 thermistor, by-passed with 10K, to positive. The actual connection to base is through a 10K resistor and portion of the calibrating pot.

"At first sight, it might appear that the 'common' terminal for the external circuit would be connected to this junction of the potential divider, but that is a trap for the unwary.

"The few microamps which maintain bias on the transistor, cause a small volt drop across the resistance in the base circuit, so that a "common" terminal, connected as above, would not be at zero potential with ref. to the base.

"For that reason a separate divider, consisting of an 82K to neg. and a 5K pot to positive is provided for the common, the pot enabling adjustment to the correct point.

"If you think this trouble could be overcome by having no bias on the transistor, connecting the common direct to positive line, and the emitter, instead of the collector to the base of the output one, and then using negative instead of positive measuring voltages; you would be correct - you could. But there is a catch to it: you would need a very non-linear scale on the meter for one thing and, for another, an applied voltage would have to reach a value sufficient to overcome the 'hill' of the transistor before you got any reading at all.

"A separate battery is used for Ohms so as to obtain positive for this.

"The method of operation is to first adjust the balancing pot to give zero. Then short circuit the 15 mV. terminal to common and adjust 'common pot' to maintain zero. Apply one volt to the 1V terminal and adjust calibrating pot to give full scale. Alternatively, short-circuit the Ohms terminals and adjust the Ohms pot to full scale, then apply a 150K resistance of known accuracy to the Ohms terminals and adjust the cal. pot to read midscale.

"Transistors used: Three 2N 220. Battery: Three type 935 cells. Full scale reading on lowest range: 15 millivolts. Current drain at full scale: approximately 4 microamps. Linearity: Poor at extreme low end of scale but quite good for the rest - from 7.5 per cent up to 100 per cent of scale.

"The meter used for this instrument was a 0-1 MA type, of 80 ohms, with scales graduated for full scale readings of 10, 50, 250 and 1,000 volts and an Ohms scale from zero at the full scale end down to 500 near the low end and with 15 in the centre. Thus it was good for direct reading of all the new ranges except the 15 millivolt one, for which it is necessary to multiply the '10' reading by  $1\frac{1}{2}$  and call it millivolts.

The arrangement was not without problems. It was realised right off that variations with temperature would affect the accuracy of the instrument. For this reason, the first model was made up using silicon transistors.

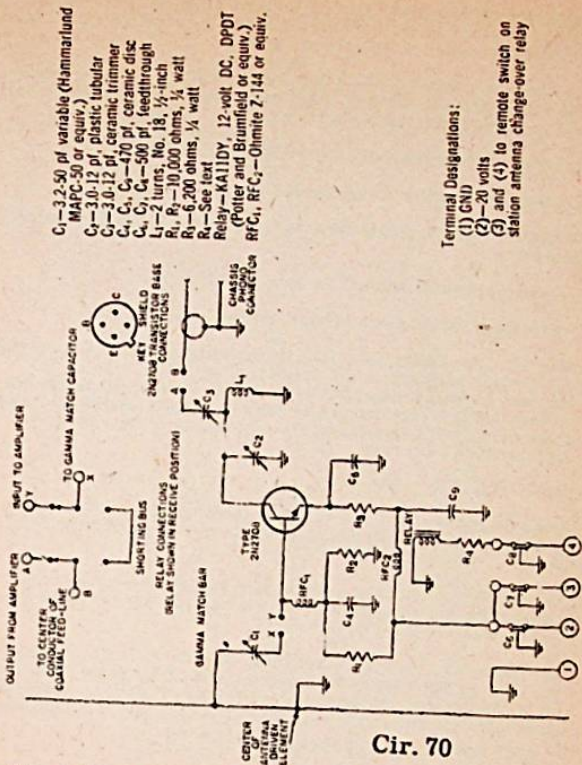

- $C_1$ —3-2-50 pf variable (Hammarlund  
 MAC-50 or equiv.)  
 $C_2$ —3.0-12 pf, plastic tubular  
 $C_3$ —3.0-12 pf, ceramic trimmer  
 $C_4$ — $C_5$ —470 pf, ceramic disc  
 $C_6$ — $C_7$ —500 pf, feedthrough  
 $L_1$ —2 turns, No. 18, 1/2-inch  
 $R_1$ ,  $R_2$ —10,000 ohms, 1/4 watt  
 $R_3$ —6,200 ohms, 1/4 watt  
 $R_4$ —See text  
 Relay—KAL1DY, 12-volt DC, DPDT  
 (Potter and Brumfield or equiv.)  
 RFC<sub>1</sub>, RFC<sub>2</sub>—Ohmite Z-144 or equiv.

- Terminal Designations:**  
 (1) GND  
 (2)—20 volts  
 (3) and (1) to remote switch on  
 station antenna change-over relay

Schematic diagram and parts list of K3QAX/W2QEX's antenna-matching preamplifier.

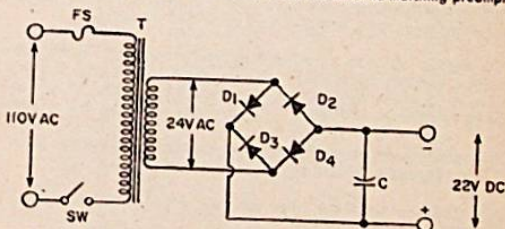

- $F_1$ —Fuse, 1 ampere, 110 volts  
 $SW$ —Switch, AC toggle-type  
 $T$ —110-volt primary, 24-volt secondary,  
 or two transformers with 110-volt  
 primaries in parallel and 12-volt  
 secondaries in series

- $D_1$ ,  $D_2$ ,  $D_3$ ,  $D_4$ —RCA 1N3754 tubular,  
 single-ended type, silicon diffused-  
 junction rectifiers  
 $C$ —10  $\mu$ f



"Although this was fairly good, it still required temperature compensation and the desired degree of sensitivity combined with linearity of readings could not be obtained easily.

"The common germanium transistors used finally gave much better results in conjunction with a CZ3 thermistor controlling the input one and with potentiometer adjustments.

#### A 144-Mc ANTENNA - MATCHING PREAMPLIFIER Cir. 70

Looking for a reliable, economical way to:

- Amplify signals before they are lost in the noise of your antenna system?
- Overcome losses inherent in long feed lines?
- Provide a better match between antenna and feed line?

Here is a new device for radio amateurs which integrates an antenna-matching circuit with a VHF transistor amplifier. The device combines an antenna-matching arrangement, a relay to switch the antenna between receiver and transmitter, and a 2N2708 VHF preamplifier stage. Simplicity in construction and operation insures easy duplication of the unit.

#### AUDIO OSCILLATOR Cir. 71

Those of you who are interested in learning Morse code may be interested in building a simple low-frequency oscillator from scrap parts.

The oscillator can be used as a tone generator as shown, or, if you replace the power switch with a code key the device can be used as a code practice oscillator.

Any audio transistor such as OC44N, OC70 or OC71 can be used, or if you have an NPN type on hand such as a BC108 or BC109, you can use it if you reverse the battery connections. Almost any centre-tapped output transformer and low impedance loudspeaker will probably work.

#### A POWER SUPPLY UNIT FOR TRANSISTORS Cir. 72

For transistorised equipment, a great deal of attention has been focused on suitable low voltage power supply units, in many cases featuring variable voltage and overload protection.

This design is for a transistor power supply. There are many such designs around, but none of them seemed to satisfy all needs, namely: (1) Inexpensive overload protection. (2) output to 25 volts at 1A, easily modified to higher ratings when needed, and (3) moderate cost.

"This power supply meets the requirements very well and is satisfying to use, because of the facilities it offers.

"Basic to the supply is the voltage regulating action; this is standard.

"The difference is that this regulator has two voltage reference sources to obtain the widest range possible of output voltage.

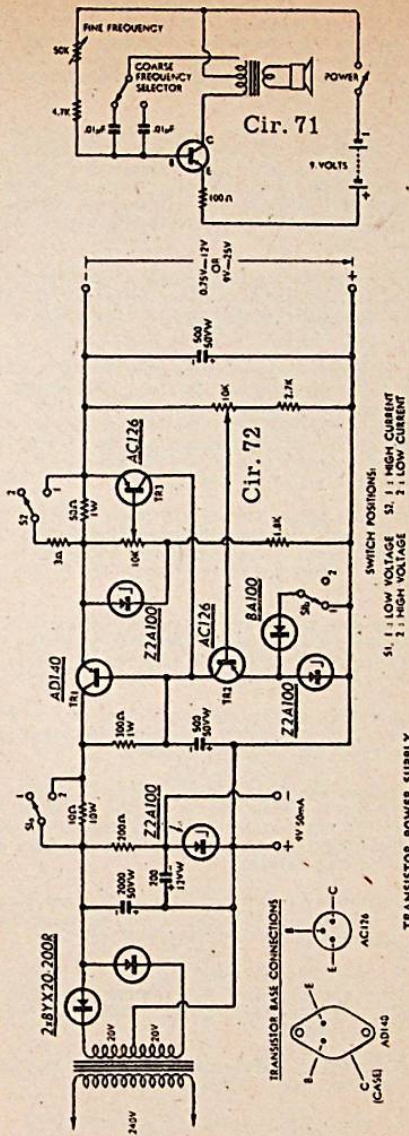



"In the unit constructed, the 9V zener gave a range of 9-25V and, by the nature of the section, this voltage could not be reduced. As lower voltages than 9V are often needed, a forward biased silicon diode was added to make a new range of .75V-12V, providing quite a low minimum voltage, with a reasonable overlap of voltage at high end.

"When low voltage is selected, and high current drawn, the transistor could have almost the full voltage across it, and thus would dissipate a large amount of power, requiring a big heatsink. To avoid this situation, a 10 ohm resistor has been incorporated so that when the unit is delivering low voltage, the resistor is in series with the supply, thus reducing dissipation within the power transistor.

"The variable current cutoff circuit is interesting, for it provides reliable cutoff over a wide range, without the need for an additional high-power transistor, which would unduly raise the unit's cost.

"This is achieved in the following manner: TR3 is reverse-biased by a voltage picked off from the 10K spot. This voltage is counteracted by the voltage across the 50 ohm or 3 ohm resistor, caused by current through the load. When the load current is such that the offset voltage is a little greater than the reverse voltage on the pot, TR3 draws current through the 300 ohm resistor, thus decreasing the bias on TR1, and so decreasing the voltage at the load.

"The zener diode across the 10K pot is for calibration purposes; above 9V, the zener keeps a constant voltage across the pot, thus enabling calibration of cut-off current points on the front panel. However, this feature may not be wanted, and in that case, simply omit the zener.

"It is quite easy to operate the control without the zener. When the load is inserted the pot can be turned to just give the maximum voltage indicated by the voltage selector pot. Then, if any more current is drawn by the load, the voltage will immediately diminish.

"The supplementary power supply consisting of a 9V zener, resistor, and capacitor, is very useful when two different voltages are needed for equipments operating simultaneously.

"The resistor values given are for a 25V, 1A supply. If it is required to extend the current to 2A, the following changes should be made: the 300 ohm resistor should be changed to 150 ohms; another cutoff-circuit resistor, 1.5 ohms, should be added, and the 10 ohm resistor should be halved.

"Also - and this is a very important point - the heat sink for the transistor should be made large, as the increased dissipation could overheat and ruin it.

"The unit constructed was tried out on a 40V input, and it performed quite well in giving 1A, but as a new and much higher-powered transistor would have to be used to supply 40V at 2A, I did not try out the higher current.

"If it is desired to operate the unit at 40V, the 300 ohm, and the 200 ohm resistors should both be doubled.

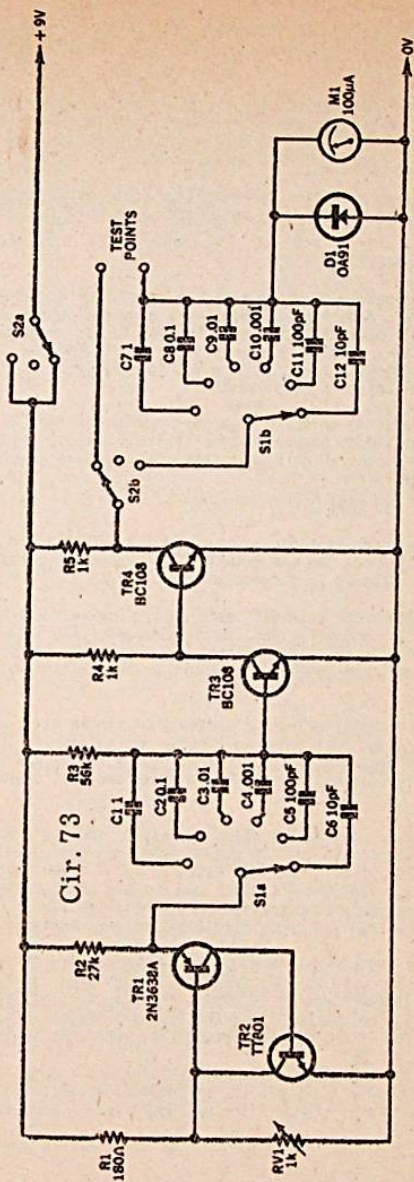



"For operation at 25V 1A, the power transistor was mounted on a 6in x 6in piece of aluminium, with no mica, and with silicone grease.

"The complete unit, except for the high power components, was mounted on a piece of sample "Veroboard," making a very compact unit feasible. The cutoff-circuit resistor was made from a piece of toaster wire, but a suitable resistor could be bought.

We have made no provision for metering, as it is up to the individual to decide whether to use his multimeter or a fully switched metering system

#### CAPACITANCE METER Cir. 73

This little instrument gives a direct readout of any value from a few pF to  $\mu$ F, enabling the value of a capacitor to be determined by the simple operation of a switch. The circuit consists of a ramp generator, squarer, differentiator and integrator. TR1 and TR2 perform the function of a PUT in a relaxation oscillator, the frequency of which is made variable.

It is important to select a high gain transistor for TR1 and one of low gain for TR2 to ensure that oscillation readily occurs. The alternative is to reduce R1 but this will increase an already heavy current drain.

#### LOW NOISE PREAMPLIFIER Cir. 74

The need has been felt for a long time for a really low noise, high gain RIAA preamplifier. One was eventually designed using the latest technology and the circuit is reproduced here.

Several experimental circuits were evolved using the 709C alone, but these were far too noisy for the requirements. The data books were searched for low noise transistors and the 2N3117 was selected as the best. However, the 2N4250 with its ready availability was a more logical choice.

Circuits were built using the 2N4250 in a single stage straight amplifier and it was found that the lowest noise was obtained at low collector current. An operating point of  $I_c = 10\mu A$ ,  $V_{CE} = 5V$  was finally chosen as a reasonable compromise between low noise and good overload characteristics.

The combination of the low noise transistor and the uA709C1C to provide large open loop gain and low output impedance seemed very attractive. The resultant circuit consists essentially of a two stage amplifier, with feedback from the output to the emitter of T1 determining both the gain and frequency compensation characteristics. The network R5, R6, C4, C5 gives the required three time constant characteristic.

The gain of the circuit is given by  $1 + Z_f/R_3$ , where  $Z_f$  is the feedback impedance. The gain at 1KHz is about 300, raising the 3.5mV output of a Shure V15 II cartridge to 1V RMS at the output. Since the gain at 20KHz is about 30, the factor "1" in the last expression introduces a maximum error of 3pc at high frequencies, which is insignificant.

In the actual amplifier, using close tolerance components, the measured response is within 1dB of the RIAA curve from 20Hz to 20KHz, and the individual channels are balanced within 0.1dB over the same range.

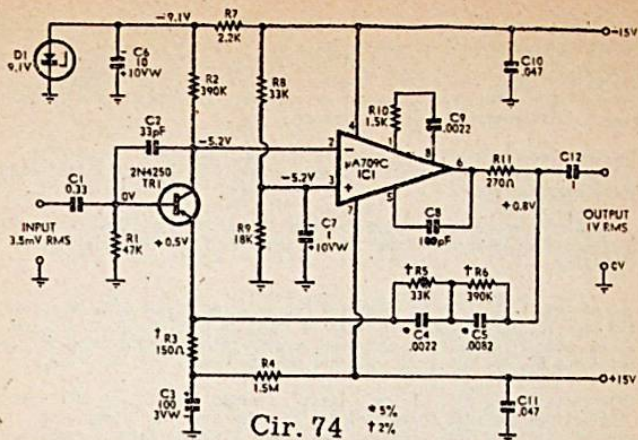

Cir. 74

The preamplifier is a combination of a low noise type transistor and an IC. It has a mid frequency gain of approximately 300 and negligible hum and noise.

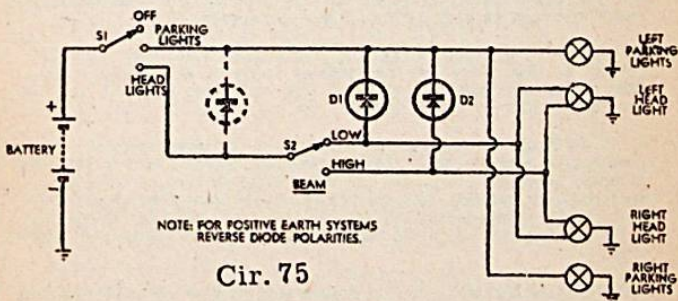

Cir. 75

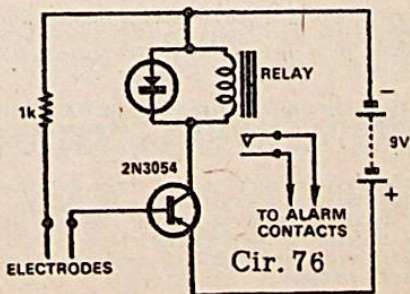

Cir. 76



The method of biasing the first stage is rather interesting, the emitter being returned DC wise to the positive rail. This gives almost zero voltage across R1 (with a typical beta of 300, current is approximately 10/300 or 1/30uA) and reduces the inherent noise to the theoretical Johnson noise. This was borne out in practice since metal film resistors made no difference to the noise figure.

The open loop gain of T1 is about 80 with no load, thus the overall noise figure will be determined almost entirely by T1 itself (and associated components).

It should be noted that, while the gain is 300 at 1KHz, the DC gain is determined by  $R5+R6/R3+R4$  and this is about 0.25, giving excellent DC stability.

The collector of T1 is at -5.2V and the bypassed divider R8, R9 applies the same voltage at the non-inverting input of the 709 for DC balance. R2 is returned to -9.1V to provide a symmetrical collector swing of plus and minus 5V. The quiescent voltages for the circuit are as shown.

Components C2, C9-R10, C8 are necessary to stabilise the circuit against oscillations and some adjustment may be necessary. For higher gain versions (ie., R3 less than 150 ohms) less stabilisation is needed and the capacitors can be reduced in value. (I have had a version working with a gain of 500 at 1KHz.) Capacitors C10 and C11 are HF supply bypasses and also assist in stabilisation of the 709.

The time constants of C1-R1, C3-R3, C12-Rload (20K) provide 18dB/octave rumble attenuation with a 10Hz turnover frequency.

The 709 works at a gain of 2000 at 1KHz and the total open loop gain is 160,000 at 1KHz. Therefore the feedback factor is  $160,000/300 = 500$  at 1KHz and an open loop distortion of 10pc would give a closed loop distortion of .02pc (0.2pc at 20KHz).

It is difficult to make meaningful signal-to-noise measurements for comparative purposes. When the amplifier was mounted in cast metal box directly under the pickup arm the total wideband hum and noise was measured at 0.1mV RMS. This corresponds to an unweighted signal-to-noise ratio of over 60dB with respect to 3.5mV input, and it must be borne in mind that weighting factors would probably add another 10dB to this.

Suffice it to say that, at full volume setting on a 36W amplifier, one has to hold one's head very close to the speaker to hear the noise, and the hum is virtually inaudible.

The use of an IC results in another advantage: very good overload capability. Twenty volts peak-to-peak signal is available at low frequencies, falling to 5V peak-to-peak at 20KHz (corresponding to 170mV peak-to-peak input at 20KHz).

All in all the circuit performs very well and has better parameters (noise distortion, etc.) than any other I have constructed, or any commercial amplifier I have heard - and that includes the best.

(Editorial note: With a voltage gain of around 300 and an estimated maximum output signal swing of around 15 volts peak-to-peak, the maximum output signal will be of the order of 17mV RMS (all at 1KHz). This will be adequate for low output cartridges such as the Shure V15. However, higher output cartridges could overload the preamplifier on heavily recorded passages.

If this is a problem, the overall gain should be reduced by increasing the 150ohm resistor in the emitter circuit of T1. This will have the attendant effect of lowering the "turnover" frequency of 10Hz and to maintain the original rumble cut-off of the 100uF electrolytic capacitor should be reduced.

#### ROAD SAFETY ROLE FOR THE DIODE Cir. 75.

From time to time, a motor vehicle headlamp filament fails and this can be a serious safety hazard. A worthwhile feature incorporated in some new vehicles to reduce this problem, is to have the parking lamps burning when the headlamps are switched on. This feature may be added to existing vehicles by the simple addition of one, or two, low voltage silicon diodes as shown in the diagram.

When the switch S1 is in the "headlights" position, D1 or D2 allows current to pass through the parking lamps for either the low beam or high beam positions of the dip switch S2. With S1 in the "arcing" position the diodes block the flow of current to the headlamps. It will be noted that when the headlamps are switched on the parking lamps receive a reduced supply voltage, due to the forward voltage drop of conducting diode. This will be about 0.7 volt. If good access is available at the rear of the lighting switch, then only a single diode (shown dotted) is required. In some vehicles however, it may be more convenient to mount the diodes on a terminal block installed inside the engine compartment.

The current rating of the diodes is determined by the combined wattage rating of the two front parking lamps. A typical value is six watts each for 12 volt systems, so that the popular 1 amp diodes BY126 etc, may be used. Alternatively, the 3 amp series or the higher current stud-mounting types may be required.

#### FLOOD WARNING ALARM Cir. 76

Here is a simple circuit for a flood warning alarm; the alarm sounds when the water reaches a predetermined height.

When the water reaches the electrodes it forms a conducting path between them which allows forward bias (negative in this case) to reach the base of the transistor.

This switches the transistor into a conducting condition and operates the relay. The relay can be used to operate a warning buzzer or a mechanism to stop the water level rising. When the water level drops below the electrodes the relay drops out.

The type of transistor used depends on the current required to operate the relay. I found that a 2N3054 power transistor was suitable for most relays, but most transistors will suit, provided the relay current does not exceed their maximum ratings.

Although the transistor shown is a PNP type, an NPN type could be used just as easily by reversing the battery and diode polarity. The system would not work with pure water, but this is not likely to a problem in practice.



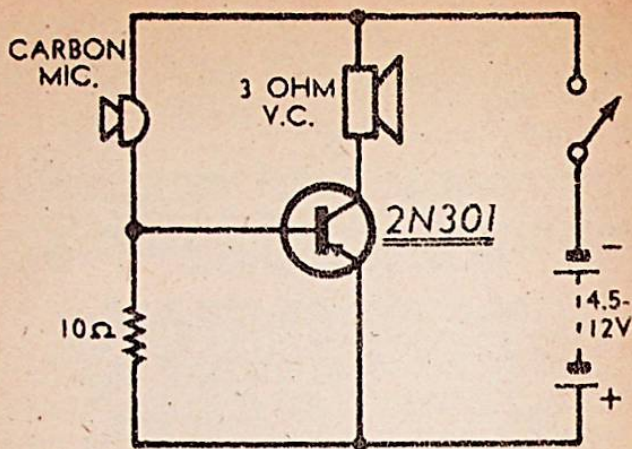

*Above, the circuit of the one-transistor P.A. and, below a method of construction.*

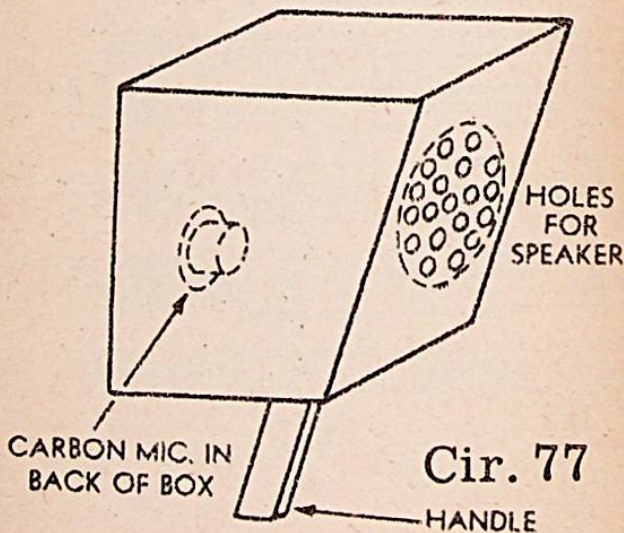

## ONE TRANSISTOR PA SYSTEM Cir. 77

The circuit is that of a loud hailer amplifier. It uses one transistor (power transistor 2N301 or equivalent) and a few very minor parts.

"A carbon microphone is used and, because of this, it should be noted that the amplifier is built for reinforcement rather than quality reproduction of the sound.

"Parts placement is not critical, but the power transistor should be mounted, along with the 10-ohm,  $\frac{1}{2}$ -watt resistor, on a heat sink. The battery I used was a cycle lamp (4.5V) and it worked quite well, though better results can be obtained from higher voltage batteries, within the ratings of the transistor.

"The whole assembly can be mounted in a suitable wooden or metal box, and a handle under the box is well worth fitting. The box I built is as shown.

"At the top of the handle I mounted a trigger switch. This was one that I salvaged from an old wooden wall mounting telephone. When the receiver was hung up, on this model, the circuit was switched off but if the switch contacts are reversed, and the two prongs that hold the receiver removed with a hacksaw, then the switch is quite useful.

"Output from the model I built, using a 5inch 3-ohm loudspeaker, was slightly under 250mW but, as mentioned earlier, better results are obtained from higher voltages.

## A MODEL TRAIN "CHUFFER" Cir. 78

This novel sound effect simulator will add realism to model railway setups, by simulating the familiar steam train "chuff chuff" sound. The chuff rate is variable via an external control, allowing the user to synchronise the sound to the speed of the model.

Our chuffer was developed as follow up to the Steam Whistle. We were not aware of any similar type of sound effects simulator, thus it was necessary to develop this unit from scratch.

Most readers will be familiar with the sounds a steam loco makes as it stands in a station. These vary, but in many cases there is a low level hiss of steam punctuated by chuffs from the Westinghouse braking system. Our chuffer can simulate this type of sound when the chuff rate control is set at minimum.

As the loco moves out of the station, the low level hiss disappears and the chuffs (now from the exhaust valves) become more frequent. At this time the duration of each chuff is short compared to the time between chuffs.

Eventually the loco reaches a constant speed and, in most cases, the chuff duration now appears to equal the time between chuffs. When the driver decides to slow down he reduces or shuts off steam to the cylinders. Thus the chuff sound may cease completely, or continue at a lower level and a decreasing rate. Appropriate manipulation can produce these effects.



The steam component for our chuffer is derived from the white noise output on the Steam Whistle. If the reader has not built this unit the noise generator and amplifier section from it could be wired on a separate tag board by following the instructions in the appropriate section.

on page 86 of our book entitled "Handbook of Practical Electronic Musical Novelties" No: 200 in the original edition or Tandy edition No: 62-9015.

The chuffer circuit consists of a diode gate and a modified sinewave multivibrator. The diode is merely a reverse biased diode which is biased on by one half cycle of the oscillator output. The output from a multivibrator can be made roughly sinusoidal by introducing certain amounts of positive and negative feedback. Our oscillator is designed so that the output waveshape changes with frequency.

At minimum chuff rate there is a short positive pulse, after which the output goes negative and then decays exponentially to zero, where it remains for several seconds. During this off time the diode gate is reverse biased, and only the most positive peaks of the white noise pass through it. This results in a faint background hiss between chuffs which, while somewhat accidental, is not out of keeping with the sound normally encountered in the vicinity of a loco.

When the positive pulse recurs, the diode is forward biased to allow the maximum noise through. At minimum chuff rate our unit gave one chuff approximately every 2.5 seconds, or 24 chuffs per minute.

As the chuff rate is increased, the positive excursion of the oscillator output, becomes roughly sinusoidal, while the duration of the negative excursion decreases until at maximum chuff rate, the positive and negative excursions are approximately equal. The maximum chuff rate from our unit was approximately 12 per second.

The oscillator frequency is varied by shunting a .047uF feedback capacitor with a 47uF in series with a 5M pot. (Base circuit of TR1.) Minimum resistance gives minimum frequency.

The pot marked "Chuff Width" allows variation of the diode reverse bias, thus the diode can be made to conduct for the full duration of the positive excursion of the oscillator output, or for any portion of it. Maximum bias cuts the diode off completely.

#### TURN ON (ALMOST ANYTHING) WITH A SENSOR SWITCH Cir. 79

Have you something that requires switching on when it reaches a certain temperature? Or off? How about when the light level falls or rises - to a certain level? Or when it gets wet? Or dry? Then this project may solve your problem.





This device is what we call a "sensor switch"; a switch which actuates when any resistive sensor falls or rises beyond a certain pre-set value. A relay pulls in, giving the user the choice of either turning something on or off, by choosing either the normally closed contacts.

The circuit is basically a level-detecting switch based on a common integrated circuit, the uA741. The 741 is actually an operational amplifier.

One input of the operational amplifier (op amp) is connected to a voltage divider across the supply voltage. As the op amp has a high input impedance the voltage divider resistors can also have a high value. We used two 10k resistors, which cause a drain of less than 0.5mA.

The other input of the operational amplifier is connected to a second voltage divider, again connected across the supply voltage. This divider consists of a variable resistor and our sensing component. A protective resistor (1k) is included in each leg to limit current in the event of either leg falling to a very low value of resistance.

If you look closely at the circuitry we have just been talking about, you should recognise a bridge. The two divider resistors, the variable resistor and the sensing resistance make up the four legs of a bridge.

The op amp is connected across the bridge in the same position as that occupied by the indicating meter in the more conventional bridge configuration (Points A and B).

In accordance with normal bridge behaviour, there will be no voltage between these two points when the bridge is balanced, ie, when the resistance of the variable resistor and resistance of the sensing device are equal. Under these conditions there would be no output from the op amp apart from leakage current.

When the bridge is unbalanced a voltage will appear between these two points. Its value and polarity will indicate, respectively, the amount of unbalance and the direction of unbalance.

For example: If, in the circuit shown, the resistance of the sensing element should increase, the voltage at B will swing negative with respect to A. This will have no effect on the op amp, the output of which will remain virtually zero.

Conversely, assume that the sensing element resistance decreases. The voltage at B will now swing positive with respect to A and the output from the op amp will increase.

This output can drive a transistor, which in turn operates a relay, which switches on or off whatever device is to be controlled.

We apply AC negative feedback around the op amp, by means of a capacitor connected between the output and the inverting (-) input. This is to prevent the circuit oscillating when the input circuit is close to the threshold voltage, ie, when the bridge is at, or close to, balance.

This form of feedback is preferable to a combination of AC and DC feedback, such as would be provided by a resistor. Either feed-

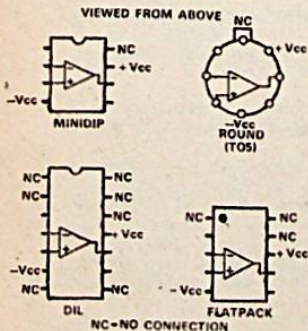
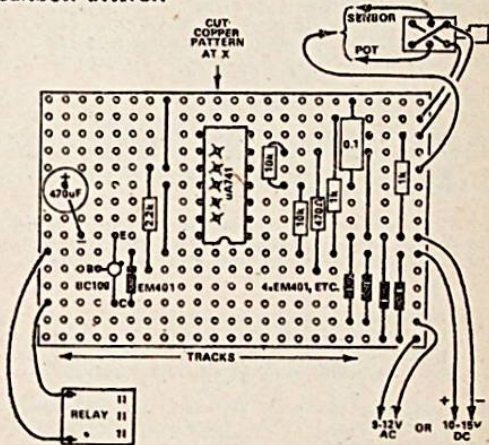
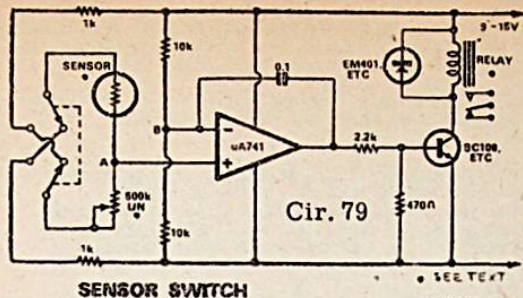

*These three diagrams are all that should be needed to construct the Sensor Switch. Note the orientation of tracks on the Veroboard, and the 5 cuts to be made. Also note that unmarked pins on the base diagrams are internally connected, and should not be connected to other parts of the circuit.*



back system will reduce the gain of the amplifier but an AC feedback circuit can be designed to function only at the higher frequencies, whereas the DC network will function at all frequencies.

While on the subject of gain, a typical figure for the 741 is around 200,000 times - while the worst case figure is still more than 20,000 times.

Since the natural tendency is for oscillation to occur at the higher frequencies, the AC feedback circuit can be made to reduce gain at these frequencies, without affecting gain at the lower frequencies where a circuit of this kind will normally be required to operate. The feedback is thus made selective - it functions only where it is required.

Now let us reconsider the input circuit - the bridge. As it stands, the circuit can be used to sense any change which causes a device to change resistance. A common device would be a light dependent resistor (LDR) which can be used to sense a change of light level.

An alternative is the phototransistor, these having the advantage of a much faster "rise time". In other words, the phototransistor changes value virtually instantaneously as the light level changes; an LDR may take tenths of a second to do the same (or even seconds at low light levels). While not important in some applications it can be important in others.

Another simple device which can be used directly with the circuit is a thermistor; a resistor which changes its resistance as its temperature changes. There are many types of thermistors, suitable for a variety of roles.

Some thermistors have negative temperature coefficients (resistance falls as temperature rises) and others positive temperature coefficients (resistance rises as temperature rises). NTC thermistors are the most common, and would be the better choice.

Ask your parts supplier for an NTC thermistor, which has a 20 degree C resistance of around 50-100k. There are many thermistors which fall into this category.

Another "sensor" is a piece of "Veroboard" with alternate tracks connected together. This can act as a rain alarm - or, by careful setting of the potentiometer, as a "dry" alarm as the Veroboard dries off.

Other applications for similar types of moisture detectors (such as a garden moisture indicator) may suggest themselves to readers.

The potentiometer used as the balance control in the bridge is not critical, but there is one proviso. As it must be able to balance the bridge, and the ratio resistors are equal in value, the pot must have a maximum resistance equal to, or greater than, the maximum working resistance of the sensor. We have specified a 500k linear in the parts list, but if phototransistors are used, this should be increased to, say, 2M  $\Omega$ . Linear types give easiest control.

A power supply is shown, but this need not be used. The circuit works quite happily from a 12V battery. The supply as shown gives approximately 14V DC out.

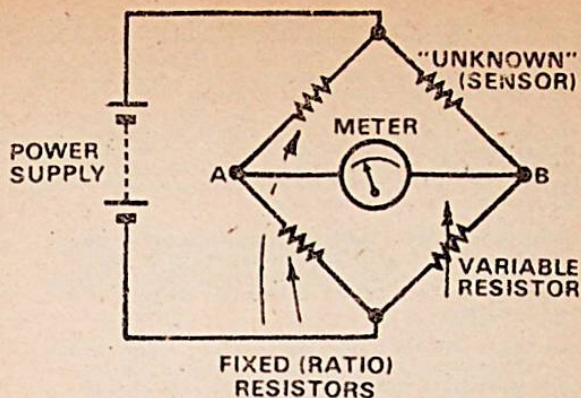

*The bridge circuit, on which the sensor switch is based. The meter corresponds to the op amp.*

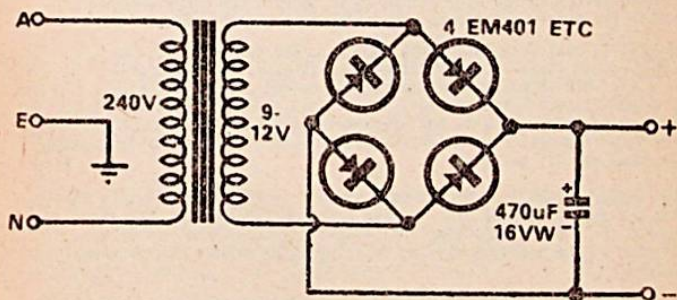

Bridge power supply

Cir. 79 continued



In some circumstances it may be desirable to have the relay remain pulled in after it has been activated - for example, when it forms part of a burglar alarm circuit. There is not much point in having an intruder pass through a light beam, and trigger a relay, if the alarm bell rings for only a fraction of a second.

There are two easy ways to overcome this difficulty. One is to use a pair of contacts on the relay as a latch - as soon as they close, they bypass the transistor and hold the coil energised. There may be objections to this - the most obvious being that the relay may have only one set of contacts.

The alternative is to use a small SCR (silicon controlled rectifier) in place of the transistor. This latches on by itself, freeing relay contacts for other uses. Low power SCRs (2SF106 etc) are now commonly available for little more than the price of an equivalent transistor.

Most types should directly replace the transistor - gate for base, anode for collector and cathode for emitter. However, in the event of low gate sensitivity, one resistor may need to be changed.

Increasing the value of the 470 ohm resistor will provide more drive, thus catering for lower sensitivities.

Once such a system is latched up, by whichever means, it will remain latched until it is deliberately unlatched; usually by turning the whole system off. This may be done manually or, with some added complication, by means of a time delay circuit.

If space permits, we plan to show a couple more "sensors" for the switch, which will enable it to be used for other phenomena, plus a few other circuits showing a 741 in different modes.

The 741 is available in several packages. The one we used is a standard DIP (dual inline plastic) with 14 pins. Also available is a mini-DIP (8 pins) a 14 pin ceramic or metal cased DIL, a 10 pin flatpack, and an 8 pin TO5 (round) package. There is nothing to stop you using any of these packages - internal connections are shown for all. The basic arrangement of the connections is roughly the same for all packages.

The sensor switch is laid out on 0.1in matrix Veroboard. This is ideal for the job, as the DIP IC pins are spaced 0.1in apart. A certain amount of "knife and forking" is necessary if the relay is to be mounted on the board, including drilling larger holes between normal holes.

In fact, some types of relay are not suitable for mounting on the board at all. In this case, leads can be run from the relay coil to the respective positions on the board. There are a number of different types of relay, with varying contact ratings. We imagine that readers will use the one most suitable for their application. Make sure, however, that the relay will pull in with a voltage less than 10.

One type of relay which we have used is the Siemens V23016-A005-A101. This has a slot arrangement for mounting, intended to go over the head of a screw, and has contacts rated at 240V, 7A. Its one disadvantage is that it has only one set of changeover contacts. A number of other relays, by Siemens and others, also have contacts with fairly heavy current ratings.

Solder all components to the Veroboard except the IC, which should be left until last. An IC socket is recommended, especially if you plan to use the 741 for any other purpose. ICs are particularly difficult to remove once they have been soldered in place. Apart from mechanical damage, there is a risk of heat damage.

Extreme care must be taken when soldering to 0.1in Veroboard, especially around the IC pins, as it is very easy to flow solder between the tracks. At best, this will stop the circuit working properly; at worst, it could be disastrous for the IC and other components.

There are five cuts to be made in the copper pattern between the pins of the IC. These are easiest made with a twist drill - about 3/16in or so. The copper should come away cleanly. Make sure that there are no copper bridges around the hole, or between tracks.

This bridge power supply is quite suitable for the sensor switch. Output voltage depends mainly on transformer secondary voltage.

Mounting arrangements for the board, relay switch and sensor are left to the reader. Some may wish to mount them inside a box for safety - this is recommended if a mains supply is to be used. Also on the safety angle, the relay terminals should be shrouded properly if mains voltages are being switched.

It is preferable to have the relay coil deenergised for the greater part of the time the circuit is in operation. This is especially important if batteries are to be used, as a relay coil has quite a heavy drain. If, for example, the circuit is being used as a light beam alarm, the relay should only be energised when the beam is cut. Therefore, most of the time (presuming there aren't too many intruders!) the photocell is illuminated, holding the op amp output at minimum.

In the event that opposite circuit operation is required (for example, a daybreak monitor or a safe alarm where the normal state is dark and light triggers the circuit) we have provided a changeover switch so that, once again, the relay coil is energised for the least possible time. In this case, a dark photocell holds the output down and an illuminated one allows it to go high.

We used a McMurdo push-button switch for the changeover function, but any 2 pole changeover type switch could be used. The switch is wired so that in one position the sensor connects to the positive rail and the variable resistor to the negative, while the opposite position, the connections are reversed.

A diode must be placed across the relay coil to protect the transistor. During switching, quite high voltages are generated across the coil - and these could easily damage the transistor. The diode shunts these voltages, preventing them from reaching the transistor.

The relay we used draws around 65 milliamps in the energised position, which is quite within the capability of a BC108 or equivalent transistor. The relay coil becomes quite warm after prolonged operation - another good reason for making the relay normally off.



## BERNARDS & BABANI PRESS RADIO AND ELECTRONICS BOOKS

BP1	First Book of Transistor Equivalents and Substitutes	40p
BP2	Handbook of Radio, TV and Industrial & Transmitting Tube & Valve Equiv.	60p
BP3	Handbook of Tested Transistor Circuits	40p
BP4	World's Short, Med. & Long Wave FM & TV Broadcasting Stations Listing (International Edition)	60p
BP5	Handbook of Simple Transistor Circuits	35p
BP6	Engineers and Machinists Reference Tables	30p
BP7	Radio and Electronic Colour Codes and Data Chart	15p
BP8	Sound and Loudspeaker Manual	50p
BP9	38 Practical Tested Diode Circuits for the Home Constructor	35p
BP10	Modern Crystal and Transistor Set Circuits for Beginners	35p
BP11	Practical Transistor Novelty Circuits	40p
BP12	Hi-Fi, P.A., Guitar & Discotheque Amplifier Handbook	75p
BP13	Electronic Novelties for the Motorist	50p
BP14	Second Book of Transistor Equivalents	95p
BP15	Constructors Manual of Electronic Circuits for the Home	50p
BP16	Handbook of Electronic Circuits for the Amateur Photographer	60p
BP17	Radio Receiver Construction Handbook using IC's and Transistors	60p
BP18	Boys and Beginners Book of Practical Radio and Electronics	60p
BP22	79 Electronic Novelty Circuits	75p
BP23	First Book of Practical Electronic Projects	75p
BP24	52 Projects using IC741 (or Equivalents)	75p
BP25	How to Build Your Own Electronic and Quartz Controlled Watches & Clocks	85p
BP26	Radio Antenna Handbook for Long Distance Reception & Transmission	85p
BP27	Giant Chart of Radio Electronic Semiconductor & Logic Symbols	60p
BP28	Resistor Selection Handbook (International Edition)	60p
BP29	Major Solid State Audio Hi-Fi Construction Projects	85p
BP30	Two Transistor Electronic Projects	85p
BP31	Practical Electrical Re-wiring & Repairs	85p
BP32	How to Build Your Own Metal and Treasure Locators	85p
100	A Comprehensive Radio Valve Guide - Book 1	40p
121	A Comprehensive Radio Valve Guide - Book 2	40p
126	Boys Book of Crystal Sets	25p
129	Universal Gram-Motor Speed Indicator (Combined 50 & 60 c/s model)	10p
138	How to Make Aerials for TV (Band 1-2-3)	25p
143	A Comprehensive Radio Valve Guide - Book 3	40p
150	Practical Radio Inside Out	40p
157	A Comprehensive Radio Valve Guide - Book 4	40p
160	Coil Design and Construction Manual	50p
161	Radio, TV and Electronics Data Book	60p
170	Transistor Circuits for Radio Controlled Models	40p
177	Modern Transistor Circuits for Beginners	40p
178	A Comprehensive Radio Valve Guide - Book 5	40p
183	How to Receive Foreign TV Programmes on your Set by Simple Modifications	35p
196	AF-RF Reactance - Frequency Chart for Constructors	15p
200	Handbook of Practical Electronic Musical Novelties	50p
201	Practical Transistorised Novelties for Hi-Fi Enthusiasts	35p
202	Handbook of Integrated Circuits (IC's) Equivalents and Substitutes	75p
203	IC's and Transistor Gadgets Construction Handbook	60p
204	Second Book of Hi-Fi Loudspeaker Enclosures	60p
205	First Book of Hi-Fi Loudspeaker Enclosures	60p
206	Practical Transistor Circuits for Modern Test Equipment	60p
207	Practical Electronic Science Projects	75p
208	Practical Stereo and Quadrophony Handbook	75p
209	Modern Tape Recording Handbook	75p
210	The Complete Car Radio Manual	75p
211	First Book of Diode Characteristics Equivalents and Substitutes	75p
213	Electronic Circuits for Model Railways	85p
214	Audio Enthusiasts Handbook	85p
215	Shortwave Circuits and Gear for Experimenters and Radio Hams	85p
216	Electronic Gadgets and Games	85p
217	Solid State Power Supply Handbook	85p
218	Build Your Own Electronic Experimenters Laboratory	85p
219	Solid State Novelty Projects	85p
220	Build Your Own Solid State Hi-Fi and Audio Accessories	85p
RCC	Resistor Colour Code Disc Calculator	85p

The Grampians, Shepherds Bush Road, London W6 7H  
Telephone: 01-603 2581/7296

Library Ned. Ver