

# BBC

## ENGINEERING DIVISION

# MONOGRAPH

---

NUMBER 42: JULY 1962

### Apparatus for Television and Sound Relay Stations

Translators, Receivers, and Drive Equipment

by

F. A. PEACHEY, M.I.E.E.

R. TOOMBS, D.I.C., A.C.G.I., B.Sc.(Eng.), A.M.I.E.E.

and

D. L. SMART, Grad.I.E.E.

(Designs Department, BBC Engineering Division)

---

BRITISH BROADCASTING CORPORATION

PRICE FIVE SHILLINGS





BBC ENGINEERING MONOGRAPH

No. 42

APPARATUS FOR TELEVISION AND SOUND RELAY STATIONS  
TRANSLATORS, RECEIVERS, AND DRIVE EQUIPMENT

by

F. A. Peachey, M.I.E.E.

R. Toombs, D.I.C., A.C.G.I., B.Sc.(Eng.), A.M.I.E.E.

and

D. L. Smart, Grad.I.E.E.

(DESIGNS DEPARTMENT, BBC ENGINEERING DIVISION)

JULY 1962

BRITISH BROADCASTING CORPORATION

## FOREWORD

**T**HIS is one of a series of Engineering Monographs published by the British Broadcasting Corporation. About six are produced every year, each dealing with a technical subject within the field of television and sound broadcasting. Each Monograph describes work that has been done by the Engineering Division of the BBC and includes, where appropriate, a survey of earlier work on the same subject. From time to time the series may include selected reprints of articles by BBC authors that have appeared in technical journals. Papers dealing with general engineering developments in broadcasting may also be included occasionally.

This series should be of interest and value to engineers engaged in the fields of broadcasting and of telecommunications generally.

Individual copies cost 5s. post free, while the annual subscription is £1 post free. Orders can be placed with newsagents and booksellers, or BBC PUBLICATIONS, 35 MARYLEBONE HIGH STREET, LONDON, W.1.

# CONTENTS

<i>Section</i>	<i>Title</i>	<i>Page</i>
	PREVIOUS ISSUES IN THIS SERIES . . . . .	4
	SUMMARY . . . . .	5
1.	INTRODUCTION . . . . .	5
2.	PROBLEMS DUE TO LACK OF FREQUENCY CHANNELS . . . . .	5
3.	TYPES OF RELAY STATION . . . . .	5
4.	SITING OF RELAY STATIONS . . . . .	5
5.	TYPES OF TRANSMISSION APPARATUS EMPLOYED . . . . .	6
5.1	The Television Translator . . . . .	6
5.1.1	Methods of Frequency Translation . . . . .	6
5.1.2	Feedback between Output and Input . . . . .	6
	(a) Overload . . . . .	7
	(b) Intermodulation . . . . .	7
	(c) Noise . . . . .	8
	(d) Instability . . . . .	8
5.1.3	Filters . . . . .	8
5.1.4	Stability of Frequency . . . . .	9
5.1.5	Automatic Gain Control . . . . .	12
5.1.6	Performance and Design . . . . .	12
5.2	VHF/FM Sound Translator . . . . .	13
5.2.1	Feedback between Output and Input . . . . .	15
	(a) Overload . . . . .	15
	(b) Noise . . . . .	15
	(c) Instability . . . . .	15
5.3	Receiver/Transmitter Combinations (Television and FM Sound) . . . . .	17
5.3.1	FM Drive Unit . . . . .	17
5.3.2	FM Receiver . . . . .	18
5.3.3	Television Receiver . . . . .	18
6.	RELIABILITY AND MONITORING OF RELAY STATIONS . . . . .	19
7.	MAINTENANCE . . . . .	20
8.	PLANNING AND INSTALLATION . . . . .	20
9.	ACKNOWLEDGMENT . . . . .	20
10.	REFERENCES . . . . .	20

## PREVIOUS ISSUES IN THIS SERIES

No.	Title	Date
1.	<i>The Suppressed Frame System of Telerecording</i>	JUNE 1955
2.	<i>Absolute Measurements in Magnetic Recording</i>	SEPTEMBER 1955
3.	<i>The Visibility of Noise in Television</i>	OCTOBER 1955
4.	<i>The Design of a Ribbon Type Pressure-gradient Microphone for Broadcast Transmission</i>	DECEMBER 1955
5.	<i>Reproducing Equipment for Fine-groove Records</i>	FEBRUARY 1956
6.	<i>A V.H.F./U.H.F. Field-strength Recording Receiver using Post-detector Selectivity</i>	APRIL 1956
7.	<i>The Design of a High Quality Commentator's Microphone Insensitive to Ambient Noise</i>	JUNE 1956
8.	<i>An Automatic Integrator for Determining the Mean Spherical Response of Loudspeakers and Microphones</i>	AUGUST 1956
9.	<i>The Application of Phase-coherent Detection and Correlation Methods to Room Acoustics</i>	NOVEMBER 1956
10.	<i>An Automatic System for Synchronizing Sound on Quarter-inch Magnetic Tape with Action on 35-mm Cinematograph Film</i>	JANUARY 1957
11.	<i>Engineering Training in the BBC</i>	MARCH 1957
12.	<i>An Improved 'Roving Eye'</i>	APRIL 1957
13.	<i>The BBC Riverside Television Studios: The Architectural Aspects</i>	JULY 1957
14.	<i>The BBC Riverside Television Studios: Some Aspects of Technical Planning and Equipment</i>	OCTOBER 1957
15.	<i>New Equipment and Methods for the Evaluation of the Performance of Lenses for Television</i>	DECEMBER 1957
16.	<i>Analysis and Measurement of Programme Levels</i>	MARCH 1958
17.	<i>The Design of a Linear Phase-Shift Low-pass Filter</i>	APRIL 1958
18.	<i>The BBC Colour Television Tests: An Appraisal of Results</i>	MAY 1958
19.	<i>A U.H.F. Television Link for Outside Broadcasts</i>	JUNE 1958
20.	<i>The BBC's Mark II Mobile Studio and Control Room for the Sound Broadcasting Service</i>	AUGUST 1958
21.	<i>Two New BBC Transparencies for Testing Television Camera Channels</i>	NOVEMBER 1958
22.	<i>The Engineering Facilities of the BBC Monitoring Service</i>	DECEMBER 1958
23.	<i>The Crystal Palace Band I Television Transmitting Aerial</i>	FEBRUARY 1959
24.	<i>The Measurement of Random Noise in the presence of a Television Signal</i>	MARCH 1959
25.	<i>A Quality-Checking Receiver for V.H.F. F.M. Sound Broadcasting</i>	JUNE 1959
26.	<i>Transistor Amplifiers for Sound Broadcasting</i>	AUGUST 1959
27.	<i>The Equipment of the BBC Television Film Studios at Ealing</i>	JANUARY 1960
28.	<i>Programme Switching, Control, and Monitoring in Sound Broadcasting</i>	FEBRUARY 1960
29.	<i>A Summary of the Present Position of Stereophonic Broadcasting</i>	APRIL 1960
30.	<i>Film Processing and After-processing Treatment of 16-mm Films</i>	MAY 1960
31.	<i>The Power Gain of Multi-Tiered V.H.F. Transmitting Aerials</i>	JULY 1960
32.	<i>A New Survey of the BBC Experimental Colour Transmissions</i>	OCTOBER 1960
33.	<i>Sensitometric Control in Film Making</i>	DECEMBER 1960
34.	<i>A Mobile Laboratory for U.H.F. and V.H.F. Television Surveys</i>	FEBRUARY 1961
35.	<i>Tables of Horizontal Radiation Patterns of Dipoles Mounted on Cylinders</i>	FEBRUARY 1961
36.	<i>Some Aspects of Optical Lens Performance</i>	APRIL 1961
37.	<i>An Instrument for Measuring Television Signal-to-noise Ratio</i>	JUNE 1961
38.	<i>Operational Research on Microphone and Studio Techniques in Stereophony</i>	SEPTEMBER 1961
39.	<i>Twenty-five Years of BBC Television</i>	OCTOBER 1961
40.	<i>The Broadcasting of Music in Television</i>	FEBRUARY 1962
41.	<i>The Design of a Group of Plug-in Television Studio Amplifiers</i>	APRIL 1962

# APPARATUS FOR TELEVISION AND SOUND RELAY STATIONS

## TRANSLATORS, RECEIVERS, AND DRIVE EQUIPMENT

### SUMMARY

The development of remote and automatic control facilities for semi-attended broadcasting transmitters was described in a paper published in 1957.<sup>1</sup> This was the first stage of a plan to extend the BBC coverage without a proportionate increase in staff. The present monograph describes new equipment for rebroadcasting stations which has now been developed to meet new requirements encountered in later stages of the expansion of the television and sound coverage.

#### 1. Introduction

It is the BBC's aim to provide an adequate television and sound service for the whole populace of the United Kingdom. The television service is now available to 98.8 per cent of the population and the VHF/FM sound service to 97.9 per cent. The population which is beyond the range of existing stations is scattered in the less densely populated areas. There are also small areas which although within the normal range of the transmitters are screened by intervening hills or lie in valleys and cannot therefore receive an adequate signal.

This monograph describes new apparatus which has been designed to extend the television and VHF sound service coverage and to improve reception in the inadequately served areas.

#### 2. Problems Due to Lack of Frequency Channels

One of the greatest problems in extending the broadcasting services is the limitation in the number of frequency channels available for broadcasting purposes. This applies particularly to the television service, for which the BBC is at present allocated only the five channels in Band I\*. These are used by five high-power stations with e.r.p.s. of not less than 100 kW giving a coverage of about 78 per cent of the population on the basis of a minimum field-strength of 0.1 mV/m. They are also shared by seven medium-power stations with mean e.r.p.s. of about 12 kW which bring the coverage up to about 94 per cent and by a further group of 16 low-power stations to give the present figure of 98.8 per cent. It is possible to achieve a further extension of the coverage and to provide some improvement in areas where there are reception difficulties by means of additional low-power relay stations sharing the five channels in Band I. The number and power of such stations that can be used in Band I is, however, limited by the need to avoid co-channel interference and additional frequency channels are needed if the coverage is to be satisfactorily completed.

The 1.2 per cent of the population outside the present television coverage represents some 600,000 people, many of whom are in scattered and remote areas where other forms of entertainment are not readily available.

For VHF sound broadcasting the situation is a little easier, although by no means satisfactory for establishing a first-class overall service.

\* 41-68 Mc/s in the United Kingdom.

The apparatus described in this monograph will enable whatever channels are available to be used to the best advantage but will not reduce the need for additional channels if a first-class service is to be made available to all.

#### 3. Types of Relay Station

In filling the gaps in the sound and television coverage, two types of relay station are being used at the present stage; stations which cover a fairly wide area and much smaller stations which provide a service to a particular town or village.

The larger stations are partially attended by staff as the amount of necessary maintenance work justifies this. These stations are frequently situated outside the normal service area of an existing station, in which case they obtain their programme signal via a land line or specially provided radio link. If, however, broadcast reception can be employed to good advantage it is generally used as a source of programme for re-transmission.

It is intended that the smaller stations shall be in substantial numbers and scattered over many fairly isolated districts, and for economic reasons they will be unattended. They will usually be within the service area of an existing transmitter and sited so that they not only receive a satisfactory signal from the parent station but can also transmit an adequate signal to the intended reception area.

This paper is largely concerned with these smaller stations.

#### 4. Siting of Relay Stations

A subsidiary transmitter receiving its input signal from a parent transmitter must be sited so that it receives a signal considerably better than that hitherto available to the bulk of the people it serves. In addition, it must be situated so that it directs the maximum signal to the local population but the minimum signal to other areas which may already be receiving an adequate signal. At first sight these conditions may appear conflicting but often enough a good compromise is possible. For example, such a site may be on a hill overlooking the town in the valley below. Fig. 1 (pages 10 and 11) shows how the site at Folkestone provides a line-of-sight path to a large part of the town.

In relatively flat areas where reception has to be improved, the topography does not help in providing the necessary conditions, and high and costly aerial masts, or special radio links, provide the only solution.

## 5. Types of Transmission Apparatus Employed

For those relay stations which employ direct broadcast pick-up it would, in most cases, seem pointless to do other than receive the radio signal, amplify it without detecting the audio or video modulation and re-radiate it at another frequency. Apparatus which performs this process is called a 'Translator'. The term 'Transposer' is sometimes used.

Attempts have also been made in other countries to simplify this process even further by merely receiving, amplifying, and re-radiating at the same frequency but in such circumstances difficulties usually arise. A device for this purpose might be called an 'Active Deflector' as it derives from a 'Passive Deflector'—an aerial system in which one high-gain array collects the signal and another redirects it to produce increased field-strength in a limited area without using any power other than that picked up by the receiving array.

Unless topography can be exploited to obtain an unusual amount of separation between the sending and receiving aerials, an active deflector cannot work well. For television applications it would also, in most cases, produce objectionable 'ghosts' for people who unavoidably receive signals from both the main and relay stations.

If deflectors are used at all, they are likely to be extremely limited in number and therefore most of the activity in the relay station field has been devoted to design of equipment of the translator type.

### 5.1 The Television Translator

This, as has already been suggested, is a device which receives the radio signal, amplifies it, and changes its frequency to that required for local transmission. It provides for no extraction of the video or sound and so avoids the difficulties that arise when this is done. Compared with a receiver/transmitter combination, the circuitry is simplified and, as a consequence, a translator has greater reliability.

Summarizing, a relay station which relies on radio reception for its input signal may comprise one of the following arrangements:

- (1) A passive deflector
- (2) An active deflector
- (3) A translator
- (4) An orthodox receiver/transmitter combination.

#### 5.1.1. Methods of Frequency Translation

The simplest conception of the translation process is that of a single mixer in which the received signal has added to it or subtracted from it the frequency by which it is to be shifted for re-radiation. In practice it is necessary to reduce the received signal to an intermediate frequency. This involves two steps in frequency changing, with local oscillator frequencies arranged to avoid sideband inversion.

If, with the close channel separation in Band I, an attempt is made to translate, using only one frequency change, difficulties arise due to harmonics of the oscillator

falling in or near the passbands. (In addition, of course, the use of a fixed intermediate frequency renders the process of amplification simpler.)

In such a process, particularly when amplitude modulation is used for both vision and sound, any appreciable non-linearity will produce intermodulation between the vision and sound carriers when both share a common amplifier. Although this presents no difficulties in the earlier stages of the translator, towards the output, where for economic reasons the valves are operated nearer to their maximum capabilities, it becomes difficult to attain sufficient linearity for the satisfactory transmission of the combined vision and sound signal.

It is therefore desirable to separate the two components of the television signal at some intermediate point in the translator chain and to recombine after the output stages.

Such considerations have resulted in a television translator with the basic schematic shown in Fig. 2.

#### 5.1.2 Feedback between Output and Input

As a translator is a receiving/transmitting device it follows that coupling must exist between its output and input via the transmitting and receiving aerials. Also, as in most cases it is economically desirable to receive and re-transmit on the same site, usually with both aerials on the same mast, the coupling is by no means insignificant. Fig. 3, which shows the mast and aerials at Folkestone, gives some idea of the average separation between receiving and transmitting arrays. In this case, the mast height is 120 ft and the mean height of the four-tier transmitting array is 94 ft. Some of the effects produced by aerial feedback are described in the following paragraphs.

If a translator with a normal gain of  $S_m$  dB will operate satisfactorily providing the aerial loss is not less than  $L_m$  dB, then  $(S_m - L_m)$  is the maximum permissible loop gain, and this quantity must also be regarded as a figure of merit for the translator. A margin should of course be provided against spurious fluctuations in  $S_m$  or  $L_m$  and so, in practice, a figure of merit equivalent to  $(S_m - L_m - 6)$  dB is adopted. This figure sets the limit on operating conditions for all permutations of channel translation, except for some adjacent-channel translations where the additional limiting condition mentioned below becomes the overriding consideration.

$S_m$  can be reduced if the aerials are arranged to produce a bigger input signal or to require less output power.  $L_m$  can usually be increased by increased spacing between the receiving and transmitting aerials and also by arranging, if it is possible to do so, for one aerial to be within the neutral plane of the other. The latter device is of course limited in application. All this would point to increase in aerial height and consequently increased cost.

In adjacent channel translation (other than Channels 1 and 2\*), noise on the fringe of the input band passes

\* As Channel 1 formerly included a double-sideband vision signal, the spacing between the Channel 1 vision carrier and the Channel 2 sound carrier is 3.25 Mc/s, while the corresponding spacing in the other pairs of adjacent channels, which have always been vestigial-sideband, is 1.5 Mc/s.



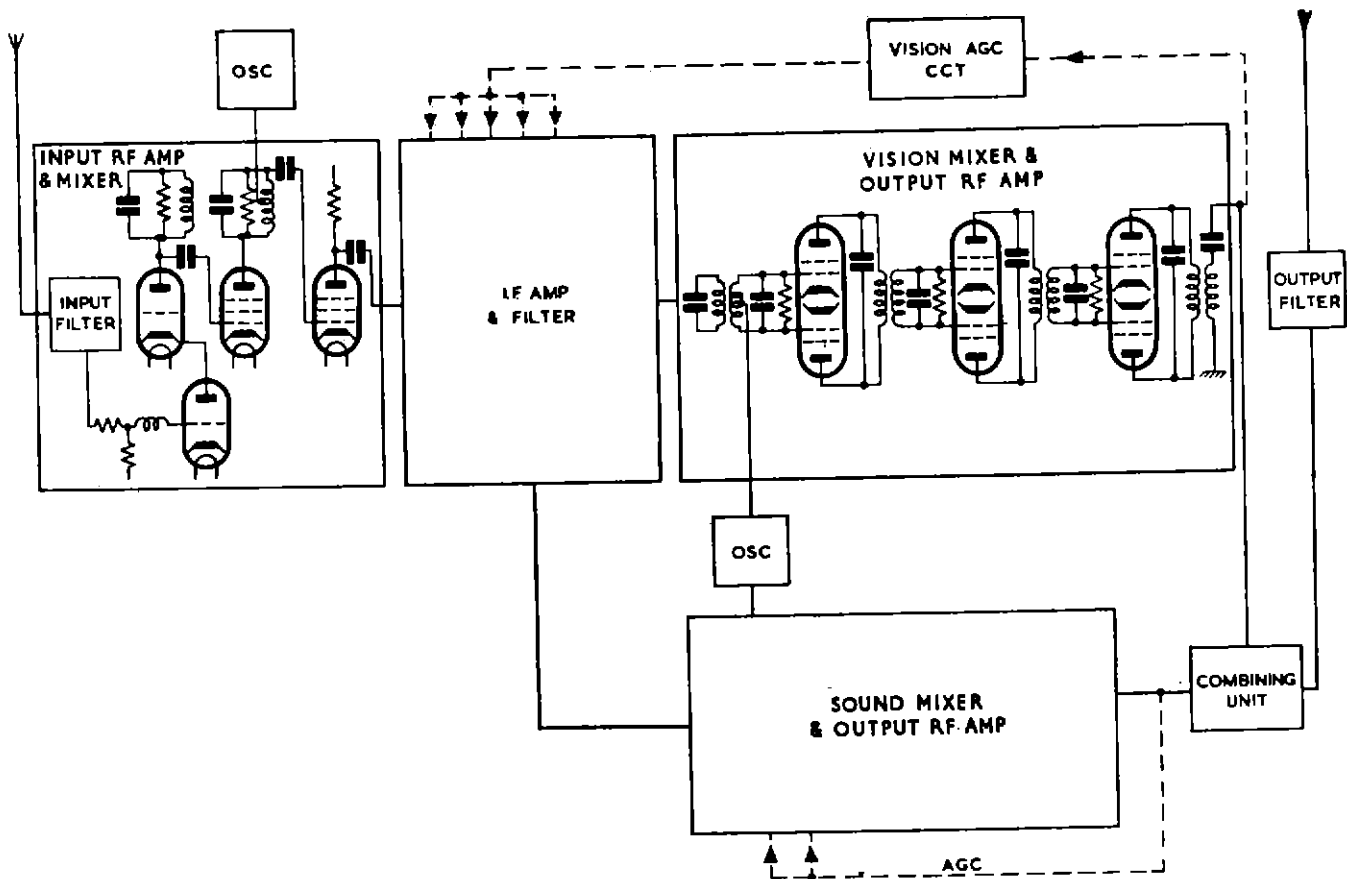

Fig. 2 — Television translator block schematic.

through the translator twice and the feedback path once before it is displaced in frequency sufficiently to be rejected by the filters. In this mode of operation, the values of  $S_m$  and  $L_m$  must be such that the quantity  $(2S_m - L_m - 6)$  dB does not exceed a limiting value, while at the same time the earlier limiting value of loop gain must also be satisfied. Although the second expression has a greater numerical value than the first, it usually calls for a lower value of  $S_m$  and/or a higher value of  $L_m$ .

(a) *Overload*

At a typical station the coupling between transmitting and receiving aerials may be about 40 dB, and the gain of the translator about 100 dB. A part of the output signal is therefore fed back to the input at a level of about 60 dB above the wanted input signal. This would normally cause overload in the early valve stages, and, to avoid this, input filters having a considerable loss (50 or 60 dB) at the output carrier frequencies are provided.

(b) *Intermodulation*

This is usually manifested by patterning and may be due to a multiplicity of causes. For example, a term  $2S - V$

(where  $S$  is the sound output carrier frequency and  $V$  is the vision output carrier frequency) may be generated. In translating the British Channel 1\* to Channel 2,† this results in a frequency of 44.75 Mc/s, which lies within the input channel. In any other translation to the adjacent higher channel, the corresponding term also lies within the input channel. This term may be generated in any part of the circuit where there is non-linearity and where  $S$  and  $V$  exist together. It may be generated in either the sound or vision output stages, in which case its effects may be minimized by (a) providing an output filter (attenuating at 44.75 Mc/s) after the combining unit or (b) providing output filters after the translator sound output or vision output to isolate them from each other.

The term  $2S - V$  may also be generated in the early valve stages of the translator in which case an input filter providing a loss to both  $S$  and  $V$  is beneficial.

Such terms may also be generated by rectification at joints in the metal, masts, and supporting stays, etc. In this case, filters can be of no assistance and the remedy is to eliminate the source of rectification. With this in view,

\* Vision: 45 Mc/s      Sound: 41.5 Mc/s.  
 † Vision: 51.75 Mc/s      Sound: 48.25 Mc/s.

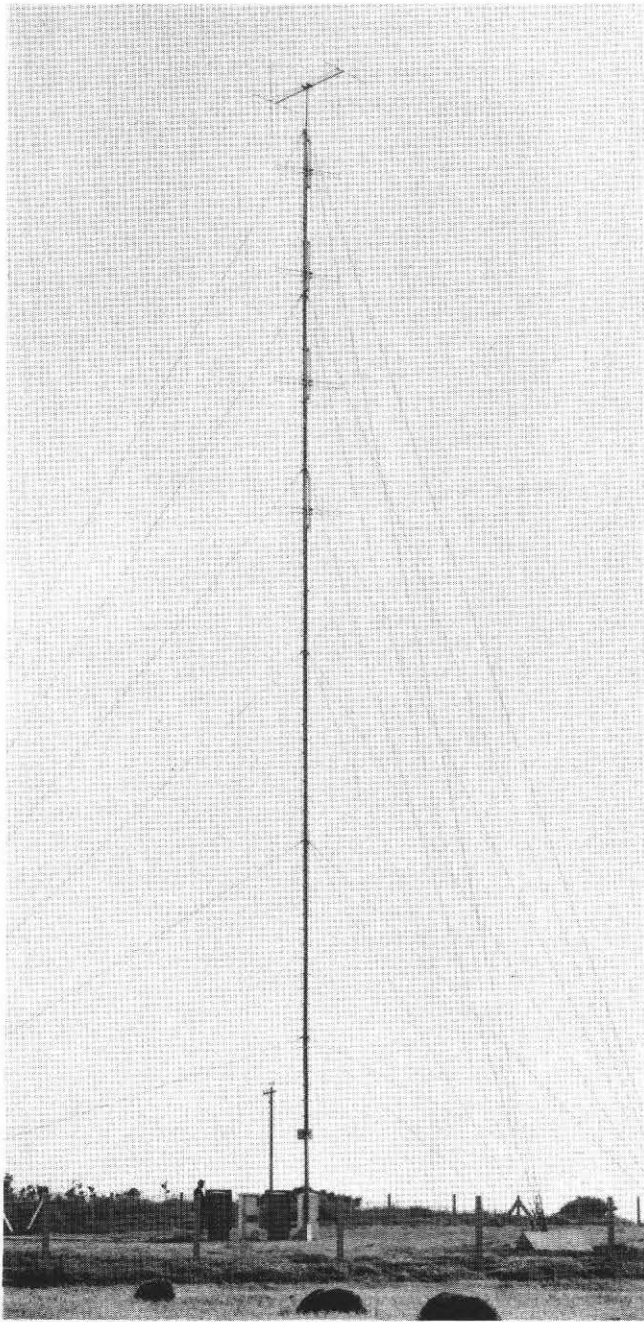

Fig. 3 — 120 ft stayed mast at the Folkestone television translator, showing the double broadside receiving array and 4-tier transmitting array.

experiments have been carried out with wooden masts and nylon supporting stays.

#### (c) Noise

Feedback between input and output in a translator produces an increase in noise.

White noise generated in a translator has its spectrum modified by subsequent amplifier stages before it arrives

at the output. This results in a spectrum of noise at the translator output, slightly broader than that which would result from the frequency response of the complete translator because of contributions from the later stages. It follows therefore that there will be some noise at the output of the translator which will fall within 3 Mc/s either side of the input vision carrier. Through the aerial coupling this noise will be fed back to the input and will increase the in-band noise level.

This effect can be minimized by use of an output filter having loss at all frequencies within 3 Mc/s of the input vision carrier frequency. Additionally, an input filter having loss just outside the vestigial sideband of the input channel will further reduce this effect.

#### (d) Instability

Under feedback conditions it is possible for input terms to generate output terms of the same frequency. This arises through a frequency translation subsidiary to that normally planned, and occurs only when output/input feedback is applied.

If the input frequency =  $f_i$   
 frequency translation =  $f_a$   
 1st oscillator frequency =  $f_1$   
 2nd oscillator frequency =  $f_2$   
 then output frequency =  $f_i + f_a$

With feedback or coupling between the output and input of the translator, such as that provided by the transmitting and receiving aerials, if any signal of frequency of  $f_s$  is applied, the frequencies which exist at the input are:

$$f_i, (f_i + f_a), f_s$$

When these components reach the first mixer or any non-linear stage, one of the resultant components will be

$$f_i - (f_i + f_a) + f_s = f_s - f_a$$

This will beat with the first mixer oscillator in the normal way to produce

$$f_1 - f_s + f_a$$

At the second mixer this term will produce

$$f_2 - f_1 + f_s - f_a = f_a + f_s - f_a = f_s \text{ (as } f_2 - f_1 = f_a \text{)}$$

Thus, any frequency at the input will produce the same frequency at the output when feedback is applied to the translator.

When a signal passes straight through the translator in this fashion, the gain is a maximum when the frequency  $f_s$  lies between the input and output channels. This can be seen from Fig. 4 which shows that under these conditions the frequency  $f_s$  will pass through the input stages, i.f. stages, and output stages just outside their respective pass-bands. For close channel translations the gain in these circumstances can be sufficient for the translator to oscillate when sufficient feedback occurs.

This effect can be reduced by the provision of filters with sharp cut-off characteristics at the input and output of the translator and within the intermediate frequency amplifier.

#### 5.1.3 Filters

To avoid any appreciable impairment of the signal/noise ratio, the loss due to the input filter should be kept small within its pass range. Typical filters used for this purpose have a pass range loss of less than 1 dB but an

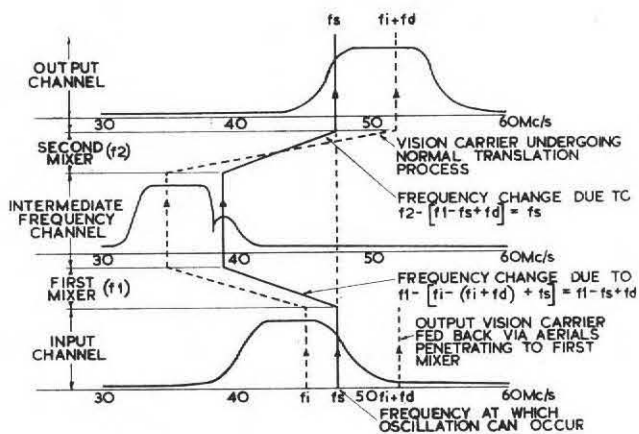

Fig. 4 — Translator instability produced by aerial coupling.

attenuation of over 50 dB at the output sound and vision carrier frequencies.

Likewise, to avoid unnecessary waste of output power, the output filter is designed to have a low loss (less than  $\frac{1}{2}$  dB) in the output pass-band.

The sum of the losses due to these two filters should be substantial at any frequency within the range which includes the input and output pass-bands together. In the equipment described this loss is at least 40 dB for translation such as Channel 1 to Channel 2 but may be relaxed considerably for translation between channels with wider frequency separation. It also provides for an operation margin against feedback effects, of 6–10 dB.

To enable the translator to meet the current regulations regarding spurious radiation, the output filter must also provide adequate attenuation of the harmonics of the output carrier frequencies, and of any other spurious frequencies radiated. The input filter must likewise provide adequate attenuation to protect against unwanted signals entering the translator, in particular any which fall within the intermediate frequency band.

To carry out the relay station programme, large numbers of these filters will be required. An investigation into the rationalization of manufacture and alignment has therefore been undertaken. This has resulted in the use of printed circuit techniques to make filters which are easily reproducible and simple to align. Some of the printed inductances used in the filters are seen in Fig. 5.

#### 5.1.4 Stability of Frequency

If the output frequency of a translator is to remain stable within the internationally agreed limits, the translator and the parent transmitter must each maintain a frequency stability closer than the overall limits.

The minimum shift in output frequency occurs if both mixer oscillators vary in frequency in the same sense at the same time. For example, if  $f_1$  and  $f_2$  are the two mixer oscillator frequencies and the change in frequency, input to output, of the translator is  $f_d$ , then as

$$f_2 - f_1 = f_d$$

if the oscillators both change in frequency by  $\Delta f$ ,

$$(f_2 \pm \Delta f_2) - (f_1 \pm \Delta f_1) = f_d \pm (\Delta f_2 \pm \Delta f_1)$$

The error in frequency ( $\Delta f_2 \pm \Delta f_1$ ) may lie between the maximum value ( $\Delta f_2 + \Delta f_1$ ) and a minimum value ( $\Delta f_2 - \Delta f_1$ ).

The lower value is naturally preferred, and this would be attained if crystals were chosen with temperature coefficients in the same sense and if, at the same time, it were possible to arrange that variations in frequency due to power supply changes, etc., were also in the same sense. Crystals of the type used in this equipment age in the same sense, and so it follows that with reasonable oven temperature control it is not particularly difficult to maintain the output frequency well within internationally agreed limits.

For most small stations, ordinary thermostatically controlled ovens are probably suitable for stabilizing the crystal temperature, but at larger stations or for small stations operating in cascade, closer control of frequency stability is desirable. An improved type of oven control has therefore been designed in a form that can be added to the translator chassis if it is considered necessary. In this design a small commercially manufactured oven is fitted with a thermistor in addition to the normal crystal. The former is used as the temperature sensitive device and forms one part of the Wheatstone bridge,<sup>2</sup> Fig. 6. The bridge is sufficiently off balance at the required oven temperature to provide a steady d.c. output. This is amplified through a small transistorized d.c. amplifier and provides

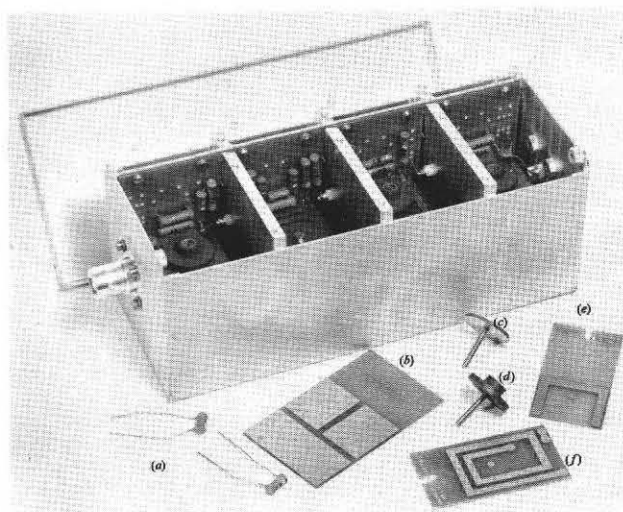

Fig. 5 — Translator R.F. filter and principal components.

- (a) Precision capacitors.
- (b) Printed circuit mounting card.
- (c) Inductance trimmer formed of copper etching on plastic laminate disc.
- (d) Inductance trimmer using iron-dust core material.
- (e) and (f) Printed inductances.



*Fig. 1 — Panoramic view of Folkestone*





*from the Creteway Down translator site.*

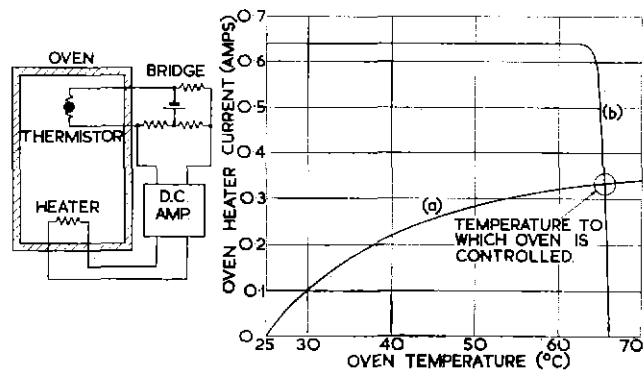

Fig. 6 — Crystal control oven.  
 (a) Current required to maintain oven with an external temperature of 25°C.  
 (b) Heater current output from amplifier and bridge circuit.

the source of power for heating the oven. The arrangement is such that an increase of oven temperature causes a reduction in the heater current, and the system tends to reach equilibrium at a set temperature. Any variation in temperature within the oven alters the input to the amplifier, changes the power supplied to the oven, and readjusts the temperature towards its original value.

The accuracy of the oven from the short-term point of view is largely controlled by the accuracy of the temperature sensing device, i.e. the thermistor. Variations of gain in the d.c. amplifier will also upset the accuracy to a small degree, particularly if the time constants in the self-regulating circuit are long in comparison with the amount of control available.

### 5.1.5 Automatic Gain Control

Fig. 7 shows the circuit which provides A.G.C. from the 'Back Porch' of the synchronizing signals. At first sight it might appear unduly elaborate as, in view of the A.G.C. provided on most domestic receivers, there is little or no need to provide other than a rough A.G.C. at the translator point. However, as some domestic receivers are not equipped with A.G.C., and as it is possible that these might find their way into an area served by a translator, a reasonable amount of gated A.G.C., which is not influenced by picture brightness, has been applied. This elaboration detracts little from the overall reliability as, in most cases, valve failure in the A.G.C. circuit will not produce a complete failure, but will cause reversion to mean level A.G.C. which is dependent on the average value of picture modulation. The A.G.C. is provided primarily to compensate for changes in valve characteristics which, in an additive fashion, might otherwise produce large changes in output power, despite a constant value of input signal.

Separate A.G.C. is applied to the sound and vision chains within the translator, to compensate independently for gain variations within these chains and, to a lesser

extent, to correct for differential fading between the sound and vision input signals.

The maximum gain of a translator must be restricted if ill effects due to output/input feedback are to be avoided. For this reason, the A.G.C. on the equipment described in this paper ceases to operate at input voltages below 150  $\mu$ V. On sites where the coupling between transmitting and receiving aerials is too great to permit even this sensitivity, the maximum gain may be restricted still further by means of a manual sensitivity control.

As the A.G.C. operates from the output signal, it may also be used for monitoring purposes or for causing automatic changeover to spare equipment.

### 5.1.6 Performance and Design

Television translators must be sufficiently reliable to operate without attention for long periods and, as some will be installed on sites difficult of access and remote from servicing facilities, they must not require much maintenance. For this reason reliability is paramount and simplicity of great importance. No attempt has been made to exceed the required minimum performance specified, where this would involve additional complexity. Translators have been designed primarily to operate as single units although, with slight modification, they are suitable for operation in cascade.

For installations where it is desirable to use different sites for receiving and transmitting, the translator may be split within the intermediate frequency amplifier, and the two parts used separately. A transistorized version of the remote receiving section is being developed for this purpose. This will require such a small amount of power that it can be supplied over the interconnecting cable.

The response of the translator to a pulse and bar waveform<sup>8</sup> is shown in Fig. 8. A *K* rating of less than 2 per cent is normally attained. Details of the amplitude distortion are shown in Fig. 9. The distortion is still within acceptable limits at double the rated output power, and this is regarded as an ample margin against normal deterioration in valve performances.

The frequency response of the vision translator is flat, within  $\pm 1$  dB, from 3 Mc/s below vision carrier frequency to 1 Mc/s above.

RF input and output filters, specially designed to give precise performance without any great difficulty in the manufacture or adjustment, allow these television translators to operate with a 'maximum loop gain'— $(S_m - L_m - 6)^*$  of 85 dB for three channels separation and 65–70 dB for adjacent channels, which involve upward translations. For upward translations the ' $2S_m - L_m - 6$ ' term is approximately 160 dB and for the corresponding downward translations approximately 140 dB.

The translator is normally mounted in a weatherproof cubicle for installation outdoors at the foot of the aerial mast. The case is weatherproof, and cooling is provided entirely by internal circulation of air by means of a fan. Fig. 10 shows a television translator installation (with a

\* See Section 5.1.2.

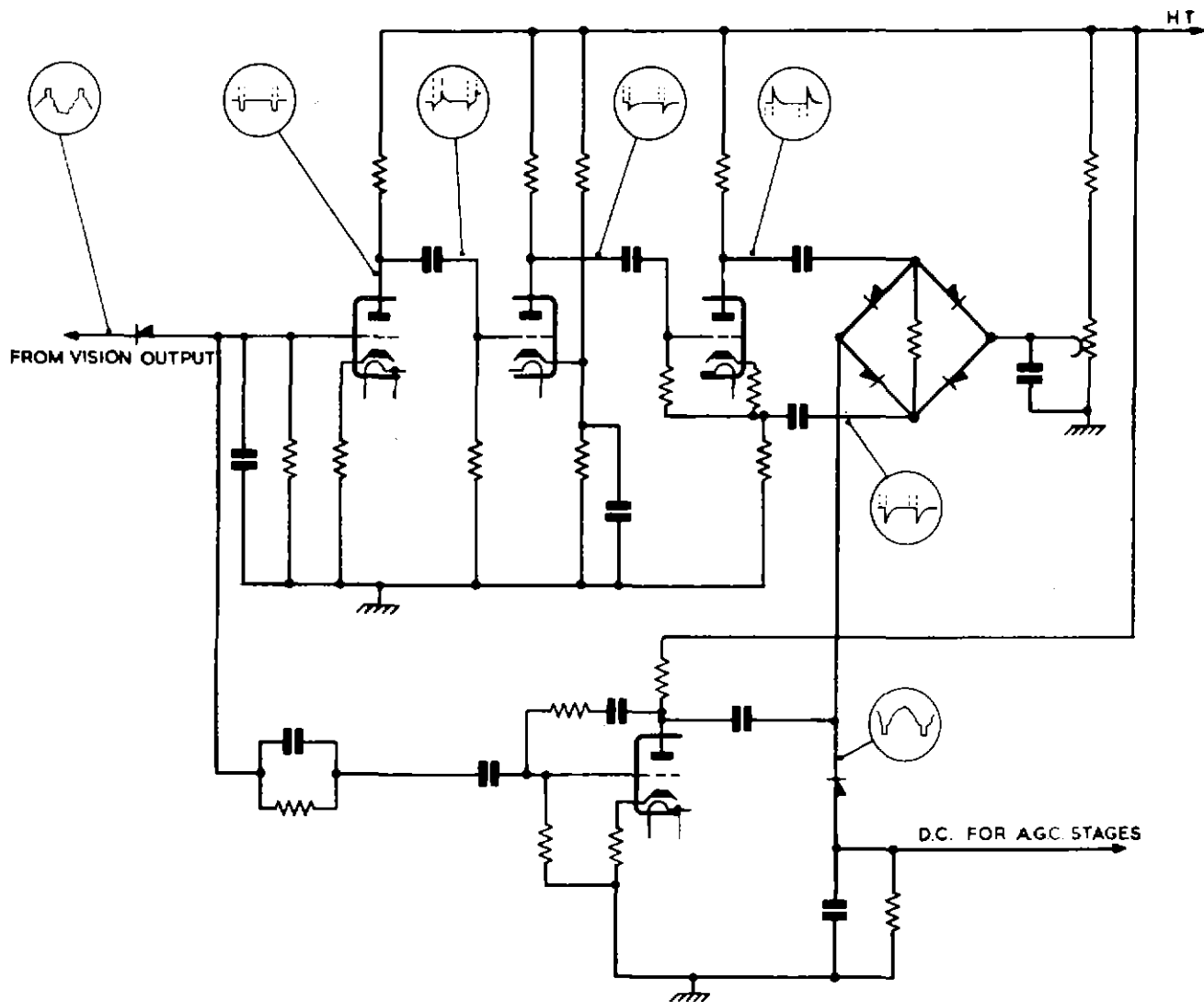

Fig. 7 — Vision A.G.C. circuit.

vision transmitter power of 2 watts) in its cubicle, and identifies the main units.

A sun screen is also provided so that the internal temperature remains at a reasonable value even on hot summer days. The size of the cabinet is such that it not only provides convenient accommodation for the apparatus, but also enough cooling surface for the heat dissipated. The components used in the translator equipment have temperature ratings which will meet the higher temperature conditions which may arise in the cabinet if the cooling fan should stop.

### 5.2 VHF/FM Sound Translator

In general, the same overall principles apply to the sound translator as those described for the television translator. There are, however, several main differences.

Fig. 11 shows the general schematic form, and Fig. 12 is a photograph of a three-channel FM translator unit.

Since the translator is to deal with a frequency modulated signal, there is no particular problem from the point of view of amplitude linearity, but the relatively smaller bandwidth and higher frequency increase the filtration difficulties. In most cases coaxial filters have to be used to supplement 'lumped' filters. As it is normal for all three domestic services to be transmitted from the one site, the filtration is made more complicated.

At most of the stations, the three transmitters providing the Home, Third, and Light programme services are spaced 2.2 Mc/s apart (i.e. 4.4 Mc/s overall), but as all but two of the channels so far allocated are within a band less than 7 Mc/s wide, most sets of received and retransmitted signals overlap. This means that, even if there were free

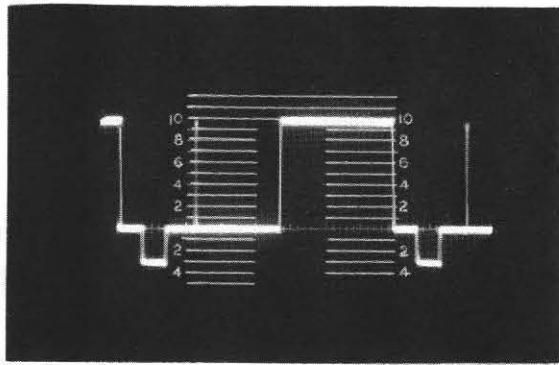

(a<sub>1</sub>) 2T pulse and bar. Test gear only (< 1 per cent).

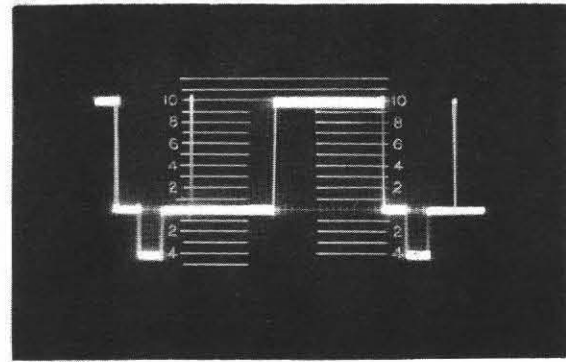

(a<sub>2</sub>) 2T pulse and bar. Translator and test gear (~ 2 per cent).

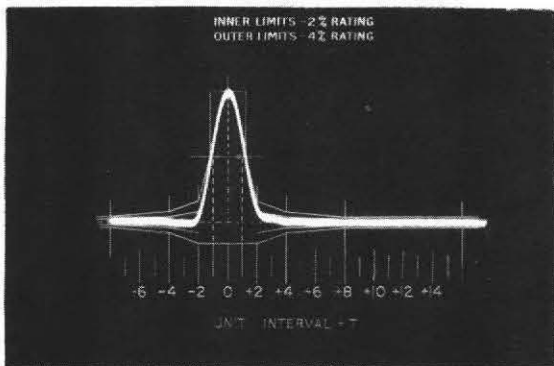

(b<sub>1</sub>) 2T pulse. Test gear only (2 per cent).

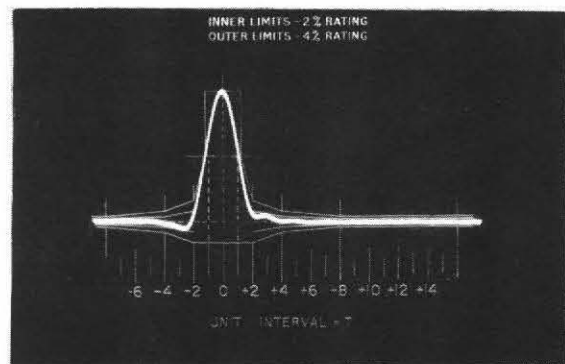

(b<sub>2</sub>) 2T pulse. Translator and test gear (2 per cent).

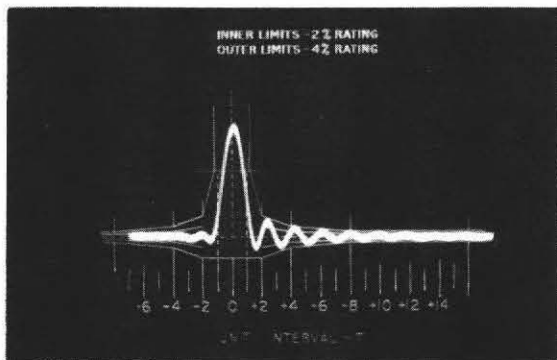

(c<sub>1</sub>) 1T pulse. Test gear only.

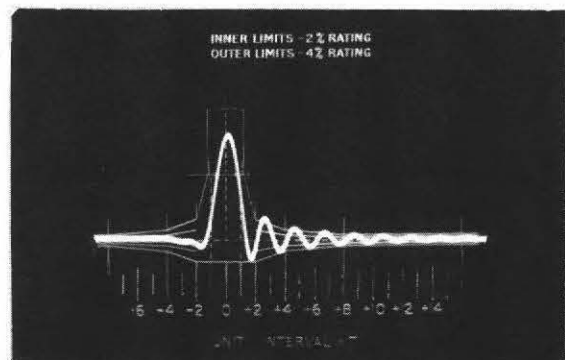

(c<sub>2</sub>) 1T pulse. Translator and test gear.

Fig. 8 — Waveform response of television translator. The 1T pulse and 2T pulse are to the same scale.



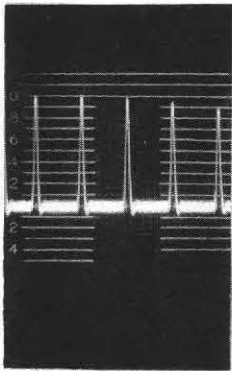

(a) Response of test gear only—9 per cent distortion.

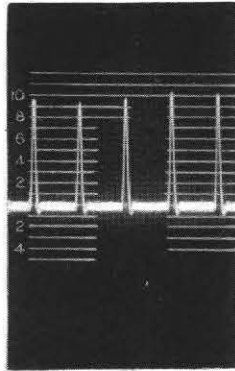

(b) Response of translator at normal output (i.e. 10 watts) together with test gear—11 per cent distortion.

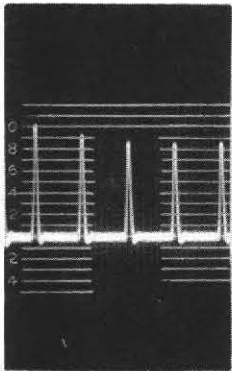

(c) As (b), but 5 watts output—17 per cent distortion.

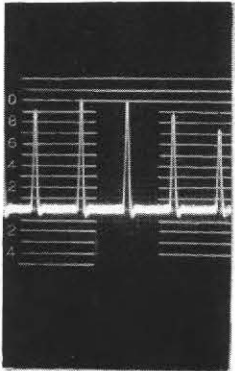

(d) As (b), but 20 watts output—27 per cent distortion.

Fig. 9 — Amplitude distortion of translator.

Measured with a five-step staircase signal increasing in amplitude to the right. The spikes represent the successive step heights.

After correction for non-linearity in test gear, the output distortion at 10 watts is 16 per cent.

choice of frequencies for retransmission, the spacing could not be more than a maximum of 1.1 Mc/s.

Feedback between the transmitting and receiving aerials makes it extremely difficult to provide sufficient filtration for practical applications if the separation between neighbouring channels is much less than 0.5 Mc/s. The selection of channel frequencies is determined primarily by area interference considerations and this means that, with the present rather restricted band, difficulties may often arise which prevent the economical exploitation of translator equipment.

The handling of three channels simultaneously has some

advantages. From the design point of view there is a choice between a wide-band amplifier to accommodate three channels simultaneously, or separate narrow-band channels. The narrow-band translator would seem preferable as it affords better opportunities for the filtration which is so important, and also leaves a choice between using oscillators common to all three channels or separate oscillators. This in turn leaves a choice between common intermediate frequencies or separate intermediate frequencies.

The translator described here normally uses a common oscillator. This produces a degree of simplification compared with the use of a separate oscillator for each channel, and ensures that no 'burble' occurs due to crosstalk between the i.f. channels which, although nominally the same, are actually of slightly different frequency. It also simplifies the connecting link if separation between the receiving and transmitting parts is desirable.

### 5.2.1 Feedback between Output and Input

Coupling between the receiving and transmitting aerials produces defects in the sound translator similar in principle to those already described for the television translators, but the effects are different in magnitude and in the mode of manifestation.

It has, in practice, proved extremely difficult to diagnose the exact mechanism by which feedback between the output and input of these translators causes the various types of degradation of performance, but it is known that the degradation occurs only under feedback conditions. It has become evident, by experiment, that beyond a certain amount of input and output filtration, additional filtration produces no appreciable improvement. Experiments in this field are continuing with the hope that some further easement of the feedback problem may be possible.

Aerial coupling problems are more acute in the FM translator than in the television translator, as all FM transmissions in this country are at present horizontally polarized and high attenuation between aerials mounted on the same mast is more difficult to attain. For this reason, it may be profitable to consider changing the polarization of FM transmission at some of the small relay stations.

#### (a) Overload

The requirements are not quite so critical as in the case of the television translator. In practice, if adequate filtration is provided to avoid other feedback troubles, there is usually sufficient protection against undue overloading.

#### (b) Noise

Additional noise is generated under feedback conditions in the same way as described for the television translator, except that with the FM system there is difference in both magnitude and subjective effect.

#### (c) Instability

Excessive feedback between the output and the input can produce instability in the same way as has already been described for the television translator. The fault is manifested by 'breaking up' of the sound signal.

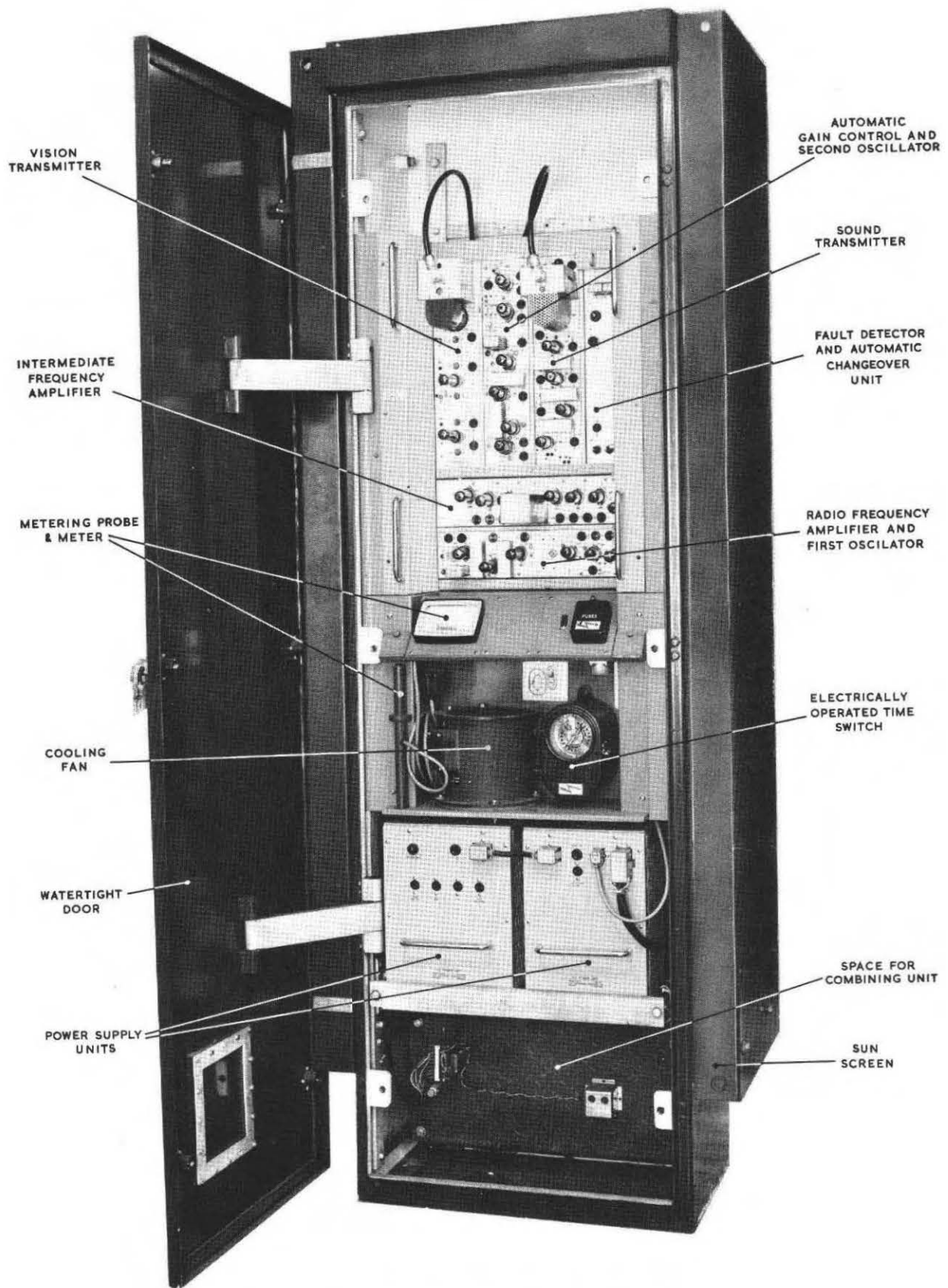

Fig. 10 — Television translator in cubicle for outdoor use.

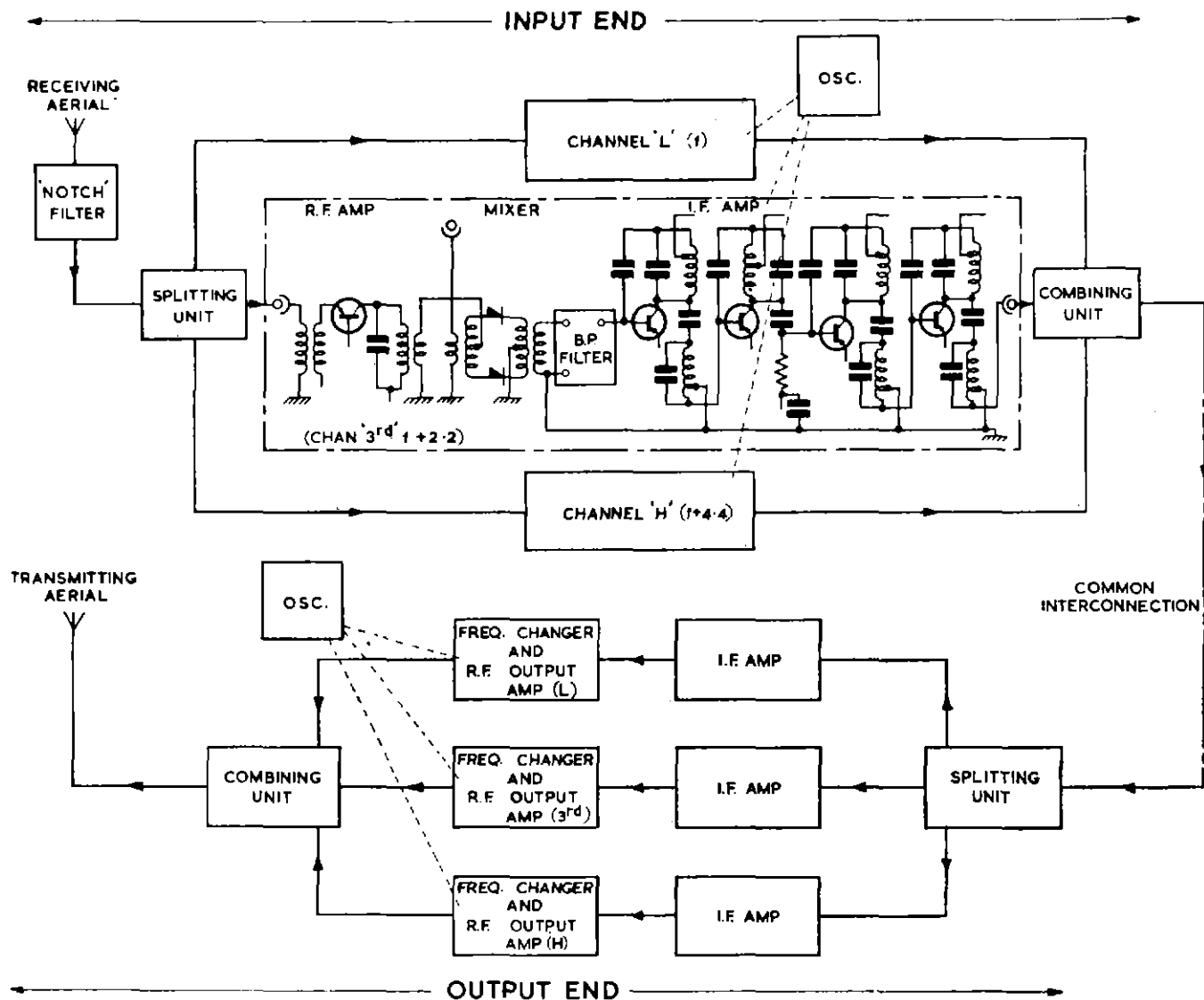

Fig. 11 — FM translator—block schematic.

### 5.3 Receiver/Transmitter Combinations (Television and FM Sound)

A receiver/transmitter combination provides a somewhat easier solution to the aerial coupling problems. It is sometimes desirable to use such a combination if there is to be programme injection from some local source, or if the necessary separation between the receiving and retransmitting aerials is such that the only form of economical connection is by cable carrying the basic video or sound signal.

#### 5.3.1 FM Drive Unit

For use at these stations which receive the programme signal by line, or where, for some reason, a translator cannot be applied, a simplified form of FM drive equipment

has been developed in the BBC Engineering Division.<sup>4</sup> Its basic circuit is shown in Fig. 13, and Fig. 14 is a photograph of the complete drive equipment for a single channel.

Referring to Fig. 13, it will be seen that the frequency of oscillation is determined by the value of inductances  $L_1$  and  $L_2$  in association with the capacitance  $C$  and the capacitance between the base of VT1 and ground. The value of the latter capacitance is varied in a number of ways. It may be regarded as approximately proportional to the current flowing through VT1 and inversely proportional to the amount of negative feedback provided by VT2. An audio signal causes variation in the current flowing through both VT1 and VT2, thus changing the capacitance across the base and emitter of VT1, and also the resistance of VT2. The current may be adjusted so that the change in oscillation

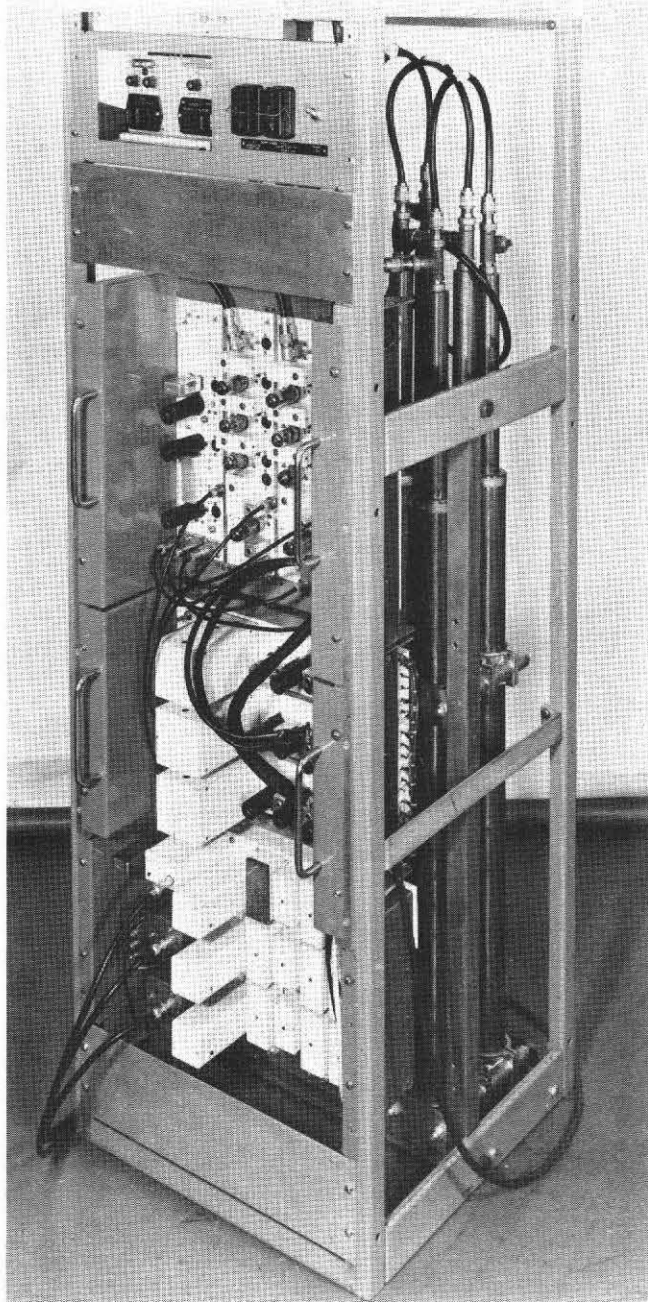

Fig. 12 — Three-channel FM sound translator. The lengths of tubing in the rear are the coaxial filters.

lator frequency is linear with respect to the applied audio signal.

This arrangement can be made to provide full deviation (i.e.  $\pm 100$  kc/s) at a very low mean carrier frequency (in this instance, 2.6 Mc/s) without loss of linearity. This frequency is raised to the required Band II value by the addition of a separately generated frequency. The separate oscillator can be crystal controlled to a high order of stability and the overall frequency errors are consequently less than in a system using multipliers.

### 5.3.2 FM Receiver

A transistorized FM receiver has been designed to give rebroadcast quality and to be suitable for the diversity of purposes for which it is required.

It employs the same basic input and i.f. unit as the translator, and to this may be added the various parts required for different receiver arrangements. There are two types of crystal-controlled oscillator. In the one a single crystal is provided, whereas in the other there is a choice of three crystals so that the receiver may be switched from one channel to another. In both cases the oscillator frequency may be set above or below the input signal frequency according to the arrangement which provides the better reception.

The discriminator is of a modified Foster Seeley type,<sup>5</sup> and sufficient audio output is provided for rebroadcast or monitoring purposes according to how the receiver is employed.

As normal power supply arrangements may be difficult at some receiving sites, the power consumption of the receiver is restricted so that it may be supplied over the interconnecting signal line.

### 5.3.3 Television Receiver

This has been specially designed to have good reliability for unattended working and to minimize the amount of distortion which inevitably arises in the detection process. The i.f. stages are arranged to work at a lower frequency than that commonly employed so that delay distortion correction may be more easily introduced.

It is desirable to reduce the number of stages of detection and modulation in the chain to a minimum, and these receivers will therefore only be employed for subsidiary unattended stations in circumstances which make the use of translators unprofitable.

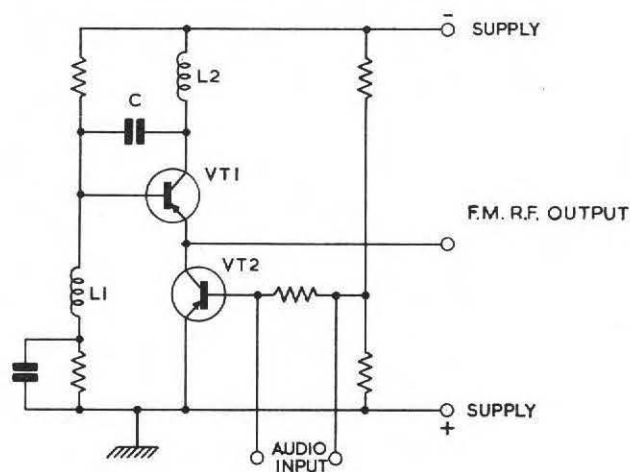

Fig. 13 — Basic FM drive circuit.



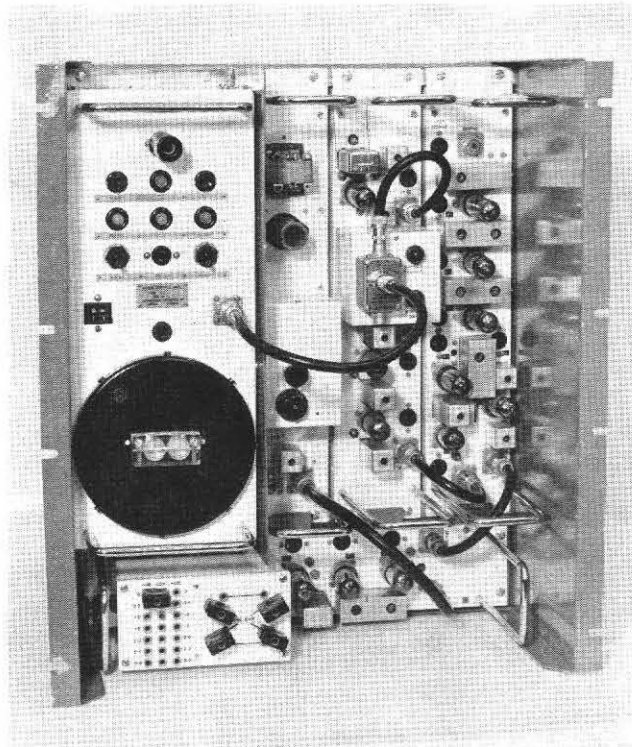

Fig. 14 — Drive equipment for modulating one FM channel from an audio signal. The basic 2·6 Mc/s drive (see Sec. 5.3.1.) is in the oven on the left, and the two small crystal ovens on the other panels form part of a two-stage frequency-changing system.

## 6. Reliability and Monitoring of Relay Stations

There is no doubt that an appreciable advance has been made in reliability of unattended stations since the data on this subject was given in a previous paper,<sup>1</sup> and this increase in reliability has made an extensive subsidiary station expansion a really worthwhile project.

Reliability is being improved in several ways. Past experience has shown that it is wise to remove from the apparatus, or its linkage, anything with which a maintenance worker or an operator can tinker. It is well known, for example, that the number of faults on the land lines which have been used for broadcasting is approximately proportional to the number of interception points. Although radio links may be liable to noise, avoidance of the use of land lines produces a great simplification, but on the other hand it practically removes the chance of having an indication, back at the base or parent station, that a failure has occurred.

With the larger relay stations, particularly where failure would have a widespread effect, some attempt is being made to replace partially the monitoring facility that has been lost.

Equipment is sometimes provided to make an automatic replacement when a breakdown occurs. For example, some of the larger television translators will be provided with translator units in duplicate. A relay, operated by an appreciable change in A.G.C. feedback voltage, is used to initiate the changeover. This means that both the normal and the spare equipment must be powered when transmission from the parent station is about to start, so that failure is known by a difference between the A.G.C. voltages in the two sets of equipment, i.e. if the spare equipment A.G.C. voltage indicates that a signal is being received and the normal equipment has no such indication, it may be assumed that the normal equipment is at fault, and a changeover is made.

An additional aid to monitoring television transmissions is a device which receives the vision and sound carriers and detects the 3·5 Mc/s difference frequency between them. Should either carrier fail the 3·5 Mc/s beat signal will disappear and the device will give an alarm. This may be fitted in the home of a local maintenance engineer.

In order to avoid the translator equipment having to be left running for the twelve hours or so when there is no transmission, a time-switch is fitted to reduce the value of the h.t. supply for most of this period. The filaments of the valves are left running as it is doubtful whether switching filaments, even only once a day, provides any economy in life against leaving them running continuously. It is likely, however, that the life may be extended if the anode dissipation is cut. A trickle of anode current is allowed to flow in the dormant period so that cathode poisoning is less likely to ensue.

Naturally, wherever possible, transistors are employed, as experience so far suggests that further improvement in reliability can be attained by their use. Although a part of the small subsidiary station equipment is transistorized, the only unit where this is complete, so far, is in the FM receiver. Full transistorization is made possible in this unit as, at the higher power levels, only audio amplification is required.

To assist in the monitoring of VHF/FM relay stations, at some of the parent stations a monitoring tone of 20 kc/s is superimposed on the programme at such a level as to be below the threshold of audibility. At the relay stations a detector may be fitted to monitor the 20 kc/s tone in the transmitter output so that if, during normal broadcast hours, the detector shows a failure of 20 kc/s tone it may be assumed that one of two things has happened: either the parent station transmission or the apparatus being monitored at the relay station has failed.

The receivers are also fitted with a relay which releases if the received carrier drops substantially below its normal amplitude, and this further facilitates the automatic location of trouble.

In general, however, it is hoped to make both the television and sound subsidiaries, at least those of lower power output, so reliable that breakdowns are extremely rare, and this should avoid the additional complication and expense of automatic changeover arrangements.

## 7. Maintenance

The small-station equipment has been designed so that it can be rack-mounted or installed in a weatherproof cabinet.

The weatherproof cabinet seems to be the logical solution for small isolated stations, but where a larger amount of apparatus is needed, such as at a combined television and VHF sound station, the weatherproof cabinets will probably be replaced by a kiosk in which there is also some standing room for servicing of the equipment by a visiting engineer.

The plan, so far, is for a regular call to be made at each of the new unattended stations. The function of the call will be to ensure that the equipment is working, and to examine valve feeds. When a valve feed appears to be approaching its lower limit, the valve will be replaced in anticipation of failure. No attempt will normally be made to repair a unit in the field, other than by the obvious replacement of a valve, etc. If such action does not restore the operation of the apparatus, the whole unit will be removed and replaced by a spare.

Naturally, if the relay station is reasonably near to some main station where staff is available, such staff may be used for visits of this kind. More often, however, these stations will be situated in remote and isolated districts and in such circumstances it might be considered advantageous to employ an engineer resident in the area.

If automatic changeover is generally discarded it seems logical to expect nominated members of the public or radio trade to call attention to a complete breakdown so that the occasional fault may be repaired with the minimum delay.

It is evident that experience in the next few years will shape the methods by which such plant is maintained.

## 8. Planning and Installation

In addition to the original television translator at Folkestone, seven television and six multi-programme VHF

stations have now been brought into service. Work is proceeding on a further thirteen television stations, eight of which will have VHF transmitters on the same sites. VHF sound transmitters are also being installed at Sheffield, where a television station is already in service. Approval has been obtained in principle for the erection of combined television and VHF stations at another eighteen sites, as well as television stations at eleven sites and VHF stations at five sites. Tables 1 and 2 give lists of the stations to which this monograph primarily refers, i.e. those which have been completed since the first translator came into service in July 1958, or which are now being installed, and (in Table 2) those whose future commissioning has been authorized.

Wherever possible the translator principle as described in this paper is also used in the larger stations for both television and VHF retransmission.

The selection of new station sites, so that the best compromise is obtained in every way, is an extremely complicated process and will necessitate a great deal of planning work before it can be brought to fruition. It is possible that this work will be the subject of a further monograph.

## 9. Acknowledgment

Acknowledgment is made to the authors' colleagues who have collaborated in designing the apparatus needed in the provision of these stations.

## 10. References

1. Wynn, R. T. B. and Peachey, F. A. *The Remote and Automatic Control of Semi-Attended Broadcasting Transmitters*. Proceedings I.E.E. paper No. 2329R, 1957 (104B).
2. British Provisional Patent Application No. 41605.
3. Macdiarmid, I. F. *Waveform Distortion in Television Links*, Post Office Electrical Engineers' Journal, 52, Parts 2 and 3, July and Oct. 1959.
4. British Patent No. 880,728 by F. L. Coombs.
5. Head, J. W. and Mayo, C. G. *Combined Limiter and Discriminator*, *Electronic and Radio Engineer*, Vol. 35, No. 3, p. 85. March 1958.

TABLE I  
RELAY STATIONS IN SERVICE AND UNDER CONSTRUCTION

Location	Television			VHF Sound			
	Type	Mean e.r.p.	Method of Programme Feed	Type	Mean e.r.p.	Method of Programme Feed	
Stations now in service	Dover*	Transmitter	0.38 kW	Line or Broadcast Reception	Translator	3.1 kW	Broadcast Reception
	Folkestone	Translator	2 W	Broadcast Reception	—	—	—
	Hastings	Translator	2 W	Broadcast Reception	—	—	—
	Les Platons*	Transmitter	0.8 kW	SHF Link or Broadcast Reception	Transmitter	0.8 kW	Broadcast Reception
	Llanddona	Transmitter	2.3 kW	SHF Link	*Transmitter	5.9 kW	Broadcast Reception and line
	Llandrindod Wells	Translator	1.3 kW	Broadcast Reception	Translator	1.4 kW	Broadcast Reception
	Londonderry*	Transmitter	0.8 kW	SHF Link or Broadcast Reception	Transmitter	5.6 kW	Broadcast Reception
	Manningtree (Ipswich)	Transmitter	1.8 kW	G.P.O. Link	—	—	—
	Beckley (Oxford)	Translator	0.4 kW	Broadcast Reception	Translator†	11.5 kW	Broadcast Reception
	Redruth	Translator	4.6 kW	Broadcast Reception	Translator	4.2 kW	Broadcast Reception
	Sheffield	Translator	50 W	Broadcast Reception	Under construction (see below)		
	Ashkirk (Galashiels)	Translator	7 kW	Broadcast Reception	Translator	9.8 kW	Broadcast Reception
	Ballachulish	Transmitter	50 W	SHF Link	—	—	—
	Stations under construction	Enniskillen	Translator	3.4 kW	Broadcast Reception	Translator	2.9 kW
Forfar		Translator	2.3 kW	Broadcast Reception	Translator	5.4 kW	Broadcast Reception
Fort William		Transmitter	1.6 kW	SHF Link	Transmitter	1.5 kW	Broadcast Reception
Kinlochleven		Translator	3 W	Broadcast Reception	Transmitter	2 W	Line
Morecambe Bay		Split‡ Translator	1.8 kW	SHF Link (mod. at I.F.)	—	—	—
Oban		Transmitter	1.6 kW	SHF Link	Transmitter	1.5 kW	Line
Pembroke		Transmitter	4.3 kW	SHF Link	Transmitter	1.7 kW	Broadcast Reception
Scarborough		Translator	70 W	Broadcast Reception	(See Table 2)		
Sheffield		Translator in service (see above)			Translator	60 W	Broadcast Reception
Shetland		Transmitter	3.0 kW	SHF Link	Transmitter	5.5 kW	Broadcast Reception
Skegness	Transmitter	60 W	SHF Link	—	—	—	
Swindon	Translator	80 W	Broadcast Reception	—	—	—	

\*These stations were in service before the first translator was commissioned in July 1958. They are included in this list in order to make it clear that the places in question have both television and VHF sound coverage.

†Four-programme station using both translators and transmitters.

‡In a split translator the receiving end of the translator is remote from the transmitting part, and interconnection is made at i.f.

TABLE 2

## PROJECTED RELAY STATIONS

The commissioning of stations in the following areas has been approved in principle, but the exact sites and details of the installations have not yet been finally settled:

<i>Station</i>	<i>Service(s) provided</i>		<i>Station</i>	<i>Service(s) provided</i>	
Barnstaple	TV	VHF	Hereford	TV	VHF
Barrow		VHF	Holyhead	TV	
Bath	TV	VHF	Kendal	TV	VHF
Bedford	TV		Larne	TV	VHF
Berwick-on-Tweed*	TV	VHF	Lewis	TV	VHF
Bexhill	TV		Machynlleth	TV	VHF
Blackpool	TV		Newry	TV	VHF
Brecon		VHF	Northampton	TV	VHF
Brighton	†	VHF	Okehampton	TV	VHF
Cambridge	TV	VHF	Perth	TV	VHF
Canterbury	TV		Pitlochry	TV	VHF
Carmarthen	TV	VHF	Rothesay/Largs	TV	VHF
Cheltenham/ Gloucester	TV	VHF	Scarborough (See Table 1)		VHF
Dundee	TV		Skye	TV	VHF
Eastbourne	TV		South-west Scotland		VHF
Grantown-on-Spey	TV	VHF	Ventnor	TV	
Grimsby	TV		Weardale	TV	
			Woofferton	TV	

\*Will not be required if Ashkirk gives an adequate service in Berwick.

†Television service already provided from Whitehawk Hill.



## BBC ENGINEERING TRAINING MANUALS

The following manuals by members of the Engineering Division of the BBC have been prepared primarily for the Corporation's operating and maintenance staff. They have been made available to a wider public so that the specialized knowledge and experience contained in them may be open to all interested in the engineering side of sound and television broadcasting.

**Sound and Television Broadcasting: General Principles**—K. R. Sturley, Ph.D., B.Sc., M.I.E.E. 45s. net, by post 46s. 4d. 378 pp.

*This manual explains the basic principles of sound and television broadcast engineering and operations.*

**Studio Engineering for Sound Broadcasting**—General Editor: J. W. Godfrey. 25s. net, by post 26s. 208 pp.

*Explains the principles underlying current operational procedures at BBC studio centres. Covers the whole range of equipment used and the problems arising in the studio.*

**Television Engineering: Principles and Practice**—S. W. Amos, B.Sc.(Hons.), A.M.I.E.E., and D. C. Birkinshaw, M.B.E., M.A., M.I.E.E.

*Vol. I: Fundamentals, camera tubes, television optics, electron optics. 35s. net, by post 36s. 2d. 302 pp.*

*Vol. II: Video-frequency amplification. 35s. net, by post 36s. 2d. 270 pp.*

*Vol. III: Waveform Generation. 30s. net, by post 31s. 2d. 224 pp.*

*Vol. IV: General circuit techniques. 35s. net, by post 36s. 2d. 268 pp.*

These Manuals are published by ILIFFE BOOKS LTD, DORSET HOUSE, STAMFORD STREET, LONDON, S.E.1, for the British Broadcasting Corporation, and are available from the publishers or from BBC PUBLICATIONS, 35 MARYLEBONE HIGH STREET, LONDON, W.1.

