

M. MCINTHEATY

BBC ENGINEERING

Number 98 May 1974

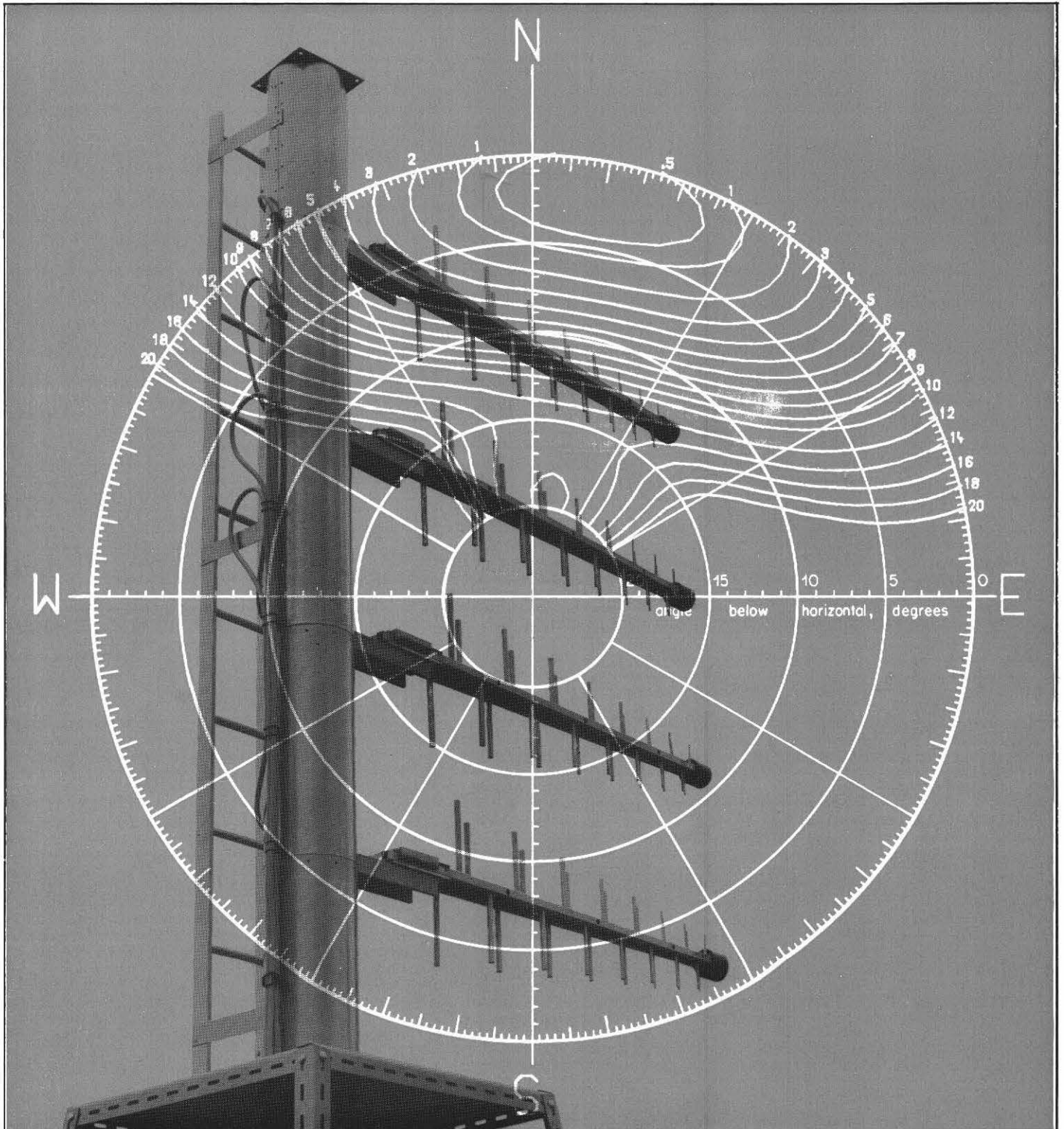

BBC Engineering

including Engineering Division Monographs

A record of BBC technical experience and developments
in radio and television broadcasting

Contents

Published approximately four times per year by
BBC Publications,
35 Marylebone High Street,
London W1M 4AA
ISBN 0 563 127600

Edited by
BBC Engineering Information Department,
Broadcasting House,
London W1A 1AA

Printed by
The Broadwater Press Ltd,
Welwyn Garden City,
Herts.

Price
40p or \$1.00 per issue post free
Annual Subscription
£1.50 or \$4.00 for 4 issues post free

Articles are copyright © 1974 by the
British Broadcasting Corporation
and may not be reproduced in whole
or part without written permission.

Editorial: Highways and Byways of Communication 2

Principal Articles

Maida Vale: A Radio Music Centre
by A. R. Neale 4

Digital Television Recording:
A Review of Current Developments
by A. H. Jones 18

The Automatic Plotting of Aerial Radiation Patterns
by G. H. Millard and N. F. Spring 28

An Automatic Shot-change Detector for Telecine
by J. R. Sanders and M. Weston 35

Short Items

8-bit Analogue-to-digital and Digital-to-analogue
Converters for Vision Signals 41

Insertion Communication Equipment (ICE) 42

Multiplexed Transmission of Vision Signals 42

*Publications available from Engineering Information
Department 44*

The cover photograph shows the Ogmore Vale u.h.f. transmitting aerial and a polar contour plot of its radiation pattern.

The major contributions are preceded by individual lists of contents.

Editorial

Highways and Byways of Communication

The majority of broadcasting is confined to the region which extends from 100kHz or so up to 1000 MHz and in this region of the spectrum approximately 60% is allocated to broadcasting. Nevertheless the world need for broadcasting frequencies is such that even higher frequencies are being considered and the search at the moment is only limited at the upper end by absorption due to water vapour etc., and the lower end due to the poor efficiency of the aerials employed. The desire to introduce the new CEEFAX data service prompted a search of the existing broadcasting frequencies to see whether space was available for this new activity.

At first sight, the broadcast bands appear to be relatively empty. An uninformed person might accuse society of wasteful planning and search for some means of using this spectrum space more efficiently. This leads us to further consideration of modulation systems. To a great extent our choice of modulation systems has been determined by the ease with which a tuned circuit can select a frequency and the simplicity of a diode circuit which detects the presence of modulation. If we assume that a satisfactory service for an audio frequency signal requires 30dB of co-channel protection, it follows that, statistically, a large part of the earth is in a twilight area where the signal is not good enough to be useful but sufficiently large to contaminate the channel and render it useless for other purposes. Planning problems are further complicated by the vagaries of the ionosphere and the changes which take place between night and day.

There are small spaces within the v.h.f. and u.h.f. spectra which can still be used but, in common with many other things, the world's resources in available frequencies are becoming rapidly exhausted. However, to exploit the remaining new frequencies the public would need new receivers and the ever-present financial limitations would make this a difficult course of action.

As the CEEFAX system has to live in a practical world which has a large investment in broadcasting systems and receivers, the search for a possible communication system is necessarily limited to two lines of approach:

(a) *Frequency Division Multiplex*

Consideration was given to phase modulation of existing amplitude-modulated transmitters and conversely, to amplitude modulation of frequency-modulated transmitters, without much success. Some thought was also given to the possibility of radiating signals above and below the audio band

and to adding subliminal signals in 5Hz notches within the audio band. None of these investigations proved to be very profitable when more than a few bits per second had to be transmitted and our attention was soon focused on to the prospect of sending CEEFAX signals in conjunction with the television signal.

For the frequency division multiplex one may consider squeezing in a signal anywhere within the 8 MHz of the u.h.f. television channel. At first sight, there are two possibilities. One is to add a signal to the sound carrier as an a.m. or f.m. sub-carrier. To some extent these options have been pre-empted by the international consideration of second sound channels in this region. However, if the need arose, this could be used for the transmission of about 8kbits/s. The second is to use a separate carrier outside the normal energy spectrum of the television waveform: consideration of receiver characteristics suggested that it would be possible to insert a separate carrier at 6.25 MHz from the existing vision carrier and create a data transmission service of about 47kbits/s. The problems of ensuring receiver compatibility throughout the country limit the amplitude of this carrier and might well limit the service area to something less than the existing television service area.

It is also worth while considering the fine structure of the television waveform and noting that by choosing a sub-carrier which is an odd multiple of half-line frequency, one could transmit a low-level data signal in a manner very similar to that employed by the sub-carrier of a compatible colour system. We are assured that such a data transmission system is possible in the region below the existing colour sub-carrier, but the communication capacity may, in practice, be limited to about 7.5 kbits/s. Unfortunately, the system is somewhat inflexible in that it is difficult to alter or process such a signal without disturbing the data component.*

(b) *Time Division Multiplex*

If one studies the television waveform it becomes clear that there are times when a data signal could be inserted without disturbing conventional receivers.

In the line synchronising and suppression periods, earlier work considered introducing a pulse and modulating its amplitude or position. Other alternatives were to introduce phase-keyed bursts of a high-frequency carrier or to amplitude-modulate the colour burst.

Other alternatives involve using the television lines within the vertical interval. If, for example, one inserts the signal on

* Hazeltine Laboratories, Chicago, USA.

one line in the vertical interval one can create a flexible data communication system which will initially carry an average figure of 17 kbits/s using one television line and this signalling capacity can be extended if there is sufficient demand by including further lines in the vertical interval.

Unfortunately, we cannot use all of the lines in the vertical interval. If we use the early lines, the data may appear on the flyback of some receivers and if we use the very late lines, the data will appear at the top of the picture. This latter complaint was thought to be less serious in that most receivers could have their vertical scan amplitude adjusted to exclude the data signal.

Conclusion

Regrettably, there are competing bids for the use of the vertical interval for purely engineering purposes. However, it appeared that it was not too late to satisfy both needs and a decision was made to radiate experimental CEEFAX signals on lines seventeen and eighteen of the television waveform and the corresponding lines of the interlace field. The system has the additional advantage that it is flexible and data may be added or removed to produce local variations if required.

Maida Vale: A Radio Music Centre

A. R. Neale, C.Eng, MIERE

Project Leader, Studio Capital Projects Department

Summary: A description is given of the restructuring of the studio complex at Maida Vale in order to contend with the increasing volume in music programme origination and to provide an additional studio.

- 1 Introduction
- 2 Restructuring necessitated by the new developments
 - 2.1 Stereo on all networks
 - 2.2 Impending loss of other music studios
 - 2.3 'Pop' at very high level
 - 2.4 Introduction of new techniques in recording
 - 2.5 Additional work carried out
- 3 Order of work
- 4 Constraints
- 5 Common conditions for studios and control rooms
 - 5.1 Air-conditioning
 - 5.2 Lighting
- 6 Special building requirements for studios and control rooms
 - 6.1 Studio 2
 - 6.2 Studio 3
 - 6.3 Studios 2 and 3 control rooms and V2 recording channel
 - 6.4 Studios 4 and 5 and associated control rooms
 - 6.5 Studio 6 and associated control room
- 7 Technical equipment
 - 7.1 Studios 2 and 3 and associated control rooms
 - 7.2 Recording channel V2
 - 7.3 Studios 4 and 5 and associated control room
 - 7.4 Studio 6 and associated control room
 - 7.5 Main apparatus room
- 8 Services
 - 8.1 Restaurant
 - 8.2 Outside broadcast furniture store
 - 8.3 Heating
 - 8.4 Air-conditioning
 - 8.5 Electricity supply
 - 8.6 Emergency generator supply
 - 8.7 Emergency lighting
 - 8.8 Fifty-volt power supply
 - 8.9 The clock system
- 9 Probable future work
 - 9.1 Rehearsal room/ancillary technical area
 - 9.1.1 Rehearsal room
 - 9.1.2 Ancillary technical area

- 9.2 Studio 1
- 9.3 Additional accommodation
- 10 Present situation

1 Introduction

Since the beginning of the nineteen-seventies radio broadcasting, and BBC Radio in particular, has faced several new developments for which answers have had to be found. These developments may be cited as:

- (a) The introduction of stereo on all networks.
- (b) The loss of a leasehold building containing music studios.
- (c) 'Pop' groups playing at very high levels.
- (d) The introduction of new techniques in recording.

This article sets out to show how the BBC, having recently acquired the freehold of the Maida Vale sound studio complex, has met the situations created by these developments in its replanning of this building.

The five studios at present available in Maida Vale (Fig. 1), and their dimensions when the current replanning has been completed, are:

- No. 1 31 m × 22m
This is the BBC's principal large orchestral studio, and is used for symphony orchestras, sometimes accompanied by choirs. In recent years the interior of this studio has undergone a number of modifications which have been described in the literature, and the studio is involved in the current replanning only in so far as its air-conditioning system will be improved.
- No. 2 21 m × 12.5m
Classical music recording.
- No. 3 22 m × 13m
Large light orchestras and bands.
- Nos. 4 Both 11.5 m × 8.5m
& 5 'Pop' groups and small bands or orchestras.

When the replanning has been completed, a new studio, No. 6, of 16 m × 12 m will be available. This will be for 'pop' groups and dance bands.

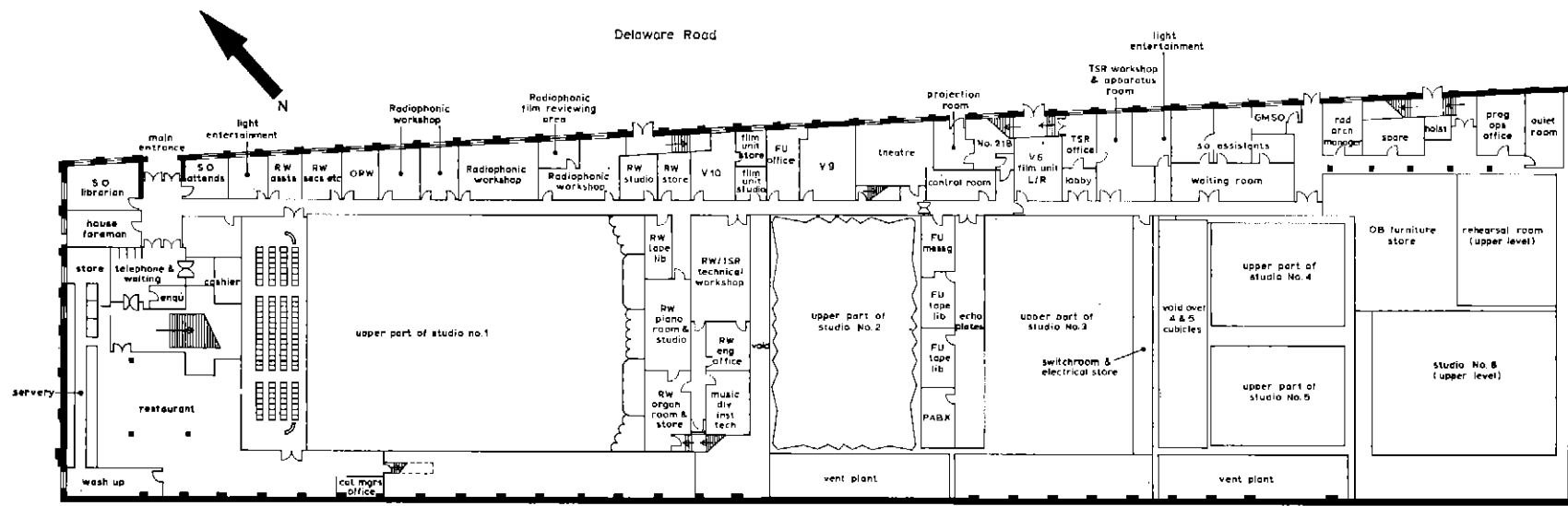

Ground floor plan

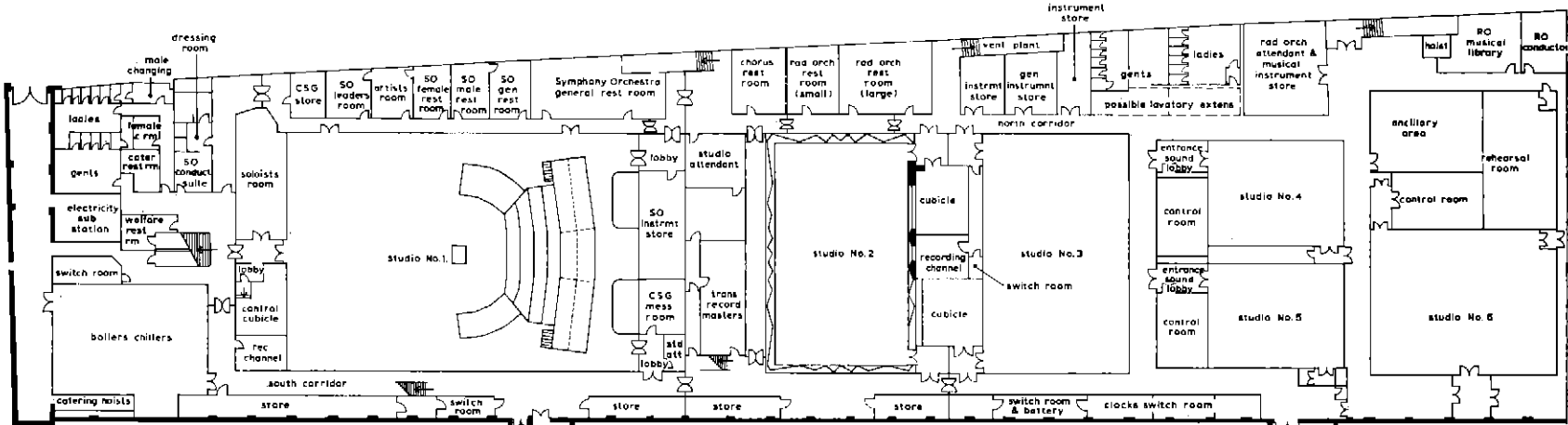

Lower ground floor plan

Scale 1:200

EID 028LP 10/73

Fig. 1 Floor plans of Maida Vale after rebuilding

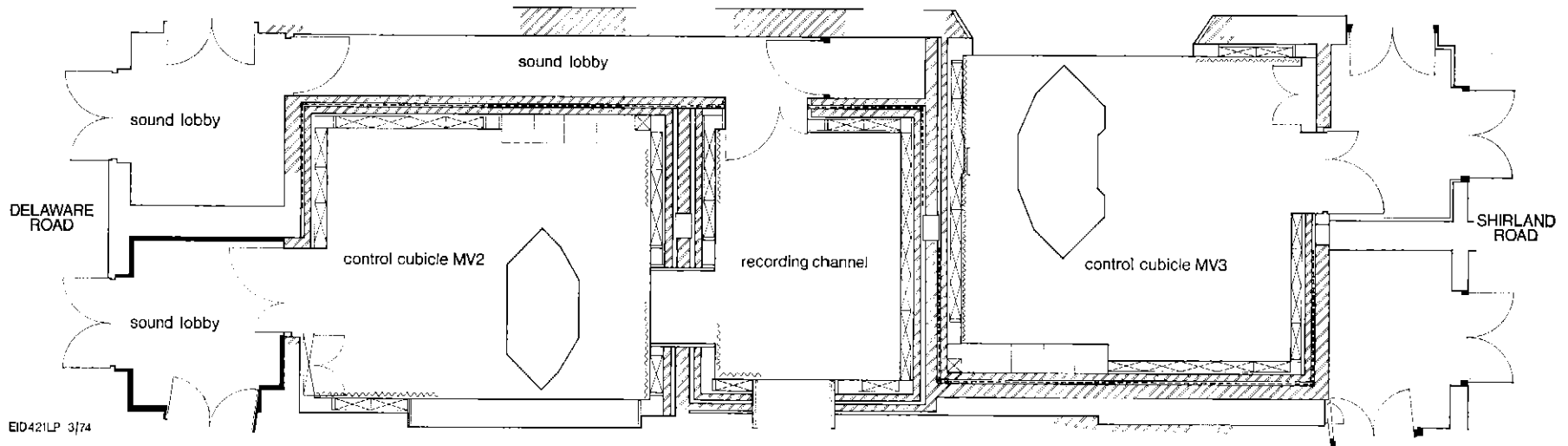
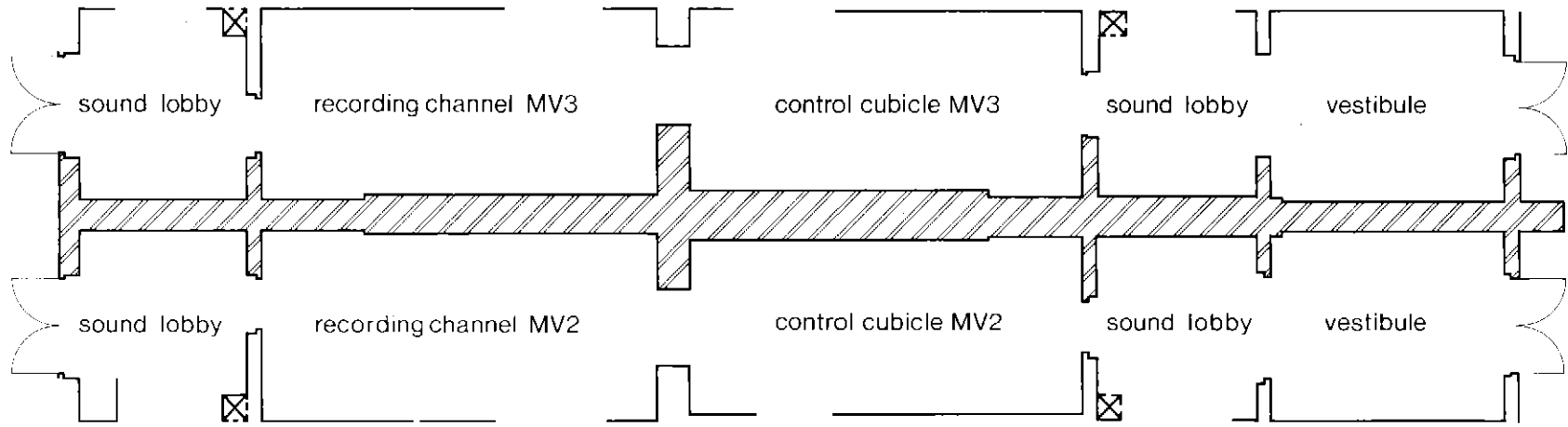

EID421LP 3/74

Fig. 2 Control rooms and recording room of studios 2 and 3 before and after rebuilding

A rehearsal room will also probably be made available in the replanning. This will be mainly for rehearsals by symphony orchestras and other 'serious' music combinations, but it will also be possible to use it as a studio.

For convenience, the dimensions of these studios are repeated in the descriptions which follow.

2 Restructuring necessitated by the new developments

2.1 Stereo on all networks

The sudden increase in the output of stereo on the Radio Networks called for provision of extra music studios capable of stereo production.

The shape of the existing control rooms (e.g. studios 2 and 3 as in Fig. 2) was unsuitable for stereo. In order to accommodate the equipment required, and to present the correct aspect ratio for stereo, the control rooms needed to be changed in shape and enlarged. The aspect ratio required should be in the range of 1:1.2-1.4 (e.g. 5 m wide by 7 m long), whilst the overall size is governed by:

- (a) The size of the desk.
- (b) The equilateral triangle between the speakers and the Studio Manager – normally with sides of not less than 2.5m.
- (c) Space required behind the desk for the Producer, Arrangers, Artists, Managers etc.
- (d) Space required for the provision of reproducing and recording machines etc. – i.e. tape recorders and disc reproducers.

With the exception of studio 1 – the control room of which was already converted to stereo in 1967, using the BBC designed Type 'D' stereo desk – all of the studios were equipped with BBC designed Type 'A' monophonic desks. These desks, installed in the 1950s, were obsolete, being valve equipment, were lacking in facilities, and were becoming more and more difficult to maintain.

2.2 Impending loss of other music studios

The termination of the lease of Aeolian Hall in 1975 will deny Radio the use of two music studios – one of 19 m × 9 m, and the other of 13.5 m × 7 m. Although these are monophonic studios, it would be possible to convert them to stereo, and in fact the smaller studio was converted on a temporary basis for stereo and multi-track working (see section 4).

Investigation by Radio into the allocation of its music studios, showed that only the larger studio needed to be replaced. The load of the smaller studio could be redistributed over existing studio resources in London and the Regions.

Space existed for this studio at Maida Vale, providing that the services for the building (e.g. heating and ventilation etc.), were reorganised. Further explanation of this is given in section 8.

2.3 'Pop' at very high level

The increase in the level of sound generated by 'pop' groups – now of the order of 120dBA – was breaking through into adjacent studios and interfering with the production of other programmes taking place in these studios. This could only

Fig. 3 Control room of studio 2 at Aeolian Hall



be dealt with by a rebuilding programme which satisfied the sound isolation requirements, involving a different concept (see section 6.4).

2.4 Introduction of new techniques in recording

Members of 'pop' groups often play a variety of instruments for the same piece of music, so that each instrument must be recorded and then played back into the final balance. Using conventional quarter-inch tape a succession of 'takes' are necessary, with the subsequent increase in tape noise and distortion. Furthermore, each balance must be correct before moving on to the recording of the next 'take'. With the use of multi-track recording, each instrument may be recorded at full level on the tape, and subsequently balanced and positioned into a stereo image. Tape noise is further reduced by the use of Dolby Noise Reduction on recording and replaying from the multi-track machine.

The use of this technique has not been allowed to increase the time taken for the overall recording session.

2.5 Additional work carried out

Whilst the studio complex was being extensively altered for the previous reasons, air-conditioning was added, levels and standards of lighting improved, and the areas in general were refurbished.

3 Order of work

Work began with the stereo conversion of the control rooms of studios 2 and 3, the refurbishing of the studios being planned for later.

With the evolution of the main scheme, the refurbishing of studios 2 and 3 was brought forward, and carried out with the stereo conversion of the control rooms. To a certain extent this order was dictated by the ventilation system. Studios 2, 3, 4, and 5 were all fed from one central plant, sited at the south end of the building, the main inlet and extract ducts running at high level down the south corridor (see Fig. 1).

While the work was carried out on studios 2 and 3 the main ventilation plant was derated to serve studios 4 and 5 only. On commencement of the work on studios 4 and 5 the ventilation plant was completely shut down ready for removal.

4 Constraints

Work had already begun on the control rooms of studios 2 and 3 before planning of the major scheme was started. Before work could start on studios 4 and 5 replacement studio accommodation needed to be provided, and studios 2 and 3 returned into service, complete with new air-conditioning plant, new lighting, and completely refurbished.

Alternative accommodation was provided by using more fully the existing studios in London and the Regions. In addition, two new multi-track studios were set up – one in the Langham, Studio Langham One, the other in Aeolian Hall, Studio Aeolian Two – the smaller of the two Aeolian studios (see Fig. 3). While the work was being carried out in any section of Maida Vale, the other sections of the building

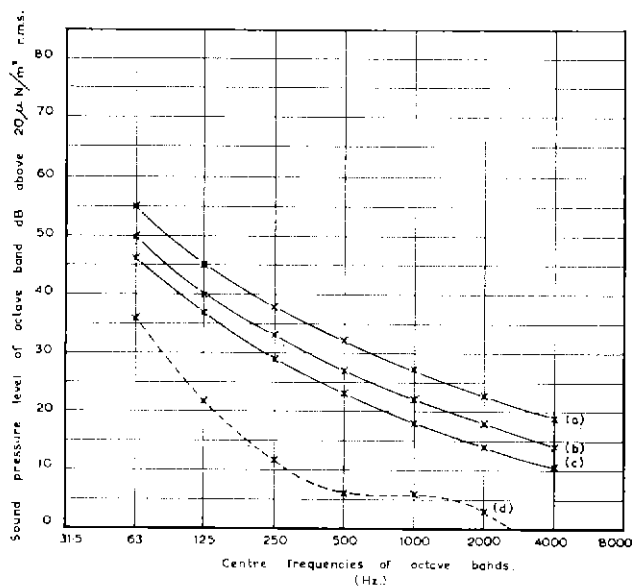

Fig. 4 BBC criteria for permissible noise level in studios. (a) Sound studios for light entertainment; (b) Sound studios (except drama); (c) Sound drama studios; (d) Threshold of hearing for continuous spectrum noise. All Maida Vale studios are built to curve (b).

containing studios and associated facilities were required to function normally and, therefore, any heavy 'knocking' work had to be carried out when the studios were not in use.

The forthcoming termination of the lease of Aeolian Hall, with the resulting loss of two music studios in the Spring of 1975, combined with the expansion of stereo, and hence the need for more stereo studios, set a tight schedule for the completion of the project.

Having explained the reason, the order of work, and constraints, for the Maida Vale Project, each stage of the work with its special problems may now be explained in detail.

5 Common conditions for studios and control rooms

Certain aspects of studios 2, 3, 4, 5, and 6 are common to all studios. These will be dealt with first, before looking at the special aspects concerned with each studio.

5.1 Air-conditioning

In studios 2, 3, 4, and 5 the existing ventilation system was incapable of holding the studio temperature below the outside ambient temperature if this was at the maximum value allowed for in the design, and if peak internal heat gains occurred at the same time. It has been replaced by an air-conditioning system which is capable of holding the temperature in the studio in the range of 21.3–23.9°C, with a relative humidity of 45–65 per cent provided that the external ambient conditions do not exceed 27.8°C dry bulb and 19.4°C wet bulb. In the control room, the temperature will lie in the range of 21.3–23.9°C with a relative humidity of 40–60 per cent for the ambient limits given above.

BBC noise level criterion curve 'B' (see Fig. 4), which is the curve recommended for music studios, applies to all studios at Maida Vale.



Fig. 5 Studio 2

5.2 Lighting

The original lighting of the studios was generally from fluorescent lights. These are now agreed to give a quality of light that is unsuitable for music studios. High-quality shadowless illumination is required for the reading of difficult music from badly printed, and often discoloured, scores. The new system is functional, rather than decorative. It consists of tungsten sources giving a high quality illumination, at a lighting level of 600lux.

The control rooms are lit by fluorescent and tungsten lights. During operational conditions the fluorescent lights are often switched out, and the control desk etc. lit by the local tungsten sources.

Fig. 6 Studio 3



Fig. 7 Construction of studios 4 and 5

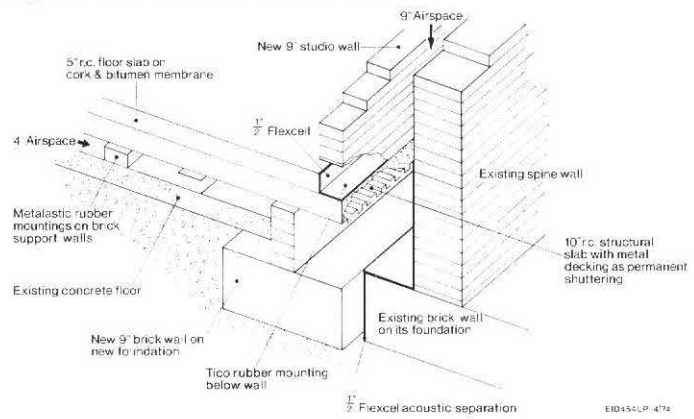

(a) Construction of floating floor

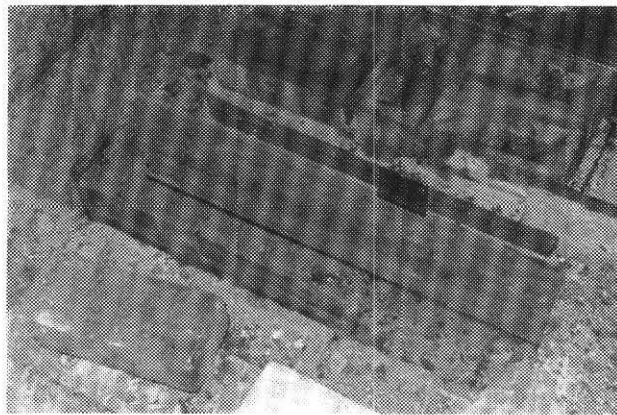

(b) Photograph of floating floor during construction



(c) Observation window showing dividing wall

6 Special building requirements for Studios and Control Rooms

Music studios are usually allocated for specific purposes, and the acoustic standards and building techniques, therefore, vary for each one.

6.1 Studio 2

It is normal in classical music production to make use of the studio acoustics, and to use very little additional electronic reverberation.

The continued use of studio 2 for classical music required the existing reverberation time to be retained after the addition of air-conditioning and other changes.

The construction of this 21 m × 12.5 m studio was, therefore, left unchanged, made good around the air-conditioning ducting, lighting changes etc., and then generally redecorated (see Fig. 5).

6.2 Studio 3

Studio 3, measuring 22 m × 13 m, is used primarily for light music. For the type of music forming the bulk of Radio 2 output, a different microphone technique is used to that for classical music. With modern light music, the microphone is placed close to the instrument, and reverberation is added by electronic means. Some acoustic reverberation is, however, necessary for the comfort of the musicians.

In order to achieve some degree of acoustic isolation between the wind instruments and the string instruments, a dividing curtain may be drawn across the middle of the studio, at right angles to the control room side. The side of this curtain farthest from the control room is reflective, and therefore brightens this end of the studio for the string players. The side of the curtain nearest to the control room window is absorbent and deadens this end for wind instruments. The orchestra is positioned in this way (see Fig. 6), in order that the Studio Manager may work on visual cues from the wind instruments.

For these reasons, the original reverberation time of 1.5 sec was too high for the intended use by large orchestras, bands etc. The reverberation time was reduced to 0.5 sec by completely redesigning the acoustic treatment using modular acoustic boxes. The reverberation time could be increased by the removal of acoustic boxes, if desired, but this would only be possible for a permanent change in the use of the studio. Final décor is achieved by covering the walls with loose curtains, made of material which is acoustically transparent.

6.3 Studios 2 and 3, Control Rooms and V2 Recording Room

Reference to the original layout of studios 2 and 3 (see Fig. 2), shows that the control rooms and recording rooms were of a long, narrow shape, and entirely the wrong aspect ratio required for stereo.

It is now general practice for modern music programmes to be recorded in the control room, whilst classical music is normally recorded in a separate recording room. Because studio 2 is basically for classical music and studio 3 basically for large orchestras, bands etc., the area was reshaped (as in

Fig. 2) with a control room for each studio, but only one recording room. This recording room (V2) will normally work with studio 2 but can work with studio 3 or on its own, when required.

To reshape this area, it was essential that the middle spine wall should be removed. This wall was originally built to divide the area into separate compartments for acoustic isolation (i.e. between 2 and 3) and was therefore taken right up into the apex of the roof. It consisted of solid brick to a thickness at the base of approximately 850 mm, all of its joints being infilled with sand and cement. Before it could be removed at the lower ground floor level steel needles were inserted above the ceiling level of the control room (i.e. above ground floor level) and supported from the lower ground floor slab by scaffold pole props, whilst a new reinforced concrete ground beam, rolled steel joist stanchions, and rolled steel joist cross-beams were added. Finally, with the wall firmly sitting on the cross-beams the scaffold pole props and needles were removed and the wall made good.

A void was left between studio 2 and the control room of studio 3 to improve the acoustic isolation between these two areas. Similarly, the corridor to the recording channel, which runs between studio 3 and the control room of studio 2, was used for the same purpose.

To further improve acoustic isolation between the control rooms and the studio, the control room floors were supported on metalastic pads, the walls being constructed as shown in Fig. 2.

Great care was taken when building the cavity walls to make sure that there was no bridging of the cavity.

The common concrete slab which existed over the control rooms and the recording channel was cut in the position shown in Fig. 2, so that it did not bridge these cavities.

Further acoustic isolation was obtained by the use of triple and quadruple glazing in the observation windows, and the use of newly-designed studio doors, consisting of two sheets of 25 mm blockboard, separated by a 2.24 mm (BS Code No. 5) sheet of lead. The door and window surrounds were solidly packed with a dense filling to reduce acoustic leakage by airborne routes.

The combination of these techniques has improved the overall acoustic isolation between the studios and the control rooms, but the increase in volume from the originating sources and the monitoring equipment has largely eroded the advantages gained.

6.4 Studios 4 and 5 and associated control rooms

These studios, when originally constructed, were of an irregular shape and wasteful of space: the shapes and sizes of the existing control rooms were unsuitable for stereo. The studios were therefore rebuilt to a size of 11.5 m × 8.5 m, with the control rooms suitably sized for stereo.

It was intended that the studios should be used for 'pop' groups, small dance-bands, or small orchestras, with or without strings etc. Because the microphone technique used is similar to that in studio 3 and also due to the very infrequent use of the string part of the orchestra, a reverberation time of 0.4 sec was required. The main problem, however, on the building side, was to contain the high sound level now being generated by 'pop' groups.

The existing conventional structure of studio and control room walls – i.e. a wall built on to a solid foundation – gives an acoustic isolation between studios of approximately 95dBA. Current trends indicated that ‘pop’ groups would be producing levels in the region of 120dBA.

Cost analysis showed that it was comparatively inexpensive to provide a floating studio structure when rebuilding the studios and control rooms for stereo, rather than rebuilding with a conventional structure. It was therefore decided that studios 4 and 5 should be constructed to give an acoustic isolation of 120dBA and their control rooms should have an acoustic isolation of 100dBA.

Acoustic energy is transmitted through three main routes:

- (a) structure-borne through common foundations, roof slabs etc.
- (b) air-borne energy exciting intermediate walls, and then being re-radiated.
- (c) air-borne routes involving ducting for ventilation and electrical services.

Of these (c) could have been dealt with under the existing structure by fitting silencers in the ventilation ducting and plugging service ducts etc. (a) and (b) required demolition of the existing construction, and then rebuilding of the two studios as individual floating structures of massive construction.

The slabs supporting the floating structures are mounted on rubber pads, and sit on massive structural floors, which in turn sit directly on the subsoil. The structural floors mounted directly on the subsoil should show no resonance, whilst any resonance within the floating slabs will be damped by cork membranes (see Fig. 7). If resonances are not damped, they will reduce the effectiveness of the rubber pads.

The studio walls, which are mounted on the floating slab, are of 228mm brickwork, plastered on the studio side. The central non-floating wall, which was already in existence, is of 580mm thick brickwork. A cavity exists around both studios of 257mm between the fixed and floating wall. A store on the studio 4 side of the main wall gives an effective cavity of 1450mm.

The roof construction consists of two 150mm concrete slabs, separated by a 350mm damped air space, the second slab being supported on rubber pads by upstand beams off the first slab. Roofs of this construction, with the heavy non-floating wall in between, are capable of providing a better acoustic isolation than required. This heavy construction is used, however, in consideration of nearby householders, the outside roof of Maida Vale being of very light construction.

Acoustic isolation between the control room and the studio was further increased by the use of triple glazing, and by lead-sheeted doors (see section 6.3), the surrounds being solidly packed with a dense filling to reduce airborne acoustic leakage.

Having achieved the acoustic isolation, the required reverberation time of 0.4sec was provided by the use of modular acoustic boxes. Final décor was achieved by the use of acoustically transparent curtains.

The size of the studio proper, in both 4 and 5 after modification was 11.5m × 8.5m. An acoustic curtain was provided in each studio to reduce the size by half, if required.

6.5 Studio 6 and associated Control Room

The new 16m × 12m studio will be built to the same acoustic isolation standards as studios 4 and 5, the comparative cost of building the floating structure being only marginally higher than the cost of a conventional construction. Furthermore, the high acoustic isolation standard of 120dBA will give adequate production planning flexibility, allowing the loudest ‘pop’ dance-bands and groups to be used in this studio.

The intended use of this studio is for ‘pop’ music orchestras, Radio 2 dance-bands, with or without strings etc., ‘pop’ dance-bands, Radio 2 groups and soloists. For this type of music, a reverberation time of 0.7sec is required. The acoustic treatment will be designed to give a reverberation time of 0.5 sec by the use of modular acoustic boxes, although only enough will be fitted initially to give a reverberation time of 0.7sec.

When the studio is used for dance-bands etc., in order to achieve some degree of acoustic isolation between the wind instruments and the string instruments, a dividing curtain will be provided, similar to that in studio 3 (see section 6.2).

7 Technical Equipment

As the building requirements vary for each studio so also does the technical equipment, depending upon the normal allocated use of the studio.

7.1 Studios 2 and 3 and associated Control Rooms

The control rooms of both 2 and 3 are fitted with Rupert Neve Ltd control desks, consisting basically of standard production modules. The shape of the desk, the facilities provided, and the monitoring system, were specified by the BBC before manufacture.

Studio 2 desk is equipped with twenty-four identical mono channels, and the studio 3 desk (as Fig. 8) with thirty-two channels. Each channel has an input gain control in 5dBm steps which covers levels from minus 80dBm to plus 10dBm; comprehensive frequency correction; phase reversal; choice of two echo chains, two foldback chains, and one public address chain – pre- or post-fader; pan pot; fine gain control in 0.5dBm steps, and a pre- and after-fader level monitoring on check PPM and check loudspeaker.

Stereo channels are formed by combining two adjacent channel faders with a bridging clip, and setting the pan pots fully left and right respectively. Any channel may be switched to any of the four stereo groups or to an independent busbar, and may be panned between A and B. The four groups are controlled by a master group fader which immediately precedes the main fader.

The desks also include eight compressor limiters, capable of being linked in pairs for use in stereo channels, groups or main output, and three stereo width units which may be plugged to stereo channels. A stereo reproduce source selector and an auxiliary mixer are also available.

Comprehensive monitoring is provided including stereo and monophonic monitoring of groups, main output, echo go, public address etc., and also of the ring main facilities.

For setting up the control room loudspeakers, volume, balance, phase reversal on one speaker, A and B signals on

both speakers etc., are provided. These may all be operated so that the speakers may be set with the Studio Manager in the operating position.

The layout of equipment in the two control rooms, was kept as standard as possible, the difference being the loudspeakers. The decision as to the type of loudspeaker depends on the volume required for monitoring, many loudspeakers being incapable of supplying the power required for modern music balance. Therefore, studio 2 was equipped with the BBC-designed LS.5/5 loudspeaker which is normally used for monitoring classical music, and studio 3 with commercial Tannoy York units – modern music requiring a much higher monitoring level.

Four pattrass positions are provided in studio 2 (six in studio 3) giving four stereo microphone points (six in studio 3), twenty-eight mono microphone points (thirty-five in studio 3), studio loudspeaker points, conductor's talkback, fold-back, cue lights, technical power sockets etc.

One stereo microphone point and one mono microphone point on each pattrass is capable of remote polar diagram control.

7.2 Recording Room V2

The recording channel is equipped with a standard BBC DK.1/3 linking console, which accepts an incoming signal and distributes it to the tape machines for recording. For the replay condition a simple mixer is provided so that the outputs of the tape machine may be played direct to an outside line. It is normally used in conjunction with two 'Studer' stereo tape machines, although a third may be added if required. The machines may be remotely started from the console, but must first be switched to the record or replay mode.

Full audio monitoring comprising volume control, balance control, phase reversal on one speaker, A and B signals on both speakers are provided. The loudspeakers used are BBC-designed LS5/5s.

Visual monitoring is provided by a PPM which may be switched to A and B signals or the mono signal.

Selection of the channel to either control room is made by plugging the console into the appropriate control room socket.

7.3 Studios 4 and 5 and associated Control Rooms

The control rooms of both 4 and 5 are fitted with Rupert Neve Ltd four-track output, eight-track monitor control desks. These are capable of being switched to three output configurations:

Mono – in which group two is the main output, and groups one, three, and four are routed back into group two.

Stereo – in which groups three and four are the main outputs A and B. Groups one and two can be routed via pan pots into groups three and four, giving a stereo sub-group.

Four-track – in which all four groups are independent mono groups which can be plugged to a multi-track tape machine. If more than four tracks are to be recorded simultaneously, this can only be achieved by single channels plugged direct to the tape machine.

The desk is equipped with twenty-four identical channels, each with an input gain control in three ranges, all in 5dB steps. The first is for line input, e.g. tape reproduction etc., with a range from -20 to $+10$ dB. The second two are for microphone inputs ranging from -20 to -50 dB and from -55 to -80 dB.

Comprehensive frequency correction, phase reversal; choice of two echo chains, two foldback chains, pre- or post-fader, pan pot, a fine gain control in 0.5dB steps, a cut button, and pre-fade monitoring are provided.

Any channel may be selected to any number of output groups, and when the desk is in the stereo mode, panning is normally done between groups one and three, and two and four, the pan control being selected by means of an illuminated push-button.

Although the desk is capable of giving a stereo output, until the final balance when the stereo tape is recorded, it is normally used with an eight-track recording machine. The Dolby system of noise reduction is used on the inputs and outputs of the eight-track machine.

Four Tannoy York loudspeakers are used for monitoring. Any of the eight tracks may be fed to any speaker when working with the eight-track machine, but when the final stereo balance is being achieved only the extreme outside loudspeakers are normally used.

Five pattrass positions are provided in each studio, giving thirty-five mono microphone points, studio loudspeaker points, conductor's talkback, cue lights, and technical power sockets. Eight microphone points in the studio will be suitable for remote polar diagram control, although only two will be provided, the others will be wired for phantom powering where the polar diagram configuration is set at the microphone head.

Because the studios are to be used for multi-track work only, no stereo microphones or microphone points are provided, although stereo microphones may be used, using suitable adaptors fitting into two mono microphone points.

7.4 Studio 6 and associated Control Room

The control desk used in this studio will probably be similar to that used in studios 4 and 5.

The installation of the Rupert Neve Ltd control desk in studio Aeolian 2 was carried out in such a way that it is possible to reinstall it in studio 6 control room, if required.

Because of the larger size of the studio, the number of microphone points etc. will approximate to the scale of studio 3.

7.5 Main Apparatus Room

Studio 1 is the only one which normally carries out live broadcasts and, therefore, it is the only studio to feed to Broadcasting House on a direct line. The other studios are selected to a common line by remote control from Broadcasting House.

8 Services

In section 2.2 it was stated that the studio 6 could be built at the south end of the building, provided that the existing services (i.e. boilers and ventilation plant), were moved first.

This section covers the move of these services.

8.1 Restaurant

In order to rehouse the services at the north end of the building, work initially started in this area.

The original concept of the restaurant was that the servery and main seating area were on the ground floor, whilst the kitchen existed on the lower ground floor. By redeveloping completely the servery area, the main seating area, and the cooking facilities could all be accommodated on the ground floor.

The cooking and serving equipment is arranged so that the preparation of frozen, tinned, and dry store food starts at one end of the servery area, and progresses logically to the serving counter. Because of the large number of people employed in the studios, all of whom may break for coffee etc. at the same time, a double-sided tea and coffee dispenser was installed.

During the period when the main servery was being reorganised, a temporary servery was established in the main seating area. When the temporary facility was removed, the restaurant was redecorated, and the standard of lighting improved. The replanned restaurant is shown in Fig. 9.

In order to meet the Ministry of Health regulations, separate toilets, showers, and a rest-room were provided for catering personnel.

The old kitchen area released on the lower ground floor formed part of the main plant room.

8.2 Outside Broadcast Furniture Store

This area, adjacent to the old kitchen, also required clearing in order to obtain sufficient floor area to form the main plant room, housing the boilers and the chilled water equipment associated with the air-conditioning etc.

Consideration was given to moving the Outside Broadcast Furniture Store from Maida Vale completely. This was impracticable as:

- (a) The store needs to be near to the centre of London radio operation because of the constant traffic of furniture to and from outside broadcasting sites. No other BBC building exists in central London with sufficient parking facilities to cover this constant traffic.
- (b) By storing the furniture in a studio centre, such as Maida Vale, it is under constant supervision of Central Services, and any handling is done by their skilled studio porters.

Having decided that it was necessary to store this furniture at Maida Vale, it was moved to a new area on the ground floor, with good access, which had previously been used for the storage of publication material.

8.3 Heating

The original boilers at Maida Vale were oil-fired and situated at the south end of the building. In the new area where the new boilers were to be installed, space was at a premium, and there was no room for large diesel storage tanks, without expensive structural work. Furthermore, an almost-unused 150mm gas main already existed in Delaware Road, with sufficient capacity to deal with our requirements. In view of these considerations, the new system will consist of two gas-

fired low-pressure hot-water boilers. Hot water is distributed throughout the building by two suitably-sized mains at high level, with feeds to the studios and to the house heating, which is tapped off at appropriate points. Due to the time taken to install the boilers, the old and new systems will be run in tandem for a period, the changeover from steam to hot water taking place during the summer of 1974.

Instrumentation of the heating system will be repeated in the main plant monitoring system at Broadcasting House, 4km away.

8.4 Air-Conditioning

Refurbishing of studios 2, 3, 4, and 5 will be complete before the cooling system is installed. Separate air-handling plants have been provided for studios 2 and 3 and for studios 4, 5, and 6. Initially, these air-handling plants will work as ventilation only, until the completion of the cooling system.

The common cooling equipment related to the air-conditioning will consist of two reciprocating package water coolers with associated condenser water circuits and cooling towers. The cooling towers will be mounted on a platform at high level over the driveway at the north end of the building. The cooled water will be distributed to the various users by a system of pipework suitably sized for future extension of the system.

Instrumentation of the air-conditioning system will be repeated in the main plant monitoring system at Broadcasting House.

8.5 Electricity Supply

The final estimated maximum demand for Maida Vale will be approximately 550kVA. A London Electricity Board substation, which contains a 750kVA transformer feeding the BBC and other consumers, already exists at the north end of the building. The complete output of this transformer is to be made available to the BBC and will take the form of three 400A three-phase and neutral feeders, each of which will terminate in the new Maida Vale switch-room where it will be fully metered.

8.6 Emergency Generator Supply

In order to cover the loss of electrical power due to industrial action or fault conditions, the switchboard is to be capable of taking the output of transportable generators. Should this condition arise, load shedding will have to take place at Maida Vale, so that the load may be contained within 160kW.

8.7 Emergency Lighting

Studios 1, 2, 3 and 6 are capable of use as audience studios. In order to meet the statutory requirements of the Greater London Council regarding the illumination of audience escape routes, a fully maintained emergency lighting system is provided. The system is normally fed from a 240V d.c. 5kW battery, the standing load being supplied by a charger connected to the mains supply. In the event of mains failure, the duration of the battery is 3 hours.



Fig. 8 Studio 3 control desk

Fig. 9 Staff restaurant



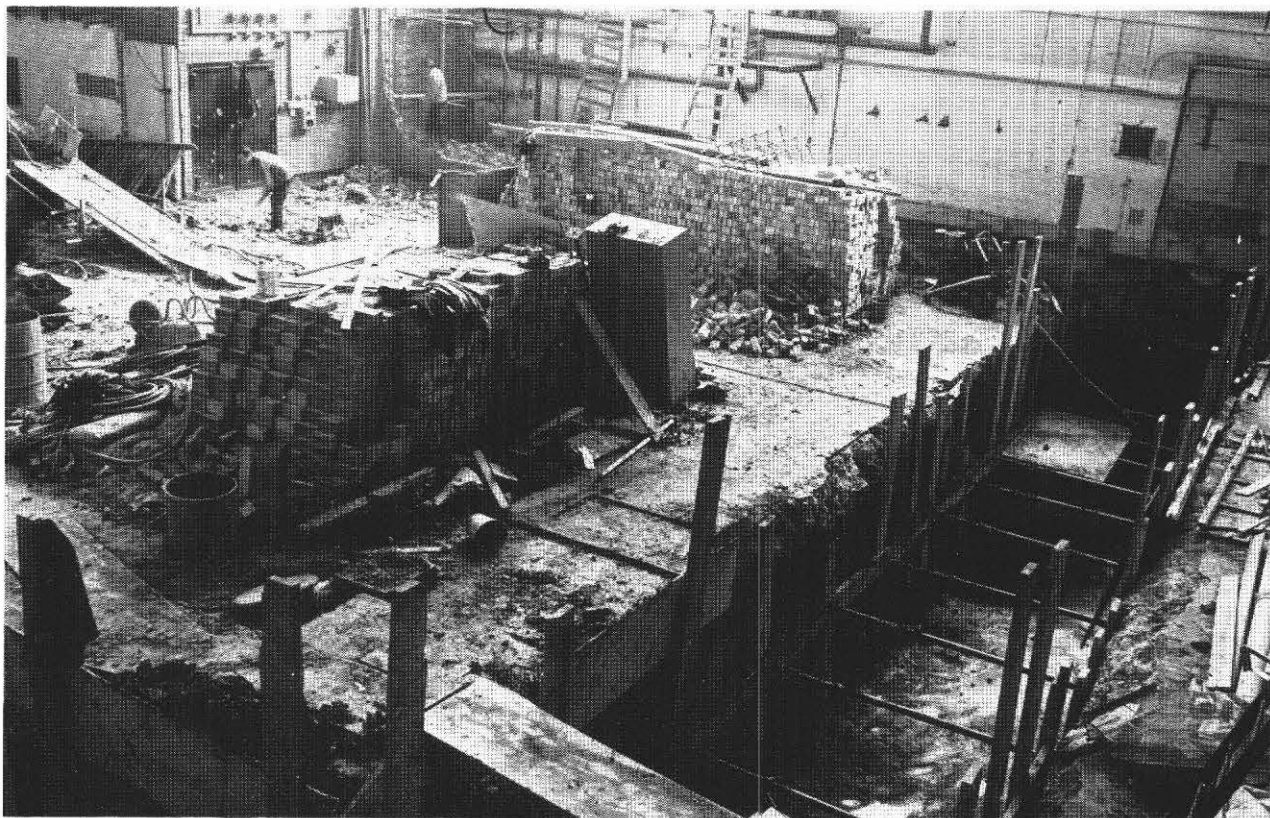

Fig. 10 Studio 6 foundations

8.8 50V Power Supplies

The existing 50V battery is in very poor condition. Separate 50V power supplies are being installed for the different areas, thereby reducing battery maintenance.

8.9 The Clock System

The new clock system will consist of a Quartz Crystal Master Clock providing an accuracy of timekeeping better than plus or minus 0.01 sec per day. In the event of failure of this clock, the system will automatically change to a standby standard pendulum master clock mechanism. The slave clocks will be fed on the normal loop system.

9 Probable Future Work

This section deals with the work which it is anticipated will take place but which is not in the present scheme.

9.1 Rehearsal Room/Ancillary Technical Area

The clearing of the ventilation plant and boilers etc., besides providing space for studio 6, also provided space for a Rehearsal Room and an Ancillary Technical Area. These are the intended primary functions of these areas, but it is proposed that they be built in such a way that they may be used as a studio and control room for use when other studios are being refurbished.

9.1.1 Rehearsal room

It is probable that the Rehearsal Room will be used mainly

for sectional rehearsals of the BBC Symphony Orchestra and other orchestras, Chamber Music rehearsals, BBC Chorus rehearsals etc. For this variety of work the acoustic treatment, consisting of modular acoustic boxes, will probably give a reverberation time of 1.0 sec. If a lower reverberation time is required, additional acoustic boxes may be added.

In order to achieve maximum production planning flexibility, it would be desirable, when the Rehearsal Room is being used temporarily as a studio, that it should be able to accommodate the loudest 'pop' groups and dance-bands. Consideration must also be given to sound leakage to the nearby residences, as well as to other studios. However, despite the 'super' construction of surrounding studios, the probable use of the rehearsal room as a 'pop' studio may make it necessary to carry out the floating construction. A firm decision has yet to be taken.

9.1.2 Ancillary technical area

As yet, no firm proposals have been made regarding this area. Discussions have ranged between a simple recording channel and a multitrack reduction room.

9.2 Studio 1

Studio 1, the large orchestral studio, has its own ventilation plant, but this is incapable of holding the studio temperature below the outside ambient temperature if this is at the maximum value allowed for in the design, and if peak internal heat gains occur at the same time. An allowance of refrigerator capacity in the central system has therefore been provided to

cater for this studio. When air-conditioning is installed the temperature will be in the range of 18.3–20°C, with a relative humidity of 50–65 per cent provided that the external ambient condition does not exceed 27.8°C dry bulb and 19.4°C wet bulb. These conditions are different to those for the other studios both in temperature and humidity. Symphony Orchestras tend to play pieces of music with very fast string movements and, therefore, the higher temperature would be very warm. In the control room the temperature will lie in the range of 21.3–23.9°C, with a relative humidity of 40–60 per cent for ambient limits as above. BBC noise level criterion curve 'B' will apply to this studio.

A new rostrum was installed in 1972, to improve the orchestra layout, and to make more effective use of the studio. The existing fluorescent lighting over this rostrum was improved by the addition of tungsten lighting, giving a quality illumination at a level of 600 lux. This interim version was within the limits of the existing ventilation system. When air-conditioning is added, the rest of the studio will be lit with tungsten sources, and the studio refurbished.

9.3 Additional Accommodation

The BBC Radio Orchestra – one of the main users of the Maida Vale studios – has at the moment no base facilities equivalent to any other full-time house orchestra.

Provision could be made at Maida Vale for two rest rooms, a Conductor's Room, a Library outpost, an Orchestral Manager's Office, Instrument Store, and an Attendant's Room. If these areas are provided, the existing areas on the ground floor and the lower ground floor, at the south end of the building, which are wasteful in space, will be redeveloped. The new offices will make more efficient use of this area and will be contained within the existing structure.

10 Present Situation

The position of the work at the present time is:

- (a) *Studios 2 and 3*
These are complete and in normal use but the air handling plant is running on ventilation only.
- (b) *Studios 4 and 5*
These are at the second roof slab stage with the air-conditioning and the studio fitting out still to be completed. The technical installation has just commenced. Completion should be by August 1974.
- (c) *Studio 6*
This is at the foundation stage (see fig. 10). Because of the poor soil loading the foundations are more massive than were originally envisaged. Difficulty has been experienced with existing drains which have required diverting and the foundations of some of the existing walls have required underpinning. Completion of the studio should be by the end of 1974.
- (d) *Heating and Air-conditioning*
Work has just commenced. Again difficulty is being experienced with foundations for the cooling platform and boiler chimney due to their close proximity to existing foundations.
Four eight-inch pipes (two for chilled water and two for heating) with their accompanying structural implications are to be installed over the roofs of all studios, whilst they carry on their normal function of programme origination.
Completion should be by the end of 1974 although as with studio 6 the effect of the strike by the coal miners and the 3-day working week on the delivery of materials is as yet unknown.

Digital Television Recording: A Review of Current Developments

A. H. Jones, B.Sc.(Hons.)

Head of Storage and Recording Section, Research Department

Summary: This article examines current developments in high density digital recording in the light of present and probable future requirements of broadcast television recording. Consideration is given to the techniques most likely to feature in future digital television recorders and it is concluded that operational machines could be made using magnetic heads and tape but that the long-term solution may well be provided by one of the newer technologies using laser beams.

- 1 Introduction
- 2 Present-day and desirable future recording facilities
- 3 Digital signal parameters
- 4 Possible recording techniques
 - 4.1 Electron and laser beam recording
 - 4.1.1 Electron beam: photographic film
 - 4.1.2 Laser beam: holographic: photographic film
 - 4.1.3 Electron beam: thermoplastic film
 - 4.1.4 Laser beam: holographic: thermoplastic film
 - 4.1.5 Laser beam: metal film
 - 4.1.6 Laser beams: magnetic films
 - 4.1.7 Laser beam: holographic: magnetic film
 - 4.2 Conventional magnetic recording
- 5 Discussion
- 6 Conclusions
- 7 References

1 Introduction

The potential benefits of digital recording have been discussed from the time that the application of digital techniques to broadcast television was contemplated. It was readily appreciated that the particular advantage of digital processing, the preservation of the original signal quality with mathematical precision, would be especially valuable in the recording area and would give greater freedom to programme makers in using editing techniques involving extensive copying. A previous report¹ reviewed a number of possible methods for recording digital signals and concluded that a technique suitable for television would ultimately emerge, and recommended that magnetic tape recording using conventional heads could meantime provide a useful basis for experiment.

Since that report was written, a considerable amount of work has been carried out on digital signal processing, and some basic investigations have been made into digital magnetic recording. As a result of this work it is now possible to assess more accurately the potential advantages of digital

recording and developments have moved appreciably closer to the point at which the basic specification of a digital magnetic recorder could be defined. Meantime, fundamental work on new recording technologies has been done in a number of laboratories including BBC Research Department.

This report gives a broad up-to-date account of these developments and attempts to predict those approaches to high-density recording, now being pursued, which are likely to prove most suitable. First, however, a brief outline will be given of the present and likely future technical requirements of the television recording area.

2 Present-day and desirable future recording ties

Video tape recording plays a major role in television programme making, and the recording machines at Television Centre are heavily employed. At any one time a machine may be used for recording the whole or sections of a programme, replaying to the network, or for rehearsals, editing, dubbing, or providing programme inserts.

A considerable amount of time is spent on editing, each one-hour programme requiring an average of eight hours of editing time. The machines can readily be coupled together in pairs, and editing is carried out mainly by running a pair in synchronism and then copying from the one to the other. Video tape editing suffers from the disadvantage, as compared with film, that the tape cannot easily be inched forward or backward to find the right frame at which to edit, but it has the valuable advantage that it is possible to arrange to rehearse the cut before making a final decision. A useful semi-automated aid to the process using a time-code address system has been installed. Bearing in mind that the cost of an editing channel is much less than that of a studio, it is likely that, as editing aids become more sophisticated, the demand for editing facilities will grow. A technique sometimes used involves the provision of a lower-grade copy of the original tape, made using a cheap helical scan machine, which enables the programme maker to arrive at editing decisions without tying up expensive quadruplex machines and their operators. This

technique could ultimately lead to a largely automated process, the decisions being fed into a computer which would then control the editing operations carried out on the quadruplex machines. This presupposes, however, that the remotely-operated high-grade machines used in the final programme assembly could be left largely unattended, so their reliability would need to be very high.

The present quadruplex machines are reasonably reliable, complete breakdowns being very rare, but minor problems of various sorts crop up from time to time. Most failures are due to mechanical difficulties involving brakes, electrical contacts, pneumatic components, and so on. However, this situation needs to be viewed against the background of extensive routine maintenance necessary to keep the machines in good order: this occupies something like half a day a week, with further adjustments to optimise recording parameters taking about an hour every two or three days. A set of heads lasts for about 250 hours; if the heads are not regularly serviced, colour banding appears and compatibility between machines suffers.

The transmission recording is generally a second-generation tape, i.e. a first copy of the original, but it may often contain third-generation inserts. Fourth- and fifth-generation material is not uncommon, however, although multiple generations are avoided wherever possible. Some tape is re-used after checking, but much of it finds its way into the archives. The tape library now represents a large capital investment, and tape costs account for a sizeable proportion of the total recording cost.

With a well-adjusted machine, a typical first-generation (i.e. an original) tape gives a fully acceptable signal with a K-rating of $1\frac{1}{2}$ per cent, 4° differential-phase distortion and 4 per cent differential-gain distortion. The signal-to-noise ratio is at least 43 dB but moiré patterning, head banding, and l.f. disturbances make the picture look somewhat worse than this suggests. The pictures from a first-generation tape would be graded about 2 on the EBU 6-point impairment scale, and in the case of the more usual second-generation tape the grading would be $2\frac{1}{2}$. If further generations are involved, and they often are, the impairments begin to get more noticeable, depending on picture content. The quality of the audio signal also shows a marked deterioration with further generations of copying.

These picture impairments are mainly due to non-linearities in the overall transfer-characteristic, limitations in the frequency response of the head/tape system, the basic granularity of the medium, timing irregularities in the transport mechanism, and mismatch in the alignment and performance of the heads. Ingenious mechanical and electro-mechanical systems have been devised to minimise these problems, and sophisticated analogue circuitry has been developed to provide correction. Recently, the basic problems themselves have been somewhat eased by improvements in heads and tape.

A variety of different machines based on helical scanning are currently being developed, but the optimum helical format has not yet been established. Meantime, quadruplex recorders could be made to take advantage of improvements in heads and tape, either as a reduction of tape consumption or as improvements in signal-to-noise ratio (by modifying the f.m. parameters to exploit the wider bandwidth available).

Further improvements in analogue recording can be provided by converting the replayed signals to digital form for

subsequent processing. The availability and relative cheapness of digital storage, for example, make it an attractive technique for timing correction. It would clearly be better, however, for the signal to be in digital form throughout the transducer/medium/transducer stages of the recording/replay process where most of the troubles associated with analogue recording originate. In principle, it would then be possible to obtain, in the recording area, the advantages provided by full digital working, i.e. the preservation of the original signal quality with a mathematical precision regardless of the number of copying processes, immunity from circuit drifts, and the almost complete absence of complicated mechanical and electronic alignment and adjustment. These ideal characteristics would not in practice be fully met; some undetected digital errors might arise, for example, and there might need to be some residual routine adjustment. If a digital recorder is to be viable, however, such departures from the ideal must be minimal.

Thus the chief benefits to be expected from digital recording are an extremely high signal quality, 'hands-off' operation, automatic monitoring and minimum maintenance. These features could give rise to significant cost savings but such savings might be absorbed if digital recording demanded an increase in the cost of the medium; in fact it is desirable that both the cost, and the physical size and weight, of the medium be reduced. With signal quality no longer very dependent on the number of copying processes, digital recording will doubtless make editing even more attractive than it is at present, and the particular suitability of digital techniques to automated editing should therefore be exploited to the full.

A reduction in the capital cost of the equipment is, of course, always desirable. For most studio applications the size of the present machines is not an undue embarrassment, but there is a need for a lightweight portable recorder, perhaps with replay facilities limited to an arrangement for confirming that the recording is satisfactory.

All of the above aspects will need to be borne in mind when a decision as to the suitability of a proposed digital recorder is made.

3 Digital signal parameters

The television signal chain may conveniently be divided into a number of interconnected areas, e.g. signal origination in cameras and telecines, mixing for programme assembly, recording, standards conversion, distribution etc. The application of digital processing to each of these areas is currently being investigated to determine the form in which the digital signal should be handled in each area and the form in which it might best be passed from one area to another. Whilst no definite conclusions have yet been reached, it can be argued, particularly if systems based upon digital methods were to be inserted into the signal chain in a somewhat piecemeal fashion, that the signal at the interfaces between areas should be in digital PAL form employing 8-bit words with a sampling rate equal to thrice subcarrier frequency, the samples being symmetrically disposed about the unswitched axis. Thus the serial data rate at the interfaces would be approximately $3 \times 4.43 \times 8 = 106$ Mbits/sec, plus any extra allowed for parity protection. Other proposed forms of coding, e.g. digital Y, U, and V, require a similar bit rate. It would appear, therefore, that

digital television recorders ought to be capable of dealing with a data rate of this order.

The precision of digital processing, however, is such that it is possible to employ a number of techniques which lower the required bit-rate by removing redundancy and exploiting the limited perception of the observer; such techniques would have been impracticable using analogue processing. Experimental systems of bit-rate reduction are being investigated and present indications are that it may be possible to halve the above rate without causing perceptible picture impairment.

Bit-rate reduction applied to a digital recorder should enable a valuable saving in medium consumption to be achieved and might reduce the amount of electronic processing required in the machine.

The influence of bit-rate reduction methods on possibilities for minimising the effects of digital errors is not yet fully explored. Moreover, it is not yet known how many times the proposed techniques can be applied during the 'history' of a signal before a given degree of overall picture impairment is reached. Indeed, it is expected that an experimental digital television recorder now being constructed will prove to be a useful tool in these investigations.

It appears likely, however, that digital television recorders will ultimately be required to handle no more than 60 Mbits/sec, though it is intended that the experimental machine should handle the full bit-rate referred to above.

It is anticipated that imperfections will occur in whatever recording medium is finally adopted, and that these will give rise to digital errors, probably in the form of lengthy bursts. Work carried out so far on error concealment suggests that a modest increase in bit-rate will provide for an effective means of parity protection and that it will be possible to process the replayed signal even in the presence of bit-rate reduction so as to prevent the observer from detecting these unexpected and hopefully infrequent events.

4 Possible recording techniques

Digital television recording may be considered to be a particular form of high-speed, high-density data recording. The demand for the efficient storage of large quantities of digital data is increasing, and several of the techniques developed to satisfy this need potentially have application to television.

Bulk data storage is still mainly provided by conventional magnetic tape recording. Substantial improvements have been made in both heads and tape during the last few years, and digital packing densities are still increasing. It is generally accepted, however, that the most recent developments approach the limit attainable with this technique, and that the long-term future of bulk data storage lies in the development of new recording technologies, probably making use of laser or electron beams. Several of these new approaches to digital recording were described in the previous report.¹

It is worth bearing in mind, however, that such developments are mainly directed to the setting up of large data banks associated with computers and one of the important conditions governing their design is that it must be possible to extract relatively small quantities of data very rapidly from the very large total stock. This requirement contrasts very much with that of digital television in which it is necessary

to record and replay, at high speed, a very large quantity of data as a continuous sequence. When rapid access is required to only part of the total recorded information, it is realistic to consider using a stack of rigid substrates on which recording medium has been deposited as 'pages', with an arrangement somewhat similar to a mechanical 'juke box' that enables very rapid access to the page of information required. Whilst in principle the same technique could be employed for television, it would clearly be more satisfactory to use a flexible medium capable of being wound on a reel.* This arrangement is then similar to that of present-day VTRs, wherein two-dimensional scanning of a moving medium is achieved by deflecting the transducer in one direction whilst moving the medium in another.

New technologies are also being developed in connection with analogue recording systems for home video players. Reference will be made to these developments in so far as they are relevant to possible systems of digital recording.

4.1 Electron and laser beam recording

Both electron beams and laser beams can be focused to very fine spots and hold out the possibility of an improvement of about 50:1 in digital packing density as compared with that achieved using conventional magnetic tape and heads.

A comparison of the properties of electron and laser beams was given in the previous report.¹ Electron beams are easily generated, modulated and deflected, but they have the disadvantage that they require a vacuum of about 10^{-6} torr in which to operate, and the medium must therefore be suitable for use in the vacuum. Laser beams are also easy to generate and can be made to have very high power. They do not require a vacuum but they are more difficult to modulate and deflect. Electro optic devices can be used for modulation, as previously described,¹ and also for deflection.²

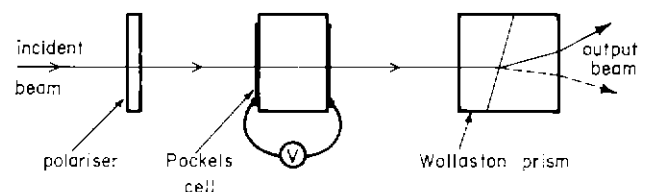

Fig. 1 Electro-optic ('digital') light deflector

Fig. 1 shows one method by which an electro optic Pockels cell may be used for deflection. The cell rotates the plane of polarisation of the incident light beam, and the emergent light is then passed to a birefringent prism which deflects light in two directions; with the correct orientation of the prism, the amount of light deflected in one direction, compared to that deflected in the other, depends on the direction of polarisation. n of these so-called 'digital deflectors' can be arranged to provide a total of 2^n different beam-deflection angles, and they can, of course, be arranged to cover a two-dimensional field if required. An interval of about one microsecond is required to switch from one deflection angle to another.³

* Given a sufficient packing density, e.g. one second of television (say 60-100 Mbits) per square centimetre, rigid recording media may be acceptable for short excerpts of programme, e.g. for requirements at present fulfilled by the H.S.100 disc machine.

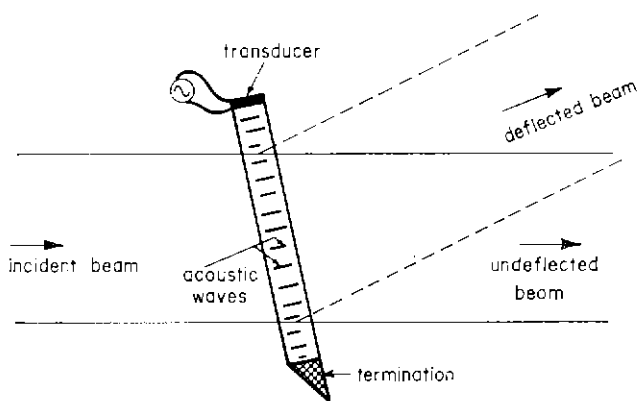

Fig. 2 Acousto optic light deflector

An alternative deflector, described more fully in a separate report,¹ is shown in Fig. 2. An ultrasonic wave propagated through a Bragg cell produces a spatial variation in the refractive index of the cell material, and the cell then operates as a diffraction grating of variable pitch; the angle through which the light is deflected depends on the frequency of the ultrasonic wave. To achieve good resolution with such a device, the beam should be several millimetres in width as it passes through the cell, so as to encompass many cycles of the grating, but this limits the speed with which the ultrasonic wave corresponding to one deflection angle can be replaced by another (as a result of the finite time required for the acoustic wave to traverse the active portion of the cell). In practice, a resolution corresponding to 500 separately identifiable spots across the field of deflection can be obtained, with a linear scan, in about a television line period.

Thus the speed at which both of the above devices can operate is limited. Neither are suitable for the bit-by-bit recording of digital television signals unless several laser beams can be deflected in parallel. To switch a laser beam to, say, 10⁸ separate positions every second would require the use of a mechanical deflector, e.g. a rotating polygon, possibly augmented by an array of fibre optic pipes to transform a circular scan pattern into a linear one.

When employing lasers for digital recording, however, it is possible to make use of their coherence properties by recording holograms corresponding to groups of bits rather than dealing with each bit separately. A comprehensive explanation of the principles of holography, and an account of an investigation into its potential use for recording is given in two other reports.^{5,6} A third⁷ describes recent work carried out on the recording of micro-holograms on photographic film. The following account is therefore provided merely as a brief summary of the technique.

Holography is a method of recording the optical wavefront, obtained from an object illuminated by coherent light, by mixing the light reflected from or transmitted by the object with a reference beam to form a standing wave pattern. When the recorded pattern is subsequently illuminated by the reference beam alone, an image of the original object is reconstructed by diffraction.

This technique is particularly attractive for recording digital bit-patterns; it potentially overcomes two of the problems to which high-density, bit-by-bit recording is particularly susceptible. First, for the order of packing density required for tele-

vision recording, a system in which individual bits are recorded in separate positions on the medium is very susceptible to defects, e.g. dirt, scratches and so on. Secondly, in such a system it is necessary to track the recorded information accurately in order to recover the signal, and this imposes severe mechanical constraints. Holography provides a convenient technique for spreading the information describing each bit over a relatively large area of the recording medium and thus reduces the susceptibility of both the defects in the medium and to tracking errors; it is possible, for example, to shift the position of the hologram with regard to the reference beam without altering the position at which the image is reconstructed. This property is exploited in the R.C.A. Holo-tape domestic player;⁸ as the tape containing the holograms is moved, the reconstructed images are 'lap dissolved', one frame to the next. A further advantage of holography is that the optical systems required for recording and replaying the signal are relatively simple.

About the same amount of laser power and about the same area of medium are required to record the hologram of a given number of bits as to record the bits individually. However, holographic recording involves deflecting the beam to a smaller number of positions, so the frequencies with which the beam has to be moved to a new position and the laser has to be switched are both reduced. This can be a very useful advantage.

Clearly, therefore, it would be very advantageous to involve as many bits as possible in each hologram; however, the number is limited in practice by the availability of suitable modulator and sensor arrays.

A modulator array is needed in order to compose the 'page of information' (group of bits) from which the hologram is made. Two types of modulator have been proposed for real-time holographic recording. One type uses nematic liquid crystals sandwiched between two conductive layers;⁹ one of these layers is continuous, the other being broken up into a mosaic of elements connected to an electronic register in which the binary data is temporarily stored. With no voltage between the layers, the liquid crystal is transparent; when a voltage is connected the light is scattered. These devices provide a high contrast ratio and require very little power, but their switching times are at present of the order of several milliseconds and this limits their usefulness in the application under consideration.

A more promising technique for page composing makes use of ferroelectric ceramics based on lead zirconate titanate or PLZT. These are electro-optic Pockels cell devices and can readily be fitted with an array of suitable electrodes. A notable development along these lines consists of a PLZT crystal with a number of conducting fingers on 300 micron centres.¹⁰ When voltages of no more than about 200 volts are connected appropriately to these, the beam can be switched on or off in 100 nanoseconds with an optical-transmission on/off ratio of greater than 100 to 1.

The development of solid-state sensor arrays for reading the bit-patterns reconstructed from holograms is proceeding in several laboratories.¹¹ Linear arrays of up to 1024 elements and two-dimensional arrays of about 250 elements square can now be obtained; they consist either of photodiodes addressed in sequence by associated shift registers, or of photo-sensitive bucket-brigade or charge-coupled devices. Their maximum

clocking rates (and hence bit rates) are at present limited to only a few MHz, so it would be necessary to use a number in parallel, perhaps with fibre-optic pipes to convey the light to them from the reconstructed image.

The present state of development of modulator and sensor arrays is such that it is more realistic, at this stage, to consider holograms containing a relatively modest number of bits. If, in recording the holograms, bit-cells were arranged in a line at right angles to the direction of motion of the recording medium, the recorded wave patterns would lie in the direction of motion, and this would avoid the need for a short exposure to prevent blurring.

Electron-beam holograms are in theory possible, but the coherence necessary within the beam has in practice only been achieved by restricting the size of the source to the point where unacceptably long exposure times are necessary.

Electron and laser beams can be made to interact with many substances, and a large number of processes have been investigated to see if they could be used in recording. The potential media range from the well-known photographic films through alkali-halide crystals, magneto-optical materials, photo-activated liquid crystals, photochromic materials, electrooptic materials, photo-conductive-thermoplastic 'sandwiches', dichromated gelatine, photo-resists, photo-polymers, and thin metal films.

Several of these media are not likely to prove practicable for television; the remainder can be divided into two classes. Those in the first use a relatively low-power electron or laser beam to create what amounts to a 'latent image' which is subsequently developed into a readable image by taking energy from a different source. The second class of materials use a high-power laser beam to form the image directly by heating the medium.

As an alternative classification, the potential media may be divided into those which are re-usable and those which are not.

There are two broad fields of application for video recording, namely programme assembly and archival storage; the first requires a re-usable medium, preferably with instant replay, the second demands neither. It follows that, in principle, two different recording technologies could be used, one for assembling the programme and the other when long-term storage is required. Both systems should operate in real time.

The following survey of proposed electron and laser beam systems categorises them according to which type of beam is used, whether holography is employed, and which medium is adopted.

4.1.1 Electron beam : photographic film

An electron beam recorder of the type suggested in the previous report¹ has been developed by the Ampex Corporation;¹⁸ it is a basically analogue device, but could be adapted for digital operation. A bandwidth of 100 MHz and a SNR of 23 dB (peak-peak signal/r.m.s. noise) have been achieved and 10 minutes of recording can be accommodated on a reel of film, the film transport pump-down time to usable vacuum being 25 sec. Replay is somewhat different to that suggested in Ref. 1. After development the film is re-inserted into the recorder and the scanning electron beam focused onto its scintillator-coated surface. This produces a spot of light which scans the recorded image, and a photomultiplier

mounted on the far side of the film collects the transmitted light. The reading beam is kept on track by the use of spot wobble which imparts a component to the output signal whose form changes if the mean position of the beam moves away from the centre of the desired track.

The scanning spot is 10 μm in diameter and the track pitch is 24 μm . This suggests a possible digital packing density of 2.6 Mbits per square inch. In other laboratory experiments¹³ a density of 120 Mbits per square inch has been achieved, but this would probably be unrealistic in a practical environment.

4.1.2 Laser beam : holographic : photographic film

Holographic memories are receiving attention in many laboratories and some systems of modest capability have already been sold. Work carried out at the Plessey Research Laboratories is probably as advanced as any in this field. Engineers there have predicted¹⁴ that, using a linear array of bits for each hologram, it would be possible to construct a recorder working at 100 Mbits/sec, packing perhaps a day's output onto a single reel of film.

4.1.3 Electron beam : thermoplastic film

Very little has been reported in the literature about electron beam recording on thermoplastic tape since the previous report was issued. It appears that most of the known investigations into the thermoplastic medium have, since that time, been concentrated on its use with laser beams.

4.1.4 Laser beam : holographic : thermoplastic film

The thermoplastic medium is capable of extremely high definition and when combined with a photoconductor can be made to have a sensitivity equal to that of high resolution photographic emulsions;¹⁵ phase holograms can be produced which have a high readout efficiency.

The photoconductor is applied either mixed with the thermoplastic or forming a separate layer between it and a conductive backing sheet. The latter form of construction is indicated in Fig. 3(a). Four steps are involved in recording as shown in Fig. 3(b); they may in practice be combined into a fewer number. The complete 'sandwich' is first charged by a corona device to a voltage which is divided between the thermoplastic and photoconductive layers in inverse proportion to their capacitances per unit area. The sandwich is then exposed to the light pattern that constitutes the hologram. Where the photoconductor is illuminated it discharges itself so that the original charge now appears across the thermoplastic layer alone. The electrostatic forces through the thermoplastic film are, however, left unchanged by the movement of charge through the photoconductor and a further charge is therefore added to the complete sandwich by a second exposure to the corona. This increases the field through the thermoplastic layer below the areas that were illuminated and a relief image constituting a phase hologram therefore appears when the medium is softened by applied heat.

If the thermoplastic and photoconductive materials are combined as a single layer, the sensitivity of the medium is somewhat reduced, but the requirement for a second exposure to the corona device is removed.

As part of an investigation into the application of thermoplastic media to holographic recording, RCA have produced an experimental system which can easily be switched from the record to the replay mode by switching the plane of polarisation of the light emerging from the laser.¹⁶ A schematic of the arrangement is shown in Fig. 4. After deflection the laser beam is split, by a device called a 'hololens', into an object beam which travels, via a page composer, to the storage medium and a reference beam which effectively passes directly to the medium. When the polarisation of the incident light is suitably switched, the object beam is arrested and the stored

Fig. 3 Laser beam thermoplastic recording
(a) Structure of medium

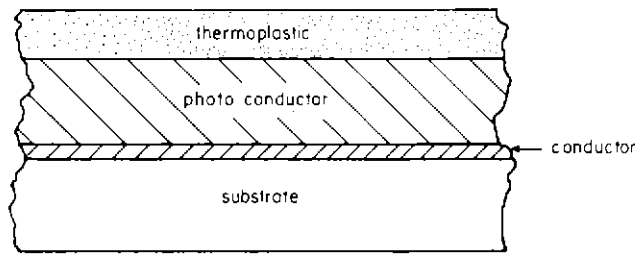

(b) Method of recording

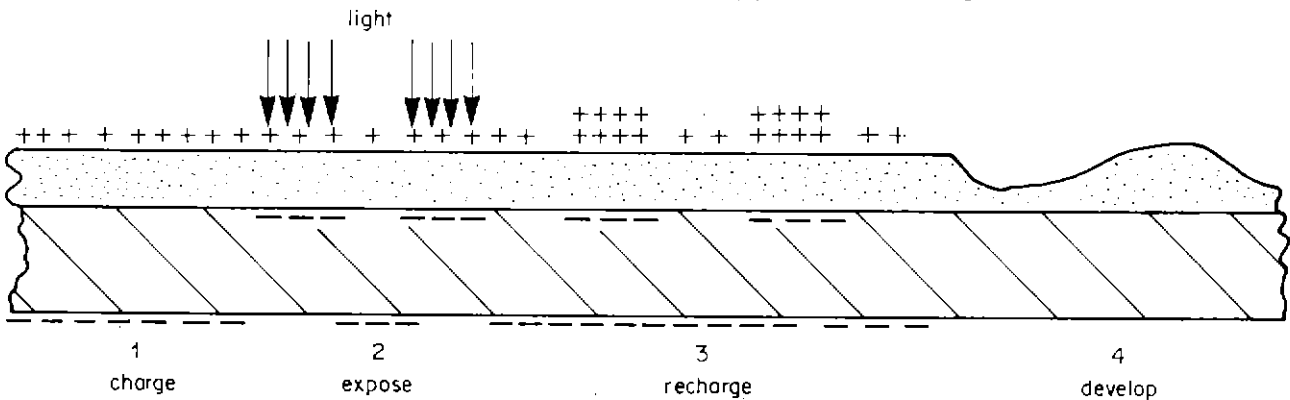
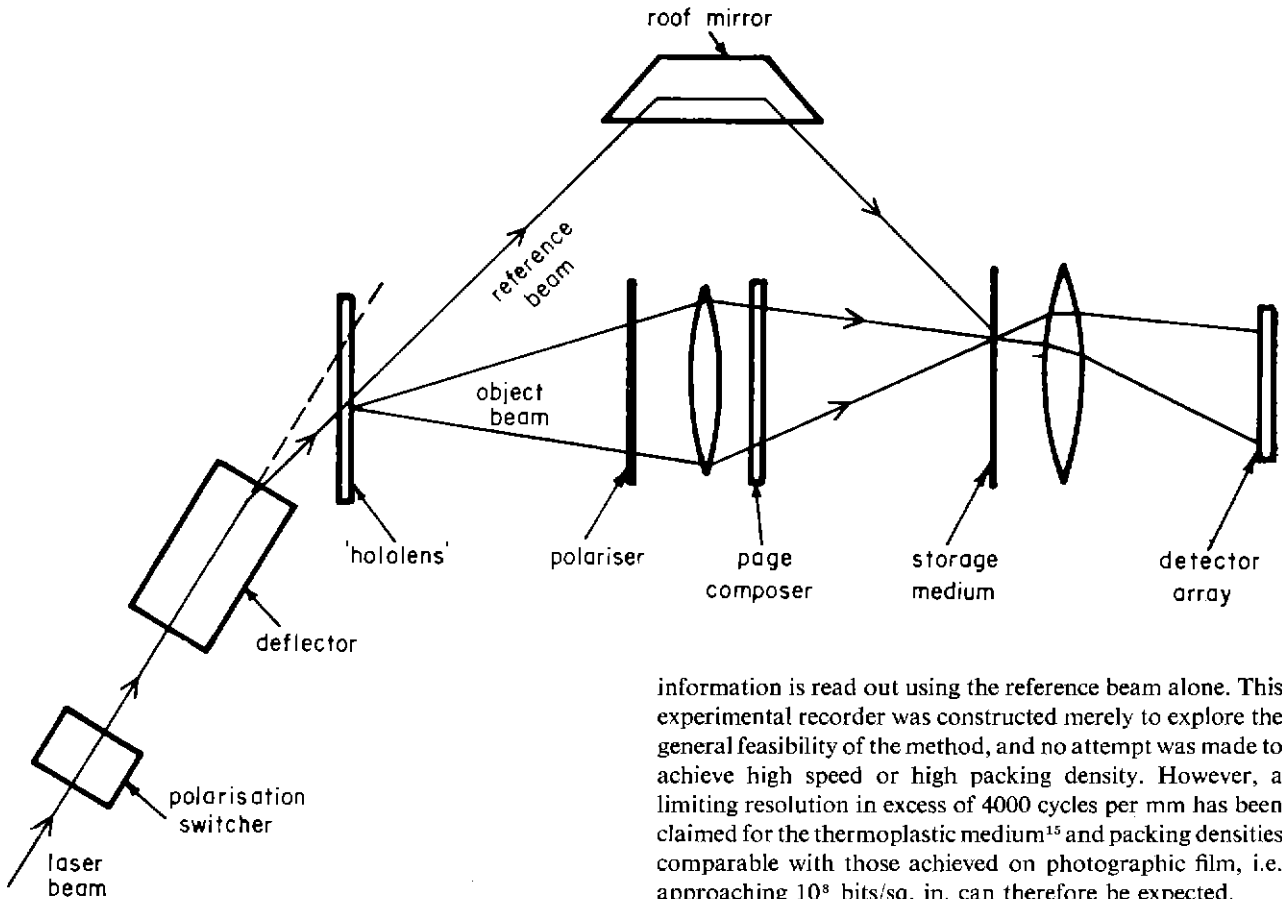

Fig. 4 Experimental holographic recorder



information is read out using the reference beam alone. This experimental recorder was constructed merely to explore the general feasibility of the method, and no attempt was made to achieve high speed or high packing density. However, a limiting resolution in excess of 4000 cycles per mm has been claimed for the thermoplastic medium¹⁵ and packing densities comparable with those achieved on photographic film, i.e. approaching 10^8 bits/sq. in. can therefore be expected.

4.1.5 Laser beam : metal film

A number of machines based on the laser-punch tape technique described in the previous report¹ have now been delivered to users. They achieve a packing density of 17 Mbits/sq. in. and will work at a transfer rate of about 5 Mbits/sec. The intended extension of the technique to helical scanning on continuous tape has not yet taken place and it seems doubtful that a transfer rate suitable for television will be achieved.

The thermal evaporation technique has also been used on thin metal films.¹⁷ Very intense laser beams are needed.

An alternative approach to laser beam recording on metal film is provided by the Philips Video Long Player (VLP) disc.¹⁸ A low-power laser beam exposes a layer of photoresist, and the recorded pattern of 'pits'* is subsequently produced by etching. Photographs of the disc obtained using a scanning electron microscope reveal that the ultimate resolution of the medium is by no means fully exploited by the 1 micron focused laser beam and imply that this recording technique could also be used for holography.

4.1.6 Laser beams : magnetic films

Work has continued on the thermo-magnetic/magnetic-optic recording technique described in the previous report.^{1,19} One

* The pits represent analogue information and are effectively modulated in both frequency and duration.

Fig. 5 Magneto optical recording, method of improving output signal
(a) Structure of medium

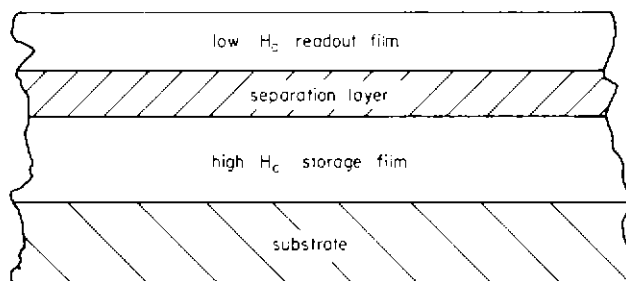

(b) Replay technique

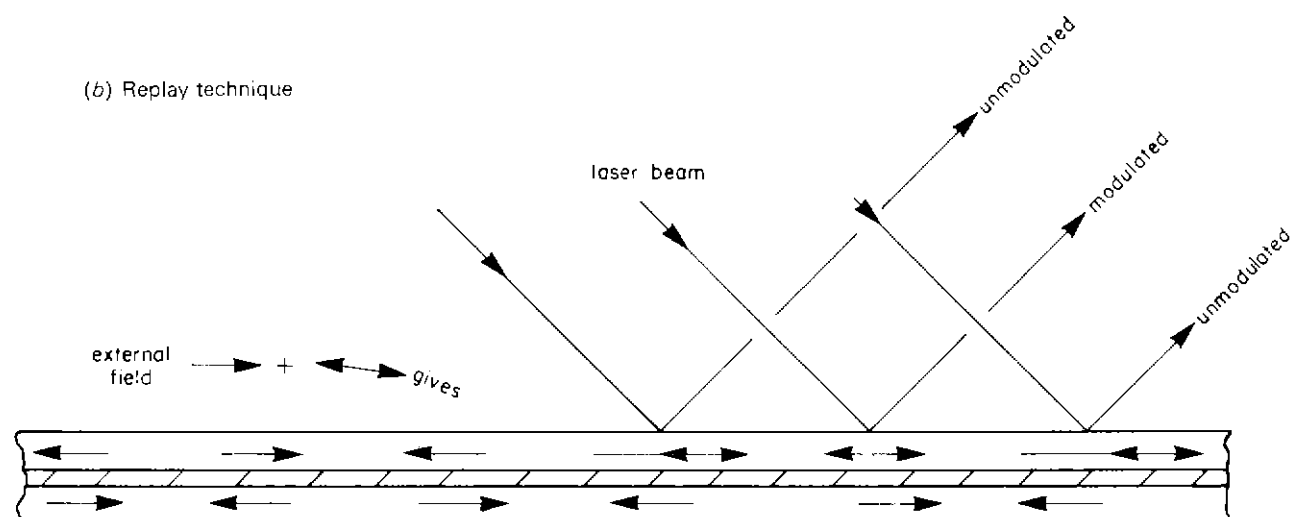

difficulty arises from the fact that the Faraday or Kerr rotation in the polarisation of the reading beam is very small, and the consequently inefficient reading process can be disturbed by noise and surface irregularities. In an experimental bit-by-bit recorder of this type, built by Ampex,²⁰ the problem was overcome by using tape comprising a cobalt-phosphorous storage film of high coercivity covered first with a thin non-magnetic separation layer and then with a shiny low-coercivity cobalt-nickel-iron surface layer (see Fig. 5). During reading, the surface film is acted upon by the field produced by the storage film together with an externally applied field which has both a d.c. and an a.c. component. These fields combine in such a way that the surface film is either pushed hard into saturation or else switched to and fro by the a.c. component, depending on the direction in which the storage film is magnetised. Thus the recorded information appears in the reflected beam as amplitude modulation of a carrier whose frequency is that of the a.c. field. A considerable increase in signal to noise ratio is claimed when this technique is used.

4.1.7 Laser beam : holographic : magnetic film

The experimental thermoplastic recorder mentioned above was first developed as a magneto-optical recorder using a thin film of manganese bismuthide as the recording medium.²¹ Serious difficulties were encountered, however, not only with the reading process, but also with the insensitivity of the medium in the recording mode.²² Holographic recording requires high resolution and, in magneto-optical recording (as in laser-punch recording), this can only be achieved by using a laser pulse of very short duration, say 20 ns; otherwise the heat pattern spreads in the film before the process of recording is completed. In the present arrangement, this means a laser with a peak power of about 100kW for a 10 kilobit hologram, i.e. 10W/bit.²³ On the other hand, the bit-by-bit recorder mentioned above works at about 10Mbits/sec using a 1½ W laser.

4.2 Conventional magnetic recording

A previous report²⁴ on digital magnetic recording described the factors limiting packing density in terms of the width of

the replayed pulses corresponding to the spacing of transitions in the two-level recording current. Two factors determine the width of these pulses. One is the blurring by self-magnetisation effects; the duration of the recorded transition may approximately be described in terms of a 'spread' factor.

$$a = \frac{(B_r) C}{2\pi\mu_0 (H_c)}$$

where B_r is the retentivity of the medium
 C is the thickness
 and H_c is the coercivity

It may therefore be reduced either by reducing B_r or C or by increasing H_c . The effective thickness of the coating can be reduced by turning down the record current so as to magnetise only the surface of the medium. B_r can be reduced and H_c can be increased by altering the constituents of the tape. The limit imposed upon a reduction of B_r or C is that either will reduce the replayed signal and thus degrade the signal-to-noise ratio and increase the susceptibility to drop-outs caused by partial separation between the tape and the replay head. A higher value of H_c , on the other hand, demands a higher record current with the danger of saturation of the recording-head pole-tips and difficulties with erasure.

There has been considerable effort devoted to this problem during the past few years in response to demands for higher packing densities in both analogue and digital recording;^{25,26,27} chromium dioxide has been introduced as an alternative to the more common gamma-ferric oxide, while the latter has been doped with cobalt and other materials (the so-called 'high-energy' tapes) and metal films and particles have been tried. In practice, the over-riding constraints are often those concerned with how well the particles can be formed and dispersed within their plastic binder, the cost of the material and the abrasivity of the tape and therefore the head wear. Presently available high-energy tapes have a typical retentivity of 1500 Gauss and a coercivity of 530 Oersteds.*

The other factor limiting packing density is the gap length (i.e. along the axis on the recorded track) of the replay head; replayed pulses are broadened by the aperture effect of the finite reading gap and the latter should therefore be made as small as possible. With each reduction in gap length, however, the gap length (i.e. normal to the surface of the tape) needs also to be reduced so as to preserve the efficiency of the magnetic circuit. Such a reduction poses serious wear problems and, in order to obtain the required combination of long life and low loss with small well-defined gaps, instrumentation heads have been constructed using ferrite cores fitted with caps made with very hard alloys.²⁸ More recently, very dense ferrites have been developed using a glass bonding technique that permits the construction of well-defined narrow gaps with shallow pole-tips.²⁹ All-ferrite heads are already used for single-track helical-scan recording, and multitrack instrumentation replay-heads have begun to be made in this way. This trend will probably continue.³⁰

It seems unlikely that a single-track head could be made to work at 100 Mbits/sec or even 50 Mbits/sec, and to cope with these data rates the signal would have to be subdivided into a

number of channels operating in parallel. A few heads could be arranged to scan across the tape, say in the manner of a helical recorder, or many more heads could be arranged to record and replay longitudinally. The second of these two approaches is being used in the design of the experimental digital television recorder already mentioned. Multitrack heads have been built which lay down sixty tracks on 2 in. tape or forty-two tracks on 1 in. tape. Within each track, densities of more than 20000 magnetic 'cycles' per inch are realisable, and it seems probable that data at a rate well in excess of 2 Mbits/sec/track could satisfactorily be recorded at a speed of 120 i.p.s. using delay-modulation as the signal code.³¹ These arrangements would provide a packing density of about 1 Mbit/sq. in. Still higher linear packing densities have been claimed using experimental heads capable of 2 MHz at 60 i.p.s. and further improvements in track packing densities (i.e. number of tracks per unit tape width) are expected. The upper practical limit of packing density using multitrack longitudinal recording appears to be about 4 Mbits/sq. in. A similar limit might be approached using multitrack helical scanning, but the potential tracking difficulties associated with such an arrangement might call for impracticably stringent mechanical tolerances.

5 Discussion

The brief summary of current developments given in Section 4 has made it clear that, in the short run, relatively conventional magnetic techniques are most likely to satisfy the requirements of digital television recording. Fig. 6 illustrates that the presently achievable packing density of 1 Mbit/sq. in. contrasts markedly with computer tape recording at 1600 bits per inch with nine tracks on half-inch tape, but at 100 Mbits/sec implies a four-fold increase in tape consumption as compared with present high-grade analogue recording. This factor of four would prevent such a system replacing the recorders currently in service.

Further increases in packing densities, perhaps assisted by successful bit-rate reduction techniques might, however, make digital television recording using magnetic tapes and heads a realistic proposition in the not too distant future. It should, however, be borne in mind that the improvements in heads and tape that would contribute towards higher digital packing densities would probably also provide improvements in analogue recording.

What seems certain, however, is that conventional magnetic recording will never be able to compete with the newer technologies so far as packing density is concerned (see Fig. 6). It appears probable therefore that conventional magnetic recording will eventually be replaced. Considering the difficulties that attend electron beam recording, and the progress being made with optical techniques, it seems likely that laser beams will prove to be the more convenient. Moreover, the clear advantages of holographic as compared with bit-by-bit recording point the way to holography as the most satisfactory method of laying down the information.

The biggest imponderable at present is which medium will prove best suited to television recording. Laser-addressed magnetic films possess many desirable characteristics – e.g. no image development process, reusability, selective erasure capability, long storage life. Progress in magneto-optics is,

* Scotch type 971 high-energy tape.

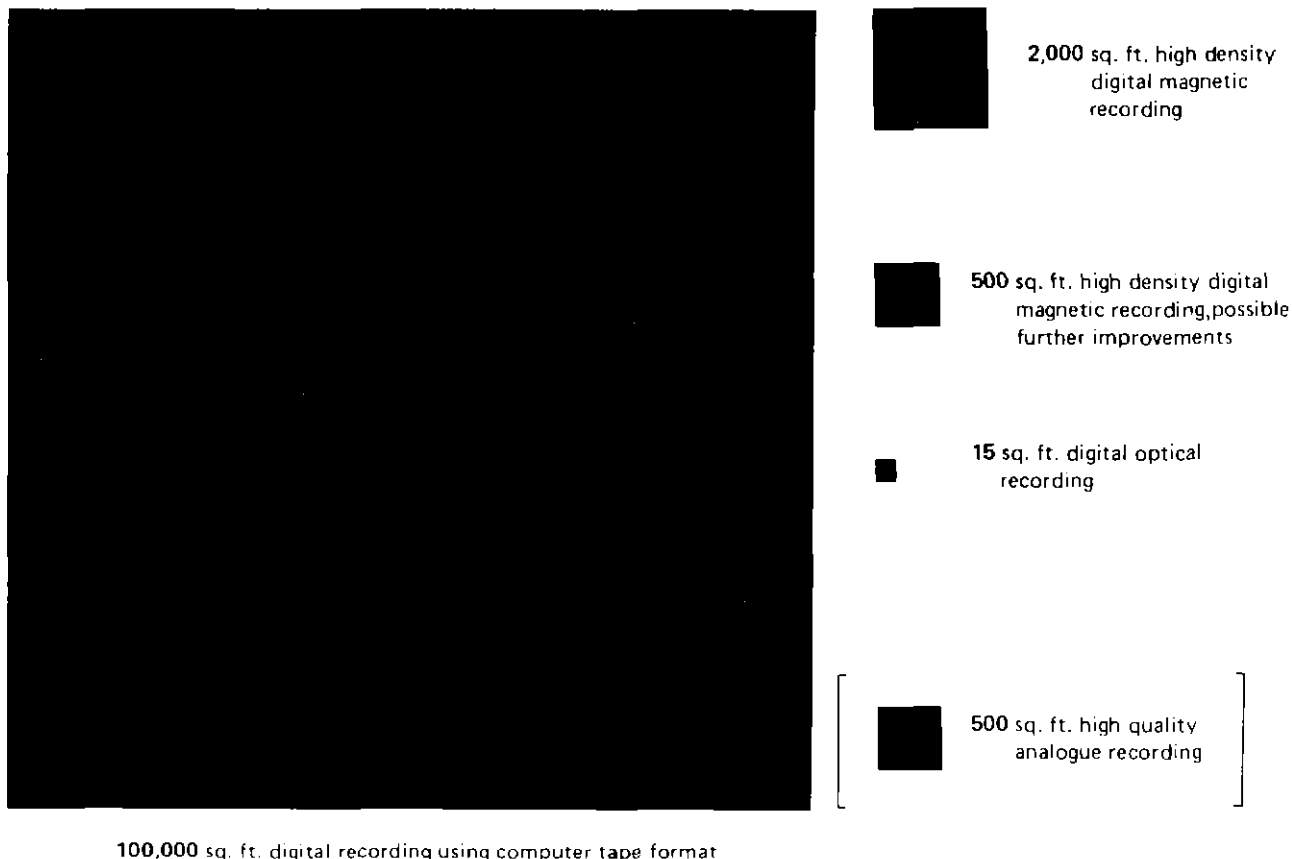

Fig. 6 Television recording – area of medium required for half-hour programme

however, slow, and the insensitivity of the medium has so far precluded data rates of the order required for television. RCA's switch from magneto-optical to thermoplastic recording is a significant comment on the relative potentialities of the two media. The thermoplastic medium is not seriously limited in sensitivity, but many problems remain with this medium also; in particular, its suitability for selective rewriting and long-term storage have yet to be demonstrated. Photographic film is certainly a possibility, but could only be considered for long-term storage.

In this rather nebulous situation it is difficult to make a firm prediction. Evidence to date points to a thermoplastic medium for programme assembly, and photographic film, possibly using a very similar form of recorder, for long-term storage. However, a more suitable magneto-optical medium might be developed which would displace both of these, or some entirely different type of medium, at present the subject of basic research, might emerge. What seems certain is that digital recording by conventional magnetic methods will have been thoroughly explored and probably stretched to the limit before it is seriously threatened by a rival technology.

6 Conclusions

Television recording has much to gain from the application of digital techniques; the digital recorder will provide significant improvements in picture quality, reliability, and operational convenience. Work carried out to date on digital signal-pro-

cessing suggests that digital television recorders will eventually need to handle data at a rate of about 60 Mbits/sec and that it will be possible with the aid of appropriate coding techniques satisfactorily to conceal the presence of digital errors.

Conventional magnetic recording using presently available components can cope with the data rate required for digital television, but improvements in packing density are required if the advantages of digital recording by this method are not to be offset by an increase in tape cost.

Very large savings in medium consumption are expected, however, from the newer technologies using laser or electron beams. The development of most of these technologies is still at a very early stage, and it is not yet clear which will prove most suitable for the television application. The most promising methods use laser-beam holography employing magneto-optic or photoconductive thermoplastic media. It is anticipated that by the time a laser beam system emerges as a serious contender the limiting performance of conventional magnetic recording will have been reached.

7 References

1. Lunn, J. D. and Moffat, M. E. B. 1969. Possible techniques for the recording of digital television signals, BBC Research Department Report No. 1969/42.
2. Kulcke, W. *et al.* 1966. Digital light deflectors. *Proc. IEEE*, 1966, 54, 10, pp. 1419-29.
3. Deflector steers laser beam into million-spot matrix. *Electronics*, 1971, 44, 3, p. 5E.

4. Laser beam deflection. BBC Research Department Report in course of preparation.
5. Holography: a general survey. BBC Research Department Report in course of preparation.
6. Recording using hologram arrays: a general survey. BBC Research Department Report in course of preparation.
7. Digital recording using hologram arrays: low frequency micro-holograms on photographic film. BBC Research Department Report in course of preparation.
8. Bartolini, R., *et al.* 1970. Embossed hologram motion pictures for television playback. *Applied Optics*, 1970, 9, 10, pp. 2283-90.
9. Hellmeier, G. H., Zaroni, L. A. and Barton, L. A. 1968. Dynamic scattering: a new electro optic effect in certain classes of nematic liquid crystals. *Proc. IEEE*, 1968, 56, pp. 1162-71.
10. Waterworth, P. and Chilton, G. A. A. 1972. Integrated electro-optic modulator arrays. *Opto-Electron*, 1972, 4, 3, pp. 339-40.
11. Melen, R. 1973. The tradeoffs in monolithic image sensors: MOS vs CCD. *Electronics*, 1973, 46, 11, pp. 106-11.
12. Engberg, E. W. 1970. State-of-the-art wide-bandwidth electron beam analogue recorder and reproducer. Record of the 11th Symposium on Electron, Ion, and Laser Beam Technology.
13. Newberry, S. P. 1966. An electron optical technique for large capacity random-access memories. *A.F.I.P.S. Conf. Proc.*, 1966, 29, pp. 717-28.
14. Waterworth, P. Holographic data storage. To be published in Inst. of Physics Bulletin.
15. Credelle, T. L. and Spong, F. W. 1972. Thermoplastic media for holographic recording. *RCA Rev.*, 1972, 33, pp. 206-26.
16. Stewart, W. C. *et al.* 1973. An experimental read-write holographic memory. *RCA Rev.*, 1973, 34, 1, pp. 3-44.
17. Ramberg, E. G. 1972. Holographic information storage. *RCA Rev.*, 1972, 33, 1, pp. 5-53.
18. Philips TV disk, read by light beam, could shape market. *Electronics*, 1972, 45, 19, pp. 29-30.
19. Hunt, R. P., Elser, T. and Wolf, I. W. 1970. The future role of magneto-optical memory systems. 1970. *Datamation*, April.
20. Treeves, D. 1972. Magneto-optics: experimental. *Annals of New York Academy of Sciences*, 1972, 189, pp. 278-310.
21. Lohman, R. D., Mezrich, R. S. and Stewart, W. C. 1971. Holographic mass memory promise: megabits accessible in microseconds. *Electronics*, 1971, 44, 2, pp. 61-6.
22. Cohen, R. W. and Mezrich, R. S. 1972. Materials for magneto-optic memories. *RCA Rev.*, 1972, 33, 1, pp. 54-70.
23. Hunt, R. P., Magyary, A. K. and Dickey, B. C. 1970. Optical scanning for a magneto-optic memory. *J. Applied Physics*, 1970, 41, pp. 1399.
24. Jones, A. H. and Chambers, J. P. Digital magnetic recording: conventional saturation techniques. BBC Research Department No. 1972/9.
25. Speliotis, D. E. 1972. Recent developments in the theory and materials for digital recording. *Intermag*, 1972.
26. Morrison, J. R. 1972. Particulate materials vs thin film, a system overview. *Annals of New York Academy of Sciences*, 1972, 189, pp. 69-101.
27. Smaller, P. 1972. Particulate media. *Annals of New York Academy of Sciences*, 1972, 189, pp. 102-15.
28. Lemke, J. U. 1972. Recent advances in magnetic recording heads; presented at International Aerospace Symposium, Cranfield 1972.
29. Lemke, J. U. 1972. Ferrite transducers. *Annals of New York Academy of Sciences*, 1972, 189, pp. 171-90.
30. Sugaya, H. 1968. Newly developed hot-pressed ferrite head. *IEEE Trans Magnetics*, 1968, MAG-4, 3, pp. 295-301.
31. Hecht, M. and Guida, A. 1969. Delay modulation. *Proc. IEEE*, 1969, 57, 7, pp. 1314-16.

The Automatic Plotting of Aerial Radiation Patterns

G. H. Millard, B.Sc., M.Inst.P.

N. F. Spring, B.Sc., A.R.C.S., M.Inst.P.

Research Department

Summary: The presentation of aerial radiation patterns in the form of contour plots is described and a brief account is given of the plotting algorithm.

- 1 Introduction
- 2 Radiation patterns of u.h.f. aeriels
- 3 The polar-contour plot
- 4 The plotting algorithm
- 5 Calculation of the radiation pattern matrix
- 6 Implementation of plotting algorithm
- 7 Conclusions
- 8 References

1 Introduction

It has been common practice in the past to represent an aerial radiation pattern in terms of separate horizontal and vertical patterns, it being tacitly assumed that the field in any other direction would be given by the product of the two. A common form of presentation is the polar plot on which field strength at a constant distance is represented linearly on the radius co-ordinate. An example is shown in Fig. 1 of a horizontal pattern of this type. The polar/voltage diagram is not very satisfactory when it is desired to show the performance of a very directional aerial. In Fig. 1 it will be seen that the field in the minima cannot be read with any great accuracy and to overcome this difficulty the polar plot is sometimes shown with a logarithmic radial scale. A better arrangement is to use cartesian rather than polar co-ordinates for the logarithmic plot. This has the advantage that the angular scale can be chosen to suit the aerial; in particular an expanded scale can be used for an aerial with a very narrow beam. Fig. 2 shows the radiation pattern of Fig. 1 in this form. This diagram is used in connection with the automatic measurement of aerial radiation patterns.

The use of two sections at right-angles (i.e. the radiation patterns in the horizontal and vertical planes) to represent a three-dimensional radiation pattern is acceptable only in special cases. With a complex array having a multi-lobed radiation pattern a different presentation must be used. A diagram which is sometimes used to illustrate the performance of large high-frequency arrays is the power distribution diagram (sometimes called an 'onion diagram') shown in Fig. 3. The characteristic shape arises because the length of the lines of latitude are proportional to the sine of the latitude;

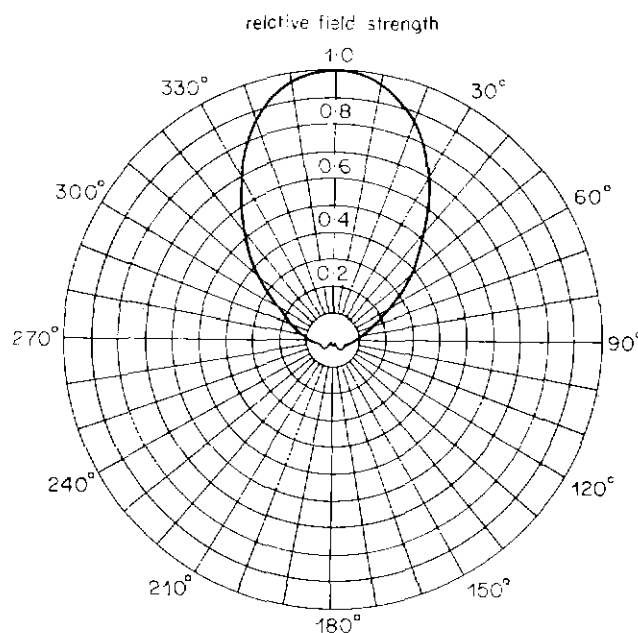

Fig. 1 Polar-voltage diagram (u.h.f. panel aerial)

as a result, areas on this chart are equal to the corresponding areas on the surface of the corresponding sphere. The radiation pattern of the aerial is shown in the form of contours of equal field strength or power flow; if the latter are plotted the diagram may be used to deduce the gain of the array by graphical integration.¹

2 Radiation patterns of u.h.f. aeriels

Certain difficulties arise in the presentation of radiation patterns of u.h.f. aeriels. First, the aeriels are often several wavelengths long so that there is considerable detail in the patterns. Second, the maximum field in any vertical plane is normally arranged to fall at some arbitrary angle below the horizontal, known as the beam-tilt angle. Where a 'horizontal' radiation pattern is required it is usually measured or calculated at the beam-tilt angle. However, at some stations the beam tilt angle may vary with azimuth so that an adequate representation of the three-dimensional radiation pattern would need several

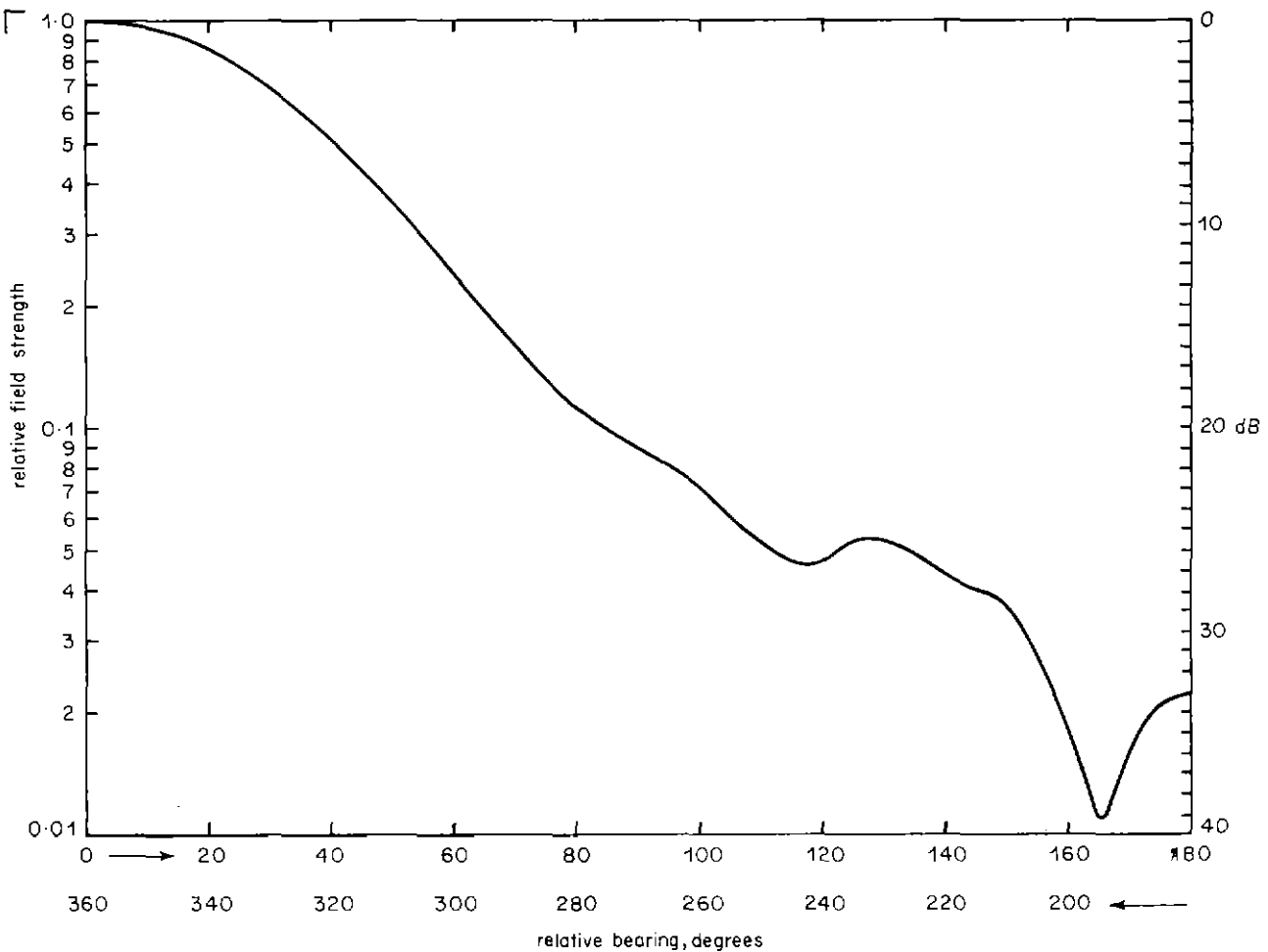

Fig. 2 Cartesian-logarithmic diagram (u.h.f. panel aerial)

'horizontal' radiation patterns corresponding to several angles in the vertical plane. Diagrams comprising several such patterns superposed have been produced for particular aerials but they are not easy to interpret. It was this consideration together with the need to be more specific about the detailed structure of radiation patterns which led to the devising of a new form of representation.

3 The polar-contour plot

A number of basic requirements were laid down for the new form of presentation. First, all the relevant information relating to the radiation pattern had to be condensed on to one diagram. Second, the diagram needed to have a pictorial quality so that the reader could readily visualise what was represented. Third, the diagram needed to yield decibel values of field strength readily so that it would be easy to use in predicting field strength. Finally, it was desired to be able to produce the diagram directly from a computer. This latter requirement meant that diagrams could be considered which would have been unduly time-consuming to produce by hand.

The form of diagram* meeting these requirements is shown in Fig. 4. The polar angle corresponds to the angle of azimuth

* First proposed by R. I. Black.

with the cardinal points of the compass marked. The radial distance corresponds to the angle below the horizontal, the outermost circle corresponding to the horizontal. The range of vertical angles shown (0–20°) is chosen to include those angles of greatest interest at the majority of stations.

Fig. 5 shows the representation of a typical aerial. The contours are of equal field strength and are shown in decibels below the maximum. The whole diagram may be considered as representative of the way the aerial distributes energy over the service area.

A more complicated example is given in Fig. 6; the diagram shows clearly areas of low field strength which might easily have been overlooked with other forms of presentation.

4 The plotting algorithm

It was required to produce a plot of contours of constant effective radiated power from a matrix containing samples of the radiation pattern for the appropriate range of azimuthal and zenithal angles. Such a programme could be adapted to plot contours of any function of the form $Z = f(\theta, \phi)$ where Z is the 'height' of a contour.

The task of devising a contour-plotting algorithm is full of pitfalls for the unwary. The basic problem is to ensure that no contours of a given height are overlooked in the area under

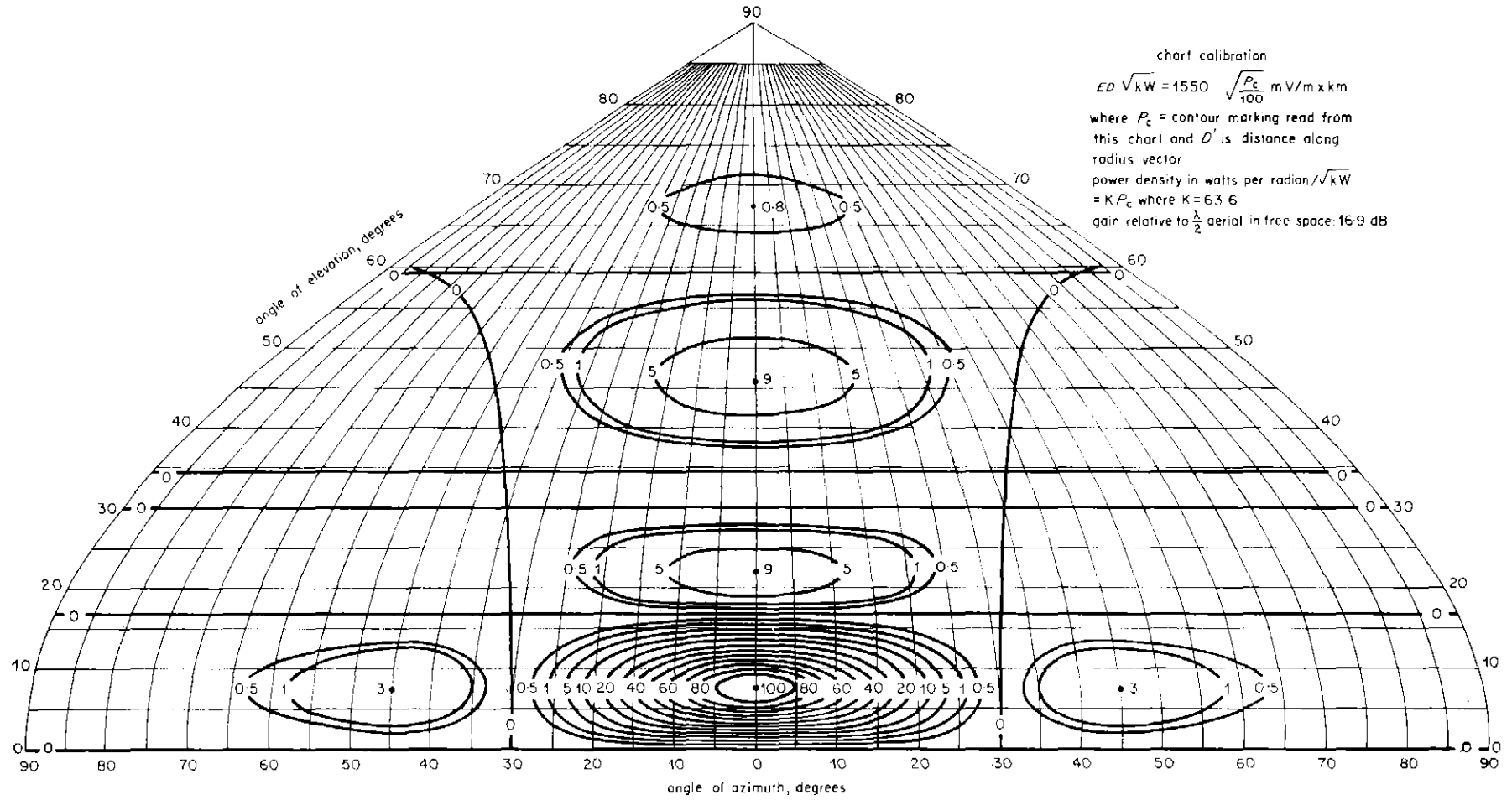
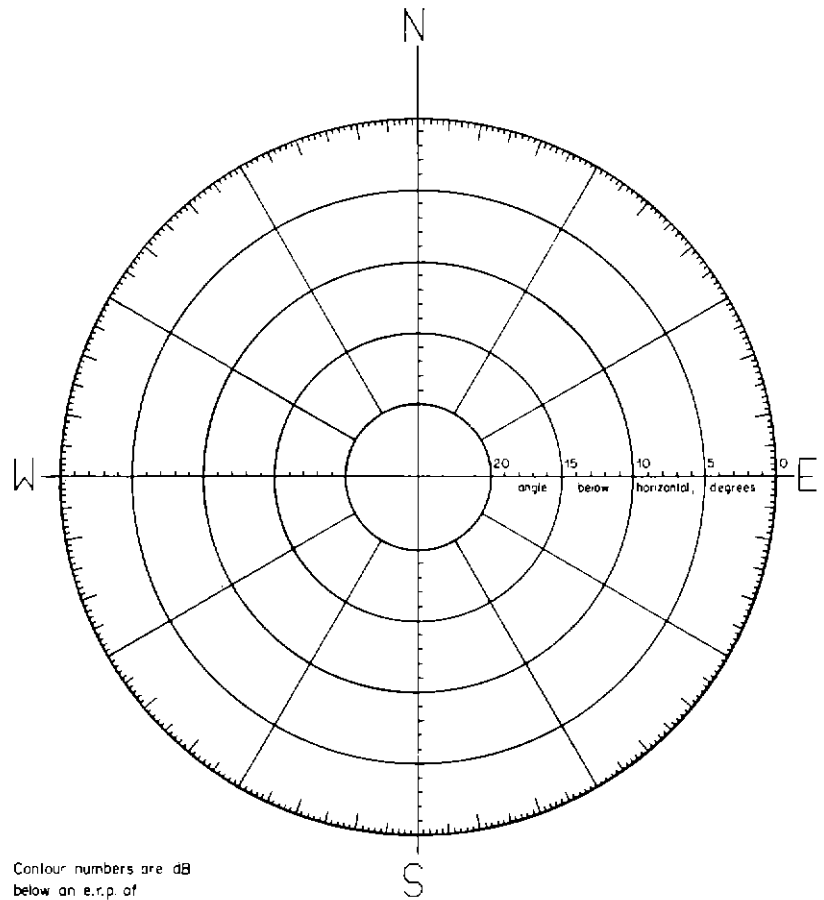

Fig. 3 Power distribution diagram: antenna array H4/4/1

Fig. 4 Graticule for polar/contour plot



Contour numbers are dB
below an e.r.p. of

Fig. 5 Polar/contour plot: 4 tiers each of two panels set at 120°, 2'5° beam tilt

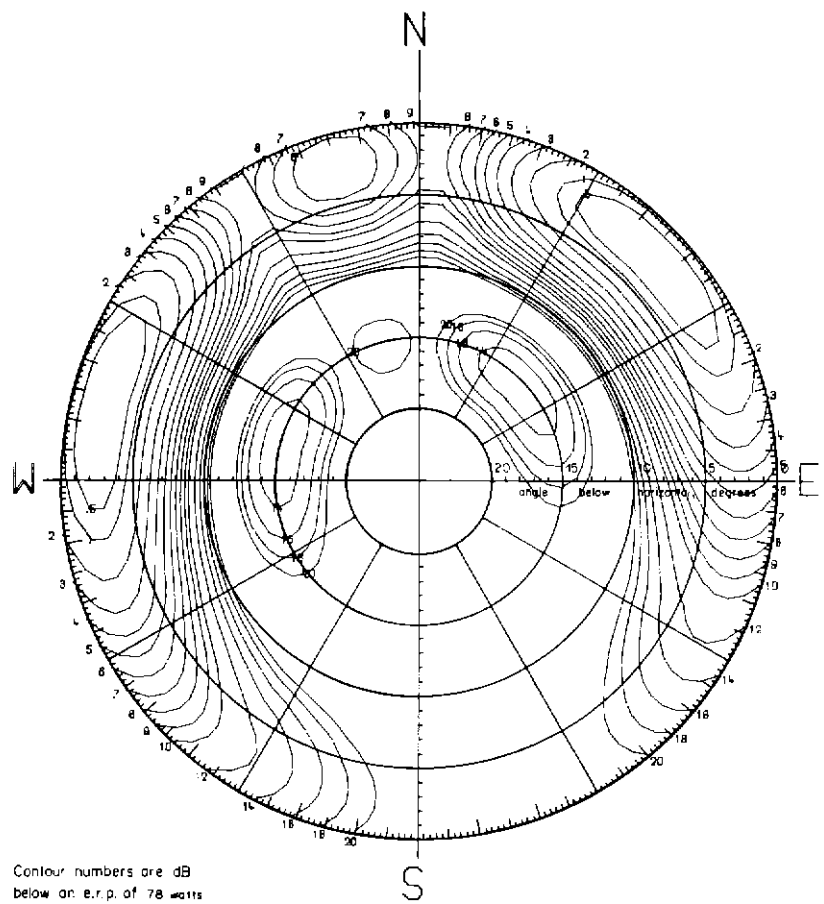

Contour numbers are dB
below an e.r.p. of 78 watts

Fig. 6 Polar/contour plot: 4 tiers each of two panels on 0° and 90° ETN. Panels on 0° carry unit power and have beam tilt of 2°. Panels on 90° carry quarter power and have beam tilt of 12°

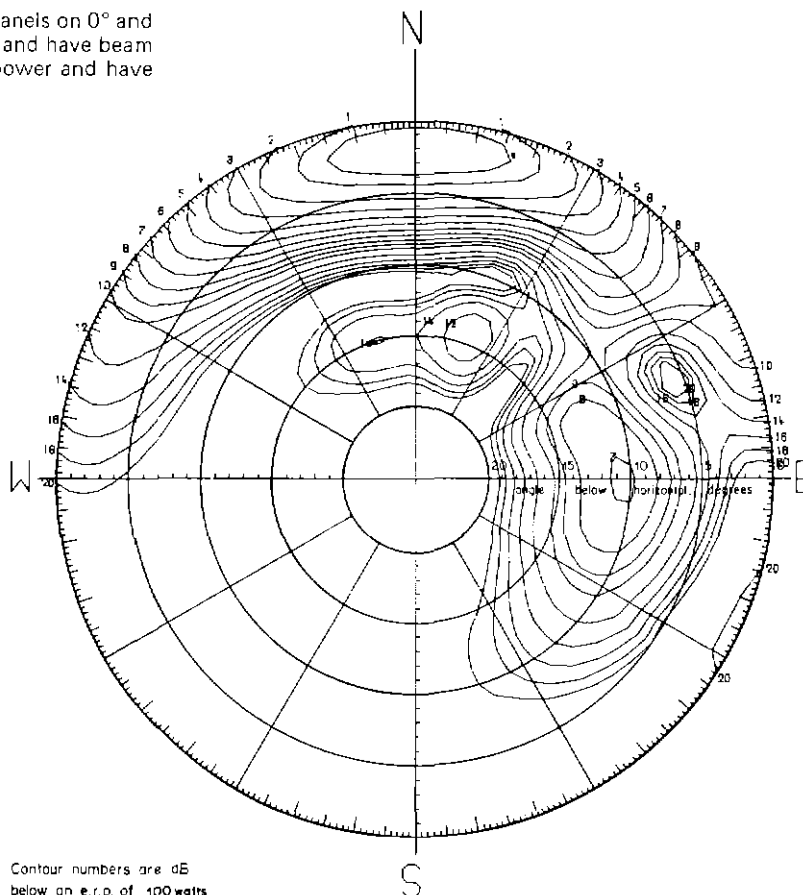

construction, that no contours are drawn more than once, and that those conditions are fulfilled without consuming unacceptable amounts of computer storage and run-time.

Consider a rectangular area ABCD (Fig. 7) divided up into a rectangular grid. It is assumed that the values of Z are known at every intersection-point on the grid and that it is required to plot all the contours of a 'height' $Z = Z_0$ over the area ABCD. The procedure is as follows:

- (i) Mark every intersection where $X \geq Z_0$ with the label 'high'. Mark all others 'low'.
- (ii) Scan every horizontal side of the elemental rectangles (such as ab and cd) except those on the boundaries AB and CD . Whenever a 'high' intersection has a 'low' intersection immediately to the left of it, mark the 'high' intersection as 'uncrossed'.
- (iii) Contours starting and finishing on the boundary ABCD are now drawn as follows. Examine the intersections of the grid-lines with the boundary ABCD until there is found a pair for which, from the viewpoint of an observer outside the boundary, the right-hand intersection is marked 'high' and the left-hand intersection is marked 'low'. P_2 and P_3 in Fig. 1 are such a pair. The start of the contour is obtained by inverse interpolation of Z_0 between the values of Z at P_2 and P_3 . If P_4 is 'low' the contour is assumed to exit $P_2 P_3 P_4 P_5$ via the side $P_3 P_4$. If not, then P_5 is examined to see whether the exit is via $P_4 P_5$ or $P_2 P_5$.

On whatever side the exit occurs, a new $P_2 P_3 P_4 P_5$ rectangle is set up and the process repeated until the boundary ABCD is reached.

In tracing out a contour, whenever a horizontal edge is traversed upwards, then the label 'uncrossed' at the right-hand edge is changed to 'crossed'. The remainder of the boundary ABCD is scanned systematically for starts of other contours.

- (iv) Having drawn all the contours which terminate on the boundary ABCD ('open' contours), it is now necessary to find those which do not ('closed' contours). This is done by scanning the internal horizontal edges (such as ab or cd) until one is found for which the right-hand end is marked 'uncrossed'. A test rectangle $P_2 P_3 P_4 P_5$ is then erected on top of this edge and the contour followed in the same way as for open contours. However, the test for terminating a closed contour is that a horizontal edge is encountered such that its right-hand end is marked 'crossed'. The rest of the horizontal edges are scanned and closed contours plotted until there are no 'uncrossed' edges left.
- (v) The whole of the above procedure is repeated for each different contour height.

Note that the contours are shown as being made up of straight lines joining the intersections of the contours with the grid. This has the advantages of simplicity and the assurance that contours will never intersect each other (al-

Fig. 7 Method of drawing contours

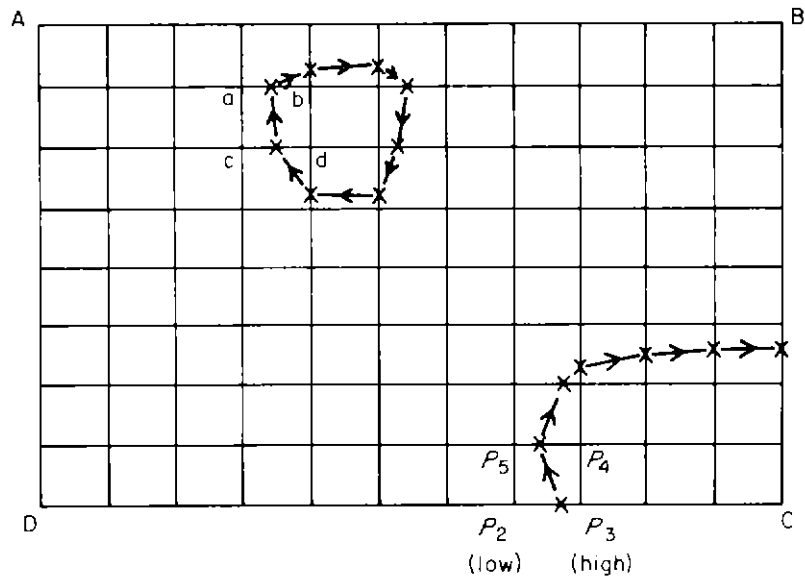

though they may touch each other).² Judicious choice of cell-size in the grid makes the straight line method satisfactory for most contours. It is thought that the expense of curve-drawing procedures would not be justified.

5 Calculation of the radiation pattern matrix

The radiation pattern is evaluated from the formula:

$$E_j = \sum_i A_i R_{ij} e^{j \left(Q_i + P_{ij} \frac{2\pi}{\lambda} (l_j x_i + m_j y_i + n_j z_i) \right)}$$

- E_j is the field of intensity in direction (θ_j', ϕ_j')
- (θ_j', ϕ_j') are a set of directions in spherical-polar co-ordinates
- (l_j, m_j, n_j) are the direction cosines of (θ_j', ϕ_j')
- $A_i e^{jQ_i}$ is the current in the i th source
- $R_{ij} e^{jP_{ij}}$ is the radiated field intensity of source no. i in direction (θ_j', ϕ_j')
- (x_i, y_i, z_i) are the cartesian co-ordinates of the position of source no. i .

It is assumed that for each source the co-ordinate (x_i, y_i, z_i) , the current $A_i e^{jQ_i}$, the direction of fire (θ_i, ϕ_i) are given and the radiation pattern $R e^{jP}$ is given (relative to the 'natural axes' of the source) as a function of (θ, ϕ) . If the source is 'turned' through an angle ϕ_i and 'tilted' through an angle θ_i (see Fig. 8), then to determine $R e^{jP}$ in direction (θ_j', ϕ_j') it is necessary to evaluate the co-ordinate $(\theta_{ij}'', \phi_{ij}'')$ of the direction (θ_j', ϕ_j') relative to (θ_i, ϕ_i) . The appropriate formulae were determined using the formulae of spherical trigonometry and are given below:

$$\begin{aligned} \cos \theta_{ij}'' \cos \phi_{ij}'' &= \sin \theta_j' \sin \theta_i + \cos \theta_j' \cos \theta_i \sin(\phi_j' - \phi_i) \\ \cos \theta_{ij}'' \sin \phi_{ij}'' &= \cos \theta_j' \sin(\phi_j' - \phi_i) \\ \sin \theta_{ij}'' &= \sin \theta_j' \cos \theta_i - \cos \theta_j' \sin \theta_i \cos(\phi_j' - \phi_i). \end{aligned}$$

For the purposes of this programme the axes and co-ordinates are slightly non-standard. OX, OY, OZ, are mutually orthogonal cartesian axes with OZ pointing vertically upwards. The spherical polar co-ordinates (θ, ϕ) are such that ϕ is measured from OX towards OY and lies between 0° and 360° , and θ is measured from the horizontal towards OZ and

Fig. 8 Calculation of relative θ, ϕ

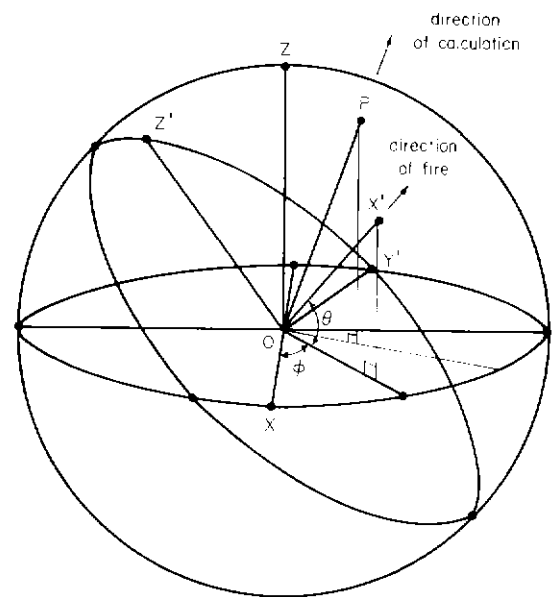

- OXYZ - cartesian axes
- OX'Y'Z' - "natural axes" of source
- (θ, ϕ) - direction of fire of source
- OP (θ', ϕ') - direction in which R.F. is to be calculated
- $(\theta'' \phi'')$ of OP relative to OX'Y'Z' is to be determined

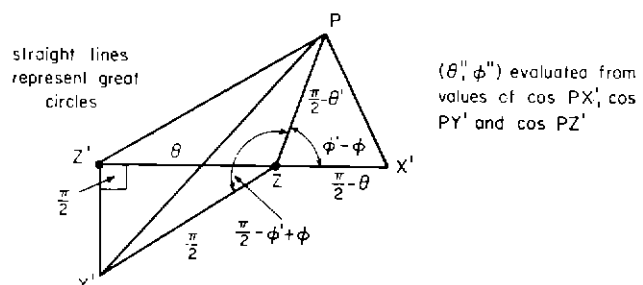

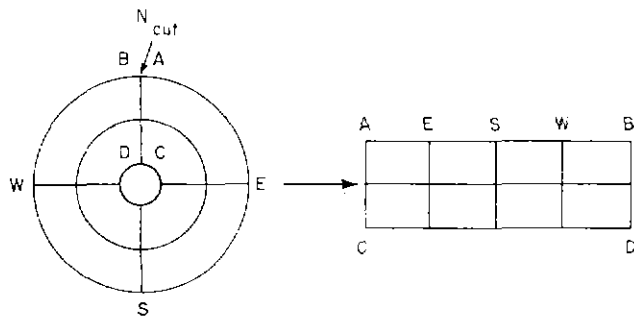

Fig. 9 Conversion of polar to rectangular grid

lies between -90° and $+90^\circ$; +ve angles are above the horizontal and -ve angles below.

It should be noted that individual sources could have a further angular degree of freedom apart from 'turn', ϕ , and 'tilt', θ . This might be described as 'twist' about the direction of fire. This parameter has been excluded from the present programme because it would be necessary to evaluate both planes of polarisation.

The most commonly used source at low power relay stations is the printed panel aerial.³ Radiation pattern data for this aerial at a number of frequencies are stored in the computer along with the programme. This results in a great reduction of the number of data cards to be prepared for each calculation on arrays of this aerial.

6 Implementation of plotting algorithm

The algorithm described in Section 4 has been followed broadly in the contour-plotting subroutine but there are some minor differences. In particular, the area over which contours are drawn is circular, not rectangular. For the contouring algorithm, the polar pattern is cut along the North radius and opened out into a rectangular as shown in Fig. 9.

Another difference is that, when the grid is being scanned for contour starts, each part of the grid is examined for each contour height in turn before moving to the next part of the grid. As a consequence, marks 'high', 'low', 'crossed' and 'uncrossed' must be stored for each contour height.

Provision is made for plotting two sizes of the diagram. The

smaller is contained within A4 size paper and is intended for record purposes. The larger, which is almost twice the size is intended for those cases where detailed work has to be done using the diagram. Either diagram, or both, may be plotted as required.

The programme is written in Fortran V.*

Figs. 5 and 6 show the most commonly used ranges of vertical and horizontal angles. Any other vertical range extending over not more than 20° may be provided and the azimuth angle may be restricted if so desired. The cell size of the grid must be chosen sufficiently fine in relation to the expected complexity of the radiation pattern to avoid overlooking significant detail. Intervals of 1° in the zenithal angle and 5° in the azimuthal angle were chosen for Figs. 5 and 6. In practice, a plot in which the straight segments of the contours are not unduly obtrusive is unlikely to omit significant detail.

The computer programme is arranged to draw the graticule in a different colour to the contours. If, however, it is desired to produce many copies of a diagram, it is more economical to produce a plot of the contours only and then to print this on to blank graticules. In order to facilitate this operation, the letters labelling the cardinal points of the compass are drawn by both the contour- and axes-plotting routines and are then available as registration marks. Figs. 5 and 6 have been reproduced in this way.

7 Conclusions

A new form of aerial radiation pattern diagram has been devised to give more complete and accurate information of aerial performance. A computer programme has been written in Fortran V which calculates the aerial radiation pattern and plots it in the new form.

8 References

1. Page, H. 1963. An introduction to the theory of aeriels. BBC Research Department Report No. E-085, Serial No. 1963/27.
2. Heap, B. R. and Pink, Monica G. 1969. Three contouring algorithms. DNAM Report 81, Division of Numerical and Applied Mathematics, National Physical Laboratory, December 1969.
3. Millard, G. H. 1970. U.H.F. relay stations: vertically polarized printed panel aerial. BBC Research Department Report No. 1970/17.

* The programme calculating the radiation pattern matrix and the first version of the plotting programme were written by R. E. Davies.

An Automatic Shot-Change Detector for Telecine

J. R. Sanders, M.A.

Head of Image Scanning Section

M. Weston, B.A.

both of Research Department

Summary: A system for the detection of shot changes occurring in films reproduced by telecine has been developed. This information is required for pre-programmed systems of telecine control and was, in the past, always obtained by visual inspection of the film in order to make a record, usually on paper tape, of the positions in the film at which shot changes occurred.

The detector described in this report eliminates the need for visual inspection of film and is being used to effect a useful saving in the time and cost of preparing pre-programmed correction information.

- 1 Introduction
- 2 Possible systems
 - 2.1 Physical detection of a splice
 - 2.2 Change of mean brightness and/or colour
 - 2.3 Sudden change of picture detail
 - 2.3.1 Correlation
 - 2.3.2 Subtraction
- 3 The field delay
- 4 The detector
 - 4.1 Movement protection
 - 4.2 Instrumentation of movement protection
- 5 Practical problems
 - 5.1 Dark scene
 - 5.2 Mean brightness errors
 - 5.3 Splice marks
- 6 Performance and limitations
- 7 Conclusions
- 8 References

1 Introduction

In order to reduce the visibility of scene-to-scene colour and exposure errors which can arise when colour film is reproduced by telecine, it has been common practice for many years to correct for these changes by manual operation of a colour corrector, such as **TARIF**,¹ when the changes are observed. This method is satisfactory provided a well-graded print is available, since scene-to-scene colour exposure variations are then small. If 'camera original' reversal, colour negative,² or 'one light' prints (all of which can have large shot variations) form a significant proportion of a film programme, then it is advantageous to be able to pre-programme colour and exposure error-correction settings. Corrections determined during rehearsal of the film may then be introduced when the film is broadcast at the beginning of each shot, rather than gradually (and visibly) by an operator.³

An essential piece of information required is the location in the film of each shot change so that the new correction can be introduced in the field-blanking interval between shots. In the BBC-designed pre-programming equipment the locations of scene changes in a film can be indicated in several ways, including the preparation of a 'frame-cue tape'; this is a record, on paper tape, of the film frame numbers at which scene changes occur. The preparation of this tape involves visual inspection of the film either in the telecine itself or on a modified editing bench, and since the film must be stopped at each shot change this procedure can take a considerable time. A more satisfactory method is to add metal cue-dots to the edge of the film during the editing operation; these dots can be detected as the film runs in the telecine and a control pulse fed to the programming equipment to indicate that a shot change has occurred. Although cue-dotting is better than making a separate frame-cue tape, since the film does not have to be handled twice (which increases the risk of it picking up dirt), the editing operation takes slightly longer and advance notice of pre-programming is required at the editing stage. This report describes a detector capable of recognising shot changes as the film runs in the telecine and feeding control pulses to the programmer, enabling pre-programming to be carried out with very little extra work.

No detector so far envisaged can detect dissolves or fades, but fortunately these are not always present in significant numbers in conventionally-printed films and are never present in films assembled from camera-original reversal or negative films. It is these types of film which are most likely to benefit from pre-programmed corrections, since they involve no printing operation in which colour grading can be carried out.

2 Possible systems

Several different methods of detecting shot changes were considered.

2.1 Physical detection of a splice

This was ruled out since printed films would produce no indications and the system would be unduly sensitive to critical mechanical adjustment and film damage.

2.2 Change of mean brightness and/or colour

A prototype system which integrated the Y, R-Y, B-Y signals over each field period, and compared the results from successive fields was built and tested.

Since a shot change is not necessarily accompanied by a change in mean brightness or colour larger than that normally produced by motion of the camera or scene, the adjustment of the detector proved to be a critical compromise between missed shot changes (when the sensitivity was too low) and false indications (when the sensitivity was too high). The performance depended on the programme content and, when tested with a large variety of material, the detector, on average, missed approximately 20 per cent of all shot changes and gave 10 per cent false indications. This performance was not considered adequate since, with some films the detector made more mistakes (either misses or false indications) than correct indications.

2.3 Sudden change of picture detail*

The method finally adopted is based on a comparison of video signals derived from successive film frames. This is achieved by delaying video signals for one television field (20ms) duration so that information from two successive fields is continuously available for comparison.* This comparison could be made by deriving the correlation function (as described below) but since this would have been complicated to instrument the simpler method of subtraction is in fact used. A simple form of detector thus registers a shot change when the comparison of successive fields shows a significant change in detail content. This is the basic principle on which the detector operates, but protection against spurious indications due to normal movement in the scene is also provided (see Section 4).

2.3.1 Correlation

The video signals appearing at the input and output of a 20ms video delay may be represented as functions of time $x(t)$ and $y(t)$ respectively, thus $x(t) = y(t + T)$ where T is the delay time of the delay line (20ms). If $x(t)$ and $y(t)$ are only considered over the range $T_1 < t < T_2$, where the time T_1 and T_2 represent the beginning and end of the active field of the television waveform, then $x(t)$ and $y(t)$ represent the video signals of two consecutive fields which are now available simultaneously.

The degree of similarity of the two fields may be found by evaluating the correlation of $x(t)$ and $y(t)$ over the period T_1 to T_2 . This correlation may be expressed as the correlation coefficient r of $x(t)$ and $y(t)$:

$$r = \frac{\int_{T_1}^{T_2} [x(t) - \bar{x}] \cdot [y(t) - \bar{y}] dt}{\left(\int_{T_1}^{T_2} [x(t) - \bar{x}]^2 dt \cdot \int_{T_1}^{T_2} [y(t) - \bar{y}]^2 dt \right)^{\frac{1}{2}}}$$

In this expression \bar{x} and \bar{y} represent the mean of $x(t)$ and $y(t)$ respectively. In practice the terms $(x(t) - \bar{x})$ and $(y(t) - \bar{y})$ may be approximated by a.c. coupling the input signals $x(t)$ and $y(t)$ to remove their d.c. components; the time constant of the coupling circuit should be less than a field period. If the a.c. coupled input signals are $x'(t)$ and $y'(t)$ the modified correlation coefficient r' may be defined:

$$r' = \frac{\int_{T_1}^{T_2} [x'(t) \cdot y'(t)] dt}{\left(\int_{T_1}^{T_2} [x'(t)]^2 dt \cdot \int_{T_1}^{T_2} [y'(t)]^2 dt \right)^{\frac{1}{2}}}$$

A simplified schematic diagram of a correlator to generate the above function is shown in Fig. 1. In order to correlate over the active field period all the integrators shown in Fig. 1 must be set to zero at the beginning of the active field (at T_1), and the output of the correlator sampled at the end of the active field (at T_2).

The degree of similarity of the two fields is determined by measuring the correlation coefficient. If the two fields are identical, i.e. $x(t) = y(t)$ then the correlation coefficient is unity. Two dissimilar fields produce a correlation of smaller magnitude.

The output of the correlator can be sampled at the end of each active field period, the correlation coefficient obtained, and applied to a level detector. If the threshold of the level detector is set to a value less than unity a shot change is indicated when the input to the level detector is less than the threshold. Although the generation of the correlation coefficient is the ideal form of comparison, it will be seen from Fig. 1 that the instrumentation is complicated since it requires several multipliers and integrators. A simpler alternative was therefore sought.

2.3.2 Subtraction

A simplified block diagram of the comparator finally used is shown in Fig. 2. One field of video signal is stored in a 20ms delay and compared with the next field by subtracting the undelayed video signal from it. Any difference between the two fields appears at the subtractor output and may be used to recognise shot changes.

High-frequency difference components which may be generated by slow movement of detail within the scene are removed by a low-pass filter. The bandwidth of this filter is a compromise between reducing the unwanted effects of motion

* This is only possible if the telecine machine is locked at 25 film frames per second to the synchronising pulses of a 50 fields per second television system, so that each complete film frame is scanned in exactly two television fields.

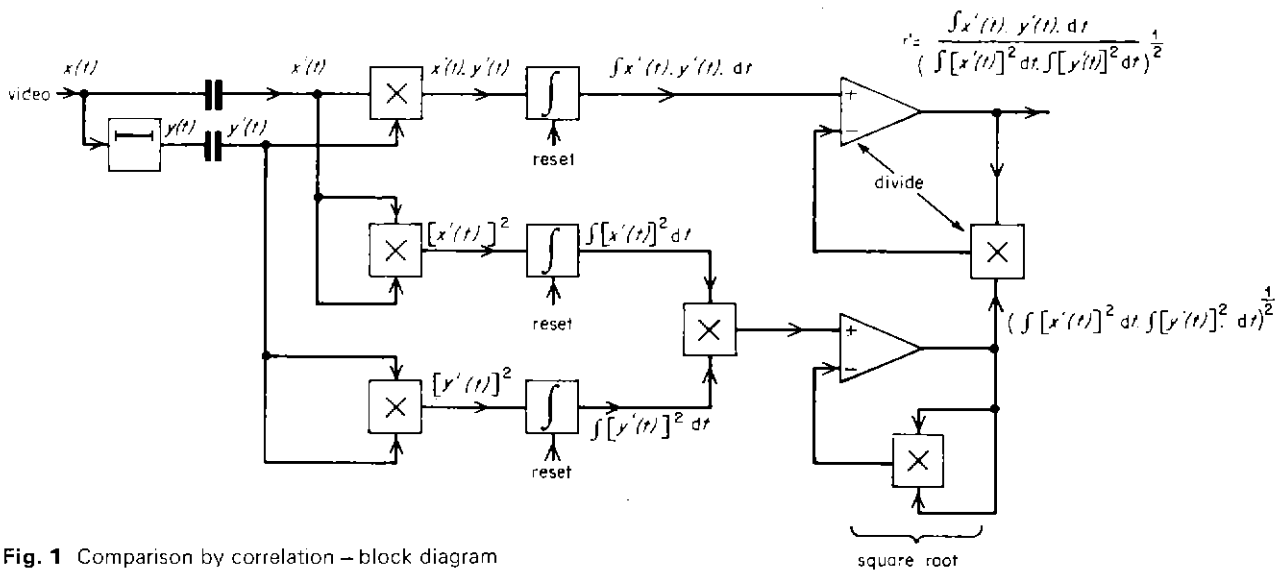

Fig. 1 Comparison by correlation – block diagram

and removing difference information which would aid in the recognition of a shot change. A bandwidth of 200 Hz has been found to be suitable but, even with this low bandwidth, very rapid motion can still give rise to larger differences than sometimes occur at real shot changes. This difficulty is overcome by the protection circuits described in Section 4.

The low-bandwidth difference signal is full-wave rectified and integrated over a field period. At the end of each field period the integrator output is sampled and the integrator reset to zero ready for the next field.

The sampled integrator output represents the total low-

bandwidth difference between successive fields and a shot change may be indicated if this exceeds a certain level.

If $y(t)$ and $x(t)$ represent the delayed and undelayed signals:

$$\text{Integrator Output} = \int_{T_1}^{T_2} \int_{-\infty}^{+\infty} [y(t - \tau) - x(t - \tau)] y(\tau) \cdot d\tau \cdot dt$$

(where T_1 and T_2 represent the limits of the active field and $y(\tau)$ is the impulse response of the low-pass filter).

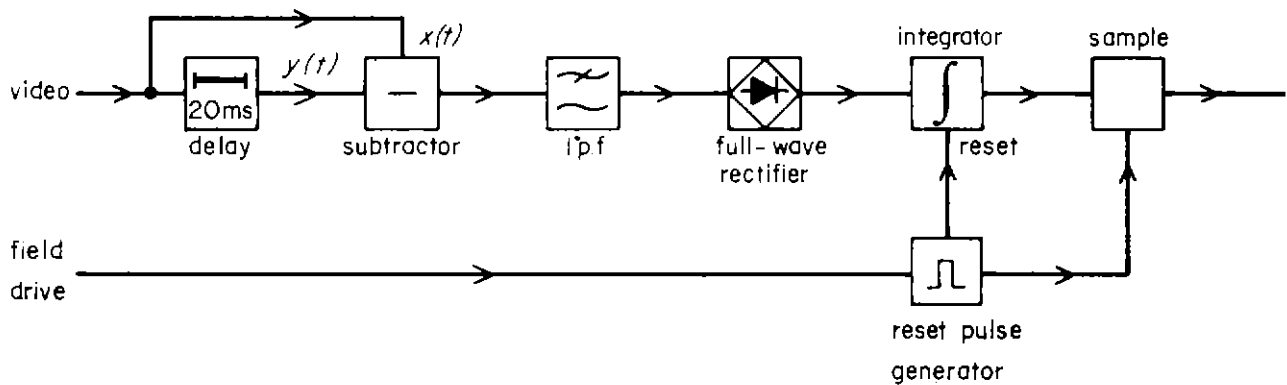
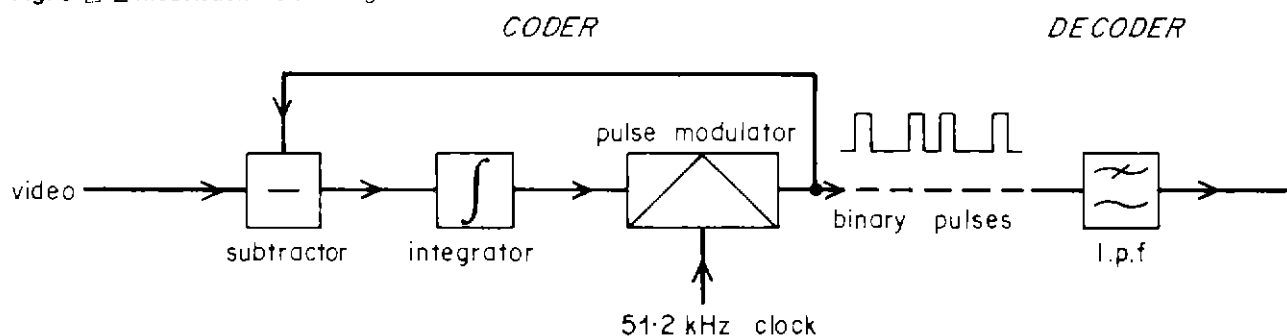

Fig. 2 Comparison by subtraction – block diagram

Fig. 3 $\Delta \Sigma$ Modulation – block diagram



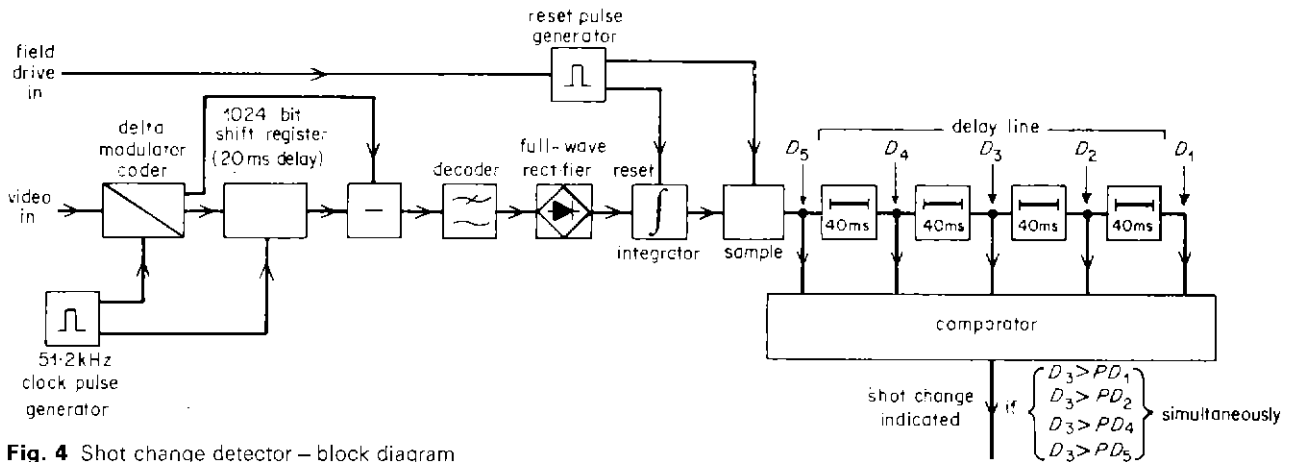

Fig. 4 Shot change detector – block diagram

This method of comparison is mathematically less elegant than correlation, but it is simple to instrument and has been found to work sufficiently well to make the added complication unnecessary.

3 The field delay

A delay of 20ms for a full-bandwidth video signal is both very elaborate and expensive. Fortunately, since the output is to be low-pass filtered, the delay need only be capable of passing a 200Hz bandwidth signal and a great reduction of cost and complexity is possible.

Mechanical or acoustic delay lines could be used to provide a delay of 20ms with a bandwidth of 200Hz, however, a more compact electronic delay can be constructed if the signal is encoded into a train of binary pulses which may be stored in a shift register. The incoming video is encoded into binary form by a process known as Delta-Sigma Modulation ($\Delta\Sigma$ Mod.) and a 1024 stage shift register clocked at 51.2KHz provides the required 20ms delay between input and output.

Delta-Sigma Modulation has the advantage that both coding and decoding are extremely simple to instrument. The coder (shown in Fig. 3) produces a train of binary pulses whose mean level is equal to that of the input signal. The output pulses are subtracted from the input and the difference integrated to determine the mean error. The polarity of this error is used to control the polarity of the next output pulse so that the error is continuously minimised. The coded signal may be simply decoded by a low-pass filter to remove the clock frequency components and leave low-bandwidth mean level information. In the complete comparator (shown as part of Fig. 4) the coded input pulses are subtracted from the delayed pulses and the low-pass filter serves the dual function of decoding the $\Delta\Sigma$ Modulation and restricting the bandwidth of the difference signal to 200Hz. The signal-to-noise ratio depends on the ratio of clock to filter bandwidth. With a 51.2KHz clock and a 200Hz filter the peak signal to peak quantising noise ratio is approximately 50dB which is ample.

4 The detector

Fig. 4 shows a simplified block diagram of the complete shot-change detector incorporating 'movement protection' which will be explained in Section 4.1. The video input is band limited

and coded into serial binary form by the delta modulator using a sampling frequency of 51.2KHz. The resulting train of binary digits is then delayed in a 1024-bit M.O.S. shift register, also clocked at 51.2KHz, to provide a 20ms delay. Comparison of information from successive fields is achieved by subtracting the undelayed bit stream from the delayed version, the resulting output being decoded by a low-pass filter to produce a low-frequency difference signal; this difference signal is then rectified and integrated over a field period. At the end of each field the integrated signal is sampled and the integrator reset. This sampled output thus represents the difference between successive fields.

The 'ideal' shot change which is most easily detected is that in which successive film frames describe radically different stationary scenes. Fig. 5 shows waveforms associated with such an 'ideal' shot change. Fig. 5(a) shows the low-pass filtered video signal associated with three film frames either side of a shot change. Fig. 5(b) shows the video difference signal between successive fields and Fig. 5(c) the integrator output. (It should be noted that due to a d.c. offset at the input to the integrator there is a constant output with no video difference signal input; this is instrumental and should be ignored.) The integrator output associated with such a shot change may easily be detected by means of a monostable which is triggered by pulses that exceed a pre-determined magnitude. Some discrimination against movement producing sufficient integrator output to indicate a spurious shot change can be provided by a suitable choice of the minimum magnitude of the integrator output necessary to trigger the monostable. This method is, however, most unsatisfactory and results either in insufficient movement protection or in lack of sensitivity causing many true shot changes to be missed.

A very much more satisfactory method is to examine the integrator output for single pulses which are produced at shot changes, so that a succession of pulses on alternate fields which will be produced by scene or camera movement may be ignored.

4.1 Movement protection

Fig. 6(a) shows a typical video signal resulting from steady motion in the picture with no shot change. Fig. 6(b) shows the resulting difference signal from eight successive film frames, and Fig. 6(c) shows the integrated, rectified difference signals.

It will be seen that Fig. 5(c) and Fig. 6(c) waveforms would both operate a simple output-level detector, but that the output at Fig. 6(c) contains a succession of pulses whereas the output in Fig. 5(c) is unique. Thus movement can be discriminated against by examining the integrator output for unique changes.

In order to do this it is necessary to store integrator outputs over several successive film frames and to compare them. It has been found experimentally that five frames is a suitable choice and that a shot change should only be indicated if any integrator output is greater than that from the two preceding and two succeeding frames by a factor P . If this factor P is too large, shot changes during even moderate movement will not be indicated. If it is too small, there will be insufficient movement protection, particularly for movement involving high rates of acceleration. The optimum value was determined by experiment involving the examination of a great deal of film, since different types of film, for example, hand-held camera shots and static scenic subject matter, represent the extremes which must be dealt with. Although the final choice must be a compromise, a value of 2.0 for the factor P was found to be suitable and provides quite remarkable protection against movement without resulting in a serious loss of true shot-change indications for the majority of film material.

4.2 Instrumentation of movement protection

Successive integrated frame difference signals are stored in a bucket-brigade delay-line which acts as an analogue shift register (see Fig. 4).

The signal is represented by a charge which is passed from one storage capacitor to the next by clock pulses at frame rate. At any time there are, therefore, five successive integrator outputs available for comparison.

A shot change is indicated if the voltage at D_3 is greater, by the factor P , than all the voltages at D_1 , D_2 , D_4 and D_5 , with which it is compared.

5 Practical problems

The detector as described detects shot changes in signals from electronic cameras with a high success rate. Film shot changes, however, are rarely ideal and may be missed unless refinements are made. Three kinds of problems are common.

5.1 Dark scene

Under-exposed camera original film, or film of very dark scenes, contains changes from one dark scene to another which produce such low integrator outputs that the comparator output is too low to provide a reliable indication. This can be solved by applying automatic gain control to the incoming video signal so that the mean level is maintained constant. If the time constant of the gain compensation is made long compared with a field period, no interference with shot change detection will be caused by the resulting slow changes of gain occurring with changes of scene content. Alternatively, the incoming video signal to the detector may be logarithmically related to the linear signal from the telecine head-amplifier by means of a logarithmic amplifier. This logarithmic video signal represents density changes in the film and, to a first

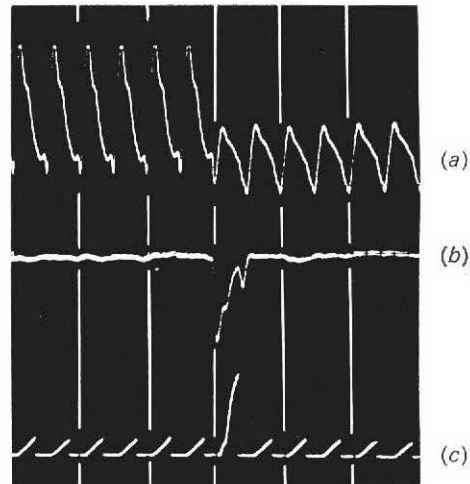

Fig. 5 Ideal shot change
(a) Filtered video input (b) Difference between fields
(c) Integrated (rectified) difference (reset during blanking)

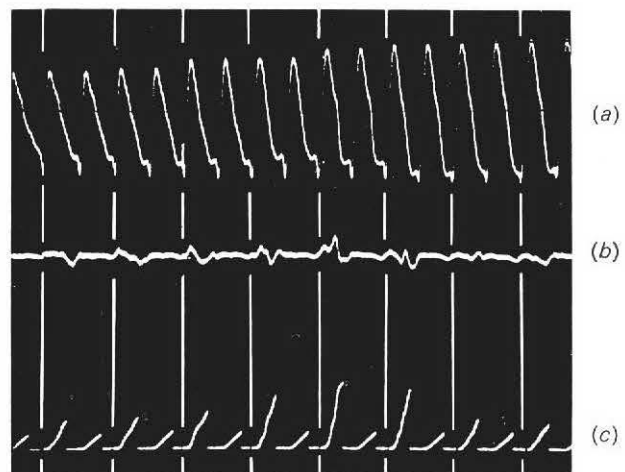

Fig. 6 The effect of motion
(a) Filtered video input (b) Difference between fields
(c) Integrated (rectified) difference

approximation, these remain constant whether the film is under- or over-exposed. This last method was the one adopted for the final detector.

5.2 Mean brightness errors

When an 'A roll, B roll' print is made the printer light valve is opened and closed at the beginning and end of each shot. Sometimes the valve does not open sufficiently fast and, in the resulting print from a negative, the first frame of each shot is lighter than the remainder of that shot. This effect is shown in Fig. 7(a). The valve may also start to close too early at the end of a shot, with the result that the last frame is also lighter than the rest. Similar errors in mean brightness also occur when the film is joined with tape which covers the frames before and after a shot change.

The detector, as described so far, would register the changes in mean brightness occurring before or after a shot change; this is illustrated in Fig. 7(b). The shot change could be mis-

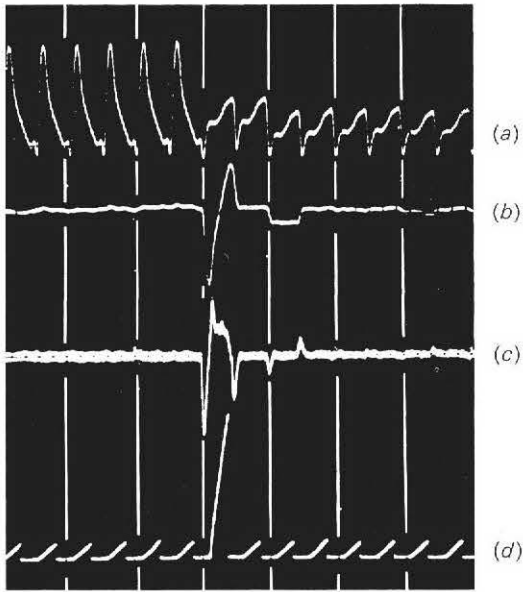

Fig. 7 Printer errors
 (a) Filtered video input (b) Difference between fields
 (c) Differentiated difference
 (d) Integrated (rectified) differentiated difference

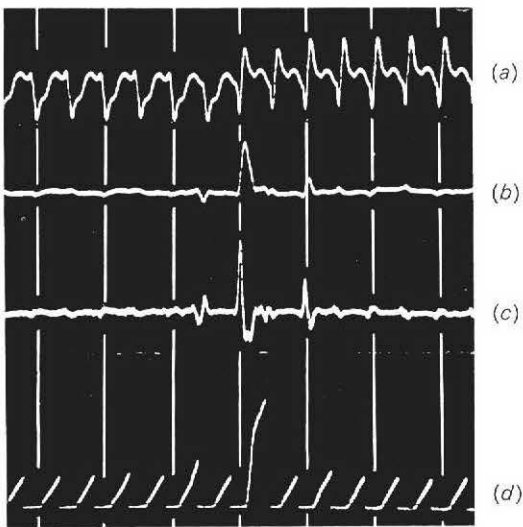

Fig. 8 Splice marks
 (a) Filtered video input (b) Difference between fields
 (c) Differentiated difference
 (d) Integrated (rectified) differentiated difference

taken for movement and no indication would be produced. This problem may be overcome by differentiating the filtered difference signal. Waveform 7(c) shows how mean brightness information is then substantially confined to the field-blanking periods, and is thus ignored by the integrator which is reset to zero during these periods.

Very little shot change information is lost by ignoring mean brightness in this way since mean brightness is frequently nearly constant.

5.3 Splice marks

Most methods of splicing film leave marks on either side of the join, extending a short distance into the image area of the film. The effect of these marks is that the frames immediately before and after the splice differ slightly from adjacent frames. The movement protection circuit therefore may interpret this information as movement, and inhibit the output.

Fig. 8(a) shows the video signal which results from a typical cement splice involving an overlap of about 2 mm with 16 mm film. The spurious outputs due to the splice are clearly visible in Figs. 8(b) and 8(c). If no precautions are taken, the integrator output which results is as shown in Fig. 8(d). It will be seen that there are increased integrator outputs corresponding to film frames on either side of the splice, and that these are likely to be interpreted as motion, causing the movement protection logic to operate. This problem arises with almost all forms of splices, including thermal butt welds which often leave heat stains extending into the image area.

Since such marks are usually confined to reasonably well defined areas at the top and bottom of the image, their effect can conveniently be eliminated by inhibiting the integrator during the scanning of the top and bottom 20 per cent of the image. In the detector this is carried out by lengthening the interval during which the integrator is reset to zero.

6 Performance and limitations

The typical performance which is regularly obtained when the detector is used in conjunction with a flying-spot telecine is such that 98 per cent of all true shot changes are detected, 2 per cent are missed and there are 5 per cent spurious indications. The missed shot changes are usually due to rapid movement occurring just before or just after a shot change, causing the movement protection to operate and inhibit the shot-change indication.

It should be noted that in its present form the detector can only be used when the telecine machine is rigidly locked at twenty-five film frames per second to the synchronising pulses of a fifty-fields-per-second television system, so that each complete film frame is scanned in exactly two television fields. A modification to the integration intervals, so that they occur correctly timed in relation to the scanning of film frames, would be necessary if the detector were to be used in conjunction with a sixty-fields-per-second system, or with a telecine which was not locked and frame phased to the television system.

Problems have been encountered when the detector is used in conjunction with pre-programming equipment due to spurious operation during the run-up and stopping of the telecine and during reverse running. These have been solved

by inhibiting the output from the detector unless the telecine machine is running forward and is correctly synchronised at normal speed. The detector cannot detect fades or dissolves and, when these occur, the telecine must be stopped and the shot-change information inserted by hand. If many fades or dissolves are known to be present, the preparation of a frame-cue tape is probably still the better method of ensuring the accurate timing of colour correction changes.

7 Conclusions

A shot-change detector has been developed and used for almost all pre-programming operations during the last year and has, by its high detection success rate, virtually eliminated the need for the preparation of frame-cue tapes for normal

types of film. The reduced handling of the film has not only saved time and cost, but reduced the problem of dust accumulation which is particularly troublesome when reproducing negative film directly in a telecine.

8 References

1. Wood, C. B. B., Sanders, J. R. and Griffiths, F. A. 1965. Electronic compensation for color film processing errors. *J. Soc. Motion Pict. Telev. Engrs.*, 1965, 74, 9, pp. 755-9.
2. Wood, C. B. B., Palmer, A. B. and Griffiths, F. A. 1972. Color negative in the telecine. *J. Soc. Motion Pict. Telev. Engrs.*, 1972, 81, 9, pp. 661-4.
3. Kitson, D. J. M., Palmer, A. B., Spencer, R. H., Sanders, J. R. and Weston, M. 1972. The programming of film-scanner controls. *EBU Rev.*, 1972, 134A, pp. 156-62.
4. Patent No. 42574/71.

8-bit Analogue-to-digital and Digital-to-analogue Converters for Vision Signals

Analogue-to-Digital Converter CO8/501

This converter is suitable for use with full-bandwidth 625-line colour television signals, which it encodes into 8-bit parallel digital form. Such a digital signal is capable of being stored electrically, and therefore lends itself better than an analogue signal to standards-conversion, timing-correction, synchronisation, and similar processes. Further encoded into serial form, it is a very robust signal suitable for transmission over long distances via SHF links.

The conversion method used is the two-stage Parallel-Serial-Parallel system. The input signal is first resolved with respect to sixteen coarse levels. The difference between the chosen coarse level and the input level is then found by subtraction and resolved in a second stage having a range of a further sixteen levels. The input signal is hence resolved to one part in 256 (16×16), i.e., eight bits.

The converter includes the following standard features normally associated with video peripheral units in other applications.

- * Video sample-and-hold system with sub-nanosecond aperture time.
- * Subcarrier tripler to produce a 13.3 MHz clock signal from PAL subcarrier (external clock input can be used if required).
- * Black-level clamping to provide stabilisation with respect to a known digital code.
- * Automatic digital overflow correction to maintain d.c. stability and conversion linearity.

The converter is constructed on a special chassis measuring 432 mm and 263 mm, which can be accommodated in a modified special Imhof 222 mm CDX panel. Supplies of d.c. at +12 V, +5 V and -12 V are required.

Digital-to-Analogue Converter CO9/501

This unit is designed for use with the analogue-to-digital converter described above. It decodes 8-bit parallel digital in-

formation having a word-rate between 5 million and 15 million words per second.

Data input line receivers are provided which give a choice of the following types of input signal:

- (a) Balanced, into TTL or ECL positive or negative logic circuits, with synchronous clock pulses.
- (b) Unbalanced, into TTL or ECL positive or negative logic circuits, with synchronous clock pulses and adjustable-threshold facility.
- (c) External clock pulses, into positive TTL circuits to enable the timing of the video output signal from the unit to be varied remotely over a range of approximately ± 25 ns.

The video output amplifier is d.c.-coupled and hence, when the unit is used in conjunction with the analogue-to-digital converter CO8/501, the output signal is clamped. Unwanted transients at data transitions are removed by internal sampling. A two-setting gain switch is provided to enable either composite or non-composite video output signal to be delivered at standard amplitude.

General data

Analogue-to-Digital Converter

Power requirements	D.C. at ± 12 V, -12 V and ± 5 V
Input signals	1 V p-p 625-line colour video 1 V p-p PAL colour subcarrier
Input impedance	75 Ω (both inputs)
Output signal	8-bit parallel code with synchronous clock. (Compatible with normal TTL levels)
Word rate	13.3×10^6 per second (nominal) 15×10^6 per second (maximum)
Equivalent bit rate	106.4×10^6 per second (nominal) 120×10^6 per second (maximum)
Encoding accuracy	= half least-significant bit on 15.625 kHz sawtooth signal with 4.43 MHz colour subcarrier (worst case)

Digital-to-Analogue Converter

Power requirements	D.C. at ± 24 V and ± 5 V
Input signals	See text

Output signal	Video, 1 V p-p composite or 0.7 V p-p non-composite
Word rate	As for A.D.C.
Equivalent bit rate	As for A.D.C.
Decoding accuracy	Better than one-half least-significant bit or a digitally generated 15.625 kHz sawtooth signal with a 4.43 MHz sub-carrier. Switching spikes less than one-quarter least-significant bit.

Insertion Communication Equipment (ICE)

Insertion communication is the process of transmitting and receiving data in digitally coded form via a video link using one or more lines during the field blanking-intervals of a video signal. Typical applications envisaged for the system are network- and source-identification, the transmission of monitoring data and Natlock error-signals, and the remote control of equipment at Regions or transmitters. The system is unaffected by the presence of encoded sound in the synchronising pulses.

The equipments here described utilise lines sixteen and 329 of the 625-line video signal. Parallel input data is inserted into the video signal after conversion into serial binary-coded form, each serial 'bit' being encoded by the 180° phase-shift-keying of a 2.5 MHz carrier signal. (This arrangement provides the system with a parity-check, since normally only two consecutive elements can be in the same state and departure from this rule denotes an error.) The inserted signal occupies 50.4 μ s of line time and 126 bits (used as fourteen channels of nine bits each) can be accommodated.

The first channel carries a 5-bit reference-'burst' to serve as a datum for the insertion-signals during the remainder of the line followed by a 4-bit 'start'-signal. In the second channel, the first bit identifies the field as odd- or even-numbered, this provision enables different sets of signals to be inserted on lines sixteen and 329 if necessary. The remaining bits of this channel form a signal identifying the origin of the programme-signal as BBC, IBA or P.O.; a network, a Region or an outside broadcast; and any one of up to thirty-two sources denoted by assigned numbers. In each of the remaining channels the first bit is not used, but forms a 'guard' to give time for an erasing-circuit to come into operation, if required. The remaining 8-bits form the equivalent of an 8-wire cable which can accept a change-in-data rate of up to 50 Hz (i.e., field-frequency) or two 8-wire cables which can accept a change-in-data rate of up to 25 Hz (i.e., picture-frequency).

The equipment type EP8M/504 exploits the whole of the capacity of the system. A variety of types of plug-in unit can be fitted to enable the equipment to insert or extract information or to erase information already present in any of channels three to fourteen. Data can be inserted into unoccupied channels, or erased, at intermediate points in a circuit. Additionally, in anticipation of requirements in the future, when it is intended that the equipment shall form part of a complex signalling-system, provision is made for the erasure, by remote control, of any information in lines 11-22 and 324-335.

The equipments types EP8L/505 and EP8L/506 are smaller, and can insert, extract, or erase information in eight and four

channels, respectively. The two remaining equipments, types EP8L/507 and EP8L/508, are capable only of extracting signals from six or two channels, respectively.

The allocation of channels one and two described above is that proposed for use on main networks. A provisional allocation of the remaining channels is as follows:

3 and 4	Natlock error-signals and address
5	Switching-signals and address
6-10	Available for use
11-14	Monitoring and control-data from transmitters.

The channel-allocations and the insertion-signal waveforms are considered in greater detail in Designs Department Technical Memorandum No. 2.402(73).

The equipments EP8M/504 to EP8L/508 comprise up to 14, 10, 5, and 3 plug-in units, respectively, as required to accommodate the functions and number of channels at a particular point in a circuit. Type EP8M/504 includes a termination-panel and a general-purpose panel PN3/23 which, in its complete form, it fills. The other equipments, which occupy less panel-space, include termination-panels for mounting in general-purpose panels housing other apparatus. All the equipments require a supply of a.c. mains.

For further information, please contact A. R. Hoare, Room 504, Western House (PABX B.H. 4126).

Multiplexed Transmission of Vision Signals

Frequency-division multiplex equipments have been developed to enable a second television circuit to be carried by a non-repeated cable already equipped for direct, baseband, video operation. The equipments types EP2M/501 and EP2M/502 perform carrier sending and receiving functions, respectively, and are capable of working over (for example) up to 7.5 km of 9.5 mm coaxial cable. Equipments coded EP2M/501A and EP2M/502A are also available for use on shorter circuits; any combination of sending and receiving equipments can be used, according to the loss of the cable.

The second signal is transmitted as an amplitude-modulated carrier with a nominal frequency of 10 MHz. The signal is pre-emphasised before modulation takes place; the depth of modulation is well over 100 per cent, giving a semi-suppressed-carrier mode.

In the receiving equipment, the modulated carrier is converted by a high-pass shaping-filter into a vestigial-sideband signal in which the carrier-frequency is attenuated 6 dB and all sideband-components below 8.75 MHz by more than 20 dB. This is applied to a synchronous demodulator, the locally-generated carrier-frequency input of which is phase-locked to the carrier-component of the received signal. De-emphasis complementary to the pre-emphasis in the transmitting equipment then takes place, to yield the original video signal.

Isolation between the video and carrier-terminal apparatus at each end of the circuit is maintained by the provision of duplexing filters which form part of the equipment.

A test-equipment, the Vision-carrier Test-equipment

EP14M/506, is available to facilitate the maintenance of the carrier-equipments or their sub-units. This is essentially a reference 'modem' (modulator and demodulator) which can be switched to provide the conditions required for the necessary performance-checks.

All the equipments are constructed for mounting on a standard 483mm bay, and are 330mm deep. The carrier-equipments occupy 178mm of bay-height, and the test-equipment, 267mm.

General data

Power requirement	240 V a.c. mains EP2M/501: 55 watts EP2M/502: 35 watts EP14M/506: 45 watts
Ambient-temperature range	0–50°C
Input-and-output impedance	75Ω

Performance data

With bearer-circuit having cable-loss equal to, or less than,

55dB at 10MHz (e.g. 7.5km of 9.5mm diameter coaxial cable):

Baseband Circuit

Performance as without carrier-equipment.

Carrier Circuit

2T K-rating	1%
Chrominance-Luminance Gain inequality	± 3%
Chrominance-Luminance Delay inequality	± 10ns

Gain

Luminance non-linearity:

Input Signal-level = 0dB	1%
Input Signal-level = ± 3dB	2%

Differential-gain Distortion,

Input Signal-level = 0dB	1%
Input Signal-level = ± 3dB	2%

Differential-phase Distortion

Input Signal-level = 0dB	1°
Input Signal-level = ± 3dB	2°

Chrominance-luminance Crosstalk

Input Signal-level = 0dB	1%
Input Signal-level = ± 3dB	2%

Signal/noise ratio (weighted)

> 64dB

Publications available from Engineering Information Department

Information Sheets on the following subjects can be obtained from Head of Engineering Information Department, Broadcasting House, London W1A 1AA, and are available free of charge, except where otherwise indicated.

General

9002 Wavebands and Frequencies Allocated to Broadcasting in the United Kingdom

Television

- 4006 UHF Television Reception
- 9003 Television Channels and Nominal Carrier Frequencies
- 2701 Television Interference from Distant Transmitting Stations
- 4101 Television Receiving Aerials
- 4306 Test Card F
- 2001 Transmitting Stations, 405-line Services (BBC-1 and BBC Wales): Channels, Polarisation, and Powers
- 2901 Transmitting Stations, 405-line Services (BBC-1 and BBC Wales): Map of Locations
- 4003 Transmitting Stations, 625-line Services: Channels, Polarisation, and Powers
- 4919 Main Transmitting Stations, 625-line Services: Map of Locations
- 2020 405-line Television: Nominal Specification of Transmitted Waveform

- 4202 625-line Television (Colour and Monochrome): Brief Specification of Transmitted Waveform
How to receive BBC TV – 625 lines and colour

Radio

- 1042 BBC Local Radio Transmitting Stations (MF2 VHF): Frequencies and Powers
- 1701 Medium-wave Radio Services: Interference
- 1603 Stereophonic Broadcasting: Brief Description
- 1604 Stereophonic Broadcasting: Technical Details of Pilot-tone System
- 1605 Stereophonic Broadcasting: Test Tone Transmissions
- 1034 VHF Radio Transmitting Stations: Frequencies and Powers
- 1919 VHF Radio Transmitting Stations: Map of Locations

Service Area Maps

Individual maps showing the service areas for many radio and television transmitters are also available.

Specification of Television Standards for 625-Line System I Transmissions

A detailed specification of the 625-line PAL colour-television signal transmitted in the United Kingdom is published jointly by the British Broadcasting Corporation and the Independent Broadcasting Authority, and can be obtained for 50p post free from Head of Engineering Information Department, Broadcasting House, London W1A 1AA.