

BBC ENGINEERING

Number 87 July 1971

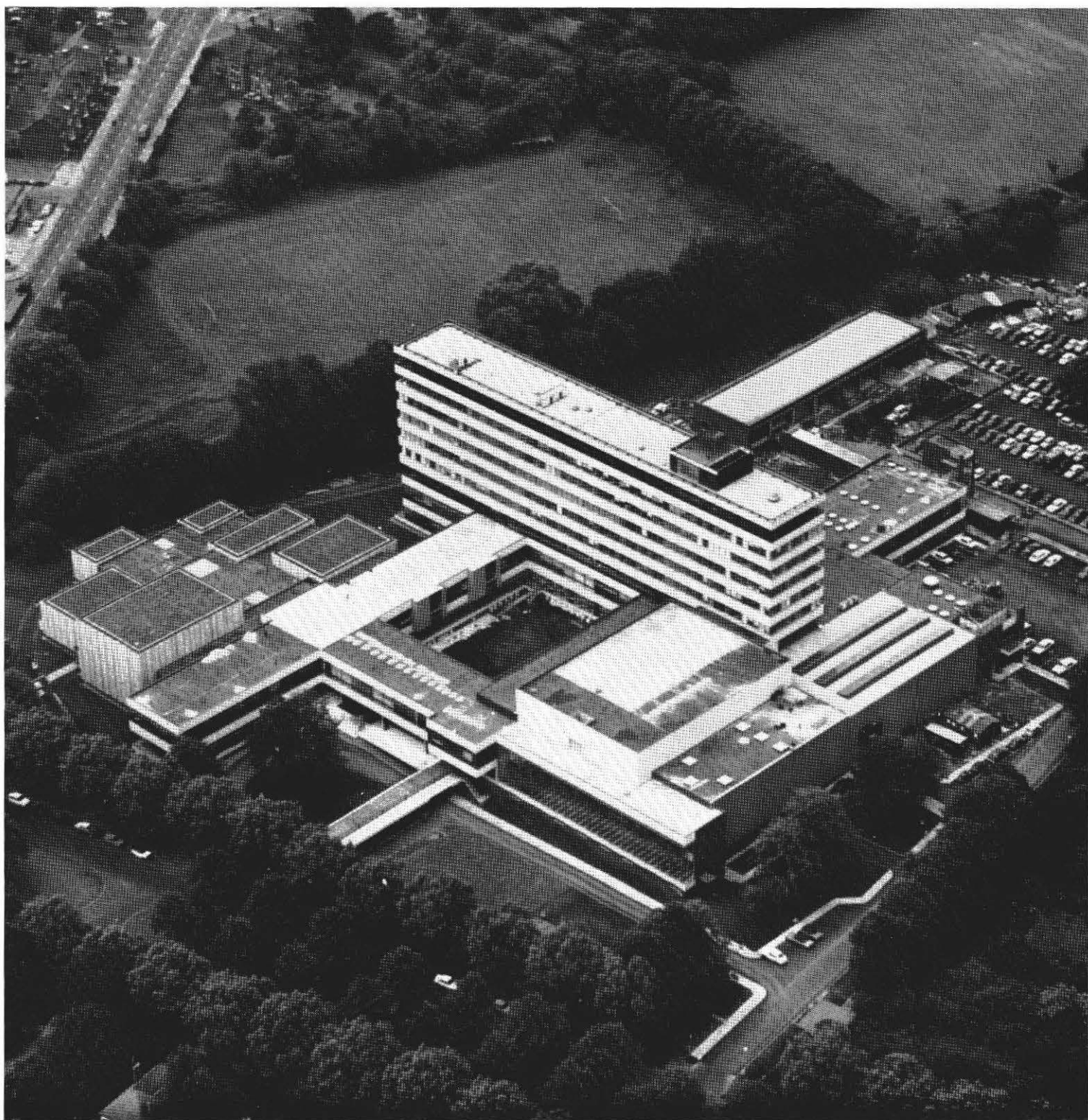

BBC Engineering

including Engineering Division Monographs

A record of BBC technical experience and developments
in radio and television broadcasting

Published approximately four times per year by
BBC Publications,
35 Marylebone High Street,
London W1M 4AA
ISBN 0 563 12124 6

Edited by
BBC Technical Publications Section,
Harewood House,
Hanover Square,
London W1A 1AA

Printed by
The Broadwater Press Ltd,
Welwyn Garden City,
Herts.

Price
40p or \$1.00 per issue post free
Annual Subscription
£1.50 or \$4.00 for 4 issues post free

Articles are copyright © 1971 by the
British Broadcasting Corporation
and may not be reproduced in whole
or part without written permission.

Cover illustration:

The photograph shows the Regional Studio Centre at Pebble Mill, near Birmingham. The various blocks in the building complex are identified in the site plan on page 7. This photograph, and those in the two parts of the article on Pebble Mill, were taken by Willoughby Gullachsen. Thanks are due to the Automobile Association for providing the aircraft from which the cover photograph was taken.

Contents

Editorial: The Changing Pattern of Broadcasting in the United Kingdom	2
Principal Articles:	
A New Concept of Regional Broadcasting J. D. MacEwan	3
Regional Studio Centre, Birmingham	
Part I: Architectural Aspects R. A. Sparks	6
Part II: Technical Facilities D. R. Kinally	15
Local Radio D. H. Cummings and R. E. Bliss	23
Short Items:	
Radio Camera Aerials for the 2.5-GHz band	5
On-air Switching Facilities for Birmingham	22
Anchor: Modification to Provide Clock Facilities	22
U.H.F. Offset Plan for Europe	37
Insertion Communication Equipment: Field Trial	37
Contributors to this issue	38
Books by BBC Authors	39
Contents of previous issues in 1971	40

The major contributions are preceded by individual lists of contents.

The Changing Pattern of Broadcasting in the United Kingdom

In July 1969, the BBC published *Broadcasting in the Seventies* which contained its plans for network radio and non-metropolitan broadcasting over the next decade. This was followed in March 1971 by the White Paper announcing the Government's proposals for establishing an alternative service for sound broadcasting to be financed from the sale of advertising time. These two documents shape the future pattern of radio broadcasting in this country and introduce some fundamental changes in which local radio stations play an important part. The BBC plans, although mainly concerned with radio, also include important changes in the regional pattern of its television services. In this issue of BBC ENGINEERING the engineering aspects of the BBC's plans are reviewed in the article entitled 'A New Concept of Regional Broadcasting', and the engineering problems involved in launching a service of local broadcasting are discussed in the article on 'Local Radio'.

The prime purpose of the BBC plans, now being implemented, is to adapt its service to changing tastes and habits, and to meet the specific needs of audiences in different parts of the country. In this development the technical and programme aspects are closely related and it is interesting to consider how the development of the technical means has helped to shape programme policy in providing both radio and television programmes for localised audiences.

In the earliest days of sound broadcasting in this country, before the existence of networks, low-power medium-wave transmitters were set up in many cities and because the facilities for simultaneous broadcasting developed only gradually, a high proportion of the programme material was locally produced. It was soon apparent, however, that listeners wanted to hear not only news of local affairs, weather, sport etc., but also the best in music, drama, and talks from other parts of the country, and especially from the capital.

The change from low-power to high-power medium-wave stations under the Regional Scheme of 1929 arose partly from the growing shortage of channels, and partly from the need to serve the rural areas as well as the large towns and cities. This led to the large BBC regions which existed right up to 1970. The scheme has been criticised, particularly in recent times, on the ground that the way in which programmes are

distributed ought to suit the needs of the audience rather than the convenience of engineers. Nevertheless, the planning had to have regard to what was technically feasible at the time. At one time in the 1930s the regional programmes each contained a high proportion of locally produced material but it was gradually realised that much of this material, if acceptable to the wide regional audience, was also likely to be of interest to the whole country.

The advent of v.h.f. radio made possible the adoption of more compact and realistic areas and in recent years the Radio 4 v.h.f. transmitters have been used to a limited extent to provide localised news and weather services for their areas.

In *Broadcasting in the Seventies* the old pattern of the large English regions is replaced by a new plan based on areas served by one or more v.h.f. (or u.h.f. in the case of television) transmitters. In the case of radio, it was proposed that Radio 4 in England should be a single programme and that all local programmes should be provided by the new local stations, primarily on v.h.f. with m.f. support where practicable. In television the previous four large English regions are replaced by eight smaller and more socially-logical regions plus London, which continues to cater for the South-east. Each of these regions is served by one or more v.h.f. and u.h.f. transmitters. In this way the move to higher frequencies with more limited and precisely defined range has led to the adoption of areas for local programmes which accord much more closely with the loyalties and interests which people have in the areas where they live.

The BBC's plans for Local Radio, published two years ago, envisaged a total of about forty v.h.f. stations providing 90 per cent coverage of the population of England, but the recent White Paper concluded that, for the time being, only the twenty BBC v.h.f. local stations (with about 75 per cent coverage of England) which were in service or approaching completion when the White Paper was issued, should continue in operation and that the local services provided should be transmitted also on m.f. In this way the White Paper concludes that it is possible to plan the proposed new commercial radio services with a network of up to sixty v.h.f. radio stations, also supplemented by m.f. stations, providing about the same population coverage as that of the BBC's local-station network.

A New Concept of Regional Broadcasting

J. D. MacEwan, B.Sc., C.Eng., F.I.E.E., M.I.E.R.E., M. Inst. P.

Chief Engineer, Regions*

UDC 621.396.97

Summary A description is given of the engineering aspects of changes in the regional structure and programming policy of both radio and television, which the BBC began to put into effect in 1970.

Radio networks

Although the former Light, Home, and Third programmes were often identified as being respectively 'low-brow', 'middle-brow', and 'high-brow', radio broadcasting in this country had been traditionally based on a mixed programming principle whereby any single channel offered the public a whole range of programmes covering all interests and many different levels of 'brow'. The new plans outlined in *Broadcasting in the Seventies*[†] were based on a different concept – one of specialised or 'generic' networks which experience both in this country and abroad suggested was more in tune with the listening habits likely to prevail in the seventies. In essence this meant that Radio 1 would be devoted to pop music, Radio 2 would cater for the light music listeners, Radio 3 would carry mainly serious music, and Radio 4 would be strengthened for its role as the speech network carrying the main News and Current Affairs programmes. The plans also detailed the means by which all the other various programme strands – drama, religion, education, sport etc. – would be accommodated within this broad format of four networks. Expansion of stereo into other channels and further parts of the United Kingdom was also predicted.

In considering the composition of the new networks in all their detailed programme content, the importance of the existing regional contributions was fully recognised. Plans were laid to maintain and foster these. Thus, in reviewing the facilities which would be required to meet the demands of the new network formats, there was a commitment to up-date and rationalise the BBC's radio resources in London and throughout the United Kingdom.

Television networks

Again in the case of television the value of contributions to the two networks, BBC-1 and BBC-2, from 'non-metropolitan' led the directorate to reinforce its policy of including regional material from both the outside broadcast field and main studios beyond London. Regional talent was to be fostered and local initiative was to be an inbuilt feature. With the conversion of programme sources to colour nearly complete in London, it was possible to examine the service's overall requirements for the seventies.

* Now Chief Engineer, Radio Broadcasting.

† Published by the BBC in July 1969. See the Editorial in this issue.

Network production outside London

The combined look by the radio and television directorates of the BBC has permitted an overall rationalisation of expensive technical facilities to be effected.

One outcome of the new plans has been the decision to establish three network production centres in England, located in Birmingham (Pebble Mill), Bristol, and Manchester, modernised and equipped to cope with the needs of the radio and television networks of the seventies. In the case of Pebble Mill there are, for example, two radio music studios with stereo facilities and the largest television studio outside London. Programme material from the three national regions – Scotland, Northern Ireland, and Wales – will continue to come principally from Glasgow, Belfast, and Cardiff (using up-dated facilities) although contributions from the whole of their territories are, of course, obtainable through the means of their radio and television outside broadcast units, and the sub-centres.

Regions before 1970

Prior to April 1970 the BBC's broadcasting outside London was based on six large regions – three National and three in England (North, Midlands, South and West), London acting as the centre for the South-east. The boundaries of these date back over forty years and were necessarily arranged to match the service areas of the developing chain of high-power medium-wave transmitters of the early thirties, rather than on the basis of more localised community interests. These regional boundaries had remained substantially the same (Map 1) ever since, although certain steps had been taken over the intervening period to subdivide wherever and whenever possible as radio and television developed outside the metropolitan area. The reasons for these steps are not hard to seek – North Region initially covered everything from Merseyside across to the North Sea and from Manchester to Carlisle and the borders of Scotland, Midland Region extended from the Marches and Welsh border to the Wash and Great Yarmouth, 'South and West' included such diverse places as the Scillies, Brighton, and Gloucester. In a word they were still much too big for either Radio's or Television's purposes, and plans were laid to replace them with areas having more restricted boundaries.



Map 1 Original English regional boundaries

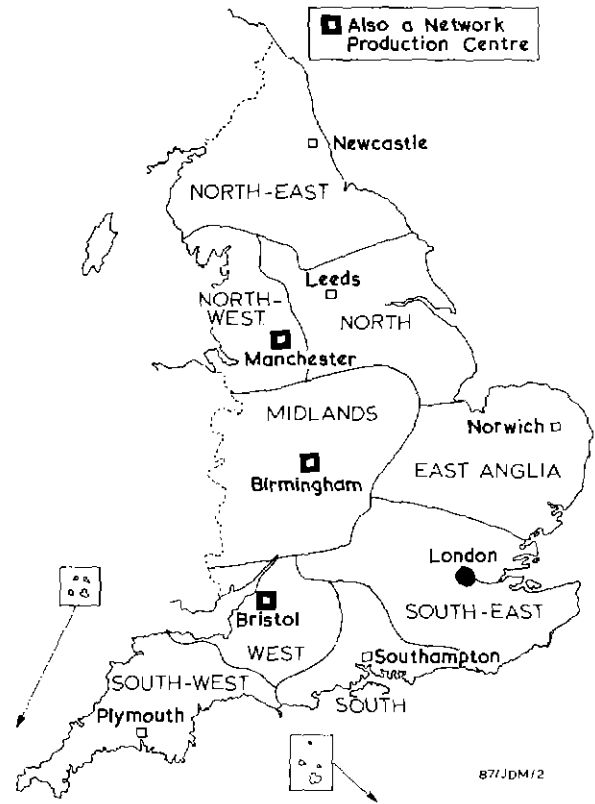

Map 2 Editorial boundaries of the eight English BBC television regions established in 1970

Television regions after 1970

Eight smaller and more socially-logical regions have been created in England, based on and at the existing regional and area centres:

- | | |
|-------------------------|------------------------|
| Birmingham (Midlands) | Newcastle (North East) |
| Bristol (West) | Norwich (East Anglia) |
| Leeds (North) | Plymouth (South West) |
| Manchester (North West) | Southampton (South) |

Each is run by a Regional Television Manager who enjoys autonomy in conducting his operations. London continues to cater for the South-east and thus makes in effect a ninth 'region'. Each of the new regions originates about 2½ hours of local material a week, and in total they produce over 400 programmes per year over and above the nightly News Magazines. Map 2 shows the Editorial boundaries established by the Controller, English Regions, who, with his new headquarters staff, is based in the heart of the operation at Birmingham. As far as possible the boundaries have been chosen to coincide with the 625-line u.h.f. Preferred Service areas, due note being taken of the existence of the prevailing 405-line service. Technical plans have also been laid to establish in the longer term further Television Regions as money permits.

The National Regions – Scotland, Wales, and Northern Ireland – continue largely in their present form, each offering a single national regional service; technical possibilities exist for subdivision on the basis of their sub-centres and elsewhere should it prove desirable at any time in the future.



Map 3 Cities and areas served by the twenty BBC local radio stations authorised in March 1971 (the coverages are shown in the larger map on page 24)

Local Radio

The success of the eight-station experiment (Radios Brighton, Durham, Leeds, Leicester, Merseyside, Nottingham, Sheffield, and Stoke) begun by the BBC in 1967 led to a decision to develop local radio as a major and vital element in its range of comprehensive services. Following the publication of *Broadcasting in the Seventies* the BBC put forward plans to the then Postmaster General for a provisional scheme to expand its local network to about forty stations, which would progressively supersede the present regional and area programmes. Their v.h.f. outlets would reach about 90 per cent of the population of England. A complex frequency package covering the reallocation of the BBC's medium wavelengths accompanied the proposal; one element of this made it possible to provide a supplementary daytime medium-wave service for each of these local stations.

Authority was given by the Government in the autumn of 1969 to develop the next stage of the system, i.e. a further twelve stations (making twenty in all) using v.h.f. as the only transmission medium (Map 3). One of these new stations was for Birmingham, the studios being located in Pebble Mill. The twelve new stations were:

Radio Birmingham	Radio Manchester
Blackburn	Medway (Chatham)
Bristol	Newcastle
Derby	Oxford
Humberside (Hull)	Solent (Southampton)
London	Teesside
	(Middlesbrough)

A White Paper issued by the present Government in March of this year limited BBC local radio for the time being to the above-named twenty stations (all of which were in service or approaching completion when the White Paper was issued) but envisaged medium-wave daytime outlets in addition to v.h.f. The estimated coverage of the twenty stations on v.h.f. is 75 per cent of the population of England. The twentieth station came into service in April.

For reasons of economy three of the stations are co-located at Network Production Centres, one at an 'island site' Regional Television station (Radio Solent) and a number of others in BBC-owned buildings or ones which were already on lease. Each Station Manager is, however, fully autonomous, having complete editorial independence and his own staff including a Station Engineer and an Assistant—the total engineering complement for a weekly programme output

which varies between forty and eighty hours of locally originated material each week.

News

With the advent of Local Radio and more localised Regional Television the BBC's news-gathering potential from England and the National Regions has increased. Accordingly, certain steps have been taken to capitalise on this, e.g. each Local Radio station has co-sited with it a Network News 'self-drive' studio fed directly to London for use by its own reporters and freelance journalists. Single camera contribution sources at places beyond the new Regional Television centres are also being developed to increase the Corporation's visual catchment area.

Special teleprinter arrangements which are centrally controlled by computer have been made at Local Radio and Regional Television stations to improve the dissemination of news and information from the central Radio and Television Network Newsrooms.

Conclusion

In England

A change has been made from the four types of radio programming which existed prior to 1970, viz:

- Network
- Regional opting out
- Areas opting out from the networks
- Experimental local radio,

to two, i.e.:

- Four reconstituted national networks (Radios 1, 2, 3, and 4).
- Local radio.

Network production centres have been established for both radio's and television's purposes, and the number of regional television centres has been increased from three in England to eight, with London/South continuing as before. Area Television outside London has been dropped.

In Scotland, Northern Ireland, and Wales

Equipments are being modernised to meet the redefined requirements of the Radio and Television networks, while the main regional broadcasting centres in Glasgow, Belfast, and Cardiff continue to meet their countries' needs with support from Edinburgh, Aberdeen, Londonderry and, Bangor respectively.

Radio-Camera Aerials for the 2.5-GHz Band

UDC 621.396.677

Two experimental 2.5-GHz aerials for radio cameras have been designed and made in Research Department for use in television Outside Broadcasts. They are intended for transmitting colour television signals from roving-eye vehicles or helicopters.

At present Band V is used for roving-eye links but an increasing use of the 2.5-GHz band will be necessary in the future to avoid interference from the 625-line television services.

Two types of aerial were required, one with a vertical beam width of 30°, for use with road vehicles, and the other with a 60° beam for helicopters. Both were required to be vertically polarised and to have omnidirectional horizontal radiation patterns.

Both types of aerial were mounted in sturdy glass-fibre tubes for robustness and ease of mounting. Television O.B.s have been using the aerials in trials and recently the Franklin aerial was used successfully with a roving-eye during an O.B. from Ascot.

Regional Studio Centre, Birmingham

Part I: Architectural Aspects

R. A. Sparks, A.R.I.B.A., F.R.S.A., Chief Architect

Architectural and Civil Engineering Department

UDC 725.1

Summary: A description is given of the new building complex which provides a network production centre and which houses on one site the facilities and accommodation that have existed at Birmingham in separate premises for a number of years.

- 1 Introduction
- 2 Site
- 3 Planning
 - 3.1 Radio complex
 - 3.2 Television complex
 - 3.3 Interview studio
 - 3.4 Newsroom
 - 3.5 Scenery workshop and store
 - 3.6 Technical areas
 - 3.7 Local Radio
 - 3.8 BBC Club facilities
 - 3.9 Restaurant kitchen
 - 3.10 Restaurant
 - 3.11 Outside Broadcast building
 - 3.12 Film processing
 - 3.13 Lift installation
- 4 Construction
 - 4.1 Foundation
 - 4.2 Frame, structural walls, and floors
 - 4.3 Roofs
 - 4.4 Sound studios
 - 4.5 Television studios
 - 4.6 News studio
 - 4.7 Film review, dubbing theatre, and control areas
- 5 Fire precautions
- 6 Air-conditioning installation
- 7 Heating installation
- 8 External works
- 9 Site progress
 - 9.1 Occupation
- 10 Conclusion
- 11 Contractors and Consultants

1 Introduction

The proposal to create a new radio and television complex in Birmingham was first discussed in the nineteen-forties, when it was realised that the existing BBC premises in the city were too limited to meet the future requirements of broadcasting in the Midlands. The current needs of the BBC in Birmingham were met by the acquisition of additional premises for television and office staff (although these had the disadvantages

of being physically separated by several miles) and of limited leases which could not be renewed indefinitely.

A suitable building site at Pebble Mill Road, Edgbaston – some three miles from the centre of the city – was acquired in 1951 and it was intended that this should be developed for the Birmingham New Headquarters as soon as finance could be allocated for the project.

Preliminary technical planning was begun at the end of the nineteen-fifties, although it was not possible to start construction work on the site until 1967. The original planning of technical facilities was based on monophonic radio studios, black-and-white television, and a large Outside Broadcast (O.B.) complex. However, major changes in these plans have since occurred, including the introduction of stereo, colour television, and the decision to set up a Local Radio station in Birmingham. In addition, the scale of the O.B. building has been drastically reduced and many of the functions formerly planned for this part of the complex, e.g. Central Maintenance and Film Camera rooms etc., have been transferred to the main building.

Birmingham is a main production centre within the eight English regions which cover the Midlands, North, and South West parts of England and the new centre will originate local network programmes for both radio and television services.

Facilities are being brought into use as a phased operation, which began with Local Radio in November 1970 and will end with the main television production studio in mid-July 1971. The complex is now virtually complete and will be officially opened towards the end of 1971.

2 Site

The site (Fig. 1) formed part of the Calthorpe Estate and is situated in Pebble Mill Road, Edgbaston, a high-class residential area, about three miles south-west of the Civic Centre. The frontage to Pebble Mill Road is approximately 580ft (177m) and the return frontage to the Pershore Road is about 110ft (34m).

The southern boundary is formed by the Bourne Brook and in time will no doubt be made a pleasant feature. The presence of this water, however, was indicative that ground conditions for foundations would not be ideal.

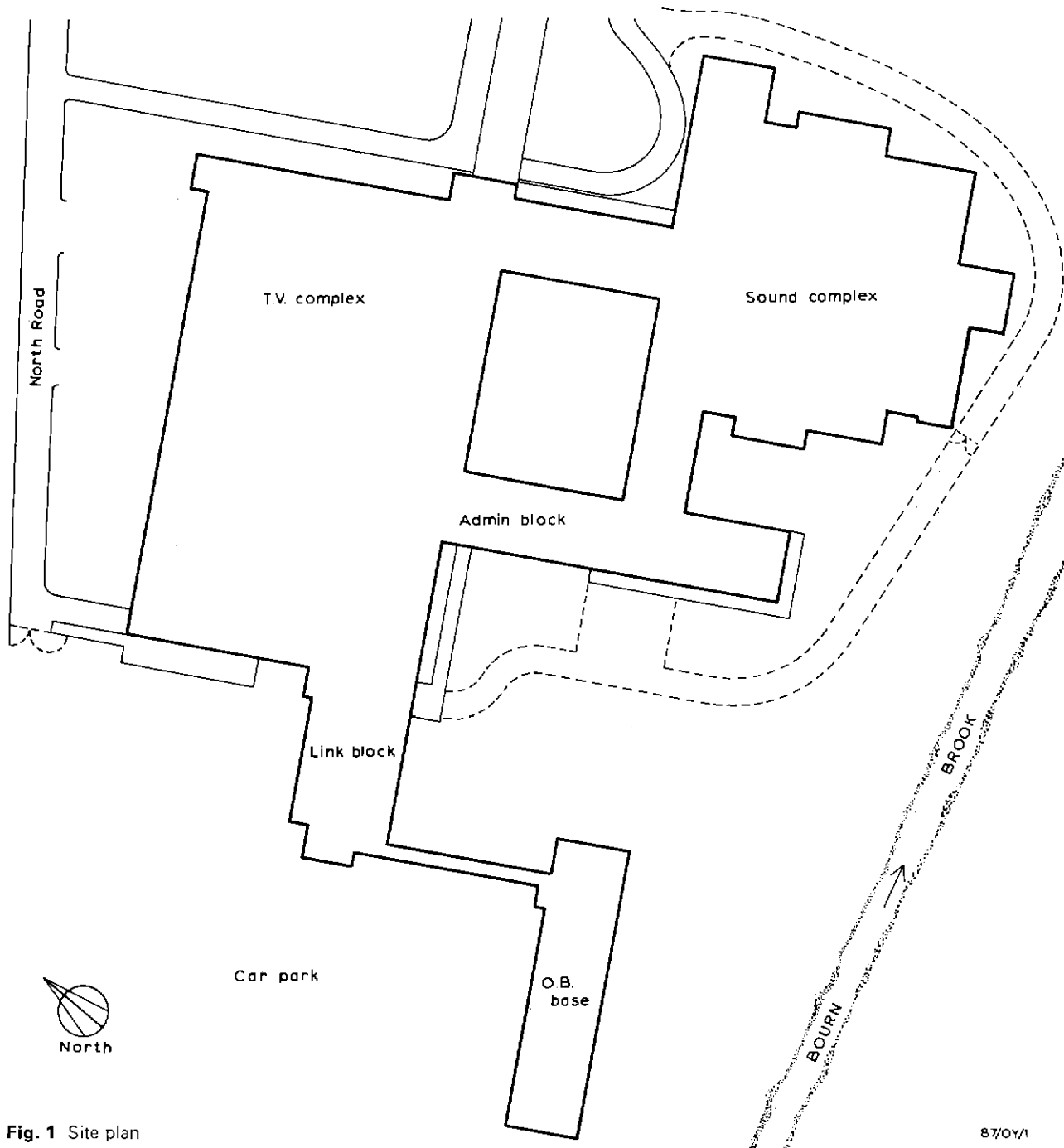

Fig. 1 Site plan

Thirteen trial holes were bored to establish the type of sub-soil to be encountered and the results were:

- (a) *Upper Strata* - 1 ft (30cm) to 10ft (3m) depth of field material composed of clay and silt with a number of soft patches;
- (b) *Lower Strata* - consisted of 'Keuper Marl', a stiff clay common to the Birmingham area which extends to a depth of at least 60ft (18m).

Water was found at between 5ft (1.5m) and 15ft (4.5m) below the surface but this disappeared after piling commenced and it would appear that there is a geological fault approximately 500 yards (460 m) north-west of the site which may be responsible for the phenomenon.

Apart from any natural desire on the part of the Corporation to provide an aesthetically satisfactory appearance to the building, the town planning authorities and the ground landlords were anxious that a 'prestige' building should be designed which would satisfy the public and the local residents in particular.

3 Planning

The BBC's Schedule of Requirements formed the basis for the design process and the architects were given all facilities to make a detailed investigation of the techniques of production and technical installation needed for a broadcasting building.

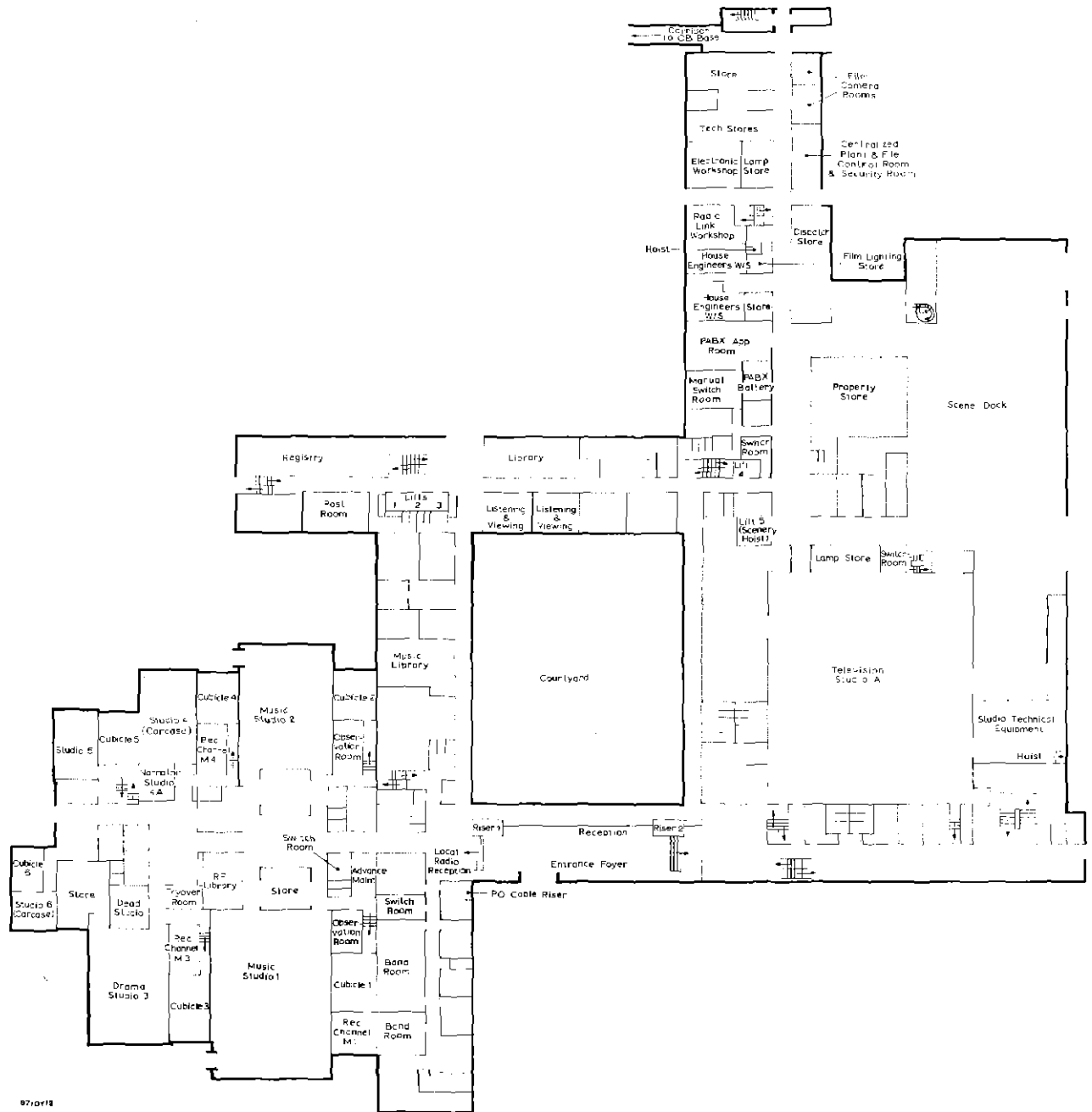

Fig. 2 Plan of ground-floor technical areas

The building was evolved as a result of the natural separation of Radio operations, Television operations, technical areas, and the Outside Broadcast elements.

The building materials were selected for appearance, permanence, and self-cleansing qualities which would reduce external maintenance to the minimum. In the main these requirements were met by: glass, mosaics, profiled concrete with exposed aggregate, aluminium, and marble. As a result, the contrast between the concrete cladding and the rhythmic glass façade should satisfy most tastes.

In any multi-million-pound project of high technical content which occupies a number of years in construction, the problem always arises how from a planning point of view to

keep pace, or even ahead, of technical progress. This inevitable condition has made some of the technical areas rather too generous in size, whilst the term 'prestige building' does not conform to current thinking in terms of economy in finishes, circulation space, or in flexibility enabling alterations to internal areas to expand or contract as the technical need may dictate.

Internal planning was dictated by the logical pattern of production and technical links. Finishes in technical areas were governed by the acoustic treatment demanded for high-quality sound reproduction.

Accommodation requirements eventually consisted of the following (Fig. 2):

3.1 Radio complex

Six sound studios: four only are to be equipped at this stage.

They include, one large music studio of 3000sq. ft (279sq. m) to be used principally by the Midland Light Orchestra. See Part II, Fig. 5 (page 21).

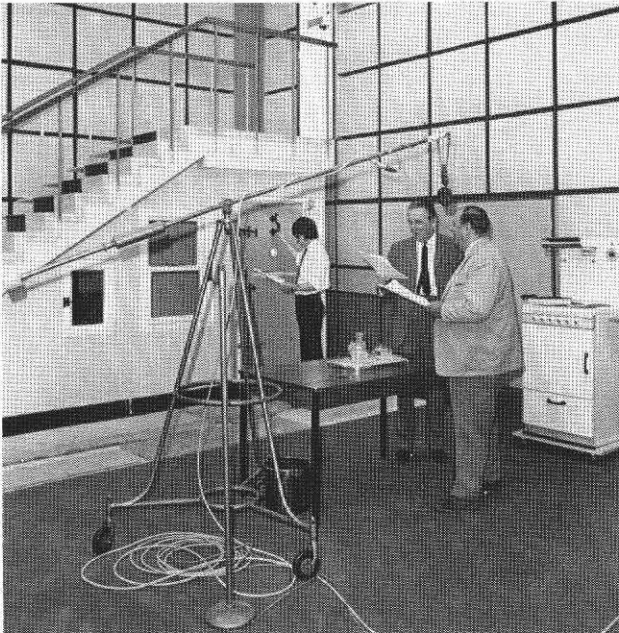

Fig. 3 Radio Studio 3, the drama studio, with a recording of *The Archers* in progress. Sound effects facilities, including a stair, a door with knockers, and a cooker, can be seen

A second studio of 1750sq. ft (163sq. m) for Light Entertainment and Pop. See Part II, Fig. 7 (page 21).

A third studio of 1500sq. ft (140sq. m) for Drama. (Fig. 3.) Other studios which are purely of the small interview type. (Fig. 4.)

An assembly area unites all Radio studios, their control



Fig. 4 Radio Studio 5, a small talks studio, seen from the control cubicle

rooms etc. and could serve also as a 'Green Room' if a large number of artists were engaged.

3.2 Television complex

Studio A (Fig. 5) is a general-purpose colour studio of 6500 sq. ft (604sq. m) with Production, Vision, and Sound Control rooms together with all necessary ancillary areas including local make-up and wardrobe.

The Production Control room is designed with 'back viewing' and as with the other control rooms has one entirely glass wall to the studio for those who must have direct visual contact with the studio floor. The studio has acoustic treatment with a very high standard of finish and is provided with an extremely functional and uncluttered lighting grid which should enable maintenance to be carried out quickly and easily.

The overall design provides for another studio to be added at a later date, without undue disturbance to production, maintaining direct connection with the ancillary areas which can be shared.

3.3 Interview studio

Studio B (see Part II, Fig. 4, page 20) is a smaller interview-type studio of 1050sq. ft (98sq. m) on the first floor with a combined Production, Sound, and Vision Control room, equipped for colour. This studio will no doubt often be used for News but it is intended for multi-purpose use.

A similar area adjacent to this studio has been built in carcase form for completion at a later date as an additional studio.

3.4 Newsroom

An open planned office, positioned on the first floor of the technical building, has hardwood-framed glazed partitions to isolate editorial staff from noisy machines, e.g. Telex.

3.5 Scenery workshop and store

This adjoins the general-purpose studios and is equipped with a paint frame and all the necessary plant to produce scenery in quantity.

Once again provision has been made for this building to be extended should the need arise.

The Radio and Television building complexes are separated by a Technical Block and courtyard, the fourth side being enclosed by the Administration Building, a linear slab type construction which spans and unites the whole concept.

3.6 Technical areas

The technical areas, which are mainly at first-floor level, have been provided with demountable ceilings and computer-type* floors for ease of installation and access to cables. Expansion areas have been provided, if additional telecine and videotape machines should be required.

* A floor which provides a void underneath for wiring, ventilation and any other services and which is finished with easily removable modular panels. The type selected for Birmingham is supported by steel 'mushrooms' fixed to the sub-floor with adhesive, and with threaded columns to obtain a true level. Rubber inserts ensure dust-proofing and silencing.

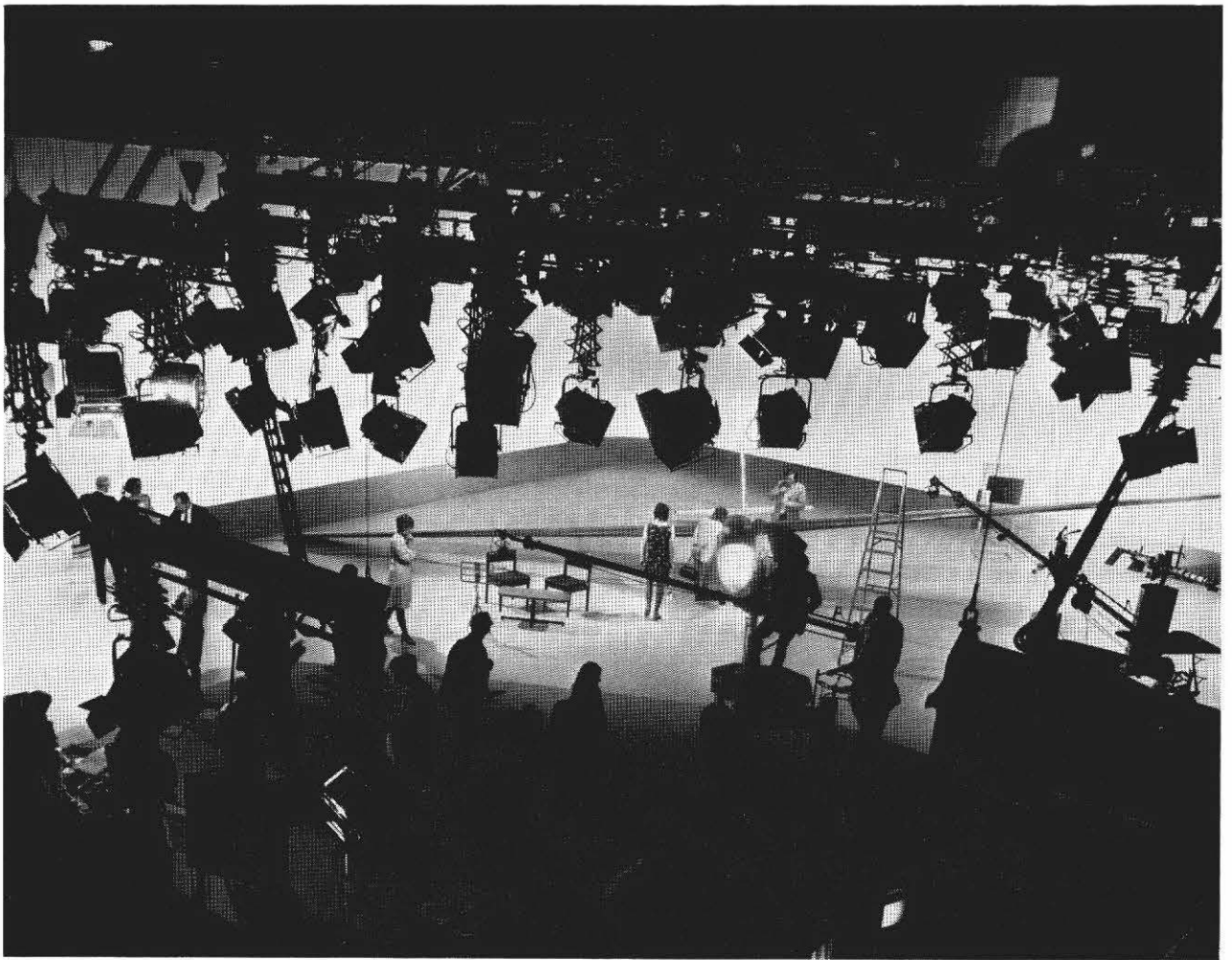

Fig. 5 Television Studio A, a general-purpose studio, viewed from the production control room

3.7 Local Radio

Local Radio is accommodated and shares technical facilities at the first-floor level but has the convenience of its own enquiry desk in the entrance hall with self-contained access to the suite. Although the introduction of Local Radio came at a late construction stage, this element has integrated remarkably well into the building.

3.8 BBC Club facilities

The Club premises are on the second floor, providing a comfortable bar, quiet-room, and billiard room, each room opening on to a terrace overlooking a courtyard, which should enable staff to enjoy the few warm summer evenings this climate of ours provides. Total club accommodation is 3300sq. ft. (307sq.m).

3.9 Restaurant kitchen

The kitchen has been placed on the top (eighth) floor of the Administration Block to ensure that smells of cooking do not permeate into any part of the building—a fault which seems to occur in many buildings no matter how efficient the ventilation system may be. Cooking equipment is of the latest design

and is sufficiently comprehensive to satisfy all the 'Philip Harbens' and 'Galloping Gourmets' of this world.

The kitchen is spacious and has tiled walls and floor. A central island suite of equipment comprises convection ovens, ranges, grill, and a new type of high-compression steamer for fast cooking of fresh-frozen vegetables, fish etc.

Stainless-steel preparation sinks and benches are sited around the walls. The dishwashing area is at one end of the kitchen, the machine being a *Rack-O-Matic* type. Racks, into which dishes are loaded, circulate continuously on a stainless-steel conveyor, through pre-wash, wash, and rinse sections. Handling of racks is therefore eliminated.

From the kitchen food is dispensed by way of elevators to the 51-ft (15.5m) long L-shaped servery counter on the seventh floor which includes refrigerated display and storage sections, hot sections, cold drinks, and ice-cream sections, and a self-service tea and coffee set. A back bar supports the front servery and comprises griddle plate, fryers, refrigerators, and sink unit. This means that grilled items, such as steaks, chops, etc., can be cooked to customers' order, while they wait.

A feature of the counter is the extensive use of mobile elevators, which automatically dispense crockery at convenient serving units.



Fig. 6 The staff restaurant

3.10 Restaurant – see above

The restaurant, which has seating for approximately 200 customers, enjoys splendid views from the seventh floor, the Edgbaston cricket ground being visible but too far away to enjoy the game. Internal finishes have 'wipe-clean' surfaces as far as possible, and a p.v.c.-tiled floor.

3.11 Outside Broadcast building

In the original conception the O.B. element was intended to provide full-scale Regional facilities for outside broadcasting purposes and the development plans included an annular-ring building to provide garages, workshops etc. at ground level, surrounded by a helical structure designed as a multi-storey car park and connected to the main complex by a further building known as The Link. At the time of evolution of the whole complex the Planning Authority was very concerned that, in a largely residential area, surface car parking was not a correct planning decision.

After a review of the accommodation requirement for Radio and Television O.B. activities and the granting of permission for surface car parking, subject to satisfactory screening and landscaping, together with the financial saving that would result, it was decided to construct this building to the

rear of the site and connect it by means of a covered way to the main building (see cover photograph). This O.B. base is a simple single-storey steel framed building with a flat roof and a floor area of 6400sq.ft (595sq.m), and includes a mechanical workshop with inspection pit, garage, stores, and toilet facilities.

3.12 Film processing

The film processing plant is sited on the first floor adjoining the Link to the Outside Broadcast building and adjacent to the film review theatre. The area is finished with an acid-resisting tiled floor and polyurethane-painted walls, and is provided with an acoustic ceiling.

3.13 Lift installation

The lift installation was designed and specified by the BBC Architectural and Civil Engineering Department to meet the various requirements of staff, technical departments, catering services, and the large number of people who will visit the premises in one capacity or another.

Three electric lifts are installed in the administration building and deal with the main passenger traffic serving all floors from ground to the seventh. Each car has a capacity of seven-

teen persons, and is finished in decorative laminated board and stainless steel. The three lifts work automatically together as an interconnected group on an electronically-decided traffic pattern to meet the loading requirements at any time. There is a comprehensive visual signalling system and an audible car-arrival warning system incorporating an electronic call button which only requires touching lightly at a landing in the direction of travel required, or in the car, to select the desired floor.

In this building there is also a 1 ton-capacity lift serving from the basement to the eighth floor, intended for use as a passenger/goods lift. This has a signalling system similar to that of the main passenger lifts and is fitted with collective control which ensures that the car stops at landings to pick up passengers who are wishing to travel in the direction in which the car is travelling.

No. 5 lift is a hydraulic lift of 7000lb capacity serving the basement and ground floors and is intended to handle large or heavy loads between these points. This lift works on an automatic push-button control and because of its duty and type it has manually operated car and landing gates.

Two technical service lifts of 660lb and 220lb have been provided. The former transports cameras, monitors etc. between the ground floor studios and the first floor workshops and the latter carries cans of film between ground and first floors.

Four service lifts of 220lb capacity, provided for use by catering department, are constructed in stainless steel to give a high standard of cleanliness. These serve fifth, seventh, and eighth floors, and have automatic push-button control with a system of signals including 'In use' and 'Car here' signs.

4 Construction

4.1 Foundations

Approximately 1200 piles varying from 60 to 100 ton capacity and between 25 and 30ft (7.6m to 9.1m) in length were used in the foundation.

4.2 Frame, structural walls, and floors

These are in reinforced concrete and the floors are designed for various loadings to cater for heavy point loads imposed by machines such as videotape recorders, telecine machines, cameras etc.

Computer-type floors have been provided in all technical areas for wiring and ventilation and further precautions have been taken to dustproof the sub-floor to avoid damage to equipment.

4.3 Roofs

These generally are flat and constructed of reinforced concrete finished with asphalt and chippings. The roofs of the O.B. base and scenery workshop, however, are of lightweight construction using steel trusses and patent roof decking.

4.4 Sound studios

The design is on the 'box within a box' principle, the inner box of 4½ in. (11.5cm) brickwork floating on rubber pads.

Roofs have double 6 in. (15.3cm) reinforced concrete slabs with 2ft (61cm) airspace between, the slabs being constructed

so that they are isolated from the frame with bonded-rubber anti-vibration mountings.

4.5 Television studio

This studio has a suspended reinforced-concrete floor, cavity walls of 9 in. (22.9cm) and 4½ in. (11.5cm)-thick brick skins and a single-skin reinforced-concrete roof. The floor is finished to engineering tolerances of smoothness ready to receive 4.5mm linoleum.

The lighting grid is hung from steel roof trusses and is provided with lifting beams, cyclorama tracks and an all-over removable decking and fixings for lighting and scenery hoists and tracks.

The reverberation time is 0.75s.

4.6 News studio

The same 'box within a box' principle used in the sound studios has been applied in the television news studio, but in this case there is a simple lighting grid of Coborn tracks. The reverberation time is 0.35s.

4.7 Film review, dubbing theatre, and control areas

These have a reverberation time of 0.30s. All other control areas have a reverberation time of 0.35–0.30s.

5 Fire precautions

The building has been compartmented to prevent the spread of fire from one area to another and all dressing rooms, wardrobes, scenery workshops, etc. are covered by an automatic sprinkler installation.

In technical areas where the presence of water would be undesirable, rate-of-temperature-rise alarms have been installed and these alert the resident fire-fighting service, who then take the appropriate action.

The normal wet and dry risers and hose reels are provided throughout the building to assist the fire authorities to suppress any fires.

All automatic systems are relayed to the fire duty room and any alarm is automatically given to the Fire Brigade.

6 Air-conditioning installation

The studios and associated technical areas in both the sound and television complexes are air-conditioned by a combination of high- and low-velocity, all-air systems designed to hold internal temperatures within the range 20°C–24°C with the relative humidity varying in the comfort zone when external conditions are between –4°C dry bulb and –4°C wet bulb and 27°C dry bulb and 19°C wet bulb. The main air-handling plants are grouped in the basement although some smaller plants have been positioned at the upper levels local to the areas they serve in order to minimise ducting.

Conditioned air is conveyed from the various plants by ranges of thermally and acoustically-insulated-sheet ducting and enters the conditioned spaces through terminal grilles or diffusers. A notable exception occurs in the television studio where the conditioned air is discharged above the lighting grid and drops with a blanket effect over the entire studio area, a feature first used at Television Centre.

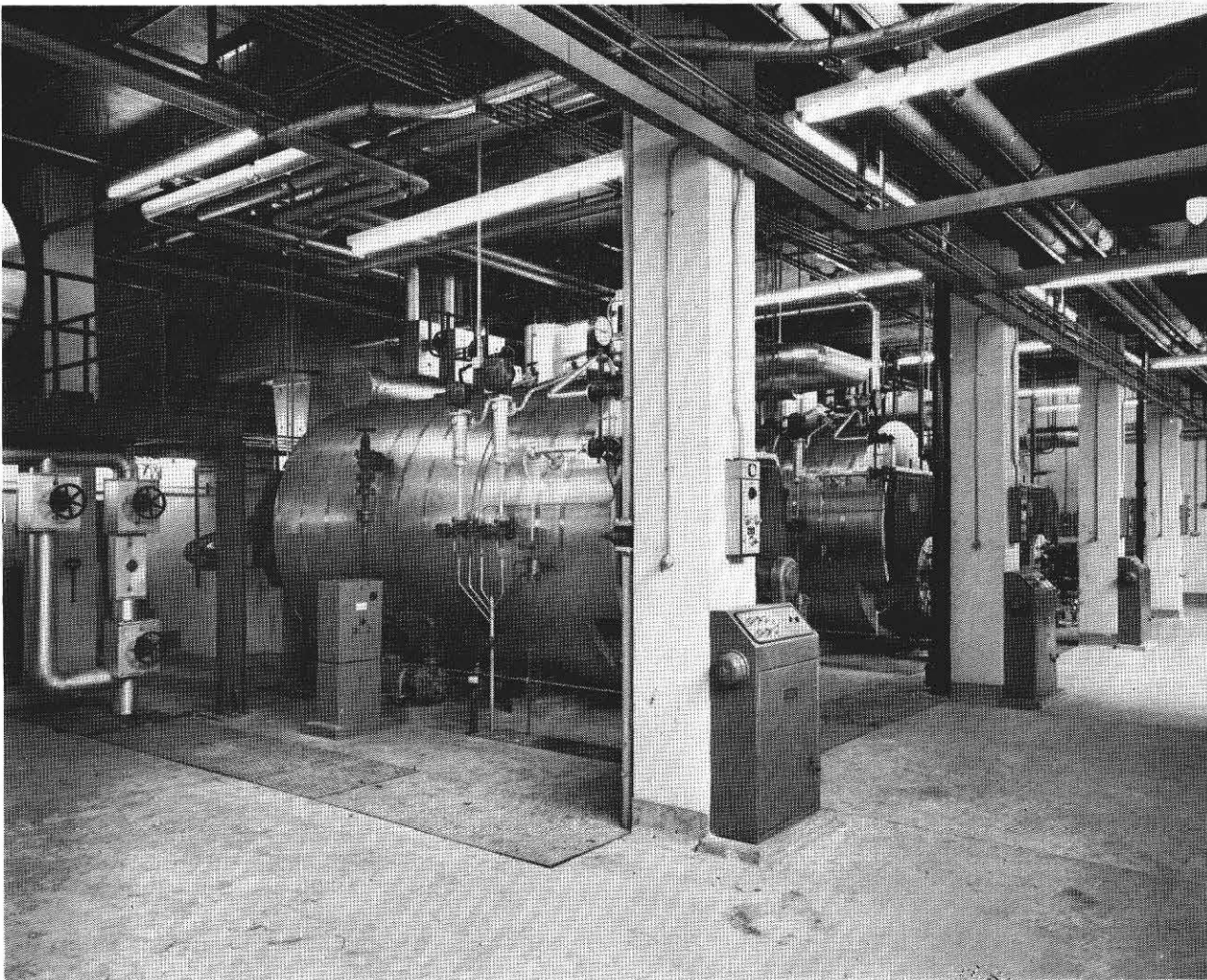

Fig. 7 Oil-fired boilers

Where possible, direct extraction is provided to remove the heat generated by equipment at source and reduce the overall cooling load.

The facility is provided to utilise outside air for cooling purposes during colder weather to reduce the operating hours of the refrigeration plant. The plants are served with 7°C chilled water from a central refrigeration plant which comprises two steam absorption chillers, each having a nominal capacity of 230 tons of refrigeration. The combined duty of these machines is slightly in excess of the calculated present cooling requirements and offers scope for future expansion if a reasonable diversity factor is applied to the load.

The refrigeration units are accommodated in the basement and fed with low-pressure steam from the adjacent boiler house. Under maximum cooling conditions each machine uses slightly in excess of 4500lb of steam per hour. The choice of absorption machines in this instance ensures that maximum use is made of the installed boiler plant, and also assists in keeping electrical requirements – already over 500 h.p. for fan motors etc. – to the minimum.

Water for condensing purposes is obtained from a water cooling tower positioned externally near the scene dock. This

is a conventional induced-draught unit in which the falling water is 'broken up' by plastics packing similar to that used in egg crates. Once started, the various systems operate automatically. The control system is mainly pneumatic. A central monitoring panel is provided in the Fire Duty Room for the air-conditioning and ventilation plants. The indicating section of the panel monitors space temperatures and humidity, and if the allowable tolerances are exceeded then remedial action can be taken before occupants or equipment are unduly affected.

7 Heating Installation

Steam is the basic heating medium used in the whole of the complex and is generated in three oil-fired boilers (Fig. 7) located in the basement of the Administration Block. The boilers are fitted with the latest safety devices for unattended operation, maintenance staff entering the boiler house only to carry out daily tests of the safety devices and routine maintenance. The oil burners of the rotary-cup type are capable of modulating their capacity and as well as following variations in load to give a 4-1 turndown ratio, they are linked in a sequence control system which will start a second or third

boiler should there be an increase in demand over the capacity of the lead boiler.

Flue gas temperatures, CO₂ percentages, smoke density valves and steam flows, are continuously recorded for each boiler to provide information to check efficiency.

Each boiler is connected to an individual flue, which passes through the middle of the building, thereby maintaining a high temperature in the flue structure and assisting in the prevention of smutting.

Oil fuel of medium (950sec.) viscosity is stored in three tanks adjacent to the boiler house providing approximately 4-6 weeks' running, depending on weather conditions. Oil from these tanks passes through an outflow heater to bring it to pumping temperature and circulated through a ring main at constant pressure by duplicate-grading-type pumps to the three oil burners. At the burner it is heated further to burning temperature where controls meter the oil to ensure constant oil/air ratio at all stages of the modulating range of burner capacity.

From the boiler house, steam passes to five calorifier rooms where heat exchangers produce low-pressure hot water for heating, and domestic hot water for toilets, kitchen, and film processing.

Heating in the ventilation and air-conditioning plants is carried out by steam/air heat exchangers with local thermostatic control.

Variations of the outside air temperature produce a corresponding fluctuation in the flow temperature to the radiator circuits by means of a Wheatstone Bridge type control operating a mixing valve and thereby maintaining constant temperature in the heated spaces.

Office and other technical areas are generally heated by radiators, but in large open areas such as the scene dock etc. unit heaters use steam direct from the boilers as the heating medium.

8 External works

Macadam access roads and service yards and an exterior Tarmacadam car park have been tailored into the landscaping as the whole of the site must be completed to blend with the surrounding residential area. Similarly the external lighting has been designed to be both functional and aesthetically satisfactory.

9 Site progress

The contractors commenced work on the site in April 1967 and the whole work, including the Technical Installation, was programmed for completion by the autumn of 1971.

The basis of the programme was a 104-week construction period, after which the BBC engineers would move in to carry out the technical installation for a period of seventy-eight weeks approximately, with the main contractor providing attendance during this period of time. Finally, the contractor would move back into the building for a period of twenty-six weeks to complete all outstanding work, and in particular, the decoration.

In the event, the changes occasioned by colour, local radio, stereo etc. made this type of programme unworkable but as the result of co-operation between the contractor and the BBC engineers the final service dates are ahead of schedule.

9.1 Occupation

The complexities of constructing a major broadcasting centre do not finish when the contractor leaves the site. The problems of moving into such a centre have a widespread impact for many outside the building team; this would apply especially in the whole of the Administration Block. The BBC had for many years provided Midland Regional programmes from a miscellany of buildings in Birmingham and staff had to be trained to operate the more sophisticated equipment in the new building.

The move alone into the Administration Block from the old Headquarters in Carpenter Road involved 20 000 items of furniture etc. and required eight vehicles and fifty men to execute the transfer of 100 loads in 60 hours because, essentially, there must be the minimum of interruption to programme production.

10 Conclusion

The BBC now has a broadcasting building complex as modern as any in the world; well sited, long lasting, and reasonably maintenance-free whilst still permitting expansion on the site for further development. The imposition by the Landlords and Town Planning Authorities of a prestige type building, which is a very difficult word to define in terms of building planning and construction, has not in the event produced the ideal answer to BBC Headquarters design particularly in regard to internal features. There was insufficient horizontal and vertical flexibility to deal with changes and progress in the technical field and the extent to which design and planning can deal with this situation need to be carefully considered in any future design. It is certain, in retrospect, that the use of reinforced concrete generally, as distinct from its use only in the frame of the structure, creates problems when any changes are necessary. Again, flexibility in floor loading capacity, provision for internal expansion and extension, and additions to air-conditioning and heating systems need careful thought at the design stage.

There is no doubt, however, that the amalgamation of all radio and television broadcasting activities in one centre will lead to a considerable saving of time and effort and therefore to a more efficient operation.

11 Contractors and Consultants

Designed by	Messrs John Madin Design Group
in association with	R. A. Brown, C.Eng., M.I.C.E., Head of Architectural & Civil Eng. Department
Quantity Surveyor	Messrs Ainsley
Consultants	
Structural Design	Messrs Bolsover and Associates (Consulting Engineers)
Electrical Engineering	BBC Capital Projects Department
Mechanical Services	Messrs Carrier Engineering
Acoustics	A. Brown, A.R.I.B.A. BBC Acoustics Architect
Main Contractors	Messrs Taylor Woodrow (Midlands) Ltd.

Regional Studio Centre, Birmingham

Part II : Technical Facilities

D. R. Kinally, C.Eng., M.I.E.R.E.

Project Manager, Birmingham

UDC 621.396.69

Summary: This article describes the technical facilities at the new Birmingham Studio Centre and explains how these have been designed to fit into the pattern of sound and television broadcasting envisaged for the 1970s. The major features of this pattern for a regional station such as Birmingham are described in another article in this issue.

Introduction

- 1 Central technical areas
 - 1.1 Communications centre
 - 1.1.1 Routing and switching facilities
 - 1.1.2 Monitoring and communications facilities
 - 1.1.3 Post Office circuits
 - 1.1.4 General
 - 1.2 Television apparatus room
- 2 Television facilities
 - 2.1 Television studio A
 - 2.2 Television studio B
 - 2.3 Regional presentation
 - 2.4 Captions
 - 2.5 Telecine and video tape
 - 2.6 Dubbing suite
 - 2.7 Colour-film processing
 - 2.8 Film review theatre
- 3 Radio studios
- 4 Local Radio suite
- 5 Electrical supplies
- 6 General
 - 6.1 Centralised plant control
 - 6.2 PABX and ancillary facilities
- 7 O.B. maintenance depot

Introduction

The technical facilities in the new Birmingham headquarters replace those previously housed in three main locations in the centre of the city. For the first time, all BBC radio and television activities in Birmingham are combined in one building, designed to cover the requirements of the following:

- Network Television
- Network Radio
- Regional Television
- O.B. Activity
- Local Radio

The amalgamation of these various activities in one centre can only result in a considerable saving of time and effort, leading to a more efficient operation.

Birmingham is a key station in the S.B. (simultaneous broadcast) network which connects studio centres and transmitters throughout the country. The main technical facilities include central areas, two television studios, telecine/video tape, film equipment, five radio studios, a colour mobile control room, and a Local Radio suite.

The television areas provide for operation on 625-line PAL and two of the radio studios are equipped for stereo. The existing Outside Broadcast facilities in Birmingham covering television, radio, and radio links will be transferred to the O.B. Maintenance Depot now nearing completion at the rear of the site.

The basic technical planning used in the new building takes account of the principles established in recent years at the Television Centre and Broadcasting House in London. It has been possible to integrate the television and radio operations in the main programme distribution area, where the same staff are responsible for handling the requirements of both services. This policy of integration has also been followed, wherever possible, in ancillary facilities such as Centralised Maintenance, House Services etc.

The majority of the technical areas are located at first floor level, excluding the Radio Studio Complex, which is virtually self-contained on the ground floor. The main television studio is slightly detached from the regional television operation, where the television News Studio, News Area, Dubbing Suite, Telecine and Film Processing are closely linked geographically (see Fig. 1).

1 Central technical areas

This group of areas covers the Communications Centre, Selector Room, Television Continuity, and Television Apparatus Room etc.

1.1 Communications centre

Birmingham is an important station in the BBC's distribution network and the Communications Centre is the key operational area and focal point for programme distribution both internally and externally. Network programmes (four radio and two television) and contributions are routed via this area

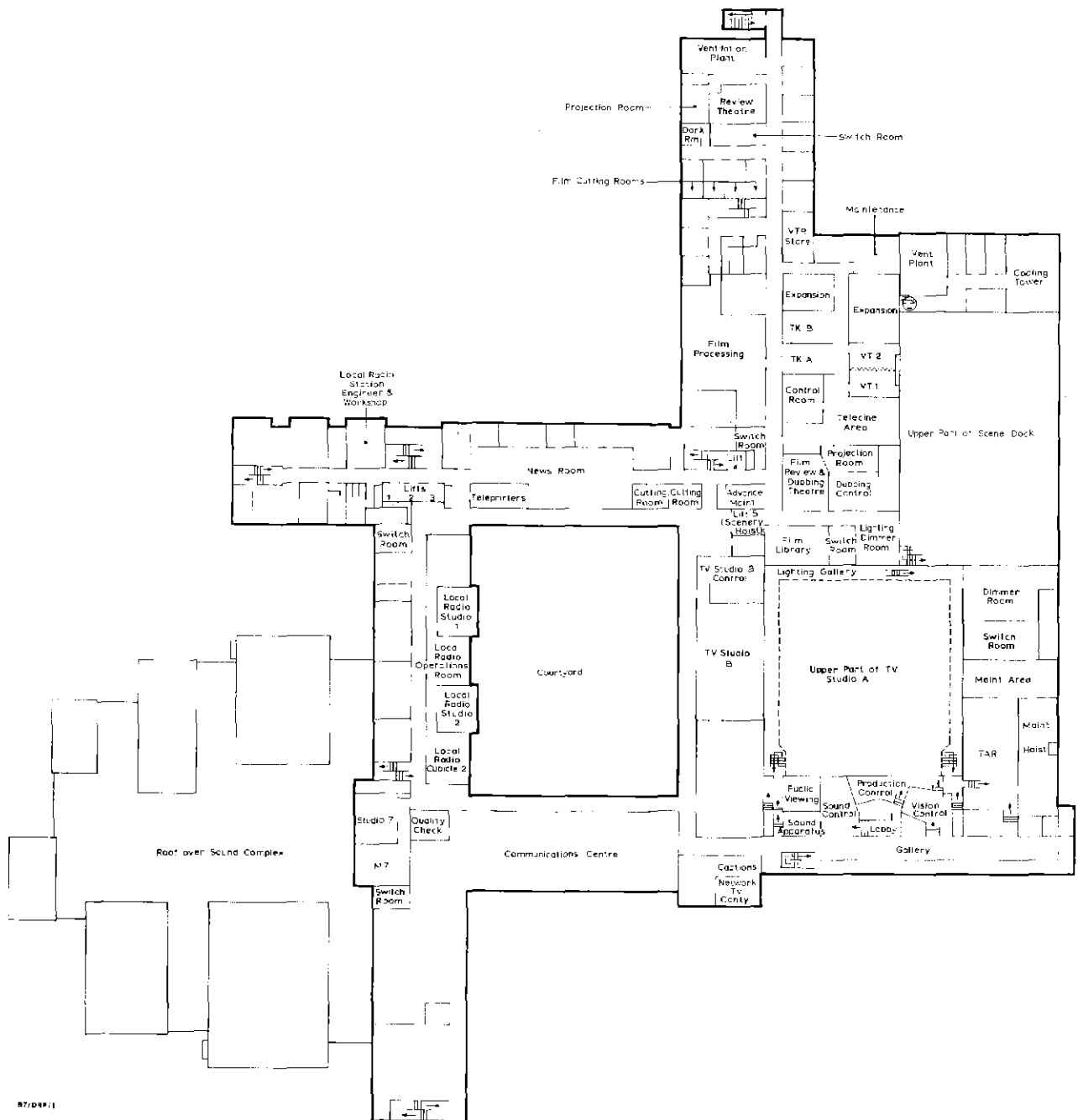

Fig. 1 Plan of first floor technical areas

for distribution to other BBC stations in the network, including local transmitters which service the Midlands. The radio and television operations are fully integrated, allowing advantage to be taken of the variations in programme load which occur between the two services. This integration ensures a reduction in the requirements for staff, audio circuits, and equipment.

The basic technical facilities comprise programme routing, S.B. switching, monitoring, and communications which are required to meet the needs of both radio and television. All the essential operational controls are grouped on the main desk (Fig. 2), which is designed for minimum staffing. Controls for injecting contributions into programme feeds to transmitters are located on this desk, and the appropriate

switching (known as opt-out) can be extended to other technical areas for remote operation.

Part of the Communications Centre is allocated for lines termination and equalisation.

1.1.1 Routing and switching facilities

The various switching facilities have been planned to provide operational flexibility, in order to meet peak demand and breakdown situations.

(a) A married switcher (combined vision and sound) deals with 'on air' switching for television. The equipment comprises a vision solid-state matrix combined with a relay



Fig. 2 Main control desk in the Communications Centre. The left-hand section beneath the monitor stack deals with vision (and television sound) switching and routing, pulse chain control, and vision measurement. The section from centre to right is concerned with sound (Radio) switching and routing, EMX, and control line routing. The main part of this section is the S.B. switcher (centre right). Beneath the left-hand colour monitor is the married switcher for television (vision and sound) routing

matrix for the associated programme sound, and handles twenty-five sources to nine external destinations.

The majority of television internal and external sources appear on the twenty-five inputs to the matrix and are routed to the main S.B. circuits and transmitter feeds. The opt-out switching which is also available on this equipment can be extended to other areas, such as the Regional Presentation desk, for remote operation.

Provision has been made for P.C.M. (pulse code modulation) mode of operation at some later stage.

- (b) The routing of television programme sources to internal destinations such as Studio A and B, etc. is carried out using a manual cross-hatch employing gold-plated Rendar plugs and sockets. These are arranged in the form of two 25×10 plug fields on apparatus bays adjacent to the main control desk.

The Rendar plug has twelve contacts and routes the basic facilities, audio plus d.c. circuits, and also controls a solid-state matrix for vision signal routing.

The facilities associated with Telecine remote control etc. are routed by means of a manual patching system employing plugs and sockets.

- (c) An incoming sound line switcher employing a fifteen source/fifteen destination relay matrix assembles the radio and television network feeds and distributes programme sound to local transmitters.
- (d) An S.B. switcher (forty sources to twenty destinations) is provided for switching programme sound associated with radio and television networks and local sources to outgoing S.B. circuits feeding other BBC stations, such as London and Manchester.
- (e) A source ring main is connected to all of the radio studios for feeding outside sources. The thirty sources terminate on jack-fields in the studios and are normally allocated to ten O.B. circuits, ten local sources, and ten S.B. and Network sources, all of these originating from the Communications Centre.

1.1.2 Monitoring and communications facilities

Comprehensive monitoring is provided on the main desk, allowing independent access to sound and television sources and key parts of the distribution system. A measurement position is installed for checking television waveforms and equipment includes a colour monitor, vectorscope, and a high-grade oscilloscope.

Extensive communications facilities are provided by the Communications Centre. These include a 200-way E.M.X. (Engineering Manual Exchange) for connecting internal and external subscribers. External control lines associated with programmes are routed on crossbar switches providing thirty circuits to ninety-six destinations inside the building.

A main loudspeaker intercom system is installed between the key technical areas, and the design allows for several conversations to take place between the areas served.

A set of 48 kHz telephone carrier equipment has been installed and this will provide twelve telephone channels between London and Birmingham. Seven of these will be used for inter-office telephone traffic and the remaining channels will provide engineering and production control circuits. The equipment is of solid-state design similar to systems installed between BBC stations in London and Bristol/Manchester.

1.1.3 Post Office circuits

P.O. circuits are used to interconnect the new building with other BBC studio centres and transmitters. To meet this requirement twenty $\frac{3}{8}$ in. (10 mm) coaxial tubes and 120 audio lines are rented from the Post Office and are extended between the new building and Telephone House in the centre of Birmingham.

1.1.4 General

- (a) Two control positions, one radio and one television, are installed in the Communications Centre. The technical facilities are on a simple scale and will provide a useful mixing point for programmes which do not require the full resources of a radio or television studio.
- (b) A Television Continuity Suite located adjacent to the Communications Centre provides comprehensive vision and sound mixing facilities. This area will be used as an ancillary mixing point for both radio and television and can also operate as an 'out of vision' or radio continuity.
- (c) The requirements for office viewing and listening are met by: (i) an r.f. viewing system; and (ii) a sound ring main.

1.2 Television apparatus room – see Fig. 3

This area contains all the vision equipment for Studio A, Studio B, Television Continuity, and central pulse distribution. The T.A.R. has been divided into two parts and the half adjoining the main equipment area, with the adjacent maintenance room, will be used to provide central maintenance facilities for the building.

The use of a common equipment area facilitates the sharing of camera equipment and ensures efficient use of staff and the reduction of problems associated with equipment installation, such as system timing etc.

The vision mixing equipment for the studios, together with programme distribution, is mounted on two rows of apparatus bays. The line-up desks contain the operational colour camera



Fig. 3 Television Apparatus Room. In addition to housing the central pulse distribution equipment, this area serves as a common vision apparatus room for both the television studios

control units for Studios A and B. Each desk is self-contained for monitoring (monochrome and colour), communications, and measurement. A folding curtain is fitted between the two desks to enable maintenance to be carried out on one set of cameras whilst the others are being lined up for programme purposes.

The colour transparency caption scanner and the apparatus bays associated with the 'Q-File' lighting control system* are located off the main equipment area of T.A.R.

The equipment for the two 625-line pulse chains provides the standard waveforms required for colour operation. The pulse chains are driven from crystal units and provision is made to operate the chains from separate crystals.

The internal timing of vision signals is achieved by the use of the path length method for monochrome and by employing phase comparators at the mixing point which send back a d.c. error signal to the source for colour phasing. This technique enables sync timing to be within ± 25 ns and colour timing within $\pm 2^\circ$.

External sources are locked for synchronous working, using BBC-designed equipment operating in the Natlock and Genlock modes. In addition, Superlock† facilities are provided to allow monochrome captions to be mixed with outside contributions, such as O.B.s etc.

2 Television facilities

2.1 Television studio A – see Part I, Fig. 5 (page 10)

This general-purpose studio is 6500 sq. ft (604 sq. m) in area and will be mainly used for network drama productions. The

* A system, using computer techniques, in which dimmer settings and switching information for up to 100 different lighting combinations are held for immediate and future use in a magnetic core memory store.

† Superlock is a facility which allows captions to be superimposed on the pictures from any source routed through a studio vision mixer.

control suite, situated at first floor level, comprises separate areas for Production, Sound and Vision Control, and Lighting. Ancillary areas off the studio floor include a Production and Technical Equipment Store.

Back viewing is employed for the production team (apart from the sound mixer) and observation windows are provided along the whole length of the control suite. A small area located at the end of the control rooms is used for public viewing purposes.

Studio A is equipped with four operational, and one installed spare EMI type 2001 colour cameras and these are fitted with 10:1 zoom lenses covering the range 5–50°. The vision mixing facilities are of standard BBC design of type EP5/502, having two 8-channel banks (complete with cut/fade on each channel) working into a group mixer. The ancillary facilities include colour separation overlay and electronic wipes.

The vision and lighting control facilities, following well-established practice, are contained on a single control desk. These include remote camera controls and the appropriate indication and controls for the 'Q-File' production lighting system. The monitor stack, with both colour and monochrome monitors, is shared between the vision control operator and the lighting engineer.

The studio is equipped with seventy-four 8ft and four 4ft lighting hoists and fifty-two scenery hoists mounted on the main studio grid. These are motor driven and are raised and lowered from a panel situated on the studio floor. The 8ft lighting hoists are each fitted with two dual-source lanterns, having a hard source light on one side and a soft light on the other. Additional lanterns are provided, including 10kW spotlights. The studio lighting power is based on 50 W/sq. ft (540 W/sq. m).

The studio production lighting system comprises a Thorn 'Q-File', containing 310 channels and 100 files and employing thyristor dimmers. No patching arrangements are required as each lantern is normally tied to a 5kW dimmer. A mimic display of all lanterns and their studio positions is mounted above the vision control monitor stack.

A dimmer room for the thyristor equipment is located at gantry level, with direct access to the studio.

The sound control facilities are provided by a Pye desk transferred from London. This transistorised equipment, containing thirty-six channels, has been modified to give group switching facilities. Each channel can be routed to any of three destinations – either of two groups or auxiliary – and each group of six channels can be switched to main clean feed, main output or independent. Auxiliary facilities include sixteen R.S.A.s (Response Selection Amplifiers) and three echo chains and a separate six-channel mixer for audience use.

A small apparatus area is provided off the control room and this can be separated from the control desk by means of a folding door.

Studio distribution boxes are installed in the studio at floor level, containing microphone, talkback, and cue programme feeds. Comprehensive communication facilities provided in all technical areas include programme/producer's talkback feed to all dressing-rooms, make-up, and wardrobe, which are situated at ground floor and basement level with good access to the studio floor.

A scene dock, transit area, and carpenters' workshop etc

are located immediately adjacent to Studio A. These areas will be used for scenery manufacture and painting.

2.2 Television studio B – see Fig. 4

This studio is 1050sq ft (98sq. m) in area and will be used mainly for the regional opt-out programmes

The production control room, situated at studio floor level, contains a curved desk equipped with the appropriate facilities for sound control, vision mixing, vision and lighting control. A large observation window fitted into the studio wall ensures that all members of the production team have a good view into the studio.

Studio B is equipped with two EMI type 2001 colour cameras, complete with 10:1 zoom lenses, with access to a third channel, when not in use in Studio A.

The vision mixing equipment is of A/B type and BBC designed, similar to that used in C.M.C.R.s. It has ten channels (two rows of ten cut buttons with separate A and B faders) and is equipped with electronic wipes and colour separation overlay.

The vision control facilities consist of standard remote camera controls, together with a local preview colour monitor. The operator and the production team share the monitor stack, which contains one monochrome monitor for each camera and two previews and colour monitors for studio output and preview purposes.

The production lighting system uses a 40-channel thyristor dimmer bank. Seven Colborn tracks run the length of the studio, each track fitted with four rolling pantographs equipped with dual source lanterns. Provision has also been made for a 9-ft cyclorama cloth.

The sound control facilities employ the BBC-designed type D module and provide eighteen channels, four groups and six independents. Ancillary equipment includes R.S.A.s and grams/tape machines.

The studio is located at first-floor level and scenery is transported from the scene dock via a large purpose-designed service lift.

2.3 Regional presentation

An announcer-operated desk, initially situated in one corner of Studio B, is provided for 'in vision' presentation purposes. It is intended that this function will ultimately be carried out from a small annexe to be developed at the end of the studio. The desk contains simple sound and vision mixing facilities, together with means of controlling opt-outs for inserts on BBC-1 programme feed to the local transmitter. A monitor stack allows for viewing of camera, network, and other sources, including captions and telecine. The production lighting arrangement is fixed and a colour camera is locked off and left unattended during the regional presentation operation.

2.4 Captions

One 35 mm flying-spot colour-transparency machine is provided, together with two monochrome scanners employing vidicon cameras. This equipment can be routed to the television areas on a shared basis and the associated control facilities are based on sequential operation. A colour synthesiser

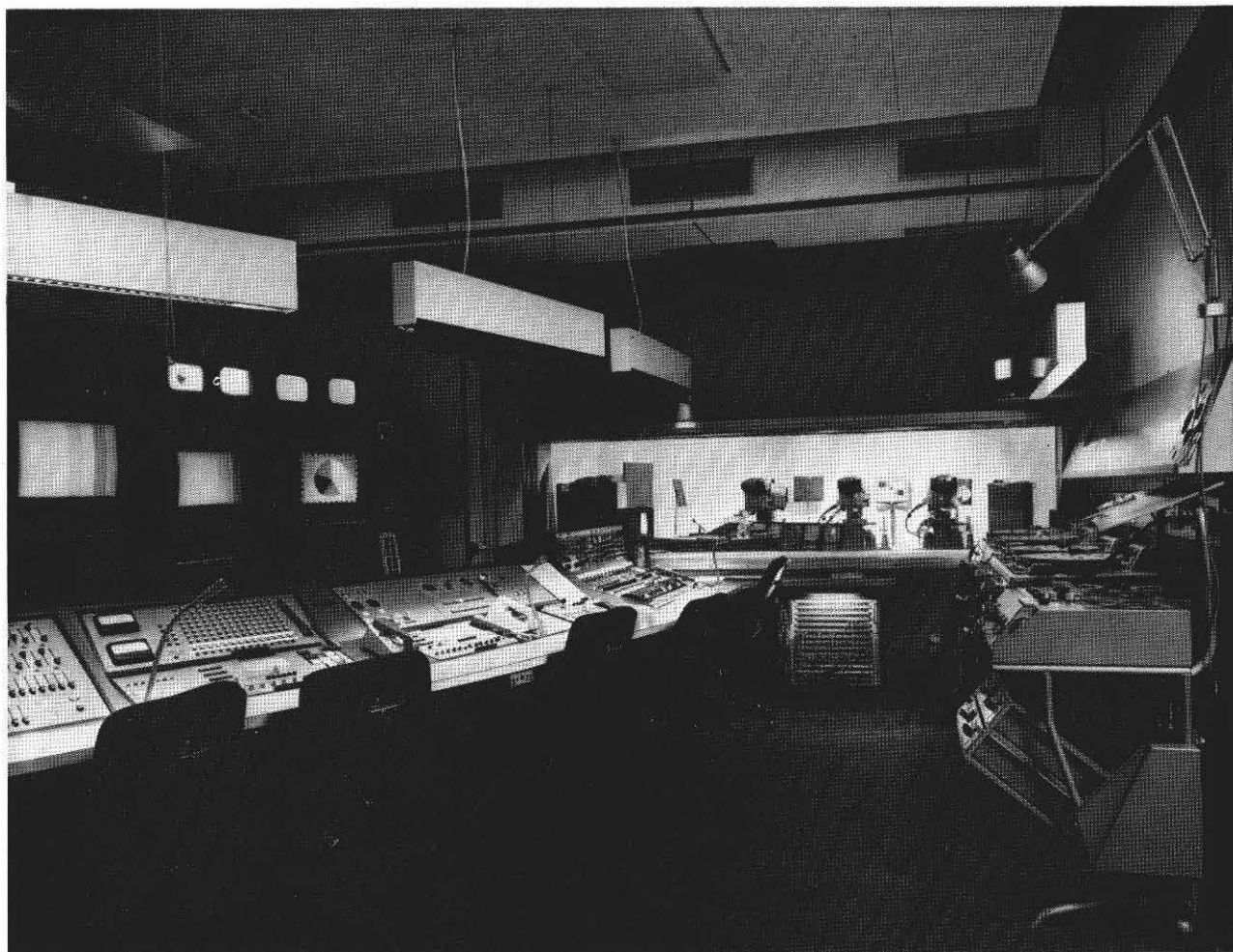

Fig. 4 Television Studio B. This small news and interview studio is seen from the control room

has been provided at the various mixing points and this can be fed from caption sources.

2.5 Telecine and video tape

This area is divided into an apparatus area, quality check, and individual cubicles for two 16mm colour telecine machines and two video tape machines. Rank Cintel flying-spot telecines, equipped with T.A.R.I.F. (Television Apparatus for Rectification of Indifferent Film) and electronic masking and capable of commag and comopt sound, have been installed. Sepsmag sound facilities, both replay and record, are provided by Sondor equipment incorporating a digital type of drive system in place of the Selsyns normally used on other types of equipment.

The telecine can be operated locally or remotely, offering both 'simple' or 'full' facilities. In the simple mode, remote control is limited to start, stop, and reverse, and this method of working would be used when contributing to regional presentation. However, when telecine is working with either Studio A or B, full facilities will be controlled from the studio, including automatic sequence selection and T.A.R.I.F.

The telecine cubicle installations are, in general, similar to those recently completed in London and in other Regional Centres.

Colour Ampex 2000 video tape machines are provided in two v.t.r. cubicles, which are separated by a folding curtain. One of these machines is complete with electronic editing facilities. Video tape storage is available in an adjacent area.

Simple remote-control facilities, controlled from destination, are available.

The apparatus area contains all of the pulse and programme distribution equipment for telecine and v.t.r. The output of both telecine and video tape is distributed to the Communications Centre for routing to any internal or external destination.

2.6 Dubbing suite

The Dubbing Suite consists of a studio, control room, and projection room, which is equipped with a Siemens Bauer 16mm double-band projector. A picture is displayed on the studio screen for viewing by announcer and production staff.

Two sets of 16mm Sondor sepmag equipment have been provided in the adjoining telecine apparatus area and these, together with the sepmags in the telecine cubicles, are used with the Siemens Bauer projector for dubbing purposes. It is possible to lock all of the above equipment for synchronous

operation and all sepmags, except for one of the Sondors, have been modified for record facilities. A 16mm Westrex bay and tape machine can also act as a synchronous source with the Sondor equipment.

It is possible to transfer commag, sepmag, comopt, and $\frac{1}{4}$ in. tape to sepmag.

The dubbing/sound-mixing desk employs BBC-designed type D modules and the facilities include eight channels, two groups, R.S.A.s etc., complete with tape and grams, which incorporate variable speeds and quick-start facilities.

2.7 Colour-film processing

This area is located at first-floor level and accommodates film-processing equipment, chemical mixing and dark rooms. The main facilities comprise a Photomec colour-processing machine operating on the Kodak ME4 process, and one black-and-white processing machine.

2.8 Film review theatre

A small theatre, seating some twenty people, has been built close to the film processing and telecine area. This will be equipped with 35mm and 16mm projectors. Four film cutting rooms have also been provided adjacent to the theatre.

3 Radio studios

The main Radio Complex comprises six radio studios, although only four are being finished and equipped at this stage. An additional radio studio is provided adjacent to the Local Radio suite on the first floor.

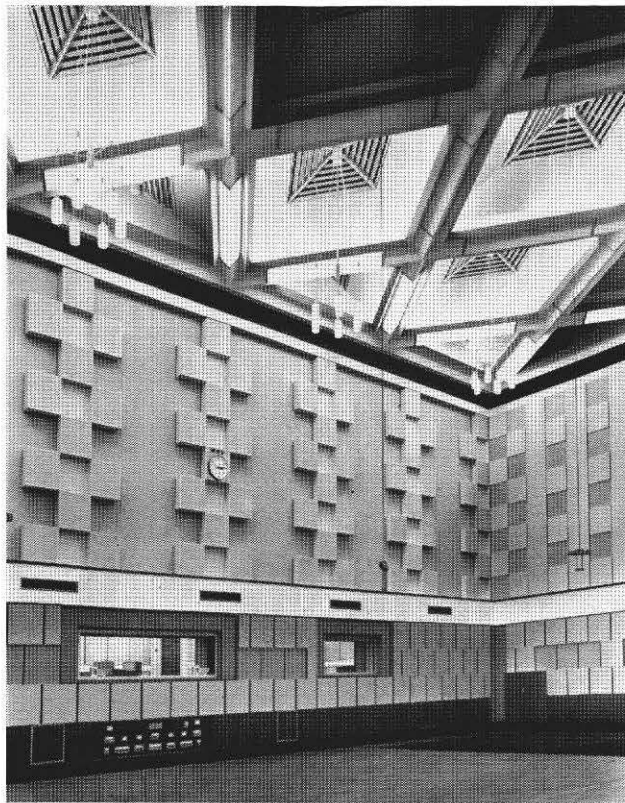

Fig. 5 Radio Studio 1. This large music studio is used by the Midland Light Orchestra



Fig. 6 Radio Studio 1 Control Desk. This is a fully stereophonic 'Type D' installation



Fig. 7 Radio Studio 2, which is used primarily for light and pop music. The control desk is identical to that used in Studio 1

Studio 1 (Figs 5 and 6) and Studio 2 (Fig. 7) are both equipped for stereo operation and will be used for music and pop programmes. The large music studio is some 3000sq. ft in area and will normally be used by the Midland Light Orchestra. Each studio is provided with a local control suite consisting of a control cubicle and a recording room equipped with stereo tape machines. An observation window fitted into the studio wall ensures that the production team have a clear view into the studio. All of the sound desks used in the complex employ type D modules of BBC design. The basic channel unit is $2\frac{1}{2}$ in. (6.3cm) wide by 16 in. (40.7cm) high and contains two channels in the monophonic equipment. The stereo module has the two faders linked to provide A and B channels.

The stereo desks for both Studios 1 and 2 are similar and have angled side wings for ease of operation. The technical facilities on the desk comprise sixteen mono and four stereo channels, three groups, a master group, and main channel, all of these being equipped with public address and foldback.

Two independent channels may be switched before or after the main control.

Twenty R.S.A.s and four limiter-compressors are available for insertion into channels, group, or main via a jackfield located on the desk.

The channels can be routed to two mono echo sources or a stereo echo source. The reverberation time of the remote echo plates can be controlled from the desk.

Ancillary equipment, which is housed on two apparatus bays in the control cubicle, includes all output amplifiers, power supplies, and regulators for electrostatic microphones.

Studio 3 (see Part I, Fig. 3, page 9) will be used for drama productions and its control facilities comprise eight channels, two independents and two groups, together with six R.S.A.s and tape/desk machines. The studio contains appropriate equipment for special effects, such as staircases, doors, sink etc.

Studio 5 (see Part I, Fig. 4, page 9) is a talks studio equipped with a 12-channel control desk.

Each of the radio studios has, in addition to PABX, EMX, and control-line telephones, a separate telephone system which gives communication with the other radio studios. Several conversations can take place simultaneously and conferences are possible, enabling several studios to be linked together.

Supporting areas in the Radio Complex include Recorded Programmes Library and an Advanced Maintenance Room.

4 Local radio suite

Radio Birmingham has been in service since early November 1970. The technical facilities and ancillary accommodation are housed at first-floor level and use the areas originally planned for regional radio continuity.

The equipment and accommodation follow the pattern established for the standard local radio stations throughout the country. These are described in another article in this issue.

5 Electrical supplies

The building is fed from two separate sub-stations on the Midland Electricity Board's 11 kV network. Normally, only one feeder is in use and automatic changeover of the supply occurs in the event of a breakdown. Three air-cooled 11 kV/415 V three-phase transformers are provided and these can be switched to cover maintenance and faults. A diesel alternator of 120 kVA is installed to meet essential programme demand in the event of a power breakdown.

Medium-voltage power is distributed from the sub-station to some twenty-four switchrooms located throughout the building complex. Each switchroom forms the focal point for electrical services distribution covering mains power, emergency lighting, fire alarms, clocks, and diesel supplies, where applicable.

General lighting fittings throughout domestic and technical areas are of the recessed modular fluorescent pattern, basically 4ft 40W tubes. The fluorescent lighting control gear for the radio studios is located externally to the studios to avoid acoustically generated hum.

A technical earth, designated 'Noise Free Earth', is provided in all technical areas, comprising a system of aluminium PVC-insulated conductors which radiate from the main earth in the sub-station.

6 General

6.1 Centralised plant control

Key items of the House Services plant are remotely controlled from a central point, and the facilities provided allow stop/start of ventilation plant etc. This method of working ensures the efficient use of staff and it is hoped that services faults will be detected and appropriate action taken before staff in the areas concerned are aware of them.

The Fire Alarm board, also located in this room, gives comprehensive control indication and alarm facilities for the various fire protection systems installed throughout the building.

6.2 PABX and ancillary facilities

An STC No. 3 system is provided and, initially, the exchange will be equipped with some 400 extensions. A radio paging system operating on 27 MHz is used by key personnel and this is integrated with the PABX.

7 O.B. maintenance depot

The depot will have an area of some 6400 sq. ft (595 sq. m), providing basic accommodation for transport workshop, garage, stores, and a mechanical workshop. A completely-enclosed corridor connecting the O.B. Depot to the main building will be used by staff, and for transporting equipment.

Immediately outside the depot is a concrete hardstanding to accommodate vehicles which cannot be housed in the garage.

Outside Broadcast vehicles using the depot will include a C.M.C.R., radio links, and mobile radio vehicles.

On-air Switching Facilities for Birmingham

UDC 621.396.69

The Switching Centre at the Regional Studio Centre at Birmingham (described in this issue) uses a 25 × 36 video matrix in which it is required to carry out 'on-air' switching between twenty-five inputs and ten outputs. This is the first instance of field-synchronous switching in a matrix and it has been made possible by the manufacture in Designs Department of a semi-conductor logic and memory interface between the matrix and the source-selection control panels and by the modification of 250 cross-points in the matrix destination amplifiers on site.

New designs of matrix amplifier have been completed which will permit preselection and 'on-air' switching operations.

ANCHOR: Modification to Provide Clock Facilities

UDC 621.397.611

A modification has been fitted to one of the ANCHOR character generators described in BBC ENGINEERING No. 84 to convert it into a video digital clock. This was used to display event times during various phases of the television programmes on the Apollo 14 moon shot. This clock facility cannot be added to a standard ANCHOR generator but will shortly be available as a separate unit.

Local Radio

D. H. Cummings,

B.Sc.(Eng.), A.C.G.I., C.Eng.

Superintendent Engineer, Radio Broadcasting Operations

R. E. Bliss,

C.Eng., M.I.E.R.E.

Project Manager, Radio Developments

UDC 621.396.712 621.396.975

Summary: The engineering problems involved in launching a service of local radio broadcasting in England on v.h.f. are discussed and the standardised designs used in the studios, transmitters, and aerials are described.

- 1 Introduction
- 2 Frequency planning on v.h.f.
- 3 Polarisation
- 4 V.H.F. transmitters and aerials
- 5 Programme origination facilities at base
 - 5.1 Staff
 - 5.2 Basic programme requirements
 - 5.3 The 'Kit of Parts'
 - 5.4 Studios 1 and 2
 - 5.5 Control desks
 - 5.6 Gramophone records
 - 5.7 Tape recording machines
 - 5.8 Tape cartridge machines
 - 5.9 Loudspeakers
 - 5.10 Microphones
- 6 Outside broadcasts
- 7 Use of Post Office telephone
- 8 Radio cars
 - 8.1 Vehicle
 - 8.2 Mobile radio equipment
 - 8.3 Mobile audio equipment
 - 8.4 Base stations
 - 8.4.1 Receiving aerial system
 - 8.4.2 Radio equipment
 - 8.5 Studio equipment for control of radio cars
 - 8.6 Typical performance of the u.h.f. link
- 9 Teleprinters
- 10 Description of Radio Solent

1 Introduction

Early in 1967 governmental approval was given to the BBC's proposals for an experiment in Local Radio, and it was decided that eight experimental stations should be set up. The locations selected were Brighton, Durham, Leeds, Leicester, Liverpool, Nottingham, Sheffield, and Stoke-on-Trent.

Many factors influenced the choice of location, but prominent among them was the need to carry out the experiment at locations which were typical of those likely to be served by Local Radio stations, in the event of a nation-wide plan being adopted. For example, Liverpool is a major port, Brighton is

a holiday resort with a large retired population, and County Durham consists of several separate areas of high population density.

The studio premises for each station were obtained near to the centre of one of the populated areas and each was provided with a low-power v.h.f. transmitter.

In 1969, following the success of the eight-station experiment, approval in principle was given to the BBC's proposals for a permanent Local Radio system and plans were drawn up for a total of forty stations. It was envisaged that these stations would cover some 90 per cent of the population of England.

The first twelve of the new stations (making a total of twenty in all) were named as Birmingham, Blackburn, Bristol, Chatham (Medway), Derby, Hull (Humberside), London, Manchester, Middlesbrough (Teesside), Newcastle, Oxford, and Southampton (Solent). Initially, approval was given for these stations to broadcast on v.h.f. only but a supplementary medium-wave service was always envisaged and the addition of this has now been agreed in principle by the Government. The v.h.f. coverage of the stations is shown in Fig. 1.

2 Frequency planning on v.h.f.

One of the first problems to be solved before setting up the Local Radio system was that of frequency planning.

In the United Kingdom the frequencies between 88 and 94.6 MHz are used to transmit the BBC's Radio 2, Radio 3, and Radio 4 services. Those between 94.6 and 97.6 MHz are used for Home Office communication services although the Radio 3 transmitter at Wenvoe, the Radio 4 transmitter at Sandale, and the low-power Radio 4 transmitter at Les Platons also use frequencies in this part of the band. The frequencies between 97.6 and 100 MHz are used extensively by the Home Office.

There was no room for the Local Radio transmitters in the band 88–94.6 MHz and therefore it was agreed that they would be allocated frequencies in the sub-band 94.6–97.6 MHz and that the Home Office would be allocated new frequencies in areas where the services overlapped.

The Local Radio planning was based on the aim of protecting all stations from mutual interference down to a wanted signal level of 48 dB above $1\mu\text{V/m}$ ($250\mu\text{V/m}$) for monophonic transmission for 95 per cent of the time. It was assumed that

V.H.F. LOCAL RADIO SERVICES

- KEY**
- Towns with populations of 50000 or over
 - Towns with populations less than 50000
 - + Transmitter sites
 - } Service areas

- NOTES**
1. The contours shown are those of the outer service areas (satisfactory reception with outdoor aerials)
 2. **Sheffield** The contours for the Sheffield and Rotherham transmitters have been combined.



Fig. 1 V.H.F. coverage of local stations

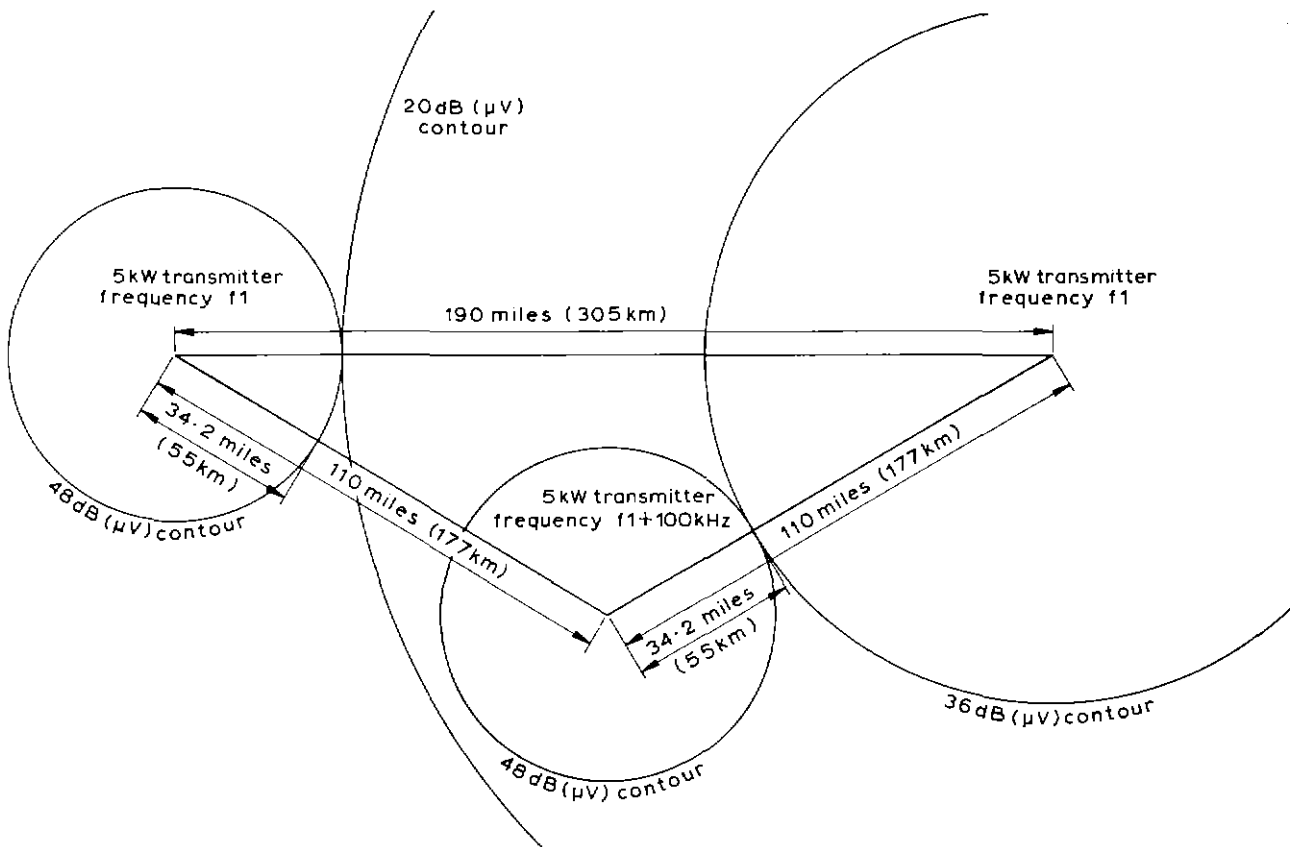

Fig. 2 Effect of frequency difference on minimum geographical separation
The field strength values should, of course, read $\mu\text{V}/\text{m}$

no receiving aerial directivity was available but that in the event of stereophonic transmissions being radiated by Local Radio stations the listeners towards the fringe of the service area would be prepared to use a directional receiving aerial in order to obtain the stronger signal needed for satisfactory stereo reception.

The difference in signal strength between wanted and unwanted stations on the same frequency must be at least 28 dB. This means that for average terrain and transmitting-aerial height the minimum geographical separation between stations on the same frequency, each having in the direction of the other an effective radiated power of 5 kW, is 190 miles (306 km). With directional transmitting aerials arranged to protect the service area of the co-channel station, the stations can be closer together. When the stations are not on the same frequency then the difference in signal between wanted and unwanted transmissions may be reduced, this in turn permitting closer geographical spacing. In the example above, if the frequency difference is 100 kHz, the required ratio between the wanted and unwanted transmission is reduced to 12 dB and therefore the minimum geographical separation necessary with omnidirectional transmitting aerials is 110 miles (177 km) as shown in Fig. 2.

3 Polarisation

In the United Kingdom horizontal polarisation is used for v.h.f./f.m. broadcasting. This plane of polarisation was

originally chosen to provide the maximum protection against multi-path distortion and impulse interference, but the difference compared with vertical polarisation is now recognised as being small.

With the development of Local Radio, using v.h.f., a series of investigations was carried out by Research Department in order to assess the relative advantages of circular and slant polarisation compared with horizontal polarisation using the same total e.r.p. The results of these tests* showed that both circular and slant polarisation increased the signal input to car radios, using a vertical whip receiving aerial, by some 6–8 dB. The effect on a portable receiver used within a building was negligible (due to the random nature of polarisation within a building) but a similar receiver used out of doors in a picnic situation benefited to a similar or even greater extent than car radios. As a result of these tests it was decided to employ slant polarisation at Local Radio sites where this could be conveniently applied.

An advantage of slant polarisation compared with circular polarisation is that the transmitting aerial is easier and cheaper to build.

The stations at which slant polarisation has been applied are Blackburn, Manchester, Leicester, Nottingham, and Derby. To limit the cost and complexity of the transmitting aerial system, the application of this technique was limited to stations requiring an omnidirectional radiation pattern or those required to radiate over an arc of less than 90°.

* Described in BBC ENGINEERING, No. 83 (July 1970).

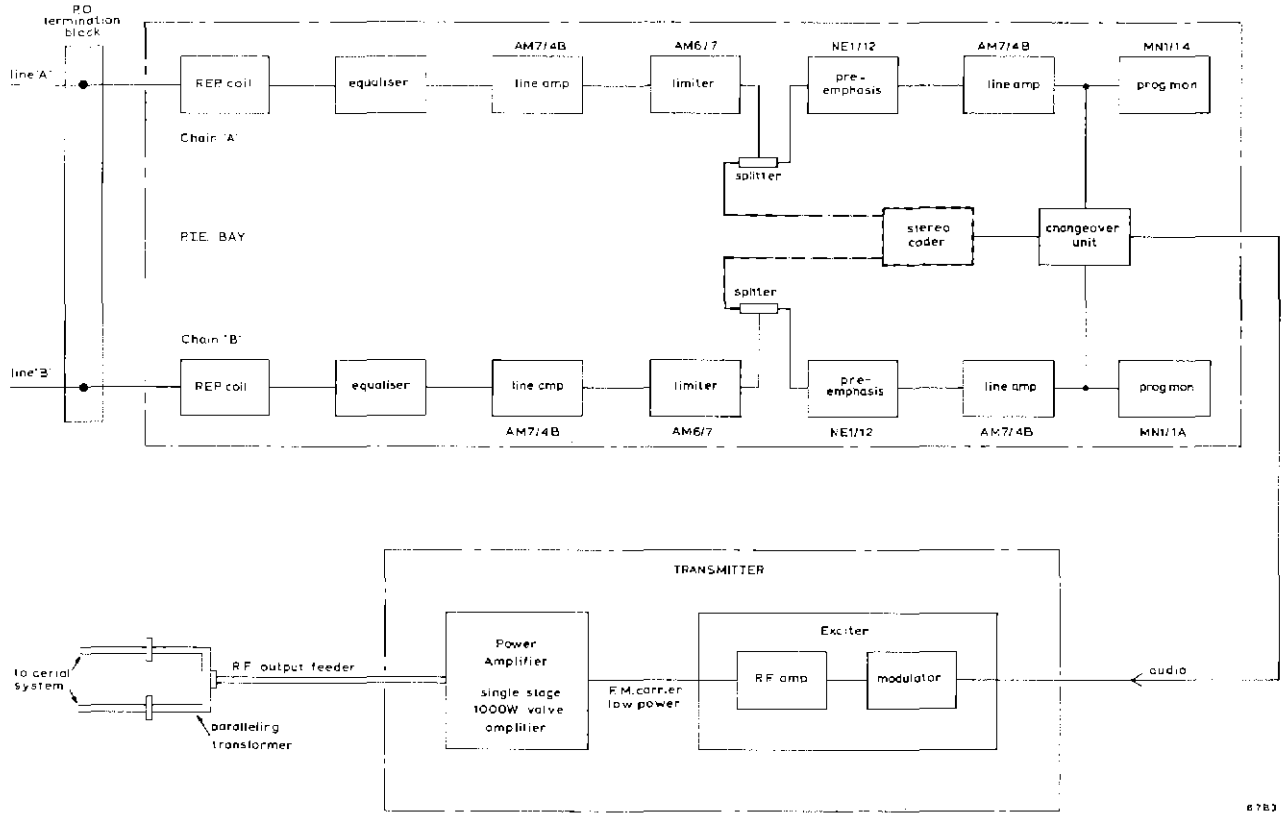

Fig. 3 Block diagram of 1-kW transmitter

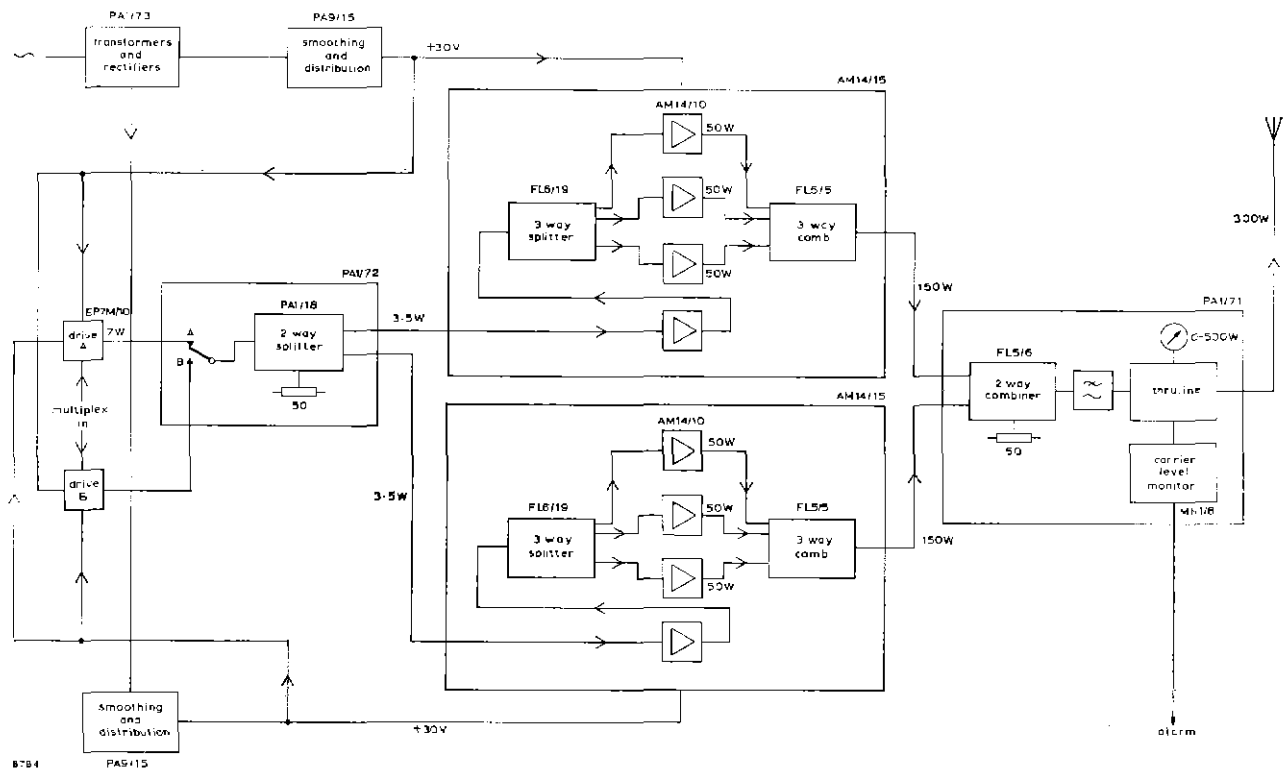
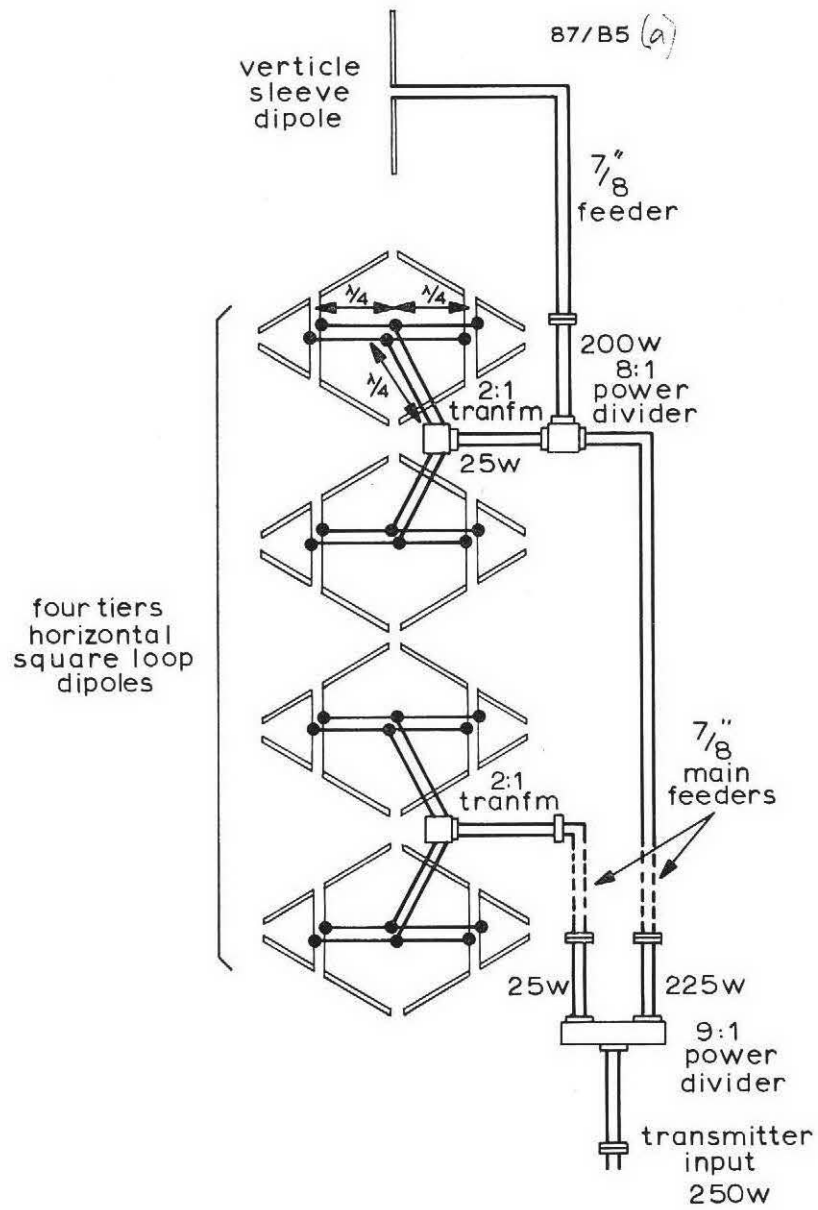
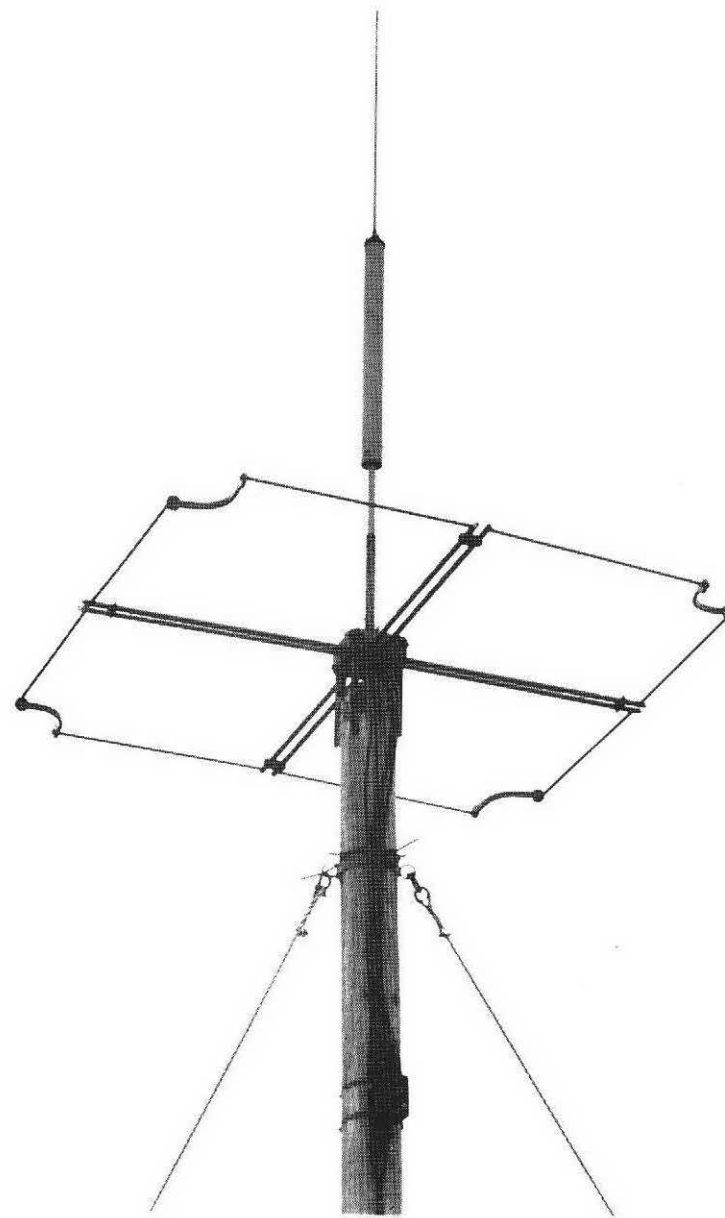

Fig. 4 Block diagram of low-power transmitter



(a) Diagram of four-tier arrangement



(b) Photograph of prototype single-tier arrangement

Fig. 5 Omnidirectional slant-polarised v.h.f. transmitting aerial

4 V.H.F. transmitters and aerials

At most of the twenty stations a 1 kW transmitter was installed driving a simple transmitting aerial system to give the required radiated power. Three exceptions to this were London, Humberside, and Merseyside where 2 kW of transmitter power was required and at these stations two 1 kW transmitters are operated in parallel.

A block diagram of a typical transmitting station is shown in Fig. 3. The two lines from the studio are connected to two independent chains of programme input equipment. One chain is in use at any given time, with automatic changeover in the event of failure of the working one. Provision is made for the addition of a stereo encoder should this be required later. The output of the selected programme input equipment chain is fed to the 1 kW transmitter.

The 1 kW transmitters, which were purchased from two manufacturers, are similar in design. They each consist of a low-level, solid-state, frequency-modulated drive followed by a solid-state r.f. amplifier driving a tetrode valve output stage.

At three of the stations the transmitter power required was less than 500 W and for these a BBC-designed transmitter was provided. A block diagram of this equipment is shown in Fig. 4.

The transmitting aerial system normally consists of tiers of square-loop dipoles or an array of two or more yagi aerials. The square-loop aerials are used when the horizontal radiation pattern is required to be either omnidirectional or directional over a broad arc. The yagi system is used for very directional arrays. When slant polarisation is required, a single vertical dipole is added above the square-loop arrays and the two sections of the aerial are supplied with different power levels to compensate for the different gains (see Fig. 5). With the yagi arrays the individual aerials are set at an angle of approximately 45° to the horizontal. A photograph of a typical transmitting station is shown in Fig. 6.

For Radio Solent, Radio Newcastle, and Radio Oxford the existing radio network transmitting aerials at Rowridge, Pontop Pike, and Oxford were used and additional combining units installed.

5 Programme origination facilities at base

To meet the stringent timetable for the construction of the Local Radio studios, planning work had to start before staff were appointed or detailed programme requirements known. The formula adopted was to equip each station to a basic standard and to allow considerable freedom, after the station was open, in adapting the equipment to provide special facilities.

5.1 Staff

Each station has two engineers, the Station Engineer and his assistant. The Station Engineer was recruited early in the development stages of each station and was closely concerned with the installation of equipment enabling him to be in the best position to maintain and adapt it.

5.2 Basic programme requirements

The facilities provided at each station are based on the following broad requirements:

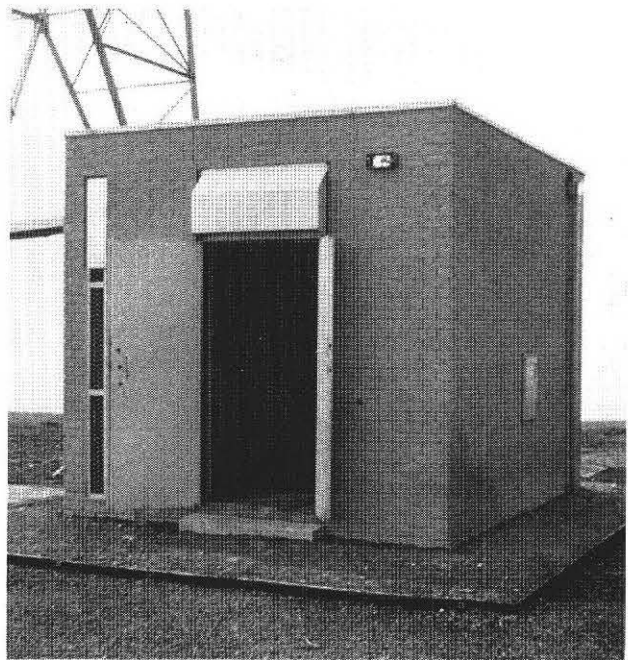

Fig. 6 Photograph of typical transmitting station

- (a) Each station should be able to produce some 30–40 hours of programme a week, which, with repeats, would enable it to originate its own programme for 8–10 hours per day.
- (b) The technical quality of the transmissions on v.h.f. should be high and comparable with that from the Radios 2, 3, and 4 v.h.f. transmissions.
- (c) All operations at the station, with the exception of some of the more complicated outside broadcasts, would be carried out by non-technical staff, many with little previous experience of broadcasting.

5.3 The 'Kit of Parts'

To meet these requirements each station is provided with a basic set of equipment and facilities. They are each given an operations room, about 300 sq. ft (28 sq.m) in area, from where all transmissions can be controlled.

The station output may be derived from either the operations-room control desk or direct from one of the following programme sources:

- (a) Either of two studios;
- (b) The output of Radio 2, 3, or 4 v.h.f. receivers;
- (c) A tape reproducing machine.

When the output is taken from a control desk, the following additional programme of sources are available:

- (d) Further tape machines;
- (e) Gramophone record players;
- (f) Microphones in the main studio;
- (g) The radio car;
- (h) Incoming music lines from outside broadcasts or remote studios;
- (i) Telephone calls.

Further details of the equipment are given in the following paragraphs. Fig. 7 shows the general overall arrangement.

Fig. 7 Block diagram of complete chain

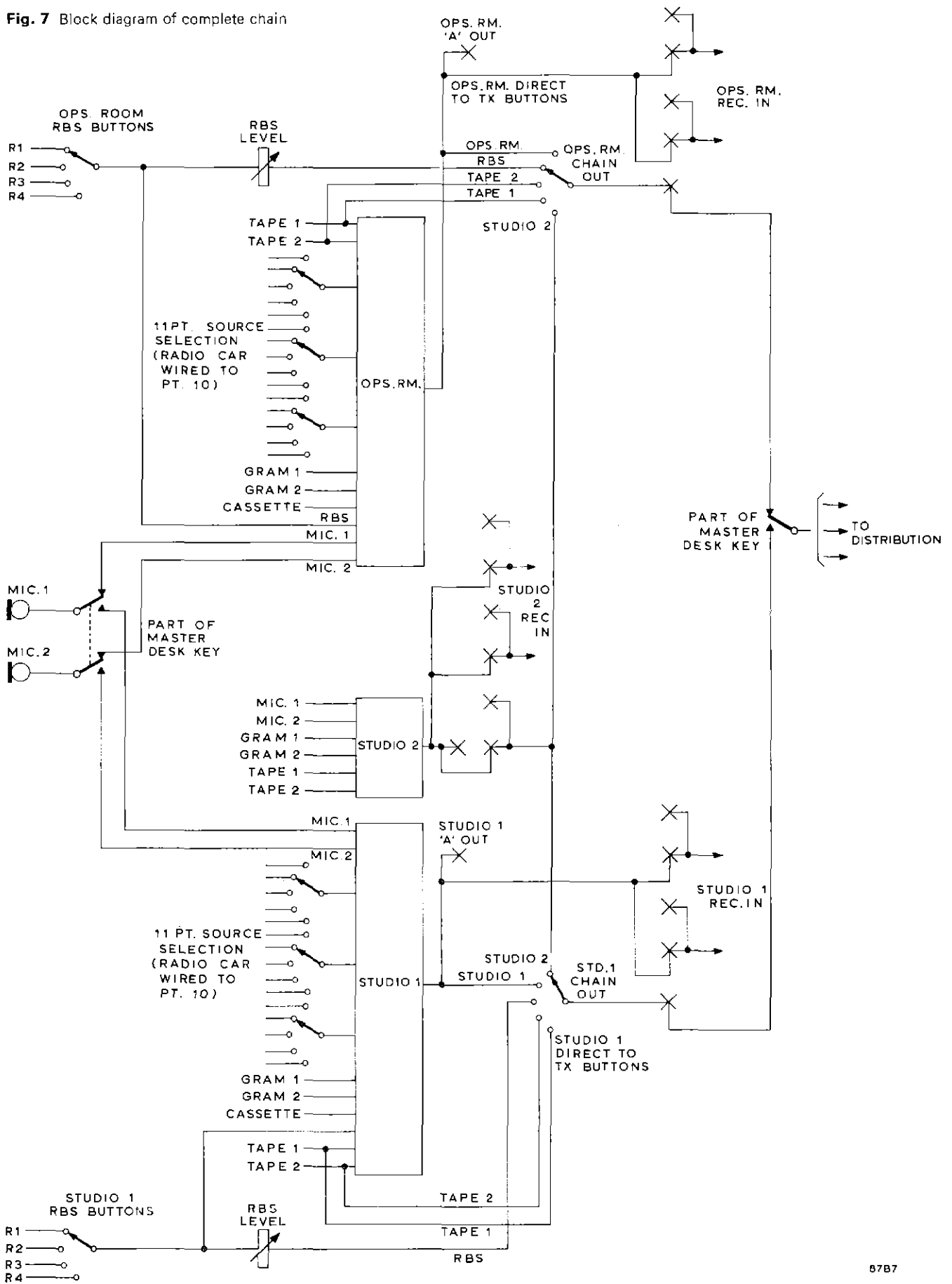

5.4 Studios 1 and 2

The main studio is associated with the operations room. A double-glazed window between the two areas allows them to be used as a suite with the output of the studio controlled in the operations room. Alternatively, the control desk in the studio itself may be used: this is designed to provide one-man operation of microphone, tape and disc machines and incoming lines or radio-car transmissions.

Studio 2 was originally envisaged in the experimental stations as a simple recording studio, with separate cubicle, for talks and discussions mainly associated with educational programmes. Experience proved that the studio is put to much wider use and must be capable of handling live broadcasts.

It was expected that the studios would mainly be used for speech. They are both about 300sq. ft (28sq. m) and were designed to have a reverberation time of about 0.3s (see Fig. 8). The acoustic treatment makes use of 2ft (60cm) square, 7½ in. (19cm) deep prefabricated boxes designed by BBC Research Department. The boxes, mounted against a wall or a ceiling, each have a front layer of high-density rock wool. The air space between this front and the wall is divided 'egg-crate' fashion into four compartments. The lowest frequency efficiently absorbed by the box depends on the depth and the size of the subdivisions. Generally speaking, the greater the depth and the greater the number of subdivisions, the lower the frequency. The front of each box is covered by perforated hardboard, the percentage perforation controlling the high-frequency absorption. Two types were used, a 25 per cent perforation giving wide-band absorption up to about 4 or 5kHz gradually falling at higher frequencies and ½ per cent giving higher efficiency at lower frequencies and a sharpish cut-off at mid frequencies (see Fig. 9).

The sound insulation of the studios aimed at a noise level normal for talks studios, using conventional building methods. Where this was difficult to achieve at reasonable cost some degradation was accepted. In the later studios air conditioning was included in both the studios and the operations room.

5.5 Control desks

Mixing desks are provided in the operations room, Studio 1, and in the control cubicle of Studio 2. The desks which are of BBC design are built around commercially produced channel modules. The wiring arrangements are conventional and a simplified diagram of the operations room control desk is shown in Fig. 10. Perhaps the most unusual elements are the limiters type AM6/7.* These were developed by the BBC and have several interesting features of which the two most important are:

- The programme is delayed electronically so that the gain may be reduced in time to prevent any overshoot, but at a rate which causes no audible distortion.
- The gain recovery time varies automatically to suit the nature of the programme. If the programme exceeds the limiting level only very briefly, the recovery of gain is rapid. After high programme volume, which causes gain reduction for a longer period, recovery time is long unless the programme falls more than 15dB below the limiting level when the gain is restored more rapidly. This prevents any

* See Engineering Division Monograph No. 70 (Oct. 1967).

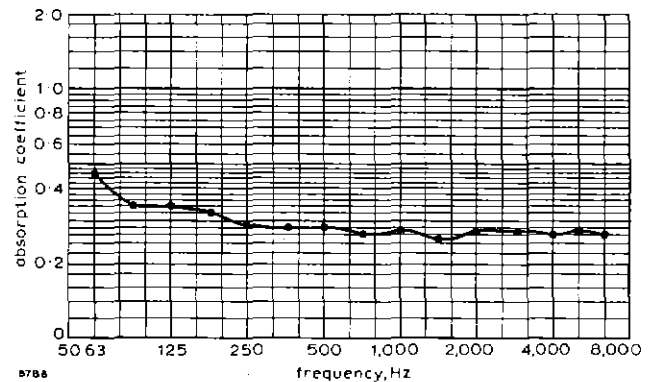

Fig. 8 Reverberation time/frequency characteristic of studio

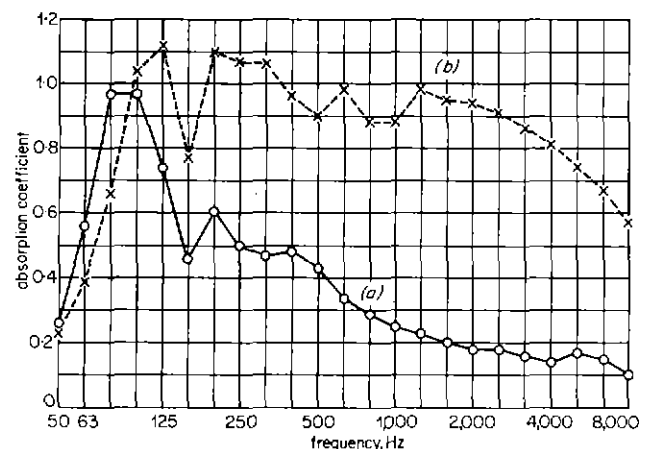

Fig. 9 Absorption/frequency characteristics of boxes
(a) Low-frequency type
(b) Wide-band type

noticeable 'gain pumping' effect or unnatural interference with reverberation.

The first eight stations make use of the limiter on the output of the studio, particularly when a single presenter or announcer is operating the equipment. It is normally set to provide about 8dB of compression and is effective in smoothing out any inconsistencies of level. The limitation of using a single unit is that music and speech are controlled to the same peak level. The main desk in the latest stations (Fig. 10) has two limiters and it can be arranged to control music and speech to different peak levels so that the apparent loudness to the listener is more acceptable. (Speech needs to peak 4-6dB more than popular music; limiters for compression are not used for 'serious' music on v.h.f.)

5.6 Gramophone records

Each station has eight commercially produced turntables, two associated with each control desk and two portable ones.

5.7 Tape recording machines

Each station is equipped with six professional tape recorders, three high-quality domestic machines, and twelve portable battery-operated recorders.

The tape speed used is 7½ in/s (19cm/s), which appears to

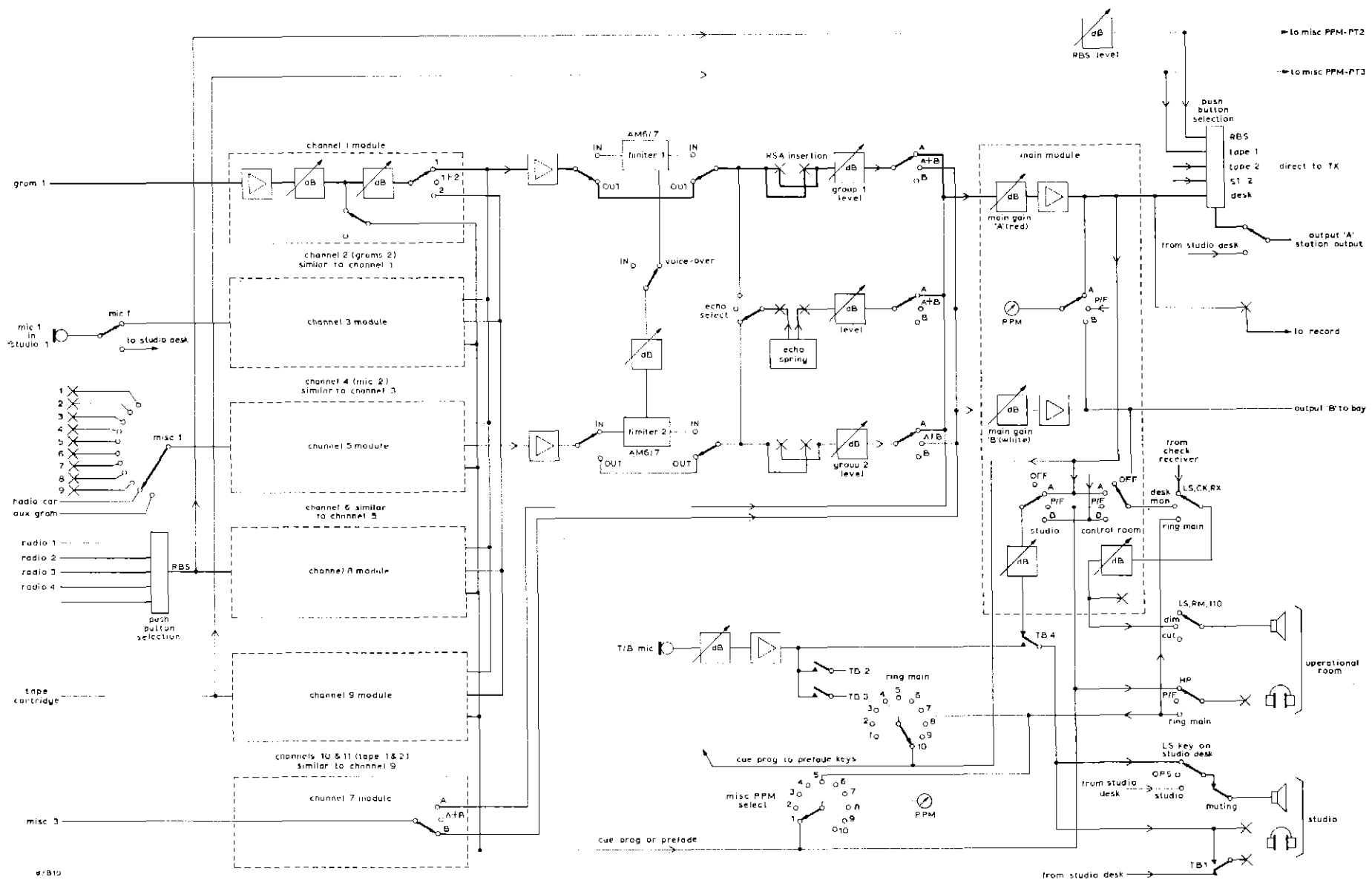

Fig. 10 Block diagram of operations room control desk

be the best compromise between reasonably high quality and easy editing on the one hand and economy in the use of tape and small portable recorders on the other.

The tape used is centrally bought and accepted to BBC specification, to reduce tape sensitivity variations.

Experience has shown that for heavy editing work the life of domestic type recorders is limited to two or three years unless they are carefully handled. Editing is generally easier and quicker on a professional machine. However, editing tends to increase according to the number of machines available and it is not easy to decide on the correct allocation.

The professional recording machines are trolley-mounted and fitted with individual faders and monitoring facilities. Two are generally allocated to the operations room and the others to Studios 1 and 2.

In most Local Stations the portable tape machines, when not in use, are kept in a central store with the batteries on charge. Portable recorders are used at $7\frac{1}{2}$ in/s (19 cm/s) so that the tapes are compatible with those recorded in the studio and, although the machines are half-track, use is made of only one track so that editing is possible.

5.8 Tape cartridge machines

Experience with tape cartridge machines, playing a continuous loop of tape, has shown that it is necessary to use a fully professional machine to achieve reliable operation. They are normally used for station identification and programme trails.

5.9 Loudspeakers

Loudspeakers for high-quality monitoring are expensive and not readily available in large quantities. It was decided that for Local Radio purposes monitoring in the studios and operations room could be adequately covered with a medium-priced bookshelf-type commercial loudspeaker produced for the domestic market. These were later augmented by providing each station with one high-quality BBC-designed loudspeaker unit.

5.10 Microphones

Each station was provided with a basic kit of microphones, augmented later by different types to suit special requirements. The most frequently used type of microphone is a moving-coil cardioid but all stations also have some ribbon microphones, lip microphones, and omnidirectional moving-coil microphones. A few stations have also acquired condenser microphones.

6 Outside broadcasts

Very simple outside broadcasts may be carried out with the radio car (described in Section 8). For more complicated programmes a portable five-channel mixer, using the same modules as the studio desks, has been provided. Most stations have augmented this unit with additional low-level mixers and other ancillary equipment.

The first stations made use of high-quality domestic recorders on outside broadcasts but these are gradually being replaced for most purposes by professional-standard battery-operated recorders.

The flexibility in the use of equipment by station engineers is perhaps best illustrated by some of their activities on the larger outside broadcasts. Coverage of the 'Liverpool Show' by Radio Merseyside has been achieved by rigging a 'Disc-Jockey'-operated studio in a tent, using some borrowed equipment, and radio-link O.B. coverage to other venues at the show with equipment taken out of the radio car. At the 'Leicester Show' coverage by Radio Leicester was achieved by taking all the equipment from the station's Studio 2 and rigging it at the show.

7 Use of Post Office telephone

For some Local Radio programmes broadcast telephone conversations or reports are required. This has possibly been more effectively done in Local Radio than in network programmes because many of the calls are local and the listener's interest in contributing to some local programme is more direct and immediate. The technical arrangements are similar to those used in network radio and have been worked out with the agreement of the Post Office. All stations are equipped with a constant-volume speech amplifier of BBC design. The equipment provides proper terminating arrangements for the telephone circuit so that no interference can be caused to other users of the Post Office telephone service.

One end of the telephone conversation is nearly always much louder than the other end and the different levels are balanced by means of a compressor (set to one of four ranges on a test call) followed by a limiter. In this way differences in audio level of about 30dB can be dealt with without undue increase in distortion.

Arrangements have also been agreed with the Post Office for using selected telephones with a portable recorder so that high-quality microphones may be used and tapes reproduced over a telephone line. The call would be received at the radio station through the constant-volume speech amplifier with the compression set to a minimum.

8 Radio cars

Each station has been provided with a radio car for news reporting and as an outside-broadcast vehicle.

The cars are provided with a car-to-base u.h.f. programme link and a two-way v.h.f. communications channel. The audio equipment is designed to accept several types of input including microphone, radio microphone, tape recorder, and the output of multi-channel mixing equipment.

8.1 Vehicle

Estate cars are used with the front passenger seat removed to provide space for the technical equipment (Fig. 11). A 30ft (9.14m) pneumatically operated telescopic mast is mounted either on the rear door of the vehicle (Fig. 12) or in some cases through the roof.

8.2 Mobile radio equipment

The car-to-base programme link consists of a 5-W frequency-modulated u.h.f. transmitter feeding into an omnidirectional transmitting aerial. The aerial is mounted on the top of the telescopic mast.

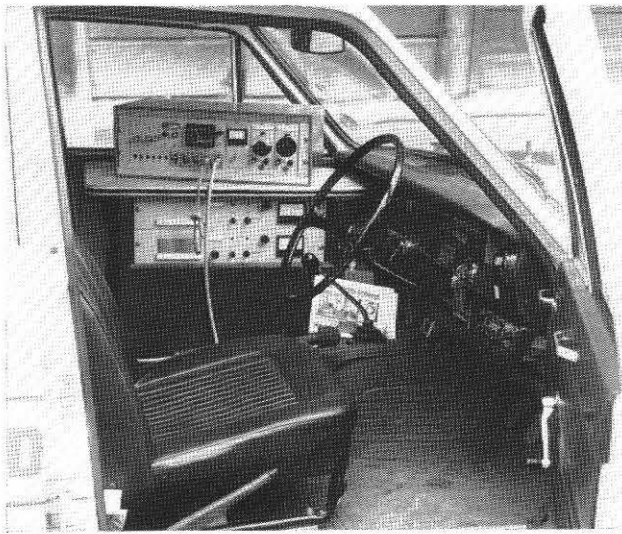

Fig. 11 Equipment in the radio car. The three units on the left of the driver's seat are:
 Upper: Microphone amplifiers, p.p.m., and input selector
 Middle: U.H.F. transmitter for programme link
 Lower: U.H.F. receiver for radio microphone

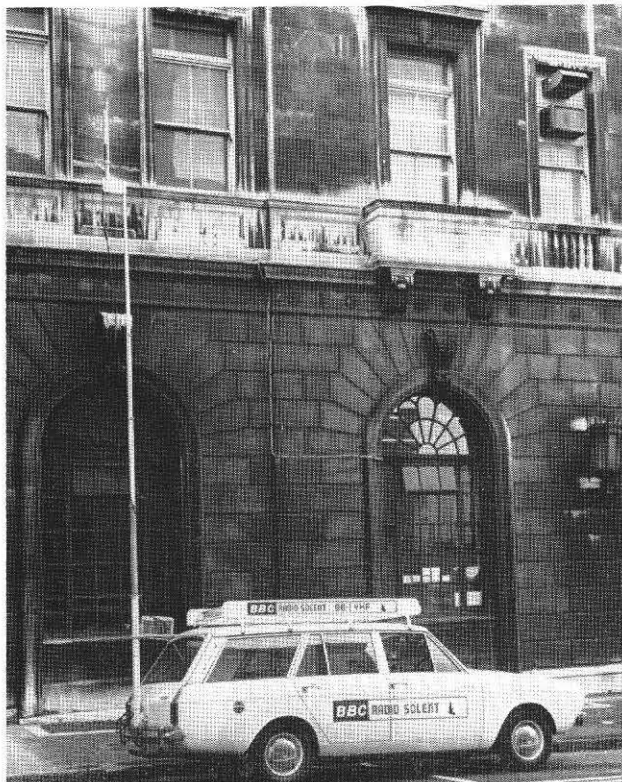

Fig. 12 Radio car with telescopic aerial extended

The communications channel operates in single frequency simplex mode at mid-band v.h.f. The transmitter has an output of 25W and is frequency modulated. A wing-mounted whip aerial is used for both transmission and reception.

In addition to the above equipment a radio microphone is provided for the programme link from reporter to car and a

portable v.h.f. radio telephone is used to supplement the communications channel when the reporter is away from the vehicle.

A separate battery provides the power supply for the programme channel equipment and the normal car battery is used to power the communications plant. A functional diagram of the radio car is shown in Fig. 13.

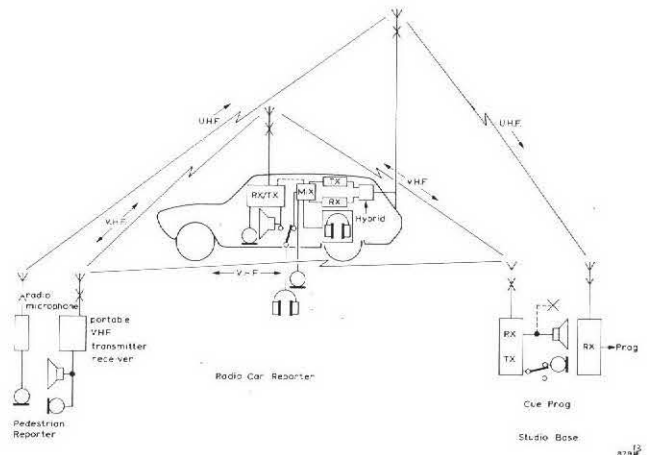

Fig. 13 Block diagram of radio-car facilities

8.3 Mobile audio equipment

A simplified diagram of the car audio circuits is shown in Fig. 14. It will be seen that input channel 1 is used for the reporter's microphone and input channel 2 has a three-position selector enabling a tape recorder, a mixer, or the radio microphone to be connected to the u.h.f. programme link.

Two further inputs are provided for auxiliary use.

The v.h.f. communications equipment has a microphone input only but in the event of an emergency the output of the programme channel may be fed to the v.h.f. transmitter via a relay contact. The v.h.f. receiver output may be connected via switches to the reporter's headphone or to the headphone socket adjacent to the driving position. A three-position switch is provided enabling the outgoing programme, the output of the v.h.f. receiver, or the output of the radio microphone to be monitored.

Local cue programme may be fed into the system via Socket J8.

8.4 Base stations

The base-station aerial systems must be situated in a position above the surrounding buildings. Where possible these aerials have been mounted on the roof of the studio premises but at some locations it has been necessary to set up a separate base station on an adjacent tall building and link back to the studio by Post Office line.

8.4.1 Receiving aerial system

The u.h.f. receiving aerial consists of a double yagi array. Facilities are provided to adjust, from the studio, the azimuth of the aerial to any bearing. The double yagi array has a

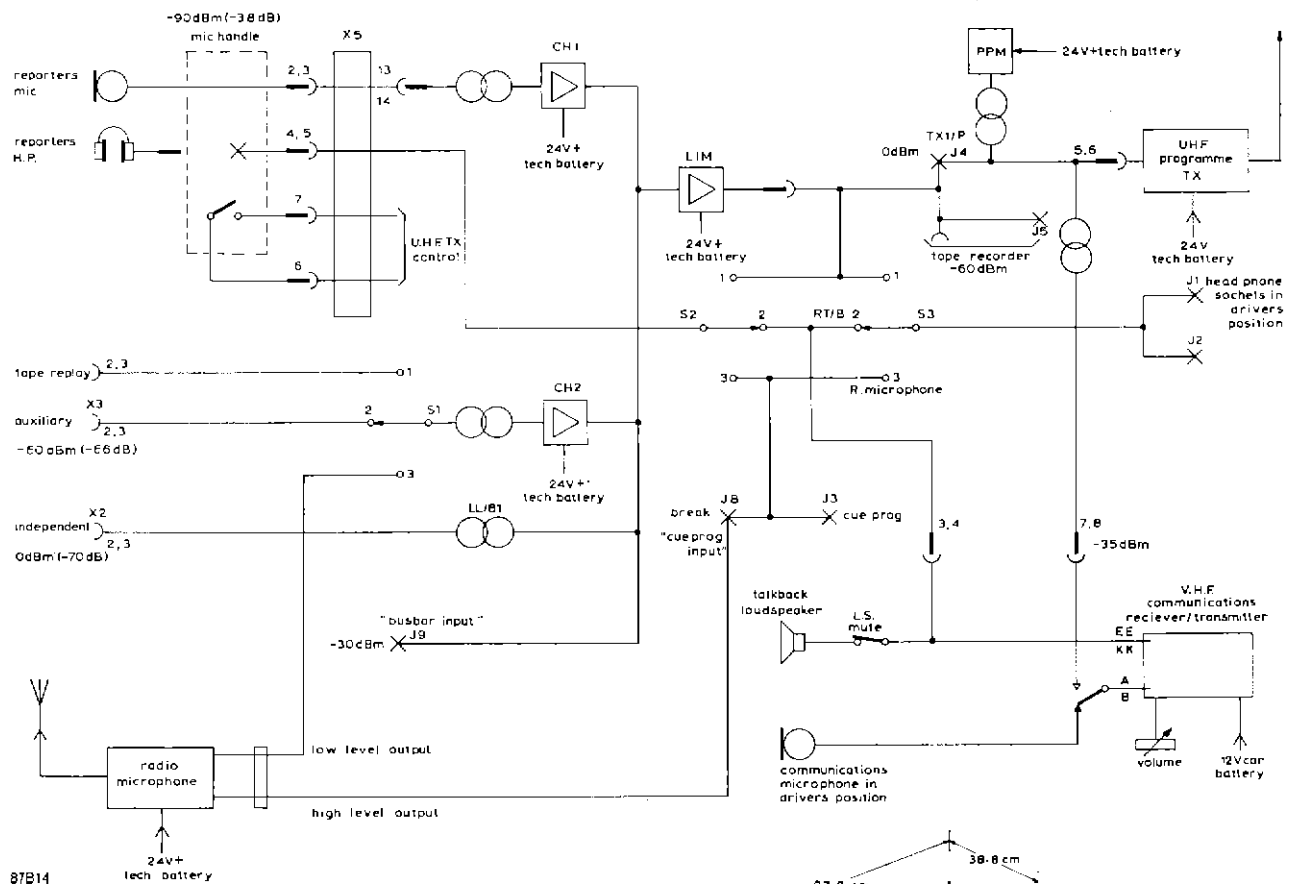

87B14 Fig. 14 Block diagram of radio-car audio circuits

forward gain of $12\frac{1}{2}$ dB and the additional benefit of reducing multi-path reception.

The v.h.f. communications aerial is a folded dipole. A sketch of the base station aeriels is shown in Fig. 15.

8.4.2 Radio equipment

This consists of a u.h.f. receiver, v.h.f. transmitter/receiver, and control equipment. When the base station is remote from the studio the transmitter/receiver switching and aerial azimuth control are all effected via phantom circuits on the interconnecting Post Office lines.

8.5 Studio equipment for control of radio cars

Studio 1 and the operations-room desk each have facilities for controlling the radio cars and in addition control can be switched to the engineer's office enabling tests and alignment checks to be carried out away from the operational areas.

8.6 Typical performance of the u.h.f. link

Under average conditions the u.h.f. programme link has a weighted signal-to-noise ratio of 55 dB, the frequency response is level to within 3dB between 100Hz and 9kHz, and the distortion at the maximum modulation depth does not exceed 3 per cent.

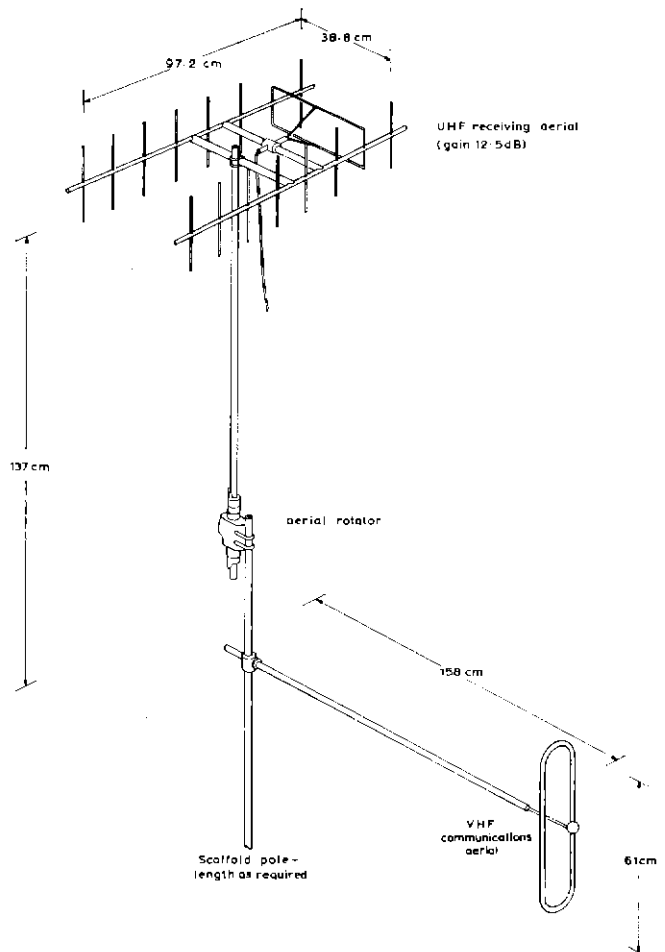

Fig. 15 Radio-car base station aeriels

9 Teleprinters

The distribution of news material to Local Radio stations presented a number of problems. The news facilities in London, press agencies, etc., are available in limited form only in provincial cities, and sometimes not at all. Therefore it was decided to connect the Local Radio stations on to the existing BBC General News Service distribution.

Teleprinter circuits already existed to main Regional Centres and there was adequate capacity on these routes to cope with the additional Local Radio traffic. New permanent lines were provided between the Regional Centres and the Local Radio stations. The system operates in the following way: News is prepared in the General News Service Unit in the London Newsroom. This is then punched on to perforated tape complete with the necessary address information for the Automatic Switching Computer (ADX). *These tapes are then fed into the ADX via tape readers. The ADX processes the messages, simultaneously passing them to those outstations which are immediately available. Material for any outstations already engaged is stored until the channel is free. (Urgent news material can be given a priority which enables it to be placed at the head of any queue which might form as the result of traffic peaks or a circuit fault.)

In addition to passing the material to individual stations the ADX also inserts additional codes on channels used to feed groups of Local Radio stations. These codes are detected at a remote centre thereby causing a further switching operation. For example, a news story for Radio Durham would be routed by ADX to Newcastle where a solid-state telegraph selector would switch in the Durham circuit. Multi-addressed material for any or all of the North East group of Local Radio stations (Durham, Newcastle, and Teesside) together with the Newcastle Area Newsroom can be handled as one transmission, the Newcastle selector connecting the outstations required as directed by the ADX. This technique has enabled all twenty existing Local Radio stations to be covered, using the solid-state selectors in Newcastle, Leeds, Manchester, Birmingham, Bristol, Southampton, and London with adequate provision for expansion if required.



Fig. 18 Newsroom

* Described in BBC ENGINEERING, No. 83 (July 1970).

At the Local Radio outstations the choice of teleprinter machine lay between rental (with maintenance) and purchase. A compromise was reached whereby redeployed BBC machines could be provided at eight sites where maintenance effort is available. Machines were rented for the remaining twelve. Experience has now led to the proposal for duplicating the machines at each location with a simple change-over switch between main and standby in order to maintain the service.

Because of the large population coverage, the stations for London, Birmingham, and Manchester are also provided with some news agency teleprinters. All stations are provided with a Telex machine.

10 Description of Radio Solent

Most of the studio premises for Local Radio stations are isolated from other BBC activities in the area, but Radio Solent, in common with the Local Radio stations at Bristol, Birmingham, and Manchester, shares accommodation with other BBC Departments.

The BBC south of England television operation is based on the first and second floors of South Western House, Southampton, and in order to provide accommodation for Radio Solent the third floor was acquired. The building was originally designed as a hotel and the problems of fitting a Local Radio station into the available accommodation were typical of those encountered at other locations. For this reason the station has been chosen for a more detailed description of typical studio premises.

The location of the building is in many ways ideal for the purpose as it is near the centre of the city and close to the harbour areas which form the base for much of the local industry. Radio Solent also covers most of the Isle of Wight and the location of the studio premises near one of the ferry terminals is an advantage.

A service area map showing the coverage of the Radio Solent v.h.f. transmitter is shown in Fig. 16. Although a satisfactory service is received out to the 48 dB contour the editorial area limit is generally the 60 dB contour.

A floor plan showing the layout of the areas in the studio premises is given in Fig. 17.

Access to the station is by lift from the ground floor to the reception areas on the third floor.

Most of the news-collection activities are concentrated near the entrance, including the News Editor's office and the Newsroom, which also accommodates teleprinters, telex, and portable tape recorders (Fig. 18).

The operations room and Studio 1 (Fig. 19) are also in this area and as will be seen from the floor plan, Studio 2 (Fig. 20) and its control cubicle are adjacent to the operations room. A small gram/tape library is provided with disk and tape-storage accommodation and facilities for disk-to-tape transfer.

In addition to the office accommodation for the Manager, Programme Organiser, Engineer, and production staff a small engineering workshop is provided.

As South Western House is a comparatively tall building, the radio-car base station is situated on the roof.

A reporter-operated radio contribution studio for Network News and Current Affairs shares accommodation with

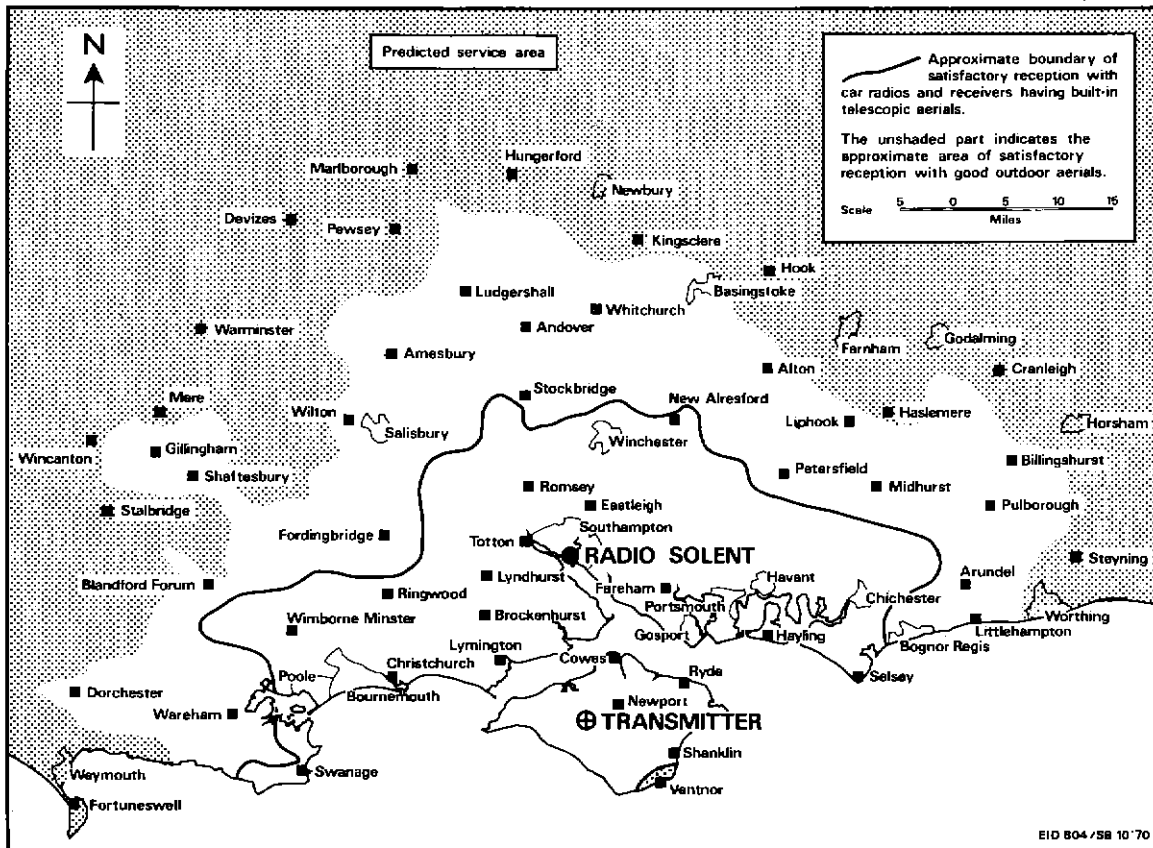

Fig. 16 Radio Solent coverage map. The solid line is the 60 dB ($\mu\text{V}/\text{m}$) contour. The limit of the unshaded area indicates the 48 dB ($\mu\text{V}/\text{m}$) contour

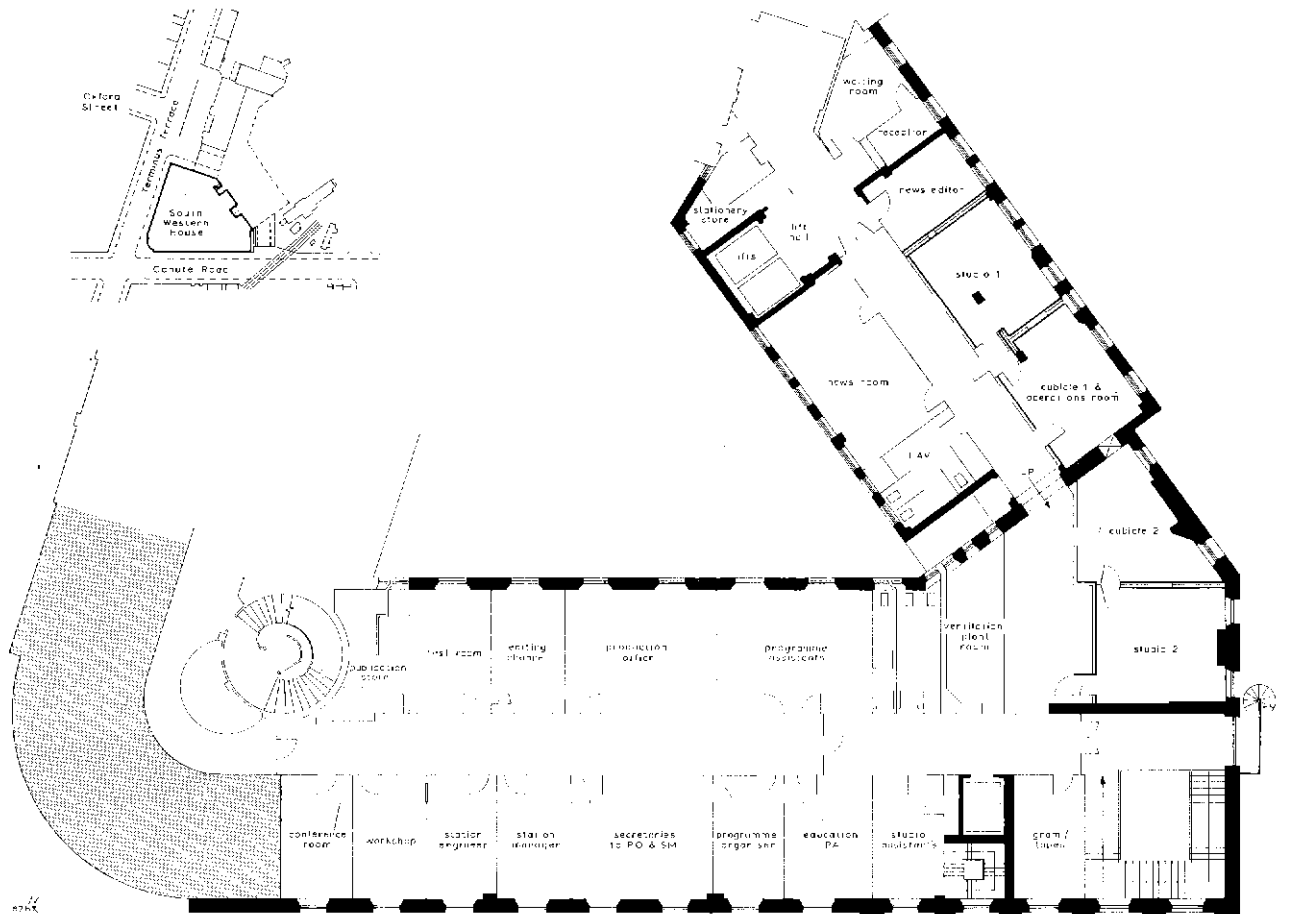

Fig. 17 Radio Solent: floor plan of studio premises



Fig. 19 Studio 1 viewed from the operations room, which also serves as the control cubicle for this studio



Fig. 20 The control desk in Studio 1, which can be operated by the announcer

the regional television station on the second floor of the building.

The Radio Solent v.h.f. transmitter is installed at the BBC

transmitting station, Rowridge, Isle of Wight. The transmitter is powered into the main Band II transmitting aerial by means of additional combining filters.

U.H.F. Offset Plan for Europe

UDC 621.396.74

Work on the new offset plan for the u.h.f. television services of East and West Europe was completed at the beginning of March 1971. This plan (known as the *London Plan 1968* to distinguish it from that prepared at Stockholm in 1961) has been carried to a successful conclusion largely due to the efforts of the BBC Research Department. It has been accepted by most of the forty-two countries concerned, and because its preparation took account of modifications to European u.h.f. plans carried out or proposed since the Stockholm Conference, it effectively up-dates the latter agreement. The modifications have included not only offset changes but also extensive alterations to other operating characteristics such as effective radiated powers, aerial heights etc. It was also necessary to accommodate several channel changes, and what amounted to a completely new plan for Scandinavia and northern Russia. The considerable degree of international co-operation achieved throughout contributed greatly to the success of the work.

The preparation of the London Plan has been spread over four years. During this time a mass of data relating to the operating characteristics of nearly 2,000 stations throughout Europe has been assembled. These data together with computer calculations carried out by the Post Office and other records have now been passed to the EBU Technical Centre, who will send information to the I.F.R.B. in Geneva to assist with the publication of the official notifications.

A detailed programme of offset changes for main and relay stations in both the BBC and ITA services has been prepared and the timing of these changes will be negotiated with the ITA, the Ministry of Posts and Telecommunications, and with the appropriate foreign administrations.

Insertion Communication Equipment: Field Trial

UDC 621.396.69

One of the many techniques which is likely to be used in future

automation of the television network is the transmission of data during one or more lines of the field blanking interval of the 625-line waveform. Various proposals for the transmission of such data (Insertion Communication Systems) are being actively studied by many broadcasting organisations and among the applications envisaged are:

1. Network Identification
2. Source Identification
3. Network Switching
4. Programme Co-ordination Information
5. Network Information
6. Monitoring Information
7. General Data Transmission

Designs Department has produced a prototype system which is now undergoing field trial on both BBC distribution networks. The system allows digitally coded pulses to be inserted into a video signal at a distant point. The data is transmitted on line 16 (329) and provision has been made for eight independent channels, each containing eight bits. In the field trial Channel 1 will be used for network identification (one pulse for BBC-1 and two pulses for BBC-2) and Channel 8 will carry experimental data. Equipment for both networks is being installed at Kirk o'Shotts and Wenvoe, and this will automatically indicate the loss of network identification. Auxiliary equipment is to be installed to decode the various data transmissions on Channel 8. At some later date equipment will be installed to insert and extract data at intermediate points in the distribution system.

Although the first part of the field trial will be concerned with network identification, the possibility of transmitting data over the network should stimulate suggestions for other operational requirements. It is also hoped that information will be gained indicating how insertion communication equipment can be applied on a long-term basis, e.g. source identification and network switching, monitoring etc. The establishment of future operational and technical requirements on which to base the final system design are regarded as a major objective of this field trial.

Contributors to this issue

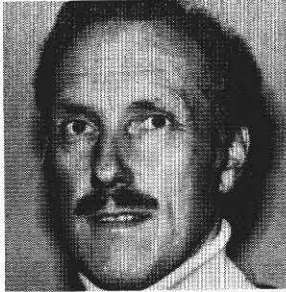

James Duncan MacEwan graduated in mathematics and radio-physics from Glasgow University in 1944, and served in the Royal Signals from 1944 to 1947. He remained in the Army Emergency Reserve and the Territorial Army, working on special communication systems, until 1966. On demobilisation from his wartime commission in 1947 he joined the BBC in Glasgow as a Direct Entry engineer and worked on radio until 1953, when he transferred to television. In 1956 Mr MacEwan left Scotland to become a senior lecturer in Engineering Training Department, and he afterwards held senior appointments in the regions until 1968, when he moved to a London-based appointment as the engineering member of the BBC Policy Study Group. At the time of writing his article for this issue of BBC ENGINEERING he was Chief Engineer, Regions, but he has since been appointed Chief Engineer, Radio Broadcasting.



Bob Sparks joined the BBC in 1953 from private architectural practice following experience in the Ministry of Works on Post Office buildings. He qualified as an architect in 1950 and was elected an Associate of the Royal Institute of British Architects in 1951 and a Fellow of the Royal Society of Arts in 1964.

Appointed a Senior Architect in 1963 he was involved in many of the Television and Radio developments in London area and was entirely responsible for all work in the London area as Head of London Building Section from July 1968. In his present position as Chief Architect, to which he was promoted in January 1970, he is responsible for all architectural design and construction work on studio and office premises required by the BBC throughout the country.



Ken Kinally joined the BBC in 1944 and, after a brief period at the studio centre in Birmingham, was a member of the Control Room staff of the European Service at Bush House until 1952. At this time he joined Planning and Installation Department, working on television studio and central area projects, including Television Centre. In 1960 he transferred to a post in Television Operations and Maintenance Department concerned with the overall planning of facilities in London and regional studio centres. He was appointed Project Manager, Birmingham, at the end of December 1969.



Donald Cummings graduated from Imperial College and joined the BBC after service in the RNVR. He spent some four years in Planning and Installation Department then joined the head office staff of Radio Engineering with responsibilities for maintenance and later new projects and operations. He became Superintendent Engineer (Operations) in 1963.



Roy Bliss joined the BBC in 1956 as a member of the Operations and Maintenance staff of the Sutton Coldfield Transmitting Station. In 1961, after service in the Les Platons Transmitting Station, he was appointed to Transmitter Planning and Installation Department and was associated with the development of the TV/VHF Relay Station network and several high-power UHF transmitting stations. In 1968, he transferred to Transmitter Department Head Office Staff and in 1969 was appointed to his present post of Project Manager, Radio Developments in Transmitter Capital Projects Department. Since taking up this post he has been mainly responsible for the planning and installation of the BBC's Local Radio studios and transmitting stations.

Books by BBC Authors

The following books, written by BBC authors for engineering training purposes, can be obtained from technical bookshops or by direct application to the publisher.

Focal Press Ltd, 31 Fitzroy Square, London, W1

Motion Picture and Television Film Image Control and Processing Techniques (£4.50) by D. J. Corbett

Butterworth & Co., 88 Kingsway, London, WC2

High-quality Sound Production and Reproduction (case-bound £2.10; limp 75p) by H. Burrell Hadden

Microphones by A. E. Robertson (£3.75)

Principles of PAL Colour Television and Related Systems (case-bound £1.75; limp £1.05) by H. V. Sims

Principles of Transistor Circuits (case-bound £3; limp £1.50) by S. W. Amos

Sound and Television Broadcasting: General Principles (£2.25) edited by K. R. Sturley

Television Engineering: Principles and Practice by D. C. Birkinshaw, S. W. Amos, and K. H. Green

Volume 1: Fundamentals, Optics, Electron Optics, Camera Tubes, Picture Tubes (£2.25)

Volume 2: Video-frequency amplification (£3.50)

Volume 3: Waveform Generation (£3.50)

Volume 4: General Circuit Techniques (£2.25)

The following Engineering Training Supplements, also written by BBC authors for engineering training purposes, can be obtained by application to Head of Technical Publications Section, BBC, Broadcasting House, London W1A 1AA:

No. 6 Programme Meters (15p)

No. 11 Lighting for Television Outside Broadcasts (30p)

No. 13 Monitoring and Relaying of Short-wave Broadcast Signals (62½p)

No. 14 Colorimetry (22½p)

CEMAST: A brief description of the fundamental features of the BBC computerised stores-control system (22½p)

Publications available from Engineering Information Department

Information Sheets on the following subjects can be obtained from Head of Engineering Information Department, Broadcasting House, London W1A 1AA, and are available free of charge, except where otherwise indicated.

General

9002 Wavebands and Frequencies Allocated to Broadcasting in the United Kingdom

Television

4006 UHF Television Reception

2103 Band-I and II Receiving Aerials: Dimensions

4005 BBC-1 625-line Colour Transmissions

9003 Television Channels and Nominal Carrier Frequencies

2701 Television Interference from Distant Transmitting Stations

4101 Television Receiving Aerials

4306 Test Card F

2001 Transmitting Stations, 405-line Services (BBC-1 and BBC Wales): Channels, Polarisation and Powers

2901 Transmitting Stations, 405-line Services (BBC-1 and BBC Wales): Map of Locations

4003 Transmitting Stations, 625-line Services: Channels, Polarisation and Powers

4919 Main Transmitting Stations, 625-line Services: Map of Locations

2020 405-line Television: Nominal Specification of Transmitted Waveform

4202 625-line Television (Colour and Monochrome): Brief Specification of Transmitted Waveform

Radio

1701 Medium-wave Radio Services: Interference

1603 Stereophonic Broadcasting: Brief Description

1604 Stereophonic Broadcasting: Technical Details of Pilot-tone System

1605 Stereophonic Broadcasting: Test Tone Transmissions

1924 Stereophonic Broadcasting: Service Area Map and List of Stations

1102 VHF Radio Receiving Aerials

1034 VHF Radio Transmitting Stations: Frequencies and Powers

1919 VHF Radio Transmitting Stations: Map of Locations

Service Area Maps

Individual maps showing the service areas for most radio and television transmitters are also available.

Specification of Television Standards for 625-Line System I Transmissions

A detailed specification of the 625-line PAL colour-television signal transmitted in the United Kingdom is published jointly by the British Broadcasting Corporation and the Independent Television Authority, and can be obtained for 50p post free from Head of Engineering Information Department, Broadcasting House, London W1A 1AA.

Contents of previous issues

Number 85 (January)

Editorial: The Unattended Operation of u.h.f. Broadcasting Transmitters

Multiplex System for Standby Operation of u.h.f. Television Transmitters. *R. W. Leslie*

Technical Monitoring of Transmitters and Programme Links. *R. W. Holmes*

The Choice of Primary Colours for Colour Television. *C. B. B. Wood and W. N. Sproson*

New Automatic Monitor for Television Transmitters

Joystick Control Unit for TARIF

Automatic Modification of Receiving Aerial Polar Diagrams

Receiving Aerials for Satellite Broadcasting

Computer Storage of Ground Profile and Population Density Data

Number 86 (April)

Editorial: Digital Techniques in Broadcasting Service Area Planning by Computer

R. W. Lee, J. H. Causebrook, and R. S. Sandell

A P.C.M. Sound-in-Syncs System for Outside Broadcasts
C. J. Dalton

Differential Phase Measurement in Television:
A New Method of Using the Insertion Test Signal
P. A. Tingey

Improvement in Quality of Telephone Contributions in Programmes

Telecine Transmissions from Negative Colour Film

Optimum Bandwidth Restrictions of A.M. Transmitters

BBC Engineering Monographs

1	The suppressed frame system of telerecording	June 1955
3	The visibility of noise in television	October 1955
4	The design of a ribbon-type pressure-gradient microphone for broadcast transmission	December 1955
5	Reproducing equipment for fine-groove records	February 1956
6	A vhf/uhf field-strength recording receiver using post-detector selectivity	April 1956
7	The design of a high-quality commentator's microphone insensitive to ambient noise	June 1956
8	An automatic integrator for determining the mean spherical response of loudspeakers and microphones	August 1956
9	The application of phase-coherent detection and correlation methods to room acoustics	November 1956
12	An improved 'Roving Eye'	April 1957
13	The BBC Riverside television studios: The architectural aspects	July 1957
14	The BBC Riverside television studios: Some aspects of technical planning and equipment	October 1957
15	New equipment and methods for the evaluation of the performance of lenses for television	December 1957
16	Analysis and measurement of programme levels	March 1958
18	The BBC colour television tests: An appraisal of results	May 1958
19	A uhf television link for outside broadcasts	June 1958
20	The BBC's Mark II mobile studio and control room for the sound broadcasting service	August 1958
22	The engineering facilities of the BBC monitoring service	January 1959
23	The Crystal Palace Band I television transmitting aerial	February 1959
24	The measurement of random noise in the presence of a television signal	March 1959
25	A quality-checking receiver for vhf/fm sound broadcasting	June 1959
26	Transistor amplifiers for sound broadcasting	August 1959
27	The equipment of the BBC television film studios at Ealing	January 1960
28	Programme switching, control, and monitoring in sound broadcasting	February 1960
29	A summary of the present position of stereophonic broadcasting	April 1960
31	The power gain of multi-tiered vhf transmitting aerials	July 1960
32	A new survey of the BBC experimental colour transmissions	October 1960
33	Sensitometric control in film making	December 1960
34	A mobile laboratory for uhf and vhf television surveys	February 1961
35	Tables of Horizontal radiation patterns of dipoles mounted on cylinders	February 1961
36	Some aspects of optical lens performance	April 1961
37	An instrument for measuring television signal-to-noise ratio	June 1961
39	Twenty-five years of BBC television	October 1961
40	The broadcasting of music in television	February 1962
41	The design of a group of plug-in television studio amplifiers	April 1962
42	Apparatus for television and sound relay stations	July 1962
43	Propagational factors in short-wave broadcasting	August 1962
44	A Band V signal-frequency unit and a correlation detector for a vhf/uhf field-strength recording receiver	October 1962
45	Vertical resolution and line broadening	December 1962
46	The application of transistors to sound broadcasting	February 1963
47	Vertical aperture correction using continuously variable ultrasonic delay lines	May 1963
48	The development of BBC internal telecommunications	May 1963
49	Apparatus for measurement of non-linear distortion as a continuous function of frequency	July 1963
50	New methods of lens testing and measurement	September 1963
51	Radiophysics in the BBC	November 1963
52	Stereophony: The effect of cross-talk between left and right channels	March 1964
53	Aerial distribution systems for receiving stations in the l.f., m.f., and h.f. bands	July 1964
54	An analysis of film granularity in television reproduction	August 1964
55	A review of television standards conversion	December 1964
56	Stereophony: The effect of interchannel differences in the phase/frequency and amplitude/frequency characteristics	December 1964
57	Drop-out in video-tape recording	June 1965
58	Sine-squared pulse and bar testing in colour television	August 1965
59	The acoustic design and performance of a new free-field sound measurement room	September 1965
60	Colorimetric analysis of interference in colour television	February 1966
61	Sporadic E ionisation and television interference	March 1966
62	Automatic monitoring	April 1966
63	The design of transmission lines and single-stage switching circuits for a line-store standards converter	August 1966
64	Data for the acoustic design of studios	November 1966
65	Tristimulus spot colorimeter	December 1966
66	VHF aerial gain calculation using tables of mutual resistance between the radiating elements	February 1967
67	Pulse sound: A system of television sound broadcasting using pulses in the video waveform	March 1967
68	Recent research on studio sound problems	July 1967
69	A survey of the development of television test cards used in the BBC	September 1967
70	The dynamic characteristics of limiters for sound programme circuits	October 1967
71	The programme effects generator	November 1967
72	Colour sensitometric parameters in colour film telerecording	March 1968
73	Sonic booms and other aircraft noise in studios	April 1968
74	The non-linear characteristics of klystron amplifiers	June 1968
75	Pulse-code modulation for high-quality sound-signal distribution	December 1968
76	The variable inductance frequency modulator	December 1968
77	The automatic control of sound-signal level in broadcasting studios	March 1969
78	Aspects of high-quality monitoring loudspeakers	September 1969
79	F.M. deviation: Calibration and measurement by edge coincidence techniques	December 1969
80	An automatic method for the measurement of reverberation time	December 1969

Copies of BBC Engineering Monographs are available at 40p or \$1.00 a copy, post free, from BBC Publications, 35 Marylebone High Street, London W1M 4AA.