

DR PHILLIPS

# BBC ENGINEERING

① SLE      ② BSS<sup>4</sup>      ③ RWL

④ GSP

Number 109

April 1978



# BBC Engineering

including Engineering Division Monographs

A record of BBC technical experience and developments  
in radio and television broadcasting

---

Published approximately four times per year by  
BBC Publications,  
35 Marylebone High Street,  
London W1M 4AA.  
ISSN 0308-2369  
ISBN 0 563 17611 3

Edited by  
BBC Engineering Information Department,  
Broadcasting House,  
London W1A 1AA.

Printed by  
The Yale Press Ltd,  
London SE25 5LY.

Price  
80p or \$2.00 per issue post free.  
Annual Subscription  
£3.00 or \$8.00 for 4 issues post free.

Articles are copyright © 1978 by the  
British Broadcasting Corporation  
and may not be reproduced in whole  
or part without written permission.

## Contents

<b>Notebook</b>	2
<b>Principal articles</b>	
Automatic Operation of the BBC's Transmission Network D. East, I.J. Shelley, and G.C. Wands	7
EMIAS G.E. Buck	16
Demonstration Equipment for Television Engineering Training M.B. Tancock	20
Airborne Television Transmission M.W. Harman and J. Middleton	26
Contributors to this issue	38

The cover picture shows an MIC (Monitoring and Information Centre) display. The role of the MIC in the automatic operation of the BBC's transmitting station networks is discussed in the article beginning on page 7.

## Notebook

---

### BBC chooses NICAM 3 for Digital Sound Distribution

Digital transmission systems are growing apace and the British Post Office will soon introduce short distance 2048 kbit/s circuits on balanced pair cables. By the mid-eighties they expect to have an extensive digital network at this and higher bit rates up to 140 Mbit/s.

The BBC already has a lot of experience in the digital transmission of high-quality sound signals. Since April 1972, 'Sound-in-Syncs' has been used to distribute television sound to the networks of BBC 1 and BBC 2 transmitters and it is also widely used in other countries. Sound signals for the BBC radio services are distributed in PCM multiplex form on analogue television links. Indeed it was the introduction of digital methods that led to the rapid expansion of stereo coverage during the early 1970s. The emergence of the Post Office digital network will provide further opportunities for digital sound transmission.

The Post Office 2048 kbit/s links are designed principally for telephony; they have thirty-two 64 kbit/s channels of which 30 can carry one telephone signal each and the other two are reserved for framing and signalling. The broadcaster may rent the complete link, in which case all 2048 kbit/s are available to him. But another possibility now being explored would allow asynchronous access at a convenient multiple of the 64 kbit/s telephony rate. ('Asynchronous' means that the broadcaster would offer his signal at a little less than  $n \times 64$  kbit/s and the Post Office would provide extra bits as necessary to fit it into their own data stream.) In this method of operation the sound signals provided by the broadcaster would be interleaved with telephony and so the 128 kbit/s provided for framing and signalling would have to be left alone.

The BBC has already produced experimental equipment (known as NICAM — 'near-instantaneous companding and multiplexing') which can convey six high-quality sound signals at a bit rate of 2048 kbit/s. It was used in 1976 in a live transmission of the opening concert of the Edinburgh Festival. Requirements for sound circuits do not, however, usually come in multiples of six and it is desirable that future equipment should be able to take advantage of the 'partial access' option.

BBC engineers have therefore carried out a

comprehensive series of subjective tests to decide which of the many proposed digital sound coding systems will give adequate sound quality and fit conveniently into a whole number of 64 kbit/s telephony channels. NICAM was one of the systems tested and the others included a French system based on NICAM, an Italian system based on the 'A-law' characteristic used for telephony and two variants of NICAM specially devised with partial access in mind. The 13-bit linear PCM system now used for radio distribution was included as a basis for comparison.

It was one of the modified NICAM systems, NICAM 3, which emerged as optimum. This is based on a 14-bit primary code but only 10 bits per sample are transmitted. The signal is divided into 32-sample blocks and the highest sample value within each block determines the significance of the 10-bit words sent during that block. Thus the quantisation noise associated with quiet passages is very low, corresponding to a signal/noise ratio of 89 dB (peak signal/rms noise). This figure is reduced at higher sound levels but the extra noise is then masked by the pre-emphasised programme.

With a sampling frequency of 32 kHz the sound signal requires 320 kbit/s, plus 3 kbit/s for the scale factor that indicates the significance of the transmitted bits. Some additional capacity needs to be provided for framing, signalling and justification but with a total bit-rate of 384 kbit/s corresponding to six telephony channels there is plenty of room left for error protection. Comprehensive error protection is regarded as important because NICAM 3 is expected to have widespread applications apart from its use on Post Office 2048 kbit/s circuits and in some of these applications the error rate could be high.

The BBC intends to use NICAM 3 on all appropriate distribution networks. Meanwhile, European broadcasters are still trying to agree on a code for the international exchange of sound signals. All the systems being considered, including NICAM 3, are produced by digital companding of pre-emphasised PCM signals. Thus it will be a simple matter to interface between the different codes or for that matter with the studio code because that also is expected to be based on simple PCM.

## New OB Unit for Manchester

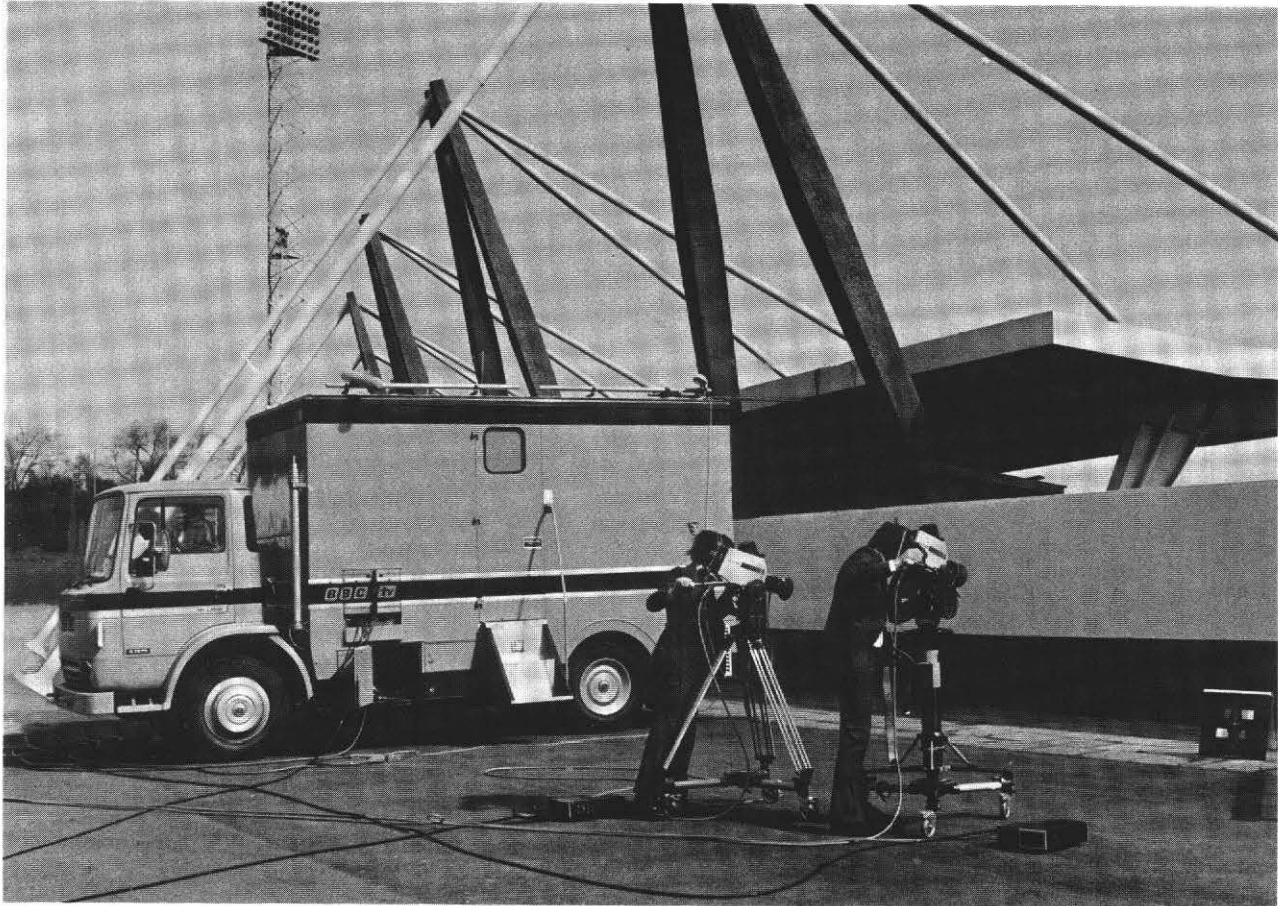

Television outside broadcasts vehicles are evolving rapidly, particularly toward smaller, highly versatile units such as the one shown here, which will shortly enter service with BBC Television North West in Manchester. It carries two light-weight cameras which can be used on the Portaped tripod shown on the right in the photograph, or shoulder-mounted. Installed in the vehicle are two one-inch helical-scan

videotape machines, six-channel vision and sound mixers and a caption camera.

The vehicle is designed to operate as a self-contained location production unit and the cameras can be connected direct to the videotape machines, or through the mixer with or without other picture sources.

---

## Broadcasting of Parliament

Regular radio broadcasting of the proceedings of the British Parliament has now begun. Preparations for this have been in hand for the past year and have involved close co-operation between the BBC and the Department of the Environment. The Department has been responsible for the work to accommodate the broadcasting facilities in the Palace of Westminster, including the construction of unobtrusive commentary boxes in the Chambers of the House of Commons and House of Lords.

The BBC has equipped these commentary boxes for use by its Parliamentary Correspondents and editorial staff and has also set up signal origination suites near the Chambers and an editorial area and two small studio suites in an adjacent building. The photograph shows one of the studio control cubicles.

It is hoped to publish a full description of the engineering facilities for Parliamentary broadcasting in a forthcoming issue of *BBC Engineering*.



## BBC Director of Engineering to be next IEE President

James Redmond, Director of Engineering, is to be the next President of the Institution of Electrical Engineers and will take office on 1 October 1978.



Mr. Redmond has been Director of Engineering since 1968; before that he had been Assistant Director and had held a number of senior posts in BBC Television. For many years he has taken a close interest in the workings of the IEE and for three years from 1973 he was a Vice-President.

## Research Department Reports

BBC Research Department has recently published the following reports.

- 1977/31 Perceptible levels of audio-frequency tones in the presence of programme
- 1977/32 Experimental digital transmission of multiplexed video and audio signals at 60 Mbit/s through a satellite
- 1977/33 New block-codes for digital tape recording
- 1977/34 A 2.5 GHz circularly polarized aerial
- 1977/35 Traffic information service: the dependence of FM capture effect upon modulation index
- 1977/36 An active aerial element for HF/MF receiving arrays
- 1977/37 Improvements to cheap loudspeakers
- 1977/38 Experimental 704 kbit/s multiplex equipment for two 15 kHz sound channels
- 1977/39 Direct satellite broadcasting: intermodulation between multiple FM sound subcarriers
- 1977/40 Audio non-linearity: an initial appraisal of a double comb-filter method of measurement
- 1977/41 A digital split-band compandor for 64 kbit/s coding of speech with a 7 kHz bandwidth
- 1977/42 LF and MF sky-wave propagation: the origin of the Cairo curves
- 1977/43 CEEFAX: spectrum-shaping filter
- 1977/44 Traffic information service: trials and developments 1975/76

A subscription to BBC Research Department Reports, of which about 35 are published each year, costs £25.00. Further information and subscription forms are available from: *Research Executive, BBC Research Department, Kingwood Warren, TADWORTH, Surrey, England.*

## Digital Transmission on Stereo Outside Broadcasts

When stereo signals originating at outside broadcast (OB) sites are to be broadcast throughout the United Kingdom they have first to be sent to London where they are mixed into the appropriate Network programme. Analogue contribution circuits are normally used for the route to London but they have the disadvantage that their quality is generally inferior to that of the digital distribution circuits which take the signals out from London to the VHF FM transmitters.

The BBC has recently been using an experimental two-channel digital transmission system to assess the feasibility of conveying high-quality stereo signals from OB sites to London in digital form. The first two broadcasts handled in this way took place last December. On both occasions the stereo signals, using 4-phase differential phase-shift keying (DPSK) modulation, were transmitted by radio-link from the OB site to a convenient BBC centre. The photograph was taken during an OB from Cardiff and shows the radio-link dish which transmitted signals to Broadcasting House, Llandaff.

From the BBC centre the signals were conveyed in suitably transcoded form on a television contribution circuit to London where they were decoded to analogue form and mixed into the Radio 4 or Radio 3 programme.

The majority of listeners are in the range of stereo VHF transmitters whose programme feeds from London also make use of digital circuits. Apart, therefore, from the short journey through the London continuity area, the signals were in digital form all the way from the OB site to the local transmitter. This meant that the transmitted signal quality was virtually identical to that at the OB site.

Associated engineering tests have confirmed that the DPSK system can work satisfactorily over what would normally be regarded as very difficult propagation paths for a radio-link.

## Radio Microphone System at Television Theatre

The radio microphone diversity receiving system described in *BBC Engineering Issue 101 (December 1975)* has been installed in the BBC Television Theatre in London and the photograph shows one of the receiving aerials near the proscenium arch.

The receiving system was developed especially for use in television studios where the efficacy of radio microphones is impaired by the reflection of radio waves from walls, floor and roof, scenery and lighting, etc. This leads to large variations of signal strength as the performer moves, to the extent that in some positions the noise is unacceptably high or there may even be complete failure.

The diversity system uses up to four receivers connected to separate aerials which need not be repositioned for each production. The signals from the receivers are combined in



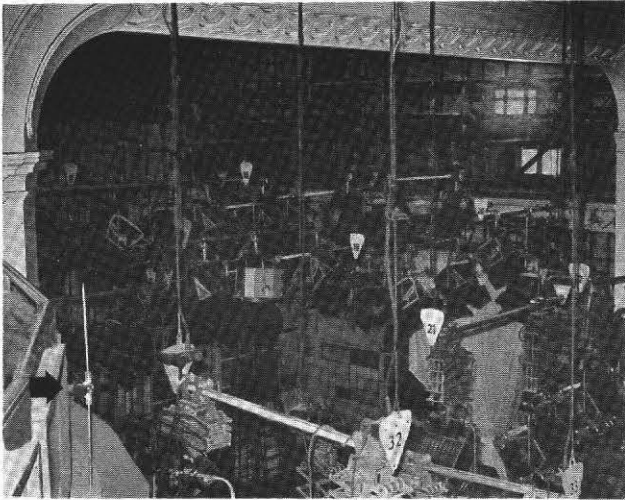

### New Sound Desk for TC1

proportions that are varied automatically to maintain the best results as the performer moves. The unit uses post-detection combination and achieves near-optimum signal-to-noise performance by way of a digitally processed control signal.

Two additional diversity receiving systems have been built in transportable form and are available for use as required in other studios or on outside broadcasts.

Television Centre Studio 1 — the BBC's largest — now has the BBC's largest sound desk. Installation was completed late last year and the desk is now in service. It has 50 input channels and is stereo-capable with eight separate groups. The desk was made to BBC specification to handle large drama and multi-microphone musical programmes, including those produced for simultaneous television and stereo radio broadcasts.

### Staff Changes



The Head of the BBC's Transmitter Capital Projects Department for the last 9½ years, Bill Wharton, retired on 31 January 1978. His BBC career spanned nearly 40 years during the last eighteen of which he held the senior posts of Head of Aerial Section, Head of Special Studies Section (both in Research Department) and Head of Transmitter Planning in the Capital Projects Department before becoming Head of the Department in May 1968.



Derek East succeeded Bill Wharton as Head of Transmitter Capital Projects Department on 1 February. He had been on the Headquarters staff of Transmitter Group since 1964, first as one of the two Superintendent Engineers and latterly as Assistant Chief Engineer in which post he was responsible for the operation and maintenance of all the BBC transmitting stations at home and abroad. His previous career was also concerned with transmitters, at first on various stations and with mobile maintenance teams and later on Capital Projects associated with the expansion of the VHF FM and Band I television services.

Derek East is co-author of an article in this issue — see pages 7-15



The new Assistant Chief Engineer Transmitters is Bill Dennay, who took up the appointment on 1 January. After two years in the Scientific Civil Service he joined the BBC in 1956 and has been closely involved since then with the work of Transmitter Group. He has served as an engineer at various transmitting stations and as a lecturer in the Engineering Training Department where he was particularly concerned with the training of transmitter staff.

Bill Dennay joined the headquarters staff of Transmitter Group in 1963 and since 1976 had been Head of Engineering, Transmitter Operations.



## Colour Television Tests on Optical Fibre Link

Last November BBC Research Department collaborated with Standard Telephones and Cables Limited (STC) in the successful simultaneous transmission of colour television and stereophonic sound signals over a 19 km optical fibre link. The objective of the tests was to explore fundamental aspects of transmitting highly structured signals such as those for colour television over this new medium.

The optical system of cable and repeaters was manufactured by STC and installed by them in ordinary Post Office cable ducts between the towns of Hitchin and Stevenage about 32 km north of London. With a capacity to handle nearly 2,000 simultaneous telephone conversations the link was inaugurated in June 1977 and has since undergone exhaustive testing. For the television tests the link

was looped at Stevenage to give the 19 km route of Hitchin-Stevenage-Hitchin through five repeaters spaced at 3.2 km intervals.

The BBC's experimental audio and video transmission equipment had been used previously during field trials of a 120 Mbit/s PCM circuit over a Post Office digital cable system at Portsmouth in 1975 and a 60 Mbit/s circuit through the Indian Ocean satellite via the earth station at Goonhilly in 1976. Research Department made minor modifications to the equipment so that it would operate at the 140 Mbit/s rate of the optical link using 'dummy' extra pulses.

The photograph was taken in the Hitchin telephone exchange and shows the BBC sending and receiving equipment to the left and right respectively of the vertical bay which contains the fibre optics sending and receiving terminals.

# Automatic Operation of the BBC's Transmission Network

D. East, C Eng., MIERE

Head of Transmitter Capital Projects Department

I. J. Shelley, C Eng., MIEE, MIERE

Designs Department

G. C. Wands

Transmitter Group

**Summary:** Considerable progress has been made towards fully automatic operation of the BBC's transmitter networks. Monitoring and Information Centres are an important part of this progress, and the article describes how a small number of staff at these Centres, together with automatic control and monitoring equipment at the individual stations, supervise the operation of a large number of transmitting stations. The early-morning Open University television programmes are radiated without any staff at any point in the broadcasting chain, from VTR source to transmitter.

- 1 Introduction
- 2 Staffing
- 3 The UHF television transmitting network
  - 3.1 Transmitter start-up and closedown
  - 3.2 Monitoring
  - 3.3 Video
- 4 Monitoring and Information Centres (MICs)
  - 4.1 System design
  - 4.2 Outstation equipment — automatic fault reporters
  - 4.3 Signalling system
  - 4.4 Processor store
  - 4.5 Information displays
  - 4.6 Operator controls
  - 4.7 Quality monitoring
  - 4.8 Apology captions
  - 4.9 Operational facilities
- 5 The automatic transmission of early morning programmes
  - 5.1 Method
  - 5.2 Operational experience
- 6 Conclusions
- 7 Reference

## 1 Introduction

From the early days of British broadcasting to the late 1940s manual switching and monitoring of signal distribution and transmission equipment were the only means of ensuring that the necessary standards of quality were maintained. In the early 1950s many broadcasting authorities began to

develop automatic equipment for monitoring and control purposes. The methods adopted were largely dependent upon the broadcaster's degree of control over transmission systems, the constraints of national regulations, and historical factors. The aim of these developments was a reduction in operational staff either by fully automatic operation or by remote control techniques, generally in conjunction with partially automatic operation.

The BBC decided to aim for fully automatic control. There is, however, no universal 'correct' approach because of the constraints previously mentioned.

The policy of aiming for completely automatic working has produced incentives for designing new equipment for distribution and control, and it has given engineering staff the expectation that operational work will be reduced to a minimum and that they will be fully engaged on the type of work for which they are trained.

Since 1967, the considerable expansion arising from the development of a two-service UHF television transmitter network has required further automation, to avoid the need for a corresponding expansion of staff numbers. All new installations are designed for automatic working and older installations have been converted. This has made possible a new approach to maintenance and monitoring methods, based on extension of the role of mobile maintenance teams. A BBC working party, reporting in 1973, recommended the establishment of a limited number of Monitoring and Information Centres (MICs) to rationalise the monitoring of transmitter networks. Situated at a strategic point in the distribution network, each centre would be responsible for the supervision of technical quality and continuity of service from transmitting stations over its own (extensive)



geographical area. Close liaison would be required with other MICs and Network Centres, including programme staff at source. As the last link before the audience, the MIC would play an important role in the initiation of apologies as well as the correction of transmission defects.

Solid state equipment has led to considerably greater reliability but we have not yet reached the stage where we can completely dispense with automatic monitoring and control. Improved reliability has reduced the number of staffed centres needed to monitor the network: in the late 1960s 35 manned centres were necessary to process the amount of fault information from the MF, UHF, and VHF services; in the early 1970s 12 centres were being considered; but in 1976 a review indicated that only four centres would be required.

The four monitoring centres will be supported by eight Monitoring (Data) Collection Points (MCPs). For convenience, both types of centre are located at the principal existing staffed Band I television stations; these serve the major population areas and thus, in combination, allow direct off-air quality assessment of all broadcast services to about 90% of the UK population. The MCPs have reduced MIC facilities and are not staffed full-time, but permit quality monitoring of some stations beyond the reach of the MICs. Information collected at these points is forwarded automatically to the appropriate MIC.

The BBC's Transmitter Group is responsible for many transmitters of widely differing types, both radio and television, the maintenance of which is carried out by teams of engineers based at various locations. Each team functions independently of the others, relying on information from the area monitoring centre. Much depends, therefore, on the provision of comprehensive and unambiguous equipment status information to the MIC operator and an effective system of communication with these maintenance teams. It would be possible to reduce the number of MICs to one, but this would delay information reaching the teams and also reduce the geographical and technical familiarity of the centre's staff with the areas concerned.

## 2 Staffing

The BBC's policy of automatic transmitter operation has been taking effect over the past 10 years, but it will be the early 1980s before its full advantages are realised. During the 1960s there was a gradual reduction in the number of staff employed in supervising the network. In 1967 the engineering staff requirements of the BBC's television, VHF radio, and unattended MF stations, totalled 275 and for every two engineers engaged on maintenance there were three engineers or technical assistants engaged on operational work.

In the 10 years up to 1977 the number of services\* increased by 200% (to 1,130) and the associated maintenance workload doubled, but staff numbers only

\*In this context a service is one or more transmitters used to transmit a programme service from a given station in a given frequency band. Thus BBC 1 on UHF at any station counts as one service even if two transmitters are used in parallel for the vision signal and two for the sound. On the other hand, BBC 1 VHF (405 lines) and BBC 1 UHF (625 lines) count as two services.

increased by 7%. This was achieved by changing the ratio of maintenance to operational staff to 10:3. By 1982 this ratio will have changed to 9:1 and only 32 operational posts will be required.

The gradual introduction of the developments, coupled with good co-operation from the staff and unions, avoided any forced staff redundancies. The introduction of new services and the associated workload kept pace with the transfer of staff from operational to maintenance duties.

## 3 The UHF television transmitting network

The UHF network at present consists of over 600 transmitters at 300 locations. The transmitters have been designed for fully automatic operation, remote control being avoided as far as possible in order to minimise the staff requirement. A typical system is shown in figure 1 and is designed to perform the following functions:—

- (i) Initiate automatic start-up and closedown of transmitters in accordance with transmission requirements.
- (ii) Monitor sound and vision signals and either give warning or take executive action, should a fault develop.
- (iii) Provide information on the state of the equipment to the appropriate monitoring centre.

### 3.1 Transmitter start-up and closedown

Signals are obtained at the main transmitters either by SHF links or by off-air reception; where main and reserve feeds are available either can initiate start-up.

The transmitters are switched on automatically when field and line sync pulse monitors and audio detectors register the presence of incoming signals and they remain switched on until the audio and composite video signals are removed.

The audio detectors have a two-second delay in the start-up action to prevent spurious operation by noise. Silent passages in the programme are allowed for by a 120-second delay in closedown procedure.

Main transmitting stations, using klystron amplifiers, take about five minutes to start radiating after receiving incoming signals. In the UHF network up to four stations may operate in tandem and, consequently, signals must be originated at least 20 minutes before programme start. A further 5 minutes is allowed for stabilisation of performance. Following the removal of the vision signal, there is a delay of 10 minutes before the transmitters close down. This prevents extensive transmitter shutdowns which could otherwise arise from brief network faults. Faults of this nature are normally cleared rapidly, and rarely exceed ten minutes in duration.

In the case of transposers, start-up and shut-down are initiated by a vision/sound intercarrier detector.

### 3.2 Monitoring

Transmitters receiving audio signals by sound-in-syncs distribution are provided with a 'bit-stream' detector and should this register a fault, the transmitter input is switched to the reserve programme feed.

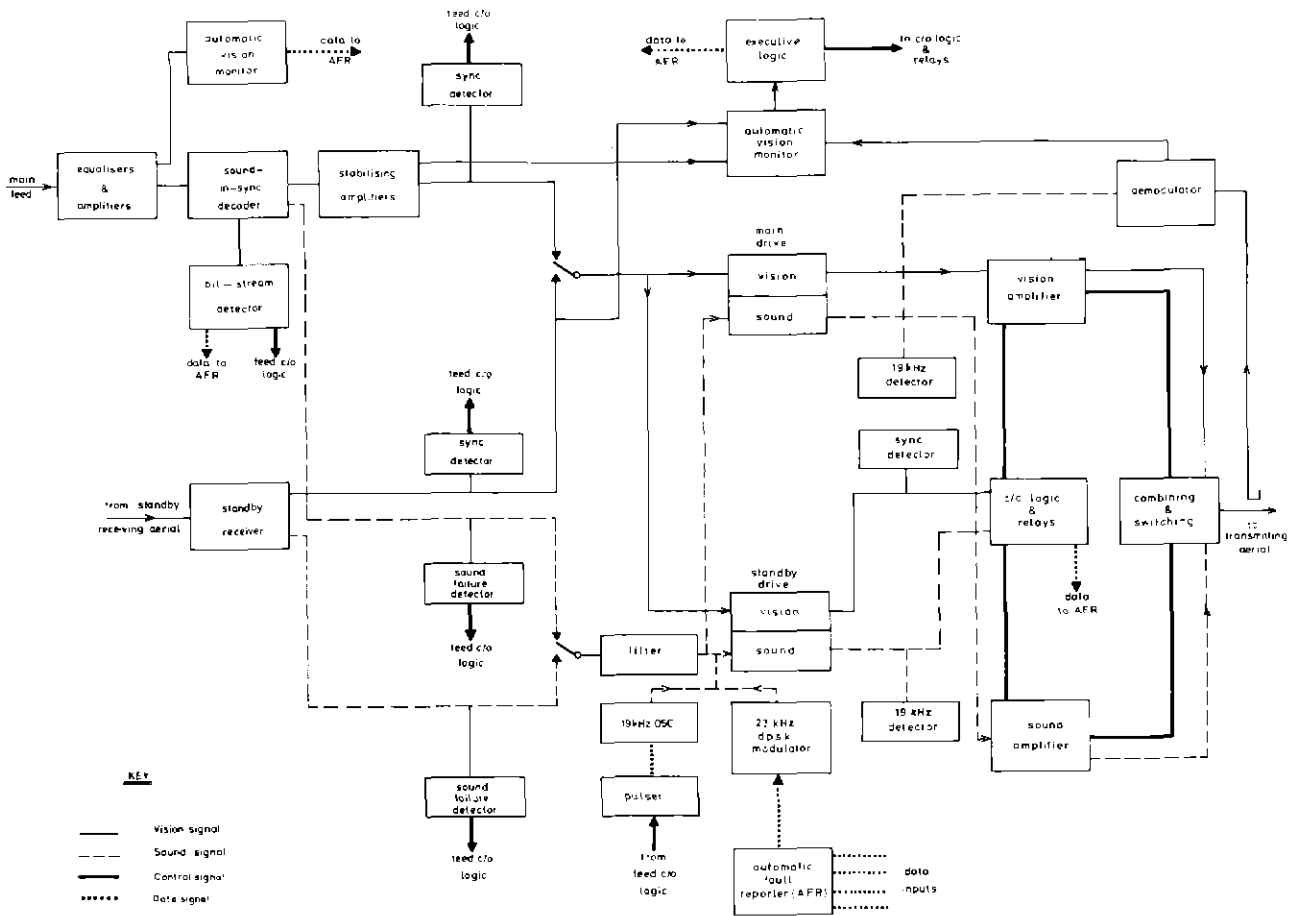

Fig. 1 Arrangement of equipment at a relay station designed for fully automatic operation.

A low-level 19-kHz continuous tone is inserted at the input of the sound transmitter and detected at the output. Standby arrangements are brought into service if this tone fails. At stations receiving signals off-air, the incoming 19-kHz tone is used to control the changeover to the reserve receiver. Incoming tones are removed from the signal before the station's own tones are added.

Some parent transmitting stations use a dependent relay station as an alternative programme source. When the parent station loses its incoming programme, the 19-kHz tone at its output is pulsed, causing a detector at the dependent station to change over to a reserve feed. A few seconds later, the parent station automatically changes over to the dependent station. As soon as programme is available at the parent station from its normal source, it automatically reverts to that source and restores continuous transmission of the 19-kHz tone. The dependent station then returns to its normal source — the parent station.

In addition to the executive 19-kHz tone, a 23-kHz phase-modulated subcarrier is also used for providing monitoring information to a remote centre.

### 3.3 Video

Video signals at main transmitters are monitored by a BBC-designed equipment which measures the eight most

significant parameters of the Insertion Test Signals. Pre-set limits for each parameter give rise to two categories of alarm:—

- a. 'Amber' to give warning of faults. The amber limits depend on the position of the station in the distribution chain and the method by which it is fed.
- b. 'Red' alarms, which initiate executive action on noticeable quality deterioration; these limits are the same at all stations.

The video monitor is normally connected to the transmitter output. When a red alarm occurs it is switched to each of the input feeds in turn and compares them with the output. If the signals at all these points are similar no action is taken and the monitor connection returns to the transmitter output. If a discrepancy is found between the output and the input in use the implication is that the transmitter should be switched to a different condition. The cause of the discrepancy could, however, be a temporary disturbance, and so no change is initiated unless similar results are obtained on a second monitoring cycle. If, however, the input signal also shows the fault, the required change is to switch to the alternative feed, provided that is not also faulty. This change, too, is deferred until the monitor has returned to the transmitter output and confirmed that the fault persists.

When the reserve feed is in use the monitor continues to

cycle until the main feed becomes normal. The transmitter input is then re-connected to the normal feed and the monitor stops cycling and remains connected to the transmitter output.

#### 4 Monitoring and Information Centres (MICs)

The four centres will be situated at transmitting stations and each will receive monitoring information from BBC radio and television transmitters in its area. The centres are normally staffed between the hours of 0800 and midnight and the monitoring function is carried out by one operator. During the unstaffed early morning period the information is stored ready for analysis when the operator arrives. It is then passed to the appropriate maintenance team for action. There may be up to ten such teams in one area.

The first Monitoring and Information Centre was put into operation at Kirk o'Shotts in November 1975. It covers transmitters in Scotland and Northern Ireland and figure 2 shows all automatically monitored sites in its area. The second centre at Wenvoe will enter service in April 1978 and cover Wales and the South West of England — a total of 180 stations. Those automatically monitored are shown in figure 3. (Stations serving very small populations do not justify automatic monitoring; breakdown information is obtained from local dealers or the general public.) The remaining centres at Crystal Palace and Sutton Coldfield are due to be completed by 1980.

A simplified schematic diagram of an MIC is shown in figure 4.

##### 4.1 System design

The overall monitoring system may be divided conveniently into two parts; the first is concerned with the relatively large number of outstations while the second relates to the facilities within the Monitoring and Information Centres. The most important factor underlying the development was that all the various elements should not only provide economically the services and flexibility needed to meet present and future operational requirements, but also be capable of being integrated progressively into an expanding system with the very minimum of disturbance.

##### 4.2 Outstation equipment — automatic fault reporters

Information is originated at outstations by automatic fault-reporting units. These units continuously monitor the condition of critical points in the installation, a simple 'fault/no fault' indication being derived from each point. All changes in conditions at the outstation are detected, and if a fault persists for longer than a pre-set time (46 seconds) for main stations (3 minutes for smaller relay stations) an alarm is given. To prevent spurious alarms outside normal programme hours, e.g. during a transmitter start-up sequence, comprehensive muting facilities have been provided.

Messages from a fault reporter to the MIC consist of a series of numbers and contain codes identifying the originating site, the type of equipment installed and points in the installation which are in the fault condition. When there is an alarm the message is modified by adding an alarm indication followed by a list of the points which have changed state. In these circumstances the complete message contains separate lists of faults and changes, so that the sense of each change may be determined logically from one message. The alarm is cleared when it has been communicated to the MIC, and the condition of the installation at that time is taken as the new reference, in order to detect future changes.

When a maintenance team arrives at an unattended station the fault reporter is switched to local control, the appropriate monitoring centre is informed, and a Personnel Safety system is automatically initiated. Normally two engineers are present when work is being carried out and the system can be inhibited by the simultaneous operation of two switches, so spaced that they cannot be operated simultaneously by one engineer. On those occasions when only one person is on site, timing systems are initiated both at the relay station and at the MIC. After a period of 30 minutes the equipment at the unattended station will automatically call the MIC unless the timer has been manually reset. If the reset signal is not received before the MIC timer has reached 35 minutes (whether because no signal has been sent or because of a communications failure) the MIC equipment automatically signals the situation to the operator by means of a flashing display. The operator then tries to contact the engineer at the outstation. If this attempt fails, a suitable rescue service is notified.

##### 4.3 Signalling system

Messages from outstations to the monitoring centre use one of two types of signalling system. At the larger television and VHF radio stations, information is conveyed continuously by phase-shift keying of a low-level subcarrier, which is radiated by the FM sound transmitters. The data signal occupies a very narrow band of frequencies above the useful audio range and the mode of transmission, coupled with error protection in the transmitted message, provides a very rugged system.

For the smaller or more distant stations frequency-shift keying of an audio tone is used, either on a private audio circuit or over the Post Office switched telephone network. In the latter case, when an alarm occurs, the monitoring centre is dialled automatically and as soon as the correct connection has been established the information is transmitted. These stations may also be interrogated by telephone to check the state of the remote equipment.

##### 4.4 Processor store

All messages from outstations are held in a static semiconductor store (see figure 4). The store is organised in blocks prefixed by the code of the originating site and block sizes are expanded automatically to suit the length of message. Each block is in two sections, one containing a list of the fault codes in force and the other a list of the last set





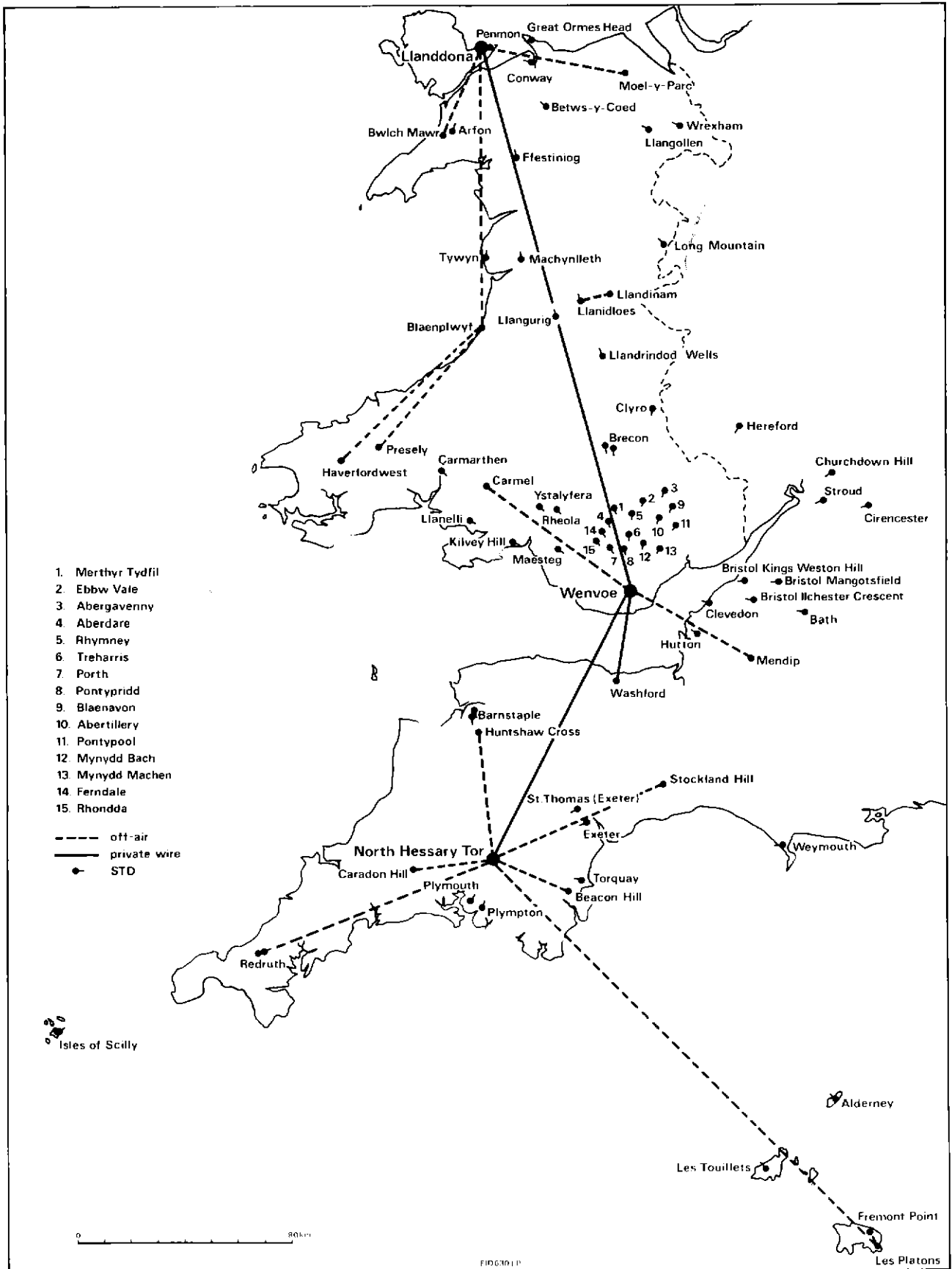

**Fig. 3** Map showing all stations which will be automatically monitored from Wenvoe when installations currently planned have been completed. (Some of the stations shown are not yet in operation and the automatic monitoring equipment has not yet been installed at some of the others.)

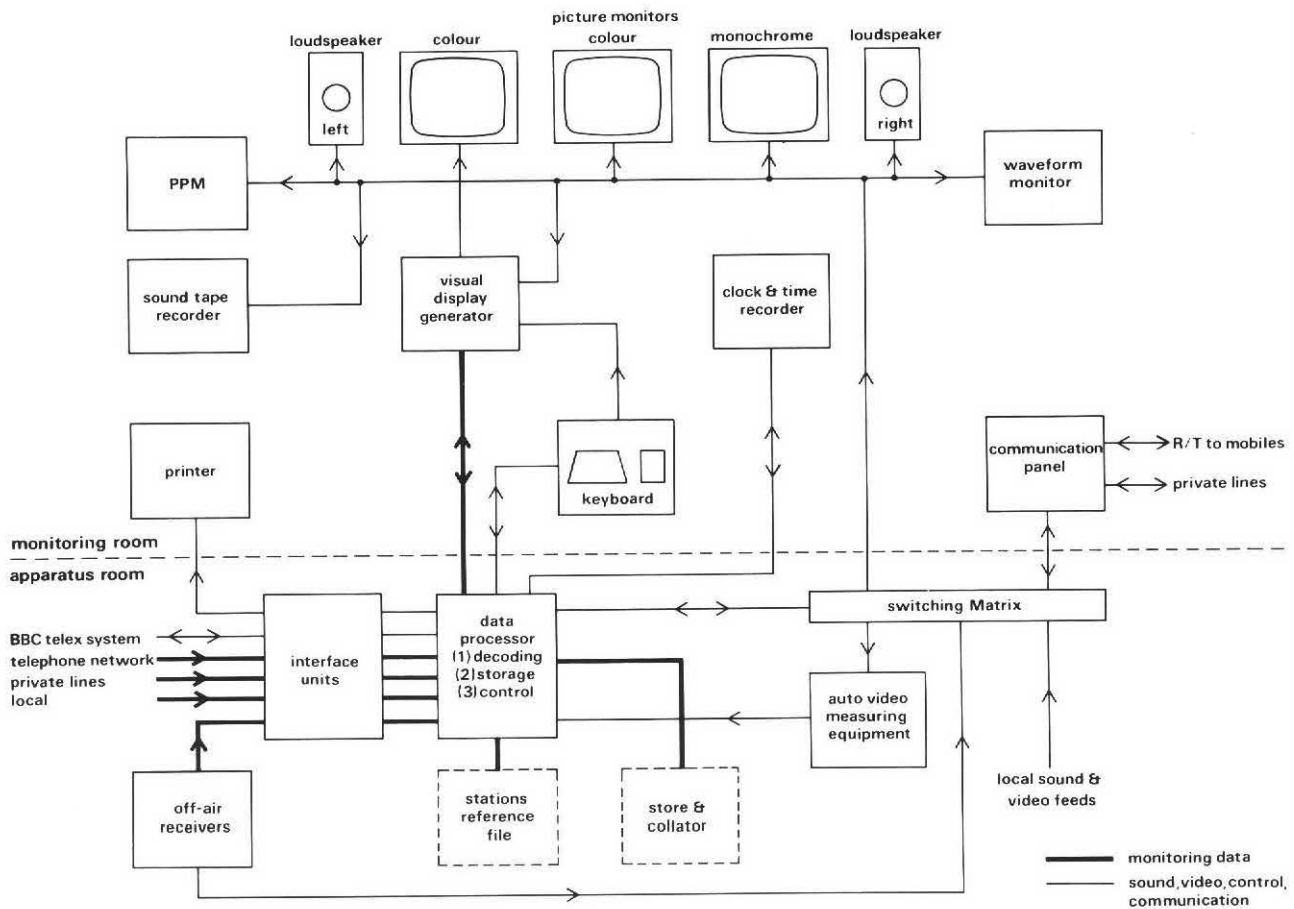

EID 638LP

**Fig. 4** Arrangement of equipment at a Monitoring and Information Centre. The items enclosed by broken lines are currently under development and are expected to be put into service later this year.

of changes to occur. Each list is prefixed by the time and date of entry.

The incoming data streams enter the store via interface units. Subcarrier transmissions are received by crystal-controlled receivers and p.s.k. demodulators; the f.s.k. transmissions use conventional frequency discriminators. All the demodulated data streams have a common data speed and message format. For data streams containing messages from one station only, the interface unit stores the message directly in a pre-set location, with the time and date obtained from the master clock. Where data streams contain messages from several stations, an interface unit searches the store for the blocks that contain previous messages from those stations. If the store search is unsuccessful, unused blocks are automatically assigned.

#### 4.5 Information displays

Information presented to the operator is as explicit and unambiguous as possible. All messages are transmitted and stored as binary numbers but before information is presented to the operator each number is translated into a fourteen-character caption identifying the fault in plain language and selected from a standard directory of fault codes containing over one thousand separately identifiable captions. These captions are held in semiconductor read-

only memories.

The main source of communication with the operator is by an interactive Visual Display, utilising one of the standard 625-line picture monitors normally used for quality assessment. Information is superimposed on the picture as required, as shown in figure 5. The display, which may show a page of up to 24 lines of 40 characters each, is split into

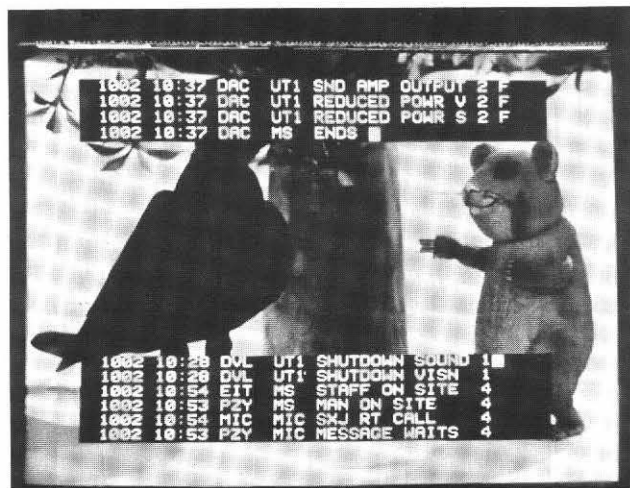

**Fig. 5** Monitoring messages superimposed on the pictures.

two halves, the 'main' and the 'lower'. The main display consists of a group of lines from a store with a capacity of 112 lines, the portion shown being 'rolled' up and down manually. This part of the display appears at the top of the screen and gives, on request, either lists of the current faults or the last alarm message from any station. Each fault condition is given a level of priority to indicate its relative importance, these being established using the following guide lines:—

- Priority 1 : Shutdown or safety of personnel
- Priority 2 : Transmission likely to be degraded
- Priority 3 : No effect on transmission
- Priority 4 : Information only, including faults cleared.

Every alarm from an outstation produces a caption on the lower display, indicating the site concerned and the most urgent priority in the message. When the operator has taken action by requesting full details via the main display, the indication on the lower display disappears. The lower display is limited to 16 lines written from the bottom of the screen upwards. There is no direct manual control over this part of the display and it is used for messages and reminders from the processor to the operator, e.g. it lists all current Priority 1 faults.

#### 4.6 Operator controls

The operator communicates with the processor by means of an extended typewriter keyboard in conjunction with the Visual Display. Furthermore, to remove the necessity for banks of switches for all the other MIC facilities such as the selection of video and sound sources to the picture monitors and loudspeakers, this switching is also controlled from the keyboard. Plain language commands entered via the keyboard appear on the display so that the format may be checked. Pressing an 'Instruction' key sends the command to the processor. The commands consist of one or two words; the first (or only) word identifies the type of instruction and the second the signal source or outstation involved. Only four characters in each word are needed. For example, SEEA 1NET connects picture monitor A to BBC 1 network.

This system controls the selection of sources to all three picture monitors and the loudspeakers, as well as tuning UHF television and VHF sound monitoring receivers. Further commands display the current faults or last alarm message from any site, a CEEFAX page, or the measurement of insertion test signal parameters, as shown in figure 6. The flexibility introduced by using a keyboard in this way makes the addition of extra sources and operations a simple matter. The operator may also add notes to the printer output via the keyboard. The entries are composed first on the Visual Display and then transferred to the printer by pressing a 'Print' key.

The operator also has access to two additional 24-line page stores which can be used for the composition of messages prior to printing or to automatic transmission to any station on the BBC teleprinter network. Any text from the main display store or the two auxiliary stores may be printed or transmitted in this way. The auxiliary stores can

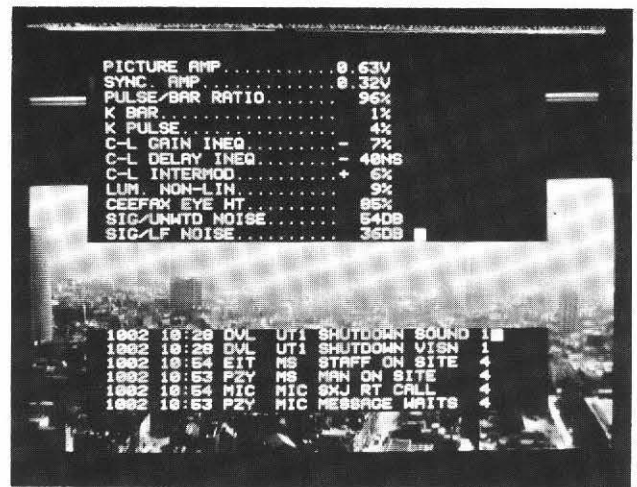

Fig. 6 A display of insertion test signal measurements.

also be used as memory aids or as notes from one shift to another.

#### 4.7 Quality monitoring

Distant stations are received off-air and their performance assessed by means of high-quality professional receivers, colour picture monitors, and loudspeakers. Facilities are included to monitor VHF/FM and MF radio broadcasts and a stereo tape recorder enables sample sound recordings to be made for fault investigation and centralised quality control purposes. All these operations are controlled from the keyboard, so that there is no need for a complex switching panel.

The television receiver used for quality monitoring is a BBC-designed high-quality unit equipped with multiple front ends. Each front end consists of a mixer and a crystal local oscillator and is fed from an aerial aligned in the direction of the desired outstation. IF outputs from the front ends are switched by coaxial relays which in turn are controlled from the keyboard. The VHF/FM receiver is a commercial synthesiser-controlled tuner and source selection is achieved by adjusting the synthesiser and selecting the appropriate aerial.

MF transmissions are monitored by BBC-designed fixed-tuned receivers,<sup>1</sup> one for each service. A highly directional ferrite aerial provides the RF pick-up and can be adjusted to minimise interference.

#### 4.8 Apology captions

Response to fault conditions must be prompt and must avoid unnecessary disturbance to listeners and viewers not affected. The MIC is in the best position to assess situations as they develop and provide rapid response. For television, remotely controlled caption generators are being installed at strategic points, each capable of selecting one of a limited number of pre-programmed captions and superimposing it on the picture. These will be controlled by the MIC operator under clearly defined conditions and integrated with the service provided by studio presentation.

#### 4.9 Operational facilities

The general design of the monitoring centre is based on the use of a relatively small room with floor dimensions of about 4m x 5m and furnished functionally. Windows and air conditioning are provided for the purpose of minimising operator fatigue. Acoustic treatment and subdued lighting enable sound and vision transmission quality to be assessed critically.

A simple purpose-made desk contains the keyboard used with the data processing apparatus, and auxiliary facilities in the area include:—

- (i) Picture monitors and loudspeakers.
- (ii) Telephone lines to studio centres and other transmitting stations.
- (iii) Oscilloscope and stereo peak-programme meter.
- (iv) Digital master clock with lapsed time facilities.
- (v) Miscellaneous controls associated with picture monitors, loudspeakers, room lighting, etc.
- (vi) RT communication with mobile maintenance teams. This ensures that the team can be notified of any fault condition with the minimum of delay.

The remainder of the apparatus is bay-mounted in a remote area to isolate the monitoring centre from equipment noise, heat, and the distraction of maintenance activity.

#### 5 The automatic transmission of early morning programmes

In 1970 the Open University was founded and the BBC agreed to transmit early morning programmes.

About 300 television programmes per year are made and each programme could not be transmitted at peak times but had to be shown at times when most of the University's students would be expected to be at home. Initially, television transmissions took place on BBC 2 in the early evening and on Saturday and Sunday mornings. By the start of 1974 additional times were required and the extra transmissions were arranged for 0640-0755 on Monday to Friday and 0740-0855 on Saturday and Sunday on BBC 2 and these programmes are now originated automatically. In January 1976 further air time was required and this was provided by opening BBC 1 for early morning transmissions between 0705 and 0755 on Monday to Friday. At the same time improved arrangements were introduced for the unattended transmissions.

##### 5.1 Method

When there are no Open University programmes (e.g. out of term) the audio and video signals which start the BBC 1 and BBC 2 transmitter network are routed to line by engineers working in the Central Apparatus Room of the Television Centre in London. When early-morning Open University programmes start the day the operation is initiated automatically by a time switch which also controls further events including the powering, starting, and switching to line of 2" video tape recorders.

Daily compilation tapes are made for both networks

containing the whole of the required material to be transmitted, including opening routines, programmes, and junctions. These tapes are placed on the appropriate machines in the Videotape Area at the conclusion of the previous day's activities. The two networks are then ready for the following early-morning transmissions.

#### 5.2 Operational experience

When the unattended operation of programme origination was first introduced in 1974, trouble was expected with the VTR origination. Accordingly, main and back-up compilation tapes were made, and two videotape machines provided with automatic changeover facilities in the event of failure (total or partial) of the main machine. In the event, these precautions were found to be unnecessary and after about four months of operation the 'back-up' precautions were abandoned.

When the programmes were extended to BBC 1 the opportunity was taken to simplify the operational procedures and the system described above was devised. The system has provided efficient and reliable unattended transmission of Open University programmes.

#### 6 Conclusions

The prototype MIC at Kirk o'Shotts has been in service since November 1975. Staff readily accepted the new facilities and, in general terms, operation has proved most satisfactory. Experience has, naturally, suggested minor improvements to desk layout and details of technical design. In addition, the automatic log has introduced a useful discipline by ensuring that attention is paid to minor long-term faults, which otherwise tend to be reduced in priority.

Two principal areas requiring action were also highlighted:—

- (i) Spurious fault information tended to appear during normal closedown. Further development of the muting provisions in outstation automatic fault reporters was therefore required.
- (ii) The long-term record of faults is printed in strict chronological order and does not lend itself to tracing the course of the situation at any individual station. To overcome this problem a collator is being developed which, in conjunction with a store which will retain all the alarm messages received in the day, will permit the presentation of information concerning any selected station. A floppy-disc store is also to be provided, holding a series of 'reference sheets' for each outstation.

The MIC has already improved monitoring and maintenance standards and plays an essential part in reducing to a minimum the number of operational staff. When all four are complete the ratio of operational to maintenance staff should be at about the lowest practical figure.

#### 7 Reference

1. Tingey, P.A. A crystal-controlled monitoring receiver for medium and low frequencies. BBC Engineering No. 103, June 1976.



# EMIAS

G. E. Buck, ACMA

Controller, Finance (formerly Chief Accountant, Engineering)

**Summary:** This article describes the computer system which has been developed to provide the BBC's Engineering Management Information and Accounting System. To provide efficiently and economically the services required, using a vast amount of data relating to the handling of capital projects and the operation of transmitter and programme networks, a database system was developed and this is now being transferred to a new ICL 2960 computer. EMIAS was the first database system in the BBC and was developed by its own small team of systems analysts and programmers.

- 1 Introduction
- 2 History and problem
- 3 Concept and planning
- 4 Design
- 5 Progress
- 6 Future
- 7 Conclusion

## 1 Introduction

The name EMIAS may well conjure up visions of a character from the Old Testament but such an impression would be very wide of the mark; EMIAS is undoubtedly a child of the twentieth century. The word itself is an acronym for the BBC's Engineering Management Information and Accounting System. EMIAS is an advanced computer application — the BBC's first operational database system — and was developed by its own staff of systems analysts and programmers. These facts are worthy of mention as it is one thing to successfully develop a database system which operates on an ICL 1904S installation, and quite another to do so with such a compact team — three systems analysts and seven to eight programmers — with most of the work being completed in 3½ years. Moreover, to do so when there was little suitable software available to the EMIAS team from computer manufacturers meant also that success was achieved at modest cost in a field which has had its share of high-cost project failures.

## 2 History and problem

The EMIAS story began in 1969 when the McKinsey management consultant team was examining, as part of its overall BBC study, how to make the best use of engineering resources. A lack of co-ordinated management information was identified as one obstacle. Whilst a lot of information was available, very little of it stemmed from a reliable or synchronised financial base. Where information was available it was often fragmented and repeated in different areas and far too much time was spent discussing which piece of information was right and which was wrong. What was needed was to provide management at all levels with reliable financial information so that cost control could be

effectively applied across the whole field of engineering activity and to enhance the *atmosphere* of cost consciousness.

The field of activity referred to is a very wide one. It ranges from the need of an individual engineer to control his budget for a particular package of work within a specific project to the budget and costing for operating a transmitting station or programme distribution network. It has to cover all the engineering departments, Transmitter, Communications, Research, Designs, Capital Projects, Training, Manufacturing etc. and has to be capable of costing and charging for the services provided. The normal financial accounts for all these activities also have to be produced.

The rather limited information systems that existed in 1969 were beginning to prove inadequate as the number of capital projects grew and the building of UHF transmitting stations gained momentum. Also it was becoming increasingly difficult to recruit clerical staff of the required quality and to find staff who were willing to undertake the detailed analysis which was necessary to enable the existing systems to cope with the expansion that was taking place.

In true McKinsey style the alternative solutions to the problem were identified and examined and the examination revealed clearly that only a limited choice was available. The only solution which held out any real hope of casting off the shackles of fragmentation, staff shortages, lack of accommodation, excessive costs and lengthy manual processes required a start on the long journey to a computerised system.

The concept which eventually emerged was simple but adventurous. It was based on the following principles and general philosophy.

- a) The data would be captured within the system as soon as possible after origination.
- b) The data would be stored in such a way that easy access was provided to all who required information.
- c) The responsibility for ensuring prompt and accurate entry of the data would be placed on the people most closely interested or the people who would experience the most serious problems if the data were missing or faulty.
- d) The data would be input in as random a manner as possible but comprehensive validation checks would obviate the 'garbage in — garbage out' situation.

- e) The number of links between the provider or user of the data and the computer would be minimised. The staff should be encouraged to think of the computer as their machine and not as a mysterious process in which they had no involvement.
- f) The boring clerical tasks would be removed from the staff and transferred to the computer.

### 3 Concept and planning

Many computer systems have had as their objectives and philosophy the six principles detailed above but often only partial success has been achieved. This was because information was stored in such a way that a lengthy process of program writing and development was necessary to restructure files and access them to meet any new, enhanced or changed requirements. The EMIAS team came to the conclusion that if their system was to be a success a better way than the traditional one had to be found for storing the data. Computer data storage traditionally takes a form analogous to an office filing system, i.e. in exclusive files within a series of filing 'cabinets' albeit with the information held on magnetic tapes or discs.

In some cases once the information is filed it may be forgotten for ever simply because the manager's or secretary's memory or the index description cannot link the data with a need for information which arises some time after it has been stored. On the other hand most offices have a pile of papers awaiting transfer into the traditional structured filing system. This pile of papers is relatively easy to access because of its simple location and because, if it is not too large and is frequently handled, its contents are well known. The EMIAS team decided that there were significant advantages in the single location for the storage of data if it were coupled with the power and versatility of a computer. Only in this way could a satisfactory service be provided for the customer. So it was decided that the data would be stored in a refined 'heap' system or, to use the correct jargon, a database system. A conventional system would have needed much larger computer resources to be able to deal with at least fifty types of record in random input sequence, accessing twelve different conventional files.

The decision to develop a database was not taken lightly. Many computer experts were sceptical of the chance of success and pointed to the lack of manufacturers' software and the number of costly alternative attempts made by other organisations to develop this type of system. The warnings had a constructive and two-fold effect. It resulted in a decision to seek for the team a consultant who had a record of experience and success in the database field and with whom the team would be able to discuss both general concepts and the technical aspects of the development. It also emphasised the need for thorough and detailed planning from the start.

It became clear that, during the EMIAS development period, some existing information systems using old computing facilities would have to be replaced before EMIAS was operational. Consequently, once the overall concept and design had been established, EMIAS would have to be planned in modules. A module's priority would be determined not by the ease or logical sequence of the

development of the system but by the need to meet existing information requirements. This decision was coupled with the desire to so phase the work and arrange resources that the next target date was never more than twelve to fifteen months ahead. Ideally, each time a target was reached the users should be provided with a new or improved service or facility and the progress being made would be demonstrated.

### 4 Design

Because of the computer resources which were available, the design had to be capable of working in a batch mode initially and of being converted to on-line working when the next generation of computers arrived to replace the 1900 series. As explained earlier, it had to be capable of dealing with at least fifty different types of record in random order. A facility to hold explicit cross-references between certain records was seen to be advantageous in that it simplified both input validation and the production of complex output reports. Flexibility was considered to be of paramount importance. The system had to be capable of expansion by the introduction of new types of record and cross-referencing relationships with the absolute minimum of amendment to the original programs. The type of record, its format or length, should not be a source of constraint in the future.

The database system is designed around only three physical files (see figure 1). Into one of these, named the WELL, is poured the data which would have required twelve separate master files in a conventional system. The data are kept in chronological order and it is as if all the filing in an office had been put into one large file.

The second of the three files is the INDEX file. This holds pointers to the physical address of each data record in the WELL and the INDEX file is arranged to reflect a logical view of the database — in pseudo-master-file format. Thus to read the data the appropriate INDEX file record is located, the required pointer is picked up and is used to retrieve the corresponding data record from the WELL.

The third file is the LINKS file which describes the relationships or cross-references between a part or the whole of any data record. It is the LINKS file which depicts the real-life associations implicit in the stored data and acts as an important and variable window into the data. For example, one link record read from the LINKS file would give all the job numbers associated with the approval of a particular project. In a conventional system it would be necessary to scan the appropriate master file or files to get this information.

Within the data held in the WELL there are tables which define the files, records and links catered for in EMIAS. The system also has the facility to re-create automatically the files, using a new set of tables and generating a completely new set of cross-references so that the system can respond much more rapidly to changes in user requirements.

To handle the three system files — WELL, INDEX and LINKS — the team designed a special package of software named DATABASE HOUSEKEEPING (DBH in figure 1). This housekeeping package consists of a number of modules each of which has a specific function. Examples are the PUT

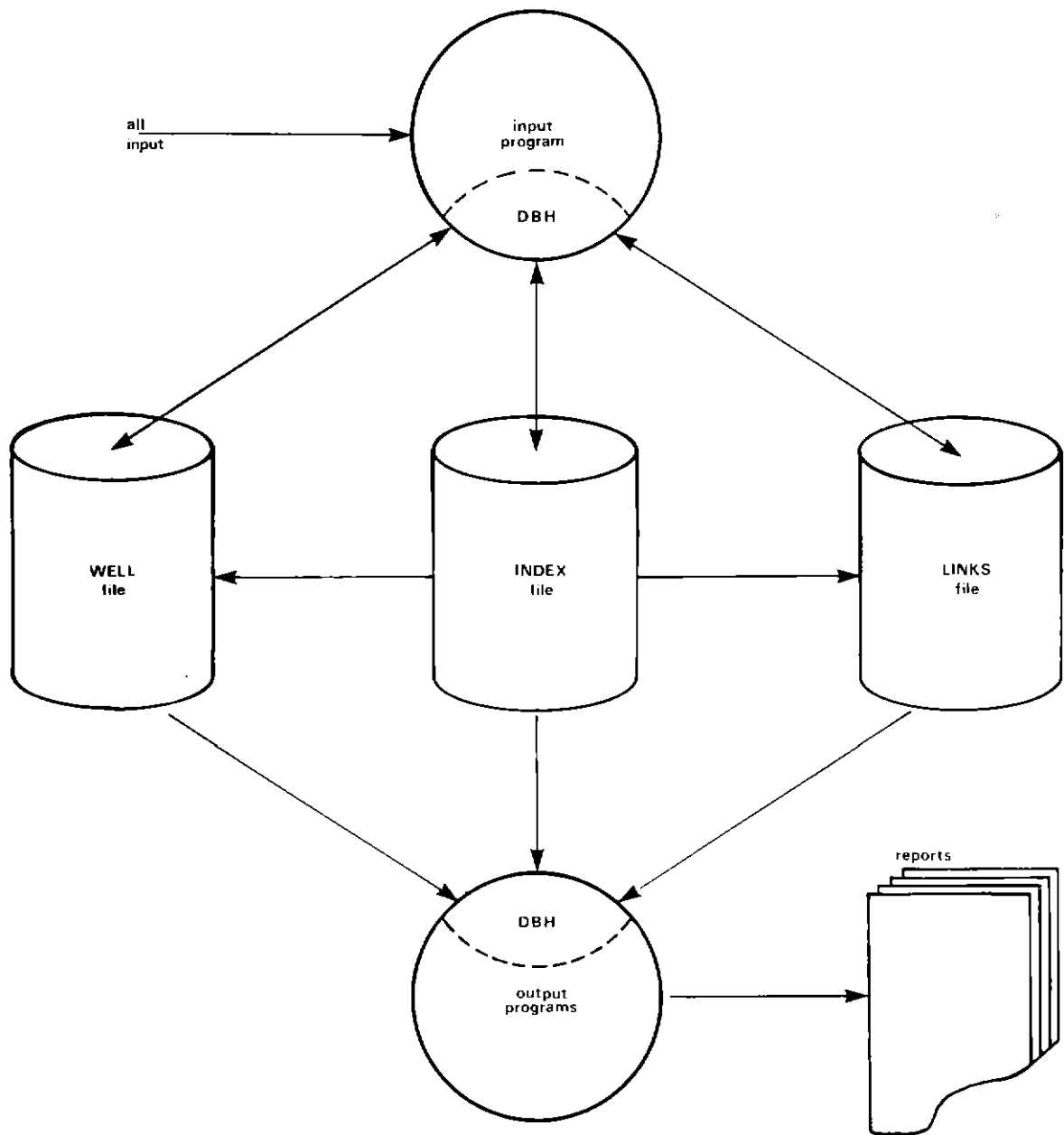

Fig. 1 Arrangement of EMIAS database system.

module which stores a record in the WELL and creates cross-references in conjunction with the tables; the GET module which will retrieve a specific record or stream of records from the WELL; the DELETE module; and others. Particular attention has been paid to the retrieval modules and they are available in different modes so that records can be found singly or in streams of data. This contrasts again with a conventional computer system where the file-reading logic normally requires an explicit instruction to read a particular file. It tests both the type of record and the key value required by making many reads and tests until the required record is found. The DBH package enables individual records to be retrieved directly. Another advantage is that neither the systems analyst nor the programmer needs to understand the underlying file structure before

implementing an applications program.

Special programs within the housekeeping package open and close the database and provide statistics about its state, e.g. how full the WELL is. After an EMIAS run a log is available which details both the procedures which have been carried out and the number of records handled within the database.

The other main program is the input program which is structured to allow different users to update the database independently of one another within the integrated system. This means that the system is ideal for future on-line working from remote terminals. The input program validates each item of data against all the relevant logical files and stores it once only in the database. This ensures the integrity of the data and contrasts with a conventional

system where each separate file is updated by several passes of the input data with the associated difficulties of making sure that the same data have actually updated each separate file, and the necessity to run the separate files many times in order to produce a composite file from which to print. The database also provides a security advantage which stems from the fact that data storage is in more or less random order in the WELL. Because of this the data would be very difficult to interpret by anyone who obtained unauthorised access.

The structure of the INDEX and LINKS files enables reports to be produced without an intermediate sorting of the data. As EMIAS has a logical print-formatting file, users can change the sequence and totalling levels of the output reports without modifying the actual print programs. The appropriate *print-formatting records* are simply updated through the standard input program if the user needs to modify his original requirements.

## 5 Progress

Specification of the database housekeeping package began early in 1974. It was fully programmed and tested a year later, at which time it had absorbed two man-years of effort. It was effectively tested for a further year as the user applications were developed for the EMIAS modules dealing with manpower-costing of the Capital Projects Departments' staff effort and authorisation of funds and associated expenditure records. This part of the project was completed by March 1976, having required eighteen man-years of effort. *The massive task of creating the database from existing records then began.*

In effect all financial data relating to 700 Engineering Cost Centres had to be fed into the WELL. All the information relating to more than 3,500 capital projects had to be stored also. This mass of data came from existing manual, machine, and computing sources. It represented a substantial portion of the BBC's accounting records and so precise reconciliations between the old and the new information banks were essential. It was a very testing time for clerical and computer staff alike. The system was being subjected to extremely large volumes of data for the first time and there were, not unexpectedly, the usual minor teething troubles and one or two problems of substance. Also numerous checks had to be made to establish *confidence in the incorruptible nature of the data and the database* because for the first time use was being made of information input by someone else, possibly in a different format and for another purpose.

*The magnitude of the task can be judged from the fact that, at the end of the file take-on exercise, the WELL contained 36 million items of information and was 75 per cent full.*

The early planning sessions had identified the need to change progressively, expand, and improve the existing manual and machine records before EMIAS became operational. This was so that the database system would have available to it from the start a reliable and comprehensive package of information, even though in the intervening years it was not possible to exploit and use this information with the existing systems. These changes were

introduced progressively from 1971 and without them it is extremely unlikely that the successful transfer of data to the WELL could have been accomplished.

When the results were reviewed, it was clear that the problems associated with *setting up and reconciling the database* had been underestimated. One reason was that, before being accepted into the database, information had to reach higher standards of quality than was the case with existing systems. Estimated timings on some output programs proved to be optimistic and some programs had to be modified to improve their efficiency. This emphasised the need for the EMIAS systems analysts to be of a high standard with a technical bias. In general, timings of computer runs were underestimated by about 10 per cent. Bearing in mind that the system was sharing a 1904S installation with other users in a batch-processing mode, this was considered an encouraging commentary on the efficiency of its 'home-developed' database software.

## 6 Future

The team is now working on the task of converting the system from the 1904S installation to the new 2960 ICL computer. In parallel the systems analysts are looking at the first of the two remaining EMIAS modules. Embodied within this will be commitments with suppliers both inside and outside the BBC and the subsequent payment and accounting for the resultant goods or services. It will be the first EMIAS on-line operation. On completion of it, the staff should operate directly into the database using visual display units and possibly a small dedicated buffer computer. It should also mean that the number of distinct clerical steps necessary for batch-processing on a large central computer, i.e. assembling information for data preparation, batch-control procedures, transport to and from the computer centre etc., as well as the associated delays, should be avoided.

Conversion to the new computer is planned to be completed by the end of 1978 and the new commitments/payments module will be ready by the end of 1979.

The final module is to deal with the BBC's five-year budget. On its completion EMIAS will be capable of providing, from a reliable and accredited source, a powerful information and accounting service which will cover activities from the budgeting plan to the execution of a project or the running of a department or a facility.

## 7 Conclusion

*There seems little doubt that database has come to stay.* Many systems are currently being developed and manufacturers' software is becoming available in the United Kingdom. The decision to develop EMIAS as a database system is now seen to have been far-sighted and correct. An experienced and successful team exists within the BBC and this bodes well for the future of EMIAS and other database BBC developments generally. Users can look forward to the time when the database system is available to them in the same way as a desk calculator or superior office filing system — the latter manned by a secretary with a perfect memory.



# Demonstration Equipment for Television Engineering Training

M. B. Tancock

Engineering Training Department

---

**Summary:** A classroom at the BBC Engineering Training Centre at Wood Norton has been equipped with comprehensive demonstration facilities to help student engineers and technicians to understand the television system as a whole. The design of the installation was based on an appraisal of the problems of engineering training and on experience of using less versatile arrangements. The improved set-up has found favour with lecturers and students alike.

- 1 Introduction
- 2 The problem of television training
- 3 Possible solutions
- 4 The television demonstration classroom
  - 4.1 Basic facilities
  - 4.2 Refinements
    - 4.2.1 Pointer
    - 4.2.2 Oscilloscope triggering
    - 4.2.3 Additional facilities
  - 4.3 More elaborate demonstrations
- 5 Future developments
- 6 Conclusions

## 1 Introduction

The training of engineers and technician engineers for work in the field of television broadcast engineering falls into two major categories.

First and foremost it is essential that the student should acquire a good understanding of the overall television system, from the origination of the picture in a studio to the final display on the viewer's receiver. He must be able to recognise the limitations of the system, particularly where colour transmissions are involved. In addition a study of possible defects is necessary, in order that they may be recognised on future occasions and the appropriate remedial action taken.

The second category of training is concerned with the equipment itself. Here a study in greater depth of individual parts of the system, such as cameras, videotape recorders, etc., is required. The engineer will be called upon to align and maintain such items, and consequently requires a specialised knowledge of the equipment he will be concerned with.

The aim of this article is to examine the problems involved in engineering training, with particular emphasis on the first

category above, and to outline the techniques and equipment that have been devised and constructed to facilitate better training methods at the BBC Engineering Training Centre.

## 2 The problem of television training

The major problem in dealing with the overall television system is that of trying to bring together enough of the system at any one time, while attempting to marry it with the classroom environment. The student needs to see demonstrations of the operation of many parts of the system. He often needs to study television pictures displayed on suitable monitors, and more often to study waveform traces of appropriate signals.

## 3 Possible solutions

A possible solution to these problems would be to record suitable demonstrations on videotape for replay to students in the classroom. The advantage of this technique is that it is possible to achieve a very high standard of demonstration, as the demonstrator is able to view 'rehearsals' and make any necessary improvements to the final recording.

The major disadvantage is its lack of flexibility. Once recorded the demonstration is fixed; it is impossible to make even minor changes to suit individual lecture or course needs without a complete re-recording. (Editing is theoretically possible but it demands sophisticated and very expensive equipment.) Furthermore the taped demonstration cannot respond to questioning; thus the skilled lecturer must be retained or an invaluable part of the training sacrificed.

A second approach might be to ask whether a classroom is necessary at all, on the grounds that television engineering is essentially a practical problem. Training could therefore be undertaken in the operational field. Effective and efficient operation of the system, however, can usually only be obtained if the engineer has a firm understanding of the theory behind the practice.

To take students to a television studio, for instance, is

neither economic nor effective. A studio is essentially an operational area geared not to training but to the production of programmes. As such it will often be impossible to examine the parts of the system required, and the student will not easily be able to see how one part of the system is related to the others. For groups of more than two or three the classroom is the only practical place for much of the training.

The solution adopted was to design and equip a classroom specifically for television engineering training. The classroom is capable of demonstrating, or accommodating demonstrations for, many aspects of the television system. Demonstrations range from such basic concepts as mixing light of three suitable primary colours to complex demonstrations of the coding and decoding processes.

#### 4 The television demonstration classroom

##### 4.1 Basic facilities

A view of the television demonstration classroom, seen from a typical student position, is shown in figure 1. The equipment includes the normal 16 mm, 35 mm, and overhead projection facilities but the most notable feature of the room is the two pairs of monitors, one colour and one black and white in each pair, positioned on either side. On these monitors can be displayed many different signals, both pictures and wave-forms, controlled as required by the lecturer at the front of the class.

Much of the engineer's work involves the use of test signals. He needs to recognise such signals when viewed on monitors and oscilloscopes, and to interpret correctly the resulting displays. At the same time he needs to observe the effect on such signals of defects arising in the transmission system, and the resulting effect on the final display.

Bearing these points in mind design criteria were laid down for the demonstration equipment. A block diagram of the basic facilities is reproduced in figure 2.

The essentials of the installation are a test-signal selection system, a 'special demonstration unit', and a display selection system.

Although for simplicity the selection systems are shown in figure 2 as rotary switches, the test signals are switched by relays controlled by push-buttons on the lecturer's console. Up to ten different signals can be selected, eight of which are standard signals which are permanently available: the other two buttons select whatever additional signals may be temporarily connected for particular purposes.

The 'special demonstration unit' processes the signal in some way, introducing either a modification which is a normal part of the programme chain, e.g. gamma correction, or a type of distortion, e.g. poor frequency response.

A vidicon camera is focused on an oscilloscope displaying the waveform of the test signal (before or after passing through the demonstration unit). The display selection system permits the display monitors to be fed with either the test signal or the output of the vidicon camera — i.e. a picture of the test-signal waveform.

Smooth presentation without distraction of the students requires that the displays may be prepared in advance. To



Fig. 1 The television demonstration classroom.

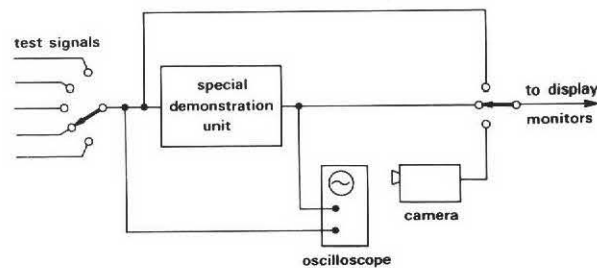

Fig. 2 Basic facilities.

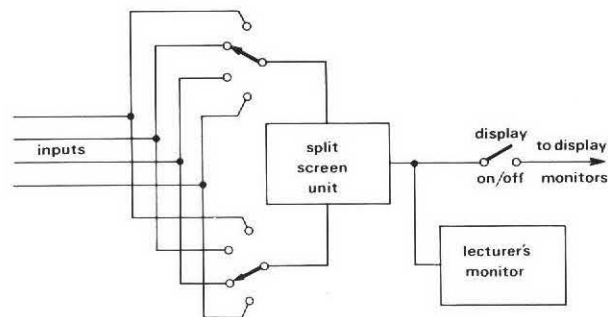
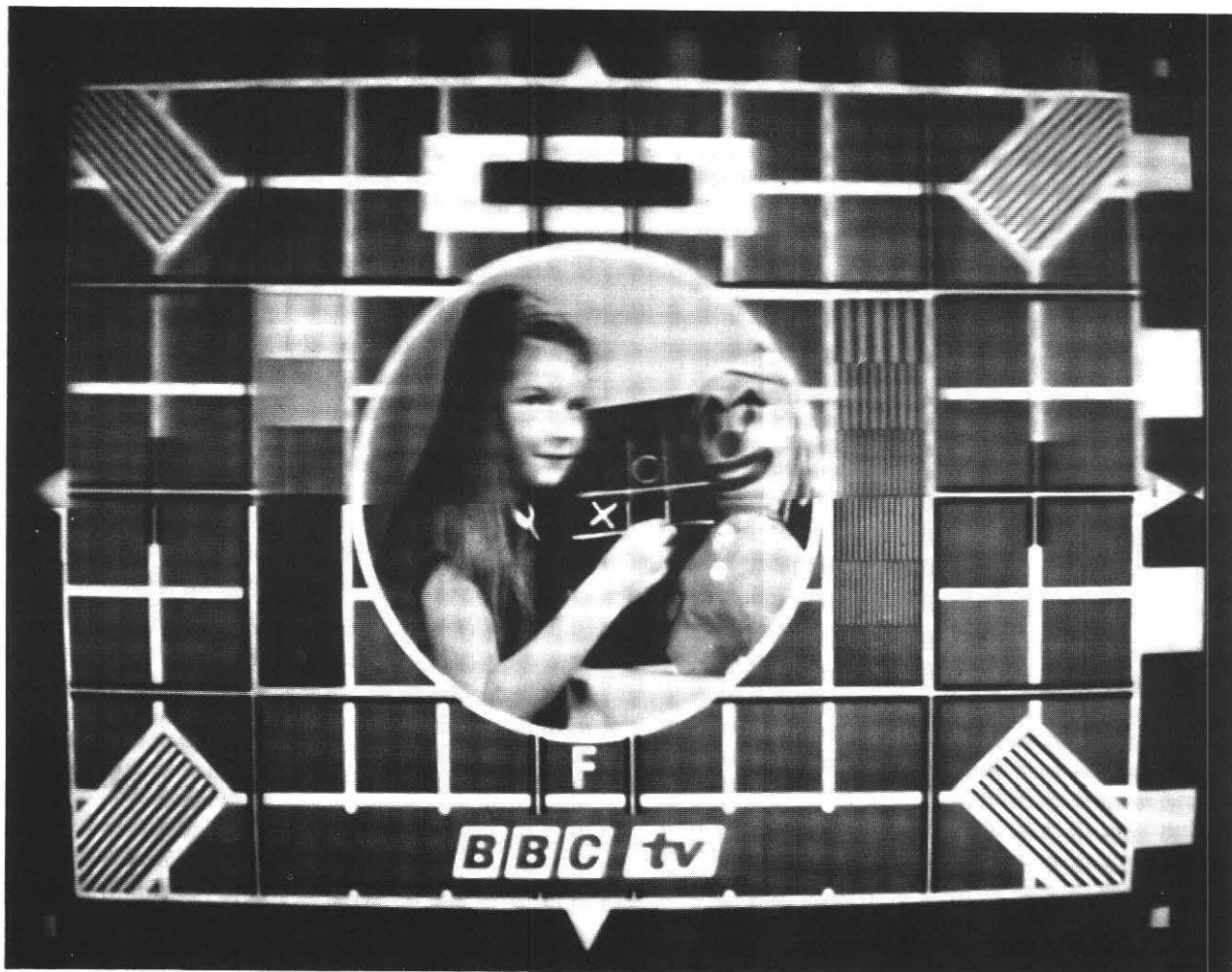

Fig. 3 Split-screen unit.

this end a switch is provided to interrupt the feed to the students' display monitors without affecting that to a small black-and-white monitor built into the control desk.

When examining the effect of any particular adjustment or distortion it is useful to be able to view simultaneously both 'before' and 'after' versions of the signal. To permit this the circuit shown in figure 2 is extended to include a split-screen unit. By this means two independent signals can be displayed side by side (or one above the other) on the monitors as illustrated in figure 3.



**Fig. 4a** Applications of the split-screen switch: comparison of test card subject to streaking with undistorted test card.

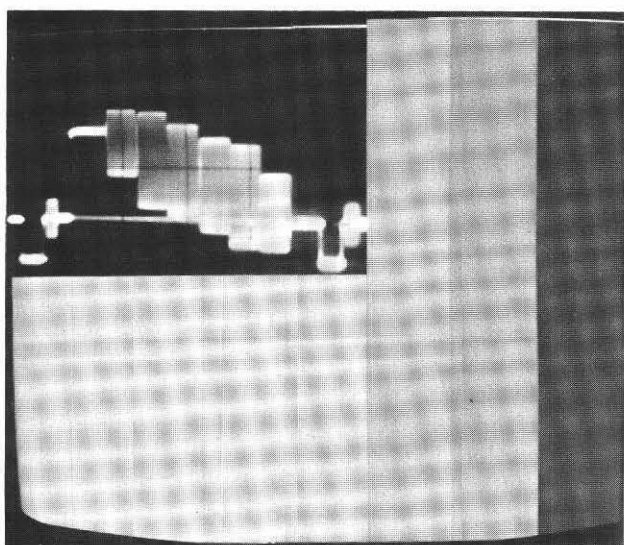

**Fig. 4b** Applications of the split-screen switch: colour bar display with waveform inset.

In addition to displaying processed and unprocessed signals simultaneously it is also possible to display a picture together with its associated waveform. Two typical displays are shown in figure 4. Figure 4a is a display showing the effects of streaking on a test card, while figure 4b shows a colour-bar display.

A view of the lecturer's control panel to produce these effects is shown in figure 5. Two independent test signal selection systems are provided, and this permits the selection of two special demonstration units.

## 4.2 Refinements

Training is most effectively accomplished when the student's mind is led along the appropriate path without distraction by irrelevant incidents. The equipment therefore includes refinements designed to further this end.

### 4.2.1 Pointer

With any form of visual presentation it is important that the

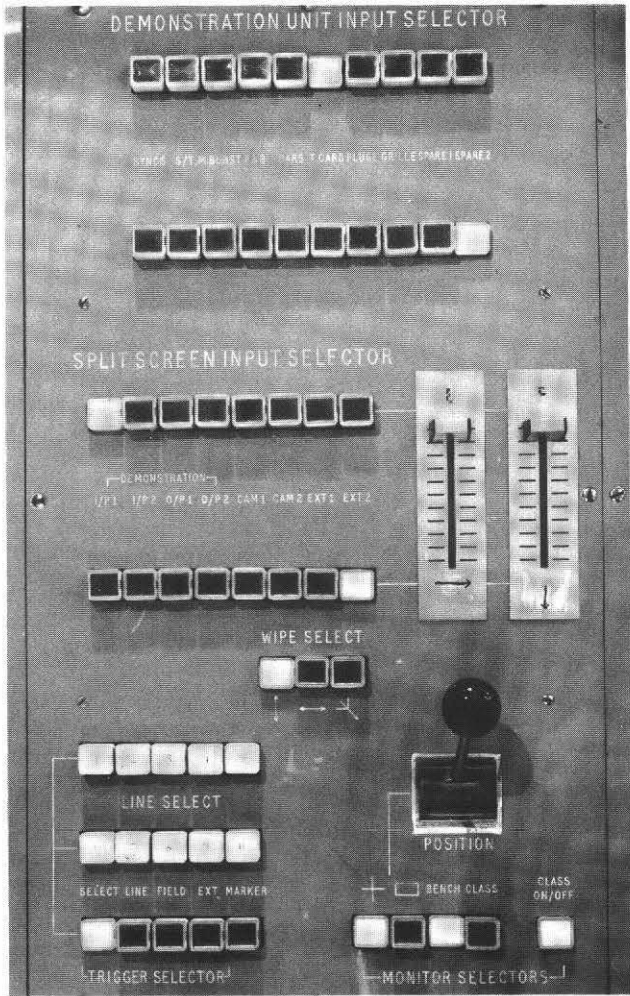

Fig. 5 Lecturer's control panel.

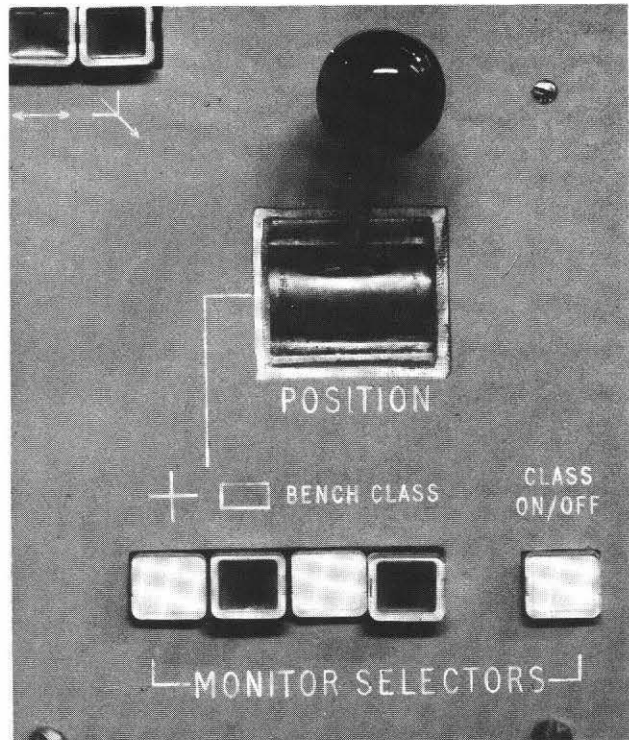

Fig. 6 Marker controls.

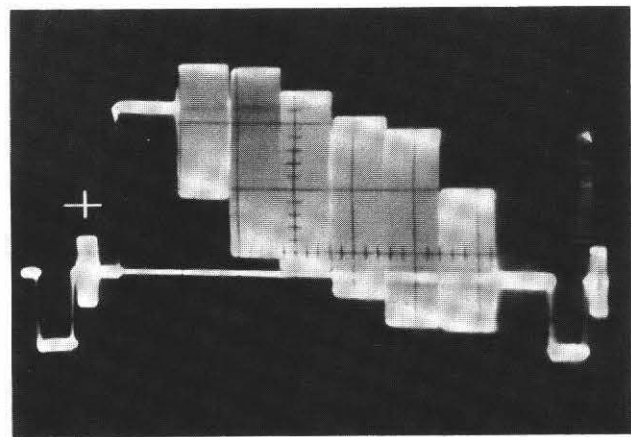

Fig. 7a Markers in use: the cross.

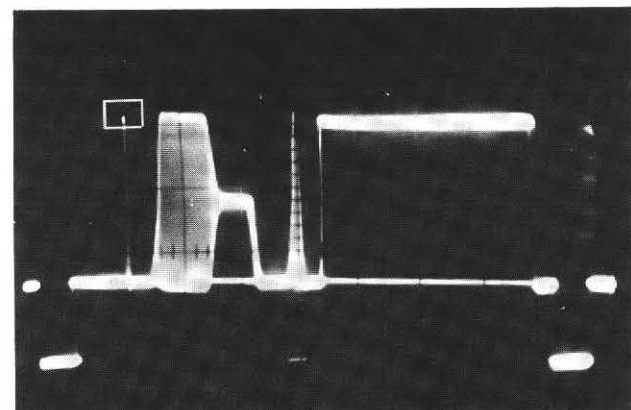

Fig. 7b Markers in use: the rectangle.

student is left in no doubt about which part of the display he should be observing. An electronic 'pointer' is therefore provided to indicate the part of the display screen currently of interest. The pointer consists of a small cross or rectangle which may be positioned anywhere in the monitor display.

The marker is positioned by means of a joystick on the main control panel. It can be connected independently to the lecturer's monitor, so that its position may be adjusted before it is switched to the students' displays.

Figure 6 shows the controls required to select and position the marker, while figure 7 shows examples of both types of marker in use.

#### 4.2.2 Oscilloscope triggering

Watching unstable oscilloscope displays while adjustments are made to obtain the required trace would certainly come under the heading of 'distraction by irrelevant incidents'. The risk of such distractions is avoided by triggering the oscilloscope from an external source of synchronising information.



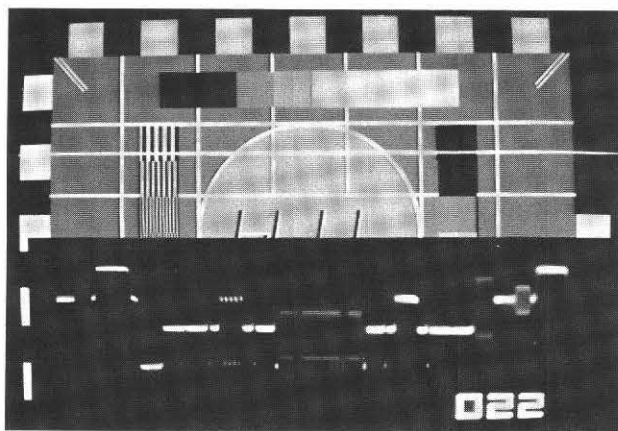
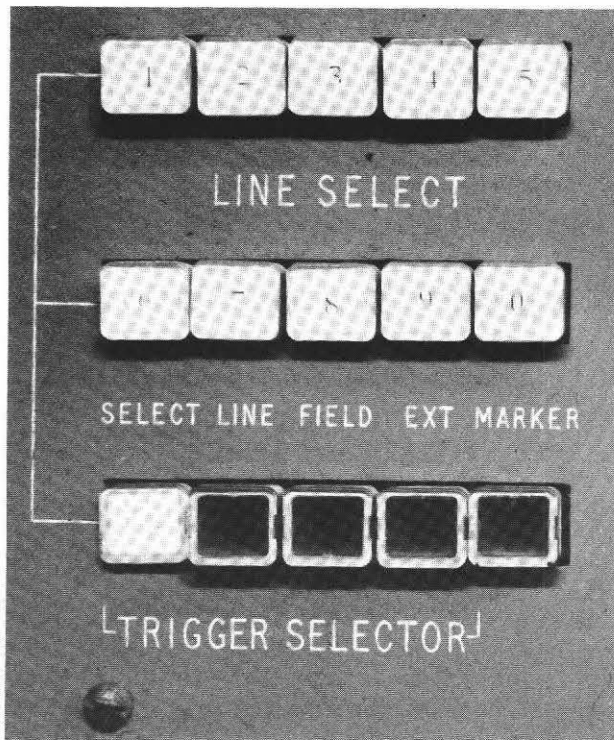

Fig. 9 Line selector in use.

Most of the oscilloscope displays required are of a complete television line or field. In these cases line or field synchronising pulses may be selected for triggering purposes. On some occasions, however, it is necessary to examine a single line of the television signal in isolation (when examining insertion test signals, for example).

To permit this to be quickly and easily achieved a special line-selection triggering unit was designed. This unit produces a trigger pulse only for the line required. The line is selected by pushbutton, digital counting techniques ensuring accuracy and stability of the output trigger.

Figure 8 shows the controls for the oscilloscope triggering, while figure 9 shows a typical display of a single line. To provide identification for the student the line being examined is made brighter on the picture display, while the figures in the top left-hand corner give its number. The test card illustrated in figure 9 is an electronically generated one

produced by an instrument designed and built at the Engineering Training Centre.

#### 4.2.3 Additional facilities

Various other refinements are incorporated in the desk.

Provision is made for remote selection of the operating mode of the colour monitors, and for remote operation of the 35 mm projector. The lecturer is able to dim the classroom lights and control spotlights on two eight-foot lighting tracks. A permanent feature of the spotlighting is a demonstration of additive colour mixing with red, green, and blue primaries.

An overall view of the control desk showing the controls for these, and other facilities, is shown in figure 10.

#### 4.3 More elaborate demonstrations

To cater for demonstrations of a more complex nature, for example those showing the coding and decoding system, complete demonstration bays may be brought into the classroom.

These bays make use of the basic signals available from the desk, and also use the display facilities. A free-standing television camera may be used with such bays to permit easy student viewing of the demonstrations. A typical demonstration bay together with the camera is shown in figure 11.

### 5 Future developments

Although the aim in building the demonstration classroom was to produce as comprehensive an installation as possible the likelihood of future expansion was also recognised. The mechanical construction of the desk is such as to make it reasonably simple to make modifications and additions to the control panel. Spare cables were installed at the outset to provide for future circuit requirements.

One obvious feature that could be included is a video-tape machine. This would not be seen as superseding the existing demonstration facilities but it would permit the demonstration of effects and equipment not available locally.

### 6 Conclusions

The demonstration classroom in no way represents the ultimate in training facilities but it has resulted in more effective presentation of many topics. Much of this benefit arises from the fact that visual aids have been effectively replaced by the real thing. Obviously there are many pitfalls with such complex facilities — the lecturer has to develop skill in his use of the equipment, and must ensure that the students are not so overwhelmed by the demonstration techniques that they lose track of the purpose of the lecture.

An obvious criticism is that the installation is too complicated in having many demonstrations available simultaneously. Would it not have been better to employ smaller demonstrations set up for particular purposes? This latter technique was in fact employed before the demonstration classroom was introduced, and it is generally

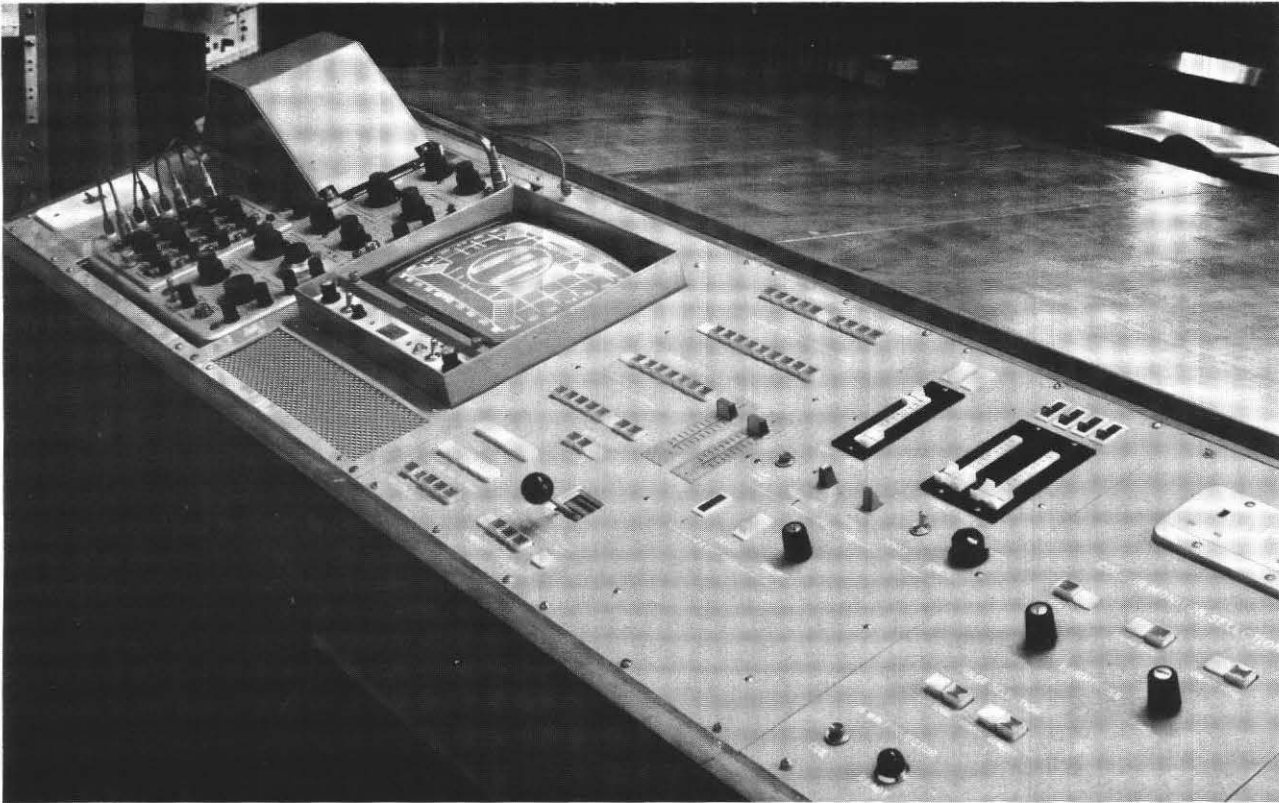

Fig. 10 Control desk.

felt that the present system is far more flexible in its approach.

It is now a relatively simple matter to specify a particular demonstration in a manner that enables a laboratory technician to set up any additional equipment necessary with the minimum of effort and lecturer assistance; a standard 'demonstration requirement' form has been produced to standardise such specification. In addition it is much easier to produce an impromptu demonstration should the occasion demand.

It has been interesting to consider the views of students who have undertaken training courses both before and after the introduction of the new demonstration facilities. In all cases their reaction to the improvements has been highly favourable; often interest is so great that a demonstration of the demonstration is necessary to avoid the risk, mentioned above, of distraction by the style of presentation. Students who have not been to the establishment before, however, are much more inclined to accept the facilities as a matter of course.

The only regret from both sides of the house is that having a large control desk places a sizeable barrier between lecturer and student — it is interesting to observe the resulting tendencies of some lecturers to sit on the desk or to conduct most of the class from the 'wrong' side.

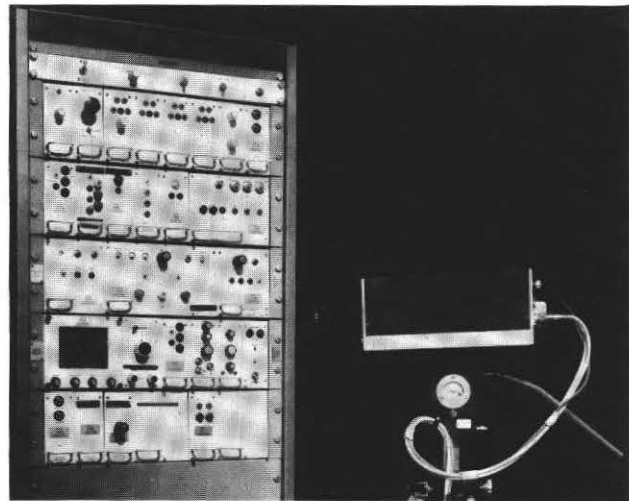

Fig. 11 A demonstration bay in use.

A great deal has been learned in the three years the room has been in service and the experience gained will no doubt contribute to the design of a second classroom which is planned for the teaching of electronic fundamentals.

# Airborne Television Transmission

M. W. Harman, C Eng., MIERE

J. Middleton, B Sc.

Research Department

**Summary:** Certain countries with favourable climates have already obtained satisfactory results using high-flying aircraft and captive balloons to provide a rapid solution to their television coverage problems. In general, these techniques have been considered or applied in situations with no existing ground station network or where unused parts of the radio spectrum are available for broadcasting. While the United Kingdom has no immediate plans to re-engineer the VHF television broadcasting bands, at present used for 405-line black-and-white transmissions, it is worth considering various methods, conventional or otherwise, that might be used to re-arrange the channelling for 625-line colour. Some of the propagation effects of transmitting from high-altitude aerials have been investigated and the results obtained are submitted as a contribution to Band III service area prediction under such conditions.

Approximate cost comparisons are made between different methods of transmission based on both capital and revenue expenditure.

- 1 Introduction
- 2 Theoretical analysis
- 3 Airborne transmission tests at 224 MHz
  - 3.1 Purpose of experimental work
  - 3.2 Equipment
  - 3.3 Flight trials
  - 3.4 Outcome of flight trials
- 4 Airborne television as an aid to VHF re-engineering
  - 4.1 An outline plan for the United Kingdom
  - 4.2 Service area prediction
  - 4.3 Co-channel interference
  - 4.4 Channel allocations
- 5 Discussion
  - 5.1 Cost comparison: Ground stations with aircraft transmission
  - 5.2 Advantages and disadvantages of airborne television
  - 5.3 Balloons as an alternative to aircraft
- 6 Conclusions
- 7 Acknowledgements
- 8 References
  - APPENDIX I: Flight test details
  - APPENDIX II: Roughness criteria
  - APPENDIX III: Cost comparison
  - APPENDIX IV: An all-systems cost comparison

## 1 Introduction

When starting a television service, broadcasting authorities all over the world have been guided by the social, economic, and political factors prevailing in their country. Also the type of transmitting equipment available at the time of

initial planning tends to dictate the way in which any network will evolve. The developing countries are, of course, at an advantage in this respect and it is therefore not surprising that the question of non-conventional transmitting techniques has been considered especially for educational programmes. The suitability of airborne television transmitters in certain circumstances has been confirmed largely as a result of experimental work conducted in America by the Westinghouse Electric Corporation. In the early days, their work was based on the use of high-flying aircraft but more recently tethered balloon systems capable of operating at heights between 10,000 and 15,000 ft\* have been perfected and marketed as an alternative solution for obtaining extensive service areas quickly.

However, provided airborne television could be co-ordinated with existing ground systems, the concept need not necessarily be confined to people with unused spectrum at their disposal and who require a service for the first time. The idea of integrating airborne and ground stations underwent close examination in 1961 when a Douglas DC-6 aircraft, flying over Indiana and Ohio at 23,000 ft, successfully transmitted an educational television service using the higher-frequency part of Band V. The experiment in 'Stratovision' systems lasted for three years, and hundreds of schools participated, but the Federal Communications Commission decided that it would not be in the best interest of spectrum allocation to recommend permanent operation.<sup>1,2</sup>

The possibility that similar systems may be applicable

\*In view of the current practice of giving aircraft height in feet, all transmitting heights in this report are given in feet rather than SI units.

elsewhere has now been taken up by the European Broadcasting Union and certain member countries are undertaking feasibility studies embracing both airborne transmission and satellite broadcasting. In the German Federal Republic an investigation has been made on a plan for the 12 GHz band, based on a specially designed aircraft flying at around 60,000 ft and the French have expressed interest in captive balloons. While the BBC has no immediate plans for domestic transmission by other than the established methods, the need to re-engineer Bands I and III for 625-line colour gives the subject greater importance.

The work described in this article examined the possibility of using conventional civil aircraft, suitably modified, to serve the United Kingdom with VHF television. Aircraft could be used either as an interim measure to help convert existing 405-line ground stations to 625-line colour transmission or provide a permanent solution giving two-programme national coverage. The choice of frequency band is important; if channels in the upper part of Band III are assumed, there will be maximum apparent terrain roughness and the amplitude of any reflected signals will be duly attenuated. Thus, in a situation where aircraft movement causes ground reflections near the viewer's aerial to vary in phase relative to the direct wave, the disturbance to the picture would be least.

## 2 Theoretical analysis

Because of the extreme height of the transmitting aerial, compared with normal terrestrial systems, the signal can of course cover a much larger area. Also screening by hills, trees, or buildings will be less pronounced except at the edge of the service area where the elevation of the airborne transmitter is small. On the other hand, a problem could arise due to the motion of the airborne transmitter.

Before looking further into the effects of a moving transmitter it is necessary to consider the simple case of a fixed transmitter radiating over a smooth earth (see figure 1). The ground-reflected signal has obviously travelled a slightly greater distance than the direct signal and the path difference determines the relative phase. Depending whether the two signals add roughly in phase or tend to cancel, the resultant signal is greater or less than the direct component. When two equal-amplitude signals are exactly 180° out of phase they cancel one another. In practice, the minimum field strength falls by no more than 30 dB below the direct signal and in many cases the difference is less than 10 dB because the reflection coefficient of the ground affects the amplitude and phase of the reflected signal.

The reflection coefficient is determined by three main factors:

- i) the electrical properties of the ground at the reflection point
- ii) the angle  $\alpha$  in figure 1
- iii) the polarisation and frequency of the transmitted signal.

If these are known it is possible to calculate the reflection coefficient and hence the resultant field strength. Figure 2 shows how this field strength varies with distance when vertically and horizontally polarised transmitting aerials are flown at 26,000 ft and signals are received 10 m a.g.l.

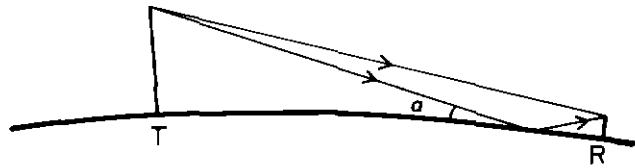

Fig. 1 Propagation over smooth earth.

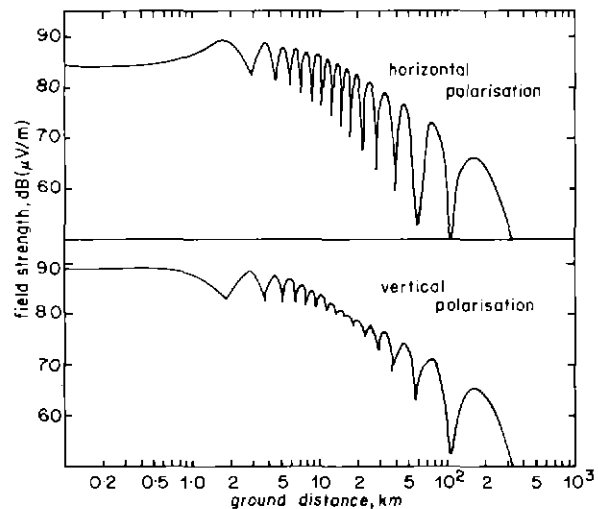

Fig. 2 Calculated field strength variations for a transmitting height of 26,000 ft a.g.l. and a receiving height of 10 metres a.g.l. Calculations assume:

- i) isotropic sources
- ii) ground constants  $\epsilon = 4, \delta = 10 \text{ mS/m}$
- iii) a smooth curved earth with  $4/3$  true radius
- iv) 1 kW e.r.p.
- v) frequency = 224 MHz.

It is clear that there are smaller field strength variations with vertically polarised waves and so such transmissions would be recommended for any final system. Even then minima of at least 10 dB would occur at distances of 50 km or more from the transmitter, and a receiving aerial could be badly positioned in a relatively low field. In such situations the field strength could be substantially increased by simply altering the receiving aerial height, thereby changing the path difference.

Because the transmitter is in a moving aircraft there will be many cases where the received field strength is continually rising and falling. Thus, adopting the assumptions of figure 2, with vertical polarisation and using an aircraft flying in a circle of 5 km radius at 314 km/h, the received field strength would fall by about 10 dB in three minutes if the aircraft-to-receiver distance rose from 47 to 57 km, and then return to its original value in the next three minutes. This in itself would not present a problem to a receiver with good a.g.c. but where the minima are more closely grouped (i.e. higher receiving aerials or lower transmitter-to-receiver distances) the fluctuations due to aircraft movement would be much quicker and the effect might become visible on the received signal, despite a.g.c.



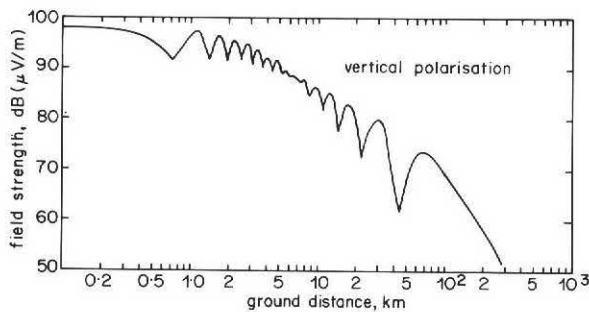

**Fig. 3** Calculated field strength variations for a transmitting height of 10,000 ft a.g.l. and a receiving height of 10 metres a.g.l. Calculations assume:  
 i) isotropic source  
 ii) ground constants  $\epsilon = 4, \delta = 10 \text{ mS/m}$   
 iii) a smooth curved earth with  $4/3$  true radius  
 iv) 1 kW e.r.p.  
 v) frequency = 224 MHz.

Picture degradation could also arise from the frequency-dependence of the minima and the sound-to-vision ratio could well depart from the nominal value by several decibels. However, it is estimated that a typical 'tilt' across a 6 MHz channel would be no more than 3 dB, especially when the effect of the vertical radiation pattern (v.r.p.) of the receiving aerial in reducing the level of foreground reflections is taken into account.

Figure 3 shows the calculated field-strength variation for a vertically polarised signal transmitted from 10,000 ft, the polarisation and height chosen for tests. The calculation assumes a nominal effective radiated power, (e.r.p.) of 1 kW over a smooth curved earth having a ground conductivity of 10 mS/m and a dielectric constant of 4, both values being typical for the United Kingdom.

### 3 Airborne transmission tests at 224 MHz

#### 3.1 Purpose of experimental work

In order to investigate the propagation of Band III signals from high-flying aircraft a series of tests at 23,000 ft was originally proposed, but aircraft limitations and air traffic restrictions prevented flying above 10,000 ft. Nevertheless, tests from a transmitter at 10,000 ft would serve to check the theoretical basis of the calculations and give confidence in similar calculations for 20,000 ft or higher.

An out-of-band frequency of 224 MHz was used for the tests to avoid interference to existing Band III television services.

#### 3.2 Equipment

An Auster (figure 4) belonging to the Royal Aircraft Establishment (RAE) at Farnborough was used to carry the transmitting equipment. The merits of using this aircraft were its relatively low flying speed, which would give time to adjust the measuring equipment on the ground, and the fact that it could readily carry, attached beneath the fuselage, an active aerial with a near omnidirectional horizontal radiation pattern (h.r.p.) which had been developed at the RAE.

This active aerial was housed in an aerofoil section containing a transistor power amplifier, with the aerial itself running along the trailing edge (figure 5). It was not possible to measure the radio frequency power going into the aerial because the active aerial unit was an integrated assembly, but an estimate was made by measuring the power drawn from the supply and making a plausible assumption of efficiency. In any case it was not essential to know the absolute power: the object of the test was to measure the



**Fig. 4** Mk. IX Auster used for flight trials.

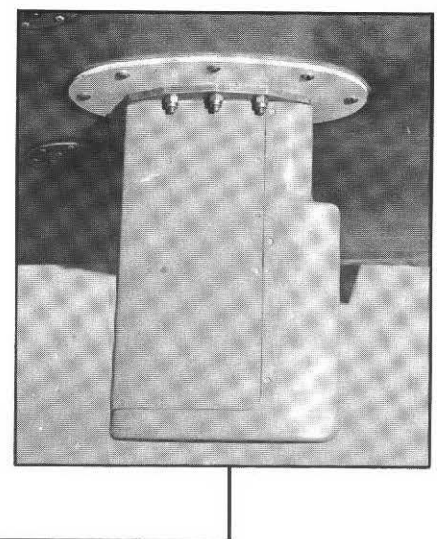

**Fig. 5** Active aerial mounted beneath fuselage of Mk. IX Auster.

range of maximum to minimum field strength. Because the RAE equipment was available the only item which had to be constructed by BBC Research Department was a simple crystal-controlled drive oscillator. Details of the transmitting equipment and the ground profile along the flight path are summarised in Appendix 1. The field strength measuring apparatus comprised a five-element log-periodic aerial mounted at 10 metres a.g.l., a receiver, and a pen recorder.

### 3.3 Flight trials

As far as possible, the aim was to fly a straight course at 10,000 ft. Measuring equipment was positioned at Lasham and the field strength was recorded as the aircraft approached and passed overhead. The pilot reported his position by radio-telephone so that transmitter-to-receiver distances could be related to the chart recordings. It was arranged that the aircraft would take off from Farnborough, and fly south westerly towards Lyme Bay on the Dorset coast.

The flight took place on 23 April 1975. Although well below expectations, the radiated transmitter power was adequate to provide useful measurements. On the outward run performance limitations and a 28 km/h tailwind prevented the aircraft reaching 10,000 ft until it had covered 74 km which meant that the field strength recordings were difficult to relate to theoretical curves based on a constant height. Wind conditions were more favourable on the return flight and the aircraft passed over Lasham at 10,000 ft maintaining height until about 16 km from Farnborough. Consequently a useful field-strength recording was made during this flight.

Part of the chart is reproduced in figure 6, and figure 7 shows the same results plotted on a logarithmic distance scale and compared with the theoretical curves for an e.r.p. of 1 W. It will be seen that a transmitting aerial height of 9,500 ft has been used for calculating the field strength because the Lasham receiving site was approximately 500 ft a.m.s.l. The surrounding area was fairly flat with the reflection point never more than 330 metres away and so the foreground was also assumed to be about 500 ft a.m.s.l.

### 3.4 Outcome of flight trials

From figure 7 it is obvious that the power radiated from the test transmitting aerial was only of the order of 1 mW and regrettably it was impossible to measure all the way to the radio horizon. In spite of low power, however, signals were measured over a substantial part of the flight path and valuable experimental data obtained to assist the prediction of reflection coefficients at uncluttered receiving sites.

The calculated field strength/distance curve applies only when the reflecting surface is smooth but, because the transmitter is very high, the effect of surface roughness may be significant. For instance, at aircraft ranges of 3 to 10 km, where the indirect wave has an angle of incidence approximating to the Brewster angle, the reflection coefficient should go through a minimum resulting in a

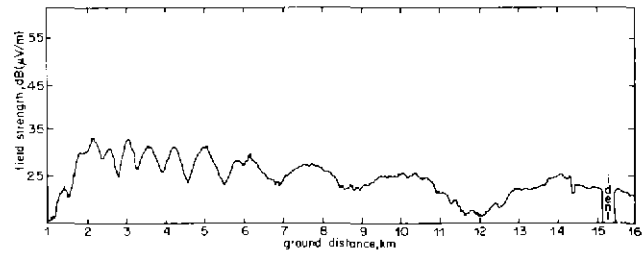

Fig. 6 Aircraft altitude = 10,000 ft a.m.s.l. Field strength/distance chart recording made at Lasham.

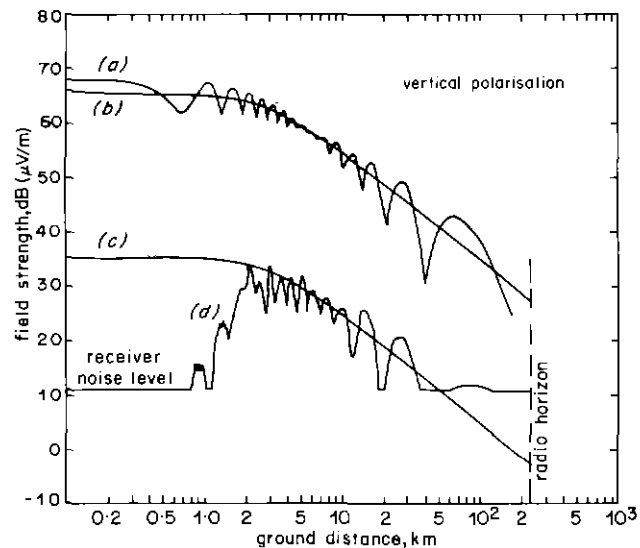

Fig. 7 Calculated and measured field strength variations for a transmitting height of 9,500 ft a.g.l., a receiving height of 10 metres a.g.l., and a frequency of 224 MHz.  
 (a) Calculated field strength for 1 watt e.r.p.  
 (b) Free space field strength for 1 watt e.r.p.  
 (c) Free space field strength for 1 mW e.r.p.  
 (d) Measured field strength at Lasham receiving site.  
 Calculated curves (a), (b), and (c) assume:  
 i) isotropic sources  
 ii) ground constants  $\epsilon = 4$ ,  $\delta = 10$  mS/m  
 iii) a smooth curved earth with  $2/3$  true radius.

decrease in the field-strength variation. In Band III, the average surface roughness between these ranges would have to be less than 20 cm to be considered free from perceptible irregularities<sup>3</sup> (see Appendix II). Since the terrain around the Lasham site has surface undulations greater than 20 cm, it is not surprising that the variations on the chart recording between 3 km and 10 km are greater than the theoretical curve might suggest, but the variation does go through a minimum, though at most ranges it has an amplitude similar to the calculated value. The results fully justify the choice of vertical polarisation for a more constant field. Even at greater aerial heights, where the theoretical reflection coefficient is less likely to apply due to the increased 'smoothness' requirement of the ground, the theoretical curves should give a good indication of practical field-strength variations with aircraft distance.

The absence of measured field strength as the aircraft passed over the receiving site was mainly a consequence of



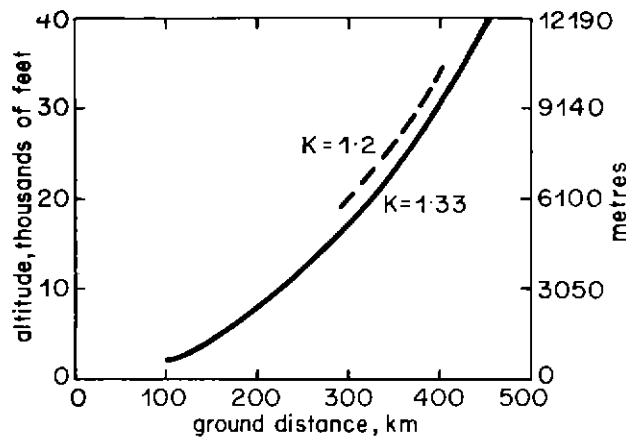

Fig. 8 Horizon distance versus altitude for earth radius modified by factor K.

the receiving aerial v.r.p. The transmitting aerial also radiated a horizontally polarised component which gave it a reasonably omnidirectional v.r.p. in the lower hemisphere. Throughout the tests the angle of elevation of the receiving aerial was zero, so that when the aircraft was nearly overhead the gain was about 20 dB below the maximum.

#### 4 Airborne television as an aid to VHF re-engineering

##### 4.1 An outline plan for the United Kingdom

To derive the best general coverage in the main centres of population, it is desirable that such places in London, Birmingham, Bristol, Cardiff, Manchester, Edinburgh, and Glasgow all fall well inside the limits of service.

For complete coverage it would still be necessary to operate a few ground relay stations. These could be kept to a minimum when selecting the flying zones, by satisfying two main criteria in areas particularly susceptible to large shadow losses. Firstly, angles of reception above the horizontal should be as high as possible in the mountainous and densely populated areas of industrial South Wales and secondly a two-transmitting-station 'crossfire' plan should be used to cover the Pennine valleys, thereby illuminating north- and south-facing slopes from opposite directions.

It is also desirable to restrict the level of signal falling outside the target area. The use of directional transmitting aerials should therefore be considered, with appropriate reduction in e.r.p. towards the continent.

Another factor in preparing the basic specification is to decide whether to modify an available aircraft (which may be lacking in ceiling and flight duration) or to have one specially designed to meet the needs of airborne broadcasting. Clearly, unless there is likely to be a continuing demand for airborne transmitters, the latter course would probably prove uneconomic and for the plan to be

discussed, the Bristol Britannia was chosen as suitable for modification. 'Turbo-prop' airliners like the Britannia can carry sufficient fuel to maintain an operational altitude for about eight hours and still have two hours reserve with which to arrive on station and return to the base airport.

Near line-of-sight coverage of most of the UK would be obtained from two suitably stationed Britannia aircraft at around 26,000 ft, a height approaching their ceiling. Figure 8 shows range versus altitude for the earth's radius modified by two values of the factor K (1.33 and 1.2). While the standard  $K = 1.33$  still gives a useful approximation, it may slightly over-estimate the distance to the radio horizon. The range, however, is unlikely to fall below that indicated by the dashed curve ( $K = 1.2$ ), according to available data on the mean refractive index gradient up to 26,000 ft. The curves give the horizon distance for differing values of aerial elevation and, at 26,000 ft, a television coverage range of 348 km to 367 km would be a practical possibility.

If the majority of people are to be served, it is essential that more than one aircraft be used. Each must be capable of operating at the specified altitude with similar flight duration and have transmitters of similar e.r.p., tunable to either of the two channel groups. Otherwise, any routine exchange of an unserviceable aircraft for a standby would become difficult and, in an emergency, almost impossible.

One way of dealing with the numerous propagation and aeronautical constraints would be to station one transmitter over Somerset and another over Angus, each flying in a circle of about 5 km radius. Alternatively, to provide greater crew comfort, they could fly a 'race track' pattern at holding speed (minimum drag airspeed) with the major axis no greater than 10 km in length. This would give the pilot an opportunity to fly straight and level and so re-set his instruments occasionally.

Consideration has been given to a transmitting aerial which has directivity in both horizontal and vertical planes. One problem associated with the application of any such directional array is the need to maintain positional stability, irrespective of aircraft heading and attitude, but this is not insuperable. Moreover, it may be justified to ensure an economic coverage, particularly if, by using horizontal directivity the service area is confined to viewers in the United Kingdom. It could also be deemed more acceptable to the aviation authorities if it permits the transmitting flight zone to be to one side of the country rather than centrally located in the main air lanes.

Viewers in the area immediately below the transmission zone would need to be served by a small downward-directed component which must, therefore, have its electric vector horizontal. The use of plane polarisation for this component would be unsatisfactory if the plane of polarisation rotated with the aircraft, but the aerial stabilisation mentioned in the previous paragraph would solve the problem. Alternatively, circular polarisation of the downward-directed component would avoid the problem whether the transmitting aerial were stabilised or not. In the worst case of reception below the centre of the flight path (assuming a circle of 5 km radius at an altitude of 8 km) a three-element Yagi pointed vertically upwards would be satisfactory. Reception would be required over an angle of  $\pm 32^\circ$ , which is well within the half-power beam width of such an aerial.

## 4.2 Service area prediction

For calculation purposes, the Somerset and Angus transmitting stations are taken to have aerials with the same radiation characteristics. Alignment of the h.r.p. shown in figure 9 is for the greatest radiation towards the north-east and south-west respectively. CCIR Recommendation 417-2, paragraph 1, gives 55 dB ( $\mu\text{V}/\text{m}$ ) as the minimum median field strength that can be expected to be protected against foreign co-channel interference for 95% of the time for Band III. We may estimate that, for the higher channels, about 15 dB will be lost near the radio horizon for aerials at 10 m a.g.l. through the effects of the terrain, ground reflections, and clutter: this loss is likely to be reasonably constant because conditions giving high terrain and clutter loss correspond to reduced foreground reflections. Thus, a free-space field of some 70 dB ( $\mu\text{V}/\text{m}$ ) is required at the radio horizon in the direction of maximum radiation. This can be achieved with a maximum e.r.p. of 28 kW. A modification of the h.r.p. of the transmitting aerial shown by the broken line in figure 9 improves the service in Cornwall and north-east Scotland. Although it also has the disadvantage of increasing the interference range it is this modified h.r.p. which has been used in calculating the service areas for the flight conditions described in section 4.1. The results are shown in figure 10.

## 4.3 Co-channel interference

To determine the theoretical distance necessary between co-channel stations requires reference to the way field strength decays with distance beyond the radio horizon. Whether the interfering transmitter is an airborne or a ground station, any plan must arrange for a certain minimum spacing between the unwanted source and the nearest co-channel receiving location.

Figure 11, in addition to providing data for service area limits, curve (a), also shows as curve (b) a simplified field strength/distance prediction exceeded for about 5% time out to 1000 km. Curve (b) approximates at the greatest range to a tropospheric scatter calculation in the diffracted region.<sup>4</sup> At shorter ranges (450 to 700km) the curve is based partly on CCIR propagation curves and partly on an effective earth radius which, from limited meteorological evidence, would apply for 5% of the time, assuming the rate of change of refractive index to be uniform for the whole path and independent of height. Little is known about field strength/time behaviour when transmissions from aerials situated high above tropospheric inversions are received near ground level. Furthermore the proportion of time during abnormal propagation, for which signals would be stronger or weaker than indicated by the established empirical curves, is far from certain. This deficiency in our understanding of propagation over the type of path under consideration limits the reliability of our estimate of the minimum distance between the transmitting aircraft and nearest co-channel viewer.

The planning ratio to avoid objectionable interference between wanted and unwanted 625-line television signals, having the same nominal carrier frequency, is 45 dB. This is the CCIR protection ratio acceptable for 1% to 10% of time

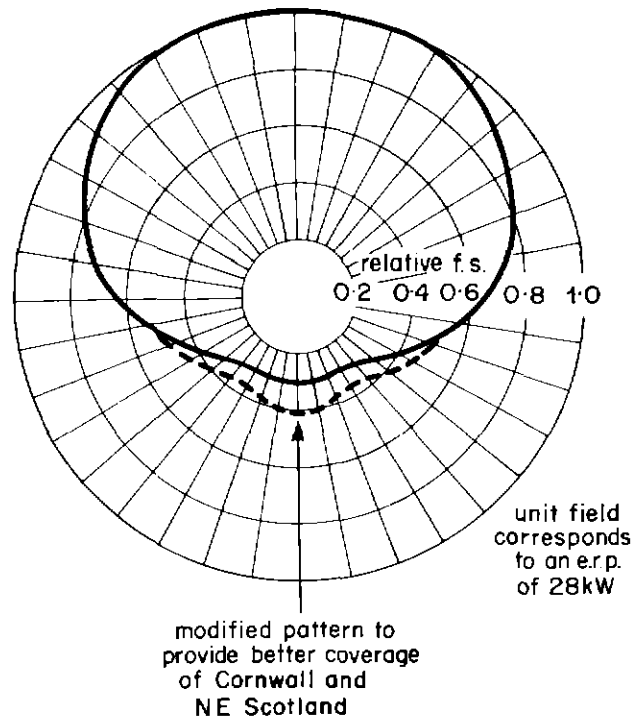

Fig. 9 Horizontal radiation pattern of postulated Band III transmitting aerial.

in terrestrial services in which interference normally has a large fading range and variability. We will ignore the beneficial effect of vision frequency line-offset, receiving aerial discrimination, and terrain loss, any of which could reduce the ratio to less than 30 dB, so the calculation will cater for the worst case. Section 4.2 has already stated that 55 dB ( $\mu\text{V}/\text{m}$ ) is the minimum field strength that can be expected to be protected against interference for 95% of the time. Hence the unwanted signal must not exceed 10 dB ( $\mu\text{V}/\text{m}$ ). Figure 11 predicts that for a suggested maximum e.r.p. of 28 kW the field would have fallen to the value of 10 dB ( $\mu\text{V}/\text{m}$ ) at a distance of 860 km and, by taking account of the directional aerial h.r.p., figure 10 shows the interference areas bounded by the broken lines. It is also pertinent to note how this interference distance only falls by 205 km if the e.r.p. is reduced by some 14.5 dB to 1 kW; indicating that a directional transmitting aerial is not nearly as effective as might be thought in protecting co-channel services operating well beyond the radio horizon.

To derive the minimum distance between airborne transmitting stations at 26,000 ft, the planning engineer should arrange to repeat a channel in the usual lattice configuration, and simply add the service area range (367 km) to the interference range (860 km) to give a total separation of 1227 km. For outline prediction purposes a figure of 1200 km would seem a fairly safe guide for basic network calculations.

## 4.4 Channel allocations

Clearly, with the Britannia's maximum flying height restricted by certain performance limitations, it would be

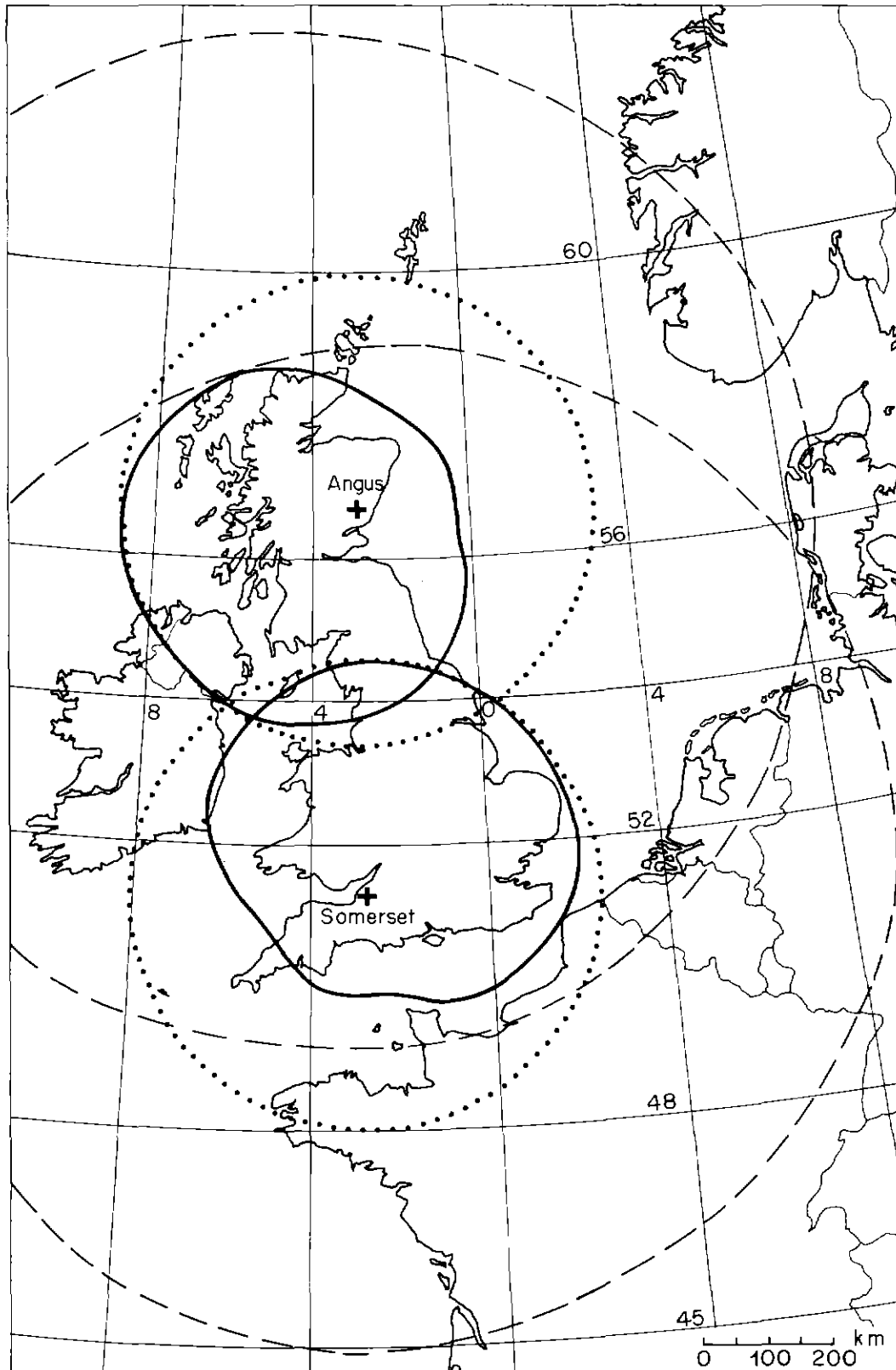

- 55 dB( $\mu$ V/m) limit of service
- - - - - 10 dB( $\mu$ V/m) interference distance
- ..... Radio horizon

Fig. 10 Band III coverage using two identically equipped aircraft at 26,000 ft.

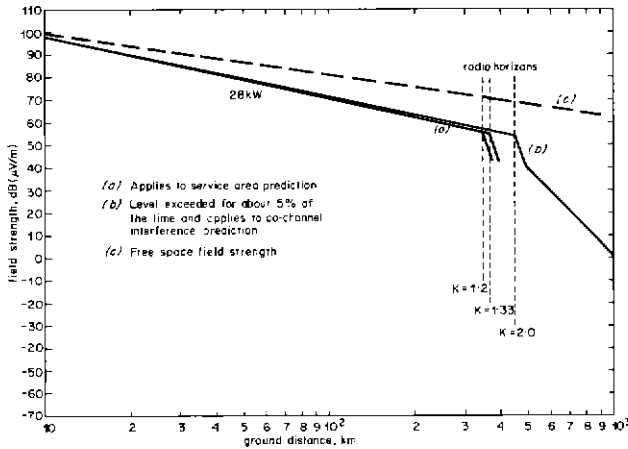

Fig. 11 Simplified field strength versus distance prediction for 26,000 ft a.g.l. transmitting aerial height at 50% of locations.

necessary to employ two aircraft to provide a national replacement service. It would therefore be necessary to allocate a total of four channels so that both stations may transmit a BBC and an IBA service simultaneously, without mutual interference. The Somerset transmissions would seriously affect Eire, France, Belgium, Holland, and West Germany, while Angus would also cause interference to Eire together with the coastline of Scandinavia and continental Europe. To complete the investigation of frequency choice would require detailed consultation with all concerned. By making far more efficient use of the VHF spectrum with airborne techniques serious interference problems could be restricted to only two channels for most of our neighbours; some form of international plan might, therefore, be agreed. Without it, the satisfactory integration of an airborne system with operational ground stations could prove too difficult. Any reduction in channel requirements brought about by using a single purpose-built aircraft would be of little advantage, because flying at 48,000 ft in order to maintain the same coverage would result in an equally difficult co-channel problem. One way of virtually eliminating a severe international situation would be to operate a single Britannia over Angus at reduced height. Such an arrangement would serve a substantial number of people in the northern half of the United Kingdom and also overcome the well known difficulties of developing programme distribution and coverage networks for scattered communities in the Highlands and Islands using ground stations. Co-channel signals would be mainly domestic in origin and could be taken into account when re-engineering existing ground transmitters in Wales, Northern Ireland, and the southern half of England, although consultation with Eire would be necessary.

**5 Discussion**

**5.1 Cost comparison: Ground stations with aircraft transmission**

A financial comparison with ground station re-engineering has been based on typical operating figures for the Bristol

TABLE 1  
Financial Summary

System	Capital	Revenue (Expenditure)
Aircraft	£M 0.88	£M 1.54
Ground (UK re-engineering)	£M 4.5	£M 0.2

Britannia turbo-prop airliner. Appendix III gives details of a cost breakdown and includes all the main items of hardware and running expenses. Table 1 summarises both the capital and revenue totals for the cost to each organisation if a re-engineered two-programme network were shared equally between two broadcasting authorities, while Appendix IV gives a near-complete financial comparison between all broadcasting systems, including satellites. However, it should be realised that the aircraft costs under the VHF column may be considerably less than certain estimates made by others because they are based on an available out-of-date airliner rather than a specially designed aircraft.

In terms of capital expenditure the use of aircraft would given an estimated 80% saving and this could be greater if the need to radiate new VHF parameters required the replacement of more of the existing transmitting aerials than currently envisaged. The largest single item of revenue saving on closing the ground network would be electricity supply costs, because virtually all buildings and masts must remain to accommodate the UHF television and VHF radio services. Applying the estimates of Table 1 the annual cost of using aircraft would be seven and a half times that of ground stations. It is apparent that an economic comparison between the two methods is very dependent on the length of time over which the service is operated, as well as interest rates and changes in fuel prices. Because the total of revenue and capital costs is roughly the same over a period of three years it follows that the aircraft solution would only be attractive in the short term, and that as far as the UK is concerned, the conventional method is more economic in the long term, i.e. for periods greater than about three years.

There are two final topics for discussion which fall outside the scope of this article and would require appraisal at a time when re-engineering for 625-line colour transmission became more imminent. Firstly, the number of staff needed to operate and maintain a revised VHF network would depend very much on the degree to which the latest-technology ground stations could be left unattended. If aircraft were chosen, then, to a first approximation, the number of staff currently involved with 405-line stations would be about right to form an engineering flying unit. Consequently staff costs tend to balance out in the comparison that has been made and so do not appear in Appendix III.

Secondly, the vast majority of viewers would have to buy a new VHF receiving aerial and the overall expense to the public could vary considerably. For example, with ground stations, the total domestic aerial bill for the nation would depend very much on how the Band I and Band III channels were allocated relative to area population density. The planning engineer would have to bear in mind that some

viewers may once again require an aerial for both VHF bands and it would be desirable to restrict such a situation to areas of low population. With airborne transmission the field strength distribution over the United Kingdom would tend to be fairly even and most receivers would give satisfactory results using a single medium-gain Band III aerial, in contrast with ground station service areas which give extremes of high and low field. The main demand would therefore be for a uniform aerial design with sufficient bandwidth merely to cover the top four channels in Band III. By reducing the range of aerial designs on the market, it would probably be possible for manufacturers to minimise costs.

### 5.2 Advantages and disadvantages of airborne television

In terms of capital outlay, the use of airborne transmitters appears attractive and in return gives almost total coverage when commissioned, but any concept of regional or local television broadcasting would have to be abandoned. Even so, by employing the two-station plan, a small degree of area content could always be introduced by feeding separate Northern and Southern programmes to the Angus and Somerset ground control stations. One method of programme feed from each ground control would be to site a conventional SHF link beneath the flight path. The need for some form of automatic aerial tracking to keep the aircraft within the microwave beam could be eliminated by taking advantage of the short transmission distance and using fairly low-gain aerials with broad radiation patterns. Engineering talk-back and transmitter performance telemetry could also use the same link.

Any comparison between airborne and ground transmitters must cover the question of relative reliability. A failure in the proposed airborne system is bound to affect at least half the country and a shut-down could run to several hours. Even with a third aircraft on standby, budgeted for in Appendix III, it could be some time before it was on station to relieve the faulty equipment. Bad weather could also delay take-off and upset programme schedules, but selection of landing places in the light of weather forecasts could help to avoid such circumstances. Mention has already been made of an experimental educational service using a DC-6 and in their report the operators explain how the availability of programmes was maintained for 98.7% of the time for the year of best performance. This record is most impressive, bearing in mind all the things that could have gone wrong, but does not compare well with the reliability of ground stations.

The advantages and disadvantages of the systems are summarised in Tables 2 and 3.

### 5.3 Balloons as an alternative to aircraft

The use of captive balloons as a means of increasing reliability certainly merits investigation. Again it has been the work of the Westinghouse Electric Corporation that has received study and in particular their subsidiary, Tethered Communications (T.COM.). It is claimed that, for broadcast

TABLE 2  
Ground Station Transmission

ADVANTAGES
Easily switched for either regional or local broadcasting.
High reliability, with breakdowns only affecting a small area.
Unlimited programme hours.
Low annual running costs.
DISADVANTAGES
Insufficient frequency spectrum for effective two-service coverage.
High cost of coverage to remote rural areas.
High capital investment to complete a national network.

TABLE 3  
Aircraft Transmission

ADVANTAGES
Large coverage from the moment of commissioning.
Low capital cost per head for population served.
Conserves television channels.
Inherently covers scattered communities.
DISADVANTAGES
Large areas are subject to co channel interference.
A greater degree of international co-ordination is required.
Inferior reliability.
Restricted daily operating times.
High annual running costs.

periods up to 24 hours a day, a single-balloon system can achieve better than 99.9% availability. The initial testing and assembly work was carried out in the Bahama Islands off Miami, Florida. Until practical experience has been gained in northern latitudes where wind speeds in excess of the 190 km/h working limit are sometimes encountered, it is difficult to estimate how often high winds would prohibit flying, especially in the more exposed parts of Scotland. According to the makers, the prototype model continued to function throughout a hurricane blowing at 150 km/h with squalls of more than 180 km/h (force 12, Beaufort scale). It is evident from the information supplied by T.COM. that balloon equipment is aimed at use in developing countries where no conventional ground station network exists. Under these conditions the system is ideal and caters well for community viewing in transportable receiving auditoriums that are supplied as part of an entire broadcasting package.

In spite of the success of the 'Stratovision' experiment, further development in the field of extra-high transmitting aerials seems to have favoured the captive balloon rather than more sophisticated aircraft systems. Consequently, it can only be assumed that on balance a balloon is seen as the better commercial prospect. Considering United Kingdom coverage with balloons at 13,000 ft rather than aircraft at twice the height, much of the same propagation theory would apply, including changes in field strength with shifts in balloon position. Because of the lower operating height comparable coverage would require three stations rather

than two, assuming that the fringe viewer would use both a high-gain aerial and a masthead pre-amplifier. As the provisional cost of three double-channel T.COM. equipments has been quoted at between £M 5.75 and £M 7.35, it implies a substantial capital expenditure amounting to as much as £M9.8 if a spare system is included.

Neglecting all operating costs, this initial outlay could be more than the sum needed to re-engineer existing ground stations and so the use of balloons is not economically attractive in the short term.

## 6 Conclusion

Airborne transmitters can be used to provide extensive coverage of television services. How the application of airborne techniques modifies established understanding of propagation at Band III and whether editorial limitations, together with the risk of total programme loss are acceptable, are questions that all require clarification before preparing any final specification. The postulated e.r.p. of 28 kW may be too ambitious in terms of aircraft power supplies. A field strength of 53 dB ( $\mu\text{V}/\text{m}$ ) at the service fringe is the minimum that will give a satisfactory grade of picture and, although it may not be protected from co-channel interference for quite so long as the 55 dB ( $\mu\text{V}/\text{m}$ ) assumed, would reduce the e.r.p. to the more acceptable level of 18 kW. The final choice of e.r.p. would depend on international negotiations, reception quality at cluttered sites near the limit of service, and the extent to which signal variation was reduced by the breakup of anti-phase foreground reflections compared with the results reported here. A second series of reception experiments would therefore be necessary in various urban environments, to resolve a number of remaining problems.

With reference to the relative costs of complete VHF systems over a ten-year period, there is little difference between ground stations and ex-airline Bristol Britannias.

Bearing in mind there are likely to be difficult regulatory and international planning problems, the long-term choice favours a conventional terrestrial network. However, the use of aircraft may be economic on a temporary basis. As an aid to re-engineering, the 405-line black-and-white transmissions could be transferred to aircraft while ground stations are rebuilt, thereby avoiding the need to maintain the established service at these stations. If all the administrative constraints on VHF airborne transmission could be overcome, the use of captive balloons (T.COM.) is a better economic prospect for the long-term. Nevertheless, this would still be more expensive than modifying existing buildings and masts for a new 625-line colour service.

## 7 Acknowledgements

The authors acknowledge the unfailing co-operation of the Royal Aircraft Establishment, Farnborough, including members of the Radio Department, Cove and Lasham measuring stations. Also, valuable discussions with Westinghouse International Defence and Public Systems Corporation and Shackleton Aviation Ltd., London, are gratefully acknowledged.

## 8 References

1. MULLINS, F. G. An Airborne UHF Television Transmitter for Educational TV: IRE Transactions November 1961.
2. MULLINS, F. G. A Progress Report on Airborne Educational Television: IEEE Transactions May 1964.
3. MATTHEWS, P. A. (1965) Radio Wave Propagation VHF and above.
4. KING, R. W. and CAUSEBROOK, J. H. 1974. Computer programmes for UHF\* co-channel interference prediction using a terrain data bank. BBC Research Department Report No. 1974/6.

\*This work has also been undertaken for VHF.

## APPENDIX I

### Flight test details

1. Course of aircraft : Farnborough-Lasham-Dorchester-Lyme Bay
2. Maximum altitude : 10,000 ft

3. Type of aerial : Folded monopole
4. Radiation pattern : Nominally omnidirectional
5. Polarisation : Vertical
6. Type of emission : Unmodulated Carrier Wave with 5-second interruptions every 15 minutes for identification purposes
7. Frequency : 224 MHz

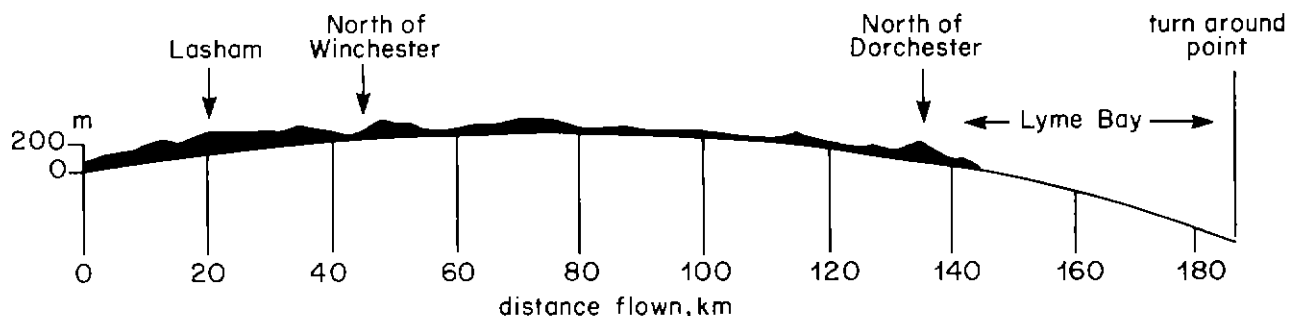

Fig. 12 Ground profile along flight path.



**APPENDIX II**

**Roughness criteria**

The reflection coefficient used in calculating the value of ground-reflected signals only applies when the reflecting surface is smooth. A surface may be considered rough if the variations in surface height are sufficient to cause a variation in path length of more than an eighth of a wavelength.

In figure 13 the path difference between ray 1 and ray 2 is  $\delta$  and the angle of incidence is  $\alpha$ .  $H$  is the variation in the surface height. From the above definition of roughness, for the surface to be considered smooth

$$\delta < \frac{\lambda}{8}$$

hence  $2H \sin \alpha < \frac{\lambda}{8}$

or  $H < \frac{\lambda}{16 \sin \alpha}$

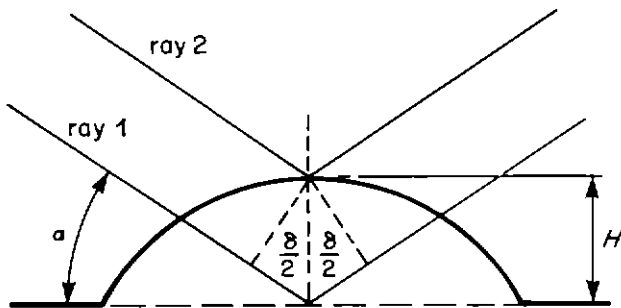

Fig. 13 Surface roughness.

For large transmitting aerial heights and small receiving aerial heights the ground distance between transmitter and reflection point  $d$  is approximately equal to the distance between transmitter and receiver  $D$  (see figure 14).

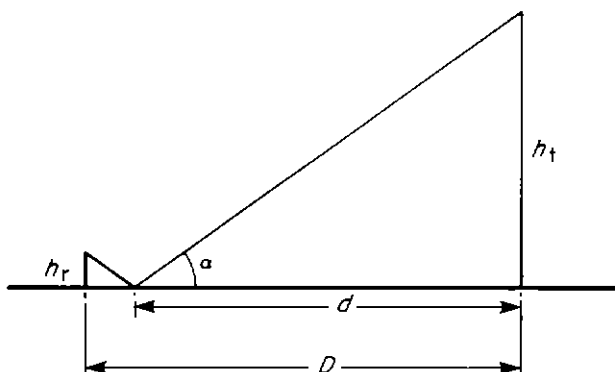

Fig. 14 Reflection point position.

hence  $\sin \alpha \approx \frac{h_t}{\sqrt{h_t^2 + D^2}}$

or  $H < \frac{\lambda \sqrt{h_t^2 + D^2}}{16 h_t}$

It follows that with a transmitter height of 9,500 ft, a ground distance of say 6.5 km, and a frequency of 224 MHz the surface height variations must be less than 20 cm for the ground to be considered smooth.

**APPENDIX III**

**Cost comparison (valid January 1976)**

**Aircraft transmission**

	Items	Totals
Capital		
Aircraft:		
Three second-hand Britannias	£175,000	£525,000
Airborne equipment for two programmes:		
Two 5 kW vision/sound transmitters plus reserves	£300,000	
Transmitting aerial	£50,000	
Link Receiver and aerial	£25,000	
Telemetry, etc.	£5,000	
	<u>£380,000</u>	
Equipment for three aircraft		£1,140,000
Link ground equipment per site:		
SHF transmitters	£30,000	
Aerials and support structures, buildings, etc.	£20,000	
	<u>£50,000</u>	
Equipment for two ground bases		£100,000
		<u>£1,765,000</u>
Cost to each organisation if shared equally between the BBC and IBA	<u>£882,500</u>	(Say £M 0.88)

Revenue (Expenditure)		
Aircraft:		
Annual servicing costs for a Britannia	£65,000	
Annual servicing costs for three Britannias		£195,000
Annual operating costs for a Britannia airborne 10 hours per day, at £450 per hr.	£1,642,500	
Annual operating costs for two Britannias		<u>£3,285,000</u>
		<u>£3,480,000</u>

Revenue (Savings)		
Overheads:		
Public electricity supply charges for existing two-service VHF ground station network, including maintenance and valves	£400,000	£3,080,000
Net revenue cost to each organisation if shared equally between the BBC and IBA	<u>£1,540,000</u>	(£M 1.54)

**Ground station transmission**

Capital			Revenue (Expenditure)	
Transmitters/aerials:				
Re-engineering costs quoted in 1972 for one service only	£4,000,000			
Add 50% for inflation and disposal of old equipment to obtain current cost		£6,000,000	Overheads:	
Less 25% for possible use of existing aerials	£1,500,000	<u>£4,500,000</u>	Annual public electricity supply charges for new single-service VHF ground station network, including maintenance and valves	<u>£200,000</u>
		(£M 4.5)		(£M 0.2)

**APPENDIX IV**

Approximate total costs for about 90% coverage of the United Kingdom with one service. (Savings available by using existing equipment and costs to the viewer have been ignored).

COST  (SOURCE)	GROUND	AIRCRAFT 8 hr. transmission per day <sup>(1)</sup>		BALLOONS		SATELLITES
	(a) VHF (BRITISH)	(b) VHF <sup>(2)</sup> 26,000' (BRITISH)	(c) SHF <sup>(3)</sup> 68,000' (GERMAN)	(d) VHF <sup>(2)</sup> 15,000' (AMERICAN)	(e) SHF 76,000' (FRENCH)	(f) SHF <sup>(6)</sup> (TAC-1972-P49)
CAPITAL	£M 25 <sup>(5)</sup>	£M 0.88	Charges on capital included in revenue	£M 4.9	£M 100 total	£M 38
COSTS (per annum)	£M 0.5 <sup>(7)</sup>	£M 1.74	£M 6.38	£M 0.1 <sup>(8)</sup>		£M 0.38
TOTAL COST FOR 10 YEARS USE	£M 17.5 <sup>(9)</sup>	£M 18.28	£M 63.83 <sup>(4)</sup>	£M 5.9	£M 25 <sup>(10)</sup>	£M 41.75

- (1) The 8 hours transmission cost also includes two additional hours flying time to arrive/depart transmitting zone.
- (2) Cost to a single organisation if a two-service network were shared equally between the two broadcasting authorities.
- (3) Estimate by Institut fur Aerodynamik Braunschweig and exchange rate 4.7 DM/£.
- (4) The cost would be reduced (but not pro rata) if shared by more than one authority.
- (5) Very rough estimate including £M 7 for rebroadcast link equipment and programme links.
- (6) Single-service satellite for direct domestic reception.
- (7) 50 stations with 70 staff at an average salary of £4,000 p.a. plus maintenance, rates, and electricity costs.
- (8) Very rough estimate.
- (9) It is assumed that the equipment has a 20-year life span.
- (10) Assuming 4-service capacity.

Figures based on:

- (a) and (b) UK/BBC estimate.
- (c) Com. T(K) 305
- (d) T.COM. Corporation literature.
- (e) PAGASE proposal for 30 balloons.
- (f) UK Television Advisory Committee documents (Papers of the Technical Sub-Committee. 1972).

## Contributors to this issue



**G. E. (Geoff) Buck** joined the BBC in 1959 having previously worked for the EMI and John Mowlem companies following service in the Royal Air Force as a navigator. He has recently been appointed Controller, Finance, having started his BBC career as one of the early Cost Accountants, becoming Engineering Accountant in 1963 and Chief Accountant, Engineering, in 1969. He is an Associate of the Institute of Cost and Management Accountants and has had an interest in computer applications since his involvement at EMI with the production of their prototype digital computer.

A short item about Derek East appears on page 5

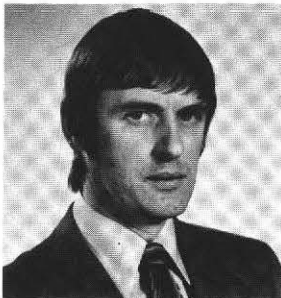

**Malcolm Harman** obtained his technical qualifications at the college of Electronics, Royal Radar Establishment, Malvern and entered the BBC as an Engineer in 1960. Initially he worked with Television Outside Broadcasts, Radio Links Unit and then became a member of Television Recording Section at Lime Grove. In 1961 he transferred to Research Department and joined what was then known as Field Strength Section where he contributed to planning the expansion of the VHF and UHF television and radio networks. From 1969 to 1974 he was with Transmitter Group head office staff but has now returned to Service Planning work at Research Department as leader of a Special Projects and Facilities Unit.

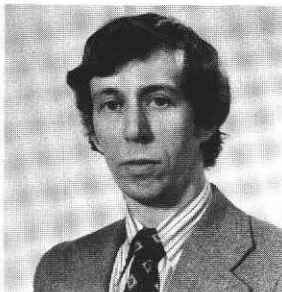

**Joseph Middleton** graduated in Electrical Engineering in 1967 at the University of Manchester Institute of Science and Technology. After a short time in industry he joined the BBC as a transmitter engineer and in 1970 he transferred to the Service Planning Section of Research Department. Here he was initially concerned with the site testing and surveying of UHF transmitters, later becoming involved with other aspects of broadcast planning work, airborne television being one example. At present his work is connected mainly with traffic information broadcasting.



**Irving John Shelley** is Head of Monitoring and Control in the BBC's Designs Department. He joined the BBC Lines Department in 1946, later transferring to Designs Department where for many years he has been concerned with the development of radio, cable, and satellite transmission systems. He was a member of the BBC team which developed the 'Cablefilm' equipment for sending short items of news film over the transatlantic telephone cable. In 1963 he became Head of Signal Processing dealing with optical standards conversion, colour system transcoding, and automatic correctors for the PAL system. He was a member of the UK delegation which visited the Soviet Union in 1964/65 during the period in which the Russian Television Service was experimenting with various colour systems. Since 1969, when he was appointed to his present position, he has been responsible for the development and application of automatic monitoring and control equipment for unattended transmitting stations, automatic waveform correction, and information acquisition and transmission systems. For his work on automatic monitoring he was awarded the 1974 Geoffrey Parr Award of the Royal Television Society.

In 1962, he attended the first meeting of the CCIR Study Group and Space Communication in Washington, and since then he has been associated with the development of satellite systems for the international exchange of television programmes. As a member of the CMTT he was connected closely with the evolution and exploitation of Insertion Test Signals and automatic measuring techniques. He is also associated with the work of the European Broadcasting Union, being a member of the Technical Committee and Chairman of the European Communication Satellite Working Party.

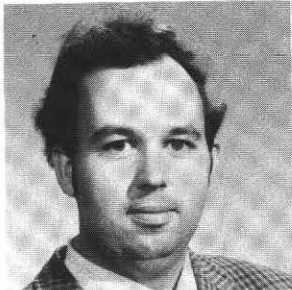

**Mike Tancock** joined the BBC in 1968 as a Technical Assistant at the Bristol regional centre. He continued there as technical assistant and later, engineer, until 1972 when he was attached to the Engineering Training Department at Wood Norton as an assistant lecturer. A permanent post as lecturer followed in 1973, a post he has held ever since.

He is the Engineering Training Section's specialist on Natlock, vision mixers, and television fundamentals. During his time at Wood Norton he has been responsible for the design and construction of many demonstration and experimental chassis, many of which were eventually embodied in the demonstration classroom.



**Graham Wands** joined the BBC as a Technical Assistant at Westerglen MF transmitting station in 1956 after four years with the RAF working on ground radar equipment. He moved to Kirk o'Shotts television and VHF radio station in 1959 and then to a maintenance team responsible for unattended and semi-attended stations in Scotland and northern England. In 1963 he joined the headquarters of Transmitter Group, where he was first concerned with the operation of Band I and Band II relay transmitters and then the introduction of UHF main stations. More recently he has been responsible for the automation of older Band I and Band II equipment and the development of Monitoring and Information Centres. His current post is that of Senior Engineer, Projects.

