

JR PHILLIPS

# BBC ENGINEERING

Number 108 December 1977



# BBC Engineering

including Engineering Division Monographs

A record of BBC technical experience and developments  
in radio and television broadcasting

---

Published approximately four times per year by  
BBC Publications,  
35 Marylebone High Street,  
London W1M 4AA.  
ISSN 0308-2369  
ISBN 0 563 175001

Edited by  
BBC Engineering Information Department,  
Broadcasting House,  
London W1A 1AA.

Printed by  
The Yale Press Ltd,  
London SE25 5LY.

Price  
80p or \$2.00 per issue post free.  
Annual Subscription  
£3.00 or \$8.00 for 4 issues post free.

Articles are copyright © 1977 by the  
British Broadcasting Corporation  
and may not be reproduced in whole  
or part without written permission.

## Contents

<b>Notebook</b>	2
<b>Principal articles</b>	
General-Purpose CMCRs in the BBC G.R. Key	8
A Two-Watt UHF Transposer Designed for Modular Maintenance S.W.P. Collier	14
Sypher: Videotape Sound Post-Dubbing J. Eden-Eadon	23
Colour Picture Improvement Using Simple Analogue Comb Filters S.J. Auty, D.C. Read, and G.D. Roe	28
Contributors to this issue	34

The cover picture shows the BBC Television news  
ENG unit deployed for demonstration at  
Television Centre.

## Notebook

### Alphabets for CEEFAX

CEEFAX is now an established part of British broadcasting and the complete specification<sup>1</sup> of the system used in the United Kingdom was published in September 1976. Although the specification lists the character alphabet required for use with mainly English-language text, much of the technical foundation of the system can be used directly in applications requiring alternative or extended alphabets in other countries. The basic CEEFAX data transmission standard is designed for use with any 625-line television system having a video bandwidth of not less than 5MHz and so can be used throughout Europe and in many other places.

The simplest option for a country requiring an alternative alphabet within the 94-character limit of the basic CEEFAX system is to specify a national version of the character code table for use in its transmissions and decoders, in the same way that alternative character sets are specified for typewriters. Where a basic Latin alphabet is used the unaccented characters would be allocated the same codes as in the UK because these are the subject of international standards. A maximum of about ten additional characters can be allocated in place of the symbols such as  $\frac{1}{2}$ ,  $\frac{3}{4}$ , etc. which are used in the UK. This approach has already been used in Sweden where a CEEFAX decoder can be converted to the 'Swedish' alphabet by merely removing the 'English' character ROM (Read-Only-Memory) from its socket and replacing it by the 'Swedish' ROM. A decoder could have several character sets available, selectable by switching between different ROMs and the switch could be coupled to the channel selector. The CEEFAX specification provides for the possibility of using control bits on each page to select the correct character set for that page. This would allow automatic selection from alternative character sets in places where more than one character set is needed, although the allocation of these control bits (C12, C13 and C14) would need to be standardised to allow all necessary combinations to be possible. These bits would then be presumed to be 000 for the UK alphabet given in the CEEFAX specification.

There may be circumstances where the total number of characters required, including numerals and punctuation signs, exceeds the 94 available in the basic CEEFAX system. In such cases the code set can be augmented<sup>2</sup> by using another 126 'even parity' codes. The codes 00000000 and 11111111 are excluded in order to retain the limit on the maximum period between data transitions to ensure good clock recovery. Some or all of these extra codes could be allocated to the various accented and special letters, and

extra punctuation symbols, required in addition to the basic 94-character set. It would then be necessary to include, for example, a cyclic-redundancy-check word within and relating to each data line in order to provide error detection. This word could take the place of an end character code on the line (reducing the system to 39 characters per row) or it could be provided by using alternative 'space' codes between words to signal the additional information. It is apparent that a system using such an augmented alphabet can be designed to handle English text entirely in accordance with the CEEFAX specification, and that a CEEFAX decoder presented with a signal using the augmented alphabet will display the basic alphabet correctly and the additional characters as 'substitute' characters (usually spaces, queries or deletes). So here is a fully compatible basis for extending CEEFAX to handle up to 220 different characters where needed. Clearly a similar approach can be used to extend the graphics character set, or to send arbitrary data, where needed.

An even more powerful method of extending the range of available characters is given by allowing the editor to define and redefine as necessary the shapes of any new characters he wishes to use on a particular page or in an entire magazine. A system has been devised<sup>3</sup> in which a non-displayed page or part of a page can be used to define some or all of the characters as a 10 by 7 dot matrix. These shapes can be stored in a decoder auxiliary memory and used in place of some or all of the basic stored shapes. Using the technique described above, the newly defined characters could form part of the additional set. Here then is a system in which the characters displayed by suitably-equipped decoders can be varied whenever necessary, entirely by remote control. It is interesting to note that storage sufficient for a page of CEEFAX is just sufficient for storing a set of 96 character shapes.

While CEEFAX continues to fulfil the requirements for information broadcasting in the UK it is clear that there is sufficient flexibility in the basic system to accommodate special alphabet requirements in other countries.

### References

1. Broadcast Teletext Specification, September 1976, BBC/IBA/BREMA. ISBN 0 563 17261 4.
2. Patent application 41265/77.
3. Patent application 47338/75.

## Site Acquisition Survey Vehicle



The present phase of UHF relay station building is now dealing with many remote and isolated sites and the Site Acquisition Section of Transmitter Group has recently commissioned the vehicle shown above for reception checks of signal quality for rebroadcasting at such sites. The vehicle uses a Unimog chassis on which is mounted the specially-built bodywork to house complex technical equipment and a telescopic mast.

A basic requirement for reception at a UHF relay station site is precise positioning of the receiving aerials because in many cases the reception conditions vary markedly with height. For this reason the vehicle has been equipped to measure automatically and plot on a 3-channel chart recorder the level of vision carrier, the vision/sound carrier ratio and the video chrominance/luminance ratio.

An article describing the BBC's site acquisition work and containing a fuller description of this vehicle is in preparation for a future issue of *BBC Engineering*.

## Quadraphony — BBC/NRDC System HJ

The co-operation between the BBC and the National Research Development Council (NRDC), mentioned in the Notebook section of *BBC Engineering* Number 107, August 1977, has already resulted in a unified specification for quadraphonic encoding.

Mainly as a result of Matrix H broadcasting experience gained by the BBC during the 1977 Promenade Concert season, the BBC and NRDC jointly decided that it would be advantageous to make minor alterations to their respective systems, BBC Matrix H and NRDC System 45J. The change primarily affects the phase of signals related to a centre-front source and improves stereo compatibility with very little effect upon either mono or surround reproduction. Thus existing decoders do not require any alteration.

As a result of these changes the two systems moved even closer together and it became possible to agree upon a unified specification which takes the form of tolerance zones on the Scheiber Sphere in which the encoding points will lie.

The joint system will be known as BBC/NRDC System HJ to mark the fusion of two extensive programmes of research and development. Future BBC surround-sound

broadcasts will use this system. Collaboration between the BBC and NRDC in the fields of production and microphone techniques and decoder technology will continue.

### Technical note

For any particular system there always exists a multiplicity of loci for different but equally acceptable microphone techniques. The 'tolerance zones' method is a useful way of specifying the practical implementation of the system. A single-line locus is valid for only one microphone set-up and, if only the coefficients of the encoding matrix are specified, the strong influence of microphone technique on the overall system is ignored. The design of the decoder must take into account all possible loci falling within the tolerance zones given. The tolerance zones for System HJ are specified in the diagram and table below.

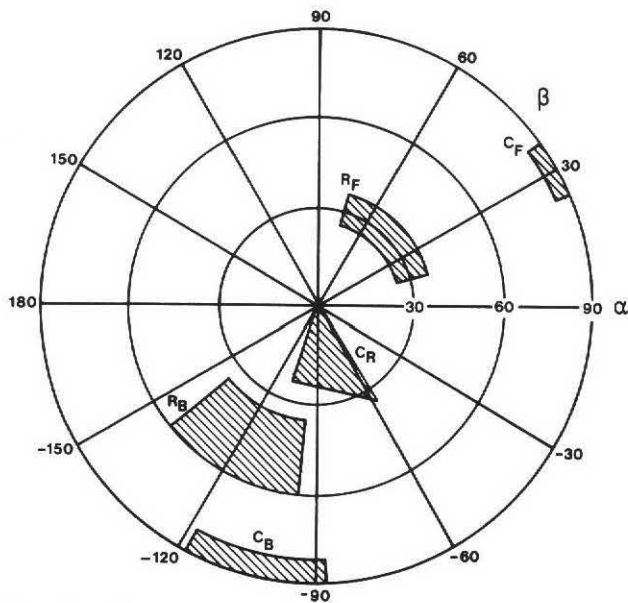

Stage location	$ \alpha $	$\beta$
$C_F$	$90 \pm 5$	$30 \pm 6$
$R_F$	$30 \pm 5$	$45 \pm 30$
$C_R$	Bounded by points ( $\alpha = 0$ ), ( $\alpha = -25, \beta = -110$ ), ( $\alpha = 35, \beta = -58$ )	
$R_B$	$47.5 \pm 12.5$	$-117.5 \pm 22.5$
$C_B$	$90 \pm 5$	$-102.5 \pm 15$
$L_B$	$132.5 \pm 12.5$	$-117.5 \pm 22.5$
$C_L$	Bounded by points ( $\alpha = 180$ ), ( $\alpha = -155, \beta = -110$ ), ( $\alpha = 145, \beta = -58$ )	
$L_F$	$150 \pm 5$	$45 \pm 30$

## BBC/3M Digital Audio Recorder

The BBC and the 3M Company, of St. Paul, Minnesota, USA, have collaborated in the development of a digital audio recording system which promises to revolutionise professional sound recording. The use of digital techniques derived from computer technology has resulted in a system which is virtually distortionless and noise-free — a performance unattainable with conventional analogue techniques.

The system is the result of research conducted by the BBC and 3M jointly during the past two years and independently by both organisations before that. The BBC, for long prominent in audio research, has pioneered the use of digital techniques. The 3M Company has been a pioneer in the US in the development of magnetic tapes for computer, video and audio applications and is a leading manufacturer of professional audio equipment and tape. This technological achievement is particularly significant because earlier attempts at digital audio recording required huge quantities of magnetic tape and too many recording tracks; also the static-like noise created by tape drop-outs destroyed the otherwise noise-free characteristic of digital recording.

The advantages of the new system include the absence of tape noise, modulation noise, distortion and flutter, and a very high signal-to-noise ratio. The highest grade of analogue recording system now available has a signal-to-noise ratio of some 68dB. When coupled with a noise reduction system other compromises have to be made and even then an improvement of only 10dB to 20dB is obtained. Figures released by 3M show that the new digital system is achieving better than 90dB. Other advantages include the lack of deterioration of signal quality in making multiple-generation copies during dubbing and mix-down, the elimination of involved equalisation and bias settings, and operational simplicity.

## ENG

The one-year experiment in electronic news gathering (ENG) techniques, announced in the last issue, page 36, began on 10 October. The advantages of ENG lie in the immediacy of transmitting news from location and the elimination of film processing time.

The ENG crew of two, with a Range Rover as their vehicle, operate the highly mobile equipment which includes a portable electronic camera, cassette video recorder, short-range radio link to carry camera signals back to the vehicle and a higher-powered radio link from the vehicle via a base station to BBC Television Centre. The story can be recorded on location and the cassette taken back by despatch rider to Television Centre; the story can be transmitted by radio link to the Centre for recording and editing there; or the picture signals carried by the radio link can go live to the transmitter network. All three modes of operation will be tried during the experiment.

The 13GHz short-range radio link transmitter can be taken with the camera to the scene of the news story and will often be used to transmit out of a window in a building back to the vehicle; hence its common name of 'window' unit. The 25-watt 2.5GHz link transmitter feeds a circularly-polarised aerial with dish reflector on the roof of the vehicle and its signals are received on specially-positioned Nural horn aerials at the reception point. Indication of the received signal strength at this point will be available in the vehicle via the radio communication system. In order to optimise the quality of the received signal, remote control of the receiving aerial polarisation, including horizontal, vertical, clockwise and counter-clockwise selection, is possible from Television Centre.

The pictures below show the ENG camera and the Range Rover with its roof-mounted radio-link aerial.

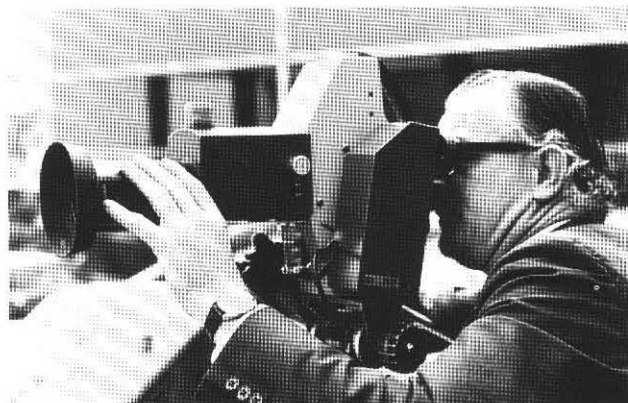

The cover picture shows the ENG vehicle and equipment set up for demonstration. On this occasion the 'window' unit was used 'in reverse', to transmit the camera signal into Television Centre for recording.

## Variable-emphasis limiter in disc recording

Until very recently disc-cutting equipment has been designed on the assumption that, except for very brief periods, the programme signal would contain high-level components only within the range of the fundamentals of normal musical instruments. The advent of electronic effects and synthesised music has removed the foundations of that

assumption, and all but the latest equipment is liable to mis-handle such material to the extent of cutting an unplayable groove or, worse, damaging the cutting head.

This problem was brought abruptly into focus a year ago in the Transcription Recording Unit of the BBC when recording some radiophonic music. In spite of the protection devices in the recording equipment, more than £1000 worth of damage was caused. As a result of this incident the Unit's tape preparation channels were fitted with equipment to detect dangerous material in order to permit it to be modified before disc cutting was attempted.

By this means the programmes were recorded safely, albeit with less than complete fulfilment of the producer's intentions. Eventually, however, a programme came along which could not be recorded without drastic modification. The synthesised music had been specially composed and was an essential part of the programme, so a solution of the problem was eagerly sought.

It was found in the variable-emphasis limiter<sup>1</sup> normally used for avoiding over-modulation of FM transmitters. The device operates by modifying the pre-emphasis characteristic in accordance with the level of the high-frequency components. Thus, a burst of high-frequency energy in the signal will operate the limiter and avoid over-modulation, but *without* reducing the level of the low and middle frequencies. This method causes much less subjective degradation of a programme than conventional limiting.

The programme which had given rise to such an apparently intractable problem was recorded on disc at normal level, using the variable-emphasis limiter. There was a slight modification of the original effect but it was small enough to be acceptable to composer and producer.

1. Gleave, M.M. and Manson, W.I. The Development of Sound-Programme Limiters in the BBC. BBC Engineering No. 107, August 1977.

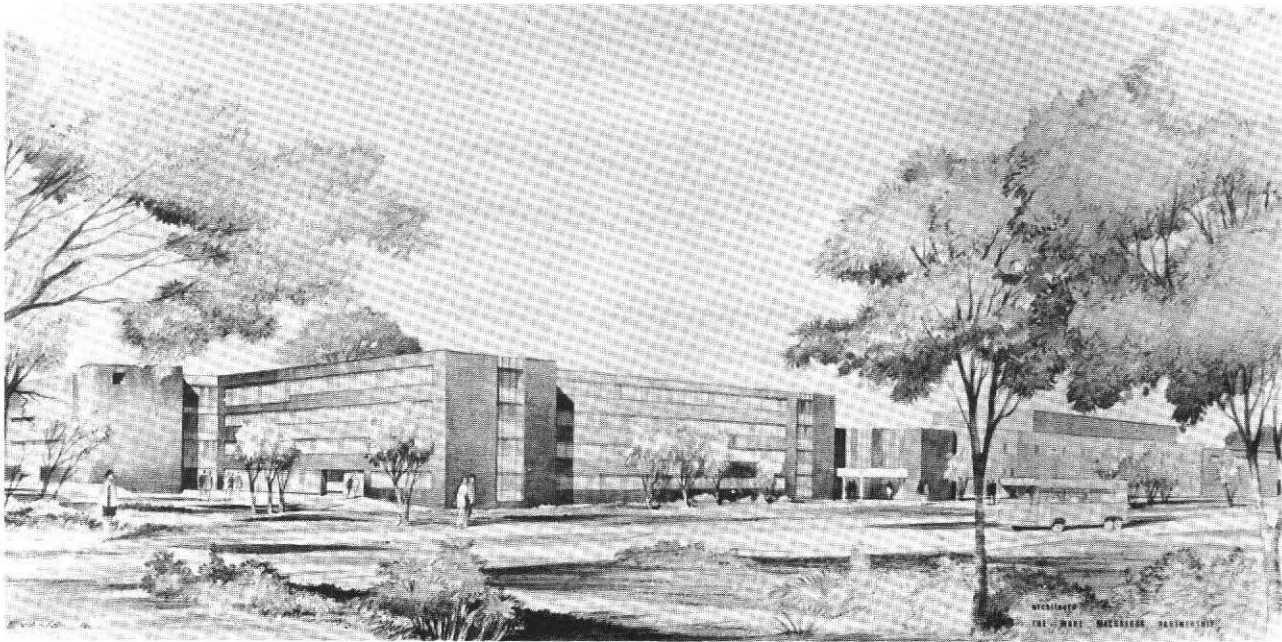

## BBC/Open University Production Centre

In Britain the Open University makes widespread use of television and radio programmes which have been made since 1970 in the BBC studios at Alexandra Palace in North London. As a replacement for these, construction work has begun on a new £6m studio centre, on the University campus at Milton Keynes some 80 km northwest of London. Facilities in the new building will allow programme output to be increased to 400 television and 400 radio programmes a year from the present level of 300, with provision for further expansion as the Open University develops.

The illustration shows an artist's impression of the finished building, which will consist of an office block and a technical block. There will be two television studios, a radio

studio suite, central technical area, film dubbing suite, review theatres, cutting rooms, design areas and all the usual ancillaries required in a self-contained studio complex.

Architects for the project are the Ware MacGregor Partnership who have worked with the Open University and the BBC to produce a building design which satisfies the requirements of both organisations and the cost constraints imposed by the Department of Education and Science. Planning and installation of the technical plant is being undertaken by the BBC Studio Capital Projects Department.

When the centre is completed in four years' time, some 300 BBC staff will move to Milton Keynes, ending an historic link between the BBC and Alexandra Palace where the world's first high-definition television service began in 1936.

## Remote Control of Monitoring Receivers and Recorders

The BBC Monitoring Service has developed a system of remote control of receivers and recorders which is economical in use and has operated reliably over distances up to 1300 km over a four-wire telephone circuit. Provision has been made for the connection of any of ten receivers to the input of any of five tape machines or to the programme line, and for the connection of the output of any of the machines to the line. The capital cost of the equipment is low in relation to the revenue savings it brings.

At the control terminal the operation required at the remote terminal is selected and the equipment transmits a 16-bit message character consisting of:

	<i>Bits</i>
Start	1 and 2
Command	3-5
Source address	6-9
Tape machine address	10-12
Operation code	13 and 14
Stop	15 and 16

The command (bits 3-5) instructs the remote terminal to write the rest of the data (bits 6-14) in its transfer memory. No other action is called for at the remote terminal except its automatic response to the reception of a message character, i.e. to transmit a similar character back to the control terminal. The return character contains a 'verification-of-execution' code in bits 3-5 (in place of the command code) and the contents of the transfer memory in bits 6-14.

The character received at the control terminal should, therefore, be identical with that transmitted as far as bits 6-14 are concerned, and a comparator checks for this condition. If the two groups of bits are *not* identical the same message character is sent again. When the groups *are* identical the control terminal changes the command code to instruct the remote terminal to execute the operation defined in its transfer memory.

The execution consists of appropriately revising the contents of the status memory which, in turn, performs the required functions. When execution is complete the verification code generator is triggered to confirm the fact.

On receipt of this confirmation the control terminal revises its own status display and sends a 'clear' command. On arrival at the remote terminal this instruction resets to zero both the transfer memory and the verification code generator so that the next character sent back to the control terminal has a zero in each bit position from 3 to 14. A 'ready' indication is given and the system is once more able to accept a fresh instruction.

The transmission of one complete 16-bit character takes approximately half a second and the receipt of a character at either terminal initiates the appropriate action followed by the transmission of a suitable return character. Thus characters from the remote terminal arrive at the control terminal at intervals of about one second. The interval is

monitored in the 'clock and trigger circuits' unit and if it exceeds 1.5 seconds a circuit failure alarm is given. The control terminal continues to transmit characters at 1.5 s intervals until a return character is received, when the alarm is automatically reset.

Circuit failure does not affect the status of the system. New instructions cannot, of course, be sent until the circuit is restored, but incorrect operation cannot be initiated, and existing operations cannot be interrupted, by a circuit failure. Maintained power supplies are provided to guard against supply failures.

Interlocks are provided to prevent certain types of erroneous operation (such as connecting two sources to the same tape machine). In addition, the tapes are rewound automatically on completion of a record or replay period. This avoids the need to remember — all too easily overlooked when the machine is out of sight — that rewinding is necessary. The information conveyed in the message characters is handled in parallel form in both terminals and serial-to-parallel and parallel-to-serial converters are used between the main terminal equipment and the line.

It is, of course, essential that the tape machines used should be highly reliable, because they have long periods of unattended operation, and that they should be fitted with end-of-tape indication and remote control facilities. So far the system has been in operation for over two years. The few failures have been due to components and are consistent with the manufacturers' published reliability figures.

## Research Department Reports

BBC Research Department has published the following Reports during the last three months.

<i>Report No.</i>	<i>Title</i>
1977/23	Metal-halide discharge lamps: the measurement of intensity ripple and a note on operation at high supply frequencies
1977/24	Domestic installations for direct broadcasting from a satellite
1977/25	Ground-wave propagation at medium frequency in built-up areas
1977/26	CEEFAX: evolution and potential
1977/27	Digital television: the use of waveform estimates in error correction
1977/28	The electronic concealment of blemishes on the output of solid state image sensors
1977/29	The HMI 575-watt metal-halide discharge lamp: measurements and predicted effects of intensity ripple using sinusoidal lamp excitation
1977/30	A wideband microstrip uhf hybrid

A subscription to BBC Research Department Reports, of which about 35 are published each year, costs £25.00. Further information and subscription forms are available from: *Research Executive, BBC Research Department, Kingswood Warren, TADWORTH, Surrey, England.*

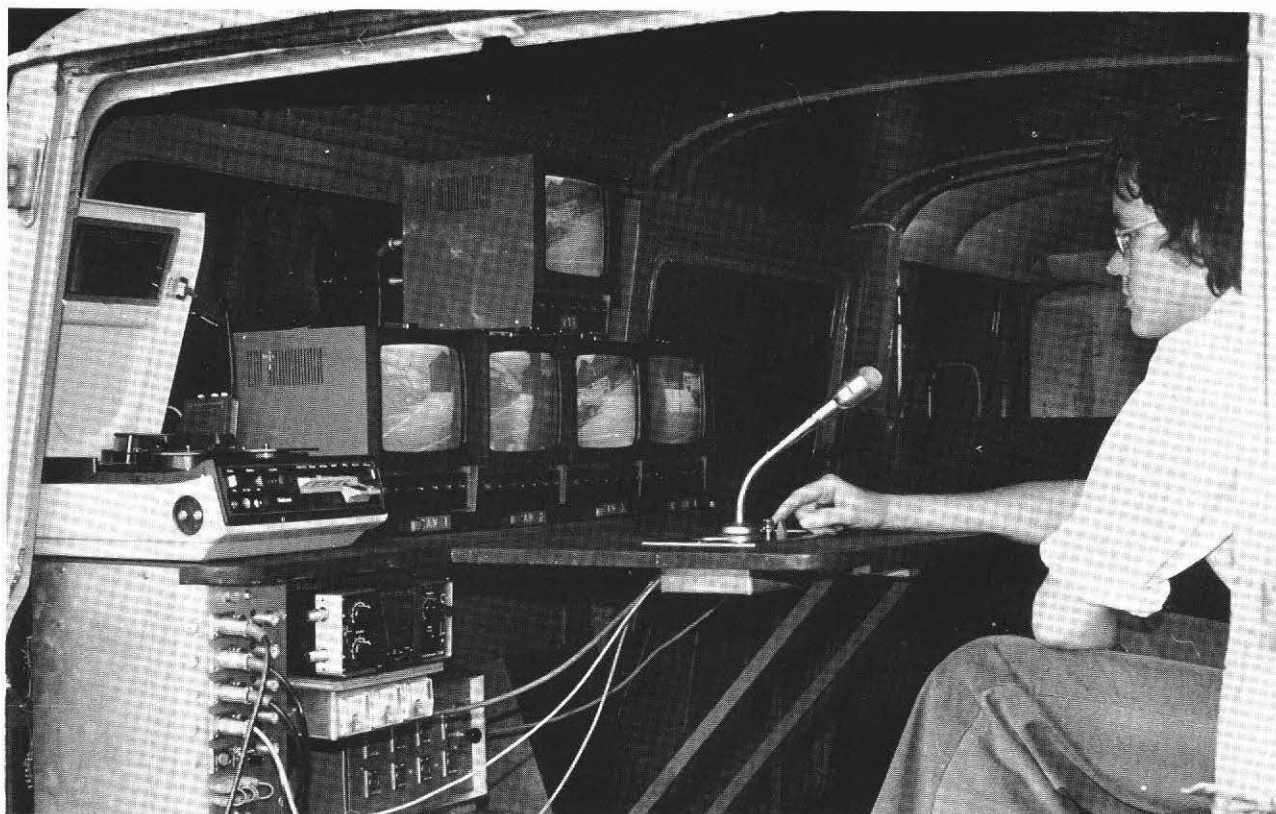

## Film Control Vehicle

A van has recently been fitted with equipment which allows film cameras to be monitored and directed from a central

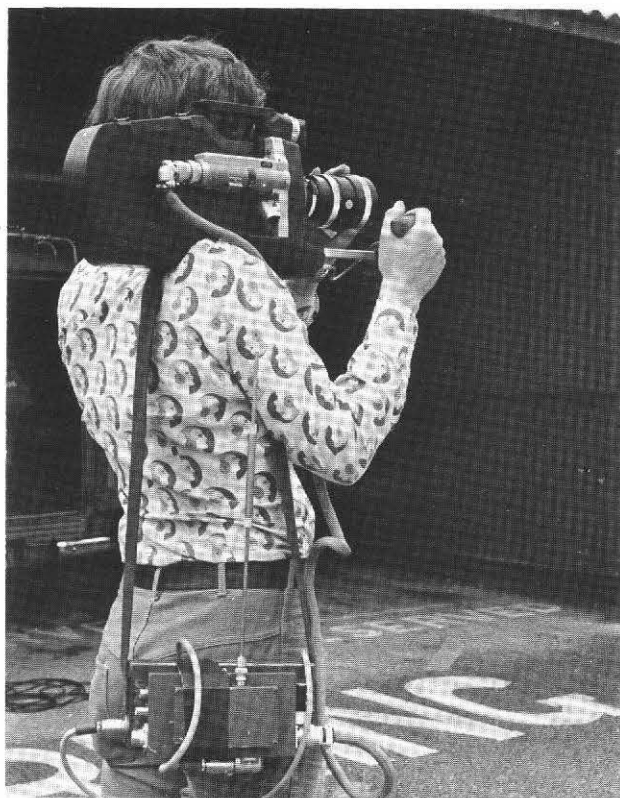

point. Up to four film cameras, each fitted with an electronic viewfinder, can be handled. Monitors in the van display the pictures from the viewfinders and other equipment fitted includes a small helical-scan video recorder, a simple video switcher and communication equipment. The first picture shows the interior of the van. All the equipment can be quickly removed and used elsewhere, for example inside a building.

The recorder can record from any of the viewfinders or from the output of the switcher, thus allowing cutting from one camera to another and the making of an intercut recording where a number of cameras are used on continuous action. Programme sound is also recorded. The videotape recording can be replayed immediately in the vehicle or studied later.

The cameras are usually connected to the vehicle by a cable which may be up to about 100 metres in length. One camera can also be operated over a radio link carrying viewfinder output and intercom so that completely isolated and distant operation is possible. The second picture shows a camera with electronic viewfinder and radio link.

Except when using the radio link camera, all the electronic viewfinders are in synchronism, giving stable operation and clean vision cuts and videotape recording. Cuts to and from the radio camera are possible but there may be some picture disturbance.

All the equipment in the vehicle is powered from a heavy-duty battery which has sufficient capacity for a normal day's filming. The battery can be continuously recharged from a charger in the vehicle if a mains supply is available at the location.



# General-Purpose CMCRs in the BBC

G. R. Key, B.Sc.

Studio Capital Projects Department

**Summary:** This article traces the development of CMCRs (Colour Mobile Control Rooms) in the BBC and describes in some detail the latest model (Type 4) which entered service in 1976. It also includes brief information about the design of the Type 5 CMCR which is due to enter service in 1978.

The author describes only general-purpose vehicles and does not deal with those made for specific applications, such as drama or news, or those which have limited facilities.

- 1 Introduction
- 2 Type 1 CMCR — 1967
- 3 Type 2 CMCR — 1969
- 4 Type 3 CMCR
- 5 Type 4 CMCR — 1976
  - 5.1 Production Control Room
    - 5.1.1 Vision Mixer
    - 5.1.2 Flexible Cue System
  - 5.2 Vision Engineering Control
  - 5.3 Sound Control
  - 5.4 Talkback System
  - 5.5 Power Distribution
- 6 Type 5 CMCR — 1978
- 7 Conclusion

## 1 Introduction

A CMCR has to accommodate all necessary personnel and control equipment in a vehicle of acceptable (and usually minimal) overall dimensions. There are two alternative basic arrangements.

- a) Personnel are seated in rows across the vehicle (crosswise layout). If the rows of seats are on different levels, monitors may be shared.
- b) Personnel are seated side-by-side in line along the vehicle (in-line layout).

In both cases the vehicle may be divided into areas separated by semi-glazed partitions to facilitate the operations of the various sections of the production team whilst reducing acoustic crosstalk between areas.

Disadvantages of the crosswise layout are:

- i) A maximum of four operators in any one line.
- ii) The number of monitors in a stack is limited by the height and width of the vehicle, so putting a limit on complex productions.
- iii) It is difficult to provide satisfactory visibility between areas without having uncomfortable viewing angles for the operators.

The main limitation of the in-line layout is set by the vehicle width (maximum 2.5 m in the United Kingdom) which restricts access behind operating positions. If precision slimline colour monitors ever become a reality more space will be available, although it is likely that equipment for additional facilities will fill some of it at least.

Especially on sports and multi-location programmes the sound operator needs to see the vision mixer panel in order to anticipate picture location changes and synchronise the sound accordingly. This requirement is particularly important on outside broadcasts as it is usual for the producer to do the vision mixing and not unusual for shots to be called after the event.

## 2 Type 1 CMCR — 1967

This type of CMCR, of which three were built on BBC premises, opened the BBC colour television service in July 1967 with outside broadcasts of the Wimbledon Tennis Championships.

Reflecting the lack of operational experience the vehicles were designed to use any of several types of camera but were eventually equipped with Philips PC60 cameras which were judged to be the most suitable for outside broadcast use at that time.

The equipment was capable of 625/PAL and 525/NTSC standards of operation, the latter to facilitate programme production for the United States market as there were no colour standards converters available at the time. All the equipment was built into demountable frameworks (sub-racks) to permit a complete de-rig into a theatre or other building — a technique which has since proved too expensive in time to be practicable for colour operation although it was routine at some venues in the monochrome days.

The crosswise vehicle layout (figure 1) shows strong evidence of its monochrome ancestry, having a shared operational area in front of an economical monitor stack which included only two (later augmented to three) colour

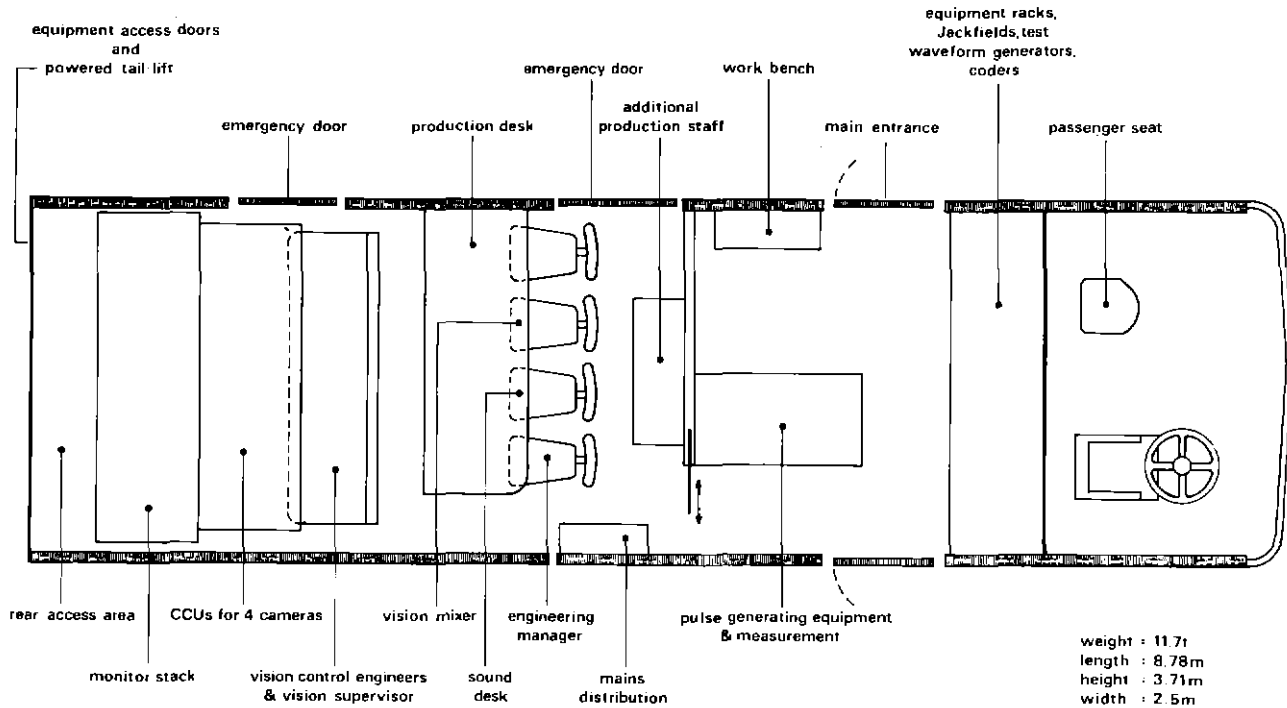

Fig. 1 Layout of Type 1 CMCR

monitors. The camera control units were heavy console units which could be removed through large rear doors through a powered tail lift. Such rear access is, however, unsatisfactory in wet or cold weather.

Experience with the Type 1 CMCRs led to a major review of the design before construction of the fleet of nine CMCRs of Type 2 which were still in service when this article was published.

### 3 Type 2 CMCR — 1969

The rapid growth in the complexity of colour outside broadcasts soon made the limitations of the crosswise layout unacceptable. The in-line layout (figure 2) was therefore adopted for Type 2 and all subsequent large vehicles. The Type 2 CMCR, of which nine were built under contract by Pye TVT Limited, became the main fleet vehicle.

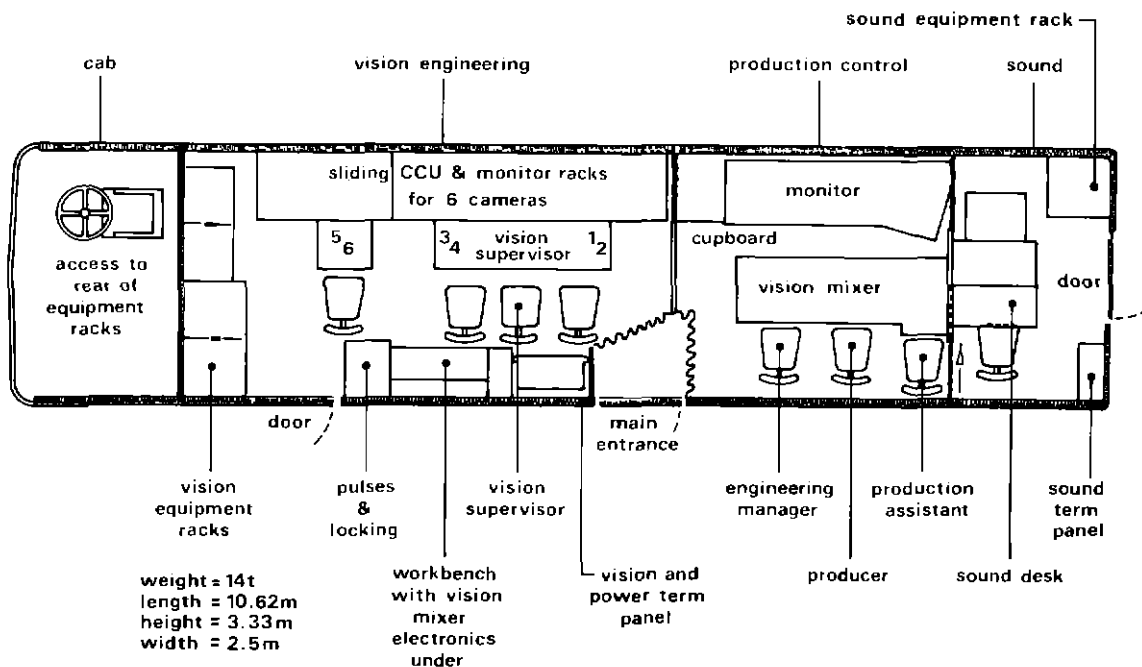

Fig. 2 Layout of Type 2 CMCR

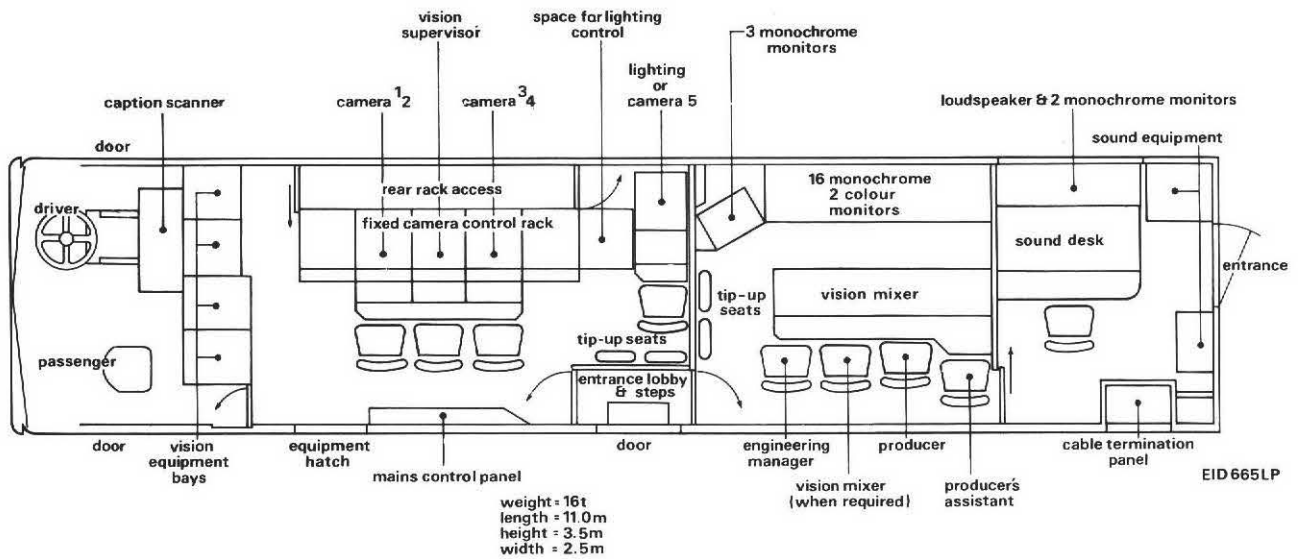

Fig. 3 Layout of Type 4 CMCR

Among other innovations were the use of the driving cab to give access to the rear of the main vision equipment racks and the installation of lighting control equipment. Access to the rear of the camera control units is obtained by sliding them forward on runners. This arrangement gives maximum area for personnel under operating conditions.

#### 4 Type 3 CMCR

The Type 3 CMCR was a design concept which was not implemented. It was to have been a two-channel vehicle offering full facilities but preliminary costing showed that it would have been too expensive to justify the benefits envisaged from the design. As the proposal has been superseded, no details are given here.

#### 5 Type 4 CMCR – 1976

The Type 2 CMCRs were generally well liked although the design did have some weaknesses and so in 1975, when it became necessary to replace two of the Type 1 vehicles, comprehensive discussions between operational and engineering departments resulted in a BBC Specification for Type 4 vehicles. Two vehicles, CMCRs 16 and 17, were built by Pye TVT Limited and entered service in Wales and Scotland respectively in 1976. The design brief for Type 4 included the following improvements or additional facilities.

- i) An entrance lobby to reduce draughts and light from outside. Its doors to close quietly and securely.
- ii) A layout which should preclude the need for sliding equipment racks, especially where there is frequent need for rear access to camera control units and monitors. Such access has contributed to some reliability troubles and has impeded access to racks at the far end of a row.
- iii) A lighting control position, which would double as a fifth camera position.

- iv) Comprehensive termination panels including more tie-lines to enable on-site cables to be easily connected outside the vehicle. Appropriate services to be connected on jackfields within the vehicle.



Fig. 4 General view of Type 4 CMCR



Fig. 5 Type 4 CMCR: Production Control Room

- v) New communication facilities with improved quality and greater versatility. Communication to be direct between relevant operators without need for special arrangements (add-on boxes) for unusual programmes. Most outside broadcasts are unusual in some way.
- vi) Enough monitors for large and complex shows to be permanently built in, so that the need for supplementary racking was obviated.

Consideration was given to the use of an articulated vehicle, but it would have had serious disadvantages. The coupling arrangements between tractor and trailer would add about 2 m dead space to the overall length and this would make parking and garaging more difficult. The coupling also results in a high floor level. Instead, a rigid chassis of the maximum legal length (11 m) was chosen and a second steered axle was added to achieve a uniform weight distribution. (A rear axle with four wheels may carry 10 tonnes while a single steering axle with two wheels is limited to 6 tonnes, assuming appropriate tyre and suspension ratings. Adding a second steered axle allows a 16-tonne vehicle to be uniformly loaded.) Experience shows that the normal load of a CMCR should not exceed 80 per cent of the suspension rating. This is because the load is permanent, unlike that of a transport lorry, the suspension of which can recover whenever the load is removed.

Figure 3 shows the layout of the two Type 4 CMCRs and a general view of CMCR 17 is in figure 4. The flaps above the cab are raised to ventilate the air-conditioning equipment supplying the operational areas. Technical equipment is ventilated with fresh air only; extra air-conditioning equipment to cool it would impose an additional load of 25 A on the mains supply.

The following description applies to both vehicles although the photographs are mainly of CMCR 17.

### 5.1 Production Control Room

A general view is in figure 5 and the personnel are, in order from the foreground, the Engineering Manager, the Producer and the Producer's Assistant. The control desk is adjustable in position to allow optimum viewing distance (within the constraint set by the vehicle width) of the monitor stack which houses two 17-inch colour monitors and up to nineteen 11-inch monochrome monitors. These can be allocated as required but a typical arrangement would be as follows.

Colour	transmission switchable preview
Monochrome	12 vision mixer channels 2 radio check (both BBC networks) caption engineering preview video tape 2 vision mixer auxiliary outputs

The Engineering Manager's control panel has, at the left, controls for ten lighting dimmers which are used direct for simple productions or could be used as master controls working with auxiliary dimmer systems where the

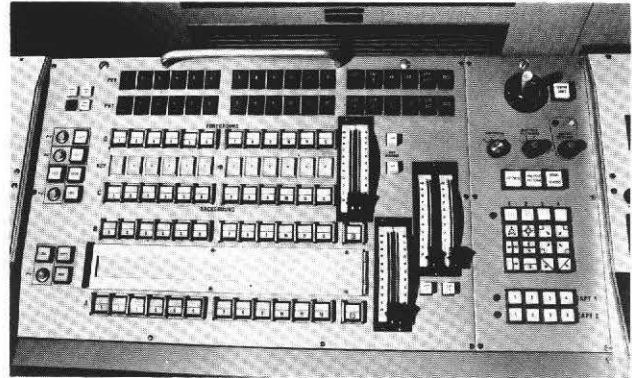

Fig. 6 Type 4 CMCR: Close-up of Vision Mixer Control Panel

requirements are more complex. The other panel assists the Manager to exercise his responsibility for the technical quality of the production. It enables him to preview the outputs from the picture sources and to communicate with the other members of the team, outside sources, the studio centre, etc.

On outside broadcasts the vision mixer panel is often operated by the Producer, as shown in figure 5. The mixer is described in the next section. The other member of the team shown, the Producer's Assistant, calls the shot numbers and keeps a close check on the timing of the production.

#### 5.1.1 Vision Mixer (figure 6)

Although BBC studios usually use 'knob-a-channel' mixing which, as the name implies, provides a control for each source connected to the mixer, for the unscripted conditions which are typical of outside broadcasts the two-bank A-B mixer is ideal and this is the type used in the CMCR. Inter-camera cutting on either bank is possible as well as mixes, wipes and other effects between the banks. A second pair of banks added above the A-B banks increases the capacity available for special effects to a level not far short of that required for full studio operation, while retaining the basic simplicity of allowing the operator to cut along a bank. At the same time this configuration makes available a second mixer which can either be kept as a reserve or used to feed an independent output. An example of the latter occurs when interviews are recorded during a sports event for transmission during an interval or after the event.

In the mixer in CMCRs 16 and 17, only the upper (C and D) banks are equipped with Colour Separation Overlay or Chroma-Key. The keying waveform may be selected by the KEY row of buttons or may automatically follow the foreground selection by using the FOREGROUND key.

The design of the mixer allows captions to be added after the fader controls. A monochrome caption scanner is installed in the CMCR and the mixer can provide synthetic colouring of the lettering and background and the selection of all-round-black or coloured edging if required.

Pairs of faders are provided for mixing; these can be operated separately to provide fades to black or to allow non-proportional mixing. The white paper strip between the A and B banks is for source identification.

Each mixer channel is provided with synchronous/non-

synchronous colour monitoring and a Natlock synchronism comparator. The associated logic and sync stabilising amplifiers ensure full broadcast performance at all times, regardless of input signal and fader states.

### 5.1.2 Flexible Cue System

On-air cues are correctly produced by the vision mixer, regardless of its mode of operation. For example, the cues are correct when the upper (C-D) bank is re-entered into the lower (A-B) bank when both the A-B and C-D banks are producing transmission outputs. They are also correct when, in an emergency cut mode, the mixer is replaced by the preview system.

Cues are fed to appropriate cameras, whether working with the CMCR or to other contributing CMCRs. Cameras are not rigidly allocated to mixer channels but may be numbered in a logical 'production' pattern on the outside broadcast site, the cues being allocated via a pin matrix.

## 5.2 Vision Engineering Control

Figure 7 shows the vision supervisor sitting between the two camera engineers. The supervisor is responsible for colour balance and overall picture quality. The racks in the background of the photograph house the vision mixer, pulse generators and test and measurement equipment.

Each camera engineer normally controls the alignment and exposure of two cameras, and views their outputs, and the CMCR output, on a single colour monitor. Monochrome monitors are provided above to facilitate the adjustment of camera registration using colour difference signals.

The supervisor's headset and microphone is an alternative to the open microphone and loudspeaker.

## 5.3 Sound Control (figure 8)

The sound control desk is a 24-channel 4-group modular desk manufactured to the BBC's requirements by Rupert Neve and Co. Ltd. Each channel has an input sensitivity range from  $-70$  dB to  $+10$  dB and is fitted with a response selection amplifier. Channels can be routed to any of the four groups or to four sub-groups. The main groups can then be routed to the Main Output or to the Main Clean Feed or independent outputs.

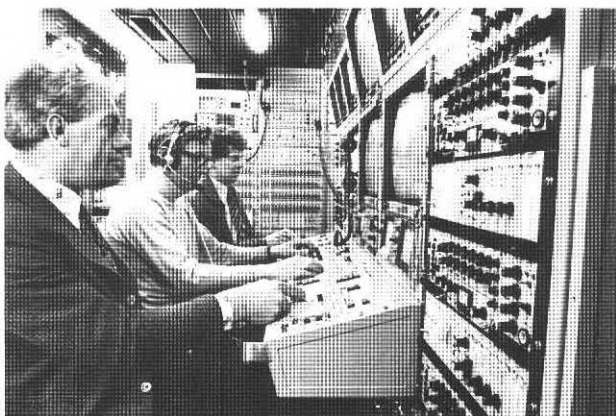

Fig. 7 Type 4 CMCR: Vision Engineering Control

A comprehensive insert jackfield is incorporated in the desk to allow limiter-compressors to be used where necessary. Echo, public address and four foldback outputs are available from the desk in addition to outputs from individual channels and groups. Groups and sub-groups can also be combined in a matrix to form four outputs for recording purposes.

Comprehensive peak programme meter and loudspeaker monitoring facilities are provided.

## 5.4 Talkback system

The equipment rack shown in figure 9 is the heart of the talkback system of a Type 4 CMCR. Operators' control panels in the CMCR are fitted with microphones and loudspeakers only and these operate through remotely controlled amplifiers in the rack. Each amplifier is fitted with a limiter-compressor. A system of peak programme meter monitoring and tone injection permits full checking of the system without recourse to jackfields and external test equipment.

The matrix shown alongside the peak programme meter in



Fig. 8 Type 4 CMCR: Sound Control Desk

figure 8 allows external positions to be fed with the specific mixture of talkback required.

## 5.5 Power distribution

The panel shown in figure 10 controls the power distribution. The left-hand section houses magnetic circuit-breakers for 240 V a.c. distribution, from two incoming 80 A supplies; metering is on a subsidiary panel.

The CMCR relies on an external earth for safety and an installed line earth loop tester enables the earth impedance to be checked before a broadcast. The white earth-leakage circuit breakers in a row near the bottom of the panel protect supplies for commentators and other external facilities.

The right-hand section of the panel controls the distribution of 24 V d.c. supplies. Batteries are used to power the CMCR lighting, communications and sound facilities during a mains failure and the facility is also invaluable during rigging, before mains supplies are established. The 250 A h batteries get their main charge from automatic mains-powered chargers but also get a top-up charge from the vehicle's alternator.

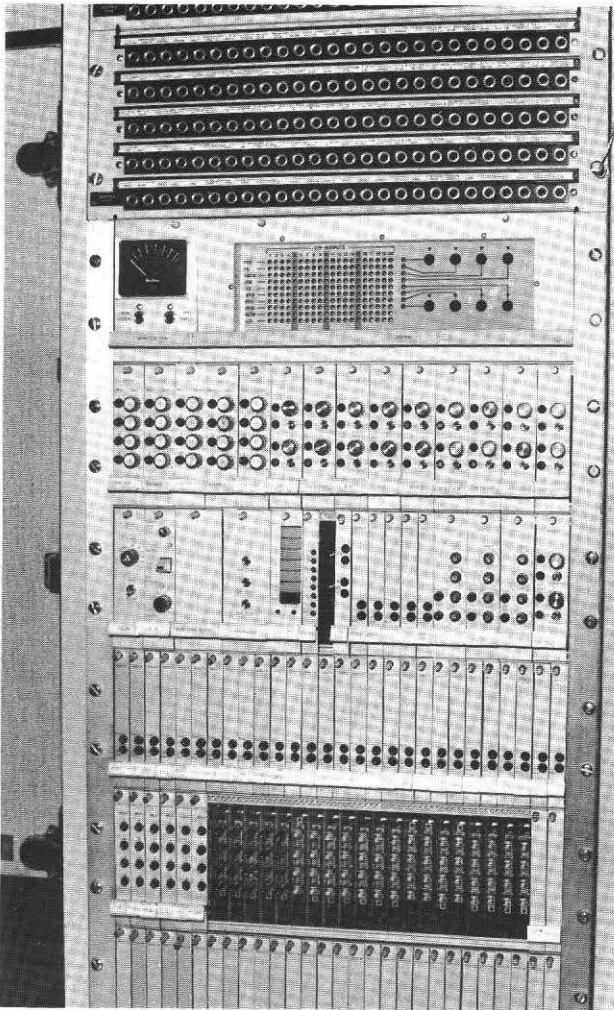

Fig. 9 Type 4 CMCR: Talkback equipment

## 6 Type 5 CMCR — 1978

Planning is now in progress for CMCRs to replace the Type 2 vehicles which are showing signs of old age even though they continue to give good service. The new units will continue the trend toward greater flexibility so that they can cope with complex productions without an excessive need for special arrangements. Each vehicle will accept up to eight installed camera control units. They will use lightweight (tri-ax) cables and their control units will be capable of accepting inputs from standard or lightweight cameras.

It is planned to minimise on-site cabling by using multi-core cables for the video and communication channels and multiplexed signalling to allow video selection from commentary positions. Cues to truly remote cameras can be

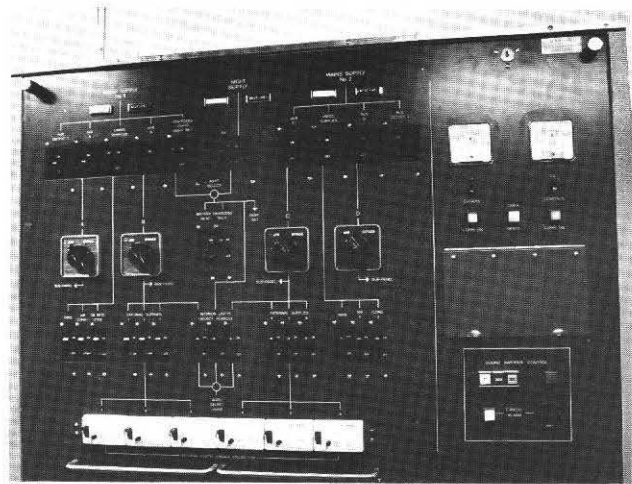

Fig. 10 Type 4 CMCR: Power Distribution Control Panel

multiplexed over production talkback using rapid bleeps of tone within the audio band (Selcue). Thus all cameras receive accurate 'on-air' information.

Telephone and talkback facilities will be improved and will allow the comprehensive selection of any of 100 sources to any operator, using proportional mixing to the talkback loudspeakers. The telephone system will allow automatic access between operators in separate vehicles on a common site without recourse to a numerical system which would require some form of directory.

Since this article was written, a contract has been placed with Link Electronics Ltd for five Type 5 vehicles. They will be the subject of a detailed description in a forthcoming issue of *BBC Engineering*.

## 7 Conclusion

A CMCR is an essential part of any outside broadcast, from the simple interview to a major sporting event. The facilities it provides set a limit to the complexity of a production. For this reason the main demands influencing the design have been the requirements of a vehicle, restricted in size and shape by the United Kingdom Road Traffic Acts, which will provide the maximum flexibility of operation together with minimal on-site rigging and complexity.

From the first CMCRs in 1967, as this review has indicated, there has been steady evolution in design. New techniques, especially the miniaturisation of electronic equipment and the development of cameras using lightweight cables, will contribute significantly to the improvements which will be realised in the Type 5 vehicles.

# A Two-Watt UHF Transposer Designed for Modular Maintenance

S. W. P. Collier, C Eng., MIEE, MIERE.

Designs Department

**Summary:** The channel-dependent parts of the transposer are almost all passive: the active units in general operate over the whole of Bands IV and V so that maintenance at the transposer site can normally be restricted to a simple substitution of a replacement unit. The oscillator unit, which has to be both active and channel-dependent, has nevertheless been designed so that it can be set up for any specified pair of channels in a matter of minutes without using any specialised test equipment.

- 1 Introduction
- 2 Design aims
- 3 Implications of design aims
- 4 General arrangement
- 5 Modules
  - 5.1 Input group filter
  - 5.2 Distribution amplifier
  - 5.3 Input channel filter
  - 5.4 Intermediate-frequency amplifier
  - 5.5 Output channel filter
  - 5.6 Output amplifier
  - 5.7 Output coupler
  - 5.8 Local oscillator
  - 5.9 Local oscillator filters
  - 5.10 Power supplies
  - 5.11 Test meter
- 6 Adjustments at transposer sites
- 7 Mechanical design
- 8 Performance
- 9 Reliability
- 10 References

## 1 Introduction

At present, UHF television relay stations are being built to serve areas with unserved populations down to 1000 people. This work, known as Phase 1, will involve a total of more than 350 relay stations.

Phase 2 is intended to deal with areas with unserved populations down to 500 people and will require a large number of additional relay stations. The cost of such an undertaking is bound to be high even though the stations will, in general, radiate considerably less power. As another author has pointed out,<sup>1</sup> quite modest economies at each individual station can represent substantial sums overall and there is therefore a very strong motive for seeking methods of reducing costs.

Lower capital costs can be achieved mainly by relaxing the performance specification or by using cheaper methods of

manufacture. While the former can be allowed to a limited degree for stations serving small numbers of people and not providing signals for other relay stations,<sup>1,2</sup> the savings which can be achieved by this means alone are small. The latter tends, as a rule, to lead to higher maintenance costs and might even result in higher overall costs. The design of the transposer described in this article was therefore based chiefly on the aim of reducing maintenance costs by providing high reliability and simplifying maintenance procedures.

The new design has an output power of 2 W which is sufficient for most of the relay stations concerned but, where higher power is required, the transposer can be used to drive a power amplifier.

## 2 Design aims

Low-power relay stations are not staffed and a transmitter maintenance team is responsible for the maintenance of a large number of stations within a prescribed area. The more often each station has to be visited and the more complicated the work which has to be done at each visit, the smaller is the number of stations which each team can successfully maintain. Furthermore, the need for detailed maintenance work at the transposer site would call for the presence of suitable test equipment there: this, in turn, would require either that such equipment be installed at each site or that it be carried about by the team. The former would be costly in capital terms and the latter could involve a good deal of maintenance of the test equipment as well as the extra delays of loading and unloading.

The 'modular maintenance' approach was therefore adopted. As far as possible all the active modules had to be made completely standard so that a spare module would be suitable for replacing the corresponding unit in any transposer, while the channel-dependent items must be made passive and, hence, highly reliable. The specialised test equipment could then be held at the team's base where the repair of faulty modules would be carried out, the repaired

module thereupon becoming a spare in readiness for future faults. The standardisation of active modules would also allow the number of spares needed (and hence the capital cost of the spares holding) to be drastically reduced. This approach enables almost any fault to be put right with only a single visit to the transposer site. This, in itself, constitutes a considerable economy.

The mean time between failures (MTBF) for a complete transposer was required to be at least a year.

### 3 Implications of design aims

Testing individual units at base in isolation from any specific transposer is likely to require a variety of jigs and adapters unless a standard impedance for signal inputs and outputs is adopted. In the present design an impedance of 50Ω is used, which is convenient for a wide range of test equipment.

The intermediate-frequency amplifier, of course, operates on a signal in a fixed channel, regardless of the received and transmitted channels: there is no difficulty in making an active unit of such a type interchangeable with the corresponding unit in another transposer. Amplifiers for the UHF input and output signals, however, may be required to accept signals in any channel in Bands IV and V, depending on the application. Interchangeability is provided by making these amplifiers broadband and restricting the function of channel selection to passive filters external to the amplifiers.

The Engelbrecht-Kurokawa configuration,<sup>3</sup> in which the signal is divided between two active devices which jointly provide the output, is used in many parts of the transposer for two reasons. It improves the input and output impedances and this minimises performance changes when units are replaced so that the transposer still meets its specification. It also substantially diminishes liability to catastrophic failures because complete failure of one of the active devices causes only a 6 dB drop in output.

The local oscillator unit is both active and channel-dependent, and the principle of modular maintenance is therefore more difficult to apply. Nevertheless, the number of different quartz crystals required to provide for all possible transpositions has been kept down to sixteen and the channel-dependent adjustments required in the active unit have been minimised. The operation of the unit is described in section 5.8.

### 4 General arrangement

The functions of the main modules of a transposer installation are indicated in the block diagram (figure 1).

The four channels allocated to a UHF transmitting station are normally all within one of three ranges: 21-34, 39-53, or 48-68. A filter which allows signals in one of these ranges to pass is connected between the receiving aerial and the rest of the installation. The output of the filter is connected to a UHF distribution amplifier with four outputs, each of which can supply the input signal for a single-channel transposer.

An input-channel filter selects the individual channel to be handled by that transposer, and the signal in that channel is fed to the IF module where it is shifted down to the intermediate frequency, amplified, and shifted back to UHF,

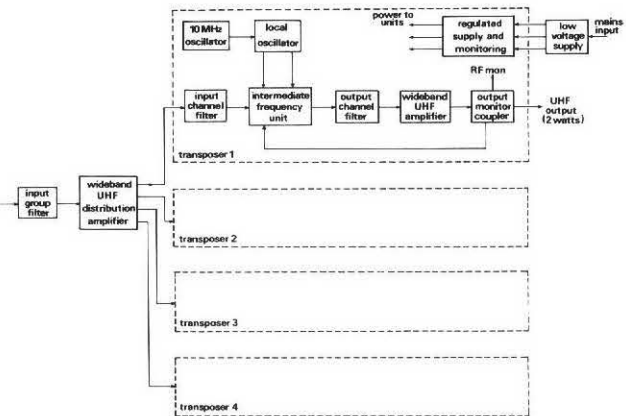

Fig. 1 Configuration of the two-watt transposer.

into the channel required for the output signal. For this purpose the local oscillator module provides two drives of different frequency for the two frequency changes.

An output-channel filter selects the required output channel, rejecting the unwanted signals at other frequencies which are produced in the mixer. The power amplifier then raises the level to 2 W and the signal passes via a coupler to the transmitting aerial. The coupler gives three other (low level) outputs, for monitoring of forward or reflected signals and for controlling the gain of the IF module to maintain constant output level.

An external power supply unit provides unstabilised low voltage supplies to a regulator on the main transposer plate. This arrangement keeps high voltages away from the signal-handling equipment.

### 5 Modules

#### 5.1 Input group filter

The input filter is normally one of only three types, covering channels 21-34, 39-53, or 48-68: there is therefore no need to

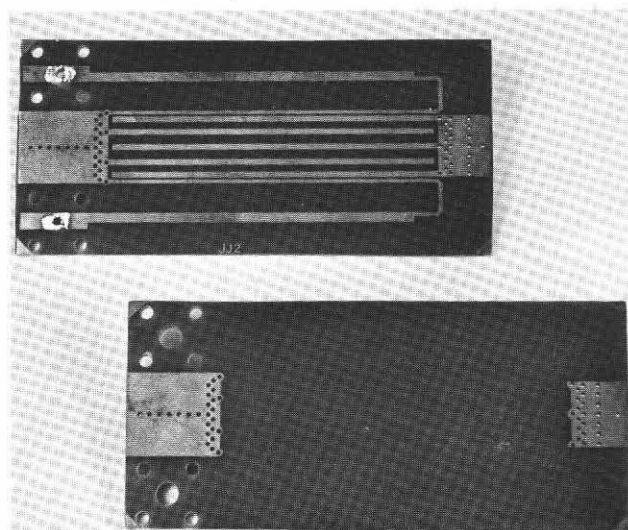

Fig. 2 Input group filter fabricated as a printed circuit on low-loss board.



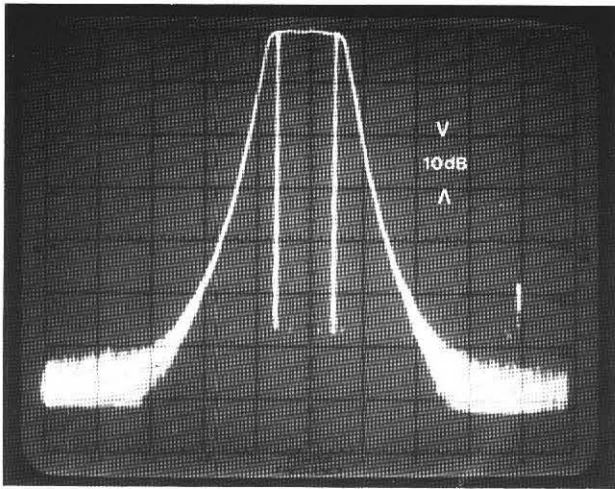

Fig. 3 Stop-band loss of input group filter.

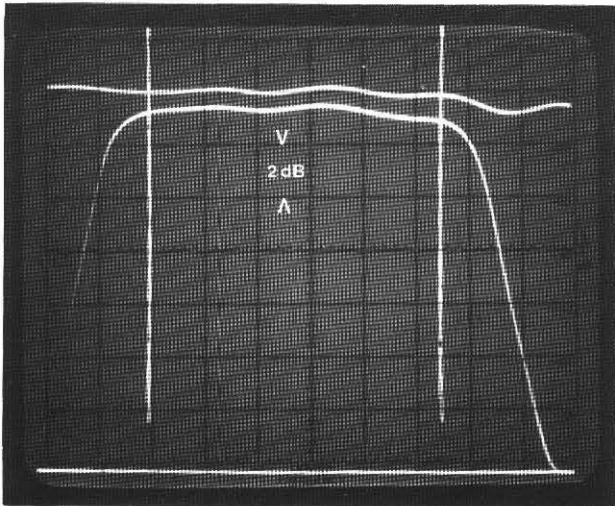

Fig. 4 Pass-band loss of input group filter.

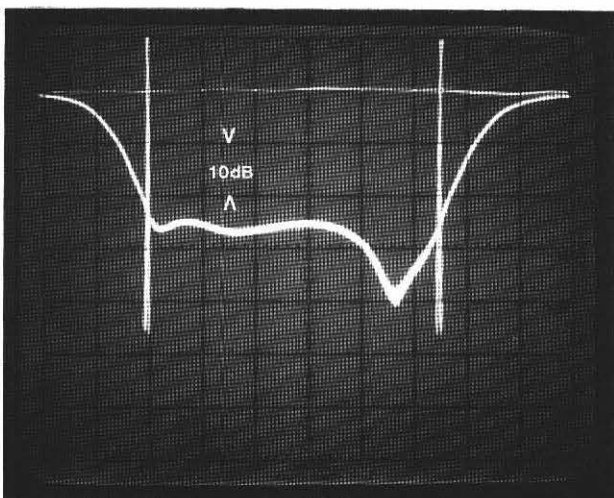

Fig. 5 Return loss of input group filter.

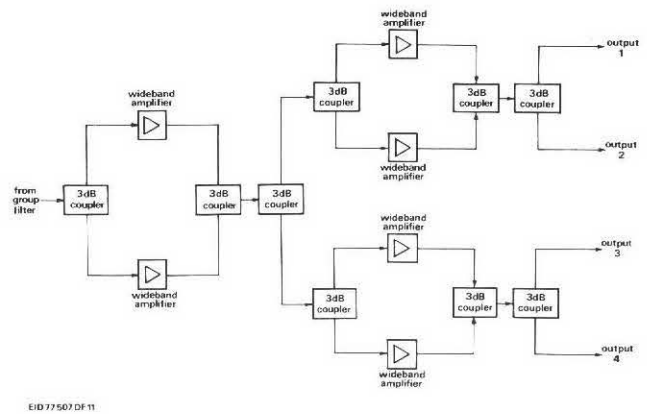

Fig. 6 Configuration of distribution amplifier.

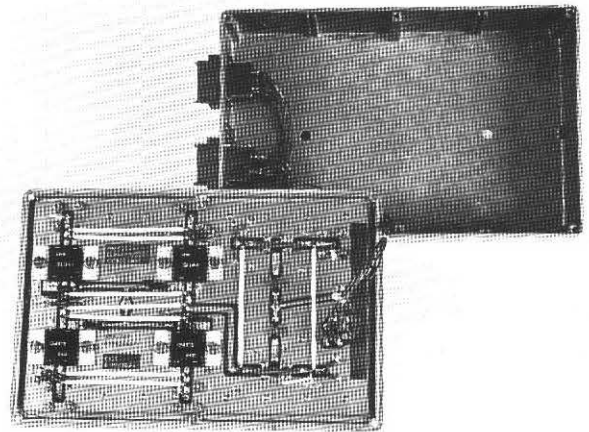

Fig. 7 Construction of distribution amplifier.

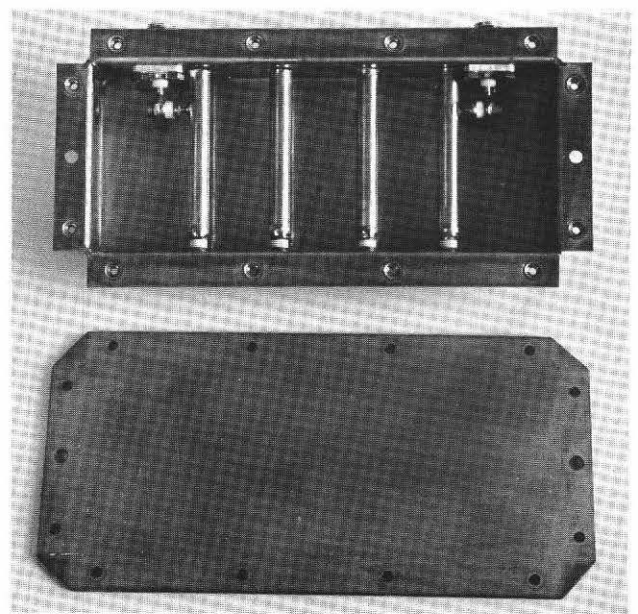

Fig. 8 Comb line channel filter constructed from copper sheet and tube.

make the filter adjustable. High reliability can be expected from a passive device without adjustments.

The filters are of the interdigital type printed on low-loss boards which are mounted inside a strong box to give stability. The board is shown in figure 2. Figures 3 and 4 show the amplitude/frequency response of a channel 21-34 filter on different scales: figure 3 indicates the stop-band attenuation while figure 4 shows the pass-band loss. The return loss is shown in figure 5. In all three figures the frequency markers are at 469.75 MHz and 581.25 MHz.

## 5.2 Distribution amplifier

The input signals at UHF relay stations have hitherto been routed via passive splitters to the individual transposer inputs. This practice involves a loss of 2 to 3 dB which, in the absence of a pre-amplifier, will adversely affect the noise figure of the installation.

To overcome this problem active splitting is provided in the new design by the distribution amplifier, which has four outputs, one for each transposer. Two versions are available, with nominal gains of 8 dB and 22 dB: the appropriate type is chosen according to the magnitude of the received signal.

In keeping with the modular maintenance concept the amplifier's bandwidth extends over the whole of Bands IV and V. The Engelbrecht-Kurokawa configuration is used (see section 3), giving an input return loss better than 20 dB. The noise figure of the high-gain version is  $\leq 6.5$  dB and that of the low-gain version  $\leq 8$  dB. A block diagram is shown in figure 6.

No tuning adjustments are required. After repair of a faulty unit the only adjustment called for is the optimisation of the return loss. This will, of course, be carried out at base and no adjustments at the transposer site are necessary.

Because the distribution amplifier can provide signals to up to four transposers, a failure of this module would be more serious than a failure of an individual transposer. The protection against catastrophic failures has already been mentioned, but a failure of the power supply to the unit would be equally serious. For this reason power is made available to the distribution amplifier from each translator, up to four inputs being connected to the unit through diodes so that the input which has the highest voltage (or lowest-impedance diode) automatically provides the power. If that supply fails another takes over without a break.

Figure 7 is a photograph of a distribution amplifier.

## 5.3 Input channel filter

A comb-line filter, consisting of parallel-coupled tuned transmission lines, selects the individual channel from the input signal: its construction can be seen in figure 8. The filter has been designed in two versions: one for channels in Band IV and one for channels in Band V.

The bodies of filters of this type have hitherto been milled from solid blocks: the result was a very stable, low-loss device, but also a rather expensive one. The present design is fabricated from copper sheet and tube, which gives a considerable cost saving. The loss is higher than for filters of

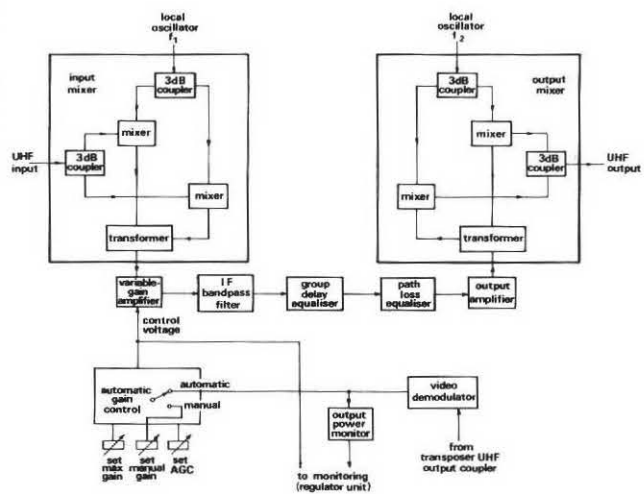

Fig. 9 Configuration of IF amplifier module.

the traditional construction (1.5 dB) but the extra loss is more than offset by the gain of the distribution amplifier so that the transposer noise figure is not significantly degraded.

## 5.4 Intermediate-frequency amplifier

The module known as the intermediate-frequency amplifier in fact includes much more. Both mixers, a path loss equaliser, manual and automatic gain control facilities, and provision for output power monitoring are housed in it. A block diagram is given in figure 9 and a photograph in figure 10.

The frequencies of the incoming UHF carriers are changed in the input mixer to 37.5 MHz (vision) and 31.5 MHz (sound). The input mixer consists of two separate balanced mixers, fed with signal via one 3 dB coupler and with local oscillator drive via another: this arrangement greatly improves the input impedance, giving a return loss of at least 18 dB.

The IF outputs of the two mixers are combined in a transformer and fed to a variable-gain IF amplifier. The signal passes next to a delay-corrected IF band-pass filter (with a bandwidth of 9 MHz) and then to the adjustable path-loss equaliser. Vision/sound ratio errors up to 4.5 dB (either way) arising from propagation difficulties can be corrected

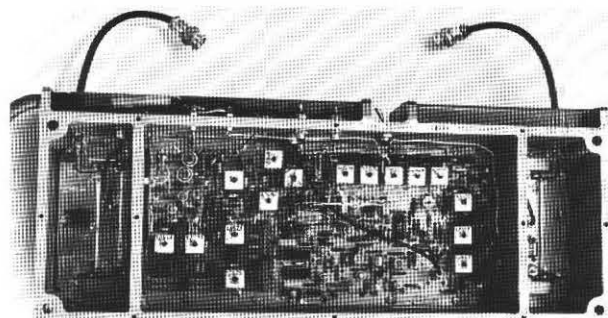

Fig. 10 IF amplifier with cover removed.

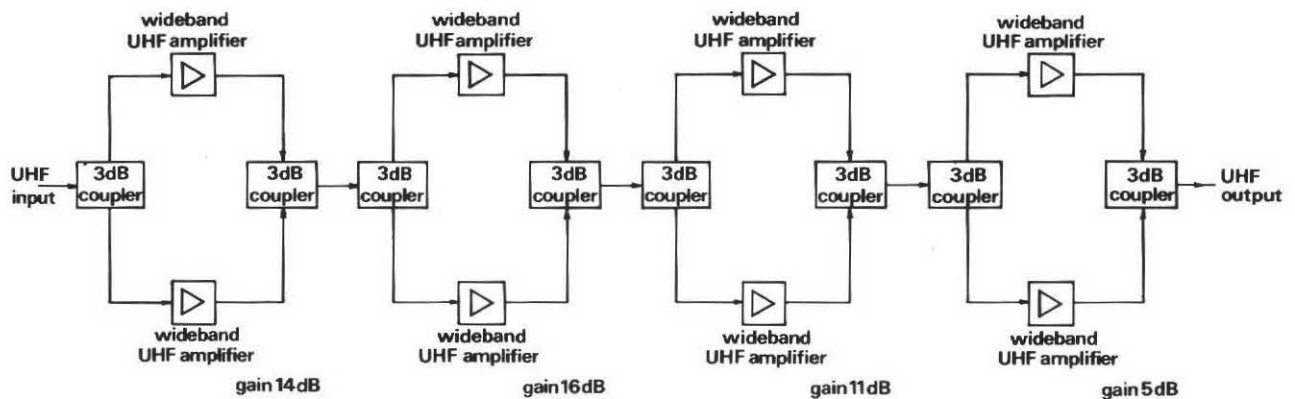

Fig. 11 Configuration of output amplifier.

by means of the equaliser, which is adjustable in 0.75 dB steps.

After further amplification, the IF signal is passed to the output mixer which, like the input mixer and for the corresponding reason, consists of a pair of balanced mixers: the output return loss is at least 18 dB. An additional advantage is the possibility of raising the output power for a given level of intermodulation products (or, conversely, of lowering the intermodulation products for a given output level).

A UHF signal derived from the transposer output is demodulated in this unit to provide a control voltage for the variable-gain section of the amplifier and also to provide output power monitoring. The gain of the IF amplifier may be controlled automatically or manually and, when AGC is used, the gain can be restricted to any lower pre-set value if the maximum available gain of 35 dB is not required.

### 5.5 Output channel filter

The unwanted products of the output mixer at frequencies outside the output channel are removed by a filter of the same type and construction as the input channel filter.

### 5.6 Output amplifier

This module, like the distribution amplifier, operates over the whole range from channel 21 to channel 68 and is divided into sections operating between 3 dB couplers in the Engelbrecht/Kurokawa configuration. The overall nominal gain is 46 dB. Figure 11 is a block diagram and figure 12 shows the appearance of the unit with its cover removed.

The use of the Engelbrecht/Kurokawa arrangement (see section 3) allows separate testing of each section of the amplifier. Although the failure of a single transistor would reduce the overall gain of the amplifier by 6 dB it would not in general reduce the transposer output to 0.5 W. AGC would maintain the output at 2 W, but the operating level would be raised at points between the variable-gain IF amplifier and the failed transistor. This would lead to higher levels of intermodulation products, the degree being dependent on the stage in which the transistor had failed.

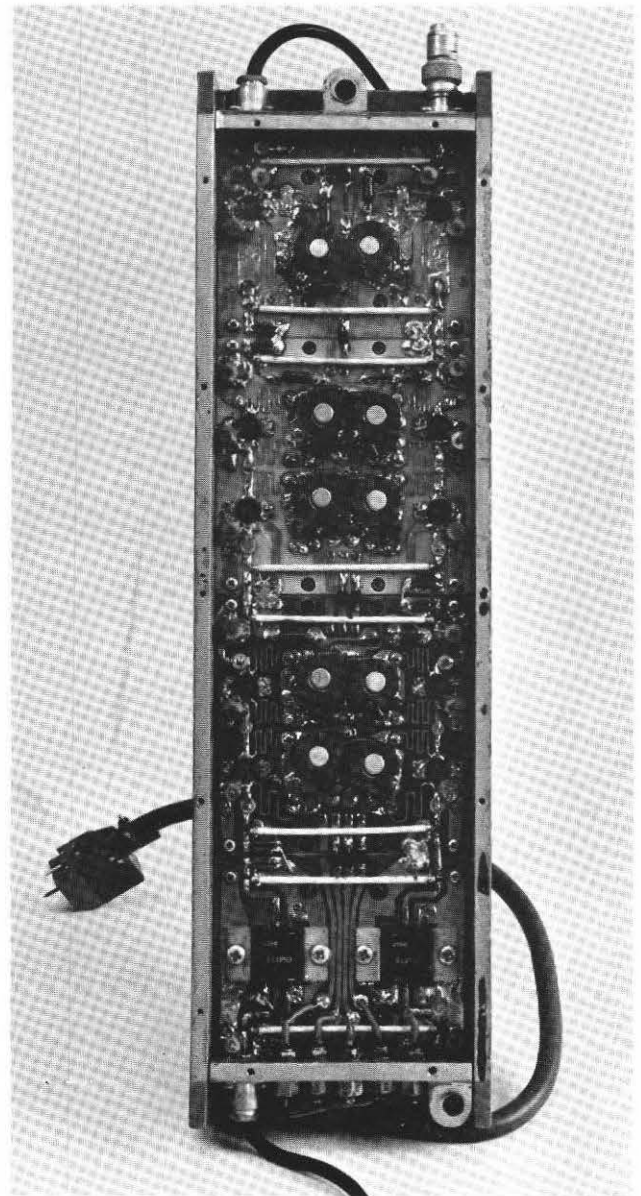

Fig. 12 Output amplifier with cover removed.

## 5.7 Output coupler

The transposer output is taken from the amplifier output via a dual 20 dB directional coupler. One of the coupled outputs is connected to the IF amplifier module to provide AGC and output power measurement, while the other may be used for RF output monitoring. Provision is also made for sampling the power reflected from the transposer load.

## 5.8 Local oscillator

The IF amplifier unit requires two local oscillator drives, one for the input mixer and one for the output mixer. There are various ways of producing these drives.

If only one transposer were to be built the requirement would most easily be met by using two crystal oscillators, one at a suitable frequency to convert the input signal to the intermediate frequencies and one at a suitable frequency to convert the IF signal to the output channel. If many transposers are to be built, however, and the design is required to be able to deal with any input channel and any output channel in Bands IV and V, up to 44 different oscillator frequencies (one for each channel) would have to be catered for. This could mean up to 44 different active units with up to 132 different crystals. (Each channel can have zero, positive, or negative offset from the nominal frequencies.) Such an arrangement would be a serious blow to the concept of modular maintenance and would require a formidable stock of spare crystals.

An alternative approach uses an 8 MHz oscillator which can be made to yield a 'comb' of harmonics at the spacing of the UHF channels. The desired component can then be selected by a passive filter and mixed (in a wideband mixer) with the output of an 'offset generator' — an oscillator at one of three frequencies depending on the offset allocated to the channel concerned. Another passive filter can then be used to select the appropriate component in the mixer's output.

This system can reduce the total number of different crystals required to four — one for the 8 MHz oscillator and three for the offset generators. All the channel-dependent filtering can be passive. Unfortunately the filtering requirements are quite onerous and the filters are therefore elaborate and expensive.

In the present design a compromise is adopted by using a 10 MHz basic oscillator, the frequency of which is quadrupled and used to generate a comb of components at 40 MHz intervals. This considerably simplifies the filtering requirements but still requires only 15 different crystals for the offset generators (three for each of the five channels in the 40 MHz spacing) together with the 10 MHz crystal for the basic oscillator. A block diagram of the unit is given in figure 14 and a photograph in figure 13. The four filters outside the active module are the principal channel-dependent items.

The 10 MHz oscillator is also separate from the main local oscillator unit and its crystal is kept in an oven because, for transpositions with large frequency shifts, frequency errors in this oscillator have a greater influence on the output frequencies of the transposer than similar errors in the offset generators.

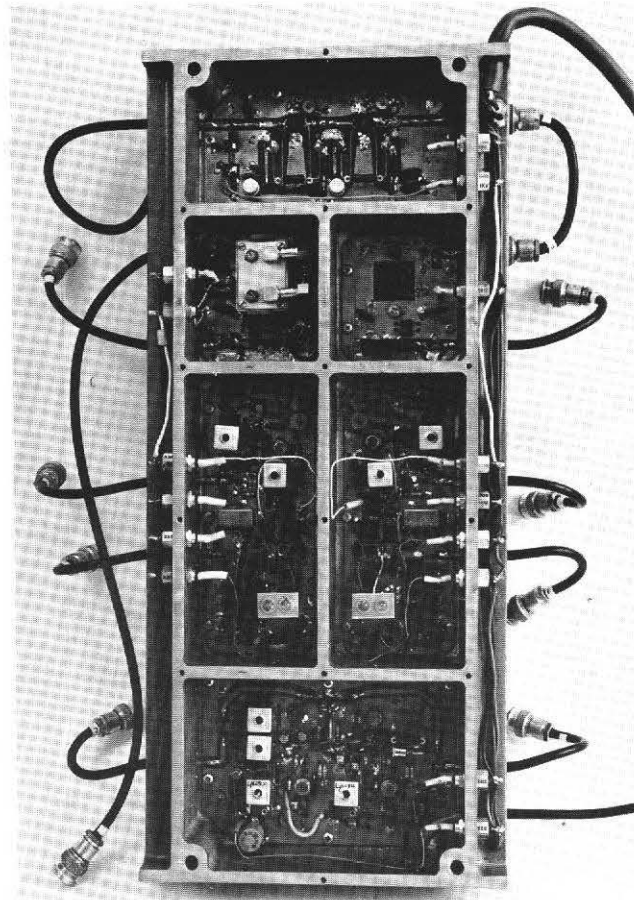

Fig. 13 Local oscillator with cover removed.

The module contains two essentially similar sections for providing the two local oscillator drives, and the principal differences lie in the crystals chosen for the offset generators and the external filters chosen to suit the specific channel requirements. One difference between the two sections which is also channel-dependent is the simple band-pass filter incorporated in the output amplifier of the lower level output section (the one used for the input mixer). This filter is required to suppress the out-of-band noise generated in the first stage of the amplifier which could otherwise be transferred into the signal channel in the input mixer, thus degrading the transposer noise figure. The filter is readily removable for maintenance.

Six light-emitting diodes have been provided in the unit as indicators to permit adjustment of a replacement module at a transposer site. Three diodes are used in each section and indicate the levels of the selected comb frequency component, the offset generator output, and the output drive.

## 5.9 Local oscillator filters

The four filters shown outside the local oscillator unit in figure 13 use a very similar mechanical design to the input and output channel filters but the electrical design is such that they can be tuned for any channel in Bands IV or V. They have a bandwidth of about 7 MHz with an insertion loss of less than 3.5 dB and a rejection greater than 70 dB at

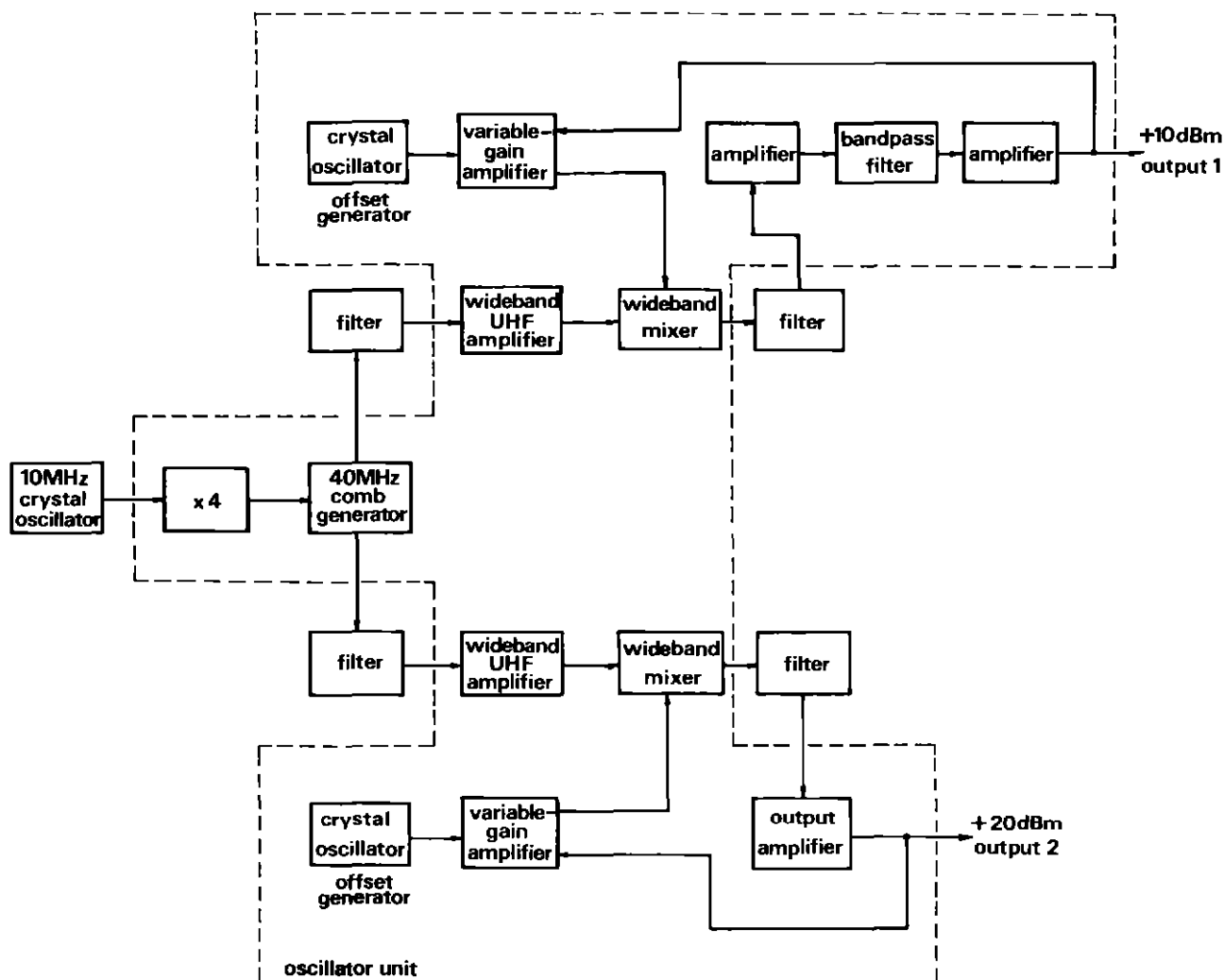

Fig. 14 Configuration of local oscillator.

frequencies 40 MHz away from the centre frequency. The relatively high pass-band loss is a consequence of the wide tuning range but is acceptable in this application.

### 5.10 Power supplies

Each transposer has its own power supply unit so that failure of the unit will affect only one service. The unit is also kept separate from the main plate on which most of the transposer equipment is mounted in order to restrict the voltages available there. 'Raw' supplies of +30 V, +15 V, and -15 V are brought from the mains unit to the regulator unit on the main plate. From these supplies the regulator derives stabilised voltages of +25 and  $\pm 12$ . Current limiting is provided on all the lines and over-voltage limiting on the 25 V line.

The regulator unit also contains all the voltage calibration resistors for the test meter and all the current shunts except

one: the distribution amplifier contains its own current shunt because it can derive its power from any of four supplies.

### 5.11 Test meter

The test meter is provided for monitoring the direct voltages and currents in various parts of the transposer, as well as the transposer output power, AGC voltage, and 10 MHz oscillator level.

One test meter unit is provided at each transposer site. It can be hung on any transposer plate and plugged into the regulator unit to check any of the chief operating characteristics. The distribution amplifier current can be measured from any transposer. The meter unit contains only a meter and a switch.

The shunts and calibrating resistors are so chosen that the meter indicates a nominal 70 on most positions. Space is provided on the label of the regulator unit for recording the

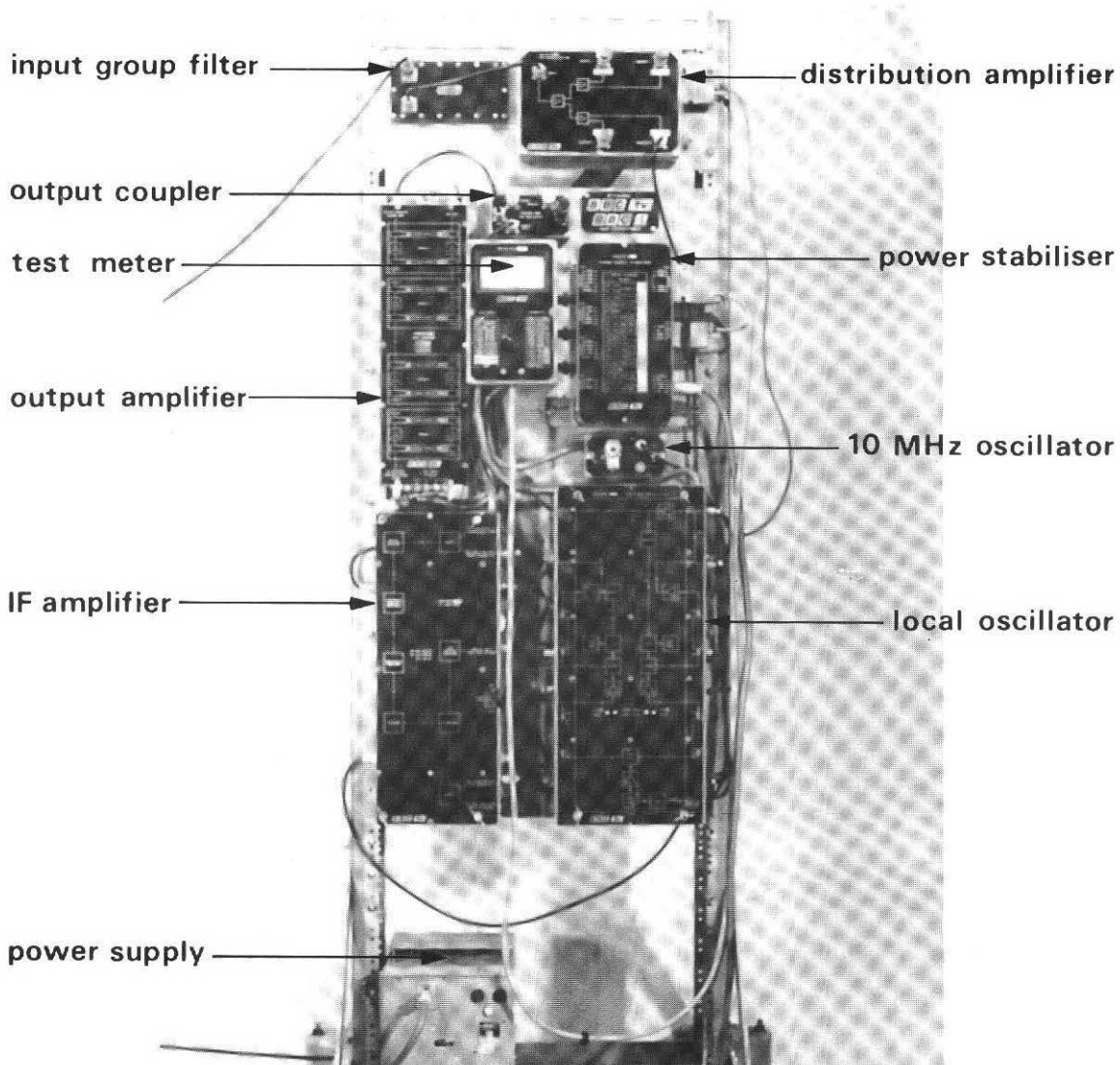

Fig. 15 A single bay-mounted transposer with input group filter and distribution amplifier mounted above.

meter indications so that changes can more easily be checked.

## 6 Adjustments at transposer sites

One of the main objects of the design was to minimise the number of adjustments required at the transposer site and it is appropriate therefore to review the results.

No adjustments should be necessary when replacing the 10 MHz oscillator, the distribution amplifier, the output amplifier, or the power supply units. When the IF amplifier is replaced the path loss equaliser may need to be adjusted and the AGC must be set to give the correct transposer output power. The local oscillator unit must, of course, be fitted with the correct crystals and band-pass filter for that particular transposer (these can frequently be taken from the faulty unit) and two variable inductors must be adjusted for each output to give maximum brightness from the LED indicator.

## 7 Mechanical design

Most of the modules are mounted on a flat 6 mm plate which can be supported by a standard equipment bay or by wall brackets. When fitted in the latter way the equipment projects only about 240 mm from the wall. Figure 15 illustrates the appearance.

The channel-dependent passive filters are fixed directly to the plate and are expected to require very little maintenance. The active modules with which they are associated — the IF amplifier and local oscillator units — are then mounted in front of them (spaced from the plate by pillars) so that the filters cannot be removed without first removing the corresponding active unit.

Holes through the active modules fit over studs fixed to the plate and the modules are secured by wing nuts so that mounting and removing an active unit are very simple operations. Even when the active module is the IF amplifier or local oscillator unit, the filters remain fixed to the plate

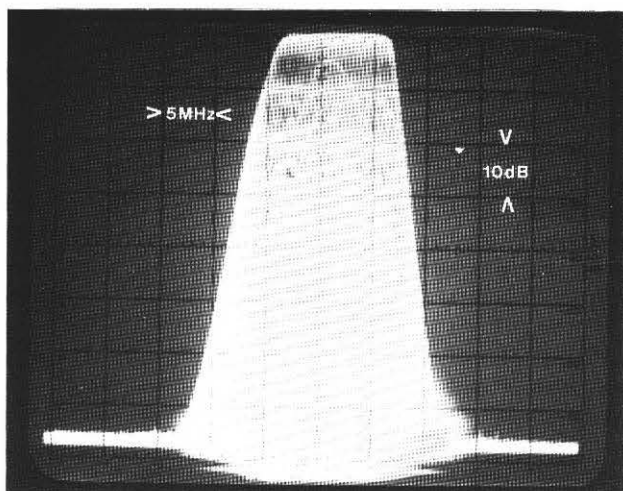

Fig. 16 Overall amplitude/frequency response of transposer showing out-of-band loss.

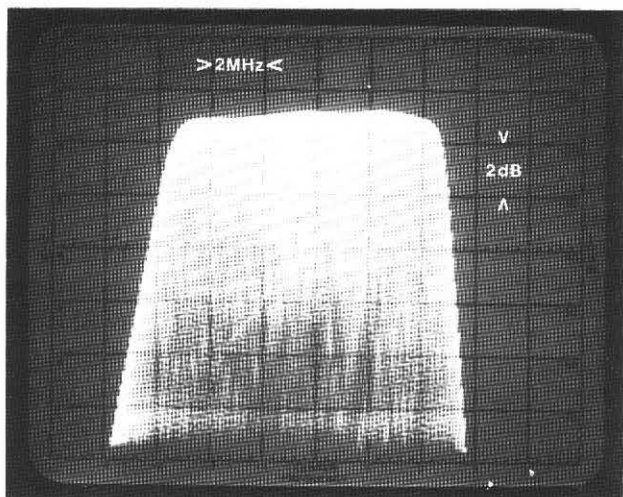

Fig. 17 Overall amplitude/frequency response of transposer showing in-band performance.

and are not disturbed by changing the unit. All the interconnections are made at the front and all the units can be removed from the front.

The active parts of the transposer are built on printed circuit boards and mounted in strong cast boxes. The interconnecting leads are fixed at one end to one unit or the other and have connectors at the other end. This arrangement minimises the number of plug-and-socket connections. Two of the modules, the output amplifier and the regulator, have integral heat sinks which project through holes in the main plate and are cooled by convection from the rear.

The group filter and distribution amplifier are not associated with any particular transposer and so no

provision is made for mounting them on the main plate. They are normally mounted on a separate plate which can be fitted to the same bay or attached to the same wall by simple brackets. Alternatively, they may be mounted in conjunction with other auxiliary equipment.

## 8 Performance

The transposer is capable of working between any input channel and any output channel in Bands IV or V provided only that the difference between the channel numbers is not less than 3. The principal characteristics are:

Amplitude/frequency response: see figures 16 and 17.

Group delay distortion:  $\leq 20$  ns over vision band.

Noise figure at input level of:

-53 dBm (0.5 mV)	< 8 dB.
-41 dBm (2 mV)	< 10 dB.
-35 dBm (4 mV)	< 14 dB.

Three-tone test intermodulation products:  $\leq -50$  dB.

Vision/sound cross-modulation: < 6%.

AGC: less than 0.5 dB output level change for 16 dB input level variation

## 9 Reliability

Estimates of the MTBF of a transposer of the completed design suggest that it should be more than 15 months. Practical experience is not yet sufficient to confirm this expectation but the first four transposers have, at the time of writing, been in operation for 16 months without failures. This is, at least, an encouraging sign.

## 10 References

1. Davis, D. C. Low-cost relay stations for the extension of the UHF colour television service to small populations. BBC Engineering No. 106, April 1977.
2. Riley, J. L. Some considerations on the use of pre-amplifiers at low-power UHF relay stations. BBC Engineering No. 107, August 1977.
3. Engelbrecht, R. S. and Kurokawa, K. A wide-band low-noise L-band balanced transistor amplifier. Proc. IEEE, Vol. 53, No. 3, March 1965, pp. 237-247.

# Sypher: Videotape Sound Post-Dubbing

J. Eden-Eadon

Sound Manager, Television Studios Department

**Summary:** The Sypher method of videotape sound post-dubbing has now been in use at BBC Television Centre for more than three years. It has been used for processing some 1300 programmes of all types and continues to be popular with Production and Operational staff. This article deals with the origins of the system, its operational functions and the influence it has had on programme-making.

- 1 Original system of dubbing
- 2 Beginnings of a new system
- 3 Proposal for new system
- 4 Technical procedures
  - 4.1 'Dub to Sypher' in videotape
  - 4.2 'Sypher dub'
- 5 Sound control desk
- 6 The dubbing operation
  - 6.1 Assemble 'mix mode'
  - 6.2 'Track lay mode'
  - 6.3 Mode selector
  - 6.4 Review mode
  - 6.5 Insert mode
  - 6.6 Dub back to master
- 7 Peripheral facilities
  - 7.1 Quarter-inch recorders
  - 7.2 Source switching
  - 7.3 Studio
- 8 Philosophy of design

## 1 Original system of dubbing

Soon after the introduction of the videotape recording process, it became obvious that sound dubbing would follow. The ability to edit videotape and the consequences of discontinuous recording made the process inevitable but there were serious limitations. For example, a director who needed to embellish a programme with incidental music and effects was hindered by shortage of videotape review time to assess the precise needs.

The dubbing system was very simple: it involved the use of two videotape machines, one to replay and one to record the sound after rebalancing in a separate sound control room. The recording was intended to be continuous, but it seldom happened that way. Balance errors, operational mistakes, changes of mind, all incurred breaks which required retakes with overlaps. These were time-consuming jobs for the sound supervisor and particularly for the videotape editor, who had subsequently to join the pieces together to form a continuous synchronised track to accompany the picture.

These difficulties persisted despite the introduction of extra pairs of hands at the dubbing stage and more reproducing machines to break down the operation into precise sections. It was not uncommon on a 'Dr Who' dub to use two tape/gram operators, the Musical Adviser, the Producer and a trainee, all of them taking part in the operation to keep the exercise running.

Figure 1 indicates the laboriousness of the system for a 50-minute programme such as 'Onedin Line'. The operation

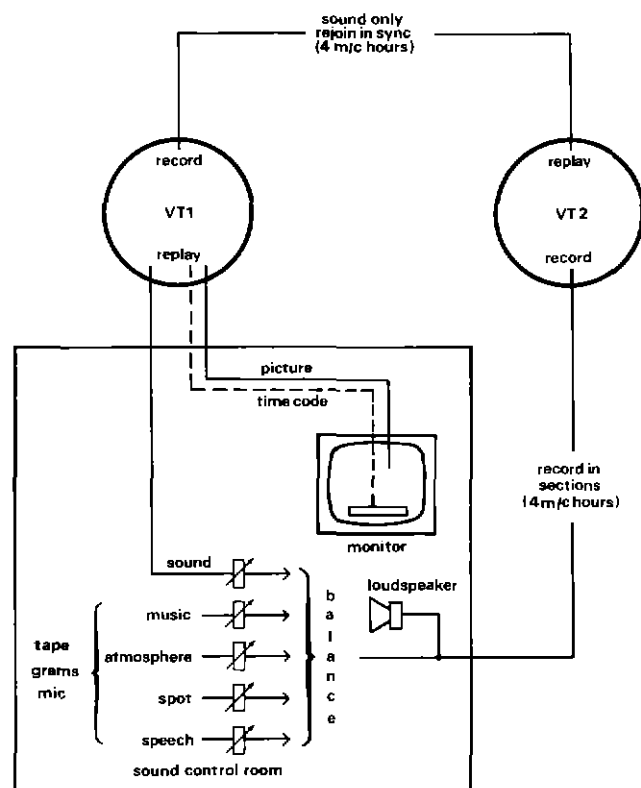

Fig. 1 Dub from videotape machine to videotape machine: time taken for 50-minute programme, 10 machine hours including technical reviews.



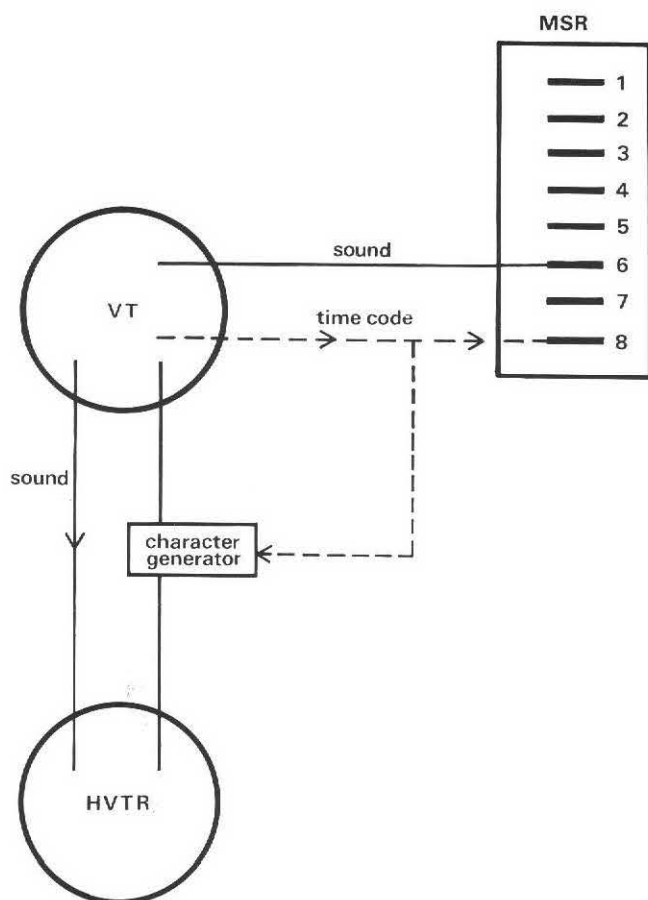

Fig. 2 Dub to Sypher in videotape.



Fig. 3 Helical-scan videotape recorder and multitrack sound recorder used in 'Dub to Sypher'. Similar equipment is used in the control room for 'Sypher dub'.

was, however, always carried out with as much professionalism as time and the Sound Supervisor's expertise would allow. The element of adventure which accompanied it was frequently tinged with disappointment when the review of the dub showed deficiencies of balance, timing or content.

It was in 1966, when the 'Paul Temple' series was being recorded that incidental music was specially composed by Dudley Simpson to heighten and augment the action. The opportunity to review the programme was limited to

observing the studio run-through and recording, and the edited programme as it was finally reviewed, non-stop, in the videotape cubicle. With stopwatch and script, and to the incessant noise of the videotape machine, the composer had to make notes and timings so that, at his piano a few hours later, he could compose suitable mood music to fit the action and vision or sound edits.

## 2 Beginnings of a new system

The first step toward an improved system was taken when it became possible to use a helical-scan videotape machine as a review machine for the Musical Adviser. Later the introduction of other helical-scan machines into Drama Department for a trial period as 'Pre-VT Edit' office review machines for directors prompted their use also for increasing rehearsal time before a videotape machine-to-machine dub.

When time-code editing appeared and Wattesta read-out units displayed the 8-figure code, ways of using this visual indication of timing were examined. Logically it was inserted into the picture so that production and operational staff could use it during both rehearsal and dubbing. For the first time since the introduction of video recording there was an accurate reference, in real clock time, to the artists' dialogue, the action, or picture changes which, once established, was irrefutable. It compared with footage counters in film dubbing and marked the beginning of new thinking into an entirely different system of dubbing. Additional impetus came from the increased popularity of drama dubbing, the consequential extra loading on videotape machine scheduling and the resulting extra cost of hiring videotape facilities. The high cost of the system was obvious and led to a comprehensive analysis of technical facilities.

## 3 Proposal for a new system

The proposed new system would make use of a multitrack sound recorder (MSR) to accommodate a copy of the edited videotape sound track, the rebalanced and dubbed track and a time-code sync track. Synchronised with the MSR would be a helical-scan videotape recorder (HVTR) to provide a copy of the videotape picture and an identical time-code track. An essential accessory would be a comparator/synchroniser to ensure that Playback and Record functions would produce accurate synchronism of sound and pictures.

The advantages to be expected were as follows.

1. Reduced use of videotape machines — only two machine hours required instead of ten (for a 50-minute programme). In other terms, a saving of 1000-1500 machine hours per year.
2. Lessening of multigeneration tape noise because two of the recordings occur on tape designed specifically for sound, not picture signals.
3. Allocation of sound staff made independently from the videotape operation. The practice of keeping members of the realisation team (Director and Sound Supervisor) together from studio through to the dub, would be attainable.
4. Lengthy technical line-up of videotape — sound

control room — videotape no longer required.

5. Rehearse/record (rock 'n' roll in film terms) would become normal practice.
6. Track-laying would become the normal method of resolving complex balances and a combination of the two would provide the Sound Supervisor with flexibility that had for long been denied him.

The overriding advantage of the proposed system would be the reduced use of videotape machines in the sound dubbing operation, thereby returning them to their main use of editing. With his independence from the videotape machine, the Sound Supervisor would be free to meet all the artistic needs of the Director in the manner of his choice.

The arguments were accepted, the installation was built and it was christened *SYPHER*. This is a contraction of *S*ynchronous *P*ost-dub *H*elical-scan and *E*ight-track *R*ecorders. It is also a dictionary word meaning, appropriately, to join up flush with overlapping joints.

## 4 Technical procedures

### 4.1 'Dub to Sypher' in videotape (figure 2)

The programme to be dubbed is transferred to a helical-scan colour videotape machine (HVTR) with time-code taken from the videotape cue track. Simultaneously the sound track is transferred to track 6 of the MSR, accompanied with the same time-code to track 8. The HVTR and MSR machines are shown in figure 3.

### 4.2 'Sypher dub'

The two one-inch tapes are loaded onto HVTR and MSR machines of the same type as are used in 'Dub to Sypher' and shown in figure 3. They are in the custom-built Sypher control room. The machines are synchronised, via a BBC-designed comparator, but thereafter refer to station synchronising pulses for PLAY and RECORD selections.

During a SPOOL selection, when the tape is withdrawn from all head stacks, time-code is read off from a separate jockeyed head so that the two tapes run at the same speed, that of the HVTR. When coming to rest after a STOP selection synchronism is within 12 frames (1 frame =  $\frac{1}{25}$  second = 1 television picture). On PLAY, synchronism is obtained after two to five seconds. All transport controls are made remotely operable from the sound control desk (figure 4) for operation by the Sound Supervisor. The HVTR provides an external time-code read-out so that spool positioning may be monitored. This display can be 'frozen' to permit the noting of significant times, updating occurring automatically on release.

## 5 Sound control desk (figure 5)

This is a 12-channel 8-group Neve desk with a comprehensive 8-group monitoring matrix. The twelve channels may be either MSR playback control (tracks 1 to 8) or source material from tape and disc machines or microphones from the adjacent studio. The eight group controls accept routings



Fig. 4 Part of sound control desk showing, at top, monitoring matrix for MSR, at bottom, remote controls for HVTR and MSR transports, mode and time-code selectors and source switcher.



Fig. 5 Sound control desk and picture monitor showing inset time-code.

from the channels and are main faders to the MSR record heads.

The monitoring matrix provides 8-track playback, 8-group output or a combination of both according to recording circumstances. It should be noted that playback is not monitored during recording because of the displacement relationship with the picture, hence 'sync' (record head) monitoring is used.

## 6 The dubbing operation

### 6.1 Assemble 'mix mode' (figure 6)

The simplest form of dub and the one recommended wherever possible is the ASSEMBLE. The ORIGINAL DIALOGUE track (6) is balanced as a playback source 'on the fly' with the new material and is recorded direct via group 5 onto the FINAL MIX, track 5. The operation is carried out in a rehearse/record or 'rock 'n' roll' fashion, assembling track 5 progressively throughout the programme.

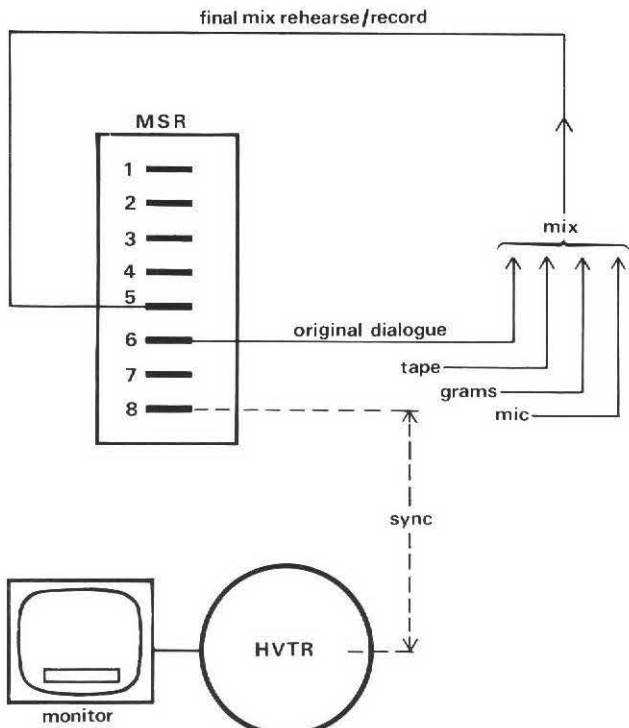

Fig. 6 Sypher dub (ASSEMBLE).

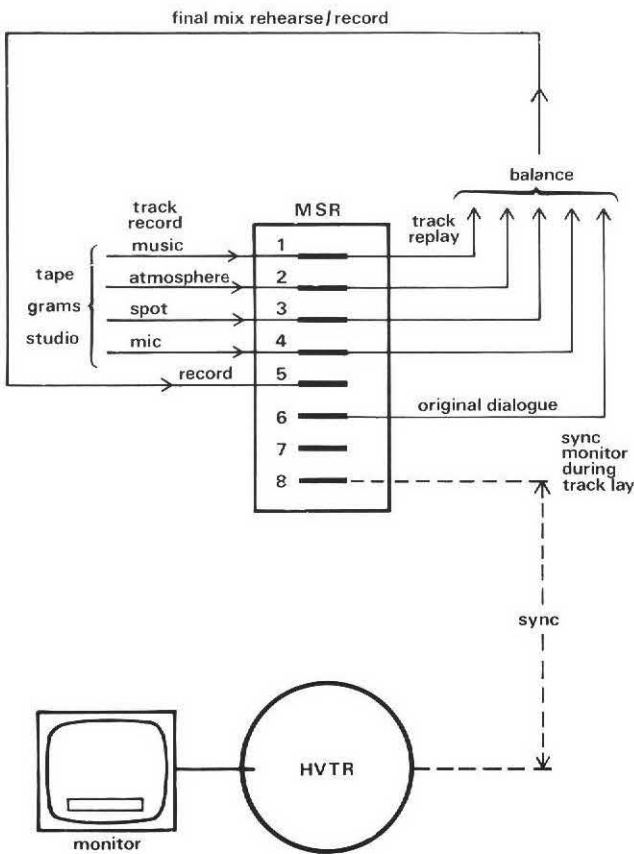

Fig. 7 Sypher dub (TRACK LAY followed by ASSEMBLE).

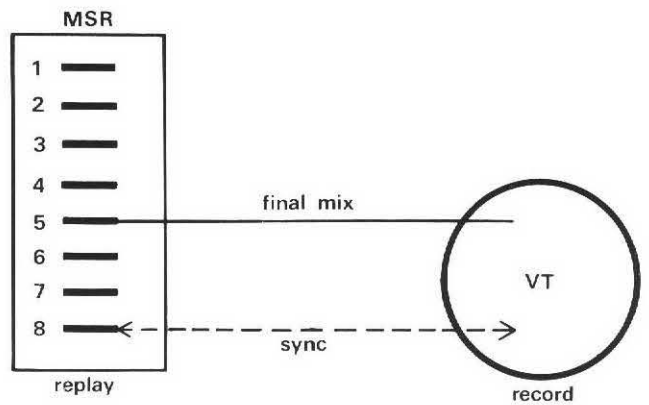

Fig. 8 Dub back to master.



Fig. 9 Sypher control room showing control desk, loudspeakers, picture monitors and twin-track quarter-inch tape machines.



Fig. 10 Studio adjacent to Sypher suite, showing commentators' sound and picture facilities. On right, sound effects tray for footstep effects on gravel, stone, wood and linoleum.

## 6.2 'Track lay mode' (figure 7)

When it is necessary to balance a number of sound sources, each requiring accurate timing as well as careful blending, TRACK LAYING becomes the mode of operation.

The ORIGINAL DIALOGUE track (6) is monitored 'off record head' (sync). Music, effects, backgrounds, spots and voices are then recorded selectively on tracks 1 to 4. They are

then treated as playback sources and balanced with the ORIGINAL DIALOGUE in an 'assemble' mode onto track 5, again in the rehearse/record fashion.

A whole programme may be considered for a track-lay operation and 'Dr Who' is an example. The majority of programmes, however, use the ASSEMBLE, with the TRACK LAY mode used only to handle complex sections within it.

### 6.3 Mode selector

The correct MSR head requirements (Sync, Safe, Ready) for the ASSEMBLE (mix) and TRACK LAY operations are automatically available by operating single controls. ASSEMBLE mode provides record function on track 5 and inhibits record function on all other tracks. TRACK LAY mode provides record function on tracks 1 to 4 and 7, and inhibits record functions on tracks 5, 6 and 8.

### 6.4 Review mode

At the completion of a dub the programme is reviewed to provide a check of technical performance and balance. REVIEW mode provides an offset between the MSR and HVTR equivalent to the time difference between the playback and record heads. This allows playback quality to be monitored in synchronism with the picture, which was originally recorded adjacent to the record head.

### 6.5 Insert mode

If, during the review of the dub, blemishes or errors of balance have to be corrected, the INSERT mode allows 'record in — record out' conditions without noticeable overlap or gap.

### 6.6 Dub back to master (figure 8)

The last stage of the Sypher operation is to transfer the 'final mix' track (5) back to the original videotape machine from which the 'original dialogue' track (6) was recorded. This substitution does not eliminate the possibility of further editing of dubbed sequences because the undubbed 'original dialogue' remains available on the one-inch MSR.

## 7 Peripheral facilities

Equipment which is linked to the main system by the use of time-code is becoming increasingly important and the frequency and range of problems from different production departments is increasing.

### 7.1 Quarter-inch recorders

These are shown in figure 9 and offer the following facilities.

1. 'Twin-track' operation.

2. 'Frame-lock' operation in which the television frame signal is used on track 2 and then referred to station syncs in replay. This will allow the removal and return of material from the MSR or to replace music tracks after multigeneration videotape edits.
3. 'Remote start', using coincidence detectors which respond to a preset time-code. Accuracy of cueing new material is essential and is now certain.
4. Variable-speed capability of  $\pm 30\%$ . This will enable lengthening or shortening of a sound, provided that the resulting pitch change is not a disadvantage. Conversely of course, it permits pitch changes as a deliberate effect.

### 7.2 Source switching

Facilities for manually or automatically switching or mixing MSR tracks, quarter-inch tape or disc outputs are available from either time-code selections or time-code-controlled tone on track 7 of the MSR. The Sound Supervisor can arrange for music or effects perspectives to match changing pictures, the repositioning of effects to create more realism or the substitution of individual words if necessary.

### 7.3 Studio (figure 10)

The adjacent studio is equipped to handle 'voice-over' situations such as were used in 'One Man and his Dog', 'World Wide' and 'Sporting Super Stars'. Effects surfaces, doors, chains, etc. are available and were used extensively on 'Hunchback of Notre Dame'.

## 8 Philosophy of design

The philosophy in the design of Sypher has been to service the production departments quickly and effectively and to provide technical facilities which enable the Sound Supervisor to do his job in a discriminating way in relation to the artistic needs of the Director. The basic system is straightforward and the associated facilities are adjuncts to it.

There is no doubt that Directors are making much better use of Sypher now that they are more familiar with it. Directors who are also accustomed to film production realise that they may ask for a wide range of sound treatment to be provided at the dub, which is now the last production stage before transmission. There is also no cost or time involvement for pre-recorded contributions on sepmag as in a film dub. The Sound Supervisor who does the dubbing is the Supervisor who balanced the sound content of the programme in the studio. Familiarity with the Director's intentions is important and the ability to contribute aesthetically to the programme style is an extremely desirable feature of the Supervisor's work.

# Colour Picture Improvement Using Simple Analogue Comb Filters

S. J. Auty, B.Sc.(Eng.)

D. C. Read, B.Sc.(Eng.)

G. D. Roe, M.I.E.E., A.C.G.I., B.Sc.(Eng.)

Designs Department

**Summary:** Simple comb filters can be used to give better separation of luminance and chrominance in PAL decoders, thereby improving luminance resolution and reducing cross-colour and cross-luminance. An important application is to decoders used by broadcasters but the extra cost compared with a conventional decoder might be made low enough for such devices to be considered for domestic receivers.

Further benefits can be obtained by using the principle in coders, and a suitable design is outlined.

- 1 The problem and the principles
- 2 Practical decoder comb filters
- 3 PAL coder comb filter for cross-colour reduction
- 4 References

## 1 The problem and the principles

The total bandwidth of a PAL signal is that of the luminance component. The colour information is contained within this bandwidth, as modulation of a colour subcarrier as shown in figure 1.

The conventional decoder separates the two parts of the combined signal by means of a notch filter in the luminance path and a bandpass filter in the chrominance path.

The decoder notch is optimised to retain as much high-frequency luminance as possible while removing most of the chrominance energy. Separation is not complete and the luminance signal remains contaminated by chrominance resulting, typically, in bands of crawling dots at sharp colour transitions. This effect has been termed *cross-luminance*.

Similarly, the bandpass filter used in the chrominance channel passes high-frequency luminance energy which is decoded as spurious chrominance. This gives rise to *cross-colour*, the characteristic 'rainbow' interference seen on clothes made of material patterned by fine checks or stripes.

Closer examination of the frequency spectrum shared by chrominance and luminance reveals that chrominance and luminance energy peaks occur at different frequencies<sup>1</sup> (see figure 2). Those of luminance occur at harmonics of line-scanning frequency and those of chrominance at frequencies offset from these harmonics by a quarter of the line frequency. A more effective separation of luminance and chrominance could therefore be obtained by a filter able to discriminate between these components.

Such discrimination may be obtained by a comb filter which operates by cancellation rather than passive loss. This technique involves the combination of two signals, one being delayed with respect to the other. When one signal is subtracted from the other, frequencies for which the delay represents a whole number of periods cancel whereas trans-

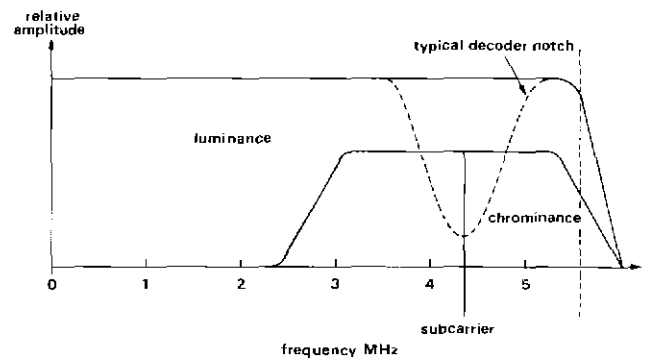

Fig. 1 PAL signal spectrum.

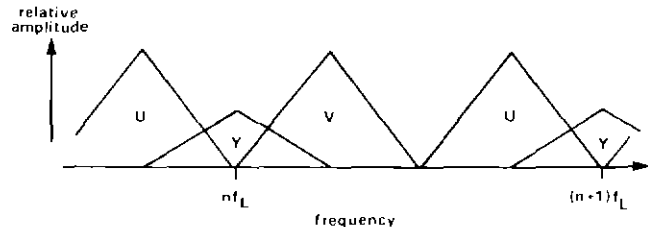

Fig. 2 Detail of PAL spectrum within chrominance band.

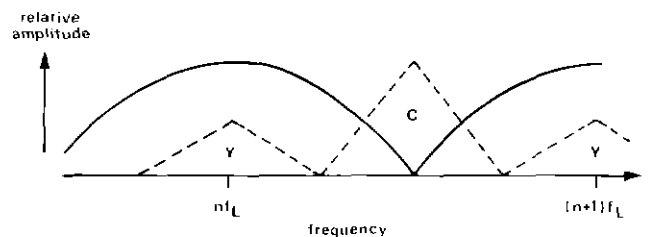

Fig. 3 Amplitude/frequency characteristic of one-line comb filter for NTSC.

mission is maintained at other frequencies. These techniques may be simply applied to NTSC colour signals<sup>2</sup> where the chrominance components are midway between the line harmonics. A line-period delay can be used for elimination of the chrominance sidebands from the luminance signal provided, of course, that there is no significant change of chrominance information from one line to the next. The

response of such a filter is shown in figure 3.

A complementary system can be included in the feed to the demodulators so that the luminance-component groups of frequencies are removed, assisting the natural rejection of the synchronous demodulation.

Because the chrominance energy is present only at the upper end of the video spectrum, it is not necessary to 'comb' through the whole video band and suitable bandpass filters are included to limit the frequencies affected.

Although this technique is straightforward with NTSC signals, properties peculiar to PAL preclude the use of a simple filter with this system.

With PAL the method of coding is changed after each line such that the phase of the V signal is reversed on successive lines. Also, the relationship of the subcarrier to the line-scanning frequency is more complex giving an offset of a quarter of the line frequency between the luminance and chrominance components. For both of these reasons, the simple one-line comb filter does not work.

In more formal terms, the equations defining the PAL signal are:

$$E'_n = E'_Y + E'_U \cos \omega_{sc} t + E'_V \sin \omega_{sc} t$$

$$E'_{n+1} = E'_Y + E'_U \cos \omega_{sc} t - E'_V \sin \omega_{sc} t$$

$$f_{sc} = \frac{\omega_{sc}}{2\pi} = (284 - \frac{1}{2}) f_L + 25 \text{ Hz}$$

where  $E'_n; E'_{n+1}$  are the coded voltage signals on successive lines

$E'_Y$  is the luminance voltage signal

$E'_U; E'_V$  are the two weighted colour-difference voltage waveforms

$f_{sc}$  is the subcarrier frequency

$f_L$  is the line-scanning frequency.

The convenient phase relationships of the NTSC system do occur on alternate lines in the PAL system and so a comb of the type already described could be constructed using two one-line delays. Prototype systems using such combs have been constructed (c. 1968) but achieved only poor performance. The main reason for this was that a comb filter loses its effectiveness if the colour information has changed within the period of the delay used. The probability of a significant change across two lines in a television field is unacceptably high. Fortunately, a technique exists to modify the chrominance signal in such a way that a fixed phase relationship can be established between successive lines and thus a filter using only one line of delay can be employed. The technique, known as *modification*, was devised by Bruch for use in equipment for the correction of differential phase and differential gain in the PAL waveform<sup>3</sup>.

The modification process is carried out by modulating a carrier of double the colour subcarrier frequency with the chrominance signal, and selecting the lower sideband of the resulting output. The carrier must bear a fixed phase relationship to the chrominance signal and this is achieved by an established technique using a burst- or chrominance-locked oscillator. The theory of operation is expounded fully in Bruch's paper.

The modified colour signal has the equations:

$$E'^*_n = E'_Y + E'_U \cos \omega_{sc} t - E'_V \sin \omega_{sc} t$$

$$E'^*_{n+1} = E'_Y + E'_U \cos \omega_{sc} t + E'_V \sin \omega_{sc} t$$

The modified and delayed chrominance has the same V-axis polarity as the undelayed signal and therefore subtraction of the one from the other removes both U and V components.

## 2 Practical decoder comb filters

A comb filter embodying these techniques is shown in figure 4.

The modifier in the practical decoders uses a Motorola

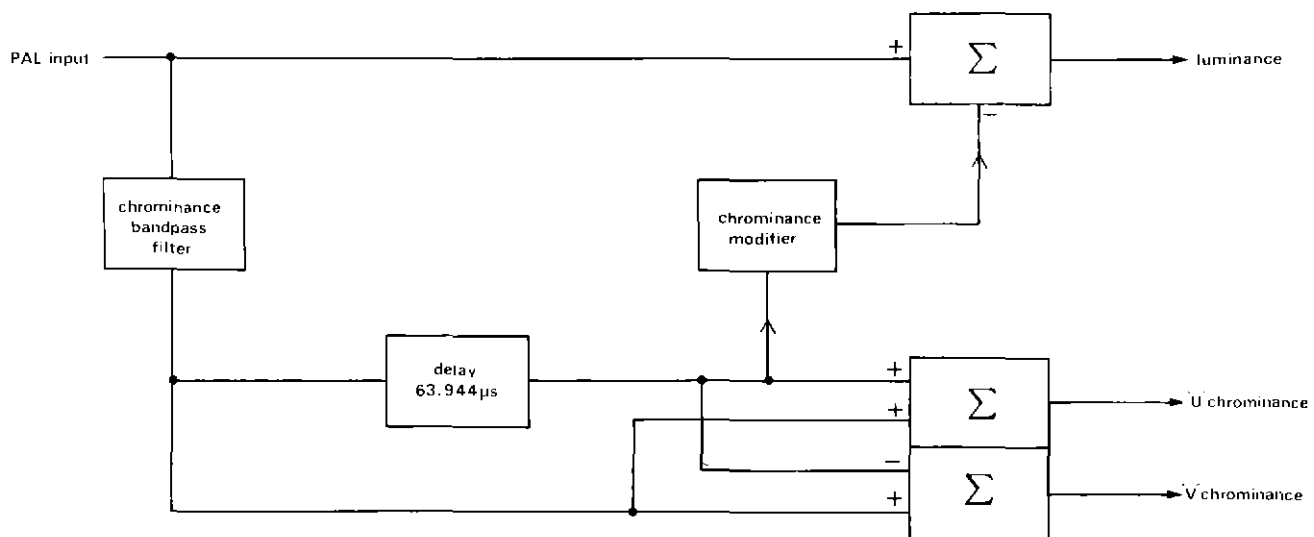

Fig. 4 PAL decoder embodying comb filter.

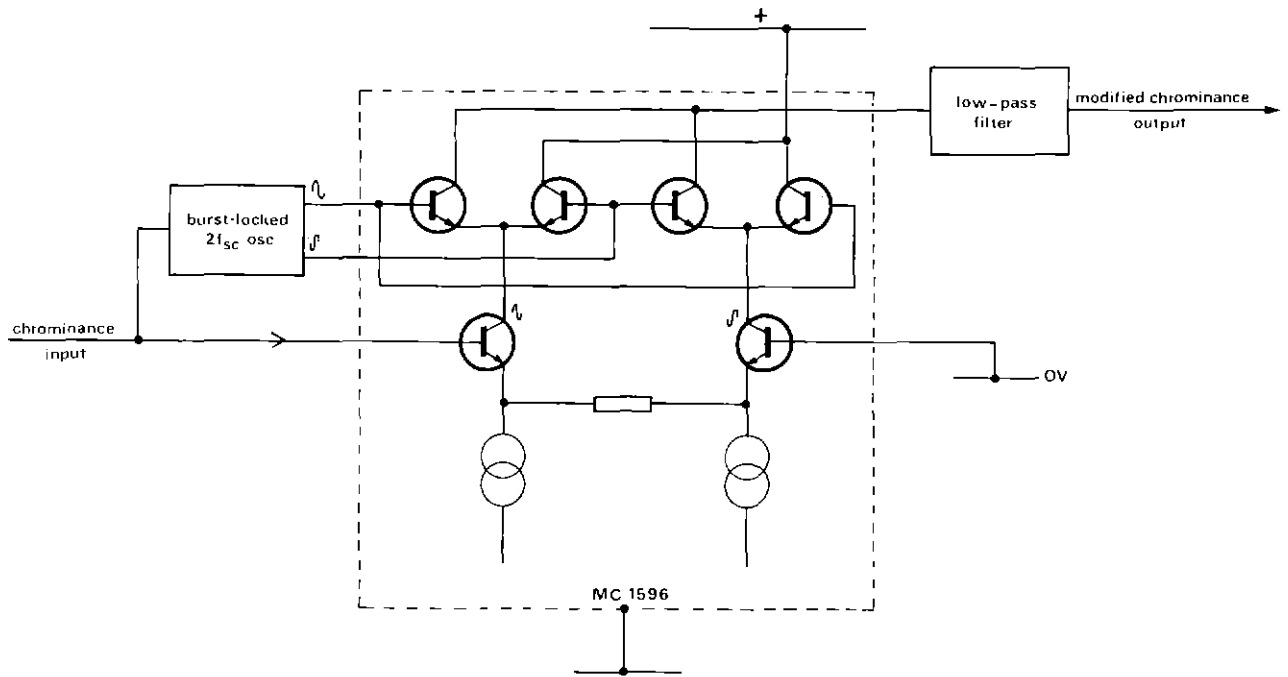

Fig. 5 PAL signal modifier.

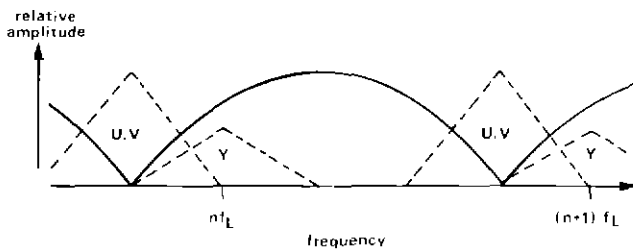

Fig. 6 Amplitude/frequency characteristic of one-line comb filter for PAL. Modification combined with switching or averaging effectively cancels the PAL phase reversal of the V signal and thus transfers the V components to the same regions as the U components, thus permitting the use of a one-line comb.

MC1596 double-balanced modulator connected as shown in figure 5. The output from this modulator contains frequency components at  $2f_{sc}$  and  $3f_{sc}$  as well as  $f_{sc}$  and so a low-pass filter is required to extract the lower sideband ( $f_{sc}$ ). Also, particular care must be taken to balance out any breakthrough of the unmodified  $f_{sc}$  components from the input.

The modified PAL chrominance signal is delayed by one line (less 56 ns to compensate for the subcarrier quarter-cycle offset) and subtracted from the incoming signal so that the chrominance components are cancelled. The response of such a filter is shown in figure 6 and this cancellation remains effective over the bandwidth of the delay path, nominally  $f_{sc} \pm 1.3$  MHz.

The benefits of this method of separation are illustrated in figures 7-9. The luminance detail in the 4.5 MHz (next-to-lowest) grating of the standard test card has been almost

removed by the notch filter in a conventional decoder (figure 7) whereas the output of a decoder using a comb filter shows an effectively full-amplitude signal (figure 8).

The second benefit of comb filtering, already mentioned, is illustrated in figure 9. Both traces here show the steps of the received luminance component of one line of a 100-per cent colour-bar test signal. The upper trace is the output from a conventional notch-filter decoder. The large signal transients at each step show inadequate attenuation of the colour sidebands (see figure 1). The lower trace shows, for the same input signal, the luminance output from a comb filter. From this it is evident that the sideband 'splashes' at colour transitions have been virtually eliminated. In terms of a colour-picture display, this means that the 'dot-crawling' interference which normally mars a sudden change of colour with an unnatural liveliness is now of negligible proportions. Note that the subcarrier rejection is substantially improved in areas of constant colour also.

A side effect of the cancellation system employed in the comb-filtering process should be mentioned here. The signal being modified contains luminance components which are not phase coherent with the colour subcarrier. Such components appear at the modified output together with the chrominance and are injected back into the luminance channel as aliasing components. They have an equal tendency to cancel or to add to the existing luminance, and the result is effectively an unchanged average luminance response despite peaks to +6 dB. This results in a subjectively uniform response on pictures containing a wide range of grating frequencies and angles. The point is illustrated in figure 10 which shows the response of a comb-filter decoder to a test slide with picture detail along all possible radii covering the total spatial bandwidth.

The comb-filter circuit so far described is a simple

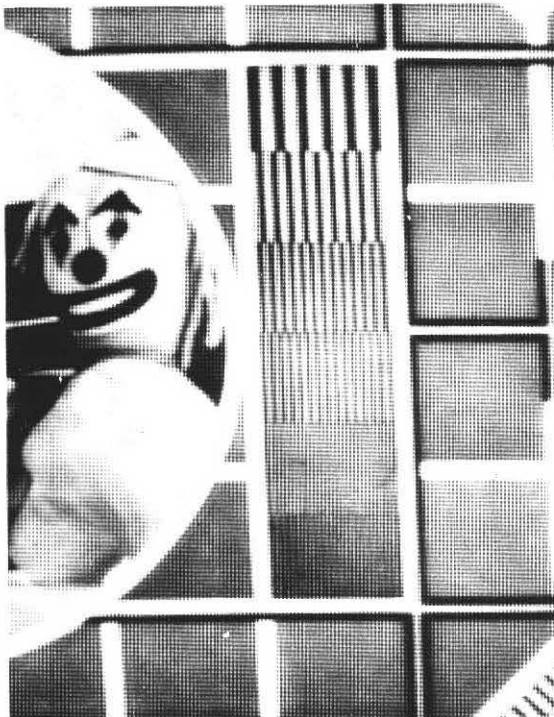

**Fig. 7** Part of test card F after passing through a conventional decoder notch filter.

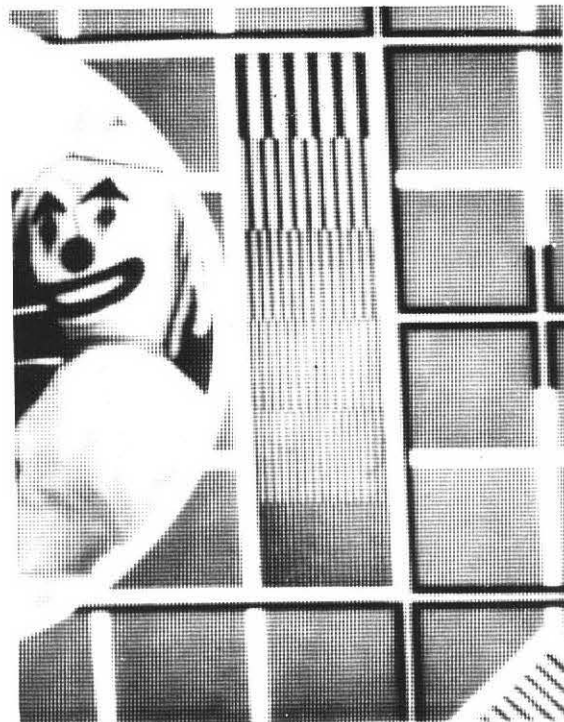

**Fig. 8** Part of test card F after passing through the improved decoder comb filter.

implementation of the technique which nevertheless would enhance picture quality in a receiver. However, for use by broadcasters a more complex PAL comb-filter circuit has been developed with an improved and more symmetrical response at sharp horizontal colour boundaries. This also overcomes a further disadvantage of both the simple comb filter and the standard delay-line PAL decoder; this is the effective half-line misregistration (in the vertical direction) between the luminance and related chrominance caused by using the average of the chrominance relating to the line which produces the luminance and that from the preceding line. Such minor misregistration is trivial in a receiver but is important in a broadcast application where the decoded signal is processed and then re-coded for transmission, thus contributing a cumulative error.

Figure 11 is a block diagram of this decoder. A wide-band delay of one line period is included in the luminance channel and there are two chrominance-bandwidth delays in cascade in the chrominance channel. As with the simple comb-filter circuit, there is a locked, twice-subcarrier-frequency oscillator and a PAL modifier.

The action of the circuit is fundamentally the same as for the simple version but the signal which provides the input to the PAL modifier is now the average of the chrominance signals present during the line before and the line after that which emerges as the luminance output.

This method of averaging the 'outside' lines of the three-line aperture is optimum for overcoming the defects in vertical resolution just outlined. First it improves the

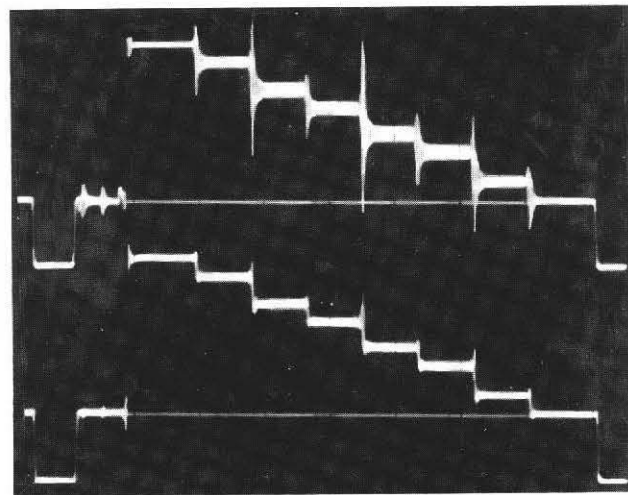

**Fig. 9** Luminance waveform of a colour bar signal after separation by conventional decoder notch and by comb filter.

correlation between the colour information in the resultant and that in the line between; the cancelling effect using this average line is therefore improved. Second, it reduces the spurious dot-crawling effect which, when using the simple comb filter appears along each of a pair of lines at a sharp horizontal colour boundary: (this occurs because at such boundaries the delayed signal ceases to be related to the undelayed signal so that the comb-filtering action breaks



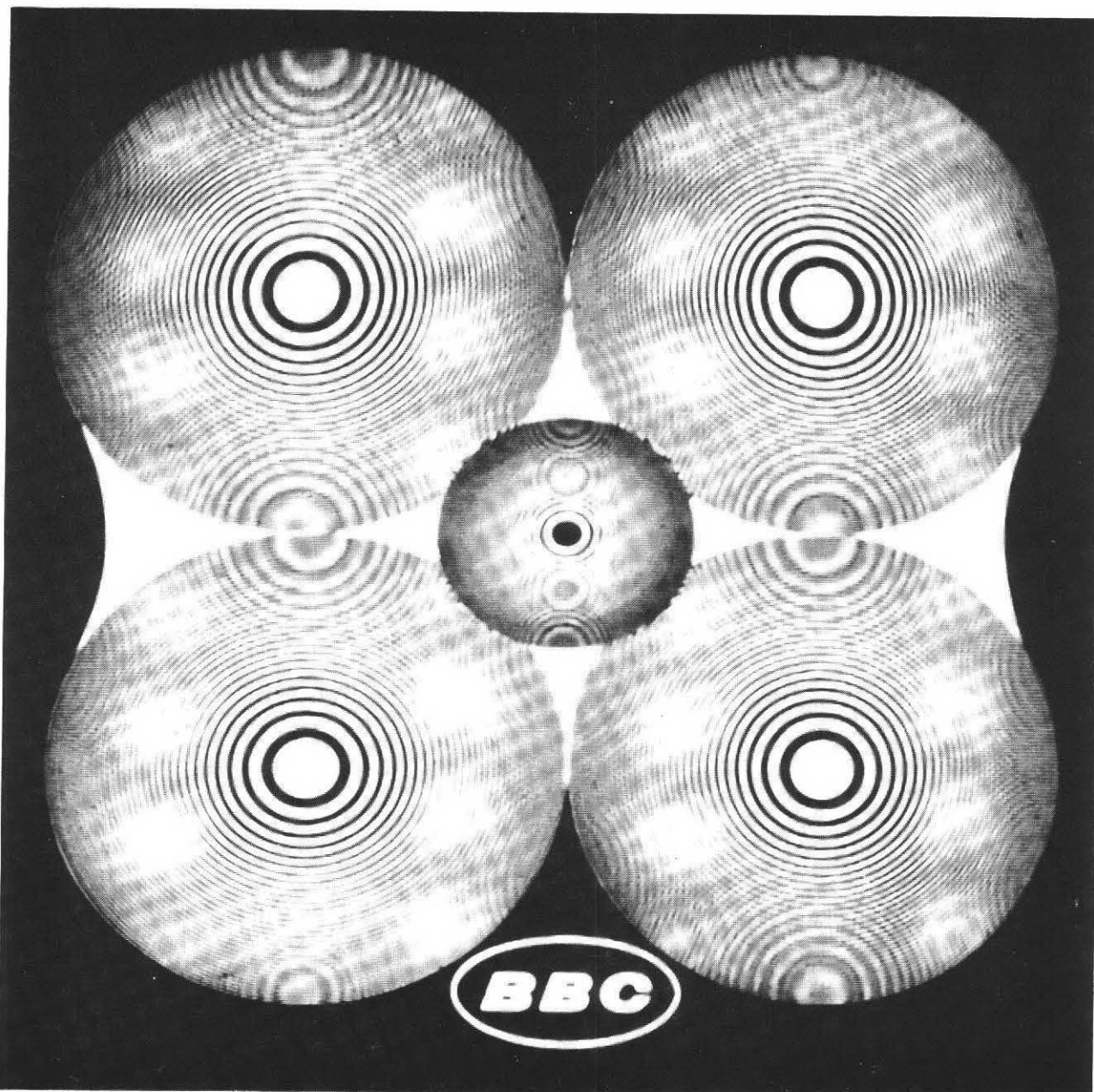

**Fig. 10** The effect of the comb-filter decoder on a test slide with luminance detail at all angles. The picture also shows the aliasing components produced by the sampling action of the scanning process.

down). Furthermore, the luminance characteristic has broader nulls. The same 'average' chrominance line is fed to the synchronous demodulators to obtain the U and V colour-difference signals so that the resulting line of colour information is spatially coherent with the related luminance.

### **3 PAL coder comb filter for cross-colour reduction**

The basic comb-filtering technique described above can also be used in the coder to attenuate luminance components

close to subcarrier frequency and so reduce cross-colour on decoding. This 'once for all' improvement will be maintained irrespective of the type of decoder being used.

Figure 12 shows a comb filter incorporated in a standard PAL coder. The simple version of the filter is employed because the inclusion of a wide-band luminance delay raises problems in maintaining vertical blanking standards in the studio.

The operation of this filter is similar to that in the decoder. An additional signal path has been used to limit the peak luminance gain to unity, thus reducing the visibility of the luminance aliasing components from the modifier and

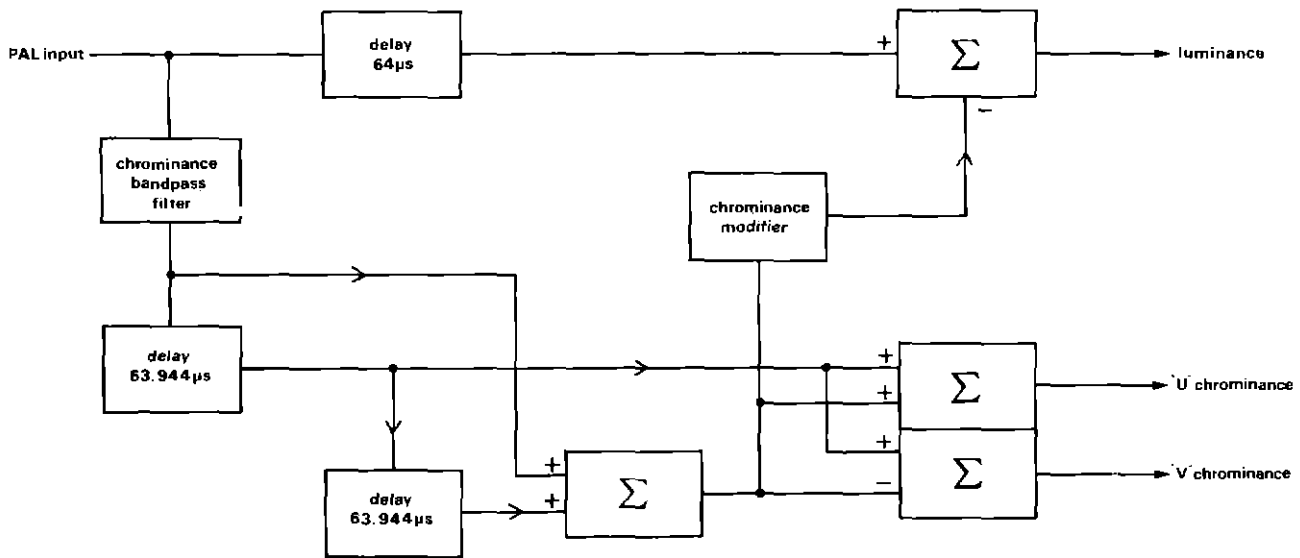

Fig. 11 Comb-filter decoder for use on signals which will be re-coded.

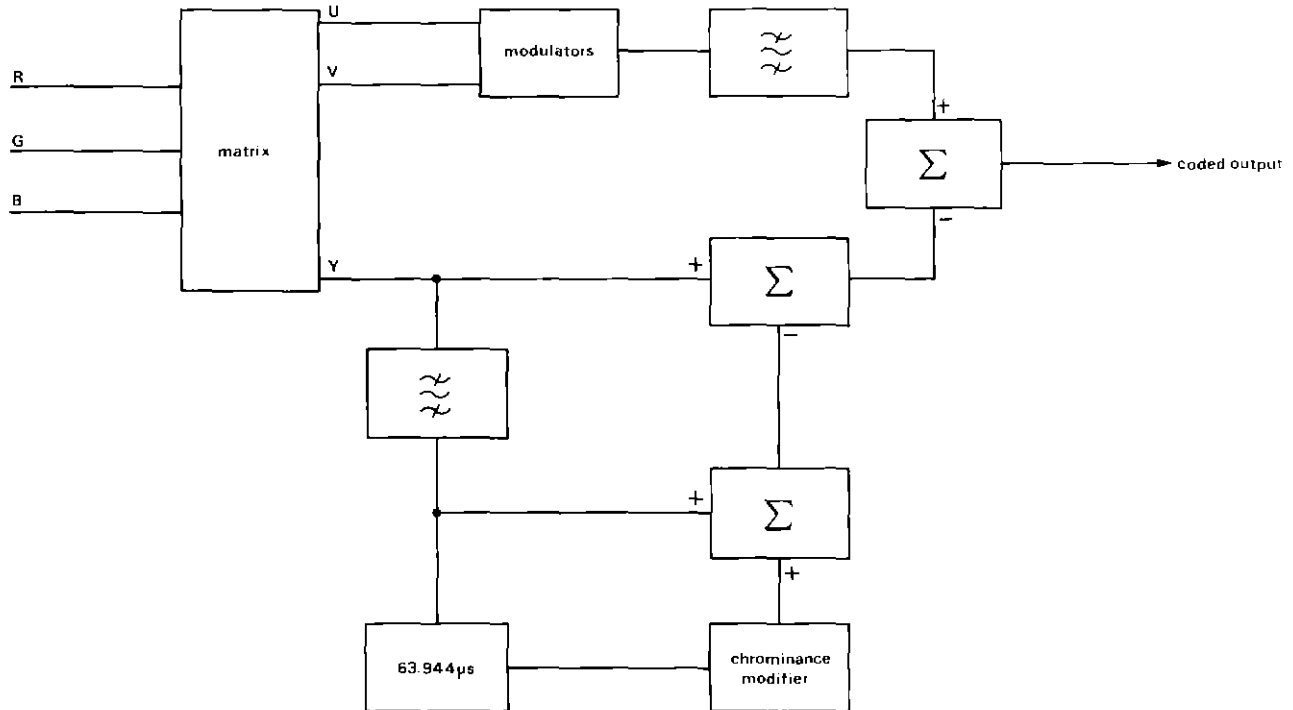

Fig. 12 Coder incorporating a comb filter.

the noise in the luminance channel. In this case the twice-subcarrier-frequency generator feeding the modifier uses a simple frequency doubler instead of a locked oscillator.

To summarise, as a result of the filtering process, 'slots' are produced in the luminance signal spectrum into which the chrominance components are inserted. Thus two sets of information — colour and luminance — are combined in the same overall bandwidth while being substantially separate in terms of the fine structure of the spectrum. As a result, the cross-colour effects produced on demodulation are considerably reduced.

This work is the subject of patent applications.

#### 4 References

1. Drewery, J.O. The filtering of luminance and chrominance signals to avoid cross-colour in a PAL colour system. BBC Engineering No. 104, Sep. 1976.
2. Kaiser, A. Comb filter improvement with spurious chroma deletion. JSMPT, Vol. 86, No. 1, Jan. 1977.
3. Bruch, W. Ein neues Verfahren zur zentralen Phasenfehlerkorrektur eines PAL-Farbferrnsehsignals. Rundfunktechn. Mitt. 9 (1965) No. 4. (An English translation of this article was published in June, 1966 in a special edition of Telefunken-Zeitung: Selected papers II; PAL, a variant of the NTSC colour television system.)

## Contributors to this issue



**Simon Auty** first joined the BBC as a Technical Assistant in 1964 before taking an electrical engineering course at King's College, London. In 1967 he rejoined the Corporation as a graduate trainee in Designs Department, where he is at present an engineer working on television studio apparatus. Past work has been concerned with the design of caption effects and control systems for vision mixers as well as PAL coding and decoding.



**Stanley Collier** joined the BBC in 1954 and spent a short period working in the London Control Room. In 1956 he joined the Television Transmission Group of Designs Department, working first on the problems of television rebroadcast receiver design. In 1958 he was a member of the team that developed 'Cablefilm', a system for sending television news pictures over the transatlantic cable. His work in Designs Department has included a wide range of television transmission equipment using frequencies from video to UHF.



**John Eden-Eadon** is Sound Manager responsible for drama sound in London Television Studios. He progressed from Boom Operator to Sound Supervisor, and joined the Sound Management to start Sound Training Courses. During the past few years his main interest has been in the development of post-production sound dubbing techniques.



**G.R. (Geoff) Key** joined the BBC in 1956 after graduating at Kings College, London. After two years on operational work with Television Outside Broadcasts he joined the Outside Broadcast Unit of the Planning and Installation Department, later Studio Capital Projects Department. Apart from a three-year break when he was responsible for the installation of BBC-2 Network Control facilities at Television Centre, he has continued to be involved with the procurement of Outside Broadcast facilities. He is now Senior Engineer in the Unit and is responsible for the provision of five Type 5 CMCRs.



**David Read** joined the BBC in September 1965 on a graduate training scheme. After moving about many departments as part of the scheme he joined Designs Department in December 1966. There he worked on UHF television transposers before moving to automatic colour camera registration and then a colour transparency scanner. With a newly formed special studies section he was involved with the BBC's first digital standards converter. His present work is concerned with coders and decoders for the various colour television systems for use in standards conversion/synchronisation.

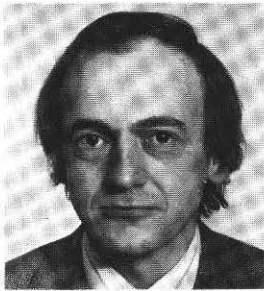

**Graham Roe** graduated from Imperial College and joined Designs Department in 1963. He has specialised in colour systems and the design of colour studio equipment such as coders, vision mixers, and special effects generators. His present work concerns the storage and manipulation of digital television signals with particular reference to standards conversion and source synchronisation.