

# ENGINEERING

The quarterly for BBC engineering, technical and operational staff

WINTER 1991/2

No. 47

## NEW POST PRODUCTION BLOCK

Over the past few weeks, Post Production Resources has been completing its move into the new Stage V block at Television Centre.

The new accommodation comprises seven office levels at the front and internally provides basement, ground and five technical floors. An extensive signal-routing network has been installed to provide the necessary recording, dubbing, replay and monitoring circuits within Stage V, and to and from other areas inside and external to Television Centre.

Neil Pittaway — Head of Post Production — is delighted with the

*new facilities: "The move from paper to reality over the past two years has been remarkable — thanks to the enormous efforts of the PID Tel team, led by Peter Smith, and the Post Production team, led by Don Kershaw. It must now give them as much pleasure as it gives me to see our new customers and staff enjoying the undoubted success of the new area with its D3 videotape machines."*

*"With Producer Choice critical to us, it is gratifying to see that producers now have the facilities they have been requesting for so long — thanks to good foresight and careful planning" added Neil.*

Starting on page 4, John Frisby describes the technical facilities which have been provided within the new block.

### CONTENTS

|                                |    |
|--------------------------------|----|
| <b>ELECTRONIC GRAPHICS</b>     |    |
| — Part I: Introduction         | 21 |
| <b>FAMILY TREES</b>            |    |
| — Radio Ops & Eng              | 3  |
| <b>FILM</b>                    |    |
| — Super 16 format              | 22 |
| <b>LOCAL RADIO</b>             |    |
| — Radio Stoke's Reporter car   | 16 |
| <b>NORTH REGION</b>            |    |
| — Manchester's Studio A        | 14 |
| <b>NETWORK RADIO</b>           |    |
| — MV4's new control room       | 12 |
| <b>NETWORK TELEVISION</b>      |    |
| — 9m satellite antenna         | 18 |
| — New Post Production block    | 4  |
| — TOTP moves to Elstree        | 9  |
| <b>RADIOPHONIC WORKSHOP</b>    |    |
| — Making CDs write             | 7  |
| <b>SCART CONNECTORS</b>        | 13 |
| <b>SOUTH REGION</b>            |    |
| — Soton's new title sequence   | 16 |
| <b>SAFETY</b>                  |    |
| — Locking device for 13A plugs | 2  |
| <b>TRANSMITTER NEWS</b>        | 2  |
| <b>TV TRAINING</b>             |    |
| — New book titles added        | 2  |



Mike Meyer

The Stage V extension block at Television Centre showing the mural designed by 15 year old Vicky Askew and, bottom right, the 6m dish antenna referred to on page 20.

# ENG INF

Edited and designed by EID, Room 3402, White City. Tel: (07) 24316  
Editor Mike Meyer  
Secretary Tracy Quinn  
Graphic Artist Paul Ashton May  
Typeset by Townsend Typesetter Ltd of Worcester

☆ ☆ ☆ ☆

As *Eng Inf* is an internal BBC magazine, it would be appreciated if no reference was made to it in articles, magazines, etc., published outside the BBC.

☆ ☆ ☆ ☆

Stories for the Summer edition should be forwarded to the editor by Friday 15th May, 1992 (please note the new room number at White City).

## Transmitter News

The following services opened or changed between 16th November and 21st January:

### New TV relays

|              |                 |
|--------------|-----------------|
| Barnstaple   | Devon           |
| Bethesda     | North Gwynedd   |
| Canongate    | Edinburgh       |
| Lincoln      | Central Lincoln |
| Little Eaton | Derbyshire      |

### New FM stations

|               |               |
|---------------|---------------|
| Beecroft Hill | Leeds         |
| Darwen        | Lancashire    |
| Rhydney       | Mid Glamorgan |

### Radios 1 and 4 on FM

|                   |             |
|-------------------|-------------|
| Llandrindod Wells | Powys       |
| Millburn Muir     | Strathclyde |

### Local Radio

An opt-out service of Radio Oxford opened on 21st January. Known as *BBC Radio Berkshire*, it broadcasts 40 hours of local programmes each week, taking Radio Oxford's output at other times. Four FM transmitters have been provided: Hannington (104.1 MHz), Henley (94.6 MHz), Reading (104.4 MHz) and Windsor (95.4 MHz).

During the period under review, four other local radio fillers have also opened or changed:

|               |                  |
|---------------|------------------|
| Beecroft Hill | Radio Leeds      |
| Cirencester   | Radio Gloucester |
| Nuneaton      | CWR              |
| Salisbury     | Wiltshire Sound  |

## In Brief.....

### Television Training Manuals

Several new titles have been added to Television Training's catalogue of publications, including:

*Teletalk: a Dictionary of Broadcasting Terms* (£10.50) which is an invaluable reference work for anyone who has ever needed or wanted to understand the acronyms, neologisms, abbreviations and sundry jargon slipped into conversation by television folk.

*The Television Graphics Handbook* (£2.95) which is a basic guide to the equipment used to produce sophisticated graphics and special effects, especially in relation to urgent needs, for example, in the newsroom. The handbook explains how the graphic designer works and how the facility is organised.

*Television — Out on Location wallchart* (£5.99) which is a natural successor to the In the Studio wallchart. It depicts a typical drama crew filming a period piece using a real street, and aims to show most of the activities that would be found on a location for a major shoot.

Further details of these — and other training manuals, together with price lists, applications forms, etc — are available from Television Training, Room 322, Elstree. Telephone: (066) 2592. BBC staff are eligible for a discount of 25% on the quoted prices.

### Safety

In the Middle Ages, knights who went to the wars would take good care to lock up anything desirable which they might leave behind. We have just heard of a modern locking device which has a faint echo of this ancient device. In order to prevent violation of Safety Regulations, it allows one to lock up a 13 Amp mains plug, so that electrical equipment can be isolated securely (Regulation 12 of the *Electricity at Work Regulations, 1989*).

Using this device, anyone who maintains equipment on one side of a bay — which has its power plug on the other side — will appreciate the reassurance that no-one else can plug them in by mistake! The device — a B & R Safety Lock, Type H27 — is now stocked by D&ED (Cemast Number: 064 6839). The unit price is £4.13.

Martin Nutt  
Sec to EMSC

### Corrections

On page 3 of our previous issue, an error crept in to the D&ED section of the family tree. Peter Gregory (Business & Information Manager) and Ray Marie (Head of Production) actually work to David Walker and not David Brown as shown. Our apologies go to all concerned.

And on page 5, the fluid returning from the hot aquifer at Southampton was stated to be at 760°C. In fact this should have read 76°C. Our apologies go to the grossly overheated staff of Southampton RBC.

# FAMILY TREES

## Engineering & Operations, Radio

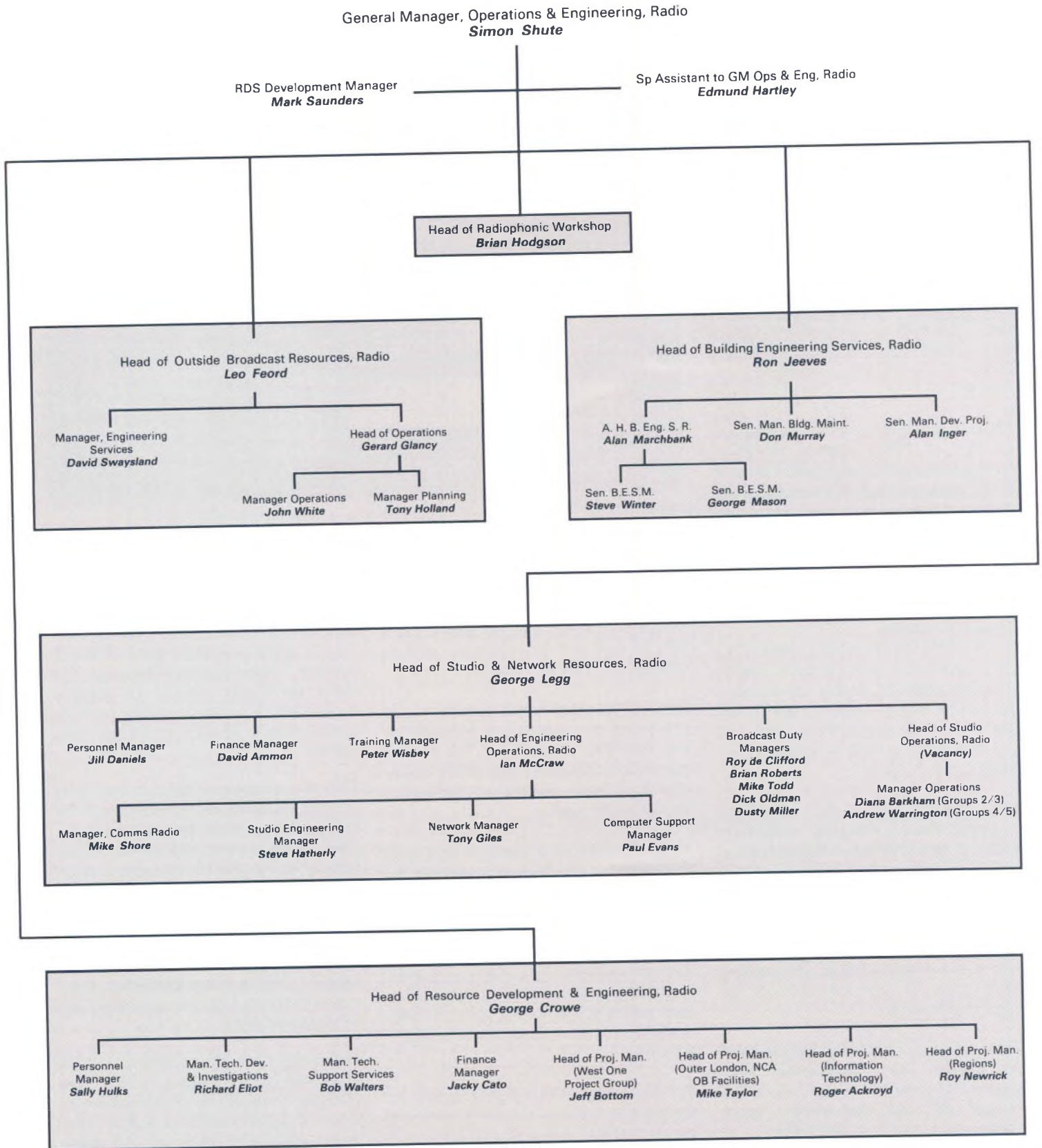

Engineering & Operations, Radio — 11th February 1992

# NETWORK TELEVISION

## New Post Production block

As reported on page 1, Post Production Resources (PPR) has now moved into the Stage V block at Television Centre. John Frisby describes the technical facilities which have been provided in this new area.

The new Post Production block has been built as a continuation of the 'Spur' to the main building at TC. The block has seven office levels at the front and internally provides basement, ground, and five technical floors. The general structure of the block and its air conditioning were agreed some eight years ago but many major changes to the technical requirements have been successfully accommodated over the past few years.

A wide range of operational facilities has been installed in the new building. These have been built to specifications written by a team of engineers from PID Tel and executed by seven different contract companies.

The new facility will take over a high percentage of PPR's current workload. However, the existing transmission suites in the basement have been retained; this operation will be integrated into a new Network Transmission Area, due to enter service in 1993.

### Signal Routing

An extensive signal routing network has been installed to provide the necessary recording, dubbing, replay and monitoring circuits within Stage V, and to and from other areas such as TC's studios and network areas as well as locations external to the building.

Many alternatives were considered including manual plugging, multi-stage routing, and different configurations of the single-stage matrix philosophy. The resulting choice — a particular configuration of six single-stage matrices — was selected on the basis of efficient utilisation of staff effort and price — not only of the matrices but of the resulting implications of post-selection at the signal destinations.

Video signals are routed in conventional Pal format. Other alternatives were seriously considered but rejected on the grounds of cost, availability, space requirements, and heat dissipation.

The central matrices, as now installed, occupy twenty bays and provide nearly



One of the general-purpose VT cubicles (2nd floor).

John Frisby

40,000 crosspoint sets or almost 160,000 crosspoint switches. They comprise a record matrix (160 x 96); a monitor matrix (176 x 96); a replay matrix (80 x 48), as well as small reference, remote control, and comms matrices.

Record, monitor, pulse reference and remote control matrices are controlled at the individual destinations. The comms matrix and the major part of the replay matrix, however, are controlled from the main control room.

Each TC studio is allocated a dedicated destination on the Stage V replay router; the remaining replay router destinations are presented as sources to the TC Central Apparatus Room router.

The routing system provides a high level of security, each matrix circuit level being dual-powered and backed up with status displays, extensive diagnostics and fault reporting.

The control panels are purpose-designed; all vt and tk cubicles are provided with a panel which combines control of reference pulse signal selection, record line source selection, and monitor matrix source selection.

### Choice of VTRs

The television service has been using C-format as its mainstream machine for many years. More recently it has invested heavily in analogue component VTRs (in practice, overwhelmingly Betacam SP) which are highly suitable for portable acquisition. It is also convenient to do certain post-production operations in this format.

However, the choice of signal to be routed in Stage V clearly affects the type of VTR to be used as a mainstream machine. Since Pal signals are to be routed, there is nothing to be gained by using a component recorder, either analogue or digital.

A machine was needed that had all the operational features of the C-format machine but in a cassette-based form, with at least four high quality audio tracks for stereo working.

At decision time, two contending digital composite cassette-based VTRs were available, both offering excellent multi-generation performance as well as interfacing effectively with the Pal infrastructure of Stage V. However, they were not interchangeable as they used different tape widths.

Following tests of these two formats, which involved PID Tel, PPR, RD and D&ED, together with the relevant manufacturers, the Panasonic D3 was eventually chosen. The decision took into account the fact that the cassettes for this machine were smaller and lighter for a given recording time, giving significant savings in tape storage accommodation costs and easing tape-handling problems considerably.

## The Technical Areas

### Floor 1

The first technical floor provides accommodation for telecine cubicles, colour grading cubicles and film post-production areas, together with related support areas.

Telecine cubicles are used mainly for the transfer of film to tape. The process usually involves colour grading, but can also include processing cinema film sound for television compatibility, conversion from widescreen format, or addition of titles or subtitles as well as editing together the individual reels of a feature film. Each telecine room also has a digital composite VTR for recording the completed film programme, ready for transmission.

The colour grading cubicles are used for correcting material arriving in Pal composite or analogue component form. This

could either be an assembled programme or un-edited material originated on Betacam SP.

The film post-production areas each have one dedicated telecine machine and access to a second source machine (tk or vt) via the central router. They are used for compiling programmes from film and videotape which require more facilities than would be available in a simple tk room. They are, in many ways, similar to a vt edit suite but are intended mainly for film-originated programmes, performing many of the functions previously undertaken by a film laboratory.

### Floor 2

This technical floor accommodates general-purpose vt cubicles, 'Quad' VTR rooms and the main control room. In addition, two 'Multiplexer' (replay source switching) areas are provided, which allow studio production staff to direct locally a group of cubicles involved in a complex sport operation. Off-tube commentary areas are also provided to complement the tape playback contributions for this type of programme.

The design philosophy for the general-purpose cubicles is that, in addition to record and playback operations, they can (when fully equipped) support a fairly complex editing session. Each cubicle is provided with a machine complement of



John Frisby

One of the 4th floor on-line edit suites.



John Frisby

The Multiplexer area being set up in readiness for a shadow "Match of the Day" trial (November).

## — NEW POST PRODUCTION BLOCK —

two digital composite VTRs, one Betacam SP and one C-format machine.

The control desk houses a simple edit controller, a small video mixer and a stereo audio mixer, together with cubicle signal routing, monitoring and communications panels. The desk also houses the panel which controls the centrally located routers. Other cubicle facilities include a dedicated countdown leader clock, a colour corrector and communications with other Stage V areas via a commercial intercom system.

### Floor 4

This floor accommodates both off-line and on-line vt edit suites.

During the past few years, the BBC has moved away from its in-house designed on-line edit control system towards commercially-produced equipment, and this has led to a completely new layout for

the edit control desk. Edit control panels, audio mixers, etc are now free-standing units, allowing editors to customise their own equipment layout to some extent.

The suites are each equipped with an edit controller, vision mixer, audio mixer, stills store and simple DVE, and have shared access to slidefile and more sophisticated DVEs.

An enclosure, adjacent to each edit control room, houses up to five cassette VTRs (D3 and Betacam SP) together with other more-noisy equipment needing to be near but preferably not in the control room. C-format VTRs are accommodated in the central equipment area on this floor.

### Floors 5 and 7

These two floors house film and electronic editing activities for material acquired on location, and accommodate

dubbing suites with studios, and a sound transfer area. The main dubbing suite uses an overhead video projector to give a 1800mm picture from either video, 16mm or 35mm film sources, working with either sepmag, 24-track or Audiofile sound tracks, all under serial control. The fifth floor has been in service since April 1990.

### Ground and Basement

Tape storage, other support services, and a relocated music studio have been formed on these two floors. Details of the music studio, which has been in service since summer 1989, were given in *Eng Inf* No 39.

John Frisby,  
Recording & Film Group  
PID Tel

*(Adapted from a contribution to IBC 90, by kind permission of the IEE.)*



One of the telecine cubicles on Floor 1 (TK2).

# RADIOPHONIC WORKSHOP

## Making CDs write

Ray White describes the CD system now used by the Radiophonic Workshop to store archive sound recordings.

There it is on the turntable — the only copy of his or her most important work. Invariably someone, whose talents might be better used elsewhere, scratches those delicate grooves. All is lost, you might think. Not so!

A quick transfer to digital audio tape and our precious recording is on its way to that warren of rooms hidden in the depths of Maida Vale studios. Here resides Mr Dick Mills, custodian of the Sonic Solutions *No Noise* system and, incidentally, author of a number of books on fish keeping.

For many years Dick created Radiophonic sounds more appropriate to the future: he now concentrates his efforts on rescuing those of the past. Firstly the ancient analogue material is hacked up into little digital pieces and stored as data on a hard disk: this process is known as *loading*. Then this digital version is processed, passing it back and forth between computer and hard disk.

Most of this processing happens in real time; de-crackling, de-noising and de-hissing. Finally out of the end comes a near-pristine copy of our ancient artists work: this is called *dumping*. But what do we do with it now?

### Worm-CDs

Compact Disc is the answer: it is the ideal medium for radio, convenient to mix with other material and provides those essential track and indexing facilities. And so it is to the laser that we turn and the Write Once Read Many (Worm) CD.

The blank discs are gold plated and come coated with a rather sickly looking green vegetable dye. Curiously, Dick has to use these within one year otherwise they turn stale, thus converting themselves into very expensive, but decorative, beer mats. They come with a spiral groove already cut into the surface, which a laser can follow. As the CD spins, the intensity of the laser varies, warming the dye layer and so changing the reflectivity of the disc. By this simple process the recorded disc has all the properties of a normal 'pressed' disc; the 'spiral of pits' simulated by the changes in reflectivity.



General view of Studio X with the No Noise computer in the centre, and the Koch CD-tester and the CD-writer stack on the right-hand side.

Barry Boxall

### Archive recordings

The BBC is required to create for itself a vast repository of recorded material; really our heritage in sound. To do this, Sound Archives regularly gathers in material which may be needed for future programmes; raw war reports from the Gulf, historic occasions in news and sport, speeches from apparently important people, etc.

Until recently, we would get someone down the road to cut an LP record especially for us — an expensive business whilst 'someone' was willing to do it. Now they are not, so Dick's in-house CD-making facility is put into action for this as well. The manufacturer says that the discs, once recorded, will last at least ten years. Only time will tell: even if they do not, at least the original recordings will not be exposed to the violent rigours of day-to-day broadcasting.

### Equipment housing

So what was needed to provide Mr Mills with this wondrous facility? Well, obviously a lot of equipment and, perhaps most important of all, a housing to contain it all.

Jeremy Quinn, designer and cabinet maker extraordinaire, was our man. Based on the modular consoles used in previous studios, his men in Telford constructed an excellent oval-shaped desk, pleasingly finished in 'limed' ash. The free-form cabling is restrained and concealed by removable covers running around its periphery. It is also provided with numerous drawers to hold blank CDs, and equipment cupboards with doors back and front to give easy access to their contents.

The task of designing and installing this pioneering project was achieved by the author, ably assisted by Ray Riley. Audio cables were prepared off-site at Ray Cooper's excellent wiring shop at Broadcasting House.

### System outline

And now to the Sonic Solutions system itself. This comprises an Apple Macintosh II FX computer which is fitted out with three NuBus cards, connected to a total disk storage space of 2.8 GBytes. All three of these horribly complex cards perform digital signal processing of sound material. The cards also connect to an

## — MAKING CDs WRITE —

audio input-output box sporting both AES/EBU and SDIF2 digital interfaces.

The first two cards are concerned with the basic provisions of the Sonic system — an on-screen four-channel mixing desk with faders, pan pots and a huge range of equalisation which you can adjust to suit your taste. They also deal with the small computer system interface (SCSI) to the disk drives and the CD encoder. The final card does the really hard work of de-noising and then transfers the results of its labours to its fellows, and on to the disk drives.

So how is the system presented to our intrepid sound expert? Well, it actually works very much as you would expect a Macintosh to behave: Window, Icon, Mouse, Pointer (WIMP) and What You See Is What You Get (WYSIWYG) — well almost! The sounds themselves appear as sets of wavy lines across the screen: the system lets you zoom in or out to see detail or to gain a more general view.

You can do exactly what you like to the sounds: hack out sections of sound, replace the gap with 'black' silence or allow the remaining material to join up around the gap, repeat sections or swap and copy material between the stereo tracks. Having made the changes you can compile a new sound file onto the disk. Of course you need to take care with disk space: at a rate of 10MByte per stereo minute, it is quickly consumed.

### System operation

No Noise processing is quite simple to operate. Firstly you set a number of parameters to suit the material to be treated: here the artistic judgement of our sound expert is vital. If the treatment is just that little bit too harsh, it might well knock the 'sparkle' off the original recording: the on-screen mixer comes in useful here since Dick can 'rehearse' the process before taking the final step.

Once he is happy with the results, the machine can be set up to treat an entire sound file (de-crackling, de-noising and de-hissing require separate 'passes' through the system). Finally, he can dump the entire contents of the ultimate sound file to tape or CD as desired.

Fortunately the system allows Dick to continue working on 'foreground' tasks, using the on-screen mixer, whilst those busy cards compute their way through

their material. Dumping to CD, however, stretches the system's computer power and therefore provides a handy prompt for Mr Mills to proceed to his lunch or tea break.

Compact Discs include an essential, and to many, a mysterious thing called a Table of Contents (TOC) which is recorded at the centre of the disc. Without this vital component, our expensive CD will simply refuse to play. Fortunately, creating a TOC is very easy with the Sonic Solutions system.

Our expert can use one of two methods; either manually, by simply marking start and end flags onto the graphical display or, with delightful laziness, he may set a 'silence' threshold and duration, after which the machine will create the table all by itself. The lazy option may require some gentle manual 'trimming' of the track ends: care also needs to be taken to avoid acquiring additional erroneous tracks, often of surprising shortness and containing perhaps just a solitary cough or click.

### Peripheral equipment

I shall now proceed to list in gruesome detail the peripheral equipment vital to make this studio complete. Audio signals are routed through a vast amount of Klotz

Monocore 16' cable by means of four Akai DP3200 routers, each sporting thirty-two inputs and outputs and controlled using software developed by Tony Morson. Mixing is accomplished by three 8-channel Yamaha DMP7Ds with associated AD8X 20-bit A-to-D converters and Yamaha SPX1000 digital effects devices.

Also included is a Roland SN-550 Digital Noise Eliminator, a Precision Power Phase Chaser and an Audioscope spectrum analyser. Digital audio tapes are accommodated by Sony PCM2500 and PCM7030 machines. The latter features excellent timecode facilities and can be controlled from the Sonic system, thus providing automated loading and dumping.

And so the vital work of our ancient artiste, or the sounds of more recent times, travel via SCSI to the Sony CD encoder and hence via fibre-optic cable to the bank of five CD writers. For a little while longer these sounds are safer than they were before: that is until someone devises something even better. When they do I am sure that the Radiophonic Workshop will still be the first to use it.

Ray White  
Senior Engineer  
Radiophonic Workshop

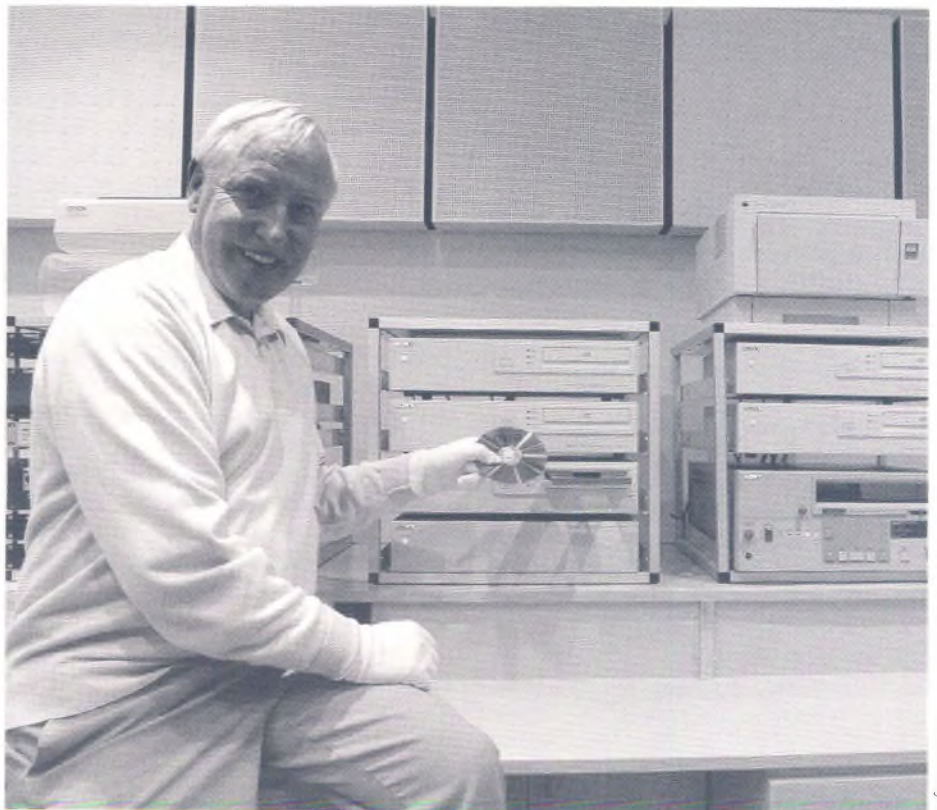

Dick Mills holds a CD-Worm in front of the CD-writer stack.

Mike Meyer



# NETWORK TELEVISION

## TOTP moves to Elstree

Fred Humphrey describes the new facilities provided for *Top of the Pops* at Elstree.

*Top of the Pops* has been part of BBC 1's output for over 25 years. For most of that time, it has been recorded in — or transmitted live from — one of the larger studios in Television Centre.

With the closure of Lime Grove and Television Theatre, studio time at TC had become more restricted; two-and-half days for TOTP — a 30 minute programme — was looking rather uneconomic! Furthermore, weekly setting & striking of the set was high in labour, maintenance and storage costs.

### Elstree developments

As a separate project, *EastEnders* recently vacated its home in Studio C at Elstree, as described in the previous issue of *Eng Inf*. This released a studio floor of suitable size for TOTP. Furthermore, Studio A at Elstree was extensively refurbished in 1989 and its control rooms have been laid out for large-scale productions, such as TOTP.

Studio A's control rooms had already been linked with the floor area of Studio D and it was decided to similarly link them with the floor area of Studio C. Thus, with TOTP occupying the floor of Studio C, the vision and sound could be controlled from Studio A. (With careful programme planning, the floor of Studio A could be re-set on those days when either C or D were recording in its control room.)

It was decided that the lighting for TOTP should continue to be controlled from Studio C, as the lighting director needs to be close to the action for last-minute adjustments. Initially, lighting control was to be on the studio floor but the usual TOTP noise levels would have made effective communications impossible. The existing lighting control room was therefore retained, together with the facility to fully monitor each camera.

### The Set

In order to provide a seamless show with four or more groups, the TOTP set at TC had (for a long period) comprised four stages. This allowed time for the stages to be prepared for each act, it enabled the cameras to pan across from one to the next, and it provided variety.



The show in rehearsal at Elstree.

Rod Litherland

The new set at Elstree was to continue this idea, but one large plain stage would be incorporated as a 'rock concert' area. There would be two high-level platforms, for follow spots, and bridge extensions to one other stage for the presenters and some audience.

### Lighting

The existing 260 dimmers in Studio C, although old, were in reasonable condition and have been retained, with new control cards to improve their reaction time. These provide outlets at grid and floor level, which have been changed to modern 32 A sockets.

In order to provide enough circuits, two additional 72-way 2.5 kW portable racks from Avolites have been hired — one installed on the floor, the other at gantry level. Both these feed floor and suspended luminaires via 6-way multi-core cables. New lighting switchgear has been installed, together with additional supplies for the 'dry ice' machines that TOTP regularly uses.

The suspension system originally installed at Elstree consisted of extending telescopes called Harps, each holding one luminaire. Each telescope could be wheeled anywhere in the slots of the grid above, and let down to the required height

with a compressed air tool. As with most BBC studios, they were equipped with dual-source luminaires, which provided both a focusing key and soft light in one enclosure. A number of these have been retained for lighting individual artists and presenters.

But a pop show demands much more than this. In order to provide deep bright colours, TOTP has for some years used a large number of parcans. These are a sealed-beam unit, between 500 and 1000 W, and provide a 'punchy' beam of light.

At Television Centre, these were provided on 2.4 m long bars (each holding six parcans) which were rapidly clipped to the barrels of lighting winches. At Elstree, a single parcan per telescope would not have been enough, so some fifty 'parbars' mounted on luminaire stirrups have been provided. The stirrup enables each bar of six parcans to be panned or tilted with a pole, just as for a standard luminaire.

In addition to these, a series of aluminium lighting trusses of different shapes and sizes have been provided to hold additional luminaires, again mostly parcans. These have been positioned not only to light the different stages, but also so they can be lowered to the floor for lamp and colour changing. Some twenty-six portable chain winches suspend these trusses,

## — TOTP MOVES TO ELSTREE —

controlled from the floor. Future alterations to the lighting truss layout can be achieved by moving the winches around the grid.

Twenty-four of the parcans have been provided with hired colour scrollers, which consist of a motor-driven roll of colour media, fixed to the front of the parcan. These provide up to eleven colours and are controlled from the lighting desk via a DMX multiplex signal.

Additional effects luminaires — such as remotely-controlled discharge sources — are generally hired in each week and rigged as required. On a typical week, some four hundred parcans are used, plus fifty-five dual sources, thirty special effects or scrollers, and about ten to twenty other luminaires.

### Lighting Control

The control of this number of luminaires, for a fast-moving show, presented some problems. Initially the control specification called for a 'Rock Show' type of desk and assumed that the format of the show was basically unchanged. At the first 'dry run', a Celco Gold control desk with ninety channels plus a slave Celco Major with thirty channels were used, both hired on a long-term contract. Either of these, with patching, can control up to 512 dimmers.

After the first rehearsal, the requirements changed. The format of the show was to change from a series of generally-mimed numbers and promotion videos, to a regular cycle of up to eight bands, with live vocals. This would reduce the rehearsal time to one run through, and

would have significant implications to the way that both the lighting and sound were controlled.

The Celco desk is designed with one rock stage in mind, and it is not easy to quickly modify lighting memories during rehearsal. This limitation causes particular difficulty in covering any lighting changes while the presenter does the link between one stage and the next. Also, the number of channels that can be addressed without patching is limited to 120 and, with reduced rehearsal time, that would not be enough.

So the control system had to be re-designed in two weeks. Fortunately, the control desk that originally served *East-Enders* — a Strand Galaxy — was still available. The problem was to enable the Galaxy and the large Celco desk to control any of the dimmers. The Galaxy could easily address the old 5 kW analogue dimmers while the Celco could talk to the Avolite dimmers, via DMX — but not the other way round. The final solution, engineered by Bob Peill of PID Tel, is illustrated in Fig 1.

Devices that will combine different streams of DMX multiplex signals are not generally available, and certainly not within two weeks. It was therefore decided to combine all the control signals in analogue format, ie 0-10 volts dc.

The Galaxy (which has its own multiplex output) is demultiplexed into analogue signals and addresses the old dimmers through junction box 1, which also gives access to a back-up pinpatch input. The new dimmers are addressed through junction box 2. But as the new dimmers respond only to DMX, the analogue signals from junction box 2 are re-multiplexed with a BBC-made DMX unit called *Lima Mux*.

Conversely, the Celco desk DMX output is demultiplexed by a combination of commercial DMX decoders and a BBC-made demultiplexer — *Lima Demux*. Unfortunately it was not possible for the Celco to directly drive the Avolites dimmers, as it would mean combining two different DMX signals.

The colour-change scrollers mentioned above also respond to DMX and it was proposed to drive these from a slave desk attached to the Celco. This meant inserting the scrollers in the DMX stream between the commercial decoders and the Lima Demux.

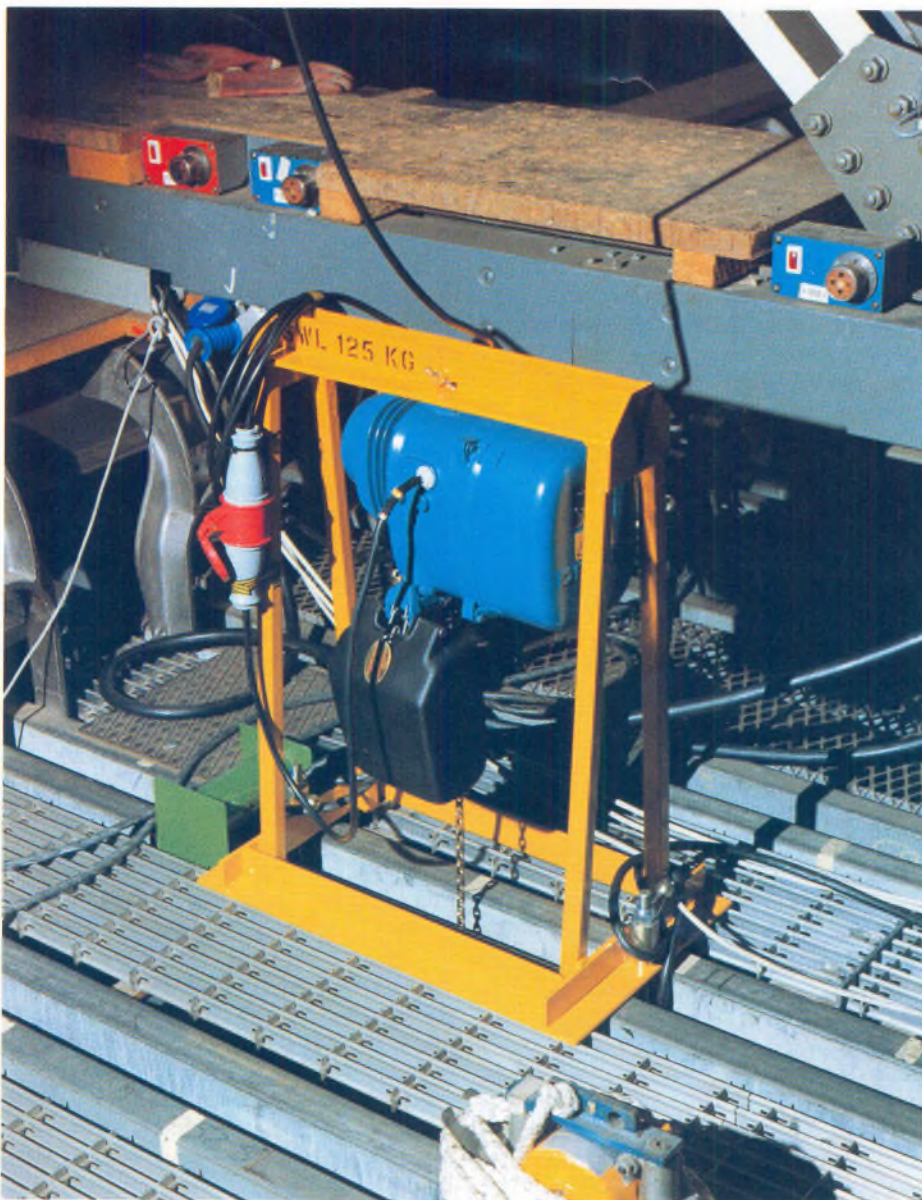

Portable winch to support lighting trusses.

## — TOTP MOVES TO ELSTREE —

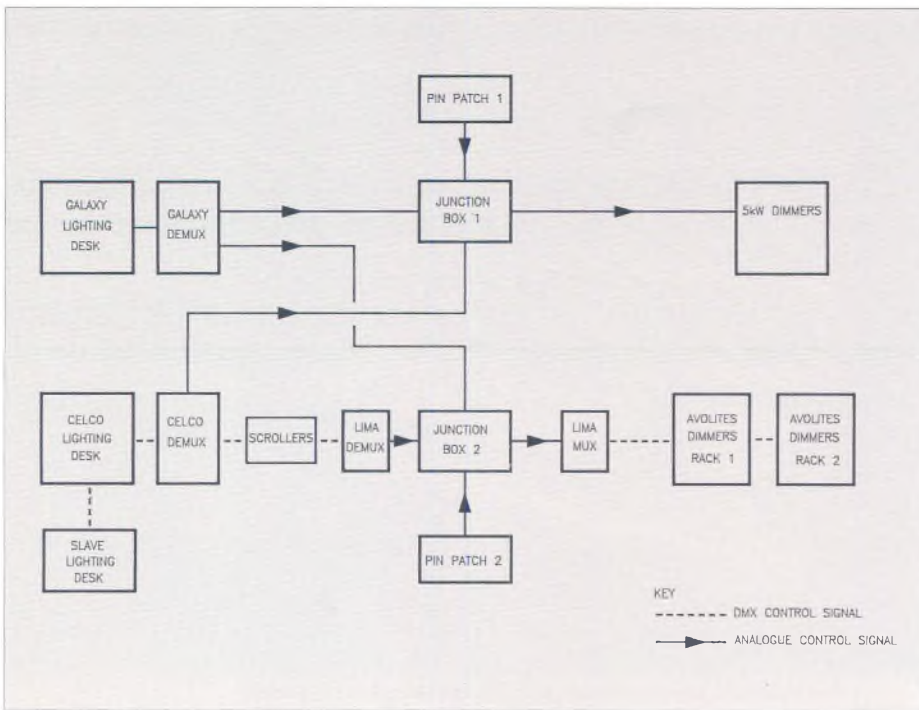

Fig. 1: the lighting control system used for "Top of the Pops".

During a show, the Galaxy generally controls the basic lighting of the artists, while the Celco controls the flashing banks of colour luminaires. Additional control desks are brought in each week to control the special effects luminaires and to provide extra sound-to-light facilities. Some of these are connected via separate DMX routes which were provided as part of the installation.

### The Sound

The design of the sound system had to ensure that the rig for TOTP could be plugged and unplugged very easily, as Studio A floor could be in use for another programme the day before and the day after its control rooms were in use for TOTP.

Studio C has been provided with six new wallboxes, all linked back to Studio A via a floor bay in C which isolates and buffers all the feeds. This was found necessary, because the cable run is about 150 metres. The mic lines, which are phantom powered, are fed directly to Studio A's sound desk. The fact that A and C have different technical mains supplies and earths proved not to be a problem. About sixty tielines have been provided in various routes between the studios.

Radio talkback from Studio A is transmitted in Studio C also, via a split aerial feed which allows the frequency allocations of both studios to be used. This gives a capacity of four duplex channels, covering the floor manager, the lighting

and sound areas, and the presenters. A complete new comms station for the Lighting Director in Studio C was added to the comms system in Studio A.

An Akai S1000 sampler, a Sony DTC1000 pro R-Dat machine and a 6-channel Glen Sound mixer have been added to the system.

When the requirement for up to eight live bands emerged, Sound Operations had to think quickly in order to set up a PA rig. There was an immediate need to have a monitor position on the studio floor to

control the live feeds of each band and provide foldback. Eight Turbosound TMW212 low-profile foldback speakers, nominally two for each stage, have been added to the PA rig which comprises eight slung Bose speakers distributed over the studio and two Ohm bass bins.

There are four audience mics but, additionally, Sennheiser radio-mics can be rigged as required for the bands. To control these, a Soundtracs Megasc monitor desk — with twenty-four inputs, ten monitor inputs and a stereo output — has been installed on a portable trolley. The desk was obtained very quickly by PID Tel and rigged during a busy 36-hour period by Sound Operations.

### The Vision

As part of the linking of Studio A control with Studio C floor, new camera triax and tielines have been added, and vision pre-view and camera monitoring have been extended to Studio C's lighting control room.

The main Grass Valley GVG200-2 Mixer has been enhanced with a Streamline disk controller and a second mixer has been upgraded and installed. The effects package has been expanded with a Pro-Bel HD matrix, so that routing is also memorised. It also enables the manual playback of complex sequences, and provides 'salvo' switching to change 32 crosspoints in one field interval.

A small room near Studio A has been

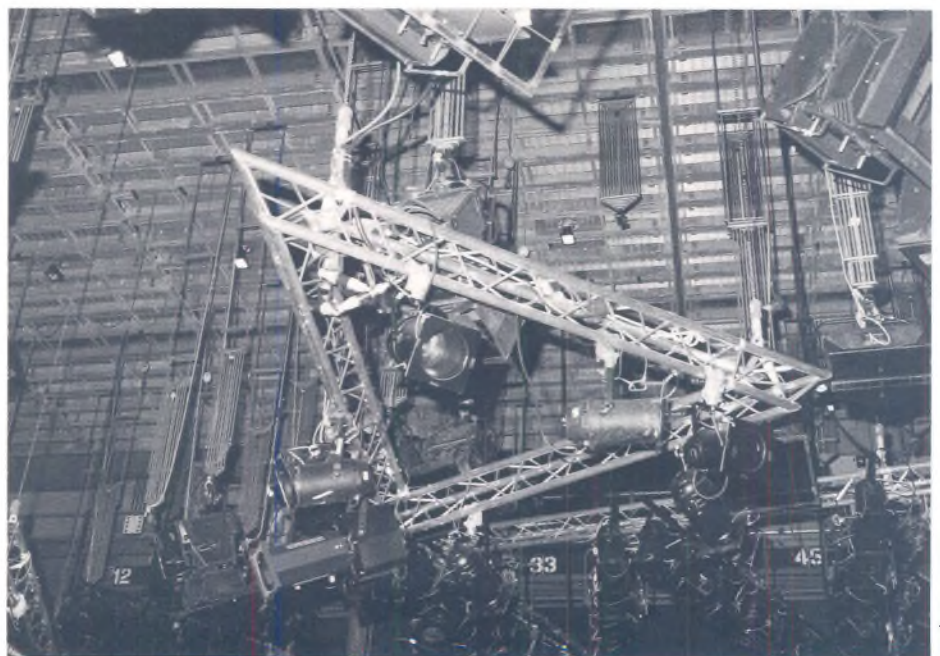

Typical lighting truss to support parcans

James Campbell

## — TOTP MOVES TO ELSTREE —

constructed at ground floor level to house both a 2-channel Charisma DVE with Cleo, and a Quantel Cypher generator. Also, various alterations have been made to the production desk layout to make room for vision effects.

The programme now uses up to four Thomson 1531 and two lightweight cameras, either from Studio A or from a central pool.

### Credits

Studio C became available when *East-Enders* finally moved out at the end of June last year. The first TOTP rehearsal was on 5th September and the first recording on 2nd October.

The work was carried out by a team from PID Tel, with advice from ACED's Structural Section, and important contributions from Studio Electrical Services, Studio Engineering and Studio Operations.

Fred Humphrey  
Power, Mechanical & Lighting Group  
PID Tel



Lighting Control Room showing Galaxy and Celco desks running in parallel.

James Campbell

# NETWORK RADIO MV4's new control room

Simon Cooke describes the new control room to Maida Vale Studio 4.

In 1988, the BBC started the refurbishment of Studios 4 and 5 at Maida Vale — producing a large control room (Cubicle 5) and a number of recording areas that could work to either the new control room or to Cubicle 4, which remained untouched. At the time of this refurbishment, it was the longterm aim to include and integrate Cubicle 4 more fully into the new recording complex at a later stage.

In subsequent years, a number of refurbishments took place — mainly to the acoustic treatment — in an effort to create

a more commercial-type environment. However, this resulted in the size of the cubicle being reduced to the extent that it had become very cramped with little room for extra equipment or musicians.

When the desk in Cubicle 4 came up for replacement, the opportunity was taken to integrate this area with the rest of the Maida Vale 4/5 complex. Harris Grant Associates, the consultancy who designed Studio 5 and its control room, were engaged to undertake the design of the new area.

An existing void between Cubicle 4 and the lobby to Cubicle 5 was opened up to form a machine room which would house the multitrack tape machine, SSL computer, loudspeaker amplifiers, patching and noise reduction equipment. In Cubicle 4, the walls were stripped back and framed out to take new acoustic treatment, which included RPG diffusors and abfusers.

The desk has been turned through ninety degrees and a new monitor wall formed,

with the loudspeakers built into the wall. After extensive listening trials in Studio 5, the loudspeakers chosen were BB5/4s from Professional Monitor Company. A work surface has been formed behind the desk to provide an area for the producer and to place various keyboards. The front facing of this area accommodates all the outboard effects equipment.

Cubicle 4 is equipped with an SSL 4000G series desk, fitted with forty-eight mono inputs, eight stereo inputs and computer automation. It also offers a wide range of outboard processing, CCTV monitoring of studio areas, alternative monitoring via Yamaha NS10 loudspeakers, and mastering on ¼-inch or R-Dat.

The revamped control room returned to service at the end of September and has been well received by its users, especially the general increase in space it now provides.

Simon Cooke  
Project Leader  
Radio Projects



General view of Cubicle 4

Radio Projects

# SCART CONNECTORS

Scart connectors — also known as Cenlec, Euro or 21-pin connectors — are used for linking VCRs, computers, etc to television receivers and monitors. Two different pin arrangements are in use, as shown in the accompanying table.

The original version — Arrangement 1 in the table — allows for RGB inputs as well as inputs/outputs for composite video and stereo audio.

Arrangement 2 was subsequently developed to accommodate S-VHS/Hi-8 inputs, by re-allocating pins 15 and 20 to take the chrominance and luminance signals.

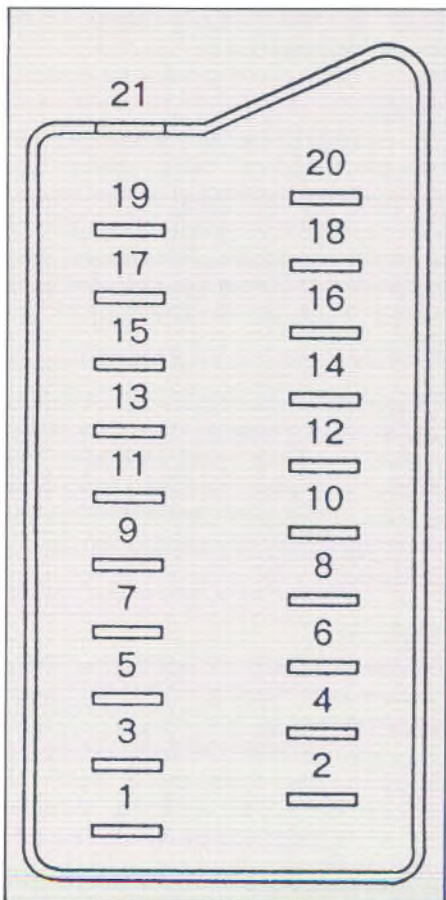

| Pin No | 1 | 2 | Signal                       | Signal level   |
|--------|---|---|------------------------------|--|
| 1      | ○ | ○ | Audio output B (right)       | Standard level : 0.5Vrms<br>Output impedance : Less than 1kohm*  |
| 2      | ○ | ○ | Audio input B (right)        | Standard level : 0.5Vrms<br>Input impedance : More than 10kohm*  |
| 3      | ○ | ○ | Audio output A (left)        | Standard level : 0.5Vrms<br>Output impedance : Less than 1kohm*  |
| 4      | ○ | ○ | Ground (audio)               |  |
| 5      | ○ | ○ | Ground (blue)                |  |
| 6      | ○ | ○ | Audio input A (left)         | Standard level : 0.5Vrms<br>Input impedance : More than 10kohm*  |
| 7      | ○ |   | Blue input                   | 0.7±3dB, 75ohms, positive  |
| 8      | ○ | ○ | Function select (AV control) | High state (9.5-12 V) : AV mode<br>Low state (0-2 V) : TV mode<br>input impedance : More than 10kohm<br>input capacitance : Less than 2 nf |
| 9      | ○ | ○ | Ground (green)               |  |
| 10     | ○ | ○ | Comms Data 2                 |  |
| 11     | ○ |   | Green input                  | 0.7±3dB, 75ohm, positive   |
| 12     | ○ | ○ | Comms Data 1                 |  |
| 13     | ○ | ○ | Ground (red)                 |  |
| 14     | ○ | ○ | Ground (blanking)            |  |
| 15     | ○ |   | Red input                    | 0.7±3dB, 75ohm, positive   |
|        |   | ○ | Croma input (S-VHS/Hi8)      | 0.3±3dB, 75ohm, positive   |
| 16     | ○ |   | Switching control            | High state (1-3 V): RGB<br>Low state (0-0.4 V): Composite<br>Input impedance : 75ohms  |
| 17     | ○ | ○ | Ground (video output)        |  |
| 18     | ○ | ○ | Ground (video input)         |  |
| 19     | ○ | ○ | Video output (composite)     | 1V±3dB, 75ohm, positive<br>Sync : 0.3V (-3, +10dB)   |
|        | ○ |   | Video input (composite)      | 1 V±3dB, 75ohm, positive<br>Sync : 0.3V (-3, +10dB)  |
| 20     |   | ○ | Luminance input (S-VHS/Hi8)  | 1V±3dB, 75ohm, positive<br>Sync : 0.3V (-3, +10dB)   |
| 21     | ○ | ○ | Common ground (plug, shield) |  |

○ = connected

\* at 20Hz-20kHz

# NORTH REGION

## Manchester's Studio A refurbished

Richard Howell and Anthony Robinson describe the improvements recently carried out to Manchester's Studio A.

A new extension — designed and supervised by ACED — has been built on the side of Studio A to increase its volume by some 80%. As part of this project, the control room suites have been remodelled, the plant room adapted, the dressing rooms re-equipped and numerous ancillary areas refurbished. The overall Project Manager was John Dyer of PID Tel.

The building and installation teams had to face several difficult tasks including:

1. Re-routing of the main underground sewer whilst maintaining toilet services on five floors.
2. The erection of very large steel frame sections and their connection to the existing concrete frame, whilst the existing studio was still in use.
3. Demolition of 2 m deep reinforced concrete wallbeams without disturbance.
4. Removal of asbestos whilst building works proceeded.
5. The installation of the technical equipment whilst major building works

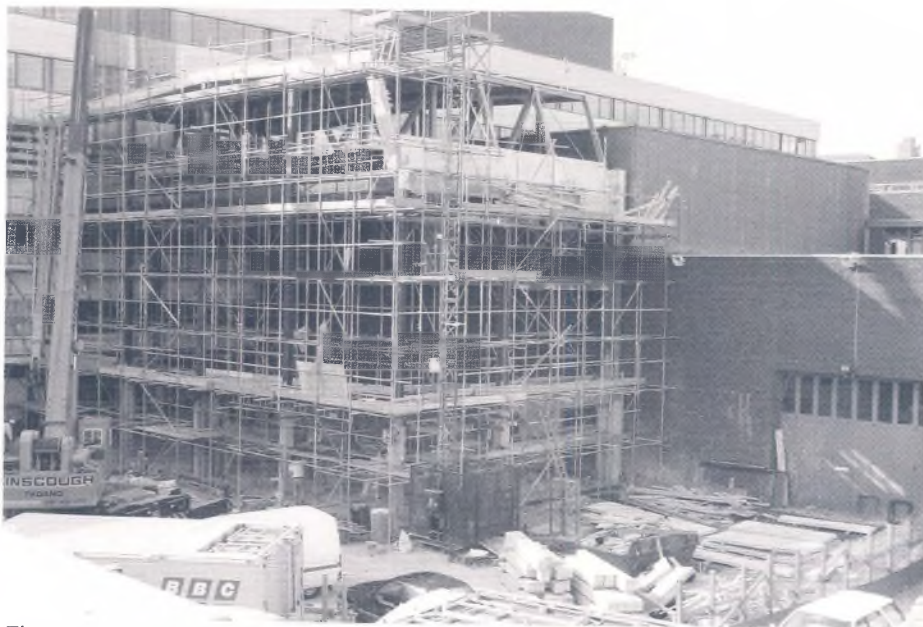

The extension under construction with the original studio behind (grey cladding).

continued, eg bricklayers working next to specialists wiring up the technical wallboxes.

The project was undertaken in 18 months and during the first half of this period,

Studio A was fully operational. During the second half, temporary studio facilities were provided in the adjacent Scenery Dock so that internal works could proceed in Studio A.

### Studio

The extension provides for an additional internal height of three metres and increases the total floor area to around 696 sq metres, of which about 570 sq metres is now usable. This area has been gridded into 600 mm squares to aid quick setting when turn-around time is important.

The low-level cyclorama track is 6 m high and has been extended around the whole perimeter of the enlarged studio. The studio extension enables extra-wide camera angles to be used, because the cyclorama track surrounding this area is 8.5 m high.

### Lighting

Saturated facilities for lighting and flying scenery have been provided in the old part of the studio, by means of additional winches; the studio extension, whilst not fully saturated, is also amply fitted with winches. In total, the studio has 101 lighting barrel winches, each of which can be loaded with up to three of the 137 pantographs provided.

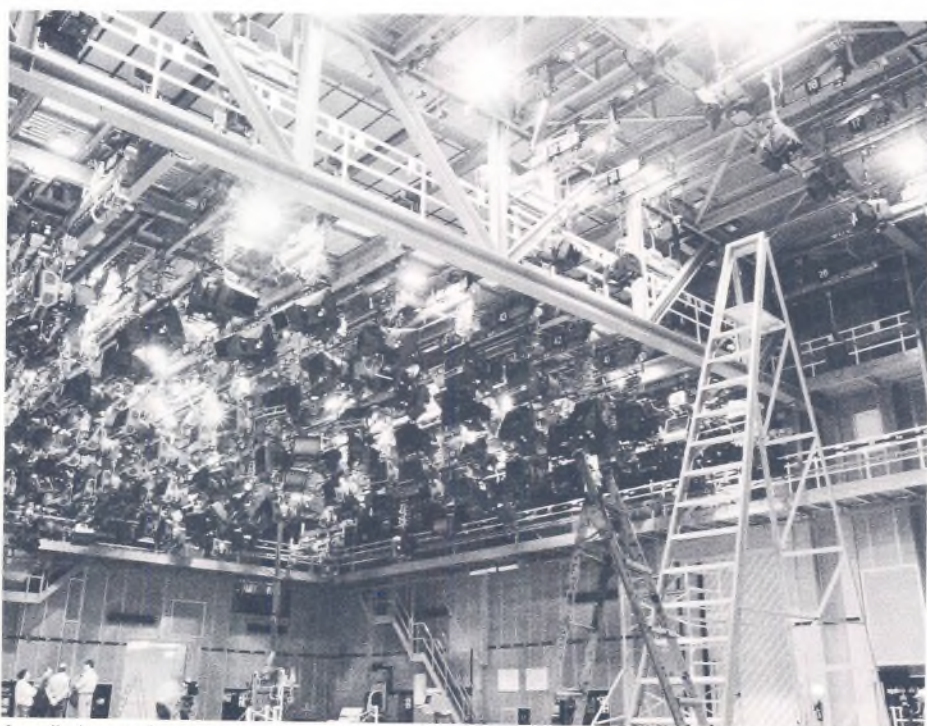

Installation work nears completion with the original studio, bottom left, and the additional-height extension, top right.

BBC North

BBC North



External view of the finished extension.

The studio lighting is controlled from a Strand Galaxy 3 desk which drives 397 dimmers; sixteen are rated at 10 kW, the remainder at 5 kW. At any given time, 750 amps is available for the total lighting load. A handheld designer's control panel — which can individually control any circuit — may be plugged in to any of four floor outlets for use during setting and lighting.

### Cameras

The studio is equipped with seven Ikegami 355 ccd cameras, three of which are hand-held models. Up to six can be used simultaneously and each comes with the full range of lens files, scene files, variable gammas and other facilities expected on modern channels.

There are four 16 x 8 camera lenses for the studio cameras, and three Canon 13 x 9 plus two 8 x 6 lenses for the portable cameras.

A number of wallboxes with camera, microphone, talkback and vision feeds are provided around the building, such as at Reception, on the fifth floor for roof and office uses, and at floor level exterior to the building.

### Production area

The refurbished production gallery offers a 24-channel GVE 300 vision mixer with three mix effects. The Vision Mixer has control of two isolated outputs from the studio, in both composite and component format depending upon origination.

A comfortable area for the Editor and Graphics Control has been provided at

the rear of the gallery, with full monitoring and communications facilities.

The Technical Co-ordinator has remote control of two 1-inch vt machines for both record and playback purposes.

### Monitoring and control

The studio's viewable sources — both internal and external — feed the sixty-four inputs of the matrix which feeds the monitoring chains. These include the six chains on the studio floor and one which is shared by the four wallboxes elsewhere in the building. This saturated approach reduces effort without impairing flexibility.

The sound gallery has a Calrec desk which provides twenty-four stereo and thirty-

eight mono inputs. The area has 24-track control facilities and comes with a range of CD, cart and tape machines.

The lighting and vision control area has a full geographic lighting mimic of the studio, as well as the Galaxy control desk. The camera electronic settings are also controlled from here; the design of the Ikegami 355 allows lift, gain and colours to be controlled from one seated position, if the show is simple in its requirements.

The heart of the communications system is a Drake 6000 which offers flexible routing of feeds, as required, to any of the seated control positions in the galleries. Any other connections can be made from the keyboard.

### Recording and effects

VT support is offered from any of the eight record/editing channels in Manchester NBH, which are a mixture of 1-inch composite, U-Matic and Beta SP.

A dedicated Slidefile has been built into Studio A but a mobile Charisma DVE or E-Flex DVE can easily be assembled in the apparatus room, and the control panel placed at the vision mixer position on prewired outlets.

The whole suite can also be supported by the main-block graphics area, which has two Quantel Classic paintboxes, one Quantel V paintbox with Harriet, two Rank Cintel Slidefiles, one Aston 4 capgen and one Aston 3 capgen.

Richard Howell  
Senior Development Engineer  
Manchester

Anthony Robinson  
Project Architect  
ACED

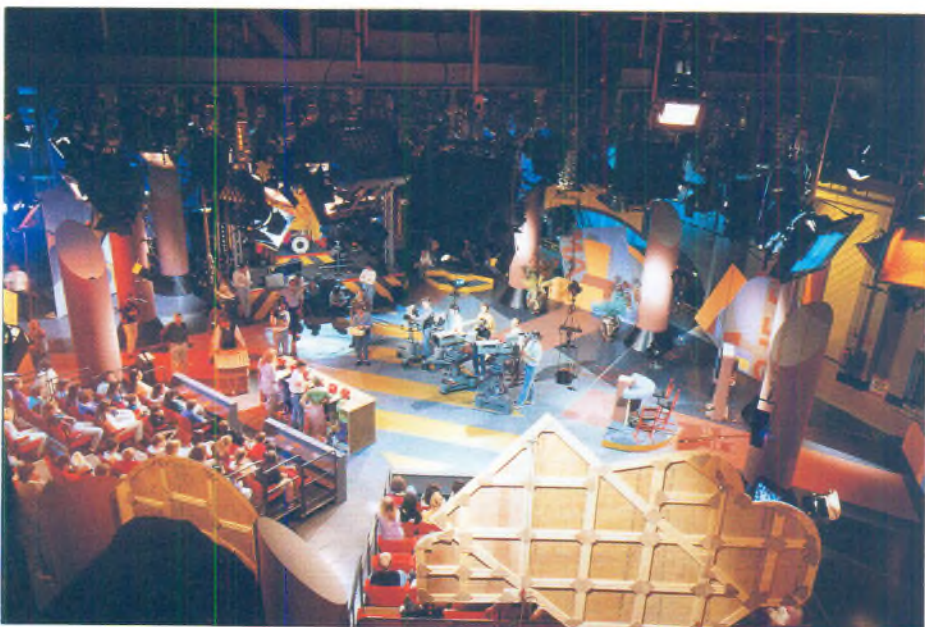

Studio A in use for "8.15 from Manchester".

# SOUTH REGION

## Southampton's new title sequence

The title sequence for Southampton's new-look regional news programme *South Today* involves a sundial casting a trapezoidal shadow which is cut away to reveal relevant pictures from vt. The trapezoid is fed into the mask input on the vision mixer such that it can be wiped in and out — nothing remarkable about that alone but the generation of the waveform itself required a little local ingenuity, according to Simon Marks.

The Southampton engineering group came up with a 2U rack-mount device which was designed from scratch and cost around £150 to build. The key is generated from data stored in eproms as 16-bit words; two for each active video line. These provide positional information for two transitions — one black-to-white, the other white-to-black — together with anti-alias details such as edge time constant and direction.

The eproms are accessed at line rate whilst a 10MHz clock, locked to reference syncs, processes the data which is fed to an analogue output stage.



BBC South

A cursor generator was included which, when activated, provides an on-screen

display superimposed over the target video, in this case a still frame vt. The cursor is moved to the four corners of the shape where co-ordinates are read off and entered into a BBC Micro for which software has been written to generate the data files and blow the eproms.

The device is in daily use, producing a fully interlaced, anti-aliased key with a horizontal resolution of 520 pixels. The results can be seen each weekday during the headlines of *South Today*.

Simon Marks  
Broadcast Engineer  
Southampton

## LOCAL RADIO

### Radio Stoke's Reporter Car

Radio Stoke has developed a new generation of Reporter Car, based on a Ford Fiesta . . .

The new Reporter Car had to be simple to use, it should give the reporter a high degree of freedom, and it should be extremely cost-effective to enable a station to run more than one vehicle if required. In fact, the cost of the vehicle, fully-equipped, has worked out at under £10,000.

The Ford Fiesta was chosen as the basic vehicle, as it is small and easily driven by all members of staff and has sufficient space to accommodate the technical equipment and wiring. The station now has four Reporter Cars — three based at

Stoke and one covering the Crewe/Nantwich area — and each vehicle has been kitted out with minimal disturbance to the bodywork and trim. This should permit easy disposal (ie resale of the stripped down vehicle) at the end of its useful life as a Reporter Car.

The operator's equipment fits into the glove compartment and has been designed so that it needs no special provision from the car, apart from aerials and a power supply via the ignition switch.

The main facilities provided by the operator's equipment are:

1. A reporter's mic input via an eight-way bayonet connector. A 30 m cable drum is carried in the vehicle to extend the reporter's mic lead.
2. A tape input for recorded contributions via a Uher or similar.
3. A reporter's radio-mic input for occasions requiring greater freedom.
4. For the reporter, comprehensive

monitoring of incoming and outgoing signals via standard headphones, or via radio-headphones for those occasions when the radio-mic is in use.

5. For the operator, comprehensive monitoring of incoming and outgoing signals via headphones and a VU meter.
6. Comprehensive transmission and reception facilities on vhf and uhf.

The control and signal cables run under the lower door frame to a transmitter rack which is fitted, within the boot area, to the rear seat-back. It is thus accessible to the



Radio Stoke



Radio Stoke



operator when the rear seat-back is folded down.

### Comms facilities

Five frequencies in the following bands are used for communications purposes:

**446MHz:** this wideband fm channel provides the programme feed back to base via one of the many cellular receive sites covering the Radio Stoke service area.

**224MHz:** this provides car-to-base communications, in conjunction with the 141MHz duplex channel. It is also used for simplex car-to-car communications.

**141MHz:** this provides base-to-car communications, in conjunction with the 224MHz duplex channel.

**200MHz:** this provides the link from the reporter's spot-frequency radio-mic to the car.

**49MHz:** this provides talkback and cue feeds to the reporter's radio-headphones via a Maxon 5 mW transmitter in the car.

These five channels have separate whip aerials on the roof of the vehicle, while the car radio (check receiver) uses an aerial mounted on the front o/s wing. A pneumatic mast was not thought necessary, as it would have impaired operational safety and provided little improvement within Radio Stoke's cellular receiving system. For operation outside the cellular area, the radio-van can be called in to assist, with its telescopic mast and more sophisticated comms facilities.

### Monitoring

There are eight monitoring points fed to two independent output amps — one each of the reporter and the operator — while a VU meter has also been provided for the operator's use. With reference to the accompanying diagram, the following points can be monitored:

- M1. A mix of the car radio check receiver and the two comms signals (141 and 224MHz)
- M2. A separate feed of the 141MHz comms signal.
- M3. A separate feed of the 224MHz comms signal.
- M4. A buffered feed from the uhf transmitter monitor.
- M5. The output from the tape recorder.

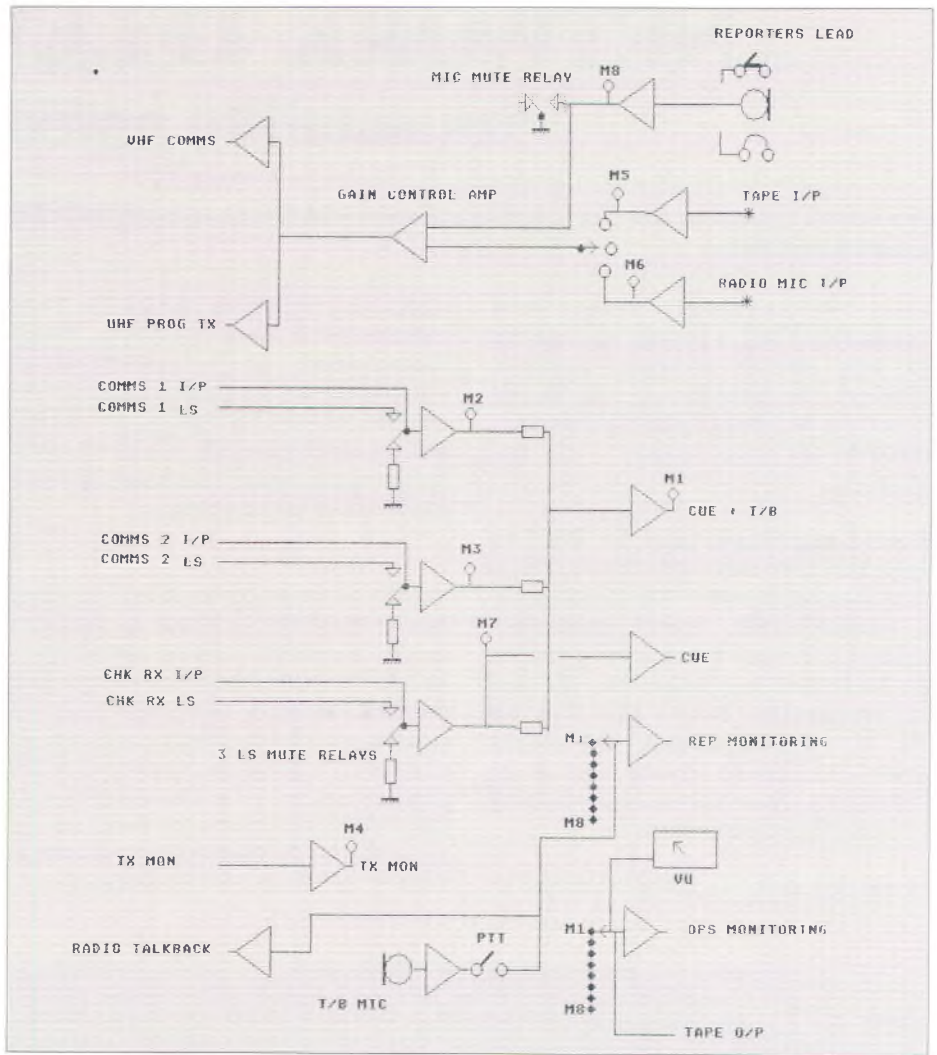

Diagram of the Reporter's panel showing the monitoring points.

- M6. The output from the radio-mic.
- M7. A separate feed of the car radio check receiver.
- M8. The un-muted output from the reporter's mic.

The VU meter reads whatever signal has been selected for headphone listening by the operator. Talkback to the reporter is from an electret mic on the front panel, via a PTT (push to talk) switch. When the operator presses this switch, the reporter's normal headphone feed is cut.



Two views of the Reporter's panel

### Power supply

Power for the audio circuits is derived from the car's 12-volt supply, via a 2A fuse and an rf filter to suppress interference. A reverse diode is also fitted to the supply — to prevent destruction if the battery is inadvertently connected in reverse. The operator's panel is powered whenever the car is in the radio/ignition position; to power the programme link transmitter, the 'UHF TX' switch must also be in the ON position.

*(With many thanks to Simon Penfold, Roger Crick and Des Richards of Radio Stoke, whose instruction manual formed the basis of this article. Anyone requiring further information on the Reporter's Car should contact Simon Penfold, EiC Radio Stoke.)*

# NETWORK TELEVISION

## 9m satellite antenna

**Jim Smith describes the 9m satellite antenna which was recently installed on the roof of the Central Wedge at Television Centre.**

Since 1989, regulatory changes have enabled the BBC to provide and operate its own satellite reception facilities. Hitherto, the reception of contribution signals for broadcasting had to be undertaken by the main carriers — BT and Mercury.

These changes have given the BBC the opportunity to make substantial savings in its operating budget — by making only a relatively-small capital investment. Initially, a 3 metre antenna was provided for Radio and was installed on the roof of Broadcasting House (see *Eng Inf* No 37). This installation has already made considerable savings and, as an added bonus, has improved the reliability of stereo OB contributions.

In parallel with the advances made by

Radio, the Television service has been wrestling with larger problems. Whilst radio signals can be accommodated within a narrow bandwidth and received on relatively small antennas, the weaker and greater-bandwidth signals required for television make it necessary to use a considerably larger antenna.

Consideration was given to the long-term aim of the EBU, viz that its members should eventually provide *uplinking* as well as *receiving* facilities for use within the EBU network. The EBU technical requirements for members' earth stations effectively became the specification for BBC Television. (It is interesting to note that EBU specification GTT 637 owes a great deal to the contributions of staff in D&ED and Research Department.)

At an early stage of the project it was necessary to establish the minimum size of antenna that would be technically acceptable. The EBU requirement was for a unified weighted signal/noise ratio of 50 dB to be achieved for at least 90% of the worst month. Using uncooled GaAs FET amplifiers, it was calculated (and later experimentally proved) that an antenna of approximately 9 metres diameter would be required.

### Choosing the site

Finding a site for such a large antenna within the confines of TC was not without its problems. The site not only had to be available but also had to be close to the appropriate technical area and have a clear view of the required part of the geostationary arc. A location was eventually



Applying the finishing touches to the dish before the final hoist into position.

ACED



The dish being lowered onto its support column.

selected above the Central Wedge which, at that time, was occupied by a 3 metre antenna. This dish was subsequently relocated a short distance to the west and now provides downlink facilities for transatlantic programme feeds via the *Panamast* satellite.

The roof of the Central Wedge was originally designed as an open-air studio and the support columns were built to carry the additional load that this would have imposed on the building. It was thus possible — without major strengthening works — to accommodate the load imposed by a 9 metre, 10 tonne, antenna together with its 20 tonne support platform within these existing columns.

Planning consents and the design and installation of the support platform were undertaken by ACED.

### Installation

The careful planning of the erection was an essential part of the project. The site

had limited access and all heavy plant had to be craned into position from the junction of West Hill with the Ring Road. The antenna reflector was assembled on the



The downward load (approx 30 tonnes) is supported on a single bearing.

roof of Studio 4, prior to being relocated to its final position on top of the Central Wedge.

To avoid unacceptable disruption, all lifting operations were restricted to weekends with the clearance of hazard areas and traffic diversions being managed by Television Premises Operations. The crucial weekend was 21st/22nd November when a 43 m crane hoisted the assembled reflector dish from the roof of Studio 4 onto the support column which, by now, was firmly bolted to the roof of the Central Wedge.

### Technical details

The 9 m antenna has been configured in a *dual reflector cassegrain* arrangement. It is equipped with a four-port linear feed, with orthogonal pairs for receiving (10.95-11.70GHz) and transmitting (14.00-14.50GHz). This means that it can simultaneously transmit and receive on all polarisations. It has motor drives for adjusting the polarisation, elevation and azimuth and is capable of accessing satellites located between longitudes 53 degrees east and 56 degrees west.

The gain of the antenna together with the system noise give rise to a figure of merit for the station known as the G/T. For this system, 36 dB/K was specified. While the antenna size determines the gain, the most significant source of system noise is the Low Noise Block (LNB) down-converter. This unit — which is mounted in the hub of the antenna — provides two functions; firstly, it provides essential amplification of the received signals with

## — 9m SATELLITE ANTENNA —

minimal additional noise and, secondly, it converts the received Ku-band signal down to the more manageable L-band (950-1750 MHz) for transport across the site.

An LNB of 100 deg Kelvin was necessary to meet a system G/T of 36 dB/K. Although the system has been provided primarily for the reception of analogue television, externally-referenced LNBS have been installed to provide the phase stability necessary for the reception of digital transmissions now being considered by the EBU.

An equipment cabin has been provided close to the antenna to house local control equipment and also provide accom-

modation for transmission equipment at a later date. The cross-site L-band cables terminate on two bays in the apparatus room. Five video receivers, two beacon receivers, LNB reference oscillators and the antenna control system are installed in these two bays. The video receivers can be plugged manually to receive either of the two polarisations available. The beacon receivers provide signal level information to the antenna controller which, by the use of step track, maintains antenna pointing. This feature will play an important role as the satellite operators allow more satellites to drift into inclined orbits.

Commissioning tests through a satellite have been successfully completed and the

results have been submitted to both Intelsat and Eutelsat for clearance. By meeting the target G/T of 36 dB/K, this 9 metre antenna exceeds the performance of even the 11 and 13 metre antennas at BT's *Teleport*, in London's Docklands!

The antenna's receiving facilities entered service this January, and should save the BBC an estimated £250,000 per annum. When the system obtains its licence to transmit, transmission savings will exceed £750,000 per annum.

### Credits

The project was led by Jim Smith of TED and managed for Network Television by Peter Barlow. From PID Tel, the Power, Lighting and Mechanical Group and Central Systems Group were involved while ACED's contribution — led by Ray Ralls — was of particular value. Other contributions were from Network Tel and Tel OBs.

### Footnote

During the course of this project, the Gulf conflict arose. Because of the heavy demands put on the circuit-providers (PTT's) by all sections of the media, the BBC had to consider ways of utilising its circuits to better effect. Those normally used to provide the EBU feeds could have been redeployed — had the 9 metre installation been completed in the latter half of 1990. However, this was logistically impossible within the short time frame required.

The alternative was to build a temporary 6 metre installation in front of the Stage V extension at TC (see the photograph on page 1). This antenna — although inferior in performance — was used to receive all later EBU transmissions from the Gulf, during the conflict, and is still providing a good service. It will be moved to a new location when a suitable site has been found.

Jim Smith  
Snr Proj Eng, Satellites  
TED



The 9m satellite antenna in operation.

# ELECTRONIC GRAPHICS

## Part 1: Introduction

In this five-part series — based on lecture notes supplied by Mike Winston — we will be looking at the various devices and techniques which are available for producing electronic graphics for television. So to start the series, here is a summary of the devices which are currently used in the BBC.

The traditional methods of producing graphic material for television (ie paper, pencils, pens, paint, Letraset, stencils, scissors, glue, photographic materials, etc) are being superseded by electronic devices. These machines either simulate the traditional materials and working methods, or provide new facilities not previously available.

Most equipment used for producing stills in electronic graphics areas falls into one of three categories, although the latest machines tend to combine these functions:

- Character Generators
- Stills Stores
- Painting Systems

### Character Generators

Early character generators were intended as simple caption generators with only one choice of character font and size (eg *Anchor*). Some of these used the chips and character sets designed for Teletext.

Current machines can produce elaborate captions with shaded backgrounds, multiple colours, and many different fonts. The fonts and completed captions are stored on hard or floppy disks for recall later, sometimes as a 'roller caption'. The main devices currently used in the BBC are the Aston 3, 4 and *Caption* machines.

The Aston 4 and *Caption* were a major advance because they generate high quality anti-aliased text with a linear key (more about this in a later part). They are more expensive but can produce some of the work previously only possible with a painting system. Master fonts are supplied in a high resolution format, and working typefaces of any size are prepared in advance from these masters as required.

|                      |         |
|----------------------|---------|
| Costs: Aston 3       | £10-14k |
| Aston 4              | £25-35k |
| Aston <i>Caption</i> | £18k    |

The BBC has bought about ten Aston 4s and fifty Aston *Captions*, mostly to replace Aston 3 machines.



Rostrum cameras in the Electronic Caption Production Area (ECPA) at Television Centre.

Mike Meyer

Three new machines have come on the market recently — the Abekas *A72*, Ampex *Alex* and Aston *Motif*. They all offer the new facility of processing fonts to any size 'on the fly', rather than having to prepare them in advance. The BBC has three of the *A72* machines; two in Birmingham and one in Cardiff.

### Stills Stores

The standard stills store used in the BBC is the Rank Cintel *Slidefile* and there are about eighty now installed. The system was originally developed by Research Department as a replacement for the photographic slide scanner and provides much the same replay facilities.

The pictures are grabbed from a live video input and stored digitally on a Winchester disk (160 or 330 Mbyte). They can be recalled in any order or stored off-line on a streaming-tape cartridge. *Slidefile* is no longer made, but has been superseded by *Silhouette*, also made by Rank Cintel. *Slidefile* cost about £45k but *Silhouette* is cheaper at around £23k.

An alternative is the Quantel *Digital Library System* (DLS) and the BBC has

several of these in News & Current Affairs, and Presentation. It is similar to the *Slidefile* but provides some additional video effects and the ability to catalogue and search for stills by title.

The cost of a full-facilities DLS was about £56K but this machine has been superseded by the Quantel *Picturebox* which offers improved facilities with much more compact hardware. Cost range is £30-50k.

The Aston *Wallet* stills store was introduced in late 1988. It stores pictures on small Winchester disks (about 40Mbyte), either fixed or removable. Operational facilities are limited but it has the facility to record pictures with linear key signals which neither of the other two machines can do. At £13k, it is much cheaper than the devices mentioned above, so is being bought for many areas where simple facilities are adequate.

*Wallet 2* was recently added to the range and provides most of the *Slidefile* facilities, eg cross-fades, main and preview outputs, polyphoto-style browsing, etc. It also offers larger disks including removable magneto-optic ones able to store 700 pictures. The cost of *Wallet 2* is £16k.

### Painting Systems

A painting system is an attempt to simulate electronically the effect of drawing or painting on paper. The artist sits at a graphic tablet in front of a monitor and 'draws' with a stylus, the result appearing directly on the monitor screen.

Painting systems range very greatly in price — from less than £1,000 to more than £100,000. As usual, you get what you pay for. The cheapest is merely a software package to run on a BBC micro or pc; the more expensive ones use custom-built hardware with multiple frame stores and provide many facilities: different brush sizes and types; stencils; cut and paste; typesetting; grabbing from live video; zooming; 2D and 3D animation, etc.

The best known and most widely used machine throughout the TV industry is the Quantel *Paintbox*. The BBC owns about forty of these, mostly in the graphics areas of Network Production Centres.

A new version of *Paintbox*, known as the *V series*, was introduced recently. This uses custom vlsi chips and so is much more compact (3U instead of 20U). The cost range is £30-80k.

The other painting system used in the BBC is *Artfile*, developed by Research

Department. This was designed to provide the most important facilities of a *Paintbox* but at a fraction of the cost — by writing painting software to run on standard Slidefile hardware. The result is a combined painting system and stills store, but it can only be used in one mode at a time.

About twenty *Artfiles* have been installed, mostly by providing add-on packages for existing Slidefiles in regional graphics areas — extra cost about £10k. However, combined stills stores and painting systems inevitably lead to operational conflict so, in most cases, a separate Slidefile/*Artfile* package has been provided at a total cost of about £55k. It is doubtful whether *Artfile* will be available on *Silhouette*, the Slidefile replacement.

Painting systems are used by artists who generally have no engineering background and so ease-of-use and the way in which an artist can establish a rapport with the machine is especially important. In general, the machines that are liked the most are the ones which are most interactive from the drawing tablet, and need the least use of a keyboard and vdu.

Several years ago there was a spate of new machines in the middle-price range. Invariably they were software packages to

run on PCs with a graphics board to generate the video output. In general they were not very successful because, being software based, their speed of response was poor. *Artfile* is also software based, and so suffers a similar lack of speed.

The latest machines are much better and designed more as general-purpose workstations with a range of facilities including painting, 2- and 3-D animation etc.

Examples of these are:

- Aston *Power Paint*
- Aurora *Videographics*
- Colourgraphics *DP422*
- Dubner *Graphics Factory*
- Electronic Graphics *Pastiche*
- EVS *Video Paint*
- Spaceward *Matisse*

The BBC has bought three *Matisse* and two *Pastiche* machines but, following legal action by Quantel over infringement of their patents, neither of these machines is still available. In fact, the threat of further legal action against other suppliers has led to the withdrawal from the UK market of all serious competitors to the *Paintbox*.

Mike Winston  
Central Systems Group  
PID Tel

## FILM

### The Super 16mm format

Film Production Resources recently held a seminar to discuss the Super 16mm film format and its possible applications. The event was aimed at promoting discussion between programme makers and craft people, and not at setting policy either for shooting or transmission. Here, Walt Denning outlines some of the principal points about Super 16 which prefaced the discussion.

Super 16 is not new! It was promoted about 20 years ago by a Swedish film maker, Rune Ericsson, who wished to make documentary-style films on a wide-screen format. He realised that a 1.66:1 aspect ratio (15 x 9) might be achieved if *single* perforation negative stock was used.

The most likely motivation for using this format was cost. Film shot more-cheaply on 16mm could be blown up to 35mm gauge for distribution to cinemas. However, blow-ups at that time were far from straightforward and very costly. The blow-up process itself was slow, because



*Del Boy* (David Jason) of "Only Fools and Horses" on location with an Arriflex Super 16mm camera.

BBC Television

an optical printer was used to photograph one frame at a time with appropriate magnification. (Copies made in the same gauge were made on a contact printer at high speed and were comparatively cheap.)

In the 1970s, there were two ways of achieving a duplicate 35mm negative from 16mm:

- (1) by making a Colour Reversal Intermediate (CRI)
- (2) by using the interpositive/inter-negative route.

The CRI process retained the best detail and granularity, as might be expected of a single-stage process, but lacked reliability and was therefore expensive (the customer ultimately pays for the copies which the lab throws away!) The interpos/interneg route was more reliable and almost always used for cinema distribution. However, it lacked the sharpness and minimal grain of the CRI. The difference in cost between the two processes was small.

Over the years, 16mm (and 35mm) negative stocks have improved. There have been four generations of new emulsions introduced in the last 20 years — all with improvements in colour fidelity, sharpness and grain structure. The CRI process is now a thing of the past and the modern interpos/interneg will reliably maintain the characteristics of the original negative.

Anyone who has seen recent blow-ups in the cinema — the BBC 16mm productions *Truly, Madly, Deeply* and *Galahad of Everest* are good examples — cannot fail to have been impressed with the quality which can now be obtained from the 16mm negative. Blow-ups have, perhaps, come of age. However, it cannot be denied that if the purpose of making a film is for theatric distribution, then shooting should take place on 35mm with the conventional post-production process.

With the increasing interest in HDTV and widescreen television — both having display aspect ratios of 16 x 9 — it is not surprising that Super 16 is seen as a useful medium on which to originate programmes which may have a long shelf life. It is accepted that 35mm film is eminently suitable as an origination medium for any currently-conceived HDTV systems, or for widescreen television. Super 16, however, lives under a cloud and a recent EBU statement, of which a portion is reproduced below, is helpful:

To see clearly how the Super 16 format has been developed from the standard frame, a normal double perforated frame has been reproduced below.

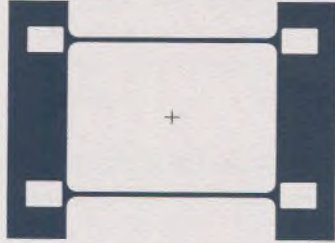

This represents a scale drawing of the negative image as recorded on normal double perforated stock. The centre of the image is centred down the middle of the film.

The frame dimensions give an aspect ratio of 4:3 or 1.33 to 1. This aspect ratio matches that of the normally transmitted picture for broadcast television.

Comparing this frame with the Super 16 frame below, shows why single perforated stock must be used.

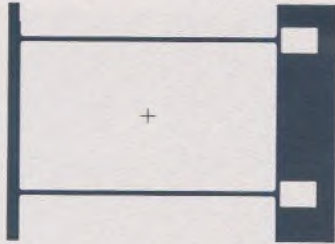

Although the picture height remains the same, the frame has been extended outwards to produce an aspect ratio of 5:3 or 1.66 to 1.

The centreline of the frame is now offset from the centre of the film, meaning that the lens axis will need an equal shift to the left.

(Note that the point of view here is looking at the back of the film with the camera lens on the far side.)

A modern lens design will produce good flat fields over the working area of the frame but quality will drop off quite rapidly outside this area. The diagram below shows how a lens manufactured for standard 16mm, produces a flat field in an area that encompasses the 4:3 frame. Superimposed on this diagram is the extra area of coverage required for Super 16 and the circle in which a flat field is required. It is evident that some lenses may not be able to maintain full image quality at the extremes of the Super 16 frame.

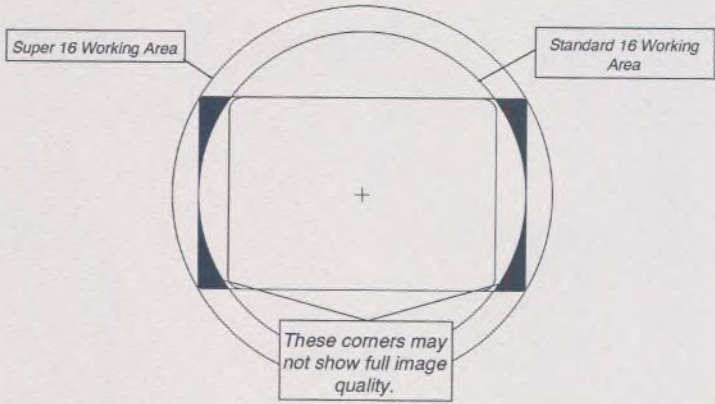

Super 16 Working Area

Standard 16 Working Area

These corners may not show full image quality.

- The Super 16mm format is totally adequate as a basic format for production of 625/50 television programmes in the 16:9 (1.78:1) image format.
- The Super 16mm format does not yet fully meet the specific requirements of a source for high quality programme material for HDTV.
- The technical performance which can be achieved today from the Super

16mm format on HDTV displays seems adequate, from the quality point of view, if technical restrictions have to be accepted to conform to the demands of the production procedures.

- To gain the optimum quality from the Super 16mm format it is recommended that the negative is transferred directly to tape.

## — SUPER 16mm FORMAT —

*Continued from previous page*

Since Super 16 requires the use of single perforation film stock, there are a number of restrictions on its use. Some cameras such as the 16mm Panaflex cannot be used and some laboratory printing equipment has sprockets with two rows of teeth. It is not possible to 'flip' Super 16 or to print from the tail which is sometimes required when perforations are damaged. However, the Arri SR and Aaton cameras

in use with the BBC are perfectly happy with single perforation stock and it becomes a matter of increasing curiosity as to why we routinely shoot with two sets of perforations.

This does not mean that all of our cameras can automatically shoot Super 16. As can be seen from the diagram on page 23, there are two further issues. Firstly, the film gate must be enlarged to cope with the wider format and edge guidance

employed on Super 16 and, secondly, the optical axis of the lens must be moved to a new centre, off-set from the centre-line of the film stock. Standard 16 cameras can be converted at a price while new ones can be specified to be convertible between the formats.

The range of lenses available for Super 16 is also limited. As can be seen from the diagram, the Super 16 lens is required to cover a large image area and many designed for Standard 16 have good flat fields over the required image area but drop off rapidly outside this. It might be supposed that 35mm lenses would be suitable but these are often produced to a lower specification than 16mm lenses (the 16mm lens must resolve twice the amount of detail as its 35mm counterpart). Also, care must be taken in the selection process to ensure that the limit of resolution is controlled by the film stock and not the lens.

The post-production of Super 16 may take place in the conventional filmic manner, or by transferring to videotape and employing off-line editing techniques. If conventional film editing is employed, then Super 16 Compeditors and Steenbecks are required in order to see the full frame. It is, of course, possible to edit with Standard 16 equipment but with the centre-line of the picture offset and 20% of the picture unobserved. This is not a sensible thing to do. There is also the matter that unrelieved guide rollers may scratch the film print. Super 16 equipment is readily available or Standard 16 may be converted — all at a price.

The question of how Super 16 should be shown on television is a fascinating subject and ultimately for programme people and the viewing public to decide. However, the current interest in Super 16 and the list of projects which are investigating its possible use may lead us to suppose that pressure for more widescreen transmissions will increase. This may then enable widescreen television to be introduced — with less hassle than many experts had supposed.

Walt Denning  
Head of Film Prod Res  
TFS Ealing



BBC Television

*"Galahad of Everest" with Brian Blessed (right) was shot on Super 16mm*