

**BBC**  
**RECORDING TRAINING**  
**MANUAL**

**BRITISH BROADCASTING CORPORATION**

# BBC RECORDING TRAINING MANUAL

BBC  
RECORDING TRAINING  
MANUAL



BRITISH BROADCASTING CORPORATION

1950

*The British Broadcasting Corporation*  
*Broadcasting House, London, W.1*

Set in Plantin 10 on 11 point,  
and printed in Great Britain by  
Electrical Press Ltd., Maidenhead





## ACKNOWLEDGEMENTS

The BBC acknowledges with thanks the courtesy of the following authorities in permitting the publication in this book of quotations, references and illustrations as listed below. If, through obscurity of origin or other cause, any acknowledgement due has been omitted from this list, such acknowledgement will be made in subsequent editions provided that the BBC has been notified of the omission.

<i>Authority</i>	<i>Reference</i>
The Royal Society of Arts	Note 1, Ch. 1.
Messrs. Methuen & Co. Ltd.	Note 2, Ch. 1.
Messrs. Chatto and Windus	Note 11, Ch. 1.
Encyclopaedia Britannica Ltd.	Note 14, Ch. 1.
The Institution of Electrical Engineers	Note 1, Ch. 2 ; App. G.
The Acoustical Society of America	Notes 2 and 3, Ch. 2
Messrs. McGraw-Hill Publishing Co., Inc., New York.	Note 4, Ch. 2, App. H.
Messrs. Electrical Musical Industries Ltd.	Figs. 13-16, 111-114.
Messrs. Voigt Patents Ltd.	Fig. 80.
Messrs. Francis Shaw & Co. Ltd.	Plate 7.
Marconi's Wireless Telegraph Co. Ltd.	Plate 9.

Thanks are also due to the following for their co-operation in reading the proofs : Messrs. British Homophone Co. Ltd. (Ch. 5), Messrs. Electrical Musical Industries Ltd. (Ch. 6, Section 3), and Messrs. Philips Electrical Ltd. (Ch. 7).

Extracts from British Standard 204 : 1943 (Glossary of Terms used in Telecommunication) and British Standard 205 : 1943 (Glossary of Terms used in Electrical Engineering) have been used freely throughout the Manual by permission of British Standards Institution, 28, Victoria Street, London, S.W.1, from whom copies of the official specifications can be obtained, price 5s. od. and 10s. 6d. respectively, post free.



## CONTENTS

<i>Chapter</i>		<i>Page</i>
1.	GENERAL PRINCIPLES OF SOUND RECORDING AND REPRODUCTION .. .. .	I
	Definition of Sound—Characteristics of Sound—Distortion in Electrical Communication Circuits—Historical Survey of Sound Recording—Sound Recording in a Broadcasting Service.	
2.	PRINCIPLES OF DISK RECORDING .. .. .	24
	General Considerations—Effect of Groove Diameter and Cutting Speed on Fidelity—Recorded Wavelengths—Turntable Speed—Disk Diameter and Recording Time—Groove Spacing and Groove Pitch—Amplitudes and Velocities—The Groove—Radius Compensation—Recording Characteristic—Effect of Groove Loading on Frequency Response—The Disk—The Cutting Stylus—The Recording Head—The Recording Amplifier—The Recording Machine.	
3.	BBC DISK RECORDING EQUIPMENT .. .. .	49
	Introduction—The MSS Disk Recorder—BBC Portable Disk Recording Equipment, Type C—Presto Disk Recording Equipment—BBC Disk Recording Equipment, Type D.	
4.	REPRODUCTION OF DISKS AND PRESSINGS .. .. .	84
	Acoustic Reproduction—Electrical Reproduction—Electrical Reproducing Heads—Reproducing Heads used by the BBC—Pickup Equalisation—Disk and Needle Wear—Tracking Arms—Groove-locating Unit—Speed Accuracy of Reproducing Turntable—BBC Disk Reproducing Equipment—Frequency Characteristic of Disk Reproducing Apparatus.	
5.	THE PROCESSING OF DISKS .. .. .	113
	Introduction—General Principles of Processing—Processing in Detail.	
6.	MAGNETIC RECORDING AND REPRODUCTION .. .. .	117
	Definition of Terms—Fundamental Principles of Magnetic Recording—The Hysteresis Loop—The Marconi-Stille System—The Magnetophon System—The E.M.I. Magnetic Recorder.	
7.	FILM RECORDING AND REPRODUCTION .. .. .	135
	Introduction—Variable-density Recording—Variable-width Recording—Effect of Recording-slit Width—Push-pull Recording—Noise Reduction in Photographic Film Recording—Reproduction of Photographic Film Recording—Advantages and Disadvantages of Photographic Film Recording—The Philips-Miller Film Recording System—The Philips-Miller Machine—Philips-Miller Amplifiers.	

*CONTENTS (continued)*

<i>Appendices</i>	<i>Page</i>
A    Maximum Disk Recording Time and Most Economical Speed of Rotation .. .. .	153
B    Manufacture of Sapphire-tipped Recording Cutters and Reproducing Needles .. .. .	155
C    Induction and Synchronous Motors .. .. .	159
D    Analogy between Mechanical and Electrical Circuits .. .. .	167
E    The Buchmann-Meyer Image .. .. .	173
F    Scanning in Variable-width Film Reproduction .. .. .	178
G    Frequency Fluctuations in Sound Recording and Reproducing Systems .. .. .	185
H    Tracking Angle in Phonograph Pickups .. .. .	210
J    Reference Data .. .. .	224
i. Recording Diameters and Duration (BBC Standards)	
2. Decibel/Voltage Ratio Table	
3. Graphical Symbols for Recording and Reproducing Heads	
Index .. .. .	227

*LIST OF PLATES*

<i>Plate</i>	<i>Opposite Page</i>
1. BBC Disk Recording Machine Type C .. .. .	54
2. Presto Disk Recording Machine Type 8N .. .. .	55
3. BBC Disk Recording Machine Type D .. .. .	62
4. BBC Disk Reproducing Desk Type DRD/1 (Exterior) .. .. .	100
5. BBC Disk Reproducing Desk Type DRD/1 (Interior) .. .. .	101
6. BBC Disk Reproducing Channel .. .. .	106
7. Gramophone-record Press .. .. .	116
8. Blattnerphones .. .. .	126
9. Marconi-Stille Machine .. .. .	127

## *PREFACE*

The use of Sound Recording by the BBC has increased considerably in the past few years, largely under the stress of wartime needs. For many years, recording fulfilled an important function in the Empire Service, and was regarded as a worthwhile auxiliary in many other directions. Now, however, it has become an essential facility both in programme planning and in programme production.

The extension of the service has involved, amongst other things, the recruitment and training of a large number of additional staff. The BBC has not previously issued a recording training manual for their use ; indeed, no comprehensive textbook on the subject exists, so far as is known.

The Recording Training Manual has been written by the Engineering Training Department primarily for the use of BBC staff. It does not claim to be an exhaustive treatise on the art and science of Sound Recording and Reproduction, but is intended to give to the staff of the Recording Department of the BBC Engineering Division a good grounding in the fundamentals of their subject with particular reference to BBC equipment in current use.



## CHAPTER I

# GENERAL PRINCIPLES OF SOUND RECORDING AND REPRODUCTION

### 1.1 DEFINITION OF SOUND

**B**EFORE proceeding to discuss the principles of sound recording and reproduction, we shall try to define what is meant by sound and outline its more important characteristics. There are many different interpretations of the term "sound," ranging from the popular conception, expressed by phrases such as "he heard the sound of a distant bell" to authoritative statements<sup>1</sup> that sound as a sensation does not exist but merely expresses the reaction of the mind to atmospheric pressures communicated to it through the ear. Others define sound as "longitudinal vibrations in a medium which may be gas (e.g., air), liquid (water) or solid (iron)." This definition is incomplete, for it takes into account neither the source of vibrations nor the effect they produce. On the other hand, the first phrase quoted suggests that the listener associates the sound he hears with its source, the bell, and that the sound has been conveyed over the intervening distance.

If we combine the popular conception with the academic definition, we can arrive at a new definition which is sufficiently comprehensive for the purposes of this Manual. We will therefore define sound as "the longitudinal vibrations set up in the surrounding medium by a vibrating body, which, when communicated to the brain by the ear, produce the physical sensation of hearing."

In considering the recording of sound, we are concerned mainly with vibrations in the air and their conversion into some form of energy which can be used to produce a "sound track." When discussing the reproduction of sound, we are concerned with reconstituting from the sound track air vibrations which, as far as the listener can judge, are faithful copies of the original vibrations.

In the end, it is the sense of hearing which decides whether or not the reproduced sound is a faithful copy of the original. Measurements by instruments may indicate discrepancies between the original and the reproduced waveform which the ear cannot detect. Thus, the average ear does not respond to vibrations occurring at rates above about 18,000 per second nor to those below about 20 per second; the frequency limits vary considerably for different individuals and the upper limit falls as age increases. The average ear is less critical than the above limit suggests; it is generally accepted that if all vibrations between 50 and 10,000 per second are accurately reproduced, the fidelity of the reproduced sound will not normally be questioned.

The rate of vibration is called the frequency of the sound, and is expressed in cycles per second (c/s). Broadcasting services normally attempt to transmit frequencies within the range just mentioned, namely 50 to 10,000 c/s; it is therefore desirable that a sound recording and reproducing system for use in



## BBC RECORDING TRAINING MANUAL

such a service should have an overall frequency response which extends at least to these values.

### 1.2 CHARACTERISTICS OF SOUND

#### 1.2.1 PROPAGATION OF SOUND WAVES

The medium through which sound normally travels is air and disturbances produced in the air by a vibrating body, such as a tuning fork or a violin string spread out from the source of vibration in all directions. If the physical dimensions of the vibrating body are small the sound may be regarded as emanating from a point source and the disturbances produced in the air near the source will have a curved formation, but as the distance from the source increases the curvature of the wave front decreases. If it were possible to take a snapshot of a section of the wave front at some distance from the source, the wave front of the section would appear as in the top part of Fig. 1. This figure depicts the wave produced by a vibrating tuning fork; the closely spaced lines indicate areas of compression and the widely spaced lines areas of rarefaction. In the graph in the lower part of the figure, the line AB represents the normal atmospheric pressure and the curved line shows the variations in pressure above and below this value at the instant of our investigation.

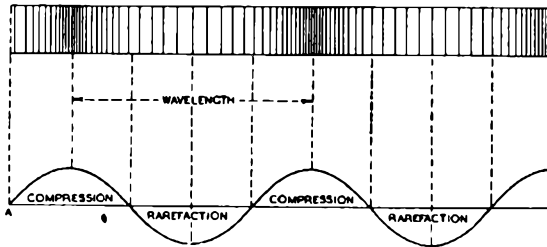

FIG. 1. DIAGRAM INDICATING VARIATIONS IN PRESSURE WHEN A SOUND WAVE FROM A PURE TONE SOURCE IS PROPAGATED THROUGH THE AIR

We must now consider the rate at which these variations move through the sound-conducting medium. The velocity at which a sound wave is propagated is dependent upon the elasticity/density ratio of the medium and for air at a temperature of 60° F. is 1,120 ft. per sec. The velocity is much higher for water (4,680 ft. per sec.) and higher still for iron (17,000 ft. per sec.).

Although the sound waves travel in air at 1,120 ft. per sec. there is no movement of the medium as a whole; the air particles oscillate to and fro along the direction of propagation, but do not move very far from their mean position. The instantaneous value of particle velocity depends upon the instantaneous pressure and the frequency of vibration.

#### 1.2.2 WAVELENGTH AND FREQUENCY OF SOUND

Before the length of a sound wave can be determined it is necessary to take into account the frequency at which it is propagated; for example, if a

## 1.2 CHARACTERISTICS OF SOUND

tuning fork vibrates 1,120 times per second the frequency of the sound wave it produces is 1,120 c/s.

Referring to Fig. 1, the wavelength is the distance between two corresponding points in successive cycles of the wave. A little thought will show that if the frequency of vibration is 1,120 c/s, and the velocity of propagation 1,120 ft. per second, the wavelength is 1 ft. If the frequency were lowered to 560 c/s, the wavelength would be 2 ft. ; that is to say, the wavelength is inversely proportional to frequency and the product of wavelength and frequency is equal to velocity. Thus we have a simple equation

$$\lambda f = v$$

where  $\lambda$  is the wavelength in feet,  $f$  the frequency in cycles per second and  $v$  the velocity in feet per second. This relationship will be referred to again in the discussions on the principles of sound recording and reproduction.

### 1.2.3 PITCH AND QUALITY

The two characteristics which cause sounds to differ from each other are pitch and quality. The pitch of the sound is determined by the fundamental frequency of vibration at the source. The musician uses the terms bass and treble, which represent low-pitched and high-pitched tones respectively. If, however, the character of sound depended solely upon pitch then two instruments vibrating at the same frequency would produce identical sounds,

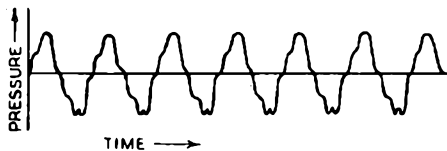

FIG. 2. COMPLEX PRESSURE WAVEFORM PRODUCED BY CLARINET

whereas it is well known that if the same note is played on a violin and a piano two quite different sounds are produced.

We have seen from Fig. 1 that if the sound wave produced by a vibrating tuning fork is plotted on a graph the waveform is smooth and symmetrical ; Fig. 2 illustrates the waveform of a clarinet note. If we assume the frequency of the tuning fork in Fig. 1 to be the same as that of the clarinet note in Fig. 2, it is clear that the respective sound waves produced by the two instruments are different in character. This is because the tuning fork vibrates with simple harmonic motion, like a pendulum, producing what is known as a sinusoidal waveform whilst the vibrations produced by the clarinet have a complex waveform. Such a waveform is composed of a fundamental vibration frequency together with other frequencies which are multiples of the fundamental. These other frequencies are known as harmonics and if a sound contains a harmonic having twice the frequency of the fundamental, this is referred to as the second

harmonic. A clarinet note, for example, may contain a proportion of second, third, fifth and seventh harmonics. We are, however, not concerned with the specific harmonics contained in a particular musical note ; it is sufficient for our purpose to indicate that the character of a sound is dependent upon the number of audible harmonics it contains and the relationship between individual harmonics and the fundamental ; these relationships include the order (2nd, 3rd, etc.), amplitude and phase.

The presence of harmonics has an important bearing on the faithful recording and reproduction of sound, for if the audible harmonics are not reproduced in their proper proportion the quality of the reproduced sound will lack fidelity. It is generally accepted that, for perfect reproduction of orchestral music, a frequency range of 20-18,000 c/s is necessary, but the average listener is usually unable to detect any noticeable lack in fidelity if the range is restricted to 50-10,000 c/s, and this latter range is normally acceptable to a recording service.

#### 1.2.4 INTENSITY AND LOUDNESS

The characteristics, intensity and loudness of sound are closely inter-related and in this section we shall show that whereas the intensity of sound is directly proportional to the power radiated by the source, an increase in sound intensity does not necessarily produce an equal increase in loudness. The power radiated in the form of sound is extremely small compared with the power required to produce it ; for example, the power developed by a pianist in producing a loud note may be as much as 200 watts, but the power of the sound radiated would be less than half a watt.<sup>2</sup> The intensity of a sound (i.e., its objective strength related to r.m.s. pressure in dynes per sq. cm.) at a given distance from its source can be calculated if the power at the source is known. If the source vibrations take place in free air, sound radiates freely in all directions and, at a given point, the intensity is in direct proportion to the power, but in inverse proportion to the square of the distance from the source.

Since we have assumed the source to be in free air, the sound may be regarded as being propagated from the centre of a sphere. The intensity at a point distant  $r$  from the source equals  $power/4\pi r^2$ .

The power developed at the source of sound is dependent upon the amplitude of vibration ; as vibration amplitude increases, so also does the pressure amplitude (that is, the maximum air-pressure displacement above or below normal air pressure, indicated by the peaks of the curve in Fig. 1). The intensity at any point is proportional to the square of the pressure amplitude at the same point, so that an increase in pressure amplitude causes an increase in intensity and also in loudness.

We must now consider the effect on the ear of a sound, when the intensity is varied. If the volume control of a radio receiver is gradually turned down, a position is reached where the sound from the loudspeaker becomes inaudible ; there is thus a lower limit of sound intensity below which the ear does not respond. This limit is termed the threshold of hearing and is shown, for an

## 1.2 CHARACTERISTICS OF SOUND

average individual, in Fig. 3. It will be seen that the limit varies at different frequencies. It should be remembered, however, that the sensitivity of the ear varies between individuals and it is necessary to fix a standard of intensity with which other intensities may be compared. The universally accepted zero level of sound intensity corresponds to a power of  $10^{-16}$  watt per sq. cm. which is equivalent to an r.m.s. pressure amplitude of 0.0002 dyne per sq. cm.

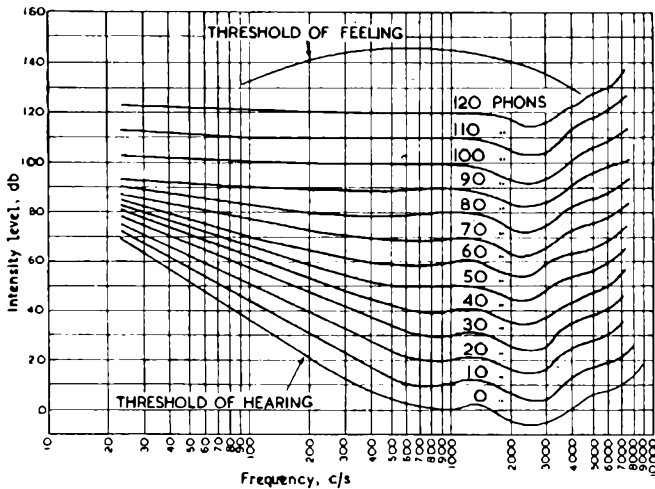

FIG. 3. INTENSITY LIMIT CURVES. (AFTER FLETCHER, MUNSON & WEIGAL)  
Showing variation of thresholds of hearing and feeling with variation in frequency

The next step is to consider a convenient means of expressing different intensity values in relation to this standard intensity. We must first emphasise that it is not the actual intensity changes which matter but the effect which such changes produce on the ear; this effect is sometimes called the *sensation level*, and whilst it is true that as the intensity of a sound increases there is an increase in the sensation of hearing, equal increments in intensity do not produce equal increments in sensation level. This is best illustrated by comparing the sound intensity of a solo violin playing *pianissimo* with a full orchestra playing *fortissimo*; the intensity of the orchestral sound may be many million times that of the solo violin, but it would be most unfortunate for the listener if the sensation level were increased by the same amount. There is, however, a very practical relationship between intensity and sensation level based on a law which postulates that sensation changes are proportional to the logarithm of the changes in the stimulus. This means that if the stimulus is increased in steps of multiples of 10 (10, 100, 1,000, etc.), the sensation is increased in steps corresponding to the logarithms of those multiples, which for the figures given are 1, 2, 3. Therefore, if we call the standard threshold intensity  $I_1$  and a

## BBC RECORDING TRAINING MANUAL

second intensity  $I_2$ , the difference in sensation level resulting from these two intensities may be expressed in logarithmic terms as

$$\text{Difference in Sensation Level} \propto \log \frac{I_2}{I_1}$$

It has been seen that intensity is directly proportional to power, and we may therefore use the same unit for expressing the ratio of two intensities as that used to express the ratio of two powers, namely, the decibel. (See Appendix 1.) Thus, if the ratio of two intensities is 1 : 2 then the difference in the sensation

levels they produce will be  $10 \log \frac{2}{1} = 10 \log 2 = 10 \times 0.3 = 3 \text{ db}$ .

We have seen that there is a given intensity level below which a sound cannot be heard ; there is also an intensity level, called the threshold of feeling, above which the sensation becomes one of pain rather than of hearing. The

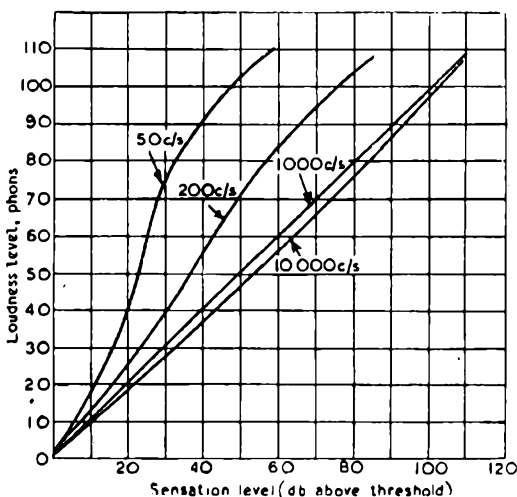

FIG. 4. SENSATION-LEVEL, LOUDNESS-LEVEL CURVES

threshold of feeling, like that of hearing, varies with frequency and from individual to individual.

The thresholds of hearing and feeling for an average individual are indicated in Fig. 3. From these, we see that the intensity level corresponding to the threshold of feeling is greatest at about 1,000 c/s and falls off as the frequency is increased or decreased. Between the two thresholds, the range of intensity level is not the same at all frequencies, and is much less at low than at high frequencies. It follows that a given intensity change of an audible low-frequency note will give greater change in loudness than the same intensity change of a high-frequency note. Thus, in Fig. 3, if at 1,000 c/s the sensation level is

## 1.2 CHARACTERISTICS OF SOUND

changed from 40 db to 60 db the change in loudness is 20 phons, whereas for a similar change in sensation level at 100 c/s the change in loudness is approximately 30 phons.

In the example quoted, we have used the term loudness somewhat loosely to simplify the explanation ; loudness, by definition, is subjective and cannot be expressed in practical units ; the *phon*, therefore, is not the unit of loudness, but of *loudness level*. Now we cannot measure the loudness level of a sound unless we have a standard reference level and scale. If this level and scale is fixed for a given frequency, the loudness level of sounds at any audible frequency may be expressed in terms related to this standard. The frequency generally accepted for this purpose is 1,000 c/s and the scale, that of sensation level in db for that frequency ; zero level on this scale is the sensation level at the threshold of hearing. Using this scale, the loudness level of a sound at a given frequency is the sensation level of a 1,000 c/s tone judged aurally to be of equal loudness to the sound being measured.

For example, if it is desired to measure the loudness level of a 200-c/s note, the level of a 1,000-c/s tone is adjusted until the sound is judged to have the same apparent loudness as the sound being measured ; the sensation level of the 1,000-c/s tone on the db scale is then noted ; if this were 30 db the loudness level of the 200-c/s note would be 30 phons. Fig. 4 illustrates that for sounds between 1,000 c/s and 10,000 c/s the loudness level in phons maintains a fairly close relationship with sensation level in decibels, but that at lower frequencies, a given change in sensation level produces a greater change in loudness level.

The foregoing relationships are of considerable importance and are worth summarising as follows :—

- i. The power of a sound in free air is greatest at its source and is dependent on the amplitude of vibration.
- ii. Intensity (at a given point) is directly proportional to power and inversely proportional to the square of the distance from the source ; for the purposes of measurement zero intensity level is taken as  $10^{-16}$  watt per sq. cm. or a pressure amplitude of 0.0002 dynes per sq. cm.
- iii. Sensation levels (i.e., levels above threshold intensity) increase in logarithmic proportion to increase in intensity levels and may be expressed in decibels.
- iv. Loudness level increases in step with sensation level at 1,000 c/s and nearly so between 1,000 and 10,000 c/s, but below 1,000 c/s a given increase in sensation level is accompanied by a greater increase in loudness level ; for this reason the phon and not the decibel is used to express loudness level.

### 1.2.5 INTENSITY RANGE

We must now consider how the relationships discussed in the previous section are applied to the recording and reproduction of sound. It has been said that there are two limits of audibility, the threshold of hearing and the

threshold of feeling ; the maximum sensation-level range between these two limits is generally accepted as 140 decibels. If the intensity of the loudest sound from a full orchestra is twenty million times as great as the weakest sound from a single violin<sup>2</sup>, the sensation-level range of the orchestra approximates 73 decibels. The sensation-level range of speech is, of course, much lower than this and is generally accepted as being about 20 db. It will be shown later that the maximum range which can be accommodated by practical recording systems is greater than 20 db but less than 70 db, which indicates at once that whereas speech may be recorded at its full range, the range of certain musical programmes must be compressed. The intensity limits between which a broadcasting or recording system can operate satisfactorily is sometimes referred to as the dynamic range. The factors which control this range are noise level and overloading ; the lower limit must be such that the weakest sound to be reproduced is heard above background noise composed of incidental noises of a studio or concert hall together with the noise inherent in electronic amplifiers and recording and reproducing processes ; the upper limit is set by the necessity for avoiding overloading any component in the broadcasting or recording chain. Both these conditions can be fulfilled when the dynamic range of programme is restricted to about 30 db.

#### 1.2.6 ABSORPTION, REFLECTION AND REVERBERATION

In the previous sections, we have confined our attention to sounds originating in free air and have seen that the intensity of such sounds decreases in proportion to the square of the distance from the source. When considering sound recording we are less concerned with open air sounds than with sounds originating in enclosed spaces such as studios and concert halls, in which the sound is reflected from the ceilings, the walls and the floors. The combined effect of these reflections is called *reverberation* and the *reverberation* time of a studio is defined as the time which elapses between the instant when the source of sound is cut off and the instant when the sensation level has fallen by 60 db. This is an important factor in the design of studios. The subject of acoustics is, however, far too complicated to be discussed fully in this Manual and we must limit our attention to a brief survey of reverberation and absorption.

First let us imagine ourselves in a room in which a sustained note from an organ is being played and then suddenly cut off. The intensity will gradually build up until it reaches a certain value, which will remain constant as long as the note is sustained. Immediately the note is cut off, the intensity begins to die down until the sound becomes inaudible. The building up of the intensity is due to reflections from the boundaries of the room and if there were no absorption, the intensity would continue to build up for so long as the note was being played ; since, however, a point is reached when the intensity appears to be steady, it follows that some of the sound energy is being absorbed and that, whilst the intensity is steady, the rate of absorption is equal to the rate of increase in intensity due to reflection. When the initial sound ceases the absorption continues and the sound gradually dies away.

The reverberation time of a room may be calculated if the total absorption

## 1.2 CHARACTERISTICS OF SOUND

is known. The unit for measuring total absorption was first used by Sabine and is called the Open Window Unit (O.W.U.). If we imagine a room having no absorption other than that due to an open window, the reverberation time of the room will depend on the area of the window. The sound is absorbed by virtue of this space, and by taking one square foot of open window space as a standard, we have a unit for comparing the absorption of other materials. For example, if the reverberation time for a room having an open window space of 0.25 sq. ft. is similar to that for the same room when the open window is replaced by 1 sq. ft. of absorbent material, then the absorption co-efficient of that material is 0.25. If, therefore, the absorption co-efficients and areas of the materials in the room are known, the total absorption can be obtained and expressed in open window units. Further, it can be shown that, given the total absorption of a room, the reverberation time  $T$  can be calculated from the formula  $T = 0.05 \frac{V}{A}$  seconds where  $V$  is the volume of the room in cubic feet and  $A$  the total absorption in O.W.U.

From the above considerations, it would appear that the reverberation time of a room could be predetermined by selecting materials for treating the boundaries of a room having due regard to their coefficients of absorption; in practice, it is often found that a desired reverberation time is best obtained by trial and error methods. Typical values for the absorption coefficient of well known materials are shown in the table below:—

	Absorption Coefficient		
	125 c/s	500 c/s.	2,000 c/s.
Celotex tiles . . . . .	0.16	0.50	0.55
2 inches of rock wool . . . . .	0.21	0.65	0.65
Hard plaster . . . . .	0.02	0.02	0.02
Building board . . . . .	0.06	0.15	0.25
Carpet and felt . . . . .	0.15	0.20	0.25
Wooden floor (oak strips on battens)* . . . . .	0.10	0.25-0.30	0.02

The desirable reverberation time of a studio depends largely upon the purpose for which the studio is used. For example, a studio used for a large symphony orchestra should have a reverberation time of about 1 to 2 seconds, whereas a studio used for speech requires a reverberation time of less than 0.5 second. It is important that the reverberation time should be reasonably constant over the audio-frequency range; thus, if the reverberation time of a particular studio is 6 seconds at 100 c/s and 2 seconds at 1,000 c/s and above, the bass instruments of an orchestra playing in such a studio would be given undue prominence, i.e., the studio would be very "boomy."

Fortunately, some control may be exercised over the reverberation/frequency characteristics of a studio by special treatment of walls, floor or ceiling. Thus, absorption of middle frequencies can be obtained by hanging curtains on the

---

\*This type of floor has a maximum absorption co-efficient of about 0.30 at approximately 350 c/s.



walls, treating the walls with material such as rock wool or by using celotex tiles. Bass absorption is usually obtained by attaching large sheets of plywood firmly to the walls.<sup>3</sup> Sheets are chosen which would normally resonate at low frequencies but which, when securely fixed to battens, will hardly vibrate at all. This treatment is referred to as damped resonant panelling and the walls of most modern orchestral studios are treated in this way for about two-thirds of their area and the remainder, together with about one-third of the ceiling area, with high-frequency absorbent material.

The effectiveness of this method decreases as studio size decreases. Consider a panel having a resonant frequency  $f$ ; if a sound of this frequency strikes the panel, the latter will vibrate, and if the decay time for the panel is greater than the reverberation time of the studio, the panel will of itself, produce sound after the source has been cut. Clearly, a large studio with a long reverberation time, will be less susceptible to this effect than will a small studio having a short reverberation time. For sounds of frequency just above or just below  $f$ , the panel may be forced into vibration, and again, will continue to vibrate at a frequency  $f$  after the sound has been cut off. This emphasises the necessity for very high damping to ensure a rapid decay time for the panelling. There is, however, no general rule and in attempting to obtain the best possible reverberation conditions for individual rooms, each room presents its own acoustic problem, requiring a particular solution.

### 1.3 DISTORTION IN ELECTRICAL COMMUNICATION CIRCUITS

Having considered the methods of propagation and the characteristics of sound waves, we must now turn our attention to the behaviour of the electrical counterpart of these waves, paying particular attention to the various types of distortion which are met with when the sounds have been converted into electrical impulses and transmitted over an electrical circuit. There are four types of distortion to be considered, namely attenuation (or frequency) distortion, harmonic distortion, intermodulation distortion and amplitude distortion.

#### 1.3.1 ATTENUATION DISTORTION

Attenuation distortion is defined in British Standard 204 as "Distortion due to variation of loss or gain with frequency."<sup>4</sup> Let us suppose that in a given electrical circuit the input power is the same for all frequencies, whereas the output power is less at 5,000 c/s than at 100 c/s; this indicates that the circuit contains a component which offers higher impedance at one frequency than at another. Because of this frequency discrimination, attenuation distortion is sometimes referred to as frequency distortion. For the purposes of this Manual, a circuit is considered as having negligible attenuation distortion if the gain or loss does not change by more than 1 db. between 50 and 10,000 c/s. Such a circuit is said to have a flat frequency response.

Forms of attenuation distortion commonly met with are illustrated in curves B, C, D and E, Fig. 5. The effect of curve A-B would not be very noticeable on speech but would cause a lack of realism in the reproduction of orchestral

### 1.3 DISTORTION IN COMMUNICATION CIRCUITS

music ; curve A-C would add shrillness to the reproduction of both speech and music ; curve D-A1 would cause speech to sound boomy and would give undue prominence to the bass instruments of an orchestra ; curve E-A1 would cause both male speech and orchestral music to lack fullness of tone, but its effect would be less noticeable than that of curve D-A1.

Attenuation distortion can usually be corrected ; for example, a post office line, because of its distributed inductance and capacitance introduces attenuation distortion in the form of "top cur" (curve A-B) but this can be corrected by means of an electrical circuit having an opposite characteristic ; thus, if the distortion is as indicated by curve A-B, the introduction of an equaliser having the response of curve A-C would give a flat response. Attenuation distortion is sometimes deliberately introduced into a sound recording or reproducing system to obtain a good "signal-to-noise" ratio, i.e., the ratio, expressed in

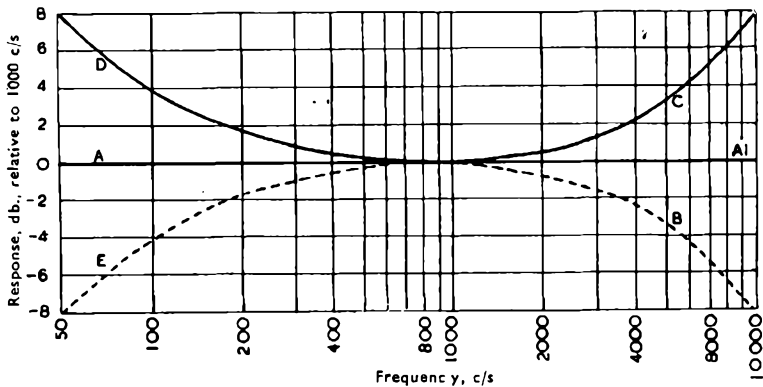

FIG. 5. TYPICAL ATTENUATION DISTORTION CURVES

decibels, of the volume of a signal to that of noise superimposed on it.<sup>5</sup> If, in a given system, the frequency of inherent noise is high, it is desirable that the higher frequencies of the programme should be recorded at a higher level than the lower ; attenuation of the higher frequencies is introduced into the reproducing system and by these means the reproduced programme will have a flat frequency response and the unwanted noise will be reduced.

It is often found that attenuation distortion is introduced by microphones, recording and reproducing heads, or loudspeakers, largely because of the mechanical resonance of the moving parts. Such distortion can sometimes be reduced by arranging for this resonance to be at a frequency outside the required audio range. In other cases, a resonant circuit having precisely the opposite response, is introduced into the associated electrical system. Practical examples of this are given in Chapter 4.

#### 1.3.2 HARMONIC DISTORTION

Harmonic distortion is defined in British Standard 204 as "The production of harmonic frequencies at the output by the non-linearity of a network when a

## BBC RECORDING TRAINING MANUAL

sinusoidal voltage of specified amplitude is applied at the input. It is expressed as the ratio of the total r.m.s. voltage of all harmonics at the output to the total r.m.s. voltage at the output.”<sup>6</sup> Applying this definition to an electrical network or to an amplifier, the network or amplifier would be free from harmonic dis-

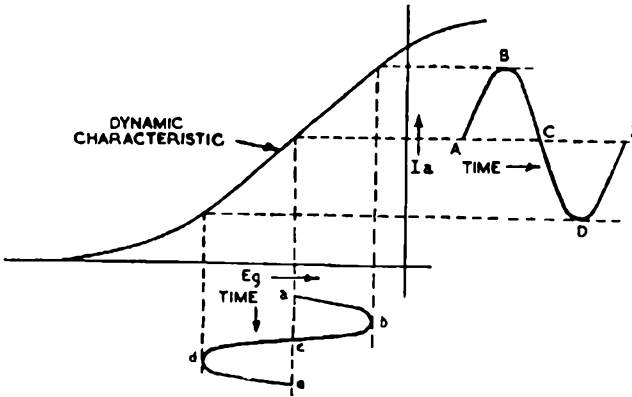

FIG. 6. ANODE-CURRENT—GRID-VOLTS CHARACTERISTICS OF AMPLIFYING VALVE  
Input and output signal curves are sinusoidal, indicating no distortion

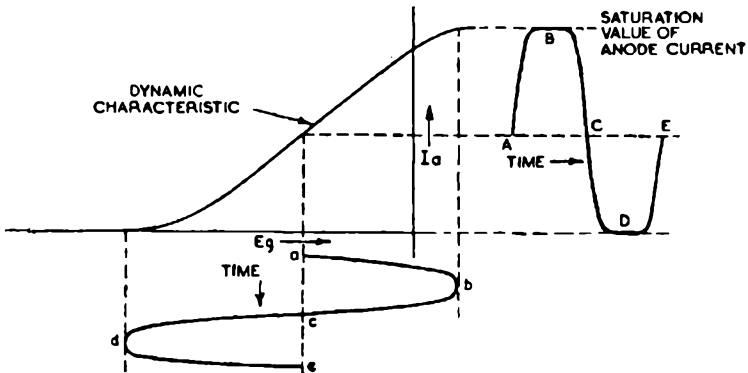

FIG. 7. ANODE-CURRENT—GRID-VOLTS CHARACTERISTICS OF AMPLIFYING VALVE  
Input signal sinusoidal but having large amplitude, causing distortion of output signal

tortion when a sinusoidal voltage applied to the input produces a sinusoidal voltage at the output, i.e., the network or amplifier introduces no mutilation of the waveform of the original signal. With an amplifier this ideal can be approached very closely if the input signal does not exceed a certain value.

### 1.3 DISTORTION IN COMMUNICATION CIRCUITS

The effect is illustrated in Fig. 6, which shows a sinusoidal input signal *abcde* applied to a valve. The dynamic characteristic is approximately linear for a certain proportion of its length, but departs from linearity at its two extremities.

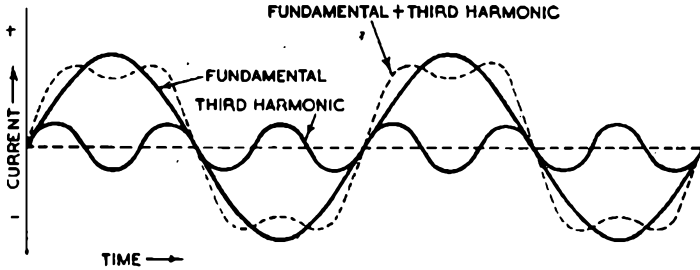

FIG. 8. WAVEFORM RESULTING FROM SUPERIMPOSING THIRD HARMONIC AND FUNDAMENTAL FREQUENCIES

Provided that the input signal is restricted so as to allow the valve to work on the linear portion of the characteristic, the waveform of the anode current represented by ABCDE, is sinusoidal, indicating that the process of amplification has introduced no harmonic distortion.

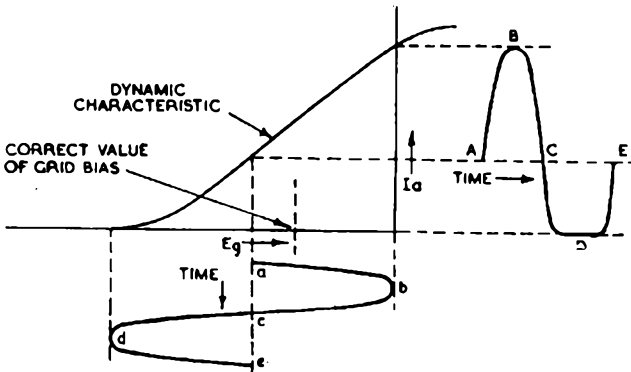

FIG. 9. EFFECT OF INCORRECTLY BIASED VALVE

Input signal sinusoidal ; output signal distorted, producing second harmonic

If, however, a large input signal is applied to the valve as shown in Fig. 7, the valve will operate over the non-linear parts of its  $I_a$ - $E_g$  characteristic introducing a distorted anode current waveform and producing harmonic distortion.

It can be shown that the distorted waveform ABCDE in Fig. 7 consists chiefly of a fundamental component having the same frequency as the input signal plus a third harmonic. This is illustrated in Fig. 8, in which the solid lines

## BBC RECORDING TRAINING MANUAL

represent a fundamental tone and its third harmonic. The relative phase is such that they pass through zero at the same time. By superimposing the two solid curves we get a resultant shown by a dotted curve ; this is very similar to curve ABCDE in Fig. 7.

So far we have considered the production of harmonic distortion by applying too great a signal to the input of an amplifier and ignoring other considerations.

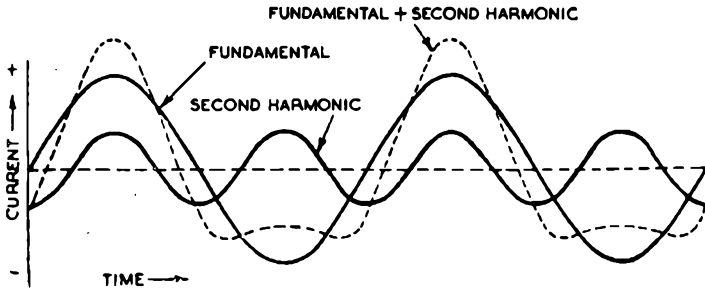

FIG. 10. WAVEFORM RESULTING FROM SUPERIMPOSING SECOND HARMONIC AND FUNDAMENTAL FREQUENCIES

Fundamental and second harmonic out of phase

Such distortion is symmetrical when related to the positive and negative portions of the waveform, and is of third harmonic order. Another possible cause of harmonic distortion in an amplifier is the application of incorrect grid bias to one of the valves. An example of this is shown in Fig. 9, in which the

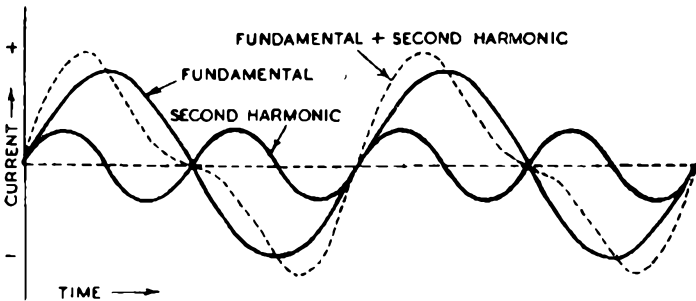

FIG. 11. WAVEFORM RESULTING FROM SUPERIMPOSING SECOND HARMONIC AND FUNDAMENTAL FREQUENCIES

Fundamental and second harmonic in phase

waveform ABCDE is not symmetrical about the centre line. This is analysed in Fig. 10, the solid lines of which show the fundamental and harmonic frequency twice that of the fundamental. If these two curves are superimposed upon each other they produce a resultant dotted curve as shown. In this figure it will be observed that the fundamental and second harmonic curves are not shown as

### 1.3 DISTORTION IN COMMUNICATION CIRCUITS

crossing the centre line simultaneously ; this indicates that there is a phase difference between the two and the precise shape of the resultant waveform is dependent upon the amount of phase displacement between fundamental and harmonic components. For the purpose of illustration, in Fig. 11, the fundamental and harmonic are shown in phase, and a comparison between Figs. 10 and 11, indicate the effect of different phase relationships upon the resultant waveform. (The condition shown in Fig. 11 is not normally met with in practice, although it can be produced artificially.)

#### 1.3.3 INTERMODULATION DISTORTION

Intermodulation distortion is defined in British Standard 204 as "The production of combination frequency tones at the output by the non-linearity of a network when two or more sinusoidal voltages of specified amplitude are applied at the input."<sup>7</sup> The essential difference between harmonic and intermodulation distortion is indicated in their respective definitions ; the former postulates a single sinusoidal input signal and the latter two or more such input signals. If the frequencies of two input voltages are designated  $f_1$  and  $f_2$ , combination (or sum-and-difference) frequencies equal to  $f_1 + f_2$  or  $f_1 - f_2$  may be produced, in which case they are said to be of second order, or frequencies equal to the second harmonic of  $f_1 \pm f_2$ , i.e.,  $2(f_1 \pm f_2)$  (third order) and so on for higher orders. It should be noted, however, that combination frequencies may be produced which are not harmonically related to any one of the input signal frequencies and it is these spurious frequencies which cause the output signal of an overloaded amplifier to have an unpleasant sound. If the two input signals themselves are rich in harmonics then a non-linear network may produce a very large number of combination frequencies. It should be understood that if a network produces harmonic distortion of a single sinusoidal tone, it is certain to produce intermodulation distortion when a number of sinusoidal signals are applied to its input simultaneously. The reduction to a minimum of such distortion, is one of the chief considerations involved in the design of sound recording and reproducing equipment.

#### 1.3.4 AMPLITUDE DISTORTION

This is defined in British Standard 204 as "the lack of consistency of the ratio of the r.m.s. value of the output of a system to that of the input at different amplitudes of the input. It is measured with the system operated under steady-state conditions with an input signal of sinusoidal waveform."<sup>8</sup> This can be stated more clearly by saying that if for a pure tone, an increase of 8 db at the input of an amplifier produces an increase of only 2 db at its output, then the amplifier is introducing amplitude distortion. It does not necessarily follow that such distortion will cause mutilation of the output waveform, and it is sometimes introduced deliberately, for example, in automatic gain control circuits of radio receivers. If it is desired to limit the output power of a recording amplifier to prevent overloading the recording head which follows it, it is convenient to make use of a device which introduces amplitude distortion, and most recording systems include some such limiting amplifier. These amplifiers

have constant gain for all amplitudes of input signal below a certain value. If the input signal exceeds this value, the amplifier operates at reduced gain, and for so long as the input signal exceeds a predetermined critical value, the output signal remains at a specified constant level. When the input signal is reduced to, or below, the limiting value, the gain of the amplifier returns to normal at a predetermined rate. The action of a BBC limiter<sup>9</sup> is shown diagrammatically in Fig. 12. The normal gain of the amplifier is represented by the slope of the line *OA*, and it will be observed that up to a given point, namely zero level, equal increases in input level produce equal increases in output level. When, however, the input level is increased above zero, the output level still remains at zero. Suppose that at a given instant the input level is + 8db, the output level remaining at zero ; clearly the gain of the limiter is less than that obtaining for an input level of zero, the explanation being that a portion of the

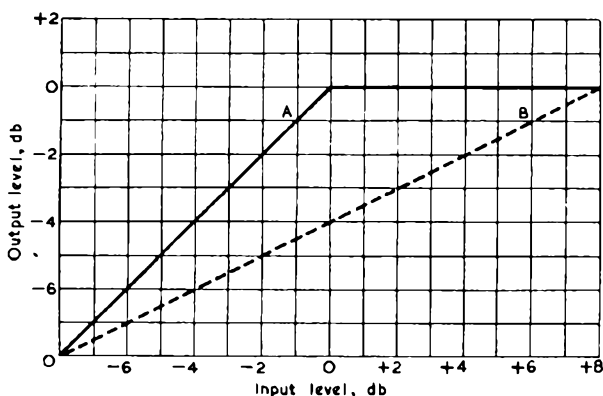

FIG. 12. OPERATING CHARACTERISTICS OF A LIMITING AMPLIFIER

input signal is fed into a side chain which applies bias to the input stage of the limiter in proportion to the increase in input level above zero level. The gain of the limiter under these conditions is represented by the slope of the line *OB*.

#### 1.4 HISTORICAL SURVEY OF SOUND RECORDING

The desirability of recording a sound wave in such a way that the waveform of different sounds could be scientifically examined has undoubtedly been recognised for very many years ; it was not until about the middle of the nineteenth century that attempts to accomplish this met with any success. The earliest successful attempt is attributed to Leon Scott, who, in 1857, devised a means for recording sound waves. His instrument was called a Phonograph and consisted of a vibrating diaphragm to which was attached a lever carrying a small bristle at its end ; the recording medium consisted of a revolving cylinder coated with lamp black, and as the diaphragm vibrated in sympathy with the sound waves, a trace was made by the bristle on the surface of the cylinder.

## 1.4 HISTORICAL SURVEY OF SOUND RECORDING

The first phonograph was invented by Thomas Alva Edison in 1876, and the first patent for the invention taken out in 1877. According to Edison's own story the principle was discovered accidentally;<sup>10</sup> he was carrying out experiments in telephony when he found that a needle attached to the diaphragm of a telephone mouthpiece pricked his finger when the diaphragm vibrated. He realised at once that the vibrating needle could be used to trace the vibrations on a strip of paper. Proceeding at once with this experiment, not only were his conclusions confirmed, but he also found that by running the indented paper over the point of the needle, the diaphragm could be set in vibration and the recorded sounds reproduced.

His first machine<sup>11</sup> consisted of a metal drum containing a fine spiral groove over its full length, the drum being covered by a sheet of tin-foil, the ends of which were fastened in a slot across the drum. When the handle attached to the drum was turned, a mica diaphragm, carrying a needle, tracked across the



FIG. 13. EARLY PHONOGRAPH

surface of the drum; as the diaphragm vibrated in sympathy with sound waves impinging on it, the needle "indented" a sound track on the tin foil. By causing the same (or a similar) needle and diaphragm to trace the recorded groove, the original sounds were reproduced on the same machine. An early phonograph is shown in Fig. 13.

The tin-foil phonograph had little commercial value, and it was some ten years before the invention was put to practical use. As a result of experiments by Alexander Graham Bell and C. S. Tainter, in 1886, the Volta Graphophone Company of America lodged a patent for recording sound on a wax surface having a paper or cardboard foundation,<sup>13</sup> and instead of indenting, the sound track was cut or gouged in the wax by a sharp stylus. Edison adopted a similar method in 1888,<sup>12</sup> and in that year his first phonograph record or phonogram was mailed to England, and demonstrations of the phonograph given at a Crystal-Palace Exhibition. In the same year, a performance of Handel's "Israel in Egypt" at the Crystal Palace was recorded on Edison's phonograph,<sup>10</sup> and the cylinders were sent to America and demonstrated throughout the country.

In 1887, Emile Berliner investigated the possibilities of Leon Scott's phona-



tograph ; in his first attempt he used a cylinder covered with blackened paper, and having made the recording, removed the paper and had the trace engraved on a metal strip ; he then placed the engraved strip on the drum and reproduced the sound track by means of a needle and diaphragm.



FIG. 14. BERLINER GRAMOPHONE

It may be well to mention here that in 1876, before Edison's invention had been patented, Charles Cros, a Frenchman, deposited a sealed envelope with the Academie des Sciences, Paris. When this was opened some months later it was found to contain a suggestion for sound recording and reproduction by a method almost identical to that first used by Berliner.<sup>13</sup>

The essential difference between the Berliner and Edison experiments was that the Berliner track was "lateral," the recording needle moving from side to side, whereas with the Edison phonograph it moved up and down, producing what was later known as a "hill-and-dale" track.

Berliner also experimented with a flat disk instead of a drum, and in his original specification for the "gramophone" he used a glass disk covered with soluble material, such as ink or paint, in which a spiral groove was cut and then engraved. The specification also included a turntable to rotate the disk (Fig. 14). His next step was to use a wax and benzine compound on a glass or zinc disk, the recorded groove then being etched into the base. From this etched disk he was able to produce a matrix by means of which copies of the recording could be produced on rubber or similar material ; the chief advantage of the gramophone over the phonograph as claimed by Berliner was this comparatively simple method of producing copies.<sup>13</sup>

For some time both phonograph and gramophone records were produced from wax masters, but the flat disks had such obvious advantages over the phonograph of cylinders that eventually (apart from dictation machines) they replaced them altogether.

#### 1.4 HISTORICAL SURVEY OF SOUND RECORDING

Considerable improvement was made from time to time on the Berliner gramophone but there was a limit to such improvement since the sound power for driving the diaphragm of the recording machine could only be obtained acoustically ; a large horn or a number of such horns were attached to the diaphragm and the performers grouped in close proximity to the horns.

In addition to the limitation in power for driving the cutting stylus, the frequency response of the acoustic system was restricted to a rather narrow band, the high frequencies being attenuated by the diaphragm and the low frequencies by the horn (4.1). Because of these limitations, the fidelity and musical balance of acoustic recordings left much to be desired. In the early 1920's, however, a new impetus was given to the sound-recording industry as a result of the introduction of amplification into electrical communication. In recording studios it was no longer necessary to group the artists round a horn, for a single microphone, followed by valve amplifiers, could provide all the power needed to actuate the groove-forming stylus. More than this, the range of frequencies which could be accommodated was greatly increased and could be controlled.



FIG. 15. ACOUSTIC GRAMOPHONE (1925)  
Showing well-designed horn with logarithmic flare

Since by this time radio receivers incorporating valve amplifiers and loudspeakers were becoming commonplace, it was logical that an electric instead of an acoustic reproducing device should be considered. The movement of the reproducing needle could be used to generate small electric impulses which, when applied to the amplifying valves of the receiver, reproduced the recorded

## BBC RECORDING TRAINING MANUAL

sound through the loudspeaker associated with the receiver. It is to this development that we owe the modern "pickup" and radio-gramophone.

It should be noted that whereas electrical recording became general within a few years of its inception, the acoustic sound-box and flared horn were used for reproduction for many years and, in fact, acoustic gramophones are still being manufactured. Owing to improvements in sound-box design, records which have been electrically recorded can be reproduced on such machines with satisfactory results, although the frequency response obtained falls short of that possible for the same records when reproduced electrically. A familiar type of acoustic gramophone, dated about 1925, is shown in Fig. 15, and a portable acoustic gramophone, dated about 1929, in Fig. 16. With regard



FIG. 16. PORTABLE ACOUSTIC GRAMOPHONE. (1929)

The space beneath the turntable is used to house the horn, which is flared from the base of the tone arm

to the latter it will be observed that there is no external horn, for by this time it was common practice to incorporate the horn within the instrument casing.

In 1927 disks were first used to provide sound for cinema films. The normal gramophone record was unsuitable because its playing time was restricted to four or five minutes ; larger disks were therefore used having a much lower rotational speed and a playing time of approximately 15 minutes. It soon became apparent, however, that this was not the final solution for talking films, since the problem of synchronising sound and picture tracks was beset with many difficulties, and the possibility of recording sound on photographic film was explored.

A method of recording electrical waveforms on photographic film had been discovered by Duddell in 1902, and the waveforms thus recorded could be

## 1.4 HISTORICAL SURVEY OF SOUND RECORDING

reproduced by means of a light beam and a photocell. It is from this discovery, coupled with the use of electronic amplifiers, that modern sound-on-film recording and reproduction has been developed. In another film recording system introduced by Miller and developed by the Philips organisation, sound is recorded by cutting a track with a stylus on a coated celluloid film, leaving a transparent track which can be reproduced by means of a photocell. (Chapter 7.)

An entirely different system of sound recording takes us into the world of magnetism. Magnetic recording depends upon subjecting a length of wire or other magnetisable material to a magnetic field which is caused to vary in intensity in accordance with the frequency and amplitude of the sound wave. The principle was first introduced in 1899 by Poulsen who invented the "Telegraphone," principally for recording morse signals on a steel wire. His invention had practical significance since it permitted the high-speed transmission of telegraphy and its subsequent transcription by reproducing the recorded signals at a slower speed. Poulsen also discovered that sound variations could be similarly recorded and reproduced but, again, it was electronic amplification which made magnetic recording of speech and music practicable.

The principle was developed in Germany in 1924 by Stille and has been used by the BBC, in one form or another, since 1930, the original machine being known as the Blattnerphone (Plate 8). This was replaced in 1933-34 by a more elaborate machine called the Marconi-Stille Recorder (Plate 9); both these machines used a steel tape. In recent years successful experiments have been made with a plastic tape impregnated with iron dust; and a machine which uses this tape, called the Magnetophon, was developed in Germany between 1939 and 1945. Magnetic recording is discussed more fully in Chapter 6.

## 1.5 SOUND RECORDING IN A BROADCASTING SERVICE

Since the earliest days of broadcasting, gramophone records have been used extensively as programme material, but as the services expanded, it became clear that sound-recording facilities within a broadcasting organisation would have many advantages.\* These may be summarised as follows:—

- (a) Programme material available only outside broadcasting hours, or originating at a place inconvenient for direct transmission could be recorded and reproduced at will.
- (b) Where a broadcasting service had to cater for listeners in different parts of the globe, a given programme could be broadcast a number of times at suitable listening hours without gathering together the performers more than once.
- (c) Rehearsals of important programmes could be recorded and played back to the performers, a particularly useful facility in the production of dramatic and feature programmes.
- (d) Programmes of historic or other special interest could be recorded and stored for future use.

---

\* It must be emphasised that before a BBC recording can take place, contractual arrangements have to be made with any copyright owners or artists concerned.

Before a recording system can be regarded as acceptable to a broadcasting organisation, certain conditions must be fulfilled : the first and most important is that the overall performance should compare favourably with that of other apparatus in the broadcasting chain. This implies an adequate frequency response, low intermodulation distortion and high signal-to-noise ratio. In the early days of broadcasting no known recording system fulfilled these conditions adequately but much progress has been made since then and there are now a number of electrical recording systems which approach very nearly to this ideal.

Secondly, it is important that both recording and reproducing machines should have high reliability in operation and that the materials on which the recordings are made should have sufficient durability to stand up to the considerable wear imposed by repeated reproduction.

Thirdly, it should be possible to play the records back immediately after recording ; this requirement precludes the use of wax (gramophone) recording and also of photographic sound film.

Fourthly, the system should be capable of recording programmes of short or long duration without unnecessary wastage in recording material. Experience has shown that this condition is not easy to achieve, and generally, short programmes are best recorded on disks, whereas long programmes suggest the desirability of strip recordings, such as film or tape, to simplify continuity during reproduction. An important point in this connection is that it is often necessary for excerpts from different programmes to be incorporated in another programme ; thus the completed recording should be capable of editing.

In certain circumstances, it is desirable for duplicate copies to be made from the original recording and "comprehensive checking" should always be available during recording (that is, it should be possible to compare the recorded version of the programme with the original whilst recording is proceeding). In addition, completed records should be compact and easy to transport.

It is too much to expect any one system to incorporate all the above requirements and because of this the BBC employs three different recording systems, namely the direct-recorded disk system, magnetic recording and non-photographic film recording.

The direct-recorded disk system has the merit of good quality ; the completed records are simple to handle, easy to edit, and convenient to store ; they have the additional advantage that copies may be obtained by processing. The chief disadvantage of this system is the changing linear speed of the recording medium which, for a given turntable speed, decreases as the centre of the disk is approached ; the worst effects of this can be eliminated by careful design and operation of the equipment. (Chapters 2-5.)

The chief advantage of magnetic recording is that a single tape can be used for an unlimited number of recordings, provided that such programmes have no permanent value ; when a programme recorded on tape is no longer required, the tape can be used for another recording and during the recording process the previous programme will be automatically obliterated. The reels of tape can conveniently have a playing time of up to 30 minutes which makes

## 1.5 SOUND RECORDING IN A BROADCASTING SERVICE

the system suitable for programmes of long duration. The chief disadvantage of the system hitherto has been its inherent surface noise but recent advances in technique have resulted in a reduction of noise to an acceptable level.

The photographic film recording system is unsuitable for use in a broadcasting service because of the time delay between recording and reproduction resulting from the necessity for processing. There is, however, a sound-on-film system which avoids this delay ; it is known as the Philips-Miller system and has been used by the BBC for many years. (Chapter 7.)

### *References*

- 1 Fisk, Sir Ernest T., "The Development of Sound Recording and Reproduction," *Journal of the Royal Society of Arts*, No. 4750, Vol. xcvi, Jan. 16th, 1948.
- 2 Wood, A. *The Physics of Music*. Methuen
- 3 McLaren, J. "The Acoustical Planning of Broadcasting Studios." *BBC Quarterly*, Vol. 1. No. 4
- 4 British Standard 204 : 1943 Glossary of terms used in Telecommunication 1302. British Standards Institution
- 5 Technical Glossary for BBC Engineers
- 6 British Standard 204 : 1943 Glossary of terms used in Telecommunication 1307. British Standards Institution
- 7 British Standard 204 : 1943 Glossary of terms used in Telecommunication 1308. British Standards Institution
- 8 British Standard 204 : 1943 Glossary of terms used in Telecommunication 1306. British Standards Institution
- 9 BBC Technical Instructions, Studios Vol. 1, S3
- 10 Dickson, "Life and Inventions of T. A. Edison." Chatto and Windus, 1894
- 11 Br. Patent No. 6027 1886
- 12 Br. Patent No. 12593 1888
- 13 Encyclopaedia Britannica

## PRINCIPLES OF DISK RECORDING

## 2.1 GENERAL CONSIDERATIONS

THE term disk recording implies the cutting of a sound track in the form of a spiral groove on a flat disk of suitable material. The disk may be a solid wax blank or it may be made of more durable material such as a metal disk coated with cellulose. Both these materials are employed for commercial gramophone recording and either can be used for the mass production of gramophone records, but the BBC uses cellulose-coated disks only because, unlike wax blanks, these can be reproduced immediately after recording without being materially damaged; it is for this reason that a system using cellulose disks is called a "direct-recording" disk system.

Methods of acoustic recording on cylinders and disks have been briefly described in Chapter 1; this chapter is concerned solely with electrical recording. The sounds to be recorded are converted by a microphone into electric potentials which are amplified, and passed to a recording head which incorporates the groove-forming stylus. The stylus may be arranged so that its tip moves up and down in a direction perpendicular to the plane of the rotating disk, when the groove will have varying depth (hill-and-dale) or the stylus may have a side-to-side motion in the plane of the disk, when the groove will have constant depth but will undulate about a mean position (lateral).

We have seen in Chapter 1 that the hill-and-dale system was used for the early phonograph recordings introduced by Edison, and the lateral system for the disks first used by Berliner. The hill-and-dale system did not entirely disappear with the phonograph, for it is still used in some types of office dictating machines, but for commercial records the lateral cut is used almost without exception. An important point to remember is that direct-recorded lateral-cut disks can be reproduced on the same machines as commercial records, whereas the hill-and-dale system requires a different reproducing head; it is largely for this reason that the BBC has adopted the lateral-cut method and it is with this that we are primarily concerned.

A disadvantage of any disk system is that only comparatively short recordings can be made on a disk of reasonable size although the recording time can be increased to some extent at the expense of fidelity. Ten-inch and twelve-inch disks have a maximum recording time of approximately three-and-a-half and four-and-a-half minutes respectively, whereas many broadcast programmes are timed for fifteen minutes or multiples of fifteen minutes; by using disks having a diameter of seventeen and a quarter inches and a turntable speed of  $33\frac{1}{3}$  r.p.m., instead of the more usual 78 r.p.m., programmes of fifteen minutes' duration can be accommodated on one side of a single disk. Such a system introduces some loss in fidelity when the reproducing head approaches the centre of the disk. This loss of fidelity with decreasing groove

## 2.2 GROOVE DIAMETER AND CUTTING SPEED

diameter is one of the greatest disadvantages in disk recording and must be discussed in some detail.

### 2.2 EFFECT OF GROOVE DIAMETER AND CUTTING SPEED ON FIDELITY

If a recording head is caused to move radially across a rotating disk, the stylus cuts a spiral groove. If the turntable speed is constant, it follows that the cutting speed, i.e., the speed of the disk past the cutting point, decreases as the diameter of the groove becomes smaller.

If a pure tone of constant frequency is applied to the recording head, the stylus vibrates sideways at this frequency and the groove undulates laterally in the form of a sine wave, the wavelength being proportional to the cutting speed. If this wavelength is of the same order or less than the tip radius of the reproducing needle, the latter will not accurately trace the undulations and there will be attenuation of the reproduced tone. This problem does not arise at very low audio frequencies because, for normal turntable speeds, the recorded wavelengths, even at minimum groove diameter, are considerably greater than the tip radius of the reproducing needle; for high frequencies there is a minimum cutting speed, below which recording cannot usefully be carried out. The lower the cutting speed the more difficult it is to reproduce the higher frequencies and the greater the distortion that arises in the process, so that the minimum cutting speed is a rough index to the fidelity obtainable. (Appendix A.)

### 2.3 RECORDED WAVELENGTHS

If  $\lambda$  is the recorded wavelength in inches,  $f$  the frequency in c/s, and  $S$  the cutting speed in inches per second,

$$\lambda = \frac{S}{f}$$

If  $n$  is the speed of rotation of the disk in r.p.m. and  $d$  the diameter at the point at which cutting is taking place (usually referred to as the groove diameter)

$$S = \frac{\pi nd}{60} \text{ in. per second.}$$

$$\text{and } \lambda = \frac{S}{f} = \frac{\pi nd}{60f} \text{ in.}$$

Hence, for a given diameter and rotational speed, the recorded wavelength is inversely proportional to frequency, and for a given frequency and rotational speed it is directly proportional to the diameter.

The wavelengths for any frequency within the normally recorded range, for disks recorded at 78 and  $33\frac{1}{3}$  r.p.m., can be obtained from Figs. 17 and 18 respectively, which shows the results for four different diameters.

### 2.4 TURNTABLE SPEED

We have seen that the fidelity of a disk recording system is largely dependent upon cutting speed and that there is a minimum cutting speed below which



## BBC RECORDING TRAINING MANUAL

the recording of the higher frequencies becomes ineffective. The cutting speed depends upon two factors, the rotational speed of the turntable and the diameter of the groove. For a given turntable speed, cutting speed decreases as the groove diameter decreases; therefore a minimum cutting speed implies a minimum groove diameter, and for a specified minimum cutting speed, the lower the turntable speed, the greater must be the minimum groove diameter. The design of a high-fidelity disk recording system would be greatly simplified if a turntable speed could be chosen which gave maximum

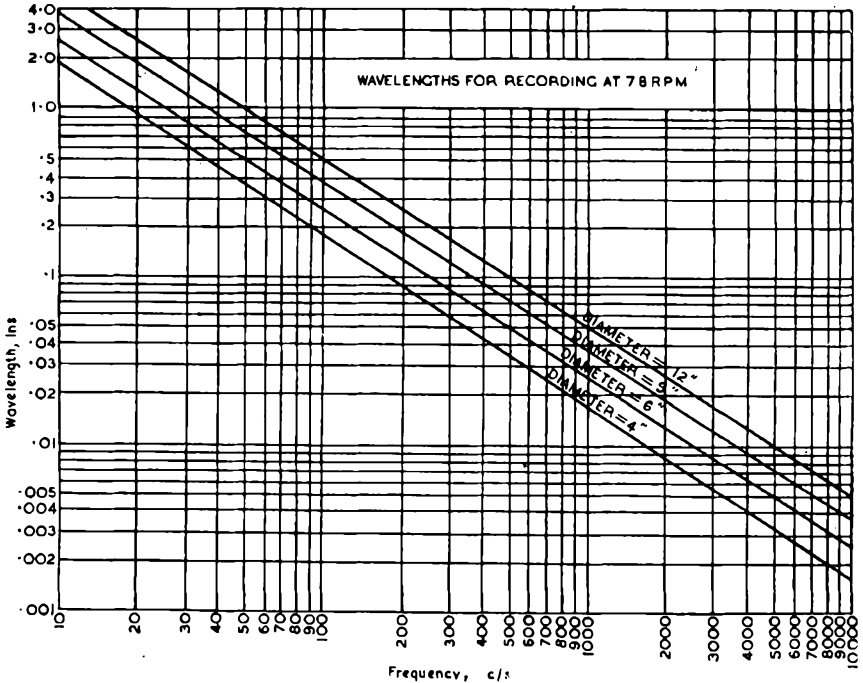

FIG. 17. RELATIONSHIP BETWEEN RECORDED WAVELENGTH, FREQUENCY AND DIAMETER AT 78 R.P.M.

recording time for a specified minimum cutting speed, and it is shown in Appendix A that this obtains when the diameter of the outer groove on a given disk is exactly twice that of the innermost groove. Appendix A also shows that for a 12-inch disk, a recording time of 4.9 minutes is obtained with a turntable speed of 78 r.p.m., whereas for the same minimum cutting speed (and hence the same fidelity) a recording time of 5.5 minutes can be obtained from the same disk with a turntable speed of 54 r.p.m.

It is thus seen that 78 r.p.m. is not the most economical turntable speed for 12-inch diameter disks, but since it has been adopted universally for gramophone records, this speed is used by the BBC so that disks and records can be reproduced on the same turntables.

## 2.4 TURNTABLE SPEED

Another difficulty is that a synchronous motor cannot be made to run at precisely 78 r.p.m. on either 50-c/s or 60-c/s mains supplies. A turntable speed of 78 r.p.m. could, of course, be obtained by the use of some form of gearing, but even so, it is not possible to design a stroboscope (page 45) having an integral number of bars for 78 r.p.m. Hence a nominal speed of 78 r.p.m. is indicated by using a 77-bar stroboscope on 50-c/s mains lighting, which, when giving a stationary pattern, indicates a precise speed of 77.92 r.p.m. In America, where the frequency of the mains supply is usually 60 c/s, a 92-bar

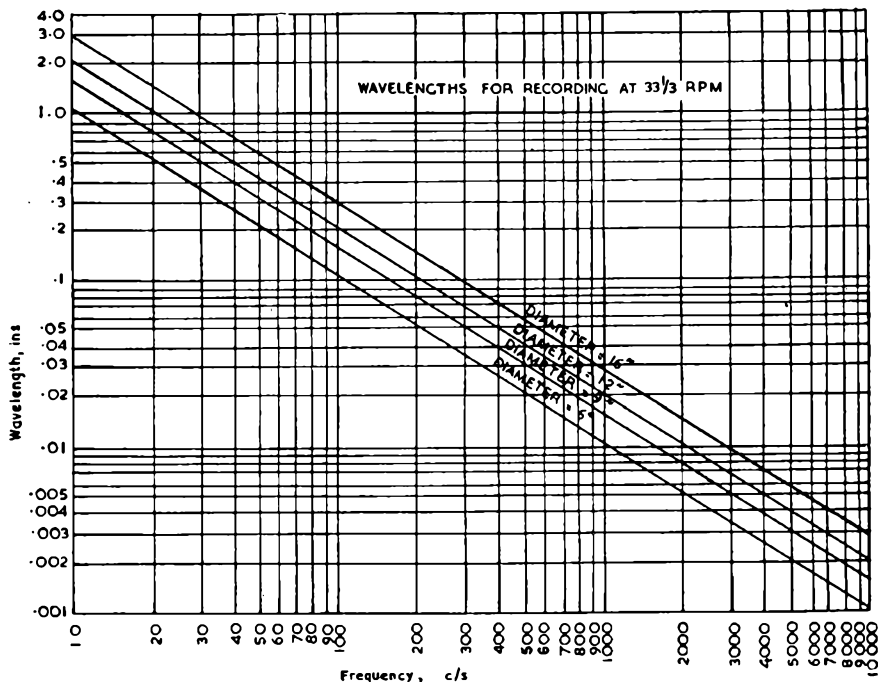

FIG. 18. RELATIONSHIP BETWEEN RECORDED WAVELENGTH, FREQUENCY AND DIAMETER AT 33 1/3 R.P.M.

stroboscope is used, the turntable speed being 78.26 r.p.m. There is, therefore, a speed difference of 0.44% between American and English commercial records, which means that a one-hour programme recorded in America at 78 r.p.m. would occupy one hour sixteen seconds when reproduced in England.

This problem does not arise with a turntable speed of 33 1/3 r.p.m., for a 180-bar stroboscope on 50-c/s mains indicates this speed precisely; so also does a 216-bar stroboscope on 60 c/s mains. Moreover, for a disk of 17 1/4 inches diameter, and a minimum cutting speed of 14 in./sec., 33 1/3 r.p.m. is about the most economical speed of rotation, and by adopting a pitch of 120 grooves per inch, 15 minutes recording time can be obtained between diameters of 16 1/4 and 8 3/8 inches.

## BBC RECORDING TRAINING MANUAL

### 2.5 DISK DIAMETER AND RECORDING TIME

The recording time required for broadcast programmes varies from extracts of one minute or less to full programmes lasting an hour or more. The BBC meets these varied requirements by using disks of different sizes, the smallest being 10 inches in diameter and the largest 17½ inches. Twelve-inch disks are used for 78-r.p.m. recordings when processing is not required and these give a normal playing time of about 4½ minutes. When recording for processing at 78 r.p.m., 13-inch disks are used producing 12-inch diameter pressings with a recording time of about 4½ minutes. For programmes of 15 minutes or more, 17½-inch disks are used at 33½ r.p.m., giving 15 minutes playing time per disk side ; these disks are also used for the production of pressings having a diameter of 16 inches. Full details of diameters and recording times are shown in Appendix J.

### 2.6 GROOVE SPACING AND GROOVE PITCH

For disks of a given diameter, recorded at a given speed, the closer the groove spacing the greater the playing time. If, however, the grooves are too closely spaced, there is a risk of overlap between adjacent grooves at high signal amplitudes, which may produce echo effects, and in extreme cases may cause the needle to break through the spiral and continuously repeat a groove. These risks can be avoided by recording at a lower signal level (thus reducing groove amplitude) but this is an undesirable expedient because it reduces the signal-to-noise ratio. Furthermore, the modulation amplitude of commercial records must be sufficient to give adequate volume when the records are reproduced on acoustic gramophones ; since BBC 78-r.p.m. disks and commercial records are reproduced over the same electrical circuits, it is undesirable that the modulation amplitude of the disks should vary by more than a few decibels from that of records. For these reasons, there is a minimum groove spacing below which it is impracticable to record.

For want of a better name, the space between adjacent grooves is commonly referred to as "land" and, for a given number of grooves per inch (groove-pitch) the groove-to-land ratio is determined by the depth of the groove. This is because the cutting stylus is V-shaped, so that the deeper the cut, the wider the top of the groove and the smaller the space between adjacent grooves. To meet the conditions outlined in the previous paragraph, the groove-to-land ratio in BBC practice is fixed at 2 : 1, and since the groove pitch is normally 120, the width of the top of the groove is approximately 0.0056 inch, and the space between unmodulated grooves approximately 0.0028 inch.

### 2.7 AMPLITUDES AND VELOCITIES

In the foregoing sections of this chapter, we have dealt with the more important constants applied to the BBC disk recording system. We must now turn our attention to the amplitudes and velocities of the groove-forming stylus and follow this by an examination of the characteristics of the groove. For this purpose, we shall quote from an I.E.E. paper on disk recording.<sup>1</sup>

## 2.7 AMPLITUDES AND VELOCITIES

“If a recording stylus moves laterally with a sinusoidal motion of amplitude  $a$  and frequency  $f$ , its peak velocity is  $2\pi fa$  and its peak acceleration  $4\pi^2 f^2 a$ .\* Recording heads are most commonly of the moving-iron type, and a constant voltage applied to an ideal head of this kind gives the same alternating velocity to the cutter at all frequencies. The amplitudes of the waveforms recorded on the disk are then inversely proportional to frequency but, on reproduction by an ideal reproducing head of the same type, a constant output voltage is obtained. The signal level that has been recorded on the disk at a given frequency may be defined by stating the amplitude, the velocity or the acceleration of the recording stylus, but since, ideally, a flat velocity-frequency characteristic corresponds to constant input and output voltages, the velocity may be regarded as corresponding to voltage. In fact, it is usual not only to specify recorded levels in terms of r.m.s. velocities, but even to state the ratio of two velocities in decibels.

If the same velocity is recorded at all frequencies, the largest amplitudes will occur at the low frequencies and the largest accelerations at the high frequencies. The maximum amplitude to be recorded must be limited, if only to avoid unduly wide groove spacing and consequent short recording time. The maximum acceleration must also be limited, for the greater the acceleration the greater is the force applied to the reproducing stylus tip by the groove wall, and this force must not be large enough to cause permanent deformation of the groove. Since acceleration is proportional to the curvature of the groove walls, it must also be limited to suit the shape of the recording and replay styli.

By placing frequency-weighting networks in the recording amplifier, the recorded velocity, and therefore the amplitude and acceleration, may be made to vary with frequency in any way desired, and if an inverse correction is applied to the reproducing system the overall response remains flat. The relation between frequency and the velocity recorded with a constant input voltage to the chain is known as the recording characteristic. This is discussed more fully on page 34, but, as an indication of the magnitudes involved, Fig. 19 shows the approximate amplitudes, velocities and accelerations which would be obtained if tone of various frequencies were recorded at the maximum levels used by the BBC. On commercial records more than double these velocities and accelerations may occur. The accelerations, given in multiples of  $g$ , are not the maximum possible values even for BBC recording levels, for radius compensation (page 33) may increase the high-frequency levels recorded, and, of course, still higher accelerations may occur in recording complex waveforms. The likelihood of accelerations exceeding 1,000  $g$  indicates how important it is that the reproducing head should have a low mechanical impedance to lateral motion of the stylus tip.”

$$* x = a \sin 2\pi ft.$$

$$v = \frac{dx}{dt} = 2\pi fa \cos 2\pi ft.$$

$$\alpha = \frac{dv}{dt} = -(2\pi f)^2 a \sin 2\pi ft.$$

Where  $x$  = displacement of needle tip at right angles to the groove,

$a$  = amplitude,

$v$  = velocity,

$\alpha$  = acceleration.

## 2.7.1 CALCULATION OF GROOVE AMPLITUDE

Since peak velocity of the recording stylus is  $2\pi fa$ , it follows that the r.m.s. velocity

$$v_{r.m.s.} = \frac{2\pi fa}{\sqrt{2}} = 4.44 fa$$

and

$$a = \frac{v_{r.m.s.}}{4.44 f}$$

where  $f$  is the signal frequency and  $a$  the groove amplitude.

For example, if  $v_{r.m.s.} = 2$  cm/sec at 1,000 c/s

$$a = \frac{2}{4.44 \times 1,000} = 0.0005 \text{ cm} = 0.0002 \text{ in.}$$

If the r.m.s. velocity for a given input voltage is the same for all frequencies, the amplitude at any frequency can be obtained by deduction; thus for the example given, the amplitudes at 5,000 c/s and 50 c/s would be 0.00004 inch and 0.004 inch respectively.

The latter figure is interesting, because it exceeds the normal groove-spacing (2.6) and shows that the r.m.s. velocity must be reduced below 2 cm/sec at the lower frequencies to prevent the risk of groove overlap.

2.8 THE GROOVE<sup>1</sup>

Fig. 19 shows that maximum level at all frequencies above 1,000 c/s will give recorded amplitudes less than 0.0005 inch, and, since it must be possible to reproduce satisfactorily with amplitudes only one-thousandth of this, it is essential to eliminate backlash or lost motion between the groove walls and the replay stylus. This can be done only by keeping the stylus always in contact with both walls of the groove, which is therefore of triangular section (Fig. 20). The apex, however, must be rounded so that the recording cutter may have a reasonably robust tip, and the replay stylus will remain in contact with both walls only if its tip radius is greater than the radius at the bottom of the groove. For a given groove angle, the maximum permissible radius on the tip of the cutting stylus is therefore settled by that of the reproducing stylus and, since this is itself a compromise, it is not surprising that a variety of sizes of replay stylus tip and of groove cross-section has come into use. It is not always appreciated, however, how much these variations affect the results obtained, particularly at low cutting speeds. The physical characteristics of the groove are as much a part of the reproducing mechanism as the reproducing head itself, and it is quite usual to find that the high-frequency resonance of a reproducing head occurs at different frequencies according to whether a cellulose disk or a shellac pressing is being reproduced. However accurately the movement of the recording stylus is controlled, variation of the groove cross-section, the material of the disk or the contour of the replay stylus tip may significantly affect the output obtained from the reproducing head and standardisation of

## 2.8 THE GROOVE

disk recordings therefore cannot be achieved merely by standardising the recording characteristic.

### 2.8.1 PINCH EFFECT

Fig. 20 shows the position of the reproducing stylus tip in a rigid, unmodulated groove of the dimensions standardised by the BBC. Fig. 21 shows that when the groove is modulated, its effective cross-section is changed, for

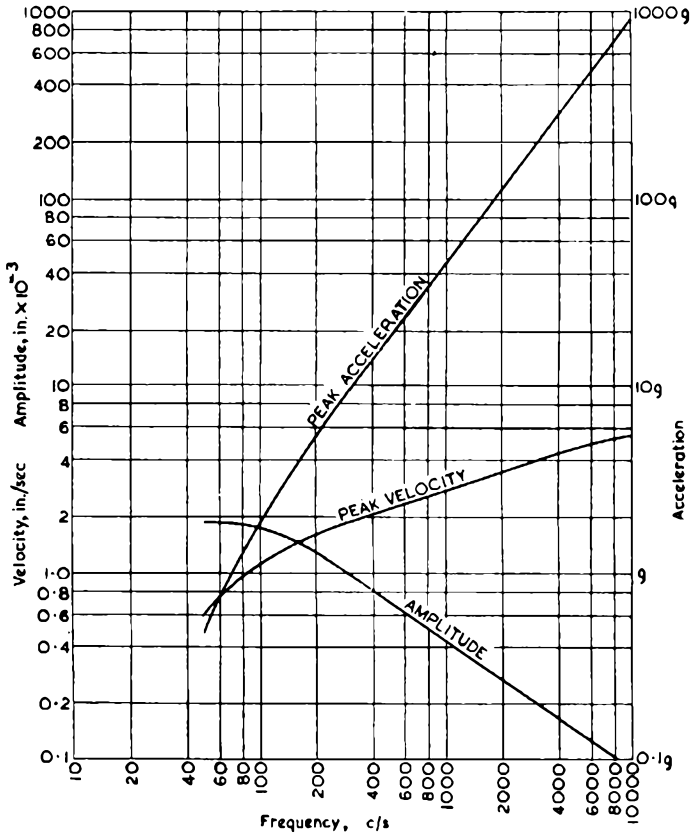

FIG. 19. AMPLITUDES, PEAK VELOCITIES AND ACCELERATIONS FOR MAXIMUM LEVEL TONE WITH BBC RECORDING CHARACTERISTIC

since the width  $x_0$ , measured in the plane of cutter movement, necessarily remains constant, the width  $x$ , measured transversely to the groove, must vary continuously. With sinusoidal modulation,  $x$  reaches a maximum equal to  $x_0$  at the peaks of the waveform, but at other points in the wave the groove is, in effect, narrower, and because of this so-called "pinch effect" the reproducing point must move up and down, as well as from side to side, if it is to retain

## BBC RECORDING TRAINING MANUAL

contact with both walls of the groove without deforming them. The vertical movement is of small amplitude but, since it occurs at double the signal frequency, appreciable accelerational forces may be involved unless the reproducing stylus tip has a low mechanical impedance to vertical as well as to lateral movement.

Fig. 21 is drawn in the form commonly used to illustrate the mechanism of the pinch effect, but while it is convenient for this purpose it should not be forgotten that it is so out of scale as to be seriously misleading as regards magnitudes. This will be seen from Fig. 22, which shows, approximately to scale, the plan view of a length of the groove of Fig. 20 (104 grooves per inch)

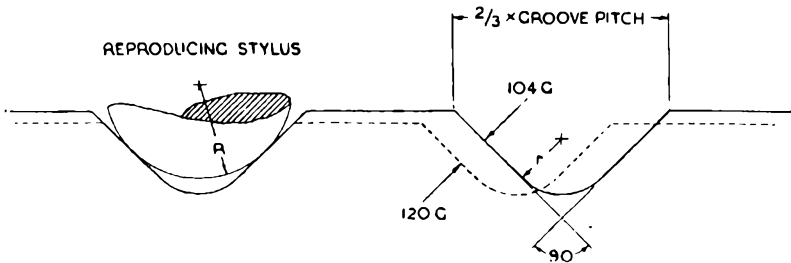

FIG. 20. SECTION OF STANDARD UNMODULATED GROOVE :

- $r$  = tip radius of cutter point = 0.0015 in.
- $R$  = " " of reproducing point = 0.0025 in.
- $G$  = grooves/in.

modulated sinusoidally with a wavelength of 0.005 inch and an amplitude of 0.0001 inch. This corresponds to a 5,000 c/s tone at a cutting speed of 25 in./sec (6.1 inches diameter at 78 r.p.m., or 14.3 inches diameter at 33 $\frac{1}{3}$  r.p.m.) and with an amplitude approximately 3 db below the BBC maximum level for that frequency (Fig. 19). The full lines show the outline of the groove,

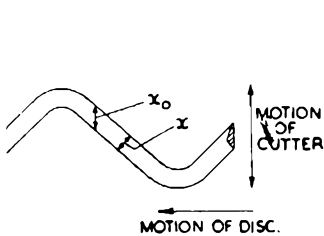

FIG. 21. DIAGRAM ILLUSTRATING PINCH EFFECT

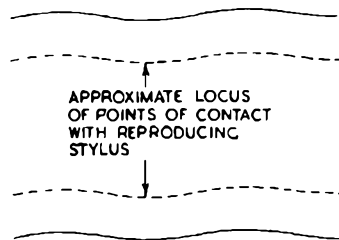

FIG. 22. PLAN VIEW OF GROOVE, 5,000-c/s TONE AT CUTTING SPEED OF 25 IN. PER SECOND. AMPLITUDE 3 DB BELOW MAXIMUM LEVEL

and the dotted lines show approximately the path followed by the points of contact of the stylus tip. It will be seen that the width of the groove between the points of contact is very much greater than the amplitude, and is comparable with the wavelength.

## 2.9 RADIUS COMPENSATION

### 2.8.2 TRACING DISTORTION<sup>1</sup>

When the hemispherical end of a reproducing stylus is moved in contact with a sinusoidal surface of comparable curvature, the stylus tip does not itself move sinusoidally. Consequently, if serious amplitude distortion is to be avoided, the curvature of the groove walls must not be too acute. It follows that for a given wavelength (or for a given cutting speed and frequency) there is a limit to the recorded velocity that can satisfactorily be reproduced by a given size of stylus tip. A number of studies<sup>2,3</sup> have been made of the "tracing" distortions that arise when the curvatures of the grooves and the stylus are comparable, and it has been shown that, with given groove and stylus dimensions, distortion should be less with lateral recording than with hill-and-dale because, in the ideal case, the lateral groove has a push-pull action, giving cancellation of even harmonics. The importance of this point should not be exaggerated, however, for cancellation is not necessarily fully realised in practice and, in any case, distortions other than tracing distortion may be present.

The limitations that are imposed in practice by considerations of groove curvature are naturally not easy to estimate with any precision, for even with specified conditions of stylus tip size, recording characteristic (2.10) and radius compensation (2.9), the groove curvatures obtained when recording the complex waveforms of speech and music depend both on the frequency distribution of energy in the programme and on the relative phasing of the components. In practice, therefore, these limitations, which to some extent control the choice of recording characteristic, must be found empirically.

### 2.9 RADIUS COMPENSATION<sup>1</sup>

If a steady high-frequency tone is recorded over the whole of a disk, it will be found, on reproduction, that the output of the reproducing head falls progressively as it approaches the centre. This loss, which increases with frequency, has two principal causes. The first is that at low cutting speeds the disk presents a larger mechanical impedance to movement of the cutting stylus, and consequently smaller velocities are recorded. The second is that as the recorded wavelengths become shorter the reproducing stylus has increasing difficulty in following the groove undulations, so that the output of the reproducing head falls and amplitude distortion is introduced.

The loss of the higher frequencies at the inside of the disk could be offset, at least in part, by arranging for the high-frequency response of the reproducing amplifiers to be increased progressively as the reproducing head approaches the centre of the disk. This would have the disadvantage of increasing the background noise as well, and the movement of the reproducing-head arm would have to be made to vary a resistance or a reactance. To do this without detracting from its freedom of movement would be difficult and expensive, particularly as it would have to be applied to a large number of reproducing equipments. In practice, therefore, the response of the recording amplifier is varied instead, and this is comparatively easy to do since a variable resistance or reactance can be driven by the traversing mechanism. As a result of this "radius compensation," the recorded level of the higher frequencies is increased



progressively as the cutter approaches the centre of the disk and, since this makes the curvature of the short waveforms even more acute, it further increases the amplitude distortion. The amount of radius compensation that can profitably be used is therefore a compromise between distortion and frequency response, and since the results obtained are affected greatly by the disk material, by the shape of the recording and reproducing styli, and by the behaviour of the reproducing head, the best compromise depends very much on the detailed nature of the equipment used, as well as on the extent to which the cutting speed is lowered to obtain a long recording time.

As an indication of magnitude in a particular case, Fig. 23 shows the radius compensation that is applied to the recording amplifier of the BBC Type-D equipment (page 62) at 78 r.p.m. At  $33\frac{1}{3}$  r.p.m. the compensation increases progressively as the recording head moves inwards until a maximum value of 10 db is reached, after which the maximum value remains constant, but the frequency at which it occurs is progressively reduced until the stylus is at 8-in. diameter. From this point onwards the radius compensation remains unchanged. The circuit arrangement used is described in 3.5.4.

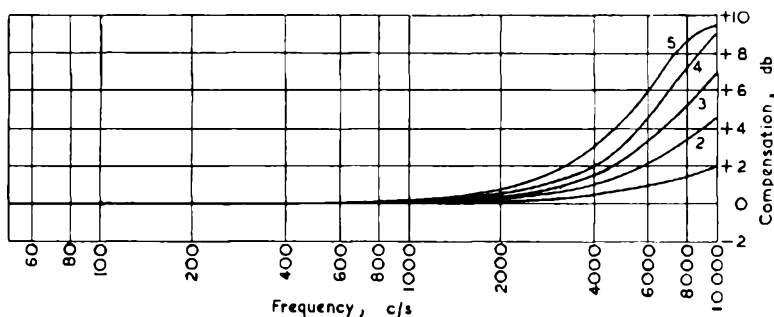

FIG. 23. RADIUS COMPENSATION, 78 R.P.M.

The figures 1-5 indicate different settings on the Automatic Control (See Fig. 69)

## 2.10 RECORDING CHARACTERISTIC<sup>1</sup>

If constant input voltage is applied to a recording amplifier the curve relating frequency and the r.m.s. velocities recorded is known as the recording characteristic. If, with a given recording characteristic, the amplifier gain is continuously increased, a point will be reached beyond which distortion becomes unacceptable; this indicates that at some frequency, or frequencies, the recorded levels are as high as practicable. Background noise will be minimised, however, by recording at as high a level as possible at all frequencies, and it follows that the best signal-to-noise ratio, with a given signal, is obtained by choosing the recording characteristic so that, on increasing the recording level, the limit of permissible distortion is reached simultaneously at all frequencies. Ideally, therefore, the recording characteristic should vary according to the frequency distribution of energy in the signal to be recorded; with speech and music the optimum can be met only on the average. In practice it is necessary, of course, to consider not only the distribution of energy in the programme but also the effect of radius compensation (2.9).

## 2.10 RECORDING CHARACTERISTIC

Since the criterion in choosing a recording characteristic is that there should be an equal likelihood of unacceptable distortion at all frequencies, the choice is governed by the distortions introduced by the recording and reproducing heads, by the amplifiers and by tracing losses (2.8.2), so that the characteristic which is most suitable for one kind of recording equipment is not necessarily the most suitable for another. The determination of the best characteristic for recording speech and music on a variety of recording equipments is, therefore, a complex one and must, to some extent, be made empirically.

It will be noticed that in discussing the fundamental considerations governing the choice of recording characteristic it has not been necessary to introduce conceptions such as "pre- and post-equalisation," "turnover frequency" or hypothetical "constant velocity" or "constant amplitude" characteristics.

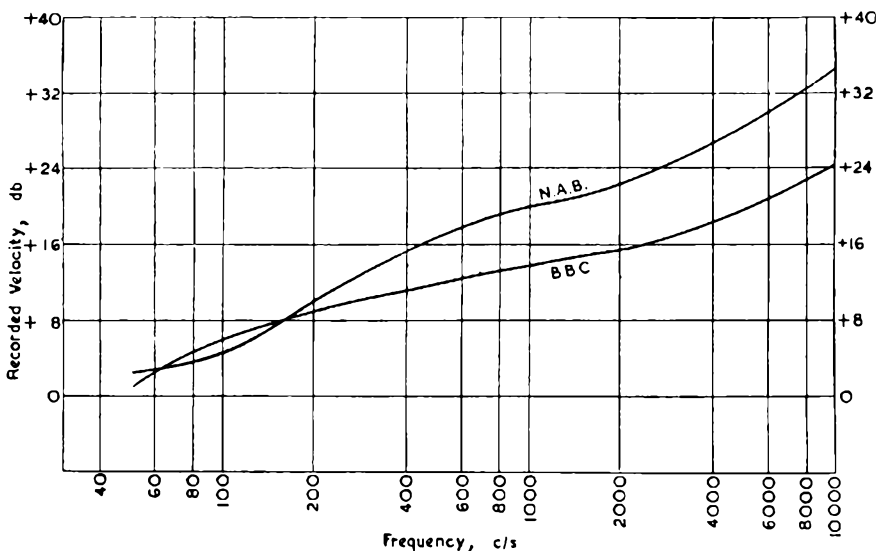

FIG. 24. BBC AND N.A.B. RECORDING CHARACTERISTICS (33½ R.P.M.)'

Nor has any reference been made to the commonly assumed need to restrict amplitudes at the lower frequencies so as to avoid unduly wide groove spacing. It is true that if the recording characteristics that give minimum background noise were, in practice, to call for excessive amplitudes, it would be necessary to impose a definite (amplitude) limitation so as to avoid undue reduction of playing time. In fact, however, amplitudes are in any case restricted by the limitations of practicable recording equipment, in particular by those of the recording head, and it is found that practical recording characteristics, such as those in Fig. 24 approach the condition of equal liability to distortion at all frequencies under normal conditions, without requiring amplitudes greater than can be accommodated with the usual groove pitches (2.6).

While the only fundamental advantage to be gained by the choice of one recording characteristic rather than another is an improvement in signal-to-

noise ratio, nevertheless the choice of recording characteristic does considerably affect the demands upon the various parts of the recording and reproducing chain, and, in some cases, it may be worth while to adopt a recording characteristic which does not give the minimum of background noise, in order to simplify or cheapen some part of the equipment. The subject will not be discussed in detail here, but it may be worth while to indicate briefly and rather summarily how the choice of recording characteristic affects the demands made upon the recording amplifier.

Let us assume a recording-reproducing chain with a flat overall response and with a recording characteristic that rises with frequency so that the corresponding reproducing amplifier response falls by, say, 6 db per octave. Any second harmonic in the output from the reproducing head will then be attenuated 6 db relative to its fundamental, and higher harmonics will be attenuated proportionately more. On the other hand, suppose that two tones of, say, 5,000 c/s and 5,100 c/s have been recorded, and that the input to the reproducing amplifier contains 1% of a 100-c/s intermodulation tone (page 15). In the amplifier, the 5,000-c/s tones are attenuated some 34 db relative to 100 c/s, and the output therefore contains approximately 50% of the intermodulation tone. A steeply rising recording characteristic therefore tends to reduce the importance of harmonic generation as such, but it greatly increases the stringency of the intermodulation requirements in the recording-reproducing process and in those stages of the recording amplifier that follow the frequency-weighting networks. It will also be seen from 2.15 that, generally speaking, the more steeply the recording characteristic rises with frequency, the greater will be the output required from the recording amplifier.

Another point not always fully appreciated is that it is difficult to measure a recording characteristic with any precision. The usual procedure is to record a test disk with various frequencies of tone applied at a fixed level to the input of the recording amplifier. The velocities that have been recorded are then measured. Since radius compensation is usually only an approximate adjustment, changing in a series of steps, it is generally not used in making the test disk. Without it, however, the velocity recorded in each frequency band varies somewhat with the position of the band on the disk (2.9) and a different velocity/frequency curve is obtained if the bands of tone are differently distributed over the disk surface. Comparative measurements are therefore simplified by the adoption of a convention which ensures that each frequency appears always at the same position on any test disk.

With high frequencies and low disk speeds, however, it is not easy to measure the velocities on the test disk. A calibrated reproducing head is commonly used, but this means, in effect, that the response of the reproducing head on the cellulose test disk is compared with its response on a similar reference disk, usually a pressing, the velocities on which are assumed to be known. It has been mentioned, however, in 2.8, that the response of a reproducing head may be appreciably affected by change in groove shape or in the material of the disk, and it follows that the change in the reproducing-head response between the reference disk and the test disk is not necessarily wholly due to

## 2.10 RECORDING CHARACTERISTIC

differences in the recorded velocities. It is, in fact, a matter of some difficulty to deduce how much of the change is due to the other variables, and unless allowance is made for these factors the "measurement" is arbitrary and peculiar to the equipment used. The velocities recorded on the test disc may be measured without this ambiguity by the Buchmann-Meyer light-band method (Appendix E), but this does not really dispose of the difficulty, for a reproducing head must eventually be used to reproduce programme recordings, and it is therefore the output from the reproducing head that really interests us. These difficulties of measurement may be reduced in the future by the development of reproducing heads with more satisfactory mechanical impedances (2.8), but in the meantime care must be taken, and if necessary due allowance made, when comparing recording characteristics that have been determined with different equipments.<sup>1</sup>

Fig. 24 shows a recording characteristic recommended by the National Association of Broadcasters (U.S.A.) and used to some extent for 33 $\frac{1}{3}$ -r.p.m. recording in America. The BBC characteristic is also shown, drawn to the same basis. Neither of these curves can be said to represent finality of choice, for there is as yet no finality in disk quality, nor is there uniformity in equipment design; these factors are inter-related, for the advantage gained in increasing velocities at high frequencies to increase signal-to-noise ratio may well be offset by distortions introduced by the recording equipment.

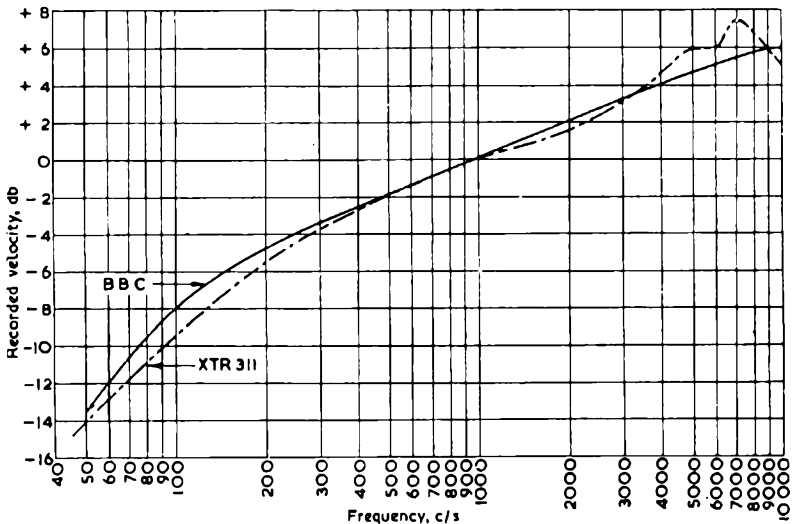

FIG. 25. BBC RECORDING CHARACTERISTIC (78 R.P.M.)

The dotted curve shows the velocities recorded on Test Record XTR 311

Fig. 25 shows the approximate shape of the BBC recording characteristic as applied to 78-r.p.m. recording; in considering this curve, due allowance must be made for the effects of radius compensation (Fig. 23).

*Practical Considerations*

In spite of the many variables discussed in the preceding paragraphs, it is essential to have a standard by which the frequency/velocity relationship on different machines may be maintained at reasonable uniformity. The frequency/velocity relationship of the BBC test record XTR 311 approximates the BBC recording characteristic for 78 r.p.m. (Fig. 25), and the overall characteristic obtained from this record (i.e., the curve relating constant input volts to the recording amplifier with reproduced volts at the output of the reproducing amplifier) is used to maintain a uniform recording characteristic.

The method employed is to record tone at the same frequencies and cutting speeds as on XTR 33, and compare the overall characteristic of the recorded disk with that of the test record, using the same reproducing needle, pickup and amplifier. Correction to the curves thus obtained is then applied, such correction being based on the slight difference between XTR 311 and the true BBC characteristic (Fig. 25).

2.11 THE EFFECT OF GROOVE LOADING ON FREQUENCY RESPONSE

In the same way that an electrical circuit containing inductance and capacitance is said to be damped or loaded when resistance is connected in series with it, the mechanical system represented by the moving parts of the recording head is loaded by the resistance offered by the lacquer coating when a groove is cut. The degree of loading, i.e., the value of the resistance, depends on the depth of cut, the degree to which the effective cutting edge at the tip of the cutter is bevelled, the speed of the recording medium and the composition of the disk material. It is desirable that the resistance should make as little difference as possible to the performance of the head, and this can be achieved by making the mechanical impedance at the tip of the cutter large.

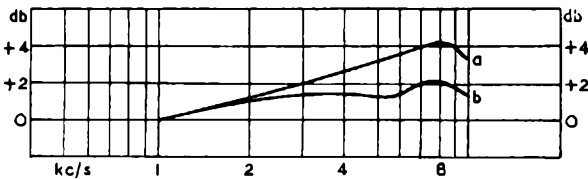

FIG. 26. EFFECT OF GROOVE LOADING ON RECORDING-HEAD FREQUENCY CHARACTERISTIC

It is shown in Section 2.14 that a recording head should be stiffness-controlled in order to cut a constant-velocity track, and such a head automatically has a large stiffness reactance at low frequencies and the effect of groove loading is small. At high frequencies, however, where mechanical resonance of the moving parts occurs, the mechanical impedance is at a minimum and groove loading makes a difference to the output, reducing the velocity of the cutting stylus as the loading increases. To illustrate this point, Fig. 25 shows the response curve of a BBC recording head Type B for two different types of lacquer coating. As predicted from theory, maximum differences occur near the frequency of mechanical resonance.

## 2.12 THE DISK

### 2.12 THE DISK<sup>1</sup>

The recording blank usually consists of a fairly rigid base of metal or glass, coated with a layer of cellulose lacquer about 6 mils thick, the composition and physical characteristics of which vary from manufacturer to manufacturer. So do the results obtained, for different lacquers give background noises of different character and different intensity, while the abrasion resistance and the load/deformation characteristics of the material settle the response that can be obtained on reproduction. A discussion of the ways in which the various properties of the lacquer affect the performance would be lengthy, but it may be mentioned here that, in addition to the more obviously desirable properties, a good disk lacquer should not produce a static charge when cut, since this makes the swarf cling to the disk so that its removal becomes difficult.

It is of the utmost importance, as shown in 2.16.4, that the surface of the disk shall be flat and a tolerance much closer than the  $\pm \frac{1}{16}$  in. specified by N.A.B. is desirable. Difficulty has been experienced in obtaining material for the blanks sufficiently flat to meet a tolerance of 0.005 inch, but efforts are being made to achieve this degree of flatness. In addition, of course, the lacquer should be of uniform thickness, the BBC specification being that the difference between the maximum and the minimum lacquer thickness must not exceed 0.003 inch, and that abrupt changes of thickness must be less than 0.0005 inch. Standard sizes of disk blank and maximum recording diameters as used by the BBC are shown in Appendix J.

It will be seen that in America 15½ inches is the standard starting diameter for all 33½-r.p.m. recordings, a 17¼-inch or 16-inch diameter blank being used according to whether processing is required or not. In the BBC, however, 16-inch diameter blanks are not used, and all 33½-r.p.m. recordings are made on 17¼-inch diameter disks. If processing is required, the starting diameter is 15½ inches but if not, the recording starts at 16¼-inches diameter, so that the cutting speed at the end of the recording is as high and the quality as good as possible. The centre-hole diameter is specified as 0.286  $\pm$  0.001 inch by both N.A.B. and BBC.

### 2.13 THE CUTTING STYLUS

The cutting stylus consists of a steel rod about the size of a loud-tone gramophone needle, the tip being ground to a V-shaped point, or a duralumin rod of similar size with a sapphire point fixed into a hole drilled at one end of the rod. Steel cutters were used by the BBC for a number of years and, for 78 r.p.m., gave reasonably satisfactory results. With the introduction of recording at 33½ r.p.m., however, it became necessary to use sapphire-tipped cutters because of the additional wear imposed by increased recording time. Moreover, the steel cutter had operational disadvantages in that a fresh cutter had to be inserted for each disk and there was considerable difficulty in obtaining uniformity in size and shape.

The sapphire-tipped cutter is capable of recording a large number of disks but its durability depends very largely on the shape of its tip; if V-shaped, it is easily fractured because of the brittleness of the material; BBC sapphire-tipped cutters are therefore radiused at the tip (Fig. 27). If the cutting edges

## BBC RECORDING TRAINING MANUAL

of the sapphire are sharp there is a tendency for the groove walls to be ragged because of the tearing action during cutting ; to avoid this, the cutting edge is slightly bevelled around the extreme tip. This has the effect of producing

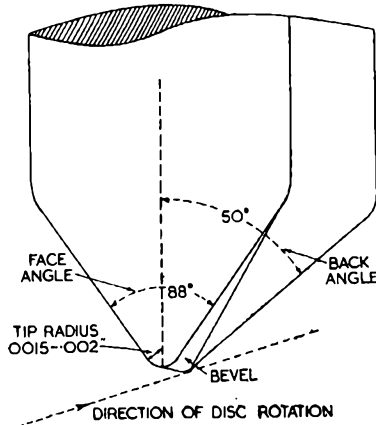

FIG. 27. SAPPHIRE TIP OF A BBC STANDARD CUTTER

a cleaner groove, a better signal-to-noise ratio and an improved appearance to the finished recording. Methods of manufacturing sapphire-tipped cutters are discussed in Appendix B.

### 2.14 THE RECORDING HEAD

The function of the recording head is to transform the electrical energy from the recording amplifier into mechanical energy to actuate the cutting stylus. Three types of movement are practicable, moving-iron, moving-coil and piezo-electric ; of these, the moving-iron is most popular because of its relative simplicity and robustness. The moving-iron head also has the advantage of considerable power-handling capacity for a relatively small overall mass.

Most modern heads have balanced armatures because this form of suspension gives a more linear relationship between the electrical input to the coil and the movement of the stylus ; in effect, a balanced armature has a push-pull motion, tending to cancel even-harmonic distortion. The principle of operation of a moving-iron head is illustrated in Fig. 28. The armature is within the magnetic field of a permanent magnet and is subjected to a turning movement about its pivot due to the changing flux set up by the currents in the coil. Since these currents are alternating in character, the armature oscillates at the frequency of the current and the stylus vibrates laterally at this frequency.

The armature requires a restoring force to prevent it from being deflected to one or other pole-piece. The force may be provided by a torsion bar or a spring which, in conjunction with the effective mass of the armature, forms a mechanical system (see Appendix D) with a resonant frequency. The value of

## 2.14 THE RECORDING HEAD

the latter depends on the moment of inertia of the armature and the magnitude of the restoring force. This frequency often falls within the audible range and some form of mechanical damping is necessary to avoid excessive amplitude at this frequency, the damping acting in the same way as resistance in an electrical circuit containing inductance and capacitance. When the effective mass of a pivoted armature is known, it is possible to obtain almost any value of mechanical resonant frequency by adjustment of the restoring force.

Suppose it is required to provide a constant-velocity characteristic and that the recording head is supplied with a constant e.m.f. at all frequencies. If the winding of the recording head is predominantly inductive over the audible frequency range, the current in the winding and hence the magnetic force on the armature, will be inversely proportional to frequency. Appendix D shows that, if a constant-velocity characteristic is required from a mechanical system, in which the force is inversely proportional to frequency, stiffness control is necessary. To obtain this control, the frequency of mechanical resonance

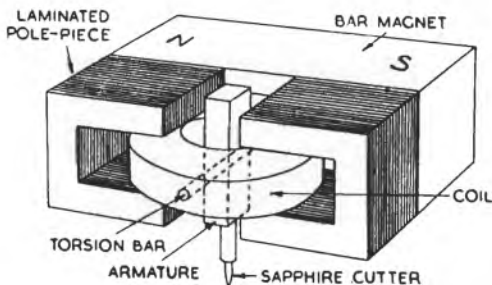

FIG. 28. THEORETICAL DIAGRAM OF MOVING-IRON RECORDING HEAD

should be as high as possible, the effective mass of the armature small and the stiffness of the mounting great. There are, however, limits to what can be accomplished; the cross-sectional area (and hence the mass) of the armature must be such that it can carry the magnetic flux induced in it without saturation (note that the cutting stylus adds to the mass); the stiffness cannot be increased unduly, otherwise the head becomes very insensitive, and considerable power is necessary to operate it, increasing the danger of armature saturation. Early recording heads had a resonant frequency of about 4,000 c/s, but in the BBC Type-B head this frequency has been increased to 10,000 c/s.

In practice, the assumption that the winding is purely inductive is not justified at low frequencies, where resistance losses in the coil become important and cause a reduction in the mechanical output of the head. In the BBC Type-A head (3.3.4) advantage is taken of this loss to help obtain the required recording characteristic.

## 2.15 THE RECORDING AMPLIFIER

The main function of the recording amplifier is to supply the recording head with adequate power to drive the cutting stylus; in certain circumstances



the amplifier incorporates frequency-discriminating networks necessary for a given recording characteristic.

High-quality recording heads usually have low sensitivity, which at once suggests that the amplifier must have relatively high output power. Because of the inductance of the coil the impedance of the head increases as the frequency of the signal increases ; for this reason, the output stage of the amplifier must supply *low voltage and high current* for low frequencies, and *high voltage low current* for high frequencies ; both these conditions are often required simultaneously.

Since the recording head provides an inductive load, the currents in the load are to a large extent wattless, and the amplifier power is expressed, not in watts, but in volt-amps. The minimum power required is roughly equal to the product of the volt-amps for two frequencies at the extremities of the range, for example, 10,000 c/s and 50 c/s ; thus for 2 volt-amps at 10,000 c/s and 10 at 50 c/s, a minimum power of 20 volt-amps is necessary. In practice, the problem may be more complicated, particularly when radius compensation is used, and a practical example is discussed on page 77.

#### 2.15.1 NEGATIVE FEEDBACK

The use of negative feedback in the output stage is almost essential because of the highly inductive nature of moving-iron recording heads, and the tendency of tetrode and pentode valves to behave as constant-current generators. The use of feedback not only tends to give the output stage a constant voltage characteristic but also reduces attenuation and harmonic distortion. The feedback voltage is sometimes taken from a special secondary winding on the output transformer and sometimes from a special winding within the recording head itself. Ideally, the feedback voltage should be directly proportional to the movement of the cutting stylus, but the nearest practical approach to this is obtained, as in the BBC Type-B head, by making the feedback directly proportional to the magnetic flux within the armature.

#### 2.15.2 FREQUENCY CORRECTION IN RECORDING AMPLIFIERS

It sometimes happens that the mechanical and electrical design of a recording head is such that it produces the required recording characteristic without external correction, but more often the recording characteristic is obtained by the incorporation of a frequency-correcting network in the recording amplifier. In an RC-coupled amplifier the coupling components consist of an anode resistor, a coupling capacitor and a grid leak. The frequency response of such a circuit is dictated almost entirely by the product of the coupling capacitance and grid leak resistance ; for any values of C and R, there is a loss at 3 db at the frequency  $f$  for which the reactance of C is equal to R, and, with the same values of C and R, the loss at  $2f$  is 1 db. Below  $f$ , the rate of loss gradually increases as frequency decreases until it reaches 6 db per octave which is the maximum rate of loss obtainable for a single RC network. Fig. 29 shows a typical loss curve for such a circuit.

It is sometimes necessary to modify the shape of the loss curve so that it

## 2.15 THE RECORDING AMPLIFIER

extends over a greater part of the frequency range ; this can be done by inserting two or more RC networks in cascade, as shown in Fig. 30. A circuit of this type was used in the original BBC disk recording amplifier to produce the recording characteristic.

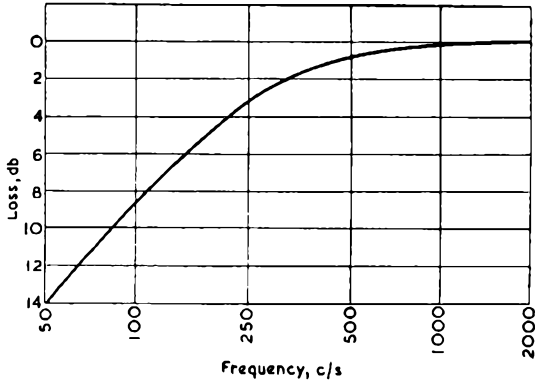

FIG. 29. TYPICAL LOSS CURVE FOR A SINGLE RC CORRECTION NETWORK

Frequency correction is sometimes applied by arranging negative feedback circuits so that the amount of feedback, and hence the amplifier gain, varies at different frequencies ; an example occurs in the Presto recording amplifier, the circuit of which is discussed on page 61.

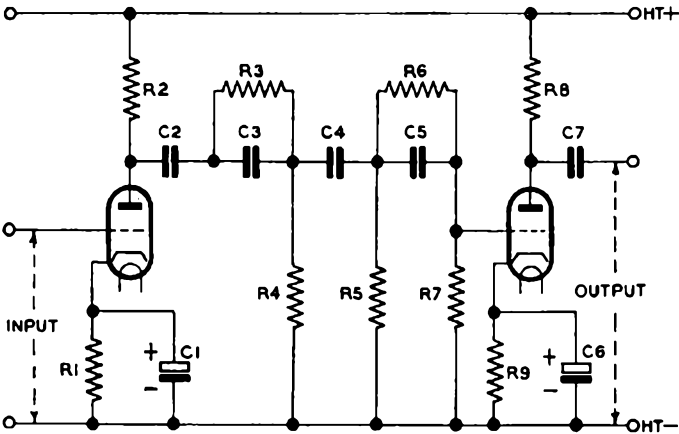

FIG. 30. INTERVALVE COUPLING CIRCUIT FOR GIVING RECORDING CHARACTERISTIC

Resonant circuits may be included in the recording amplifier to counteract the effects of resonance in the moving parts of the recording head, but whilst such circuits may be so proportioned that they produce a satisfactory frequency response on pure tone, they tend to set up ringing at the resonant frequency

on programme transients. It is therefore desirable for recording heads to be so designed that the resonant frequency of their moving parts lies outside the required audio range ; if the resonant frequency of the head falls within this range, the amplitude of the resonance should be reduced as far as possible by mechanical damping within the head itself.

## 2.16 THE RECORDING MACHINE

The two main functions of the recording machine are to drive the turntable at an accurate and constant speed and to cause the recording head to track across the disk at a speed which produces the required groove pitch.

### 2.16.1 THE TURNTABLE DRIVE

Turntable-drive design presents the problem of combining high uniformity of speed with a low level of vibration. The mean speed may have a tolerance of  $\pm 0.5\%$  without causing serious trouble, but uniformity of speed must be kept within narrower limits, for speed fluctuations cause frequency modulation of the recorded signals, a form of distortion to which the ear is rather sensitive. If speed fluctuations occur at a few cycles per second, they produce a rhythmic rise and fall in pitch on steady tones, usually referred to as *wow*, whilst more rapid changes of speed cause a form of distortion known as *flutter*. (App. G.) These effects are more noticeable on some kinds of signal than on others, but with steady tone, both slow and rapid speed fluctuations are particularly apparent in the frequency range of 1,000-3,000 c/s. The degree of *tolerance* acceptable for normal purposes depends upon listening conditions, and is much smaller for loudspeaker than for headphone listening. With loudspeaker listening in reverberant surroundings, frequency changes in the reproduced signal are particularly noticeable when they occur at rates varying between 0.5 and 5.0 c/s ; it follows that if the turntable speed varies once (or a very few times) per revolution, frequency changes resulting therefrom will be objectionable.

It is, of course, essential to take into consideration speed fluctuations of both recording and reproducing turntables, and although it is difficult to assess precise permissible tolerances, it is generally accepted that if speed fluctuations of both recording and reproducing turntables do not exceed 0.05% *wow* or *flutter* will be negligible, provided that other conditions, discussed on page 46 have been met.

We must now consider the effect of vibration on a recording machine. If machine vibrations at a given frequency are transmitted to the recording stylus, the amplitude of the recorded signal at that frequency will be affected. Fig. 19 shows that at 100 c/s, the maximum groove displacement amplitude is less than 0.002 inch. Suppose that a turntable vibration at this frequency produces a groove-displacement of  $10^{-5}$  inch : the signal and vibration groove amplitudes will be in the ratio of 200 : 1 ; hence the turntable vibration will have been recorded at a level only 46 db below that of maximum signal level for 100 c/s and the spurious signal produced by vibration will certainly be audible. A little thought will show that a similar vibration at a higher frequency would be still more noticeable. In addition to the amplitude distortion produced

## 2.16 THE RECORDING MACHINE

by horizontal vibration, uniformity of groove depth may be seriously affected if the vibration has a vertical component. Methods adopted to reduce speed fluctuations and vibration to a minimum are discussed in Section 3.5.2.

### 2.16.2 THE STROBOSCOPE

A stroboscope is a device used for indicating whether a wheel, pulley or turntable is rotating at correct speed. It may take the form of black and white segments or bars on the edge of a turntable, or it may consist of a cardboard disk, having a number of black and white divisions. With either of these types, the number of bars is so calculated that, when the turntable is rotating at its correct speed, the bars when illuminated from an a.c. supply, appear to produce a stationary pattern.

Consider light from an a.c. source falling on the moving stroboscope ; the light will reach peak value twice per alternating cycle ; if the stroboscope is moving at such a rate that one bar is replaced by the next in sequence in precisely the same time period as that between two successive light peaks, the pattern will appear to be stationary, and the rotational speed will be that for which the stroboscope was designed. If the speed is above normal, the bars will appear to move in the direction of rotation ; if the speed is below normal, they will appear to move in the opposite direction.

Another form of stroboscope is used on some BBC reproducing turntables. This consists of a neon lamp, the beam from which is viewed through holes in the periphery of the turntable and when the turntable speed is correct, the light from the neon as seen through the holes, produces a stationary pattern ; if the speed is incorrect, the pattern appears to move with or against the turntable rotation, according to whether the turntable is running fast or slow. (See also, page 27.)

*Calculation of Stroboscopic Bars.* If the lamp used to illuminate the stroboscope operates from an a.c. supply of frequency  $f$  c/s, it gives  $2f$  light pulses per second and the interval between two successive pulses is  $1/2f$  seconds. The stroboscope bars must be so spaced that one is replaced by the next  $1/2f$  seconds later, when the turntable rotates at the correct speed of  $n$  r.p.m. In  $1/2f$  seconds the turntable describes

$\frac{n}{60} \times \frac{1}{2f}$  i.e.,  $\frac{n}{120f}$  of a revolution ; hence the number of bars required is  $120f/n$ .

When  $f = 50$  and  $n = 78$ , the precise number of bars required is  $76.92$  ; in practice the stroboscope is constructed with 77 equally-spaced bars, and when the pattern appears stationary, the turntable speed is  $77.92$  r.p.m.

When  $f = 50$  and  $n = 33\frac{1}{2}$ , the required number of bars is 180.

If the turntable is driven by a synchronous motor and the light is taken from the same mains supply as the motor, any variations in the mains frequency affect the turntable speed and the number of light pulses per second to the same degree ; under these conditions, the stroboscope does not indicate whether the turntable speed is accurate or not.

## BBC RECORDING TRAINING MANUAL

For a stroboscope viewed by a lamp supplied from 50-c/s mains, the number of bars which appear to pass a given point in one second is numerically equal to the percentage inaccuracy in the turntable speed.

If the accuracy of a stroboscope is required to be independent of fluctuations in the mains frequency, a stable oscillator (preferably crystal-controlled) is necessary to operate the lamp by which the pattern is illuminated.

### 2.16.3 THE TRAVERSE MECHANISM

The traverse mechanism of a disk recording machine comprises a carriage or arm supporting the recording head, and some form of drive to track the head across the disk. The direction of traverse may be from outside to inside of the disk (out-in) or vice versa. BBC machines normally track from out to in for two reasons ; first, this conforms with gramophone practice and therefore simplifies the reproducing operation ; secondly, if a programme or part of a programme is too short to fill a disk side, this is recorded where cutting speed is greatest. (2.2.)

With in-to-out tracking it is unnecessary to provide special means for swarf removal because the thread tends to throw inwards towards the centre of the disk ; also, when using steel reproducing needles, the inner grooves, where the waveform curvature is greatest, are reproduced before the needle tip is worn. On balance, the advantages of out-to-in tracking are the greater, provided that an efficient swarf remover is used when recording (p. 74) and permanent or semi-permanent needles when reproducing.

The *traverse drive* usually comprises a threaded rod called a *lead-screw* (or feed-screw) which is rotated by a friction disk or other suitable drive ; a half-nut attached to the cutter-head carriage engages with this lead-screw and drives the carriage across the disk. The speed of traverse drive and threads-per-inch on the lead-screw are calculated to give the correct groove pitch (p.28). Arrangements are usually made so that the traverse-drive speed can be varied to provide for a different groove pitch if required ; alternatively, two or more lead-screws having different threads, are provided.

### 2.16.4 THE RECORDING-HEAD MOUNTING

The recording head is usually mounted on a pivoted arm, so that it may follow any rise and fall due to imperfect flatness of the rotating disk, and the pressure of the cutter on the disk is adjusted by springs or counterweights. Since a uniform depth of cut is required, in spite of any rise and fall of the disk surface, the spring should have a high compliance and the natural frequency of the head on this spring alone is therefore low. Suppose now that the machine, indicated diagrammatically in Fig. 31, has been built so rigidly that vibration cannot cause relative movement between the pivots and the disk. If a vertical vibration is applied to the machine, the pivots move vertically but the head, by reason of its inertia, tends to remain stationary in space, so that the cutting pressure varies cyclically. Similar effects may occur with a horizontal vibration. Since the groove appears darker where the cut is deeper, cyclic variations in

## 2.16 THE RECORDING MACHINE

depth of cut show as a pattern of light and dark bands, radial if the frequency is an exact multiple of the turntable rotation frequency or spiral if it is not and the phenomenon is therefore usually known as *patterning*. This particular cause of patterning can be overcome for all translational vibrations by counterweighting the head, and placing the pivots at the centre of gravity of the complete unit.<sup>4</sup> A high-compliance spring may then apply the cutting pressure, as shown diagrammatically in Fig. 32. This arrangement implies some limitation on the position of the pivots and it is therefore necessary to consider the other factors involved.

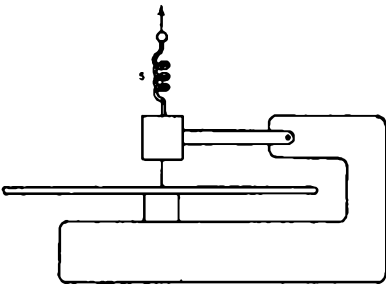

FIG. 31. DIAGRAMMATIC ILLUSTRATION OF RECORDING MACHINE; RECORDING HEAD IS PIVOTED AT EXTREMITY OF ARM

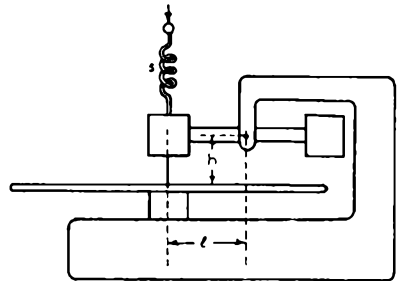

FIG. 32. SHOWING COUNTER-BALANCED HEAD, WITH PIVOTS AT CENTRE OF GRAVITY

The dimensions  $l$  and  $h$  in Fig. 32 are important. If the cutter is raised a slight distance (due to an imperfection in the disk flatness) it is displaced longitudinally in the direction of the groove; this alters the effective cutting speed. If these movements occur at regular intervals wow may be produced, particularly at low cutting speeds; but the effect can be minimised by increasing  $l$  and making  $h = 0$ , i.e., by pivoting the head assembly in the plane of the disk. This, however, is not a practicable solution for it increases the variations in the depth of cut caused by vibration.

If, during recording, any relative vertical motion between the head and the disk takes place, the head behaves as if it were resting on a spring, the compliance of which may be called the *cutting compliance*. The mass of the head (together with the counterbalance weight) and this spring forms a mechanical circuit which resonates at a frequency dependent on the dimensions  $l$  and  $h$  and other factors. If the frequency of this *cutting resonance*<sup>1</sup> coincides with that of an applied vibration, violent variations in depth of cut result. To minimise this tendency,  $h$  should be large and  $l$  small, a condition in direct opposition to that for minimum wow. In practice a compromise is necessary, giving reasonable constancy in depth of cut and fairly low wow.

To prevent large vertical movements of the head and consequent variations in depth of cut when the head receives a mechanical shock, it is necessary to include some resistance  $R$  in the mechanical circuit comprising the head assembly

## BBC RECORDING TRAINING MANUAL

and the cutting compliance. This can be achieved by the use of a dashpot, or equivalent device, connected between the recording head and the carriage frame, as shown in Fig. 33, but the amount of mechanical resistance which can be introduced in this way should be limited since resistance here increases

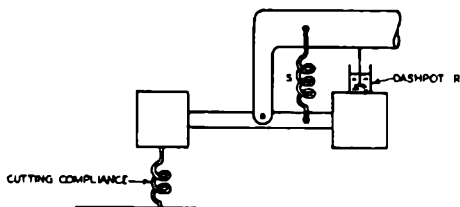

FIG. 33. COUNTERBALANCED HEAD WITH DASH-POT.

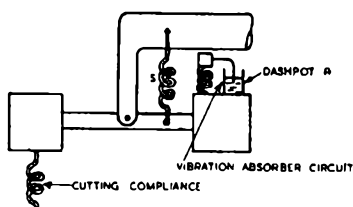

FIG. 34. COUNTERBALANCED HEAD WITH DASH-POT AND ABSORBER CIRCUIT.

the variations in depth of cut caused by imperfections in the flatness of disks. A better solution is to replace the damping resistance by a parallel-tuned absorber circuit with a resonant frequency below that of cutting resonance. Such a system is illustrated in Fig. 34.

### 2.16.3 SWARF REMOVAL

Whilst a disk is being cut, the material gouged out by the stylus takes the form of a continuous thread, known as *swarf* which normally tends to throw in towards the centre of the turntable. If the traverse is in-to-out, the recording head is moving away from the swarf and little difficulty arises. With out-to-in tracking, the swarf must either be brushed to the centre or removed altogether. Recording machines originally used by the BBC were fitted with a brush which was caused to oscillate radially over the disk surface by means of an eccentric disk-clamping boss. Later machines are supplied with a suction plant (3.5.3).

One of the major difficulties in swarf removal is the electrostatic charge, set up by friction, which causes the swarf to adhere to the disk surface. This charge can be neutralised by the application of a so-called anti-static fluid before the disk is cut. The fluid consists of a "wetting" agent such as alcohol, and a "conducting" agent such as bicarbonate of soda.

### References

- 1 Davies, H., "The Design of a High-fidelity Disk Recording Equipment," *Journal I.E.E.*, 1947, 94, 3, 30.
- 2 Pierce, J. A., and Hunt, F. V., "On Distortion in Sound Reproduction from Phonograph Records," *Journal of the Acoustical Society of America*, 1938, 10, p. 14.
- 3 Lewis, W. D., and Hunt, F. V., "A Theory of Tracing Distortion in Sound Reproduction from Phonograph Records," *ibid.*, 1941, 12, p. 348.
- 4 Patent 3819/40

## CHAPTER 3

### BBC DISK RECORDING EQUIPMENT

#### 3.1 INTRODUCTION

THE first disk recording machine used by the BBC was known as the M.S.S. (Marguerite Sound Studios) recorder (3.2); its amplifying and control equipment were of BBC design. For some years, the M.S.S. machine was used both at studio centres and for mobile recording; for the latter purpose three vans were each equipped with two sets of recording equipment.

About 1937, experiments were made with a smaller recording machine for operation in saloon cars. These experiments led to the design of the BBC Portable Disk Recording Equipment Type C (3.3); this is the standard mobile recording equipment and many sets are in use.

During the war years (1939-1945), there was considerable expansion of the recording service and a number of Presto recording machines and amplifiers (3.4) were obtained from the U.S.A. Like the M.S.S. machines, these were mains-operated and normally installed in pairs or "channels."

In 1943 the Research Department began work on the design of a high-fidelity disk recording equipment, now known as Type D (3.5). This will eventually replace some of the existing static channels but, since most of the equipments mentioned above are likely to remain in service for some time to come, we shall describe each of them in chronological order.

#### 3.2 THE M.S.S. (MARGUERITE SOUND STUDIOS) DISK RECORDER<sup>1</sup>

##### 3.2.1 THE TURNTABLE AND TRAVERSE DRIVE

A photograph of the recorder is given in Fig. 35, and the main and traverse drives in Fig. 36.

The heavy turntable is driven by a  $\frac{1}{2}$ -h.p. 3-phase induction motor. The motor drives a reduction gear (25) through a flexible coupling (24); the gear box is coupled (26) to a belt-and-pulley system (27 and 28) which drives the turntable. The traversing mechanism is driven by a friction disk (20) via a small wheel (36) which is connected to the shaft of the left-hand pulley through a universal joint; this wheel can be moved vertically across the diameter of the friction disk by adjusting a knurled-headed screw (22); this adjustment permits a limited variation in groove pitch and also provides means for changing the direction of traverse. Three turntable speeds, 78 r.p.m., 60 r.p.m., and  $33\frac{1}{3}$  r.p.m. are available by adjustment of the belt-and-pulley drive; the machine is normally used for 78-r.p.m. recording and direction of traverse is out-to-in. A hand traverse (37) is fitted for setting the recording head at the starting position for cutting, a lever (39) being provided to change from hand to automatic traverse.



BBC RECORDING TRAINING MANUAL

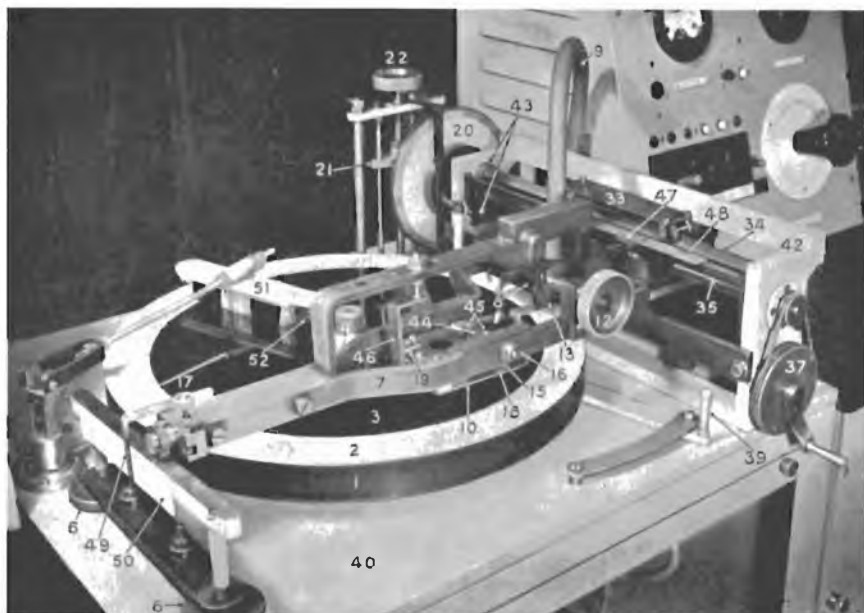

FIG. 35. M.S.S. DISK RECORDER : GENERAL VIEW

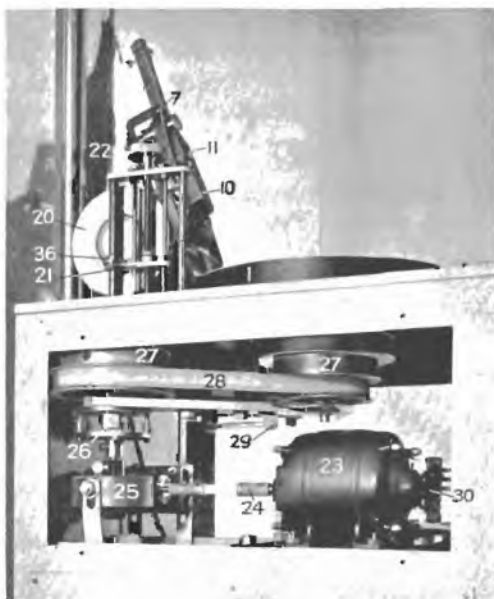

FIG. 36. M.S.S. DISK RECORDER : MAIN AND TRAVERSE-DRIVE MECHANISMS

## 3.2 M.S.S. DISK RECORDING EQUIPMENT

Swarf is collected by a brush (51) which is kept in motion by an eccentric disk-clamping boss.

### 3.2.2 RECORDING-HEAD MOUNTING

The method of mounting the recording head in the traversing carriage is indicated in Fig. 35. The pivot screw (16) passes through either side of the frame (7) into the selected holes in the saddle (Fig. 37). The arrangement of the holes is such that the head can be moved horizontally or vertically with respect to the pivot points. The horizontal adjustment permits the pivot points to be moved with respect to the centre of gravity of the head, thus controlling the pressure on the cutter point and hence the depth of cut. The vertical adjustment decides the angle of rake of the cutter and is usually fixed so that the cutter trails at an angle of roughly 5 degrees; this angle can be adjusted by a set-screw (17) which raises or lowers the arm with respect to the carrying ramp (5).

### 3.2.3 THE RECORDING HEAD

The recording head (Fig. 37) is a moving-iron type with a balanced-armature

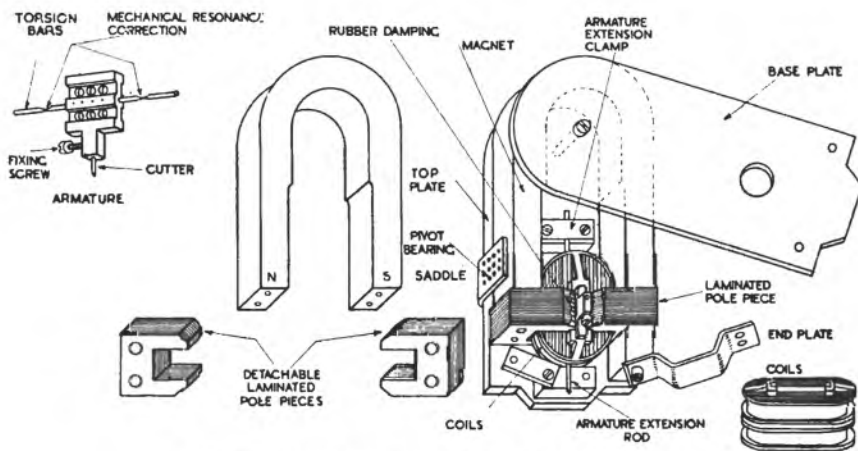

FIG. 37. CONSTRUCTION OF M.S.S. RECORDING HEAD

movement. The frequency of mechanical resonance is determined by the moment of inertia of the armature and the compliance provided by the torsion bars; holes are drilled in the armature to keep the moment of inertia low, and flats are ground at suitable points on the torsion bars to bring the resonant frequency of the armature to about 4,000 c/s. Mechanical damping and electrical correction are used to prevent an excessive increase in groove amplitude at or near the frequency of resonance. The damping takes the form of rubber pads inserted between armature and pole pieces; electrical correction is provided in the recording amplifier by an equaliser containing a rejector circuit

(Fig. 38), tuned to the resonant frequency of the armature. Since the resonant frequency varies considerably for different heads, a change of head invariably involves a change of equaliser and a separate panel-mounted equaliser is provided for each head.

### 3.2.4 THE RECORDING CHAIN

The recording chain includes a limiter, a voltage amplifier, a power amplifier and a peak programme meter. The voltage amplifier consists of three triode stages, equalisation for the recording characteristic being inserted between

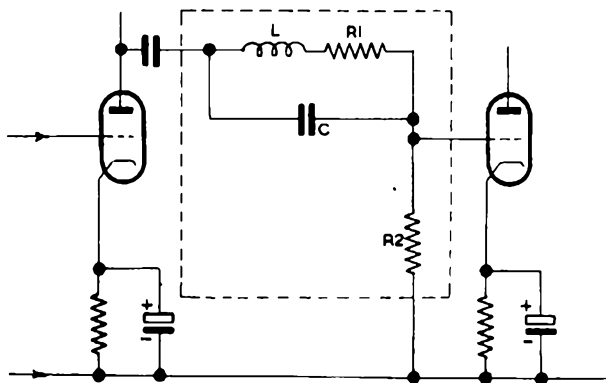

FIG. 38. RECORDING AMPLIFIER EQUALISER CIRCUIT

The circuit introduces a "dip" at the frequency of recording-head resonance

the first and second stages and for recording-head resonance between the second and third stages (Fig. 38). The power amplifier contains four triodes connected in parallel push-pull, choke-capacitance coupled to the recording head.

Because of the inductance of the winding, the electrical impedance of the recording head varies greatly with frequency and it is impossible to match the head to the output stage of the amplifier accurately over a wide frequency range. With the choke-capacitance coupling used, the impedance of the head greatly exceeds the output impedance of the amplifier over the audible frequency range, with the result that the head is well damped electrically and is fed from a substantially constant voltage source.

## 3.3 BBC PORTABLE DISK RECORDING EQUIPMENT, TYPE C

### 3.3.1 GENERAL

The Type-C portable recorder<sup>2</sup> was designed by the BBC Research Department in 1938-39 to meet the demand for a battery-operated recorder which could be carried and operated in an 18-20 h.p. saloon car.

This called for some sacrifice of performance. For example, the speed constancy is barely good enough for the successful recording of music, the overall frequency-response range is more restricted than that of a static recorder, there is neither radius compensation nor facilities for monitoring the recorded

### 3.3 BBC PORTABLE DISK RECORDER

disk during recording, and the machine is designed for 78 r.p.m. only. On the other hand, the equipment is extremely robust and reliable, is entirely independent of mains supply and, because of the unit construction adopted, is reasonably easy to transport.

The equipment can be used for recording or reproduction ; in addition, facilities are provided for connecting the output of the amplifier to a Post Office line and the microphones and amplifier can therefore be used for purposes of outside broadcasting (including the reproduction of disks) if occasion demands.

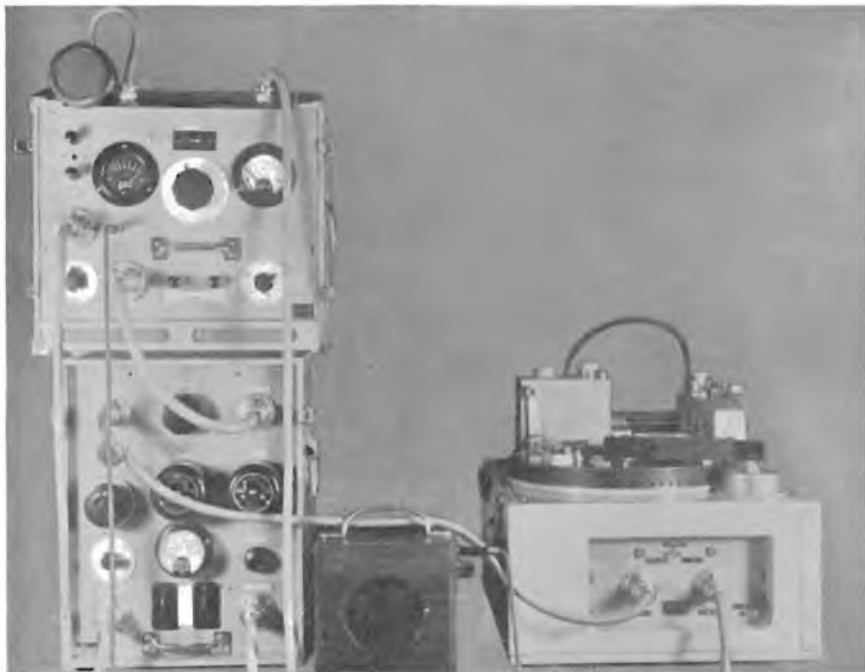

FIG. 39. PORTABLE RECORDING EQUIPMENT TYPE C : GENERAL VIEW

The complete equipment comprises the following units (Fig. 39) :—

- (a) A recording or reproducing machine.
- (b) A recording or reproducing amplifier.
- (c) A supply unit incorporating the power circuit controls and H.T. motor generator.
- (d) Two 6-volt Nife batteries supplying power to the recording motor, the amplifier L.T. circuits and the H.T. motor generator.
- (e) Microphones and mixing equipment.

## 3.3.2 THE RECORDING MACHINE

The machine is illustrated in Fig. 40. The turntable is driven by a 12-volt d.c. motor, the shaft of which carries a rubber-covered roller to drive the turntable plate. The traverse drive is rotated by a belt, driven from the underside of the turntable shaft ; a friction disk, similar to that on the M.S.S. machine, gives a groove pitch adjustable between 100 and 125 grooves per inch. The machine is not fitted with hand traverse, but the recording-head carriage can be moved along its slides by depressing a catch which releases the half-nut from the lead-screw.

The swarf-collecting brush is actuated by an eccentric disk-clamping boss. When the machine is used for reproduction, the brush unit is replaced by the reproducing-head mounting, which incorporates connections to the amplifier input.

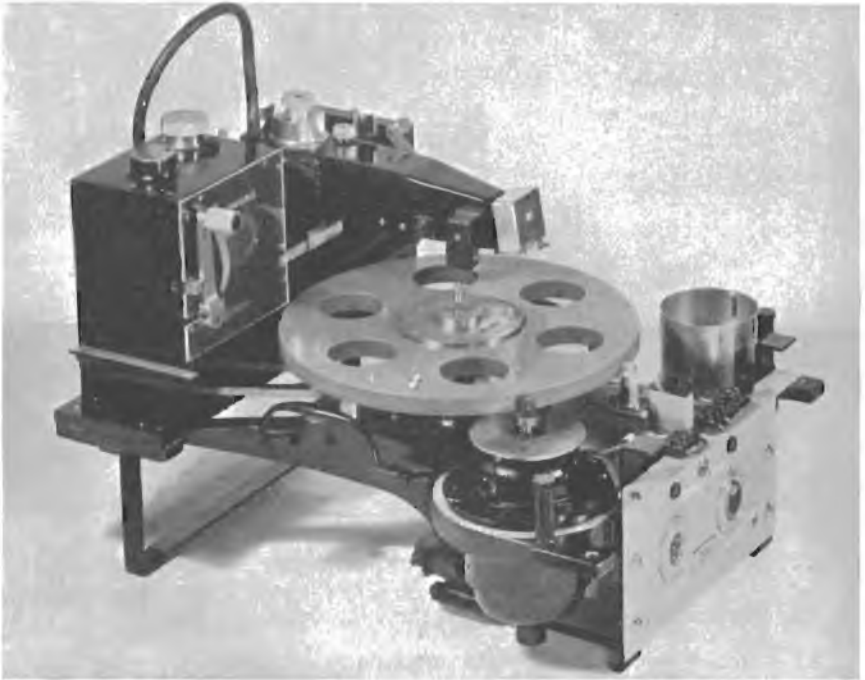

FIG. 40. PORTABLE RECORDING MACHINE TYPE C : REMOVED FROM CASE

*Recording-head Mounting.* The recording head is attached to a tubular arm, pivoted at its centre of gravity within the carriage extension. A counter-balance weight is attached to the opposite end of the arm (Fig. 41). This method of mounting conforms to the principles discussed in section 2.16.4 for reducing variations in the depth of cut resulting from machine vibration.



*BBC Disk Recording Machine Type C*

*A battery-operated, transportable machine used for news reporting*



*Presto Disk Recording Machine Type 8N*

*Showing details of Traverse Mechanism. The Recording Head is BBC Type B 1.4*

### 3.3 BBC PORTABLE DISK RECORDER

Depth of cut is adjusted by a screw, the setting of which controls the tension of a leaf-spring which presses on the counter-balanced arm at the recording-head end.

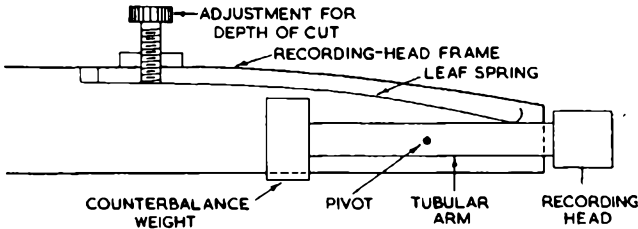

FIG. 41. PORTABLE RECORDING MACHINE TYPE C: RECORDING-HEAD FRAME

*Turntable Speed Control.* Turntable speed is adjusted by means of a variable resistance in series with the motor field, correct speed being indicated by means of a stroboscope consisting of a number of holes spaced at equal intervals around the periphery of the turntable. Since the equipment is battery operated, the stroboscope is illuminated by a neon lamp fed from an oscillator having good frequency stability.

It has been explained in Chapter 2 that 77 holes are required for stroboscopic indication of 78 r.p.m. with 50-c/s mains. The same number is used with this turntable but, because the neon lamp strikes once only per cycle, i.e., on the positive half-cycle, the oscillation frequency is fixed at 100 c/s.

#### 3.3.3 RECORDING AMPLIFIER DR/5A

This amplifier is designed to meet the following requirements:—

- (i) A voltage gain sufficient to raise microphone level to that required to operate a power stage;
- (ii) A power stage to drive the cutting stylus;
- (iii) Aural and visual monitoring facilities.

All these requirements are fulfilled by the adaptation of existing amplifiers; the standard BBC microphone amplifier<sup>3</sup> OBA/8 provides the basis for the voltage-amplifying section, and the circuit of the loudspeaker amplifier<sup>3</sup> LSM/4 is used for the power stage.

The programme meter incorporated in the amplifier provides visual monitoring, and output jacks from both voltage-amplifying and power stages provide easy means for either headphone or loudspeaker listening.

#### 3.3.4 BBC RECORDING HEAD, TYPE A

The BBC Type-A recording head is a moving-iron instrument using grease damping. In mobile recording equipment, where amplifier power supplies are limited, adequate sensitivity of the head is of greater importance than a full audio-frequency range. The Type-A head has high sensitivity compared with



## BBC RECORDING TRAINING MANUAL

the Type-B (page 69) but its useful frequency range is restricted to roughly 60-6,000 c/s;

The head has a cantilever-type armature of small dimensions (Fig. 42); the frequency of mechanical resonance is about 4,500 c/s so that the armature

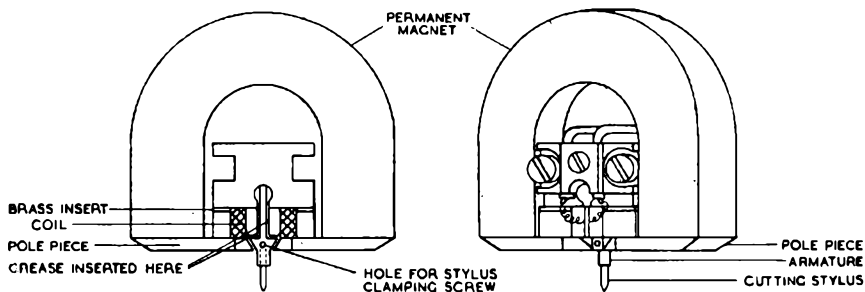

FIG. 42. CONSTRUCTION OF TYPE-A RECORDING HEAD

is effectively stiffness-controlled at frequencies below this value (See Appendix D). The mechanical damping necessary to prevent excessive amplitudes at 4,500 c/s is provided by grease inserted in two small air gaps, as shown in Fig. 42. The bass-cut required by the recording characteristic is obtained by correct choice of the ratio of resistance to inductance in the winding and no electrical correction is necessary in the amplifier.

### 3.4 PRESTO DISK RECORDING EQUIPMENT

#### 3.4.1 GENERAL

This equipment is manufactured by the Presto Recording Corporation of New York. It is capable of recording either at 78 r.p.m. or at  $33\frac{1}{3}$  r.p.m. and includes automatic radius compensation. Two slightly different types are in use, the earlier being designated 6N and the later 8N. In the first equipments received, two 6N machines were mounted on a single pedestal. Some of these have been modified, the machines being mounted on separate pedestals to prevent inter-machine vibration. The 8N machines have an improved traverse drive (Plate 2) and are mounted singly, on BBC pedestals. With both types, BBC Type-B recording heads replace the Presto heads. Presto amplifiers and switching equipment are provided for each pair of machines on a single rack.

#### 3.4.2 THE TURNTABLE DRIVE AND TRAVERSE UNIT

The turntable drive and speed-change mechanism are illustrated in Figs. 43 and 44. The turntable is flanged and the motor shaft coupled to the inner side of the flange through a rubber idler-wheel; the motor shaft carries a sleeve, machined to two diameters, to obtain either of the two speeds. Fig. 43 shows the speed-change lever in the  $33\frac{1}{3}$ -r.p.m. position; the smaller section of the motor-shaft sleeve is coupled to the turntable-rim through the right-hand idler-wheel. When the speed-change lever is moved to the 78-r.p.m. position

### 3.4 PRESTO DISK RECORDING EQUIPMENT

(i.e., to the right), the larger section of the sleeve engages with the lower of two concentric idler-wheels (shown in Fig. 44), the upper of which engages with the turntable rim. In the central position of the speed-change

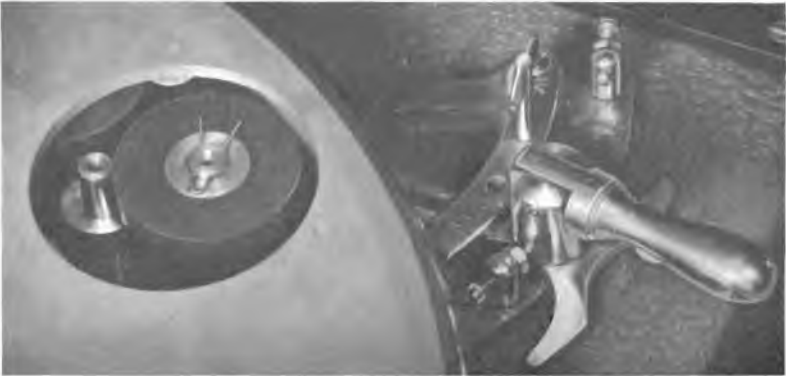

FIG. 43. PRESTO RECORDER 8N : DRIVE UNIT

Removal of inspection plate on turntable permits idler-wheel pressure adjustment with turntable in position

lever, the idler-wheels are freed from both motor shaft and turntable ; this prevents flats being worn on the idler-wheels when the machine is not in use. A bracket on the underside of the speed-change lever operates the conical motor-starting switch (Fig. 44).



FIG. 44. PRESTO RECORDER 8N : DETAILS OF DRIVE AND SPEED-CHANGE MECHANISM

The traversing assembly is shown in Plate 2. The recording-head carriage is driven in the manner of a lathe by means of a lead-screw and half-nut ; a worm-wheel attached to one end of the lead-screw engages a pinion driven by the turntable shaft. A number of lead-screws having different threads are provided to give different values of groove pitch. The whole unit is detachable

## BBC RECORDING TRAINING MANUAL

by releasing a screw at the top of the domed pillar below the hand-traverse wheel. When in operation the two finger-levers shown above the recording head on Plate 2 are in the horizontal position. The upper of these two levers engages the half-nut (attached to the carriage) with the lead-screw and the lower lever carries a cam which lowers the recording head.

### 3.4.3 RECORDING-HEAD MOUNTING

The recording head is mounted on an arm pivoted to the underside of the carriage (Fig. 45); at the other end of the arm there is a dash-pot; the plunger of which is fixed to an extension rod on the carriage. The function of the



FIG. 45. PRESTO RECORDER 8N : RECORDING-HEAD MOUNTING

dash-pot is, of course, to damp out vertical vibration of the cutter head. The downward pressure at the point of the cutting stylus, and hence the depth of cut, is controlled by adjustment of the tension of a spring. (Plate 2.) The rake of the cutter (i.e., the angle formed by the shank of the cutter and the plane of the disk) is adjustable by means of the large knurled-headed screw shown at the top of Plate 2. Adjustment of this screw raises or lowers the cutter head arm in relation to the plane of the disk, by means of a pair of sliding bars recessed into the carriage.

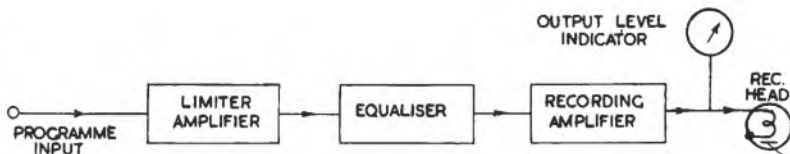

FIG. 46. PRESTO RECORDING CHAIN : BLOCK SCHEMATIC DIAGRAM

### 3.4.4 PRESTO RECORDING CHAIN

The basic circuit of the recording chain for Presto recording equipment is shown in Fig. 46.

The limiter amplifier incorporates a protective device to ensure that programme peaks fed to the recording head are not greater than 8 db above BBC

### 3.4 PRESTO DISK RECORDING EQUIPMENT

line-up level. It is a three-stage amplifier using push-pull operation throughout, the first pair of valves having variable-mu characteristics. The limiting action is achieved by means of a circuit (Fig. 47) resembling that used in the BBC limiter and similar to the circuits used for automatic gain-control in receivers.

A double-diode valve is connected as a full-wave rectifier between the anodes of the final push-pull stage by means of two resistors,  $R_1$ ,  $R_2$ , of very

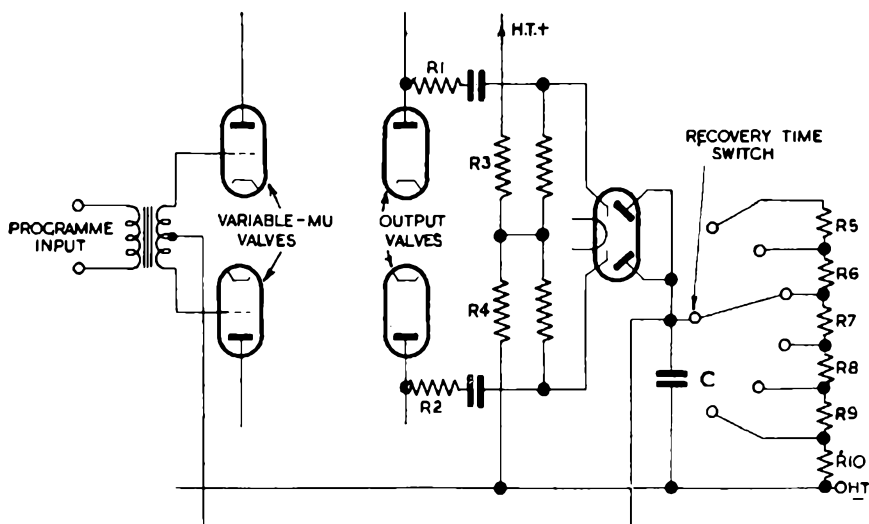

FIG. 47. PRESTO LIMITER AMPLIFIER : SIMPLIFIED CIRCUIT

high value. A potential divider,  $R_3$ ,  $R_4$ , connected across the H.T. supply biases the cathodes of the diodes positively with respect to their anodes, so that conduction cannot occur until the peak value of the output of the main amplifier exceeds the p.d. across  $R_4$ . The d.c. output of the rectifier, developed across a parallel RC circuit ( $C$  and  $R_5$ - $R_{10}$ ), is used as additional negative bias to control the gain of the first stage of the amplifier. If the output of the last stage exceeds the bias on the diode cathodes, the capacitor  $C$  becomes charged, and the charge begins to leak away, through the series network  $R_5$ - $R_{10}$ , at a rate depending on the time constant\* of the circuit, unless the charge is maintained by diode conduction. As in the BBC limiter, the value of the resistance and hence the value of the time constant, is adjustable to give various values of recovery time ; normally a period of several seconds is used.

*The Equaliser.* The function of the equaliser is primarily that of radius compensation, i.e., a progressive increase in the high-frequency response of the recording amplifier as the recording head approaches the centre of the disk, thus partially compensating for losses occurring on recording and reproduction (Chapter 2).

\*The time constant of an RC circuit is the time taken for the potential of the charged capacitor to fall to  $1/e$  (0.368) of its initial value. It is given in seconds by the product of capacitance in farads and resistance in ohms.



FIG. 48. PRESTO DISK RECORDER TRAVERSE UNIT TYPE-6N MACHINE  
 Similar sliding contacts are fitted to the traverse unit on Type-8N machine

The equaliser shown in the block diagram of Fig. 46 has fixed and variable components, the former being mounted on the bay and the latter on the machines. Attached to each tracking carriage are two spring-loaded arms (Fig. 48)

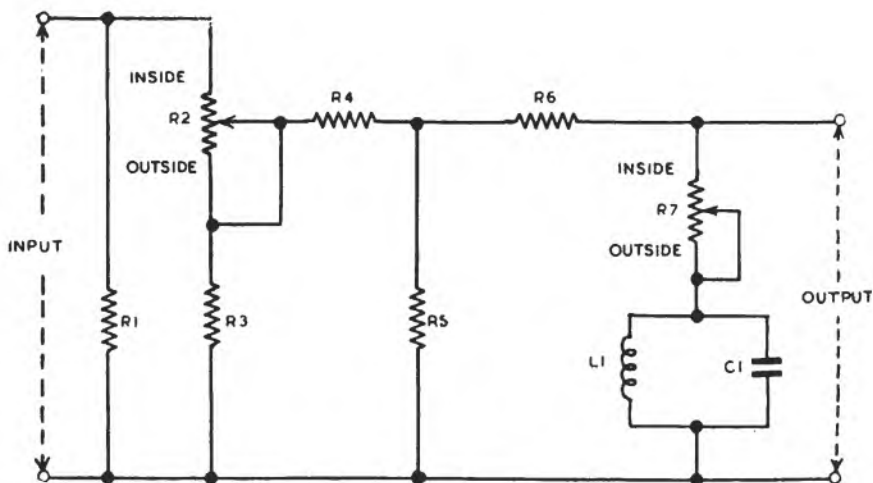

FIG. 49. PRESTO RADIUS COMPENSATOR : SIMPLIFIED CIRCUIT

making contact with and moving over two rows of stationary studs, which form the tapping points of two variable attenuators. One attenuator is represented by R1, R2 and R3 and the other by R7 (Fig. 49). The latter is connected in

### 3.4 PRESTO DISK RECORDING EQUIPMENT

series with a parallel tuned circuit  $L_1$ ,  $C_1$ , the inductor of which is tapped to resonate at either 4, 6, 8 or 10 kc/s. This series combination shunts the output of the fixed T-type attenuator  $R_4$ ,  $R_5$  and  $R_6$ .

The circuit is so arranged that when the recording head is at the outside of the disk, the attenuation provided by  $R_2$  is at a maximum ; at the same time the value of  $R_7$  is at a maximum and is considerably greater than the impedance of the circuit  $L_1$ ,  $C_1$  at any frequency. In these circumstances, the entire circuit behaves as an attenuator with approximately 30-db loss at all frequencies. As the recording head moves towards the centre of the disk,  $R_2$  and  $R_7$  are progressively short-circuited. The attenuation due to the potential divider  $R_2$ ,  $R_3$  is reduced but the loss of the shunt circuit  $R_7$ ,  $L_1$ ,  $C_1$  becomes correspondingly greater at all frequencies except those near the resonant frequency of  $L_1$ ,  $C_1$ , where the impedance of the tuned circuit is greatest. When the head is near the centre of the disk, the total loss of the equaliser as a whole is still approximately 30 db except at, or near, the resonant frequency of  $L_1$ ,  $C_1$ , where it is less. The net effect of this circuit arrangement is to increase the amplifier response gradually at those frequencies over which the tuned circuit operates as the recording head tracks towards the centre of the disk.

*The Recording Amplifier.* The recording amplifier following the equaliser incorporates an unbalanced section, amplifying the output from the automatic

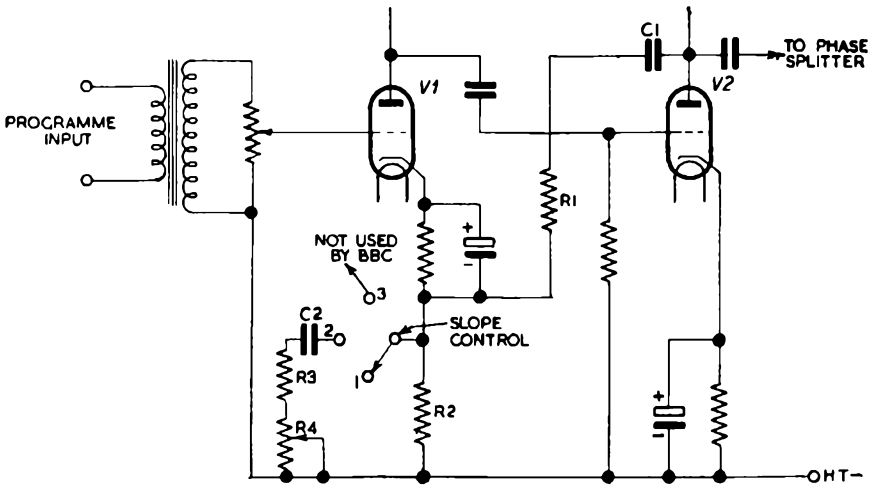

FIG. 50. PRESTO RECORDING AMPLIFIER : INPUT CIRCUIT SHOWING FREQUENCY CORRECTION BY NEGATIVE FEEDBACK

radius compensation circuit, a phase-splitting stage, and an output consisting of four beam tetrodes in parallel push-pull. Voltage feedback is applied between the anode of the second valve and the cathode of the first by means of the components  $C_1$ ,  $R_1$  and  $R_2$  (Fig. 50). Operation of a switch (known as the "slope

## BBC RECORDING TRAINING MANUAL

control") gives a choice between a level frequency response (position 1) or a response which rises as the frequency increases (position 2).

In position 1 of the slope control, the gain and frequency response of  $V_1$  and  $V_2$  are dictated almost entirely by the values of the components  $C_1$ ,  $R_1$  and  $R_2$  and the gain is almost equal to  $(R_1 + R_2)/R_2$ .<sup>5</sup> The audio-frequency response is made level by making the reactance of  $C_1$  small compared with the value of  $R_1 + R_2$ .

In position 2 of the switch,  $R_2$  is shunted by  $C_2$ ,  $R_3$  and  $R_4$ . The sum of  $R_3$  and  $R_4$  is smaller than  $R_2$  and the reactance of  $C_2$  is less than  $R_2$  at high audio frequencies, so that at high frequencies the impedance of the network  $R_2$ ,  $R_3$ ,  $R_4$ ,  $C_2$  falls, giving reduced negative feedback and greater gain.

### 3.5 BBC DISK RECORDING EQUIPMENT, TYPE D<sup>6,7</sup>

#### 3.5.1 GENERAL

The Disk Recording Equipment Type D was designed by the BBC Research Department to meet the demand for a disk recording system which would have a high standard of performance, be reliable in service and simple to operate.



FIG. 51. BBC DISK RECORDING EQUIPMENT, TYPE D

In view of the incomplete standardisation of disk-recording practice, it was considered desirable that the new equipment should be flexible. The machine, therefore, has two turntable speeds 78 and  $33\frac{1}{3}$  r.p.m. and two directions of traverse. Any groove pitch from 95 to 130 grooves per inch can be obtained by a simple adjustment. Disks up to  $17\frac{1}{2}$  inches diameter and up to  $\frac{5}{16}$  inch thick can be used and a wide range of cutting pressure is provided by a coarse adjust-



*BBC Disk Recording Machine Type D with Swarf Remover  
Amplifier and Mains Unit are housed within the cabinet behind the flaps*



### 3.5 BBC DISK RECORDER TYPE D

ment (in three steps) and a continuous fine control so scaled that any setting can be quickly repeated. The recording amplifier has sufficient gain to accommodate a wide range of recording characteristics, and the frequency characteristics of both the amplifier and the radius compensation circuits can be changed by replacing the tag boards on which the appropriate components are grouped. Each machine is equipped for reproducing, and a complete Type-D equipment comprises two recording machines and a control desk (Fig. 51). The control desk incorporates all switching necessary for programme selection; it also houses the reproducing amplifiers.

#### 3.5.2 THE RECORDING MACHINE

The recording machine consists of four main sub-assemblies, the turntable, traverse, main drive and scrolling units, all of which are mounted on a cast-iron bed-plate. At the corners of the bed-plate are projecting studs which engage with elastic mountings on the top of a substantial pedestal. These mountings provide vibration isolation for the recording machine itself and, by adjustment of the corner studs, the bed-plate can be levelled accurately. The top part of the sheet-steel casing which surrounds the machine is mounted on the bed-plate and is separate from the lower part which is attached to the pedestal, to permit relative movement.

The pedestal itself consists of two cast-iron frames, tied together by steel tubes and surrounded by a sheet-steel casing, the rear portion of which is quickly detachable. Within the pedestal there are rails on which the recording amplifier and its supply unit run, and the casing is so arranged that when the amplifier is in position, its output valves lie in a duct open only at the bottom and back of the machine. In this way, the hot air rising from the output valves is directed out of the pedestal enclosure.

*The Turntable.* The turntable comprises a cast-iron friction wheel, weighing 54 lbs., on which rests a detachable top-plate,  $17\frac{1}{2}$  inches in diameter and weighing 25 lbs. This plate, to which the recording blank is clamped, is dished towards the centre. The turntable shaft is carried in bronze journals in a substantial cast housing. The journals and the single-ball footstep bearing are submerged in oil, maintained at the correct level by a stand pipe accessible on top of the machine. Beneath the turntable, and closely surrounding the top journal, there is a free-wheel pulley on which runs a belt which drives the lead-screw of the traverse unit.

*The Main Drive.* The turntable drive arrangement is shown diagrammatically in Fig. 52. A vertically mounted  $\frac{1}{8}$ -h.p. 3-phase, 1,500-r.p.m. motor, with a special coupling, drives a vertical layshaft which is coupled, by means of an idler wheel, to a large friction wheel mounted on the same shaft as the turntable. The motor is carried in elastic mountings which reduce transmission of vibration to the frame of the machine, while the coupling prevents rotor vibration from reaching the layshaft. The elastic mountings are less effective at the lower frequencies, and the motor is therefore provided with

## BBC RECORDING TRAINING MANUAL

a pair of vibration absorbers, each consisting of a weight on the end of a steel rod, and arranged to resonate at the rotational frequency of the motor, i.e., 25 c/s. The layshaft, which runs in bearings mounted solidly with the turntable bearings, rotates at correct speed free from vibration, so that the idler wheel merely couples the layshaft to the turntable, and does not have to function as a vibration isolator ; it must not, of course, introduce vibration itself.

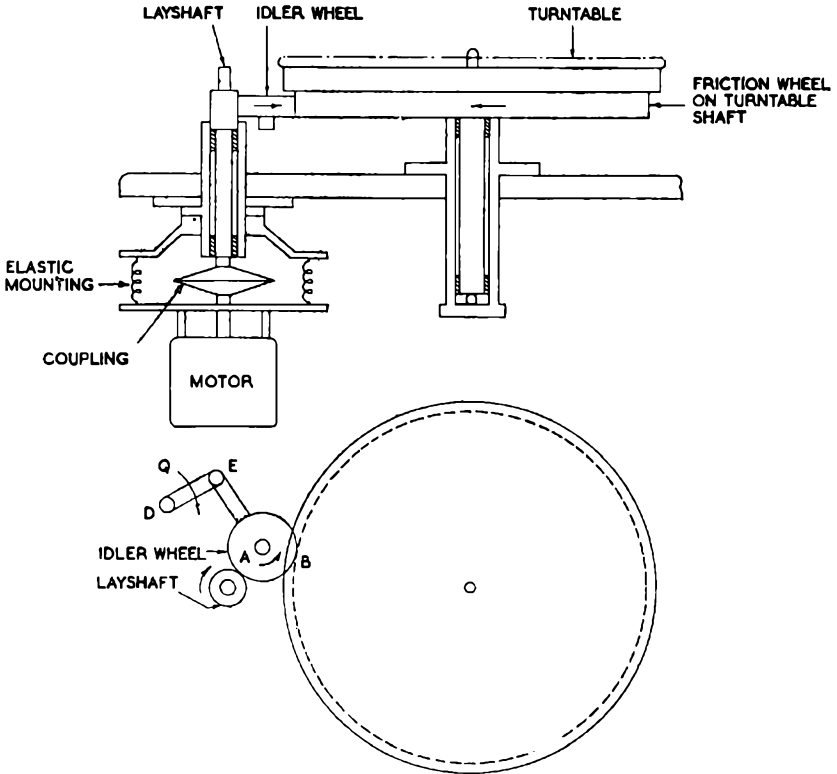

FIG. 52. DISK RECORDER, TYPE D : MAIN DRIVE DIAGRAM

A photograph of the drive mechanism is given in Fig. 53. The unit is built on a rectangular steel plate which slides into position on rails fixed to the underside of the bed-plate. Below this steel plate is a conical casting carrying the rubber mountings from which the driving motor is suspended ; the motor itself is a standard commercial type adapted for the purpose. Fig. 53 also shows the tuned vibration absorbers attached to the motor suspension plate and a stabilising ring which ties together the centre points of the upper and lower rubber mountings. The layshaft is concentric with the motor and connected to it by the coupling mentioned on page 63. This shaft runs in porous bronze bushes and has its upper end stepped to provide two speeds.

### 3.5 BBC DISK RECORDER TYPE D

The idler wheel is a neoprene moulding with a metal hub into which a porous bronze bush is pressed ; the wheel runs on a hardened steel pin carried on the end of a steel arm. This arm swings freely in ball-bearings mounted in a short aluminium link, the other end of which is carried in ball-bearings on a vertical spindle. The speed-change knob is on top of this spindle, and at the bottom is a projection which engages in a cylindrical gate. The spindle is spring-loaded and the gate is arranged so that, to change speed, the knob must



FIG. 53. DISK RECORDER, TYPE D : MAIN DRIVE UNIT

be rotated about 30 degrees anti-clockwise, raised or lowered, and then rotated clockwise. Because of the ball-bearings, the spindle is not affected by movement of the idler wheel or its supporting arm and link but, if the spindle is rotated more than 10 degrees, a projecting finger engages with the link and further rotation withdraws the idler wheel from contact with the driving and driven surfaces, so that it may be raised or lowered to the appropriate position on the driving shaft.

The idler wheel is fully withdrawn only when changing speed. When the turntable is stopped, however, a camshaft, operated by the starting control, rocks the idler link about the speed-change spindle just far enough to disengage the idler wheel from the driving and driven surfaces so that flats are not formed by continued pressure when the turntable is stationary. This camshaft also

operates a brake which brings the turntable to rest in two or three revolutions. When the starting control is operated, the first part of the rotation of the cam-shaft engages the idler wheel with the driving and driven surfaces, and it is only after this has been done that the motor is switched on.

Power is applied to the motor through series resistors ; the starting torque is therefore low and the motor runs up to speed comparatively slowly. This avoids any possibility of overloading the coupling or of causing idler-wheel slip during starting. Once the voltage across the terminals has reached a predetermined value, a relay closes and short-circuits the series resistors. During the starting period, when the motor is gathering speed, the indicator plate behind the starting control is illuminated by a concealed red lamp, but as soon as full voltage is applied to the motor this lamp is extinguished.

*Traverse Unit.* The traverse unit is of the parallel-motion type and is mounted to the left of the turntable.

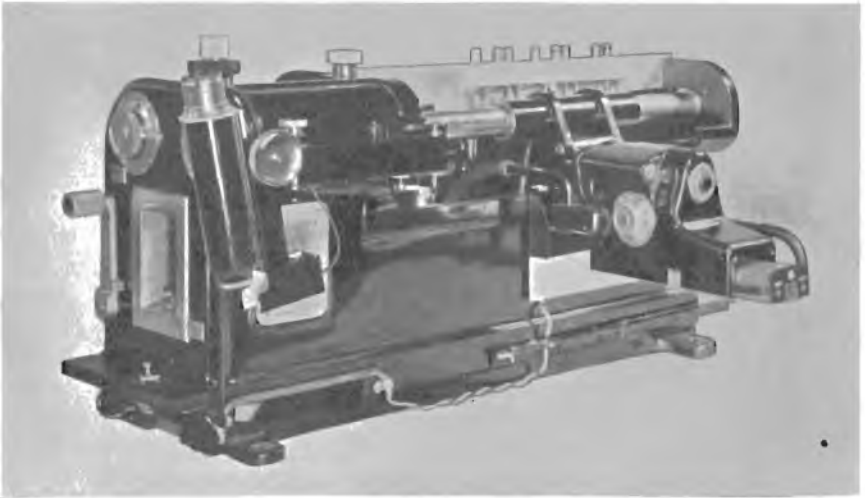

FIG. 54. DISK RECORDER, TYPE D : TRAVERSE UNIT

The unit consists of a cast frame with removable covers within which are two widely-spaced slide-rods and a lead-screw having 32 threads per inch. An L-shaped carriage, Fig. 54, rests on the slide-rods and has a self-aligning "half-nut" which can engage with or disengage from the lead-screw. The carriage is attached to self-lubricating sliding members on the rods by means of a link at the top end and a ball joint at the bottom. It is therefore not necessary for the two slide-rods and the lead-screw to be accurately parallel or accurately spaced, and manufacture is correspondingly simplified. Advantage has been taken of this construction by mounting the top slide-rod eccentrically so that, by rotating it, the whole carriage may be rocked about the bottom slide-rod, thus raising or lowering the pivots of the recording-head mounting to adjust for

### 3.5 BBC DISK RECORDER TYPE D

different thicknesses of disk. If this adjustment is set for a thicker disk than is actually used, the cutter will be inclined so that it tends to dig into the disk surface, while if the setting is for a thinner disk the cutter will trail. The raising and lowering of the recording-head pivots is therefore usually referred to as "rake adjustment," and an indicator on the front of the traverse frame shows the position of the setting. The recording-head supporting arm carries a small spirit-level to show the inclination of the cutter.

The forward portion of the carriage, known as the traverse head, projects beyond the traverse frame and overhangs the disk. Normally it is latched in the position shown in Fig. 54, where it supports the recording head and its arm, close to the disk surface. To obtain access to the turntable for replacing the disk, it is only necessary to press the push-button on the front of the traverse head, which then swings round on a horizontal axis to the "loading" position shown in Fig. 55. To remove the recording head, or to replace the cutter,



FIG. 55. RECORDING-HEAD  
CARRIAGE : LOADING  
POSITION

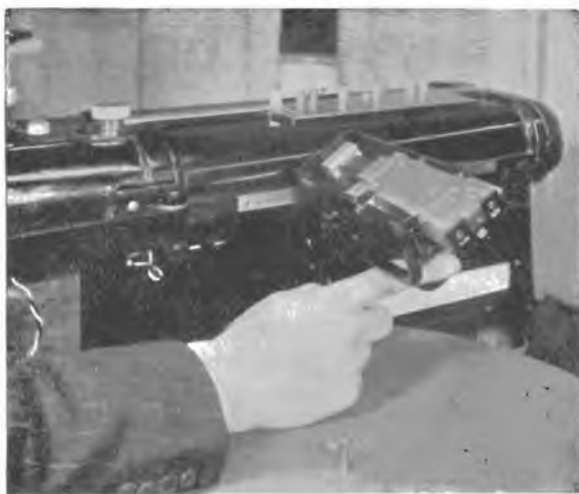

FIG. 56. RECORDING-HEAD CARRIAGE : MAINTENANCE  
POSITION

the traverse head may be rotated a further 120 degrees until it latches in the position shown in Fig. 56. It is released by pressing the same push-button and springs back to the "loading" position. On being rotated downwards into the working position it again latches into place. The rotating traverse head is joined to the remainder of the sliding carriage by a self-lubricating cone bearing which is kept under pressure by an internal spring so that, even when wear develops, the traverse head does not become loose on the carriage.

In the top of the traverse frame is a detachable bar which carries the mechanism to enable the correct starting diameter on any standard size of disk to

be found quickly and with certainty. Projecting from the bar is a series of interlocked push-buttons, one for each standard starting diameter and one to cancel. When one of these buttons is depressed, the plunger to which it is attached projects below the bar. The lower end of the plunger is so shaped that a spring-loaded projection on the carriage will pass it when the carriage is moving inwards, but will engage it as a stop when the carriage is moving outwards. To set up for recording, the appropriate push-button is depressed and the carriage is moved, first inwards and then outwards, as far as it will go. The recording-head is then at the right position to start recording.

In addition to the five push-buttons which give starting positions for the normal out-to-in direction of traverse, two similar buttons give alternative starting positions for in-to-out traverse, and the plungers on these buttons naturally face the other way to prevent the carriage from moving inwards. The danger might arise that, whichever direction of traverse is in use, a recording might be spoilt if a push-button corresponding to the other direction of traverse were depressed. To guard against this, it is arranged that the plunger on the carriage retracts as soon as the half-nut engages with the lead-screw, so that all the stops become inoperative as soon as the carriage is power-driven. The fixed end-stops, which normally limit the movement of the carriage, are also inoperative and the carriage can therefore travel a little beyond them until one or other of two limit switches is closed. This stops the driving motor and sounds a warning buzzer. The trip switches cannot be operated accidentally when moving the carriage by hand, for they are then protected by the end-stops; if the machine is allowed to over-run when recording it will stop a little beyond the normal recording limits without damage to the machine, to the cutter, or to the disk.

*The Traverse Drive.* The lead-screw is horizontal and parallel to the slide rods; it carries on its forward end a spring-loaded friction disk which engages with a sleeve on a vertical shaft, belt-driven from a pulley on the turntable shaft (Fig. 64). This sleeve has a raised ring at either end to act as a driving surface, and it can be moved up or down on its shaft by an internal screw so that one end makes contact above the centre of the disk, at the diameter required. As the contact is moved from a larger to a smaller diameter on the driven disk, the rotational speed of the lead-screw is increased and the groove pitch becomes coarser. Further movement engages the driving surface on the other end of the sleeve below the centre of the friction disk, and thus reverses the direction of traverse. The position of the sleeve, and therefore the direction of traverse and the number of grooves per inch, is shown by a raised ring on the centre of the sleeve. This ring acts as a pointer, reading on a scale engraved on the inside of an illuminated window which is recessed in the front face of the traverse unit.

Within the traverse unit are two wheels driven positively from the carriage by steel tapes. One of these wheels drives the rotary stud switch required for radius compensation via a pair of mitre gears, and the other provides the drive to an indicator on the machine control panel. This indicator contains four

### 3.5 BBC DISK RECORDER TYPE D

drums which show the position of the cutter on the disk and the number of minutes of recording time that remain before the minimum recording diameter is reached. The internal lighting of the drums is automatically switched when the turntable speed is changed, so that only the appropriate scales are illuminated.

*Recording-head Mounting.* The recording-head mounting is constructed in accordance with the principles discussed in Chapter 2. The head is mounted on an arm (Fig. 57) which is pivoted at its centre of gravity; the other end of

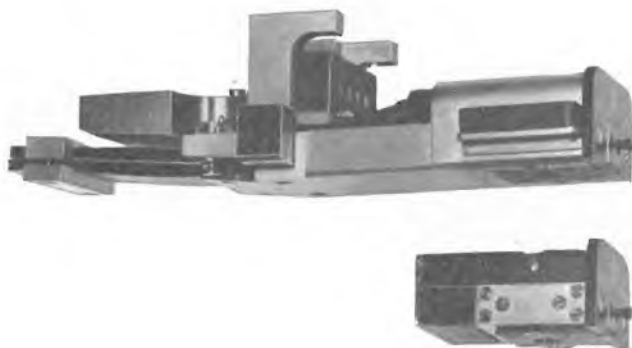

FIG. 57. TYPE-B1/B RECORDING HEAD AND ARM

the arm carries a counter-balance weight and a vibration absorber tuned to approximately 30 c/s. Depth-of-cut adjustment is effected by a spring connected between the traverse unit and the recording-head arm; a coarse control alters the position of the spring with respect to the pivots and a fine control alters the tension of the spring.

*Recording Head.* A cut-away view of the moving-iron recording-head is shown in Fig. 58. The ends of the armature unit A (which is shown separately) are clamped between two U-shaped steel yokes B, within which lie two Ticonal magnets C, and the laminated pole-pieces D, with their brass clamping blocks E. The metal at the bottom of the deep slots at either end of the unit is shaped to form torsion bars which support the active portion of the armature in the gap between the pole-pieces. To avoid trouble with non-torsional deflections these torsion bars, both of which are hollow, are made as short as possible, consistent with reasonable stress at maximum deflection. Through the centre of one of them passes the long plain shank of the cutter clamping screw F and, as the thread is carried in an external block G, it is easy to remove the broken parts if this screw should be broken by over-tightening. The shank has a high torsional compliance so that the presence of the clamping screw does not add appreciably to the mechanical impedance of the armature.

The coil H lies in slots in the faces of the pole-pieces and within this main,

## BBC RECORDING TRAINING MANUAL

or driving winding is a second coil which is connected to an intermediate stage of the recording amplifier to provide negative feedback. The voltage across this coil is proportional to the flux linked, and the amplifier is therefore controlled so as to compensate for distortion of the flux waveform.

The greatest amplitudes are usually encountered at 100 c/s, and if there is

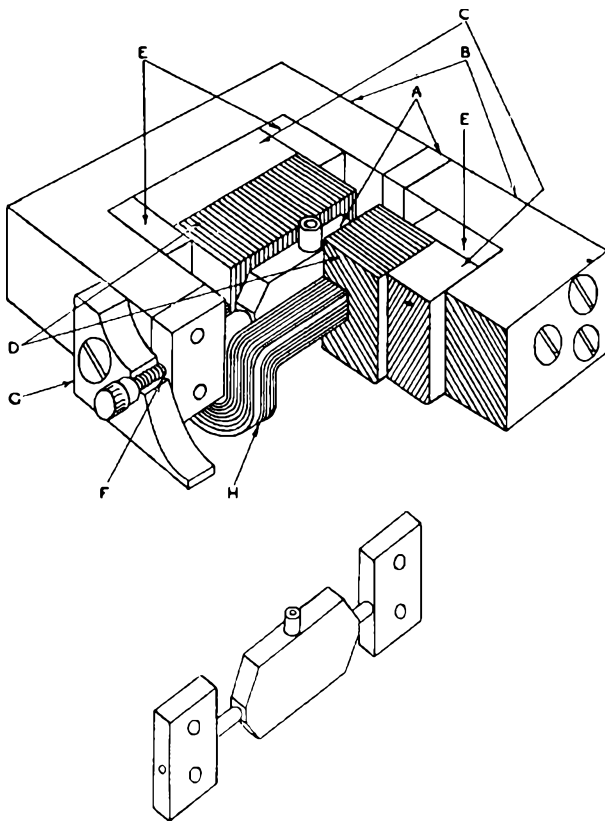

FIG. 58. BBC DISK-RECORDING HEAD TYPE B: CUT-AWAY VIEW

no distortion at the frequency for highest input level it is unlikely that distortion will occur at other frequencies where amplitudes are smaller.

The amplitude linearity of a Type-B head at 100 c/s is illustrated in Fig. 59 ; amplitude input levels and stylus velocities are plotted in decibels. The relationship between input level and velocity (and hence between input level and amplitude) is linear provided that the maximum input level does not rise by more than 8 db above normal.

On initial assembly the air-gaps between the armature and the pole-pieces are adjusted to 0.005 inch, and no further adjustments are required or provided.



### 3.5 BBC DISK RECORDER TYPE D

It is necessary only to add the damping, which is done by inserting a film of oil or grease into the bottom of the air-gaps. Oil damping is very easy to apply, but, even with a paper stirrup inserted in the air-gaps to assist in retaining it, the oil does not generally remain in position for more than a few weeks. With

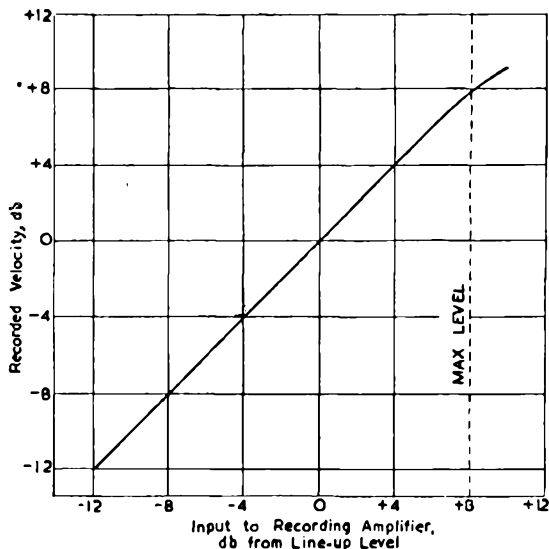

FIG. 59. RECORDING HEAD TYPE B : GRAPH SHOWING AMPLITUDE LINEARITY AT 100 C/S

grease, it is necessary to dismantle the head to apply or renew the damping but, on the other hand, once a suitable grease has been inserted the performance of the head is stable for some months. Fig. 59 shows the velocity/frequency

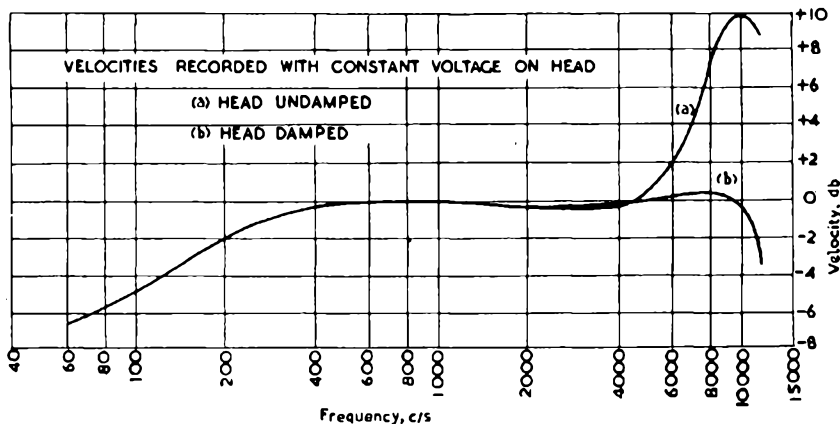

FIG. 60. RECORDING HEAD TYPE B : GRAPHS SHOWING VELOCITY-FREQUENCY CHARACTERISTICS, (a) WITHOUT DAMPING, (b) WITH DAMPING

characteristic of one of these heads when recording with constant applied voltage, (a) without damping, and (b) with normal damping ; Fig. 61 shows the change in response, from that obtained at 64° F., when the ambient temperature is raised to 80° F., 100° F. and 120° deg. F. Because of this temperature effect and other variables, the response of the head becomes more

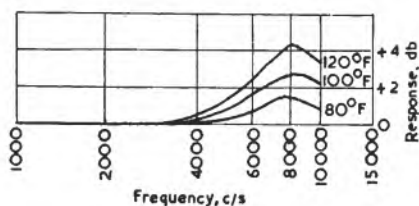

FIG. 61. RECORDING HEAD TYPE B : GRAPH SHOWING HOW FREQUENCY RESPONSE VARIES WITH TEMPERATURE

variable as the frequency is increased above 5,000 c/s and, under normally satisfactory operating conditions, a tolerance of  $\pm 2$  db is allowed on the 10,000 c/s response. The recording amplifier is provided with a "top-tip" control which adjusts the amplifier response at the higher frequencies in small steps so that the overall response may be kept within close limits.

The lower part of Fig. 57 shows a complete recording head ready for insertion in its supporting arm. Fig. 62 shows the recording head with cover removed ; the electrical connections are made by a 4-way socket so that the head can be rapidly removed and replaced. It is known that the performance

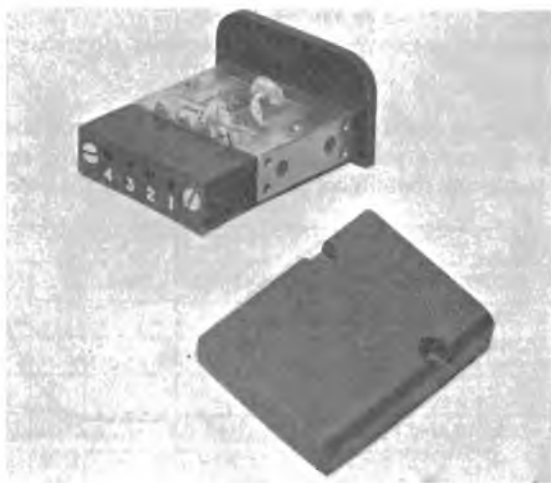

FIG. 62. RECORDING HEAD TYPE B1/B : COVER REMOVED

of the head could be improved by dispensing with the normal detachable cutter and fixing the sapphire tip directly to the armature. If this arrangement is adopted in the future a faulty cutting point will be replaced by changing the complete head.

### 3.5 BBC DISK RECORDER TYPE D

Even with the limitation imposed by the use of a detachable cutter, however, the undamped armature resonance is at about 10,000 c/s, and a good performance has been combined with a robust construction in the comparatively small space of  $1\frac{1}{4}$  in.  $\times$   $1\frac{1}{2}$  in.  $\times$   $\frac{7}{16}$  in. for the head itself. The total weight, including covers and socket, is 4.9 oz., and the centre of gravity is only  $\frac{1}{4}$  inch above the base of the head and  $\frac{1}{2}$  inch from the cutter point.

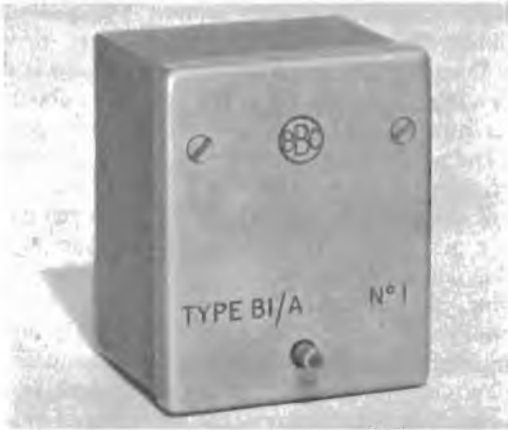

FIG. 63. RECORDING HEAD TYPE BI/A ADAPTED FOR PRESTO MACHINES

The Type-B recording head is also used on Presto recording machines. For this purpose it is assembled in a different case (Fig. 63) and designated BI/A.

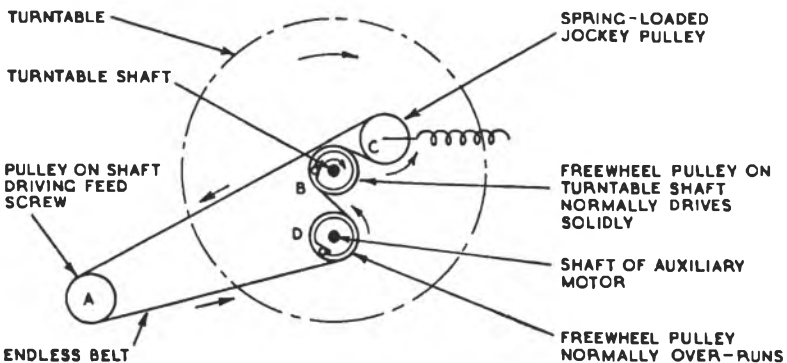

FIG. 64. DISK RECORDER, TYPE D : DIAGRAM OF TRAVERSE AND SCROLLING DRIVES

*The Scrolling Unit.* The function of this unit is two-fold ; it provides means for producing a run-off groove or scroll, or it can be used for cue-marking consecutive disks, i.e., for producing a visible identification mark at the end

of one disk and at the beginning of another to facilitate linking the disks on reproduction. The arrangement is shown diagrammatically in Fig. 64.

The horizontal lead-screw which traverses the recording head across the disk is geared to a vertical shaft A ; this shaft is driven from a pulley B on the turntable shaft by a belt carried on jockey pulleys C and D. Jockey pulley C is spring-loaded to maintain correct belt tension and pulley D contains a friction freewheel with gravity-loaded steel balls, through which it is connected to the concentrically mounted auxiliary motor. Pulley B on the turntable shaft houses a similar free-wheel which, in normal use, drives solidly while that in the pulley D runs free. When the auxiliary motor is started, the free-wheel in the pulley D engages and the belt is driven at about fifteen times its normal speed, over-running the free-wheel in the turntable pulley B, increasing the traverse speed and producing a coarser groove pitch. As soon as the auxiliary motor stops, the traverse drive reverts to its normal speed.

For purposes of scrolling, the auxiliary motor is started by the closing of a relay operated by a push-button. The traverse continues at high speed until the normal traverse control is moved to the off position.

For cue-marking, the procedure is as follows : let us assume that the two machines of a Type-D channel are being used for a continuous recording. When the recording on the first disk approaches its minimum diameter, recording is begun on the second disk ; at a convenient moment when simultaneous recording on the two disks is in progress, the operation of a cue-switch on the control desk energises the scrolling motors on both machines, thus causing a widening of the groove pitch on both disks. A momentary operation of the switch is sufficient to leave a cue-mark on both disks which can be easily identified. On reproduction it is merely necessary to set the reproducing needle at the point on the second disk where the cue-marking begins and to start the second turntable when the reproducing needle on the first disk reaches the corresponding cue mark. The two disks should then be synchronised, and the change-over can be made at a convenient point in the programme.

### 3.5.3 SWARF REMOVAL

During recording, a thread of cellulose is cut from the surface of the disk, and this thread, usually termed "swarf," must be removed so that it cannot foul the cutter. A variety of brushes and pads have been used for this purpose, but they are unreliable and tend to cause "wow" by imposing varying loads on the turntable and because unless extreme care is exercised, they collect dirt and rub it into the grooves, thus increasing surface noise on reproduction.

By using a suction system to remove swarf continuously while recording, these troubles are avoided and there is little difficulty, once the thread has entered the suction nozzle, in ensuring that it will continue to be collected. It is less easy, however, to ensure that the initial entry of the thread into the nozzle will take place with absolute certainty and this is important for, if the swarf collector occasionally fails, a good deal of the operator's attention must be given to watching it.

With most disk coatings, an electrostatic charge is produced during the

### 3.5 BBC DISK RECORDER TYPE D

cutting process. This causes the swarf to cling tightly to the disk surface. The charge can be eliminated by treating the disk with an anti-static fluid before cutting, but such treatment causes the swarf to become so limp that it tends to pile up behind the cutter ; it is then difficult to collect.

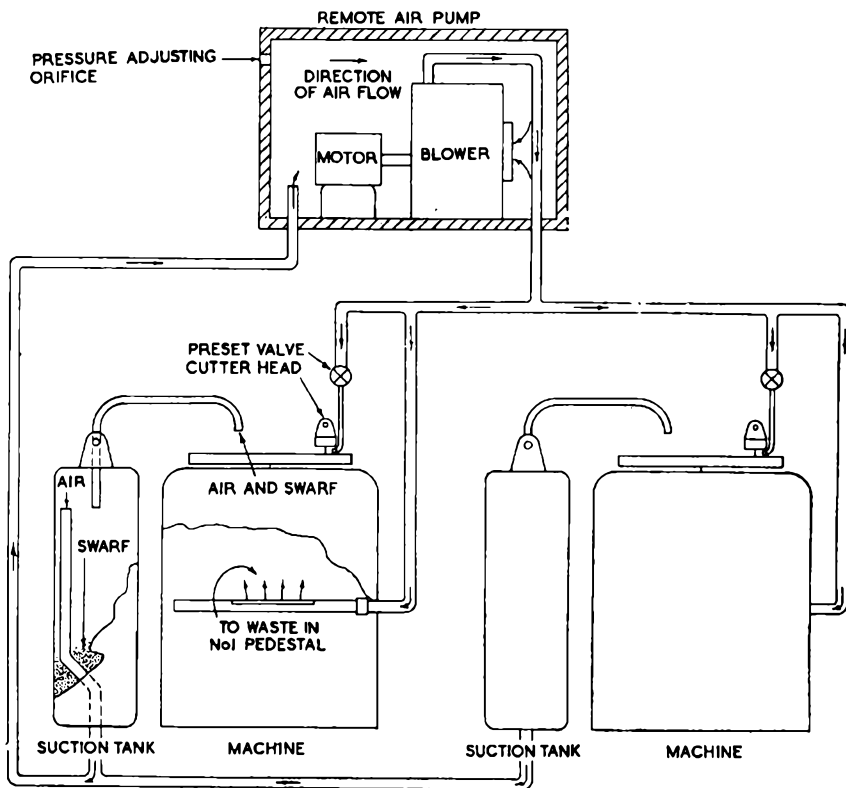

FIG. 65. DISK RECORDER, TYPE D : DIAGRAM OF SUCTION PLANT

It would therefore appear necessary to use a very powerful suction, but this inevitably produces considerable noise at the nozzle ; such noise makes it difficult to listen to the loudspeaker used for quality checking during recording. The solution to these difficulties is a compromise. The electrostatic charge is reduced, but not eliminated, by a light application of anti-static fluid. The swarf is collected by a suction system which makes little noise. A jet of air is blown across the disk surface to drive swarf from the cutter towards the centre, where it is collected by comparatively weak suction into a nozzle carried at the end of a long curved arm. (Fig. 65.) This arm may be swung down so that the nozzle is close to the disk surface but, once the thread has entered,

the arm may be swung back to the upper position and the thread will continue to run through it. Should the thread break, the air blown across the cutter will prevent it entangling either the cutter or the reproducing stylus and, in due course, the suction arm can be momentarily lowered to collect it again.

The thread passes through the tubular arm and drops into a pillar-like tank on which the arm is mounted, and the swarf can be removed at convenient intervals through a trap door. A suction pump, remotely installed, draws air from these tanks and feeds it back to the machine to supply the blowing jets. The air drawn from the tanks is more than is required for this purpose, and the remainder is blown to waste inside the machine casings where it serves to improve cooling and to prevent dust settlement by maintaining an outward flow of air.

#### 3.5.4 THE PROGRAMME CHAIN

*The Recording Chain.* The chain of apparatus linking the programme line with the recording head is shown in Fig. 66. The arrangement is self-explanatory and the only items calling for general description are the recording amplifier and the radius compensator ; the recording head has already been discussed.

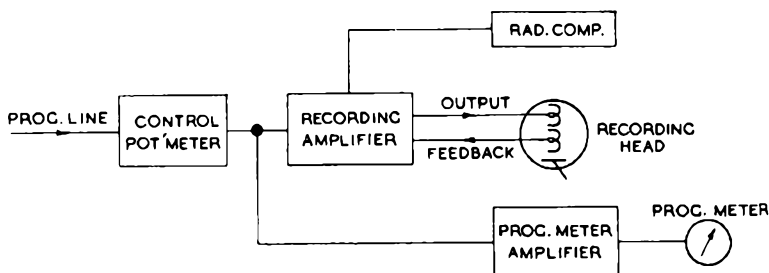

FIG. 66. RECORDING EQUIPMENT TYPE D : RECORDING CHAIN : BLOCK SCHEMATIC DIAGRAM

*The Recording Amplifier.* The recording amplifier is required to provide :—

- (i) Adequate power to feed the recording head ;
- (ii) Voltage amplification to raise the incoming programme level sufficiently to operate the power stage ;
- (iii) Equalisation to obtain the recording characteristic ;
- (iv) Radius compensation ;
- (v) Negative feedback.

The problems presented in the design of a power stage for a disk recording amplifier have been discussed in 2.1.5. The amplifier used with the Type-D recording equipment supplies about 75 volt-amps maximum to the recording head ; this is obtained by using six pentodes in parallel push-pull, and is sufficient to meet all normal requirements. If, however, momentary peaks occur in a programme which would cause the output stage to be over-loaded,

### 3.5 BBC DISK RECORDER TYPE D

such peaks are prevented from reaching the power stage by a protective circuit incorporated as a side chain within the amplifier itself.

Referring to Fig. 67, the push-pull input stage  $V_1, V_2$  is fed from the transformer  $T_1$ , and it will be observed that the centre point of the common bias to this stage is connected to the side chain ( $V_8, V_9, V_{10}$ ); the function of the side chain is to provide additional bias to the input stage, if the input signal to the amplifier exceeds a certain predetermined value.

The voltage-amplifying stage incorporates  $V_3, V_4, V_5$ , together with frequency-discriminating networks at the points CDE, HJK and LMN; these networks give the amplifier the frequency response required to produce the desired recording characteristic. The networks are constructed on tag-boards which can be changed easily if a different recording characteristic is wanted. Normally, the networks for two amplifiers in a given channel are identical; the two recording heads, however, may not have precisely similar frequency characteristics. To compensate for this possible discrepancy, an additional network, having variable components, is included in the cathode circuit of  $V_3$  of each amplifier.

The radius-compensating network is incorporated in the cathode circuit of  $V_4$ ; as explained on page 68 the variable components of this circuit are controlled from the traverse mechanism.

$V_6, V_7$  constitute a phase-splitting stage for feeding the output of  $V_5$  into the push-pull power stage  $V_{11}$  to  $V_{16}$ ; negative feedback is applied to the grid of  $V_6$ , the feedback voltage being obtained from the feedback winding of the recording head. (Should a different type of head, having no feedback winding, be used with this equipment, feedback voltage can be obtained from a special winding on the output transformer.)

The side chain  $V_8, V_9, V_{10}$  is normally inoperative,  $V_9$  being biased back beyond cut-off. If, however, an excessive programme peak supplies a voltage to the grid of  $V_8$ , it will cause the side chain to operate. The output of the side chain is applied in the form of bias to  $V_1$  and  $V_2$  reducing the amplifier gain and preventing overloading of the output stage. The bias voltage is produced across the capacitor  $C_{35}$ , and when the peak has passed,  $C_{35}$  discharges through  $R_{72}$  restoring the amplifier gain to normal at a rate depending upon the value of  $R_{72}$  and  $C_{35}$ .

*Radius Compensation.* As indicated in Section 2.9, the purpose of the radius-compensation circuits is to increase the high-frequency response of the recording amplifier progressively as the cutting speed falls. The maximum cutting speed occurs at the outside of a 12-inch diameter disk recorded at 78 r.p.m., and there is negligible change in response until the cutting diameter is less than 10 inches. As the cutter moves inwards, the 78-r.p.m. compensation should therefore commence at about 10 inches diameter, and should then increase continuously until the minimum diameter of 5 inches is reached. Recording at  $33\frac{1}{3}$  r.p.m., the cutting speed at the maximum recording diameter of  $16\frac{3}{4}$  inches is the same as that obtained at 7.16 inch diameter at 78 r.p.m., and there should therefore be the corresponding "initial compensation" when the cutter is at the outside of the disk. Quite different variations of compensation

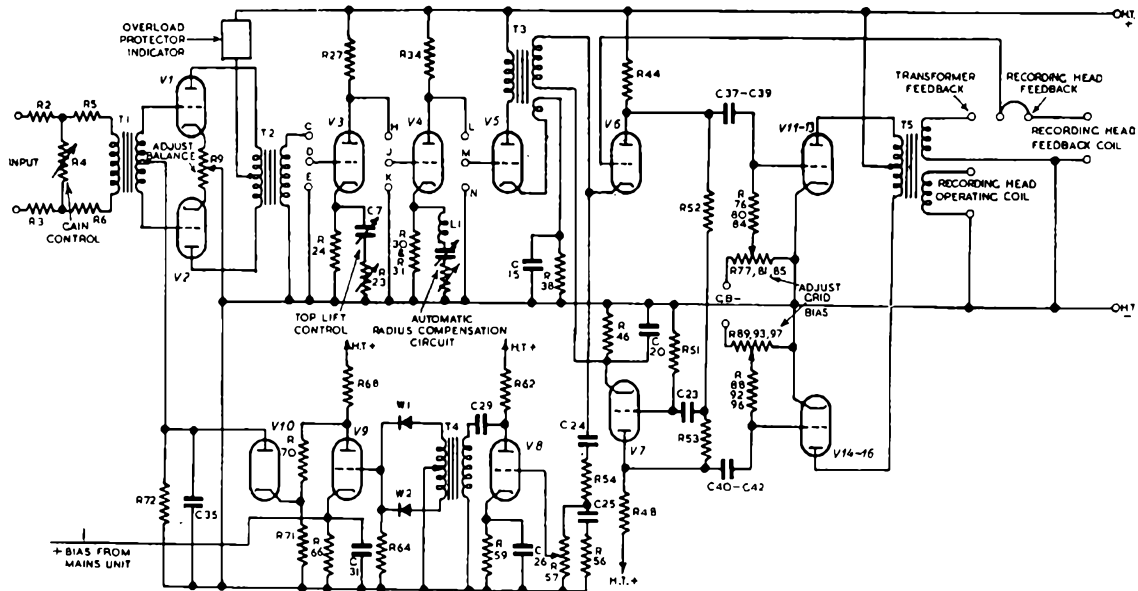

FIG. 67. AMPLIFIER DR'4 USED WITH TYPE D RECORDER : SIMPLIFIED CIRCUIT



### 3.5 BBC DISK RECORDER TYPE D

with cutter position are therefore needed at 78 and at  $33\frac{1}{2}$  r.p.m. It has already been shown that only a limited amount of radius compensation can usefully be employed and, once this limit has been reached, continued movement of the cutter should not make any further change in the compensation circuits.

Figs. 68 and 69 show the circuit arrangements used, in which resistors, capacitors and an inductor are series-connected, in parallel with a resistor in the cathode circuit of one of the gain stages of the recording amplifier. The values of R and C are varied by means of a rotary stud switch positively driven from the sliding carriage on which the recording head is mounted. As the centre of the disk is approached, the resistance and the capacitance

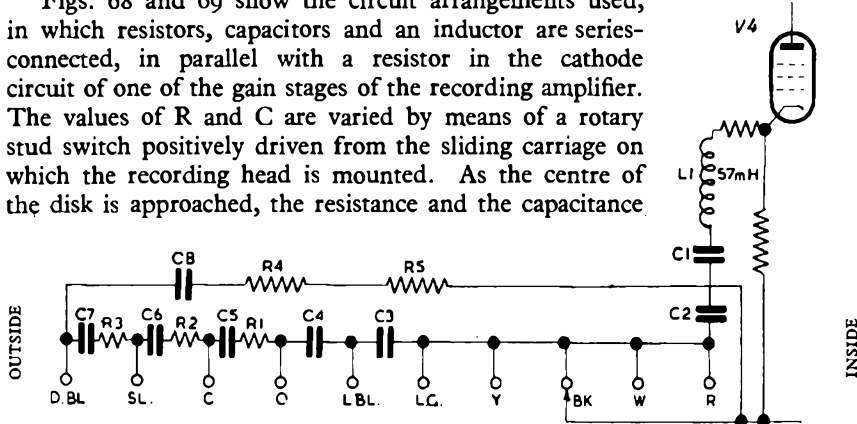

FIG. 68. RADIUS COMPENSATION CIRCUIT FOR  $33\frac{1}{2}$  R.P.M.

are altered so that the amount by which the amplifier response rises at the high frequencies is increased up to the predetermined maximum after which the frequency where maximum occurs is progressively reduced. A single set of resistors and capacitors is used to compensate either for 78-r.p.m. or for  $33\frac{1}{2}$  r.p.m. recording, the components being arranged in one or other of the circuits shown in Figs. 68 and 69 by a 12-pole 2-position switch. This switch is interconnected with the turntable drive mechanism so that changing the turntable speed automatically changes the radius-compensation circuits.

The rotary switch, which is driven by the carriage, moves one stud for approximately  $\frac{1}{4}$ -inch travel of the cutter. The studs are connected together in groups so that a minimum number of R and C changes are required, whilst the individual changes of frequency response are small enough to be inaudible. The switch itself is accessible on removal of a cover at the back of the traverse

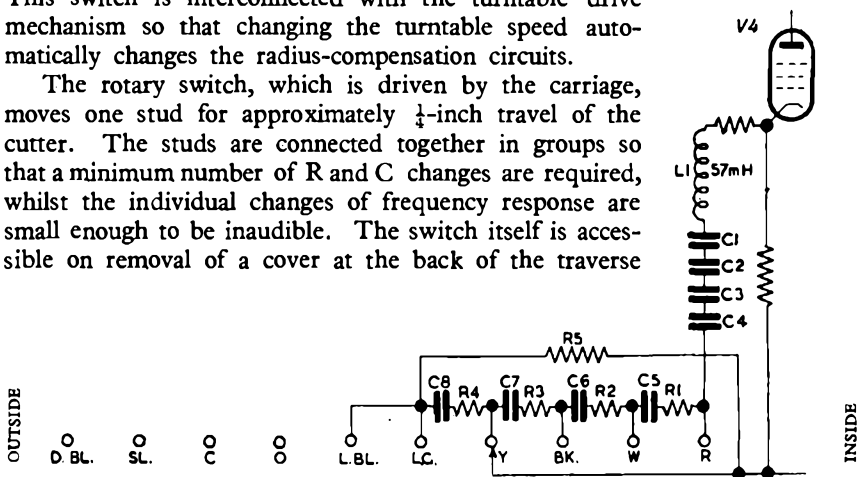

FIG. 69. RADIUS COMPENSATION CIRCUIT FOR 78 R.P.M.

## BBC RECORDING TRAINING MANUAL

unit and may be detached by undoing two screws. Adjacent to it is a toggle switch which disconnects the radius-compensation circuits for test purposes, and the cover cannot be replaced unless this switch has been returned to its working position.

*The Reproducing Chain.* This is shown in schematic form by Fig. 70. An E.M.I. Type-12 reproducing head is connected, through a transformer, to an amplifier, Type AMC/2A.

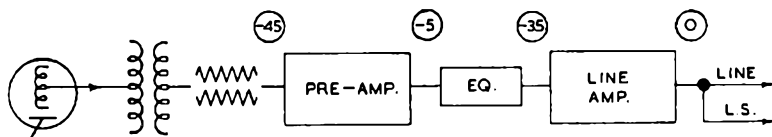

FIG. 70. RECORDING EQUIPMENT TYPE D : REPRODUCING CHAIN BLOCK SCHEMATIC DIAGRAM

This is a single-stage amplifier having a maximum gain of 50 db with a 600-ohm load, and a sensibly flat response between 50 c/s and 10,000 c/s. Its function is to raise the reproducing-head output volume before equalisation. Without this pre-amplifier, the volume at the equaliser output would be very low and it would be difficult to obtain a satisfactory signal-to-noise ratio in the remainder of the circuit. The loss introduced by the equaliser is 30 db. A line level of 0 db (1 mW) is obtained by interposing a second amplifier between the equaliser and the line. This is a two-stage, RC-coupled amplifier having a maximum gain of 53 db (600-ohm load) and a sensibly flat frequency response over the audio range.

*The Monitoring Chain.* A simplified schematic of the monitoring circuits is shown in Fig. 71. The loudspeaker amplifier can be switched to the output

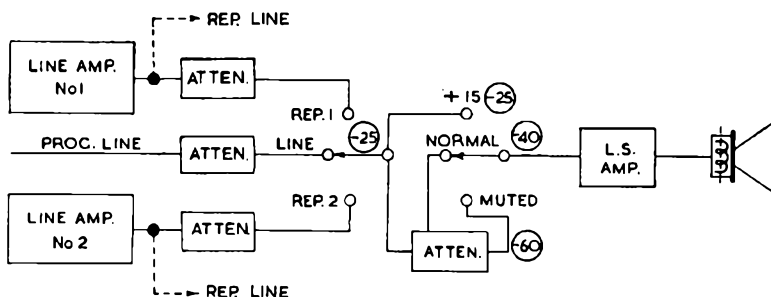

FIG. 71. RECORDING EQUIPMENT TYPE D : MONITORING CHAIN

of either reproducing circuit or to the incoming programme line ; this provides means for checking the quality of recording on either machine against the original programme during the recording process.

### 3.5 BBC DISK RECORDER TYPE D

The input level to the L.S. amplifier is controlled by a 3-way switch, the normal setting being at  $-40$  db. If additional level is required the switch is set at  $-25$  db (i.e.,  $+15$  db above normal); if it is necessary to maintain listening during telephone conversations, the loudspeaker is muted by setting the switch at  $-60$  db (i.e.,  $20$  db below normal).

The amplifier is a 3-stage RC-coupled amplifier with push-pull output. It has a maximum gain of  $52$  db into a load impedance of  $12$  ohms. It has a sensibly flat frequency response over the working range with total harmonic distortion of less than  $1\%$  at normal working level.

#### 3.5.5 THE OVERALL PROGRAMME CHAIN

A comprehensive schematic diagram embracing Figs. 66, 70 and 71 is given in Fig. 72; this also shows the operating levels (db) and impedances (ohms) at various points in the chain. The levels are in relation to the standard zero level of one milliwatt.

It will be observed that the input impedance of each recording amplifier is  $1,200$  ohms but that when the recording change-over key is switched to either one or the other, an artificial load of  $1,200$  ohms is placed across it; when the inputs of the two amplifiers are connected in parallel, the artificial load is out of circuit. In this way the actual input impedance is maintained at  $600$  ohms under all conditions.

The reproducing change-over key is arranged so that when one amplifier is feeding to line, the other is loaded by  $600$  ohms. This is to ensure that, if the free amplifier is used for monitoring on one machine whilst the other is reproducing to line, the loudspeaker amplifier input level will be the same for both reproducing amplifiers. It is, of course, undesirable for the output of the two reproducing amplifiers to be connected to line simultaneously, and the circuit arrangement prevents this happening.

#### 3.5.6 PERFORMANCE

When discussing the performance of a disk recording equipment, it is essential to remember that frequency response, amplitude distortion and background noise all vary to some extent with cutting speed<sup>7</sup>, but the following survey gives an indication of the performance of the Type-D equipment which can be obtained in practice.

Fig. 73 shows the overall frequency characteristics obtained when recording at the outside and at the inside of  $12$ -inch disks at  $78$  r.p.m. and of  $17\frac{1}{4}$ -inch disks at  $33\frac{1}{3}$  r.p.m. The frequency characteristic at the end of a  $10$ -minute  $33\frac{1}{3}$ -r.p.m. recording is approximately as curve (b). With good disks and cutters the background noise, measured through the frequency-discriminating network, is about  $58$  db below the rather low maximum signal level used by the BBC, and somewhat better signal-to-noise ratios may be obtained with selected disks and cutters. It is by no means easy to measure the speed constancy of the turntable with very great precision during recording, but measurements that have been made suggest that at  $78$  r.p.m. the maximum fluctuations in speed do not exceed  $0.05\%$  of the mean speed.



### 3.5 BBC DISK RECORDER TYPE D

It is, perhaps, worth emphasising that, while measurements of this kind give a general idea of the performance to be expected, there is at present no way in which the fidelity of a recording system can be fully described in a simple and readily comprehensible manner. The final test of a recording equipment must therefore be whether, or to what extent, a reproduction can be distinguished from the original by ear (page 1.) Tests carried out by direct comparison when making 78-r.p.m. recordings of programme material of the best quality have shown that even the critical ear, listening under good conditions, has some difficulty in distinguishing the reproduction from the original. When recording at 78 r.p.m., therefore, the fidelity is satisfactory for practically all purposes and compares very favourably with that of any other recording system. For recordings of up to about 10 minutes' duration at  $33\frac{1}{3}$  r.p.m.,

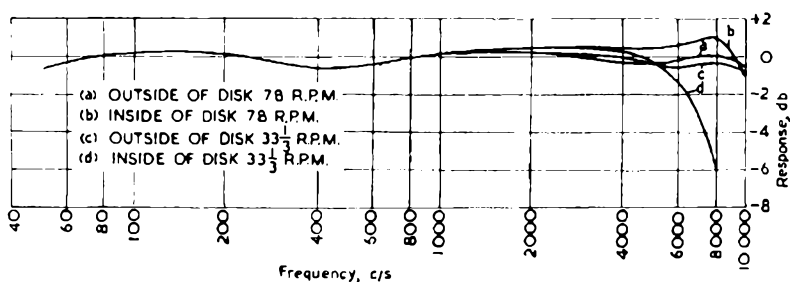

FIG. 73. RECORDING EQUIPMENT TYPE D : OVERALL FREQUENCY RESPONSE CURVES

the performance is similar except that the speed constancy of the turntable is a little inferior, but if recording is carried beyond this, the response falls progressively and at the end of 15 minutes is as indicated by (d) in Fig. 73.

#### References

- 1 Technical Instructions Vol. 1. Item 6.2.
- 2 " " Recording, Vol. 1. R.3.
- 3 " " Vol. 1. Item 7.
- 4 " " Recording, Vol. 1. R.4.
- 5 Engineering Training Supplement No. 3.
- 6 Davies H., "The Design of a High-fidelity Disk Recording Equipment," *Journal I.E.E.*, 1947, 94, 3, 30.
- 7 Technical Instructions Recording, Vol. 1. R.1.

## CHAPTER 4

### REPRODUCTION OF DISKS AND PRESSINGS

#### 4.1. ACOUSTIC REPRODUCTION

##### 4.1.1 INTRODUCTION

**F**OR many years the only means of reproducing gramophone records was by using an acoustic device comprising a sound-box and flared horn ; the frequency response was confined to a small part of the audio-frequency range and, compared with modern standards, the quality of reproduction was most inadequate. Considerable improvement was achieved at a later stage when more attention was paid to the design of the sound-box and horn but the inherent high-frequency attenuation introduced by the diaphragm and the low-frequency cut-off of the horn still imposed serious limitations on the frequency response of acoustic gramophones. The acoustic system, however, has the merit of being entirely independent of electrical supplies and for this reason is still widely used, particularly in the form of portable gramophones.

##### 4.1.2 THE SOUND-BOX

A typical sound-box is illustrated in Fig. 74. A light diaphragm, usually

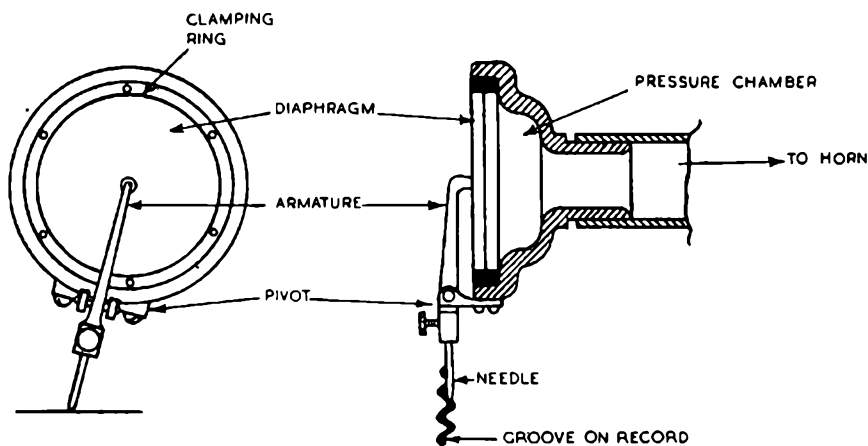

FIG. 74. ACOUSTIC SOUND-BOX : FRONT VIEW AND SECTION

of mica, is clamped at the edge to a circular frame, and an armature is attached to the centre of the diaphragm ; the armature is pivoted at the periphery of the framework and the lower end drilled to take the needle. Behind the diaphragm

## 4.1 ACOUSTIC REPRODUCTION

is an air-pressure chamber, the orifice of which is extended in the form of a short tube, over which the tone-arm or horn is fitted.

When the needle tracks the modulated groove of a record, the lateral motion causes the armature and diaphragm to vibrate. These lateral vibrations set up variations in air pressure within the air chamber, resulting in the emission of sound waves through the orifice into free air via the tone-arm and horn. The sound waves thus produced correspond, within the limitations mentioned in 4.1.1, with those applied initially to the recording apparatus which cut the groove.

As with all mechanical circuits containing mass and compliance, the amplitude of the diaphragm movement for a given applied force is greatest at the resonant frequency of the moving parts. The mass of the armature and the compliance of the diaphragm correspond with the inductance and capacitance respectively of a resonant circuit; additional resonances may be introduced by oscillation of the tone-arm about its two pivotal points, the base-mounting of the carrying arm and the tip of the needle in contact with the groove.

To some extent the resonance of the needle-holder and diaphragm may be offset by the loading imposed on the diaphragm by the tone-arm and horn, working in conjunction with the air chamber.

It is necessary to construct the diaphragm from material with a high stiffness-to-mass ratio, such as mica, to ensure a relatively high resonant frequency and a good high-frequency response.

### 4.1.3 THE HORN

In the original reproducers the horn was attached directly to the sound-box opening and was carried across the record during reproduction. In modern types the horn is fixed in a cabinet and a tone-arm interposed between the sound-box and horn. The tone-arm performs no other function than that of coupling the moving sound-box to the fixed horn and, in the paragraphs which follow, the term horn implies the combined unit of tone-arm and horn.

The two main functions of the horn are to load the diaphragm and to impart a definite direction to the sound waves in the manner of a megaphone. The chief disadvantage of a horn is the great bulk necessary to give good bass reproduction. For example, a pressure wave set up in the air chamber at a low frequency, such as 100 c/s, has a wavelength of approximately 11 feet, whereas the diameter of the horn may be less than 2 inches at the throat and less than 2 feet at the mouth. As this sound wave leaves the mouth and enters free air, considerable reflection occurs. This is due to an increase in the volume of air occupied by the wave and a consequent decrease in the pressure. This results in the setting up of reflected energy which re-enters the horn to cancel some of the outgoing wave and cause a reduction in radiated power.

The best shape for a horn is logarithmic since this form gives the lowest cut-off frequency for a given length. Even so, a horn with a cut-off frequency of 50 c/s needs to be at least 12 feet long and to have a mouth diameter of 14 feet. Practicable horn dimensions severely restrict the low-frequency response. For example, a horn with a mouth 2 feet in diameter will not radiate satisfactorily below 500 c/s.

## BBC RECORDING TRAINING MANUAL

### 4.1.4 NEEDLES FOR ACOUSTIC REPRODUCTION

In acoustic reproduction, the only practicable way of regulating the volume is by using needles having different shapes and sizes. For a given tip displacement a short thick needle gives greater volume than a long thin one of the same material. The thin (soft tone) needle flexes more easily and the movement of its tip transmits less power to the diaphragm than the thicker (loud tone) needle.

A further problem is that the needle has a resonance, the frequency of which is largely determined by the stiffness of its tip. If this stiffness be regarded as a mechanical impedance and this impedance differs from that of the diaphragm, attenuation results from the mis-match between the two.

In a well-designed sound-box, the needle-holder acts as an impedance-matching transformer and maximum output power is obtained from the sound-box when needles of the correct stiffness are used. This condition does not necessarily produce the most pleasing quality and in practice it is customary to use the type of needle which gives the most satisfactory artistic effect.

### 4.2 ELECTRICAL REPRODUCTION

The term electrical reproduction as applied to disks or gramophone records implies a production of sound waves from the modulated groove by using an electro-mechanical reproducing head in place of a sound-box, and a loudspeaker or headphones instead of an acoustic horn. Normally, the electrical potentials produced at the terminals of the reproducing head are amplified electronically before being applied to the terminals of the loudspeaker or headphones. The advantages of the system over acoustic reproduction are a better frequency response and a simple means of controlling sound volume over a wide range.

The disadvantage is the necessity for electric power supplies for the amplifier. Power for the turntable may be electrical or mechanical.

### 4.3 ELECTRICAL REPRODUCING HEADS

#### 4.3.1 GENERAL

Reproducing heads in common use may be classified under three headings, moving-iron, where the moving member consists of a soft-iron armature operating in a magnetic field and surrounded by a stationary coil; moving-coil, where the moving element is the coil itself; piezo-electric or crystal, where the electric potentials are produced by the bending of crystal plates attached to the reproducing needle.

In all these types the lateral motion of the needle in a modulated groove causes alternating electric potentials to be set up at the terminals of the instrument, these potentials being amplified and used to operate a loudspeaker.

Since all types of disk-reproducing heads contain moving parts, the output voltage will tend to be abnormally great at and near the resonant frequency of the moving parts. The effect of these resonances may be counteracted either by the use of mechanical resistance in the form of damping material, such as rubber, or by constructing the moving parts so that their resonances



### 4.3 ELECTRICAL REPRODUCING HEADS

fall outside the audio-frequency range, or by electrical equalisation in some part of the circuit embracing the head, the amplifier and the loudspeaker.

#### 4.3.2 MOVING-IRON REPRODUCING HEADS

The moving-iron reproducing head consists of a small permanent magnet (usually of horse-shoe shape), an armature or needle-holder and a coil of fine wire. As the needle tracks the groove, the armature oscillates in the field of the magnet; the alternating flux densities produced by the moving armature cause e.m.f.'s to be induced in the stationary coil surrounding the armature. The method of armature suspension varies with different types of head; a few common examples are shown in Fig. 75. In Fig. 75(a) the armature is pivoted at one end whereas, in Fig. 75(b) it is pivoted about its centre; these two methods of suspension are sometimes referred to as unbalanced and balanced, respectively, but, in fact, both types are balanced in the sense that they operate between a pair of balanced pole pieces. As far as performance is concerned there is, perhaps, little to choose between the two and the precise position of the pivot depends largely upon the general construction of the head.

In Fig. 75(c) the needle itself forms the armature and a reproducing head using this method of suspension is called a needle-armature head.

With some types of suspension, pads of rubber or similar material are inserted between armature and pole-pieces. These serve two purposes; they

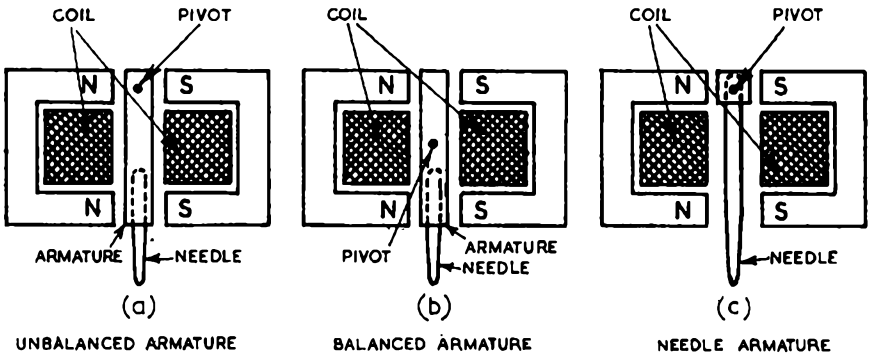

FIG. 75. MOVING-IRON REPRODUCING HEAD : METHODS OF ARMATURE SUSPENSION

provide the restoring force to counteract displacement, and they provide damping, preventing excessive output amplitudes at the resonant frequency of the moving parts. Apart from the above considerations, control of armature displacement has an important effect on output voltage. If the clearance between armature and pole-pieces is too small, the relationship between needle displacement and output voltage departs from linearity and distortion is introduced, the amount of distortion increasing with amplitude; it is, therefore, greater at the lower frequencies. If the clearance is increased, the sensitivity of the head falls. Thus it is necessary to reach a compromise where the clearance is such that the head has reasonable linearity and adequate sensitivity.

## BBC RECORDING TRAINING MANUAL

### 4.3.3 MOVING-COIL REPRODUCING HEADS

In recent years much attention has been paid to the design of moving-coil reproducing heads, because with such heads the output e.m.f. can be made closely proportional to stylus velocity over a wide range ; hence the waveform of the output e.m.f. will closely resemble that of the recorded waveform.

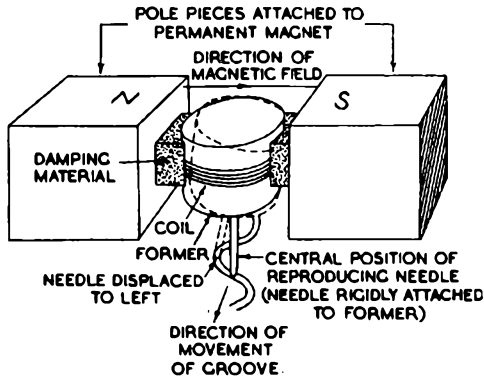

FIG. 76. MOVING-COIL REPRODUCING HEAD : METHOD OF CONSTRUCTION

The principle of operation of moving-coil reproducing heads is illustrated in Fig. 76. The needle is attached to a former carrying a few turns of wire and situated within a magnetic field ; as the needle traces the groove the coil-former oscillates about its axis in the magnetic field and causes alternating e.m.f.'s to be induced in the coil. A resilient material, usually rubber, placed between the coil-former and the pole-pieces provides a restoring force which not only keeps the coil-former and needle in a central position when not being used, but provides the damping necessary to prevent excessive amplitudes when the recorded frequencies coincide with the natural frequency of the moving parts. If the mass of the moving coil is sufficiently small the resonant frequency may be as high as 10,000 c/s and under these conditions the frequency response curve of a moving-coil head may be sensibly flat over the audio range.

Since the coil itself is of very low impedance the generated e.m.f.'s are small, and a step-up transformer having a large turns ratio is usually interposed between the reproducing head and the amplifier which follows it.

### 4.3.4 PIEZO-ELECTRIC OR CRYSTAL REPRODUCING HEADS

It is well known that plates cut from certain natural crystals, particularly quartz, Rochelle salt and tourmaline, expand or contract when an electrical potential difference is applied between different points on their surfaces.

If two plates are cut, so that when cemented together one expands and the other contracts under electrical pressure, the unit thus formed is known as a bimorph ; it has a tendency to bend or twist when subjected to a steady e.m.f. Conversely, if a bimorph is subjected to mechanical stress in an appropriate direction, its expansion or contraction causes electric potentials to be set up.

### 4.3 ELECTRICAL REPRODUCING HEADS

If the crystal is in the form of a bimorph and one end is held rigid whilst the other is deflected by mechanical stress, e.m.f.'s are produced between the outer surfaces of the two plates, and it is upon this principle that a crystal reproducing head is designed.

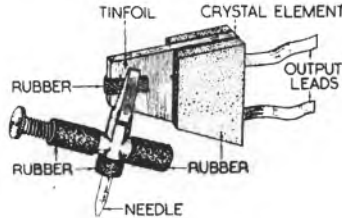

FIG. 77. CRYSTAL REPRODUCING HEAD : CARTRIDGE REMOVED FROM CASE

The construction of a typical crystal reproducing head is illustrated in Fig. 77. The crystal plates are cut from Rochelle salt, which has a greater piezo-electric effect than either quartz or tourmaline. One end of the bimorph is securely clamped between rubber pads, the other end carrying a chuck which forms the needle-holder. If the needle point is deflected the armature rocks about the needle-holder screw and the bimorph is subjected to mechanical pressure, causing an e.m.f. to be set up. When the needle tracks the groove of a disk, its deflection is alternating and the e.m.f.'s produced by the twisting

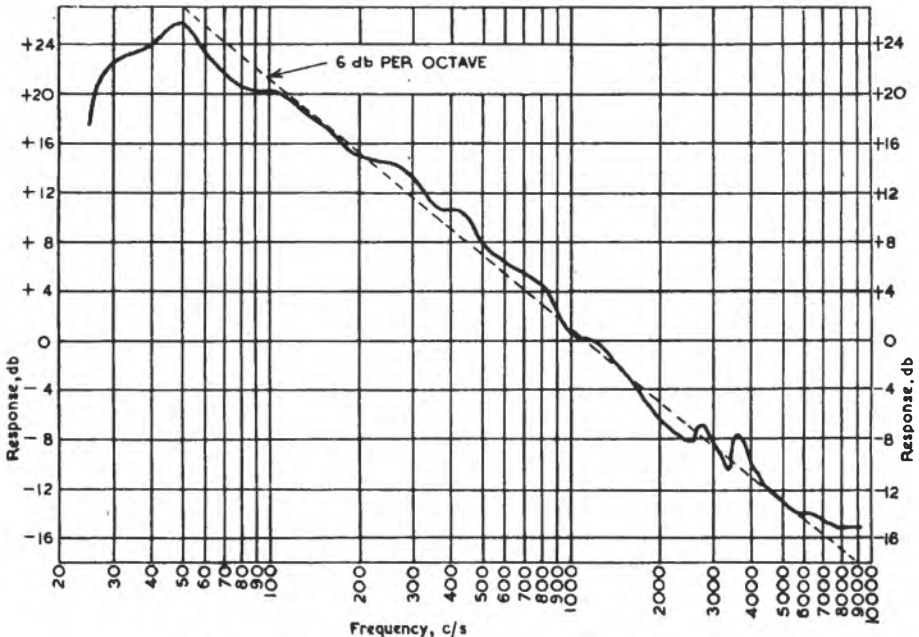

FIG. 78. RESPONSE CURVE FOR HIGH-GRADE CRYSTAL REPRODUCING HEAD

motion of the plates have a waveform similar to that of the groove. The plates forming the bimorph are covered by two sheets of tinfoil to which the output leads are connected.

As with other types of reproducing head, the performance depends to a large extent on the resonant frequencies of two mechanical circuits, the upper resonant frequency being that of the needle, armature and bimorph and the lower resonant frequency that of the mass of the head and arm vibrating about the needle point and the pivot of the arm. For the crystal head, the upper resonant frequency is often in the region of 4,000 c/s and the lower at about 50 c/s.

The e.m.f.'s developed across the plates of a crystal element are directly proportional to the mechanical pressure applied to the element. Hence, the output of a crystal reproducing head is directly proportional to groove amplitude, provided that the movements of the reproducing needle faithfully trace the groove waveform and that there is no distortion between needle and crystal. Such a head is said to have a constant-amplitude characteristic and, when reproducing disks cut under constant-velocity conditions, the output falls by 6 db per octave as the frequency rises. (Fig. 78.)

The curve shown in Fig. 78 shows the response obtainable from a high-grade crystal head having very small resonances.<sup>1</sup> Such a response would be ideal for the reproduction of disks cut with a constant-amplitude characteristic, but considerable equalisation would be necessary for satisfactory reproduction of constant-velocity gramophone records.

Many commercial crystal heads can be used for reproducing constant-velocity recordings without a complicated equaliser ; this is because they have a marked high-frequency resonance. The response, however, depends largely upon the loading resistance ; for maximum sensitivity, the value of this resistance should be high, e.g., 0.5 megohm. By reducing this value, the low-frequency response can be attenuated at the expense of overall sensitivity, but no general rule can be formulated, because the resonance referred to varies with different types of head.

#### 4.3.5 PICKUP RESONANCES

In the foregoing paragraphs we have been concerned with the reproducing head itself and not with the arm on which it is mounted ; but the performance of a reproducing head is usually affected by the mode of resonance of the head and arm as a whole. In this and subsequent paragraphs therefore, we shall use the conventional term "pickup" to define the head-and-arm assembly, whether this assembly implies a commercial pickup or a parallel-tracking unit (4.7.2).

*Low-frequency Resonance.* If with the turntable stationary and the needle lowered into the groove, the pickup is subjected to shock, the mass of the head and arm vibrates about the tip of the needle and the pivot of the arm ; this in turn causes the armature to vibrate at a frequency coincident with the natural mode of vibration of the head-and-arm assembly. This frequency (usually between 20 c/s and 200 c/s) is determined by the mass of the head and

### 4.3 ELECTRICAL REPRODUCING HEADS

arm (the frequency decreasing as the mass increases) and by the stiffness of the needle and armature in the head, i.e., the stiffness which resists the normal movement of the needle ; the frequency of resonance increases as the stiffness increases. When reproducing a disk or pressing, a somewhat similar condition obtains for audio frequencies at or near the frequency of head-and-arm resonance and the output voltage from the head is greater at this frequency.

In the design of commercial pickups, it is possible to reach a compromise between the mass of the head and stiffness of needle suspension so as to produce a low-frequency output voltage which rises as frequency falls. Such a pickup compensates for the loss at low frequencies introduced when recording.

In modern light-weight pickups having small mass, however, the bass resonance may be below the lowest frequency of interest. This is preferable because correction for recording characteristic (2.10) is more easily obtained by electrical than by mechanical means (4.5.1).

*High-frequency Resonance.* Almost all pickups, whether moving-iron, moving-coil or crystal, have a high-frequency resonance, the frequency of which varies with design over a range from 3,000 to 10,000 c/s. The resonance is caused by the natural mode of vibration of the armature assembly, including the needle, and its frequency increases as the mass of the armature-plus-needle is reduced, or as the stiffness of suspension is increased. In modern pickup design, the tendency is to reduce the mass of the moving parts, with a view to placing the frequency of resonance outside the highest frequency of interest ; a common value aimed at, and sometimes achieved is 10,000 c/s.

A problem arises when a given pickup is used for reproducing both cellulose disks and pressings, for the frequency of resonance is lower for disks than for pressings. This is because the softer cellulose material reduces the effective stiffness of the needle when in contact with the groove. Moreover, there is a tendency towards reduction in amplitude at all high frequencies when reproducing cellulose disks ; for this and other reasons, the BBC uses one pickup equalisation for pressings and another for disks (4.5.1).

#### 4.3.6 SENSITIVITY OF REPRODUCING HEADS

The sensitivity of a reproducing head is expressed as the r.m.s. voltage generated across a specific value of load resistance when the needle-point r.m.s. velocity is 1 cm/sec at 1,000 c/s. In BBC practice the measurement is made by playing a standard test record, with a recorded velocity of 2 cm/sec r.m.s., and dividing by 2 the voltage measured across the specified load.

### 4.4 REPRODUCING HEADS USED BY THE BBC

#### 4.4.1 E.M.I. TYPE-12 REPRODUCING HEAD

The E.M.I. Type-12 head is an unbalanced-armature, moving-iron unit of small physical dimensions. Its principal features are a comparatively good frequency response and light-weight construction which minimises wear on needle and disk.

The head was primarily designed for playing commercial gramophone records and the standard product has a pronounced resonance in the region

## BBC RECORDING TRAINING MANUAL

of 7,000-8,000 c/s. Whilst this resonance is not objectionable when playing gramophone records, it does tend to over-emphasise the high frequencies when playing cellulose disks recorded with the BBC characteristic. The BBC has modified the standard product by cutting off the top of the armature at an oblique angle; this slightly reduces the sensitivity, but it raises the frequency of resonance and thus extends the useful frequency range.

The general construction can be seen from Fig. 79. The armature, which passes through the coil, is fixed to a metal base plate. An elastic band holds

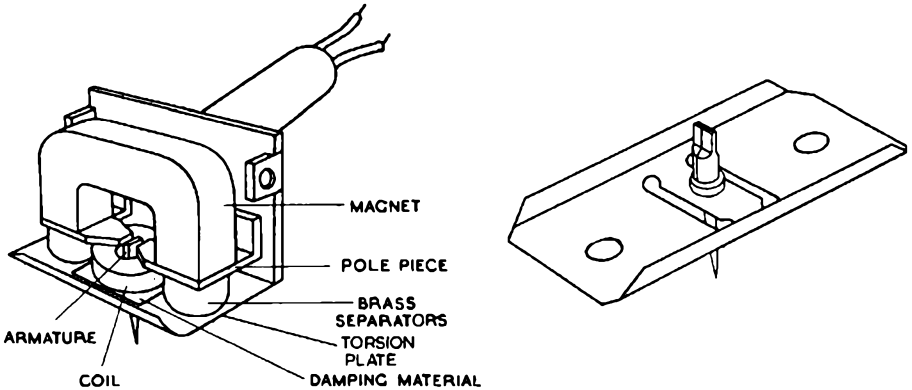

FIG. 79. E.M.I. TYPE-12 HEAD : CONSTRUCTIONAL DETAILS

the needle in position when the head is lifted off the disk, thus avoiding the need for a needle-holding screw and the added armature mass which this usually introduces. Slots are cut in the base plate on either side of the point of attachment of the armature; these are so shaped that the portion between the slots provides the requisite amount of restoring force. Damping is obtained by compressing a plastic material between this central portion of the base plate and the coil. The magnet is of the modern high-density type and when removed from the head must always have a keeper. A feature of the design is the reduction of amplitude distortion by the use of a wide gap between armature and pole-pieces; naturally, this results in reduced sensitivity. A further advantage is that the restoring force can have a lower value than would be required with a head having a smaller air-gap. This greatly reduces stiffness and, in spite of the small mass of head and arm, a bass resonance is obtained in the region of 30 c/s, i.e., below the frequency range normally required. A further advantage of reduced stiffness is a reduction in the force exerted on the needle tip by the walls of the modulated groove; this results in reduced disk and needle wear.

In BBC practice, two standard lengths of tracking arm are used, one for disks up to 13 inches in diameter and the other for disks up to 17½ inches diameter.

The head is counter-balanced to give a pressure of approximately 1½ ounces

## 4.4 REPRODUCING HEADS USED BY THE BBC

between needle and disk, compared with  $2\frac{1}{2}$  ounces for a B.T.H. counter-balanced head.

The impedance is between 6 and 10 ohms up to 1,000 c/s, rising to 33 ohms at 9,000 c/s. The normal sensitivity at 1,000 c/s is such as to produce a level of - 60 db across a 10-ohm load when playing a record having a r.m.s. velocity of 2 cm/sec.

### 4.4.2 THE VOIGT MOVING-COIL REPRODUCING HEAD

The method of construction of the Voigt moving-coil head is shown in Fig. 80. The conventional horse-shoe magnet is replaced by an equivalent system, using block magnets.

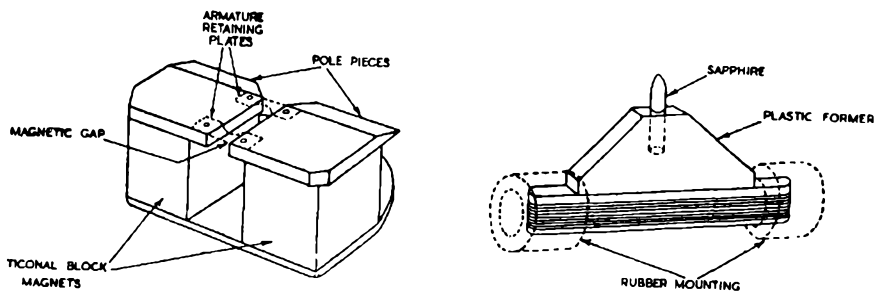

FIG. 80. VOIGT MOVING-COIL REPRODUCING HEAD : CONSTRUCTIONAL DETAILS

The moving coil is wound on a plastic former, into which the sapphire needle is fixed, the whole assembly having relatively small mass and a frequency of resonance above the normal audio range. The moving member is held in the gap between the pole-pieces on rubber mountings which provide both restoring force and damping. The mountings are clamped by two retaining plates screwed to the pole-pieces.

## 4.5 PICKUP EQUALISATION

### 4.5.1 EQUALISATION FOR E.M.I. TYPE-12 PICKUPS

The E.M.I. Type-12 pickup with modified armature has an output-voltage characteristic approximating to constant velocity on open circuit. The recording characteristic used for both disks and records usually falls by something like 4 db per octave below about 300 c/s and a constant-velocity reproducing head used without equalisation would produce a similar response. The first consideration in the design of an equaliser is, therefore, to provide a bass-lift, and since there is little variation at the low-frequency range in the recording characteristic used by different recording organisations, a standard low-frequency equaliser may be applied to them all. The circuit and loss curve of an equaliser designed for this purpose, Type EQ/102, are shown in Fig. 81. This equaliser makes no provision for the rise in the recording characteristic at the higher frequencies, but at these frequencies the response of the pickup is governed largely by the load placed across its terminals, and with the E.M.I. Type 12,

## BBC RECORDING TRAINING MANUAL

a sensibly flat response at the higher frequencies is obtained with a pickup load of about 10 ohms. This is provided by preceding the equaliser with a transformer which presents that load to the pickup coil. The circuit arrangement and overall response when reproducing test record XTR 311 are shown in Fig. 82.

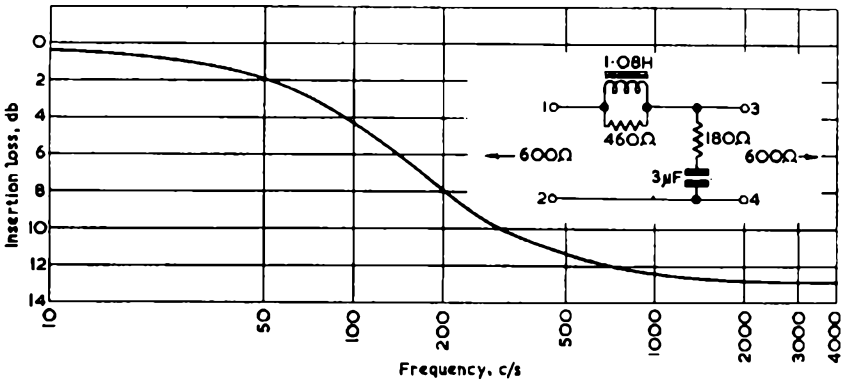

FIG. 81. EQUALISER 102 : CIRCUIT AND LOSS CURVE

When equalising for commercial records, not only must provision be made for reducing surface noise, but for reducing the overall level to that obtainable from BBC disks ; the difference between these levels is approximately 4 db. Equalisation for commercial records must, therefore, introduce an overall loss of 4 db, additional loss at the higher frequencies, and maintain the bass response of Fig. 82. For this reason, a second equaliser, EQ/202, is inserted in series

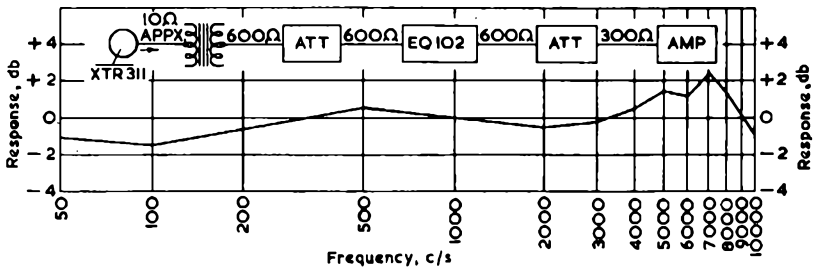

FIG. 82. OVERALL FREQUENCY RESPONSE FOR BBC DISKS

The Curve is obtained from Test Record XTR311 with E.M.I. Type-12 Pickup and Equaliser 102.

with equaliser EQ/102. The circuit and loss curve for EQ/202 are shown in Fig. 83, and the overall response from XTR311 with the two equalisers in series, in Fig. 84.



## 4.5 PICKUP EQUALISATION

Both equalisers are designed for a 600-ohm load. When amplifiers having a 300-ohm input impedance are used with the equalisers, a matching transformer is interposed between equaliser output and amplifier input. Provision is made

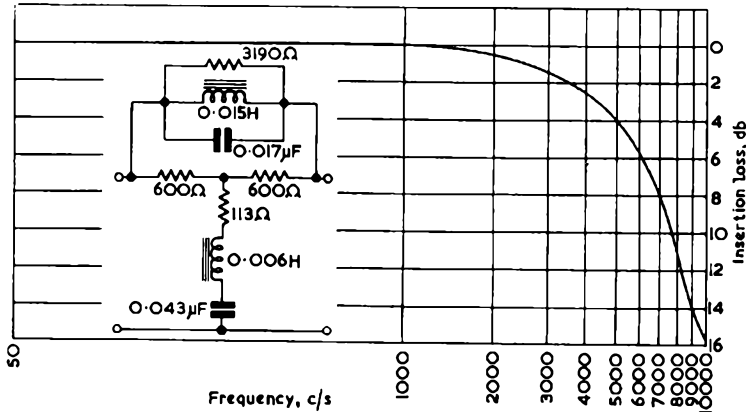

FIG. 83. EQUALISER 202 : CIRCUIT AND LOSS CURVE

on each reproducing desk for switching from gramophone-records to disk equalisation as occasion demands.

The equalisation arrangements outlined above apply in general to new reproducing equipment. For older equipment, equalisers of simpler design are used, and these vary with different equipments. For example, with a

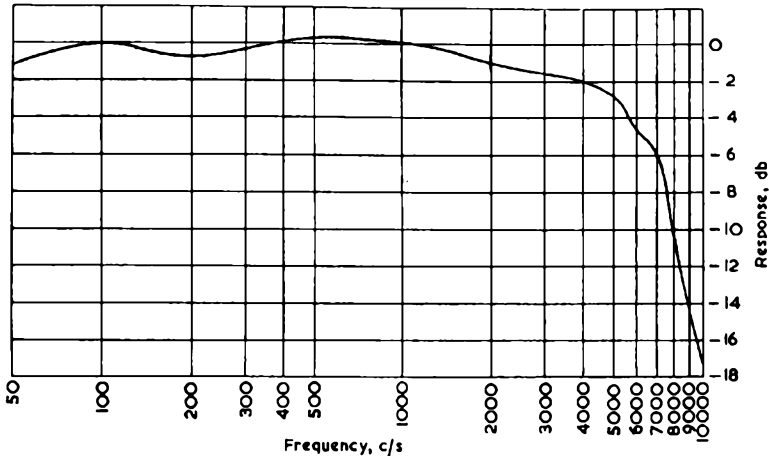

FIG. 84. FREQUENCY RESPONSE FOR RECORDS AND PRESSINGS

The Curve is obtained from Test Record XTR311 with E.M.I. Type-12 Pickup and Equalisers 102 and 202 in series.

## BBC RECORDING TRAINING MANUAL

Type-C recorder (page 52), a simple T-network is used as illustrated in Fig. 85. This equaliser is designated G/7, and produces an overall characteristic similar to that of Fig. 82, but with less bass lift.

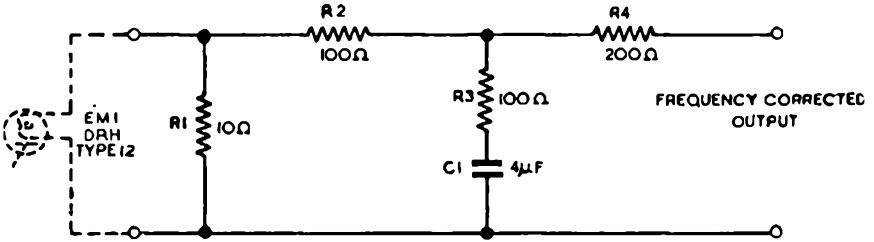

FIG. 85. EQUALISER G/7 : CIRCUIT

This is used with the Portable Disk Recording Equipment, Type C

For twin-turntable desks Type TD/7, the equaliser Type G/2D previously used with BTH pickups has been modified to the circuit shown in Fig. 86 and redesignated G/12. When using this equaliser with the switch open (disks) the overall response approximates Fig. 82, and with the switch closed, Fig. 84.

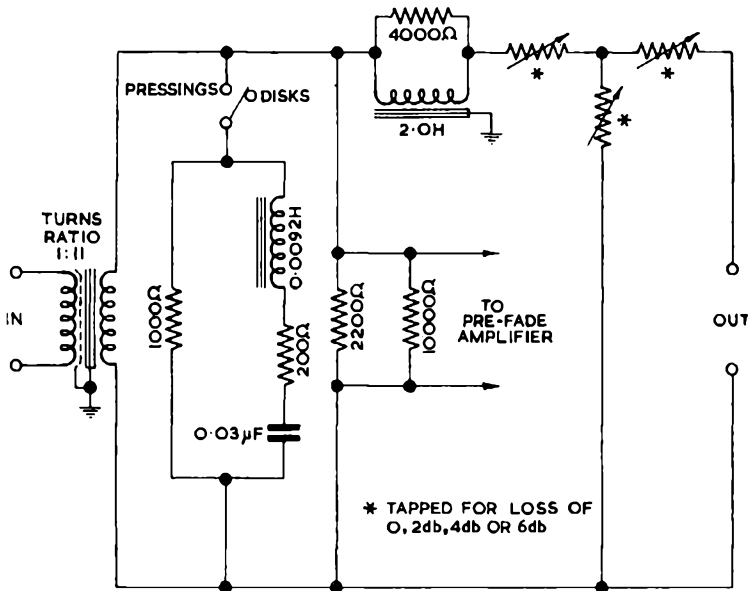

FIG. 86. EQUALISER G/12 : CIRCUIT

This is used on BBC Reproducing Desks Type TD/3702 when fitted with E.M.I. Type-12 Pickups

## 4.5 PICKUP EQUALISATION

### 4.5.2 THE VARIABLE CORRECTION UNIT<sup>3</sup>

The Variable Correction Unit consists of a variable equaliser and an amplifier. This is a versatile unit of many applications, chief of which is its use in a disk reproducing chain. The unit has four controls, providing the following facilities, which may be used independently or in any combination.

- (a) a top-lift or top-cut beginning at 1,000 c/s and having a maximum value of 4, 8, 12 or 16 db at 10,000 c/s.
- (b) a bass-lift or bass-cut beginning at 1,000 c/s and having a maximum value of 4, 8, 12 or 16 db at 100 c/s. Below 100 c/s, the response is sharply attenuated to avoid accentuation of turntable rumble.
- (c) a low-pass filter with a cut-off at 4, 5, 6, 7 or 8 kc/s.
- (d) a sharply-tuned band elimination filter for 50, 60, 100 or 120 c/s.

A wide variety of response curves can be obtained by suitable adjustment of the four controls. The amplifier section is so designed that the gain of the complete equipment at 1,000 c/s is zero, irrespective of the settings of the controls.

The unit may be used for the following purposes :

- (i) reducing surface noise ;
- (ii) reducing hum (the hum frequency is 60 c/s or 120 c/s on a recording made in countries with 60 c/s mains) ;
- (iii) reducing the change in quality which occurs during the change-over from the innermost groove of one disk to the outermost groove of the next ;
- (iv) correcting, to some extent, for a recording characteristic for which no exact compensating equaliser is available ;
- (v) improving the intelligibility of disks with a considerable background noise (e.g., a recording of a weak radio signal).

### 4.6 DISK AND NEEDLE WEAR

Each time a disk is reproduced, wear is caused to both the disk groove and the tip of the reproducing needle. The factors which determine the nature and degree of wear are as given below.

#### 4.6.1 DOWNWARD PRESSURE OF THE NEEDLE ON THE GROOVE

Wear on the disk and the needle is excessive if the mass of the head is great and no counterbalancing measures are taken. The use of counterbalancing has the disadvantage of increasing the inertia of the system and it is better to use a reproducing head of light weight and low inertia.

#### 4.6.2 HARDNESS AND SMOOTHNESS OF THE NEEDLE TIP

The effect of the hardness of the needle tip is best explained by considering extremes. If the tip is of fibre, disk wear is negligible, but needle wear may be considerable. If a diamond tip is used, needle wear is negligible and disk wear is dependent upon the smoothness of the tip, being least when the tip is smooth. With steel needles there is considerable tip wear, which varies inversely as the hardness of the needle. The sapphire-tipped needle has wearing properties similar to those of a diamond and is preferred because it is easier to make.

## BBC RECORDING TRAINING MANUAL

### 4.6.3 STIFFNESS OF ARMATURE SUSPENSION

The resonant frequency of a needle and armature assembly is determined by its mass and the stiffness of its suspension. When the mass is large, a high stiffness is necessary to raise the resonant frequency ; this produces greater disk wear than is experienced with a head having small needle-plus-armature mass and light suspension.

### 4.6.4 DISK AND PRESSING MATERIAL

The disk materials used in the BBC recording service are cellulose lacquer for disks, and shellac or vinyl for pressings. For a given type of needle and reproducing head, pressings suffer less wear than cellulose disks. This is due to the relative hardness of pressings compared with that of disks. Shellac is used almost universally for gramophone records. Vinyl is a plastic material, is practically unbreakable, and has a lower background noise than shellac (5.3.5). It is used for almost all pressings manufactured for BBC use.

## 4.7 TRACKING ARMS

### 4.7.1 CURVED AND OFFSET ARMS

The tracking arms of commercial reproducing heads are normally pivoted at some point on the turntable mounting plate ; this causes the head to track across the disk in an arc whereas the recording head usually tracks radially.

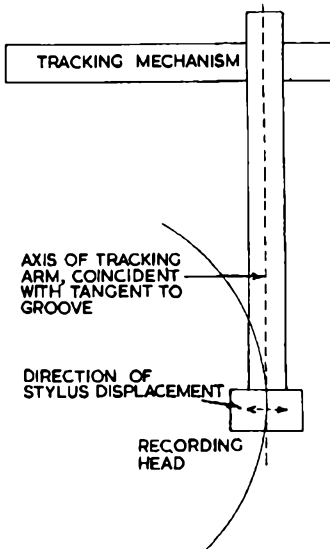

FIG. 87. ILLUSTRATING RADIAL TRACKING WHEN RECORDING

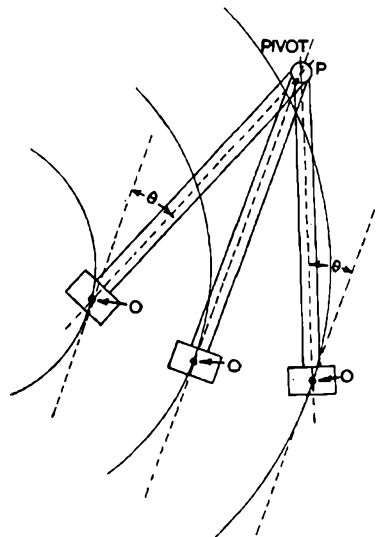

FIG. 88. PIVOTED REPRODUCING-HEAD ARM

Fig. 87 shows that at any point on the disk the plane in which the recording stylus vibrates is always at right angles to the tangent to the groove. In Fig. 88 the reproducing head is shown mounted on a straight arm in such a way that

## 4.7 TRACKING ARMS

the plane of needle vibration is at right angles to the axis of the arm. The angle formed by the line  $OP$  joining the needle point to the pivot, and the tangent to the groove at the point of contact, is called the tracking angle  $\theta$ . Quite clearly, the tracking angle varies continuously as the head moves across the disk and the needle vibrates at right angles to the tangent of the groove only when  $\theta = 0$ .

This variation in tracking angle has two important effects ; first, it introduces distortion because the needle can only trace the modulated groove accurately when it vibrates in the same plane as the recording stylus ; second, it causes wear on both needle and groove. The first effect applies to any reproducing needle, but the second is more important for steel than for sapphire-tipped needles. When a shellac pressing is reproduced by a steel needle, flats are ground on the hemispherical needle tip during the tracking of the first few grooves ; if the head tracks in an arc, the needle, as it moves across the disk, is subjected to a twisting motion causing undue wear to the groove. With sapphire-tipped needles the wear on the tip is too small to be considered and the second effect may be ignored.

To avoid distortion of the reproduced waveform, it is important that both the variation and the magnitude of the tracking angle should be reduced to a minimum. The most effective way of doing this is to use a parallel-tracking arm ; with such an arm,  $\theta$  is always 0. With a pivoted arm, the *variation* in tracking angle can be reduced by extending the arm so that the head overhangs the centre of the turntable, and the *magnitude* of the angle by offsetting the head with respect to the line joining the needle point to the centre of the pivot ; this can be done either by bending the arm or by offsetting the head at a certain angle with respect to the axis of a straight arm. The precise offset angle and amount of overhang for minimum distortion are discussed fully in Appendix H.

### 4.7.2 PARALLEL-TRACKING ARMS

A parallel-tracking arm is one which causes the reproducing needle to move accurately along a radius of the disk, thereby ensuring zero tracking angle as defined on the previous page. An additional advantage of parallel tracking is ease of manipulation, a particularly important consideration when reproducing a programme in which excerpts from a number of disks or pressings are required. A disadvantage is that the lateral force exerted by the groove wall on the needle point must overcome the frictional resistance of the head, carrying arm, carriage and counterbalance weight (if any) as the head moves across the disk. The force provided by the groove wall (represented by  $R$  in Fig. 89) may be resolved into the horizontal component  $X$ , which moves the head and carriage assembly, and the vertical component  $Y$ , which counteracts the downward pressure of the head. If the inertia and frictional resistance of the head and arm assembly is very great,  $X$  may reach a value at which the groove wall is permanently deformed or the needle may slide up the wall and escape from the groove but under good conditions

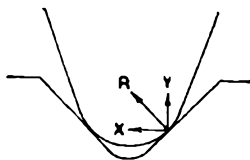

FIG. 89. ILLUSTRATING FORCE EXERTED ON NEEDLE BY GROOVE WALL

the horizontal force necessary to move the parallel tracking arm is considerably less than that required to pull the needle out of the groove.

Unsatisfactory operation is particularly likely if the centre hole of the disk or pressing is slightly eccentric; the head and carriage assembly then oscillates and the force necessary to maintain the oscillation of such a large mass may exceed the value which can safely be provided by the groove walls.

#### 4.8 GROOVE-LOCATING UNIT

The function of the groove-locating unit, used on most BBC reproducing desks, is to facilitate the setting up of the reproducing apparatus before reproduction is due to begin.



FIG. 90. GROOVE-LOCATING UNIT GLU/9B

Units Coded "B" have Short Arms for 10 in. and 12 in. Disks; Units Coded "A" have Long Arms for 17½ in. Disks

The groove-locating unit (Fig. 90) consists of four main parts: a horizontal bar known as the tracking rod; a carriage which travels along this bar and to which the pickup and counterbalance weight are attached; a lever for raising and lowering the pickup; and a vernier control for setting the precise position of the pickup when in the raised position. To minimise the force exerted on the needle by the motion of tracking, the carriage slides on rollers or ball-bearings, and to maintain uniformity of this force, the horizontal bar is accurately machined and aligned to precision.

The unit is used for 78-r.p.m. disks only and the method of operation is as follows:—the disk is played until the beginning of the required excerpt is heard on headphones connected to the output of the pre-fade amplifier; the pickup is then raised by the lever, the turntable continuing to rotate; the vernier is then turned so as to set the pickup back by a small amount. The precise setting of the vernier control is a matter of practice rather than skill and the accuracy obtained is sufficiently high for most requirements. A little thought will show



*BBC Disk Reproducing Desk Type DRD/1*

*Designed for use at main studio centres. Turntable speeds of 78 or 33 1/3 r.p.m. Amplifiers and mains units housed in the Cabinet*

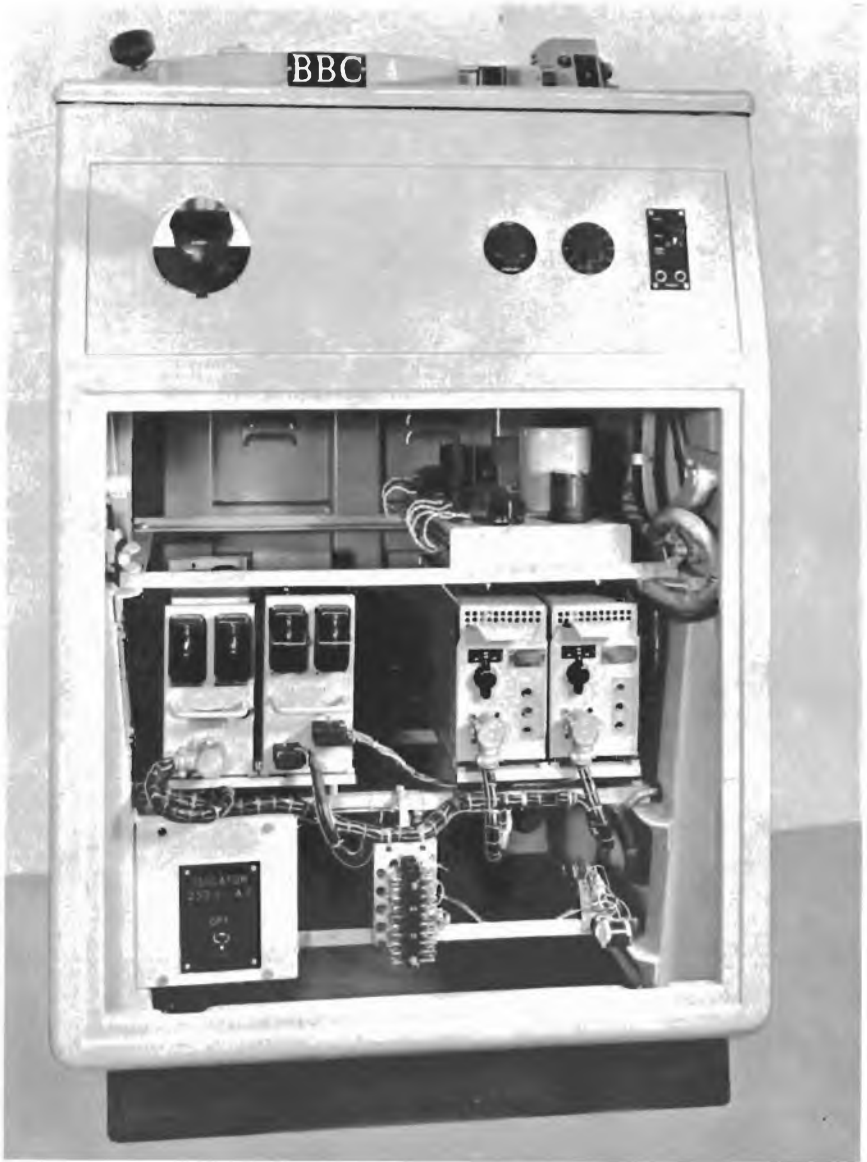

*BBC Disk Reproducing Desk Type DRD.1*

*Control Panel (left to right) : Main fader, equaliser control, variable attenuator (0-20db) control, monitor key*

*Top Deck, Equaliser-attenuator*

*Lower Deck (left to right) : Mains units, amplifiers*



## 4.8 GROOVE-LOCATING UNIT

that the application of this system to  $33\frac{1}{3}$ -r.p.m. disks would be less satisfactory, because of the increased programme time occupied by a single groove. The merits of the parallel-tracking arm have been discussed in section 4.7.2 ; a more elaborate groove-locating unit is used on the reproducing desk DRD/1 (page 104).

## 4.9 SPEED ACCURACY OF REPRODUCING TURNTABLES

The speed of reproducing turntables used for broadcasting must not only be accurate in terms of r.p.m., but must also be free from serious short-period fluctuations. If the mean speed is inaccurate over a long period, it may cause disorganisation in programme timing ; for example, a speed error of 1 per cent maintained over a  $\frac{1}{2}$ -hour reproduction will cause a timing error of some 20 seconds. In practice, it is desirable that the maximum error in mean reproducing speed should not exceed 0.5 per cent. and that this tolerance should be positive and not negative, i.e., a reproducing turntable must never run below its normal speed if over-running of programme timing is to be avoided. Mean speed accuracy can be obtained by using a synchronous motor the speed of which can only vary when the frequency of the mains varies.

With regard to short-term variations, the speed must be uniform within closer limits than those indicated above, for rapid speed variations cause unpleasant fluctuations in pitch which are usually interpreted as wow or flutter, according to whether the fluctuations are relatively slow or fast. The smallest audible change in pitch when listening to steady tone on headphones is about 0.2 per cent., but when listening to tone from a loudspeaker in reverberant surroundings, changes as small as 0.005 per cent. may be audible.

Speed constancy as high as this is not essential for satisfactory reproduction of speech and music, but it is not easy to specify the lowest degree of constancy acceptable since it varies with the type of programme, listening conditions and the rate of fluctuation. In general, a first-grade reproducing turntable should have a short-period speed constancy of  $\pm 0.05$  per cent. Speed constancy can be improved by using a heavy turntable but this prevents quick acceleration which is important when linking disks in sequence ; in practice a compromise is adopted which combines reasonable acceleration with fair speed constancy.

## 4.9 BBC DISK REPRODUCING EQUIPMENT

### 4.9.1 DISK REPRODUCING DESK DRD/1

The BBC Disk Reproducing Desk Type DRD/1 is illustrated in Plate 4. It was designed to meet the need for high-grade reproducing equipment which could be used for either direct-recorded disks or pressings recorded at 78 or  $33\frac{1}{3}$  r.p.m. An E.M.I. Type-12 pickup is used, equalised to produce the response of Figs. 82 or 84. A satisfactory driving-speed constancy has been obtained by using a specially designed drive unit friction-coupled to the turntable rim, and freedom from vibration is attained by solid construction of both turntable assembly and cabinet.

*The Turntable Unit.* The turntable unit comprises a heavy rectangular casting CH/26 mounted on top of the cabinet ; the assembly consists of the

## BBC RECORDING TRAINING MANUAL

turntable main bearings and braking mechanism, turntable-drive unit, drive control, groove-locating unit with remote vernier adjustment, and a key-and-lamp panel. The unit as a whole is hinged at the back to facilitate maintenance.



FIG. 91. REPRODUCING DESK DRD/1 ; TURNTABLE-DRIVE UNIT

The turntable-drive unit, Type TDU/2 is illustrated in Fig. 91 ; a two-diameter driving roller is attached to the motor-shaft to obtain the two speeds, 78 r.p.m. and  $33\frac{1}{3}$  r.p.m. The motor sub-assembly is pivoted on a vertical spindle, housed in a cylindrical sleeve, and to change from one speed to another, the motor assembly is swung about on this pivot by means of the handle shown in Fig. 91, the sub-assembly being raised for 78 r.p.m. and lowered from  $33\frac{1}{3}$  r.p.m.

*Turntable Controls.* The turntable controls are illustrated in Fig. 92. Mechanical operation of the turntable is centred on the speed-change lever and an operating lever which moves two sets of thrust-rods, one controlling the drive unit and the other the brake mechanism.

When the desk is not in use, the operating lever must always be in the *Free*

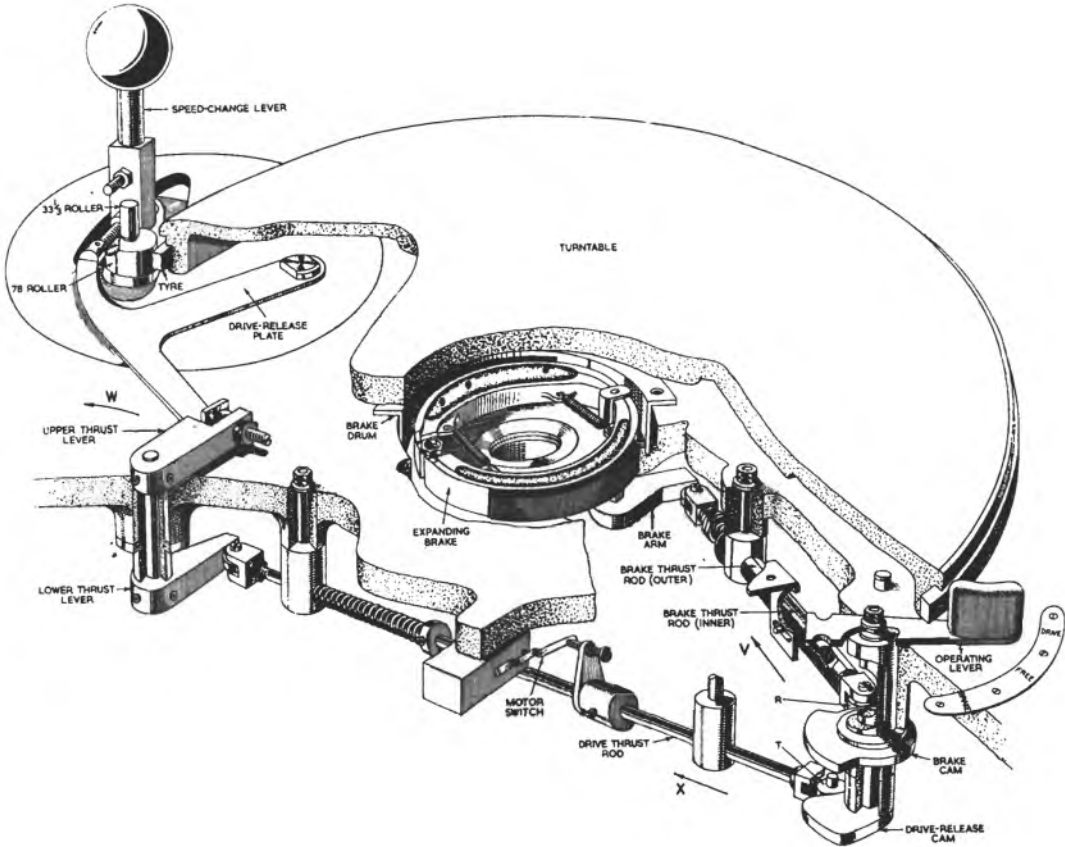

FIG. 92. REPRODUCING DESK DRD/1 ; TURNTABLE CONTROLS

position ; this ensures that the motor is switched off, that the driving rollers are disengaged from the tyre, and that the brake is off. Thus, in this position, the whole mechanism is free from strain and the turntable can be rotated freely by hand.

*Drive Position.* When the operating handle is in the *Drive* position as shown, the thrust-rod rollers, R and T, are at the roots of their respective cams, the brake shoes are released, the motor switch is made, the driving roller is engaged with the tyre and the turntable rotates at 78 or  $33\frac{1}{2}$  r.p.m., according to the setting of the speed-change lever.

*Free Position.* When the operating handle is moved from the *Drive* to the *Free* position, the cams are rotated clockwise and the thrust-rods move in the direction V and X. The roller R rests at the commencement of the rise on the brake-operating cam, leaving the brake still free ; the roller T reaches the top of the drive-operating cam, the motor-switch opens, the thrust levers move in the direction W, forcing back the drive-release plate which disengages the driving roller from the turntable tyre and the turntable is free to be rotated by hand.

*Brake Position.* When the operating handle is moved to the *Brake* position, the operating cams rotate in a clockwise direction : the roller R reaches the top of the brake-operating cam, the brake thrust-rods move in the direction V and the brake-shoes open, engaging the linings with the turntable brake-drum ; the roller T remains at the top of the drive-operating cam, leaving the motor switched off and the drive free from the turntable tyre. The *Brake* position of the operating lever is non-locking, so that braking is applied only when the lever is held in the *Brake* position, the lever being restored to the *Free* position as soon as the turntable has stopped.

*The Groove-locating Unit.* With the DRD/1 desk, an E.M.I. Type-12 pickup is mounted on a groove-locating unit, Type GLU/10A. Details of this unit are shown in Fig. 93. The carriage of the parallel-tracking arm has six ball-bearings, four of which move in a horizontal plane, and two in a vertical plane along the circular carriage rail ; this arrangement ensures maximum freedom from side-play with minimum friction when tracking (4.7.2). A special feature of this unit is a motor-driven device for lowering and raising the pickup by remote control. The motor is operated by relays, the coil-circuits of which are connected through back-contacts on the main control unit on the front panel of the desk, and also through the key-contacts of the key-and-lamp unit on top of the desk. Provision is also made for extending these circuits to other control desks, so that once the pickup has been located to start at the required groove, it can be lowered from a remote position.

An additional refinement is a continuous-vernier adjustment for groove locating, the control for which is on the left-hand front corner of the top-plate and the rotating vernier scale is at the left end of the unit. (Plate 4.)

*The Control Panel.* The sloping control panel on front of the desk is hinged so that it can be fully opened for maintenance purposes ; it contains

## 4.9 BBC DISK REPRODUCING EQUIPMENT

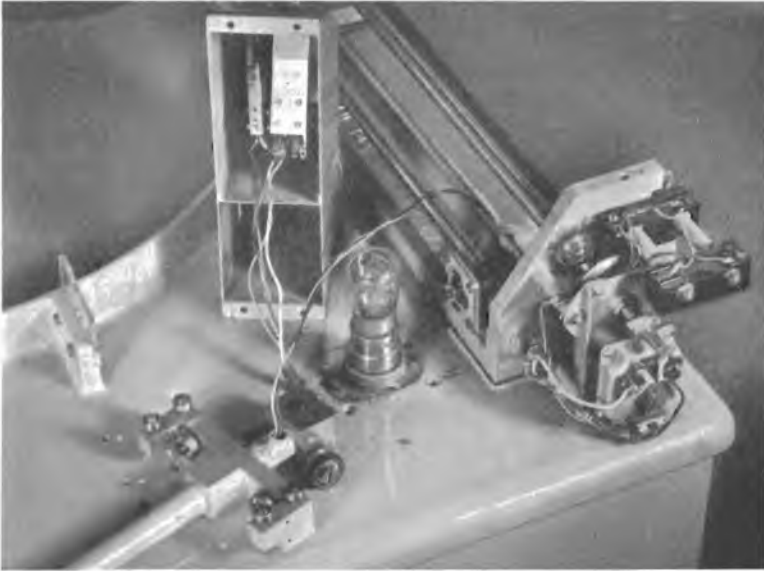

FIG. 93. REPRODUCING DESK DRD/1 ; DETAILS OF GROOVE-LOCATING UNIT GLU/IOA

the main fader, equaliser-setting switch, variable attenuator (calibrated in 2-db steps) and a 3-position selector key wired to the monitoring circuits.

*The Cabinet.* The cabinet, which is of heavy construction to safeguard against floor vibration being transmitted to the turntable, houses the equalisers, amplifiers and power-supply units. The distribution of this equipment is shown in Plate 5.

*The Programme Chain.* The programme chain associated with the DRD/1 is shown in Figs. 94-96. The equaliser-transformer-attenuator unit, ETA/1

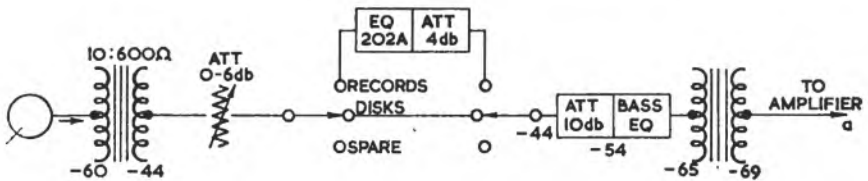

FIG. 94. PROGRAMME CHAIN : REPRODUCING HEAD TO AMPLIFIER INPUT

is mounted above the amplifiers (Plate 5) and a block schematic of the circuit is shown in Fig. 94. The transformer provides a 10-ohm load for the E.M.I. Type-12 pickup and steps up this impedance to the normal operating impedance of 600 ohms.

The variable attenuator following the transformer provides adjustment of volume for pickups having different sensitivities. For the reproduction of disks recorded with the BBC characteristic, a simple resistance-capacitance network is used for bass equalisation and this equaliser is followed by a transformer which steps down the impedance from 600 to 300 ohms ; this is because the AMC/2 amplifier following the equaliser has an input impedance of 300 ohms. A 10-db attenuator is associated with the equaliser and the total loss at 1,000 c/s introduced by the attenuator, equaliser and transformer is 25 db, giving an input level to the main amplifier of - 69 db.

When gramophone records are reproduced, an equaliser EQ/202A is switched into the circuit as shown, and because the normal volume from records is about 4 db above that from BBC disks, a 4-db attenuator is switched into circuit with the equaliser. The circuit and loss curve of equaliser EQ/202A are shown in Fig. 83.

From the main amplifier the programme chain divides into two paths, one to a star mixer, where it joins similar paths from other reproducing desks, and the second path to the monitoring circuit.

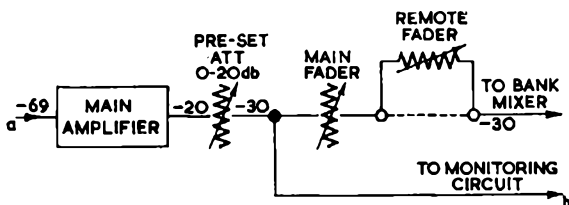

FIG. 95. PROGRAMME CHAIN : AMPLIFIER INPUT TO MIXER

The path to the mixer is shown in Fig. 95. The pre-set 0-20 db attenuator is normally set for 10-db loss ; when a number of reproducing desks are being used on the same programme, the pre-set attenuators are adjusted in 2-db steps to obtain the same volume from disks or pressings recorded at different levels. The main fader following the pre-set attenuator may feed into the star mixer direct or via a remote fader. The star mixer has provision for six reproducing desks, each having a similar programme chain.

Three circuits feed into the pre-fade monitoring amplifier via a monitoring key shown in Fig. 96. The *desk* circuit is taken from a point preceding the main fader but after the equaliser ; the transformer is connected permanently across the main circuit, but because of its high input impedance, it introduces negligible loss to that circuit. The nominal output impedance of the transformer is 600 ohms, whereas the amplifier input impedance is 300 ohms ; to obtain matched impedance, 300-ohms resistance (150 in each leg) is placed in series with the amplifier input.

The *bank-output* circuit permits listening to the combined outputs of all desks connected to the star mixer. The *programme* circuit is taken from the



*Disk Reproducing Channel, Aldenham, 1949  
Presto two-speed reproducing machines, with E.M.I. Type-12 pickups and BBC auxiliary  
equipment*

## 4.9 BBC DISK REPRODUCING EQUIPMENT

studio-centre ring-mains, which provide selective listening to any programme originating at or passing through a studio centre ; the ring-main switch (HV/7) is set to that programme to which the reproducing desk is contributing.

All three circuits are arranged to present a volume of  $-49$  db to the input of the pre-fade amplifier ; the amplifier is set at 49-db gain, giving zero output volume for feeding headphones or a loudspeaker amplifier.

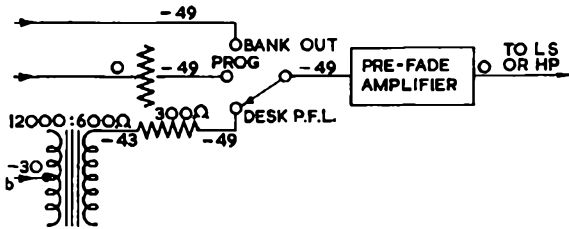

FIG. 96. PROGRAMME CHAIN : MONITORING CIRCUIT

### 4.9.2 DISK REPRODUCING DESK TYPE DRD/1A

The cabinet and turntable unit of this desk are of similar construction to the DRD/I desk but the groove-locating unit GLU/10A is replaced by a simple parallel-tracking arm with no vernier adjustment and no automatic lowering device.

The desk is intended for the reproduction of programmes recorded at  $33\frac{1}{3}$  r.p.m., two desks constituting a reproducing channel. When so used, an apparatus bay is installed with the desks, and the main faders are mounted on the bay instead of on the desk control panels.

### 4.9.3 PRESTO REPRODUCING EQUIPMENT

Presto reproducing machines are used by the BBC mainly for the reproduction of disks recorded at  $33\frac{1}{3}$  r.p.m. At studio centres, they are normally used in single units, but at recording centres, two machines are used as a complete reproducing channel (Plate 6)

E.M.I. Type-12 pickups are used on all these machines, but the amplifying equipment varies according to local requirements. Normally, a Presto amplifier Type 42E (or in older models, Type 40-BS) is supplied with each machine. With the channel illustrated in Plate 6, the two amplifiers Type 42E in the cabinets are linked on a BBC apparatus bay. This bay is equipped with all essential switching and fading facilities, line amplifiers and a variable-correction unit (page 97).

The machines are designed for both 78 and  $33\frac{1}{3}$  r.p.m. and the drive is shown in Fig. 97. A rubber tyre is fixed to the rim of the friction-driven turntable, and speed selection is by means of a two-diameter roller on the motor shaft. The speed-change lever moves vertically and horizontally ; it moves the motor



up for 78 r.p.m. and down for 33½ r.p.m., the driving roller making direct contact with the turntable tyre. In the *off* position of the speed - change lever, the driving roller is clear of the turntable ; this prevents flats being worn on the tyre when the machine is not in use.

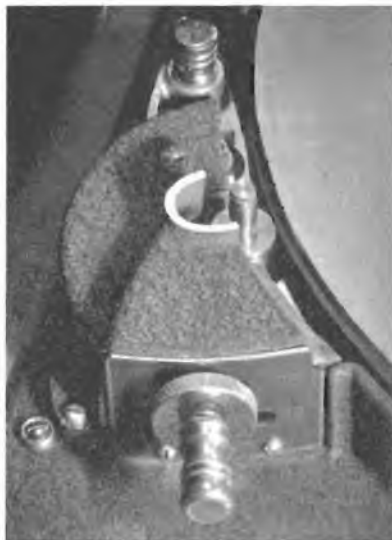

FIG. 97. PRESTO REPRODUCING DESKS :  
DRIVE AND SPEED-CHANGE LEVER

#### 4.10 FREQUENCY CHARACTERISTIC OF DISK REPRODUCING APPARATUS

##### 4.10.1 OVERALL CHARACTERISTIC

The fidelity of a disk recording and reproducing system as a whole depends upon the recording characteristic (2.10) tracing losses (2.8.2) and the frequency response of the reproducing head and amplifier. When the recording and reproducing equipment form an integral system, as with the BBC Type C and Type D equipments (Chapter 3) the frequency response at the output of the reproducing amplifier is called the overall characteristic.

We have indicated in Chapter 1 that this characteristic is satisfactory for broadcasting purposes if it is sensibly flat over an audio range of 50 c/s to 10,000 c/s. In Chapter 2, we have shown that frequencies below 250 c/s are attenuated during recording and that high frequencies are accentuated to compensate for tracing losses ; in this chapter we have discussed resonances in reproducing heads (4.3.2). The reproducing chain must be designed to compensate for the low-frequency losses in recording and for resonances in the reproducing head and arm.

Since the recording characteristic is fixed and reproducing amplifiers, if properly designed, will have a flat frequency response, the overall characteristic depends chiefly upon the performance of the reproducing head, and a frequent check must be made to ensure that the characteristic is maintained within acceptable tolerances.

##### 4.10.2 MEASUREMENT OF PICKUP FREQUENCY RESPONSE

*Multi-frequency Test Record Method.* The normal method of measuring the frequency response of pickups is to play a standard test record on which numerous audio-frequency tones are recorded according to a known character-

#### 4.10 FREQUENCY CHARACTERISTIC OF DISK REPRODUCING APPARATUS

istic and, after suitable amplification, to note the level obtained at individual frequencies. When the pickup is used with a fixed equaliser the results obtained are influenced by the latter. If the equaliser is designed to produce a standard characteristic with a given type of pickup, any deviation from this characteristic will indicate a faulty pickup provided that other conditions governing the test are maintained. These relate in particular to needle type, correct downward needle pressure and turntable speed. Specific tolerances are laid down, the pickup being considered suitable for service if its response lies within these tolerances.

It is highly desirable that the multi-frequency record should cover the complete frequency range over which the pickup and its equaliser are designed to operate. This is particularly important at the higher frequencies in order to keep a check on the top resonance which, with many types of moving-iron head, changes both in frequency and amplitude as the damping material ages. To meet this requirement the multi-frequency record used by the BBC covers the frequency range 50 c/s to 10,000 c/s recorded with the BBC recording characteristic. Adjacent frequency bands are linked by gliding tone and vocal identification. The highest frequencies are recorded on the outside of the record in order to produce the maximum wavelength at these frequencies.

*Variable-Disk-Speed Method.* The multi-frequency-record method of testing pickups is satisfactory when the average characteristics of a given type are known, and when it is required to ascertain the performance of individual pickups under service conditions. But the performance of a pickup when playing a record is not a criterion of its performance when playing cellulose disks, for not only does the groove shape and disk material affect high-frequency response, but the high-frequency resonance of the pickup occurs at a lower frequency when playing cellulose disks. Because of this, the response on cellulose disks, which is of considerable importance to the BBC, cannot be determined by playing pressings, and calibrated cellulose disks have a short life and introduce difficulties due to wear.

Even with a specified disk material and groove shape, the determination of the response of a pickup at high frequencies is less simple than it at first appears. Under normal circumstances, the stylus tip size is such that tracing losses become significant at frequencies above 5,000 c/s, and the magnitude of the loss naturally varies with disk speed. It follows that the response actually realised by a pickup when it is reproducing a disk varies continuously as it traverses towards the centre and cannot be defined by a single curve.

Nevertheless, for practical purposes a test procedure is required that will yield the most relevant information about the response of a pickup in as simple a manner as possible. With this end in view, the variable-disk-speed method of pickup calibration was introduced in Research Department several years ago, and has been used with modifications ever since. In principle, all that is required is a single test disk bearing a single band of recorded tone, and this disk is reproduced at various speeds to give the test frequencies required. In this way the stylus is driven at constant amplitude at all frequencies and the frequency characteristic of the pickup can be determined without the amplitude recorded on the test disk being known.

## Procedure

In practice it has been found to be convenient to restrict the range of speed over which any single recorded band is used to a ratio of 4 : 1. Several test bands are, therefore, required to cover the range from 20 c/s to 20,000 c/s and it might appear that they would have to be calibrated. This can be avoided, however, by arranging for consecutive disks to cover an overlapping band of frequencies. For example, if one tone band gives test frequencies from 500 c/s to 2,000 c/s, the next disk would be chosen so that, played over the same 4 : 1 speed range, it would give frequencies of say, 1,500 c/s to 6,000 c/s. The range from 1,500 c/s to 2,000 c/s would then be covered by both test disks and the shape of the response curve would be the same in both cases. Any difference in absolute level in the two tests could be ignored and the two response curves joined to give a continuous curve from 500 c/s to 6,000 c/s. The frequency

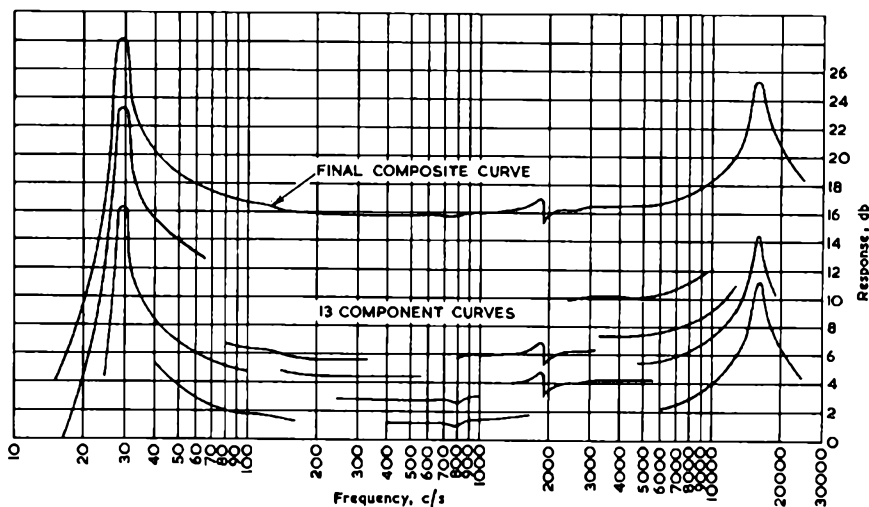

FIG. 98. VARIABLE-DISK-SPEED RESPONSE CURVES

range can clearly be extended upwards and downwards in the same way, and Fig. 98 shows a typical set of curves obtained using thirteen bands of recorded tone. It will be seen that the overlap between consecutive tests is considerable and is, in fact, more than is required if the response curve is smooth. When sharp kinks or steep slopes appear in the response curve however, a considerable overlap is convenient.

Over the range covered by a single recorded tone band, the pickup stylus is driven at constant amplitude. Consequently, for the type of pickup in which the output should be proportional to stylus amplitude, (e.g. piezo-electric), variation in output voltage indicates a departure from the ideal or "flat" response.

#### 4.10 FREQUENCY CHARACTERISTIC OF DISK REPRODUCING APPARATUS

In the case of moving-iron and moving-coil pickups, however, the output should be proportional to the stylus velocity and on any one tone band the output should, therefore, be proportional to disk speed and so to frequency. In these circumstances it is not easy to see from simple observation of the output level the extent by which the pickup response departs from the ideal. To enable this to be done it is convenient to reproduce such a pickup through an "integrating" amplifier which gives constant output when the input voltage is proportional to frequency. With such an amplifier, the gain at 20 c/s is over 60 db greater than the gain at 20,000 c/s and, consequently even a small amount of "hum" or "rumble" in the input may mask the output of a high-frequency signal. In practice it has been found necessary to insert a 400 c/s high-pass filter when measuring frequencies above 500 c/s and in some cases, for example, when a pickup has had an excessive low-frequency arm resonance, it has been necessary to insert a 100 c/s high-pass filter when measuring frequencies between 100 c/s and 500 c/s.

In testing a pickup, a usual preliminary procedure has been to vary the turntable speed continuously with each tone band so as to obtain a series of gliding tones, the "integrating" amplifier being used if the pickup is a "constant velocity" type, or a straight amplifier with a "constant amplitude" type. In either case the output meter is observed while the tone glides. If the output is steady, the response curve is smooth and only a small number of measurements need be made to define it. If there are considerable changes in output level, however, the corresponding inflections on the response curve can be examined at as close intervals of frequency as desired by appropriate adjustment of turntable speed. Up to the present the turntable speed has been measured stroboscopically, but other methods are, of course, possible.

#### Advantages and Limitations of the Variable-Disk-Speed Method of Pickup Calibration

As will have been observed, the response of a pickup can be determined at as large a number of frequencies as desired with only a small number of test disks, and these disks need not themselves be calibrated. It is, therefore, easy to provide cellulose test disks, and in some cases special groove shapes have been made to enable tests to be made on pickups with stylus dimensions differing from the BBC standard.

Generally speaking the pickup response measured by the variable-disk-speed method ignores the effects of tracing loss, since the wavelength on each test band is independent of frequency and the difference in loss between adjacent bands is ignored when the curves are fitted together. Because of this, the response curve measured in this way can be expected to show rather more "top" than is observed when a multi-frequency test record is used. In this respect the results of a variable-disk-speed calibration are unreal and hypothetical. There is the corresponding advantage, however, that substantially the same result is shown for the same pickup regardless of the precise size of the stylus tip, provided of course that it does not "bottom" in the groove.

Because of the elimination of tracing loss, high-frequency resonances may

appear more marked when the response is measured by the variable-disk-speed method. The results may, therefore, be regarded as misleading since they show a greater peak than is realised in practice. As regards frequency characteristic this is true, but the fact that the change in response resulting from a mechanical resonance is lessened by tracing loss does not mean that the other ill effects of the resonance (e.g., high wear and distortion), have also been reduced. Thus, while the variable-disk-speed measurement does tend to exaggerate the peak in the response curve, it calls attention to a fault which may be serious enough to the ear and yet be largely masked by tracing loss when measurements are made with multi-frequency records.

Some pickups have been found in which the response at a given frequency depends, to some extent, on the speed of the disk past the stylus. In these cases the measurements in the overlap region between adjacent test bands do not coincide, and an accurate calibration cannot be made in this way. The variation in response with disk speed, however, implies a corresponding variation in response as the pickup crosses the disk, and this is obviously an undesirable characteristic in a pickup.

*References*

- |   |                     |       |             |
|---|---------------------|-------|-------------|
| 1 | BBC Research Report | Co20. | 1941.       |
| 2 | „                   | „     | Co38. 1943. |
| 3 | „                   | „     | Co43. 1943. |

## CHAPTER 5

### THE PROCESSING OF DISKS

#### 5.1 INTRODUCTION

**I**N the gramophone industry the word processing is used to describe all the operations necessary for the production of copies from an original recording. The original may be a wax or a lacquer-coated disk ; gramophone companies generally record on wax but the BBC and other organisations which use lacquer-coated disks for direct playback use these disks as originals for processing. The method of processing a lacquer-coated disk differs slightly from that used for a wax, and the processes used by the various gramophone companies differ in certain details but the general principles outlined in this chapter apply to all.

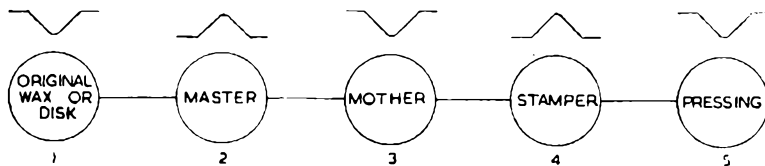

FIG. 99. FULL-PROCESS STAGES

In the 2nd and 4th stages the grooves become ridges as indicated

#### 5.2 GENERAL PRINCIPLES OF PROCESSING

##### 5.2.1 THE FULL PROCESS (FIG. 99)

Very briefly the various stages in the processing of an original recording are as follows :—

- (a) A “negative” known as a “master” is made from the original. only one master can be prepared from a wax original as the latter is of no further use except for reclamation of material, but more than one master can sometimes be made from a lacquer-coated disk.
- (b) A “positive” or “mother” is prepared from the master.
- (c) A second negative copy known as the “stamper” or “working matrix” is obtained from the mother.
- (d) The final pressings are made from the stamper.

These four stages form the process by which gramophone records are manufactured. With this process a large number of copies can be made and if a stamper becomes worn or damaged by repeated pressings, further stampers can be obtained from the mother. Moreover, to manufacture pressings abroad it is only necessary to export a single mother, stages (c) and (d) being carried out at the destination.

## 5.2.2 HALF-PROCESSING

If a small number of pressings are required, they may be obtained direct from the master, in which case the latter is described as a "master stamper." In this way the mother and stamper stages of the full process are avoided and the time taken to produce the pressings is reduced. A large number of BBC direct-recorded disks are duplicated by this shortened method.

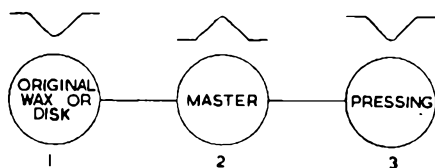

FIG. 100. HALF-PROCESS STAGES  
The master is used as a stamper

## 5.3 PROCESSING IN DETAIL

## 5.3.1 PREPARATION OF THE MASTER

*From a Wax Original.* The surface of the wax is first given an electrically conductive coating so that metal can be deposited on it electrolytically. This may be done either by brushing finely divided copper or graphite powder over it, or by sputtering with gold or silver. Sputtering is achieved by bombarding the wax surface with gold or silver particles in a vacuum chamber.

The wax is next transferred to an electro-plating bath containing a solution of copper sulphate and sulphuric acid and the conductive surface of the wax is connected to the negative terminal of a d.c. supply to act as a cathode, the anode consisting of pure copper bars or plates. The solution is agitated by air pressure and the wax moved about in the solution; a current having a density of 50-60 amperes per square foot of cathode area passed through the solution for several hours during which time copper is transferred from the anode and deposited evenly over the conductive surface. When the growth is sufficient, the copper coating is stripped from the wax and any wax adhering to it is removed by heating. The copper plate thus formed has ridges corresponding with the grooves of the original recording, i.e., it is a negative copy of the wax.

*From a Direct-recorded Disk.* The surface is first freed from grease by the application of a solvent such as carbon-tetrachloride or benzine, then cleansed by a paste composed of alkalis and a suitable wetting agent and finally washed in clean water. The disk surface is then made conductive by the wet-silvering process; the disk is immersed in silver nitrate and a thin coating of silver is formed on the disk surface. After further washing it is ready for the deposition process explained above.

*Preparation of a Master Stamper.* In half-processing (5.2.2) the master is used as a stamper. Sometimes only a thin copper coating is formed in the

## 5.3 PROCESSING IN DETAIL

plating bath and this is afterwards soldered to a thick copper plate to give it strength ; alternatively the immersion in the bath can be continued until a sufficient thickness of copper has been deposited electrolytically. Before the master is used for stamping, its centre must be determined as described in section 5.3.4 and the surface must be hardened by nickel-plating followed by chromium-plating.

### 5.3.2 PREPARATION OF THE MOTHER

The mother is derived from the master by a further electro-plating process, the master being used as a cathode. There are two essential conditions in this process : first, the deposited coating must be easily separable from the master without damage to the latter ; secondly, the deposition must only take place on the recorded surface of the master. The first requirement is met by oxidising the face of the master before immersion in the bath, and the second by protecting its back and rim with wax. The grooves of the mother thus formed are identical with those of the original recording.

### 5.3.3 PREPARATION OF THE STAMPER OR WORKING MATRIX

The stamper is prepared from the mother by a similar process of electrolytic deposition. Some manufacturers prefer a thin stamper which is afterwards soldered to a thick copper plate to form a backed stamper ; others extend the duration of the electro-plating process and produce a solid stamper which does not require backing. The stamper has ridges in place of the original grooves and is a negative copy of the original recording. The surface is too soft for the mass production of pressings and is therefore hardened by electrolytic deposition first of nickel and then of chromium. A number of stampers can be made from one mother and by this means the quantity of pressings which can be produced is almost unlimited.

Another method of processing stampers for commercial records is the "direct-nickel" process. This can be explained briefly as follows :—the mother is placed in a nickel bath and forms the cathode on which an initial film of nickel is deposited ; it is then transferred to a copper vat and normal deposition takes place. When separated from the mother the stamper has a nickel surface and only requires the application of chromium to complete the process.

### 5.3.4 CENTRING THE STAMPER

It is essential that the centre hole in the final pressings should correspond precisely with that in the original recording, or the reproducing head is subjected to an eccentric motion during reproduction, giving rise to wow.

There is no indication on the stamper as to the position of the centre hole of the original disk. The centre must, therefore, be accurately located by reference either to the run-off groove if one has been cut or to the modulated grooves. A hole of the correct diameter is then drilled. When the stamper is put into position in the press, a cylindrical pin projects through the centre hole of the stamper and forms the centre hole in the pressing.



## BBC RECORDING TRAINING MANUAL

### 5.3.5 THE PRESSING MATERIAL

*General.* The material used for making pressings is normally thermo-plastic, i.e., it must be plastic when hot and hard when cold ; it must also have hard-wearing properties and be cheap to produce.

*Shellac Pressings.* The material used in the manufacture of gramophone records is a mixture of shellac, copal, a filler and colouring matter. The shellac binds the composition and gives the walls of the grooves a smooth and glossy surface ; the copal is responsible for the hard-wearing property of the pressings ; the filler, which is a mineral, e.g., clay or silica flour, gives body to the material and should have a fine granular structure, otherwise the background noise on reproduction is excessive.

After the ingredients have been finely powdered and thoroughly mixed, the material is passed between steam-heated rollers, from which it emerges in the form of a blanket of dough-like consistency. This is divided by knives into "biscuits" suitable in size for the manufacture of 10-inch or 12-inch diameter pressings and, when the mixture has cooled sufficiently, these are broken off and stacked ready for the press.

*Vinyl Pressings.* A vinyl base resin, which is more expensive than shellac, is now used extensively as a pressing material. It is thermoplastic but requires a higher temperature during pressing than shellac. The rate of production is slower and it demands a greater degree of skill in manufacture.

A vinyl pressing is superior to one made in shellac in that it is far less fragile and weighs less, these being important advantages when, as in the BBC Transcription Service, pressings have to be sent abroad, often by air. The vinyl pressing also has a quieter background than shellac ; this not only improves the signal-to-noise ratio but allows an extension of the lower limit in the dynamic range when recording.

### 5.3.6 THE PRESSING OPERATION

The press consists of an iron framework supporting two hinged steel plates or dies, each of which carries a stamper. When the press is open (Plate 7), steam circulates within the dies at a temperature of approximately 320° F. and a biscuit of thermo-plastic material, previously heated to 300° F., is rolled into a ball and placed in the press between two labels. When the press is closed, the biscuit is subjected to great pressure at high temperature to produce a pressing, on each side of which is a positive recording. As pressure is applied, the circulating steam is replaced by a flow of cold water to harden off the pressing. The final operation is to remove the pressing, break off the surplus material from the edge and polish the rim.

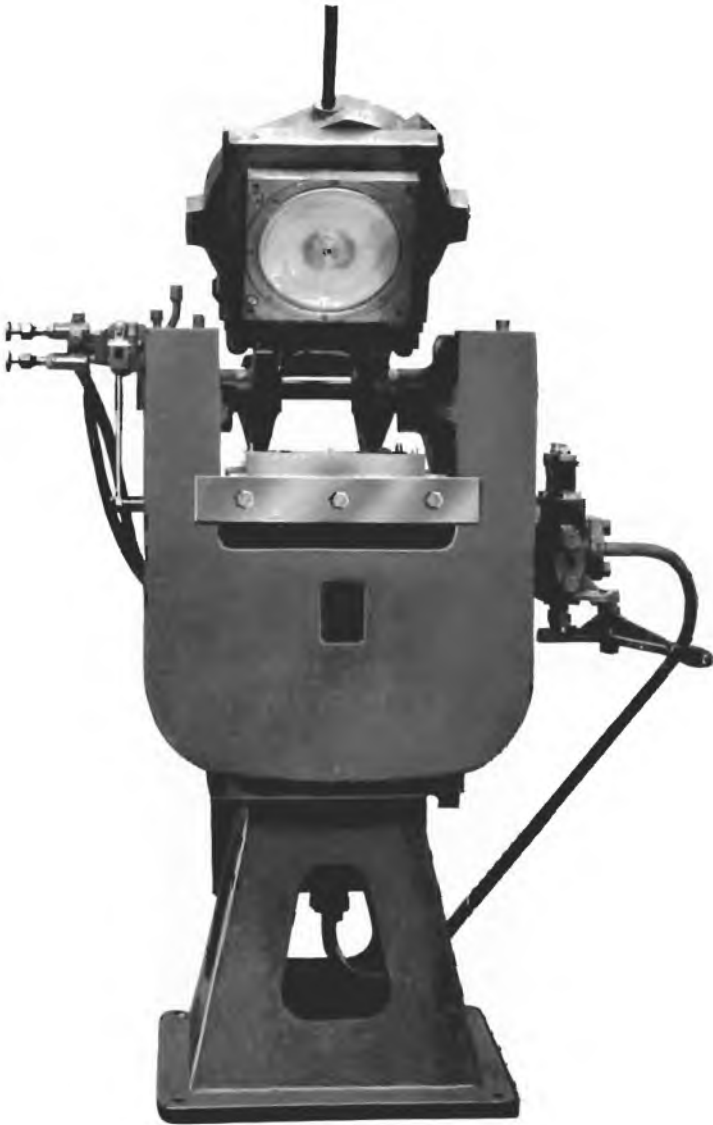

*Semi-automatic Gramophone-record Press*

*(Reproduced by courtesy of Messrs. Francis Shaw & Co. Ltd.)*

## CHAPTER 6

### MAGNETIC RECORDING AND REPRODUCTION

#### 6.1 DEFINITION OF TERMS

**B**EFORE discussing the theory of magnetic recording, we must be quite certain of the meaning of the terms given to those magnetic properties upon which the system depends. The definitions which follow are from British Standard 205.

*Coercive Force.* The demagnetising force required to reduce the magnetic flux density in a substance from the remanent value to zero. It depends on the initial magnetisation.

*Coercivity.* The value of the coercive force when the initial magnetisation has the saturation value for the substance.

*Hysteresis.* In general terms, the phenomenon by which a strain depends not only on present stress but also upon its previous values.

*Magnetic Field.* The space in the neighbourhood of an electric current, or of a permanent magnet, throughout which the forces due to the current or magnet can be detected.

*Magnetic Flux.* A phenomenon produced in the medium in the neighbourhood of electric currents or magnets. The amount of magnetic flux through any area is measured by the quantity of electricity caused to flow in an electric circuit of given resistance bounding the area when the circuit is removed from the magnetic field. It is proportional to the product of the quantity of electricity and the resistance of the circuit. It is the surface integral of the magnetic flux density or magnetic induction over any surface having the same boundary as the area. Unit magnetic flux in the electromagnetic system is that flux the removal of which from a circuit of unit resistance causes one electromagnetic unit of electricity to flow in the circuit. Symbol :  $\Phi$ . Unit : Maxwell.

*Magnetic Flux Density.* At a point. The amount of magnetic flux per square centimetre over a small area at the point, the area being in the position which gives a maximum value for the flux. The normal to the area in this position is the direction of the flux at the point, the direction of the current produced in the electric circuit on its removal and the positive direction of the magnetic flux having a right-handed screw relation. Symbol :  $B$ . Unit : Gauss.

*Magnetising Force.* At a point. The force which produces or is associated with the flux density at the point.

The magnetomotive force per centimetre measured along the lines of force.

It is measured in a vacuum by the mechanical force in dynes experienced by a unit magnetic pole placed at the point. In any other medium the unit magnetic pole is assumed to be situated in a long narrow vacuum tunnel in the direction of the magnetisation. Symbol :  $H$ . Unit : Oersted.

*Magnetomotive Force.* Along any path. The line-integral of the magnetising force along that path. If the path is closed the line-integral of the magnetising force around it is equal to  $4\pi/10$  times the ampere-turns. Symbol :  $F$ . Unit : Gilbert.

*Magnetic Hysteresis.* The phenomenon by which the magnetisation of some materials depends not only on the present magnetising force, but also on the previous magnetic state. It causes a dissipation of energy (the hysteresis loss) when the material is subjected to cyclic magnetisation (*as in magnetic sound-recording*).

*Magnetic Hysteresis Loop (B/H Loop).* The closed figure formed by plotting the values of the magnetic flux density ( $B$ ) in a magnetic material against the magnetising force ( $H$ ) when the latter is taken through a complete cycle. The hysteresis loss is proportional to the area of this loop. (6.3.)

*Permeability (absolute).* Of a material or medium. The ratio of the magnetic flux density to the magnetising force producing it. Symbol for the absolute permeability of free space :  $\mu_0$ . In the E.M. system  $\mu_0 = 1$ .

*Permeability (relative).* Of a material or medium. The ratio of the magnetic flux density produced in the medium to that produced in a vacuum by the same magnetising force. Symbol :  $\mu$ .

*Reluctance.* The ratio of the magnetomotive force acting in a magnetic circuit to the resulting magnetic flux.

*Remanence.* The remanent magnetic flux density obtained when the initial magnetisation reaches the saturation value of the material.

*Remanent Flux Density.* The magnetic flux density remaining in a substance when, after an initial magnetisation, the magnetic force is reduced to zero. The remanent flux density depends on the initial magnetisation.

*Residual Magnetism.* The magnetism remaining in a substance after the magnetising force has been removed.

## 6.2 FUNDAMENTAL PRINCIPLES OF MAGNETIC RECORDING

In the process of magnetic recording, sound waves in air are converted into varying e.m.f.'s by a microphone. These are amplified and applied to the coil of a small electromagnet forming the recording head. A magnetic field whose intensity varies in direct relationship to the sound waves is thus produced at the poles of the electromagnet.

The recording medium usually consists of a length of steel tape or wire or

## 6.2 FUNDAMENTAL PRINCIPLES OF MAGNETIC RECORDING

of plastic tape coated or impregnated with magnetic material. This is moved at a constant speed past the recording head. The field produced by the head is concentrated and the time which a particle of the tape or wire takes to pass through this field is very short. The particle leaves the field with a remanent flux density whose value is related to the strength of the field at the moment the particle passed through it. It follows that successive particles of the tape leave the head with varying flux densities. These varying flux densities along the length of the tape will, if suitable precautions are taken, correspond closely to the variations in the magnetic field of the recording head and therefore also to the sound picked up by the microphone.

These precautions are twofold :—firstly all the elements of the tape or wire must be in an identical magnetic state when they reach the recording head ; secondly, there must be a very close proportionality between the values of remanent flux density of particles after leaving the field of the head and the values of field strength which produced them.

One method of satisfying the first requirement is to ensure that before reaching the recording head each particle of the tape is magnetised to saturation. This can be done by putting an electromagnet, usually described as a wiping head or erasing head, in advance of the recording head and supplying its coil with a direct current of such a value as to produce a field strong enough to magnetise the tape or wire to saturation. By this means, whatever irregularities of flux distribution may exist before the tape or wire reaches the erasing head, the flux density of the tape approaching the recording head, is uniform, and equal to the remanent value for the material. Thus, one of the chief attributes of magnetic recording systems is that a recording on a reel of tape or wire can be erased and the same reel used for another recording. In this way a single reel can be used over and over again and this in turn leads to a considerable economy where recordings are not required for permanent retention.

The second requirement is achieved by ensuring that the steady flux in the tape as it passes through the recording head is of such a value as corresponds roughly to the mid-point of the linear portion of the  $B/H$  curve (the curve relating flux density with magnetising force) for the material. This is brought about by passing through the windings of the recording head, in addition to the recording current, a direct current of appropriate value, usually known as the polarising current or biasing current. There is a rough analogy here to Class-A valve technique where, for linear amplification, the grid is biased to the mid-point of the straight portion of the curve relating grid potential and anode current.

Turning now to the question of reproduction, if a tape or wire which has been recorded is made to pass the pole-piece of an electromagnet similar to that used for recording, the variations in flux density cause corresponding currents to be set up in the windings of this electromagnet, which is the reproducing head. These currents correspond closely to the e.m.f.'s in the recording head at the time of recording and therefore also to the original sound.

This simple description omits mention of various sources of distortion. These are referred to later in the chapter.

### 6.3 THE HYSTERESIS OR $B/H$ LOOP

When an unmagnetised material is subjected to a magnetising force  $H$ , (Fig. 101), the flux density  $B$  produced in the material increases as  $H$  increases; this is indicated by curve OA. At point A the curve becomes a straight line parallel to the  $H$  axis OE; the significance of this is that beyond the point A the flux density  $B$  remains steady however much the magnetising force  $H$  is increased.

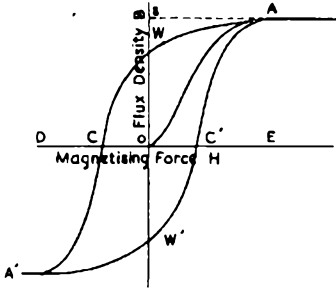

FIG. 101. MAGNETIC HYSTERESIS ( $B/H$  LOOP)

For a given material, flux density,  $B$ , varies when the magnetising force,  $H$ , is varied

OA is known as the  $B/H$  curve for the material and A as the saturation point. Suppose now that  $H$  is steadily decreased to zero: the flux density falls but slightly to a value OW. By definition, OW is the remanence for the material used. If  $H$  is now increased in the opposite direction OC, the flux density begins to fall, until, when  $H$  reaches the value OC the flux density is zero. The magnetising force OC is the coercivity.

If  $H$  is increased further in the direction OD,  $B$  begins to rise, but in the opposite direction, until, when  $H$  reaches the value OD,  $B$  reaches the saturation point A'. If now  $H$  is decreased to zero in the direction DO,  $B$  falls steadily to a value OW'; as  $H$  is increased to a value OC',  $B$  falls to zero; a further increase of  $H$  to the value OE causes  $B$  to rise again to A. This cycle of magnetisation produces the hysteresis loop A, W, C, A', W', C', A.

### 6.4 THE MARCONI-STILLE SYSTEM<sup>1</sup>

The Marconi-Stille system of magnetic recording is based on the fundamental principles outlined in the two preceding sections.

In the description which follows, no attempt is made to propound a complete theory on the magnetic processes involved, for the precise distribution of magnetic flux along the recorded tape is by no means easy to determine. We shall therefore confine ourselves to more practical considerations.

#### 6.4.1 WIPING PROCESS

The tape is magnetically saturated by passing it between the pole-pieces of a pair of electro-magnets, the wiping head; the magnetising force at the pole-pieces is provided by passing a direct current through the coils. The coils are connected in series and must produce opposite polarities at the tips of the respective pole-pieces. The magnetic state of the tape when leaving the wiping head is that of remanence.

If, with the tape in this state, it were passed through a recording head through which only alternating currents were passing, the flux density would be decreased on the "negative" half cycles, but would not be increased by

## 6.4 THE MARCONI-STILLE SYSTEM

the same amount on the "positive" half cycles. We must, therefore, have some d.c. bias to take the operating point away from the curved part of the  $B/H$  loop.

### 6.4.2 RECORDING PROCESS

The recording process must produce along the tape flux-density variations of the largest amplitude consistent with linearity; linearity here implies that the changes in flux density must be proportional to the changes in the magnetising force producing them. Therefore, the recording head is energised by a direct current which, when modulated by the alternating signal currents, produces an effective demagnetising force, the direction of which is at all times in opposition to that of the magnetising force.

As each particle (or elementary length) of tape passes the recording pole-pieces, it is subjected to a demagnetising field, the intensity of which is dependent upon the net value of the steady and alternating components of the force acting upon it. The resultant flux densities distributed along the moving tape will thus vary as the demagnetising force varies. If the signal current is sinusoidal, the wavelength  $\lambda$  of the flux variations is given by

$$\lambda = \frac{s}{f}$$

where  $s$  is the speed of the tape past the pole-pieces and  $f$  the frequency of the signal current.

The magnetic states through which the tape passes are illustrated in Fig. 102. A particle of tape entering the wiping head in an unknown magnetic state is brought to saturation  $A$ ; the remanent flux density as the particle leaves the wiping head is shown as  $OW$ . The particle enters the recording head in this state and, if at the instant it passes the pole-pieces the alternating component of the recording field is zero (no signal), the demagnetising force, operating in the direction  $OH'$  will reduce the flux density to point  $U$  on the curve. As the particle leaves the recording field, the force returns to zero in the direction  $H'O$ , and the remanent flux density has a value  $OU'$ .

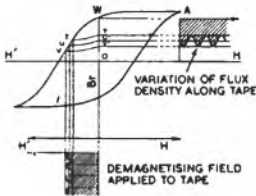

FIG. 102. HYSTERESIS LOOP FOR STEEL TAPE

If the recording field is produced by application of pure tone to the recording head and is applied to the straight portion of the  $B/H$  curve, the variation in remanent flux density  $B_r$  will be sinusoidal

The effect of superimposing an alternating component on the demagnetising force by applying a signal to the head is to cause the value of this force to increase or decrease, and the remanent flux density fluctuates between points  $T'$  and  $V'$ . If the applied signal is pure tone, the waveform of the flux distribution will be sinusoidal as shown on the right of Fig. 101; this assumes a linear relationship between the demagnetising force  $H'$  and the remanent flux density  $B_r$ .

This linear relationship is dependent

upon two conditions; first, the maximum hysteresis loop for the material must be used; this is met by magnetising the tape to saturation before recording begins; second, the value of the d.c. in the recording head must be such that, with maximum a.c. variation,  $B$ , never approaches remanence. If this condition is not met, partial rectification will occur.

*External Flux.* We must now consider the magnetic lines of force entering and leaving the surface of the tape as the remanent flux density is varied along its length. The number of lines thus produced will be proportional to the rate of change in  $B$ ; hence, if the variations in  $B$ , along the tape are sinusoidal, so also will be the distribution of the external or surface flux density  $B_s$ , and it is the transformation of these variations in external flux into variations of e.m.f. that forms the basis of the reproducing process.

#### 6.4.3 REPRODUCING PROCESS

The reproducing head is similar to and of the same dimensions as the recording head. As the moving tape passes the tip of the reproducing pole-pieces, surface poles on the tape due to the recorded signal induce poles of opposite polarity at the two ends of the pole-piece. Since the coil is wound closely round the pole-piece, a certain percentage of turns will be threaded by this induced flux, and an e.m.f. proportional to the time rate-of-change of flux-turns, is generated in the coil.

The output voltage produced at the terminals of the reproducing head at a frequency of 1,000 c/s is approximately — 55 db.

For low frequencies (long wavelengths) the flux linkage is proportional to the surface flux density  $B_s$ , but as the frequency is increased the linkage is reduced; further, the effective permeability (i.e., the ratio of flux density to the magnetising force producing it) of the pole-piece metal decreases. Thus the efficiency of the reproducing system falls rapidly as the frequency rises.

#### 6.4.4 SELF-DEMAGNETISATION

Another factor which contributes to reduction in the efficiency of a magnetic recording system at high frequencies is self-demagnetisation.

If a length of magnetic material is magnetised to saturation and then the magnetising field is removed, the density of the flux leaving the poles at the ends of the magnet is very near remanence. If the same process is applied to a shorter length of the same material, the remanent flux density will be less and this fall in flux density becomes more pronounced as the length of the magnetic material is reduced. The effect is due to the action of the pole at one end upon the pole at the other and is known as the self-demagnetising effect.

A length of tape on which sinusoidal variations of flux have been recorded can be considered as a series of magnets each half a wavelength long. If the wavelength is long, i.e., the frequency low, the external field produced at each pole of the magnet will be practically independent of the opposite pole half a wavelength away; thus the self-demagnetisation is small. If the wavelength is short, i.e., the frequency high, the external field from one pole is reduced



## 6.4 THE MARCONI-STILLE SYSTEM

because of the proximity of the opposite pole and the self-demagnetisation is considerable.

We have already seen that the efficiency of the reproducing system falls as the frequency rises, and the losses introduced in recording and reproduction must be taken into account when choosing the frequency characteristics of recording and reproducing amplifiers (6.4.7.).

### 6.4.5 BACKGROUND NOISE

As with all other sound-recording systems, reproduction is accompanied by background noise inherent in the moving medium, and this determines the lower limit of the recording level.

The level of the reproduced background noise is dependent upon

- (i) *Variations in the physical properties of the tape.*  
These are dependent upon granular structure, chemical composition, physical dimensions and surface polish of the tape, all of which depend very largely upon the degree of uniformity maintained during manufacture ; in addition, surface polish is dependent on the accuracy and smoothness of the pole-piece tips, and the granular structure is affected by uneven strain which may be caused by machine faults or careless operation.
- (ii) *The mean magnetic state of the tape as it leaves the recording head.*
- (iii) *Relative motions between pole-pieces and tape, and between coils and pole-pieces.*  
Motion between pole-pieces and tape, and the consequent motion between pole-pieces and coil, is largely due to unevenness of tape surface and to mechanical vibration. Motion of wiping pole-pieces has no effect on background noise, provided that the current through the wiping-head coils produces saturation of the tape. The amount of background noise produced by the combined effect of recording and reproducing pole-piece motion depends upon the magnitude of the motion and the resulting change in the reluctance of the magnetic circuit, consisting of the coil, pole-piece and tape.
- (iv) *The relation between frequency and the recorded flux variations.*  
This varies with the recording frequency characteristic used: The background noise covers most of the audio range ; hence, if the recorded flux variations are less at high than at low frequencies, the high-frequency variations may be swamped by background noise. The effect is minimised by choosing a suitable recording frequency characteristic, and by equalising the reproducing amplifier for maximum signal-to-noise ratio.

### 6.4.6 ARRANGEMENT OF POLE-PIECES

*Wiping-head.* It matters little whether one or two pole-pieces are used in the wiping-head. If one is used, the tape is saturated in one direction as it

approaches the pole-piece, and in the opposite direction as it leaves it. If two pole-pieces are used with a longitudinal gap between them, there is a second reversal in the direction of magnetisation along the tape, but the tape will leave the final pole-piece in a state of remanence. If placed immediately opposite each other on either side of the tape, their polarities being opposed, the net magnetising field will be zero and the tape will not be saturated. The choice of a single or a two-pole system may affect the optimum magnetising current but either system can be made to give satisfactory results.

The two-pole piece method adopted by the BBC is shown in Fig. 103. As the tape approaches the first pole-piece, it is subjected to the field  $h_1$ ; since the polarities of the pole-piece tips are opposite, the field between them,  $h_2$  is in the reverse direction; as the tape leaves the second pole-piece, it is subjected to  $h_3$  which has the same direction as  $h_1$ . Thus the final magnetic state is that produced by  $h_3$ .

*Recording Head.* The mechanical construction of the Marconi-Stillé recording head resembles that of the wiping head, but since smaller flux densities are used, the coil has less turns. Theoretically, several different arrangements of the head and pole-pieces are possible; e.g., two coils may be used, with a wide or a narrow gap separating the pole-pieces (D.P. System); a single coil and pole-piece (S.P. System), or a single operative coil, with an idle pole-piece in a second coil (S.P.I. System). The BBC uses the D.P. system, the pole-pieces being separated by a 3-mm. gap (Fig. 104). The coils are connected in series and, in addition to the speech currents, a biasing current of 4 mA d.c. is passed through them; interconnection of the coils is arranged so as to produce opposite polarities at the pole-piece tips.

As the tape approaches the first pole-piece it is partially demagnetised by  $h_2$  but when directly under the pole-piece it is subjected to the field  $h_3$  which is in the saturation direction. The field  $h_3$  is at a maximum under the trailing edge of the first pole-piece and under the leading edge of the second, while between the two it may be slightly lower. Since the thickness of the top of the pole-pieces is small compared with the shortest wavelength to be recorded, the values of the alternating components of  $h_2$  and  $h_3$  will not change appreciably as the tape passes under the first pole-piece, and the demagnetisation due to  $h_2$  is neutralised by the magnetising effect of  $h_3$ . As the tape moves away from the second pole-piece it is subjected to  $h_4$  which is in the demagnetising direction. It is this latter field which produces variations in

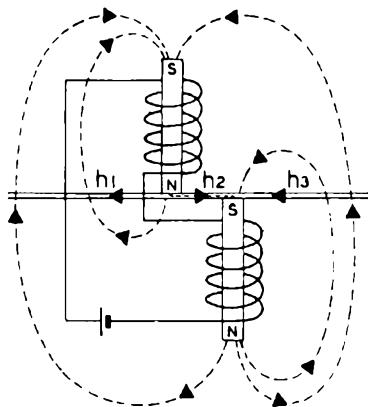

FIG. 103. MARCONI-STILLÉ TWO-POLE-PIECE WIPING SYSTEM

When leaving the pole-piece, the flux density of the tape is at remanence in the direction  $h_3$

## 6.4 THE MARCONI-STILLE SYSTEM

the longitudinal flux density of the tape when a signal is applied to the head. The purpose of the upper pole-piece is to restrict the spread of the recording field.

*Reproducing Head.* In reproduction, a single pole-piece may be used or two pole-pieces with a gap between them. The two-pole system gives slightly better response at high frequencies, provided that the gap is accurately set. The setting is too critical for practical purposes, however, and the single pole-piece method is normally used.

### 6.4.7 VOLUME RANGE AND OVERALL FREQUENCY RESPONSE

As with any sound-recording system, the volume range and frequency response of a magnetic recording system are mainly dependent upon two factors; first, maximum amplitude at any frequency must be kept below that at which distortion begins; second, the recorded level must be high enough to produce a satisfactory signal-to-noise ratio. Another factor which has to be considered is the energy distribution of the programmes to be recorded, and it is generally accepted that for all normal music and speech, the greatest energy levels occur in the frequency region of 300 c/s. Therefore, if the programme volume applied to a recording system is constant at all frequencies and if that volume be so adjusted as to preclude distortion at 300 c/s, then the system will be free from distortion over the audio range.

But with the Marconi-Stille system, the amplitude of flux-density variation falls at the higher frequencies; therefore, if the input volume is constant, at all frequencies, the signal-to-noise ratio decreases at these frequencies. Further, the reproducing system itself introduces high-frequency losses, so that even if the input level increases with frequency to an extent producing constant-amplitude flux variations, the overall response will still fall at high frequencies. The recorded amplitudes cannot be increased beyond the amplitude/flux linearity limit, and the response of the reproducing amplifier at high frequencies cannot be increased unduly if a satisfactory signal-to-noise ratio is to be obtained.

Between these conflicting requirements a compromise must be sought, and the recording, reproducing and overall characteristics used by the BBC are indicated in Fig. 105. The curves relate to the D.P. recording system shown in Fig. 104.

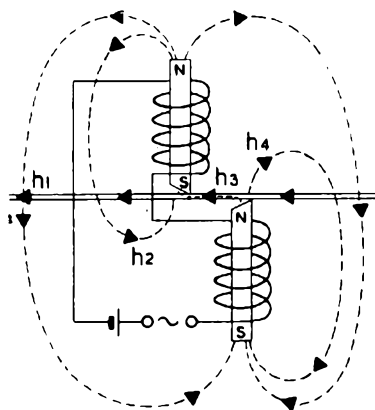

FIG. 104. MARCONI-STILLE TWO-POLE-PIECE RECORDING SYSTEM

When leaving the final pole-piece the flux density is at all times below remanence and in the direction  $h_3$

## BBC RECORDING TRAINING MANUAL

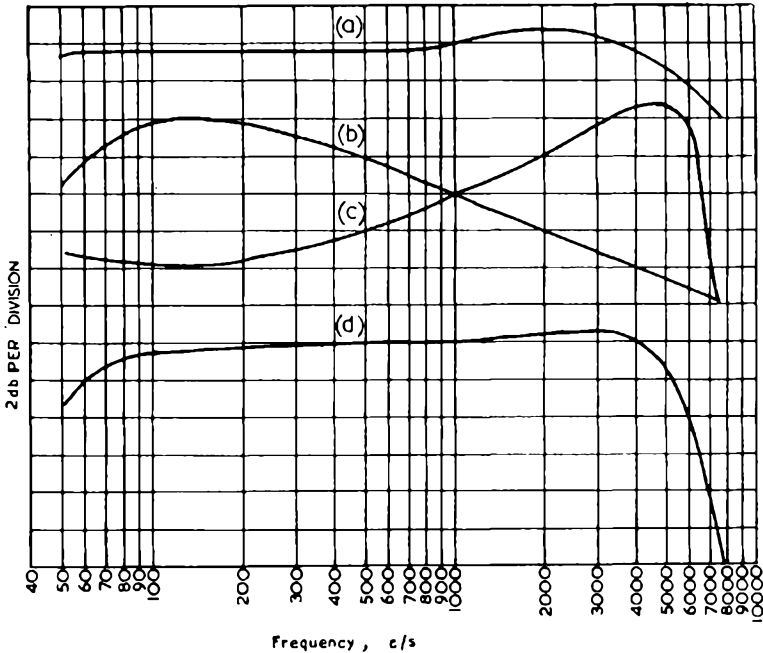

FIG. 105. FREQUENCY RESPONSE CHARACTERISTIC FOR MARCONI-STILLÉ D.P. SYSTEM

- |                                |                           |
|--------------------------------|---------------------------|
| (a) Current in recording head  | (c) Reproducing amplifier |
| (b) Output of reproducing head | (d) Overall response      |

### 6.4.8 THE TAPE

The tape used with the Marconi-Stillé system is manufactured from tungsten steel having suitable magnetic properties. Special precautions are taken to ensure that these properties do not diminish with age, and the tape is highly polished in the rolling process to give a uniformly smooth surface. The tape is 3 millimetres wide and 0.08 millimetres thick; three lengths of 1,000 metres each are joined to make a complete reel, the latter giving a recording time of rather more than 30 minutes for a tape speed of 90 metres per minute.

### 6.4.9 THE RECORDING AND REPRODUCING MACHINE<sup>2</sup>

The mechanical design of the Marconi-Stillé machine provides a satisfactory degree of speed accuracy and constancy. Speed constancy and elimination of irregularities in tension are obtained by using three motors, one of which drives the tape at constant speed through the heads, and the remaining two drive the winding and take-up spools respectively. As shown in Fig. 105, the constant-speed drive is virtually isolated from the winding and unwinding systems by the use of two reservoirs, one before and the other after the drive. The speed of the winding and unwinding motors is automatically controlled so that the reservoirs always contain a loop of tape.

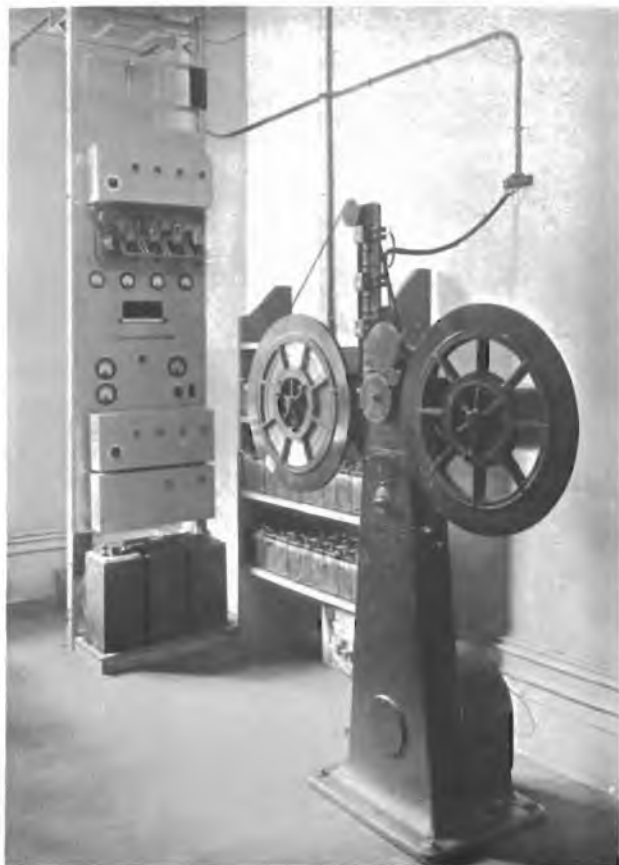

*Blattner-Stille 6-mm Tape Machine*

*First magnetic recorder used by BBC, Savoy Hill, 1930  
20-minute spools*



*Blattner-Stille 3-mm Tape Machine*

*First used at Broadcasting House for Empire Service, 1932  
30-minute spools*

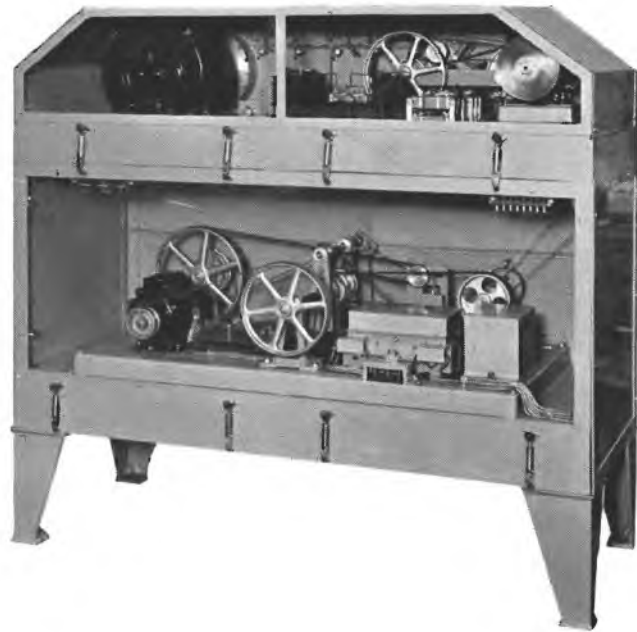

*Marconi-Stille Tape Machines*  
*Used extensively for Overseas Services from 1934 onwards*

## 6.5 THE MAGNETOPHON SYSTEM

Briefly, the principle of operation is as follows : the tape is pulled from the unwinding spool by No. 2 drive at a rate slightly faster than it is taken up by No. 3 drive and a loop forms in No. 2 reservoir. The earthed tape touches a contact which removes bias from the grid of a thyatron with a relay in the anode circuit ; the relay operates and switches resistance into the motor circuit, the motor slows down and the loop is removed, breaking the contact and restoring the thyatron to normal ; thus, the resistance is removed from the motor circuit, No. 2 drive speeds up and this sequence of operations is repeated indefinitely.

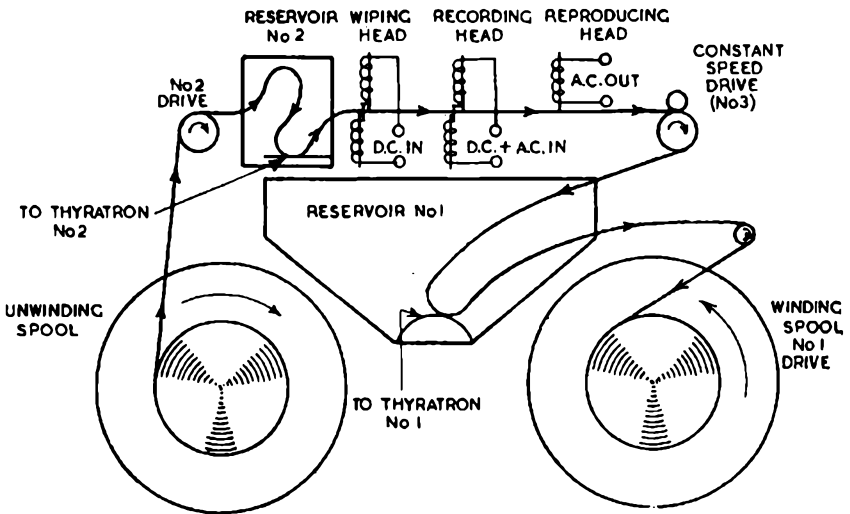

FIG. 106. SIMPLIFIED DIAGRAM OF MARCONI-STILLÉ MACHINE

On the opposite side of the machine, precisely the reverse series of operations takes place, No. 1 drive being initially slower than No. 3, the drive speed being increased by the formation of a loop in No. 1 reservoir, sufficient to touch the grid contact of thyatron No. 1.

## 6.5 THE MAGNETOPHON SYSTEM

### 6.5.1 HISTORICAL NOTE

The Magnetophon system of recording, originally developed and introduced in Germany, is based on the fundamental principles outlined in 6.2, but instead of a steel tape, uses a plastic tape coated or impregnated with iron oxide. This considerably reduces the weight and bulk of tapes, and permits the use of a driving mechanism simpler and less massive than that required for steel tape. The plastic tape was first developed in 1928 and applied to office dictation machines. Some ten years later, the method was used for sound recording by the German broadcasting organisation. Since 1945, considerable interest in



the Magnetophon system has been aroused in other countries, and a British machine of the same generic type is described in Section 6.6.

The performance of the Magnetophon system is better than that of the Marconi-Stille in that the frequency range is wider and the signal-to-noise ratio higher. A further advantage of the system is that the tape can be easily cut and joined.

#### 6.5.2 THE WIPING, RECORDING AND REPRODUCING HEADS

The three heads used in the Magnetophon system are similar in shape and consist of an annular ring of laminated permeable material, with a small gap across which the tape is pulled (Fig. 107).

The heads are constructed in two similar sections, each carrying half the total turns of wire. The gap is about 0.5 mm wide in the wiping head, 0.045 mm in the recording head and 0.02 mm in the reproducing head. Alternating currents of a frequency well above the audio range are used for both wiping and biasing.

*The Wiping Process.* An alternating magnetomotive force is applied across the gap of the wiping head by passing a current of 120 to 150 milliamps through the coil at a frequency of 35 to 40 kc/s. Let us now consider what happens when a particle of tape passes the wiping head. A magnetic field is set up across the gap, the intensity of the field being at maximum in the middle of the gap and falling away rapidly on both sides. Because of the alternating nature of the field, a particle of tape passing the gap will undergo a continually reversing magnetisation, first in a steadily increasing field and, after the middle of the gap, in a steadily decreasing one; this is illustrated in the lower half of Fig. 108. By a suitable choice of the frequency of the wiping current in relation to the speed of the tape and to the width of the gap, it is possible to ensure that, at some point on its journey across the gap, the particle is magnetised to saturation and the effect of any previous magnetisation is obliterated. In the upper part of Fig. 108, the process is traced out, but for the sake of clarity only the decreasing field is shown. As the particle enters the field, hysteresis curves of ever increasing area are described until at the middle of the gap saturation conditions are reached. After this, the particle follows continuously decreasing hysteresis curves to the origin. The recording medium thus leaves the wiping head in a completely demagnetised, i.e., non-magnetic state.

*The Recording Process.* In the Magnetophon the tape is in a completely demagnetised state as it approaches the recording head, so that unlike the tape in the Marconi-Stille system its working point is at the origin of the hysteresis loop. Any attempt to record the desired signal on the tape by applying the signal alone to the recording head would result in distortion because of the non-linearity of the curve near the origin, Fig. 109a. It would be possible

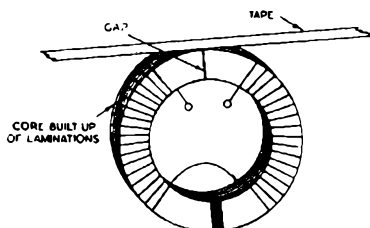

FIG. 107. MAGNETOPHON WIPING, RECORDING OR REPRODUCING HEAD: PRINCIPLES OF CONSTRUCTION

## 6.5 THE MAGNETOPHON SYSTEM

to apply a d.c. bias (in either direction) to the tape so as to remove the operating point to the centre of either the "positive" or the "negative" linear part of the  $B/H$  curve; the input signal would have to be limited to operate over the straight part of the curve.

It has been found that if a high-frequency current (e.g., 80-100 kc/s) is applied to the recording head at the same time as the signal, the distortion due to the initial curvature of the  $B/H$  curve disappears and the amplitude of the signal can be considerably greater than if a d.c. bias had been used, for we can now operate over the  $B/H$  curve on either side of the origin. The result of adding the high-frequency current to the signal current is to linearise the  $B/H$  curve as shown by Fig. 109b.

When there is no signal flux component in the gap between the pole-pieces of the recording head, the high-frequency component of the flux acts on the passing tape in exactly the same way as the demagnetising flux in the wiping head. The tape, therefore, leaves the head completely demagnetised after executing  $B/H$  excursions in the manner shown in Fig. 108.

If now there is superimposed on the biasing current a sinusoidal audio-frequency current of any specified amplitude, the force experienced by the particle during its passage past the recording-head gap will take the form shown in Fig. 110a. During the comparatively short time that the particle takes to pass the gap, the audio-frequency field is assumed to be constant. Owing to the asymmetrical nature of the curve about the axis, the particle now leaves the field in a partially magnetised state. In Fig. 110b hysteresis curves are traced illustrating what happens from the time the particle enters the field of

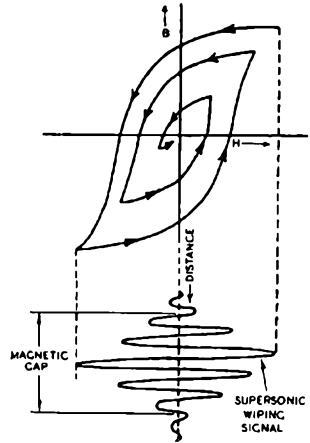

FIG. 108. WIPING PROCESS :  
MAGNETOPHON

As the tape approaches the gap, the wiping field increases, reaching saturation value at the centre; as it leaves the centre of the gap, the wiping field decreases to zero and the tape, after leaving the head is in a demagnetised state

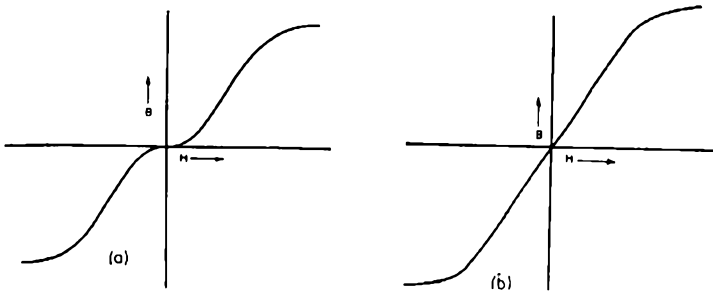

FIG. 109.  $B/H$  RELATIONSHIP AT THE STARTING-POINT OF THE  $B/H$  CURVE  
(a) without a.c. bias. (b) with a.c. bias

the recording head in a demagnetised state, point P, until the time it leaves the field, point Q. The remanent flux density of which the length PQ is a measure, is closely proportional to the instantaneous value of the audio-frequency current in the recording head over a wide range of amplitudes and it is upon this fact that the success of the a.c. biasing system largely depends.

It should be remembered, however, that in common with all magnetic recording systems, self-demagnetisation causes reduction in the remanent flux densities at the higher frequencies where particles of opposite polarity are nearer to each other, i.e., there is a tendency for the remanent flux density to fall as the frequency rises. (6.4.4.)

*The Reproducing Process.* When a recorded tape passes across the gap of a reproducing head it makes contact with the pole-pieces and because of the varying remanent flux distributed along its length, a varying magnetomotive force is applied to the magnetic circuit which induces a similarly varying e.m.f. in the coil surrounding it.

The effective permeability of the pole-piece material is reduced as the frequency increases, and some attenuation distortion is introduced. This is compensated for in the reproducing amplifier.

The magnetic gap of the reproducing head must be exactly parallel with that of the recording head or further attenuation distortion will occur on reproduction due to the comparatively small wavelengths at high audio frequencies.

6.5.3 RECORDING AND REPRODUCING CHARACTERISTICS

If the impedance of the recording head at all audio-frequencies is small compared with the anode a.c. resistance of the valve which drives it, an input signal to the valve whose amplitude is constant at all frequencies causes the head to be supplied with constant current and the amplitude of the internal flux in the tape is therefore constant at all frequencies; but it must be remembered that reproduction depends more upon external than internal flux densities and that losses at the upper frequencies occur in both recording and reproduction because the width of the gap is an appreciable fraction of the recorded wave-

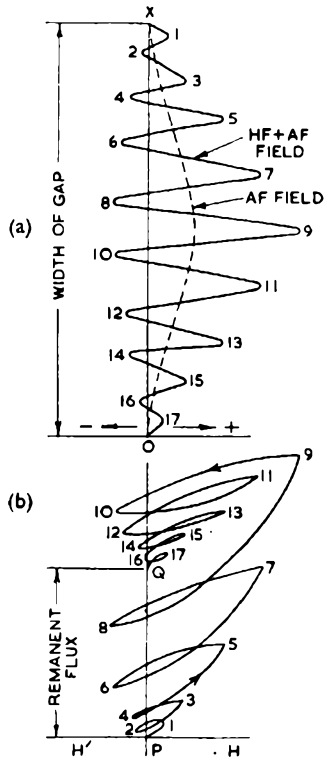

FIG. 110. EFFECT OF COMBINING H.F. BIAS AND RECORDING FIELDS. (a) showing field displaced to one side of the zero axis. (See Fig. 108.) (b) hysteresis curves resulting from the condition shown in (a). The figures indicate instantaneous values of  $B$  for corresponding values of  $H$

## 6.6 THE E.M.I. MAGNETIC RECORDER

length at the higher audio-frequencies. Additional high-frequency losses are introduced by self-demagnetisation. To compensate for these losses and to achieve a flat overall characteristic, both recording and reproducing amplifiers are given a rising characteristic.



FIG. 111. E.M.I. MAGNETIC RECORDER : GENERAL VIEW

### 6.5.4 THE TAPE

Early tapes known as Type C consisted of a cellulose acetate base coated with a layer of finely divided ferric oxide (magnetite,  $\text{Fe}_2\text{O}_3$ ) and adhesive, but these became brittle with age and tended to break when the machines were started. This difficulty was overcome by the introduction of a homogeneous tape, known as Type L, composed of polyvinyl chloride and magnetite, the tape being heat-treated and stretched after rolling.

A still later type, known as Type LG, consisted of a base layer of polyvinyl chloride which was pre-stretched along the length of the tape, and coated with a mixture of polyvinyl chloride and magnetite similar to that used in Type L. The overall thickness is no greater than that of Type L, but the pure p.v.c. base gives the tape greater mechanical strength.

## 6.6 THE E.M.I. MAGNETIC RECORDER

This is a magnetic recording machine of the same generic type as the Magnetophon.

The equipment is housed in a steel cabinet mounted on castors (Fig. 111). The head assembly and tape spools are on a metal plate at the top of the cabinet, and a control panel is placed below the plate. Amplifiers and supply units are in a cupboard below the control panel and are interconnected by plugs and sockets.

#### 6.6.1 THE DRIVE (FIG. 112)

As with the Marconi-Stillé system, there is a main constant-speed driving motor, and a separate driving motor for each spool. A rubber-faced pressure roller (3) holds the tape in contact with the spindle of a synchronous motor which drives the tape at a constant speed of 77 cm/sec (30.31 in/sec). Strobo-



FIG. 112. E.M.I. MAGNETIC RECORDER : TOP PLATE SHOWING DETAILS OF TAPE DRIVE

scopic markings on one of the guide pulleys (2) give an indication of tape speed. The spool-driving motors are arranged to maintain correct tension under all conditions and to wind the tape at high speed when required.

#### 6.6.2 HEAD ASSEMBLY. (FIG. 113)

The wiping, recording and reproducing heads are assembled as a single detachable unit, each head being fitted with a screen (6) to prevent hum pick-up from the motors. The working principle of the heads has been discussed in 6.5.2. Wiping and biasing currents are supplied by an oscillator having a frequency of 75 kc/s.

#### 6.6.3 THE CONTROL PANEL. (FIG. 114)

The operating controls are grouped on a centre panel. The principal ones are the four push-buttons marked, respectively, *Spool*, *Record*, *Replay*, and *Off*. Each one latches in position when fully depressed, and they are interlocked so that only one can be latched at a time.

When the *Record* button is depressed, current is fed to the wiping head. There is, therefore, a risk of disastrous results if the *Record* button should be inadvertently pressed in mistake for the *Replay* button. To minimise this

## 6.6 THE E.M.I. MAGNETIC RECORDER

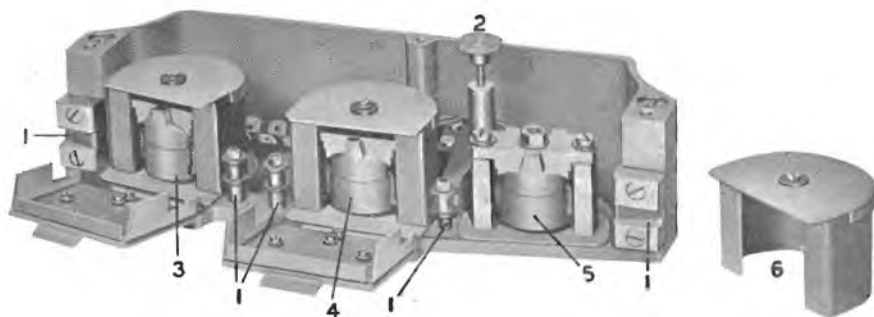

FIG. 113. E.M.I. MAGNETIC RECORDER : HEAD ASSEMBLY

risk, the *Record* button is guarded by another smaller button to the left of it which must be operated before the *Record* button can be latched.

When the *Spool* button is depressed, the control labelled *Spool* on the right-hand side of the panel is brought into operation. This varies the speed of the tape continuously from full speed forward to full speed reverse. When running at full speed, a reel of tape which plays for 21 minutes can be rewound in about 2 minutes. The variable speed control, used in conjunction with the timing device between the two spools (4, Fig. 112) is convenient for finding a particular point in the recorded programme.

A gain control (4) with its associated level meter (1) provide means for adjusting and indicating the programme volume to the recording head, whilst a



FIG. 114. E.M.I. MAGNETIC RECORDER : CONTROL PANEL

## BBC RECORDING TRAINING MANUAL

selector switch (7) permits monitoring on either the incoming or the recorded programme.

The button marked *Sync.* operates a brake which slightly slows down the main-drive motor. When two machines are used for a continuous reproduction, this can be of value in ensuring accurate synchronism between two successive reels provided an adequate overlap has been recorded. In addition a pair of headphones is needed and means for connecting one earpiece to the output of each reproducing head. The operator must make certain of starting the "incoming" reel very slightly ahead of the outgoing one ; by means of his headphones and the *Sync.* button he should then be able to bring the incoming reel into synchronism before changing over to this reel.

### *References*

- 1 A. E. Barrett and C. J. F. Tweed. "Some Aspects of Magnetic Recording and its Applications to Broadcasting," *Journal of the I.E.E.*, 1938. 82, 495.
- 2 Technical Instructions, Volume 1, Item 6.1.
- 3 M. J. L. Pulling. "The Magnetophon Sound Recording and Reproducing System." *British Intelligence Objectives Sub-committee. Final Report No. 951, Items 7 and 9.* H.M. Stationery Office.

## CHAPTER 7

### FILM RECORDING AND REPRODUCTION

#### 7.1 INTRODUCTION

**T**HE basic principle of recording sound on photographic film is to expose the photo-sensitive surface to varying degrees of light, the intensity and frequency of the variations corresponding with those of the signal to be recorded.

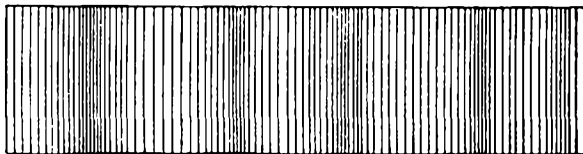

FIG. 115 VARIABLE-DENSITY SOUND TRACK

The sound track on the film takes one of two forms, designated variable density and variable width. A variable-density track (Fig. 115) is of constant width and varying density, the density variation being proportional to the amplitude and frequency of the recorded signal. A variable-density track may be produced by two different methods : in one the film is exposed to a



FIG. 116. VARIABLE-WIDTH SOUND TRACK

light of constant intensity, focused on it through a narrow slit, the effective width of which is varied according to the waveform of the signal ; in the other method the slit width is kept constant and the intensity of the light source varied.

A variable-width track (Fig. 116) consists of a transparent area adjoining an opaque area, the dividing line between the two having the waveform of the recorded signal. In the Philips-Müller system, the sound track is cut on the film by a stylus, as in disk recording, the track being similar to that shown in Fig. 116.



## 7.2 VARIABLE-DENSITY RECORDING

### 7.2.1 THE VARIABLE LIGHT-INTENSITY METHOD

This was the first method to be used commercially ; the light strikes the film through a slit of constant width interposed between a gaseous discharge lamp and the moving film. The lamp is designed to operate with d.c. bias and gives a fairly intense beam of light under "no-signal" conditions. The signal to be recorded varies the d.c. bias and produces corresponding changes in light intensity.

### 7.2.2 THE VARIABLE SLIT-WIDTH METHOD

In this method, light of constant intensity is focused by a lens system on a *light-valve*, consisting of a slit, the effective width of which is varied in accordance with the waveform of the signal to be recorded, the modulated light flux transmitted through the valve being focused on the film by a second optical system. The width of the slit is varied in a direction parallel to the motion of the film.

A conductor carrying a current and situated in a magnetic field is subjected to a force proportional to the magnitude of the current. If the current varies, the conductor moves a distance proportional to the change of current. If the two ends of the conductor are fixed, it tends to bow when a current is passed through it, and if the length of the conductor is great compared with its other dimensions, the centre portion moves parallel to itself.

Light valves commonly use two duralumin ribbons arranged so that the current flows through them in opposite directions. Depending on the direction of the signal current, the ribbons tend to close up or move apart, narrowing or widening the aperture between them and modulating the light flux passing through the valve. If the ribbons are mounted in the same plane they may collide during periods of heavy modulation ; this not only causes damage to the ribbons but produces a distorted sound track. To avoid this, they are placed close together but in parallel planes.

The ribbons have a natural resonance depending on their mass and tension, and because of the excessive displacement produced at the resonant frequency the ribbon tension is adjusted so that this frequency is above the range of frequencies to be recorded.

## 7.3 VARIABLE-WIDTH RECORDING

In this system, an image of a constant-intensity light source is focused upon a galvanometer mirror, from which the light is reflected on to the film through a slit of constant width. The signal currents cause orientation of the galvanometer mirror, allowing either more or less of the length of the slit to be illuminated. The track is of variable width but has constant density and, under no-signal conditions, one half of the slit is illuminated and one half of the sound track exposed, variations in the signal causing a movement of the light beam either way about the mean position.

In the system illustrated in Fig. 117, light from an exciter lamp is focused on a mask by a spherical lens to produce an intense beam of rectangular cross-

## 7.4 THE EFFECT OF RECORDING-SLIT WIDTH

section which, after reflection from the galvanometer mirror, is concentrated on the slit by cylindrical and spherical lenses. A reduced image of the slit is formed on the photo-sensitive surface of the film by the microscope objective, the function of which is to reduce the effective width of the light slit (7.4) and to improve the high-frequency response. When signal voltages are applied to the terminals of the galvanometer loop the mirror is deflected through a small angle and the image of the mask aperture is swept across the light slit,

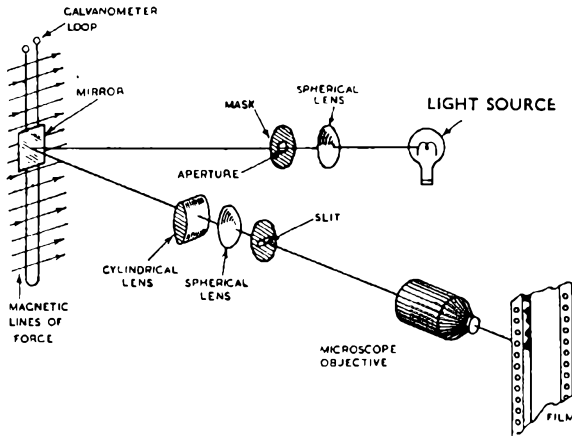

FIG. 117. A METHOD OF VARIABLE-WIDTH RECORDING

illuminating more or less of its length and producing a variable-width track of the type illustrated in Fig. 118(a). Another type of track, known as the bilateral (Fig. 118(b)) is obtained with a triangular aperture, the light beam being moved at right angles to the slit.

## 7.4 THE EFFECT OF RECORDING-SLIT WIDTH

If the recorded wavelength is comparable with the width of the slit (App. F.) second harmonic distortion and attenuation distortion are produced in exactly the same way as in magnetic recording when the longitudinal width of the recording field is appreciable. To minimise both forms of distortion the width of the slit should be small compared with the wavelength at the highest frequency to be recorded. At the standard film speed of 90 feet per minute, the wavelength of a 9,000 c/s signal is 0.002 inch. As the width of the slit is reduced, the amount of light reaching the film becomes insufficient for proper exposure and a compromise has to be adopted. The effective slit width is normally 0.001 inch in variable-width recording, and the mean value is 0.0005 inch in variable-density recording.

## 7.5 PUSH-PULL RECORDING

### 7.5.1 GENERAL

The principle of push-pull operation has been applied both to variable-density and to variable-width recording to cancel out harmonic distortion. It

involves the use of two sound tracks on the film which are reproduced by a photocell, containing two anodes and two cathodes.

Push-pull recording may be of three types : Class A, Class B or Class AB, the notation having the same significance as in valve amplifiers.

7.5.2 VARIABLE-DENSITY PUSH-PULL RECORDING

Push-pull variable-density recording is achieved by the use of a light valve with two pairs of ribbons, which expose two tracks in the area usually occupied by the single track. The modulation of light flux produced by each pair of ribbons may be in phase or in anti-phase depending on the external connections. In Class-A operation, each pair receives half the total signal energy and the resulting tracks are identical but in anti-phase ; in the Class-B track the ribbons are connected in phase opposition, one pair receiving the positive half and the other the negative half of the signal. The Class-A track is generally preferred because Class-B requires the reproducing circuits to be very accurately balanced to avoid distortion.

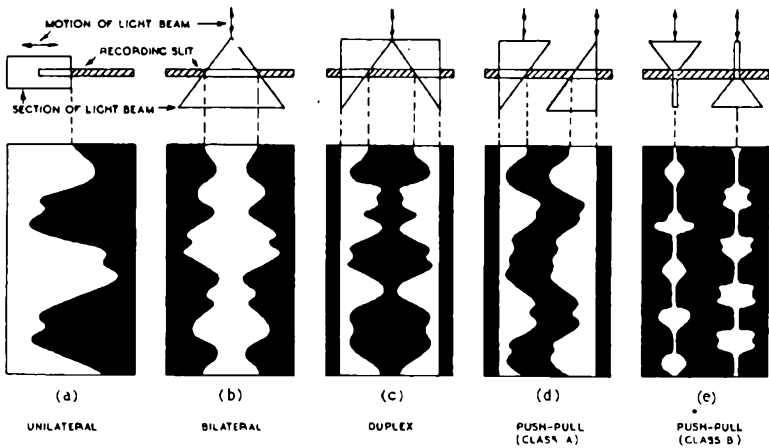

FIG. 118. TYPES OF VARIABLE-WIDTH TRACK

7.5.3 VARIABLE-WIDTH PUSH-PULL RECORDING

The sound track in a push-pull variable-width recording system is in two distinct parts, each of which is produced by light passing through an aperture, usually of triangular shape, in a mask situated in the optical system. The images of the two apertures are focused on a single parallel slit and produce two sound tracks out of phase with each other; the two tracks are brought into phase on reproduction by a double-photocell sound head. The position of the images, relative to the slit, decides the type of push-pull operation obtained ; Figs. 118(c), 118(d) and 118(e) illustrate a number of common arrangements and show the type of sound track obtained from each.

## 7.6 NOISE REDUCTION IN PHOTOGRAPHIC FILM RECORDING

### 7.6 NOISE REDUCTION IN PHOTOGRAPHIC FILM RECORDING

#### 7.6.1 GENERAL

The volume range which can be accommodated by a film recording system is determined by the maximum signal amplitude which can be accepted by the amplifiers and recording heads without overloading, and by the noise introduced on reproduction.

Noise can be reduced and dynamic range and signal-to-noise ratio correspondingly improved by using a rising high-frequency characteristic in the recording amplifier and an inverse characteristic in the reproducing amplifier.

The general method of noise reduction employs the "squeeze track" principle. This can best be explained by first considering its application to variable-width recording.

#### 7.6.2 NOISE REDUCTION WITH VARIABLE-WIDTH RECORDING

During reproduction of a variable-width track, Fig. 118(a), the transparent

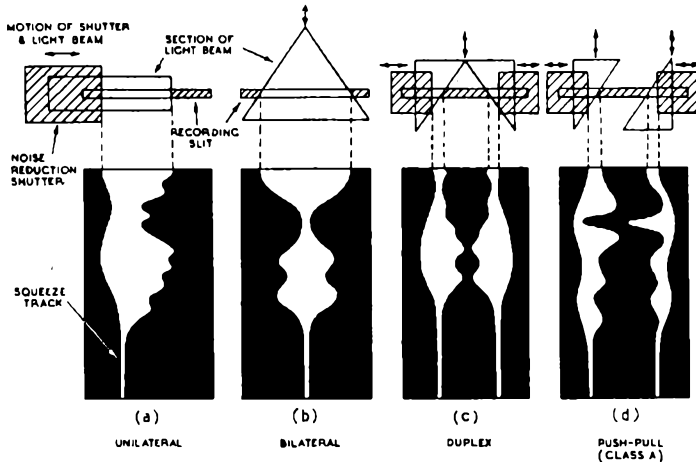

FIG. 119. VARIABLE-WIDTH TRACKS WITH NOISE REDUCTION

part of the track should produce no output from the photocell other than that due to the recorded signal, but in practice this area contains specks of silver, dirt and abrasions which interrupt the light beam and give rise to noise. Since these particles are distributed at random throughout the clear part of the track, the amount of noise reproduced is directly proportional to the width of the track. Since, in addition, the noise generated by the photocell itself is proportioned to the amount of light falling upon it, noise reduction may be effected by keeping the width of the transparent area as small as possible with no signal. This may be accomplished in two ways.

In the first method, a d.c. bias is fed to the modulating device so that, under no-signal conditions, it produces a very narrow transparent track known as the "squeeze track." During recording, the d.c. bias is reduced by the

addition of another bias of opposite polarity, the value of which is directly proportional to the signal amplitude. The bias values are so chosen that the clear part of the track is at all times just wide enough to accommodate the signal to be recorded.

In the second method, which is more frequently used, the galvanometer operates normally and a d.c. bias, directly proportional to the signal amplitude, controls the position of a shutter situated in the light path. The shutter is so biased that, in the absence of a signal, it cuts off all light from the film except for a very thin pencil which produces a squeeze track, and the bias is automatically reduced when a signal is received so that the light beam and the clear area are widened in order to accommodate the amplitude. The type of track given by this arrangement is illustrated in Fig. 119(a).

More recently a different type of mask with an aperture in the shape of an isosceles triangle has been adopted. The image of the triangle is moved at right angles to the slit to produce the bilateral type of track shown in Fig. 118(b). In this system, noise reduction is accomplished without a shutter, by biasing the galvanometer movement, and the type of track given is as indicated in Fig. 119(b).

No shutters are necessary to produce the Class-B track illustrated in Fig. 118(e), the squeeze track being obtained automatically by the thin "tail" attached to the apex of the triangular images. In the systems illustrated in Figs. 118(c) and 118(d) two shutters are necessary; they are rectangular in shape and move parallel with the slit, both being biased so that they move towards the centre of the slit in the absence of modulation. The mechanical arrangement and the type of track obtained are illustrated in Figs. 119(c) and 119(d).

#### 7.6.3 NOISE REDUCTION WITH VARIABLE DENSITY

The ribbons in the light valve of a variable-density system have a normal spacing of 0.0005 inch. Noise reduction may be applied to such a system by reducing the spacing of the ribbons to a smaller value for small signal inputs, and by increasing the spacing for larger signals.

#### 7.6.4 NOISE-REDUCTION CIRCUITS

To give maximum noise reduction, the bias applied to the shutters or modulator should be directly proportional to the instantaneous amplitude of the signal to be recorded. This objective is unattainable in practice, for such a system requires perfect amplifiers and rectifiers in the noise reduction chain and prohibits the use of frequency discriminating circuits. Moreover, some time lag is inevitable in moving a shutter. The bias is therefore varied at a very low, inaudible, frequency.

Practical circuits contain an amplifier and a full-wave rectifier followed by a filter as shown in the simplified circuit diagram (Fig. 120). The fixed d.c. bias is obtained from a battery via the high-value resistor R and the gain of the amplifier is adjusted so that, at maximum signal amplitude, the battery bias is completely cancelled by the output of the rectifier.

## 7.7 REPRODUCTION OF PHOTOGRAPHIC FILM RECORDING

In addition to the d.c. component, the output of the rectifier contains an a.c. component of double the frequency of the signal input to the amplifier. As this would produce harmonic distortion if allowed to modulate the track, a low-pass filter is introduced to suppress all audible components in the rectifier output causing the shutter to operate at a frequency below audibility.

### 7.7 REPRODUCTION OF PHOTOGRAPHIC FILM RECORDING

#### 7.7.1 SYNCHRONISING SOUND AND PICTURES.

Although it is possible to record both sound and picture on the same film, the two are usually taken separately and the tracks combined in the final prints

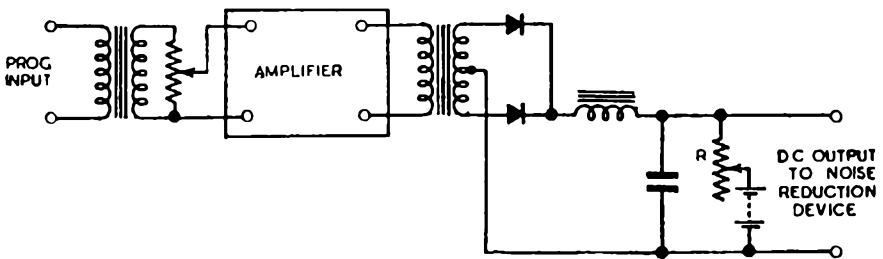

FIG. 120. SIMPLIFIED CIRCUIT FOR PRODUCING D.C. BIAS

issued to exhibitors. The projector, therefore, performs two separate functions, in that it reproduces both picture and sound. In order to project the picture, the film is moved through the aperture in regularly spaced jerks, so as to expose 24 still pictures per second. The film must, however, travel through the sound-reproducing head at constant speed; a loop is therefore formed between the picture aperture and the sound head to smooth out the intermittent motion. The smoothing is improved by interposing one or more idler rollers before the film reaches the constant-speed sprocket in the sound head.

In the final print, the picture and sound tracks are staggered to the extent of 19 pictures, or  $14\frac{1}{4}$  inches, and provided this distance is correctly gauged when setting up the film in the projector, accurate synchronisation of sound and picture is maintained throughout the film.

#### 7.7.2 PRINCIPLES OF REPRODUCTION

The sound-reproducing head for both variable-width and variable-density tracks comprises a light source, an optical system and a photocell. The optical system includes a series of focusing lenses, a narrow slit and the sound track itself. As the film is driven past the slit, the modulated sound track varies the amount of light falling on the photo cell, causing alternating e.m.f.'s to be produced between anode and cathode of the cell, the waveform of the e.m.f.'s corresponding with that of the track.

In the direct-scanning system the slit is situated between the light and the film and in the alternative rear-scanning system the slit is between the film and the photo cell.

## BBC RECORDING TRAINING MANUAL

### 7.7.3 THE EFFECT OF THE REPRODUCING-SLIT WIDTH

As in recording, the width of the slit has a great effect on the quality of the reproduced sound. If the slit is too wide, attenuation distortion occurs at the higher frequencies, whilst if it is too narrow the output of the photocell falls below a convenient level. A compromise is necessary and the standard width normally used is 0.00075 inch or 0.75 mil.

As shown in Appendix F, if the recorded wavelength is equal to the width of the slit, the output of the photocell is zero since the reproducing light beam is modulated by the positive and negative half cycles of the recorded signal simultaneously. The frequency at which this occurs is known as the "extinction frequency" and its value is 24,000 c/s for cinema-film reproduction. For a constant-amplitude recording the output of the photocell is nearly constant up to the frequency for which the recorded wavelength is equal to twice the width of the slit (12,000 c/s for cinema film).

### 7.7.4 THE PHOTOCELL

A photocell is a device for converting light energy into electrical energy. There are a number of different types operating on different principles, but in sound-film reproduction only the most sensitive, namely the photo-emissive, type is used.

Photo-emissive cells operate on the principle that when radiant energy falls on certain metals, electrons are emitted at a rate directly proportional to the total amount of light incident on the surface. A photo-emissive cell is, in effect, a diode valve in which the cathode emits electrons when subjected to light instead of heat.

Only a few metals such as sodium, potassium, rubidium and caesium emit electrons in appreciable quantity under the action of light, and each is most sensitive to a narrow band of light frequencies. Those used in cinema-film reproduction usually have a caesium-coated cathode, and they may be gas-filled or of the vacuum type; the former are the more sensitive, emission being increased by the ionisation of the gas when bombarded by the electrons from the cathode.

The relationship between photocell current and light intensity depends on a number of factors including the value of the anode load; the frequency response of the cell falls off at high frequencies because of the capacitance between the anode and cathode and a low anode-load resistance is necessary to minimise this loss. To minimise capacitance in the output circuit of the cell, it is customary to mount the first valve of the photocell amplifier in very close proximity to the cell.

## 7.8 ADVANTAGES AND DISADVANTAGES OF PHOTOGRAPHIC FILM RECORDING

The photographic film recording system is capable of excellent quality but has a number of disadvantages which, apart from television, make it unsuitable for adoption by the BBC. Firstly, its use involves processing, i.e., the development of negatives and the subsequent production of positive prints. This normally occupies at least twelve hours and precludes immediate playback

## 7.9 PHILIPS-MILLER NON-PHOTOGRAPHIC FILM RECORDING SYSTEM

and comprehensive checking, i.e., listening to the recorded version of the programme during the recording process. A second disadvantage is its relatively high cost compared with magnetic recording or with the direct-recorded disk system.

### 7.9 THE PHILIPS-MILLER NON-PHOTOGRAPHIC FILM RECORDING SYSTEM

#### 7.9.1 INTRODUCTION

The Philips-Miller system was designed to eliminate as far as possible the above disadvantages, at the same time producing technical results comparable with those of photographic film recording. The system involves no processing, and not only can it be reproduced as soon as the recorded film is rewound, but during the recording process also. Moreover, the recorded film can be edited by cutting, and visible cue-marking, for linking consecutive films, is a useful feature of the system.

#### 7.9.2 PRINCIPLES OF THE PHILIPS-MILLER SYSTEM

*General.* The unique feature of this system is that the sound is recorded by means of an electromagnetic head employing a sapphire cutter which removes a thin opaque layer from a special type of film. A bilateral variable-width track is produced similar to that shown in Fig. 119(b). This is reproduced in the same way as photographic film.

The shape of the cutting point (Fig. 121) bears some resemblance to that of a disk-recording cutter but the direction of motion is perpendicular to the surface of the film. This motion is achieved by mounting the cutter at right angles to the armature (Fig. 125). The cutter thus produces a hill-and-dale track in the film, but, as will be seen, it is the width of this track in the surface of the film in which we are interested.

*The Film.* As illustrated in Fig. 121, the film consists of three layers; a celluloid base, a middle layer of soft gelatine and a very fine surface skin of black mercuric sulphide, 3 microns in thickness (1 micron = 0.001 mm). The opaque material is applied very evenly during manufacture and is in a very fine state of division, having no sign of granular structure even under microscopic examination.\* The celluloid base gives the film mechanical strength and the gelatine layer is

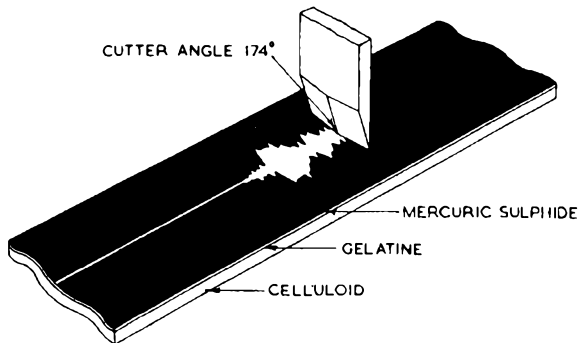

FIG. 121. CONSTRUCTION OF PHILIPS-MILLER FILM (NOT TO SCALE)

\*  $\times 100$  diameters



provided to accommodate the hill-and-dale displacement of the cutter ; its thickness (approximately 0.002 in.) exceeds the greatest cutter amplitude and prevents blunting of the cutter tip by contact with the tough celluloid base. Both the celluloid and gelatine layers are transparent and the sound track is formed by cutting away the opaque skin by a sapphire cutter having a broad V-shaped tip. A vertical section through a recorded film, parallel to the length of the film passing through the sapphire tip, is shown in Fig. 122.

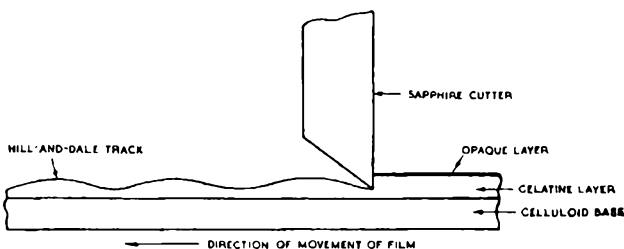

FIG. 122. SECTION THROUGH PHILIPS-MILLER FILM, SHOWING HILL-AND-DALE TRACK

To minimise bulk, it is desirable that the film should be thin and since recording is produced by the vertical displacement in the gelatine layer, the tip of the cutter is given a very obtuse angle to produce the greatest width of cut possible for a given vertical displacement. The mechanical amplification thus obtained makes necessary great constancy in the thickness of the film, for any variation in thickness causes a great change in the width of the cut.

*The Sapphire Cutter.* A greatly enlarged view of the sapphire cutter is given in Fig. 122.

The mechanical amplification  $w/d$ , i.e., the ratio between the width  $w$  and the depth of cut  $d$  is given by

$$w = 2d \tan A/2$$

where  $A$  is the angle at the cutter point.

The value chosen for  $A = 174^\circ$  and the mechanical amplification  $w/d$  is given by  $2 \tan 87^\circ = 38.16$ . This obtuse angle not only permits the use of film which is no thicker than normal cinematograph stock but has the advantage that only minute vertical movements of the cutter are needed to produce an effective sound track. Even for signals at peak level the maximum vertical displacement of the cutter is only 0.00125 inch, corresponding to a maximum track width of approximately  $40 \times 0.00125 = 0.05$  inch.

*Limitation of Amplitude.* A limitation to the amplitude which can be recorded is set by the back angle of the cutter and this limitation is most severe in the upper audio frequencies. The back angle is  $55^\circ$ , this being the minimum which can be tolerated having due regard to strength and durability. It follows that the angle between the plane of the film surface and the back edge of the sapphire is  $35^\circ$  (Fig. 123). Therefore, if the slope of the

## 7.9 PHILIPS-MILLER NON-PHOTOGRAPHIC FILM RECORDING SYSTEM

recorded waveform (Fig. 121) exceeds  $35^\circ$ , distortion of the sound track is inevitable.

Now the Philips-Miller system is designed for an upper frequency limit of 8,000 c/s, and the amplitude of a wave of this frequency which has a gradient of  $35^\circ$  is 0.00017 inch. Consequently this is the limiting amplitude at this frequency and the corresponding width of the track in the surface of the film is  $38.16 \times 2 \times 0.00017$  inch or 0.013 inch approximately.

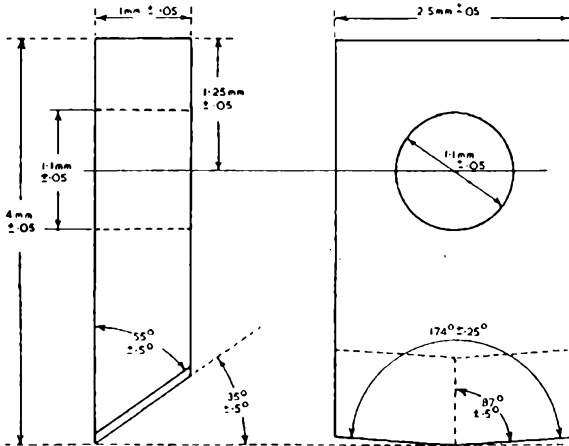

FIG. 123. DIMENSIONS OF PHILIPS-MILLER SAPPHIRE CUTTER

The amplitudes occurring at 8,000 c/s in speech and music are generally small compared with those of middle and low audio frequencies and, when the maximum signal amplitudes at middle frequencies (say 300 to 1,000 c/s) are arranged to produce maximum track width, the maximum amplitudes at 8,000 c/s are usually below the limit of 0.013 inch. This is not always the case, however, and care has to be taken when recording speakers who are particularly sibilant, otherwise distortion usually described as “s-blasting” may result.

*Ground-noise Reduction.* A high signal/noise ratio is obtained in the Philips-Miller system by biasing the cutter to an extent dependent on the average amplitude of the signal in much the same way as in photographic film recording. The recording head is supplied with signal current (a.c.) from the recording amplifier and with a d.c. biasing current from a ground-noise reduction amplifier. The d.c. component tends to pull the cutter away from the film and its magnitude is inversely proportional to the recorded signal strength. Under no-signal conditions, i.e., with the cutter withdrawn from the film to a maximum extent, the recording head is adjusted mechanically to give a very fine squeeze track. On receipt of a signal the d.c. bias falls and the cutter penetrates farther into the gelatine layer so that the amplitude of vertical oscillation can be accommodated.

## BBC RECORDING TRAINING MANUAL

The ground-noise reduction amplifier is adjusted to give the correct relationship between a.c. and d.c. components.

If a pulse of short duration is applied to the recording amplifier, the d.c. bias falls almost instantaneously to enable the waveform of the pulse to be accurately recorded, but in order to avoid imposing extra modulation on the film at the end of the pulse the d.c. bias returns comparatively slowly to its original value. The RC circuit controlling the return time has a time constant of 40 milliseconds. (See 7.11.1.)

*Reproduction.* The principles of reproduction are similar to those of photographically-recorded film. The film is driven past a narrow slit; a beam of light from an exciter lamp falls on the slit and by means of a lens an image of the slit is focused on the surface of the film. The transmitted light impinges on the

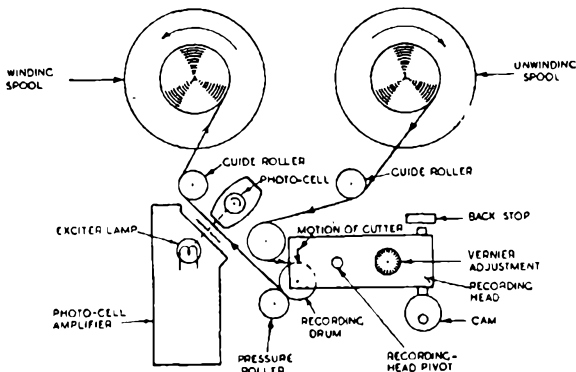

FIG. 124. MECHANICAL ARRANGEMENT OF PHILIPS-MILLER MACHINE

cathode of a photocell via a cylindrical lens. Hence the e.m.f.'s produced between cathode and anode of the cell when an external circuit is connected across them, vary in frequency and amplitude, producing a waveform corresponding with that of the recorded signal.

### 7.10 THE PHILIPS-MILLER MACHINE

#### 7.10.1 GENERAL

A simplified diagram illustrating the mechanical arrangements of a Philips-Miller machine is given in Fig. 124. The film is moved at a constant speed of 60 feet per minute by a recording drum; it is pressed firmly to the drum by a rubber-faced roller. The recording is made as the film passes over the recording drum and reproduction may be carried out almost immediately by means of the exciter lamp, light slit, photocell and amplifier. To enable recordings and reproductions of any length to be made, each machine includes two complete units, mounted side by side in two wells of a massive pedestal (Fig. 125). Both units are supported on rubber strips to minimise vibration from the main drive mechanism.

## 7.10 THE PHILIPS-MILLER MACHINE

A standard reel of film gives 15 minutes' recording time and can be rewound in about 2 minutes.

### 7.10.2 THE MAIN DRIVE

The main drive consists of a 3-phase synchronous motor which drives the recording drum, through a heavy flywheel. This arrangement, together with accurate machining of the recording drum, ensures that speed accuracy and constancy are maintained within acceptable limits. The motor shaft is nearly



FIG. 125. PHILIPS-MILLER RECORDING AND REPRODUCING MACHINE

vertical and is in the same straight line as a layshaft which it drives via a flexible leather coupling. A separate parallel shaft carries the recording drum at the top and a heavy flywheel at the bottom, the latter being driven by a rubber roller on the layshaft which makes contact with the inside of the rim.

Because of the inertia of the flywheel, some slip occurs between the flywheel and driving roller when starting the machine. To prevent this slip causing undue wear to the driving roller, the layshaft carries a hard starting roller. When the starting control is operated, the flywheel is first run up to speed on the starting roller; a further movement of the control causes the motor to be moved downwards bodily, freeing the starting roller and engaging the running roller.

## BBC RECORDING TRAINING MANUAL

### 7.10.3 THE SUBSIDIARY DRIVES

Because the film is driven at a constant linear speed, the winding and unwinding spools run at varying speeds, dependent on the amount of film on each. The problem of driving these spools is solved by a mechanical system in some machines and by the use of additional electric motors in others.

In the mechanical system the take-up spool is driven from the layshaft by a belt and a friction clutch and, to allow for the varying amount of film on the spool, the pressure between the clutch plates is automatically regulated by a pivoted lever the free end of which rests against the outside of the spool. The unwinding spool is rotated by the pull of the film, frictional resistance being provided by a pad to prevent over-running. By movement of the control lever the belt system can be arranged to drive the two spools in the opposite direction to give a quick rewind facility.

In the electrical system the winding and unwinding spools are driven by separate 3-phase motors which are connected in parallel via fixed resistors arranged so that, if one motor is connected directly to the mains supply, the other is energised via the resistors and runs at reduced torque. During recording and reproduction the mains supply is connected directly to the winding-spool motor and the unwinding motor runs at reduced torque, keeping the film under even tension. For rewinding, the right-hand spool (Fig. 124) is driven in the reverse direction by connecting the mains supply directly to the motor, one phase being reversed; the left-hand motor runs at reduced torque. A fast rewind speed is obtained by releasing the film from the recording drum so that it passes over guide rollers only.

### 7.10.4 THE RECORDING DRUM

The functions of the recording drum are to drive the film past the cutter at a constant and accurate speed, and to provide a base or *anvil* for the film during the cutting operation. To give correct pitch and programme timing, the diameter of the drum must be accurately machined to the required value. Since, as it passes round the drum, the film is cut by the vertical displacement of the sapphire point, any unevenness in the surface of the drum causes irregularities in the sound track additional to those caused by the modulation signal. The surface of the drum must be mirror-smooth, since microscopic blemishes can cause increased background noise, irrespective of the quality of the film. For example, an irregularity of  $1/1,000$  inch in the diameter of the drum causes a variation in track width of  $40/1,000$  inch, nearly equal to 100 per cent. modulation. If the squeeze track is  $0.001$  inch wide and a variation of 10 per cent. is permitted, the drum diameter must be accurate to  $1/40,000$  inch. A particle of dust may exceed this dimension appreciably, which emphasises the need for extreme cleanliness of the drum.

### 7.10.5 THE RECORDING HEAD

The recording head consists of a massive brass block carrying the electro-mechanical movement at one end and a micrometer screw adjustment at the other. The head is mounted on a supporting post on the bed-plate of the

## 7.10 THE PHILIPS-MILLER MACHINE

machine and during recording is locked in position by rotation of a cam (Fig. 123) which engages with a bolt passing through the head. The position of the bolt is regulated by the micrometer screw which controls the depth of cut and hence the width of the squeeze track.

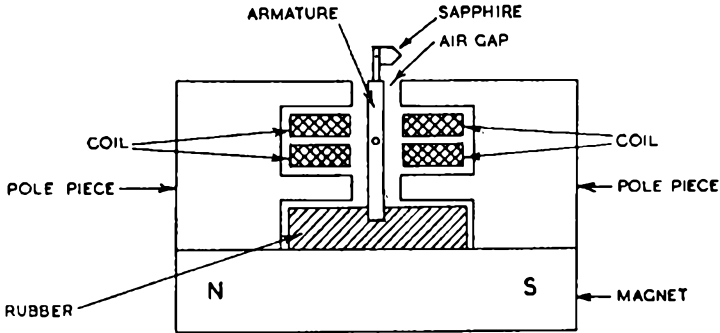

FIG. 126. CONSTRUCTION OF PHILIPS-MILLER RECORDING HEAD

The recording head proper contains a balanced armature movement and a magnetic system incorporating a bar magnet (Fig. 126). The armature is embedded at one end in a block of rubber which provides the damping and some of the compliance of the vibrating system. Resonance occurs at about 4,500 c/s but the rise in amplitude is very small and is corrected by a fixed equaliser in the recording amplifier.

### 7.10.6 REPRODUCTION

The reproducing system is illustrated diagrammatically in Fig. 127. Light from the exciter lamp is focused by a lens on a slit cut in a disk, which can be

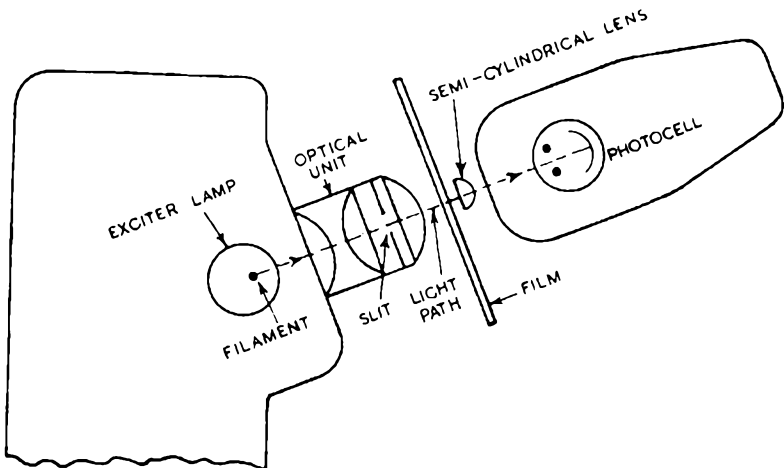

FIG. 127. PHILIPS-MILLER REPRODUCING SYSTEM

rotated by a screw mechanism to ensure that the slit is at right angles to the direction of movement of the film. The effective slit width is optically reduced by a second lens which focuses an image of the slit on the surface of the film. The beam of light is modulated by the sound track on the film and passes through an aperture in the film guide, reaching the cathode of the photocell via a semi-cylindrical lens mounted at the back of the guide.

This lens is introduced for the following reasons: because of the hill-and-dale incursion in the film, the angle between light beam and film surface is continually varying in accordance with the signal waveform; as a result, the light emerging from the film is deflected in the plane at right angles to the slit. The semi-cylindrical lens has the effect of concentrating the oscillating beam on a restricted area of the cathode.

The width of the band of light formed on the film, i.e., the effective width of the light slit, is 0.00075 inch, half the wavelength of an 8,000 c/s signal at a film speed of 60 ft/min. Because the width of the slit is comparable with the recorded wavelengths at high frequencies, scanning losses result, amounting to 6 db at 10,000 c/s. (App. F.) These losses are corrected by an equaliser in the reproducing amplifier.

7.11 PHILIPS-MILLER AMPLIFIERS

7.11.1 RECORDING

The recording chain comprises a BBC limiter, a voltage amplifier, a combined power and ground-noise-reduction amplifier, and aural and visual monitoring facilities. Each machine has its own power amplifier but the remainder of the equipment is common to both machines.

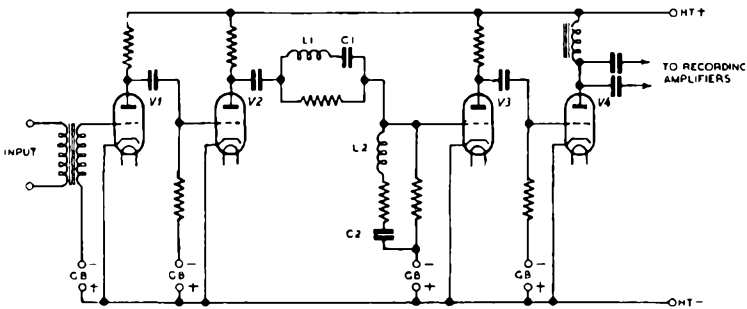

FIG. 128. VOLTAGE AMPLIFIER

*The Voltage Amplifier.* As shown in the simplified circuit diagram (Fig. 128), the gain amplifier comprises four RC-coupled triode stages with choke-capacitance output feeding both power amplifiers via separate capacitors. The frequency correction circuits included between the second and third stages are designed to counteract the attenuation distortion occurring in the recording head. The rejector circuit L2, C2 is tuned to 4,500 c/s and gives a sharp dip

## 7.11 PHILIPS-MILLER AMPLIFIERS

of about 5 db to offset the effect of resonance in the armature suspension. The acceptor circuit  $L_1, C_1$  is tuned to 8,000 c/s to give the amplifier a rising response above 4,500 c/s to counterbalance the falling response of the head above resonance.

*The Power and Ground-noise-reduction Amplifier.* A simplified circuit diagram of the power and ground-noise-reduction amplifier is given in Fig. 129. The power amplifier consists of a single triode  $V_1$  deriving its input signal from the output of the voltage amplifier and feeding the recording head via a parallel-fed matching transformer  $T_1$ .

The two direct-coupled valves  $V_2$  and  $V_3$  form the ground-noise-reduction amplifier which is fed via the transformer  $T_2$  from the p.d. developed across the small resistor  $R_2$  connected in series with the head. The secondary of  $T_2$  is loaded by a potentiometer  $R_3$  and its output is applied between one diode

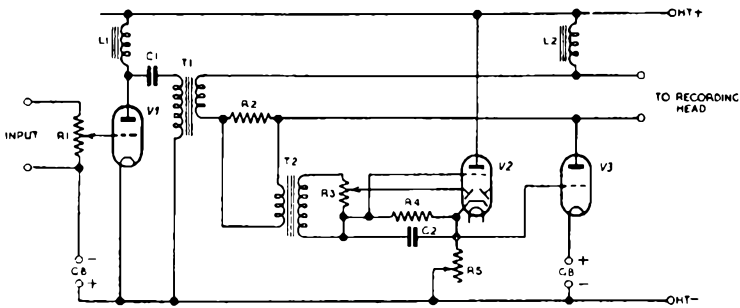

FIG. 129. POWER AND GROUND-NOISE-REDUCTION AMPLIFIER

anode and the cathode of the double-diode-triode  $V_2$ . Rectification occurs and the d.c. bias developed across the diode load  $R_4$  is used to bias the grid of the triode section negatively, reducing its anode current and hence the p.d. across  $R_5$ .

With no input to the ground-noise-reduction amplifier the anode current of  $V_3$ , which passes through  $L_2$  and the recording head, has a value dependent on the steady p.d. across  $R_5$  and the bias applied to its filament. This current tends to withdraw the cutter from the film and the value of the anode current can be controlled by varying  $R_5$  to give the desired width of squeeze track. When a signal is applied to the ground-noise-reduction amplifier the p.d. across  $R_5$  falls and the consequent drop in anode current of  $V_3$  allows the sapphire to penetrate deeper into the film. The larger the input signal to  $V_2$  the more deeply the cutter penetrates.

When a signal is applied to the recording amplifier, the time taken for the d.c. bias to fall is determined by the time constant of the conduction resistance,  $R_d$  of the diode detector and the capacitance of  $C_2$ . As  $R_d$  is very small, the time constant is small and the d.c. bias falls almost instantaneously. On removal of the input signal, the time taken for the bias to return to its normal



value is determined by the network R<sub>4</sub>, C<sub>2</sub>, which has a time constant of 40 milliseconds.

7.11.2 REPRODUCING

*The Photocell Amplifier.* The valve of the photocell amplifier is a triode mounted in a cushioned holder immediately behind the photocell itself and in the same screened container. The remaining components of the amplifier, not shown in full in Fig. 130, are situated in the same housing as the exciter lamp.

The anode of the photocell is connected to H.T. + by way of a decoupling network, indicated in simplified form as R<sub>1</sub>, C<sub>1</sub> in Fig. 130, and the cathode is connected to the grid of V<sub>1</sub> and to a source of grid bias via R<sub>2</sub> and a decoupling network (not shown). R<sub>2</sub> behaves as a grid leak for V<sub>1</sub> and is the output load for the photocell. The p.d. developed across R<sub>2</sub> depends on the current flowing from H.T. + to G.B.—via the cell, which in turn depends on the cathode emission and hence on the amount of light incident on the cell.

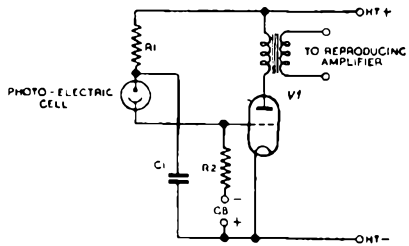

FIG. 130. PHOTOCCELL AMPLIFIER

*The Reproducing Amplifier.* The reproducing amplifier consists of two RC-coupled triodes (Fig. 131), with a transformer input and a parallel-fed output transformer. The frequency-correction circuits situated between the two

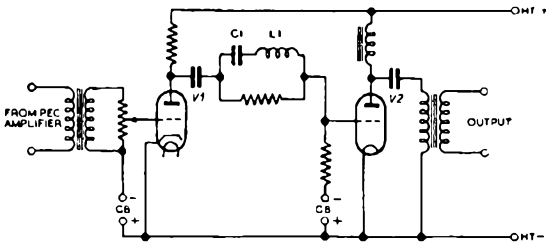

FIG. 131. REPRODUCING AMPLIFIER

valves are designed to make up for scanning losses on reproduction. The tuned acceptor circuit L<sub>1</sub>, C<sub>1</sub> resonates at 8,000 c/s and gives the amplifier a response which rises by about 10 db from 1,000 to 8,000 c/s.

## APPENDIX A

### MAXIMUM DISK RECORDING TIME AND MOST ECONOMICAL SPEED OF ROTATION

In a recording system in which a disk rotates with constant angular velocity, the cutting speed is one of the many factors which limit the high-frequency response. The cutting speed at any point on the surface of the disk is directly proportional to the angular velocity (i.e., the turntable speed) and to the distance of the point from the centre of the disk. To ensure an adequate high-frequency response, a minimum value of cutting speed must be specified and this, in turn, determines the minimum cutting diameter for a given turntable speed.

It will be shown that, for a given minimum cutting speed and diameter of disk, there is a particular turntable speed which gives maximum recording time and that this maximum is obtained for an inner recording diameter which is half the outer.

- Let  $n$  = turntable speed in r.p.m.  
 $D$  = outermost recording diameter in inches (fixed).  
 $d$  = innermost recording diameter in inches,  
 $G$  = number of grooves per inch (fixed),  
 $s$  = minimum cutting speed in inches/second (fixed)  
and  $t$  = total recording time in minutes.

The total number of grooves on the disk

$$= \frac{G(D-d)}{2}$$

$$\therefore t = \frac{G(D-d)}{2n} \quad \dots \dots \dots (1)$$

The cutting speed at the innermost recording diameter is given by

$$s = \frac{\pi n d}{60}$$

from which

$$n = \frac{60s}{\pi d} \quad \dots \dots \dots (2)$$

Substituting for  $n$  in (1)

$$t = \frac{\pi G}{120s} (Dd - d^2) \quad \dots \dots \dots (3)$$

where  $G$ ,  $D$  and  $s$  are all constants.

Now  $t$  is a maximum for choice of  $d$  when

$$\frac{dt}{d(d)} = 0$$

From (3)

$$\frac{dt}{d(d)} = \frac{\pi G}{120s} (D - 2d)$$

Hence  $\frac{dt}{d(d)}$  is zero when  $D - 2d = 0$

$$\text{i.e., when } d = \frac{D}{2} \quad \dots \dots \dots (4)$$

This shows that maximum recording time for a given minimum cutting speed is obtained when the inner recording diameter is half the outer diameter.

The turntable speed which gives maximum recording time can be obtained by substituting  $D/2$  for  $d$  in (2). This gives

$$n = \frac{120s}{\pi D} \quad \dots \dots \dots (5)$$

The recording time  $t_{max}$  can be found by substituting this expression for  $n$  in (1)

$$t_{max} = \frac{\pi GD(D - d)}{240s}$$

$$\text{But } d = \frac{D}{2}$$

$$\therefore t_{max} = \frac{\pi GD^2}{480s} \quad \dots \dots \dots (6)$$

A minimum diameter often adopted for 78-r.p.m. gramophone records is 4 inches, giving a minimum cutting speed of 16.3 in./sec. With this value, the optimum turntable speed for a 12-in. disk ( $D = 11.5$  in.) is, from (5), given by

$$n = \frac{120 \times 16.3}{3.14 \times 11.5} = 54 \text{ r.p.m.}$$

This is the speed which gives maximum recording time. If the groove pitch is 104 grooves per inch, the duration of the recording is given from (6) by

$$\begin{aligned} t_{max} &= \frac{3.14 \times 104 \times (11.5)^2}{480 \times 16.3} \text{ minutes} \\ &= 5.5 \text{ minutes.} \end{aligned}$$

Thus a 12-in. disk, recorded at 54 r.p.m. has a duration of 5.5 minutes for the same minimum cutting speed (and therefore the same upper limit of frequency response) as at 78 r.p.m. when the recording time is 4.9 minutes. Since, however, commercial pressings are mostly recorded at 78 r.p.m., the BBC has adopted this speed to permit disks and pressings to be reproduced on the same turntables.

## APPENDIX B

### THE MANUFACTURE OF SAPPHIRE-TIPPED RECORDING CUTTERS AND REPRODUCING NEEDLES

#### INTRODUCTION

The tips of BBC recording cutters and reproducing needles are made from synthetic white sapphire; they are formed from small rods of suitable diameter and length, known as blanks, which are manufactured commercially.

The grinding and polishing operations necessary to produce a stylus of the required shape are carried out by bringing the blank into contact with rotating laps of metal or wood, the surfaces of which are coated with a mixture of finely graded diamond dust and grease. The degree of polish acquired by the ground surface of the blank can be controlled by varying the hardness of the lap or the size of the particles composing the grinding dust, but it is BBC practice to use, wherever possible, a standard dust and to obtain a coarse grinding or a polishing action by appropriate choice of lap material.

If the lap is resilient, the edges of the facet ground on the blank tend to be rounded and the lap material must be carefully chosen to suit a particular operation; iron, copper, compressed laminated wood, pear wood and leather are some of the lap materials employed. During the grinding process, the cutter or needle is held in a jig designed so that a facet of the desired angle is obtained automatically.

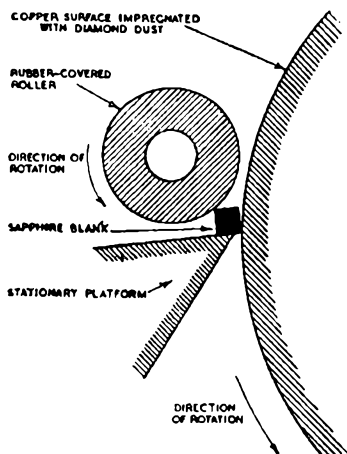

FIG. B1. PRINCIPLE OF THE CENTRELESS GRINDER

#### THE RAW MATERIAL

Synthetic sapphire possesses the same chemical and physical properties as natural sapphire and is manufactured from very finely divided and purified alumina ( $\text{Al}_2\text{O}_3$ ). This is fused by intense heat and collects as a molten mass which, on cooling, crystallises into a pear-shaped "boule" of transparent white sapphire. The "boule" is cut by a metal circular saw with an edge impregnated with comparatively coarse diamond dust. Square-section blanks are obtained and these are rolled and ground into the rods used for manufacturing cutters and needles.

The machine used for producing the rods is known as the "centreless grinder" and uses the principle illustrated in Fig. B1. The curved surface of a copper drum is coated with diamond

dust and the sapphire blank held against it by the pressure of a rubber-covered roller which, in rotating, causes the sapphire blank to rotate.

THE RECORDING CUTTER

In the first grinding operation a flat is ground along the length of the round blank and this flat ultimately becomes the cutting face of the stylus. Fig. B2 illustrates the machine used ; about 1,000 blanks are firmly stuck with shellac to a smooth horizontal cast-steel plate and a weighted copper lap is lowered upon them. The lap, which is free to rotate, is moved eccentrically over the upper surface of the blanks ; when the flats are of approximately the right size, the copper lap is replaced by a wooden one and the flat surfaces are

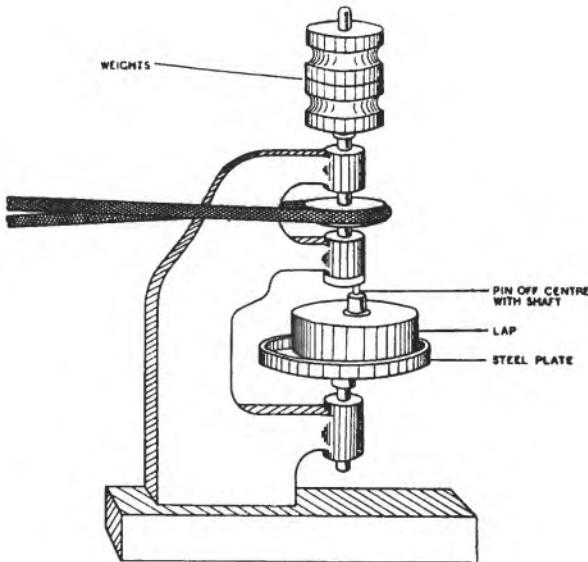

FIG. B2. GRINDING MACHINE

The lap rotates eccentrically over the surface of the plate to which the cutter blanks are fixed

polished ; the final polish is obtained by exchanging the wooden for a leather-surfaced lap.

The shank of the cutter is prepared from duralumin wire. This is cut to the correct length, a flat is machined along half its length and a hole drilled in the other end to accommodate the sapphire blank. The blank is inserted in the hole and the shank firmly clamped around the blank by a machine which automatically ensures that the flat surface of the shank is precisely parallel, but on the opposite side to the flat of the blank.

The rough grinding and polishing of the various facets on the sapphire tip can be carried out with the aid of a steel jig of the type illustrated in Fig. B3. The shank is held in position in the jig head by a screw which locates with

## APPENDIX B

the flat on the shank ; the angle between the centre axis of the jig head and  $XY$  determines the required back-angle of the cutter while the included angle of the flat surfaces which meet at  $XY$  determines the face-angle. The jig

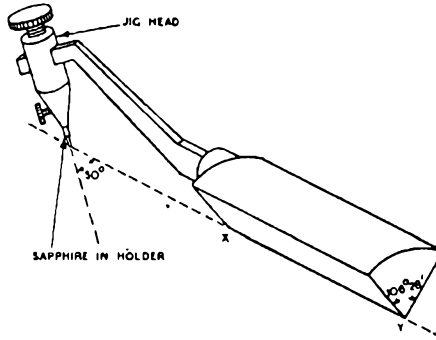

FIG. B3. JIG FOR HOLDING SAPPHIRE

is held against the vertical jig rests (Fig. B4) so that the direction of motion of the lap surface is down the cutting face of the cutter towards the apex which is being formed, the operator regulating the pressure between cutter and lap. The rests are so positioned in relation to the lap faces that the rough

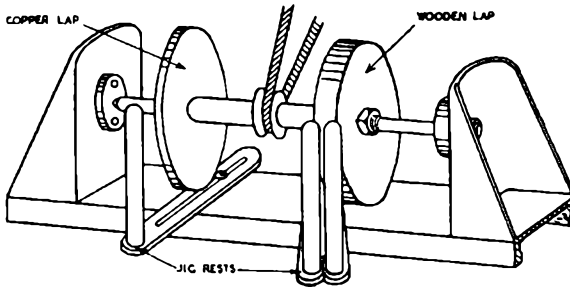

FIG. B4. LAP WITH JIG RESTS

grinding operation, carried out with a metal lap, produces a cutter with a face-angle slightly more acute than is finally required. This is done so that, in the polishing operation carried out with a wooden lap, only a limited area near the tip of the cutter is polished, resulting in a considerable saving in time.

The radiusing (Fig. 27, page 40) of the sharp back edge so obtained can be carried out either by a chamois-leather lap, the resilience of which is used to produce the required curvature, or by using a lap of hard laminated wood, and rocking the cutter on its back edge by means of a specially designed jig.

The bevelled edge (Fig. 27, page 40) is produced in a similar way except that a wooden lap charged with the finest diamond dust is used, the cutter being rocked on its cutting edge at the appropriate angle during the process.

This occupies a few seconds only because of the very small amount of material to be removed from the very sharp edge.

At various stages during the grinding and polishing operations, the cutting point is carefully examined by means of a shadowgraph with a magnification of 250 times to verify that the dimensions and angles fall within the prescribed limits. The method used is to compare the enlarged shadow of the point with a mask drawn to scale. At the end of the process measurements are made of the noise level produced by each cutter in cutting an unmodulated groove. If the noise level is too high, the performance of the cutter can usually be improved by adjustments to the dimensions of the bevel.

#### THE REPRODUCING NEEDLE

The sapphire-tipped needles used by the BBC are of three types, suitable for use in the E.M.I. Type-12, the B.T.H. needle-armature and the Voigt moving-coil reproducing heads. The tip has the same dimensions in all three types, the only difference being in the dimensions of the shank.

In the first operation a blank sapphire rod is inserted in a shank of iron or silver-steel. One end of the rod is ground into the form of a cone and the jig used is designed to give a tip angle of between  $30^\circ$  and  $40^\circ$ . A metal lap is used for rough grinding and the stylus is rotated during the process. At the same time, the needle is given a reciprocating motion so that as much of the lap surface as possible is utilised. The tip is then finally ground with a wooden lap, the jig used in this operation being designed to produce a tip angle of precisely  $40^\circ$ .

In the final operation, the tip of the reproducing needle is brought into contact with a chamois-leather lap, charged with diamond dust, the tip being rotated, and at the same time, moved radially across the lap. The axis of the cone is adjusted to a predetermined angle to suit the condition of the lap and to produce a substantially hemispherical tip with a radius between 0.0025 and 0.003 inch.

Each reproducing needle is carefully examined during and after manufacture by means of a shadowgraph and is rotated about its axis to confirm that the tip is symmetrical.

## APPENDIX C

### INDUCTION AND SYNCHRONOUS MOTORS

#### ROTATING MAGNETIC FIELDS

The method of operation of all induction and synchronous motors can be explained in terms of a rotating magnetic field. Such a field can be produced simply by the rotation of a magnet or an electromagnet about an axis at right angles to the magnetic flux. Most alternators employ a magnetic system of this nature.

A combination of stationary fluxes whose amplitudes are varied in a cyclical manner will also produce a rotating magnetic field, provided there is a phase difference between the fluxes, and their axes are suitably inclined.

These conditions are satisfied if a 3-phase supply is connected to the stator of Fig. C1. The flux produced by the winding connected to phase 1 will vary

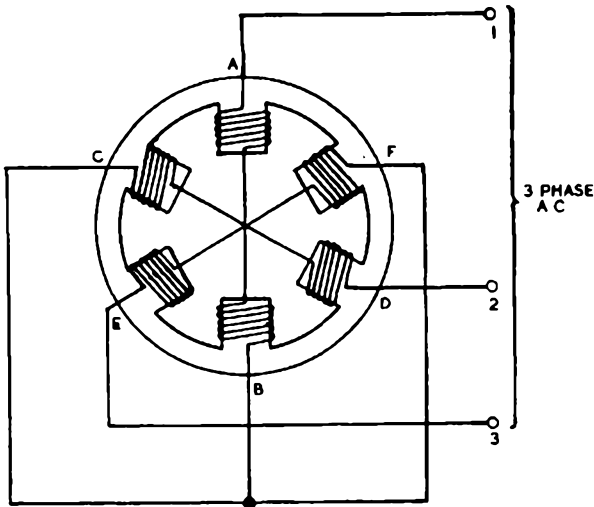

FIG. C1. STATOR WITH THREE PAIRS OF POLES ENERGISED FROM A 3-PHASE SUPPLY

both in magnitude and direction depending on the current in it, but its axis will always coincide with AB. Also phases 2 and 3 will produce varying fluxes whose axes lie along CD and EF respectively.

Let us consider a 3-phase system for which the phase current maxima are all equal to  $I$ . The instantaneous phase currents will vary with time as shown in Fig. C2. If we agree that currents above the line OP in the 3-phase current diagram of Fig. C2 flow into the windings towards the star point and that currents below OP flow away from it, we can at any instant assign both a magnitude and



a direction to any of the fluxes produced by the 3-phase windings. At the instant corresponding to point O the current in phase 1 is zero, consequently no flux is produced by this phase. The current in phase 2 is flowing away from the

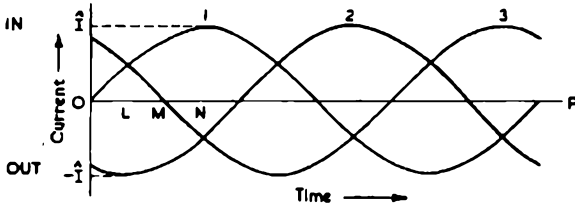

FIG. C2. 3-PHASE SUPPLY SYSTEM : INSTANTANEOUS PHASE CURRENTS VARY WITH TIME

star point and since its instantaneous value is  $\frac{\sqrt{3}}{2}i$  a flux of amplitude  $\frac{\sqrt{3}}{2}\hat{\phi}$  is developed in the direction CD. (Fig. C1). Phase 3 produces a flux of equal magnitude but directed along EF. The fluxes combine (Fig. C3a) producing a total flux  $\frac{3}{2}\hat{\phi}$  in the direction shown. A twelfth of a cycle later the current in phase 2 is a maximum and the flux it produces is in the direction CD. Now phases 1 and 3 are producing fluxes of  $\hat{\phi}/2$  in the directions AB and EF respectively whose resultant  $\hat{\phi}/2$  lies along the flux axis of phase 2. The total flux is then  $\frac{3}{2}\hat{\phi}$  in the direction shown in Fig. C3b.

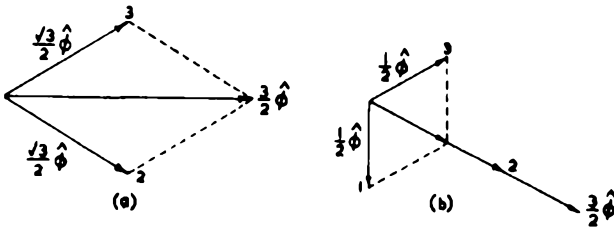

FIG. C3. 3-PHASE SUPPLY SYSTEM : CURRENT VECTORS

- (a) Conditions represented in Fig. C2 where Phase 1 is zero
- (b) Conditions one-twelfth of a cycle later

Figures C4a to C4d represent conditions separated by time intervals of a twelfth of a cycle. The magnitude of the combined fluxes at any instant is a constant equal to  $\frac{3}{2}\hat{\phi}$ , and the flux makes one complete revolution per cycle, thus producing a rotating magnetic field from a stationary electromagnetic system.

In practice the stator windings are not arranged on salient poles but located in slots, so that a uniform air gap between rotor and stator may be obtained. Nor is it usual to locate the entire winding for one pole in a single slot, but rather

## APPENDIX C

to spread it over a number of slots. With such an arrangement the flux distribution is complex, but a rotating field is still obtained.

Two-phase a.c. supplies are not common, but if the stator of Fig. C5 is

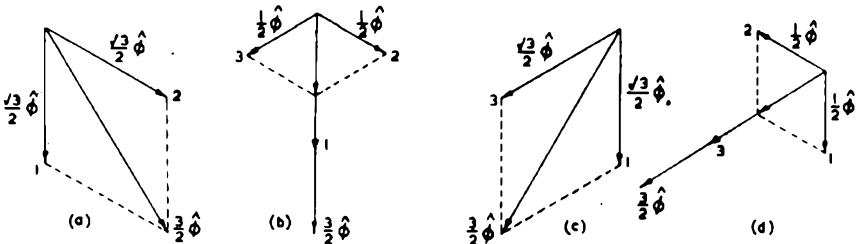

FIG. C4. 3-PHASE SUPPLY SYSTEM : CURRENT VECTORS

Conditions at twelfth of a cycle intervals, illustrating a flux revolution per cycle

connected to such a supply, by using an argument similar to that for the 3-phase supply, a rotating flux of constant amplitude  $\phi$  is produced by the 2-phase currents.

If one pair of poles is energised, a pulsating magnetic field is produced ; thus single-phase excitation cannot be used in motors. A single-phase supply can be made to produce a rotating magnetic field by obtaining from it two

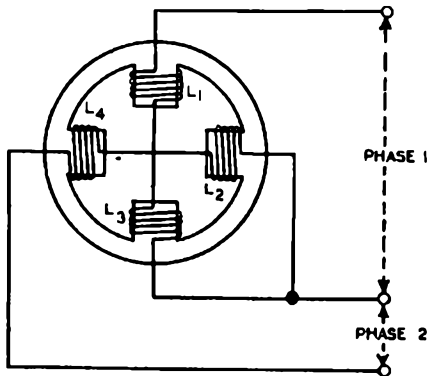

FIG. C5. 2-PHASE SUPPLY SYSTEM

With a stator having two pairs of poles, a rotating flux is produced as in the 3-phase system

currents whose phase relationship is equal to or approximates  $90^\circ$ . This is then equivalent to a 2-phase supply and can be used to energise the 2-phase stator shown in Fig. C5. One method of producing the  $90^\circ$  phase relationship of currents is illustrated in Fig. C6. This shows a stator with two pairs of poles, one pair being connected directly to the a.c. source and the other to the same supply via a capacitor. If the reactance of C exceeds that of  $L_2$  and  $L_4$  at the frequency of the supply, the circuit is capacitive and the current leads the

e.m.f. In the inductive circuit  $L_1$   $L_3$  the current lags behind the e.m.f. By a correct choice of inductance and capacitance, the currents in the two branches can be made equal and, if the resistance of the coil windings is correctly chosen, the phase angle between the two currents can be made  $90^\circ$ ; these are the conditions for the establishment of a rotating field within the stator.

An alternative method of obtaining a rotating field from a single-phase supply is to make one pair of stator windings (Fig. C5) highly inductive and the other pair highly resistive. This method is not ideal, for although it produces a rotating flux, the amplitude is not constant during a revolution, for the phase angle between the currents in the two branches cannot be precisely  $90^\circ$ .

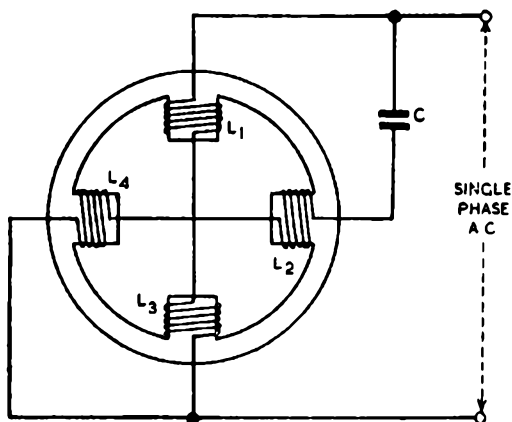

FIG. C5. SINGLE-PHASE SUPPLY SYSTEM

One pair of poles is connected direct to the supply, the other pair via a capacitor

In 2-phase and 3-phase systems the maximum speed of rotation of the flux is  $60f$  r.p.m., where  $f$  is the frequency of the supply. Since the magnetic flux is directly responsible for the rotation of the rotor it follows that the maximum possible speed of the motor is also  $60f$  r.p.m. and it is approached with induction motors and reached with synchronous motors when there is one pair of stator poles per phase. In machines having more than one pair of poles per phase the rotating flux moves from one of a pair of poles in a given phase to the other of the pair in half a cycle of the mains frequency; consequently the rotational speed (angular velocity) of the flux and of the rotor is reduced in inverse proportion to the number of poles per phase. For example, speeds of one half and one third of the maximum can be obtained by using 2 and 3 pairs of poles per phase respectively.

## INDUCTION MOTORS

An induction motor has rotor and stator windings; the rotor windings are either permanently short-circuited at the rotor itself or connected to slip rings, the circuit being completed by external variable resistors. If a rotor is situated within a stator as shown in Fig. C7, the rotating flux caused by the currents in

## APPENDIX C

the stator windings cuts the rotor windings and induces an e.m.f. in them. As the rotor circuit is closed, induced currents flow in the windings, producing a magnetic field which interacts with that of the stator, causing the rotor to revolve in the same direction as the rotating field. If the rotor revolved at the same speed as the rotating field, there would be no relative movement between the rotating field and the rotor conductors and no e.m.f. would be induced in the rotor windings ; therefore there must always be some slip between rotor and field. If the losses are low the slip is very small and the rotor runs practically at synchronous speed.

Motors of less than 1 h.p. may be started by connecting the stator windings directly to the mains, but special starting arrangements are necessary in larger types where the starting current is very heavy. When a motor has to be started

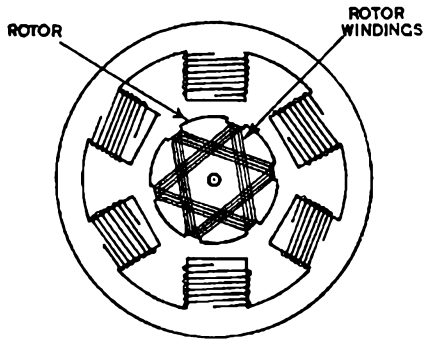

FIG. C7. PRINCIPLE OF THREE-PHASE MOTOR. THE STATOR IS SHOWN WITH SALIENT POLES AND ALL CONNECTIONS ARE OMITTED FOR SAKE OF CLARITY

under a heavy mechanical load the inclusion of resistance in the rotor windings improves the starting torque and at the same time limits the stator current. The resistance is decreased to zero in steps as the rotor speed increases.

### SYNCHRONOUS MOTORS

If the rotor of the machine shown in Fig. 7 is replaced by a permanent magnet, and the magnet is given an external impetus, causing it to rotate at the same speed and in the same direction as the magnetic field, the rotor will continue to rotate in synchronism with the magnetic field when the impetus is withdrawn. Such a machine is known as a synchronous motor.

The chief advantage of the synchronous motor is that its speed is determined solely by the frequency of the mains supply, and provided that its load does not exceed the maximum for which the motor was designed, the speed can only change when the mains-supply frequency changes. If the load exceeds the maximum, the rotor speed falls out of step with that of the stator magnetic field and the rotor stops.

The synchronous motor is ideal where constant rotational speed is needed, and although it is not self-starting, this disadvantage can be overcome by using a synchronous-induction system; with this, the rotor has the equivalent of

short-circuited windings and starts as an induction motor. When it has reached its highest speed as an induction motor, d.c. excitation is applied and the rotor pulls into step with the stator magnetic field to run at synchronous speed.

In very small machines the rotor may be designed to produce the equivalent of a permanent-magnet field so that no external d.c. excitation is required. If this kind of motor is heavily loaded mechanically, the rotor falls out of synchronism but continues to run as an induction motor at a slip speed.

#### THE SPEED OF A SYNCHRONOUS MOTOR

Since the rotor and the magnetic field of the stator rotate together, the speed of a synchronous motor is given by the rate at which the magnetic field moves round the stator. As described above, this depends on the number of pole pairs per phase ; when there is one pair per phase the magnetic field makes a complete revolution once each cycle of the mains-supply frequency. Thus, if the mains frequency is 50 c/s, the speed of the motor is 50 r.p.s. (3,000 r.p.m.) when it has one pair of poles per phase, and 25 r.p.s. (1,500 r.p.m.) when it has two pairs of poles per phase. This can be expressed as follows :—

$$\text{synchronous speed (r.p.s.)} = \frac{\text{mains frequency (c/s)}}{\text{number of pairs of poles per phase}}$$

$$\text{or synchronous speed (r.p.m.)} = \frac{60 \times \text{mains frequency (c/s)}}{\text{number of pairs of poles per phase}}$$

To obtain speeds of rotation low enough to drive disk recording or reproducing turntables directly, a large number of poles is necessary. For example, to obtain a speed of 78 r.p.m., a motor operating from 3-phase 50 c/s mains requires 38.5 pairs of poles per phase. This number is not only inconveniently large, it is also fractional, showing that a speed of precisely 78 r.p.m. cannot be obtained directly from a motor operating on this principle from 50-c/s mains. A speed of exactly  $33\frac{1}{3}$  r.p.m. could be obtained, but would require 90 pairs of poles per phase. It is therefore customary to use a high-speed motor and interpose some form of speed-reduction drive between it and the turntable for both 78 and  $33\frac{1}{3}$  r.p.m.

#### SHADED-POLE MOTORS

##### THEORY OF OPERATION

In one type of electric motor used for driving disk reproducing turntables, the effect of a rotating magnetic field is produced from a single-phase a.c. supply, by splitting the stator poles and surrounding one-half of each by a solid copper band (Fig. C8) to produce a "shaded" or "shielded" pole. The flux  $\phi_1$  (Fig. C9) produced by the alternating current flowing in the stator winding induces an alternating e.m.f. in the copper band and the resulting eddy current produces, in the shaded half of the pole, a flux  $\phi_2$  which opposes  $\phi_1$  in direction. The phase difference between  $\phi_1$  and  $\phi_2$  is not precisely  $180^\circ$  and the net flux within the shaded half of each pole is the vector sum of  $\phi_1$  and  $\phi_2$ , indicated by  $\phi_3$  in Fig. C9. Each pole thus produces two fluxes,  $\phi_1$  and  $\phi_3$ , the phase angle between them being approximately  $90^\circ$  ; the interaction between the lines of

## APPENDIX C

force of one field and the eddy currents induced in the rotor by the other field, sets up a torque which causes the rotor to revolve. This torque can be increased by using additional shaded poles.

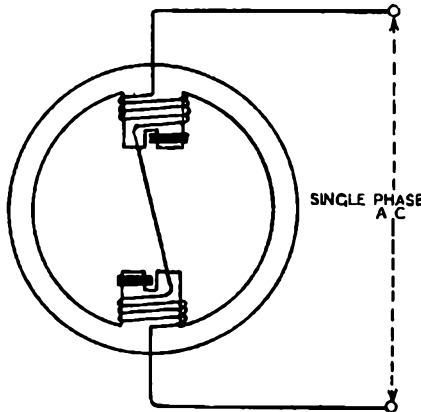

FIG. C8. PRINCIPLE OF SHADED-POLE MOTOR

### SPEED OF SHADED-POLE MOTORS

The speed at which the rotor revolves depends on the mechanical load to which the motor is subjected. As the mechanical load is reduced the speed increases to a limiting value which depends on the angular distance between

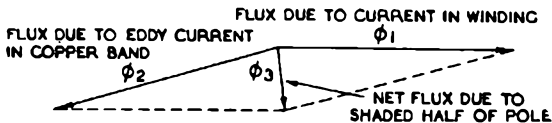

FIG. C9. VECTOR DIAGRAM FOR SHADED-POLE MOTOR

the main and subsidiary field fluxes, but it is independent of the number of poles in the stator ; this latter distinguishes its mode of operation from that of an induction motor.

Calculation of the speed of a shaded-pole motor is complicated because the flux does not cross the rotor from one pole to the opposite one as in synchronous motors, but travels over the surface of the rotor for the short distance between the unshaded and the shaded half of each pole. At its limiting speed, the rotor describes the angular displacement between the centres of the two sections of each pole in approximately one-quarter of a cycle of the mains supply and from this the speed can be calculated. In practice the phase difference between the fluxes due to the two halves of each pole is less than  $90^\circ$  and in the following numerical example is taken as  $75^\circ$ . Consider the type of motor used in the TD/7 disk reproducing desk. It has 30 poles, each split into a shaded

## BBC RECORDING TRAINING MANUAL

and unshaded half, the distance between the centres of the two halves of each pole subtending  $5^\circ$  at the centre of the rotor. If the mains frequency is 50 c/s, the limiting rotor speed is such that  $5^\circ$  are described in  $75/360 \times 1/50$  seconds, that is one complete revolution in  $75/360 \times 360/5 \times 1/50$  seconds and the speed is hence  $360/75 \times 5/360 \times 50 \times 60 = 200$  r.p.m. This is the speed of the rotor when the motor is unloaded ; a mechanical governor is used to reduce the speed to the required 78 r.p.m. and maintain that speed under varying loads.





COMPLIANCE AND CAPACITANCE

Consider a spring, Fig. D2, having a coefficient of stiffness  $S$ . If the spring is subject to a force  $F$  which produces a displacement  $x$ , then

$$F = Sx$$

The reciprocal of mechanical stiffness is called the compliance  $C_m = \frac{1}{S}$ .

$$\therefore F = \frac{x}{C_m} \quad \dots \quad (3)$$

The electrical equivalent of the spring is a capacitor  $C$  in which a charge  $Q$  is stored when an external voltage  $V$

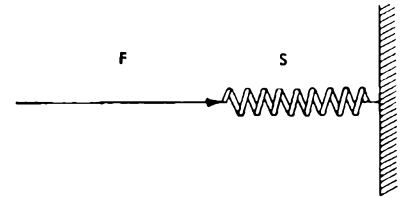

FIG. D2. THE SPRING  $S$ , SUBJECT TO A FORCE  $F$ , PRODUCES A DISPLACEMENT  $x$

is applied then

$$V = \frac{Q}{C} \quad \dots \quad (4)$$

The analogy between displacement  $x$  and charge  $Q$  is again obvious and a further analogy is apparent between compliance and capacitance.

FRICITION AND RESISTANCE

Although friction and resistance are normally associated with each other the analogy here is not quite perfect, for friction, in a viscous medium, is not proportional to velocity, except at low velocities.

The force required to drive a body of negligible mass through a viscous medium with a velocity  $v$  is

$$F = R_m v \quad \dots \quad (5)$$

where  $R_m$  is the proportionality factor called the "mechanical resistance."

The equivalent electrical concept is the voltage required to drive a current  $I$  through a resistance  $R$  where

$$V = RI \quad \dots \quad (6)$$

It will be seen from equations (5) and (6) that for small velocities friction is analogous to resistance.

We can best summarise the analogies between electrical and mechanical quantities in tabular form thus :

<i>Electrical Quantity</i>	<i>Equivalent Mechanical Quantity</i>
E.M.F	Force
Current	Velocity
Inductance	Mass
Capacitance	Compliance
Resistance	Frictional resistance
Quantity	Distance

## APPENDIX D

In general, a mechanical system possesses mass, compliance and friction. Such a system is shown in Fig. D3 and its electro-mechanical equivalent in Fig. D4. The suffix *m* indicates that the mechanical quantity is involved.

The velocity of the mass *M*, Fig. D3, resulting from the application of the

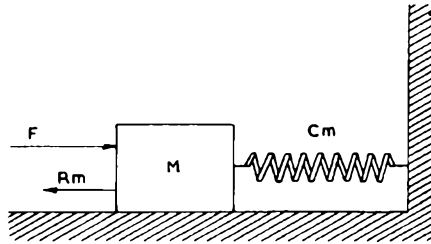

FIG. D3. ESSENTIAL PROPERTIES OF A MECHANICAL SYSTEM ARE MASS, COMPLIANCE AND FRICTION

sinusoidally varying force *F* can now be obtained from the equivalent electrical circuit, thus

$$\text{Velocity } (I) = \frac{\text{Force } (E)}{\text{Mechanical Impedance } (Z)} \quad \dots \quad (7a)$$

The equivalent electrical quantities are shown in brackets. If the angular frequency of the applied force *F* is  $\omega (= 2\pi f)$  the mechanical impedance may be written in terms of its components so that expression (7a) becomes.

$$v = \frac{F}{R_m + j\omega M - \frac{j}{\omega C_m}} \quad \text{or } |v| = \frac{F}{\sqrt{R_m^2 + \left(\omega M - \frac{1}{\omega C_m}\right)^2}} \quad (7b)$$

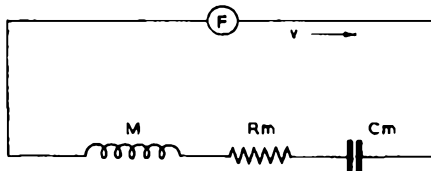

FIG. D4. ELECTRICAL EQUIVALENTS OF MASS, COMPLIANCE AND FRICTION ARE INDUCTANCE, CAPACITANCE AND RESISTANCE

- where
- v* = r.m.s. velocity (cm/sec)
  - F* = r.m.s. force (dynes)
  - M* = mass (gm)
  - C<sub>m</sub>* = compliance (cm/dyne)
  - $\omega$  =  $2\pi$  frequency of applied force (c/s)

Strictly, expression (7) applies only to the motion of mass *M* moving in a straight line under the action of a force. This is not, in fact, the type of motion

encountered in a recording or a reproducing head, where the armature performs rotational vibrations about its axis. It is possible to derive an equation similar to (7) which does apply rigorously to such motion.\* The modifications necessary are the substitution of moment of inertia for mass, torque for force, rotational mechanical resistance for linear resistance and rotational compliance for linear compliance. It was considered unnecessary to introduce here the additional complexities of this strict analysis ; we must note, however, that reference is often made to the mass of an armature when its moment of inertia is really meant.

In the same way that a series tuned circuit has a resonant frequency given by

$$f = \frac{1}{2\pi\sqrt{LC}}$$

at which, for a constant applied voltage, the current is a maximum, so also a mechanical circuit has a resonant frequency given by

$$f = \frac{1}{2\pi\sqrt{MC_m}}$$

at which for a constant applied force, maximum velocity of movement occurs.

In recording systems a constant amplitude of sound pressure variation may be made to inscribe on the recording medium a wave of constant amplitude with variation of sound pressure frequency, a wave having a constant r.m.s. velocity or a mixture of both. This result is generally achieved in part by means of an equaliser in the electrical circuit and in part by design of the recording head.

The actual characteristic provided by the recording head is determined by the component, mass compliance or resistance, which predominates in the system and we shall now examine the separate effects of control by any one of these components starting with resistance control which produces the equivalent of a constant-velocity characteristic.

#### THE RESISTANCE-CONTROLLED MECHANICAL SYSTEM

If it is necessary to produce a constant velocity  $v$  of the mass  $M$ , Fig. D3, for a constant applied force, it can be achieved by making the mechanical impedance entirely resistive. The system is then represented by

$$v = \frac{F}{R_m} \dots \dots \dots \dots \dots \dots \quad (8)$$

which is analogous to  $I = \frac{E}{R}$

and  $v$  is clearly independent of frequency for constant applied sinusoidal force.

We cannot expect to find a system where mass and compliance are both zero, and in practice, the condition represented by (8) can only be approached, and the frequency range over which the reactance is small compared with the resistance is limited to a few octaves if loss of sensitivity is to be avoided. For example, the impedance of a mechanical tuned circuit is mainly resistive over a

\* See, for example, Olson, H. F., Dynamical Analogies, Textbook, p. 31.

## APPENDIX D

narrow range of frequencies on either side of resonance and over this range the system has a constant-velocity characteristic. The range over which the resistance component predominates can be extended by damping the circuit, but for a given force, this causes the velocity to fall and the sensitivity of the system to be reduced.

### COMPLIANCE OR STIFFNESS-CONTROLLED MECHANICAL SYSTEM

If an electrical series circuit operates over a band of frequencies well below its resonant frequency the capacitive reactance is usually much larger than the circuit resistance and so controls the current in the circuit for

$$I \simeq \frac{E}{\frac{1}{\omega C}} = E\omega C$$

$$\therefore I \simeq 2\pi fCE$$

i.e. the current is directly proportional to the frequency for a given applied r.m.s. voltage.

Similarly, in the mechanical system, for a constant applied force, the velocity is directly proportional to the frequency, provided that the resonant frequency is made higher than the working range, and also provided that the resistance is small compared with the compliance reactance. Such a circuit is said to be compliance- or stiffness-controlled and compares directly with the electrical circuit which is predominantly capacitive in nature.

For a compliance-controlled mechanical system

$$v \simeq \frac{F}{\frac{1}{\omega C_m}} = F\omega C_m$$

$$\therefore v \simeq 2\pi fC_m F$$

Since the velocity is directly proportional to the frequency the system is of interest to the recording engineer. If the frequency be doubled, without altering the force, the velocity will be doubled, but the amplitude of the vibration will remain constant, for the time of the vibration has been halved by the alteration in frequency. Consequently this system exhibits a constant-amplitude characteristic for a constant applied force.

### MASS-CONTROLLED MECHANICAL SYSTEM

If a series electrical circuit operates above resonance the inductive reactance predominates, and provided the resistance is small

$$I \simeq \frac{E}{\omega L} \simeq \frac{E}{2\pi fL}$$

i.e. the current is inversely proportional to frequency for a constant applied voltage.

In a mechanical system

$$v \simeq \frac{F}{\omega M} \simeq \frac{F}{2\pi f M}$$

i.e. the velocity is inversely proportional to frequency for a constant applied force.

Mass-controlled systems are not common in recording but are used in certain types of microphones where a constant-velocity characteristic is required from an operating force that is not constant but increases with increase in frequency.

## APPENDIX E

### THE BUCHMANN-MEYER IMAGE

When a disk with grooves of sinusoidal waveform and constant amplitude and frequency is illuminated by parallel rays of light, the reflected light appears as a band of constant width at right angles to a radius. The width of this light band was investigated by Buchmann and Meyer<sup>1</sup>, who showed that it was directly proportional to the lateral velocity of the cutting stylus.

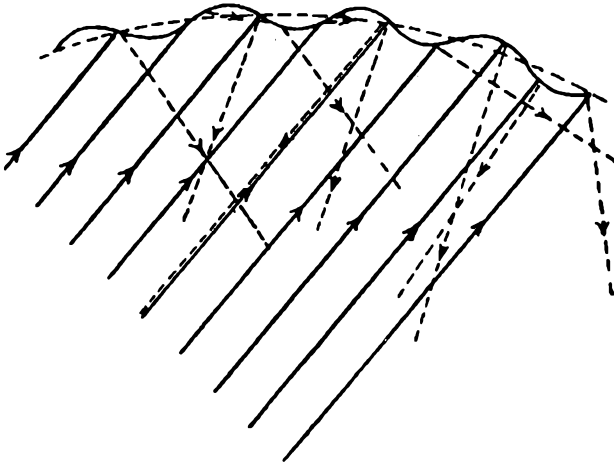

FIG. E1. SCATTERING OF LIGHT RAYS BY MODULATED GROOVE

Fig. E1 illustrates a groove of sinusoidal waveform illuminated by parallel rays of light. Reflection occurs at the walls of the groove according to the law that the angle of reflection is equal to the angle of incidence. Because of the sinusoidal shape of the grooves the incident light is scattered on reflection as shown by the dotted lines in the diagram. If the observer is near the disk, certain light rays reflected from the modulated groove converge on the eye and subtend an appreciable angle at it, as shown in Fig. E2. This diagram illustrates parallel incident light and shows those points on the sine wave at which light is reflected to form the convergent beam; these reflections are seen as separate points of light if the disk is stationary and the wavelength large enough, but are seen as a homogeneous band of light if the disk is rotated. At short viewing distances the width of the light band depends on the observer's position; for example, an observer at P sees a light band of width  $A_1B_1$  but if he moves nearer to the disk to position P<sub>2</sub> the apparent width of the light band decreases to

$A_2B_2$  and contains fewer points of reflection. As the viewing distance is increased, the width of the light band increases asymptotically to a definite value which applies when the reflected light is parallel. Because of the variation of band width with position at short viewing distances, in making precise measurements of band width the image must be formed by parallel incident light and viewed by parallel reflected light.

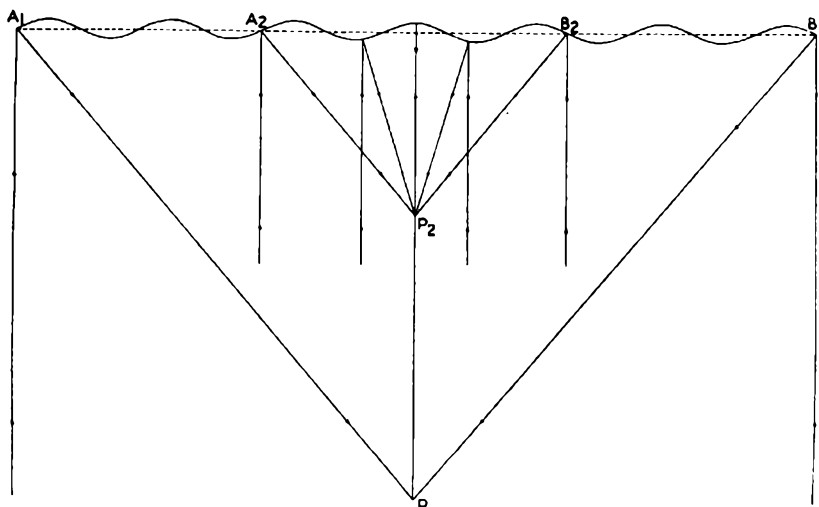

FIG. E2. VARIATION OF BAND WIDTH WITH VIEWING DISTANCE

For simplicity the groove is shown without curvature. The groove being spiral does not modify the argument

In the following mathematical work, parallel incident light and parallel reflected light are assumed, and it is further assumed that the incident and reflected beams are also parallel, i.e., that the points of light forming the image represent normal reflections. The second assumption was made for simplicity but the proof applies equally when the incident and reflected light beams are not in the same straight line. The extremities of the light band represent reflections from the points where the sine curve crosses the datum line. A sine curve has maximum slope at these points and to obtain normal reflection from a point to the left of  $A$  or the right of  $B$ , Fig. E3, would require a slope greater than at  $A$  or  $B$ , which can only be achieved by increasing the level or frequency of the recorded signal.

The proof requires the following constructions.  $A$  and  $B$  are joined to the centre of the disk by the straight lines  $AO$  and  $BO$ . Through  $O$ ,  $OD$  is drawn parallel with the direction of the incident light. At  $A$ , two straight lines are drawn,  $XY$  the tangent to the sine curve at this point and  $MN$  the tangent to the circle, centre  $O$ .

APPENDIX E

$$\begin{aligned} \angle LAO + \angle OAY &= 90^\circ \\ \angle OAY + \angle YAN &= 90^\circ \\ \therefore \angle LAO &= \angle YAN \\ \text{But } \angle LAO &= \angle AOD \\ \therefore \angle YAN &= \angle AOD \end{aligned}$$

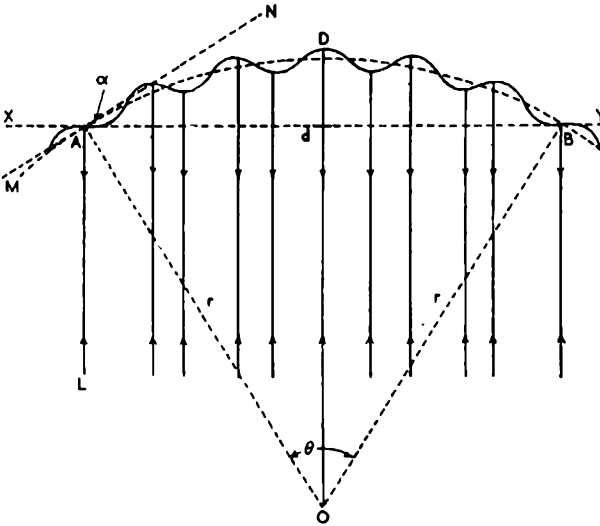

FIG. E3. BUCHMANN-MEYER IMAGE

Spiral groove with sinusoidal modulation showing parallel light rays reflected along the incident path

In a similar way it may be shown that the slope of the sine curve at B is equal to  $\angle DOB$ .

$$\begin{aligned} \therefore \angle AOD &= \angle DOB \\ \therefore \angle YAN &= \frac{1}{2} \angle AOB \\ \alpha &= \frac{\theta}{2} \quad \dots \quad \dots \quad \dots \quad \dots \quad \dots \quad (I) \end{aligned}$$

In words, the maximum slope of the sine wave,  $\alpha$ , is equal to one-half the angle  $\theta$ , subtended by the image at the centre of the disk.

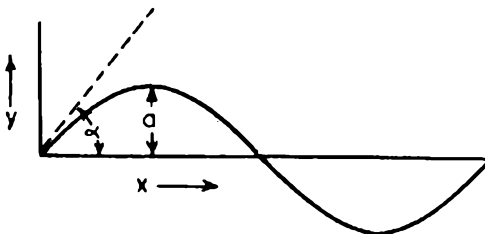

FIG. E4. RECORDED SINE WAVE



Consider Fig. E4, which illustrates one cycle of a recorded sine wave of amplitude,  $a$ , and wavelength,  $\lambda$ . The equation to this wave may be written

$$y = a \sin 2\pi \frac{x}{\lambda}$$

from which

$$\frac{dy}{dx} = 2\pi \frac{a}{\lambda} \cos 2\pi \frac{x}{\lambda}$$

The maximum value of this slope, namely its value at  $x = 0$ , is given by

$$\frac{dy}{dx} = \tan \alpha = \frac{2\pi a}{\lambda}$$

Since the values of  $\alpha$  which occur in practice are very small the tangents may be replaced by the angles themselves expressed in radians. Hence the maximum slope

$$= 2\pi \frac{a}{\lambda} \simeq \alpha \dots \dots \dots (2)$$

From Fig. E3 the width of the Buchmann-Meyer image,  $d$ , is given by

$$d = 2r \sin \frac{\theta}{2}$$

which, since  $\theta$  is very small, may be written

$$d \simeq \frac{2r \cdot \theta}{2} = r \cdot \theta \dots \dots \dots (3)$$

From (2)

$$\alpha = \frac{2\pi a}{\lambda}$$

But  $\lambda = \frac{V}{f}$  where  $V$  = the speed of the recording medium

$$\therefore \alpha = \frac{2\pi af}{V}$$

Now  $V = \frac{2\pi rn}{60}$  where  $n$  = the number of revolutions per minute of the turntable.

$$\therefore \alpha = \frac{60af}{nr} \dots \dots \dots (4)$$

Since

$$\begin{aligned} \theta &= 2\alpha \text{ from (1)} \\ \therefore \theta &= \frac{120af}{nr} \end{aligned}$$

But, from (3),  $d \simeq r \theta$

$$\therefore d \simeq \frac{120af}{n} \dots \dots \dots (5)$$

Since  $r$  does not occur in this expression for  $d$ , it follows that the width of the Buchmann-Meyer image is constant and independent of radius, and

## APPENDIX E

the pattern has parallel sides for a recording in which the product,  $af$ , and  $n$  are constant. The velocity of the cutting and reproducing styli is directly proportional to the product  $af$ , and chapter 2 gives

$$v_{r.m.s.} = 4.44 af \quad \dots \quad \dots \quad \dots \quad \dots \quad (6)$$

By combining (5) and (6)

$$d \simeq \frac{27v}{n}$$

i.e., for a given value of  $n$ , the width of the Buchmann-Meyer image depends only on the recorded velocity.

If bands of frequencies covering the whole of the working range are recorded on a disk and the recording apparatus has a constant-velocity characteristic, the Buchmann-Meyer image has the same width at all frequencies. It is assumed of course, that the level applied to the input of the recording amplifier is the same for all frequencies.

If  $v = 2$  cm/sec and  $n = 78$  r.p.m., the width of the image is given by

$$d \simeq \frac{27 \times 2}{78} = 0.69 \text{ cm}$$

and if  $v = 2$  cm/sec and  $n = 33\frac{1}{3}$  r.p.m.

$$d \simeq \frac{27 \times 2}{33\frac{1}{3}} = 1.62 \text{ cm}$$

The preceding proof is based on the assumption that the image is viewed by means of parallel light, and these values of  $d$  therefore apply when the eye is at an infinite distance from the disk. When the eye is near the disk the values of  $d$  are smaller and vary with viewing distance.

For many purposes, for example for observation of the rise in recorded velocities due to resonances in a recording chain, absolute measurement of recorded velocity is not necessary. The Buchmann-Meyer image is useful for this purpose because comparison of recorded velocities can be made by measurement of the apparent band-width at a fixed distance from the disk.

### *Reference*

- 1 Buchmann, G., and Meyer E. : "Eine neue optische Messmethode für Grammophonplatten," *Electrische Nachrichten-Technik*, 1930, 7, p. 147.

## APPENDIX F

### SCANNING IN VARIABLE-WIDTH FILM REPRODUCTION

#### GEOMETRICAL TREATMENT

Fig. F1 represents part of a unilateral variable-width sound track with sinusoidal modulation and a light image, ABCD, is superimposed on it. Consider Fig. F1 (a) in which the recorded sine wave is the shaded area CBE and represents 100 per cent. modulation.

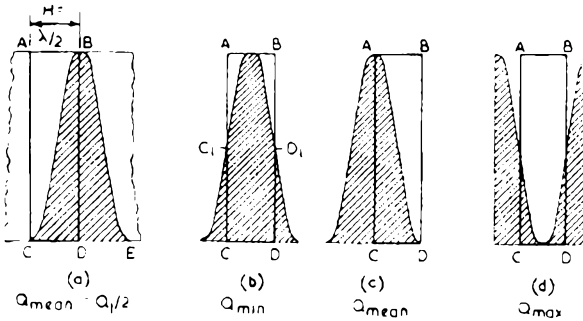

FIG. F1. GEOMETRICAL TREATMENT OF SCANNING WHERE  $H = \lambda/2$

The thickness  $H$  of the light image (AB or CD) is equal to  $\lambda/2$ . The area ABC is equal to the area BCD, and in the condition illustrated, the transmitted light quantity  $Q_2$  is half the incident light quantity  $Q_1$ , i.e.,

$$Q_2 = \frac{Q_1}{2} = \text{mean transmission}$$

Fig. F1 (b) represents conditions after the film has travelled to the left, and the peak of the wave is now in line with the centre of the slit-image. The light quantity transmitted,  $Q_2$ , is represented by the unshaded area embraced by  $ABC_1D_1$  and is a minimum.

In (c) the film has moved still farther to the left, and the diagram is a lateral inversion of (a).  $Q_2$  is again equal to  $Q_1/2$  and to the mean transmission.

Fig. F1 (d) is an inversion of (b), and represents the condition when  $Q_2$  is maximum.

The 'swing' of light flux transmission per cycle is equal to  $Q_{max} - Q_{min}$ . The value of  $Q_{min}$  is dependent upon the unshaded area at (b) relative to the area of the rectangle ABCD whilst the value of  $Q_{max}$  depends upon the area of the unshaded portion at (d) relative to the shaded area of the waveform within the light image area ABCD.

## APPENDIX F

In an ideal condition with no loss of light-flux swing and therefore of signal output, the whole of the beam would be impeded to give  $Q_{min}$  whilst the whole of the beam would be transmitted to give  $Q_{max}$ . Thus  $Q_{max}$  would equal  $Q_1$ , and  $Q_{min}$  would be zero (for maximum recorded signal amplitude).

It follows that the narrower the light image ABCD, i.e., the shorter the distance AB or CD compared with  $\lambda$ , the more nearly is this ideal condition approached, because the scanning beam thickness H covers only a small fraction of the wavelength at any instant, and conditions of  $Q_{max}$  and  $Q_{min}$  would approximate very closely to conditions of fully-opened aperture and fully-closed aperture respectively. For a given light intensity, however, the smaller the slit, the smaller is the value of the incident light quantity  $Q_1$ , and of the light transmitted, irrespective of the ratio between  $Q_{max}$  and  $Q_{min}$ .

If the aperture width H is reduced until  $Q_{min} = 0$ , and  $Q_{max} = Q_1$ , the image ABCD is infinitely thin. Thus  $Q_1$  is zero and there is no output from the photocell.

Conversely, if H is made greater than  $\lambda/2$  (to increase  $Q_1$ ), a reduction of output tends to occur. For instance if  $H = \lambda$  there is no signal output because  $Q_2$  is continuously equal to  $Q_1/2$  during transit of the waveform and the photocell delivers d.c. only although (for a given light intensity) the value of  $Q_1$  is twice that which applies when H equals  $\lambda/2$ .

In Fig. F1 (a) the condition of mean transmission, if the rectangle ABCD represents 100 arbitrary units of light, area BCD of the sine wave represents 50 units. At (b) which represents  $Q_{min}$ , ABCD is impeded to the extent of 85 units and only 15 units of light are transmitted. The light swing ( $Q_{max} - Q_{min}$ ) is thus 70 units.

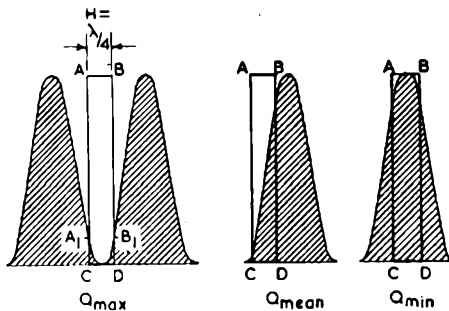

FIG. F2. GEOMETRICAL TREATMENT OF SCANNING WHERE  $H = \lambda/4$

If the unimpeded rectangle ABCD is equivalent to 100 per cent., scanning the wavelength illustrated gives a response of 70 per cent. and the output level is equivalent to a light swing of 70 units.

Fig. F2 illustrates the same sequence of events for  $H = \lambda/4$ . For the same incident light intensity,  $Q_1$  is now 50 units, but the swing  $Q_{max} - Q_{min}$ , is 40 units. If 50 units represents 100 per cent., the relative response is 80 per cent,

but the signal output is equivalent to a light swing of only 40 units, i.e. about 40 per cent lower than when  $H = \lambda/2$ . Any increase or decrease of  $H$  relative to  $\lambda/2$  reduces the response at that wavelength. Mathematical analysis of this important fact is given later.

In the Philips-Miller system, the film velocity  $V = 12,000$  mils per second and the optimum value of  $H$  at any frequency is given by

$$H = \frac{6,000}{f}$$

The extinction frequency  $f_o$  at any particular value of  $H$  is  $2f$ . Optimum  $H$  is halved for every octave increment in  $f$ , and  $f_o$  is always one octave above the value of  $f$  for which  $H = \lambda/2$ . Thus :

Optimum H at 1 kc/s	=	$\frac{6,000}{1,000}$	(mils)	=	6 mils,	and $f_o =$	2 kc/s
"    "    2    "	=	$\frac{6}{2}$	(mils)	=	3 mils,	"    "    =	4 kc/s
"    "    3    "	=	$\frac{6}{3}$	(mils)	=	2 mils,	"    "    =	6 kc/s
"    "    4    "	=	$\frac{6}{4}$	(mils)	=	1.5 mils,	"    "    =	8 kc/s
"    "    5    "	=	$\frac{6}{5}$	(mils)	=	1.2 mils,	"    "    =	10 kc/s
"    "    6    "	=	$\frac{6}{6}$	(mils)	=	1.0 mil,	"    "    =	12 kc/s
"    "    7    "	=	$\frac{6}{7}$	(mils)	=	0.857 mils,	"    "    =	14 kc/s
"    "    8    "	=	$\frac{6}{8}$	(mils)	=	0.75 mils,	"    "    =	16 kc/s

#### MATHEMATICAL TREATMENT

A mathematical treatment of the scanning process enables the deductions made above to be checked and in addition gives information about the frequency response obtained. The analysis will be carried out with the aid of Fig. 3 which represents a sinusoidal track ABCD and a light image EFGH. The total output voltage, i.e., the sum of the a.c. and d.c. components, of the photocell is directly proportional to the total light flux falling on the cathode, which, in turn, is directly proportional to the area beneath the curve ABCD and lying between the ordinates EG and FH.

It is immaterial whether the film or the slit is considered stationary. It is the relative motion between the two which is important and it is convenient to assume the sound track to be at rest and the slit to be moving at a velocity  $v$ .

If the recorded sine wave has unit amplitude the equation to the curve ABCD may be written

$$y = a + \sin 2\pi \frac{x}{\lambda}$$

APPENDIX F

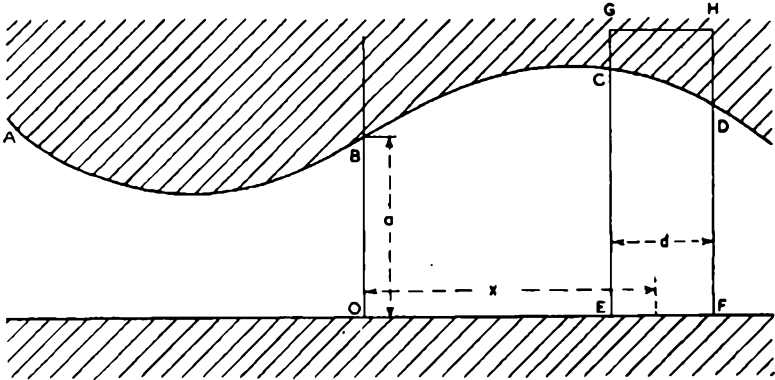

FIG. F3. A SLIT SUPERIMPOSED ON A VARIABLE-AREA TRACK

in which  $a$  is a constant and  $x$  is the distance from the reference point, O, to the centre of the light image, which has a width,  $d$ . The area beneath the curve intercepted by the slit, the edges of which are the ordinates at E and F, is given by

$$\int_{x-d/2}^{x+d/2} y \cdot dx = \int_{x-d/2}^{x+d/2} \left( a + \sin 2\pi \frac{x}{\lambda} \right) dx$$

$$= \left[ ax \right]_{x-d/2}^{x+d/2} - \frac{\lambda}{2\pi} \left[ \cos 2\pi \frac{x}{\lambda} \right]_{x-d/2}^{x+d/2}$$

$$= ad - \frac{\lambda}{2\pi} \left[ \cos \frac{2\pi}{\lambda} \left( x + \frac{d}{2} \right) - \cos \frac{2\pi}{\lambda} \left( x - \frac{d}{2} \right) \right]$$

The first of these terms represents a steady or d.c. component and the second an alternating component corresponding to the sinusoidal modulation. The latter may be written in the form

$$\frac{\lambda}{\pi} \cdot \sin \frac{\pi d}{\lambda} \cdot \sin 2\pi \frac{x}{\lambda}$$

which, since  $2\pi \frac{x}{\lambda} = 2\pi \frac{vt}{\lambda} = 2\pi ft = pt$ , may be restated

$$\frac{\lambda}{\pi} \cdot \sin \frac{\pi d}{\lambda} \cdot \sin pt \quad \dots \quad \dots \quad \dots \quad \dots \quad \dots \quad (I)$$

This alternating output of the photocell consists of a single component of sinusoidal waveform ; no harmonics are added during the reproducing process. This differs from the effect of the recording-slit width, which causes harmonic distortion of the recording signal. The amplitude of the sinusoidal function in

expression (1) is  $\frac{\lambda}{\pi} \sin \frac{\pi d}{\lambda}$  the value of which depends only on the slit width,  $d$ , and the recorded wavelength,  $\lambda$ .

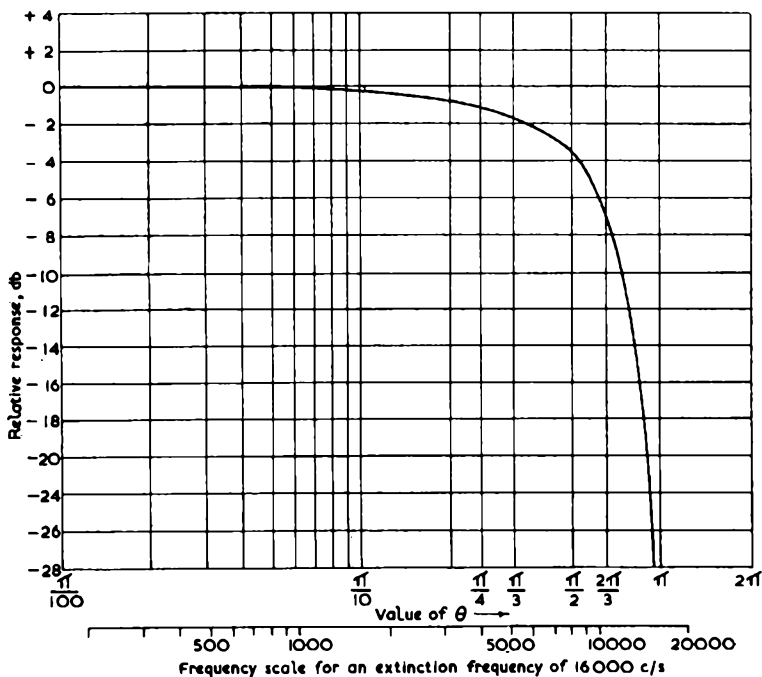

FIG. F4. SHOWING EFFECT OF REPRODUCING SYSTEM SLIT WIDTH ON FREQUENCY RESPONSE

Consider now two conditions :—

1.  $d$  fixed,  $\lambda$  variable.

Expression (1) may be used to show how the output of the photocell varies when  $d$  is fixed and  $\lambda$  varies : that is to say, it may be used to calculate the frequency response curve for a given value of  $d$ . For this purpose it is convenient to rewrite the expression in the form

$$d \cdot \frac{\lambda}{\pi d} \cdot \sin \frac{\pi d}{\lambda} \cdot pt$$

from which the amplitude of the output signal is given by

$$d \cdot \frac{\sin \theta}{\theta}$$

where  $\theta = \frac{\pi d}{\lambda}$  and is directly proportional to frequency.

Since  $d$  is fixed, the output voltage is directly proportional to  $\frac{\sin \theta}{\theta}$  and a frequency characteristic may be plotted from the expression  $20 \log_{10} \frac{\sin \theta}{\theta}$ .

## APPENDIX F

This expression is plotted in Fig. F4, from which it can be seen that the output of the cell is substantially level up to the frequency for which  $\theta = \pi/2$  and  $d = \lambda/2$ , at which the loss is approximately 4 db. When  $d = \lambda$ ,  $\sin \frac{\pi d}{\lambda} = \sin \pi = 0$  and expression (1) = 0. There is thus no a.c. output from the photocell

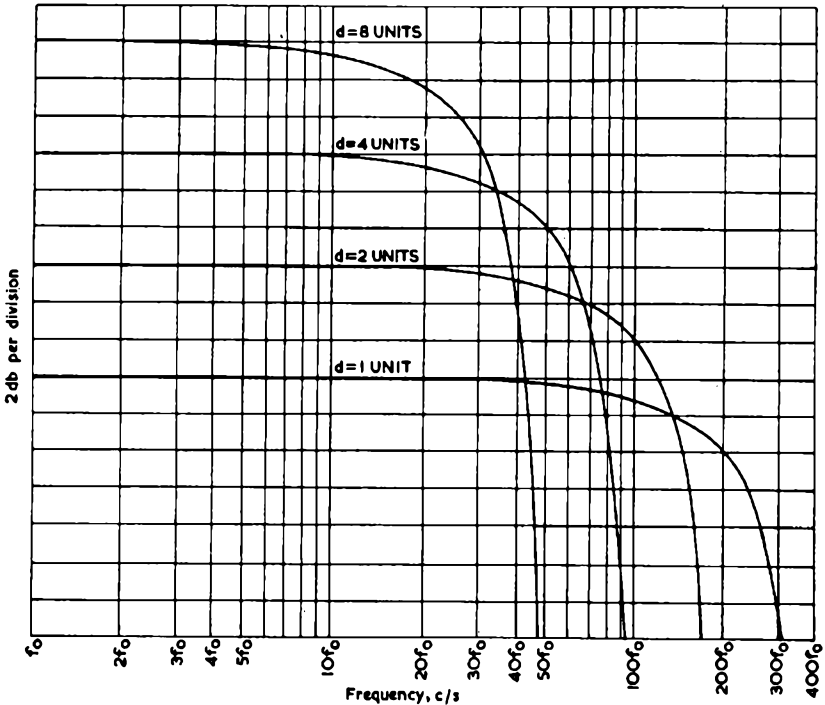

FIG. F5. EFFECT OF SLIT WIDTH ON OUTPUT LEVEL AND FREQUENCY RESPONSE

when the recorded wavelength is equal to the slit width : the frequency at which this occurs is known as the extinction frequency. Above the extinction frequency, when  $\lambda$  is less than  $d$ , the output from the cell begins to increase again but is small compared with the output at lower frequencies ; further extinction frequencies occur when  $d$  is an integral multiple of the recorded wavelength.

The horizontal axis of Fig. F4 may be calibrated directly in terms of frequency if the extinction frequency for the system is known. To do this, frequencies are plotted on the same logarithmic scale as  $\theta$  and the extinction frequency is made to coincide with a value of  $\theta$  of  $\pi$  radians. The frequency scale applicable to the Philips-Miller system (extinction frequency = 16,000 c/s) is indicated in Fig. F4.

### 2. $\lambda$ fixed, $d$ variable.

Because at low frequencies recorded wavelengths are great compared with the slit width, the fraction  $\pi d/\lambda$  is so small that  $\sin \pi d/\lambda$  may be taken as  $\pi d/\lambda$  with little error. Expression (1) then becomes  $d \cdot \sin \pi d/\lambda$  ;



i.e., at low frequencies the output of the photocell is directly proportional to the slit width. Doubling the slit width thus gives an increase in output of 6 db. To obtain a large output from the photocell, a large value of  $d$  is necessary, but such values give low extinction frequencies and the high-frequency response of the system is poor. Alternatively a small value of  $d$  gives a low output at low frequencies and a high extinction frequency. This is illustrated in Fig. F5, which shows how the output from the photocell varies with frequency for various values of  $d$ . It can be seen from this diagram that at any given frequency there is a particular value of  $d$  which gives maximum voltage output. This result can also be deduced from expression (1); for if  $\lambda$  is fixed and  $d$  varied, maximum output occurs when  $\sin \pi d/\lambda = 1$ , i.e. when  $\pi d/\lambda = \pi/2$  giving  $d = \lambda/2$ . Theoretically the optimum value of slit width is that which gives maximum output at the highest frequency it is desired to reproduce and is equal to half the wavelength at that frequency. In the Philips-Miller system  $d = 0.75$  mil equal to  $\lambda/2$  at 8,000 c/s.

## APPENDIX G

### A STUDY IN FREQUENCY FLUCTUATIONS IN SOUND RECORDING AND REPRODUCING SYSTEMS

By P. E. Axon, O.B.E., M.Sc., A.M.I.E.E. and H. Davies, M.Eng., M.I.E.E.

*Reproduced from Proc. I.E.E. Vol. 96, Part III, No. 39, Jan., 1949  
by permission of the Institution of Electrical Engineers*

#### SUMMARY

The first part of the paper discusses the occurrence of unwanted fluctuations of frequency in sound recording and reproducing systems and considers methods of measuring these fluctuations in disc-recording systems. A particular procedure is discussed in detail and new apparatus that has been developed for these measurements is described.

It has been found that frequency fluctuations vary in magnitude in a random manner, and the second part of the paper indicates how useful information may be extracted from the highly complex data that result from continuous measurement. The statistical properties of the variations of magnitude have been found to be in accordance with theory developed for analogous electrical systems, and examples are given of a number of practical cases in which statistical analysis has enabled the causes of frequency fluctuations to be identified and appropriate action to be taken.

#### I. MEASUREMENT OF FREQUENCY FLUCTUATIONS

##### 1.1 INTRODUCTION

Undesired variations in the frequency of the output signal from a sound recording/reproducing system are commonly referred to as "wow" and "flutter." These terms may perhaps be regarded as slang and certainly there does not appear to be universal agreement as to their exact meaning. On the other hand, there seems to be no other way of referring both briefly and explicitly to phenomena in which the audio signal acts as a carrier for unwanted frequency modulation, and these words are therefore used in the present paper. The term "wow" is applied to the comparatively slow variations, up to about 10 c/s, which are common in disc recording, while "flutter" is used to describe variations that are rapid enough for the individual changes not to be perceptible to the ear. These comparatively high-frequency variations of frequency are encountered in other recording systems, as, for example, 25 c/s with Magnetophon and 96 c/s with ciné film.

The paper is concerned primarily with the objective aspects of wow arising in disc recording and reproducing systems, but the methods outlined can readily be extended to deal with flutter and with other recording systems. The subjective aspects of wow and flutter are not treated here, though they are briefly referred to in Section 1.7.

## BBC RECORDING TRAINING MANUAL

Unlike some other forms of distortion, wow appears to be universally regarded as objectionable whenever it is perceived, and it is usually one of the most noticeable faults on disc reproductions. It is not easy to eliminate it, however, for the ear is very sensitive to this form of distortion, and very small frequency fluctuations may be noticeable in some circumstances. On the other hand, speed uniformity requires high mechanical accuracies in the driving mechanism, and trial-and-error experimenting is therefore both laborious and expensive. To avoid this impasse, a better understanding of wow was sought and the first step was to devise equipment for measuring it. This presented no great difficulty and the apparatus is briefly described in this Section of the paper. The understanding of the results presented more difficulty, but successful methods of treatment were evolved and are outlined in Section 2.

### 1.2 PRINCIPAL ASPECTS OF WOW

In measuring wow, as in measuring noise, information may be required in two forms. First, for operational use, it may be desired to know whether "total wow" (or noise) is above or below a previously determined acceptance limit, in the manner of a "go/not-go" gauge. Secondly, in the course of design or development, it may be desired to analyse wow (or noise) into its various components so that each may be traced to its source and appropriate action taken with a minimum of wasteful experiment. As regards the first requirement, it will not be possible to make a wholly reliable go/not-go wow gauge until more is known about the ear's response to wow, but a simple total-wow meter has been made and may be used with about the same confidence as is a "noise meter." As regards the second requirement, equipment has been devised to obtain data for analysis by drawing a curve showing the variations of frequency with time in the output of a reproducing system. Both types of equipment are described below.

Wow may vary in a very complex manner, but the data obtained from the frequency/time graph has been found to yield to statistical treatment and, in a practical case, it has been possible to determine what benefit could be derived from each of a number of interacting mechanical changes without going through expensive step-by-step experiment. Similarly it has been possible to determine whether the performance of a prototype machine is really representative, that is to say, whether production machines made to the same design could be expected, on the average, to be better or worse.

### 1.3 THE ORIGIN OF WOW

A constant-frequency signal recorded on a disc will be reproduced at a constant frequency only if the linear velocity of the disc past the stylus in the recording process is exactly duplicated on replay. The linear velocity changes at a constant rate across the disc but if it departs from its correct value at any point, in either the recording or the replay process, then the frequency of the signal will be varied and, if the variation is large enough, it will be audible as wow. Wow may therefore occur if the recording or the reproducing turntable

## APPENDIX G

varies in speed and, as is well known, this commonly happens because of imperfections in the drive system and changes in the load upon it.

It is not always so clearly realized that the relative velocity of the disc to the recording or reproducing stylus would still vary, and wow would therefore still arise, even with perfect uniformity of turntable speed. Some of the major causes of this, such as variations in the thickness of the disc, tilt of the turntable or of the disc on it, and non-flatness of the disc surface, are discussed in the Appendix (Section 5.1).

In addition, wow may be introduced by eccentricity of the disc on the replay turntable and this may arise in two ways: either the hole in the disc may be large enough to permit it being placed eccentrically on the pin, or the pin itself may be eccentric in the recording or the replay turntable.

The wow that does not depend on turntable speed is by no means negligible in practical cases. For example, the specification published by the National Association of Broadcasters (of America)<sup>1</sup> limits turntable speed deviations to  $\pm 0.1\%$  of the mean speed. The corresponding N.A.B. specifications for the disc centre-pin ( $0.2836 \pm 0.0005$  in. diameter) and the disc hole ( $0.286 \pm 0.001$  in. diameter), however, permit a disc eccentricity of  $0.002$  in., and if this occurs on recording and on replay it may result in a frequency fluctuation of about  $\pm 0.2\%$  at the inside of a 78 r.p.m. disc. This is twice as much as is permitted from turntable speed variation. Similarly the N.A.B. tolerance of  $\pm 1/16$  in. on disc thickness permits frequency fluctuations of a similar order; for example,  $\pm 0.14\%$  at the end of a 78 r.p.m. disc on a BBC disc recorder.<sup>2</sup>

It is clear that variation of turntable speed may be only a minor contribution to the total wow present and that measurement of speed alone can give no indication of the wow that will arise when a turntable is used to record or reproduce a disc.

### 1.4 TYPES OF WOW

In any practical case, wow from several causes may be expected to be present simultaneously in various degrees. Some wow such as that which arises from disc tilt and eccentricity is synchronous with the turntable. Other wow, such as that which arises from eccentricities in the drive, is periodic but not synchronous with the turntable. Some periodic wow remains constant from disc to disc while that due to disc tilt and eccentricity may change each time a disc is placed on the turntable. Again, in any one playing, the magnitude of the wow due to disc eccentricity would be expected to increase as the centre of the disc is approached. Clearly, therefore, variations in wow are to be expected even when a single disc is replayed several times.

A combination of synchronous and non-synchronous periodic wow can be expected to give a complex pattern of wow with an envelope that varies in amplitude in a cyclic manner. In the course of this study, however, a discovery of some importance was made, namely that the amplitude and waveform of successive periodic fluctuations vary in a random manner. This was found to be due to the superposition on them of random fluctuations deriving partly from

variations in disc thickness and partly from the turntable drive system. Random fluctuations can, of course, arise from the interaction of a large number of variables that are not systematically related and, in the limit, small fluctuations are to be expected in all electrical and mechanical systems because of Brownian movement. In this investigation, however, it has been found that the random fluctuations which appear with normal recording and reproducing equipment are of appreciable magnitude and that on good equipment the greater part of the audible wow may be random. Even on less good equipment, random fluctuations may considerably affect the wow pattern and, generally speaking, it is only with poor equipment, having fairly gross defects, that the random fluctuations are masked. It is, of course, the presence of random fluctuations that necessitates a statistical treatment (Section 2) in analysing complex wow patterns.

#### 1.5 WOW MEASUREMENT PROCEDURE

Changes in the angular velocity of a turntable may be measured by observing the frequency changes in the output of a "tone generator" mounted on the turntable and driven from it. Any device in which a constant speed of rotation produces a constant frequency may be used, and descriptions of electromagnetic "tone-wheel" alternators have been published at various times.<sup>3, 4</sup> If a device of this kind is constructed with sufficient accuracy and suitable precautions are taken as regards centring, satisfactory measurements of turntable speed may, of course, be made. As already explained, however, such measurements do not indicate, even approximately, what wow will arise when the same turntable is used to record or to reproduce a disc. To determine what occurs under practical conditions it is necessary to measure the frequency fluctuations when a disc is reproduced and, for convenience, the disc is normally a constant-frequency tone-disc.

If the wow in the recording of this disc is negligible compared with that involved in the reproducing process, the disc can be regarded as a fixed-frequency tone-generator, and the variations of frequency observed are a direct measure of the wow introduced in reproduction. This is the condition that obtains when a good tone-disc is used to test indifferent reproducing turntables. In testing a first-grade reproducing turntable, however, the wow on the test-disc may not be negligible and the wow which appears is then a combination of that occurring in both the recording and the reproducing processes.

The performance of a recording turntable used as a reproducer is measured in the same way. Its performance as a recorder is determined by recording a tone-disc on it, and by reproducing this disc either on the recording machine itself or on another turntable the performance of which is known.

The essential requirements for measuring wow are therefore as shown in the block schematic of Fig. G1, namely :

- (a) A tone-disc "generator."
- (b) A system for reproducing the tone-disc and feeding the resulting tone to (c).

## APPENDIX G

(c) A “discriminator” which converts the frequency fluctuations in the reproduced tone into amplitude variations which can more readily be observed and recorded.

(d) An “indicator” which shows, either by the reading of a meter or by a graph, the variations in the output from the discriminator.

These requirements are discussed separately in the following Sections.

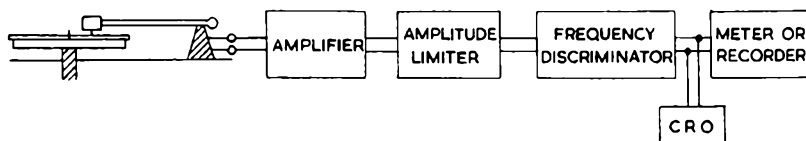

FIG. G1. WOW-MEASURING CHAIN

### 1.6 MEASUREMENT OF WOW

#### 1.6.1 *The Test-disc*

The test-disc that is cut when investigating the performance of a recording turntable necessarily contains the wow that is to be measured, but in examining the performance of reproducing turntables it is desirable that the disc itself should introduce a minimum of wow. For this purpose, test-discs have been recorded on a machine with very small speed fluctuations and with the centre pin accurately coincident with the axis of rotation. Only flat discs were used and the centre hole of each disc was closed up, before recording, to make it a tight fit on the pin. The resulting test-discs contained only such frequency fluctuations as arose from the turntable drive mechanism and from variations in disc thickness. Both kinds of fluctuations were quite small but they have been evaluated (Section 2) so that they can be allowed for when measuring the performance of very good machines.

In measuring wow in this way, the frequency recorded on the test-disc is not important except as a limitation on the possible accuracy of measurement. The higher the frequency, the smaller is the percentage change that can be detected, and for laboratory investigation of first-grade equipment a test disc frequency of 10 kc/s was adopted. For cases where a very sensitive measuring device is not required a similar, but simpler, equipment has been made for use with a 3-kc/s test-disc.

It is probably desirable to continue to use carefully prepared 10-kc/s direct recordings for laboratory measurements on good turntables but, for less precise measurement made with 3-kc/s discs, pressings would be convenient. No difficulty is likely to arise with the usual processing distortions, but care may be necessary to ensure that the hole is of the correct size and concentric with the recording.

#### 1.6.2 *The Reproducing System*

The test-disc may be replayed using any kind of disc reproducing equipment, provided that the output is sufficient to operate the discriminator and that there

is a reasonable signal/noise ratio. Only a single frequency is involved and the frequency response of the replay system is therefore unimportant.

The pick-up may have a swinging or a parallel tracking arm, but in either case the wow due to changes in the height of the disc surface depends on the length of the arm and on the height of the horizontal pivots. In testing a reproducing desk the normal pick-up is of course used, for any wows that it may introduce are part of the performance of the desk. In testing a recorder, where it is convenient to introduce as little wow as possible on reproduction, a long arm pick-up (either swinging or parallel tracking) should be used whenever practicable.

If a normal swinging-arm pick-up is used, a difficulty arises because the reproducing stylus does not follow a straight radial track across the disc, as did the recording stylus, but moves in an arc of a circle. Because of this there is a slow drift of the reproduced frequency which may introduce frequency changes comparable with those involved in audible wow. To overcome this difficulty an "auto-balance" unit has been designed for the 10-kc/s discriminator which automatically adjusts the discriminator with respect to the mean frequency of the reproduced tone and so enables it to ignore slow frequency drifts while remaining sensitive to the changes that constitute wow.

### 1.6.3 *The Discriminator*

The purpose of the discriminator is to convert any frequency modulation in the reproduction from the tone-disc into a proportional amplitude modulation and, since the output of a reproducer is usually subject to some undesired amplitude variations, these must first be removed by passing the signal through a limiter (Fig. G1).

The discriminator circuit used is shown in simplified form in Fig. G2 and is described in detail in the Appendix (Section 5.2). It consists of an inductance  $L$  and a capacitance  $C$ , in parallel, fed from one end of the secondary of a transformer  $T$  which is centre-tapped to earth. The other end of the transformer secondary feeds a resistance  $R_2$  in parallel with  $L$  and  $C$ .  $R$  represents the resistance of  $L$ , and  $R_1$  is an equal resistance connected in series with  $C$ .  $L$  and  $C$  are arranged to balance at the predetermined test frequency, 10 kc/s or 3 kc/s. Now the combination of elements in this top branch can be shown to be equivalent to a reactance in parallel with a resistance which is dependent on the  $Q$ -factor of the inductance  $L$ . This resistance is effectively constant over the narrow band of frequencies encountered in these measurements and is balanced out at all considered frequencies by the resistance  $R_2$  which is in the opposite leg of the centre-tapped transformer secondary. Thus, if a signal at the predetermined test frequency is applied to the primary of the transformer, the output at the terminals  $X$  will be zero, but any divergence from this frequency, either positive or negative, will result in an output at  $X$ . The response curves of two such circuits used for test frequencies of 10 kc/s and 3 kc/s are shown at Fig. G3.

In making measurements on ordinary turntables it would be impracticable to demand a very precise test frequency, and provision must be made for varying

## APPENDIX G

the tuning of the  $LC$  circuit within narrow limits. This is accomplished by adding a variable air condenser  $C_2$  either in parallel with the  $LC$  circuit or, as shown in Fig. G2, in parallel with  $R_2$ . In the 10-kc/s discriminator,  $C_2$  is another

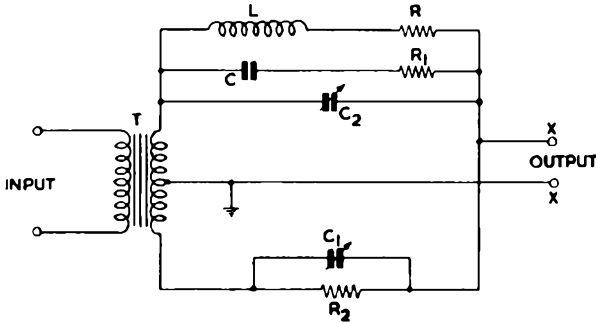

FIG. G2. BASIC DISCRIMINATOR CIRCUIT

small condenser which is effectively in parallel with  $L$  and  $C$  and which is altered in value by the auto-balance unit so that the discriminator-circuit null frequency alters slightly to follow any slow frequency drift.  $C_2$  is actually a fixed condenser supplied at variable voltage by a variable- $\mu$  valve in the auto-balance unit, and the output of this valve is controlled at a suitable delay by the output of the discriminator circuit itself. Changing the driving voltage on

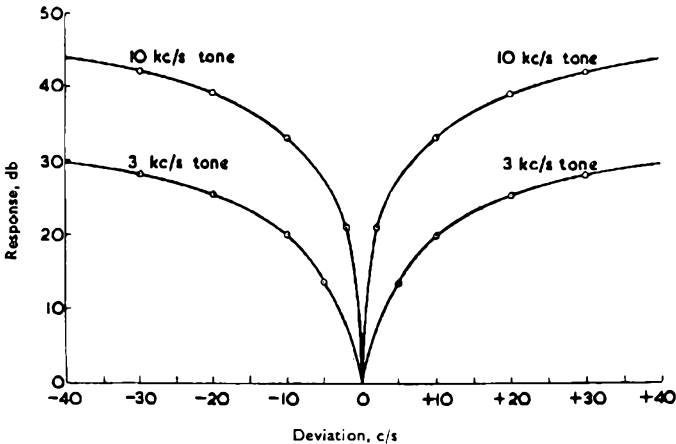

FIG. G3. RESPONSE CURVES OF THE DISCRIMINATOR CIRCUITS

the condenser  $C_2$  is equivalent, in this circuit, to altering its capacitance. This auto-balance unit has been found unnecessary in measuring indifferent turntables with the 3-kc/s discriminator.



Inspection of the response curves of Fig. G3 shows that tuning the discriminator circuit to reject the test frequency makes positive and negative frequency variations indistinguishable since both result in an increase in output. This is sometimes inconvenient and in such cases it has been usual to work to one side or the other of the null point so that positive and negative changes in frequency cause opposite variations about some steady output level. The discriminator then delivers a tone of approximately 10 kc/s or 3 kc/s, the amplitude of which varies with, and is a measure of, the frequency of the tone entering the discriminator.

#### 1.7 MEASUREMENT OF TOTAL WOW

As already mentioned, the information about wow that is contained in the output of the discriminator may be observed either by a meter indicating total wow or by drawing a graph showing continuously the variation of frequency with time. In either case it is the low-frequency variation in the amplitude of the 10 kc/s or 3 kc/s "carrier" emerging from the discriminator which is of interest.

To design a total-wow meter that will give the same reading for all equally annoying wow requires a knowledge of how the ear reacts to wow of various "amplitudes" (i.e. frequency deviations), and of various rates of frequency deviation, just as in the making of an objective noise meter it is necessary to know how the ear assesses different amplitudes and frequencies of "noise." In the case of wow, however, very little is known about the ear's response except with pure tones, and subjective experiment is more difficult than with noise. For the present therefore, it is necessary to be content with a wow meter that measures different magnitudes of the same kind of wow, but does not necessarily correspond to subjective impression in comparing wow of different kinds. A wow meter of this type is, of course, subject to much the same kind of limitation in use as is an objective noise meter.

In a complex pattern of wow the mean square of the amplitudes of the fluctuations has proved to be an important statistical factor, a knowledge of which is required in order to forecast the effect of mechanical improvements. In the absence of data on the subjective effects of wow it is useful to measure the mean-square amplitude, and this has been done by feeding the discriminator output through a suitable transformer into a normal thermocouple unit with an associated moving-coil meter. If the discriminator null-point is adjusted to coincide with the mean reproduced frequency, then both positive and negative frequency variations result in a unidirectional output, the mean-square amplitude of which is indicated by the meter.

A circuit diagram of this simple unit is shown in Fig. G4. Tc represents the standard thermocouple, the heater being fed either directly from the transformer T, when X and Y are directly connected, or from a standard audio amplifier, the input and output of which are connected to X and Y respectively. This arrangement enables a wide range of machines to be investigated, using an appropriate thermocouple and meter, and is both cheap and simple. There

## APPENDIX G

is some danger, however, of burning out the thermocouple accidentally, and for operational use it may prove advisable to substitute a more expensive but more robust thermionic square-law meter.

This kind of total-wow meter can be very useful but it is stressed that its indication depends on the amplitude, the wave-form and the frequency of occurrence of the wow, and that the way in which these contribute to making wow subjectively offensive is not known. The meter is thus to be regarded mainly as a device for indicating different magnitudes of the same kind of wow, such as may occur with a series of similar machines, and not for comparing different kinds of wow.

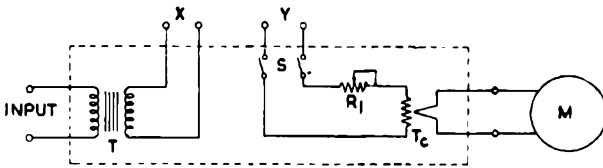

FIG. G4. TOTAL-WOW INDICATING METER

### 1.8 MEASUREMENT OF THE VARIATION OF FREQUENCY WITH TIME

To enable the character, as well as the magnitude, of a wow pattern to be examined the variation of frequency with time must be ascertained. The Neumann Level Recorder has been found very suitable for this purpose since it records the level of an audio-frequency tone continuously on a moving paper strip. All that is required, therefore, is to feed the output of the discriminator (10 kc/s or 3 kc/s as the case may be) to the Level Recorder, and the pen draws the variation of frequency on the paper strip. It is usually convenient at the end of each such instrument to apply calibration marks directly on to the strip by feeding tone at known frequencies into the discriminator.

The Level Recorder has a sufficiently rapid response to enable it to follow satisfactorily the low-frequency changes usually involved in disc reproductions, but it is too sluggish to record the flutter frequencies and a moving-coil pen recorder has been adapted for this purpose.

Fig. G5 shows typical examples of wow graphs taken from reproducing turntables. It is apparent that it is by no means easy to see what the results mean, for both graphs show variations that are irregular in waveform and in amplitude. The usefulness of simple inspection of the results may be judged from the fact that (a) and (b) are different parts of the same graph and represent precisely the same performance in the recording/reproducing equipment. It will be seen that little advantage is to be derived from the measurement of frequency fluctuations unless means are also developed to enable the results to be analysed and understood.

## 2. ANALYSIS OF WOW MEASUREMENTS

## 2.1 RANDOM VARIATIONS

If the individual amplitudes of all the fluctuations on a graph like Fig. G5 are measured and tabulated, the results may be plotted showing the number of times that fluctuations of various magnitudes have occurred. A wide variety of such distribution curves has been obtained in this investigation and three examples are shown in Fig. G6.

Distribution curves of this shape are commonly encountered in a wide variety of scientific problems ; in fact they arise whenever the magnitude of a

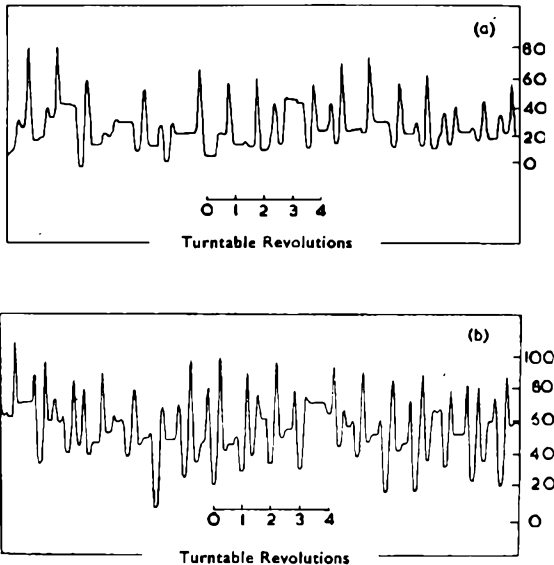

FIG. G5. RECORDS OF FREQUENCY DEVIATIONS IN A 10-KC/S TONE

recurring phenomenon is the result of the superposition of a number of variables the values of which are governed by certain probability laws. For example, Fig. G7 shows the relative frequency of occurrence of different lengths of life of a large number of 100-watt incandescent lamps under test.<sup>5</sup> It can be seen that one particular length of life is more likely than any other, but that longer and shorter lives frequently occur. Another example of this type of distribution is to be found in the amplitude of the small random (or Brownian) movements, which mechanical systems exhibit about their equilibrium positions.

Phenomena of this kind are sometimes referred to as *stochastic* and much study has been given to them. It was realised that if wow were indeed stochastic, as the distribution curves suggested, then mathematical techniques already in existence would be available for the study of it. There is nothing inherently unreasonable in the idea that wow might be stochastic, for turntable speed is

APPENDIX G

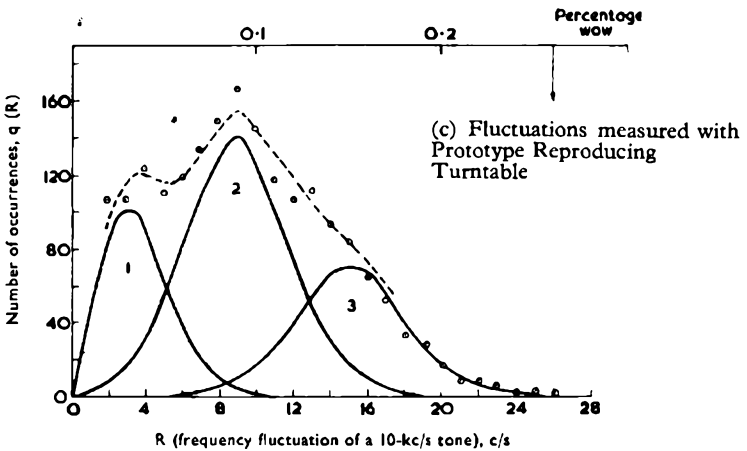
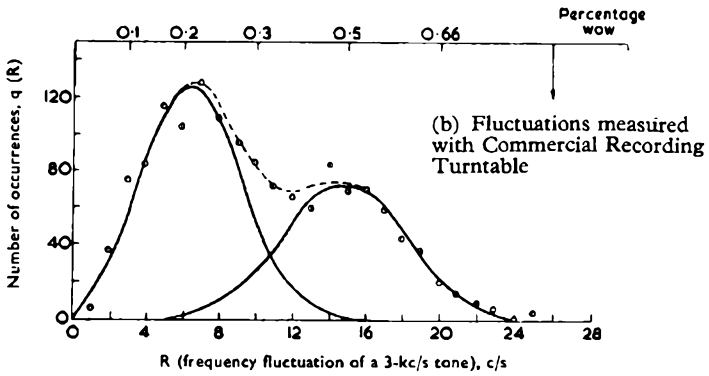
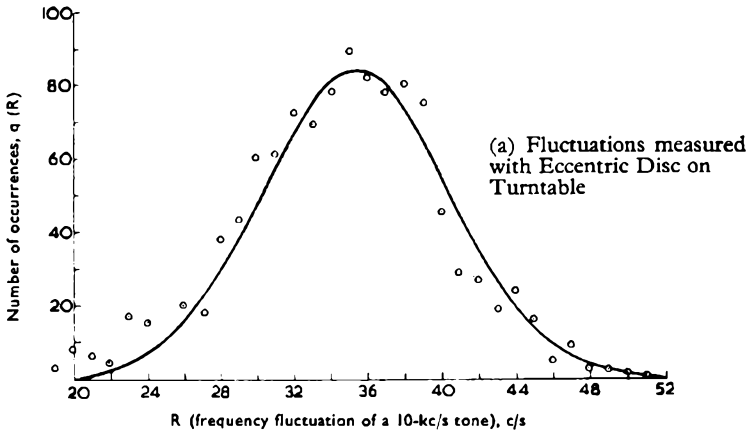

FIG. G6. AMPLITUDE DISTRIBUTION CURVES

influenced by many continually varying factors and, in fact, a study carried out in 1932 by Kappler<sup>6</sup> on a similar but much simpler system, showed that it had a random variation of amplitude. Kappler plotted the variations of amplitude of a mirror twisting on the thread by which it was suspended, and he obtained curves very much like Fig. 6(a), their precise shape depending on the air damping to which the mirror was subjected.

For the purpose of this investigation a preliminary assumption was made that normally a part of the wow occurs stochastically. Several practical cases were investigated and the predictions made on this basis correspond closely enough to observation to leave no doubt that the assumption was justified.

2.2 COMBINED RANDOM AND PERIODIC VARIATIONS

Generally speaking, a variety of fluctuations occur in any turntable drive mechanism, and the steady driving force has pulses of various shapes and amplitudes superposed on it. Like the steady driving force, these pulses are

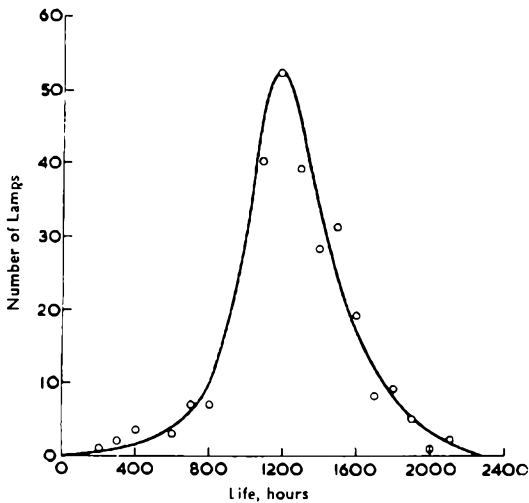

FIG. G7. LIVES OF 100-WATT ELECTRIC INCANDESCENT LAMPS

transmitted to the inertia of the turntable via a compliance, while the cutting or the pick-up load, together with bearing and other frictions, provide a load which is to a large extent resistive. The equivalent electrical circuit is, therefore, as shown in Fig. G8(a), where the turntable inertia is represented by  $L$ , the driving compliance by  $C$  and the load by  $R$ . Pulses of the driving force are represented by corresponding pulses of input voltage, and the currents appearing in  $R$  correspond to speed variations of the turntable. This circuit has a response curve of the type shown in Fig. G8(b), which is similar to that of an unsymmetrical band-pass filter.

APPENDIX G

Rice<sup>7</sup> has recently predicted the statistical variation to be expected in the amplitude of the output envelope of a dispersive device, such as a band-pass filter, when its input is fed with random electrical noise or with a mixture of random noise and one or more sinusoidal voltages. He employs a Fourier-series method in which the noise current is regarded as composed of many sinusoidal components.

He has shown that the differential probability,  $p(R)dR$ , that the amplitude  $R$  of the envelope lies at any time between  $R$  and  $R + dR$  is given by

$$p(R)dR = \frac{R}{\psi_0} \epsilon^{-R^2/2\psi_0} \dots \dots \dots (1)$$

where  $\int_0^\infty p(R)dR = 1$ . The quantity  $\psi_0$  is defined by the integral

$$\psi_0 = \int_0^\infty W(f)df, \text{ where } W(f) \text{ is the power spectrum of the fluctuating current.}$$

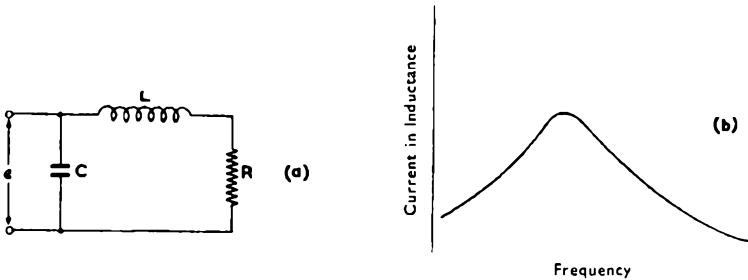

FIG. G8. TURNTABLE DRIVE MECHANISM

(a) Equivalent Circuit. (b) Response Curve of Equivalent Circuit

Thus, for example, if the fluctuating current contains all frequencies and it is allowed to flow through a resistance of one ohm, the average power dissipated by those components whose frequencies lie between  $f$  and  $f + df$  will be  $W(f)df$ . It may be shown that  $\psi_0 = \overline{R^2}/2$ , where  $\overline{R^2}$  is the mean-square amplitude of the envelope, and also that  $\sqrt{\psi_0} = R_m$ , where  $R_m$  is the most probable value of  $R$ , i.e. that value which occurs most frequently.

Now the probability of a value  $R$  occurring in the future will clearly be some multiple of the number of times  $R$  has occurred in any given period of observation. If  $q(R)$  represents the number of occurrences, then from equation (1)

$$q(R) = k \frac{R}{\psi_0} \epsilon^{-R^2/2\psi_0}$$

where  $k$  is a constant  $\gg 1$ . A strict test of whether an observed distribution

obeys this form is given by plotting  $\log_e q(R)/R$  against  $R^2$ , which should result in a straight line of slope  $-1/2\psi_0$ .

If a regular harmonic oscillation is superposed on the random fluctuations, the distribution function  $p(R)$  will take the form

$$p(R) = \frac{R}{\psi_0} \epsilon^{-(R^2 + S^2)/2\psi_0} I_0 \left( \frac{RS}{\psi_0} \right) \dots \dots (2)$$

where  $S$  is the peak amplitude of the harmonic oscillation, i.e. the steady amplitude of the output envelope as it would appear if no random fluctuations were present.  $I_0(RS/\psi_0)$  is the Bessel function of the first kind, zero order and imaginary argument. Equation (1) is, of course, a special case of the general equation (2) for  $S = 0$ . Assuming that the regular and random fluctuations are not correlated, it may be shown that in this case  $\overline{R^2} = S^2 + 2\psi_0$ .

A series of curves has been computed by Rice<sup>7</sup> for the function of equation (2) for various ratios of  $S$  to  $\sqrt{\psi_0}$ , i.e. of regular-oscillation amplitude to r.m.s. fluctuation current.

When  $S$  is large, 
$$I_0 \left( \frac{RS}{\psi_0} \right) \rightarrow \frac{\epsilon^{RS/\psi_0}}{\sqrt{(2\pi RS/\psi_0)}}$$

so that equation (2) becomes

$$p(R) = \frac{1}{\sqrt{2\pi S\psi_0}} \sqrt{\frac{R}{2\pi S\psi_0}} \epsilon^{-(R-S)^2/2\psi_0} \dots \dots \dots (3)$$

except near the beginning of the distribution, where the approximation is insufficiently accurate [cf. Fig. G6(a)]. Equation (3) represents a fluctuation amplitude almost normally distributed about the amplitude  $S$  of the regular oscillation. As before,  $p(R)$  may be identified with  $q(R)$  when multiplied by a suitable constant, so that

$$q(R) = k \sqrt{\frac{R}{2\pi S\psi_0}} \epsilon^{-(R-S)^2/2\psi_0}$$

or 
$$\log_e \frac{q(R)}{\sqrt{R}} = \left[ \log_e \frac{k}{\sqrt{(2\pi S\psi_0)}} \right] - \frac{(R-S)^2}{2\psi_0} \dots \dots (4)$$

From equation (4) it will be seen that plotting  $\log_e q(R)/\sqrt{R}$  against  $(R - S)^2$  constitutes a test of observations obeying equation (3), and the result should be a straight line of slope  $-1/2\psi_0$ .

With a recording turntable, sinusoidal fluctuations of driving force can result from mechanical imperfections, for example in the bearings, and these fluctuations will result in corresponding changes in velocity. There may also be variations of velocity due to eccentricity of disc or centre pin. If there are appreciable random fluctuations in the driving force applied to the turntable, the effects will be combined with the sinusoidal changes, and provided that the conception of the turntable as a type of bandpass filter is correct, Rice's predictions should apply to the amplitude distribution of wow envelope. This

## APPENDIX G

hypothesis has been tested by fitting theoretical curves to a variety of observed distributions, the wow envelope being measured by measuring the individual amplitudes AB, BC, CD, etc., in a wow graph such as Fig. G9. The method of fitting curves is described in the Appendix (Section 5.2) and some of the results are shown in Fig. G6. In all cases the wow is that obtained from the reproduction of a narrow band of disc (30-40 sec. playing time) at approximately 10-in. diameter, repeated so that a total playing time of 200-300 sec. is covered.

### 2.3 TYPICAL WOW DISTRIBUTIONS

The distribution of Fig. G6(a) was obtained by measuring the frequency fluctuations which occurred when an eccentricity of 0.009 in. was intentionally introduced in the reproduction of a 10-kc/s test-disc. It can be seen that a value  $R = 35$  c/s (0.35%) occurs most frequently, although values as high as 0.51% and as low as 0.19% have been recorded. Now an eccentricity of 0.009 in. should give a cyclic fluctuation of 0.36% when reproducing at 10-in. diameter and, assuming that this is superposed on random fluctuations, the computed distribution is that shown by the full line. It will be seen that agreement with the observed points is good except near the origin, where the theoretical approximations in the analysis introduce a limited error.

Again, the points of Fig. G6(b) show the distribution observed when measuring the wow obtained with a commercial recording machine, and it will be seen that it follows quite closely the dotted line which is the sum of the two theoretical distributions shown in full line. These latter consist of random fluctuations superposed on regular fluctuations of 0.06% and 0.15%, and it can be concluded that this machine had two significant sources of periodic wow.

### 2.4 AN EXAMPLE OF PROTOTYPE INVESTIGATION

The wow distribution shown by the points of Fig. G6(c) was obtained from a prototype reproducing equipment, the turntable of which was friction-driven via a soft rubber tyre set in the rim. The distribution was found to contain three sources of wow, each consisting of regular fluctuations on which the same set of random fluctuations was superposed. A further investigation showed that the machine had three major faults, each causing a cyclic variation once per revolution. One fault lay in the turntable bearings, one was an irregularity in

the tyre, and one was eccentricity of the turntable centre-pin. This eccentricity was measured by a clock gauge and it was found that the measured value was greater than that corresponding to any of the modes of the observed wow distribution of Fig. 6(c).

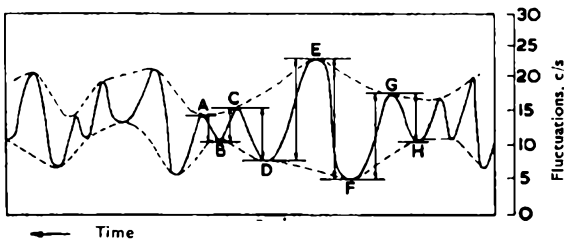

FIG. G9. MEASUREMENT OF WOW ENVELOPE  
 — Trace of Wow Fluctuation  
 - - - Envelope of Wow Fluctuation



It was clear, therefore, that wow cancellation was taking place and this was confirmed when it was observed that removal of the greater part of the centre-pin eccentricity and of the bearing fault increased the value of the largest mode, so that the performance was worse than before. Fig. G10 represents the general type of the frequency/time curve originally observed, and shows a mechanism by which cancellation could have occurred. A subsequent improvement in the tyre reduced the remaining cyclic variation and gave a satisfactory final performance which did not depend on fortuitous cancellation. Thus the statistical treatment of the observed wow amplitudes, together with consideration of the frequencies and waveforms of the wow, enabled the various sources to be identified, and measures could then be taken to reduce them to an acceptable magnitude.

An important aspect of this investigation was that the prototype had naturally been regarded as indicating the general order of the performance to be expected if a number of machines were made to the same design. From this point of view the original performance of the prototype was misleading, however, for production machines would be as likely to show addition of wow as to show cancellation and their performances would have been generally much worse than that of the prototype.

2.5 WOW CAUSED BY THE DISC

When a disc has been cut on a BBC Type-D Recorder and replayed in its cutting position on the turntable, the wow distribution obtained has not, in general, fitted satisfactorily into a Rice distribution, and plotting  $\log_{10}q(R)/R$  against  $R^2$  has revealed a systematic deviation from a straight line. In fact, the wow distribution obtained with this machine appears to be of different character to those that have been encountered on poorer turntables. In view of the design of the drive system and the mass of the turntable it is reasonable to conclude that, in this machine, the low range of wow observed does not derive principally from the turntable drive. In fact, observation of the rise and fall of the pick-up whilst the level recorder is drawing the wow graph indicates that the wow

observed is closely correlated with changes in the height of the disc surface and therefore must occur mainly in the recording process which, as explained in Section 5.1, is more sensitive to such changes than is the replay process. This type of distribution, examples of which are shown in Fig. G11, has been obtained with both glass- and aluminium-based discs, but the range of wow and its frequency of occurrence are much less in the case of the more uniform

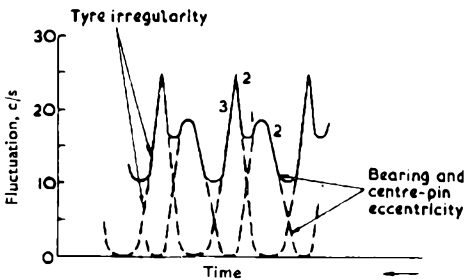

FIG. G10. MECHANISM OF WOW CANCELLATION ON A PROTOTYPE REPRODUCING TURNTABLE

Full line represents observed fluctuation pattern. Numbers denote distributions of Fig. G6(c) to which the individual fluctuations contribute

## APPENDIX G

glass discs. This dependence on the type of disc also shows that wow of this kind cannot be principally due to turntable drive fluctuations.

If a test disc possessing such a range of recorded wow is replayed on another turntable, traces of it might be expected to appear in the overall observed wow distribution provided that the wow on the second turntable is not too severe nor so frequently occurring as to mask that on the disc. It has been found, in practice, that under some conditions this recorded distribution appears quite clearly, and an example is shown in Fig. G12. Distributions (2) and (3) are due to a centre-pin eccentricity and a recording-head traverse fault respectively, and follow Rice distributions. Distribution (1), the residual component, has the same constants and properties as the distribution obtained when the test disc was replayed originally on the recording turntable.

There is thus strong evidence to suggest that most of the wow observed on the Type-D Recorder is caused by variations in the height of the disc surface. The distribution of wow from this source would not, of course, be modified by the filter properties of the turntable.

The probability function to which the observed distributions appear to conform with great consistency is the general Poisson relation

$$p(R) = \frac{1}{\bar{X}} \frac{1}{(n-1)!} \left(\frac{R}{\bar{X}}\right)^{n-1} e^{-R/\bar{X}} \quad \dots \quad (5)$$

where  $\bar{X}$  is a constant. The value  $n = 3$  appears to provide the best fit on most distributions analysed, although occasionally  $n = 2$  provides a good fit.

Lewis<sup>8</sup> has discussed the distribution represented by equation (5) and has shown that it represents the probability distribution of the combined magnitudes of  $n$  independent like variates, the magnitude of each of which follows an exponential probability distribution. Lewis derives the relation specifically for the grouping of  $n$  values of exponential life-distribution. Similar arguments may, however, be used to derive it if the variates are, say, the variations in thickness of a disc lacquer and base material, and variations in the height of the disc surface on the turntable due to warp or deformation, assuming, of course, that each of these is governed by an exponential distribution. It is the combined effect of factors such as these which determines the height of the recording stylus point and hence the magnitude of the wow which results from its vertical movement.

Now if  $p(R)$  is the probability of a wow of magnitude  $R$  occurring, then when  $N$  fluctuations of random magnitude are recorded,  $Np(R)$  should have magnitude  $R$ . Thus equation (5) may be rewritten

$$q(R) = \frac{N}{\bar{X}} \frac{1}{(n-1)!} \left(\frac{R}{\bar{X}}\right)^{n-1} e^{-R/\bar{X}} \quad \dots \quad (6)$$

When  $n = 3$  this becomes

$$q(R) = \frac{N}{2\bar{X}^3} R^2 e^{-R/\bar{X}}$$

# BBC RECORDING TRAINING MANUAL

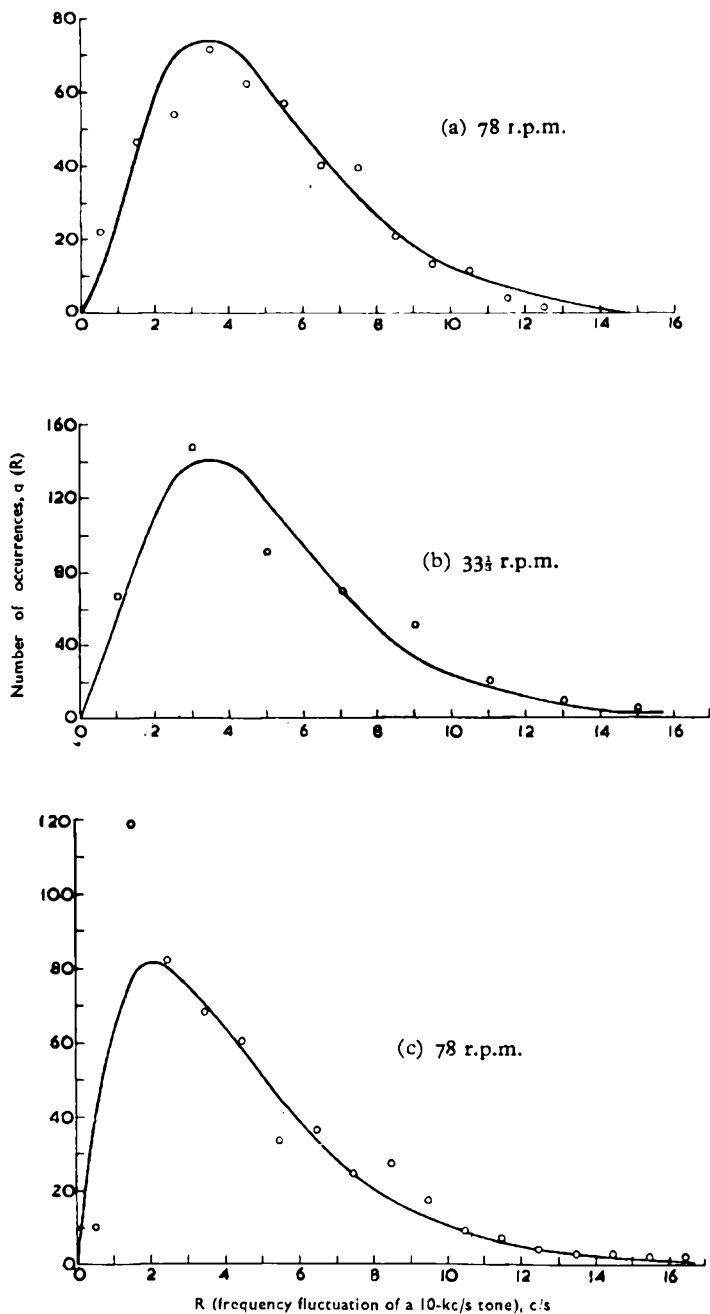

FIG. G11. EFFECT OF DISC CONTOUR

## APPENDIX G

and the mean of the distribution has a value of  $3X$  with a mode of value  $2X$ .

Fig. G11(a) shows a distribution recorded at 78 r.p.m. which is well fitted by equation (6) when  $n = 3$ . Plotting  $\log_{10}q(R)/R^2$  against  $R$  gives a value  $X = 1.66$ , so that the calculated mean is 5.0. Computing the mean from the observed results gives a value of 4.73. From this value of  $X$  values of  $R^2\epsilon^{-R/X}$  may be

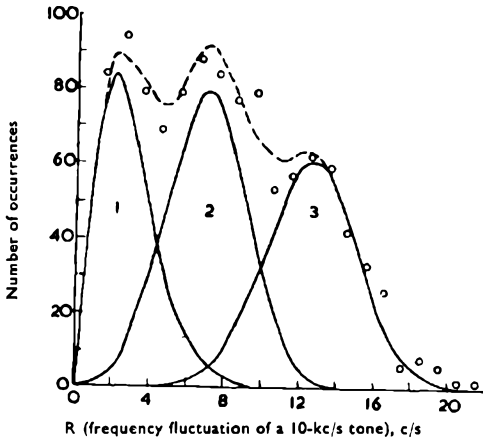

FIG. G12. DISC CONTOUR IRREGULARITY AND TWO MACHINE FAULTS

computed and when this is done they must be multiplied by a factor of 50 to give a good fit on the observed distribution. Clearly the factor 50 must be identical with  $N/2X^3$ . In this case the fluctuations measured,  $N$ , total 449, whence  $X^3 = 4.49$  and  $X = 1.65$ , which agrees well with the value obtained from the slope. Also, the observed maximum between 3 and 4 is in agreement with the calculated maximum at  $2X = 3.3$ .

Fig. G11(b) shows another distribution which can be closely fitted when  $n = 3$ , this one being obtained when a disc was recorded and reproduced on the Type-D Recorder at  $33\frac{1}{2}$  r.p.m.

Here the value of  $X$  obtained from plotting  $\log_{10}q(R)/R^2$  against  $R$  is 1.69, which gives a calculated mean of 5.08. The mean computed from the observed values is 5.04. The constant factor by which values of  $\epsilon^{-R/X}R^2$  must be multiplied to give a good fit to the observed distribution is found to be 44.8, and the total number of fluctuations measured was 455.

Thus again,  $N/2X^3 = 44.8$ , whence  $X^3 = 5.75$  and  $X = 1.69$ , which provides a good check of the value of  $X$  obtained above.

As a final example Fig. G11(c) is shown. This represents another distribution recorded at 78 r.p.m., but differs in that the value  $n = 2$  appears to provide the best fit of equation (6).

Thus

$$q(R) = \frac{N}{X^2} R \epsilon^{-R/X}$$

which gives a mean value of  $2X$  and a mode of value  $X$ . Plotting  $\log_{10}q(R)/R$  against  $R$  gives a value of  $X$  equal to  $2.2$ , whence the calculated mean is  $4.4$  and the mode is  $2.2$ . These are in close agreement with the respective observed values of  $4.46$  and between  $1$  and  $2$ .

It is found that values of  $R\epsilon^{-R/X}$  must here be multiplied by a factor of  $100$  to give a good fit on the observed distribution, so that  $N/X^2 = 100$ , and since  $N = 505$ ,  $X^2 = 5.05$ , whence  $X = 2.24$ . Thus again the constants of the theoretical curve are in good agreement with the values computed from the observed distribution.

### 3 ACKNOWLEDGMENTS

The authors gratefully acknowledge much assistance from colleagues of the BBC Research Department, especially from C. G. Mayo, M.A., who designed the discriminator circuit described in the text. Thanks are also due to the Chief Engineer, British Broadcasting Corporation, for permission to publish the paper.

### 4 REFERENCES

- 1 Smeby, L. C., "Recording and Reproducing Standards," *Proceedings of the Institute of Radio Engineers*, 1942, 30, p. 355.
- 2 Davies, H., "The Design of a High-Fidelity Disc Recording Equipment," *Journal I.E.E.*, 1947, 94, Part III, p. 275.
- 3 Kellog, E. W., and Morgan, A. R., "Measurement of Speed Fluctuations in Sound Recording and Reproducing Equipment," *Journal of the Acoustical Society of America*, 1936, 7, p. 271.
- 4 Roys, H. E., "The Measurement of Transcription-Turntable Speed Variation," *Proceedings of the Institute of Radio Engineers*, 1943, 31, p. 52.
- 5 Dudding, B. P., and Jennett, W. J., "Statistics and Engineering Practice," *Journal I.E.E.*, 1940, 87, p. 1.
- 6 Kappler, E., *Annalen der Physik*, 1931, 11, p. 233, and 1932, 15, p. 545.
- 7 Rice, S. O., "Mathematical Analysis of Random Noise," *Bell System Technical Journal*, 1944, 23, p. 282, and 1945, 24, p. 46.
- 8 Lewis, N. W., "Notes on the Exponential Distribution in Statistics," *Post Office Electrical Engineers' Journal*, 1948, 41, Part I, p. 10.

### 5 APPENDICES

#### 5.1 INFLUENCE OF DISC CONTOUR ON RECORDED AND REPRODUCED SIGNAL

Unless the disc surface is perfectly plane and at right angles to the axis of rotation of the turntable, variations in the height of stylus point will occur as the turntable rotates. On normal machines these variations will create frequency modulation of the signal in both the recording and reproducing processes, but the way in which this arises is not the same in each case. The principal effects are as follows.

Fig. G13(a) illustrates the principal effect in the recording process. If  $DD'$  is a portion of the surface of a disc not lying at right angles to the axis of rotation, then, as the disc rotates, the cutter point  $C$  will move in a vertical plane along  $XX'$ , the arc of a circle centred on the cutter head pivot  $A$ . This movement contains a component in the plane of the disc so that the relative velocity of the disc surface past the stylus will be changed; a rise in the disc surface will be



depend on the design of the pick-up suspension and is usually much less than on a recorder since a pick-up arm is generally much longer than the suspension arm of a cutter head.

Should the change of disc height be due to tilt in the turntable or tilt of the disc on the turntable, a second effect can be present. The mechanism of this effect is illustrated in Fig. G13(b), which represents a vertical section through the disc containing the axis of rotation and the point of the pick-up stylus A'. Let OO' be the axis of rotation and ACA' lie in the plane of the disc. If a concentric groove is taken through A' lying in the sloping plane of the disc it can be seen that there will be a systematic variation, around the groove, of its distances from the axis OO'. In the position shown this distance will be A'C' which, say, is the minimum. Then, when the disc has revolved through 90° it will be a maximum, B'C. Between these positions the pick-up stylus point will have moved along the arc A'B' centred at C. Now the linear velocity of the groove past the stylus depends on the distance from the axis of rotation, so that there will be two points of minimum velocity (as at A') and two points of maximum velocity (as at B') in each revolution. There will then be a corresponding fall and rise in the reproduced frequency superposed on the effects due to pick-up rise and fall described previously.

The effects described in the recording and reproducing processes will cancel if a disc is recorded, maintained in position on its recording turntable and replayed by a pick-up the suspension of which is identical in position and significant geometrical dimensions to that of the recording head. Since, in practice, the disc will be transferred to other turntables and the pick-up position and suspension dimensions will in no way resemble those of the cutter head, the fact has little practical significance. In general, the resultant frequency variations will be a complicated union of all the effects which can occur in both recording and replay processes.

## 5.2 THE CIRCUIT OF THE DISCRIMINATOR CHAIN

The basic circuit of the discriminator has been described in Section 1 and the circuit of the 10-kc/s discriminator chain, including the amplifiers and auto-balance unit, is shown in Fig. G14. The output from the discriminating network is fed into a bandpass filter of mid-point frequency 10 kc/s, and thence to the first amplifier stage at V1. The signal from V1 is fed to a cathode follower, V2, which matches the input impedance of the succeeding low-pass filter. The output from this filter passes through a gain control (R33) to a two-stage amplifier containing Valves V3 and V4. The output from V4 is fed to a pen recorder or through a suitable external transformer to the total-wow meter. The remaining stages in the circuit comprise the auto-balance unit, which maintains the frequency of the discriminator circuit at the required off-balance setting during conditions of slow frequency drift.

The auto-balance stages, when required, are fed through a gain control R32, which determines the input to an amplifier stage V5. The output of V5, after rectification by the small diode V7, supplies a bias to the grid of a variable- $\mu$  valve V6. This grid is also connected through the potentiometer R34 to the

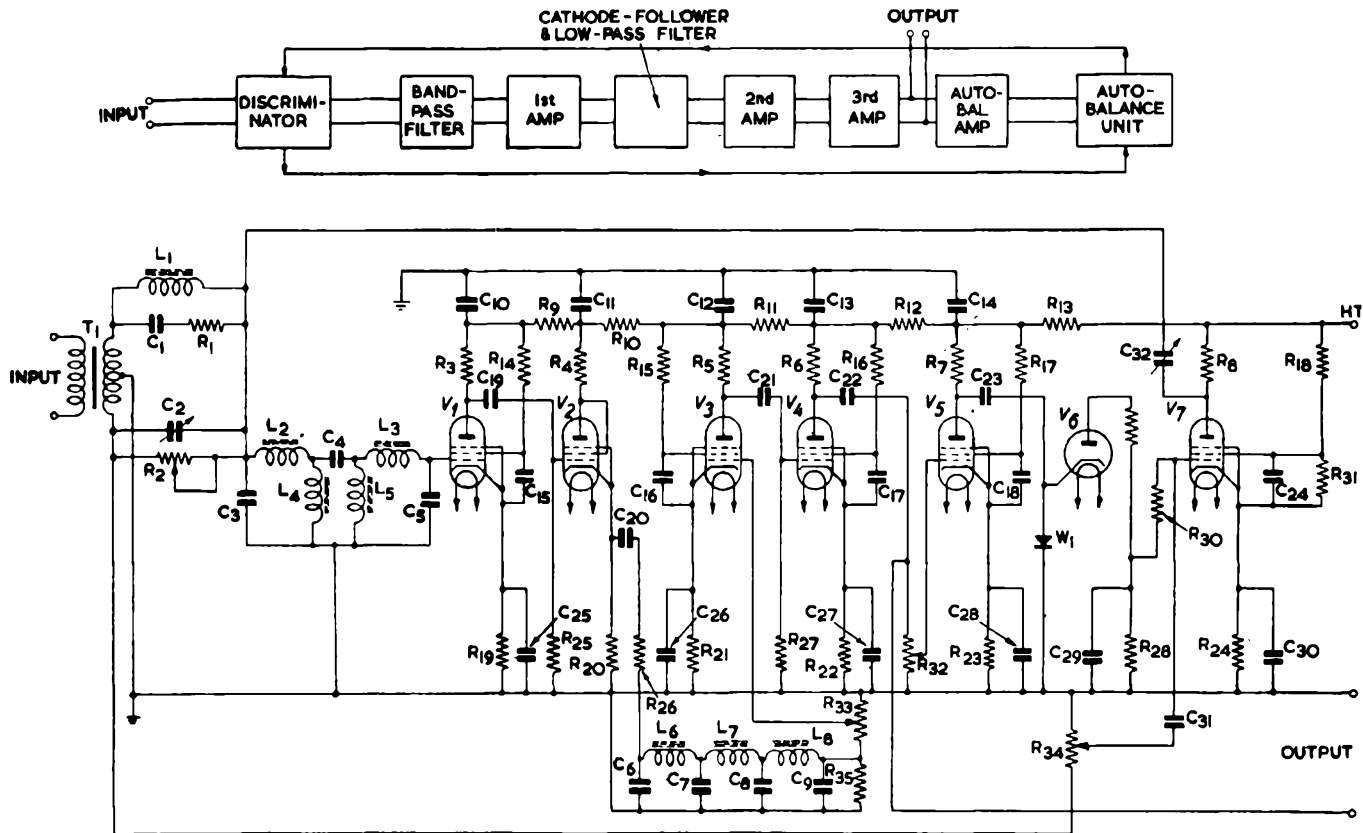

FIG. G14. BLOCK SCHEMATIC AND CIRCUIT DIAGRAMS OF IO-KC/S WOW-MEASURING EQUIPMENT



resistance leg ( $R_2$ ) of the discriminator transformer. The output of the variable- $\mu$  valve is fed through condenser  $C_{32}$ , to the junction of the tuned circuit ( $L_1C_1$ ) in the transformer leg. Now suppose that the discriminator setting is on the high-frequency side of the 10-kc/s response curve shown in Fig. G3. An increase in the mean output of  $V_4$ , due to a gradual frequency rise, will increase the bias on  $V_6$ . This means that the gain of this variable- $\mu$  valve will decrease and hence its amplification of the input signal from  $R_{34}$  will be reduced. Decrease of the driving voltage on  $C_{32}$  is equivalent to reducing its capacitance. A phase reversal of the input signal takes place through  $V_6$ , and  $C_{32}$  is thus effectively a capacitance in parallel with  $C_1$  and  $L_1$ . The effect of a gradual frequency rise is, therefore to decrease  $C_{32}$  so that the resonance frequency of the tuned circuit rises correspondingly. A slow drop in the carrier frequency of the input signal from the reproducing chain will have the effect of increasing the effective value of  $C_{32}$  so that the discriminator tuning moves to a lower frequency to follow it. The setting of  $R_2$  holds, to the first order, over a fair range of frequency.

Since an increase in the unbalance signal causes a decrease in the effective value of  $C_{32}$ , this particular form of auto-balance unit is effective only when the carrier lies on the high-frequency side of the discriminator null-frequency, although the action of the circuit can be reversed by suitable modification. A more complicated design of auto-balance unit could keep the circuit at the null point but in practice the auto-balance unit has been required only when working with 10-kc/s tone on a pen recorder. This requires off-balance working and the form of auto-balance unit described has proved quite satisfactory. The auto-balance unit has not been required in carrying out measurements on poorer quality turntables using 3-kc/s tone. Consequently the 3-kc/s discriminator has been constructed as a small separate unit exactly as shown in the circuit of Fig. G2, except that  $C_2$  has been omitted. This discriminator may be used in conjunction with a standard amplifier and limiter chain.

### 5.3 PROCEDURE FOR FITTING CURVES TO OBSERVED DISTRIBUTION

The following process has been employed to fit curves governed by equation (2) to observed wow amplitude distributions and has usually proved sufficiently accurate :

(a) In accordance with equation (4),  $\log_{10}q(R)/\sqrt{R}$  has been plotted against  $(R - S)^2$  for the tail of the distribution where  $R$  is large and greater than  $S$ .  $S$  is easily discernible as the most frequently occurring (the modal) value of  $R$ . Thus, in Fig. G6(a), it can be seen that  $S = 35$ . A fairly obvious straight line has usually resulted, but where there is some scatter the usual curve-fitting techniques provide the line. In no case of machine (as opposed to disc-thickness) wow has there been a systematic deviation from a straight line, and this in itself provides a test of the basic hypothesis.

(b) The slope of this line provides a value of  $\psi_0$  and thus the ratio  $S/\sqrt{\psi_0}$  can be evaluated.

(c) Since the shape of the curve of equation (2) changes only slowly with variation of this ratio, Rice's computed curve of nearest value has been trans-

## APPENDIX G

ferred to the observed distribution by scaling it to agree at the maximum.

(d) This has proved insufficiently accurate only in a few cases where the ratio  $S/\sqrt{\psi_0}$  is greater than 5. These have been fitted by computing a curve with the relevant values of  $S$  and  $\psi_0$ . Fig. G6(a) is an example of such a computation made from equation (3), and in that case  $S/\sqrt{\psi_0} \simeq 7$ .

When the observed distribution has more than one major peak, as in Figs. G6(b) and G6(c) it has been found to be composed of a corresponding number of component distributions. Each of these components, with the exception of those due to disc wow (Section 2.5), has possessed a particular value of  $S$  with a common value of  $\psi_0$ .

The component distributions have been extracted as follows :

(a)  $\text{Log}_{10}q(R)/R$  has been plotted against  $(R - S)^2$  for the extreme tail of the distribution, e.g. for  $R > 17$  in Fig. G6(b) and  $R > 18$  in Fig. G6(c). This tail has been chosen because it invariably represents the tail of the component distribution of greatest modal magnitude and is therefore uncontaminated by wow observations belonging to any lower-amplitude component. This has provided the value of  $\psi_0$  common to all the components.

(b) Using this value of  $\psi_0$  and the indicated value of  $S$ , a Rice curve has been fitted to the tail as described.

(c) At lower values of  $R$ , where the adjoining component distribution has become appreciable, the observed values of  $q(R)$  have shown a systematic divergence above the curve fitted to the tail. The differences in the observed and computed values of  $q(R)$  have provided the tail of the lower-amplitude component to which a Rice curve has been fitted as before.

(d) In cases such as that illustrated by Fig. G6(b) this has been sufficient to account for all the observed data but in many cases more components have been present. They have been systematically extracted by this method.

(e) Where the component nearest the ordinate axis has not provided a good fit on a Rice curve it has always been found to obey a Poisson distribution ; a detailed discussion of the interpretation of this property has been given in Section 2.5.

Some trial and error is at times necessary in both the above processes, but practice and the use of Rice's computed curves have enabled distributions to be analysed without excessive labour.

## APPENDIX H

### TRACKING ANGLE IN PHONOGRAPH PICKUPS

By B. B. Bauer

*Reproduced from **electronics** Vol. 18, p. 110, by permission of the publishers, McGraw Hill Inc., New York*

Almost everyone conversant with phonograph reproduction is familiar with the fact that in a straight tone-arm the needle enters the groove laterally at an angle, which has some undesirable effects upon the record and upon the quality of reproduction. The exact nature and the quantitative amounts of these effects appear to be considerably less well known.

It is widely recognised that such effects can be corrected by offsetting the tone-arm head and adjusting its position in respect to the centre of the turntable. Theory dealing with the actual amount of the necessary adjustments, however, is not generally available to tone-arm designers and users. The purpose of this article is to present to phonograph designers, in readily useful form, quantitative information regarding tracking angle and its effects, and means for minimising these effects in modern phonograph equipment.

It is generally accepted that tracking angle produces the following effects : (a) Record wear ; (b) Distortion ; (c) Side-thrust upon the record grooves. Much has been written in the past ten years about these effects. Oftentimes only one of them has been emphasised at the expense of the others. This resulted in many offset arm designs which were inferior in performance to the equivalent straight arms.

Additional factors have entered the picture recently as a result of the introduction of home recording, light-weight pickups, permanent-point styli, and the widespread use of record-changers. In order to deal with these subjects systematically the various effects will be treated in the following order : (1) Geometry of the tracking angle ; (2) Record wear ; (3) Side thrust ; (4) Distortion ; (5) Best arm offset ; (6) Optimum arm design.

#### DEFINITION OF TRACKING ANGLE

Let a tone arm having an effective length  $l$  inches (distance from the centre of the pivot to the needle point) be mounted on a motor-board with its pivot  $d$  inches away from the centre of the record, as shown in Fig. H1 (a). When the needle point is  $r$  inches away from the centre of the record the following relationship exist :

$$r^2 + l^2 - 2rt \cos \theta = d^2 \quad (1)$$

$$r^2 + l^2 - 2rt \sin \phi = d^2 \quad (2)$$

APPENDIX H

where  $\theta$  is the angle included between the lines  $l$  and  $r$ , and  $\phi$  is the tracking angle between  $l$  and a line tangent to the groove at the needle point. Solving for  $\sin \phi$  :

$$\sin \phi = \frac{r}{2l} + \frac{l^2 - d^2}{2lr} \quad (3)$$

It will be seen that the amount of arm overhang  $D$  (swing of the needle point beyond the centre of the turntable) is a significant parameter. Taking advantage of the fact that  $d = l - D$ , Eq. (3) may be re-written as

$$\sin \phi = \frac{r}{2l} + \frac{2lD - D^2}{2lr} \quad (4)$$

Equation (4) is precise in every respect, but does not lend itself to simple analytical treatment. We shall therefore make two simplifying assumptions, that  $D^2$  is negligibly small compared with  $2lD$ , and that  $\sin \phi = \phi$  in radians. When this is done, Eq. (4) can be re-written as

$$\phi_{rad} = \frac{r}{2l} + \frac{D}{r} \quad (5)$$

$$\phi_{deg} = 57.3 \left( \frac{r}{2l} + \frac{D}{r} \right) \quad (6)$$

The approximations tend to be mutually compensatory, and Eq. (6) provides values of  $\phi$  which are correct within approximately 1 deg, as can be readily demonstrated by substituting assumed values of variables in Eq. (4) and (6). This degree of approximation is ample for the problem on hand, and it is well justified in view of the labour saving which it affords. In all the derivations which follow,  $\phi_{rad}$  is conveniently used. This is multiplied by 57.3 to obtain  $\phi_{deg}$  for use in final calculations.

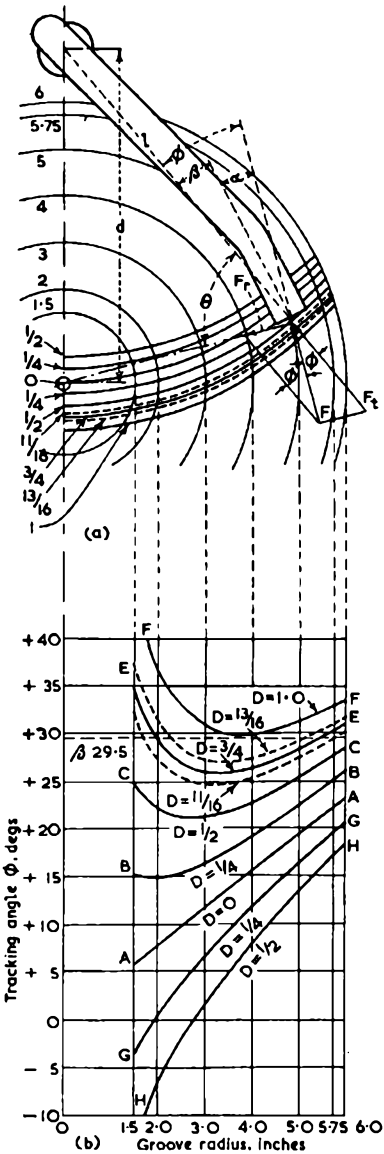

FIG. 11. DIAGRAM SHOWING DIMENSIONS AND ANGLES INVOLVED IN TONE ARM DESIGN, AND CURVES SHOWING HOW TRACKING ANGLE VARIES WITH GROOVE RADIUS FOR DIFFERENT VALUES OF NEEDLE OVERHANG  $D$ . ALL LINEAR DIMENSIONS ARE IN INCHES

## TRACKING ANGLE CURVES

Figure H1 (b) shows graphically the values of  $\phi_{deg}$  as a function of the radius for a  $7\frac{1}{2}$ -inch arm and for various values of arm overhang  $D$ . The custom in the early '30s was to use straight tone arms pivoted in such a manner that the needle point passed through the centre of the record. The tracking angle corresponding to this condition is represented by curve AA for  $D = 0$ . It is seen that  $\phi$  at the 5.75-inch radius is 22 deg and this gradually decreases to 7.6 deg at the inner radius of 2 inches. The thought of a needle point entering the record grooves at a substantial lateral angle, together with the fact that this angle changed throughout a wide range of values and thereby involved continuous regrinding of the tip, was not especially reassuring to phonograph designers.

The most obvious answer—that of greatly lengthening the tone-arm—was found to be impractical because of motor-board space limitations. A study of curves similar to those of Fig. H1 (b) indicated that the remedy might lie in performing two operations: (1) Swinging the arm beyond the centre of the record, as exemplified by curves EE in Fig. H1 (b); (2) Bending or offsetting the head through an angle  $\beta$ , approximately equal to the average angle over the range of radii (this is equivalent to raising the zero-degree ordinate on the graph to any given value of  $\beta$ ). It should be noted that  $\beta$  is measured clockwise from the line-connecting the needle point with the pivot point; it is not, as it is sometimes erroneously assumed, the angle between the body and the head of the tone arm.

As an example, if the needle point overhang  $D$  is  $\frac{1}{8}$  inch as for curve EE in Fig. H1 (b), the tracking angle varies from 32 deg at 6 inches through 27 deg at 3.3 inches back to 32 deg at the 2-inch radius. Now, if the pick-up head is bent at a 29.5-deg angle, the departure of the needle from tangency is reduced to only 2.5 deg on either side. The difference between the tracking angle,  $\phi$ , and the offset angle,  $\beta$ , has been termed tracking error  $\alpha$ , for it indicates how short of perfect the scheme is.

The above procedure for tracking angle correction (giving minimum  $\alpha$ ) appeared to remedy all of the straight-arm objections, and it was widely adopted in many reproducers built in the years of 1938-1941. This was somewhat unfortunate, for it was shown later that minimum  $\alpha$  is not a valid criterion of best tracking.

## RECORD WEAR

The theory behind record wear due to improper tracking angle was based upon the fact that the spherical point of a steel needle rapidly wears down to a chisel-point after the playing of the first few grooves. As the tracking angle varies throughout the playing of the record, the chisel-point turns with respect to the grooves and is constantly re-ground, thereby increasing record wear over and above that which would normally exist.<sup>1 2</sup>

With rare metal or sapphire-tipped needles, the point remains spherical for many hundreds or even thousands of plays. There is therefore little or no justification for fearing increased record wear due to moderate amounts of tracking angle with modern playback equipment if the permanent-point needles are not employed beyond their rated life.

## APPENDIX H

### SIDE THRUST

Due to friction between the needle and the groove, there is a force  $F$  upon the needle point in the direction of the line tangent to the groove. This force is quite independent of the angle which the pickup head makes with the groove, and it depends only upon the vertical needle force  $F_v$  and upon the coefficient of friction  $\mu$  between the needle point and the record ( $F = \mu F_v$ ). The value of  $\mu$  varies with the type of record material and also with the amount of groove modulation. For most record materials and light needle forces,  $\mu$  is roughly  $\frac{1}{3}$ . With heavy pickups and soft records,  $\mu$  may be considerably greater.

The force diagram at the needle point in Fig. H1(a) indicates the action of the frictional force. It is seen that  $F$  has a tangential component  $F_t$  which is borne by the arm pivot, and a radial component  $F_r$  which tends to pull the pickup toward the centre of the record, and which is borne by the inner side of the record groove. From the force parallelogram it is seen that  $F_r = F \tan \phi$ . This force is not altered by any conceivable twisting of the pickup head. For any given record and pickup,  $F_r$  is therefore a function only of  $r$  and  $D$ .

Take again the case of a  $7\frac{1}{2}$ -in. arm with the needle passing through the centre of the record, corresponding to curve AA in Fig. H1(b). The tracking angle is  $22.5^\circ$  ( $\tan^{-1} 0.415$ ) at the 6-in. radius and  $7.6^\circ$  ( $\tan^{-1} 0.133$ ) at the 2-in. radius. If  $\mu$  is assumed to be  $\frac{1}{3}$ , the side thrust corresponding to these angles, in a 1-oz pickup, is 0.14 and 0.05 oz respectively.

If  $D$  is  $\frac{1}{2}$  in. as for curve CC in Fig. H1(b), the angles are  $28^\circ$  ( $\tan^{-1} 0.53$ ) and  $22^\circ$  ( $\tan^{-1} 0.40$ ) and the corresponding side thrust is 0.18 and 0.13 oz respectively. Swinging the arm beyond the centre of the record thus increases the side thrust and keeps it more or less uniform throughout the playing of the record.

It has been pointed out that moderate side thrust may not be detrimental because it helps to overcome pivot bearing friction. On the other hand, the unduly large values of  $D$  employed in some instances increase  $F_r$  beyond the safe point. Some phonographs cannot reproduce home-recording records because the side thrust becomes large enough to pull the tone-arm out of the groove toward the centre of the record.

### RECORD CHANGER REQUIREMENTS

The effect of arm placement upon the side thrust is most pronounced at inner radii of the record. This makes side thrust of special interest in connection with record changers. Some changers require a force directed away from the centre of the record to actuate the tripping mechanism. In supplying this force, the tone-arm is aided by the use of low and negative values of  $D$ . Other changers required a force directed toward the centre of the record. This can be aided by the use of larger values of  $D$ . Such procedure may not be consistent with the conditions of minimum tracking-error distortion. In record changers, a slight compromise in distortion may be justified if reliable operation of the tripping mechanism is helped thereby.

An occasional source of greatly increased side thrust is found in some of the needles which have recently appeared on the market. Many of these needles

## BBC RECORDING TRAINING MANUAL

are forwardly bent so that the effective value of  $D$  is increased by  $\frac{1}{8}$  to  $\frac{1}{4}$  in. In general, there are no apparent ill effects due to the use of such needles; however, instances are known when tracking has been impaired because of increased side thrust.

The effect of side thrust can be kept within safe limits if it is recognized that the tone arm is often called upon to track at groove radii less than 2 in. Because of this, a minimum radius of  $1\frac{3}{4}$  in. is used in all the following calculations pertaining to 12-inch records. When this precaution is observed, side thrust developed with optimum values of  $D$  is quite harmless in low-weight pickups.

### DISTORTION

When the axis of the pickup cartridge is not tangent to the groove, the needle motion is not perpendicular to the groove, giving rise to distortion. Mathematical analysis of this distortion has been made by Baerwald.<sup>3</sup> The simplified derivation given below helps to bring out the essential physical factors involved and yields results which are sufficiently accurate for all intents and purposes. The solid line in Fig. H2 represents a sine-wave modulated record groove, and the dotted line is the distorted sinusoid representing the needle motion when  $\alpha = 30$  deg.

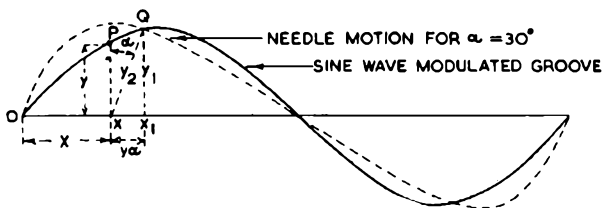

FIG. H2. MANNER IN WHICH A SINUSOIDAL WAVE FORM IS DISTORTED DUE TO TRACKING ERROR

When  $\alpha = 0$ , the equation of needle point displacement is the same as that of the groove. (Elastic deformation of the record material and pinch effect are neglected.) Assume that initially the needle point is at O and  $\alpha = 0$ . When the groove travels a distance  $x$  (from O to X), the needle moves from o to P and its lateral displacement  $y$  in inches equals

$$y = A \sin 2\pi x / \lambda \quad \dots \quad (7)$$

where  $A$  is maximum groove amplitude in inches, and  $\lambda$  is the wavelength of groove modulation in inches. However, if the tracking error  $\alpha > 0$ , the needle point moves to Q instead of P; in so doing it advances horizontally a distance approximately equal to  $d = y\alpha$ , where  $\alpha$  is in radians. This is approximate, but close enough for our purpose. Instead of being at X, the horizontal projection of the needle point is now at  $X_1$ . The equation of the motion described by the needle point is

APPENDIX H

$$y_1 = A \sin x_1 = A \sin \frac{2\pi}{\lambda}(x + y\alpha) \quad \dots \quad (8)$$

Substituting in Eq. (8) the expression for  $y$  in Eq. (7) now gives

$$y_1 = A \sin\left(\frac{2\pi x}{\lambda} + \frac{2\pi A \alpha}{\lambda} \sin \frac{2\pi x}{\lambda}\right) \quad \dots \quad (9)$$

If the groove moves with a velocity of  $V$  in. per second, then  $x = Vt$  and  $f = V/\lambda$  cycles per second, and

$$y_1 = A \sin\left(\omega t + \frac{\omega A \alpha}{V} \sin \omega t\right) \quad \dots \quad (10)$$

What is of interest is not  $y_1$  but the lateral motion of the needle point, which is  $y_2 = y_1/\cos \alpha$ ; therefore,

$$y_2 = \frac{A}{\cos \alpha} \sin\left(\omega t + \frac{\omega A \alpha}{V} \sin \omega t\right) \quad \dots \quad (11)$$

FREQUENCY-MODULATION EFFECT

Examination of Eq. (11) shows that there is a slight increase in playback level due to the  $1/\cos \alpha$  term, and frequency modulation of the signal. In Eq. (10), let  $y_1 = A \sin \psi$ . Differentiating  $\psi$  to obtain instantaneous angular velocity  $\omega_i$ ,

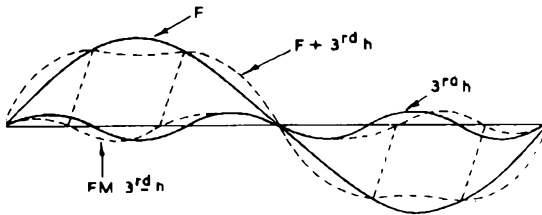

FIG. H3. FREQUENCY MODULATION EFFECT IN PHONOGRAPH PICKUP OUTPUT DUE TO TRACKING ERROR

$$\omega_i = \frac{d\psi}{dt} = \omega + \frac{\omega^2 A \alpha}{V} \cos \omega t$$

$$\alpha_i = \omega \left(1 + \frac{\omega A \alpha}{V} \cos \omega t\right) \quad \dots \quad (12)$$

The instantaneous frequency of the signal is thus modulated at a rate equal to its own frequency and with a frequency deviation of  $\omega A \alpha/V$ . This is of special interest when the wave is complex, consisting of a large-amplitude, low-frequency fundamental  $f$  and a small-amplitude higher-frequency component  $f_1$ . This effect is indicated graphically in Fig. H3. It may be shown that  $f_1$  is modulated at a frequency  $f$  by the amount given in parentheses in



Eq. (12). In a manner identical to other frequency-modulation phenomena, this gives rise to inharmonic terms having frequencies  $(f + f_1)$ ,  $(f + 2f_1)$ , etc. Analysis of the nuisance value of this distortion is somewhat complex but the overall results may be roughly estimated from harmonic analysis of Eq. (11). This equation may be expanded algebraically into its harmonic components :

$$y_2 = \frac{A}{\cos \alpha} \left[ \sin \omega t \cos \left( \frac{\omega A \alpha}{V} \sin \omega t \right) + \cos \omega t \sin \left( \frac{\omega A \alpha}{V} \sin \omega t \right) \right]$$

It will be shown later that normally  $\omega A/V > 0.06$  radian; therefore, with an error not in excess of 1 per cent., one may state that

$$\begin{aligned} \sin \left( \frac{\omega A \alpha}{V} \sin \omega t \right) &\approx \frac{\omega A \alpha}{V} \sin \omega t \\ \cos \left( \frac{\omega A \alpha}{V} \sin \omega t \right) &\approx 1 \end{aligned}$$

Substituting these simplifications in the expansion of Eq. (11) gives

$$\begin{aligned} y_2 &= \frac{A}{\cos \alpha} \left( \sin \omega t + \frac{\omega A \alpha}{V} \sin \omega t \cos \omega t \right) \\ y_2 &= \frac{A}{\cos \alpha} \left( \sin \omega t + \frac{\omega A \alpha}{2V} \sin 2 \omega t \right) \quad \dots \quad \dots \quad (13) \end{aligned}$$

SECOND HARMONIC DISTORTION

Equation (13) consists of a fundamental and a double-frequency term, representing second harmonic distortion. Distortion is given by the modulus of the second term in parentheses :

$$\text{Percent 2nd harmonic (amplitude)} = \frac{\omega A \alpha}{2V} \times 100 \quad \dots \quad \dots \quad (14)$$

This is on an amplitude basis ; on a velocity basis harmonics are accentuated in proportion to the frequency, hence

$$\text{Percent 2nd harmonic (velocity)} = \frac{\omega A \alpha}{V} \times 100 \quad \dots \quad \dots \quad (15)$$

For ease in interpreting Eq. (15) let the angular velocity  $\omega_r$  of the record be  $2\pi$  times speed in r.p.s. Then the linear groove velocity is proportional to the radius, and hence  $V = \omega_r r$ . Inserting this in Eq. (15) gives

$$\text{Percent 2nd harmonic} = \frac{\omega A \alpha}{\omega_r r} \times 100 \quad \dots \quad \dots \quad \dots \quad (16)$$

From Eq. (16) the following is concluded :

- (a) Distortion is proportional to the ratio between tracking error  $\alpha$  and

## APPENDIX H

groove radius  $r$ . The ratio  $\alpha/r$  may therefore be considered as an index of distortion. If distortion is not to exceed a given value throughout the playing of the record, this value of  $\alpha/r$  must not be exceeded.

(b) Differentiating equation (7) with respect to time, it is found that maximum groove modulation velocity equals  $\omega A$ . Distortion is therefore directly proportional to the velocity of groove modulation.

(c) Distortion is inversely proportional to the speed of the record. For equal distortion, more careful tracking angle correction is required in 33-r.p.m. discs than in 78-r.p.m. discs, other factors being the same.

### EXAMPLE OF DISTORTION

As a specific example of distortion due to straight arms, assume a modulation amplitude of 0.0017 in. and a frequency of 250 c/s, equivalent to a modulation velocity  $\omega A$  of 2.67 in. per second. These conditions are chosen because they constitute a maximum velocity on an Audiotone test record which has a constant amplitude characteristic from 50 to 250 c.p.s. and a constant velocity characteristic thereafter. In a 78-r.p.m. record  $\omega_r = 2\pi (78/60) = 8.16$  radians per second. Now, take the case of a straight pick-up with the needle passing through the centre of the record. From Eq. (5), tracking angle (and, in this case, tracking error  $\alpha$ ) equals  $r/2l$  radians and  $\alpha/r$  equals  $1/2l$  radians per in. Substituting these values into equation (16), it is found that, in the constant-velocity portion, distortion is constant at all radii and equals 2.2 per cent. This constancy is to be expected from considerations made in connection with Eq. (16).

It is doubtful that this amount of distortion is significant in the majority of phonograph apparatus. However, questions arise regarding distortion on records with levels higher than the Audiotone.

The relative levels of modulation velocity may be determined by examination of the width of reflected light patterns.<sup>4</sup> Comparison of pattern width of commercial pressings with the Audiotone record indicates that the former exhibit modulation levels 2 to 2½ times greater than the latter. Therefore, in playing commercial recordings, a tracking error distortion of 4 to 6 per cent. may be expected with straight-arm reproducers. These values are comparable to other distortions found in phonograph reproduction; no one should expect, therefore, startling improvements in fidelity due to elimination of tracking error. However, even a moderate amount of distortion added on top of other distortions in the system may become greatly annoying, especially in extended-range systems.

### DETERMINING ARM OFFSET

To determine the proper arm offset for any given  $D$ , we use tracking angle curves like those in Fig. H1(b). Curves for four selected values of  $D$  have been drawn in Fig. H4. In each instance we shall find the value of  $\beta$  for the least  $\alpha/r$ , corresponding to the least distortion possible with the given  $D$ . In so doing we shall also have solved the converse problem: "What should  $D$  be for an arm of given  $\beta$ ?"

In Fig. H4(a),  $\phi$  is shown for the condition of  $l = 7.5$  in. and  $D = 0$ . Tracking angle  $\phi$  varies from 22 deg at the 5.75-in. radius to 6.7 deg at the 1.75-in. radius. For straight arms  $\alpha = \phi$ , and  $\alpha/r = 22/5.75 = 3.8$  deg per in. This has been found to produce distortion of from four to six per cent.

Consider now the arm which is offset at an angle of 10.3 deg. Here  $\alpha$  at 5.75-in. radius is  $22 - 10.3 = 11.7$  deg;  $\alpha$  at 1.75-in. radius is  $10.3 - 6.7 = 3.6$  deg. For both radii,  $\alpha/r$  is now 2 deg per in. Offsetting the arm 10.3 deg. has reduced distortion by a ratio of almost 2 : 1.

An offset of 10.3 deg produces lowest distortion in a 7.5-in. arm, if  $D$  equals zero. This can be easily verified by repeating the above calculations for values

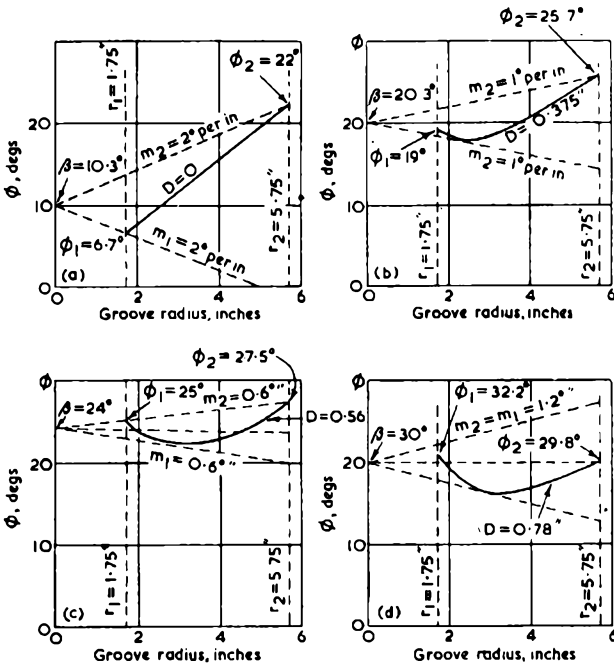

FIG. H4. GRAPHICAL PROCEDURE FOR DETERMINING THE BEST ARM OFFSET ANGLE FOR VARIOUS OVERHANG VALUES RANGING FROM NO OVERHANG (A) TO 0.78-INCH OVERHANG (D)

of  $\beta$  other than 10.3 deg. If one extends two lines from the 10.3-deg point on the zero-inch ordinate to the two terminals of the  $\phi$  curve, as shown in dotted lines in Fig. H4(a), it becomes apparent that the slopes  $m_1$  and  $m_2$ , in degrees per inch, are equal and opposite. It is not difficult to reason out that this is a necessary and sufficient condition for least  $\alpha/r$ . Therefore, in determining the arm offset for any given  $D$ , the following procedure may always be employed :

Draw the  $\phi$ -curve corresponding to the given  $l$  and  $D$  between the limits  $r_1$  and  $r_2$ . Extend straight lines just bounding the  $\phi$ -curve on each side from a point  $\beta$  on the zero-inch ordinate such that the slopes  $m_1$  and  $m_2$  are equal and

APPENDIX H

opposite. Angle  $\beta$  is then the offset angle yielding least tracking error distortion. This procedure is valid for any and all values of  $l, D, r_1$  and  $r_2$ .

In the instance when the slope lines touch the two extremities of the  $\phi$ -curve (as in the above example),  $\beta$  can also be found analytically without any difficulty. Tracking angles  $\phi_1$  and  $\phi_2$  in radians at radii  $r_1$  and  $r_2$  are

$$\phi_1 = r_1/2l + D/r_1 \dots \dots \dots (17)$$

$$\phi_2 = r_2/2l + D/r_2 \dots \dots \dots (18)$$

If the two slope lines are equal,

$$(\beta - \phi_1)/r_1 = (\phi_2 - \beta)/r_2 \dots \dots \dots (19)$$

Substituting equation (17) and (18) into (19) and solving for radians,

$$\beta = \frac{\left(\frac{1}{r_1^2} + \frac{1}{r_2^2}\right)D + \frac{1}{l}}{\frac{1}{r_1} + \frac{1}{r_2}} \dots \dots \dots (20)$$

If  $D = 0$

$$\beta = \frac{1}{l\left(\frac{1}{r_1} + \frac{1}{r_2}\right)} \dots \dots \dots (21)$$

This gives the best arm offset when the needle passes through the centre of the record. If  $\beta = 0$ ,

$$D = -\frac{1}{l\left(\frac{1}{r_1^2} + \frac{1}{r_2^2}\right)} \dots \dots \dots (22)$$

This indicates that straight arms should be underhung for least distortion.

Eq. (20) represents a family of straight lines. This family, for 12-inch disks, is given in Fig. H5, and it extends from the 0-deg ordinate to the inclined dotted line labelled "Limit of simple placement equation."

For values of  $D$  greater than indicated by the limit line, Eq. (20) is no longer valid because the lower slope-line  $m_1$  touches the  $\phi$ -curve at a point other than  $\phi_1$ . Such a situation is shown in Fig. H4(b) for a 7.5-in. arm when  $D = \frac{3}{8}$  in. For the least  $\alpha/r$ ,  $\beta$  is now found to be 20.3 deg by employing the graphical method given before. The analytical relation between  $\beta$  and  $D$  is given in this instance by

$$D = \frac{r_2}{l}\left(\frac{r_2}{l} - \beta\right)\left\{\sqrt{\left[1 + \frac{\beta^2}{\left(\frac{r_2}{l} - \beta\right)^2}\right]} - 1\right\} \dots \dots (23)$$

The derivation of this equation is not difficult, but it is tedious enough to be relegated to the Appendix. The family of curves represented is a set of curved lines which are extensions of the straight lines of Eq. (20).

A careful study of Fig. H1(b) or Fig. H4 reveals that progressive increase of  $D$  (and use of the corresponding best  $\beta$ ) diminishes the distortion index  $\alpha/r$ . This is shown by the diminishing angle between the two bounding lines  $m_1$  and  $m_2$ . In the instance of  $D = \frac{3}{8}$  in. given above,  $\alpha/r$  is 1.0 deg per inch, which is 4 : 1 decrease compared with a straight arm.

As  $D$  is increased further, the point is finally reached when  $\alpha/r$  is minimum and, distortionwise, optimum arm design is achieved. This shown in Fig. H4(c)

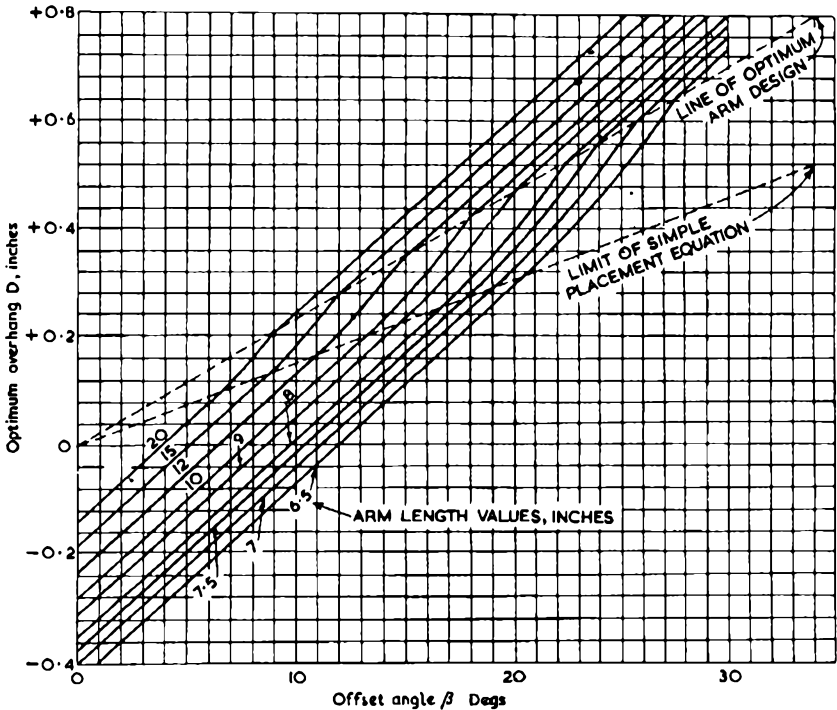

FIG. H5. DESIGN CHART FOR TONE-ARMS USED WITH 12-INCH RECORDS, IN WHICH MINIMUM GROOVE RADIUS  $r_1$  IS 1.75 INCHES AND MAXIMUM GROOVE RADIUS  $r_2$  IS 5.75 INCHES

where  $\alpha/r$  is only 0.6 deg per inch. In Fig. H5, the relation between  $\beta_{opt}$  and  $D_{opt}$  is given by the straight dotted line labelled 'Line of optimum arm design.'

EXAMPLE OF EXCESSIVE OFFSET

Beyond the optimum point, the upper slope-line  $m_2$  passes through  $\phi_1$ , and the angle between  $m_1$  and  $m_2$  again increases—and so does distortion and side thrust. This condition occurs in a number of pre-war arms.

## APPENDIX H

Fig. H4(d) shows proper placement of a  $7\frac{1}{2}$ -in. arm having an offset angle of 30 deg. The best value of  $D$  here is 0.78 in.

The derivation of the best placement equation is given in the Appendix. For least distortion, the relation between  $\beta$  (radians) and the corresponding  $D$  (inches) is as follows :

$$D = \frac{R_1}{2} \left( \beta - \frac{r_1}{l} \right) \left\{ \sqrt{ \left[ 1 + \frac{\beta^2}{\left( \beta - \frac{r_1}{l} \right)^2} \right] } + 1 \right\} \quad \dots \quad (24)$$

This equation represents a series of lines which are practically straight and which are shown in Fig. H5 extending beyond the 'Line of optimum arm design.' Fig. H5 can be used, therefore, as a universal chart for properly locating arms with predetermined  $\beta$ , or for determination of  $\beta$  in arms requiring a given amount of overhang because of tracking reasons.

### OPTIMUM ARM DESIGN

Keeping in mind the procedure for obtaining best  $\beta$ , the following conditions are fulfilled when  $\alpha/r$  is minimum : (1) Both extremities of the  $\phi$ -curve touch the upper slope-line  $m_2$  ; (2) the lower slope-line  $m_1$  is equal and oppositely slanted ( $m_1 = -m_2$ ) and just touches the lower side of the  $\phi$ -curve.

This situation is shown in Fig. H4(c). The relation between  $l, r, r_2, D$  and  $\beta$  corresponding to this instance will now be derived.

The slope of the line tangent to the  $\phi$ -curve and passing through  $\beta$  is given in the Appendix as

$$m = 1/2l - \beta^2/4D \text{ radians per inch} \quad \dots \quad (25)$$

From condition (1) above,

$$\frac{\phi_1 - \beta}{r_1} = \frac{\phi_2 - \beta}{r_2} \quad \dots \quad (26)$$

Substituting values of  $\phi_1$  and  $\phi_2$  from Eq. (17) and (18) and solving for  $\beta$  gives

$$\beta = D \frac{r_1 + r_2}{r_1 r_2} \quad \dots \quad (27)$$

From condition (2),  $\beta - m r_1 = \phi_1$ . Substituting the values of  $\beta$  from Eq. (27),  $m$  from Eq. (25), and  $\phi_1$  from Eq. (17) and solving for  $D$ ,

$$D = \frac{r_1^2}{l \left[ \frac{1}{4} \left( 1 + \frac{r_1}{r_2} \right)^2 + \frac{r_1}{r_2} \right]} \text{ inches} \quad \dots \quad (28)$$

Substituting this expression for  $D$  in Eq. (27) now gives

$$\beta = \frac{r_1 \left( 1 + \frac{r_1}{r_2} \right)}{l \left[ \frac{1}{4} \left( 1 + \frac{r_1}{r_2} \right)^2 + \frac{r_1}{r_2} \right]} \text{radians} \quad \dots \quad (29)$$

The values of  $\beta$  and  $D$  as given by Eq. (28) and (29) provide the minimum distortion attainable in a pivoted tone arm, and they should always be employed in tone-arm design unless this is not feasible because of other considerations. The reduction in distortion over the straight-arm situation is roughly 6 : 1. This renders tracking error distortion completely negligible.

*Appendix*

To derive the equation of arm placement in the region of tangency, it is first necessary to find the slope  $m_1$  of the lower slope line tangent to the  $\phi$  curve and passing through the point  $\beta$  on the zero-inch ordinate. The slope of the line connecting  $\beta$  with any point on the  $\phi$ -curve is

$$m = \frac{\phi - \beta}{r} = \frac{\phi}{r} - \frac{\beta}{r} \quad \dots \quad (30)$$

Substituting the value of  $\phi$  from Eq. (5) gives

$$m = \frac{1}{2l} + \frac{D}{r^2} - \frac{\beta}{r} \quad \dots \quad (31)$$

The point of tangency occurs when the slope is minimum ; differentiating Eq. (31) gives

$$\frac{dm}{dr} = \frac{\beta}{r^2} - \frac{2D}{r^3} \quad \dots \quad (32)$$

For minimum slope  $m_1$ ,  $dm/dr = 0$ , and

$$\beta = 2D/r \quad \dots \quad (33)$$

Substituting Eq. (33) in Eq. (31)

$$m_1 = 1/2l - \beta^2/4D \quad \dots \quad (34)$$

In order to fulfil the procedure for least  $a/r$ ,  $m_2$  must equal  $-m_1$ , or

$$m_2 = \beta^2/4D - 1/2l \quad \dots \quad (35)$$

But the upper slope  $m_2$  equals

$$m_2 = (\phi_2 - \beta) / r_2 \quad \dots \quad (36)$$

Substituting  $\phi_2$  from Eq. (18) and  $m_2$  from Eq. (35), Eq. (23) is obtained.

## APPENDIX H

Beyond the point of optimum arm design,  $m_2$  makes contact with  $\phi_1$  instead of  $\phi_2$ . Equation (36) becomes

$$m_2 = (\phi_1 - \beta) / r_1 \quad \dots \quad \dots \quad \dots \quad \dots \quad (37)$$

Substituting  $\phi_1$  from Eq. (17) and  $m_2$  from Eq. (35), Eq. (24) follows.

### References

- 1 Glover, Ralph P., "A Record Saving Pickup," *Electronics*, Feb., 1937, p. 31.
- 2 Olney, Benjamin, "Phonograph Pickup Tracing Error," *Electronics*, Nov., 1937, p. 19.
- 3 Baerwald, H. G., "Analytical Treatment of Tracking Error and Notes on Optimal Pickup Design," *Journal of the Society of Motion Picture Engineers*, XXXVII, Dec., 1941, p. 591.
- 4 Buchmann, G., and Meyer, E., A New Optical Method of Measurement for Phonograph Recordings, E.N.T., 7, p. 147, 1930. Reviewed in *Journal of the Acoustical Society of America*, 12, Oct., 1940, p. 303.



APPENDIX J

REFERENCE DATA

1. RECORDING DIAMETERS AND DURATION (BBC STANDARDS)

	For Direct Playback		Disk dia. (inches)	Dia. of finished pressing (inches)	Turntable speed (r.p.m.)
	Mobile	Static			
For Processing	17 $\frac{1}{4}$				33 $\frac{1}{3}$
	13				78
	13				78
	12				78
	12				78
	12				78
For Processing	17 $\frac{1}{4}$		16		33 $\frac{1}{3}$
	13		12		78
	13		12		78
	12		10		78
	12		10		78
	12		10		78

Pitch (grooves (inch)	Max. record- ing dia. (inches)	Min. record- ing dia. (inches)	Pitch of finishing spiral (inches)	Min. dia. of finishing circle (inches)	Max. recording time
120	$16\frac{3}{4}$	8	$\frac{1}{8}-\frac{1}{4}$	$7\frac{1}{2}$	mins. secs. 15 45
120	$12\frac{1}{2}$	5	$\frac{1}{8}-\frac{1}{4}$	$4\frac{1}{2}$	5 46
120	$11\frac{1}{2}$	5	$\frac{1}{8}-\frac{1}{4}$	$4\frac{1}{2}$	5 00
104	$12\frac{1}{2}$	5	$\frac{1}{8}-\frac{1}{4}$	$4\frac{1}{2}$	5 00
104	$11\frac{1}{2}$	5	$\frac{1}{8}-\frac{1}{4}$	$4\frac{1}{2}$	4 20
120	$15\frac{1}{2}$	$7\frac{1}{8}$	$\frac{1}{8}-\frac{1}{4}$	$6\frac{3}{4}$	15 00
120	$11\frac{1}{2}$	5	$\frac{1}{8}-\frac{1}{4}$	$4\frac{1}{2}$	5 00
104	$11\frac{1}{2}$	5	$\frac{1}{8}-\frac{1}{4}$	$4\frac{1}{2}$	4 20
120	$9\frac{1}{2}$	5	$\frac{1}{8}-\frac{1}{4}$	$4\frac{1}{2}$	3 28
104	$9\frac{1}{2}$	5	$\frac{1}{8}-\frac{1}{4}$	$4\frac{1}{2}$	3 00

## APPENDIX J

## 2. DECIBEL/VOLTAGE RATIO TABLE

<i>Decibels</i>	$\frac{V_2}{V_1}$	<i>Decibels</i>	$\frac{V_2}{V_1}$
0.5	1.0593	46	199.5
1.0	1.1220	48	251.2
2.0	1.2589	50	316.2
3.0	1.4125	52	398.1
4.0	1.585	54	501.2
5.0	1.778	56	631.0
6	1.995	58	794.3
7	2.239	60	1,000
8	2.512	62	1,259
9	2.818	64	1,585
10	3.162	66	1,995
12	3.981	68	2,512
14	5.012	70	3,162
16	6.310	72	3,981
18	7.943	74	5,012
20	10.00	76	6,310
22	12.59	78	7,943
24	15.85	80	10,000
26	19.95	82	12,590
28	25.12	84	15,950
30	31.62	86	19,950
32	39.81	88	25,120
34	50.12	90	31,620
36	63.10	92	39,810
38	79.43	94	50,120
40	100.00	96	63,100
42	125.9	98	79,430
44	158.5	100	100,000

N.B.—The power ratio,  $\frac{P_2}{P_1}$ , corresponding to any given number of decibels is the square of the voltage ratio  $\frac{V_2}{V_1}$ . It is thus the same as the voltage ratio corresponding to double the number of decibels. Conversely, the number of decibels corresponding to a given power ratio is half that corresponding to an equal voltage ratio. Both statements are conditional upon the two voltages operating between equal impedances.

Zero power and voltage reference levels are 1 mW and 0.775 V respectively.

BBC RECORDING TRAINING MANUAL

3. GRAPHICAL SYMBOLS FOR RECORDING AND REPRODUCING HEADS

Recording Head  
General Symbol



Reproducing Head  
General Symbol

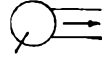

Recording Head  
Magnetic



Reproducing Head  
Magnetic

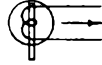

Recording Head  
Moving-coil



Reproducing Head  
Moving-coil

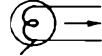

Recording Head  
Moving-iron



Reproducing Head  
Moving-iron

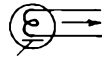

Recording Head  
Photo Type



Reproducing Head  
Photo Type



Recording Head  
Crystal



Reproducing Head  
Crystal



## INDEX

- Absorption Coefficient, 9
- Acoustic Gramophone, 19, 84
- Acoustic Horn, 85
- Acoustic Recording, 17
- Acoustic Reproduction, 84
- Acoustic Sound Box, 84
- Amplifier :
  - RC-coupled, 42
  - Recording, 41, 76
- Amplitude and Velocity, 28
- Amplitude Distortion, 15
- Anti, Static Fluid, 75
- Armature :
  - Balanced, 87
  - Unbalanced, 87
- Armature Suspension :
  - In Disk Reproducing Heads, 87
- BALANCED ARMATURE, 87
- Bass Resonance in Pickups, 90
- BBC Disk Recording Characteristic, 37
- BBC Disk Recording Equipment :
  - Type-C, 52
  - Type-D, 62
- BBC Disk Recording Head :
  - Type-A, 55
  - Type-B, 69
- BBC Disk Reproducing Equipment, 101
- Bell, Alexander Graham, 17
- Berliner, Emile, 17
- B/H Loop, 120
- Bimorph, 88
- Blattnerphone, 21
- Buchmann-Meyer Image, 173
- CELLULOSE DISKS, 39
- Characteristics of Sound, 2
- Compliance, Cutting, 47
- Coercive Force, 117
- Coercivity, 117
- Correction Unit, Variable, 97
- Counter-balanced Head, 55
- Cros, Charles, 18
- Crystal Reproducing Head, 88
- Cutters, Sapphire, 40, 155
- Cutting Compliance, 47
- Cutting Resonance, 47
- Cutting Speed, Disk Recording, 25
- Cutting Stylus, 39
- Cylinders, Recording on, 17
- DASH-POT, 58
- Decibel/Voltage Ratios, 225
- Depth-of-cut Adjustment :
  - Presto, 58
  - Type-C Recorder, 55
  - Type-D Recorder, 69
- Direct Recording, 24
- Disk :
  - Cellulose-Nitrate, 39
  - Diameter and Recording Time, 28, 153
  - Material, 39
  - Patterning, 47
  - Processing, 113
  - Recording Amplifier, 41, 55, 61, 76
- Disk Recording Equipment :
  - BBC Type-C, 52
  - BBC Type-D, 62
  - M.S.S., 49
  - Presto, 56
- Disk Recording Head :
  - BBC Type-A, 55
  - BBC Type-B, 69
  - Counter-balanced, 55
  - M.S.S., 51
- Disk Recording, Principles of, 24
- Disk Reproducing Equipment :
  - BBC, 101
  - Presto, 107
- Disk Reproducing Head :
  - E.M.I. Type 12, 91
  - Voigt Moving-coil, 93
- Disk Reproducing Heads :
  - Electrical, 86
  - Equalisers for, 93
  - Methods of Armature Suspension, 87
  - Moving-coil, 88, 93
  - Moving-iron, 87
  - Piezo-electric, 88
  - Resonance in, 90
  - Sensitivity of, 91
- Disk Wear, 97
- Disks, Cellulose, 39
- Disks, Reproduction of, 84
- Distortion in Electrical Communication Circuits, 10
- Drive, Turntable, 44
- DR/5A, Disk Recording Amplifier, 55
- DRA/4, Disk Recording Amplifier, 76
- Duddell, 20

## BBC RECORDING TRAINING MANUAL

- EDISON, THOMAS ALVA, 17
- Electrical and Mechanical Circuits Analogy between, 167
- Electrical Communication Circuits, Distortion in, 10
- Electrical Reproducing Head, 86
- Electrical Reproduction, 86
- Electrostatic Charge on Disks, 74
- E.M.I. Magnetic Recorder, 131
- E.M.I. Type-12 Disk Reproducing Head, 91
- Equalisers for BBC Disk Reproducing Heads :
  - EQ/102, 93
  - EQ/202, 94
  - EQ/202A, 106
  - ETA/1, 105
  - G/2D, 96
  - G/7, 96
  - G/12, 96
- FEEDBACK, NEGATIVE, 42
- Feed-screw, See "Lead-screw,"
- Fidelity :
  - Effect of Cutting Speed on, 25
  - Effect of Groove Diameter on, 25
- Film, Philips-Miller, 143
- Film Recording and Reproduction, 135
- Film Recording :
  - Noise Reduction Circuits, 140
  - Noise Reduction in Photographic, 139
  - Non-photographic, 143
  - Philips-Miller, 143
  - Photographic, 135
- Film Reproduction, 141, 149
- Flutter, 44, 185
- Frequency Characteristic of Disk Reproducing Apparatus, 108
- Frequency Correction in Recording Amplifiers, 42
- Frequency Fluctuation in Recording and Reproducing Systems, 185
- Frequency Response :
  - E.M.I. Type-12 Head, 95
  - Effect of Groove-loading on, 38
  - Marconi-Stille System, 126
  - Measurement of Pickup, 108
  - Type-D Recorder, 83
- GENERATION OF HARMONICS, 12
- Gramophone, Acoustic, 19, 84
- Graphical Symbols for Recording and Reproducing Heads, 226
- Groove :
  - Amplitude, 30
  - Calculation of Amplitude, 30
  - Diameter, Effect on Fidelity, 25
  - Loading, Effect on Frequency Response, 38
  - Locating Unit, 101
  - GLU/9B, 100
  - GLU/10A, 104
  - Pitch, 28
  - Shape, 32
  - Spacing, 28
- Ground-noise Reduction, Film Recording System, 139, 145
- HALF PROCESS, 114
- Harmonic Distortion, 11
- Harmonics, 11
- Hearing, Threshold of, 5
- High-frequency Resonance in Pickups, 91
- Hill-and-dale Recording, 18, 24
- Historic Survey, 16
- Horn, Acoustic, 19, 85
- Hysteresis Loop, Magnetic, 120
- INDUCTION MOTORS, 162
- Intensity, Sound, 4
- Intermodulation Distortion, 15
- Intermodulation Tone, 15
- LATERAL RECORDING, 24
- Lead-screw, 46
- Leon Scott, 16
- Light Valve, 136
- Limiter, 16, 59
- Logarithmic Horn, 85
- Loudness Level, 7
- Low-frequency Resonance in Pickups, 90
- Loudness of Sound, 4
- MAGNETIC HYSTERESIS, 118
- Magnetic Recording and Reproduction, Fundamental Principles of, 117, 118
- Magnetic Terms, Definition, 117
- Magnetism, Residual, 118
- Magnetophon, System, 127
- Marconi-Stille System, 120
- Master (Processing), 113
- Master Stamper (Processing), 113

## INDEX

- Matrix (Processing), 113
- Mechanical and Electrical Circuits, Analogy between, 167
- Monitoring Chain, Type-D Recorder, 80
- Mother (Processing), 113
- Motors, Induction and Synchronous, 159
- Moving-coil Disk Reproducing Head, 88, 93
- Moving-iron :
  - Disk Recording Head, 40
  - Disk Reproducing Head, 87
- M.S.S. Disk Recording Equipment, 49
- Multi-frequency Test Record, 108
  
- N.A.B. BROADCASTING CHARACTERISTIC, 35
- Needle :
  - Pressure, 97
  - Tip, Hardness and Softness of, 97
  - Wear, 97
- Needles, Acoustic Reproducing, 86
- Negative Feedback, 42
- Noise Reduction :
  - Philips-Miller Recording, 145, 151
  - Photographic Film Recording, 139
- Non-photographic Film Recording, 143
  
- OFF-SET REPRODUCING ARM, 98
- Open Window Unit, 9
- Overall Characteristic, Disk Reproduction, 108
  
- PARALLEL TRACKING ARMS, 99
- Patterning, Disk, 47
- Philips-Miller :
  - Amplifiers, 150
  - Machine, 146
  - Recording Head, 148
  - Reproduction, 149
  - System, Principles of, 143
- Phon, The, 7
- Phonograph, 17
- Photocell, 142
- Piezo-electric Disk Reproducing Heads, 88
- Pinch Effect, 31
- Pitch, 3
- Portable Disk Recording Equipment
  - Type-C, 52
- Poulsen, 21
- Pressing Material, 116
- Pressing Operation, The, 116
  
- Pressings :
  - Shellac, 116
  - Vinyl, 116
- Pressure Amplitude, 2
- Presto :
  - Depth-of-cut Adjustment, 58
  - Disk Recording Equipment, 56
  - Disk Reproducing Equipment, 107
  - Equaliser, 60
  - Limiter, 59
  - Radius Compensation, 60
  - Recording Amplifier, 61
  - Recording Chain, 58
  - Recording Head Mounting, 58
  - Slope Control, 61
  - Traverse Unit, 60
  - Turntable and Traverse Drive, 56
- Process :
  - Full, 113
  - Half, 114
- Processing of Disks, 113
- Programme Chain, Type-D Recorder, 76
- Programme Chain :
  - Presto Recorder, 58
  - Reproducing Desk DRD/1, 105
  - Type-D Recorder, 76
- Propagation of Sound Waves, 2
- Push-pull Film Recording, 137
  
- RADIUS COMPENSATION, 33
  - Presto, 60
  - Type-D Recorder, 77
- RC Correction Network, Loss Curve for, 43
- RC-coupled Amplifier, 42
- Recorded Wavelengths, 25
- Recording :
  - Amplifier for Type C, 55
  - Amplifier for Type D, 76
  - Amplifier, Presto, 61
  - Amplifiers, Frequency Correction in, 42
  - Chain, M.S.S., 52
  - Chain, Presto, 58
  - Chain, Type D, 76
  - Characteristic, BBC, 34, 37
  - Characteristic, N.A.B., 35
- Recording Diameters and Duration (BBC Standards), 225
- Recording Head, 40
  - BBC Type-A, 55
  - BBC Type-B, 69

## BBC RECORDING TRAINING MANUAL

- Recording Head (cont.)
  - Counter-balanced, 55
  - Magnetophon, 128
  - Marconi-Stille, 124
  - Moving-iron, 40
  - M.S.S., 51
  - Philips-Miller, 148
- Recording-head Mounting, 46, 54, 58, 69
- Recording Machine, 44
  - Type-C Equipment, 54
  - Type-D Equipment, 63
- Recording, Principles of, Disk, 24
- Recording, Principles of :
  - Disk, 24
  - Magnetic, 118
  - Film, Photographic, 135
  - Film, Philips-Miller, 143
- Recording, Slit-width, 137
- Recording Time, Disk Diameter, 28, 153
- Reference Data, 224
- Reflection of Sound, 8,
- Reluctance, 118
- Remanence, 118
- Remanent Flux Density, 118
- Reproducing Chain, Type-D Recorder, 80
- Reproducing Head Frequency Response, Measurement of, 108
- Reproducing :
  - Magnetophon, 130
  - Marconi-Stille, 122
- Reproducing Sapphires, Manufacture, 155
- Reproducing Turntables, Speed Accuracy of, 101
- Reproduction :
  - Acoustic, 84
  - Electrical, 86
  - Film, 146, 149
  - Magnetophon, 130
  - Marconi-Stille, 122
  - of Disks and Pressings, 84
  - of Photographic Film Recording, 141
- Residual Magnetism, 118
- Resonance in Pickups, 90
- Reverberation, 8
- Reverberation Time, 8
- SAPPHIRE CUTTERS
  - Manufacture of, 155
  - BBC Disk, 39
  - Philips-Miller, 145
- Scanning in Film Reproduction, 178
- Scott, Leon, 16
- Self-demagnetisation, 122
- Sensation Level, 5
- Shaded-pole Motors, 164
- Sensitivity of Disk Reproducing Heads, 91
- Shellac Pressings, 116
- Slit Width, Effect of :
  - Film Recording, 137
  - Film Reproducing, 142
- Slope Control, Presto, 61
- Sound-box, 84
- Sound :
  - Characteristics of, 2
  - Definition of, 1
  - Frequency of, 2
  - Intensity of, 4
  - Loudness of, 4
  - Velocity of, 2
  - Wavelength of, 2
- Sound Waves, Propagation of, 2
- Speed Accuracy of Reproducing Turntables, 101
- Stamper (Processing), 113
- Stamper Centring, 115
  - Stille, 21
- Stochastic Phenomena, 194
- Stroboscope, 45
- Stroboscopic Bars, Calculation of, 45
- Stylus, cutting :
  - BBC Disk, 39
  - Philips-Miller, 145
- Suction Plant, Type-D Recorder, 75
- Swarf Removal, 48
  - Type-D Recorder, 74
- Synchronising Sound and Pictures, Photographic Film Reproduction, 141
- Synchronous Motors, 163
- TAINTER, C. S., 17
- Tape :
  - Magnetophon, 131
  - Marconi-Stille, 126
- Telegraphone, 21
- Test Record Multi-frequency, 108
- Threshold of Feeling, 5
- Threshold of Hearing, 5
- Tolerance, Turntable Speed, 44
- Tone, Intermodulation, 15
- Tracing Distortion, 33
- Tracking Angle in Pickups, 210
- Tracking Arms, 98



## INDEX

- Traverse Drive, 44
- Turntable Drive Unit TDU/2, 102
- Turntable Speed, 25
- Type-D Disk Recording Equipment :
  - Frequency Response, 83
  - Machine, 63
  - Mian Drive, 63
  - Monitoring Chain, 80
  - Performance, 81
  - Programme Chain, 76
  - Radius Compensation, 77
  - Recording Amplifier, 76
  - Recording Chain, 76
  - Recording Head, 69
  - Recording-head Mounting, 69
  - Reproducing Chain, 80
  - Suction Plant, 75
  - Swarf Removal, 74
  - Traverse Drive, 68
  - Traverse Unit, 66
- VARIABLE CORRECTION UNIT, 97
- Variable-density Film Recording, 136
  - Variable-density Push-pull Film Recording, 138
  - Variable Light-intensity Film Recording, 136
  - Variable Slit-width Film Recording, 136
  - Variable-width Film Recording, 136
- Velocity :
  - Amplitude and, 28
  - of Sound, 2
- Vinyl Pressings, 116
- Voigt Reproducing Head, 93
  
- WAVELENGTH OF SOUND, 2
- Wavelengths, Recorded, 25
- Wiping Head :
  - Magnetophon, 128
  - Marconi-Stille, 120, 124
- Wiping Process :
  - Magnetophon, 128
  - Marconi-Stille, 120, 123
- Wow, 44, 185
- Wow Measurement, 189

