



To [unclear]

trans. [unclear] Dec. 1933.

with [unclear] of [unclear]

The B.B.C.
Year-Book
1934

*The Programme Year covered by this book
is from November 1st, 1932, to
October 31st, 1933*

THE BRITISH BROADCASTING
CORPORATION
BROADCASTING HOUSE
LONDON

Readers unfamiliar with broadcasting will find it easier to understand the articles in this book if they bear in mind the following:—

(1) *The words “Simultaneous^(ly) Broadcast” or “S.B.” refer to the linking of two or more transmitters by telephone lines for the purpose of broadcasting the same programme; e.g. the News Bulletins are S.B. from all B.B.C. Stations.*

(2) *The words “Outside Broadcast” or “O.B.” refer to a broadcast outside the B.B.C. studios, not necessarily out-of-doors; e.g. a concert in the Queen’s Hall or the commentary on the Derby are equally outside broadcasts.*

(3) *The B.B.C. organisation consists, roughly speaking, of a Head Office and five provincial Regions—Midland Region, North Region, Scottish Region, West Region, and Belfast. The Head Office includes the administration of the National Programmes, wherever they originate, and also the London Regional programmes. The provincial centres supply the bulk of the Regional programme broadcast from their respective Regional transmitters, although there is a considerable interchange of material between the various Regional services. The words “Region” or “Regional” refer throughout the book to this system of organisation.*

CONTENTS

	PAGE		PAGE
Introduction	11	Exhibitions	31
Notes of the Year	13	Ten Years of <i>The Radio Times</i>	35
Licences in Great Britain	22	How Broadcasting House is Run	39
"In the Eyes of the Law"	25		
Broadcasting Copyright Problems	27		

PROGRAMME SECTION

Programme Notes	57	School Broadcasting	87
The Maecenate of the Microphone	61	Religious Broadcasting	91
Broadcast Opera in Germany	67	Here is an S.O.S.	97
Retrospect of the Concert Year	73	News—A Fable	99
Learning to Broadcast	75	What the Children Like	101
Poetry	79	Outside Broadcasts	105
Topicality	81	Radio Drama	111
Arranging a Talk	85	Broadcast Variety	115
		The Function of the Sound Record	119
		Events of the Year	123

THE REGIONS

The New Studios at Leeds and Birmingham	153	Activities in the North	195
The West Region: Notes	163	Music in the North	201
The Choice of the Site	167	Midland Regional Notes	209
The Station	169	A Review of Radio Criticism in the Midlands	217
Development of Broadcasting in the West	181	Scottish Regional Notes	221
The Kingdom of Arthur	187	Programmes from the Scottish Countryside	227
Some Thoughts about Welsh	191	Scots Folk Song	231
		Northern Ireland Notes	235

EMPIRE AND FOREIGN SECTION

THE EMPIRE

Notes	243	Empire Service Events	267
The First Stages of Empire Broadcasting	249	Empire Statistics	274
A Review of Reception of the Empire Service	257	Broadcasting in Rural India	277

FOREIGN

Notes	281	Broadcasting and Anglo-American Relations	299
International Organisation of Broadcasting	287	Broadcasting and the Presidential Inauguration	303
The Re-organisation of German Broadcasting	295		

TECHNICAL SECTION

Notes	311	The Boat-race Transmitter	385
The New Droitwich Station	319	Regional Control Room	387
The New Wavelength Plan	323	Work in the London Control Room	397
The S.B. Land-line Network	329	Recent Developments in Microphone Design	407
New Provincial Studios	333	The Application of Sound Recording to Broadcasting	415
The Service to Northern Ireland	339	Valve Developments	421
Calculation and Measurement of Field Strengths	347	Modern Receiver Design	427
Modulation Recording	361	Reception of Distant Stations	437
Aerial Systems for the Empire Station	373		

APPENDIX

B.B.C. Addresses	446	Trade Associations and Technical Societies	454
Visits to B.B.C. Studios	447	New Wavelengths Plan	455
Wavelengths of British Stations	447	Advisory Councils and Committees to the B.B.C.	466
Weather Forecasts	448	Buyers' Guide	475
Rules for S.O.S. Messages	448	Index	477
The Time Signal Service	450	Calendar	480
Balance Sheet and Accounts	451		

LIST OF ILLUSTRATIONS

	PAGE		PAGE
The late Mr. J. C. Stobart	10	Speedway Test Match at	
Broadcasting House	15	Wembley Stadium	142
Prospero and Ariel	16	Mr. Rudyard Kipling	143
The B.B.C. Bookshop	18	Opening of the Graving	
Radio Exhibition, Olympia	30	Dock at Southampton	144—5
B.B.C. Revue at Olympia	32	Massed Choirs singing at the	
Printing <i>The Radio Times</i>	34	Crystal Palace	146
Broadcasting House:		Religious Service on H.M.S.	
One of the Details	40	<i>Victory</i> at Portsmouth	147
The Daily Programme	41	Richard Tauber	149
The Daily Morning Service	42	R101 Memorial at Allonno	151
Dramatic Control Panel	45	Studio No. 1 at Leeds	152
In the Effects Studio	45	The Talks Studio, Leeds	154
The Restaurant	49	Studio No. 4 at Birmingham	157
One of the Artists' Lounges	51	Studio No. 2 at Birmingham	159
The Vaudeville Studio	51	The West Regional Station:	
In the Listening Room	54	View of the Station	161
The New Organ	56	The Front Entrance	162
Serge Koussevitzky	59	The Transmitter Hall	170
Purcell's "Dido and Æneas"	66	The Power House	173
Miss Megan Lloyd George		Motor Generator Room	173
and Sir Oswald Mosley	77	The Transmitter Hall	175
Mr. G. K. Chesterton	78	Programme Control Desk	177
A London and a Paris		Cardiff:	
Policeman	84	The Dramatic Studio	179
Carlisle Cathedral	93	The Large Orchestral	
Exeter Cathedral	93	Studio	180
"Toytown" Drawing	102	No. 2 Studio	182
Elizabeth Bergner	110	The End Panels of Luca	
"Waltz Time"	114	della Robbia's Pulpit,	
The "Recorded Pro-		Florence Cathedral	185
grammes" Library	118	The Waiting Room, Leeds	196
The King Opening the		Senior 'U.T. Races, Isle of	
World Economic Con-		Man	200
ference	121	The Hallé Orchestra	204
Sir Edward Elgar	125	The Entrance Hall, Leeds	206
The Prince of Wales and		Effects and Gramophone	
Unemployed Men	126	Studio, Birmingham	210
Jean Forbes-Robertson	128	Shelsley Walsh Hill Climb	213
Sir Henry Lytton	130	"The Cheltenham Flyer"	214
Mr. Matsuoka and Mr. Quo-		The Artists' Waiting Room,	
Tai-Chai	132	Birmingham	216
The B.B.C. Dance Orchestra	133	A <i>Ceilidh</i> in the Highlands	229
The Oxford and Cambridge		The New Royal Courts of	
Boat Race	134	Justice, Ulster	237
Oscar Asche	136	The Transmitter Hall at the	
Two Football Cup Finals	138	Empire Station	242
The Aldershot Tattoo	141	The Table at which the King	
"Nelson Goes Home"	141	sat to deliver his Empire	
		Message	248

	PAGE		PAGE
Empire Marketing Board		The West Regional Station	314
Posters:		Droitwich Station under	
Australia	259	Construction	318, 322
India	260	The Large Studio, Leeds	334
South Africa	261	Mobile Transmitter	345
West Indies	263	Syphon Recorder and Paper	
Canada	264	Drums	364
Opening of S. Africa House	266	Syphon Recorder	365
Opening of England to India		Modulation Level Records	370
Telephone Service	268	A Power-output Stage of an	
Four Thousand Feet above		Empire Transmitter	372
Cape Town	269	Apparatus used on <i>Magician</i>	386
Cricket at Lord's	270	Twin Turntable Gramo-	
Indian Village Crowd	276	phone Unit, Cardiff	388
Dr. Arnold Raestad	280	Control Room, Leeds	390
Italian Children taking part		Amplifier Racks in the	
in a School Broadcast	285	Scottish Control Room	391
Lucerne Conference, 1933	286	Dramatic Control Equip-	
Some Conference Hotels	290	ment, Cardiff	395
The Inauguration of the		Testing Amplifiers and Lines	399
Holy Year, Rome	293	Moving-Coil Microphones	
Herr Hitler	294	and Stands	406
The Inauguration of Presi-		Modern Microphones	412
dent Roosevelt	304	Recording the King's Speech	414
The New Control Room,		Valve for Long-wave Trans-	
Cardiff	310	mitter at Droitwich	420

MAPS, DIAGRAMS, ETC.

Seven Years of Licence		Northern Ireland Events	240
Revenue	20	Time Zone Map of the	
Distribution of Licence		World	272—273
Revenue	21	Relays from and to America	308
Map of Licences in Great		Field Strength Measurement	
Britain	22	Diagrams	350, 354, 355
Graph of Attendance at		Essentials of a Field Strength	
Olympia	29	Measurer	357
Licences and <i>The Radio Times</i>	38	Diagram of Syphon Re-	
Some First Performances of		corder	366
Music	72	Diagram of Apparatus for	
Religious Activities	95	Recording Modulation	368
Appeals Results	96	Modulation Level Records	370
S.O.S. Results	98	Current Distribution	374
Hotel and Cinema Music	104	Radiation Diagrams	375, 376
Broadcast Plays	109	Lay-out of Aerial System of	
Plays Broadcast in Drama		the Empire Station	380—381
Festival	113	Zone Map of the World	382
Site of West Regional Station	166	Plan of Apparatus on the	
West Regional Events	183	<i>Magician</i>	385
Rhaglenni Cynreig	190	Diagram of Recorded Field	
North Regional Events	207	Strength	444
Midland Regional Events	215	Weather Forecast Map	449
Scottish Events	225	Map of Europe	464—465

THE BRITISH BROADCASTING
CORPORATION



BOARD OF GOVERNORS

The Rt. Hon. J. H. Whitley, D.C.L., LL.D.
Chairman

R. C. Norman, Esq.
Vice-Chairman

Harold G. Brown, Esq.

The Rt. Hon. the Viscount Bridgeman, LL.D.

Mrs. M. A. Hamilton

Director-General

Sir J. C. W. Reith, LL.D.

Head Office

BROADCASTING HOUSE
LONDON, W. 1

A MESSAGE BY HIS MAJESTY

THE KING

BROADCAST TO THE EMPIRE ON CHRISTMAS DAY

1932

Through one of the marvels of modern science I am enabled this Christmas Day to speak to all my people throughout the Empire. I take it as a good omen that wireless should have reached its present perfection at a time when the Empire has been linked in closer union, for it offers us immense possibilities to make that union closer still.

It maybe that our future will lay upon us more than one stern test. Our past will have taught us how to meet it unshaken. For the present the work to which we are all equally bound is to arise to a reasoned tranquillity within our borders, to regain prosperity without self-seeking, and to carry with us those whom the burden of past years has disheartened or overborne. My life's aim has been to serve as I might towards those ends. To your loyalty, to your confidence in me, has been my abundant reward.

I speak now from my home and from my heart to you all, to men and women so cut off by the snows and the deserts, or the seas, that only voices out of the air can reach them. To those cut off from fuller life by blindness, sickness or infirmity, and to those who are celebrating this day with their children and their grandchildren, to all, to each, I wish a happy Christmas.

God Bless You.



THE LATE MR. J. C. STOBART

INTRODUCTION

THE YEAR 1932 saw the close of the first decade of British broadcasting, a decade marked by a record of achievement which can have few parallels in the history of new-born public institutions.

This Year-Book for 1934, the seventh of the series, continues the story of progress and development. At the end of August, 1932, the number of licensed listeners in the United Kingdom and Northern Ireland had reached a figure of 4,821,436. A year later, on August 31st, 1933, this total had increased to 5,654,408, representing a listening public of probably not much less than twenty-five million people; and there is as yet no evidence that saturation point is in sight.

The B.B.C. has always set before itself an ideal of the highest standard of public service; and if an incentive were needed to fulfil the responsibilities which that ideal implies, it would surely be found in the remarkable and progressive increase in the number of listeners which the Corporation is called upon from year to year to serve.

In the following chapters ample evidence will be found of the determination of the B.B.C. to maintain constant improvement in every sphere of its activities. At home, during the year reviewed, the opening of the West Regional Station at Watchet has brought Wales and the West Country within the plan of distribution by high-power twin-wave transmitters, the object of which is to provide listeners with alternative programmes. In a wider field the Empire Service, which was inaugurated by His Majesty the King's imperial broadcast on

Christmas Day 1932, has been steadily progressing through the early stages of necessary experiment towards the goal of an established service, which will forge a new and powerful link to bind together ever more closely the scattered peoples of the great British Commonwealth of Nations.

As broadcasting tends to become more and more a normal adjunct of the home, and less a luxury for the few, the progressive improvement made by the Wireless Industry in the design of receiving sets and the extension of their range makes reception conditions better and more cheaply available to all. And as a result of this, the ever-widening sphere of entertainment and of information that broadcasting brings within the reach of every home cannot fail to enrich existence with a store of new interests and of new knowledge, which will surely be reflected in a fuller and a happier life, and in a better capacity to meet and face its problems.

NOTES OF THE YEAR

IT IS FITTING that these notes should begin by placing upon record the Corporation's profound regret at the loss of a unique personality in its history, John Clark Stobart, who died on May 11th, 1933, after a long illness.

In him scholarship was interwoven with good sense, irony with humanity, deep piety with charm and (as he himself described it) flippancy. For the general public his name is connected with educational and religious broadcasting and with the "Grand Good Night." But it is not generally known, even within the B.B.C., that at one time, when the multitudinous tasks that were falling to a single "Education Director" who was responsible for almost every aspect of the "spoken word" and Children's Hour to boot, were becoming too much for his health, the idea was mooted and seriously considered, that here was a man who might create and develop a specific "radio" type of humour. That the proposal proved impracticable is unimportant. That it was possible to suggest that the director of educational and religious broadcasting and the poet of the "Grand Good Night" should also create and launch a series of variety programmes is surely not an unimportant footnote to his biography.

The scope of his more serious work, the influence he exercised on the public for whom he worked, need no further comment here. It will be enough to say that St. Martin's-in-the-Fields—and that on a week-day morning—just sufficed to hold those who, in London alone, wished to pay the tribute of attending the Memorial Service. A personality that, rooted in religion, sent forth live shoots that met and embraced ordinary humanity at a score of points.

* * *

It is appropriate, too, that the Year-Book should record the B.B.C.'s appreciation of the work accomplished for it, as for British music in general, by the late Percy Pitt. The last of Pitt's many activities—and may it perhaps be said the most far-reaching in its influence?—was his tenure of the position of B.B.C. Music Director from 1923 until the end of 1929, the formative years of broadcasting in Britain. Although he had retired from this post, his contact with his old colleagues and

the listening public was kept up in one connection and another almost to the day of his sudden death on November 23rd, 1932. A public Memorial Concert of his works was broadcast on March 10th, 1933, in the Concert Hall at Broadcasting House, and a tablet to his memory has been placed in All Souls' Church, South Hampstead.

* * *

Yet another loss to be recorded is that of Mr. John Kettelwell, organiser of the Children's Hour since March 1932, who died on October 24th, 1933, just after returning from sick leave. Though relatively new to the broadcasting service, he had already endeared himself to his audience and his colleagues alike. He, too, was a characteristic figure that will not be forgotten.

* * *

The celebration of the tenth anniversary of British Broadcasting in November, 1932, synchronised with the attainment of five million licensed listeners. The week of special programmes signalling the tenth anniversary attracted much favourable comment both at home and abroad.

The Radio Times also celebrated its tenth anniversary with a special number published on September 29th, 1933. Over 2,000,000 copies of this issue were sold—a record for any number published at that time of the year. On this occasion the journal announced that in the first issue of 1934 the Northern and Southern editions would be amalgamated and the make-up of the programme pages would be revised in the interests of clarity, so that every reader could find his programmes at a glance.

* * *

World-Radio has been developed during the past year. On November 11th, 1932, *World-Radio* published its first Empire edition, giving detailed information of the programmes to be broadcast from the Empire Station. The make-up of this edition was very carefully planned in order to enable the details of the programmes for the Empire to be received well in advance of the broadcasts. The Empire edition is also published weekly, and in addition to instructive technical articles, reprints some of the talks which are broadcast in the Empire programmes, and other information likely to be of interest to



BROADCASTING HOUSE

with All Souls' Church, Langham Place, in the foreground.

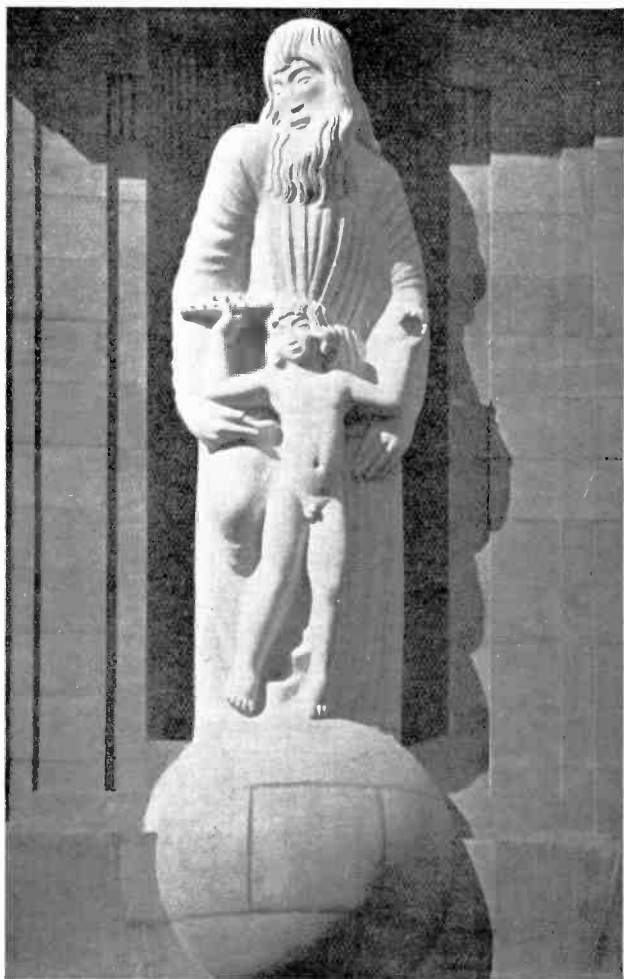

PROSPERO AND ARIEL

The Sculpture by Eric Gill in the niche above the Entrance to Broadcasting House

its subscribers. This new service has been greatly appreciated by listeners overseas.

* * *

The Listener is now established as a leading literary weekly, its circulation steadily advancing and its influence increasing even more widely. On the art side in particular *The Listener* has achieved a unique position in providing lavish illustrations for its comprehensive surveys of art of all kinds.

* * *

A feature of the year has been the number of wireless exhibitions which have been held in various parts of the country. It is realised that they provide a new and expanding field of public interest, and during 1933 B.B.C. exhibits were shown at the Olympia, Glasgow, Belfast, Manchester, Bristol, Edinburgh, and Birmingham Radio Exhibitions, the Advertising Exhibition, the British Industries Fair, and the Bath and West Agricultural Show.

* * *

The newspaper Press continues its active interest in broadcasting. More and more space is being devoted to the publication of programmes, notes, and news. There is also on the part of serious periodicals a more noticeable tendency to give consideration to broadcasting policy.

* * *

Empire broadcasting was developed both on the technical and programme sides. An analysis of reports of reception over a considerable period made it possible to allot the available wavelength channels to the maximum advantage and to study improvements in aerial design. The world tour of a special representative of the Department concerned with this work yielded much useful information. The special 1932 Christmas Day programme, with the message by His Majesty the King, and clearly received in all parts of the British Empire and beyond, is probably the high-water mark of achievement of British broadcasting so far. This programme not only thrilled the Empire, but also did much to demonstrate the unifying and consolidating effect of broadcasting when properly employed. It is hoped that soon Empire programmes of similar standard will be as widely radiated from the various Dominions.

* * *

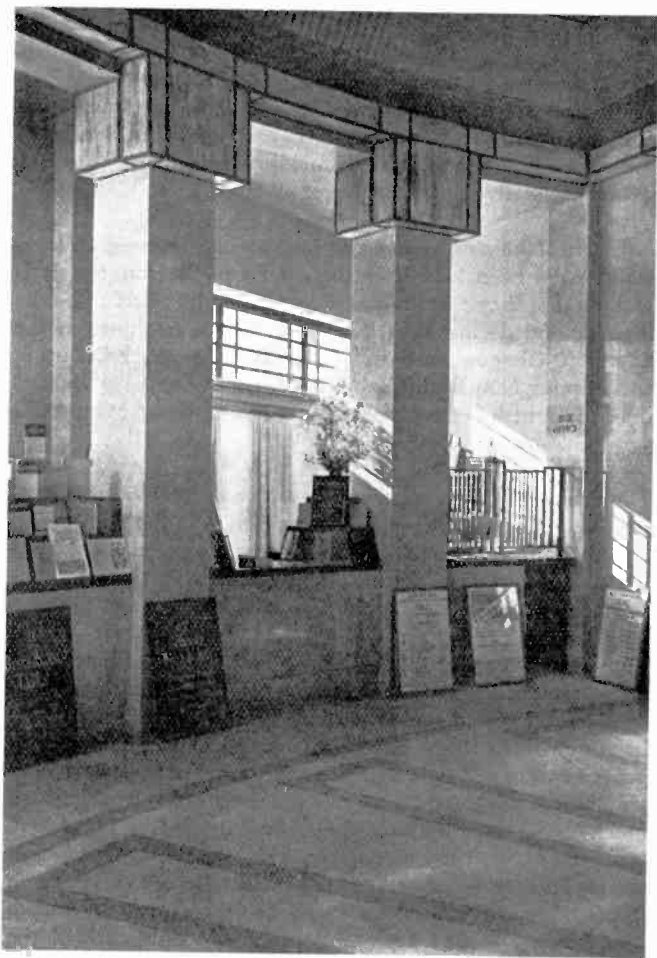

THE B.B.C. BOOKSHOP IN THE ENTRANCE HALL, BROADCASTING HOUSE, AT WHICH B.B.C. PUBLICATIONS CAN BE OBTAINED

A B.B.C. official was sent to Canada on a special mission to advise the Federal Government on the organisation of National Broadcasting. The resultant Report was published in August. The recommendations were designed to help in adapting to Canadian needs those principles of public service broadcasting which had been successfully tested elsewhere. Special attention was paid to the interests of the Provinces, to minority considerations, and to the gradual progressive adaptation of existing facilities on a kind of "Five-Years' Plan," the cost of which would not exceed the revenue from licences and from limited controlled advertisements. The Report concluded:

"Canada has an exceptional advantage in the possession already of a licence system. Broadcasters of the United States, dependent solely on advertisement revenue, faced with the increasing difficulty of providing good sustaining programmes—and these are better than most and as good as any—naturally look with envy to the state of affairs in Canada, where licence revenue provides a steady income and the freedom for planning programmes without extraneous considerations.

"In the development of public service broadcasting on a co-operative constructive basis, with management on efficient business lines and State control remote yet secure, Canada will be in a position to add immeasurably to the amenities of her civilisation and also to produce a decisive new instrument of national unity and stability."

* * *

Plans for political broadcasting are bringing the B.B.C. into prominence in Parliament. Political leaders are realising as never before the great educative potentialities of the microphone. The B.B.C., however, has to bear in mind that the public appetite for political broadcasts is not unlimited. In this connection an interesting series of talks, "The Debate Continues," is being given in which the political parties have complete freedom in their speakers and the selection of their subject, and are free to defend the Government's policy or to attack it, and to put forward their views for the furtherance of the aims of the parties they represent. Among the speakers taking part in this series are Mr. Stanley Baldwin, Mr. George Lansbury, Mr. J. H. Thomas, Sir Herbert Samuel, Sir Stafford Cripps, and Mr. Ramsay MacDonald.

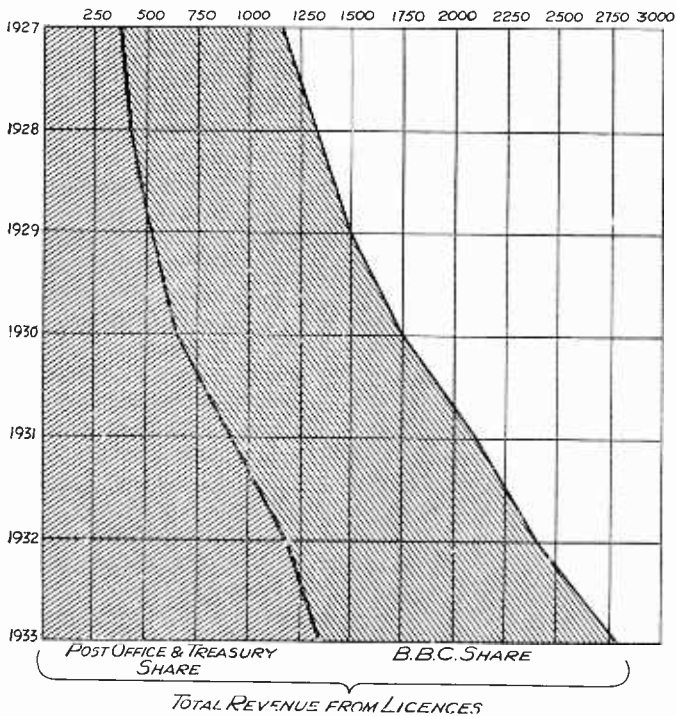

SEVEN YEARS OF LICENCE REVENUE

Note: the revenue for the years 1922-1926 (total £2,925,000—B.B.C. £1,768,000, Government £1,157,000) is not included in the diagram, owing to complications arising from a different financial year and (in the first year) royalties on receiving sets.



HOW YOUR LICENCE MONEY IS SPENT

THE listener's licence fee of TEN SHILLINGS a year was, in 1932, shared between the Government and the B.B.C. in this way:—

	s. d.
THE GOVERNMENT RECEIVED, OF EACH LICENCE FEE—	
1. Post Office—for the issue and renewal of licences; for salaries, pensions, engineering costs; for the detection of unlicensed listeners; for the diminution of electrical interference, etc.	1 0
2. The Treasury—the balance left after the Post Office and the B.B.C. have received their fixed proportions	3 5 ³ / ₄
3. Income Tax, paid to the Exchequer on the difference between the B.B.C.'s income and its revenue expenditure	5
4. Additional contribution to the Government's general revenue. To assist the national finances the B.B.C. agreed to relinquish to the Government an additional sum amounting, per licence, to	6 ¹ / ₄
TOTAL	5 5

THE B.B.C. RECEIVED FOR THE BROADCASTING SERVICE THE BALANCE	4 7
	10 0

THE INCOME AVAILABLE TO THE B.B.C. IN 1932, PER LICENCE, WAS:—

1. The B.B.C.'s share of licence income, as shown above	4 7
2. Additional income—mainly profits on the issue of publications ancillary to broadcasting—amounting, per licence, to	1 3
TOTAL	5 10

THIS TOTAL WAS EXPENDED ON THE SERVICE IN THE FOLLOWING PROPORTIONS:—

A. REVENUE EXPENDITURE—	
1. Programmes—including artists' fees, orchestras, news service, performing rights, simultaneous broadcast telephone system, programme staff salaries and expenses	2 6 ¹ / ₂
2. Engineering—including maintenance of plant, power, research, engineering staff salaries and expenses	11 ¹ / ₂
3. Standing Charges—including rents, rates, taxes, insurance, heating and lighting, upkeep of premises, telephones, bank interest, etc.	7 ¹ / ₄
4. Provision for depreciation and replacement of wireless plant, furniture and fittings, premises, etc.	4 ¹ / ₄
5. Administration—staff salaries, travelling expenses, etc.	3 ¹ / ₂
6. Pension Fund—B.B.C. payments to the contributory fund to provide for staff superannuation	1
7. Governors' Fees	¹ / ₄
	4 10 ¹ / ₂
B. PROVISION FOR CAPITAL EXPENDITURE	
The B.B.C. having no capital resources. All Capital Expenditure must be provided out of income.	
	11 ¹ / ₂
TOTAL	5 10

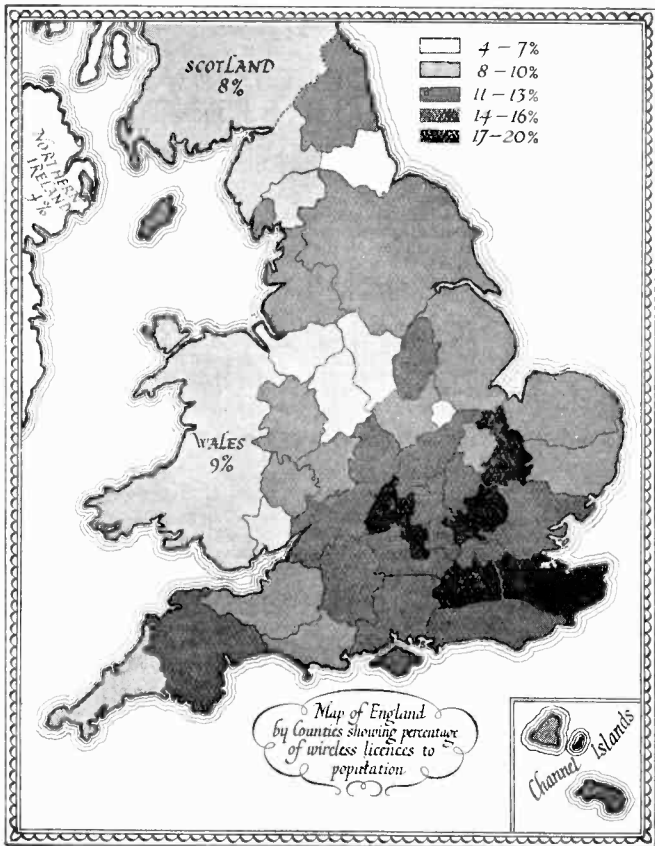

PERCENTAGES OF LICENCES TO POPULATION AS
AT AUGUST 31ST, 1933

	Licences.	Population.	%.
Bedfordshire	35,423	220,474	16
Berkshire	51,577	331,334	16
Buckinghamshire	38,653	271,565	14
Cambridgeshire	36,596	217,709	17
Cheshire	90,927	1,087,544	8
Cornwall	29,341	317,951	9
Cumberland	22,799	262,897	9
Derbyshire	64,491	757,332	9
Devonshire	102,784	732,869	14
Dorset	25,489	239,347	11
Durham	81,169	1,485,978	5
Essex	272,428	1,755,240	15
Gloucestershire	108,237	785,656	14
Hampshire	159,394	1,102,515	14
Herefordshire	13,517	111,755	12
Hertfordshire	82,041	401,159	20
Huntingdonshire	6,751	56,204	12
Kent	208,410	1,218,565	17
Lancashire	671,892	5,039,097	13
Leicestershire	72,422	541,794	13
Lincolnshire	78,931	624,553	13
Middlesex	246,098	1,638,521	15
Monmouthshire	38,461	434,821	9
Norfolk	60,341	504,846	12
Northamptonshire	57,747	361,273	16
Northumberland	87,895	756,723	12
Nottinghamshire	103,506	712,681	15
Oxfordshire	34,873	209,599	17
Rutland	1,479	17,397	9
Shropshire	29,124	244,162	12
Somerset	53,942	475,120	11
Staffordshire	128,271	1,431,175	9
Suffolk	45,996	401,114	11
Surrey	208,941	1,180,810	17
Sussex	112,653	770,078	15
Warwickshire	229,469	1,534,782	15
Westmorland	5,469	65,398	8
Wiltshire	42,602	303,258	14
Worcestershire	55,442	420,156	13
Yorkshire	569,620	4,389,465	13
London County Area	624,539	4,396,821	14
	4,989,640	37,789,738	13
Isle of Man	5,945	49,338	12
Channel Islands	10,992	93,061	12

SCOTLAND, N. IRELAND, AND WALES

	Licences.	Population.	%.
Aberdeen and Kincardine	28,234	340,294	8
Argyllshire	4,039	63,014	6
Ayrshire	23,124	285,182	8
Banffshire	2,514	54,835	5
Berwickshire	769	26,601	3
Bute	1,263	18,822	7
Caithness	1,049	25,656	4
Clackmannan	2,184	31,947	7
Dumbartonshire	4,603	147,751	3
Dumfriesshire	5,825	81,060	7
Edinburgh	60,987	526,277	12
Fife and Kinross	24,176	283,715	9
Forfarshire	24,136	270,190	9
Haddington	3,809	47,369	8
Inverness-shire	3,578	82,082	4
Kirkcudbright	1,750	30,341	6
Lanarkshire and Glasgow	132,276	1,585,968	8
Linlithgow	3,450	81,426	4
Morayshire	2,876	49,099	6
Orkney	930	22,075	4
Peebles	1,005	15,050	7
Perthshire	9,744	120,772	8
Renfrewshire	20,991	288,575	7
Ross and Cromarty	1,521	62,802	2
Roxburgh	3,604	45,787	8
Selkirk	3,657	22,608	16
Shetland	766	21,410	4
Stirlingshire	18,321	166,447	11
Sutherland	534	16,100	3
Wigtownshire	2,382	29,299	8
	394,097	4,842,554	8
Anglesey	1,562	49,025	3
Brecknockshire	1,706	57,771	3
Caernarvonshire	18,641	120,810	15
Cardiganshire	3,173	55,164	6
Carmarthenshire	13,794	179,063	8
Denbighshire	11,711	157,645	7
Flintshire	8,606	112,849	8
Glamorganshire	112,318	1,225,713	9
Merionethshire	2,428	43,198	6
Montgomeryshire	4,162	48,462	9
Pembrokeshire	6,196	87,179	7
Radnorshire	1,726	21,314	8
	186,023	2,158,193	9
Northern Ireland	50,809	1,256,561	4

“IN THE EYES OF THE LAW”

FROM A PRACTICAL point of view it is not very easy to discuss broadcasting in relation to the law, as with the exception of copyright (some problems of which are dealt with elsewhere) there are few cases in English Law to guide.

Broadcasting may be considered in so far as it affects *property* and in so far as it affects *personal relations*.

Under the first heading come such matters as electrical interference, overhead wires and aerials, nuisance on account of sound, and the obligations of electricity supply corporations to the owners of all-mains receiving sets, and under the second heading, libel and slander.

Electrical interference with reception caused by X-ray equipment, tramways, dynamos and other electrical apparatus falls to be considered in the light of the famous rule laid down by Lord Blackburn in the case of *Ryland v. Fletcher*, 1868, L.R. 3 H.L. 330, as follows: “We think that the true rule of law is, that the person who for his own purposes brings on his land and keeps there anything likely to do mischief, and it escapes, must keep it at his peril, and if he does not do so, is *prima facie* answerable for all the damage which is the natural consequence of its escape.”

This rule was held to apply to the escape of an electric current from the land of the party creating it in the case of *National Telephone Co. v. Baker*, 1893, 2 Ch. 186.

The second point of aerials and overhead wires can be dismissed quite briefly with the statement that the owner of the soil is, generally speaking, entitled to control the air space above to a reasonable extent. Although in recent years there has been considerable discussion in regard to this principle—which affects aircraft as well as radio communication—it has nowhere been definitely rejected, and it may therefore be regarded, until further notice, as valid in our own country. Thus the permission of the local authorities should be obtained where it is desired to stretch wires across highways and other passage-ways and the permission of the freeholder should be asked in the case of private property. A landlord and tenant are, of course, free to make any bargain they please with regard to wires, but it is suggested that repressive measures

against reception by a landlord are contrary to public policy. (A leaflet setting forth this law in more detail was prepared some years ago, and is available on application to the B.B.C.)

The third case to be considered is that of nuisance on account of sound from loudspeakers. The amount of sound from a loudspeaker would require to be both considerable and continuous to support a High Court action for injunction. The most satisfactory method of securing control of loudspeakers is by local by-law, provided the by-law is drafted in reasonably broad lines. There are now by-laws of this kind on many districts.

Finally, under the heading of property the rights of the owners of all-mains receiving sets require to be considered. In the recent case of *Lakeman v. The Corporation of Chester*, reported in *The Times* of 3rd March, 1933, page 4, it was decided that the owner of a plant for charging batteries was entitled to have his apparatus altered or replaced as a consequence of a change-over by a local electricity authority from direct to alternating current. It is to be noted that in this case the apparatus involved was installed before there could be any knowledge on the part of its owner that a change-over in the supply of current was contemplated. There is no case on record where a wireless receiving set has been the apparatus involved, but the decision quoted above would appear to have a bearing on such a case.

Such, in briefest summary, is the law concerning broadcasting in its relation to things. It remains to discuss it in one aspect in which it affects persons.

Happily, the microphone is so prudently administered in most countries that occasions on which it has been made the vehicle for personal attack have arisen very rarely, and there is little positive law, either statutory or "judge-made," on the subject. It is, however, somewhat interesting to consider whether the cause of action is of the nature of libel or of slander.

Defamation by wireless broadcasting is oral between a person speaking into the microphone and the listener and so constitutes slander and not libel. But if the announcer or speaker who is broadcasting reads from a written defamatory statement there would be elements of both slander and libel; the utterance of slander and the publication of a libel.

BROADCASTING COPYRIGHT PROBLEMS

IT IS BY NOW a commonplace that broadcasting has created new problems of copyright. Its advent was taken into account in the International Convention of Berne as revised at Rome in 1927, and a number of European countries have subjected, or are subjecting, their copyright laws to drastic revision in order to provide for the vast development that has taken place in broadcasting and recording. In this country, however, the legislation on the subject is twenty-two years old; that is, it was unfortunate in its date. It was the "last word" in adaptation of law to the old condition of things, but given on the verge of a revolution. And yet even that revolution did not make, and has not made it so absolute as to be quite unmanageable, and it is the boast of English jurisprudence that new legislation is the last, and not the first, method to be chosen in coping with new problems.

Hence the Act of 1911 has held the field, though in the face of increasing difficulties. Actually, however, it is perfectly possible, for instance, that the literal application of the Act would result in injustice to the copyright owner himself, particularly where electrical recording solely for broadcasting, talks and running commentaries are concerned. Needless to say, such a state of affairs is contrary to the principles of all copyright legislation, of which the very object is to protect the copyright owner in so far as they do not conflict with the interests of the community. There is therefore urgent need for a modernised Act to meet the contingencies arising as a result of broadcasting and the development of the entertainment industries generally.

As an example of a possible ill effect of the present law we may take the case of electrical recording for broadcast programme purposes. Here, the owner of the copyright in a musical work is immediately faced with a difficult problem if the work for which recording permission is asked has never previously been recorded. According to the Copyright Act, once a permission has been given for the making of a contrivance by means of which a musical work can be mechanically performed, there is nothing to prevent further recording of the

same work by others provided the statutory royalty is paid. The probable object of this was to prevent unfair monopoly in the record manufacturing trade, but it would also seem to have the effect of releasing a musical work which was electrically recorded *for broadcasting only* to the gramophone trade for ordinary commercial distribution. Naturally in such circumstances the copyright owner hesitates to give the initial permission if he does not wish the work to appear on gramophone records, even though he may have no desire to prevent broadcasting by means of a recording process, knowing, as he does, that such recording is frequently a convenient and sometimes the only possible method of doing so. A definite legal decision on this matter has not yet been sought.

On the other hand, it is interesting to note that it was found possible to apply the Act without difficulty to public loudspeaker "rediffusion," as in the recent case of the Performing Right Society, Ltd., *v.* Hammond's Bradford Brewery Co., Ltd. This was a test action of considerable importance, resulting in the decision that copyright material made audible by means of a loudspeaker operated in a public place is protected to the same extent as its public performance by ordinary physical means or by means of gramophone records, in that such performance may not take place without the licence of the owner of the copyright. The defendants' contention to the effect that their apparatus was merely a device for magnifying distant sounds, the production of which was already authorised by the licence to broadcast the Performing Right Society's repertoire held by the B.B.C., was not upheld, the learned Judge ruling that the sounds from the apparatus definitely constituted a reproduction which was under the direct control of the proprietors of the apparatus. This decision clarified a hitherto obscure situation, and those who operate loudspeakers in public places are now in the position of having to make their own arrangements for the rediffusion of copyright material as they would if they were themselves employing artists and bands.

It is possible that the wireless exchange may, in certain quarters, be regarded as a form of rediffusion, but having regard to the fact that it is merely a facility for private reception it would appear that the various licences held by the B.B.C. for the use of copyright matter are adequate.

An analogous problem which is arising for the B.B.C. and broadcasting organisations generally is that of the reproduction of artists' performances in connection with recording for programme purposes. An artist can have no copyright or right of property in his performances, but by virtue of the Dramatic and Musical Performers Protection Act, 1925, he has a summary (*i.e.* police-court) remedy if records of them are made without his written consent, and he is thus, and rightly so, in a position to make terms for that consent. This, of course, applies also to bodies of artists such as orchestras, and negotiations with a view to arriving at fair and mutually satisfactory rates of remuneration for the use made of recorded performances have been difficult and involved.

That there will be further copyright and other similar problems to be dealt with there is not the slightest doubt. Television alone should account for some. But at the moment there seems little hope of assistance from a new Statute.

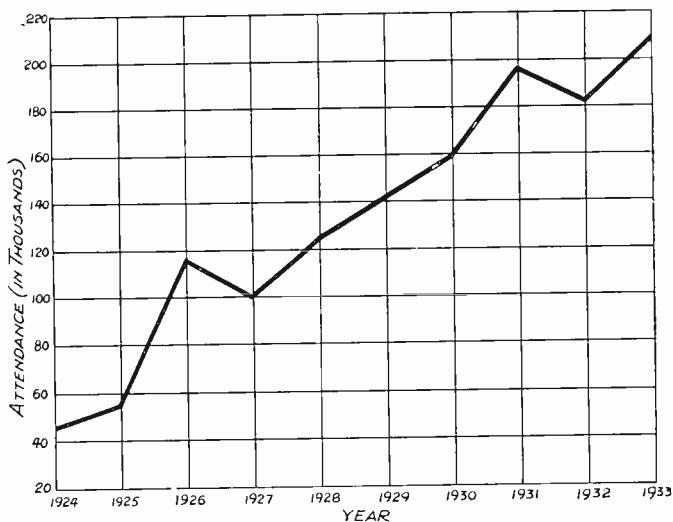

THE GROWTH OF THE ATTENDANCE AT THE NATIONAL RADIO EXHIBITION AT OLYMPIA



THE RADIO EXHIBITION AT OLYMPIA, 1933

EXHIBITIONS

IN THE ORDINARY COURSE of events the B.B.C. to most people is the organisation behind the sound that emanates from their loudspeakers ; something that cannot be approached, only switched off. It is on this account that exhibitions afford a common meeting ground, and the B.B.C. welcomes these occasions, when personal contact with listeners is possible. Much useful information is obtained by these conversations, and many of the difficulties experienced by listeners are capable of explanation.

The first time that the B.B.C. took part in an exhibition was in 1923, when the N.A.R.M.A.T. (National Association of Radio Manufacturers and Traders) organised their first independent Exhibition, which was held at the White City in London.

In 1927 an Exhibition Section was formed, and the activities were greatly increased. Exhibits were arranged at the Manchester and Scottish Wireless Exhibitions, as well as at a number of Ideal Homes Exhibitions throughout the country, and it was found that great interest was always taken in the B.B.C. stand. The main object of an exhibition is to put before the public in an interesting manner some of the many activities that go on daily behind the scenes, and of which the general public has very little knowledge. There is considerable mystery still attached to the business of broadcasting, and this is all to the good ; there is also a general tendency for listeners to try to probe these mysteries, and it is through the B.B.C. exhibits that it is possible to let in light on some of the inner mechanisms of broadcasting. In fact, exhibitions might be termed the shop-window of the B.B.C., where each year some different aspect of broadcasting is set out.

Experience has proved that the public likes to be able to see an artist performing before the microphone—the eight months' waiting list of visitors to our studio variety broadcasts is a proof. This year, to help listeners in this respect, the B.B.C., in co-operation with the Radio Manufacturers' Association, arranged for broadcasting actually to take place in public. This was achieved by the erection of a huge theatre at Olympia, capable of seating 2,300 people. A special stage was necessary, as minute attention had to be devoted to the material used, both

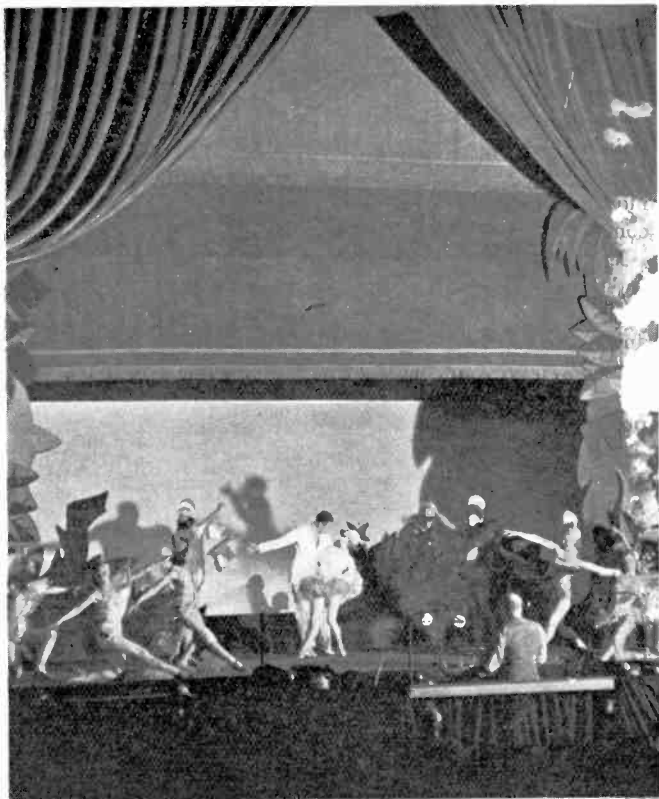

A SCENE FROM THE B.B.C. REVUE "NINE DAYS' WONDER" IN THE
THEATRE AT RADIOLYMPIA

for the structure and the decoration, in order that the right acoustic properties could be achieved. This would be of minor importance if the microphone had not to be considered, but as the performances were broadcast, the question of acoustics was vital. Two shows were staged daily, one a revue and the other a variety performance. By this means, approximately 40,000 visitors had the opportunity of seeing how a broadcast programme is performed—and were able to see the different technique that is required when playing to the microphone, as compared with an ordinary theatre performance.

Earlier in the year the B.B.C. was represented at the British Industries Fair and the Advertising and Marketing Exhibition. At the former the exhibit dealt with the new Empire Service, and useful contacts were established with overseas visitors, who showed the keenest interest in the new Service. In the latter exhibition, the exhibit was devoted entirely to B.B.C. publications, the exhibits aiming at attracting the advertiser.

Let us now turn to the provinces. This year is the first occasion on which the R.M.A. has organised an Exhibition in Scotland. A week after the close of Olympia, the Scottish Radio Exhibition opened at the Kelvin Hall; this was followed ten days later by the Northern National Radio Exhibition at Manchester.

The B.B.C. also took an active part in the Belfast Radio Exhibition, which was organised by the Ulster Wireless Traders' Association, the Bristol Radio Week, and the Scottish National Radio Exhibition, which for the last three years had been held in Edinburgh.

In addition to these general exhibitions, the B.B.C. was represented at the various conferences and meetings in connection with Schools and Adult Education, and considerable interest was taken in the B.B.C. stand at the Bath and West Agricultural Show, in which the Corporation participated with the object of establishing closer contact with the farming community. An exhibit was also arranged at the Midland Educational Conversazione in Birmingham.

It will be seen from the aforementioned exhibitions that each Region is represented and contacts established, and it is to be hoped as time goes on that each Region will have several exhibitions, so that even closer relations with listeners can be maintained.



"THE RADIO TIMES BEING PRINTED AT THE WORKS OF MESSRS.
NEWNES AND PEARSON

TEN YEARS OF "THE RADIO TIMES"

IN FEBRUARY 1923 the daily newspapers began a boycott of the B.B.C. programmes, which they had been in the habit of printing in much the same way as at present. The boycott lasted for one day; but the effect of it still remains:—*The Radio Times*, which celebrated its tenth birthday in a special number issued on September 29th 1933. The circulation of that issue (No. 522) was approximately 2,000,000 copies; that of No. 6, the earliest for which figures are recorded, was 226,114. The first agreement with George Newnes Ltd., the B.B.C.'s partners in the venture, guaranteed the B.B.C. an annual profit of £1,000, an expression of faith to which no other publishers at the time would commit themselves; in the current Revenue Account, printed in the Appendix, the figure of Net Revenue from Publications stands at approximately £322,000.

These are the bare statistics of one of the most surprising achievements of modern journalism; not surprising in retrospect perhaps, but an achievement which was more rapid and complete than anyone anticipated in the early days, even after broadcasting itself had emerged from the mechanical toy stage and proved itself to be one of the practical necessities of life.

For its first two years *The Radio Times* was under the joint editorial control of the B.B.C. and George Newnes Ltd. Mr. Leonard Crocombe, the Editor of *Tit-Bits*, acted for the latter, and was virtually the Editor, as the B.B.C.'s contribution was usually confined to the details of the programmes and a weekly front page article dealing with policy and programme matters. Even now the sight of the old front page, with its perspective map and aerials and the "What's in the Air" article with the writer's face inset like a postage stamp, has power to conjure up the days of "Will Tommy Jones look under the sideboard" or "Will residents in Acacia Avenue, Brixton, look to their sets, as they are causing severe interference to their neighbours."

In January 1926 the B.B.C. assumed full control, and the late Walter Fuller, who had come to the B.B.C. from *The Saturday Westminster*, became first Editor of *The Radio Times*. The typography and arrangement were improved, and in September the programmes appeared with notes and illustrations in a

dignified and clear three-column lay-out, which has never been bettered to this day. The Christmas number of that year, abandoning the "kiddies round the loudspeaker" tradition, appeared on the bookstalls in a modern cover, a virile design in bold colours by the great poster artist, E. McKnight Kauffer. Another landmark of this period was the Beethoven Centenary Number of March 18th, 1927, which, besides being a magnificent piece of journalism, was also the first occasion on which the printing of *The Radio Times* reached a million copies.

The second million was reached, in the Christmas number of 1931, under another Editor; for Walter Fuller died suddenly in September 1927, just a year after his reform of the programme pages, leaving an improvement in the general editorial contents to be carried out by his immediate successor, the present Variety Director of the B.B.C. The new Editor gradually improved the literary standard of the paper and in particular added a lightness of touch and a vivacity of writing and editing which helped to establish the paper as a popular favourite on its own merits. A feature which perhaps contributed to this result more than any other, was the weekly gossip of "The Broadcasters" which appeared under the heading of "Both Sides of the Microphone" and was written, mainly by the Editor himself, in a light and often frivolous vein. Every week of the five years of its publication Arthur Watts has contributed the now familiar humorous black-and-white drawings.

A problem that has always faced the staff of *The Radio Times* has been that of the design of the cover. The original design has already been mentioned. It was soon seen to be undignified and unsatisfactory artistically, and after several attempts at having it redrawn an effort was made, in the spring of 1928, to secure a better one by means of a public competition with a £50 prize. The competition was a popular success—there were over 5,000 entries—but it failed to produce anything permanently acceptable. Six well-known artists were then commissioned to try their hands, the size and shape being limited to the top third of the page and the inclusion of the B.B.C.'s coat of arms being obligatory. The result of this was the present formalised design by Karl Hagedorn, which has now been in use for five years without finding anything to displace it; and in fact when coupled with a striking photograph, as is the usual practice, it

makes an extremely effective cover. Experiments have been made continually with full-page designs for special numbers, but none of them so far have been able to show those qualities of simplicity and appropriateness which enable a design to stand the strain of being looked at week after week without appearing to "date" or lose interest.

The last three years have been a period of consolidation, in which development has mainly been confined to circulation and revenue, the necessity for the latter, to provide capital for building the new Regional transmitters, resulting in a steady increase of advertisements in the programme pages. The size of the paper has increased continuously, the largest ordinary issue so far published being one of 96 pages, that of November 11th, 1932. Messrs. Newnes and Pearson, the subsidiary printing firm of George Newnes Ltd., still carry out the printing of the paper, on huge rotary presses installed specially for *The Radio Times*. These are capable of printing, folding, and stitching a paper of 96 pages at the rate of six copies a second or 360 a minute. A little calculation on these lines will show why, in spite of this high rate of speed, *The Radio Times* takes a whole week in printing, a fact which accounts for the occasional omissions and inaccuracies in its programmes, which are mainly due to the changes and disappointments that are so apt to occur in the last few days before the performance.

There is not perhaps very much to be learned from an examination of the circulation figures for the past ten years or from a comparison of them with the licence figures. At the end of the first fifteen months of *The Radio Times* its circulation was about 800,000. In 1925-6 the circulation was almost stationary, the increase being not more than 50,000. Licences meanwhile had been going ahead at the rate of half-a-million a year. In the next three years there was a relative slump in licences, and the increases only averaged a quarter of a million, but the circulation of *The Radio Times* picked up and was only slightly under the 200,000 a year average for the six years 1927-32. In 1930 the licence increases went back to the half-million and in 1931 and 1932 almost doubled the previous best by averaging over 900,000, an increase which was in some respects the result of an intensive campaign against "pirates." This tremendous rise of licences was, however, scarcely reflected in the circulation

figures except in 1931, when the annual increase was 50 per cent. above the average.

Speculation is perhaps permissible as to the title of *The Radio Times*. How did it come about that in a country which has always talked of "wireless" and "broadcasting" and has never taken kindly to the foreign word "radio," that the British Broadcasting Company adopted the name *Radio Times* and as a corollary *World-Radio*? Suppose that from the beginning it had been called "The B.B.C. Programme," what would have been the effect? How many listeners do not realise that *The Radio Times* is the B.B.C.'s official programme?

Important improvements are being introduced during 1934. The programme pages are being cleared of advertisements, the two editions are being re-incorporated in one to enable all listeners to have the programmes of all regions. There will be new editorial features of widened interest, justifying the position of *The Radio Times* as an almost indispensable national magazine.

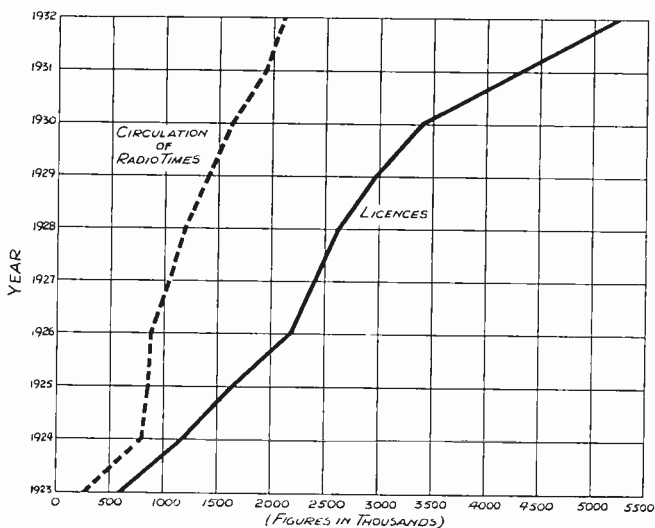

A COMPARISON OF FIGURES OF LICENCES AND OF THE CIRCULATION OF "THE RADIO TIMES"

HOW BROADCASTING HOUSE IS RUN

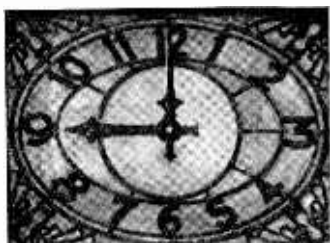

ENOUGH HAS BEEN written on Broadcasting House for it to be realised that the house itself is essentially functional, not only from a purely mechanical aspect, but from the point of view of the human element by which it is ensured that

the mechanism carries out its allotted task.

It might be thought that, apart from the actual transmissions or performances in the studios themselves, there is little about Broadcasting House to distinguish it from the thousands of other large offices in London or the Provinces. There are, however, very many differences, and while it is essentially the preparation and presentation of programmes which account for these, the organisation both of personnel and studios provides work which is in marked contrast to the normal business routine. For example, individual programmes and programmes as a whole are built on a co-ordinate design, or may be dependent upon some personality, and it can easily happen that some unexpected defection causes an unavoidable change of plan—an artist may fall sick or a musical work be not available; this will in many cases necessitate a complete revision of many days' arrangements in order to maintain the sequence and balance of the altered programme in relation to those preceding, following, or providing alternatives to it. It is also vitally essential that every cog in the intricate organisation should not only intermesh with its complementary cog, but that each and all of them should work almost to a time schedule of seconds. The organisation must therefore be sufficiently rigid to ensure punctuality in the transmissions, but at the same time be elastic enough to enable the temperamentally minded to give their best work without being irritated by too many regulations.

Let us consider the formation of a broadcast programme through its various stages from conception to performance, together with the ancillary services which those primarily con-



ONE OF THE DETAILS

cerned must needs either call upon, or with which liaison must be effected. The booking of artists is by no means necessarily the first step. An earlier stage is the casting of the programme, the requisitioning—either from the Corporation's own libraries or by hire—of the music or play as the case may be, and the settlement of any copyright questions which may be involved. Here naturally the Library, Booking, and Copyright Sections are brought in, while simultaneously the Programme Routine Section must be given the fullest possible details of the programme, in order that Regions may be advised what material is available for them to take S.B., and so that their own programmes may be suitably formed to provide good alternatives to the National transmitters. (The Regions, on the other hand, notify Head Office what material of National interest they have available for the London programmes.) The programmes are at this stage many weeks ahead of actual performance, and it is the function of the Programme Routine Section also to feed the *Radio Times* with all its programme pages. This means not only the careful checking of all details such as titles, composers' names, speakers' degrees and qualifications, etc., but also the constant advising of all who may be affected of corrigenda and addenda to programmes. The advent of Empire Broadcasting has of course meant a duplication of these services for Empire programmes, and in this case the Empire Edition of *World-Radio* has similarly to be served with its programme pages at the appropriate period in relation to the date of publi-



THE DAILY MORNING SERVICE IN THE RELIGIOUS STUDIO

cation of the various issues in time for the information to be available in the Zones themselves.

It will be appreciated that some differences between the programme actually performed and those published in the *Radio Times* or *World-Radio* are inevitable owing to the aforementioned unexpected changes, but it is vitally essential, not only for the publicity issued to the daily press to be up-to-date, but also for the actual programme which the Announcer uses at the microphone to contain every alteration or addition.

The system of simultaneous broadcasts moreover necessitates absolute accuracy at the time of performance, as the Engineering Branch, which is responsible for the provision of the inter-connecting lines, must be provided with a chart showing in every detail whither and whence every programme is to go and the route which it has to take.

All these are purely routine functions, which are carried out in regard to all programmes of whatever type, and, broadly speaking, do not vary in their nature; they may, in fact, be looked upon as the framework of the actual programme organisation.

Now a little more detail as to the preparation and performance of the programmes themselves. The various departments having been informed which periods of the day's programme they are being asked to fill, the artists, actors or speakers having been booked and their material obtained, it is necessary to arrange for rehearsals. It is probably common knowledge that Broadcasting House has twenty-two studios, and it is equally probable that the question is asked, Why are so many needed for putting out two programmes? In the first place, it is a fallacy to think in terms of two simultaneously transmitted programmes only, since it is quite possible that in transmissions alone Broadcasting House might be doing its own National and Regional programmes at the same time as an Empire transmission, as well as contributing individual items to Regional programmes. There are, however, far more hours spent in rehearsals than in transmissions, and it is a matter of considerable adjustment and mutual give and take between those needing studio accommodation before all can be fitted in. Not only the question of the actual studios has to be considered at this juncture, but also the type of microphone which is necessary for the

particular programme, whether or not echo is to be used for all or part of the transmission, and such details as what equipment is needed by the performers. Under this latter heading come such items as instruments for bands and orchestras, music stands, the conductor's rostrum or, in fact, any studio furniture of a temporary or removable nature. When, for instance, a military band is rehearsing in a studio on the eighth floor, all its instruments have to be taken from the band-instrument room in the basement, set out in the studio, and returned into safe custody afterwards; at the same time a section of the main orchestra may be playing in "No. 10" studio by Waterloo Bridge—with similar transport implications. The average listener possibly does not realise the extreme delicacy of musical instruments and the fact that only experts can be employed in handling them. Even so, damage is apt to occur, and it is essential for the Corporation to cover such contingencies by insurance, lest its employees should be responsible. In this connection an interesting point arose at No. 10 studio when it was first adapted. This building was originally a wine store, and as such was specially constructed to avoid possible deterioration of the wine through damp. This was in many ways very desirable, but it was only after a band-instrument room had been made, and used, there that it was discovered that the dryness of the atmosphere caused wooden instruments, double basses and such like, to crack. This was, of course, most serious, but the bother was eventually overcome by the construction of a series of trays containing water round the walls of the instrument-room, which provided the requisite humidity.

But to return to programmes, there are not only musical transmissions to be rehearsed; speakers, the Children's Hour, plays and variety, all and sundry, must be perfected before the final presentation. Plays, for example, need their effects, which in their turn call for the studio and staff allocated specially for producing "noises off," whilst the Dramatic Control Panel has to be manned either by the producer himself or a member of the Balance and Control staff. These activities need also the collaboration of the Engineering Branch in the form of the connecting mechanism of the Control Room—the technical nerve-centre of broadcasting.

Alongside these preparations for actual programmes there

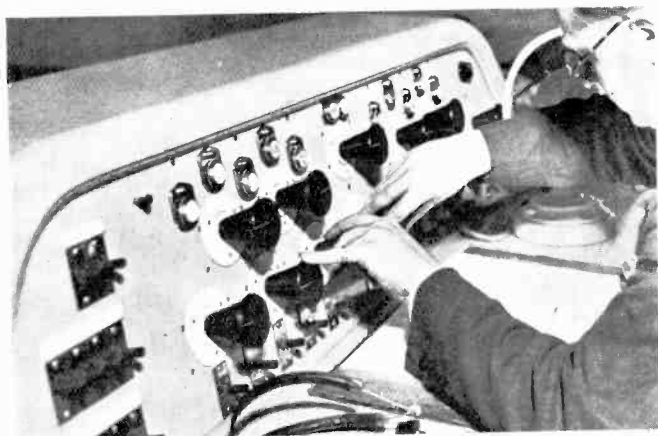

THE DRAMATIC CONTROL PANEL

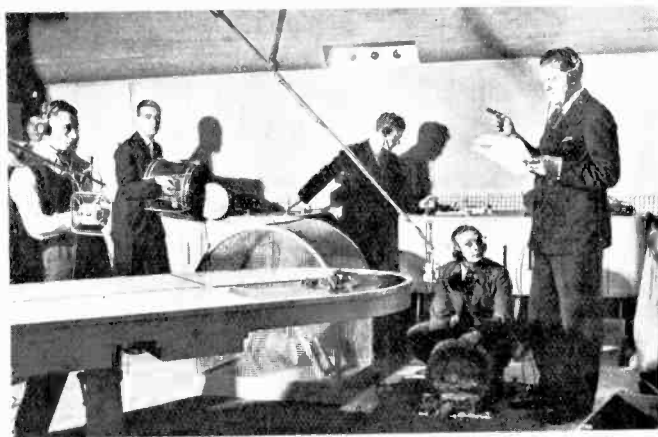

IN THE EFFECTS STUDIO

are a certain number of auditions of new talent to be held, for although at the present time there is an excess of "straight" musical artists, the Dramatic and Variety Departments, the Children's Hour and the Talks Branch are always on the look-out for new material with which to vary their fare. Thus there are the three stages of audition, rehearsal, and transmission all proceeding (though of course in relation to different programmes) simultaneously and continuously. Nor is this all that attaches to the finished article—all programmes over a given period must come within a scheduled financial budget, and it is the business of the Programme Finance Section to watch this and to keep a fatherly eye both on expenditure and—in conjunction with the respective booking sections—on the terms of the contracts themselves.

There are many opportunities for the B.B.C. to come into contact with matters legal, not only defensively on the few occasions when, perhaps, a speaker may inadvertently give offence to some vested interest, but more often to guard the rights and privileges of the Corporation against broken contracts, infringements of copyright, and such-like happenings. For this purpose, as well as for other administrative necessities (leases, agreements, etc.), there exists a legal department which must be kept in close touch with all activities which involve contractual relations with outside bodies or persons.

Finally, the broadcast itself has to put a fitting crown on all the weeks of preparation which have gone before. From the Commissionaire on the door, the Receptionist in the hall, the Lift Attendant and finally up to the Announcer at the microphone, the artist must be conveyed easily and comfortably in order that the best result may be obtained.

As to programmes, then, the following chart gives them in skeleton form, in order to show briefly the sequence of programme construction and the departments closely affected.

This naturally only visualises programmes in the form of a generalisation, and ignores such entertainments as Outside Broadcasts, Foreign Relays, News, or the hundred and one varieties of music and speech which are capable of being broadcast.

Foreign relays may take the form of an ordinary Outside Broadcast, a relay of some foreign programme, or a special

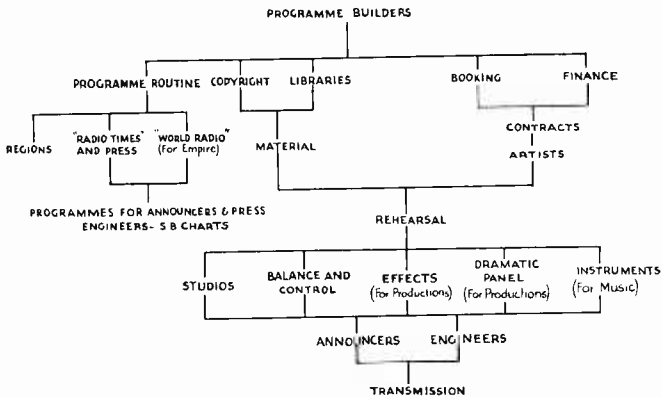

broadcast from the studio of some overseas broadcasting organisation which is not broadcast by that organisation (some of Mr. Vernon Bartlett's talks from foreign capitals are instances of the last type; see also 1933 Year-Book, pp. 139-142).

The last kind of relay quite naturally gives rise from time to time to reciprocal facilities being asked for in this country for representatives of foreign stations. This is relatively simple where time differences between this country and the places of broadcast are not great, but with America, for example, it may mean special arrangements being made as to staff, etc., in the small hours of the morning. This, however, does not call for so much extra organisation since the regular Empire service started as when midnight or thereabouts really was the B.B.C.'s "Goodnight."

More mundane matters need the attention of the broadcasting staff, and such commonplace factors as food, and even sleep, have to be catered for within the walls of Broadcasting House. As has been said, rehearsals of many programmes are taking place daily, and every session must be broken at some given time for a "breather." In the basement at the broadcasting headquarters there is a restaurant which must be capable of providing meals or light refreshments throughout the twenty-four hours of each day, since a fifteen-minute interval does not afford time to the artists to go outside for a coffee. Contrary to rumours which have been current from time to

time, the building is not licensed for the sale of alcoholic beverages, but this does not affect the patronage of the restaurant. Should the B.B.C. chorus and a large section of the orchestra be at rehearsal on the same day, as many as three hundred persons may want food within a short space of time, and it may be taken for granted that producers and conductors will brook no untoward delays.

The Empire transmissions run into most of the early morning hours—and the staff on night shift must be fed at the normal mealtime intervals as though it were day. Furthermore, it is not possible for one Announcer to cover the late evening and early morning programmes (finishing with the Canadian Zone at 3 a.m.), and also to take the Australasian Zone transmission, which begins at certain times of the year at 5.30 a.m. Neither is it economically practicable to expect these members of the staff to live either on top of the building or permanently in a near-by hotel. As a result, arrangements must be made whereby one Announcer may go to bed at 3 a.m. and be able to get a reasonable period of sleep (which means that his quarters must be sufficiently quiet to enable him to sleep whilst the day-time staff arrive and work), whilst the man who starts announcing at 5.30 a.m. must have facilities for sleeping up to the time he has to prepare for his programme. Similarly the Control Room staff concerned must be present all night as well as those House Engineers who are responsible for services such as the ventilation plant, heating, lighting, lifts, etc.

Some little time ago the listening public was “scandalised” by a speaker being unable to give his talk owing to a missing manuscript. There was naturally no excuse for such a lapse, but it may be of interest to realise that the routine must be such that the manuscript is submitted in reasonable time for it to be read, altered if necessary, and returned to the speaker, and for copies to be made for the *Listener* and *World-Radio* (in case it is desired to publish), for the Announcer (in case the speaker forgets to bring his copy), for file purposes (in case the speaker takes away the copy he has used) and in many cases for re-reading later in the evening for an Empire Zone. This is all fairly plain sailing provided the original MS. comes in punctually—which it frequently does not—although last-minute alterations are apt to be troublesome, but there are



THE RESTAURANT

added complications when a topical talk is broadcast without a manuscript having been submitted or when a debate is extempore. The B.B.C. must be in a position to know definitely what has been said over the microphone, and where there is no manuscript a night stenographer (with reporter's speed of shorthand) must be present, who will not only provide a permanent record of the talk, but may have to get it typed in time for an Empire Zone the same night, or for sending to the printers the next morning if it happens to be press day for the journal concerned in the publication of it.

Some talks, or maybe composite programmes, are recorded either on wax or on magnetised steel tape for subsequent reproduction to the Empire Zones. This is an obvious convenience, since it enables the Empire listeners to benefit by items which could not be repeated several times for their especial benefit. The Blattner-Stille system, which uses steel tape, provides facilities for immediate replaying, while wax recording necessarily involves some delay between the actual performance and its reproduction. The Recorded Programmes Section of the B.B.C. handles the programme aspect of this work in liaison with the Engineers, who are responsible for the technical side. It is the Recorded Programmes Section also which provides—in response to requisition from the programme builders—the gramophone recitals which are such a popular feature of current programmes. This work may not be quite so simple as it appears on the surface, since not only must the gramophone programmes be constructed as artistic entities, but it is desirable in common equity to ensure that no one publisher, composer or record-making company obtains an unfair representation in them. There is also the routine work of obtaining from the manufacturers the records required, and, in the case of Regional recitals, their packing and despatch. The Corporation is building an extensive library of gramophone records, and the provision of records for all broadcast recitals is handled at Broadcasting House; the records being returned to the library after use. It is not usual to employ the same actual disc for transmission as has been used in rehearsal.

It is naturally most useful to the Corporation to know from listeners' letters how programmes are appreciated or disliked, and the Correspondence Sections provide tabulated details of

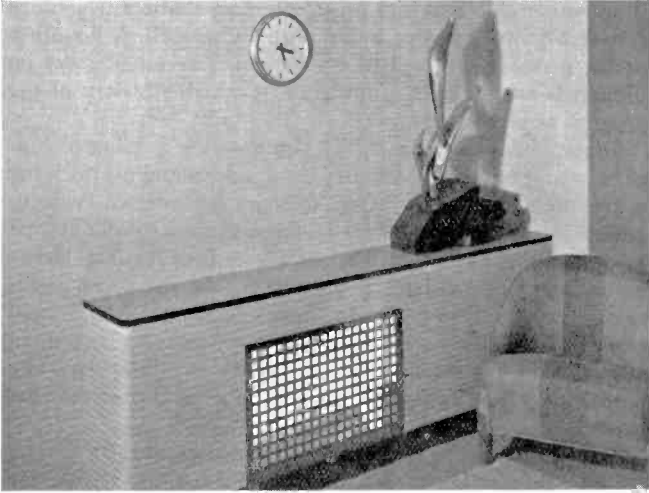

A CORNER OF ONE OF THE ARTISTS' LOUNGES



BROADCASTING IN THE VAUDEVILLE STUDIO

criticism or appreciation, as the case may be, besides answering the innumerable inquiries on programme matters which are received daily. For this latter purpose, as well as for other needs, a detailed record of every item transmitted must be prepared—which in itself forms an invaluable history of the progress of broadcasting.

Other activities of the B.B.C. comprise the holding of concerts, a part or all of which may be broadcast and to which the public are admitted, including, of course, the annual Promenade season at the Queen's Hall. These necessitate the normal box-office facilities, the ticket office at Broadcasting House being alongside the bookshop where B.B.C. and other publications may be obtained. The *Radio Times*, *World-Radio*, and other broadcasting journals must naturally carry their quota of advertisements to enable them to pay their way, and one of the busiest departments is that responsible for selling advertising space.

Television must be referred to in this survey of the activities within Broadcasting House, even if only because it calls for many requirements (other than technical) that ordinary broadcasting does not. To begin with, the studio itself is peculiar, in that the background for the artist is a white sheet, whilst the floor is designed in large black and white squares—like a chess board. Special lighting is also needed. Then, in view of the fact that television in its present state gives better results when the object is coloured black and white, artists' faces have to be made up with a dead white skin with the features marked out in black. Artificially blacked eyebrows are not perhaps uncommon to-day, but black lips have not yet become generally fashionable. Finally, the necessity for using two wavelengths—one for sound and one for vision—means that television must be given at times which do not interfere with the ordinary programmes; at present, then, these transmissions usually take place between 11 p.m. and midnight.

It is not possible to do more than mention many of these services which are so much part and parcel of the satisfactory conduct of a broadcasting organisation, but it may not be obvious to all listeners that such supplementary activities do exist, or that the home of British broadcasting does house so much that is not actual programme compilation or transmission.



IN THE LISTENING ROOM

One of these extraneous organisations has been created by the advent of Broadcasting House itself—namely, the handling of the thousands of applications from all and sundry for permission to see over the building. The B.B.C. is anxious to meet such requests from listeners as far as it is able, but it has been found quite impracticable to keep open house for all. In the first place, it is not possible for parties exceeding fifteen at a time to go round the building, since, for one reason, the guide's explanations would not be audible to a greater number; moreover, the congestion in passages, lifts and studios would become impossible. Furthermore it has been found from experience that considerable disturbance is caused to rehearsals by a procession of sightseers passing through studios, whilst, naturally, actual transmissions must exclude visitors from considerable parts of the building at all hours of the day. In consequence, only one tour a day (excluding Saturdays and Sundays, which are "closed" days) is all that can be handled, preference being given to those who have some definite contact with broadcasting, such as technical societies, persons in business relations with the B.B.C., visitors from Empire or foreign broadcasting staffs and so forth. It is regretted, then, that disappointment is caused to many hundreds of applicants each week, but is quite unavoidable.

The administrative machinery required to co-ordinate all the different and differing sides of the B.B.C.'s work must of necessity be comprehensive and exact in its action, since as has already been pointed out, the aim of all departments must be to focus results on a nearly inflexible time schedule, while working under conditions of fluctuating circumstances where the human element is inevitably preponderant. Many details have been covered in this or earlier issues of the Year-Book, and the object here has been to try to enable those interested to picture some of the pieces which go to form the composite structure of broadcast entertainment.

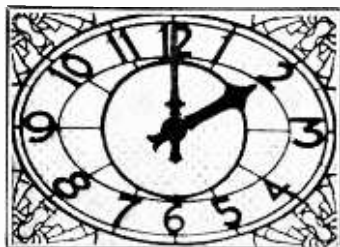

PROGRAMME SECTION

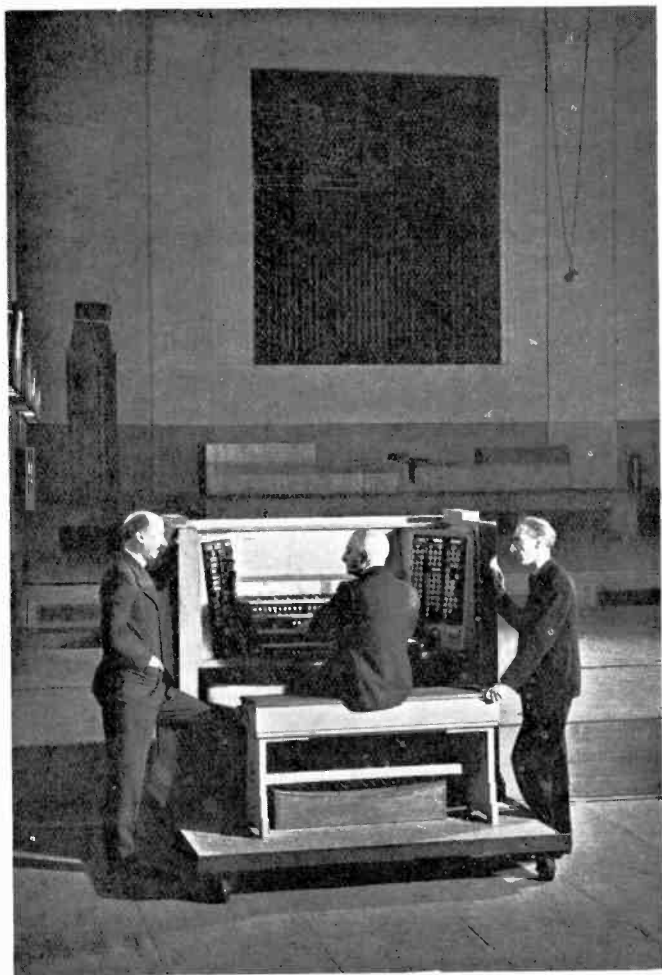

THE NEW ORGAN IN THE CONCERT HALL, BROADCASTING HOUSE, WAS
OFFICIALLY OPENED ON JUNE 16TH, 1933

*Sir Walter Alcock is seated at the Organ, with Dr. Adrian Boult (left) and
Mr. Berkeley Mason.*

NOTES OF THE YEAR

WITH THE REVIVAL of twelve representative broadcast plays during the last three months of 1933, what may be called the first phase of development of radio drama has come to an end. The over-emphasised, over-publicised special technique of presenting drama through the medium of the microphone has now become crystallised as far, at any rate, as its fundamentals are concerned. It now remains to concentrate attention rather on finding the plays. This problem is a very serious one. Firstly, because of the inability of any broadcasting organisation to enter into open economic competition with the theatre or the cinema for the services of the best-known dramatic authors, and secondly, owing to the necessary limitations of subject that must be preserved in the case of a national service presenting drama by every fireside. However, certain steps have already been taken towards finding a solution. The search for material is being extended, and there is considerable probability of obtaining good results from a further pooling of international resources, while it is perhaps not unreasonable to draw certain optimistic conclusions from the fact that during the past few months, certain recognised authors such as Miss E. M. Delafield and Lord Dunsany have written plays specially for the microphone, and others, who have not yet established themselves as writers for the stage proper, have gone a long way towards establishing themselves as writers in the specialised field of broadcasting.

* * *

A notable feature of the year's variety programmes has been the return of the Musical Play to broadcasting. In early days at Savoy Hill there were monthly broadcasts of musical comedy, but between 1928 and 1931 this form of entertainment almost disappeared from the programmes, largely owing to difficulties of copyright. Musical plays broadcast in 1933 include *Chu Chin Chow*, *No, No, Nanette*, *The Circus Princess* (first English performance of Kálmán's famous operetta), *The Pride of the Regiment*, *La Vie Parisienne*, *The Blue Boar* (*première* of Roger Quilter's first musical play), and *A Waltz Dream*. "Radio-operetta"—*i.e.* musical fare specially written to microphone requirements—was represented by *The Castle on the Hill* and a "revival" of *Good*

Night, Vienna. Unlike revue the musical play represents an almost ideal form of broadcasting entertainment; the linking story serves to frame the music and to hold the listener's interest (always the first object of the entertainment builder). Proven stage successes of the past, adapted for the studio, provide a fruitful field of material. There are signs, too, of a growing interest in "radio-operetta" among authors and composers.

* * *

New ground has been broken in the field of Burlesque. Satire and Burlesque should provide lively, topical material for Broadcasting, though, as a matter of fact, Satire has so far proved, "on the air" as in the theatre, a little too strong meat for British audiences. Burlesque had almost vanished from the theatre, and it has been left to broadcasting to restore the tradition. Three burlesques by the Melluish Brothers—*Only a Mill Girl*, *The King's Double* and *A Thief in the Night*—were broadcast during the year and welcomed as warmly as the same authors' *Beaten at the Post*.

* * *

Most of the operatic transmissions during the coming season will be relayed from outside theatres, chiefly the Old Vic and Sadler's Wells, and some of the principal continental opera houses. Additional opera from the studio will include *The Magic Flute*, directed by Bruno Walter, and, it is hoped, scenes from Glinka's opera *Khovantchina* in its original version, conducted by Nicolai Malko.

* * *

On 22nd August, 1932, the first television programme was transmitted from Broadcasting House. Singers sang in the position giving a head and shoulders image; dancers worked 20 feet further away, with consequent loss of detail, and were allowed lateral movement of 12 feet. Frontal approach was impossible. New ways of using photo cells enabled artists to be followed from "long shot" to "close up" and vice versa. As the programme technique developed so the field of talent was widened. Programme features included animals; various forms of dancing and Ballet; cyclist and roller skating acts, puppets, shadowgraphs and lightning cartoons. There were topical items such as the appearance of Mr. and Mrs. Mollison after returning from their Atlantic Flight. The Elizabethan



SERGE KOUSSEVITZKY
the guest conductor at the London Music Festival

Exhibition opened by Lord David Cecil was presented to "lookers" before its opening to the public in London, and Winter and Spring fashions were also included. Scenery was introduced first by means of sub-title cards in the first pantomime to be televised, "Dick Whittington," in December, 1932.

* * *

Many new forms of talks have been introduced in the last twelve months. Mr. Vernon Bartlett, for instance, used to talk on foreign affairs from the comparative security of a London studio; but during the last year he has spoken to English listeners from Berlin, Prague, Vienna, Budapest, Geneva, Milan and Warsaw, and at other times he has described his interviews with the "Strong Men of Europe"—Signor Mussolini, Herr Hitler, Dr. Dollfuss, etc. Others who have gone afield to observe and question on behalf of the microphone are Mr. Howard Marshall to our slums, Mr. S. P. B. Mais to America, Mr. Julian Huxley to our Research Stations, Professor Scott Watson to the countryside, and Professor Hilton to the towns. There has been another development of this new service by "special correspondents" in the five-minute topical talk which in turn has now been extended to the "News Reel."

* * *

In June of last year the Central Council for School Broadcasting (see page 87) was reconstituted. A year's work under the new Council has now been completed and with the term that began in September a certain amount of fresh ground is being covered.

The Council has organised a series of meetings and demonstrations of School Broadcasting in Training Colleges throughout the country, culminating last September in a week-end Conference held at Lady Margaret Hall, Oxford, with members of the Training College Association.

THE MAECENATE OF THE MICROPHONE

By C. HENRY WARREN

[Broadcasting not only in this country but in most others has, in the last ten years, acquired a peculiar position with respect to the Arts and the artist. Its public service character and its scale of operation naturally suggest the question of whether, and to what extent, the patronage of the Arts—in the old sense of patronage, which linked a Prince Esterhazy with a Haydn—have become incumbent upon it. The question is as interesting as it is, practically, complicated. and we have asked Mr. Warren to express his views on it. These views are, of course, personal, and do not necessarily represent those of the Corporation. EDITOR]

ART, when all is said, is a luxury. But it is a luxury which mankind would dispense with to its incalculable loss. Certainly we cannot live by bread alone.

Some years ago a weekly paper was launched which aimed at appealing primarily to the working classes. The editor was a well-known socialist: he was also a man keenly interested in the arts. He therefore devoted quite a considerable space in his paper, each week, to the publication of poems, stories and essays. (It says much for his foresight, by the way, that many writers who have since become famous had their first work printed in his pages.) He also included each week a woodcut—usually of modernist conception.

But it was all too good to last. One day his directors called him to task. Politely but firmly they demanded a change of policy in the paper. In effect this is what they said: "It's no use giving a starving man poems." Whereupon the editor replied: "Perhaps that is about all you can give him." But his directors were not convinced: being politicians, they did not realise that a man has a spirit to feed as well as a body. In due course, therefore, the editor resigned.

I mention these things because they seem to me pertinent to this question of patronage and the B.B.C. The B.B.C. is in much the same position (though of course on an incomparably vaster scale) as that editor. And listeners without number have voiced a similar complaint to that made by his directors. "Your job," they say, "is to provide us with amusement—just

that. We are going through a hard time: you should therefore do your best to amuse us, so that we may forget our miseries." But the B.B.C., like the editor, is adamant. Politely but firmly it replies: "Certainly we will do our very best to amuse you; but we shall not stop at that. We have a further responsibility towards you. We believe that it is our duty not merely to make you forget your miseries; for that, anyhow, is no real and lasting way out of them. We believe that we can also give you something which, in the end, may perhaps help you to rise clear of those miseries. We can give you great music, poetry, drama and prose."

So much, then, for the B.B.C.'s policy of including in its programmes a very considerable proportion of such of the high arts as are suitable to broadcasting. It is a policy which has brought much abuse upon the B.B.C.; but there was no denying the far-sighted wisdom of it, and in the end it was bound to triumph. But I suggest the B.B.C. might justifiably go a good deal further.

Let us consider the case, for instance, in regard to music. During the course of the year we are provided with an opportunity to hear practically all the major classical works, besides a representative selection of modern music. That, you may say, is as much as anybody ought to expect. But is it? It seems to me that the B.B.C. has a duty to music itself as well as to its millions of listeners. It enjoys the privilege of performing for our enjoyment the great music of composers long since dead: why should it not, in return, do something to foster the creation of music which may be enjoyed by others in the years to come? Most of the classical music which has now passed into the "common heritage" of the world was written by men who enjoyed (and suffered) the benefits of patronage. Such patronage—whatever the penalties it exacted in return—gave those men a certain immunity from the more mundane cares of this life. It had a further advantage in that it provided an often necessary goad to composition—for it is an outworn fallacy that genius thrives best in a garret or that it has only to whistle and divine music will come tumbling out of the skies. Sometimes that patronage, as in the case of Bach, was provided by the Church; sometimes, as in the case of Haydn, by a private person. But whoever provided it, provided thereby an incen-

tive quite denied to the composers of the present day. And who shall say what glorious music that denial has cost us?

Now the only possible patron I can envisage to-day in this country is the B.B.C. Certainly neither Church nor Court nor private person can now be looked to to patronise music in any worth-while way. This is a democratic age, and a democratic body must provide whatever patronage the arts are to expect. Obviously the State is out of the question, since as a patron it would be too remote and impersonal. There remains the B.B.C., which, as a possible patron, seems to me as nearly ideal as anything that can be hoped for: it has the wealth, it has the standards of good taste necessary in a wise patron, and it has the means for performing for the pleasure of all the music which its patronage makes possible. It may be argued, of course, that the B.B.C. already does its ample share by performing the best music of such living composers as manage to survive the uncongenial conditions under which they are compelled to work; but I maintain that that is not enough. It is admitted that we have in this country to-day a wealth of potential music such as has scarcely been equalled in our history. If that wealth is to be exploited to its highest possibilities, the composers who hold it in fee must be provided with such an immunity and such a goad as was provided for the great masters of the past; and therein, surely, lies the B.B.C.'s superb opportunity. I am not concerned here with how that opportunity should be put into practice nor with the obvious adverse criticism which such a practice would involve. That the B.B.C.'s standard of broadcast music is as high as it is is due to the courage and foresight with which it has framed and maintained its musical policy. Cannot that courage and foresight be extended in the direction I have indicated?

That, perhaps, is the most ideal aspect of this question of patronage and the B.B.C. There are, however, other aspects, less daring, perhaps, but not the less worthy of consideration. There is, for instance, the much-debated question of the B.B.C.'s patronage of those amateur musical festivals which, until the advent of broadcasting, provided such a valuable and practical stimulus to the maintenance of our national musical heritage. At the recent Conference of the British Federation of Musical Competition Festivals, it was apparently a matter for comment

that there was so little said by way of abuse of the B.B.C. Despite the pessimists, broadcasting has not killed the Musical Competition Festivals movement: what it has done is to kill a large number of those choral and orchestral societies which were in the habit of foisting (mainly very second-rate) performances upon the particular locality in which they thrived. But Dr. Adrian Boult effectively scotched all criticism here when he said: "If broadcasting has killed some choirs and orchestras, it is all to the good. It means that people will not be bothered to go to hear a poor performance by a choir or orchestra when they can hear a better performance by wireless. . . ." The B.B.C. did well, in fact, not to respond to the plea for a direct and substantial patronage of amateur music-making. The right kind of musical amateur will not be prevented by wireless from making music, and the wrong kind ought not to be encouraged. As for the broadcasting of local amateur effort, there is not the slightest excuse for multiplying a small, suffering audience into a vast one.

But music is not the only art included in this question. The past year has seen the advent into the broadcast programmes of a more or less regular poetry feature. This feature was, I believe, the direct outcome of an insistent demand on the part of listeners; and its popularity has proved once again the fact that the average level of intelligent and æsthetic appreciation is never as low as the majority of critics seem to suppose. Incidental to this feature was the inauguration of a competition whereby listeners were invited to send in original poems, the best of which would be selected for broadcasting. Eleven thousand poems were submitted, of which twenty-eight were considered good enough to broadcast. Leaving aside the question of the quality of those twenty-eight poems, the fact remains that here was a step in the right direction. I do not say that it was wise to throw open the competition to all and sundry, nor even that competitive methods are likely to bring to light the best hidden talent. But the gesture showed a most commendable willingness on the part of the B.B.C. to take a progressive action on behalf of modern poetry—an art which, even more than music, has suffered in these transitional times. Here again, however, I suggest that the B.B.C. might well go further. As a nation our poetical heritage is great, but never before in

history have our poets been so handicapped as they are to-day. Some, doubting even whether there is a place for poetry in modern life, have turned to the more remunerative medium of prose; others, sternly tenacious of their craft but forced into an increasing disregard for their audience, have made of poetry an expression so exclusively individualist that they have whittled their appreciators down to a mere handful of intellectuals. From this pitiable impasse the B.B.C. could well do something to save us: it would be a most laudable form of patronage.

There remain prose and the drama. It is obvious that in neither of these fields is there much scope for patronage on the part of the B.B.C. In prose, indeed, there is no need for any such gesture—even if it were a branch of literature more apposite to broadcasting. The prose-writers are well able to look after themselves: it is their hey-day. Writers of the novel, which at present is the peak-form of creative prose, were never more advantageously placed; whilst the writers of travel-books, biography, and even belles lettres, have nothing to complain of in a world of omnivorous readers. As for drama, clearly the B.B.C. is already doing all it possibly can do for the encouragement of that branch of the art peculiar to wireless, and I see no reason why it should be looked to for aid in the theatre.

Music and poetry, then, are the two fields of art in which the B.B.C. might most profitably bestow the benefits of patronage. If the B.B.C. does not, it is certain that no one else will—or can. Moreover, there would be something very fitting if the rôle should pass into such hands. Broadcasting is somewhat in the nature of a link between the old world and the new. Of its very nature, in fact, it seeks to combine the best of those two worlds. It is one of the greatest marvels of science, and it is one of the greatest distributors of the arts. It lives in the new world and fetches its life from the old. The most and best of the music it brings into our homes is drawn from the old world. Indeed, it is impossible to imagine programmes shorn of the names of those great composers to whom patronage was almost the breath of their being. Is it not decent and reasonable, therefore, that the B.B.C. should do something towards ensuring for future generations as noble an expression of our day as the music of those great masters was of theirs? It has the courage and it has the power.



THE BALLET-SCENE FROM PURCELL'S "DIDO AND ÆNEAS"

BROADCAST OPERA IN GERMANY

BY ERNST SCHOEN

(formerly Programme Manager
of Frankfurt Broadcasting Station)

“ONCE UPON A TIME”—these are the words I should like to begin with, and yet it cannot be much more than a year and a half ago, a German broadcasting station planned a pageant recalling the history of one of the former German Grand Duchies. Some of the men who had to execute this plan boldly set out for a meeting with the venerable professors in charge of the Duchy’s historical documents. During this meeting, one of these old scholars uttered the following remarkable sentence: “There is one episode in the seventeenth century particularly fitted for broadcasting.”—“Why?” was the question. “Well, because of the wonderful costumes you can use in it.” A long and respectful silence followed this suggestion.

Broadcasting and its procedure is by now so familiar to the world that any child could have told the poor old man that it is not its purpose to make an exhibition of stage dresses and decorations in its transmissions, and that, in fact, its performances are largely done in shirt-sleeves. Most people know, too, that the artist’s performance and his acoustic environment are wisely separated and given to different departments and even to different rooms and microphones. Still, underneath the professor’s naïve words, the self-evidence of his belief in the physical completeness of dramatic performance could not but impress itself upon the consciousness of any responsible and sensitive broadcast producer.

At the beginning of dramatic broadcasting in Germany there was once an attempt in a Berlin studio to invest the actors—or shall we say the speakers?—in a mediæval play with all the ancillary effect of their rattling knightly armour. Whether it was to impress the imagination of the listeners or of the actors, or only because the producer was glad of any opportunity of spending money, I don’t know. I only know that this was a typical display of lack of style-sense.

But despite all that! It is a fact that constantly through the ten years of its young career and up to the present day, every dramatic form has remained a problem to the broadcaster. It

is not merely that the listener finds it difficult to distinguish the voices of a dramatic cast and to follow an acoustic performance of any kind for several hours, nor even that it requires painful effort to grasp the meaning of an acoustically produced dramatic plot. The problem lies deeper. Its roots lie, in my view, in the undeniable problematicalness of the broadcasting process as a means of artistic production in general. Every means of reproduction has its special intricate paradox. The paradox of broadcasting consists in three main points. First, it addresses itself to one sense only, viz. to hearing; secondly, it works one way only, namely, from the producer to the listener, excluding any reciprocity; and thirdly, it is addressed to one detached individual. Broadcasting can properly speaking deal only with matters not susceptible to discussion. Experience seems to prove the correctness of this assumption. There are two kinds of transmission cherished by all classes of listeners, viz. sport reports, which are statements of a sensational character, and light music, which is an emotional sensation. Provided always that they are not definitely boring, lectures may be acceptable as statements, if their topic is above discussion, as, for instance, in poetry, in language lessons, or in certain governmental and political speeches, and do not excite question or answer. Serious music, too, may be reckoned among the emotional sensations, as far as it is already known to the listener and does not demand a special mental effort and therefore the atmosphere of a social gathering of specially interested people. But, in spite of perpetual efforts and experiments, dramatic production, both literary and musical, has proved the prodigal son of broadcasting. To alter this, dramatic production in broadcasting would have to put itself outside the plane of discussion and become a compound of statement brought into epic form and of emotional experience, *i.e.* a genuine work of art of popular appeal. The most appreciated operas of the broadcasting programme are those relayed from the Italian opera houses. They are generally well known by their adepts, and, relying mostly on the voices, they provide an emotional sensation. But why then not cut off the whole dramatic element, plot, recitative and so on, and only leave the emotional part of the arias, for bringing this kind of opera into a genuine and well-adapted broadcasting form?

Well, there *is* a tendency, in broadcast opera, which is feebly striving in this direction. Broadcasting in Germany, and, I think, everywhere, began not as a creative work, with a style of its own, but as a technical experiment. And I should say, that, as a matter of fact, it is and will ever remain not an end but a means. Every listener, and still more every broadcaster, will remember, I suppose, with a tender emotion the times when the fact that a sound uttered before a microphone could be heard a couple of miles away, without a wire between, was enough to satisfy the highest wants of all concerned. In these times of Paradise and innocence, broadcasting people were eager to put every sound and every noise within their reach before the microphone. The producers, in their search for programmes of any sort, went to the opera directors amongst others, asking them the permission of putting the microphone in front of the stage and of transmitting the operas to broadcast listeners. In so doing, by the way, they merely followed a tradition, already existing in the legendary days of the first telephone, when first (I think) the King of Bavaria and then other sovereigns and wealthy people listened to opera performances through their special telephone lines. The difference, of course, was that what was then a privilege of the happy few was now to become accessible to the masses. The writer is not aware of what happened in other countries, but in Germany at any rate the opera directors (as well, by the way, as the concert societies and other public and private enterprises) resisted with all their might, and for a long time, the most persuasive money offers of the broadcasting authorities. They maintained that in view of the ugliness of a microphone hanging in front of their beautiful scenery, in view of the distortion of musical beauty by the imperfect means of radio transmission, and (paradoxically, last but not least) in view of the presumable loss of subscribers through the competition of broadcasting, the transmission of operas was absolutely out of the question. It is one of the most pathetic events in the historical development and downfall of the opera during these last years—intricate and fateful in consequence not of economic factors alone but of social causes as well—that after a couple of years this situation became entirely reversed, that it was then the opera directors who ran after the goodwill of the broadcasting people, trying by persuasion and

force to get as many paid transmissions as possible and even to have themselves supported by part of the broadcasting revenues. But meanwhile the broadcasting producers had become more and more doubtful whether they were not committing a cultural barbarism by transmitting operas in their original and complex form, which was after all intended only for the stage. They thought, for instance, of the home listener, assisting dumbly in his chair at the endless scenic transformations of the second act of the "Magic Flute," listening only to the low thunder of the turning stage and wondering what will come next. They wondered if, at best, the radio listener of a stage opera performance was not in the position of the opera visitor who is late and, as a punishment, is condemned to press his ear on the wall and to listen to all the complicated sounds of this performance without making out their real scenic meaning. He hears the hollow sound of the voices in the big resonant theatre, hears perhaps a double bass or a part of the choir instead of the leading melody, hears the coughs and the applause, the laughter accompanying a gesture which he doesn't see, and which therefore remains meaningless to him, and he wonders at the silence during a pantomimic scene.

But in spite of all this definite and essential imperfection, a word has to be said in favour of operatic transmissions even in their roughest form. It was a big event in the history of German broadcasting when the performances of all the opera houses became available for broadcasting. It was a big event when "Parsifal" was transmitted for the first time, a big event when Toscanini's Berlin performance of "Aïda" was radiated all over the country, when the opera performances of Bayreuth and Salzburg became familiar to every listener. And ever since then, all these transmissions, as well as those of the Scala and other Italian opera stages, have met with the appreciation of those thousands of people in more or less financial distress who form the audience of this sort of grand opera and never seem to become tired of it.

If I were asked, therefore, what was and is the opera policy of German broadcasting, I could only answer that it is precisely the same, and covers the same field, as the German opera programme in general. Wagner, Mozart, Verdi—these are the leading figures of every fresh opera season all over the world,

and every opera visitor knows by heart the order in which the less favoured opera composers of musical history and the changing favourites of the day follow them.

That is why I agree with the relay of opera performances, as long as they are not regarded as artistic productions but as *reported* art—comparable to the reproduction of pictures in a book—and so long also as they are restricted to the proportion corresponding to the number of opera-adepts amongst listeners, and strictly limited to the best of their kind in matter and performance.

But, if there does exist anything like a public cultural taste for broadcasting, then the future lies with those broadcast producers who, like, for instance, the conductors Scherchen and Rosbaud in Germany—both bitter enemies of relayed opera—strive constantly for a form of radio-opera that is essentially original and its own. Considering the undeniable crisis, economic but also material, of the conventional opera routine of to-day, considering the insurmountable stylistic ineffectiveness of most dramatic and operatic matter that is merely relayed, and considering the mighty economic and cultural responsibility of present-day broadcasting, I think that radio authorities should have the courage to divert their hitherto somewhat conventional round of operatic experiments into scenic presentation-forms of their own. I shall never forget two experiments of a certain German broadcasting studio in this direction. Timid as they were, they were a revelation of new possibilities to everyone concerned (on one of these occasions, by the way, Purcell's "Dido" was performed and broadcast under entirely new perspectives). The operatic crisis referred to sets to men who are independent and able to take a grip on it the task of facing and mastering all sorts of possibilities in a new popular style—as indeed has always been the case in times of stylistic emergency. The opera department may not seem to be a very important one amongst the manifold branches of broadcasting organisation, but the opportunity is in their hands, and as an old colleague I would like to ask them everywhere to grasp the responsibilities of that opportunity with both hands.

SOME FIRST PERFORMANCES OF MUSIC IN THE YEAR

ARMSTRONG GIBBS	Quartet for String
BENJAMIN	Violin Concerto
BERG	Three Fragments from Wozzeck (Concert Performance) Two Movements from the Lyric Suite Kammer konzert for Pianoforte and Violin with 13 Wind Instruments
BRITTEN	Phantasy for Oboe and Strings
COLLINS	Chamber Music No. II for Flute, Viola, and Harp
CUNDELL	Quartet for Strings
DELIUS	Idyll, for Soprano, Baritone and Orchestra
D'ÉRLANGER	Prelude Lyrique
GERHARD	Six Catalan Folk Songs
GOOSSENS	Suite, Kaleidoscope
HINDEMITH	Das Unaufhörliche Lehrstück (The Lesson) Philharmonic Concerto
HONEGGER	Symphonic Movement, No. 3
IRELAND	Intruder Indian Summer
KODALY	Székely Fonó
KRENEK	Durch die Nacht, Song Cycle from "Worte in Versen" by Karl Kraus, for Soprano and Chamber Or- chestra (1930-31)
MACONCHY	Quartet for Oboe and Strings
RESPIGHI	Antiche Danze ed Arie, for String Orchestra
SCHÖNBERG	Variations, Op. 31 (Concert Per- formance)
STRAVINSKY	Suite on Themes of Giambattista Pergolesi (First Performance in England of New Version)
VAN GILSE	Trio for Flute, Violin and Viola
VAUGHAN WILLIAMS	Pianoforte Concerto
WOODGATE	The Three Maries, a Cornish Mir- acle Play

RETROSPECT OF THE CONCERT YEAR

DURING the past year of serious broadcast music listeners probably noticed developments. It is possible, however, that they were not aware to what extent the developments have been part of the B.B.C.'s musical policy or a particular experiment instituted for a definite purpose.

Consider, for instance, the Symphony Concerts at Queen's Hall. These again numbered twenty-four, but the last six concerts were apart, late in the season, in May; and they marked the revival of the London Musical Festival, which before the War was one of the most brilliant events in the world of music. In those days eminent contemporary composers figured largely in the Festival: Strauss, for example, was several times invited to take part in it. In the London Musical Festival of 1933 half the concerts commemorated the Centenary of Brahms. These were conducted by Adrian Boult. For the remainder a cordial invitation, cordially accepted, gave us the welcome re-appearance in London after an absence of seven years in America of the brilliant and magnetic Serge Koussevitzky.

Then there were the Christmas Promenade Concerts. These were quite an experiment—successful, too. For thirteen crowded nights Sir Henry Wood recaptured the atmosphere and the enthusiasm of those evenings which for thirty-eight autumns have provided in Queen's Hall an experience unique in concert history.

These concerts are to be repeated in the Christmas holidays of 1933, although in their reappearance, while retaining the "Prom" form of a long first part and a lighter second part, they will consist exclusively of music by contemporary British composers. Fewer concerts are possible because of the exceptionally heavy rehearsal required by the new or unfamiliar music. Various important new works will receive first performance, including pianoforte concertos by Bridge and Ireland, and Symphonies by R. O. Morris and Patrick Hadley; one concert will be devoted to Dame Ethel Smyth, who celebrates her seventy-fifth birthday this year.

To commemorate Elgar's "seventy-fifth" the three Symphony Concerts preceding Christmas 1932 comprised his music. He

personally took part in two of them. In addition most of his Chamber Music was played at a public concert at Broadcasting House. This concert was one of a series of six Chamber Concerts given on Saturday evenings at nine o'clock, and which led the way to the Monday concerts referred to later.

While Elgar, Delius and Bantock, to quote three names known and honoured the world over, are "contemporary" in the literal sense, and their new music readily finds a place in broadcasting programmes, its first hearing is less strange than that of the so-called "ultra-moderns." Think, for instance, of the difference between the early and late works of Frank Bridge, and the still further steps traversed by Bax, Walton and Lambert. This newer music is to some extent represented variously in this concert or that—an orchestral piece here, a song cycle there—but following the policy of seven previous seasons, the B.B.C. gave eight monthly concerts devoted solely to it. Music Critics were invited in order to afford the composers the press opinions, formed in the concert atmosphere for which the music was designed, which they naturally value so much.

It was possible this year to hold these Friday evening concerts in the Hall of Broadcasting House, and so to include in them a recital of contemporary organ music, played by Thalben Ball on the new organ. The public opening of this instrument on June 16th, when three of the foremost British organists took part, marked the beginning of a series of recitals, in which throughout the coming year listeners will hear a wide repertoire of organ music, from before Bach up to the present day.

This Hall has also provided a setting for another experiment in concert giving, in the series of eight weekly Chamber Concerts in February and March. These further helped to put the Hall "on the map," so to speak; the prospectus included the first reappearance in London since before the War of Carl Flesch, whose playing of Beethoven with Lamond confirmed our memory of him as one of the greatest classical violinists of all time. A further series of twelve similar concerts will be given fortnightly on Fridays in the coming season.

LEARNING TO BROADCAST

By JOHN GLOAG

WRITING COMPELS YOU to arrange your thoughts. Hard work plus what H. G. Wells has called "the poetic gift of the creative phrase" may secure readers for what you write. Speaking in public also compels you to arrange your thoughts—four or five sentences ahead if you are going to be coherent; and hard work and a good voice may induce a sufficient number of people to sit through your speech or lecture, and so encourage you to perform on other occasions until in time you become used to speaking in public, and, what is even more remarkable, people expect you to speak in public. By comparison with writing and public speaking, broadcasting through a microphone to unresponsive space may sound easy.

A writer may be forgiven for thinking that he has learned all about it years ago, especially if he writes fiction and has invented conversations and monologues. A lecturer or political speaker, heartened by memories of respectful or enthusiastic audiences, may be tempted to forget that people don't go to lectures or meetings unless they are interested or enthusiastic. Both the writer and the speaker may, with the bland confidence of accomplished craftsmen in words, write down very carefully what they are going to say when they broadcast. Then they are left alone in a studio at Broadcasting House in front of that bleakly impersonal instrument the microphone. There it stands on the table before them, symbolic of the uncaring void through which their words are to be flung.

Even at the first rehearsal the utter strangeness of the proceeding impresses itself.

Then you begin to make discoveries about what you have written. You read it; and it becomes an agony to read, like a piece of dictation given at school. It seems stilted, and it imparts to your voice a barrenness of expression that makes you expect the polite interruption from your mentor in the listening room who addresses you through a loud speaker.

"I say, Mr. Gloag, you sound frightfully depressed, if you don't mind my saying so."

You do mind, although you are conscious yourself that you

have given to your words something of the doleful cadences of the Western Brothers when they sing: "Oh, it *has* gone down!" You go too fast at first: then you go too slow. Then you emphasise the wrong words, until you suddenly realise why you are so disgustingly self-conscious and unnatural. *You are trying to be conversational to an audience you can't see with material that is wholly unconversational in form.* You are reading something that was written either to be printed and read, or to be spoken from a platform.

Then you tear up what you've written, if you're wise, and learn to write all over again.

First of all you learn to avoid long and complicated words. You cut out every needless word above two syllables. You study the ends of each sentence, and take care that you don't finish with words of awkward or ambiguous sound. You take particular care that in your typed manuscript "do not" is rendered as "don't," and "cannot" as "can't." Otherwise in reading you may unconsciously become unbearably stilted.

After every sentence, when you are writing this talk in this new technique, you must, for the good of your soul, think of a switch being turned to secure another programme for a bored listener to the accompaniment of some such remark as: "Gosh, what bilge! Let's have something else!" You can't hear it, but, as many a theatre manager knows, the public won't pay to be bored, *ever*; and unless you learn what to leave out and how to humanise what you leave in, that piece of criticism will be earned by your talk.

Don't make the mistake of being sparkingly witty and epigrammatic in every other sentence. It has an air of having been mugged up for the occasion. Illustrate what you mean by material and incidents drawn from the lives and normal everyday experience of your listeners.

Time what you have written. About 4,000 words fits into half an hour comfortably. Then go to your next rehearsal and take your time.

Speak slowly, for you will never before the microphone speak quite as slowly as you think you are speaking. Feel about for your words, not theatrically, but with the natural pauses that everyone makes in ordinary conversation. Take little liberties with your typescript. Alter a word here and there. Visualise a



A DISCUSSION BETWEEN MISS MEGAN LLOYD GEORGE AND SIR
OSWALD MOSLEY ON "FASCISM"

few of the people whom you know will be listening: picture them in their armchairs, and try to be conversational with *them*. Don't just read what you've written. Let your voice play about as it normally would, and make gestures with your hands. That helps to create the illusion of an audience.

Don't rustle your typescript. Throw each sheet as you finish with it on the floor instead of turning it over. Don't look at the clock every five minutes. Do all the water drinking you want to before the red light goes on in the studio, as your ingurgitations become amplified to the mystification if not the alarm of listeners.

Keep yourself humble all the time, in preparing and broadcasting your talk, by remembering your responsibility to your listeners. Before broadcasting was invented nobody had ever had such opportunities as you for boring simultaneously so large a number of people, or helping them to appreciate and enjoy something that you think should be appreciated and enjoyed.



MR. G. K. CHESTERTON

POETRY

OCCASIONALLY, in optimistic moments, B.B.C. officials nourish a theory that grim-lipped Admirals of the Fleet, inarticulate navvies, bombastic politicians, defeatist spinsters and exhausted postmen, steal secretly to their loudspeakers round about the witching hour of eleven and listen with furtive joy to the poetry reading which is broadcast every evening at the close of the National programme. The theory may sound improbable; but the reader must not suppose that it is quite without foundation, since all these people and many more such sent to the B.B.C. their contributions for the recent poetry competition, and if they write poetry, may they not also listen to it? Furthermore, those who pursue the ungrateful task of arranging these readings which vanish into unechoing space comfort themselves with the peculiar fact that the English, having produced the world's finest poetry, choose to assume towards it a faintly apologetic air, and rejoice to disclaim any partiality for verse, although (judging again from the number of contributors to the poetry competition) the bulk of the population of Great Britain seems to employ its leisure in writing poems on nature, patriotism and unrequited love. Well, hope is eternal; and meanwhile poetry (rather startled by the sudden limelight after so many years of lying on the bookshelf) speaks to the immensity of the ether for five minutes every day. Week by week the reader changes; and to him or her come back a few appreciative, a few disgruntled, letters from listeners. The disgruntled ones complain (*a*) that the poetry is mournful, and (*b*) that the reading might be better (with an implication that it *would* be better if the writer did it). To the first criticism the only reply is that poetry on the whole *is* mournful and nothing can be done about it: to the second, that the B.B.C. after hearing, during the last ten years, nearly every would-be poetry reader from Land's End to John o' Groats, realises that no one interpretation of any poem can please everyone, and ventures to think that in Robert Harris, Felix Aylmer, Ian Sinclair Phail, Fabia Drake, Nesta Sawyer and Nadja Green it commands readers who, each in their own way, possess qualities of voice, rhythm, and intelligence which are nearly ideal for the interpretation of poetry at the microphone.

Such a statement of course amounts to a headlong plunge into a sea of controversy: the great British public, if we mistake not, yearns for something more sentimental, or "dramatic," than these readers will give: while the elect of Bloomsbury hanker (if they hanker at all) after a far more monotonous and matter-of-fact style. But the microphone itself has a word to say to both parties: the "dramatic rendering" which may be effective on a platform is apt to come through the loudspeaker as an affectation which is embarrassing or simply comic: the matter-of-fact style, which is attractive on the lips of a friend sitting in your room, may, by the mere lack of vision and propinquity, become suddenly devoid of all personality and charm. For such judgments there is no Solomon at Broadcasting House: in the last resort all poetry reading is a matter of personality in the reader and taste in the listener, and prospective readers are judged by a committee of people who have long since abandoned the hopeless task of assessing values by a mere addition of qualities. A pleasing voice, and control of it: good diction: a sense of rhythm: a knowledge and love of poetry: all these are desirable, yet all may be united without the ability to charm a single listener into even the slight effort of attention which the listener must certainly make.

It may be as well to mention here that even within Broadcasting House there are two opposing schools of thought on the vexed question of how poetry should be read: the curious listener may find a distinction (without, perhaps, much difference) between the late evening readings, and "Mosaics," both of which are arranged by the General Talks Department, and "Miscellanies," poetry in plays, and Armistice Day Programmes, all of which fall under the Productions Department. In the former case, the aim is to discover intelligent readers and leave them as much as possible to give their own interpretations: in the latter, to use obedient actors and impose an interpretation upon them. The "General Talks" will not welcome a gold medallist if he cannot distinguish Milton from Kipling; nor "Productions" a reader with too fixed ideas of his own about inflection and rhythm. Meanwhile poetry, amid the bickering, keeps a place in the programmes and *may* (as remarked above) be heard with secret pleasure by admirals, navvies, spinsters, politicians and postmen.

TOPICALITY

IF YOU WERE an assiduous and attentive listener and someone asked you which part of the broadcast programmes had been least affected by the shifts of time and thought during the ten years of broadcasting, you might—after some quite natural hesitation over the Sunday programmes—reply “The News.” Your reply would be considered bright; and if it wasn’t the whole of your reply, if you added “Thank Heaven!” or “Worse luck!” according to your outlook on life, this article is especially written for you.

The News Bulletins, their place, space, order and presentation in the programmes, have indeed been little affected by the experiments and reforms which have beset the rest of the programmes. They have sailed a comparatively smooth and uneventful course, while all about them the waves of fresh ideas have reared their crests, subsided and been replaced. You might quite excusably have felt cheated and indignant if you had turned on the National programme at 9.0 p.m. any night and had not been greeted by the dispassionate accents of the Announcer offering, without comment, items of the day’s news for a quarter of an hour and no more.

Indeed the News Bulletins have become almost an institution, and even the Announcers might have been thought to have acquired a particular and identical kind of voice suitable to the solemnity of the occasion, since it is often supposed that there is only one of them. But the old order always changes, and you may have noticed, perhaps with pleasure, perhaps with misgiving, that there have lately been signs of tampering. The Bulletins didn’t change in any fundamental way, it’s true; but they formed a permanent alliance with another item in the programmes with which they had sometimes flirted before—the Topical Talks. Hitherto these nomadic creatures had wandered restlessly all over the evening programmes, occupying all sorts of positions and sometimes called Topical Talks and sometimes called other names.

But however they might be called, their value was news value—comment upon current affairs—and it was eventually decided that since the bulletins were related to them they had better take care of them.

The Topical Talks were therefore organised; they were given five minutes every evening in which to deal with the "head line" of the day, and were tacked on like a tail to the news bulletins, receiving reference and announcement therein.

That was the first sign of change. Then there were developments; still small, still tentative, but the tap of the hammer nevertheless. Instead of sitting contentedly on the tail of the news, the topical talk sometimes found its way into the body of it, to get closer to the particular item it was illustrating and amplifying. Also, besides exhibiting this liveliness in time, the topical talks began to exhibit a greater geographic liveliness. They jumped oftener and further afield about the globe. Short statements and descriptions of the important foreign news of the day, urgent affairs in distant capitals and cities as well as in our own provincial towns, instead of being retailed by the announcer from the London Studio, were coming more frequently, more rapidly, from the actual spot. The B.B.C.'s news service was expanding. Special correspondents were springing up at home and abroad. Sometimes the bulletins were made to contain more than one topical talk, and then clearly it was becoming difficult for them, with their present limitations, to hold the baby, so to speak.

On July 1st last, the conclusion to which all these small activities were clearly tending was tried out experimentally. It may be remembered that the late general news bulletin plus topical talk period for this one night was extended from twenty minutes to forty-five. The news itself, instead of being given in a lump as hitherto, was cut up and interspersed with outside comment and description. Immediately after the latest news of the World Economic Conference, for instance, Mr. Vernon Bartlett and Mr. William Hard were heard discussing the English and American attitude towards the work of the Conference, and Paris was then called on for the French point of view. The opening of the new Liverpool airport with an air pageant was described from Manchester by one of the participants in the pageant who had flown to the Manchester Studio post-haste to broadcast an account of it, and the anniversary of the opening of the Battle of the Somme was commemorated by a private soldier recalling his experiences on that day. All these different illustrations were carefully set and dovetailed

into the bulletin, and the whole was adorned and further enlivened with very slight effects, such as trumpet calls and aeroplane noises, and rounded off with music. This experiment was by no means as simple as it may sound. Besides the selection of the news and speakers, careful timing and considerable technical negotiation and engineering skill were required—the booking of provincial and foreign studios and lines, and cue arrangements for rapid transitions; but conciseness and speed were aimed at, and achieved, and the whole bulletin moved swiftly and smoothly, without hitch or pause.

The results of this experiment were curious and instructive. There were a number of appreciations, including a personal message from H.R.H. the Prince of Wales. There were also a number of protests. Some listeners resented having had to wait half an hour longer than usual for the sports news—for this particular section had been put at the end of the bulletin as usual; and there was a complaint from someone whose game of bridge had been delayed by such a lengthy bulletin. These criticisms have received sympathetic attention; but the experiment was felt to have been, on the whole, a success, and an extended news bulletin of half an hour's duration is finding regular place in the programmes this autumn. These bulletins are designed, like the experimental one, to present the news in a more varied and vivid form. Authoritative comment, eye-witness accounts and so on are mingled with the news, and as much as possible of it comes from correspondents on the spot. It is felt that all this makes a more valuable and more vital feature of the bulletins, and that a direct provincial and foreign news service in particular will eventually be one of the most important functions of broadcasting.

An attempt is being made to fix definitely, and give advance publicity to, the timing of the sports news so that those who are interested only in this part of the bulletin may know exactly when to hear it; and for those who still prefer the system of news in brief it may be possible to provide a précis, in tabloid form, in advance of the amplified bulletin. These half-hour news reels have taken place weekly every Saturday evening from October 14th. Later on—perhaps—who knows?—they will be heard in the programmes every evening.



A DISCUSSION BETWEEN A LONDON AND A PARIS POLICEMAN IN THE
STUDIO

ARRANGING A TALK

MOST PEOPLE dismiss a talk as good, bad or indifferent, without any idea of what has been going on behind the scenes for months beforehand. It is now November. For the past six weeks, a member of the Talks Branch has had to face the problem of what to put in the programme at 9.20 p.m. on Saturday, March 31st, 1934—to face it, that is to say, with one half of his mind. With the other half he has been vetting manuscripts and rehearsing speakers for yesterday's and to-day's and to-morrow's programmes. But what is he to do about Saturday, March 31st, at 9.20 p.m.? He has got to think now of something that will be of interest to the widest possible number of listeners four months hence. And he has got to think quickly, because speakers must be found and the final programme settled in time to have the Talks Pamphlet ready by Christmas. "Something of interest to the widest possible . . ."—there was a letter in this morning's post suggesting a talk or series of talks on "how to keep mice, moth, and mildew out of grand pianos." There was a suggestion too for a stamp collector's talk, and another for a clear exposition of the Income Tax Acts. They are all subjects of interest, but none of them will really do for a Saturday night series.

However, some idea is eventually approved—a series "In Quest of Treasure" or some such thing—and then comes the search for treasure seekers—for pearl divers, gold prospectors, orchid hunters and so on. Unfortunately there is no Incorporated Society of Treasure Seekers, or the Secretary might help—subject, of course, to the President being allowed to open the series by enumerating the aims, objects and subscription rates of the Society. So other methods have to be employed and the telephone is kept busy for hours on end. But sometimes even the telephone fails. For a budgets series last summer there was need to find a householder with £350 a year, a wife and three children, and three children only, all of school age. Conventional methods were tried, but without success, so someone set out on a Sunday morning and spent the day in Regent's Park, sizing up the family groups that strolled and boated there, or sat listening to the band. Towards evening he had picked out a number of likely groups. "Excuse me, sir, I

should very much like to know if you have £350 a year and any more children at home." It was not an easy question, but one family group played up and the situation was saved.

Unfortunately the search for a speaker on any given subject does not always end when an expert on that particular subject is found—no, not even if all his friends tell him, as they invariably do, that he has a good broadcasting voice. So it is necessary to explain to the speaker that a broadcast talk needs a special technique. He must be conversational. He must forget the size of his audience and talk as he would talk to a single friend over a glass of beer or a cup of coffee. If he has a sense of humour he probably says that his remarks to a single friend over a glass of beer would not be repeatable; if he has not, he sends back a script which contains half a dozen sentences of a hundred words or more, and which invariably begins with the surprising information that he has been asked by the B.B.C. to talk about so and so, and that in the short time available he cannot do more than touch on the fringe of his subject.

However, by now the talk is booked and the speaker must be persuaded to make his script into a talk—in fact to do sufficient violence to his literary genius to turn "do not" into "don't" and write "I saw" for "A bystander might have observed." And so the manuscript passes to and fro until the day draws near and it is time for a rehearsal.

In the excitement of the occasion the lessons of the rehearsal often seem to have been forgotten. One speaker doubles his pace, another halves it, and no amount of signalling will steady the one or hurry the other. Sometimes, too, the speaker tries to improvise, and once an unrehearsed blast on a whistle put Daventry out of action for three minutes and did £200 worth of damage.

"The talk that you have just been listening to . . ."—out flicks the red light and one more speaker is being congratulated on his performance and reassured that his voice will have been clearly heard in the north of Scotland. The great monster has devoured another speaker, but he will be hungry again tomorrow and the day after. In fact he will be just as hungry at 9.20 p.m. on the 31st March, 1935, as he will be on the 31st March, 1934, and unfortunately he will want a change of diet.

SCHOOL BROADCASTING

THE GENERAL REPORT of the Central Council for School Broadcasting reviewing its three years' experience deals with four major questions. (1) What shall be broadcast? (2) Who shall broadcast? (3) How is the broadcast to be used? and (4) Why are not more schools taking the broadcast lessons?

Dealing with the first, the Council takes in turn History, Geography, Science, English, Modern Languages, and Music. As to the first-named, it appears that broadcasting can help in three ways: (*a*) Sketches of social life and of outstanding events at different periods (with dramatisations, contemporary music, etc.); (*b*) Talks on world history (again, where possible, supplemented by illustration); and (*c*) Courses combining an objective treatment of conditions of to-day with a presentation of history as traced backwards, so as to correlate present and past. In the field of geography, experience so far indicates that the true function of broadcasting is to stimulate the interest of children of 11 to 14 in the wider world by means of simple and striking travellers' tales.

In science teaching seems to lie in bringing the schools into contact with specialists who can point out the bearing of their work on the facts of everyday life.

Much experiment is being carried out in connection with English teaching, and there is evidence already that talks on speech and language can awaken that speech consciousness which is the necessary preliminary to any improvement in speaking. Broadcasting should also be used to give school-children an opportunity of regularly hearing the reading of poetry and prose. As regards modern languages, the special contribution of broadcasting is in the early stages to familiarise with the sound of the spoken language and later to give opportunities of listening to ordinary conversation and to the reading of passages of literature.

As regards music, it has been found that broadcasting can provide a primary course which should help to lay a foundation for intelligent listening. The examples used should aim at stimulating delight in music rather than at illustrating musical forms. The children should also take part in the singing. On the other hand, for schools which are already following a

comprehensive course in music, what appears to be wanted is a course definitely devoted to the child as listener, with abundant opportunity for listening to the masterpieces. This course should also aim at encouraging tune writing. In the matter of musical appreciation, broadcasting has a unique function.

The practical application of these conclusions implies the provision of talks for three age ranges, 11-14, 13-15, 15 and over. The last-named presents peculiar difficulty, and it is thought that (apart from regular readings and dialogues in modern languages), broadcasts for secondary schools should, in present circumstances, normally be given outside hours, and should be designed towards education in current events and problems, and to develop permanent cultural interests.

In answer to the question, "Who is to broadcast?", while speakers are, and ought to be, drawn from different sources—school teachers, university lecturers, outside experts—their effectiveness depends very largely on "microphone personality" and the practice and rehearsal in which this develops.

As to the use made of the broadcast in the school, it is impossible to prescribe detailed methods, and, in fact, these are being worked out independently by teachers as well as being investigated by certain Training Colleges. The general features common to these various methods may be thus described:

The broadcaster is offering to the child from a new angle and in a new voice, an educational experience which is also new, and which is perhaps related only indirectly to previous instruction in the same subject. Given proper conditions, this new experience will certainly interest the child. But a mere passing interest is not enough. It is what remains after the broadcast that matters. The teacher will naturally desire that the child shall relate his new information to what he has previously been taught by other means, and his skill is shown in making this liaison easy and logical. Some form of revision is essential, though the amount and character of this depends on the idea of the teacher. Frequently the broadcast is used with excellent results as a starting-point for stimulating individual work. In some, on available evidence, it can be stated with confidence that the new ideas and the new presentation help and enliven the children, and that broadcast lessons as employed by careful teachers are successful in arousing that individual mental effort

in the child which is perhaps the most important objective of education.

Lastly, as to the number of schools taking broadcast lessons. The register kept at Broadcasting House now numbers some four thousand schools, of which over 80 per cent. are Elementary. Changes in the list of listening schools need cause no apprehension. Obsolescence of sets, reorganisation, and transfer of teachers, are the most common reasons for discontinuing the broadcast lessons. But the question naturally arises: "Why are not more schools already employing the new medium?"

As with all new departures in education, development is governed by material circumstances on the one hand, and on the other by the human factor.

Firstly, there are the financial difficulties of these years; the Central and Local Education Authorities are avoiding new forms of expenditure, and voluntary effort in the schools is similarly handicapped.

Secondly, the difficulties experienced by schools in obtaining a reliable standard of reception have greatly hindered progress. But the importance of good reception is now coming to be generally recognised and to-day, bad reception is chiefly due to mistakes in choosing the school set. Under the auspices of the Council and with the assistance of the Department of Scientific and Industrial Research, a list of sets on the market suitable for school use has been prepared. Negotiations are also afoot with the Radio Manufacturers' Association regarding the development of a hire service with maintenance.

Even if it may be assumed that the material obstacles will in time be surmounted, development must yet wait upon the goodwill of the teacher in the school. It is always easy to advance *a priori* arguments against an educational innovation, and broadcasting, as a feature of everyday life, is itself comparatively recent. An objection often advanced, but apparently not confirmed by experience, is that when the novelty has worn off the children will be bored. There are also time-table and syllabus objections; but in the last resort teachers who are satisfied that the broadcast lessons are of value will always be able to make room for them. A more serious difficulty for the teacher is that he cannot feel sure, in giving broadcast lessons a trial, that he will be supported from above. He may also

fear to be thought to be adopting broadcasting in order to eke out his own lack of knowledge, or to save himself trouble—though the proper use of the broadcast lesson demands as much of the teacher as the use of text-books or any other apparatus.

But definite grounds for adverse criticism may exist in the school itself. While, in the nature of things, some broadcast courses are failures, it often happens also that broadcasting as used in the school is indefensible; *e.g.* Children of one age group may be set down to listen to material intended for other age groups to follow. The over-zealous believer and the teacher who embarks on broadcast lessons without sufficient thought and study often raise distrust.

Lastly, an understandable reluctance must be looked for in the teacher—and this not least in the most competent and forceful—to share his time and his authority with an unknown colleague. It is impossible to affirm that a talk arranged by a distant committee and delivered by an incorporeal voice is always more valuable as teaching material than a possibly inferior body of knowledge selected and presented by the individual who is responsible for the totality of the teaching process. Against this, the fresh voice from the outside, informed and enlightened by a type of experience other than that which is common to the teachers in the school, may sow valuable seed—a contingency which no teacher can afford to ignore.

The evidence warrants the assumption that, if Local Authorities would help in the solution of the financial and administrative problems there would be a very rapid growth in the number of listening schools—and with this a fuller study of the possibilities and a better understanding of its place in the school curriculum. No attempt, however, should be made to force the pace. Gradual growth is in the best tradition of English education.

RELIGIOUS BROADCASTING

THE YEAR 1932-33 has closed the first decade of religious broadcasting and has inaugurated an experiment which, it is hoped, will lead to important developments during the second decade now beginning. A brief statement of the principles governing the B.B.C.'s policy in this department of their work will help the reader to understand the aims of this experiment, which has already had a mixed reception from listeners.

From the outset, those responsible for religious broadcasting have chosen to regard religion as something more than a legacy of traditional beliefs which, being held by the vast majority of listeners, and varying in different sects, had to be recognised and dealt with as an item in the general programme demand. Such a view would justify Rationalist criticism of religious broadcasting. But they have been governed by the conviction that the religious impulse is the most vital force in human life, and that the highest expression of that force in relation to the community is found in the Christian Faith. They have never presumed to supply a new sort of religion, as critics have often complained, but they have believed that the fundamental and authentic Christianity of the New Testament can be conveyed without introducing the more intricate doctrinal arguments, and cannot be penned within the bounds of particular sectarian tenets. Indeed the latter were deemed unsuitable for broadcasting, which, owing to its unique opportunity for limitless dissemination of the spoken word, provided the most far-reaching medium for proclaiming the principles common to all Christian denominations, and thereby drawing together into one vast congregation members of many Christian Churches. Proportionate denominational representation between preachers has always been arranged so far as is practicable, but insistence on the points that unite, rather than on those that divide, has always been the aim. The B.B.C. is profoundly grateful to those men of all denominations who were willing to co-operate, and who, during the past ten years, have helped to evolve a system which emphasises the essentials of Christianity.

The most obvious result of ten years of religious broadcasting as reflected in listeners' correspondence has been increased tolerance. The Roman Catholic who would under no considera-

tion enter the church or chapel of any but his own Faith has written to thank the Free Church minister for the help derived from his discourse; and the Methodist who has inadvertently switched on a sermon by a Jesuit preacher has remained to listen and has then set forth his admiration in a letter of warm appreciation.

By the beginning of 1932, however, an important new current of criticism had begun to flow in, directed against a defect in religious broadcasting of which the B.B.C. themselves were becoming aware, and which was a direct consequence of their method. Broadcast preachers, in their endeavour to appeal to all sections of their vast audience, were tending more and more to repeat vague and soothing platitudes, and their addresses seemed to be losing point and vigour. Their effort to grip every listener was devitalising their discourses.

The B.B.C., while not admitting that the ideal for which they were striving was unattainable, fully realised that this criticism was justified. But the message of Christianity is not only one of consolation and quietude; it is one of vigorous militant power which can have a very real influence even in the twentieth century. The problem now is to preserve, if possible, the popularity of religious broadcasting, while injecting the additional intellectual force needed to stimulate and inspire. Help in this difficulty came to the B.B.C. from within the Churches. A group of progressive and broad-minded men made the suggestion that a series of connected addresses should be given, which would present a definite statement of the ideals and claims of Christianity, and endeavour to show its relevance to the lives of men and women to-day. As a result, a scheme of lectures was planned under the title "God and the World through Christian Eyes." It received the approval of the B.B.C.'s Central Religious Advisory Committee, and after an introductory reference in the Archbishop of Canterbury's broadcast sermon on New Year's Day, the first lecture was delivered by the Archbishop of York on January 15th. The speakers were chosen for their intellectual ability to deal with the subject, and denominational representation was not taken into account. The lectures were arranged in place of the ordinary services in the National programme on the first and third Sundays throughout 1933, and in order to emphasise their in-



CARLISLE CATHEDRAL

Will F. Taylor



EXETER CATHEDRAL

Dixon-Scott

Services in Commemoration of the Eighth Centenaries of the Cathedrals were broadcast during the year

structional and educative intent, they are being given as self-contained broadcasts and shorn of any religious accompaniment; but each lecture is preceded by a brief fifteen-minutes service from 8.0-8.15 p.m.

The criticisms of this series have been of great interest. Some listeners have written to thank the B.B.C. or individual lecturers, and evidence is not lacking that the series has confirmed many thoughtful people in the Christian Faith. On the other hand, there is no doubt that most of the lectures have been "over the heads" of the average listener. This is to be regretted; but it should be remembered that pressure of intellectual force and conviction can only come from the more thoughtful and educated section of the community, and that thought and knowledge, like everything else, filters through from the top. There is no intention, however, of disregarding those listeners who found these lectures too difficult to grasp in their full meaning; and a new series is being planned for 1934 which, while not lowering the general intellectual level of the addresses, will be expressed in simpler and more everyday language, and related more closely to common human problems. Briefly it may be said that the first series was an attempt to teach more educated listeners how to think out the Christian Faith. The new series will be devoted to teaching all listeners who wish to hear, how to live out the Christian life.

The B.B.C., however, does not mean to allow the normal broadcast services to be superseded by the new lectures, which are confined to the first and third Sundays in the month in the National programme only and will not begin until the Autumn of 1934. On all other Sundays, the services will be as usual. The Sunday programmes for 1933 show the same variety as hitherto; cathedrals, churches and chapels have contributed their share, and eminent preachers of all denominations have consented to conduct services from the studio. Comprehensive religious fare is now offered for all, and it is hoped that every type of listener may now be able to find in the Sunday programmes the spiritual help which he needs.

RELIGIOUS ACTIVITIES

Archbishop of Canterbury	Archbishop of York
Archbishop of Liverpool	Bishop of Peterborough
Bishop of Chelmsford	Bishop of Croydon
Dean of Exeter	Dean of St. Paul's
Prebendary Mackay	Prebendary Meyrick
Ven. A. E. J. Rawlinson	Rev. Monsignor Francis Gonne
Rev. Harold Anson	Rev. H. Tydeman Chilvers
Dr. Edwyn Bevan	Rev. Greville Cook
Father M. C. D'Arcy	Rev. W. H. Elliott
General Higgins	Dr. Fleming
Rev. Maldwyn Hughes	Rev. F. J. R. Humphrey
Father C. C. Martindale	Rev. J. Scott Lidgett
Rev. W. P. G. McCormick	Rt. Rev. H. R. Mackintosh
Dr. Campbell Morgan	Dr. Norwood
Mr. Hugh Redwood	Rev. J. E. Rattenbury
Rev. Wilton Rix	Rev. W. Lewis Robertson
Miss Maude Royden	Gipsy Smith
Dr. Maynard Smith	Father Ferdinand Valentine

CATHEDRALS

Birmingham	Exeter	St. Chad's
Canterbury	Gloucester	Westminster Abbey
Carlisle	Norwich	Winchester
Dunblane	Peterborough	York Minster

CHURCHES

Beckenham Congregational Church	London:
Cranleigh Parish Church	All Saints', Margaret Street
Crowstone Congregational Church	All Souls', Langham Place
Eton Parish Church	Bow Central Hall Wesleyan Mission
Gillingham, St. Barnabas Church	Brondesbury Park Congregational Church
Govan Parish Church	City Temple
Greenwich, St. Alfege Parish Church	Ealing Congregational Church
Halifax Parish Church	Friends' Meeting House
Hove Parish Church	Marylebone Presbyterian Church
Isle of Man, St. George's Church, Douglas	Metropolitan Tabernacle
Kettering, Cransley Church	St. Anne's, Soho
Manchester, Central Hall	St. Mark's, North Audley Street
Manchester, Church of the Holy Name	St. Martin-in-the-Fields
Oxted, Tandridge Church	St. Michael's, Chester Square
Staines, St. Peter's Church	Streatham Methodist Church
Windsor, St. George's Chapel	Wesley's Chapel
	Westminster Congregational Church

APPEALS RESULTS

BROADCAST FROM LONDON DURING THE FIRST HALF OF 1933.
(TO THE NEAREST POUND)

1933				
Jan.	1	† The Ranyard Mission	The Archdeacon of London	£ 309
"	8	* Royal Veterinary College	Professor F. T. G. Hobday	463
"	15	† St. Helen's Women's Settlement	Canon C. S. Woodward	155
"	15	‡ Royal East Sussex Hospital, Hastings	Lord Eustace Percy	60
"	22	* Asthma Research Council	Mr. W. Maxwell-Lyte	1,818
"	29	† Agnes Parr Nursery Home	Mrs. Frank Worthington	111
Feb.	5	† King's Roll Clerks' Association	Admiral Sir H. H. Bruce	214
"	5	‡ Harwich and District Hospital	Miss Regina Evans	90
"	12	* Missions to Seamen	Commodore Sir Bertram Hayes	577
"	19	† Theatre Girls' Club	Mr. Christopher Stone	408
"	26	* Royal National Mission to Deep Sea Fishermen	Commander R. G. Studd	3,440
Mar.	5	† St. John's Club, Westminster	Canon C. S. Woodward	1,016
"	12	* National Temperance Hospital	Lord Moynihan	380
"	19	† Seaside Camps and Settlements	Viscount Knebworth	114
"	26	* Church of England Homes for Waifs and Strays	Rev. W. H. Elliott	521
April	2	† Wireless for the Blind Maintenance Funds	Dr. Ernest Whitfield	826
"	9	* St. Columba's Hospital	Canon C. S. Woodward	3,154
"	16	† London Child Guidance Clinic	Miss E. M. Delafield	44
"	23	* St. George's Hospital	Lord Greville	1,423
"	30	† Veterans' Association	Marquess of Carisbrooke	370
"	30	‡ Royal Hampshire County Hospital	Countess of Northbrook	198
May	7	† Margaret Street Hospital for Consumption	Lord Moynihan	138
"	7	‡ Federation of Working Girls' Clubs	Mr. S. P. B. Mais	298
"	14	* London Clinic and Institute of Physical Medicine	Professor Sir Leonard Hill	447
"	21	† Women's Holiday Fund	Canon C. S. Woodward	1,540
"	28	* Student Movement House	Lord Irwin	760
June	4	* Marine Society's T.S. "Warspite"	The Earl of Romney	644
"	11	† Metropolitan Hospital Sunday Fund	Rev. P. T. B. Clayton	904
"	18	† North Kensington Nursery School	Mr. S. P. B. Mais	224
"	25	* Royal Agricultural Benevolent Institute	Mr. Cedric Hardwicke	930

* National. † London Regional. ‡ Daventry National only.

HERE IS AN S.O.S.

LIKE OTHER ASPECTS of modern broadcasting, the S.O.S. service is not immune from criticism. There are some who regard the messages as a waste of the listener's time, and others who feel that a public organisation has no business to concern itself with private lives. But in spite of these criticisms the service is welcomed by many, who find it a useful "last hope" when everything else has failed; and every year provides a number of instances in which an S.O.S. message performs a task which would otherwise have been left undone.

Most of the messages follow the conventional lines. An absent relative is needed at the bedside of someone who is dangerously ill, and there is no way of tracing the missing person except by broadcasting. Sometimes the relative has not been seen for ten or fifteen years; sometimes it is a matter of finding someone who has gone on a motor tour and is staying at a different place each night. Over fifty per cent. of these messages are successful.

On other occasions the S.O.S. messages are concerned with more unusual happenings. Two of the messages broadcast in 1933 were concerned with shopkeepers' errors, which might have had fatal results. In one case a shopkeeper had supplied a customer with petrol instead of paraffin; in another some boys had been sold live cartridges instead of blank. As these were matters "of life and death," a broadcast warning was issued, and it is pleasant to record that both the petrol and the live cartridges were discovered before they had done any damage.

Another of the odd cases in which an S.O.S. message was the only method of saving a life occurred in the previous year, when a little girl who had swallowed a pin went to a London hospital to be examined. When the X-ray photographs were developed it was found that an immediate operation was necessary, but in the meantime the girl had vanished, leaving her name but no address. The only way of finding her was by broadcasting, and an S.O.S. message had the satisfactory result of bringing the girl back to the hospital in a few minutes.

There was one important change in the service during 1933. Until September 1st the B.B.C. had frequently broadcast

descriptions of missing persons, when it was thought that the safety of the missing person was endangered. These messages, which were broadcast at the request of the public and were carefully checked by the police, were generally concerned with children or with persons who were mentally deranged. It was found, however, that a broadcast description did not provide an effective method of finding a missing person, and the figures for a number of years showed that only about one in five of such messages was successful. For this reason it was decided to discontinue the service, and the only messages for missing persons which can now be broadcast are those which the police originate in connection with the detection of crime.

The possibilities of broadcasting as a means of assisting in this connection were brought home to the public early in 1933, when two messages were broadcast in connection with what was known as "the blazing shed mystery." The second of these messages said that the missing man was "wanted for wilful murder," and it was the first occasion on which such an announcement had been conveyed to the public by broadcasting. Other police messages are those calling for witnesses of accidents.

From these instances it can be seen that the S.O.S. service has taken a definite place in the social life of the community. It is not always effective, for many of the messages are failures. But the number of successes is quite high, and they are worth recalling by listeners who become impatient when the announcer says "Here is an S.O.S. message."

S. O. S. RESULTS JULY 1st, 1932, TO JUNE 30th, 1933

	Success-ful	Unsuc-cessful	Not known	Total
Illness	304	206	32	542
Missing	58	258	—	316
Witnesses of Acci- dents, etc.	53	80	—	133
Total	415	544	32	991

NEWS—A FABLE

AFTER MATURE CONSIDERATION the News Editor of the Ruritanian Broadcasting Corporation decided to include the following paragraph in the General News Bulletin:—

“In a speech in the Ruritanian Diet this evening M. Protomanoff, the Minister of Boviculture and Piggeries, said that the Government could not accept the scheme for the nationalisation of the pig industry. It was, he said, in direct contravention of the established policy of the Government, and nothing could induce him to proceed with such a measure. M. Deuterocarpoff, the Leader of the Opposition, criticised the Government’s attitude, which he regarded as reactionary and out of tune with the spirit of the times. The Opposition, he added, would not rest until it had roused the whole of Ruritania to a sense of the Government’s deficiencies.”

The item was duly broadcast, and the News Editor went home to bed, feeling that he had given a fair summary of a discussion which had already been thrashed out a hundred times in Press and Parliament.

On the following morning the News Editor read the papers. This is what they said:—

Ruritanian Tribune (Government organ): “We have so often referred to the Oppositionist tendencies of the R.B.C. that its latest gaff will come as no surprise to our readers. In its report of the pig debate in the Diet last night the telling arguments of the Minister of Boviculture were deliberately suppressed, and only a bare outline of his speech was given. It is absurd to suppose that the omission was accidental: there is more in it than that. Who is responsible for this suppression, which was obviously done with the purpose of throwing mud at the Government? The whole matter should at once be investigated.”

Ruritanian War-Cry (Opposition organ): “The news bulletin which was broadcast last night by the R.B.C. gave another example of the secret censorship which is at work in that reactionary and subservient organisation. M. Deuterocarpoff completely shattered the Government’s arguments

against the nationalisation of pigs, and his speech was the most remarkable piece of oratory which has been heard in the Diet this session. The R.B.C. gave only two sentences of M. Deuterocarpoff's speech, for it obviously feared that any fuller summary would expose the incompetence of the Government. Who is responsible for this suppression, which was obviously done with the purpose of belittling the Opposition? The whole matter should at once be investigated."

Ruritanian Workman (Communist organ): "The R.B.C. is at it again! The Workmen's Conference, which was held at Nunsk yesterday, passed a resolution demanding the immediate confiscation of all privately-owned property. Not a word of this was included in the R.B.C. news bulletins, and instead we were treated to a long and wearisome report of the pig debate in the Diet, in which every argument of both sides was reported at great length. Who cares about the Government's views on pigs when matters of such grave import are being discussed at Nunsk? It is perfectly clear that the R.B.C. is in the pay of the Government, and the whole matter should at once be investigated."

Ruritanian Agricultural Daily: "The cursory treatment of the pig debate revealed the R.B.C.'s usual contempt for the farming industry. So much time is given to Communist propaganda that agriculture is virtually ignored."

Ruritanian Evening Light (Independent organ): "We are sick of pigs. Cannot the R.B.C. give us brighter news bulletins instead of giving us long accounts of boring debates on subjects which are so familiar that there is no possibility of any novel development? Pigs, indeed! Why pigs? The news bulletins are becoming a farce, and the whole matter should at once be investigated."

The News Editor of the Ruritanian Broadcasting Corporation read no more. He went back to bed with a splitting headache.

MORAL: Those who are looking for bias can always find it, even when it is not there.

WHAT THE CHILDREN LIKE

PROBABLY NO DEPARTMENT of broadcasting work possesses quite the variety of programme material that is presented in "Children's Hour." And yet this Children's Hour has always possessed a specific character of its own. The academic centre of radio art has even said that broadcasting has only produced two art forms of its own—being for the rest only the faithful or unfaithful translator of art forms developed before it was ever heard of. Radio drama is one of these, and Children's Hour the other. It may, therefore, be of interest to review briefly some of its components, in terms of popularity, for here at any rate there is no question of whether a programme *ought* to appeal—it simply *must*. There is no indifference so devastating as the child's.

Twice a year the Children's Hour, that period of 44 minutes between 5.15 and 5.59 p.m., asks its listeners to send in on a postcard a list of the six items they have liked best in the previous six months. A very large number, some thousands, of cards are received, and from them the programmes for Request Week, as this particular week is called, are made up.

The most popular items of Children's Hour programmes are the dialogue stories—stories, that is, told by a narrator with the characters speaking all with their proper voices. The late Mr. S. G. Hulme Beaman's 'Toytown series is a transcendently popular example. Larry the Lamb, Dennis the Dachshund, Ernest the Policeman, the Mayors of Toytown and of Arkville, the Magician and all the other characters are close friends of many thousands of listeners. Alas! there can be no more, no new ones. However, Miss Letts, with her series concerning the adventures of Pomona, Copper, Piggy and the others, has provided most popular material.

The plays produced in Children's Hour receive also a wide measure of appreciation. A series by Mr. L. du Garde Peach, "The Pageant of the Roads of England," giving pictures, vignettes of the roads throughout the centuries, has proved most successful; and fairy plays and light frivolous plays, some with musical score and all with musical interludes, are not forgotten. The Robin Hood plays of Mr. Franklyn Kelsey are also an attractive feature.



A DRAWING BY THE LATE S. G. HULME BEAMAN OF AN INCIDENT FROM HIS "TOYTOWN" STORIES

It is interesting to find that talks are immensely popular. It does not seem to matter what the subject is. Mr. Will Owen has broadcast a series on "Potted London," and there have been talks on Cornish smugglers and Cornish kitchens, on Spain, on Heraldry, on various aspects of the Zoo, on the lives of great painters, on travel in various parts of the world, on the sea-side, in fact on every conceivable subject from shoes to sealing-wax, and all seem to have a wide appeal.

Stories, just plain stories, are high up always on the list and one may say that their variety is infinite. Mr. Norman Hunter's two series, Professor Branestawm and Colonel Dedshot, and the unforgettable housekeeper Mrs. Flittersnoop, vie with an incredible King and Queen. There are Gnome stories and fairy stories and adventures, and last, but not least, animal stories.

Mr. Mortimer Batten's stories of the wild are famous and perennially popular, and there are Mr. Arthur Davenport's delightful Country Holiday series of dialogues and the more juvenile and anthropomorphic tales of Thornton W. Burgess.

So much for dialogue stories, plays, talks and tales which occupy the majority of space in these programmes; nevertheless, one-third of this period of programme time is devoted to music in, one might almost say, every single one of its many forms of manifestation. All plays and dialogue stories have musical interludes, piano, quintet or gramophone. Every week there are piano solos of a light classical nature, and there are singers of all types and artists whose virtuosity is displayed on instruments as diverse as saws, hand-bells, violins, xylophones and piano accordions. From time to time a full-length, full-dress orchestral concert is given and Dr. Boulton, Mr. Hely Hutchinson and Mr. Edward Clark have already conducted in the Children's Hour. There are also occasionally gramophone recitals and a concert of dance music to which the children may dance the old-fashioned dances as well as the new. In the gramophone recitals will be found classical music of a not too "difficult" nature by world-famous orchestras, songs by artists whose work would otherwise remain a sealed book to Children's Hour listeners, "novelty records" and, for a treat, an occasional modern dance number by a distinguished band.

Possibly the best motto for the Children's Hour would be "the higher the fewer." The great difficulty is not failing to hit the bull's-eye, but to know which bull's-eye to aim at. For what group of children shall programmes be designed? Is one to make programmes very easy or to keep the children stretching upwards? It is well known that if what are known as really good books are read to children they will enjoy them though incapable of reading them themselves. Recently the Children's Hour has inaugurated a Young Day, when endeavour is made to cater for those to whom, perhaps, the historical plays, the classical music, some of the talks and some of the stories are a little difficult. A judicious admixture of Mr. A. A. Milne, fairy stories, nonsense verse and nursery rhymes appear to make a suitable dish. The difficulty of arranging an ideal menu for Children's Hour is almost insuperable—"the golden rule is that there is no golden rule."

HOTEL AND CINEMA MUSIC

London

Carlton Hotel
Dorchester Hotel
Park Lane
Piccadilly Hotel

Commodore Theatre,
Hammersmith
Astoria Cinema, Brixton
Trocadero Cinema, Elephant and Castle
Regal Cinema, Kingston-on-Thames
Tussaud's Cinema, Marylebone
Pavilion Cinema, Shepherd's Bush
Granada Theatre, Tooting

Birmingham

Beaufort Cinema
Futurist Theatre
Lozell's Picture House
The Palace, Erdington

Blackpool

Imperial Hydro Hotel
Tower Ballroom

Bournemouth

Pavilion

Bradford

New Victoria Cinema

Buxton

Pavilion Gardens

Coventry

Hippodrome

Eastbourne

Grand Hotel
Winter Gardens

Leamington

Pump Room Gardens

Manchester

Paramount Theatre

Scarborough

The Spa

Torquay

The Pavilion

Whitby

The Spa

DANCE MUSIC

Roy Fox and his Band from the Café Anglais
Harry Roy and his Band from the Café Anglais
Casani Club Orchestra directed by Charles Kunz, from Casani's Club
Jack Jackson and his Band from the Dorchester Hotel
Ambrose's Blue Lyres from the Dorchester Hotel
Bertini and his Band from the Empress Ballroom, Blackpool
The Grosvenor House Dance Band conducted by Sydney Lipton, from Grosvenor House, Park Lane
Roy Fox and his Band from the Kit-Cat Restaurant
Ambrose and his Orchestra from the May Fair Hotel
Harry Roy and his Band from the May Fair Hotel
Lew Stone and the Monseigneur Band from Monseigneur
Sydney Kyte and his Band from the Piccadilly Hotel
Debroy Somers and his Band from the Plaza Theatre
The Savoy Hotel Orpheans, Al Collins and his Orchestra, and Geraldo and his Orchestra, from the Savoy Hotel.

OUTSIDE BROADCASTS

SOME OF THE PROBLEMS

THE "O.B.," which is a medium of communication and not an act of creation, has in consequence a dual responsibility, that towards the receiving public, in that the best broadcast possible in the conditions must be given to it, and that towards the originator—be it orchestra or team, orator or soloist—to whose output justice must be done. *What* is to be broadcast by O.B. means is a question of programme policy. *How* it is to be broadcast when "it" cannot be fitted into the smooth conditions and well-oiled machinery of the permanent studio is the concern of the O.B. staff. And "it" may be anything from an opera at Covent Garden to a religious service down a coal-mine, an open-air tattoo of marching troops, or a run on a fast express. The tentacles that broadcasting thus extends from the studio stronghold must therefore be numerous and pliable. Broadcasting has sometimes been called an octopus, from its grip on the innumerable public—but the public is rather the creature's body than its arms, and much of the varied food that that body requires must come to it through the activity of the "processes"—to use the biological term—thrown out by the O.B. organisation. That is the one side of its responsibility. The other is—so to treat the object grasped that it is satisfied to be thus fed to the public.

Thanks to the Post Office, there is usually little difficulty in maintaining the wire bodies of the "processes" intact, or, in other words, the lines part of the operation is usually secure enough. It is at the tip of the tentacle that it is sensitive. Here are nearly all the problems which lead an O.B. Engineer to write:—

"Rehearsals carried out in theatres while 'props' are being unpacked and scenery shifted, or the last moment arrangement of a vast series of signal lights all over a war-ship—these are commonplaces in the life of the O.B. staff. Few of them would exchange its constant alarms and excursions for anything else."

But the purpose of this article is not to treat of these alarms and excursions, but to catalogue briefly some of the difficulties and complexities of the problems themselves.

All Outside Broadcasts necessitate careful preliminary surveys to ensure that the sound picture is representative of the performance actually taking place. It is only too easy to broadcast "out of focus."

In the case of sporting commentaries a position must be found from which the commentator may observe the event. At Aintree and Epsom, for example, it has been difficult to find a good observation point. At Aintree it is impossible for the commentator at the Grand Stand to pick out the horses at the Canal Turn, which is nearly a mile out in "the country," and though he attempted to do so for the first three years, arrangements were made in 1930 for a second commentator to observe the race at the Canal Turn. Three circuits are installed between the van and the control point in the Grand Stand—one for the commentary from the Canal Turn, one for control, and one so that those on the van can hear the Grand Stand commentary and know when to fit in. At Epsom difficulties had arisen from the fact that on Derby Day that part of the course which bends round the Hill is lined with vehicles, which completely obstructed the commentator's view. Fortunately an improved position in the new Grand Stand became available this year, giving the commentator a position some thirty feet higher than his old one. Even so this year's Derby is not considered to have been really "good listening."

From the technical point of view, the Boat Race is perhaps the most outstanding of all outside broadcasts. The launch *Magician* which follows the crews over the course from Putney to Mortlake, is fitted up with a portable transmitter capable of sending clear signals over a range of twenty miles. (see p. 385 for technical description). The speech transmitted is picked up at a receiving position on the roof of Harrods' Depository at Barnes, and from there it is relayed to Control Room, Broadcasting House, for distribution to transmitters. One of the difficulties experienced in this broadcast is the inability to hold two-way communication between the launch and the reception point.

Commentaries from Wimbledon present a different sort of problem, as no detailed arrangements or timings can be decided upon until play has started. And though, so far as is compatible with programme commitments, the finals are broad-

cast in full, the programme value of other matches has to be decided upon after consideration of several points, including the importance of the match and the players—particularly in regard to the international position. When there is an unexpectedly close finish, at the last moment it may be decided to broadcast the last set, and arrangements are made for a commentary to break into the normal programme.

At the International Rugger matches these difficulties do not occur. The time is settled beforehand and little variation ever takes place. Though the weather has to be exceedingly unpleasant to stop play, the greatest difficulty experienced by the commentator at these matches is due to the mud! The players become indistinguishable, so the commentator must be sure of the men and cannot waste time deciding who that particular mud-covered figure is.

When broadcasting ceremonies or public speeches, careful preliminary investigation is necessary to ensure that the speeches are adequately covered microphonically, and that the programme as a whole is suitable for broadcasting. Whereas a short pause in the proceedings does not necessarily jeopardise the programme for those present, it is disastrous from the listener's point of view. Similarly, such portion of the ceremony as has a purely visual appeal means nothing to the listener. With the co-operation of the organisers, it is often possible to arrange for a continuous sound picture to be presented during the broadcast portion (see p. 303 for a description of the complicated O.B. of the inauguration of President Roosevelt).

The Ceremony of the Keys is a good example of a broadcast which requires elaborate technical arrangements to ensure "continuity." Few words are spoken, and we only hear the tramp of feet for the major part of the relay. No fewer than seven microphone points are installed on the short route of two hundred yards or so that is taken by the Chief Warder, and as he moves out of range of one microphone he comes into range of the next. The Ceremony itself, and the descriptive announcement, are carefully timed so that the ten o'clock chime on the Tower clock comes in its proper place, just before the Last Post.

In broadcasting the major ceremonies, care has to be taken in the placing of the microphones so that they do not interfere in any way with the proceedings or impair the dignity of the

ceremony by an unsightly array of microphone. For instance, when His Majesty opened the Monetary and Economic Conference, they were concealed in the table behind which His Majesty stood ; at the Cenotaph Service they are placed inside a portable lectern made specially for this event. It is occasionally possible to link up such parts of a ceremony as describe themselves by giving a commentary, as was done at the opening of the new gravings dock at Southampton, on July 26th, by H.M. the King.

When religious services are broadcast from cathedrals and churches, circuits are run to all the necessary parts of the building. In a complicated service, such as an enthronement of the Archbishop of York or Canterbury, as many as fifteen have been installed. They are all connected to a suitable position, sometimes in the crypt, where the B.B.C. engineers control the broadcast, energising the various microphones as required.

This is an ever-present difficulty in the broadcasting of Tattoos. Only certain items are suitable and, as it is usually the opening night that is broadcast, there is frequently considerable discrepancy between the scheduled and the actual timing. An official at the control position at the Tattoo keeps in close touch with the studio announcer, and warns him of probable variations. On a recent occasion the timings of the rehearsals and performance varied considerably with each other and with the scheduled programme, and it was almost impossible to give the announcer sufficiently accurate information to enable him to bring the previous programme to an artistic close, announce the Tattoo programme, and fade into it at the correct moment. Tattoos also present considerable technical problems. When bands are marching across so large a space as the Tattoo arena, it is not always easy to arrange for the microphone to pick up the band in balance and in sufficient strength. Furthermore, sound reflection from the grand stands, etc. can seriously affect the relay. At Tidworth microphone balance was achieved by an engineer suitably camouflaged in a green overall, carrying a microphone on to the arena. He wore headphones connected to a telephone in the Control Van, so that the engineer there could control his movements during the broadcast. In addition, microphones were fixed at various points on the edge of the arena, and on the roof of the grand stand.

BROADCAST PLAYS

The following were the most important plays broadcast between 1st November, 1932 and 31st October, 1933.

Microphone Plays

- "The Family Tree" and "The Game" (Philip Wade)
- "Mozart" (Whitaker Wilson)
- "Three Soldiers" (L. du Garde Peach)
- "Chopin" (Wilfred Rooke-Ley and Christopher Martin)
- "Ann and Harold" (Louis Goodrich)
- "Yours to You" (Adrian Thomas)
- "Flags on the Matterhorn" (Gasbarra and Pfeil)
- "The Mulberry Bush" (E. M. Delafield)
- "The Use of Man" (Lord Dunsany)
- "Pursuit" (Cecil Lewis)
- "The White Château" (Berkeley)

Adapted Stage Plays

- "The Captain of Köpenick" (Carl Zuckmayer)
- "The Immortal Lady" (Clifford Bax)
- "The Forest," "Escape," and "Strife" (Galsworthy)
- "The Green Goddess" (William Archer)
- "The School for Scandal" (Sheridan)
- "Hassan" (James Elroy Flecker)
- "The Ringer" (Edgar Wallace)
- "Coriolanus," "Romeo and Juliet," "As you like it," "Hamlet," "Henry V," and "Othello" (Shakespeare)
- "Aucassin and Nicolette" (trans. from the French by Eugene Mason)
- "The Wild Duck" (Ibsen)
- "The Watched Pot" (H. H. Munro and Chas. Maude)
- "R.U.R." (Karel Kapek)
- "Quinneys" (Horace Annesley Vachell)

Adapted Novels and Stories

- "The Three Musketeers" (Dumas)
- "Jane Eyre" (Charlotte Brontë)
- "Ghosts at Solberga" (Selma Lagerlöf)
- "The Fall of the House of Usher" (Edgar Allan Poe)
- "The Bottle Imp" (Robert Louis Stevenson)
- "A Voyage to Lilliput" (Swift)
- "Mr. Petre" (Hilaire Belloc)
- "The Fantastic Battle" (Burns)
- "Carnival" (Compton Mackenzie)
- "The Country of the Blind" (H. G. Wells)



Sasha

ELIZABETH BERGNER

who gave her first broadcast in Ibsen's "The Wild Duck" on May 31st, 1933

RADIO DRAMA

FROM THE POINT of view of serious dramatic production, 1933 has been both an encouraging and a disappointing year. It has been disappointing because the hopes that were raised in 1931-32 of an increase in both the quality and quantity of original radio plays were not fulfilled. It would appear that either the medium itself is insufficiently attractive, or that the economic reward appears too insignificant to attract the more talented authors to work for the microphone; and unknown authors of promise would seem still to be too strongly attracted by the stage, the screen and the publishers to realise the advantages that may be gained by experimenting in writing plays for broadcasting. Of course, there have been exceptions. Both Miss E. M. Delafield (whose "To See Ourselves" proved one of the most successful stage plays ever adapted to the microphone), and Lord Dunsany were persuaded to write original broadcast plays. Mr. Adrian Thomas, with "Yours to You," exploited with advantage a vein previously opened by Mr. Tyrone Guthrie. Mr. Du Garde Peach, with "Three Soldiers," and Mr. Philip Wade, with "The Game," produced admirable and typical work. But it cannot be said to have been a vintage year for the pure radio drama.

On the other hand, stage adaptations have been quite unusually successful. Both Ibsen and Edgar Wallace were presented to the listening audience for the first time in specially adapted broadcast versions of "The Wild Duck" and "The Ringer" respectively. The former (*pace* Mr. Bernard Shaw) was probably the outstanding dramatic broadcast of the year, largely owing to the fact that Miss Elizabeth Bergner, the celebrated German actress, was persuaded to make her first appearance before any microphone, and scored a triumphant success. This actress, with her remarkable range of vocal intonation and her really terrific emotional intensity, destroyed for ever the persistence of the legend that acting in the truest sense cannot "get over" in the theatre of the air. On the other hand, "The Ringer" showed that there is still emphatically a place amongst broadcast plays for the quick-moving story of adventure—provided its dialogue and characterisation maintain some contact with reality.

Edgar Wallace proved far more adaptable to the microphone in this *genre* than did Anthony Hope.

Notable revivals included the special adaptation of "Jane Eyre," the inimitably romantic "Chopin," "Hassan" in two parts, magnificently interpreted by Mr. Ainley, Mr. Leon Quartermaine and Mr. Ion Swinley, "Aucassin and Nicolette," "Voyage to Lilliput" and "Across the Moon."

Adaptations from novels and stories were well represented, first and most important being the broadcast version of Mr. H. G. Wells' famous story "The Country of the Blind," which was outstanding in atmosphere and dramatic force. "Ghosts at Solberga" and "The Fall of the House of Usher" proved that the weird and macabre are still among the most promising subjects for the radio dramatist.

Shakespeare was somewhat sparsely represented in the early part of the year by performances of "Much Ado about Nothing" and "Coriolanus," but the autumn sees the opening of a new Shakespearian series. This series, which, starting with "Othello," is ultimately to include the whole range of the plays with the exception of those that are either doubtful in authorship, or from subject or characterisation completely unsuitable for broadcasting, is to be given once a month on Sunday evenings, and will last accordingly over two years. The choice of this period of programme time was made principally in order that it might be possible to secure for the casts of these plays actors and actresses who are available on Sundays, but whose normal stage occupations prevent them from accepting broadcast engagements during the week. It has been abundantly proved that only the most distinguished theatrical artists can do justice to Shakespeare's plays. Even in broadcast performances these plays demand a technical training—not only of voice, but also of physique and intelligence—that cannot be supplied except by actors of distinction and experience.

Mention should also be made of what has been called the first "Festival of Radio Drama" in October. This is a series of revivals of twelve English plays specifically written for the microphone between 1924 and 1933, and covering therefore the whole range of development of the broadcast play beginning with Mr. Richard Hughes' first experiment in this new art form with "Danger," and ending with the extremely up-to-date

adaptation by Mr. Riddell and Mr. Guthrie of Dumas' "The Three Musketeers," originally produced at the end of 1932. The object of this series was in some way to celebrate the first ten years of radio drama, and also to mark the end of one definite stage in the broadcast play's history. More and more it would seem that the era of experimentation in production technique is giving place to an intensified search for more satisfactory content of plays to be broadcast. This does not mean that the Productions Department is either finally satisfied with its technical achievements, or that its production experiments will lapse; but a certain standard of reasonable professional competence in production can now be claimed, and there is a definite and valuable tendency to concentrate more upon what is broadcast and perhaps a trifle less on the method of broadcasting it. The method, within wide and elastic boundaries, has been more or less settled. It is towards better and better plays and towards a greater sympathy with, and a fuller knowledge of, the requirements of the listening audience that the efforts of broadcast producers have now to be directed. How this method of broadcasting plays has gradually grown up and crystallised it has been the object of this so-called Festival to show.

PLAYS BROADCAST IN THE DRAMA FESTIVAL

- "Danger" (Richard Hughes)
- "The Wrong Bus" (Martin Hussingtree)
- "The White Château" (Reginald Berkeley)
- "Pursuit" (Cecil Lewis)
- "Kaleidoscope 1" (L. de G. Sieveking)
- "Carnival" (Compton Mackenzie)
- "The Flowers are not for you to pick" (Tyrone Guthrie)
- "Matinée" (P. H. Lennox)
- "Obsession" (Dulcima Glasby)
- "Red Tabs" (Val Gielgud)
- "Romance" (Joseph Conrad and Ford Maddox Hueffer)
- "The Path of Glory" (L. du Garde Peach)
- "Streets of London" (Calthrop)
- "The Three Musketeers" (Alexandre Dumas)

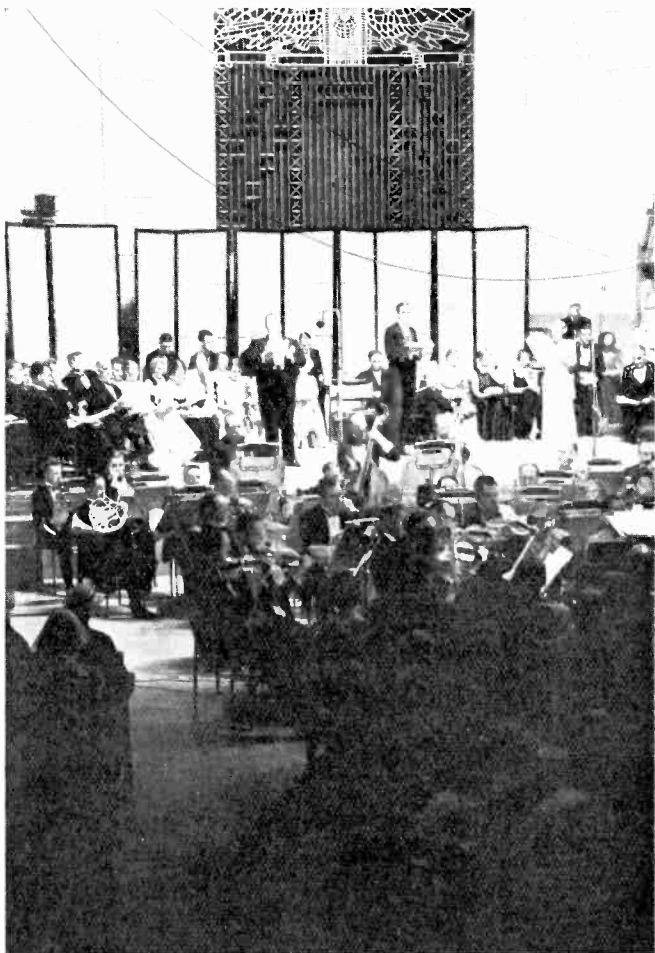

"WALTZ TIME" BEING BROADCAST BEFORE AN AUDIENCE IN THE
CONCERT HALL AT BROADCASTING HOUSE

BROADCAST VARIETY

THIS TERM "variety" is a broad one. It is used at Broadcasting House to describe vaudeville, musical comedy, revue, operetta, cabaret, and dance- and theatre-music from the studio: all of which are under the control of the same department. Variety, in effect, may be taken to mean "light musical entertainment" of every kind.

Variety is broadcast to the extent of $17\frac{1}{2}$ hours of programmes each week. Not all these programmes are ambitious on a large scale; each, however, requires devising, producing, rehearsing and transmitting. The task of creating over 900 hours of entertainment per annum is no light one. The weekly programme time is allotted as follows: the B.B.C. Dance Orchestra, $7\frac{1}{2}$ hrs.; vaudeville, 2 hrs.; Theatre Orchestra, $2\frac{1}{2}$ hrs.; revue, 2 hrs.; operetta, 2 hrs.; surprise and other items, $1\frac{1}{2}$ hrs.

"Variety" programmes are "staged" for the most part in Studio BA, which is equipped with a stage, flood-lighting and accommodation for an audience of 60. Other studios used by the department are 8A (borrowed for this purpose from the Military Band), the Concert Hall and "Number Ten" (it keeps its nomenclature from Savoy Hill days), the ex-warehouse by Waterloo Bridge which is shared by the Symphony Orchestra and musical comedy and "music hall" programmes.

The problem of providing so much light entertainment annually, though a ticklish one, is made easier by one proven fact: it is the simplest programmes that are most successful.

The superlative technical equipment of Broadcasting House has encouraged ambitious young programme-builders to experiment in elaborate productions that require many studios and microphones, with personnel and *matériel* galore, but these bold experiments, commendable though they may be, have never yet achieved the nation-wide success of straightforward unambitious programmes such as the *Songs from the Shows* (favourite songs, linked with informal announcements), Jack Payne's or Jack Hylton's band (dance music of the boldest and most "popular" type) or a Christopher Stone recital (one man put-

ting on gramophone records to the accompaniment of casual, and ever-delightful, comment).

The task of providing variety is made easier by the fact that tired listeners do not want elaborate entertainments; they ask for programmes that "give" rather than programmes that "demand."

When a programme "gives," what does it give? The answer is: vitality. Vitality is the single most essential ingredient of variety fare. The vital performer is more valuable than the "clever" performer, since the appreciation of "cleverness" demands an unwelcome mental effort, whereas vitality communicates to the listener a mental and physical stimulus. This stimulus is what the ordinary listener asks of popular entertainment. Let talks, classical music, education, a dozen other B.B.C. activities provide him with brain food; it is Variety's business to provide him with something less exacting.

The creation of a special Variety Department during the past year resulted from a recognition of this important fact—and an examination of the policy of this department so far will show that its producers have aimed at the broadest and simplest form of entertainment.

The wireless correspondents of the Press "think in milleniums"; each new B.B.C. development is held by them to herald an era of sweeping change and improvement. Without being in the least defeatist, we should say that there is little room in the field of light entertainment for cataclysmic changes of the kind these writers are for ever demanding and expecting. Broadcast variety is deprived, for one reason and another, of three-fifths of the facilities that are at the disposal of theatre, vaudeville, and film producers. The wireless audience cannot see as yet and is therefore deprived of a large proportion of the material available in the theatre.

When you next visit a music-hall, ask yourself how many of the "acts" you see could be satisfactorily adapted for broadcasting.

The music-hall uses a thousand visual "acts," from dancers and conjurers to acrobats and "knockabouts." The studio can use none of these; its material is confined to words and music. Even broadcast humour is a cramped thing, since it cannot be allowed to offend the susceptibilities of even a minority of its

12,000,000 audience; while popular music already figures so largely in the non-variety programmes that it is difficult to find musical material capable of lending character and colour to Variety.

These shortcomings are formidable, but not insuperable; the most innocuous material, the simplest song can become truly entertaining in the hands of the performer who possesses vitality—or call it, if you like, “personality.” Vitality alone is capable of bridging the enormous gulf that lies between the broadcaster in the studio and the listener in his home. Broadcasting has been derided as “canned” entertainment. It is “canned” in so far as an enormous number of mechanical processes are used to create an illusion of reality, but the vitality of the really great broadcaster can survive these processes and emerge, a thousand miles away, as a living quality.

The quality of the man in the studio is the only weapon with which he can fight the disadvantages of the medium: the inevitable “deadness” of his surroundings, the absence of physical proximity to his audience, the absolute necessity of controlling his material and so on. Make a list of the people whom you rank as “radio stars” and decide for yourself what, however diverse their methods or material, is the quality they share. It is, broadly, vitality; some quality that keeps you listening, even though you may be surrounded with every distraction that the home setting offers a tired, and therefore inattentive, man.

Technical cleverness and elaboration only throw up a further veil between the personality in the studio and the distant audience. That is why the future of broadcast Variety lies in the simpler type of programme, one in which the human element, rather than the mechanical, preponderates. Let every other branch of the programmes be as clever as it will, Variety must aim at something simpler. Its appeal is to the majority. It must be “popular,” since the audience for which it is intended is that which we know as the People.

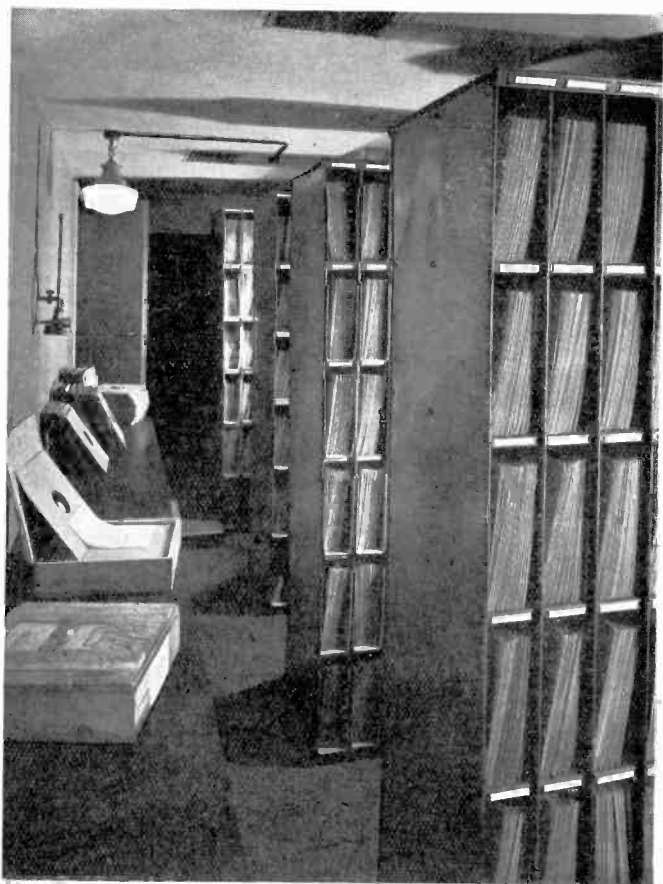

THE "RECORDED PROGRAMMES" LIBRARY

THE FUNCTION OF THE SOUND RECORD

THE LAST SIX MONTHS have seen implemented a decision that has effected a minor revolution in broadcasting in this country. From April to September, 1933, a new section—the Recorded Programmes Section—has been built up at Broadcasting House. Its essentials are a library of 25,000 records and a separate staff of programme builders, all of them experienced musicians with a knowledge of the full range of recorded music. In this period the sound record has come to play an increasingly important part in broadcasting, filling in gaps in the programme hours and giving listeners programmes available under no other conditions.

The first, and most important aspect of the work, is the programme use made of the ordinary commercial record as issued by the gramophone companies and bought by the public in the usual way. From the many catalogues there have already emerged such successful series as the "Conductors of the World," which presented week by week a concert of symphony recordings, exhibiting the characteristics in the conducting of world-famous conductors such as Toscanini, Mengelberg, Fürtwangler, etc. Similarly, the series "Celebrity Artists" has given listeners complete and representative programmes of such famous performers as Fritz Kreisler, John MacCormack, and Yehudi Menuhin.

"Rhythm in Music" has, at the same time, given proof of a truth that needed emphasis in these days of extravagant claims for the more ambitious type of Jazz; it has emphasised that Jazz, "hot" or otherwise, has no monopoly of rhythm. In the miscellaneous programmes also—built on music and speech records—while each item is complete in itself, the whole is unified by a mood or train of thought.

Another large public has been catered for by the Gilbert and Sullivan Opera series; and in this field there has also been one other notable experiment. On June 9th, "Pagliacci," played and sung by the principals, chorus and orchestra of La Scala, Milan, was given in its entirety, the opera being presented as from an opera house with applause and room noises to heighten the illusion of a relay. Later, "Madame Butterfly" and "Tosca"

were presented in the same way. In the field of dance music, listeners have been given the popular hits of the moment played by famous recording bands, including many American units which they would otherwise seldom, if ever, hear.

Christopher Stone, popular as ever, continues to build his own programmes from the current lists, consulting with the Recorded Programmes Section so that overlapping may be avoided.

Further uses were indicated by the experimental programmes "Sound Pictures" and "Voices of the British Stage," the first of which presented, without announcement, popular dance tunes, well-known classics, speakers and actors, leaving the naming of the items to the listeners; while the second was a collection of well-known actors playing famous parts, the whole being blended together with incidental music.

Thus the Sound Record has enormously enriched the material of broadcasting, and has given listeners entertainment of every type by the best performers at a time of day when it would be impossible to present either orchestras or the artists in person.

The Blattnerphone records on a magnetised steel tape that can be played back at once or stored for future use as occasion demands. At present the Blattnerphone is used extensively to record the National and Regional programmes for re-transmission to Empire listeners at the abnormal hours which local time in the various zones demands. Arising out of this, a further use has been developed in recent months for recording a broadcast that is not heard by listeners at the time, for transmission a little later. An example of this was the recording of a running commentary on the Davis Cup in the afternoon of July 1st, and the relaying of it in the News Bulletin several hours later. This was also done effectively in the case of the Grand National and the St. Leger.

Special recordings are also ordered from the gramophone companies from time to time.

The fundamental basis of all these activities is the Recorded Programmes Library. In September 1933 it comprised 25,000 records. These have been accumulated, carded and filed in six months. Two copies of every record are kept—one for rehearsal, and one for transmission—but both copies are made use of in any transmission where the tune takes up two sides of

the record, for it is possible by accurate timing and fading from record to record to play through, for example, a movement of a symphony, without break. The library falls into four sections, each of which is organised as a unit with its own indexes of titles, artists, composers, etc. The first section is by far the largest, embracing every current commercial record stored, and this section has a special subdivision (the second section) for the treatment of dance music records. When the short life of the average dance record is ended it is discarded, but in the case of records that have caught a popular mood, or in some way express the spirit of the moment, or should for any reason be likely to be of interest one or fifty years hence, two copies are retained (should the matrix be destroyed) and stored in what is called a "museum library." The third section is composed of records made specially for the B.B.C., together with "waxes" made up of material originally recorded on the Blattnerphone, while the fourth section deals exclusively with foreign records.



THE KING OPENING THE WORLD ECONOMIC CONFERENCE AT THE
GEOLOGICAL MUSEUM, LONDON, ON JUNE 12TH, 1933

EVENTS OF THE YEAR

1932
Nov.

- 1 "The Eve of All Souls," a Miracle Play by Bernard Walke, performed by the St. Hilary Players.
Municipal Election Results.
- 2 B.B.C. Symphony Concert conducted by Adrian Boult; the B.B.C. Chorus in Walton's "Belshazzar's Feast."
- 4 Talk by Sir Josiah Stamp on "National Taxation."
- 5 Talk by M. Sacha Guitry, the French author and actor.
- 7 Mr. Vernon Bartlett speaking from Berlin on 'The German Elections.
Act III of Wagner's "The Mastersingers" by the Covent Garden Opera Company.
- 9 Speech by Mr. Stanley Baldwin at the Lord Mayor's Banquet at the Guildhall.
Talk by Mr. William Hard on the American Presidential Election, relayed from the United States.
- 11 Armistice Day Service from the Cenotaph.
Festival of Empire and Remembrance, presented by the British Legion, from the Royal Albert Hall.
"In Memoriam 1914-1918," a Programme of Poetry and Music, produced by E. A. Harding and Val Gielgud.
- 13 Shakespeare's "Romeo and Juliet," produced by Val Gielgud.
- 14 Tenth Birthday of the B.B.C.
Mr. John Watt conducting "A Tour of Broadcasting House."
"Hello London, Here's Berlin," a Programme conducted by Eduard Kunneke from Broadcasting House, Berlin.
- 15 Command Variety Performance to H.R.H. the Prince of Wales in the Studio.
"This B.B.C."—Ten Years of Broadcasting discussed by Lord Allen of Hurtwood and Sir Ernest Benn.
- 16 B.B.C. Symphony Concert conducted by Ernest Ansermet, including Stravinsky's "Le Sacre du Printemps."
- 17 Part I. of Dumas' "The Three Musketeers."
Mr. Vernon Bartlett's talk from Prague, and introducing President Masaryk who spoke in English.
- 18 Message by The Prince of Wales to the Ulster People on the conclusion of his visit to Ulster.
Mr. Hugh Latimer on The Resignation of Herr von Papen.
Haydn's "The Creation" performed by the B.B.C. Orchestra conducted by Percy Pitt, and Kate Winter, John Armstrong, Arthur Cranmer, and the Wireless Chorus.
- 19 Speech by Mrs. Amy Mollison from Cape Town after her solo flight.
"Communications—1922-1932," a Programme of Ten Years' Progress by Land, Sea, and Air, including a Speech by Mr. H. G. Wells, speculating on the future.
Paul Whiteman and his Orchestra broadcasting from New York.

- Nov. 20 A Discussion on "Is there any Greek Sculpture?" between Professor Bernard Ashmole and Mr. R. H. Wilenski.
- 23 First Talk in the series "Unfinished Debates on Legal Problems."
Symphony Concert conducted by Sir Henry Wood. Pau Casals playing Haydn's Concerto in D.
Mr. Adrian Boult broadcasting an Obituary of Percy Pitt.
- 24 "The Last Watch," a Dramatic Postscript to the Dreyfus Affair, adapted and produced by Val Gielgud.
Mr. Victor Smith: "My Flight from Cape Town."
- 25 First of a Series of Contemporary Music Concerts in the Concert Hall, Broadcasting House.
- 27 Twenty-ninth Annual Scottish Festival Service from St. Columba's, Pont Street.
- 30 Elgar Celebration Concert at the Queen's Hall by the B.B.C. Symphony Orchestra conducted by Sir Edward Elgar and Sir Landon Ronald.
- Dec. 1 Speeches by Sir Robert Horne and M. Doumergue at the Annual Banquet of the United Associations of Great Britain and France.
- 2 Talk by Mr. Hugh Latimer on "The Schleicher Cabinet in Germany."
- 3 Act II of "The Mikado" from the Savoy Theatre.
Running Commentary on the American Football Match, Army *v.* Navy, relayed from Philadelphia.
Elgar Celebration Chamber Music Concert by the Catterall String Quartet and William Murdoch.
- 6 Talk by Douglas Fairbanks on his arriving in England.
Programme of English Folk Music celebrating the twenty-first birthday of the English Folk Dance Society.
Commentary on the Oxford *v.* Cambridge Rugby Football Match at Twickenham.
- 7 Dame Beatrix Lyall and Lord Buckmaster in the series of Talks on "Unfinished Debates on Legal Problems."
Elgar Celebration Concert by the B.B.C. Symphony Orchestra conducted by Sir Edward Elgar and Adrian Boult.
Commentary on the England *v.* Austria Association Football Match at Stamford Bridge.
- 9 Concert in aid of "The League of Mercy" including Sir Henry Lytton, Peggy Wood and Owen Nares.
"The Immortal Lady," a Play by Clifford Bax, produced by E. J. King-Bull.
Act I. of "The Gondoliers" from the Savoy Theatre.
- 12 Commemoration Service from King's College, London.
- 13 Galsworthy's, "The Forest," produced by Howard Rose.
- 14 Last Elgar Celebration Concert by the B.B.C. Symphony Orchestra conducted by Adrian Boult in a performance of Elgar's "The Kingdom."
Speech by Mr. R. B. Bennett, Prime Minister of Canada, at the Dinner given in his honour at Claridge's Hotel.
- 19 The Prime Minister, Mr. J. Ramsay MacDonald, speaking on "The Nation and the Unemployed."
Opening of the Empire Broadcasting Station at Daventry.



Lambert, Bath

SIR EDWARD ELGAR CELEBRATION CONCERTS IN THE QUEEN'S HALL
(November 30th, December 7th and 14th, 1933)



THE PRINCE OF WALES TALKING TO UNEMPLOYED MEN ON THE
ALLOTMENTS WHICH HAVE BEEN PROVIDED FOR THEM

(January 6th, 1933)

- Dec. 21 "Bethlehem," a Nativity Play by Bernard Walke, from the Parish Church of St. Hilary, Cornwall.
Talk by Sir Evelyn Wrench on "The World and Ourselves at Christmas."
- 22 Act I. of Weber's "Der Freischutz" from the Municipal Opera House, Berlin.
- 24 Christmas Eve Festival of Carols from King's College Chapel, Cambridge.
Carol Service by the B.B.C. Wireless Chorus and Military Band conducted by Cyril Dalmaine from St. Mary's, Whitechapel.
Extracts from "The Yeomen of the Guard" from the Savoy Theatre.
- 25 Christmas Greetings to the Empire and a Message by H.M. the King.
"All the World Over" Christmas Greetings.
Religious Service from Winchester Cathedral.
- 26 Dvorak's Slavonic Dances by the Czech Philharmonic Orchestra from the Salle Smetana, Prague.
Birmingham Festival Choral Society's performance of Handel's "The Messiah."
- 28 Isobel Elsom and Leon M. Lion in "The Green Goddess," by William Archer, produced by Howard Rose.
- 30 Eye-witness account by A. F. Kippax on the Second Test Match from Melbourne.
- 31 Opening Night of the Christmas Season of Promenade Concerts by the B.B.C. Symphony Orchestra conducted by Sir Henry Wood.
"New Year over Europe"—Short Programmes from Cities in Europe, including Watch-Night Service at All Souls', Langham Place, and the Grand Good-night by Mr. J. C. Stobart.

1933
Jan.

- 1 The Archbishop of Canterbury introducing the series of talks on "God and the World through Christian Eyes."
- 3 "Jane Eyre," by Charlotte Brontë, produced by Howard Rose.
Programme of Russian Music at the Promenade Concert in the Queen's Hall; Pouchinoff playing Tschaikevsky's Concerto No. 1.
- 4 Discussion on "Spending and Saving" between Sir Josiah Stamp and Mr. J. M. Keynes.
Presidential Address by the Earl of Athlone at the Twenty-first Annual Conference of Educational Associations.
- 5 Programme of Delius's Music at the Promenade Concert in the Queen's Hall.
- 6 Talk by "Argus" on the Cinema.
H.R.H. The Prince of Wales introducing "S.O.S.," a new series of talks on Unemployment by S. P. B. Mais.
- 7 First of a series of talks by Mr. S. P. B. Mais on "The Week-End."
Choruses from Handel's "Messiah" by the Sheffield Musical Union Chorus in the Promenade Concert at the Queen's Hall.

- Jan. 9 Dr. R. A. Young in the first of a series of talks on "Man versus Microbe."
 "The Country of the Blind," by H. G. Wells, presented as a Drama by E. J. King-Bull.
 Mr. Howard Marshall on "Other People's Houses."
- 11 Talk by Dr. L. B. S. Leakey on his Anthropological Expedition in East Africa.
 Three Concertos of Bach in the Promenade Concert in the Queen's Hall.
- 14 Last Concert of the Christmas Promenade Series in the Queen's Hall.
- 15 Professor C. G. Seligman opening the series of talks on "The Future Life."
 The Archbishop of York giving the first talk in the series on "God and the World through Christian Eyes."
- 16 Professor John Macmurray introducing the series of talks on "Some Makers of the Modern Spirit."
- 17 Mr. Hugh Ruttledge describes the proposed Mount Everest Expedition Climb on the eve of its departure for the East.
- 18 First of a series of talks by Professor H. J. Laski, on "What is the State?"
- 20 First broadcast by Jean Forbes-Robertson in "The Ghosts at Solberga," produced by Peter Creswell.



JEAN FORBES-ROBERTSON GAVE HER FIRST BROADCAST IN "THE GHOSTS AT SOLBERGA"

(January 20th, 1933)

- Jan. 21 Commentary by Captain H. B. T. Wakelam on the International Rugby Match, England *v.* Wales at Twickenham. Last Night of D'Oyly Carte's Season of Gilbert and Sullivan Operas at the Savoy Theatre with "The Mikado." Farewell Speech by Sir Henry Lytton.
- 22 Dr. Edwyn Bevan speaking in the "Future Life" series.
Programme of Russian Music by the Wireless Military Band conducted by B. Walton O'Donnell.
Haydn's "The Seasons," by the B.B.C. Orchestra conducted by Adrian Boult. Soloists: Elsie Suddaby, Eric Greene, and Keith Falkner.
- 23 Mr. R. Ellis Roberts reviewing new books.
B.B.C. Orchestra conducted by Aylmer Buesst; Denise Sternberg playing Beethoven's Pianoforte Concerto No. 3.
- 24 Mr. O'Neill on "The Irish Free State Elections."
Cyril Maude in Sheridan's "The School for Scandal," produced by Howard Rose.
A Fraser-Simson Programme by the B.B.C. Orchestra conducted by Joseph Lewis. Dale Smith, accompanied by the Composer, singing new songs from "Alice in Wonderland."
- 25 B.B.C. Symphony Concert conducted by Adrian Boult; Huberman playing Mendelssohn's Violin Concerto in E Minor.
"Our Heritage," a Programme of National Melodies of the British Isles, played by the Leslie Bridgewater Quintet.
- 27 Concert by the London Philharmonic Orchestra conducted by Nicolai Malko; Smeternin playing the first performance of Szymoanovski's Piano Concerto.
- 28 General Sir Bindon Blood: A Centenary Tribute to the Memory of General Gordon.
"Hello, Fleet Street!" A Transatlantic Discussion between Theodore Dreiser, Ernest Boyd, George Jean Nathan and Richard R. Smith of the *American Spectator*.
- 29 Sunday Orchestral Concert by the B.B.C. Orchestra conducted by Frank Bridge, including Antonio Brosa playing the first performance of Benjamin's Violin Concerto conducted by the Composer.
- Feb. 1 B.B.C. Symphony Concert, including Harriet Cohen playing the first performance of Vaughan Williams' Pianoforte Concerto in C.
- 3 Three Plays: "The Hatchet" and "The Monkey's Paw" produced by Peter Creswell; and "Forward, Please," produced by Robin Whitworth.
First performance in London of Herbert Bedford's "Vox Veris."
- 4 Commentary on the International Rugby Football Match, Wales *v.* Scotland, at Swansea.
- 5 Programme of Herman Finck's Music by the B.B.C. Theatre Orchestra conducted by the Composer.



SIR HENRY LYTTON'S FAREWELL NIGHT
In "The Mikado"
(January 21st, 1933)

- Feb. 6 Chamber Music by the Pro Arte String Quartet in the first of a series of public concerts in the Concert Hall, Broadcasting House.
- 7 Henry Ainley in "Hassan" (Part I), produced by Val Gielgud.
- 8 B.B.C. Symphony Concert including the first Concert performance in England of Schönberg's "Variations for Orchestra" conducted by the Composer.
- 11 Commentary on the International Rugby Football Match, England v. Ireland, at Twickenham.
A Discussion between Mr. Hamilton Fyfe and Mr. Tom Clarke on "Should the Press be Abolished?"
A Transatlantic Debate between Cambridge and Yale on "War Debts and Reparations."
- 15 Symphony Concert conducted by Adrian Boult; Schnabel playing The "Emperor" Concerto.
- 18 "As it Might Have Been," a Revue Programme of 150 years ago, presented by E. J. King-Bull.
- 19 Short Service and Talk in the Series "God and the World through Christian Eyes" delivered by the Dean of Exeter.
- 20 Programme of the Music of Eric Coates conducted by the Composer.
- 21 "The Captain of Kopenick," by Carl Zuckmayer, produced by E. A. Harding.
- 26 An Oratorio Programme, "Our Father," played by the B.B.C. Orchestra conducted by Joseph Lewis; and Stiles Allen, Rispah Goodacre, Tom Pickering, and Joseph Farrington, and the Wireless Chorus.
- 28 Extract from a Concert by Blind Artists given at the Armitage Hall, National Institute for the Blind. Soloists: H. V. Spanner, Sinclair Logan, and Thomas Marshall. First broadcast of Irish Songs by Danny Malone.
- Mar. 1 Speeches by Viscountess Astor and Prof. W. J. Gwffyd at the St. David's Day Dinner in London.
- 2 First talk by Mr. Geoffrey Whitworth in the series "The Making of a Play."
Mr. A. J. Alan: "A Joy Ride."
Symphony Concert by the Vienna Philharmonic Orchestra conducted by Adrian Boult relayed from the Musikvereinsaal, Vienna.
- 4 Speech by President Roosevelt at the Ceremony of his Inauguration as President of the United States of America, relayed from Washington.
- 6 Descriptive Commentary by Mr. René Caprara from the top of Table Mountain, Cape Town, introduced by the Earl of Clarendon, from Government House.
- 8 B.B.C. Symphony Orchestra conducted by Sir Henry Wood; Adolf Busch playing Bach's Concerto No. 2 in E; May Blyth in the first concert performance in England of Alban Berg's "Three Fragments from Wozzeck."
- 9 Talk by Sir Malcolm Campbell on his record-breaking speed run at Daytona Beach.

- Mar. 9 Tyrone Guthrie in "The Fall of the House of Usher," produced by Peter Creswell.
- 10 A Memorial Concert to Percy Pitt in the Concert Hall, Broadcasting House. The B.B.C. Orchestra conducted by John Barbirolli and Adrian Boult. Soloists: Miriam Licette, Walter Widdop, and Norman Allin.
- 11 Commentary on the International Rugby Match, Ireland *v.* Wales, at Belfast.
Mr. Matsuoka and Mr. Quo-Tai-Chi giving successively their views on "The Situation in Manchuria."
- 12 Sir Oliver Lodge speaking in the series of talks on "The Future Life."
Shakespeare's "Macbeth," produced by Val Gielgud and E. A. Harding.
- 13 Chamber Music Concert by Samuel Dushkin and Igor Stravinsky, including the first performance in England of Stravinsky's "Suite on Themes of Giambattista" (new version) and "Due Concertant."
- 15 B.B.C. Symphony Orchestra conducted by Adrian Boult; Cortot playing Schumann's Piano Concerto in A Minor. "A Year of Rhythm," a First Anniversary Programme by the B.B.C. Dance Orchestra directed by Henry Hall.
- 16 An Alfred Reynolds Programme by the B.B.C. Orchestra conducted by the Composer.



MR. MATSUOKA (*left*) AND MR. QUO-TAI-CHAI
gave their respective points of view on the Manchurian Situation on
March 11th, 1933

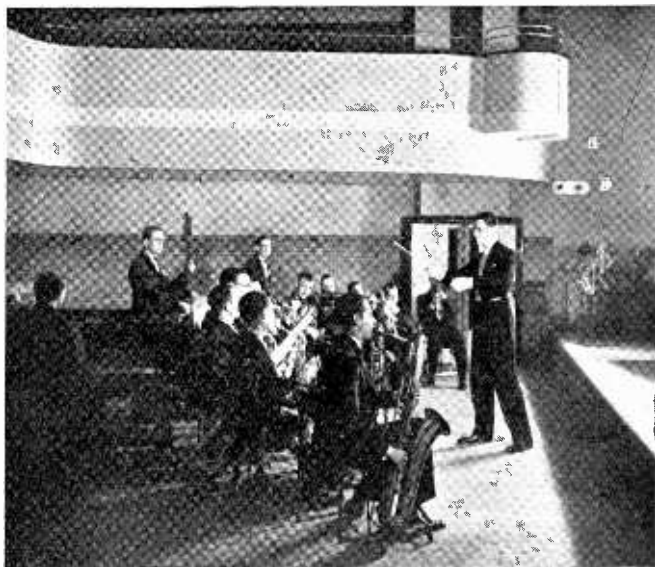

THE B.B.C. DANCE ORCHESTRA DIRECTED BY HENRY HALL
(First Anniversary Programme, March 15th, 1933)

- Mar. 16 Speech by the Prime Minister on behalf of the British Government to the Disarmament Conference, relayed from Geneva.
- 17 Two Miniature Operas by Mozart: "Bastien and Bastienne" and "An Operatic Squabble," translated and adapted by Eric Blom, produced by Gordon McConnell. "Turf Smoke," a St. Patrick's Night Programme.
- 18 Commentary on the Rugby Football International Match, Scotland *v.* England, at Murrayfield, Edinburgh. Eye-witness Account of the Oxford and Cambridge Sports at the White City, London.
- 19 The B.B.C. Orchestra conducted by Sir Henry Wood; Paul Hindemith playing his Concert Music for Solo Viola and large Chamber Orchestra.
- 20 Sir Raymond Unwin speaking on "A Proposal for a National Housing Board."
- 22 First Performance in England of Hindemith's Oratorio "Das Unaufhörliche" ("The Perpetual"), in the B.B.C. Symphony Concert in the Queen's Hall, conducted by Sir Henry Wood.
- 24 Commentary on the Grand National Steeplechase at Aintree.

- Mar. 24 First Performance in England of Hindemith's "The Lesson," in a B.B.C. Concert of Contemporary Music, conducted by Adrian Boult.
- 25 Reconstruction of a Historic Occasion—March 25th, 1833, written and produced by Peter Creswell.
- 27 Sir Edward Hilton Young summing up the series of talks on "Other People's Houses."
- 29 Last Concert of the B.B.C. Symphony Concert series at the Queen's Hall, conducted by Adrian Boult. Soloist: Backhaus.
- 31 H.R.H. The Prince of Wales speaking on his visit to Scotland as Patron of the National Council of Social Service.
- Apr. 1 The Ceremony of the Inauguration of the Holy Year conducted by H.H. the Pope, relayed from the Vatican, Rome.
 Commentary by J. D. M. Snagge on the Oxford and Cambridge Boat Race on the River Thames.
- 2 Part II of Bach's "St. Matthew Passion," by the London Symphony Orchestra conducted by Adrian Boult in the Queen's Hall.
- 3 First of the series of talks "The Economist in the Witness-Box," by Commander Stephen King-Hall and Mr. N. F. Hall.
- 4 Sir Landon Ronald Programme by Thea Philips and Norbert Wethmar, with the Composer at the Piano.
- 5 National Lecture by Sir Eric Drummond on "The League of Nations."



THE OXFORD AND CAMBRIDGE BOAT RACE

(April 1st, 1933)

- Apr. 7 Three Plays—"The Pyramid" and "Shipwrecked" produced by Robin Whitworth; and "A Visitor from Down Under" produced by C. Denis Freeman and M. H. Allen. First of Mr. J. B. Priestley's talks on "I'll tell you everything."
London Philharmonic Orchestra in the first performance in England of Pizzetti's "Rondo Veneziano" conducted by the Composer.
- 8 Mr. James Agate giving the first talk of his series entitled "Stars in their Courses."
The Glasgow Orpheus Choir conducted by Sir Hugh S. Robertson at the Queen's Hall.
Transatlantic Debate between Oxford University and Columbia College, New York, on "Resolved, that Democracy has failed."
- 10 First talk by Mr. Julian Huxley in the series on "Science in the Making."
B.B.C. Orchestra in Pizzetti's "Concerto dell' Estate" conducted by the Composer.
- 11 Talk by Dr. Leonard Woolley on "Recent Excavations at Ur."
Leon Quartermaine in Galsworthy's "Escape," produced by Howard Rose.
Kipling's "Just So" Songs, sung by Dale Smith.
- 12 First of three talks by Sir John Perronet Thompson on "India and the White Paper."
- 13 Sir Alan Cobham on "The National Aviation Day Displays."
- 14 Good Friday Service from St. Anne's, Soho, conducted by the Rev. Basil G. Bouchier.
Extracts from Wagner's "Parsifal" by the B.B.C. Symphony Orchestra conducted by Sir Henry Wood. Soloists: Oda Slobodskaya, Walter Widdop, Roy Henderson, and Horace Stevens.
- 16 Easter Sunday Religious Service from Carlisle Cathedral, conducted by the Bishop of Carlisle.
- 17 Oscar Asche in "Chu Chin Chow" produced by Harry S. Pepper and John Watt.
- 18 Introductory talk to the series on "Design in Modern Life," by Mr. John Gloag, Mr. Edward Halliday, and Mr. Geoffrey Bounphrey.
- 19 First of a series of talks by Prof. John Hilton on "Industrial Relations."
- 20 Eighth Centenary Service from Carlisle Cathedral by the Archbishop of York and the Bishop of Carlisle.
Mr. I. A. G. Strong on "The Enjoyment of Novels."
Unveiling by Prince Arthur of Connaught of Commemorative Tablet of a Cot in Middlesex Hospital endowed by the Children's Radio Circle.
- 21 Service of "The Day of Peace" relayed from the Menin Gate, Ypres, Belgium.
Dorothy Dickson in Edgar Wallace's "The Ringer" produced by Val Gielgud.



OSCAR ASCHE IN "CHU CHIN CHOW"
(April 17th, 1933)

- Apr. 23 Memorial Service to the Men of the Dover Patrol who fell at Zeebrugge on St. George's Day, 1918, relayed from the Parish Church, Dover.
First of the series of talks by Mr. Clifford Collinson on "Pioneers of World Exploration."
- 24 Sir John Harris in the first talk of the series on "Slavery, 1833-1933."
Mr. Winston Churchill proposing the Toast of "England" at the Annual Banquet of the Royal Society of St. George. Speeches at the Shakespeare Birthday Celebration at the Town Hall, Stratford-on-Avon.
- 25 Mr. Wickham Steed on "How the House received the Budget."
- 26 Sybil Thorndike and Leon Quartermaine in Shakespeare's "Coriolanus," produced by Peter Creswell.
- 29 Commentary by G. F. Allison on the Association Football Cup Final, Everton *v.* Manchester City, at Wembley Stadium.
Speeches by H.R.H. The Duke of Gloucester and Sir William Llewellyn at the Royal Academy Banquet at Burlington House.
- 30 Industrial Sunday Service from Canterbury Cathedral, with address by the Bishop of Croydon.
- May 1 The opening of the Anglo-Indian Telephone Service.
Opening Night of the Covent Garden Opera Season with Strauss's "Der Rosenkavalier," conducted by Sir Thomas Beecham.
Three "No Plays of Japan," produced by Howard Rose.
- 6 "The Kentucky Derby," relayed from Louisville, Kentucky.
Commentary on the Rugby League Cup Final, Huddersfield *v.* Warrington, at Wembley Stadium.
- 7 "The Council of the Infernal Peers," from Milton's "Paradise Lost," presented by E. J. King Bull.
- 8 First Night of the London Music Festival in the Queen's Hall by the B.B.C. Symphony Orchestra conducted by Adrian Boult. Brahms Centenary Concert, Arthur Schnabel playing Piano Concerto No. 2.
- 9 The Annual Assembly of the Congregational Union of England and Wales at the City Temple.
- 10 "The Trial of Samuel Goodere and Matthew Mahony," a drama produced by Cyril Wood.
- 14 Henry Ainley in Shakespeare's "Much Ado About Nothing," produced by Howard Rose.
- 15 London Music Festival Concert conducted by Serge Koussevitzky in the Queen's Hall.
- 17 Herr Eduard Dietze on "Herr Hitler's Speech in the Reichstag," relayed from Berlin.
- 18 R. L. Stevenson's "The Bottle Imp," produced by Lance Sieveking.
Eye-witness Account of the Ladies' Open Golf Championship from Gleneagles.
Three Valleys Festival Concert from the Pavilion, Moun-
tain Ash.



“SOCCER”
EVERTON *v.* MANCHESTER CITY
(April 29th, 1933)



“RUGGER”
HUDDERSFIELD *v.* WARRINGTON
(May 6th, 1933)
TWO FOOTBALL CUP FINALS

- May 18 Worcester City Schools Musical Festival from the Public Hall, Worcester, including the first performance of "The Woodland Stream," a Unison Song by Sir Edward Elgar.
- 19 A Meeting of the General Committee of the Disarmament Conference, relayed from Geneva.
A Concert Party Show by "The White Coons."
- 20 Programmes of "Memories of the Lyric Theatre, Hammersmith," conducted by Alfred Reynolds.
- 22 "'Tis of Aucassin and Nicolette," a Mediæval Play produced by Howard Rose.
Song of the Nightingale, relayed from the Berkshire Hills.
- 24 Speeches by Lord Derby, Mr. J. H. Thomas, and the Archbishop of Canterbury at the Empire Day Luncheon at the Junior Carlton Club.
Empire Day Programme produced by E. A. Harding, including an Empire Message by the Prime Minister.
- 26 Contemporary Music Concert in the Concert Hall, Broadcasting House, of "The Spinning Room," conducted by Zoltan Kodaly.
Mr. Ely Culbertson talking on "Contract Bridge."
- 27 Fifth Annual Eisteddfod of the Urdd from the Eisteddfod Pavilion, Caerphilly.
Commentary by Major Vernon Brook and F. J. Findon on the Shelsley Walsh Hill Climb for Racing Cars.
Festival of Music by the massed Choirs of Birmingham, Coventry and Leicester Cathedrals, relayed from Coventry Cathedral.
- 28 The new transmitter at Washford Cross takes over the West Regional programmes.
- 30 Speeches by Lady Denman and Mr. Walter Elliot at the Annual General Meeting of the National Federation of Women's Institutes at the Royal Albert Hall.
- 31 Commentary on the Derby Stakes relayed from the Epsom Racecourse.
A. P. Herbert's Comic Opera "Derby Day," produced by Gordon McConnell.
Elizabeth Bergner and Leon Quartermaine in Ibsen's play "The Wild Duck."
Speech by the Governor of Northern Ireland, the Duke of Abercorn, at the Opening Ceremony of the Royal Courts of Justice, Ulster.
- June 3 The Ceremony of Trooping the Colour on the Horse Guards Parade, Whitehall.
- 5 Commentary on the Laying of the Foundation Stone of the new Roman Catholic Cathedral at Liverpool.
Account of the British Games at the White City.
Last programme in the series of "Songs from the Shows," compèred and produced by John Watt.
- 8 Festival of Music and Drama conducted by Adrian Boult in the Cloisters, Canterbury Cathedral.
- 9 Speech by Mr. Stanley Baldwin at the National Savings Assembly Dinner, at Malvern.

- June 9 Verdi's "Don Carlos," the concluding performance of the International Opera Season at Covent Garden.
- 10 Aldershot Searchlight Tattoo relayed from Rushmoor Arena, Aldershot.
The Ceremony of the Keys at the Tower of London carried out by the Chief Warder.
- 11 Transatlantic Conversation between Mr. J. Maynard Keynes and Mr. Walter Lippmann on "The Monetary and Economic Conference."
- 12 Speech by H.M. the King at the Opening of the World Economic Conference at the Geological Museum, South Kensington, London.
- 14 First broadcast by Duke Ellington and his Orchestra in the studio.
- 16 Opening of the Organ installed in the Concert Hall, Broadcasting House, by Sir Walter G. Alcock, G. Thalben-Ball, and G. D. Cunningham.
Commentary on the Senior International Auto-Cycle Tourist Trophy Race, relayed from the Isle-of-Man.
- 17 Broadcast by Morton Downey, the American Tenor, in the studio.
The Greenwich Night Pageant relayed from the Royal Naval College, Greenwich.
- 20 Two Cantatas by the Bach Cantata Club, conducted by Charles Kennedy Scott from St. Margaret's, Westminster.
- 22 "The Royal Scots," a Tercentenary Chronicle Play of the Regiment by John Gough.
- 24 Commentary by Squadron-Leader Helmore on the Royal Air Force Display relayed from Hendon Aerodrome.
Account by Howard Marshall of the First Test Match, England *v.* The West Indies, from Lord's Cricket Ground.
Eye-witness Account by Bernard Darwin of the Amateur Golf Championship at Hoylake.
The Ceremony of "Beating the Bounds" of Hereford.
- 25 Religious Service in Celebration of the 800th Anniversary of Exeter Cathedral, with an Address by the Dean.
- 26 First of the commentaries broadcast by Colonel R. H. Brand throughout the All England Lawn Tennis Club Championship Meeting at Wimbledon.
Sir John Harris summing up the talks on "Slavery."
- 27 Eye-witness Account by Bernard Darwin of the Ryder Cup Golf Championship, at Southport.
- 28 A Discussion between Herr Eduard R. Dietze and Mr. Vernon Bartlett on the present situation in Germany.
"A Voyage to Lilliput," a musical play from Swift's "Gulliver's Travels," produced by Lance Sieveking.
- 29 Commentary by H. W. Rawnsley-Gurd on the first official Speedway Test Match, England *v.* Australia, at the Wembley Stadium.
- 30 Sir Arthur Salter on "The Progress of the World Economic Conference."
- July 1 Eye-Witness Account of the Merseyside Aviation Display at the Opening of Liverpool's New Air Port.

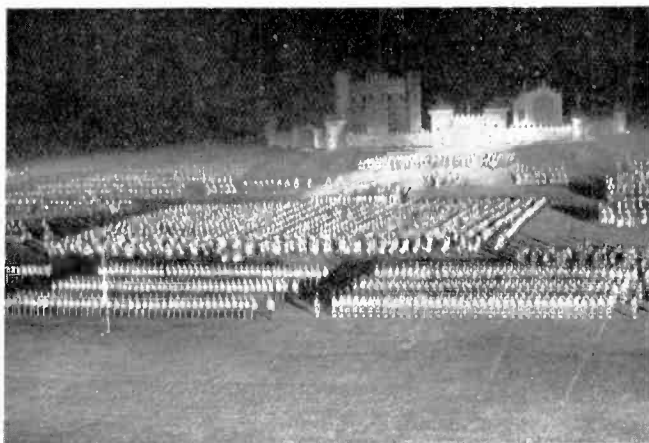

THE ALDERSHOT TATTOO

(June 10th, 1933)

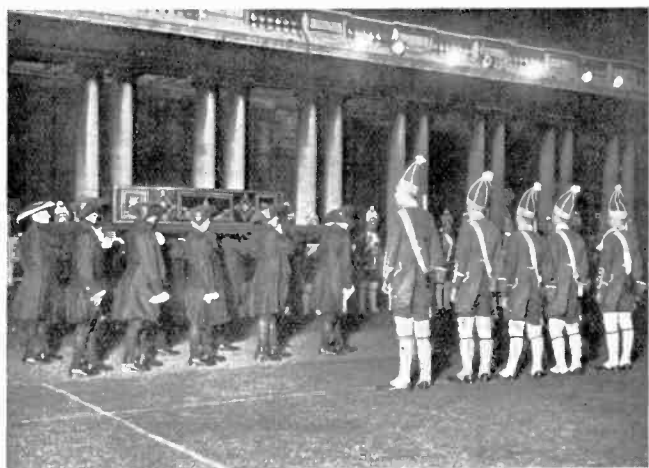

"NELSON GOES HOME"

A scene from the Greenwich Night Pageant

(June 17th, 1933)



THE FIRST SPEEDWAY TEST MATCH, ENGLAND *v.* AUSTRALIA, AT
WEMBLEY STADIUM
(*June 29th, 1933*)

- July 3 Major Elliot discusses with the farmers the "Pig and Bacon Schemes."
- 5 Programme from The Shoulder of Mutton Inn, Brecon, to commemorate the Centenary of the Birth of Mrs. Sarah Siddons.
- 6 Account of the Open Golf Championship at St. Andrews. Wing-Commander Orlebar on "The King's Cup Air Race."
- 7 Revival of "Flags on the Matterhorn," a Play produced by Barbara Burnham and Robin Whitworth.
- 8 Commentary on the Finals of the All-England Tennis Championships at Wimbledon.
Account of the A.A.A. Championships at the White City. Northern Command Tattoo at Knavesmire, York.
- 9 Service celebrating the Oxford Movement Centenary: Address by the Archbishop of Canterbury.
- 10 Talk by Prof. H. G. Moulton on "The Industry Recovery Bill" relayed from America, followed by:—
- 11 Sir Josiah Stamp's reply, relayed to America.
- 12 Speeches by the Marquess of Crewe, Mr. Rudyard Kipling, and Mr. G. K. Chesterton at the Royal Society of Literature Luncheon at Claridge's Hotel.
Account of the Heavyweight Boxing Championship of G.B., Jack Petersen *v.* Jack Doyle, at the White City.
- 14 Capek's "R.U.R.," arranged for broadcasting and produced by Cecil Lewis.



MR. RUDYARD KIPLING'S FIRST BROADCAST
(July 12th, 1933)

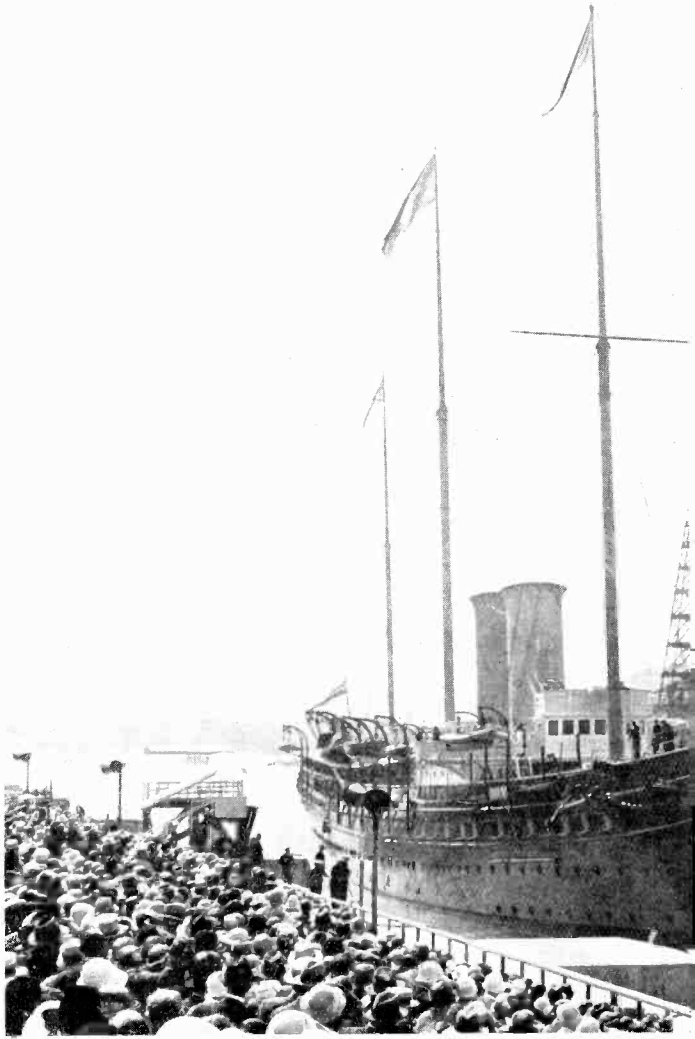

THE ROYAL YACHT ENTERING THE WORLD'S LARGEST GRAVING DOCK AT SO

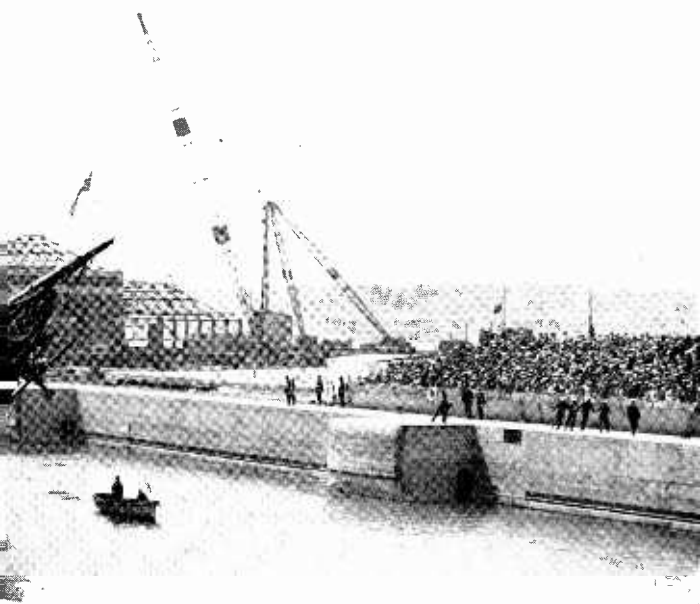

PTON ON THE OCCASION OF ITS OPENING BY THE KING ON JULY 26TH, 1933

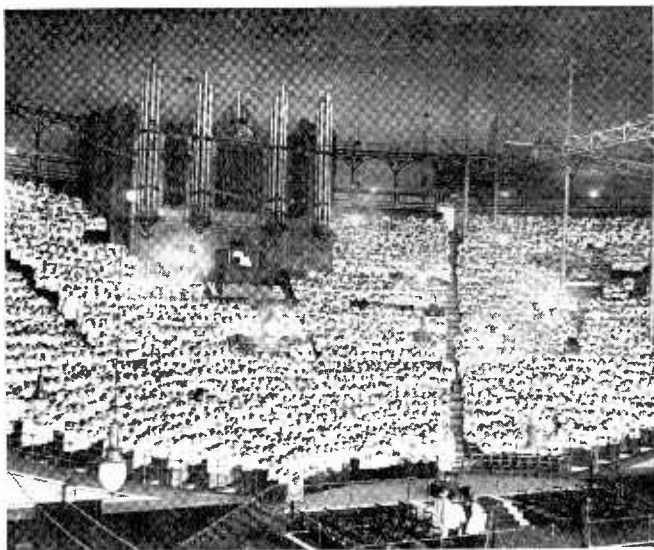

MASSED CHOIRS SINGING AT THE CRYSTAL PALACE
(July 21st, 1933)

- July 16 Drumhead Parade Service at the Woolwich Searchlight Tattoo.
- 19 Account by Howard Marshall of the Cricket Match, Gentlemen *v.* Players, at Lord's.
- 21 A Festival of English Church Music by a Choir of 4,000 voices at the Crystal Palace.
- 22 Commentary by Capt. E. H. Robinson on the final stage of the Shooting Competition at Bisley Ranges.
- 23 Wilberforce Centenary Service from Holy Trinity Church, Hull, with an Address by the Archbishop of York.
- 26 H.M. The King opening the New Graving Dock at Southampton.
- 28 Broadcast of Animals from the London Zoo in the studio.
Commentary on the Davis Cup Tennis Championships relayed from Paris.
Herman Finck conducting a programme of his own music.
Talk by Mr. and Mrs. Mollison after their arrival in America.
- 30 Act I. of "Die Meistersinger" at the Wagner Festival at Bayreuth.
Recital by Harriet Cohen, including the first performance in England of Haydn's "Adagio in F."

AUGUST

The Promenade Concerts at the Queen's Hall were broadcast nightly throughout the season, August 12th to October 7th, in either the London National or Regional programme.

- Aug. 1 Mr. F. J. Perry on "The Davis Cup Match."
2 The Fleet Street Choir conducted by T. B. Lawrence.
3 Relay of the Tattoo from Tidworth.
6 Portsmouth Navy Week, Religious Service from H.M.S. *Victory*.
Religious Service from Coventry Cathedral, with an Address by the Provost of Coventry.
7 A Trial for the Dunmow Flitch from Causeway Meadows, Dunmow.
Mr. J. N. Lampson talking from Salzburg on "The Salzburg Music Festival."
Extract from Gluck's "Orpheus and Eurydice" from the Festival Theatre, Salzburg.
8 Part of Mozart's "The Magic Flute" relayed from Munich.
9 Hilaire Belloc's "Mr. Petre," produced by Lance Sieveking.
10 A Discussion between Messrs. T. Baxter, James Crawford, and R. K. Wadsworth on "The Milk Scheme."



Cribb, Southsea

RELIGIOUS SERVICE ON H.M.S. "VICTORY" AT PORTSMOUTH

(August 6th, 1933)

- Aug. 11 Nina Boucicault and Hilda Trevelyan, the original "Peter Pan" and "Wendy," in "There's More Magic in the Air."
 12 Opening Night of the Thirty-Ninth Season of Promenade Concerts conducted by Sir Henry Wood in the Queen's Hall.
 15 "Nine Days' Wonder," a Revue from the stage of the Theatre at the Radio Exhibition at Olympia.
 First performance in England of Goossen's Suite, "Kaleidoscope."
 17 Mr. J. A. Mollison "My Flight Across the Atlantic."
 Major Walter Elliot: "The Milk Scheme."
 19 Commentary on the International Ulster Grand Prix Motor Cycle Race.
 21 A Service of Tribute to the late Sir Ronald Ross from St. Martin-in-the-Fields; Address by the Poet Laureate, Mr. John Masefield.
 "The Game," a Play by Philip Wade.
 24 Running Commentary on the Rydal Sheep-Dog Trials.
 25 Sir Charles J. Howell Thomas giving Advice to Milk Producers.
 28 Mr. Eduard Dietze: "The Leipzig Fair" relayed from Leipzig.
 Mr. Hugh Rutledge: "The Attempt on Mount Everest."
 29 Mr. F. S. Smythe on "The Highest Lone Climb on Everest."
- Sept. 2 Commentary on the R.A.C. International T.T. Motor Race over the Ards Circuit, Belfast.
 4 Galsworthy's "Strife" produced by Howard Rose.
 7 Mr. J. H. Whitley, Chairman of the B.B.C.: "An Appreciation of Viscount Grey of Fallodon."
 8 Field-Marshal Lord Allenby on the late King Feisal.
 9 A. P. Herbert's Operetta "Waltz Time."
 11 Service in Memory of Viscount Grey of Fallodon in Westminster Abbey.
 12 The Dedication of the Melanesian Mission MS. *Southern Cross* by the Bishop of Liverpool, and the naming of the ship by Lady Stanley, relayed from Liverpool.
 13 Commentary on the St. Leger from the Doncaster Race-course.
 17 Bach's Church Cantata, "Christus, der ist mein Leben," conducted by Sir Hugh Allen.
 A Carolare on "The Christian Year" from the Central Hall, Swansea.
 First of a series of Concerts by the London Symphony Orchestra conducted by Adrian Boult.
 18 Cyril Smith playing Chopin's Waltzes and Preludes in the new series of "Foundations of Music."
 Beatrice Lillie in "The Charlot Hour" directed by André Charlot.
 19 Part of Puccini's Opera, "La Bohème," conducted by Albert Coates, from Sadler's Wells Theatre.
 20 Mr. Archibald Haddon: "Let's go to the Theatre."
 21 Recital by Richard Tauber in the studio.
 22 First broadcast by Paul Robeson in a Variety programme.
 25 Mr. G. K. Chesterton reviewing New Books.



RICHARD TAUBER

- Sept. 25 Mr. Stanley Baldwin introducing the series of talks on "National Character."
- 26 Mr. S. M. Bruce introducing the series of talks on "The British Empire," relayed from Geneva.
"The Use of Man," a new play by Lord Dunsany.
- 27 Mr. Oliver Baldwin criticising the Films.
Lord Eustace Percy on "Some British Institutions."
- 28 First broadcast by Binnie Hale in "No, No, Nanette."
- 29 Sir William Bragg introducing the series of talks by Mr. Julian Huxley on "Scientific Research."
Beethoven's "Choral Symphony" in the Promenade Concert programme.
- 30 "My American Tour," a programme by Henry Hall with the B.B.C. Dance Orchestra.
- Oct. 1 Ceremony at the unveiling of the R101 Memorial at Allonne.
- 2 First broadcast by Josephine Baker in the studio.
- 3 First performance of Delius's "Idyll" at the Promenade Concert in the Queen's Hall.
First talk in the series "The British Empire" by Professor R. Coupland.
- 4 Billy Merson in a Variety programme, "Taking you Over."
- 5 Sophie Wyss singing six Catalan Folk Songs by Robert Gerhard in the Promenade Concert programme.
- 7 Last Night of the Promenade Concert Season at the Queen's Hall by the B.B.C. Symphony Orchestra conducted by Sir Henry Wood.
Margaret Bannerman broadcasting for the first time in a Variety programme.
- 8 Godfrey Tearle in Shakespeare's "Othello."
- 10 Revival of Reginald Berkeley's "The White Château."
- 11 National Lecture by Lord Rutherford on "The Transmutation of the Atom."
- 15 Sir Walford Davies's "Everyman."
- 17 Revival of "Pursuit," a radio play by Cecil Lewis.
- 18 First Concert of the B.B.C.'s Winter Season of Symphony Concerts in the Queen's Hall: Josef Hofmann playing Beethoven's "Emperor" Concerto.
- 19 A programme of Kálmán's Music conducted by the Composer.
- 20 First of the new series of Public Chamber Music Concerts in the Concert Hall, Broadcasting House.
- 21 Trafalgar Day Episode from "The Dynasts."
- 22 Sunday Orchestral Concert conducted by Adrian Boult.
- 23 "The Blue Boar," an Opera by Quilter.
- 24 "The Black Watch," an Anniversary programme of the Regiment by John Gough.
- 26 Kálmán's "The Circus Princess."
- 27 Rimsky-Korsakov's "Tsar Saltan" from Sadler's Wells.
- 28 A programme of "London by Night."
- 31 Revival of "Carnival" by Compton Mackenzie.



THE UNVEILING CEREMONY OF THE RIOI MEMORIAL AT ALLONNE
(October 1st, 1933)

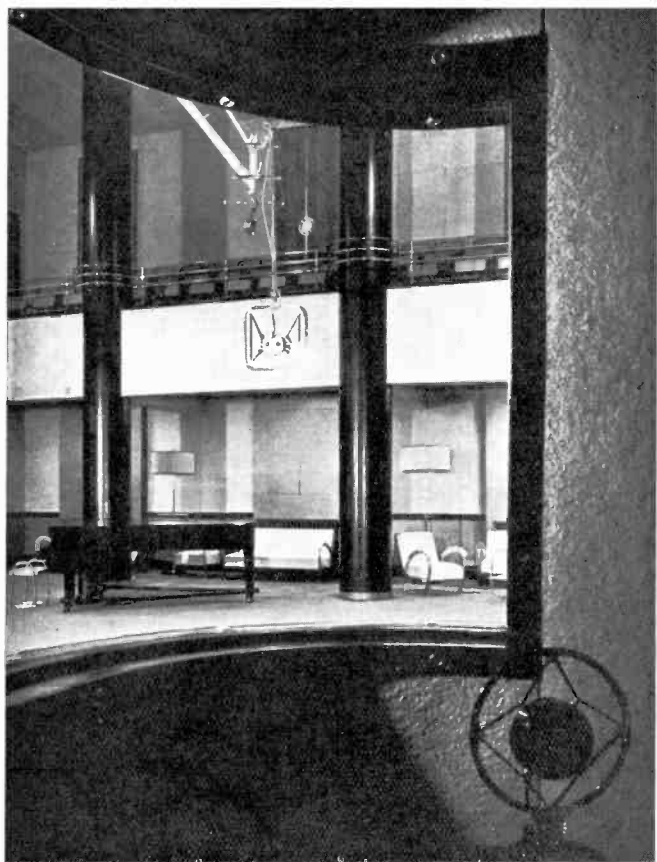

STUDIO NO. 1 AT LEEDS SEEN FROM THE ANNOUNCER'S CUBICLE

THE NEW STUDIOS AT LEEDS AND BIRMINGHAM

By RAYMOND McGRATH, B.ARCH., A.R.I.B.A.

THE B. B. C.'S POLICY of architecting rather than decorating the studios at Broadcasting House, Langham Place, has proved to be a wise course for the good reason that architecture usually means consideration of the requirements and not the imposition of superfluous details upon what may already be, for all practical purposes, an adequate shell.

It has been fairly customary to decorate concert halls, theatres, even studios, in period styles bearing practically no relation to the uses. Departure from this interesting custom may not at first appear to be very revolutionary.

The principal reason for the abandonment of period and pseudo-classical detail in theatres, concert halls, and similar buildings has been the rapid advance made in recent years in the application of the science of acoustics to building construction. When it was found, in the case of concert halls, that certain forms produced good acoustics, the decorator was faced with the problem of applying his detail to a form which had no classical precedent, and it was very soon discovered that attempts to juggle with the elements at his disposal were not likely to be attended with success. In addition, the introduction and increased use of the "acoustic" materials, such as compressed fibre boards, demanded a new technique in interior treatment.

The result of these influences may be readily appreciated in the London Broadcasting House. There is nothing mysterious about the qualities of the interiors to be seen there. The essentials of the work have been the normal ones demanded of good design—good construction, good planning, good proportion and good detail suited to the needs for which the building is intended.

Apart from the first impression which these interiors may make upon the observer, it is essential to study the construction, the planning, the proportion, the detail and the purpose of the work before the result can be adequately appreciated. And, apart from the ordinary good principles involved, the work



THE TALKS STUDIO, LEEDS

must be judged according to contemporary standards; we cannot choose between the old and the new. The Parthenon, perfect as it is, can only be accepted as a spiritual precedent and we must realise that architectural comparisons are too often sentimental. The contemporary problems of time, cost, planning and construction must largely monopolise the contemporary architects' consideration.

The studios at Broadcasting House must be regarded as straightforward solutions of a contemporary problem for which there is little precedent beyond general principles. The problems encountered have imposed straightforwardness, and the necessarily clean result has set an excellent example for interior work other than that of studios for broadcasting.

It is therefore fortunate that other Broadcasting studios of the Corporation should be situated in key positions throughout the country; at Leeds, Birmingham, Cardiff, Bristol, etc. Some of these studios have already been reconstructed, on the lines of the new Broadcasting House studios, and others are in process of reconstruction.

The new studios at Leeds were completed in April last, and the Birmingham studios are nearing completion. The Leeds studios were entrusted to Mr. John C. Procter, M.C., F.R.I.B.A., working in collaboration with the Civil Engineer of the B.C.C., Mr. M. T. Tudsbery, M.I.C.E. Mr. Procter, who is resident in Leeds, is well known there for his University College and Laboratory buildings. He is also well known for his excellent modern houses, one of the most interesting examples of which is Kirkby House, Kirkby Overblow, Yorkshire.

Broadcasting House, Leeds, is constructed out of the old Quaker Meeting House. The studios, control room and other offices, grouped within the four walls and behind the high-pitched pediment of this interesting little Victorian-Classical building, have a unity which is extremely pleasing. (Leeds has just adorned itself with new civic buildings, an immense stone pile with two Renaissance towers supporting gilded owls. Though by comparison diminutive, the old Quaker Meeting House, housing as it does the modern studios of the B.B.C., is not less interesting.)

The new Broadcasting House, Leeds, comprises the large

studio No. 1 (constructed out of the old Meeting Room), a Talks Studio, Band Room, Artists' Waiting Room, Control Room, Battery Room, Generating Room and office accommodation. This accommodation is provided on the ground and first floors. Storage and heating facilities are provided in the basement.

An attractive entrance hall with floor of grey rubber and painted cream walls gives access to the ground floor and Studio No. 1, as well as to the offices and the gallery of the main studio. Left and right of the Entrance Hall are the Band Room and the Artists' Waiting Room.

The Band Room is cleanly finished with cream walls and lighting pendants of white opal glass. The Artists' Waiting Room is grey-carpeted, the walls covered with natural-toned Donnacona building board with red cover strips; the upholstery carried out in brown leather.

The treatment of Studio No. 1, which owes its fine height to the Quakers, is largely based on the Vaudeville Studio B.A. at Broadcasting House. The old gallery of the Meeting Room has been partly retained, encased and finished acoustically, and the original superimposed orders of cast-iron columns have been replaced by cylindrical fibrous-plaster columns which case the structural supports and are filled with pumice concrete. These columns are polished jet-black, and have stainless steel kicking plates at their bases. The whole of the walls and the soffit and ceiling of the gallery are covered with Donnacona building board left natural colour, except on the one wall between the Silence Cabinet and the Artists' Entrance Lobby, where a grey water-stain has been used. The height of the studio has been further accentuated by running the wall-board vertically instead of horizontally. The usual method of fixing with linoleum cement has been employed.

Most of the sound-reflecting surface in the studio has been confined to the dado, which has been finished in parian plaster, the painted finish of which is a very interesting parchment-grey scumble. The skirting is ebonised black, a treatment which, apart from its decorative effect, was found to be very practical in the Broadcasting House studios. The skirting is the standard removable one, which contains the microphone wiring. The ventilation trunking has been carried to six extract points in



STUDIO NO. 4 AT BIRMINGHAM FOR VAUDEVILLE AND MILITARY BANDS

the suspended ceiling. The extract grilles are fitted with baffle slabs, from which are suspended the six ceiling pendants in chromium-plated metal, which are the principal lighting of the studio. The plaster ceiling is distempered a warm pink; the baffles red.

Standard commercial 300-watt fittings are incorporated in the ceiling pendants, which are fitted with suspension gear with winches in the false ceiling, enabling the fittings to be lowered for cleaning and re-lamping. In the centre of the ceiling there is a "flying" microphone suspension fitting. It appears at first to be a terrific affair, but its capacity for exploring space is obvious. It describes a circle of 32 feet diameter and has infinite adjustments in a vertical plane. The fitting is a variation of the suspended microphone designed by Mr. Wells Coates for the Effects Studio at Broadcasting House. The construction is largely of stream-line aircraft tubing.

The floor is covered with mouse-grey stippled carpet, and the special easy-chairs and seats which have been designed by the architect are upholstered with banana-yellow leather, and give an excellent touch of colour against a background of greys and browns. Otherwise the furniture and fittings of the studio are those which have been standardised at Broadcasting House—signal lights, clocks, nesting chairs, adjustable music stands.

In addition to Studio No. 1 there is a small Talks Studio, the walls, floor and ceiling of which are covered with Donnacona board, the dado being stretched with a hard-wearing mohair fabric of striped brick-red. The woodwork is painted a jade-green and the carpet is brick-red. The tubular metal furniture is bronze-finished with brown leather upholstery.

The staircases to the First Floor have been covered with grey rubber and the walls are painted cream with a buff dado. Altogether there is a general harmony throughout the building, which is enhanced by its compactness and isolation.

Though not yet finally completed, the final effect of the new studios at Birmingham can be appreciated. Birmingham is not remarkable for its architectural features, and the new Broadcasting House will be something of an oasis.

At Birmingham there are three principal studios; No. 1—Chamber music and small orchestras; No. 2—Light music and Children's Hour; and No. 4—Vaudeville and military bands.

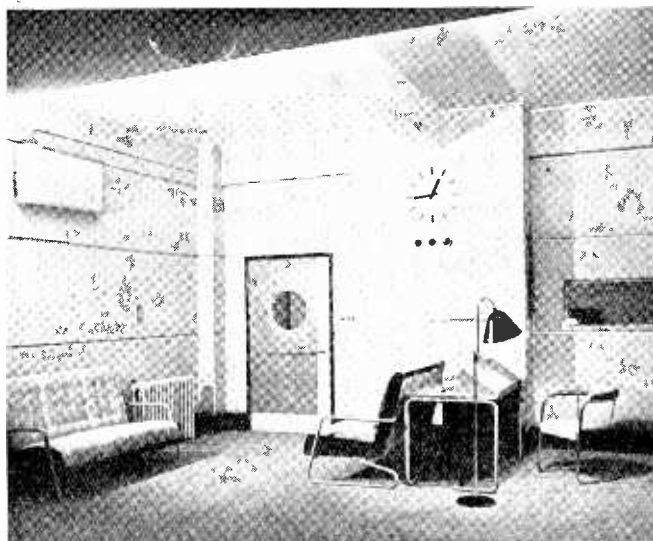

STUDIO NO. 2 AT BIRMINGHAM

The interiors have been designed by Mr. Serge Chermayeff in collaboration with the Civil Engineer of the B.B.C. These studios are in one theme of natural colours of wood and wall-board, with notes of colour introduced by the paintwork and upholstery. Doors and door furniture have been standardised throughout, all metal-work being grey anodised Birma-bright. Similarly, the same carpet in a mole-colour has been laid in all studios.

Studio No. 1 has a horizontal treatment of building board with a dado of walnut ply veneered on building board, which is grouted to the plaster wall face. The lighting is entirely indirect from lighting shelves formed by projecting the low section of the false ceiling, which covers the ventilation ducts over the centre part of the studio. The note of colour in this case is green, combining with the walnut and natural Tentest.

The walls of Studio No. 2 are also treated horizontally. The doors and other woodwork in this case are birch stained grey and waxed. The colour accent is red. Again, indirect lighting

has been employed, lighting shelves being projected from the deep beam which runs across the ceiling, dividing the rectangular area into two squares, in which different intensities of light may consequently be employed.

Adjoining this studio and entered from the Vestibule is the small Studio No. 2a, used either as a Silence Room for No. 2 or as a studio for gramophone recitals and talks. The excellent compact lay-out of furniture in this room includes a double turn-table gramophone desk, record cabinet and adjustable reading desk for talks.

The principal studio is No. 4, approximately 38 ft. \times 45 ft. \times 21 ft. in height. On the long axis the ceiling is sloped and curved to meet the flat section, like the inside of a wooden ship. The general effect is ship-like—the building board on the two short ends running horizontally and on the side walls running vertically as ribs arching over the wide coves and upholding the flat plastered ceiling.

The Listening Room projects on the entrance wall like a cabin. Its walls are birch stained grey and waxed. There is a dado of the same material on all walls, broken at intervals by the projecting radiators. The lighting is from two 40-foot troughs suspended from the ceiling and running almost the full length of the studio. The general ship-like effect is enhanced by the colouring, which, accenting the natural tone of wood and wall-board, is dark and pale blue with occasional spots of Flamingo red.

Apart from the studios the most interesting interior is that for the Regional Director, whose spacious room is generously provided with windows on two opposite sides. The room may be used as a studio, the walls being acoustically treated with Tentest.

The furniture, which consists of low cupboards and bookshelves at sill height, is in laminated wood; the desk, which abuts against a mirror-faced pier between two windows, is in polished birch, and has an extending end for the use of the typist. The curtains are woven in stripes of different texture of natural jute and cotton. A red-striped fabric has been used for the easy-chair, red leather for the desk chair and the table-lamp has a red metal shade. Indirect lighting is provided by means of a suspended lighting tray constructed of bent sheet aluminium.

THE WEST REGION





THE FRONT ENTRANCE TO THE WEST REGIONAL TRANSMITTING STATION

NOTES OF THE YEAR

ALTHOUGH Bristol has had a Talks Studio for some time, the new premises in Whiteladies Road will have Orchestral and Dramatic Studios when the alterations are completed. Plays have hitherto been given either from the Bristol Little Theatre or from the Cardiff studios, and orchestral music has been given from one or other of the large halls in the city. Bristol Radio Week was an annual event for six years and it helped not only to keep the B.B.C. in touch with Bristol listeners but also to bring talent to the forefront. With the establishment of headquarters in Bristol it has been decided to hold no further special weeks.

* * *

When Community Singing was advertised, explained and demonstrated as a post-war novelty, the people of Wales smiled, for the idea under a different name has been a distinctive feature of Welsh social life for years. The Cymanfa Ganu or Singing Festival is held in every village throughout the Principality at least once a year, the most popular days being Christmas Day, Good Friday and Easter Monday. Sometimes all sections in the village unite, and at other times the various denominations hold their own festivals. The idea is even extended to areas where Bethesda and Sion and Soar from their own villages go to Bethel in another to unite their songs of praise. With this background it is easy to see why the West Regional "Carolare" should have been a success from the start. This period of hymn-singing was started, not as an outlet for emotion but in order to lead from the singing of popular hymns to the less known ones which perhaps deserve wider recognition. Many of the best hymns in common use were either written in the nineteenth century or were prepared from translations at that time, and it is hoped that a stimulus may be given to poets and composers so that hymns expressive of the religious life of our own time may be written.

* * *

The Wrexham National Eisteddfod was a happy affair. So far as broadcasting is concerned, the timing of concerts and speeches in very difficult conditions was as accurate as could be desired. The broadcasts this year included for the first time the Champion Solo Competition, in which the winners

of all the big solo competitions sang, and, as usual, the Presidential address by Mrs. David Lloyd George, followed by the adjudication on the Chair Poem and the chairing of the successful bard.

* * *

St. David is probably more regularly remembered on his day (March 1st) than any other national Saint, and this homage is paid to a man whose history is of the scantiest. On such slender material it is hard to write a biography, but a programme in honour of St. David is given annually from the West Regional station. In 1933 it was prepared by Mr. Filson Young and took the form of a journey through space and time. On the morning of St. David's Day, Choirs of the Barry County School Girls and the Romilly Road Boys broadcast in the Empire programme and Sir Percy E. Watkins gave a talk on St. David's Day and its message.

* * *

Prizes have been offered for Radio Drama for some years at the National Eisteddfod, but no awards have yet been made. In spite of the lack of good native dramatic material, there is no slackening of interest in the drama: in some villages it is difficult to find an audience for dramatic performances as all the able-bodied are performing. A remarkable production was staged at the National Eisteddfod at Wrexham this year, when a Welsh version of *Everyman* was produced by Dr. Stefan Hock of Vienna. No such spectacle has ever been staged in Wales before, and although it was not of direct interest to broadcasting on account of its predominantly visual appeal, it is certain that it will have a profound effect upon Welsh dramatists of the future.

* * *

Evidence of the importance of the talks given in the Welsh Interlude is the fact that the majority of these talks appear later, by permission, in the Welsh press. Hitherto most of the speakers have been Welshmen in Wales, but it is to be hoped that in future a fair sprinkling of Welshmen who hold important posts in England but are still in intimate touch with Welsh life will broadcast. One hears from time to time that groups gather together to listen to these Interludes, not only in Wales, but also in the Welsh communities in England.

* * *

An interesting, and it is hoped, acceptable programme feature for the forthcoming months is a series of plays in the dialects of the various counties of the West Region; with this should be mentioned also a series of plays written round "Queer People," of the West. It is hoped, too, to broadcast plays by the Bristol Little Theatre Company and the Plymouth Repertory Players, the only two established repertory theatres in the Region.

In the talks which are at present projected, the intention is to try to reflect the life and activities of the Region, and to discuss, not only those world problems which affect the Region, but other problems that are indigenous. Many travel talks have been given in the past about the by-ways, but it is felt that the time has now come to tell of the main roads, to which a series will be devoted in the Spring. Closely linked with history is its attractive half-sister, legend, and another series is projected entitled "Legends of the West."

A very interesting Welsh feature will be discussions in the Cobbler's Shop—one of the three traditional village parliaments in Wales—in which all the burning problems of the moment will be discussed. Welsh programmes of a light nature have always proved a difficult matter, as Wales has no music-hall tradition, and an experiment which was made in 1933 was so successful that it is hoped to do further feature programmes of this nature. The experiment referred to was a programme supplied by a group of College students, in which a speech was made by a leading light in the mythical Welsh village of "Llanarfon." Other Llanarfon nights are to be given.

* * *

Two lessons in each week during the session 1933-34 on the North and West Regional wavelengths deal with Welsh language and literature and the geography and history of Wales. While each lesson is complete in itself, it is intended that the courses should be followed throughout for—to quote from the special pamphlet, "it has been the experience of the majority of us that the geography of Wales as Wales is insufficiently taught; the tendency has been far too evident to regard the geographical divisions of the country as hindrances to unity rather than as variations in unity."

THE CHOICE OF THE SITE

IN AUGUST LAST the West Regional, the fourth of the new Regional Stations, began radiating a full programme service. This event was naturally of the greatest importance to listeners in those parts of Wales and the West Country embraced by the term "the West Region," as it provided over a much wider area a programme service alternative to the National programme service already obtainable from Daventry 5XX. In previous Year-Books the other regional stations have been described, and in each case it has been explained that the stations are sited at or near the centres of very densely populated areas. In the case of the West Regional Station, however, this is not quite so obvious, as the most densely populated part of the West Region is in South Wales. From this it would appear at first sight that a broadcasting station to serve the West Region might be situated somewhere about the middle of South Wales, and the reasons for placing the station on the other side of the Bristol Channel are interesting.

Since the attenuation of wireless waves, or in other words the rate at which the strength of the waves decreases, is dependent upon the nature of the country over which the waves have to travel, the range at which a station can give a satisfactory service is not necessarily the same in all directions. Therefore, in certain circumstances, the boundaries of the service area of a station may be far from describing a circle. This is actually the case with the West Regional Station.

Owing to the topographical nature of South Wales, the attenuation of wireless waves travelling over it is extremely high, and during a number of transmitting tests, which were made before the site was decided upon, it was found that from none of the sites which were tried in South Wales could as good a service be provided as from the site which was ultimately chosen. Neither would the service be carried appreciably further into mid-Wales from a site in South Wales than it is from the present site in Somerset. On the other hand, the Washford Cross site enables a better service to be given, not only to South Wales, but also to the West of England. Further advantages are that a more even distribution over South Wales is obtained, and the area of extremely high field strength in the

immediate vicinity of the station falls over a comparatively thinly populated area, and interference with the reception of other stations is therefore minimised.

It has already been stated that the attenuation depends upon topographical conditions, by far the least attenuation occurring over water. This, of course, is the main reason for the advantages offered by the Washford Cross site so far as South Wales is concerned. It is interesting to note that, although the average service range of a 50 kW. transmitter working on 310 metres is of the order of 70 miles over land, reports indicate that the West Regional transmitter is providing a satisfactory service at considerably greater ranges in a north-westerly direction, where the first 60 miles or so is over the Bristol Channel. On the other hand, in a south-westerly direction over Devonshire the attenuation is very high, probably due to geological conditions, with the unfortunate result that complaints of weakness of the signal and fading are received from districts which are actually inside the average service range. This applies particularly to the Plymouth area and was expected from the results of preliminary tests. It was for this reason that it was decided to retain the Plymouth transmitter in service.

The fact that less technical correspondence from listeners was received during the opening of the West Regional Station than during the opening of any other regional station would seem to indicate that the standard of receivers in general use is rapidly improving.

The fact that the station itself is at Washford Cross is probably responsible for a mistaken impression which appears to exist that the studios and West Regional headquarters have been removed from Cardiff. This is not the case, however; Cardiff is still the main West Regional centre, but in order that the programme material available in the West of England can be utilised conveniently without the necessity of artists having to make the journey from the West Country to Cardiff, studios and a control room have been established at Bristol, details of which are given in the article entitled "New Provincial Studios" on p. 333. In addition to those at Cardiff on the Welsh side, the Swansea studios are being retained.

THE WEST REGIONAL STATION

THE WEST REGIONAL STATION is similar in all essential features of design to the three twin wavelength stations constructed by the B.B.C. during the past four years for the purpose of serving the London, North and Scottish Regions.

The ground plan of the building and the lay-out of plant remains unaltered; the generating plant in this instance consists of four six-cylinder, solid injection, four-stroke, vertical type Diesel engines. Each engine has an output of 420 B.H.P. at a speed of 350 r.p.m.

The practice of mounting the generating sets on an insulated foundation has again been adopted, and in this instance the superficial dimensions of the foundation block are 30 ft. by 50 ft., with a depth of 6 ft. The approximate weight of the block is 600 tons. The block rests on a sub-foundation of concrete and is insulated from it by pads of compressed cork.

The design of the West Regional Engine Room differs from that of other stations in that the space between the foundation block and the engine room walls has been excavated and forms a crypt which makes a convenient runway for all exhaust, air, water, and oil pipes; as well as for the cables from the generators, which are suspended from the roof of the crypt. The auxiliary equipment associated with the engine installation is similar in every respect to that used at other regional stations.

This is the fourth station in which Diesel engines have been installed and they have proved to be extremely satisfactory as prime movers for the generation of power for broadcast transmitters. The load imposed by the transmitters is of an extremely constant nature and this, coupled with the fact that the engines are not called upon to carry fractional loads for more than a few minutes each day, produces ideal loading for engines of this type, with consequent economy in fuel consumption.

The engines are directly coupled to direct-current shunt-wound generators, each having a normal output of 1,065 amps. at 230 volts, but they are designed to provide a current of 250 amps. at 260 volts for the purpose of charging the main storage battery in the event of a breakdown in the booster equipment or associated switchgear.

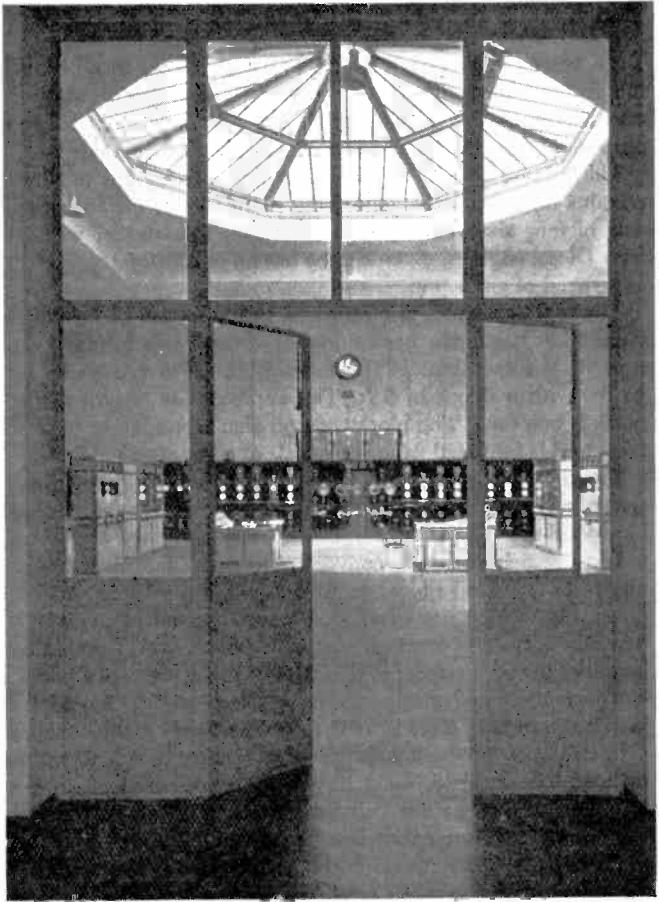

A GENERAL VIEW OF THE TRANSMITTER HALL

The generators are controlled from a flat-back switchboard situated in the engine room, and arrangements are provided on this switchboard to enable any engine and generator to be isolated on to a transmitter feeder or on to the storage battery. The shunt field regulators for control of the generators are also mounted on this board. Manual control of generator voltage is provided, the unvarying nature of the load making any form of automatic regulation unnecessary. The output from each engine is controlled by a double-pole circuit breaker fitted with overload, no-volt, and reverse-current trips.

The use of a direct-current generating system has proved to be extremely convenient, especially as motor generators are used throughout for the purpose of producing the various types of electrical supply required. It also has the obvious advantage that a storage battery of sufficient capacity to supply a large portion of the load may be used as a stand-by to cover failure of the generating units. In this case the storage battery has a capacity of 2,000 ampere hours and consists of 115 cells, being capable of discharging at a rate of 1,000 amps. for one hour. Duplicate boosters are installed for the control of the battery, and the generators of these are designed to carry the current of the battery when discharging at its maximum rate.

The engine room switchboard is connected to the motor control switchboard in the Motor Generator Room by duplicate busbars each having a cross section of two square inches.

The plant in the Motor Generator Room consists of three 12,000 volt motor generators, three low-tension motor generators, and a number of smaller auxiliary sets. The 12,000 volt sets, which are used to supply power to the anodes of the main transmitting valves, are of unique design. Each set consists of a pair of generators direct coupled to one 230 volt D.C. 725 r.p.m. motor. The armature of each of the twin generators is provided with two separate windings, each brought out to a separate commutator, the commutators being situated one at each end of the core. The voltage developed across individual commutators is 3,000 volts, and the outputs from the two commutators are arranged in series, by suitable connection of the brushes, so that each machine is capable of producing 6,000 volts. The twin machines are then connected in series, thus giving a total voltage output of 12,000 volts from the complete set.

The negative pole of the output is earthed, and in order to equalise the voltage between individual armature windings and slots a scheme has been adopted whereby the armature hub of each machine is insulated from the earthed shaft by means of a sleeve of pressed mica. This arrangement ensures that the maximum voltage stress on the slot insulation of individual windings cannot exceed 3,000 volts. To ensure this condition in practice an equalising resistance having a value of 70,000 ohms is connected between the windings and hub. A relay, connected in the equalising resistance circuit, is arranged to actuate an alarm which operates in the event of the occurrence of a leakage between either armature winding and the armature iron. The diagram below shows the arrangement of these machines schematically.

The construction described enables the frame of the machine to be run at earth potential, a fact which simplifies greatly the question of shunt field excitation, which, in this case, is taken from the 230 volt mains. The field system is of the four-pole type, with interpoles, a decomposing winding being provided in order to produce a drooping output characteristic for the purpose of limiting the current under fault conditions. These,

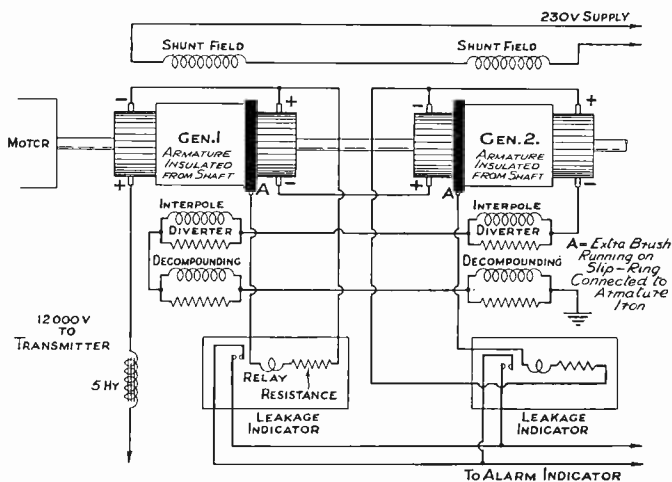



THE POWER HOUSE SHOWING THE FOUR DIESEL ENGINES AND GENERATORS

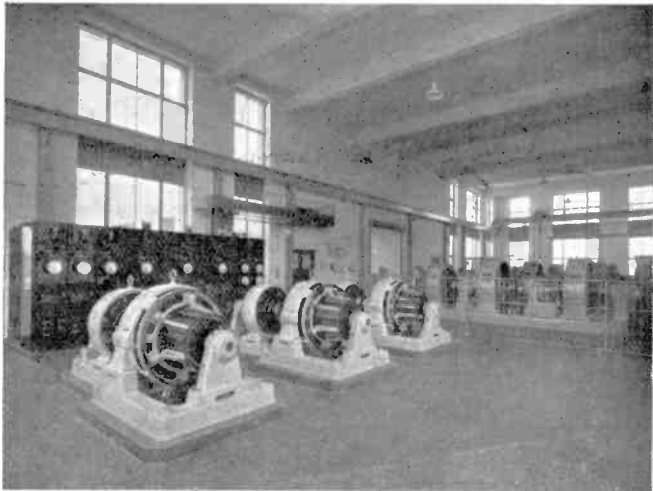

FILAMENT CURRENT MOTOR GENERATORS, AND H.T. MOTOR GENERATORS IN ENCLOSURE

together with the interpole windings, are connected in the negative output lead, which is earthed at the transmitter terminals. A non-inductive diverter resistance is connected across the series field windings, in order to by-pass the low-frequency alternating component which appears in the circuit when the transmitter is modulated. This component is kept at a small amplitude initially by a 5-henry iron-cored inductance connected in series with the positive lead to the transmitter. This choke serves also to keep the rate of increase of current under short-circuit conditions to a low value, thus limiting its amplitude until the decompounding windings come into operation and take charge.

It should be pointed out that the rate of increase of current when a discharge takes place inside a valve is limited only by the self-inductance in the supply circuit, and, in the absence of the protective circuits described, would reach extremely high values.

The filament heating current for the various valves in the transmitters is supplied by the three low-tension generators mentioned previously; two machines being normally in operation, whilst the third is held in reserve as spare. Each generator is rated at 30 volts 1,300 amperes, and is driven by a 230-volt 500 r.p.m. motor. The machines are of the open type and are similar in general design to the boosters usually used for the control of storage batteries, etc.

The supply of high-tension current to the anodes of low-power valves, and negative grid bias are supplied by a group of small motor generators also situated in the Motor Generator Room. The output of all motor generators is controlled by a switchboard in the Transmitter Hall. Selector switches are provided on this switchboard, whereby either one of a group of three machines of any type may be switched to either the Regional or National transmitter. The necessary meters, contactors, and overload relays are also mounted on this switchboard.

The field regulators for purposes of normal control of each group of machines are mounted on the respective control tables, but duplicate regulators for each machine are mounted on the switchboard and are connected in parallel with those on the control table by the operation of the selector switches mentioned

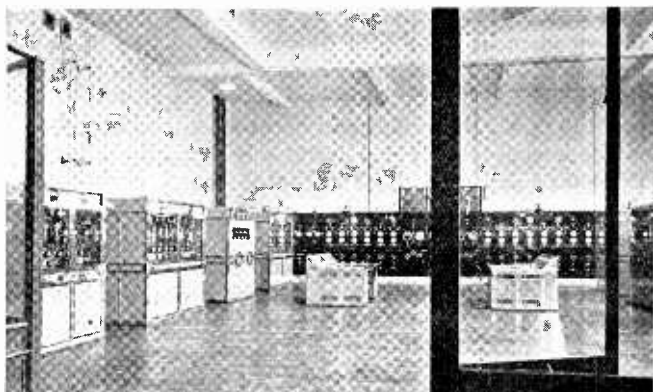

THE TRANSMITTER HALL.
SHOWING THE SWITCHBOARD AND POWER CONTROL DESKS

above. These regulators are normally set at minimum position, but can be brought into operation instantly in the event of failure of those on the control table.

The transmitters are of the B.B.C. standard design, a brief technical description of which may be of interest.

Except in cases where the transmitter is fitted with tuning-fork or crystal drive, the "carrier wave" frequency is generated by a D.E.T.2 valve used in conjunction with a "capacity tapped" closed circuit, capacity reaction being employed to maintain the circuit in oscillation. The anode input to this master oscillator valve is 40-50 m.a. at 1,750 volts.

The master oscillator circuit excites the second stage, called the separator, which has a similar, but balanced, circuit and is provided for the purpose of isolating the third stage from the master oscillator. To make the function of the separator stage more apparent it should be explained that the valve in the third stage, the modulated amplifier, must be provided with a fairly large excursion of grid potential in order to achieve maximum linearity. For this reason it is necessary to sweep the grid potential into the positive portion of the cycle, and the power absorbed by the fairly heavy grid current which will flow must be supplied by the stage exciting the grid of this valve.

It is apparent, therefore, that if the master oscillator stage

were used for this purpose, heavy variations of load would be thrown upon its valve with consequent variation in carrier frequency, which is an undesirable condition. The separator stage which is driven by the master oscillator is therefore interposed to supply the grid current to the modulated amplifier.

The modulated amplifier circuit is energised by a D.E.T.3 valve, the anode of which takes a feed of 110 m.a. at 2,000 volts. This valve is modulated by the anode choke method of control, an M.T.9L modulator valve being used for the purpose. This valve takes an anode feed of about 160 m.a. at 3,500 volts.

The modulated amplifier excites the fourth stage, which consists of two C.A.M.3 valves arranged in push-pull. This stage is a power amplifier and is used to supply the heavy current required to excite the grids of the final amplifier. The valves in the fourth stage take their power (each about 1.2 amps. at 11,000 volts) from the main H.T. supply.

The final amplifier consists of twelve or fourteen water-cooled valves of the C.A.T.6 type connected in push-pull. These valves supply power to the main closed circuit which is inductively coupled to the aerial feeder line.

The circuits of the master oscillator, separator, and modulated amplifier are contained in a separate cubicle, called for convenience Unit A. The circuits of the fourth stage, *i.e.* the first power amplifier, are mounted in a second cubicle called Unit B. The circuits of the final stage, *i.e.* the main power amplifier, owing to their size and the necessity of symmetrical lay-out are mounted in three separate cubicles.

To reduce interruptions in the programmes, due to faulty valves, to a minimum, spare valves are provided *in situ*, which can be brought into circuit by the operation of a switch. Other components, such as condensers, inductances, and resistances, are not bolted down but are located by dowels, an arrangement which reduces considerably the time taken to replace a faulty component.

The water-cooling arrangements in this station are not without interest; as, owing to troubles of a minor nature experienced in various parts of the country, due chiefly to mineral deposit on the anodes of the water-cooled valves, it was decided in this instance to use distilled water instead of water drawn from the local mains. The whole cooling system, including

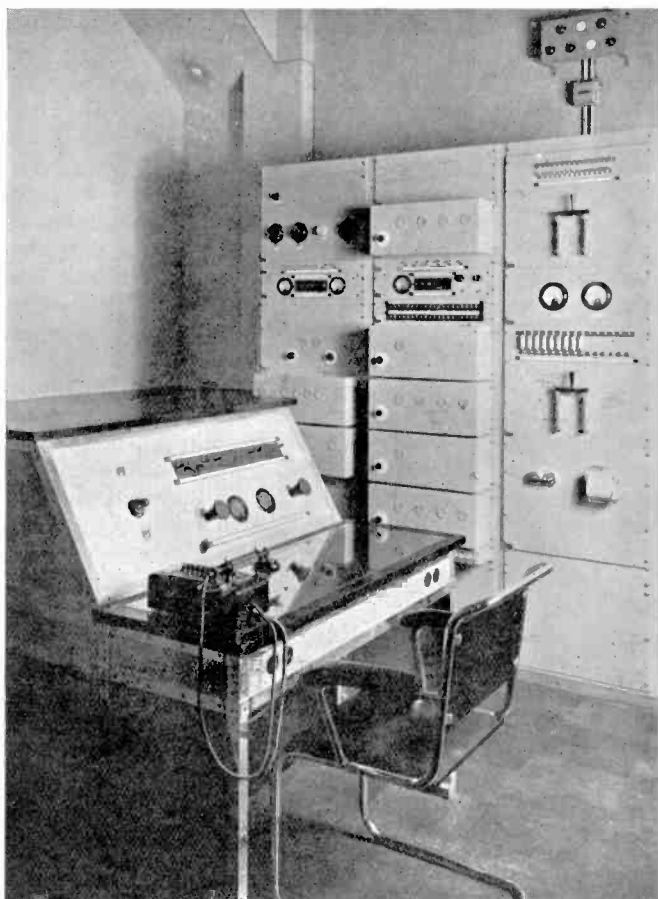

A PROGRAMME CONTROL DESK AND AMPLIFIERS

coolers and connecting pipework, has been carried out in copper. The use of distilled water prevents deposit of any description on the valve anodes and greatly reduces the leakage current down the insulating hose coils.

In this connection it should be explained that as the water jackets of the high-powered valves are at high potential above earth, water is fed to them through 60 ft. coils of $1\frac{1}{2}$ inch rubber hose. The resistance of a column of distilled water of these dimensions is about 8 megohms. Four such hose coils are used in parallel on each transmitter and it will be appreciated that the leakage current at 12,000 volts is extremely small and not sufficient to cause serious trouble due to electrolysis. The cooling system is totally enclosed and considerable care has been taken to prevent aeration of the distilled water.

Each transmitter is provided with a separate control room, in which is situated the land-line termination equipment, amplifiers, checking receivers, programme meters, etc. These rooms are acoustically treated to make them suitable for the continuous checking of programmes by means of loudspeakers. This arrangement is useful for detecting major faults in the transmissions, such as a complete break or extraneous noises, but a separate room is provided for careful quality checking. This room is fitted with a loudspeaker and a switching device arranged in such a manner that either the National or Regional programme can be checked by wireless reception or by direct listening across the audio frequency input to either transmitter.

The aerials at the station are supported by two stayed lattice masts each 500 ft. in height, each mast supporting one complete aerial system. The aerials each consist of three nearly vertical wires, spaced at 120° to each other, the upper ends of the wires being secured to insulators attached to the top of the mast, and the lower ends being taken out and stayed to a concrete block about 270 ft. from the base of the mast. Horizontal leads are taken from the lower end of each wire to insulators fixed at the base of the mast, from which a single lead connects the aerials to the lead-in insulator fixed in the wall of the aerial transformer house.

The earth system consists of a number of buried copper wires, spaced about 10° apart, radiating from the base of each aerial transformer house to a distance of 300 ft.

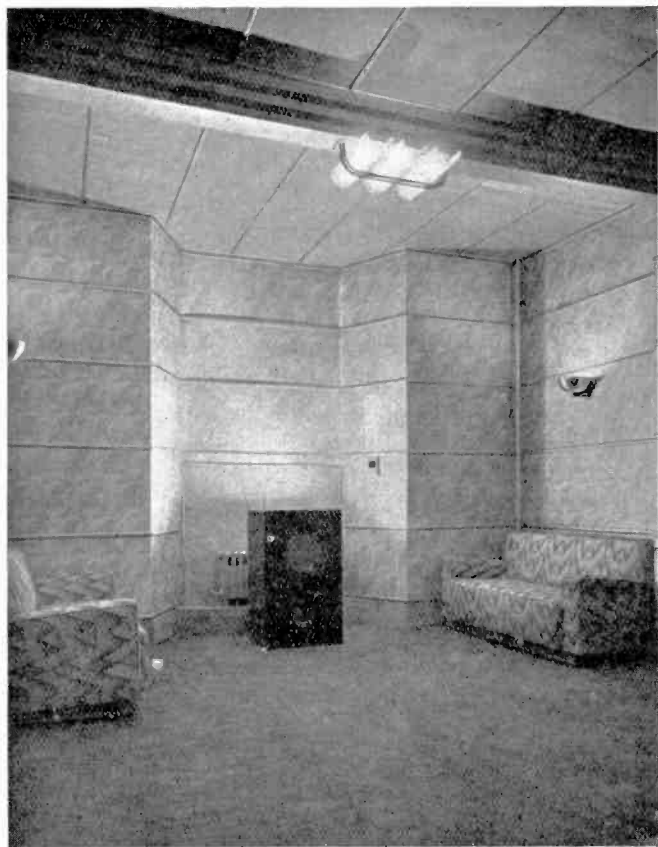

THE DRAMATIC STUDIO, CARDIFF

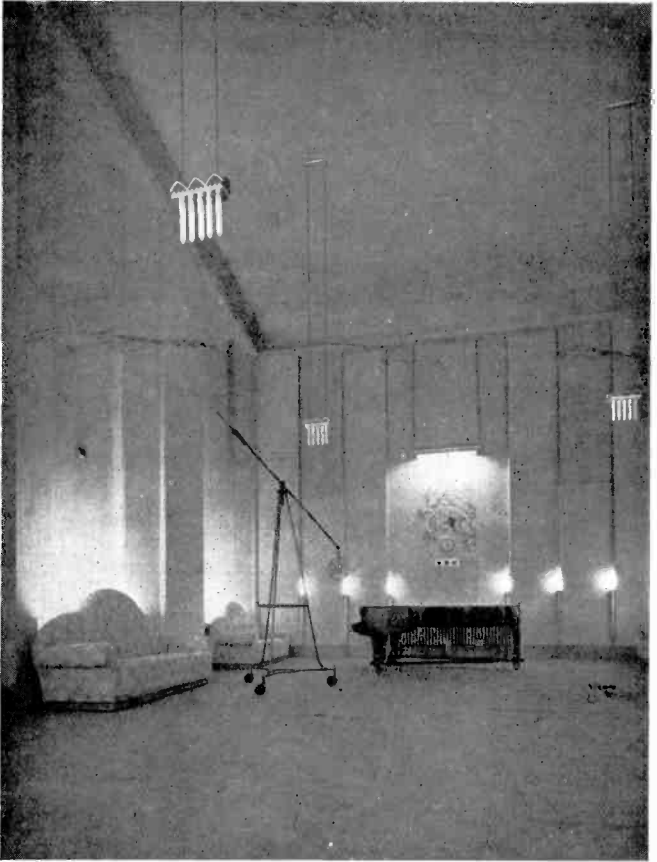

THE LARGE ORCHESTRAL STUDIO, CARDIFF

THE DEVELOPMENT OF BROADCASTING IN THE WEST

IT HAS ALWAYS BEEN rather difficult to explain satisfactorily where the West Regional Station is situated, as there is a good deal of confusion in the mind of the public between transmitters and studios. Thus when the new Regional transmitter was opened at Washford, it was believed that at last the scattered elements of the old stations would gather up their belongings and depart to the Quantocks. The history of the West Region begins in February, 1923, when Cardiff was opened as a main station, with Swansea following as a relay station in September, 1924. In September, 1926, a Repeater station was established at Gloucester. A suite of offices, with a talks studio, was opened in Bristol in 1931, and in 1933 more commodious premises were obtained in Whiteladies Road, where three large studios are in course of erection for music, plays and talks. The Repeater station was transferred from Gloucester to Whiteladies Road in the spring of 1933. The transmitter at Washford gave its first publicly announced experimental transmission on the Regional wavelength on April 24th, 1933, and the West National began its publicly announced tests on Monday, July 17th. The Cardiff and Swansea transmitters were dismantled.

Cardiff has always been and remains the headquarters of the West Region. The first studio was in Castle Street, and although it was only 18 ft. square, large orchestras and bands found their way into it to make music; in the early days, the instrumentalists turned it into a veritable Black Hole of Calcutta by smoking as they played. The present offices in 39, Park Place, were taken in 1924, and a studio was built in the garden. Later, a second studio was built over it, and as the staff increased, a process of peaceful penetration started in the main building. By slow degrees, the other tenants found premises elsewhere, and in December, 1931, the entire building was taken over by the B.B.C. It was found that the orchestral studio on the ground floor caused interference with relays from the studio above; the upper studio was abandoned, and a new studio was built on the site of the former general office. A small room was turned into a talks studio in September, 1931, and in

1932 work was started on turning the two earlier studios into one double-decker, while, at the same time, a dramatic studio was constructed in one of the front ground-floor rooms. Further development made it necessary to acquire additional accommodation, and in the spring of 1933, the house next door fortunately fell vacant. With the resultant increase in accommodation, reconstruction of the studios, designed on modern lines by Mr. Edward Maufe, M.A., F.R.I.B.A., who was responsible for the architecture of Guildford Cathedral, has taken place. At Swansea the orchestral studio remains, and a small office has been turned into a talks studio.

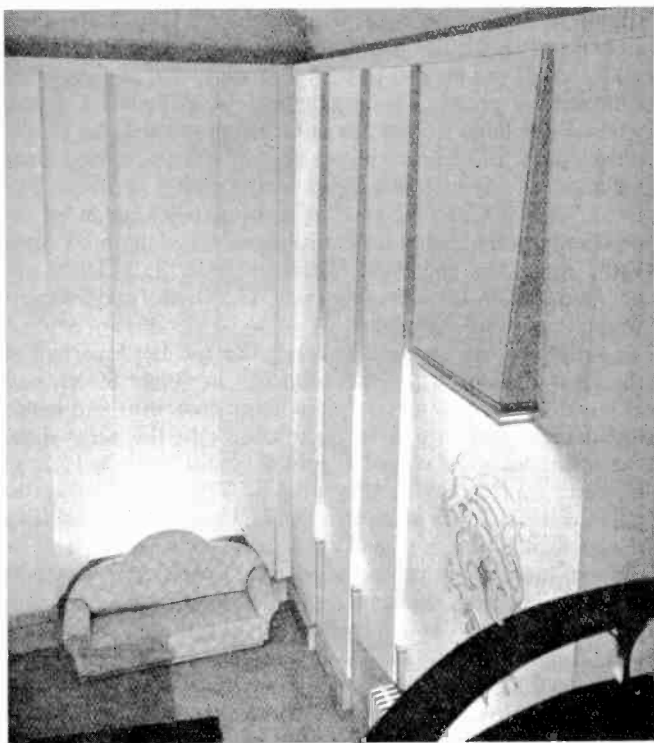

NO. 2 STUDIO AT CARDIFF, FROM THE BALCONY

WEST REGIONAL EVENTS

- | | | | |
|----------|----------|----|--|
| 1932 | November | 7 | John Drinkwater's "Bird in Hand," a West-Country Comedy. |
| | | 13 | Religious Service in Welsh from Ystradyfodwg Parish Church, Rhondda. |
| | | 20 | The Herbert Ware Symphony Orchestra conducted by Dr. Malcolm Sargent. |
| | | 22 | Concert Selection of Gounod's "Faust" by the Swansea Orpheus Choral and Orchestral Society. |
| | | 25 | "The Play Evolves," a Dramatic Surmise by Ifan Kyrle Fletcher of a thousand years in the theatre of the West Region. |
| | | 27 | "Before the Paling of the Stars" (Dale) and "Hiawatha's Departure, Part III" (Coleridge Taylor), performed by the Cardiff Musical Society at the Park Hall, Cardiff. |
| December | 4 | | Concert by the City of Bristol Police Band and Dennis Noble. |
| | 8 | | Concert by the Newport Choral Society conducted by Arthur E. Sims at the Central Hall, Newport. |
| | 11 | | Religious Service in Welsh from the Shiloh Methodist Church, Tregarth, Bangor.
"Carolare," first of the series of Hymn-singing Programmes. |
| | 12 | | "Memory's Chimes," a Welsh Old Folks' Programme. |
| | 17 | | Concert of Christmas Music by the University of Bristol Madrigal Singers. |
| | 29 | | Christmas Music from the Cathedral, Exeter. |
| 1933 | January | 2 | Eye-Witness Account of the Jack Petersen v. Hans Schonrath (Germany) Boxing Match. |
| | | 3 | "Sea Yarns and Shanties," a programme from the Seamen's Institute, Bristol. |
| | | 13 | "The Mollusc," a Comedy by Hubert Henry Davies. |
| | | 14 | Concert for Blind and Disabled Soldiers and Workers arranged by the Marquess and Marchioness of Bute, from the City Hall, Cardiff. |
| | | 18 | The Annual Inter-University Debate at the Powis Hall of the University College of North Wales, Bangor. |
| February | 4 | | Commentary on the International Rugby Football Match, Wales v. Scotland, at Swansea. |
| | 16 | | The Annual Celebrity Concert of the Cinderford Miners' Welfare Association. |
| | 25 | | Handel's Oratorio "Solomon" by the Bristol Choral Society. |
| March | 1 | | Speeches by Viscountess Astor and Prof. W. J. Gruffydd at the St. David's Day Dinner in London. |
| | 28 | | "The Sleepless Soul," a Fireside Fantasy by Froom Taylor. |
| April | 4 | | A Programme by Old Students of the Music Department, University College, Cardiff. |
| | 10 | | Speeches by Dr. Adrian Boulton and Prof. E. Ernest Hughes at the Annual Dinner of the Swansea Orpheus Choral and Orchestral Society, Swansea. |
| | 14 | | Handel's "The Messiah" by the Cardiff Musical Society. |
| | 17 | | Variety Concert by Olive Groves, Leonard Henry, and the Pump Room Orchestra at the Pavilion, Bath. |
| | 27 | | The Central Band of H.M. Royal Air Force from the Bristol "Ideal Homes" Exhibition. |

CAROLARE

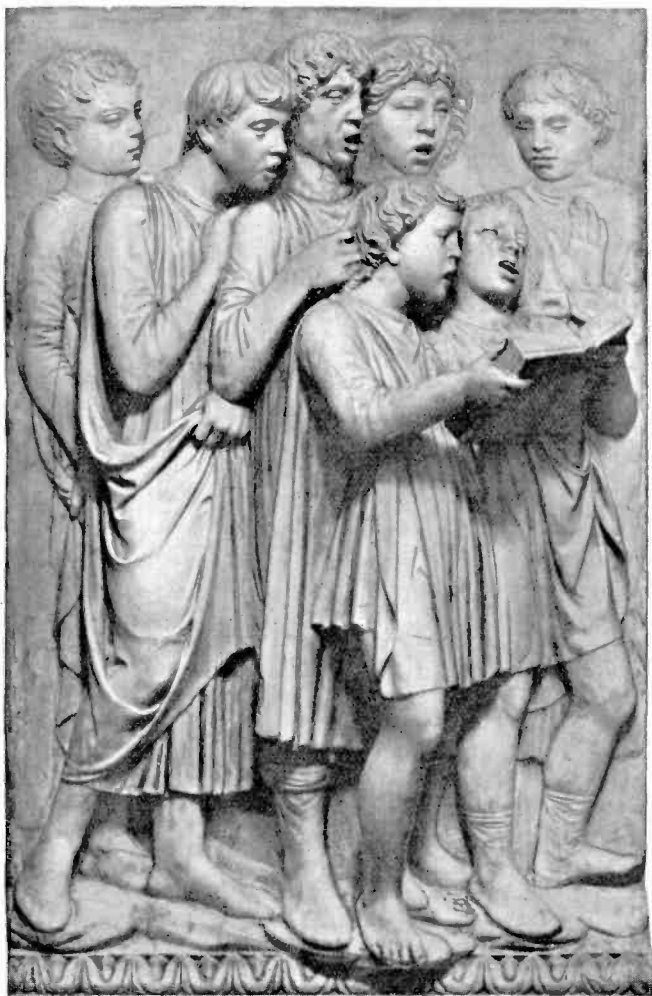

THE END PANELS OF
FLORENCE

(WEST REGION)



Anderson, Rome

LUCA DELLA ROBBIA'S PULPIT,
CATHEDRAL

[185]

*	
April	27 Three Plays of Laurence Housman, "Leading Strings," "His Favourite Flower," and "A Great Relief."
May	10 "The Trial of Samuel Goodere and Matthew Mahony," a Dramatic Reconstruction of the Sessions held in the Guildhall of the City of Bristol in 1741.
	18 First Concert at the Three Valleys Festival from the Pavilion, Mountain Ash.
	15 Eye-Witness Account of the Boxing Match, Jack Petersen v. Heine Muller, at Cardiff.
	27 Fifth Annual Eisteddfod of the Urdd at the Eisteddfod Pavilion, Caerphilly.
June	6 Welsh Concert of the Works of Vaughan Thomas by the Swansea Orpheus Choral Society conducted by Lionel Rowlands.
	9 Enthronement Service and Address by the Bishop of Bristol from Bristol Cathedral.
	15 Harlech Castle Musical Festival relayed from Harlech Castle.
	20 "The Runaways," a Devonshire Comedy by Eden Phillpotts.
	24 Bangor Diocesan Festival from the Cathedral, Bangor.
	25 Religious Service in Celebration of the 800th Anniversary of the Consecration of Exeter Cathedral, with an Address by the Dean of Exeter.
	26 Eye-Witness Account of the Jack Petersen v. George Cook Boxing Match at Cardiff.
	27 Exeter Cathedral Festival. Choral Service of Motets in the Cathedral.
July	1 The Mayor of Wrexham on The National Eisteddfod of Wales, 1933.
	5 "A Siddons At-Home," a Programme to Commemorate the Centenary of the Birth of Mrs. Sarah Siddons from the Shoulder of Mutton Inn, Brecon.
	6 Proclamation Ceremony of the Neath Eisteddfod, 1934.
	7 A Concert from the Wookey Hole Caves, Somerset.
	8 Eye-Witness Account of the Boxing Match, Kid Berg v. George Rose, at Vetch Field, Swansea.
	15 Welsh Dance Tunes played by the Western Studio Orchestra.
	20 Programme by Winners at the Urdd National Eisteddfod of Wales, Caerphilly, 1933.
	26 Speeches by H.R.H. Prince George, the Earl of Lisburne, and Lord Davies of Llandinam at the President's Luncheon of the Royal Welsh Agricultural Show, Aberystwyth.
	31 "Fat King Melon and Princess Carraway," a Children's Hour Play by A. P. Herbert presented by the Bath Citizen House Players.
August	8 Concert by Choir of 800 Children from the National Eisteddfod of Wales at Wrexham.
	10 Ceremony of Chairing of the Bard at the National Eisteddfod of Wales at Wrexham.
	Concert by the Eisteddfod Choir and the Hallé Orchestra at the National Eisteddfod.
	19 Concert from the Bridgwater Band Festival.
September	1 H.M. Welsh Guards Band at the Bristol Annual Exhibition.
	7 "The Grand Old Lady," a Play in homage to Hannah More, by Froom Taylor.
	9 Account of the Welsh Amateur Golf Championship at the Porthcawl Golf Club.
October	3 Laurence Housman's "The Firefighters" by the Plymouth Repertory Company.

THE KINGDOM OF ARTHUR

THE STUDENT OF FOLK-LORE is often in the position of the school-boy who remarked that the *Iliad* was not written by Homer, but by another poet of the same name. It is easy to turn Arthur and his Knights into the Sun and the twelve signs of the Zodiac, but that does not finish the matter, and the renowned King has an awkward trick of reappearing in such a guise as to rule out solar origins. It must be admitted, of course, that sometimes he was a very convenient fiction. The monks at Glastonbury were anxious in the time of Henry II to disavow the supremacy of Rome, and the King approved of their attitude, which struck, not only at Rome, but also at the See of St. David's. In return for the King's support, the monks discovered at Glastonbury the tombs of Arthur and his wife and the favourite Gwalchmai, in 1189, hoping thereby to annoy the Welsh, who looked to Arthur to return and lead them to victory over all their foes. To find the body is the accepted method of spoiling a rumour, for it was to the Isle of Avallon that Arthur went to be healed of his wounds, and when he was cured, it was believed that he would return to reign. Although Avallon was the place of healing, there were other stories of his resting-place. Sometimes he was seen by shepherds passing the time with one of his friends by playing chess under the rocks of Cadbury. Another story tells of Arthur and his Knights buried under the Eildon hills asleep until the blast from a horn shall wake them and

“ . . . each dark warrior rouses at the blast,
His horn, his falchion grasps with mighty hand,
And peals proud Arthur's march from Fairyland.”

But the story as told in Wales shows him with his Knights in a cave in Snowdon, surrounded by the necessary equipment and symbols, waiting for the destined hour to strike.

Somerset comes off well in the Arthurian geography, for not only can she claim the Island of healing, Avallon, but also the Kingdom of Melwas, known as *Aestiva Regio*, with Glastonbury as a stronghold, and Bath, known as *Bade*, as the capital. Chrétien de Troyes calls Glastonbury *Isle de Voirre*, or Glass Island, and he describes it as a place visited by neither tempest

nor thunder, where the sun is never too hot and where winter is unknown.

But Melwas was not only King of Somerset, he also ruled over Goire, a country from which no one returns:—

“Dont nul estranges ne retourne :
Mès par force el país séjourne
En servitude et en essil.”

Ireland becomes Hades in the story of Bran's journey on behalf of his sister, Branwen, and it appears that although Hades was sometimes regarded as an unseen place beneath the sea, it was also regarded as an island beyond the sea. To the Somerset folk, the peninsular of Gower on the other side of the Severn Sea became the shadowy realm of the departed. Yet another story mixes the two tales, and we hear of the Kingdom of Melwas as Goire and his capital as Bade. The habit of regarding the departed as living on islands derived from the superstition that water prevented them from coming back. In order to go to their destination, they had to be ferried, and there was no cause for apprehension that they might return.

Tennyson wrote of

“The goodliest fellowship of famous knights
Whereof this world holds record.”

Some of the old Welsh stories add spice to the collection, and thereby galvanise the lay-figures into life. There was the contemplative one whose only achievement was the power of standing all day on one foot. There was also the mournful one, who only smiled when his stomach was full, and when he was given the chance of asking the king for a boon, he only begged for a good meal. That the granting of his demand proved to be one of the Three Great Plagues of Cornwall, is another story.

The Welsh story of Arthur became a framework into which knightly adventure of all kinds found its way. Greatest of the stories was that of the Holy Grail, which was food and drink to worthy knights, as well as cure for all diseases. The holy vessel disappeared with the coming of Saxon invaders, but the Knights of Arthur's Court undertook to search for it, and to Galahad fell the honour of achieving the Quest.

If we take the story as a myth, we find that none of the important types are missing. Gwenhwyvar captured by Melwas fades into the rape of Prosperine by Pluto, and Orpheus trying to bring back Eurydice is paralleled by Arthur or Lancelot effecting a rescue of the Queen.

The Knight Peredur had many adventures until he came to the court of the King of Suffering. He was well received, and presently there came to the door a horse with a dead knight on his back. When a serving-woman bathed the corpse and applied a precious ointment, the dead man came to life, and he conversed with the astonished Peredur. Presently two more dead knights arrived, and were restored to life. Then Peredur learned that it was their fate to be slain daily by the Avanc of a lake in the neighbourhood. Here we have a myth of morning, noon and evening, slain daily by the power of darkness.

The hero, Gwalchmai, whose bones were reputed to be found in Glastonbury with those of Arthur and his queen, had the well-marked solar attribute of becoming stronger towards mid-day, and of losing his strength rapidly as the day lengthened towards evening. Like Osiris, he had a treacherous brother, and the story of their conflict is that of the conquest of day by night, though, in the manner of all good tales, darkness is routed in the end: it is only when we become older that we introduce recurring decimals in place of a simple and triumphant solution, and thereby spoil the story by insisting upon its meaning. But by insisting on the validity of the myth, we must repudiate the idea of the death of Arthur.

Tennyson, who was a champion of the "honest doubt" school, makes Arthur, himself, one of the doubters.

"I am going a long way with these thou seest—if indeed I go—
(For all my mind is clouded with a doubt)."

The West Regional Station re-unites the Kingdom of Arthur after centuries of separation by the Bristol Channel. So far as broadcasting is concerned, the barrier of the Channel now means nothing, and the transmitter in the Quantocks can send an outside broadcast with equal facility from the isle of Avallon or from "old Caerleon upon Usk."

RHAGLENNI CYMREIG

Os edrychir dros raglenni Gorsaf y Gorllewin, gwelir bod rhestr hir o gyngherddau, dramâu Cymraeg a sgyrsiau byrion yn Gymraeg wedi eu trefnu yn 1933. Wele ychydig enghreifftiau:—

Eisteddfod Genedlaethol Wrecsam.

Cadeirio'r Bardd; Anerchiad gan y Gwir Anrhydeddus D. Lloyd George, O.M., A.S., a phedwar cyngerdd.

Rhan o Eisteddfod Genedlaethol yr Urdd o Gaerffili.

Rhaglenni gan fuddugwyr yn yr Eisteddfodau uchod.

Nifer o ddramâu, ac yn eu plith "Yr Hogyn Drwg" (T. Rowland Hughes), "Pen-y-Daith" a "Drama Tomos" (J. Ellis Williams), "Ymado" (J. D. Jones).

Cyngherddau o adrannau cerddorol Colegau'r Brifysgol, Bangor a Chaerdydd.

Gwasanaeth grefyddol gan blant yr Urdd, Adran Aberystwyth.

Gwyl Gorawl Esgobaeth Bangor.

Dathliad Gwyl Ddewi yn Llundain ac yng Nghaerdydd.

Nifer o raglenni ysgafn, yn cynnwys "Bechgyn y Coleg 'na a Dafydd Hughes y Siop," "Ymweliad Tomos Bartley a Wil Bryan â'r Bala," "Y Llwybrau Gynt."

Dau gyngerdd o Wyl y Tri Chwm, a ledaenwyd o Bafliwn Mountain Ash.

Rhaglen gan Wersyllwyr yr Urdd yn Llangranog ynghŷd ag Adran yr Urdd, Ysgol Sir Aberteifi.

Nifer o weithiau newydd spon gan gerddorion Cymru, mewn cyngherddau gan y Cardiff Ensemble.

Rhan o Gylchwyl Gerddorol Castell Harlech.

Cyfresi yn ystod Awr y Plant yn delio â Cherddorion Cymru, Hwiangerddi Hên a Newydd, Telyn a Phen-nill.

Nifer o ddadleuon yn delio â phynciau canedlaethol, yn y gyfres yn dwyn y teitl "Siop y Crydd."

Cyngherddau gan brif Bartiau Meibion y Dê, yn cynnwys Partiau Treforus, Pendyrus a Phontypridd.

Rhaglen o weithiau y Dr. Vaughan Thomas.

Rhaglenni yn delio â'r tymhorau.

SOME THOUGHTS ABOUT WELSH

By PROFESSOR A. LLOYD JAMES

LANGUAGE is not by any means the perfect instrument that it is sometimes held to be. For the purposes of imaginative literature, prose or verse, it serves its purpose quite adequately, but when it comes to the relation of events, the statement of facts, the expression, that is, of what passes muster as the "truth" about this or that, then language is a deceiver, for when we have done our best with it, it will in the end betray us. Wars have been fought, and men have gone to the stake over the meanings of words. The printed word is bad, but the spoken word is worse; a tone of voice, a disturbance of the normal rhythms, hesitation over a consonant, a lift of the eyebrow, and the damage is done. The body of our words may affirm, but their spirit denies.

And so it is never easy to come by the "truth," or indeed to describe what you imagine it to be. "Tell us the truth about Russia," says the man in the street, and as the torrent of words, spoken or written, grows in turbulence, the conviction grows that there may be no such thing as the "truth" about Russia, or that what there is is beyond observation and relation.

What is the truth about minority languages like Welsh, Lithuanian, Finnish, Fanti and Irish, in the year 1933? Can we relate, let us say, the revival of the Esthonian language with the World Monetary and Economic Conference? Could the impartial Martian, gazing down from his own planet, present the truth about a world in which he saw a session of the League of Nations in Geneva, a Nazi demonstration in Berlin, a National Eisteddfod in Mountain Ash, and a broadcast lesson on King's English, all taking place at the same time as Mr. Gandhi was fasting in India?

We fail to find the truth, and fail to express what little we see, so we join in the hunt for a philosophy, hoping at least to find conviction; failing which we abandon ourselves to the easier life of sentimental judgments.

There are those who believe that the only goal for humanity is the abolition of national and racial misunderstandings, the reign of peace and goodwill among men. Such people have strong views about minority languages and nationalist movements. They tell us that we have seen in our generation

Western Civilisation nearly destroyed in the clash of political nationalism, and the normal life of millions made unbearable through the failure of economic nationalism; and what is there to be expected of linguistic nationalism?

There are others who believe that the future of the world is with small national, political, and economic groups, with self-supporting communities and self-contained cultures, which, while preserving the heritage of their past, strive to adjust themselves to changing conditions. Such people have other views about minority languages.

And so who shall tell us whether Ireland is "right" in reviving her dying language; whether Wales is "right" in wanting a national transmitter for Welsh alone; whether Mustapha Kemal is "right" in sacrificing the sacred alphabet of Islam in favour of the Roman; whether it is "right" to educate the millions of Africa through the medium of their countless tongues, or "right" to teach them all one of the great European tongues?

It is as difficult to produce a true answer to these questions as it is to produce the truth about Russia, for there may be no such thing. If it is helpful to cut down a few trees in order to see the wood, then we might remember that language is a means to an end, and not an end in itself. There may be differing views as to what the end is, but few will dispute that one end is communication; and if that is so, then this end is best served by the language that is most current among the people who have most to communicate.

And we might further remember that Thought and Language have more in common than meets the eye. The Greek language was admirable for the expression of Greek thought because both grew up together; whether the German language can express Greek thought equally well, or whether the Greek language could express German thought, are questions upon which there may be grave doubt. Every national language, from Telugu to Korean, is the best medium for the expression of its national ideals, aspirations, philosophies and creeds, and it takes a long time before a language can adequately express a creed or philosophy that has not grown up with it. What Christianity has done for the English language is nearly as much as what the English language has done for Christianity. There are certainly Welsh sentiments that cannot be expressed in English, but there are

equally certainly English sentiments that cannot be expressed in Welsh. Christianity, as we know it, cannot adequately be expressed, as yet, in Swahili : there is not the verbal means.

So, in one way or another, many national languages break down as means of communication ; and the business—material, intellectual and spiritual—of the world is carried on in the language of those who have most to communicate. Babylonian, Egyptian, Greek, Latin, Arabic, Chinese and English have all in their day spread beyond the lands that gave them birth, carrying with them the creeds, philosophies, literatures and cultures that were enshrined in them, and that were in part dependent for their nature and content upon the grammars and vocabularies in which they were expressed. No language has had so romantic a history as English, which was itself, not so long ago, very much of a minority language, fighting with its back to the wall.

At present it looks as though Western thought and knowledge will dominate the world for many centuries, and while this is so, one or other of the big Western languages will spread, while countless minority languages will fight, with varying success, their rear-guard actions. They will all, in time, go down fighting ; but some, like Roland at Roncesvalles, will, with their dying breath, sound the magic horn that will be heard in the far corners of the earth.

It is not easy to estimate the relative ages of languages ; the youngest may be English and the oldest may be Welsh, for all we know—two that have existed side by side in this island since English was born. English has gone to the ends of the world, and added something to the vocabulary of every language under the sun. Wales has, with one exception, stayed at home, and no languages come to enrich their vocabulary from it.

It has, like many another fighting language, produced an imperishable literature ; it is alive and vigorous, spoken daily by hundreds of thousands ; it continues to produce literature in prose and verse, and in it are enshrined that Celtic imagination, fervour and devoutness that have exerted such a remarkable influence upon the literature of Europe since the days of Arthur and the Round Table.

It is not what is generally known as an “easy” language ; none of the Celtic languages were. The very complexity of its struc-

ture, and its remoteness in form and appearance from either the Teutonic or the Romance languages, are in themselves serious obstacles to its expansion. The future is with simple languages, for it is a fallacy to imagine that complex grammars are necessary for exactitude in expression. Few grammars are as complicated as those of the Bantu languages of Africa, and few as simple as English and Chinese.

Advancing civilisation makes for simplification of grammatical structure, and in the end the simplest wins. For language is a means to an end; those who make it an end in itself are pedants.

Such are some of the considerations that pass through the mind of one whose duty it is to study some aspects of speech and language in their social and national bearing upon the life of individuals and nations all the world over. It may be possible for such a one to review the matter quite impartially when it concerns a minority language in Africa. But when it comes nearer home, our specialist may not be quite so impartial; for it may be that Welsh was the daily speech of his father and mother, and that the Mabinogion first opened his eyes to the beauty of medieval romance.

A famous scholar has recently said that what the world needs to-day is many more dead languages. This may be true, but languages, like Charles the Second, take an unconscionable time to die.

ACTIVITIES IN THE NORTH

MUSIC IN THE NORTH has been discussed elsewhere, and there is little to report here but steady progress in the discovery of new talent and considerable increase in the number of orchestras and organs available for broadcasting. The destruction by fire, however, of the Philharmonic Hall in Liverpool was a grievous disaster, and its consequences might have been more serious if the friends of music in that city had not risen nobly to the occasion. As a result of their efforts a break in the continuity of the Philharmonic Society's life has been avoided and its concerts will take place this winter as usual. In Manchester an arrangement has been made with the Hallé Society which ensures the relay of ten concerts from the Free Trade Hall during the season, and it has been decided also that the Studio Orchestra shall be augmented on thirty occasions during the winter months, all the extra players being taken from the Hallé Orchestra. This means that listeners are assured of one big concert a week from the studio, as well as of a continuance of the relays to which they have grown accustomed, in particular of the Leeds Symphony, the Leeds University, and the Manchester Tuesday Mid-day Concerts.

* * *

After careful study of the failures and successes of dramatic efforts in the North during the past year, certain conclusions have been reached. Whether or no these conclusions are correct will be discovered from their application in the future.

The omens on the whole are encouraging. There has been a perceptible increase in helpful criticism, which shows that something more than a perfunctory interest is taken by the critics. There is appreciation also that the aims of the Region are not, and must not be, the same as those of any other area; that Northern productions must be of a different texture from London productions, if there is to be any value in Northern productions at all. All the time, too, there is a strengthening of the repertory of actors and actresses in numbers, versatility and enthusiasm.

Watching the manuscripts and suggestions sent in during the year, it becomes clear that a running policy cannot effectively be maintained. It is not possible to produce a number of good

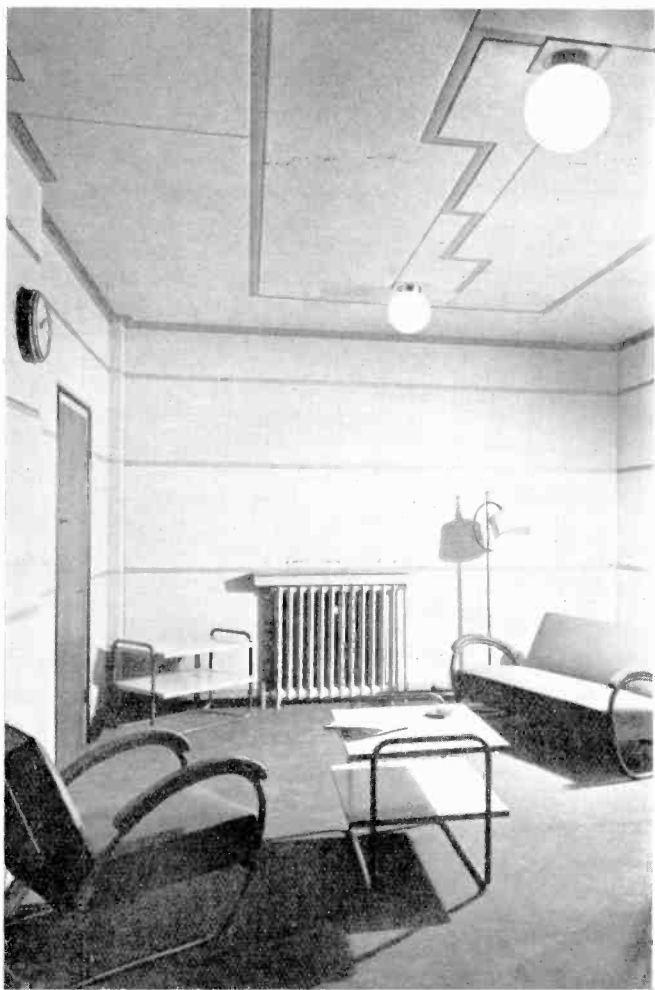

THE WAITING ROOM AT BROADCASTING HOUSE, LEEDS

plays simply because they are good plays. That is adequately done where the resources are adequate. Such plays, unless specially written, would not justify Northern production, and they are not specially written. Here, then, is a starting point for Northern policy. The North demands a good show. Ideas are demanded from outside. When the ideas do not arrive they have to be thought of from within, and, whereas sixty people could hatch one idea each and work it up, it would be as impossible as it is undesirable for one or two enthusiasts within to generate a similar number of ideas and forthwith to commission reliable radio dramatists to work them up. It is inevitable, then, until the voluntary supply from outside improves, that office ideas should be worked out in serial form. By giving each play of a series to a different author, while the theme of each is slightly different within the general title, sufficient variety can be maintained. Apart from this, the serial form has everything to recommend it when one is trying to express and use the genius of the region. It forms, as it were, a track for this to run on, and simultaneously directs the attention to a general theme and a particular instance. The disadvantages are that some people may dislike a whole series, while others may be put off by an individual play within it, if they have not heard the others, or by an unfortunate beginning when it is still in the experimental stage. It is necessary, therefore, to have no unfortunate beginnings; to mark out no series which has not every prospect of success in dramatic form; to run at least one parallel series of a different order to satisfy other interests; and lastly to keep them all so flexible that the course can be checked, altered, reconditioned anywhere according to their good or ill reception.

These series will not, of course, take the place of any of the other usual entertainments. Mummers and Variety will be here as before. Straight plays will not be given any less frequently, while the triple bill, which has already made a successful appearance, will become a regular feature. The general form of this will consist of a short curtain-raiser, appetising, but leaving the appetite intact for the more solid course of the main play; to be followed in turn by some savoury piece, usually a comedy, quick moving and perhaps in the dialect.

Needless to say, this scheme is not invariable, but it is hoped that authors will appreciate its possibilities and write deliberately for it in one part or another. Finally, the Yorkshire plays, with their dry humour and customary twist of situation, will not be dropped. But one suspects that listeners are getting to know the situations and characterisations too well. Again it is ideas that are wanted. Nevertheless, these little plays, if still in the old tradition, will have started in a new direction by the time these words are in print.

* * *

There has been of late a notable increase in the work of the North Western and Yorkshire Area Councils for Broadcast Adult Education. It may be recorded as some evidence of their success that during the spring four hundred Northern listening groups regularly functioned and that even in the summer certain broadcast talks were used by more than two hundred of such groups. It is, however, a matter of some concern that relatively few of these are composed of rural listeners, and the Yorkshire Council in particular has opened a strenuous campaign, made possible in part by the munificence of the Carnegie United Kingdom Trustees, for the establishment of listening groups in the villages of the County. A Conference called at York in May was attended by many of those engaged in educational work in rural areas, and so encouraging was the response of the assembly, that the training of group leaders is to be seriously undertaken so that full advantage may be derived from the newest series of talks about the problems and life of the countryside. The North-Western Area Conference held in Manchester in April was a remarkably keen and successful affair and it proved that in spite of the increasing popularity of the National Conference it is still highly desirable that area workers should meet together in this way.

* * *

The Northern Region has always prided itself upon the scope of its outside broadcasts and the range of this work has been doubled during the year. Most of the old features have been maintained, but a good deal of fresh ground has been broken, so that it may be said the life of the North now finds very representative expression in the programmes in most of its aspects religious, sporting, economic, civic, and artistic.

There are some new contributors of variety and entertainment, too, for the Shakespeare Theatre at Liverpool, and others in Chester, Halifax, and Huddersfield now play their part in the outside broadcast scheme and the list of summer concert parties has been greatly extended.

The Motor Races, run for the first time in Douglas, Isle of Man, were covered by a running commentary, and this, together with the commentary on the Chester Cup, provided the chief O.B. novelty in the spring, which saw also the completion of a series of outside broadcasts called "Links in the Chain." These were designed to show what goes on by day or night at the nerve centres of Northern transport and traffic enterprises, and listeners were taken behind the scenes at a railway shunting yard and a postal sorting office. A broadcast called "Fire!", too, from the Rochdale Station demonstrated the marvels and methods of modern fire-fighting.

Finally, close co-operation was established with the originators of Sheffield Week, which brought that city prominently into the programmes, and with the civic authorities of Kingston-upon-Hull, who were responsible for the celebrations of the William Wilberforce Centenary.

* * *

The B.B.C.'s studios and offices in Basinghall Street, Leeds, were transferred in the Spring to a building which was originally the Friends' Meeting House in Leeds, and the new premises were officially opened on May 3rd, 1933. They are intended as the principal studio centre for Yorkshire, and the new building, which has been completely converted for broadcasting purposes, is now known as Broadcasting House. The specialist decoration of these studios has been undertaken in a modern manner by Mr. John Procter, M.C., F.R.I.B.A., and there are now facilities for the production of most types of studio programmes. The studios are already used extensively for concert, variety, and dramatic work of all kinds, and the resources of the great county of Yorkshire are being developed to the full.

* * *

Since Newcastle became a member of the North Regional Group the question of programmes to be put out by the Newcastle transmitter has been a vexed one. Towards the end of 1932 the experiment was tried of transmitting a

composite programme consisting of a mixture of National, North Regional, and London Regional material. The experiment has been successful in so far it has enabled Newcastle to contribute a share to the North Regional programmes and it has also made it possible for items in the National programme, such as Mr. Bartlett's talks and the Mid-Week Service, to be included. These two items are expressly mentioned because they are outstandingly popular.

The unsuitability of the Newcastle premises for modern broadcasting conditions has resulted in a large scheme of internal reconstruction. The ground-floor rooms have once more been occupied and will be used for control room, offices, etc., while the first floor will be retained as three studios, band-room, waiting-room, etc. When this scheme has been completed, Newcastle will be in a position to take a greater share in broadcasting than has been possible during the last few years.



ROUNDING A BEND IN THE SENIOR T.T. RACES IN THE ISLE OF MAN

MUSIC IN THE NORTH

By KENNETH ADAM

TAKING A BIRD'S-EYE VIEW of the musical life of the North is like looking down from the Tower at Blackpool on a Bank Holiday. An enormous, changing scene lies spread out at one's feet. The crowds melt and coalesce and melt again. Yet there is a general tendency to engage in pursuits which may be broadly classified, and here and there individuals and groups stand out from the mass. Of course, to do the thing properly, you would have to write a complete social history of the Northern counties. There are so many various elements to be brought into the story, for I think we should include the hikers on the Derbyshire hills who sing as they go, as well as the Hallé Orchestra, and the brass bands from Cheshire villages no less than the choir in York Minster. Professionals as well as amateurs must be included, listeners and performers, people of all sorts and degrees of accomplishment, alike only perhaps in this, that they enjoy sounds in tune. Music is so much a part of the everyday existence of so many persons in the North that it can scarcely be separated from their lives. It should be studied against the economic background. The squalid ugliness of most Northern cities is reason enough why the people living in them should seek passionately to escape through music into a larger, freer world. Look at the factory's smoke and the glare from the furnace, at the evil-smelling canals and the unhealthy slums, and you will realise why music, flowing like a clear stream through this darkened land, is fed by the loves and hopes and faiths of the people until it becomes a very distillate of life itself. In other places music may be the crowning grace of the aristocracy, the plaything of the virtuoso, a spectacle for the idle, a commodity for the professional, but in the North it remains what it has always been, a democratic institution, a supreme need of life.

Arnold Bennett has a short story, "The Death of Simon Fuge," in which the hero, a Londoner, pays his first visit to the Five Towns and is constantly surprised by the people and their habits. One of his chief surprises comes when his hearty host takes him into the drawing-room, where there is a grand piano. To the Londoner's astonishment, Mr. Brindley and his

friend Mr. Colcough, a sanitary ware manufacturer from Manchester, sit down and proceed to play an elaborate duet. It is the "Sinfonia Domestica" of Strauss, which they had heard in Manchester the week before. The Londoner had never heard it. "Ah," said Mr. Colcough, "they won't have played it in the village yet." What was true of the Five Towns, then as now, is true of the industrial North as a whole. They have always been great listeners, but a purely passive attitude towards music has never satisfied them. I suppose no local jealousies will be aroused if the Hallé Orchestra be taken as the exemplar of Northern orchestras. For more than forty years it has represented the high-water mark of professional achievement. Grove says that it is impossible to over-estimate the value of Hallé's educational work in music, not only in the North, but also in the whole of the country. But Hallé did not create music in Manchester; he simply took over an existing tradition and developed it. Towards the end of George III's reign there were half a dozen harpsichords and as many spinets in the town on which numbers of ladies could play, with the treble hand, putting in here and there a chord with the left, "God Save the King," the 104th Psalm, and "Kitty Fisher's Minuet." About the same time Mrs. Blomiley's finishing school flourished, where the young ladies of quality learned to make pastry and play the piano. Concerts by a company of ten gentlemen who all played exquisitely, or so we are told, on the single-keyed German flute, proved so popular that they had to be removed from a tavern in the Market Place to larger quarters. Finally, the Gentlemen's Concert Hall was built, and here it was that Hallé, the young refugee from Paris, first performed. He played Beethoven's Concerto in E Flat, and the audience, though they were unused to such lengthy pieces, treated the young pianist with such kindness that he soon settled in the place for good. The readiness with which people in the North have welcomed foreigners has brought its own reward in other spheres of life as well as music. Hallé is not the only alien who has come North bringing gifts that have enriched the community.

There are half a dozen cities of the North of which, in all essentials, the same story might be told. And the tradition of good listening which appealed to Hallé still lives. To many

hundreds of people the blackened face of the Free Trade Hall represents music rather than anything else. The great political meetings still take place there, and in the winter there are boxing matches on the platform from which Hallé and Richter and Harty and Beecham have conducted. But to a majority it is the home of the finest music outside London, and some would not for a moment accept that qualification, as much a home as Wagner's theatre among the pine-woods at Bayreuth or Covent Garden with its fashionable crowds. Much has been written of the audiences at the Proms in London, but to me there is no crowd of music-lovers more fascinating than that which Thursday after Thursday, for seven months of the year, collects in the Free Trade Hall. There will you find specimens of every age and class, the Lancashire of expensive cars sitting side by side with the Lancashire of trams and buses, a boiled shirt or two at the front and plus-fours and flannels at the back, age which finds the hard seats uncomfortable, and youth which is content to stand, Indians from the University, and cotton operatives who count their shillings well spent, all of them clustered in one heap for one purpose. Their faces are eager, and nobody seems to mind the stifling atmosphere. There is a hypnotism about the place on Hallé nights to which it seems you must succumb. Here oftener than anywhere else I have heard that thrilling silence at the end of a great performance which is the mark of deep appreciation. It lasts for seconds—"Je les ai glacés," said Ysaye, under his breath, at the end of his first performance in Manchester—and then breaks into applause as a giant wave breaks into surf.

That is what I call great listening. There is no trace in it of the disease which the Americans call "spectatoritis." To the Northerner the most personal of the arts has always been a way of active worship and realisation. I mean worship in the widest sense of the word, though it is worth noting that the church and the chapel have together formed a most important agency for developing the musical consciousness of the people. Thus we find the great Colne Orpheus Glee Union was begun forty-five years ago by a few young men at a Wesleyan church. The Rossendale Male Voice Choir started by singing hymns too, those that the old "rangers" loved. Wesley in his diary speaks of preaching to "the wild men of Rossendale" and of

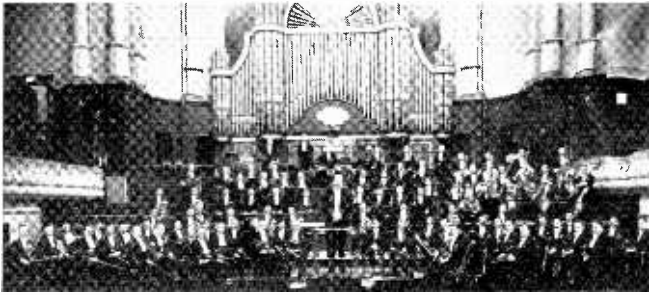

D. Reavy

THE HALLÉ ORCHESTRA CONDUCTED BY SIR HAMILTON HARTY,
IN THE FREE TRADE HALL, MANCHESTER

the gusto they put into their singing. The Hull Gleemen were originally the members of the St. Augustine's Church choir. So the story could be continued.

The best proof of the way in which the native talent of the Northerner for musical expression flowers, the talent which enabled Brindley and Colcough to sit down to read Strauss at sight, is to be found in the musical festivals. There are no fewer than forty festivals in the North of England recognised by the Federation of Musical Competitive Festivals. Since the war old festivals have taken on new life and fresh ones have been established. The work of the Women's Institutes has helped the villages to play their part in these festivals. Some, like the Mary Wakefield Festival at Kendal, have been established since 1885. The Cleveland and Durham Eisteddfod goes back ten years earlier. Others, such as Rothwell, were only founded in 1931. To some, as at Hull, as many as 11,000 competitors come. Many are open to any who care to enter, while others cater for the inhabitants of a particular district, a Yorkshire dale, an area six miles north and south of a river, as at Wansbeck, or "twenty miles square," as at the Eskdale Tournament of Song. The atmosphere of these festivals is a peculiarly happy one, giving the local leaders a chance to extend their technical knowledge, and the groups an opportunity to refresh and enlarge their experience. The commercial element, except possibly in some of the solo classes, is comparatively unimportant. The desire animating the vast majority of those attending is one to

create and to hear good music. Each festival has a character of its own. At Kendal, for instance, which is held in the spring-time, the choirs from the lonely Lakeland villages, from Patterdale and Grasmere and Hawkshead and Shap, perform. Rehearsal is difficult for these choirs when winter has a firm grip on the land, but somehow or other they manage to meet week after week, and when they come to Kendal they sing songs to express their joy at the turn of the year, songs of Maytime and blossoms and a merry England. Then there is Buxton, where the schoolchildren collect in their hundreds from the Derbyshire villages, ready with their piano pieces and their recitations; and Alderley Edge in Cheshire, where the woodwind classes are strong and small infants play in percussion bands. At York the girls from the secondary schools in the county win the choral events. The bad old days when the chemistry teacher took music as a side-line have gone for good. At Belle Vue, which is the Manchester Zoo, three brass band festivals are held each year. Nearly 150 bands from collieries and mills and factories in Lancashire and Yorkshire turn the affair into a battle of the Roses. The brass band in the North is not only an important village institution; it serves as a kind of trademark for many an industrial undertaking. On these days the elephants keep in step as they carry passengers round the gardens, and the tigers get very tired of the test piece. Just think of it, 3,500 bandmen all together in one place!

It is at Blackpool and Morecambe that the really great choral singing is to be heard. Here come choirs often made up of untutored men, some of them, it may be, in these days of depression, unemployed, yet with an artistic capacity of the highest order, giving noble renderings of the miniatures of Bach and Elgar and Brahms. Some of these choirs, Sale and Colne, and Huddersfield and Blackpool, have been coming to sing for forty years. Their conductors are veterans, men of wide culture and fine personality. But younger men, from Nelson and Skipton and Preston, are arising to carry on the tradition of leadership. The beauty of the singing of these choirs has kindled in our English composers creative faculties—they themselves are the first to acknowledge the debt—which have made the last thirty years as important a generation in musical history as any since the spacious times of Elizabeth.

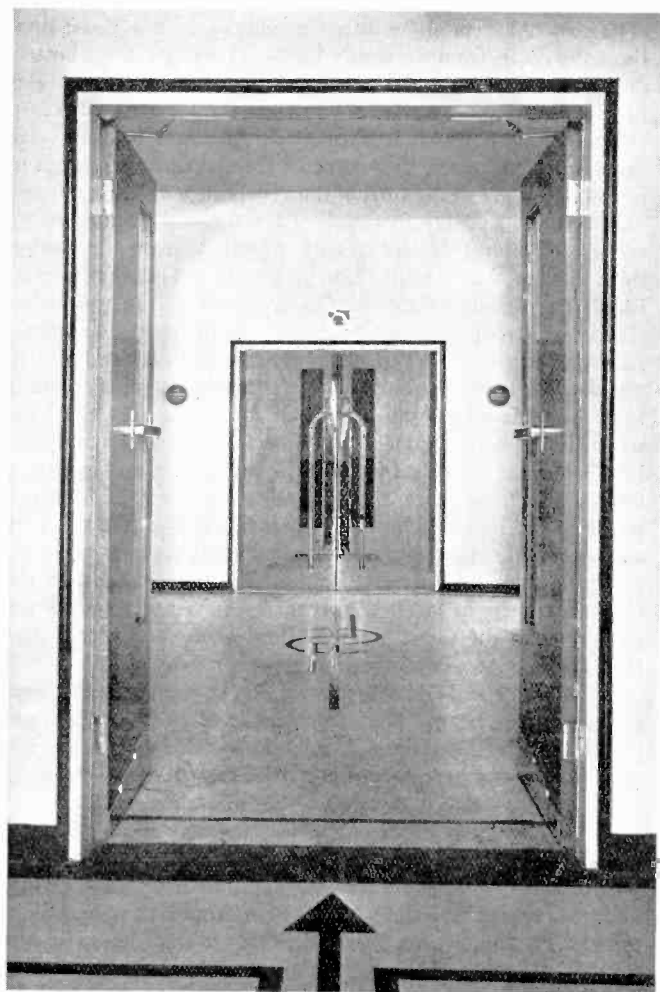

THE ENTRANCE HALL LEADING TO NO. 1 STUDIO IN BROADCASTING
HOUSE, LEEDS

NORTH REGIONAL EVENTS

- 1932
- November 1 Speech by Lord Gainford at the Bishop Auckland Radio Exhibition.
- 4 The Huddersfield Choral Society in the performance of Bach's "B Minor Mass."
- 14 "The Ship," a play by St. John Ervine.
- 15 Liverpool Philharmonic Society's Concert conducted by Sir Thomas Beecham.
- 23 Act I of "The Mastersingers" from the Theatre Royal, Halifax.
- 24 Halifax Choral Society's Concert conducted by Albert Tysoe.
- 26 Liverpool Promenade Concert conducted by Alfred Barker.
- December 4 Service relayed from Wakefield Cathedral.
- 7 Speeches by Sir Arthur Balfour and Sir Herbert Austin at the Annual Banquet of the Incorporated Sales Managers' Association.
- 9 Extract from the revue, "Sous le Rideau," relayed from the Empire, York.
- 10 "La Bohème," relayed from the Opera House, Manchester.
- 15 Handel's "The Messiah" performed by the Sheffield Musical Union, conducted by Sir Henry Coward.
- 24 "The Second Shepherd's Play" performed by the Wakefield Nativity Players from St. Mary's Chantry.
- 31 The Glasgow Orpheus Choir conducted by Sir Hugh Robertson at the Free Trade Hall, Manchester.
- 1933
- January 18 "In Marsden Bay," a radio play by Edwin Lewis from Newcastle.
- 19 The Hallé Concert conducted by Pierre Monteux.
- 27 "The Village," a play of the coalfields, by Edwin Lewis.
- 28 Hospital Service relayed from Manchester Cathedral.
- 31 The 700th Manchester Tuesday Mid-day Society's Concert in the Houldsworth Hall: a Programme of Eric Fogg's Music.
- February 15 Talk by Lady (Ernest) Simon on "Individual Happiness in an Industrial World."
- March 1 Gracie Fields at the Theatre Royal, Rochdale.
- 16 Leeds Festival of Song conducted by H. Kallaway.
- 26 Service from Selby Abbey.
- 30 "Links in the Chain"—a sound picture of the work at the L.N.E.R. Leeds-Airdsley Goods Traffic Junction.
- April 6 Speeches by H.R.H. Prince George, Sir Andrew Duncan, and the Lord Mayor of Sheffield at the Luncheon in connection with the Opening of the Blackburn Meadows Generating Station, Sheffield.
- 12 A sound picture of the General Post Office, Manchester.
- 16 Mattins from York Minster.
- Religious Service from Carlisle Cathedral.
- 30 Military Service from York Minster.

- * * *
- May
- 1 Concert by the Manchester Orchestra (Manchester's Unemployed Musicians) introduced by the Lord Mayor of Manchester.
 - 6 Commentary by L. B. Todd on the Rugby League Final, Huddersfield v. Warrington, at Wembley Stadium.
 - 27 Speeches by Lord Derby and the Mayor of Morecambe and Heysham in connection with the Opening of the New Arterial Coastal Road.
- June
- 3 "Fire!" a broadcast from the Rochdale Fire Station.
 - 5 Accounts of the County Cricket Match, Lancashire v. Yorkshire, from the Old Trafford Cricket Ground.
 - 13 Two plays, "Luck" and "Peace and Comfort," performed by the Yorkshire Comedy Players.
 - 14 The Heckmondwike Lecture relayed from the Upper Independent Chapel, Heckmondwike.
 - 16 Commentary on the Senior Tourist Trophy Race from the Isle of Man.
 - 21 Commentary on the Northumberland Plate at Gosforth Park.
 - 28 Speeches from the Forfeit Feast at the Cutlers' Hall, Sheffield.
- July
- 1 Camp Fire Sing-song by the Boy Scouts of Northumberland and Durham at the Scout Camp, Gosforth Park.
 - 5 Commentary on the Tynwald Hill Ceremony from the Isle of Man.
 - 8 Speech by Lord Baden-Powell at the All Yorkshire Scout Rally at Pontefract.
 - The Northern Command Tattoo at Knavesmire, York.
 - 12 Commentary on the "Mannin Beg" Motor Car Race from the Isle of Man.
 - 16 Special Religious Service and Address by the Rev. W. Graham Scroggie at the Keswick Convention
 - 23 Wilberforce Centenary Service from Holy Trinity Church, Hull.
 - 28 Ceremonial Civic Tribute at the Wilberforce Monument from the City Square, Hull.
- August
- 7 Account of the County Cricket Match, Yorkshire v. Lancashire, from Leeds.
 - 23 Description of the Southport Flower Show.
 - 24 Commentary on the Rydal Sheep-dog Trials.
 - 27 Religious Service from Hexham Abbey, Northumberland.
- September
- 13 Commentary on the "St. Leger" from Doncaster Race-course.
 - 18 Account of the English Water Polo Championship at Ashton-under-Lyne.
 - 27 Speeches at the Inaugural Luncheon of the Tenth Northern National Radio Exhibition at Manchester.
- October
- 7 Commentary on the Rugby League Test Match, Australia v. England, from Belle Vue, Manchester.
 - 14 Speeches from the Civic Banquet at the Guildhall, Hull.
 - 19 Hallé Society's Concert from the Free Trade Hall, Manchester.
 - 23 The London String Quartet in the Rodewald Society's Concert.
 - 25 Speeches at the Centenary Dinner of the Manchester Statistical Society.

M I D L A N D R E G I O N A L

FOR MIDLAND REGIONAL the past year can be summarised in the phrase "Development under Difficulties." Side by side with drastic reconstruction of the studios in Broad Street, Birmingham, there has been a notable advance in pursuit of the ideal of the Regional charter—programmes which reflect the life, culture and talent of the area served.

From the Autumn of 1932 to the end of the Summer of 1933 the studios were in a state of transition. In the early stages this involved limitation of the number and scope of inside broadcasts, an increase in the proportion of outside broadcasts, distraction for the administrative staff, and a severe call upon the ingenuity and the industry of the Engineers.

For one week in November, 1932, for instance, only two small studios at the station were available. That was during the reduction in size of "No. 1," in order to provide more accommodation for the Engineering Department. When "No. 1" was first opened in 1926, it was the largest studio in Europe, and before it was closed for reduction there was produced a special programme, "Farewell to No. 1." Sir Frank Benson spoke the prologue and told the story, which linked up reminiscences of "high spots" in six years of the Midland programmes.

The new Nos. 2 and 2a studios—on the floor above No. 1—did not come into use until the last week of March, and the new large studio—No. 4—not until July 4th.

To minimise interference with normal programme output, the extension of wiring from the old control room to the new had to be spread over a month. The Engineers in charge of this work had to move twenty Post Office lines, as well as many internal ones—about a mile-and-a-half of wire in all. New positions were opened in stages as soon as they were ready, and the final change was made during the Easter week-end. The work was accomplished without a hitch, but the stress and strain of this period can be imagined.

As to the administrative staff, it may be said that for some months during the reconstruction period they did their daily work to an almost continuous accompaniment from hammer, chisel and saw. It was not until the beginning of 1933 that their new offices were ready.



EFFECTS AND GRAMOPHONE STUDIO, BIRMINGHAM

Two outside studios—one kindly placed at the disposal of the Corporation by Mr. Bayliss, and the other rented from the City of Birmingham as occasion demanded—had to be used for six months. This meant much extra work and extra transport, but without the aid of this outside accommodation it would hardly have been possible to carry through the programmes.

Contemporaneous with all these difficulties there has been, as has been hinted, notable development in programmes of a purely Regional character. This growth was especially manifested in a series of Midland County Week broadcasts. These began in October, 1932, and continued until the end of April; three of the twelve counties being left for the last three months of 1933.

The general scheme included an opening Talk by the Lord Lieutenant of the County (or, where he was not available, the Chairman of the County Council); a pageant, written by a native or resident, to represent the history of the county down the centuries, and some of its most famous figures; an account of the distinctive folk-lore and customs, by a local authority; recitals by local artists and programmes representing composers born in the county—Gloucester has been especially rich in composers—and, with the co-operation of the Chambers of Commerce, a series of relays from factory, farm or harbour, showing the chief activity of each county and its most important contribution to national trade. These industrial relays have all been illustrated by appropriate noises, five or six microphones being used in some instances.

All these features were common to the County Weeks. Occasionally also it was possible to include some special event which fell within the period: a memorable example was the dedication of the new bells of St. Botolph's, Boston ("Boston Stump"), which came at the close of Lincolnshire Week.

The industrial relays had to be given in the evenings—and several manufacturers made special arrangements for this; but it was sometimes necessary to record the noises required by the Blattnerphone-Stille process in advance of the actual broadcast. The first Regional example of the use of this method was at the L.M.S. boiler works during the Derbyshire Week, at the end of October. Other notable records were of the arrival of steam trawlers and the auction of their catches in Grimsby

Fish Market, and a thousand-ton blast at the Mount Sorrel Granite Quarries, in Leicestershire. The latter was taken during a terrific snow blizzard.

Outside broadcasts of special note have been the Shelsley Walsh Hill Climbs for racing cars—there were two of these in the year for the first time, the Cheltenham “Flyer” (both were also in the Empire programmes) and Beating the Bounds at Hereford.

In November a monthly programme was introduced to include three or four short items which, for reasons of length or character, could not be included as individual features. The name “Etc. . . . Etc. . . .” was given to this series, and it has become popular with listeners. Several “Etc. . . . Etc. . . .” features have included John Overton’s Protean Interludes. These short sketches, which combined strong human interest with fantasy, were specially written by John Overton for Edgar Lane, who took all the characters; and they drew a large number of letters of appreciation. In the June “Etc. . . . Etc. . . .” programme the Virginals were played in the Midland studio for the first time: the instrument, used by Samuel Underwood, of Gloucester, was made in Venice in 1564, and must be one of the oldest keyboard instruments still in use in this country.

During the winter season, Symphony Concerts by the City of Birmingham Orchestra, and Choral Concerts from Worcester and Gloucester were the chief musical events. School Musical Festivals were relayed from Worcester and Stafford in the Spring: for the former, Sir Edward Elgar specially composed a new Unison Song, “The Woodland Stream.”

On the dramatic side there have been relays from the Birmingham Repertory Theatre’s wireless studio, and from the Coventry Repertory Theatre.

Charles Brewer, in addition to producing all the County Pageants, was responsible for the radio revues, and continued his “Nine-Thirty Novelties” and “Vignettes of Variety”—the first modern and original, the second reminiscent of the music-hall in its prime. Examples of both series were included in Empire programmes; letters of appreciation from Nigeria for the humour of Clapham and Dwyer brought home to one anew the conquest of space by broadcasting.

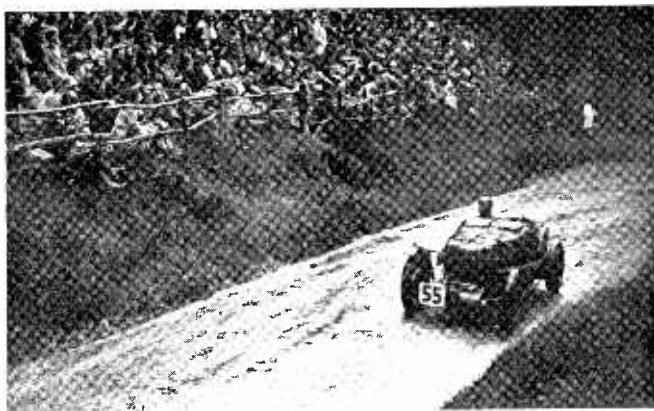

SHELSLEY WALSH HILL CLIMB

The Midland Children's Hour maintained its distinctive character. Serial plays were a popular innovation: and their exciting episodes seem to have appealed to nearly as many grown-ups as youngsters.

One interesting development which will not bear its full fruits in the Regional service till later on is the establishment of a Talks Department. The first regular features begun were weekly surveys of Midland News and Midland Sport; and a monthly talk on progress and achievements in engineering in the area. There have also been a number of general talks; and one or two discussions.

When any particular subject came prominently into the news, a short pictorial talk bearing upon it was introduced at short notice in the announcement period: thus, when the Miners' Agreement expired in July, a personal description of visits to three Midland pits was given. Most of the work of the Department in the Summer was in preparing an organic Winter programme to represent the contribution of the Midlands to English life.

As there is also in view, on the musical side, a series of programmes representing Midland composers, the expression of the Regional spirit, which has been the chief motive during the year, will continue unabated in 1934.

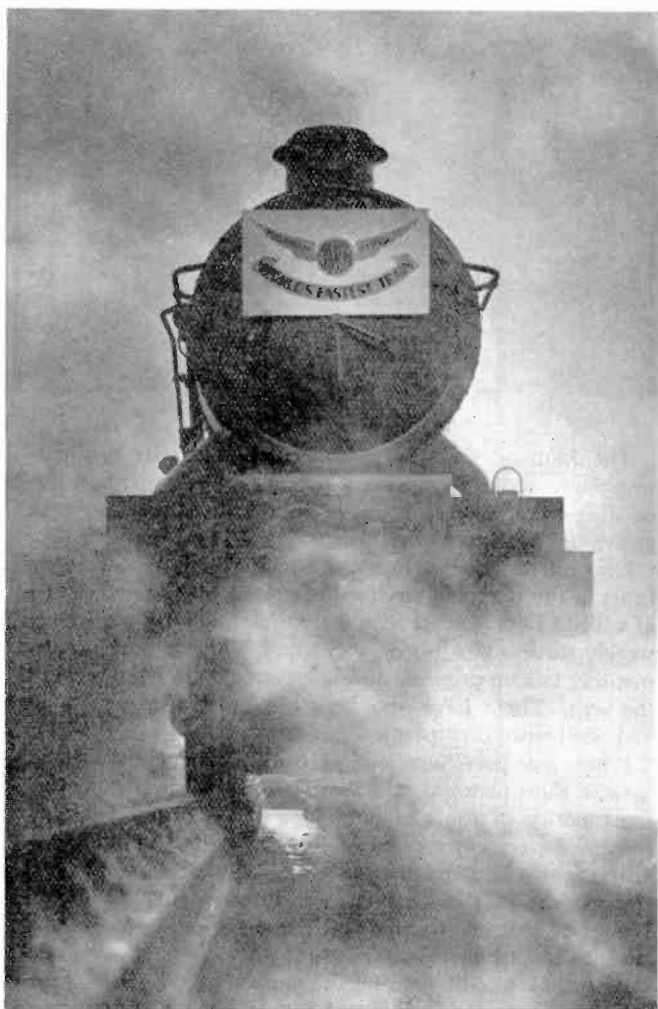

"THE CHELTENHAM FLYER"

A commentary from Gloucester Station of the arrival and departure of the fastest train in the world was broadcast on April 29th, 1933.

MIDLAND REGIONAL EVENTS

- * * *
- 1932
- Nov. 2 Derbyshire County Week. Broadcast from the L.M.S. Railway Workshops.
- Dec. 30 Coventry Repertory Players in R. L. Stevenson's "Markheim."
- 1 Gounod's "Faust" by the Carl Rosa Opera Company.
- 6 Worcester Festival Choral Concert conducted by Sir Ivor Watkins.
- 15 The Arrival of steam trawlers and the auction of their catches in Grimsby Fish Market.
- 17 Service in St. Botolph's, Boston, on the occasion of the Consecration of the Bells in the Tower (Boston Stump).
- 26 Birmingham Festival Choral Society's performance of Handel's "The Messiah."
- 1933
- Jan. 17 Pianoforte Recital by Sir Granville Bantock in the "Warwickshire Week" programme.
- 25 Reopening of Birmingham Town Hall Organ, with a Recital by G. D. Cunningham.
- 28 The Chancellor of the Exchequer speaking at the Birmingham Jewellers' Dinner.
- 30 John Foulds conducting Birmingham Philharmonic String Orchestra in his Suite "Hellas."
- Feb. 7 Clapham and Dwyer in C. Brewer's "Nine-Thirty Novelties."
- 26 Hundredth Broadcast by Dr. Harold Rhodes, Organist of Coventry.
- Mar. 4 Talk by Mr. C. H. Martin on "Granite Quarrying," with a descriptive record from the Mount Sorrel Granite Quarry.
- 13 Bromsgrove Musical Club in Mendelssohn's "Hymn of Praise."
- 28 Peterborough Cathedral Organ.
- Apr. 5 City of Birmingham Choir and Orchestra in William Walton's "Belshazzar's Feast."
- 24 Speeches at the Shakespeare Birthday Celebrations at the Town Hall, Stratford-on-Avon.
- Inauguration of Gloucestershire County Week by the Duke of Beaufort.
- 29 Commentary on the Arrival and Departure of "The Cheltenham Flyer" at Gloucester Station.
- May 18 City of Worcester Schools Festival: First performance of Elgar's Unison Song, "The Woodland Stream."
- 27 The Shelsley Walsh Hill Climb Test for Racing Cars.
- Festival by the Birmingham, Coventry and Leicester Cathedral Choirs at Coventry.
- June 1 Concert by the Winning Choirs in the Stafford Schools Musical Festival.
- 9 Speech by Mr. Stanley Baldwin at the National Savings Association Dinner at Malvern.
- 24 Ceremony of Beating the Bounds at Hereford.
- 29 Carillon Recital by Harry Withers from the Roman Catholic Church of Our Lady of the Rosary, Salfley, Birmingham.
- July 19 Clapham and Dwyer and Eugene's Tzigane Band from the Wolverhampton Flower Show.
- 30 Religious Service from Peterborough Cathedral, with an Address by the Dean.
- Aug. 7 Royal Air Force Band at Stonebridge Flower Show.
- Sept. 19 Talk by Lt.-Col. Cecil Crosskey on "Emigration."
- 30 Shelsley Walsh Autumn Hill Climb.
- Oct. 2 First Concert in the Midland Composers Series: "Eric Coates" by the Midland Studio Orchestra conducted by Frank Cantell.
- 9 City of Birmingham Orchestra conducted by Adrian Boulton.
- 14 Dr. W. W. Vaughan's Presidential Address to the Union of Educational Institutions Meeting in Birmingham.
- Recital by Michael Mullinar of Contemporary Russian Music.
- 25 Cyril Maude in "Cabbages and Kings" from Birmingham Repertory Theatre.



THE ARTISTS' WAITING ROOM, BIRMINGHAM

A REVIEW OF RADIO CRITICISM IN THE MIDLANDS

By WILLIAM G. MOFFAT

(“W. G. M.” of the *Birmingham Weekly Post*)

FROM THE “one room and a cubicle” in Kingsway which housed the first studio of the British Broadcasting Company to the palatial edifice in Portland Place which forms the present headquarters of the British Broadcasting Corporation is but a short space of time when counted in years, but, short as is that space, it more than covers the life of the broadcasting journalist. For in those days wireless was a thing of little moment to the daily Press. In some quarters it was viewed almost with suspicion and as a new “fad” which could not, and would not, last; indeed, one gentleman in editorial charge of an important provincial newspaper privately gave broadcasting “three years of life at the most.”

So far as the lay Press was concerned there was then, in the provinces at least, little scope for the writer on wireless topics. Programmes occupied but a few hours of the day, and “copy” of an interesting nature was difficult to obtain. With an entirely new medium to handle, it was not altogether surprising that the advantages of Press publicity were often overlooked by Station Directors; and at the present time, when even the laying of the first stone of a new Regional station is matter sufficient for an eulogistic column—with all technical details supplied by an efficient publicity department at headquarters—it is somewhat difficult to believe that the opening of one of the original main stations went practically unchronicled in the local press! But that belongs to the limbo of the past; the trouble now is rather to keep broadcasting out of the news than to get it into it.

The early programmes were very easy-going affairs, and waits between items were quite the natural order of things. (Incidentally, we have these gaps in the programmes even now, but most of them are, so to speak, on a legal basis and are labelled in the official journal as “intervals.”) “Stand by for so many minutes” was heard all too frequently; and it was after one of these waits that the Birmingham station for a short time anticipated the “six pips” of the Greenwich time signal,

the Station Director counting out the last seconds of one particular hour in the evening programme and banging the studio gong for the "sixty." Regarding broadcasting as a highly speculative proposition, participation in which might have an injurious effect on their careers, many artists in these early days could not be persuaded to face the microphone, and as a consequence members of the various station staffs had to possess "entertainment value" as well as business acumen. There was nothing undignified or incongruous then in station leaders assuming the rôle of "Uncle" every afternoon for the amusement of the children, and the intimacy established in this and other ways between officials and listeners was of incalculable value to the new Company and the objects for which it stood.

By the time all the original main and relay stations had got into working order there came a change in the character of many of the wireless "columns." Technical and semi-technical matter began to give place to news about the stations themselves, and desultory criticism of the various items, together with suggestions for "improvement" in the quality of the programmes, made its appearance.

Then came the Regional proposals, and London began to play an increasingly dominating part in the affairs of the provinces. Rightly or wrongly, patrons of the local stations got the idea that the main object of headquarters was to secure entire control of the broadcast programmes, and this aroused—and is still causing—much feeling. Here I may be permitted to say that it has not always seemed to be realised by London that the provinces have a musical and entertainment outlook of their own—quite different from, and, indeed, almost alien to, that of the capital—and that, save for a few "superior persons," who are to be found in every community, provincial listeners would prefer to "gang their ain gait" on their own wavelengths, being quite content to hear London's version, when they want it, as an "alternative" programme. The creation of the big Symphony Orchestra, whose full glory is reserved for the sight and hearing of Londoners, has hardly reconciled the provinces to the supersession of their various local Studio Orchestras by studio "octets" and subsidies to outside musical bodies.

Much of what may be called the middle period of the eleven years was occupied by wireless writers in speculating on the location of the intended Regional stations, and as to the part they were expected to play in the broadcast scheme. The old Company gave place to the new Corporation, with a Royal Charter, a motto, and a ten years' licence; our broadcasting masters began to take life very seriously indeed. The two official journals—rightly enough from the B.B.C. point of view—got the cream of the news, and the way of the wireless journalist in search of the wherewithal to fill his column became, like that of the transgressor, very hard indeed. The enterprising pressman on the scent of a supposedly good "story" can be very inconvenient, and even annoying, to constituted authority determined that he shall not have it; and, baulked of what he felt entitled to regard as his legitimate prey, it was small wonder that he began to scour the moors and dales of the kingdom and fill them with mythical Regional stations.

Humorous incidents, in which the indiscriminating microphone played a leading part, were plentiful in these early days. When the Sunday afternoon programmes consisted mainly of features for the children—Birmingham, by the way, supplied some of the best and most appreciated—Aberdeen's contribution one afternoon was a concert of children's voices from a large public hall. The microphone opened a minute or so too soon, and literally "all the British Isles" heard the voice of the concert-leader admonishing his charges: "Don't shuffle your feet or rustle your papers, or you will be heard all over the British Isles." A little nearer home a lull in an outside broadcast was broken into by the irruption of a breezy voice asking "Is that d--- thing open?" It was; but it shut in record-breaking time. Another time the full-blooded request of a London stage-hand who desired the lowering of a recalcitrant curtain on the conclusion of an operatic excerpt almost drowned the applause of the audience. And everyone knows that one about the Bishop and his uncompleted sentence.

But with the full coming of the Corporation, broadcasting "grew up." Bigger and better transmitting apparatus and handier and better receiving sets made listening more pleasurable; and what had previously been "high spots" in the programmes now became matters of commonplace. We heard,

as a matter of course, the voices of Royalty and the great ones of the earth; we listened to famous orchestras and singers without number; we heard—or dodged—talkers and debaters; and we had depicted for us, from the lips of those who saw, the great sporting and outside events of the day. This was, indeed, great matter for chronicle, and the Press, as a whole, made excellent use of its chance.

And now, eleven years after its advent, wireless has come to be an almost indispensable feature in our daily life. It will go on inevitably to new conquests and to an ever-increasing indispensability. In that future what part is destined to be played by the wireless writer in the daily Press? Is it part of a newspaper's function to deal with broadcast programmes on the same exalted footing as music and the drama are now dealt with in the more important journals—with an army of expert critics to essay the task of educating the listener in the direction of thinking he wants what someone else thinks he ought to want? Certain journals are now devoting space to something like ordered criticism of the programmes, and it is probable this feature will still further be developed in the future. But for what my opinion may be worth, I do not think that is the function of the newspaper. The broadcasting canvas, I am afraid, is too large for one painter to fill satisfactorily; and I doubt whether there are many writers, or critics—call them what you will—with an outlook sufficiently wide to do full justice to the intricate mosaic of high, middle, and low-brow fare which make up an evening's broadcast entertainment. After all, one cannot reasonably expect a Covent Garden or Queen's Hall enthusiast to deal faithfully with an excerpt, say, from a North Country variety theatre programme, nor can one imagine a devotee of variety or vaudeville finding any good points in a "contemporary" or chamber music recital.

SCOTTISH REGIONAL NOTES

JUST ABOUT a year ago, when the Regional Transmitter opened at Westerglen and photographs of it appeared throughout the Scottish press, a common inquiry put to broadcasters in Scotland was—"Now that your big new station is open at Westerglen, I suppose you will be closing your Edinburgh (Glasgow or Aberdeen as the case might be) Station?" Though it may seem rather obvious to comment on it here, the frequency of this question perhaps allows one to point out that the exact converse was the case. The studios at Edinburgh, Glasgow and Aberdeen began, on the contrary, to be more active than ever. The Scottish Regional programmes, with facilities now on a level with the programmes of those of the London, Midland and North Regions, have had free scope for their development, and to these programmes Edinburgh, Glasgow and Aberdeen contribute daily. They were, to put it differently, the three feeding points in various parts of Scotland on which the ever-voracious transmitter at Westerglen drew for its material.

Provided that the Scottish Regional programme gave a contrast to the item broadcast at the same time on the National Transmitter, it was free to expand or choose its material as it wished. And so Scottish broadcasting has for the period of time covered by this issue of the *B.B.C. Year-Book* enjoyed almost exactly one year of full broadcasting facilities.

Edinburgh, where the headquarters of Scottish broadcasting lie, has, of course, continued to contribute the usual daily routine of broadcasts. The Scottish Studio Orchestra, whose personnel is drawn from all over Scotland, performs in Scottish Broadcasting House in Queen Street. The Scottish announcements and general broadcasts that have no particular local significance are, of course, concentrated on Edinburgh, while Glasgow has, with its new and enlarged studios, drawn on the talent of the West to provide its own characteristic contribution of broadcasting. Aberdeen, which has asserted its traditional individuality by retaining a transmitter, has not been behind-hand in this supply of programmes, also flavoured with the strong Aberdeen character.

Since this expansion in Scottish programmes, it has been

made clear that one of the specialities of Scottish broadcasting has been the development of the wireless drama and the feature programme. The rise of broadcasting in Scotland has coincided with a widespread interest in the drama, and with this the foundation of the Community Drama Festival, the Scottish National Players and the countless dramatic societies which have sprung up all over this country. The B.B.C. has reflected this interest in the many plays broadcast in the last few years. But in the latter end of 1932 and in 1933 it has had freedom to produce many more than heretofore. The notable first performances include "Montrose" by F. C. Sillar (adapted for broadcasting by Andrew Stewart); "Edinburgh" by Christine Orr and C. A. Malcolm; "Glasgow" by Robins Millar; "Woo'd and mairrit an' a" by John Donald Kelly; "The Trial of Deacon Brodie" by Alec Macdonald; "The Bonnie Earl o' Moray" by Edith Macqueen; and lastly, but certainly not least, the highly successful "The Royal Scots" by John Gough, which celebrated the Tercentenary of the oldest of all British Regiments. Some of the above are not, strictly speaking, wireless plays, but are feature programmes—that is to say, programmes made up of short dramatic scenes, speech, and plenty of music, all on one central theme. "The Royal Scots," "Edinburgh" and "Glasgow" are examples of this type of programme which has been a product of broadcasting alone, and to the development of which Scotland has contributed its share. Amongst the better known revivals in the last year may be mentioned Compton Mackenzie's "The Lost Cause" and Christine Orr's "Dunbar," both long and ambitious but highly successful plays, based upon two of the most famous and colourful periods in Scottish history.

While on the subject of studio dramatic work, one should mention the regular broadcasts performed by the Radioptimists at Glasgow and at Edinburgh—one of the most long-lived of all wireless vaudeville combinations—and by the Silver Citizens, a recent but highly lively product of Aberdeen. The first performance of a number of revues and musical comedies has also been staged from Glasgow and Aberdeen, and at least two new radio authors in the sphere of light music and lyric writing have been discovered. The Outside Broadcasts of vaudeville have, of course, continued from a number of the best known homes

of this form of entertainment in Scotland, and during the summer months a feature of Scottish broadcasting has been the number of shows from popular Clyde and Aberdeen resorts. If any listeners supposed that the Scots were a dour and unappreciative race, incapable of showing their enthusiasm, they would speedily have lost this illusion if they listened to some of these relays. A large part of their success has been due to the infectious high spirits of the crowd at these holiday resorts as they greeted their favourite singers and comedians—whether they be the Houston Sisters (once again back in Scotland), Dave Willis, or the ever-fresh Harry Gordon and his Company. Scotland is in many ways a conservative country, and one of the oldest forms of entertainment, the pantomime, is a great favourite north of the Tweed. This year's broadcasts have included no less than five pantomimes, including, of course, the famous Princess pantomime in Glasgow, which runs from December until April, always drawing packed houses.

Amongst the most prominent outside broadcasts has been the relay of H.R.H. the Prince of Wales from the City Chambers, Dundee, when he spoke during his tour of the centres of unemployment in Scotland. The Prime Minister's voice was also heard from his home at Lossiemouth at Christmas-time and in May. Rugby International was the subject of a running commentary from Murrayfield, while Association Football was heard from Hampden Park. A regular form of outside broadcast peculiar to Scotland is the "Frac a' the Airts," which is designed to catch the local spirit of the remoter places of Scotland. The microphone has made some hazardous journeys on these outside broadcasts, but this is dealt with elsewhere.

During last winter a notable series of talks for broadcasting were arranged under the title of "Attack and Defence," when a half-hour or twenty minutes period was given to two speakers who, instead of debating a given subject, divided the time equally between them, the one attacking a certain point of view and the other defending. Compton Mackenzie defended the Wearing of the Kilt and Joseph Duncan attacked it; the Rev. David MacQueen and Mr. George Eyre-Todd were heard on "John Knox"; and Professor F. A. E. Crew and Sir Hugh S. Robertson on "This Young Scotland Business," amongst other lively topics. Already there are being arranged a series of talks entitled

“Queer Happenings,” in which Scotsmen (who are a people to whom queer things happen) are to tell of some of their more strange adventures.

Music, which necessarily supplies the major part of any broadcasting, must be given brief and inadequate space in this survey of the year's Scottish broadcasting. It is only possible here to mention that the B.B.C. has continued its policy of taking outside broadcasts of the better known orchestras in Scotland, and has encouraged the giving of concerts in cities other than Glasgow and Edinburgh from which it can broadcast. During the coming season broadcasts have been arranged with the major orchestras in Scotland, and Scottish listeners who live outside Edinburgh and Glasgow will again have a chance of hearing some of the distinguished musicians who come to Scotland each winter. There have been, of course, the regular broadcasts of concerts in the studios, and during the summer months the Scottish Philharmonic Orchestra gave five public concerts in the main studio of Scottish Broadcasting House, when a chance was given to the younger conductors in Scotland to show their talents. Though it does not come, strictly speaking, under the heading of concerts, mention must be made of the Highland Gatherings or *Ceilidhs*, at which Gaelic songs and Celtic music have been sung and performed. Your true Highlander shares with the Welshman a passion for music that even this modern age cannot eradicate, and his presence in Scotland has been a continual stimulus to those in charge of broadcasting the music of this country.

SCOTTISH EVENTS

- 1932
- Nov. 2 "Dunbar," Episodes from the Life and Times of William Dunbar written by Christine Orr, and produced by Gordon Gildard.
- 3 Concert by the Reid Symphony Orchestra conducted by Adrian Boult.
- 7 Extract from "Die Meistersingers" performed by the Covent Garden Opera Company at the King's Theatre, Edinburgh.
- 8 The Cairngorms "Frae a' the Airts" Programme at the Temperance Hotel, Aviemore.
- 11 H.R.H. the Prince of Wales, the Lord Provost of Edinburgh, and General Sir Ian Hamilton at the Armistice Day Celebration, under the Auspices of the British Legion, at the Usher Hall, Edinburgh.
- 26 Speech by the Lord Provost of Edinburgh at the Opening of the Exhibition of the Society of Scottish Artists at the Royal Scottish Academy Galleries, Edinburgh.
- 30 "Hail Caledonia," a St. Andrew's Night Fantasy by James Wallace Bell, produced by Gordon Gildard.
- Dec. 7 Choral Concert by the Glasgow Orpheus Choir conducted by Sir Hugh Robertson at St. Andrew's Hall, Glasgow.
- 8 "Frae a' the Airts" programme: a Gathering at the Dundonald Arms, Culross, of the Folk of Wester Fife.
Discussion between Eric Linklater and Donald A. Mackenzie on "The Celtic Influence in Scotland."
- 24 "No Room at the Inn," a Christmas Morality Play by D. Cleghorn Thomson, produced by Gordon Gildard.
"The Shepherds," a Nativity Play by G. Rowntree Harvey, produced by Moultrie Kelsall.
- 1933
- Jan. 2 A Scottish Concert by the Edinburgh Royal Choral Union and the Scottish Philharmonic Orchestra conducted by W. Greenhouse Allt.
- 4 "Robinson Crusoe" from the Gaiety Theatre, Ayr.
- 7 An Extract from the Pantomime "Dick Whittington" from the Theatre Royal, Edinburgh.
- 11 Operatic and Orchestral Concert by the Glasgow Grand Opera Society and the Scottish Orchestra conducted by Erik Chisholm, at the Lyric Theatre, Glasgow.
- 12 First talk by Mr. John Wilson on "Town Planning" in the series "Putting Scotland's House in Order."
- 14 "The Trial of Deacon Brodie," a Play by Alec MacDonald, produced by Gordon Gildard.
- Feb. 3 The Radioptimists in "Trailers," a Revue produced by Gordon Gildard and Kyle Hall.
- 23 "The Story of the Bride of Dionysus" by the Edinburgh Opera Company and the Reid Orchestra conducted by Professor Tovey.

- *
- Mar. 9 Concert by the Reid Symphony Orchestra conducted by Prof. D. F. Tovey. Soloist: Adolf Busch.
- 18 Eye-witness Account of the Semi-Final of the Scottish Cup, Hearts v. Celtic, at Edinburgh.
- 30 Account of the Boxing Match between Johnny MacMillan and Henri Ferrier at the Glasgow Stadium.
- 31 Speech by H.R.H. the Prince of Wales on his Visit to Scotland as Patron of the National Council of Social Service, relayed from the Caird Hall, Dundee.
- April 10 Two plays from the Final of the Scottish Community Drama Association Festival: "Glensheugh" presented by the Golspie W.R.L.; "The Long Christmas Dinner" by the Torch Theatre Club.
- 15 Concert by some of the Winners at the Twenty-third Glasgow Musical Festival.
- 21 Compton Mackenzie's "The Lost Cause," produced by Gordon Gildard.
- May 20 Concert of Massed Choirs at the Edinburgh Musical Festival at the Usher Hall, Edinburgh.
- June 15 A Gathering of Singers and Story-tellers from Lochaber, under the Chairmanship of Colonel Cameron of Lochiel, at the Highland Hotel, Fort William.
- 20 Account of the Judging at the Highland Show.
- 22 "The Royal Scots," a Chronicle Play for the Tercentenary of the Regiment, by John Gough, produced by Gordon Gildard.
- July 12 A Collieshangie comin' oot o' the Lonach Gathering at the Houghton Arms Hotel, Alford.
- 19 Mr. Robert Sheddon: "Non-Stop"—an Engine-driver's description of the Flying Scotsman's Journey between Edinburgh and London.
- 25 Concert by Prizewinners in the Edinburgh Musical (Competitions) Festival, 1933.
- 27 Account by W. B. Prentice of the National Sheep Dog Trials at Aberlady.
- Aug. 4 Harry Gordon and his Company from the Beach Pavilion, Aberdeen.
- 31 Recital of Gaelic Songs by the Inverness Gaelic Musical Association.
- Sept. 1 Opening of the Scottish Radio Exhibition from the Kelvin Hall, Glasgow.
- 6 Commentary on the Aboyne Highland Games.
- 7 The Scottish National Players in "Ayont the Hill" by Cormac Simpson.
- "Ceilidh," a Gathering in the Glasgow Studio of Singers and Story-tellers attending the Glasgow Mod.
- 29 The Glasgow Mod, 1933, from St. Andrew's Hall, Glasgow.
- Oct. 10 Aberdeen Birthday Celebrations.
- 11 Opening Ceremony of the Scottish National Radio Exhibition by the Lord Provost of Edinburgh.
- 15 Concert by the Reid Orchestra conducted by Professor Tovey at the Usher Hall, Edinburgh.
- 24 "The Black Watch," a play for the Anniversary of the Regiment by John Gough.
- 28 Edinburgh University Anniversary Celebrations.

PROGRAMMES FROM THE SCOTTISH COUNTRYSIDE

IN THE B. B. C. YEAR-BOOK FOR 1933 a chapter was devoted to the "Frae a' the Airts" broadcasts which have recently taken such a prominent part in the Scottish programmes. The writer described the reason and purport of these outside broadcasts, and showed how in the journey that the microphone makes to the remoter country places of Scotland it has often been enabled to catch a peculiar element of the Scottish genius which could hardly be brought into the studio. He pointed out that the Scottish genius was largely domestic, and that many of the best songs and stories that are native to Scotland seldom get far away from the fireside or the home. The Scot is often at his best on his own ground entertaining in his own way, and so the microphone has for this type of broadcast chosen to go to the country places of Scotland rather than to attempt to bring the genius of the countryside to the studio.

Since that article was written there have been a number of other "Frae a' the Airts," and broadcasts have been heard by Scottish listeners from village halls, from wayside inns, from country hotels and remote places where people of the countryside feel at home and often come together to sing, talk and play as they know best. The task of those whose business it is to draw the broadcasters together for these occasions and to get the best out of them has not always been easy. In some places the person who was considered to be the best local storyteller has, when confronted with the "little white box," become unexpectedly tongue-tied. Others have been—well, a little too garrulous. Some of the country folk, with the leisurely sense of time which is the heritage of those who do not live in hurried cities, have felt the presence of a microphone in their midst to be a great occasion for telling the rest of Scotland at great length exactly the merits and glories of their own part of the country. It seems rather brutal sometimes to cut short a countryman's story or the tenth verse of a Gaelic song just because the hands of the clock are moving round and somewhere miles away in a studio in Edinburgh, or Glasgow, or Aberdeen, another singer or talker is waiting to take his turn.

On the whole, however, broadcasters in the "Frac a' the Airts" series have come up to scratch wonderfully well. It is surprising (when one considers how frightened many a celebrated person, accustomed to public speaking, is when he approaches the microphone for the first time) how many of the country folk who have probably never made a public speech in their lives nor seen their names in public print before take to broadcasting easily and without any sense of effort. This is particularly so in the Highlands, where the Celtic tradition has left a splendid heritage of eloquence. Those who have heard a Highlander, roused to the occasion, telling a story with his own quick imaginative wit will understand that in the Highlands there has been little need to prompt broadcasters in the "Frac a' the Airts"—the difficulty has been, if anything, to restrain them. This does not mean to say, of course, that the Highlander is a naturally garrulous person—on the contrary, before the broadcast takes place one will often see a group of large, tweed-clad shepherds, factors, boatmen and the like gathered round the microphone in almost dead silence, broken now and again by whispered exclamations in Gaelic. When, however, the broadcast starts, one can always rely upon the Highlander rising to the occasion, and even when the story he tells or the song he sings is in Gaelic, the English listener who does not know that ancient tongue can hardly fail to be impressed by the obvious delight the artist takes in his or her own eloquence. In some cases it has hardly been necessary to translate the story back into English. The mere telling of it in Gaelic has made a first-rate broadcast.

This is not to say that the Lowland "Frac a' the Airts" have been slow or, to use broadcasting jargon, "sticky." Indeed some of the best "Frac a' the Airts" have come from Tweed-side and from Galloway. The Kingdom of Fife, too, has contributed notably to the series. The Lowland broadcasters, however, have usually preferred to have the outline of the programme that they are to give the rest of Scotland much more cut and dried than in the Highlands, not only the order of singers and story-tellers more easily and more simply adhered to than in the north and the west, but sometimes the actual stories themselves, songs, and even the dialogue between the various items have had to be sketched out so that everyone



A CEILIDH IN THE WEST HIGHLANDS

(From the picture by Keith Henderson, reproduced by courtesy of the Corporation of Manchester)

may know exactly where he is. When this procedure has been followed it has not robbed the programmes of their spontaneity. Your country Scot (especially if he has a name in the district as a story-teller or a rustic entertainer) is a born actor, as anyone who has listened to a Scotsman's accounts of his own adventures will bear out, and broadcasters, even when they have been reading from a page written in front of them, have been able to give an air of extempore entertainment which has been most convincing.

One difficulty, however, is common to both the Highland and the Lowland "Frac a' the Airts" broadcasts. Your country Scotsman is a great man for banging the table when he wishes to emphasise a point. Unfortunately the microphone when it is perched perilously on the table amongst the glasses and plates of a simple country supper does not respond very well to the thunderous bang of a country fist on the board, and broadcasting from the back parlour of an inn or a village hall has not all the facilities of a studio. Microphones cannot always be hung from the ceiling, and during rehearsals the engineers have sometimes been almost deafened by the jumps which the unfortunate microphone has endured when a large Scotsman

has wished to ram home the point of his argument or story in the traditional way.

There is, of course, a great air of uncertainty before any of these programmes comes off. It is not possible to rehearse to a point of perfection or anything like it those who are not accustomed to broadcasting, and the officials of the B.B.C. have seldom been so anxious as they are during the half-hour which immediately precedes a "Frae a' the Airts" broadcast. Will the village fiddler be so dreadfully out of tune as he sounded during the rehearsal? And if he is out of tune will he sound realistic? Will the singer who looks so nervous lose his or her nerve? Can the chairman be relied upon to keep the ball rolling? Those and many other questions crowd in on one during the moments before the broadcast, but so far there have been no disasters. Some broadcasts have not been so good as others, but as a general experiment these "Frae a' the Airts" have been a success, and when the moment of suspense is over, when the country place wherever it may be has been on the air for three-quarters of an hour, and when everyone settles back to discuss the programme and to receive telephone calls from all over the place as to how it went, there are few more enjoyable moments of a broadcaster's life. No one person on the staff of Scottish broadcasting is responsible for all the "Frae a' the Airts," but each person has his own particular district or part of the country that is his favourite, and a pleasant rivalry is stimulated amongst those whose special job it is to look for talent in various parts of the Borders or in the mountainous north and west. The search for talent itself has been a delightful part of the broadcasters' duty, and there will not be many who will forget the pleasures and uncertainties of travelling to the remote glens and along country fields in the pursuit (which always has to be very tactfully managed) of the unknown broadcasters of the countryside.

SCOTS FOLK SONG

By THOMAS HENDERSON

THE HEART OF THE STUDENT of Scots Folk Song is often fain to ease itself of its distress by quoting Milton's vain desire to

“. . . call up him that left half told
The story of Cambuscan bold.”

In what lovely world can we now hear the story whose beginning is given by Gawain Douglas :

“The ship sails owre the saut fame
Will bring thir merchants and my lemane hame”?

or where, to cite another of the Bishop's references, leaves the remainder of the love-song beginning

“I will be blyth and licht
My hert is set upon sae gudly wicht”?

In that land whose sea-entrance is the Port of Missing Men, we may see danced “the reill of Aves, the jolliest reill that ever was”; gladden our eyes with the vision of the beauty of that leman, “in land is none so fair,” for whom her lover biggit a bower, and learn all the music of “the ring of the rash, of the gowan.” But from our grey world these, and a thousand other manifestations of the spirit of the old, leal Scotland, have vanished. Wars, domestic and foreign, the turmoil of centuries, the huge upheaval of the Reformation, the growth of theological prejudices, and the fierce out-thrusting into commerce and industry of a poverty-stricken nation, have all combined to destroy the historical materials of its Folk-Song or to impair the will to learn of its own cultural past.

We know enough to be sure that the knowledge we seek is valuable. We know, for instance, that the cultural relations between Lowland Scotland and England, on the one hand, and between Highland Scotland and Ireland, on the other, were intimate. Further, Scotland's long alliance with France brought Continental music and dances into our midst. Yet we have but the scantiest knowledge of the details of these relations. The first of our manuscript records of Scottish music is the well-

known Skene MS. (early seventeenth century). It contains several quite well-known English tunes of the period, including the delightful song "The Spanish Lady," quoted in *Westward Ho!*

To balance that, we have Shakespeare's famous reference to a Scotch jig in *Much Ado about Nothing*. He makes Beatrice say:—

"Wooring, wedding, and repenting, is as a Scotch jig, a measure, and a cinque-pace; the first suit is hot and hasty, like a Scotch jig, and full as fantastical; the wedding, mannerly-modest, is as a measure full of state and ancientry, and then comes Repentance, and, with his bad legs, falls into the cinque-pace faster and faster, till he sinks into his grave."

"Hot," "hasty" and "fantastical" are not ill-chosen descriptive marks of the Scottish genius. Shakespeare evidently knew Scottish dance-tunes and could count on their characteristics being known to his audience.

Of that more important part of Scottish music—the Gaelic element—the same general criticism can be made. We know enough to be aware that the musical culture of the Highlands is essentially Irish, but of the ways in which the two Gaelic lands interchanged tunes we have only a vague knowledge. The history of the subject is visible in rough outline, but how are we to fill in the details that will make the picture literally complete? The tunes—for ballads, lyrics and dances—all need examination and analysis, but it does not seem to have occurred to the professional historians (who, it must be admitted, have troubles enough in the regions they too exclusively haunt) that the culture of the people is deserving of close study. It may be that the growth of Nationalist sentiment may bring about a much-needed transfer of interest on the part of these historians, if only as a prophylactic measure. Nationalism has, doubtless, a bad side, but Scotland has, perhaps, tended to forget that there is also a good side to it.

Fortunately, if Scots are, or seem to be, indifferent, they can rely on help from Englishmen and Americans. The most important contribution to the study of Scots Folk Song made during the past year was the publication of the enlarged edition of the late Cecil J. Sharp's *English Folk Songs from the Southern*

Appalachians (Oxford University Press—Humphrey Milford). At first sight there is something of the ironical in the fact that this excellent contribution to the study of our theme is made by an Englishman who found his materials in the remote mountain valleys of Virginia, North Carolina, Kentucky and Tennessee and labelled them "English." But not even a perfervid Scot can object, for the vital appeal of Folk Song is to the historically minded, and history is of little use unless constant and fearless use is made of the method of comparison. It is, besides, impossible to draw any clearly marked line of demarcation between English Folk Song and Scottish Lowland Folk Song. The only real dividing line must be drawn to the north of the Scottish Lowlands.

Cecil Sharp did not visit the Appalachian mountains by accident or on the off-chance. The dwellers in the recesses of the Great Smoky or of Clinch Mountain had often been described by American observers and were known to have retained many habits, social usages, modes of speech, characteristic of the England and Lowland Scotland of pre-industrial days. It was fortunate that Sharp was able to visit these people and to collect, with the skill he had developed by long experience, the remains of their simple and attractive art, for even in those secluded valleys, walled in by great mountains, the rate of change has been accelerated of late years, and it is doubtful if the old ballads found by Sharp will survive for another generation.

Sharp, in his notes to his texts and tunes, specially notes the large number of references to Dean Christie's *Traditional Ballad Airs* and Gavin Greig's *Folk Songs of the North-East*. The close connection between the Appalachians and Scotland is no cause of wonder, for among the counties visited by Sharp were Montgomery (Va.), MacDowall (N.C.), Knox (both in Tennessee and Kentucky) and Leslie (Tenn.), and whatever else can be denied to the people who settled in these parts of the United States, a Scottish origin cannot.

The extent of the connection may be estimated from the following facts: the texts of 273 Songs and Ballads are given, with 968 variants of tunes. There are 38 Ballad and 18 Song references to Gavin Greig. Dean Christie is cited 22 times for Ballads and 10 times for Songs. Other Scottish works referred

to are *The Scots Musical Museum* (7 times); Motherwell's *Minstrelsy* (5 times); Dick's *Songs of Burns* (5 times); Kinloch's *Ancient Scottish Ballads* (4 times); Ford's *Vagabond Songs and Ballads* (4 times); Chambers's *Popular Rhymes of Scotland* (3 times); Thomson's *Scottish Songs* (twice); Ford's *Children's Rhymes* (once) and Chambers's *Songs of Scotland prior to Burns* (once).

The publication of Sharp's last work is, of course, but one proof the more of the strength of the links between the cultural life of the United States and of Scotland. To span the years, a quotation from Allan Ramsay may be given. In the introduction to the 14th edition of *The Tea Table Miscellany*, honest Allan boasts that "The general demand for the book by persons of all ranks, wherever our language is understood, is a sure evidence of its being acceptable. My worthy friend Dr. Bannerman tells me from America :—

Not only do your lays in Britain flow,
Round all the globe your happy sonnets go;
Here thy soft verse, made to a Scottish air,
As often sung by our Virginian fair."

It has thus taken more than two centuries for this pleasant exchange to effect itself, and it is quite in the nature of things that the debt should have been so generously repaid.

How can the interest in this subject, the search for the materials, and the improvement of methods of analysis best be stimulated? The B.B.C. has already done much to foster distinctively Scottish forms of art. This is good—and right, since the B.B.C. must take all things human for its sphere. The B.B.C. can, and doubtless will, do more. Has the time not come when it might, for example, definitely co-ordinate many isolated and individual efforts into a really national programme? Personally, for what it is worth, the writer has discovered through his own occasional broadcasts some evidences of the existence of material yet unpublished, relating, it is true, mainly to the early nineteenth century. It might be that by such a nationwide appeal as the B.B.C.—and the B.B.C. alone—can make, and by a thorough-going co-ordination of programmes, light could be thrown on the great blanks that at present occupy so much space on the chart of Scottish Folk Song.

N O R T H E R N I R E L A N D

THE REFLECTION OF regional activities by a region's own particular station has always been recognised as one of the aims of broadcasting in the British Isles. Programmes are designed with particular reference to the characteristics of the listening population in the area served and, as far as is possible, each broadcasting centre endeavours to present to its listeners programmes truly representative of the region in which it is situated. In the compilation of such programmes the station at Belfast is working for a region with advantages and difficulties peculiar to itself.

The majority of the problems arise from a fact which also provides an opportunity, namely, the comparatively short time during which the Province of Northern Ireland has been in existence. Its character, from the cultural point of view, is still in the process of formation, and broadcasting has been called upon to play its part. The advantages are many, chief among them being the fact that in Northern Ireland broadcasting forms the chief living contact of the region with the rest of Great Britain. The narrow gulf of water which divides Northern Ireland from the parent country has much to answer for, since it forms, to some extent, a barrier to the good understanding of one another which neighbours with common loyalties desire. Broadcasting bridges this barrier, and the constant relaying of the best of British programmes cannot be other than welcome to a body of listeners whose interests lie largely in the Empire and its people. These relayed programmes are chosen with the utmost care, since Belfast has only one wavelength available, and are arranged, in conjunction with the programmes which actually originate at the Station, to provide balanced entertainment. Where possible, programmes provided by the Station itself are in contrast to those provided by Daventry at the same time, so that Northern Ireland listeners may use the high-power transmitter as an "alternative" programme.

Any review of the broadcast programmes from Belfast during the past year must start with the Station's musical activities and the important part which they are playing in the musical life of the Province. The people of Northern Ireland, and of the capital city in particular, have a reputation for musical

appreciation which is well founded. The fact that the Station employs a permanent symphony orchestra has made the development of musical policy fairly simple, and the public concert seasons, inaugurated three years ago, were continued on an even larger scale during the past year. Series of concerts were again provided at exceptionally cheap prices in co-operation with the Belfast Corporation and the Belfast City Y.M.C.A., and a number of distinguished musicians took part. Sir Henry Wood, Colonel Fritz Brase (Director of the Free State Army School of Music), Dr. Adrian Boult, and Sir Hamilton Harty were among the guest conductors, and a number of soloists of international reputation faced the microphone in the Wellington and Ulster Halls.

As usual, the concerts of the flourishing Belfast Philharmonic Society provided listeners in Northern Ireland with some important musical broadcasts. Foremost among these was a concert of music by Vaughan Williams, conducted by the composer, and a concert in which Elisabeth Schumann was the soloist. Apart from the various Saturday evening concerts, the Belfast Wireless Orchestra gave a weekly afternoon concert in the Museum and Art Gallery at Stranmillis.

Though the Province as a whole is enthusiastic about music and though the various musical "festivals" throughout the country attract entries running into four figures, there is no permanent symphony orchestra, or indeed important outside orchestra of any kind, in the Six Counties. In consequence, the burden which falls on the Belfast Wireless Symphony Orchestra is a heavy one. As far as Northern Ireland is concerned, it sets the standard of musical excellence, and the work which it has been able to do, through the medium of broadcasting, to cultivate and extend the already existing appreciation of music is of the utmost value.

As far as "outside broadcasts" are concerned, the year was also an outstanding one, for a serious and, on the whole, successful attempt was made to provide programmes from material which, at first glance, might not seem very promising. The old idea that an "outside broadcast" must be ready made for the microphone was abandoned and a number of broadcast programmes were constructed from everyday events by the use of numerous microphones and dint of careful planning. Such a



A. R. Hogg

THE NEW ROYAL COURTS OF JUSTICE, ULSTER
(Opened May 31st, 1933)

programme was "The Volunteer," which was heard by listeners on March 2nd, and which was designed to give "an impression of the work of the Ulster Division of the Royal Naval Volunteer Reserve." Microphones were fitted throughout the training ship of the Division and controlled from a central point, where a commentator gave listeners a connecting narrative of the various classes and activities which they were hearing. An interesting part of the programme was the short message which ended it, and which was broadcast by the Rt. Hon. the Viscount Craigavon, Prime Minister of Northern Ireland, who is an Honorary Captain, R.N.V.R.

Another broadcast on similar lines came from the Royal Ulster Agricultural Society's Show in May, when listeners were taken for a "conducted tour" of the show grounds, and listened to the various judges at work in the different sections. Other "outside broadcasts" of an unusual nature were included in a series of "mystery programmes," given under the heading "Dips in the Broadcast Bran Tub."

The most important event of the year in Northern Ireland, the visit of His Royal Highness the Prince of Wales, was the occasion of a Royal broadcast on Friday, November 18th, when the Prince spoke into a microphone installed in the Harbour Commissioners' Office in Belfast. On this occasion he broadcast a farewell message to Northern Ireland listeners before leaving for London. Another distinguished broadcaster, His Grace the Duke of Abercorn, Governor of Northern Ireland, was heard from Belfast on Wednesday, May 31st, when he took part in the opening ceremony of the New Royal Courts of Justice (Ulster).

Possibly the programme which gave rise to the largest volume of criticism during the year—both favourable and unfavourable—was that broadcast under the title "Turf Smoke," on St. Patrick's Day. This entertainment consisted of music, poetry, songs and a spoken Epilogue and Prologue, and was designed to appeal to Irish men and women living away from their own country. The programme was relayed by Daventry and formed, for some weeks afterwards, a subject upon which listeners refused to agree to differ. Other programmes which were heard by listeners outside Northern Ireland included the commentaries on the Ulster Tourist Trophy Motor Race and

the Ulster Grand Prix Motor Cycle Race; three plays performed by the Abbey Company (which came from Dublin to the Belfast Studio), and the Northern Ireland contribution to the Regional Programme on November 16th.

From the point of view of the dramatic producer, the year was a satisfactory one, though it provided no local work of outstanding importance. A number of playwrights in Ulster who have been studying the requirements of the microphone were responsible for new plays which made adequate broadcast material; but the majority of the authors who submitted works still have a tendency to confuse the studio with the stage and their work is hampered accordingly. The three most notable of the dialect plays broadcast were "Rose O'Neill," by Wilson Guy, "The Miracle Man," by Frederick Lyburn, and "The Leap Year Proposal," by J. H. McIlveen, the last a new play by an author who has a number of successful broadcast plays to his credit.

A few of the best-known plays produced in previous years were revived and special attention was paid to the possibilities of musical works. One of the most interesting of these was "The Ballad Singer," by Ernest H. Milligan, a story in a setting of folk music collected in Ireland, and arranged by the author. Offenbach's "Geneviève de Brabant"; a comedy by E. A. Bryan entitled "Enter Mrs. Grundy"; and a romantic play "Masquerade in Moonlight," were among the other musical works produced. The policy of presenting an occasional Shakespearean play was continued and special adaptations of "The Merchant of Venice" and "Twelfth Night" were broadcast in December and June respectively.

Observers of broadcasting in the Six Counties during the past year must have been struck by the steady increase in the number of listeners recorded. At present the figure stands at over fifty thousand, and it is probable that it be largely increased when the new high-power transmitter, which is to be erected in the Province, is completed. The existing service area of the Belfast Station is by no means generally satisfactory, and some of the more outlying parts of the Six Counties are not, under the present system, served at all. The provision of the new transmitter will ensure a satisfactory service over a very much extended area.

NORTHERN IRELAND EVENTS

- 1932
- Nov. 18 H.R.H. the Prince of Wales broadcasting a Message to the People of Northern Ireland from Belfast Harbour Commissioners' Office.
- 25 Haydn's "Te Deum in C" performed by the Belfast Philharmonic Society's Chorus and Orchestra conducted by E. Godfrey Brown. Soloist: Elisabeth Schumann.
- 26 "Tully's Experts," a Comedy by George Shiels.
- Dec. 16 "The Messiah" performed by the Belfast Philharmonic Society conducted by E. Godfrey Brown. Soloists: Alice Moxon, Ethel Barker, Trefor Jones and Stuart Robertson.
- 20 Shakespeare's "The Merchant of Venice," adapted and produced by S. A. Bulloch.
- 1933
- Jan. 7 Humperdinck's "Hansel and Gretel" at the Wellington Hall.
- Feb. 17 A Vaughan Williams Programme by the Belfast Philharmonic Society conducted by the Composer. Soloist: Keith Falkner.
- Mar. 2 "The Volunteer," a programme from the Training Ship of the Ulster Division R.N.V.R., H.M.S. *Caroline*, including Addresses by Viscount Craigavon and the Earl of Kilmorey.
- 11 Commentary on the International Rugby Match, Ireland v. Wales, at Ravenhill Park, Belfast.
- Concert in aid of the Musicians' Union Benevolent Fund at the Wellington Hall by the Belfast Wireless Symphony Orchestra conducted by E. Godfrey Brown.
- 17 "Turf Smoke," a St. Patrick's Night Programme.
- Apr. 12 "Rose O'Neill," a Drama of the Ulster Plantation by Wilson Guy.
- May 5 "Geneviève de Brabant," an Operetta by Offenbach.
- 12 Commentary on the Departure of the Liverpool Boat from Donegal Quay, Belfast.
- 25 Talks and Commentaries from the Annual Show of the Royal Ulster Agricultural Society.
- 27 Concert by the Belfast Wireless Symphony Orchestra conducted by Sir Hamilton Harty at the Ulster Hall. Soloists: Ernest Hargreaves and Lamond.
- 31 Opening Ceremony of the Royal Courts of Justice at Ulster by the Duke of Abercorn.
- June 3 "The Ballad Singer," an Ulster Comedy by Dr. Ernest H. M. Milligan.
- 14 "A Leap Year Proposal," an Ulster Play by J. H. McIlveen.
- 17 Studio Performance of Shakespeare's "Twelfth Night."
- July 18 Speeches at the Irish Society's Luncheon on the Occasion of the Opening of the Craigavon Bridge, Londonderry.
- 28 Account by Mr. James Henderson of the Irish Open Golf Championship.
- Aug. 4 "Holiday Parade" by Sibbald Treacy and his Rhythm Kings.
- 19 Commentary on the International Ulster Grand Prix Motor-Cycle Race on the Clady Circuit.
- 26 Mascagni's "Cavalleria Rusticana" in the studio.
- Sept. 2 Commentary on the International T.T. Motor Race on the Ards Circuit.
- 11 Bizet's "Carmen" in the studio.
- The Glasgow Orpheus Choir conducted by Sir Hugh S. Robertson.
- 25 Gluck's "Orpheus" in the studio.
- Oct. 4 Talk by Mr. H. Montgomery Hyde on "The Irishman Abroad."
- 13 "A Rift in the Lute," by J. H. McIlveen.
- 14 Concert by the Belfast Wireless Symphony Orchestra conducted by Sir Edward Elgar.
- 20 First Concert of the Sixtieth Season by the Belfast Philharmonic Society conducted by E. Godfrey Brown. Soloists: Poushnoff and Astra Desmond.

EMPIRE
AND FOREIGN
SECTION



THE TRANSMITTER HALL AT THE EMPIRE STATION

NOTES OF THE YEAR THE EMPIRE

“AT THE PRESENT juncture an article on the subject of Empire programmes cannot, for obvious reasons, be related to concrete achievement.” These were the opening words of an article in last year’s edition of the Year-Book, entitled “Programmes for the Empire.” Since these words were written much has happened, and programmes on a regular basis are now transmitted to all parts of the Empire. The Empire Broadcasting Station at Daventry was opened without ceremony on December 19th, 1932, but a week later, on Christmas Day, its transmitters radiated to all parts of the Empire a programme which is now generally regarded as one of the most outstanding in the history of British broadcasting. It may be remembered that plans had been made for an Empire Christmas broadcast in 1931, but that at the last moment, owing to unforeseen circumstances, this did not materialise. In 1932, before it was definitely known on what date the Empire Broadcasting Station would open, a similar, though more ambitious, programme was devised, and fortunately it was possible to arrange for the two events practically to coincide. Through the medium of the Empire and Home Broadcasting Stations, not only were the voices of the Dominions heard in this country and throughout the Empire, but also a Christmas message from His Majesty the King at Sandringham. The success of this programme was in large measure due to the wholehearted and efficient co-operation of broadcasting and telephone authorities in various parts of the Empire, and other organisations and individuals.

* * *

It has from time to time been stated that one of the ultimate objectives of Empire broadcasting is an exchange of programmes between the Dominions and Colonies and this country. The Empire Day programme, which was broadcast in this country and throughout the Empire on May 24th of this year, was the first of a series which it is hoped will be given in succeeding years by each of the Dominions in turn. The 1933 programme, with its title “News of Home,” was definitely a programme reflecting life in the United Kingdom. Early in the year the broadcasting organisations in all the Dominions were approached with the

suggestion that they should contribute to a series of Empire Day programmes, and following the favourable replies that have been received, it is anticipated that this country will not again be required to prepare such a programme for several years. In 1934, if circumstances permit, the Empire Day Programme will be supplied by Australia, and in the following years by the other Dominions in alphabetical order.

* * *

While on the subject of the exchange of programmes between the various parts of the Empire and this country, reference should be made to the interesting relay from the top of Table Mountain, which was broadcast in the home programmes, recorded, and sent out to other parts of the Empire on March 6th. This broadcast, which was arranged and carried out by the African Broadcasting Company, consisted of a descriptive commentary by the Johannesburg Station Director of the panorama from the summit of the mountain, and was preceded by a short talk by His Excellency the Governor-General. By means of electrical recording, this commentary was not only broadcast to other zones, but was also sent back the same evening to Africa. Appreciative letters were subsequently received from listeners in various parts of the world, notably Canada, about this broadcast, and the interest evoked augurs well for future broadcasts which may be possible, not only from South Africa, but from other parts of the Empire.

* * *

There was, of course, contact between the B.B.C. and broadcasting organisations in various parts of the Empire before the inauguration of the Empire Broadcasting Service, but since December of last year this contact has become closer, and much valuable help has been, and is being, given by overseas broadcasters in their reports, which deal not only with reception conditions, but also with programme matters. The assistance given has not been confined to the national or government broadcasting organisations in the Dominions and Colonies, but has also been regularly supplied by many of the privately owned stations and by radio societies and similar organisations, to whose voluntary efforts much of the local interest in broadcasting is due. No statement which acknowledges the help that has been given in the early stages of Empire broadcasting would

be complete without a reference to what the individual listener has done, but this is commented upon in greater detail in the article summarising the year's work.

* * *

It was always realised that the Empire Broadcasting Station could fulfil an important rôle in disseminating valuable information on trade and industrial matters, but it was not considered wise policy at the start to make plans for any regular broadcasts of this nature. After a few months of working, however, there seemed to be justification for experimenting in this direction, and following discussions with representatives of the Empire Marketing Board, the Travel and Industrial Association of Great Britain and Ireland, the Department of Scientific and Industrial Research, the Federation of British Industries, the Department of Overseas Trade, and the Association of British Chambers of Commerce, two projects materialised: firstly, a service of market intelligence reports supplied by the Empire Marketing Board and dealing with dairy produce and fruit; and secondly, a series of co-ordinated talks by authoritative speakers dealing with such subjects as textiles, agriculture, engineering and communications.

* * *

A representative of the B.B.C. left this country in November 1932 on an Empire tour, in order to study reception conditions and to make contact, not only with broadcasting organisations overseas, but also with listeners themselves. The tour was planned in such a way that arrival in Africa would coincide with the opening of the new Station. From Africa the itinerary was India, Ceylon, the Malay States, Hong Kong, Shanghai, Australia, New Zealand, Canada, the West Indies, and so back to this country. Unfortunately the tour was interrupted in February 1933 by the illness of the B.B.C.'s emissary. After a period of recuperation in this country, however, he was able to resume his journey in April, but the itinerary was altered, Australia and New Zealand being visited first in June and July, and the return journey being made via India. As another member of the Corporation's staff was visiting Canada in May and June in the capacity of adviser to the Government during the early stages of the work of the new Broadcasting Commission, the Dominion was omitted from the revised itinerary.

* * *

One of the duties allotted to the B.B.C.'s representative was to interest the broadcasting organisations overseas in the recorded programmes, to which reference was made in an article in the last issue of the Year-Book. It is satisfactory that the African Broadcasting Company has purchased complete sets and communicated its desire for a regular and continued supply of further programmes. The New Zealand Broadcasting Board and the Australian Broadcasting Commission have similarly taken the whole series. The Indian State Broadcasting Service has purchased two complete sets, Ceylon has purchased one complete set, and individual programmes have been bought by broadcasting concerns in Kenya Colony, Southern Rhodesia and the Falkland Islands.

* * *

A problem which confronted the B.B.C. during the period immediately preceding the opening of the Empire Station was the method of conveying programme information to overseas listeners. The overseas daily press was an obvious medium, but for a variety of reasons it was not possible by this means to give more than the bare headings of the programme for each day, and the expense involved in cabling detailed information would have been far too great. It was decided, therefore, to publish an Empire edition of *World-Radio*, the Empire programmes being substituted for the foreign programmes given in the Home edition. To be of service, however, this Empire edition had necessarily to be prepared and published many weeks in advance of radiation, and an elaborate scheme of postal dates for each zone was drawn up, which necessitated the *detailed* preparation of the programmes eight weeks in advance of actual broadcasting. The first issue of the Empire edition of *World-Radio* was published on November 11th, and since that date full details of the Empire programmes have been available in all zones for those who have cared either to purchase locally, or to subscribe to this periodical.

It has been possible to develop the scope of *World-Radio* by the inclusion not only of informative technical articles for shortwave listeners, but by reprinting talks which have been broadcast in the Empire programmes, and by publishing extracts of the many interesting letters which have been received from listeners all over the world.

Inevitably there have been deviations from the published programmes, but these have been remarkably few, and whenever they have occurred microphone announcements referring directly to the published programmes have been regularly made.

* * *

The Empire programmes are largely designed to be of service to those who are referred to as "isolated listeners." That their numbers are considerable is evident from correspondence, and their appreciation of a daily news bulletin and of being kept in touch with home has been a matter of great satisfaction to the B.B.C. But the Empire station is able to fulfil a secondary, and no less important, function, in transmitting for relaying purposes (or direct listening) to those Dominions or Colonies where local broadcasting organisations exist, broadcasts of events in which a particular Dominion or Colony is likely to be specially interested. An example of this activity was the transmission to South Africa on June 22nd of the speeches by the King and the High Commissioner for the Union on the occasion of the opening by His Majesty of South Africa House in Trafalgar Square. Similarly, on the national days of the various Dominions, special programmes or messages have been broadcast to the appropriate zones, and for the benefit of the Colonial Empire the speech of the Secretary of State for the Colonies was specially relayed from the Corona Club dinner in London.

Where events of world interest are concerned, the Empire transmitters have proved their use, for example, on June 12th, when His Majesty the King opened the World Economic Conference.

* * *

A satisfactory feature of Empire broadcasting is the interest which has been shown by small colonies of British residents in foreign countries, and, for that matter, in foreign countries themselves, notably the United States. While the Empire Service is primarily intended for those whom the title of the station designates, it has been pointed out on more than one occasion that British residents in foreign countries are not forgotten. In fact, the interests of these scattered communities are receiving considerable attention in plans for future technical development, and provided no dis-service is done to residents within the Empire, every endeavour will be made to give a

better service to those, particularly in South America, whose enthusiasm for the Empire programmes has been so marked.

* * *

A number of listeners have—and this was especially noticeable in the early days—complained of the fact that recorded material was too liberally used in the Empire programmes, but it is now understood that while transmitting hours to the Canadian and Australasian Zones are inconvenient for broadcasting “live” material, this is inevitable. There is, furthermore, a realisation of the advantages of a special recording system without which large numbers of persons would be unable to hear the outstanding sporting and public events of home life. It can be justifiably stated that every event of this kind has been broadcast throughout the Empire since last December. By means of electrical recording, a reproduction has invariably been given to all zones whose programme hours do not coincide with the times of the actual broadcasts. According to listeners’ letters, no form of programme has given greater satisfaction, and while much still remains experimental, this type of broadcast is well established, and may be regarded as a permanency.



THE TABLE AT WHICH THE KING SAT WHEN HE BROADCAST HIS CHRISTMAS MESSAGE TO THE EMPIRE. THE MICROPHONES ARE IN POSITION ON THE TABLE



EMPIRE BROADCASTING THE FIRST STAGES

ON DECEMBER 19th, 1932, at 9.30 a.m. G.M.T., the British Empire Broadcasting Station transmitted its first programme. This was directed to the Australasian Zone, and opened with short messages from the Chairman, the Director-General, the Chief Engineer and the Empire Service Director of the B.B.C. These messages were repeated in the Indian, African, West African and Canadian Zones at 2.30 p.m., 6.0 p.m., and 8.30 p.m. and 1.0 a.m. respectively. The main object of these short inaugural talks was to impress upon listeners the experimental nature of much that was being done, and the necessity, if progress was to be made, for co-operation at the listening end. How far this co-operation has been forthcoming is evident from the review of the year's work which follows.

The initial programme schedule was:

The Australasian Zone: 9.30 to 11.30 a.m. G.M.T.

The Indian Zone: 2.30 to 4.30 p.m. G.M.T.

The African Zone: 6.0 to 8.0 p.m. G.M.T.

The West African Zone: 8.30 to 10.30 p.m. G.M.T.

The Canadian Zone: 1.0 to 3.0 a.m. G.M.T.

The choice of hours was based primarily on consideration of the listener's convenience, but it was realised that these timings were as experimental as the transmissions themselves and the make-up of the programmes. The actual composition of the latter was not at first outstanding. So far as possible, use was made of existing home material, and when this was

not practicable, gramophone records, the Blattnerphone, and occasional artists or speakers were used. The reasons for this procedure were—this has been explained before, but it is worth repeating—that in the early stages, when so much technical experiment was necessary, it seemed unwise to embark upon ambitious schemes of programmes which involved expenditure of money and which might not, for one reason or another, be received satisfactorily.

Early in January reports began to come in by cable or by letter from all over the world. The bulk of these, as was only natural, had reference to the Christmas Day broadcast, and there was justification for assuming that the volume of correspondence would decrease, particularly after the novelty had worn off. Fortunately, this assumption proved incorrect, and the weekly mails maintained a steady level. It very soon became possible to collate the views and requirements of each zone, and at the beginning of February it was clear that certain apprehensions of the programme builders were well founded, particularly with regard to the times of transmissions. In the Indian Zone, for example, it had been anticipated that in the Malay Peninsula 2.30 to 4.30 p.m. G.M.T. (which in local time became 9.50 to 11.50 p.m.) would be too late for convenient listening. Furthermore, it was realised that there would probably be a demand for later transmissions in India because of the habits of life of the British listeners in that country. Listeners' evidence so clearly confirmed these suspicions that a decision to extend the transmitting hours was made, and at the beginning of April an additional two hours' broadcasting was allotted to the Indian Zone, one hour from 1.30 to 2.30 p.m. G.M.T. and the other from 4.30 to 5.30 p.m. G.M.T.

Meanwhile there was considerable evidence that the West Indies and the eastern parts of Canada and Newfoundland would, from the point of view both of reception conditions and of the personal convenience of the individual listener, prefer earlier broadcasts. There was hesitation in deciding to advance the Canadian Zone transmissions (originally 1.0 a.m. to 3.0 a.m.) to 11.0 p.m. to 1.0 a.m., as it was felt that this might have unpleasing results in Middle and Western Canada; but since little correspondence had been received from these territories, the experiment was thought to be justified, and it

was hoped that if any dissatisfaction was caused it would soon become known, and further re-adjustments might be possible. The altered Canadian Zone timings came into force on March 12th.

From correspondence it gradually became apparent that the West African Zone programmes could be heard in the African Zone, and vice versa. This led to a decision to run a continuous programme, as from the beginning of April, from 6.0 to 10.30 p.m., with a news bulletin at either end. The zonal division, however, was preserved, as the volume of evidence was not sufficient to warrant the African and West African Zones being combined. It was considerable enough, however, to justify the new arrangements, and it had the advantage of eliminating the half-hour break between 8.0 and 8.30 p.m. G.M.T.—a time at which good programme material was normally available in the Home programmes.

A review of the timing changes would be incomplete without a reference to Western Australia, where it was learnt that the Indian Zone programmes were well received. Obviously an earlier start of these latter programmes would be beneficial to listeners on the Western Australian sea-board, and the extension already mentioned took this factor into consideration.

This article is not concerned with the technical aspect of Empire broadcasting, but in order clearly to understand the position in the Australasian Zone some reference to reception conditions is necessary. The hours originally chosen—9.30 to 11.30 a.m. G.M.T.—were based mainly on listening convenience. Translated into terms of local time, the inhabitants of the eastern half of Australia were receiving programmes from approximately 7.30 to 9.30 p.m.; New Zealand, with its summer time in force until the end of March, from 9.30 to 11.30 p.m. Western Australia probably found 5.30 to 7.30 p.m. on the early side, but, as already stated, advantage was being taken of the Indian Zone programmes, which were receivable from 9.30 p.m. onwards. During the early tests, prior to the opening of the Station, results in the Australasian Zone were satisfactory, but from December 19th onwards, conditions for receiving the Empire Station consistently deteriorated, until it became apparent that, in so far as this zone was concerned, it was necessary to decide whether to transmit from the point of

view of the convenience of listeners or from the point of view of the best time for propagation. Obviously it was more important for the Empire Station to be heard in the Australasian Zone even at a slightly inconvenient time than for it not to be heard at all, and consequently in June an entirely different schedule was brought into force. This varied throughout the year, but was based on the two hours' broadcasting occurring at those times when reception and transmission conditions were known to be best, viz :

January and December :	8.0 to 10.0 a.m. G.M.T.
February and November :	7.30 to 9.30 a.m. G.M.T.
March and October :	7.0 to 9.0 a.m. G.M.T.
April and September :	6.0 to 8.0 a.m. G.M.T.
May and August :	5.15 to 7.15 a.m. G.M.T.
June and July :	4.30 to 6.30 a.m. G.M.T.

During the days of G5SW, prior to the inauguration of the new Empire Service, a midday transmission had been regularly sent out (Sundays excepted). This had proved a popular feature, and with the advent of directional broadcasting, numbers of listeners, while sending their appreciation of the new arrangements, regretted the loss of the home lunch-time music. Partly to meet this, and partly to bridge a long gap between the end of the newly timed Australasian Zone transmissions and the opening of the Indian programmes, an omni-directional broadcast, consisting mainly of relays of the Daventry National programmes, became a feature of the regular Empire Service from June 11th. This was sent out daily from 11 a.m. to 1 a.m. G.M.T. on weekdays and from 11.30 a.m. to 1 p.m. on Sundays, and was available for those who wished to listen in all zones, either in the morning, afternoon or evening, in accordance with the time variation between actual transmitting hours in this country and reception hours overseas.

The effect of these changes and developments in transmitting hours was that whereas Empire broadcasting took place during ten hours out of the twenty-four when the station opened, six months later the transmitters were working for fourteen and a half and were, with three short breaks of half an hour each, in constant operation from 11 a.m. to 1 a.m. G.M.T.

A further stage in the development of the Empire Service

was marked early in the month of October by the introduction of important alterations in regard to the designation of zones and the timing of transmissions.

It became increasingly obvious that the zonal basis on which the Empire Service was founded in December, 1932, would have to be abandoned sooner or later. Even in the early days of 1933, reports were received on reception in the West Indies of the so-called Indian Zone programme, which also gave a programme service in Western Australia; and, later, there was a marked increase in the area of reception of the latter part of the African and West African Zone's programme, which was heard satisfactorily by British communities in South America, and also in the West Indies and in New Zealand. This overlapping from zone to zone pointed to the fact that confusion would be caused by an adherence to geographical zones, even if they had broad limits. One illustration alone proved the need for change: the announcement of "London calling the African and West African zones" was being heard at night in Africa, in the evening in South America, the afternoon in the West Indies, and at breakfast-time in New Zealand.

As from October, 1933, the daily transmissions from the Empire Station were divided into five sessions known as 'Transmission Number One (former Zone I), Transmission Number Two (the omni-directional programme, etc.), in accordance with the revised Time Schedule given below. Each overseas listener was then in a position to select any programme which he was able to receive, and in which he was interested. It was realised that the majority of listeners to a particular transmission were likely to be situated in sections of the Empire on the lines of geographical zones observed in the early days of the Service. Therefore, the News Bulletins for Transmission 1 were primarily directed to Australasia; for Transmission 3 to India, Burma, Malaya, and Ceylon, but other bulletins were extended to cover listeners in the wider areas in which reception of certain Transmissions was possible.

The programme pages of the Empire edition of *World-Radio* (the programme journal of the Empire Service) assumed a different appearance after these changes came into operation. Up to October, 1933, the programmes for different weeks had been published for different zones, but from October 8th

onwards detailed programmes for all five daily Transmissions were given under date headings for a particular week. These programmes were published in time for overseas circulation in advance of radiation.

Alterations in the timing of some Transmissions also became effective as from October 8th. Throughout the period from April to the end of the first week of October, 1933, Summer Time had been observed in England; in fact, Big Ben had been one hour fast in the ears of overseas listeners, as Greenwich Mean Time had been kept as the time basis of the Empire Service. During the autumn and winter months, Greenwich Time was again observed in the home country. In consequence of this, and with a view to giving in Empire Transmissions the best possible selection of excerpts from the home programmes, at the same time effecting certain suggestions which had been made by many Empire listeners, the schedule summarised below was brought into operation.

TRANSMISSION	TIME (Greenwich Mean Time)
1	Changing from month to month throughout the year in accordance with full schedule for former Zone I (already incorporated in this article).
2	12.0 noon to 1.45 p.m. (12.30 to 1.45 p.m. on Sundays.)
3	2.0 to 6.0 p.m.
4	6.15 to 10.45 p.m.
5	11.0 p.m. to 1.0 a.m.

There has been a slow but steady development of the programmes. An extremely valuable collection of evidence has been tabulated, zone by zone, of the suggestions and criticisms that have been received from interested listeners. During the early weeks, little more was done than to transmit a fairly varied selection of items, mainly relays from the home programmes. When this was not practicable, recorded material was used. The object was to test the capabilities of transmitters and receivers and the likes and dislikes of the owners of the latter. Gradually it

became possible—and this occurred sooner than was anticipated—to base programme selection on the interests of the listeners, taking into account, of course, local reception conditions. Although opinion was not unanimous on certain types of programmes throughout the zones—talks in particular—it was possible to obtain a general and fairly accurate idea of what pleased and what displeased the Empire as a whole.

Reviewing the situation, the following is a short summary of the information that has been collated from several thousands of letters from all parts of the world.

Light music is preferred, but symphony concerts of the more popular type are appreciated, and also relays from London and provincial concerts. Dance music is generally liked, though a number of correspondents in the Canadian Zone remark that a sufficiency of this already comes to them from American Broadcasting Stations.

The news bulletins seem to be the most generally appreciated items in the daily programme. There has been a certain amount of criticism from persons living in large towns that they contain some news which has already reached listeners. But this is inevitable, since each bulletin is designed to cover events of the preceding twenty-four hours for the benefit of people living in isolated parts of the Empire where up-to-date news is not available.

Tremendous enthusiasm has been shown for running commentaries, talks and news about sporting events. Still further details are demanded by the devotees of each particular form of sport; but there is a listening public which, though rarely vocal, nevertheless exists, for whom sport holds no attraction. The interests of this section of the community cannot be overlooked, and sporting commentaries are limited to events of outstanding importance, such as the Derby, the Boat-Race, International Football matches, etc.

Evidence of appreciation for vaudeville and the lighter types of dramatic entertainment emerges from the correspondence received, and there has been a demand for relays from theatres, music halls, etc. Requests for such relays have often been made by listeners living in zones where hours of transmission would, in any case, preclude such programme items; but the request is another proof of the type of programme which is most generally

appreciated everywhere—that is, the programme which keeps the listener in touch with current events and the programme which reflects life in this country. Into this category come speeches by eminent men broadcast from conferences, dinners, etc., the relay of events of national significance, ceremonies of particular interest, talks on world affairs and special programmes such as the Christmas Day broadcast. Big Ben continues a universal favourite and suggestions have been made for further relays of familiar London features. This year the British nightingale had a wider audience than ever before, since its song was broadcast to the African and Canadian Zones at the same time as to the British Isles, and, by record, to other parts of the Empire. Many listeners have mentioned the popularity of this item, and the nightingale is to be congratulated on the success of its first Empire broadcast.

Talks—apart from the types already referred to—cannot be said to have so universal a following. The deduction can almost be made that in tropical countries these are appreciated only if they are short and given by the most eminent people. There is a more general liking for them, however, in Canada, Australia and, in particular, New Zealand.

This review of progress would be incomplete without a tribute to listeners for their co-operation. A venture of this nature and magnitude might well have failed without assistance from the listening end, but the consistent, patient, and understanding support that has been shown in all parts of the world has been largely responsible for the development that has been possible. Apart from that given by Empire listeners, most valuable help has been afforded by inhabitants of foreign countries, particularly the United States, where the modest programmes transmitted to the Canadian Zone appear to have given considerable pleasure.

If this general interest continues, prospects for the future are bright.

A REVIEW OF RECEPTION OF THE EMPIRE SERVICE

AT THE DATE of publication of this Year-Book the Empire Broadcasting Service will almost have completed one year's work. At the date of writing, however, the latest reception reports from the most distant parts of the Empire refer to reception conditions up to the middle of June, *i.e.* seven months after the opening of the service. As explained elsewhere, the system of zonal transmissions referred to in this article has now been superseded by numbered transmissions.

The initial test transmissions took place in November 1932, while the programme service was inaugurated on December 19th, 1932. A total of 6,000 letters and 500 cables have been received from Empire listeners in these first seven months, while 1,200 listeners have filled in and returned Empire Service Questionnaires.

As a result of the many letters which have been received containing appreciation or constructive criticism, both of which are equally welcome, it has become obvious that considerable time would be saved if the technical information were conveyed in the same form. A *pro forma* log sheet has therefore been prepared and sent to a number of regular listeners in each zone.

A number of alterations suggested by listeners, both on the technical and on the programme sides, have already been incorporated in the routine of the service, many of them giving very good results. Those responsible for the service are by no means complacent ; they realise only too well its shortcomings and imperfections, and this is an additional reason why the response from Empire listeners has been most gratifying.

Before giving a general analysis of listeners' reports, taken zone by zone, it is well to refer to one point which has been very evident in correspondence. It is apparent that the days on which the original tests were carried out in November last were exceptionally good from the point of view of the propagation of short waves. The result was that a very large number of enthusiastic reports was received. When the regular transmissions started on December 19th, it so happened that this coincided with a period of very bad reception conditions, lasting

for several days in most zones. Unfortunately, it is not possible to predict conditions in advance, although accumulated experience does indicate the general trend of seasonal changes. It could not be forecast that there would be so great a difference between November 19th and December 19th.

In a very general way, it may be said that at the commencement of the service, Zones 1, 2, 3 and 4 (*i.e.* Australasian, Indian, African and West African) were well reported on by listeners—whereas Canada, in Zone 5, experienced but very poor or no reception. A gradual change has come about, so that during the spring Zones 2, 3, 4 and 5, including Canada, reported good reception, whereas Zone 1 (Australia and New Zealand) got practically nothing. Seasonal variations in propagation are entirely responsible for this change.

ZONE 1. AUSTRALASIA

The original transmissions to this Zone were on GSD (25·5 metres) transmitting in a south-westerly direction from Daventry—*i.e.* over the “long” route to Australasia. Fairly good reception was reported, but tests indicated that after about 11 a.m. G.M.T. the waves arrived better *from* the north-west—*i.e.* over the “short” route. Accordingly, the direction of transmission from Daventry was changed over at 11 a.m. from January 2nd. As the Indian Zone array also covers Western Australia, the second transmitter was used on GSB or GSC during the Zone 1 programme times. (The direction of this transmission, however, could not be changed.) On the other hand, with the change in season, reception conditions in Australia and New Zealand gradually depreciated, with the exception that Western Australia reported increasingly good reception of GSB or GSC *during the Indian Zone programme times*. By the end of January, the rest of Australia and New Zealand were getting practically no worth-while reception during their own zone time. There was no obvious remedy, although there appeared to be a chance that 19 metres (GSF) might be better than 31 metres (GSB). Accordingly, GSF was brought into use on March 6th, using an omni-directional aerial, as no directional 19-metre aerial was available. This experiment was not successful as far as Australia and New Zealand were concerned, but appeared to give better reception in Hong-Kong.

It was then apparent that it was almost impossible to give a service to Australia and New Zealand at the originally chosen times, *i.e.* 9.30 a.m. to 11.30 a.m. G.M.T. The co-operation of those responsible for the England–Australia Telephone Service was sought and freely given, and, as a result, it was decided that the only way of tackling the problem was to change the time of transmission with the season—since change of wavelength was apparently useless if the wrong time were chosen, while if the time were chosen with regard to the propagation conditions, there was but little advantage to be gained by a change in wavelength from 25 and 31 metres. The change meant, of course, that the programme would not always be available in Australia and New Zealand at the most convenient time for listeners; on the other hand, it was deemed better to make the change, and give a reasonable chance of reception, than to adhere to the original timing which would give practically no reception except for about two months in the year.

The new timings could not be taken into use until June 11th, and therefore only a few cabled reports of results have come to hand to date. The timings are as follows:—



AUSTRALIA

June and July	4.30 a.m. to 6.30 a.m. G.M.T.
May and August	5.15 a.m. to 7.15 a.m. „
April and September	6.00 a.m. to 8.00 a.m. „
March and October	7.00 a.m. to 9.00 a.m. „
February and November	7.30 a.m. to 9.30 a.m. „
January and December	8.00 a.m. to 10.00 a.m. „

Early reports indicate that reception in Australia is now very much improved, but that in New Zealand it is still poor.

It was realised that these timings would be particularly early for Western Australia, but the extension of the Indian Zone programmes, involving an extra hour between 1.30 p.m. and 2.30 p.m. G.M.T., was already giving a good service at a reasonable time to this part of the Dominion.

The direction of transmission for 25 metres for the new timings is over the "long" path—*i.e.* south-westwards from Daventry. The second transmitter is at present being used on 19 m. on an omni-directional aerial, as it was realised that 4.30 a.m. to 6.30 a.m. G.M.T. would be a suitable time for reception in Western Canada, this part of Zone 5 not being well served during the normal Zone 5 transmission times.

Very concise and useful technical data have been received



INDIA

from Hong-Kong, where fair reception has been observed. A few relays of Empire programmes have been made over the local broadcasting station.

ZONE 2

This zone, which covers India, Ceylon, Burma, and Malaya, is perhaps the easiest to serve from the technical point of view, for it is possible to use a fairly narrow beam and the time difference across the zone is not very great. Reports have shown that reception is good on the whole—indeed, judging from the helpful and appreciative correspondence which has been received on the programme side, a certain standard of reception has obviously been reached. On April 2nd, the programme times were extended by two hours by the addition of one hour at the beginning and one hour at the end of the original times, the former to meet the requirements of Malaya and the latter to meet those of India. With the change in season, the wavelengths in use have been altered as follows:—Originally GSE (25.3 m.) and GSB (31.5 m.) were used. From April 20th to June 4th GSF (19.8 m.) and GSE (25.3 m.) were used for the first two hours, 1.30 p.m. to 3.30 p.m. G.M.T.; and GSE (25.3 m.) and GSB (31.5 m.) for the second two hours, 3.30 p.m. to 5.30 p.m. G.M.T.



SOUTH AFRICA

From June 5th up to the time of writing GSG (16·86 m.) has been used instead of GSF (19·8 m.), while GSF has been used instead of GSE since July 12th.

The desirability of using two waves simultaneously has been shown in the correspondence from this zone, the general tendency having been for the shorter wave to give the more consistently better signal in N.W. India, while the longer wave has been better in S.E. India and Malaya.

ZONES 3 AND 4

These two zones will be reviewed as one, as they have already been joined for programme reasons. It seems permissible to draw the conclusion, from the correspondence received, that, speaking generally, reception has been at least fair. Originally 49 m. and 31 m. were used, but as a result of reports received, 49 m. was abandoned in favour of 25 m. on January 18th. Subsequent reports from East Africa showed that only the 31 m. channel was being well received, and this was to be expected from the aerials in use.

With the amalgamation of the programmes to the two zones which took place on April 2nd, very careful consideration was given to the aerial arrangements to be adopted. It seems attractive, at first sight, to adopt an arrangement which would cover the whole zone without a change of aerial during the programme. From the point of view of directed transmission, however, the African continent is "the wrong way up" when looked at from Daventry—in other words, the narrower part of the continent is the more distant and the wider part the nearer. In order to cover the nearer extreme width, the beam would have to be so wide that there would be relatively little gain from it as compared with an omni-directional aerial. It was therefore decided to continue with two sets of directional aerials, and a 25-m. aerial was provided for East Africa, the change-over from Zone 3 to Zone 4 aerials being made at 8 p.m. G.M.T. This arrangement still left something to be desired, however, for East African listeners complained that their reception dropped off badly with the change-over at 8 p.m. G.M.T., while West African listeners, who originally had a 25-m. transmission directed to them for the whole four and a half hours, complained that they got less good reception before

8 p.m. G.M.T. However, the original object of giving each zone a two-hour programme had been practically achieved, but a further change was made on July 5th to endeavour to meet these complaints. The 31 m. transmission was directed to East Africa throughout the whole four and a half hours and that on 25 m. to West Africa for the same period.

Reception of both Zones 3 and 4 transmissions in South Africa has been reported as fair, and several relays have taken place both from Cape Town and from Johannesburg stations, the latter relaying Big Ben with regularity.

The transmissions to these two zones, particularly to the latter, have been reported on also from South America and from the West Indies. A very interesting series of field measurements was made by the Argentine Telephone Company in Buenos Aires, and showed that, although fairly strong fields were received from both 25-m. and 31-m. transmissions, yet the difference between wanted signal and noise was not great enough for relaying purposes. It must be remembered, of course, that Buenos Aires is not actually within Zone 4. However, it is evident that great interest is taken in the Empire transmissions by the very large British community, and it is hoped to provide a better signal there in the near future.



WEST INDIES

ZONE 5

Reception in Canada was practically non-existent at the beginning of the Empire service during the normal zone programmes from 1 a.m. to 3 a.m. G.M.T., but at the same time Zone 5 has provided a great deal of correspondence owing to the large number of letters received from the United States of America. The longest wave in the short-wave bands (50 metres) is too short for late night transmission over a northerly track in mid-winter at a period of minimum sunspot activity, and this explains the initial bad reception conditions in Canada. With the gradual change in season, however, reception in Canada has improved. In order to assist this improvement, the timing of Zone 5 programmes was advanced two hours on March 12th, since which date the time has been 11 p.m. to 1 a.m. G.M.T. At the present time, correspondence shows that reception conditions over the zone are good. Most of the United States letters have reported good or very good reception. The majority of the Canadian letters have come from the Eastern Provinces, but latterly, reports are coming to hand from farther West.

Many reports have been received from the West Indies, where there is obviously great interest in the service. The same applies to Newfoundland.



CANADA

OMNI-DIRECTIONAL TRANSMISSIONS

Letters from listeners situated in many different parts of the Empire, reporting on the new service, expressed regret at the discontinuance of the "lunch-time" transmissions which had been a feature of the former experimental transmissions from G5SW. It was therefore decided to transmit the London Regional or the National Programme daily on two wavelengths, using omni-directional aerials from 11 a.m. to 1 p.m. G.M.T. (Sundays, 11.30 a.m. to 1 p.m.). This was started on June 11th, the wavelengths used at present being 16.86 metres (GSG) and 19.8 metres (GSF). A number of appreciative reports have already been received.

CONCLUSION

In this relatively short review it has not been possible to mention all the various experimental changes which have been carried out, nor to deal with much of the very interesting information which has been extracted from listeners' reports. It is certain, however, that a great deal of useful knowledge is still to be gained in the field of short-wave transmission and reception, and one aspect of this is already being explored. A series of experimental short-wave transmitting aerials has been erected at Daventry, and these are used for regular and experimental transmissions. There has long been a controversy as to whether high aerials or low aerials, horizontal aerials or vertical aerials are better for short-wave transmission. A considerable amount of experimental evidence is available in relation to aerials for fixed point-to-point services, but there is much less evidence as to which aerial is best for a broadcast service which, although it can be directed in the horizontal plane, still has to be receivable over large areas of country which lie at widely different distances from the transmitter.

As to receiving aerials, it is well known that considerable advantage can be obtained by the use of directional arrays, but these are costly. Work has, however, been undertaken on the design of small aerials which the ordinary listener could erect, and preliminary experiments suggest that they could be used with advantage.

(The photographs in this article are reproductions of posters of the Empire Marketing Board, by permission of the Controller, H.M. Stationery Office.)

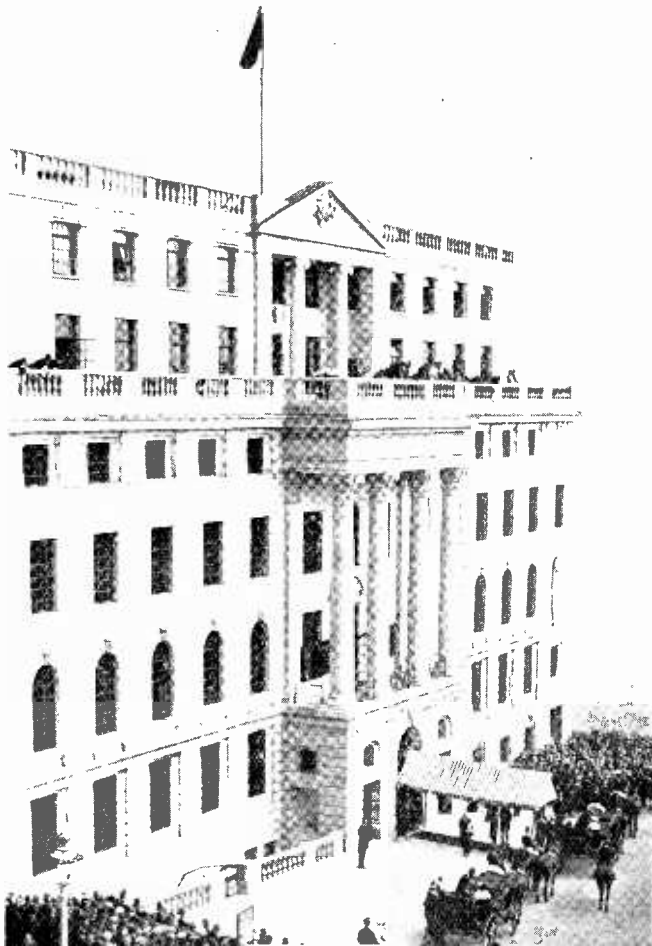

THE OPENING OF SOUTH AFRICA HOUSE, BROADCAST ON JUNE 22ND, 1933

EMPIRE SERVICE EVENTS

THE FOLLOWING is a list of some of the most outstanding programme features that have been broadcast by the Empire Station since its inauguration in December, 1932, arranged in two categories:

EXCLUSIVE EMPIRE PROGRAMMES prepared for Empire listeners and not broadcast in this country.

SPECIAL RELAYS FROM HOME PROGRAMMES direct and by electrical recording.

EXCLUSIVE EMPIRE PROGRAMMES

1933

- Jan. 1 New Year's Day Service conducted by the Rev. Pat. McCormick. (All zones.)
- 10 Speeches by Sir Archibald Weigall and the Earl of Athlone at the Royal Empire Society Luncheon to the new Governor of Newfoundland, Admiral Sir Murray Anderson. (Zones III and V.)
- 26 Australia Day: A Message from Mr. S. M. Bruce, Resident Minister for Australia in London, followed by a Recital by Australian artists. (Zone I.)
- Feb. 9 Inauguration of New Zealand Day: Special broadcasts by H.R.H. the Prince of Wales and Sir Thomas Wilford from the studio. (Zone I.)
- 13 Falkland Islands Centenary: Special Message by Sir Philip Cunliffe-Lister and Mr. George Bonner. (Zone IV.)
- 20 Opening of the British Industries Fair, in London. (All zones.)
- Mar. 1 St. David's Day Programme from Cardiff. (All zones.)
- 17 St. Patrick's Day Programme. (All zones.)
- Apr. 19 Message by Sir Percy W. Everett to West Indies Jamboree. (Zone V.)
- 24 Anzac Day Commemoration: Talk by Sir Fabian Ware, "The Empire's Care of Anzac Graves." (Zone I.)
- 25 Special Service commemorating Anzac Day from St. Clement Danes Church. (Zone I.)
- May 8 First Broadcast of Empire Marketing Board's Market Information Service. (Zones I, III and V.)
- 15 Recital by Devika Rani. (Zone II.)
- 26 Talk on Wool Sales by Mr. Walter Devereux. (Zone I.)
- 31 Union Day: Talk by Mr. C. T. de Water, High Commissioner for the Union of South Africa. (Zone III.)
- June 5 First of a series of talks entitled "Empire and Industry." (All zones.)
- 15 Speech by Sir Philip Cunliffe-Lister on the occasion of the Colonial Service Dinner at the Corona Club. (All zones.)



THE OPENING OF THE ENGLAND TO INDIA TELEPHONE SERVICE

(May 1st, 1933)

Sir B. N. Mitra, Sir Kingsley Wood, and Sir Samuel Hoare.

- June 22 Opening of South Africa House by H.M. the King and a Speech by Mr. C. T. de Water. (Zones II and III.)
 30 First Speedway Test Match: England *v.* Australia, at Wembley Stadium. (Zone I.)
- July 1 Dominion Day Programme. (Zone V.)
 3 Dominion Day Messages by H.R.H. the Prince of Wales and Mr. R. B. Bennett. (Zone V.)
 10 Special Message to Australia by Mr. J. H. Crawford, Wimbledon Tennis Singles Champion, 1933. (Zone I.)
- Aug. 28 Feature Programme: "Boxing the Compass."
- Sept. 1 Scenes from Shakespeare: "All the World's a Stage."
 11 An Irish Programme: "Coasting."
 22 Sir Walford Davies giving the first of a series of Music Talks.
 23 Talk by Mr. J. R. Stapleton, Station Director of the Indian State Broadcasting Service, Calcutta.
- Oct. 3 Recital by Miriam Licette.
 28 Concert by representative Overseas Artists.
 31 Opening of the new Harbour at Haifa, Palestine, with an exchange of Messages between the High Commissioner for Palestine and the Secretary of State for the Colonies.

*SPECIAL RELAYS FROM HOME
PROGRAMMES*

- 1932
Dec. 25 Christmas Day Programme, including a Message to the Empire by H.M. the King.
1933.
Mar. 6 Relay of the African Broadcasting Company's Programme, "Four Thousand Feet above Cape Town."
9 Sir Malcolm Campbell on his Daytona Beach Record.
11 Mr. Matsuoka and Mr. Quo Tai-chi, giving their respective points of view on the Manchurian Dispute.
24 Grand National Steeplechase at Aintree, Liverpool.
Apr. 1 Oxford and Cambridge Boat Race, Putney to Mortlake.
The Inauguration of the Holy Year by H.H. the Pope, relayed from the Vatican.
23 Zeebrugge Commemoration Service from St. Mary's Church, Dover.
24 Speech by Mr. Winston Churchill at the Dinner of the Royal Society of St. George.
29 Association Football Cup Final, Everton v. Manchester City, at Wembley Stadium.
Arrival at and Departure from Gloucester Railway Station of the "Cheltenham Flyer."
May 1 Opening of the England to India Telephone Service.
5 Talk by the Prime Minister on his visit to the United States.



FOUR THOUSAND FEET ABOVE CAPE TOWN
Broadcasting from the top of Table Mountain (March 6th, 1933)

- May 6 Rugby League Cup Final, Huddersfield *v.* Warrington, at Wembley Stadium.
 8 Opera relayed from Covent Garden (first of a number given during the International Season).
 24 Speeches by Lord Derby, Mr. J. H. Thomas, and the Archbishop of Canterbury at the Empire Day Luncheon. Empire Day Programme, and Speech by the Prime Minister.
 31 Commentary on "The Derby" relayed from Epsom.
- June 3 "Trooping the Colours" on the Horse Guards Parade, Whitehall.
 10 Aldershot Tattoo from the Rushmoor Arena.
 The Ceremony of the Keys at the Tower of London.
 11 Mr. Maynard Keynes and Mr. Walter Lippmann in a Transatlantic Debate.
 12 Opening of the World Monetary and Economic Conference by H.M. the King, and Speech by the Prime Minister.
 16 Senior Tourist Trophy Race from the Isle of Man.
 17 Greenwich Night Pageant.
 24, 26, and 27 Commentaries on three days' play in the first Cricket Test Match, England *v.* West Indies, at Lord's.
 28 Daily commentaries on the All England Tennis Championships at Wimbledon.
 29 First Speedway Test Match, England *v.* Australia, at Wembley Stadium.
- July 8 Annual Service from the Scottish National War Memorial, Edinburgh.

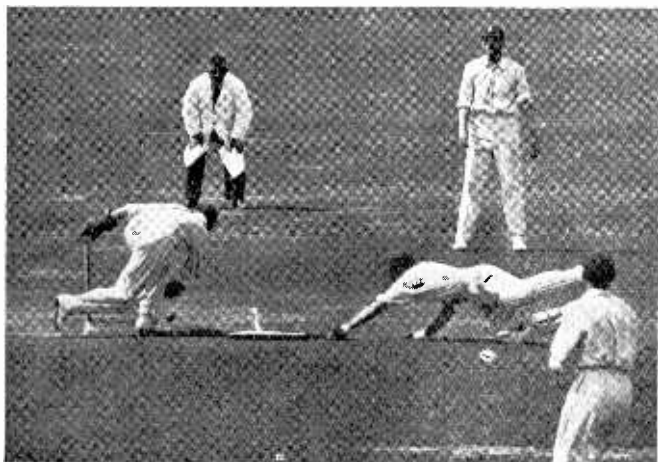

CRICKET AT LORD'S, ENGLAND *v.* THE WEST INDIES

- July 12 Speeches by the Marquess of Crewe, Mr. Rudyard Kipling, and Mr. G. K. Chesterton at a Luncheon given by the Royal Society of Literature to the Canadian Authors' Association.
- 14 Commentaries on Tennis Matches in Davis Cup Final (European Zone), England *v.* Australia.
- 16 Drumhead Service from Woolwich.
- 22, 24, and 25 Commentaries on three days' play in second Cricket Test Match, England *v.* West Indies.
- 22 Commentary on the final stages of shooting for the King's Prize at Bisley.
- 26 H.M. the King opening the new Graving Dock, Southampton.
- 27 Speech by the Prime Minister on the close of the World Economic Conference.
- Aug. 6 Service on board H.M.S. *Victory* during Navy Week at Portsmouth.
- 10 Speech by Mr. D. Lloyd George at the Welsh National Eisteddfod.
- 12 Opening of 1933 season of Promenade Concerts at the Queen's Hall, London.
- 14 Commentaries on first and second days' play in third Test Match, England *v.* West Indies.
- 15 Talk by Mr. C. Grant, captain of the West Indies Cricket Team.
- 17 Talk by Mr. J. A. Mollison, from Plymouth, on his recent Atlantic flight.
- 19 Commentary on the Ulster Grand Prix Motor Cycle Race at Carnaughlis, County Antrim.
- 21 Commemoration Service from St. Martin-in-the-Fields for the late Sir Ronald Ross. Address by the Poet Laureate, Mr. John Masefield.
- 21 and 28 B.B.C. Revue from the Theatre at the National Radio Exhibition, Olympia.
- 27 Service from Govan Old Parish Church, Glasgow.
- Sept. 2 Commentary on the Ulster Tourist Trophy Motor Race at Belfast.
- 13 Commentary on the St. Leger from the Racecourse, Doncaster.
- 19 Opera from Sadlers Wells, Puccini's "La Bohème."
- 23 First of a series of talks: "Anywhere for a News Story": Mr. C. Ward Price on "The Burning of Smyrna."
- 24 Harvest Festival Service from Cranleigh Parish Church.
- 25 Mr. Stanley Baldwin on "National Character."
- Oct. 3 Evensong from York Minster.
- 3 First of a series of talks on the British Empire.
- 14 "G. B. Cochran presents . . ." Reminiscences of Mr. Cochran's productions, with the B.B.C. Dance Orchestra.
- 18 Opening of 1933-34 season of Symphony Concerts at the Queen's Hall, London.
- 19 Hungarian Operettas of Kálmán conducted by the Composer.
- 24 "Black Watch," a Scottish Regimental programme.

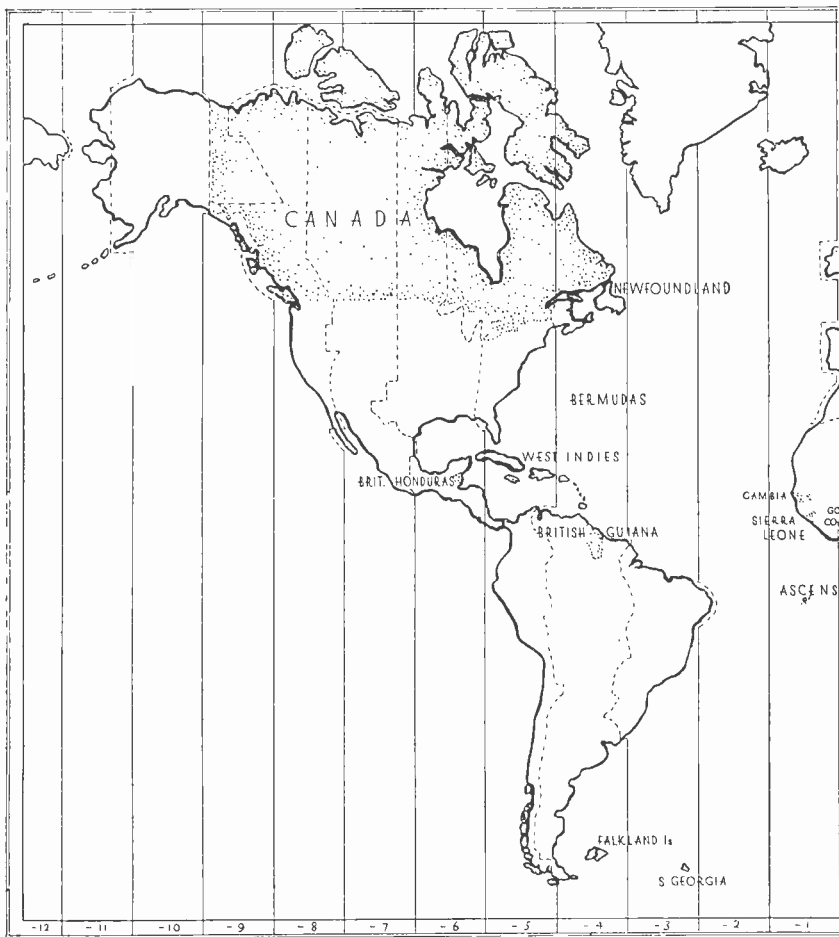

TIME-ZONE MAP OF THE WORLD SHOW
 Details of population, etc.



THE COUNTRIES OF THE BRITISH EMPIRE
 given on the next two pages.

T H E E M P I R E

THE FOLLOWING STATISTICS must be taken with the reservation that they relate to various dates; 1931, however, predominates. The figures in brackets represent a computation, from various sources, of the residents of European race in certain countries where they form a minority (groups of fewer than one hundred are not considered). The figures for service personnel and crews of ships are merely a rough estimate.

<i>Eight hours or more fast on Greenwich Time.</i>	Population to the nearest thousand.	Time Factor.
Gilbert and Ellice and other W. Pacific islands	33,000 (600)	+ 11½ to + 14
Cook Island	15,000	+ 13½
Western Samoa	47,000 (600)	+ 12½
Fiji	157,000 (4,000)	+ 12
Tonga	29,000 (500)	+ 12
Nauru	2,000 (150)	+ 11
British Solomon Islands	91,000 (500)	+ 11
New Hebrides (Anglo- French)	60,000 (c. 900)	+ 11
New Zealand	1,525,000	+ 11½
Australia	6,549,000	+ 8 to + 10
Papua and New Guinea	671,000 (5,300)	+ 10
North Borneo	270,000 (400)	+ 8
Sarawak	475,000 (?)	+ 7½
Hong Kong	1,144,000 (?)	+ 8
Service personnel and crews at sea (white)	c. 6,000	—
<i>Six hours and less than eight hours fast.</i>		
Malaya (Straits, and Federated and non-Federated Malay States)	4,339,000 (? 12,000)	+ 7
Service personnel and crews at sea (white)	c. 6,000	—
<i>Four hours and less than six hours fast.</i>		
India (incl. Burma)	352,838,000 (127,000) *	+ 5½
Ceylon	5,313,000 (8,000)	+ 5½
Mauritius	391,000 (300)	+ 4
Seychelles	28,000 (100)	+ 4
Service personnel, and crews at sea (white)	c. 70,000	—

* Incl. French and Portuguese India, Bhutan, Nepal and Baluchistan.

<i>Two hours and less than four hours fast.</i>	Population to the nearest thousand.	Time Factor.
Cyprus	354,000 (600)	+ 2
Palestine	1,036,000 (600)	+ 2
Transjordan	300,000 (200)	+ 2
Aden	100,000 (?)	—
Sudan	5,606,000 (5,500)	—
Somaliland	345,000 (?)	+ 3
Kenya	3,041,000 (1,300)	+ 3
Uganda	3,635,000 (1,800)	+ 2½
Zanzibar	235,000 (300)	+ 3
Nyasaland	1,603,000 (1,800)	+ 2½
Tanganyika	5,064,000 (3,000)	+ 3
N. Rhodesia	1,386,000 (3,100)	+ 2
S. Rhodesia	1,109,000 (27,000)	+ 2
Basutoland	500,000 (1,800)	—
Bechuanaland	160,000 (1,800)	—
Swaziland	120,000 (2,200)	—
Union of South Africa	8,251,000 (1,860,000)	+ 2
South-West Africa	240,000 (20,000)	—
Service personnel, and crews at sea (white)	c. 18,000	—

Less than two hours fast or slow.

Gibraltar	15,000	± 0
Malta	244,000	+ 1
S. Helena and Ascension	4,000	± 0
Gambia	210,000 (150)	± 0
Sierra Leone	1,541,000 (1,150)	- 1
Gold Coast (incl. Togoland)	3,121,000 (3,000)	± 0
Nigeria (incl. Cameroon)	19,315,000 (5,000)	+ 1
*Service personnel, and crews at sea (white)	c. 23,000	—

Four hours or more slow.†

Canada	10,506,000	- 5 to - 10
Newfoundland and Labrador	282,000	- 3½
Bermuda	28,000 (16,000)	- 4
Bahamas	28,000 (11,300)	- 4
Jamaica	858,000 (14,600)	- 5
Leeward Islands	122,000 (?)	- 4
Trinidad and Tobago	415,000 (?)	- 4
Barbados	174,000 (?)	- 4
Windward Islands	66,000 (?)	- 4
British Guiana	314,000 (10,800)	- 4
British Honduras	51,000 (?)	- 6
Falkland Is. and S. Georgia	3,000	- 4
Service personnel and crews at sea (white)	c. 14,000	—

* Some unavoidable duplication with the population shown for Gibraltar and Malta.

† The extreme Western Pacific is counted as "+."

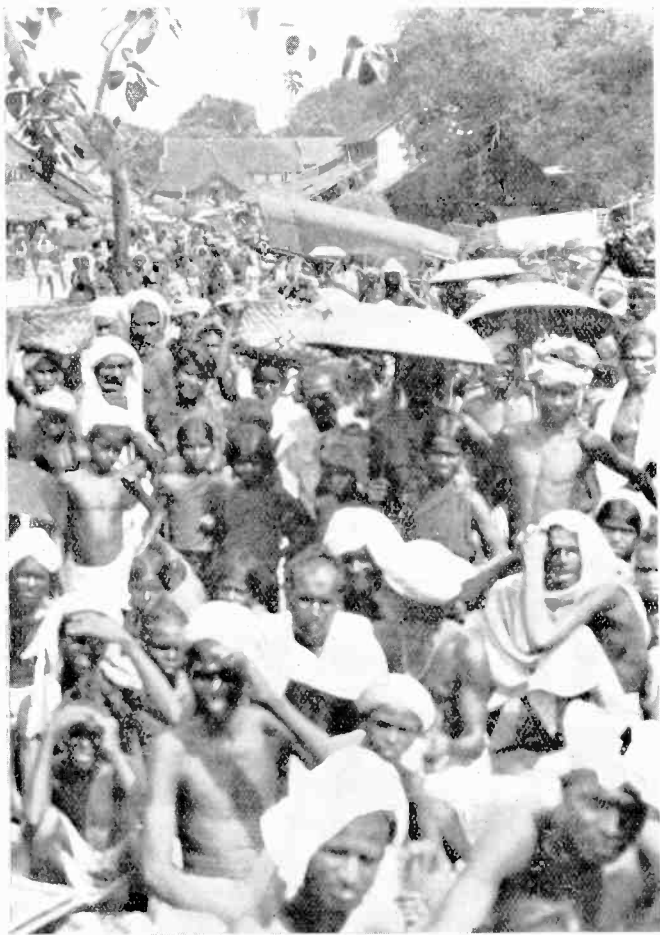

E.N.A.

A TYPICAL INDIAN VILLAGE CROWD

BROADCASTING IN RURAL INDIA

By C. F. STRICKLAND, C.I.E.

Vice-Chairman, Indian Village Welfare Association

INDIA is on the verge of self-government. The implications of a constitutional government that must ultimately depend on the votes of an enormous illiterate peasantry are obvious to every thoughtful person. The peasants of the Indian villages—300,000 peasants in 700,000 villages—are industrious but simple, kindly yet inflammable, naturally intelligent but so depressed by the isolation and dullness of their surroundings that they seek relief in excessive expenditure on weddings and in futile litigation about nothing at all. The country and the population are so huge that money and staff far in excess of what can be afforded would be necessary if schools, medical assistance, agricultural instruction, and recreation were to be spread throughout the rural areas in the near future.

The position would be entirely changed if these lonely masses could be advised, taught, and amused by means of broadcasting. Soviet Russia, finding itself in face of a somewhat similar problem, has installed countless receivers in schoolrooms or other accessible spots in the villages, and conveys to the people not only its own political propaganda but also a stream of genuine adult education. Weather news, market prices, agricultural advice, health advice, information about Russia and the world, culture and lighter items, all these enlarge and brighten the village, and mould the mind of the mujik. Is it not practicable to follow the same policy in India?

The Indian Village Welfare Association (4, Great Smith Street, London, S.W.1) believes that the difficulties, great though they are, are not insuperable, and is urging on the various governments in India the necessity of a planned attack on rural ignorance in order at the same time to create political poise and to expand the mind of the peasant. The present Indian broadcasting system is, with the exception of a few minor municipal or private installations, confined to the two transmitting stations in Calcutta and Bombay which, since the failure of the Indian Broadcasting Company, have been maintained by the Indian Government itself. The defects of this system are that

it ignores the bulk of the population and, further, does not pay. The educated urban class, which can provide itself with private receivers, is very limited—"piracy" in Calcutta and Bombay is rife even among this class—and though good reception sometimes occurs in the winter months at great distances, these are freak cases and irregular. During the hot months and the monsoon the range is very narrow. The service is thus still far from satisfactory, whether with regard to its diffusion or the programme.

The remedy for these evils is clearly to appeal, not merely to the educated classes of the towns, but to the Indian masses who live in the villages. They must be addressed in their own languages and in the local dialect of each language. The subjects of prime interest to the peasantry are—as in Russia—those which concern them closely: news of the rain, talks about prices and crop-improvements, notice of special trains to a religious fair, warnings of locusts, of epidemics, of robbers and raids. But they will also welcome Indian music and Indian songs—the old songs which they know, rather than new fashions—amusing or pious stories, a daily bulletin, as impartial as may be, about Indian politics and the latest legislation on rural affairs. The departmental officers of the Civil Services will seize this chance of approaching them and will give short talks on hygiene and education, cattle and co-operative societies, and a host of matters which they can now only explain to single groups as they plod round from village to village throughout the year. Above all, it will be possible to reach the village women, who seldom venture to join a meeting of menfolk and listen to a touring officer, but will gather happily round a loudspeaker specially reserved for them in a village building. A service has already been provided in Ceylon, but the Indian problem is bigger and more puzzling.

The plan advocated by the Indian Village Welfare Association is to install a *small* transmitter at the headquarters of each administrative district, which will broadcast in the local language and dialect. The programme will be arranged by a semi-official committee containing representatives of all communities, under the control of a Government officer, and will be of the simple and popular nature described, aiming at the general enlightenment and recreation of the people in order to make them progressive citizens and thoughtful voters. Such a programme

will be inexpensive and for the most part unpaid. Since the Indian peasant will not often afford a receiver for himself, a communal receiving set will be maintained and paid for by the village as a whole, and wires may be carried from it to loudspeakers in the schoolroom, the meeting-house or (for a fee) to private houses. The receiver will be permanently fixed to receive only on a single wavelength, and will therefore require no skilled tuning or treatment. Undesirable foreign programmes will also be excluded by this device. The schoolmaster or headman will retain a key, giving access to the switch, and the receiver will be so constructed (specially for this rural service), that no other part is accessible. It should be mentioned that a receiver of this type is being developed.

It can scarcely be doubted that Indian villages would appreciate the privilege of listening. It is, however, desirable to conduct full experiments in one or more single districts. The B.B.C. has promised to loan a transmitter to the Association as soon as the receiving end of the scheme has taken shape, and negotiations with several areas are in progress. The initial cost of the village receivers will have to be met by a courageous government, but if broadcasting proves as popular as is anticipated, the scheme contemplates that the price of the receivers will be repaid by the village in instalments, and the system will in a few years be self-supporting. Its value to India will be beyond measure.



DR. ARNOLD RÆSTAD, THE FIRST PRESIDENT OF THE NORSK
RIKSKRINGKASTING.

F O R E I G N

NOTES OF THE YEAR

HARDLY A YEAR passes without a rumour from one quarter or another that a new American network or chain of stations is about to be formed. This year's rumour, however, has more foundation than most, and during the Spring there seemed no doubt that a third network would definitely materialise, though frequent postponements of the date announced for the commencement of operations have, by the time of going to press, cast some uncertainty over the whole project. British listeners, and not only those possessing short-wave sets, are fairly familiar by now with the names of the two existing networks: the National Broadcasting Company and the Columbia Broadcasting System, which control between eighty and ninety stations each. The new network, when and if it comes into being, will be known as the Amalgamated Broadcasting System Incorporated, and will be launched and managed by Mr. Ed. Wynn, already popular with American listeners as a great radio comedian. Mr. Wynn's plans, which are said to have millionaire backing, are ambitious; although prepared to start with a small nucleus of stations, he claims that he can link up some seventy odd whenever he likes. Mr. Wynn, although entering into competition with N.B.C. and C.B.S., will not, of course, draw his stations from the groups associated with these companies; there exist in America a large number of independent stations to choose from, and the new chain will probably begin with its main outlets in New York, Trenton, Wilmington, Philadelphia, Baltimore and Washington. Although said to be aiming at a new kind of radio showmanship, the announced policy of the network appears revolutionary only as it affects advertising; Mr. Wynn intends to limit sponsorship announcements to thirty words at the beginning and end of each programme and to omit all reference to prices. Hoping, no doubt, to escape participation in the press *versus* radio war, mentioned in a previous note, Mr. Wynn has stated that at the end of all commercial announcements listeners will be referred for prices and other details to the sponsors' advertisements appearing in the daily press; they will also be referred to the newspapers

for information about the following day's broadcasting programmes.

Meantime Ed. Wynn is off to Hollywood to make a new picture for Metro-Goldwyn-Maycr, so it looks as though cinema fans would have a chance of seeing him again before radio fans can hope to listen to his stations. It is said that when his network is ready to begin operating, the President himself has promised to conduct its inauguration.

* * *

The attitude of the press in America towards broadcasting has never been friendly, but the first declaration of open warfare came in April of this year with the resolutions adopted by the Associated Press and by the American Newspaper Publishers Association at their annual meetings in New York. The A.P. resolution which is mandatory upon all affiliated newspapers—over 1,000 in number and many of them controlling radio stations—places heavy restrictions on the use of A.P. news bulletins for broadcasting purposes by independent stations and absolutely prohibits the furnishing of any news to the networks. The A.N.P.A. resolution, which is only recommendatory, and therefore less immediately serious from the broadcasters' point of view, is directed against the free publication of radio programmes in the daily newspapers; these programmes, the resolution declares, are advertising and should be paid for as such. Both resolutions, but particularly the first, are calculated to hit most severely the two big networks: the National Broadcasting Company, and the Columbia Broadcasting System. Some action of the kind had, however, been foreseen for a long time, and the necessity of evolving means of dealing with it had been realised. Indeed, although the resolutions were only passed in the spring of this year, it appears that since the elections last autumn no Associated Press, United Press, or International News service bulletins had been available for the networks.

It is obvious that if forced to go to battle in real earnest the broadcasters should be able to hold their own. Not only could they enter the enemies' field by creating a radio news association to be conducted on the same lines as the big press agencies for the collection and dissemination of news, but they could develop, as indeed they are rapidly doing, the type of news-

giving which is peculiarly their own, and which is graphically known in America as "Spot coverage"; that is to say, the running commentary or eye-witness account broadcast while the event is actually taking place. Recent examples of this type of broadcast have proved that where "hot" news is concerned the broadcasters possess facilities that cannot be rivalled by the press; there was, outstandingly, the broadcast of President Roosevelt's inauguration, and in another and very different category the description from the spot of the Californian earthquake and of the "Akron" disaster.

In countries like our own, where the commercially sponsored programme is unknown, this keen rivalry between press and broadcasting may seem difficult to account for, but the position becomes understandable when it is realised that both depend to a considerable extent on the same source of revenue. It is greatly to be hoped, however, that hostilities will go no further; in any country, but particularly in America, where radio and press interests are often so closely allied, co-operation between these two great forces is essential; competition, when it means invasion of each others' territories, is only a dissipation of energy leading to duplication of results, whereas in partnership the one power could become the complement of the other, achieving together a perfect public service.

* * *

Italy has this year introduced broadcasts to schools, and some careful and interesting experiments are now being conducted so that the new service may be firmly based. This development, however, although much importance is attached to it, is at present rather overshadowed by the movement to put a receiving-set into the category of articles without which no farmsteading will be well-found. If plans succeed, the Italian farmer will soon be adopting the habits of the Danish farmer, with power and light and telephones and wireless as familiar as pitchforks.

The state has brought into being a body called the Ente Radio Rurale; Signor Enrico Marchesi, President of the Italian broadcasting organisation, the EIAR, announced publicly on the 30th May that the Chamber of Deputies had approved a law presented by the Minister of Communications for the constitution of this new organisation, which is to introduce more

than 30,000 recalcitrant rural communities to the advantages of broadcasting, since broadcasting—the official Italian radio journal states—is already felt by the urban population to be “an indispensable food of the spirit, superior to the press, the theatre and the cinema.” Technical conditions are felt to be very favourable for the task in hand, since there are large tracts of country fortunately unvisited by electrical interference; the core of the problem is the provision of programmes that will gradually win the favour of the country dweller without interfering with his mode of living or lowering the standards of frugality and temperance that are his strength and his prerogative (*Radiocorriere*). Apparently the installation of sets for public listening is contemplated in the village schoolhouse as a beginning: this has the practical advantage of enabling the encouragement of school broadcasting, which is under the auspices of the new Ente, at the same time and without further outlay.

* * *

The Moscow Trades Union Station continues to pour out honeyed words—English words—five or six times a week and more. An almost—we are afraid—bourgeois voice is speaking at present in the accents that persons educated elsewhere agree to ascribe to Oxford; and anybody might be deceived, at the end of the transmission, in the provenance of the concluding “Good-night, everybody, *good-night*.”

* * *

Amateurs of short-waves in Germany were formerly most unfavourably placed in comparison with fellow “fans” in some other countries. Now there has been an interesting change, and “fans” are in the service of the Fatherland. The licence-fee has been reduced from 100 marks a year to 24, the cost of an ordinary receiving-licence; and it has been explained to the amateurs that they are now being encouraged, not that they may idly enjoy the fruits of their facility, but that they may serve their country as propagandists. Licences, however, will be issued only to members of the approved amateur society (*Deutsche-Amateur-Sendedienst*), which is undertaking to train new members.

* * *

The four Norwegian broadcasting companies previously existing—of which the main one was *Kringkastingselskapet*—

were replaced as from the 1st July, 1933, by one state organisation, Norsk Rikskringkasting. The governing body of the new organisation is a committee of five, nominated by the Crown for a period of four years. A National Programme Council of fifteen will be constituted, of which four members are nominated by Parliament and eleven, including the President and the Vice-President, by the Crown. The Norwegian Post Office will collect the licence fees and will install and operate transmitters, and, in fact, be responsible for the whole technical side of the service. The first president is Dr. Arnold Raestad, the well-known international jurist, who has been for several years an active participant in the work of the International Broadcasting Union, and has frequently visited the B.B.C.

The broadcaster will thus be under the control of the State. His budget must be approved by Parliament and his personnel appointed according to the terms of a statute to be drawn up by the Crown. There are, no doubt, certain potential advantages—as well as, we should imagine, certain restrictions—attaching to this form of constitution, such as that the Crown may permit the expropriation of land required for a broadcasting station.



ITALIAN CHILDREN TAKING PART IN A SCHOOL BROADCAST

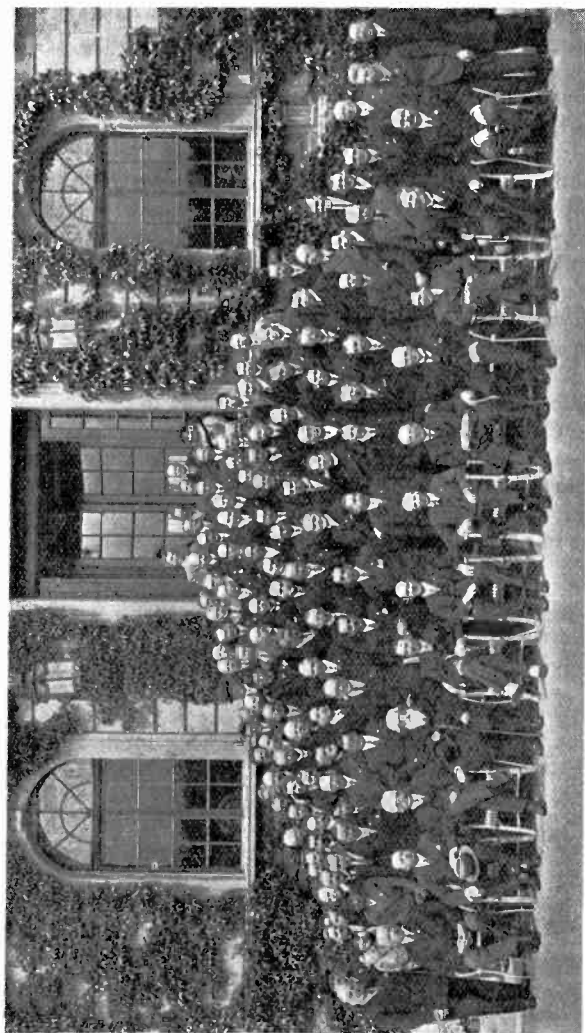

THE DELEGATES AT THE LUCERNE CONFERENCE, 1933

THE INTERNATIONAL ORGANISATION OF BROADCASTING

By A. R. BURROWS

Secretary-General of the International Broadcasting Union, Geneva

THE LUCERNE CONFERENCE of European Governments for the re-arrangement of European broadcasting wavelengths in the light of the needs of the moment and of the immediate future, required five weeks' intensive effort to reach a solution likely to give satisfaction to a majority of States. In addition to these five weeks, many others had been spent by experts, and committees of experts, in preparatory work.

These facts have led some people to indulge in the too common tendency to scoff at international organisations and conferences. A more correct perspective of the situation would have been presented by the critics had they placed emphasis on the complexity of the international wavelength position, and of international broadcasting problems generally.

The Lucerne plan, its history and purpose, is dealt with elsewhere in the Year-Book. For this reason remarks on the subject here will be confined to an assurance that, without the long series of international discussions at Lucerne and Brussels, at which account was taken of each essential element, European broadcasting would shortly have become chaotic.

The fact that the electrically-created vibrations on which the broadcast programmes are radiated do not "fade away" automatically on reaching the frontier of the country of origin gives birth to international problems other than those associated with wavelengths and mutual interference between stations. The broadcaster has been entrusted by his Government with an instrument of quite extraordinary characteristics and influence. His activities can produce more immediate, and more immediate distant, reactions than any other form of human activity. A remark, timely or indiscreet, broadcast from a studio in Europe on a short wavelength, could give pleasure or offence throughout Australasia in one-fifteenth of a second.

The International Broadcasting Union, established at Geneva in the spring of 1925, through British and Swiss

initiative, after a preliminary Conference at London, had uppermost in mind, during its first days, wavelength problems similar in character to those which puzzled the delegates at Lucerne during five wet weeks in the late spring. Nevertheless, at the very first meeting of the broadcasters at Geneva, it became evident that a wealth of other problems would arise for discussion internationally. In order that these problems might have adequate treatment by specialists, the Council adopted the practice well tried in international activity of appointing various commissions of experts. At first three commissions (one each for technical, legal and programme questions) were considered to be sufficient. Later a fourth was created to handle specially the problems arising from the development of international relays.

An office was opened at Geneva to act as a form of "clearing house" of information for broadcasters, for the assembly and digesting of material essential for the various studies, and for the organisation in Switzerland and other European countries of the meetings of the Union. This Office has issued Monthly Bulletins, nearly four thousand general documents (complete studies, offers of international concerts, etc.) and has conducted a correspondence amounting to tens of thousands of letters. At a later date a technical headquarters was created at Brussels, at which nightly observations of great exactitude are made on the technical behaviour of the European broadcasting stations, not only in regard to wavelength stability, but also in respect to depth of modulation. Researches into field strengths, and other technical activities essential to a serious examination of the international technical situation, are being made uninterruptedly at Brussels under the direction of M. Raymond Brailard and his assistant Prof. Edmond Divoire.

The International Broadcasting Union is in no sense a commercial organisation. It exists to study all the international problems arising from the development of broadcasting. In reality it provides too an opportunity for exchanges of ideas on a number of other problems which, strictly speaking, do not call for action on the international plane. The Union also exists to defend the interests of broadcasters. In this direction it has become necessary to draw attention in all countries to the fact that, although the broadcast programmes pass from the

country of their origin to other countries, and may be intercepted at great distances by simple apparatus, these programmes should be regarded as the property of the broadcasters who have spent considerable sums in their preparation and transmission, and ought not to be exploited commercially without the previous consent of the broadcasters. Legal protection, it is true, does not yet exist for the broadcast programme in all countries, but the moral obligation to respect the property right in the programme cannot be disputed.

The International Broadcasting Union has not been concerned solely with the study of problems hindering the development of broadcasting. From its foundation the members have shown a deep sense of responsibility in respect to the marvellous instrument which they have been permitted to use. At a 1925 meeting of the Union, resolutions were passed giving support to the ideals underlying the foundation of the League of Nations. Every meeting has had upon its agenda one or more questions associated with the development of broadcasting as a means of creating a better understanding between peoples.

One of the first movements in this direction was to make contact with the International Consultative Committee at Paris which studies officially the international telephone problems. In those days, although an understandable conversation was possible between two relatively distant points in Europe, the long-distance telephonic circuits were quite unfitted to carry musical sounds. The International Broadcasting Union asked that in future long-distance telephonic circuits of much higher quality should be installed. The Committee, with exemplary foresight, accepted the suggestion, which had been made fortunately just at the moment when a big overhaul and extension of the European telephone systems were under consideration. To-day it is common practice to relay internationally by telephonic means musical programmes for broadcasting purposes. The technical side of this development is not yet complete, the prevailing economic depression having compelled some countries to hold up their plans for telephonic expansion. Nevertheless, 14 European members of the Union made 909 relays from foreign countries last year. The programme side of international relays is constantly under study. The success which has attended the Transatlantic relaying of debates has led to an

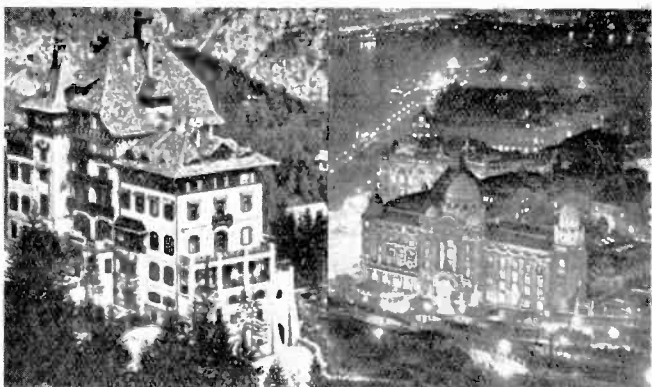

SOME CONFERENCE HOTELS

E.N.A.

SÜDBAHN, SEMMERING

ST. GELLERT, BUDAPEST

EXCELSIOR, ROME

NATIONAL, LUCERNE

BEAU RIVAGE, LAUSANNE-OUCHY

examination of the possibility of European international debates of a similar character. Contrary to what might be expected, the European problem is much the more complicated. The first step in the development of European debates has been to prepare a chart showing the circuits which can be used for the purpose. Circuits used for ordinary telephonic conversations are not suitable for the broadcasting of speech. It is necessary to use those which have been built or adapted for the transmission of music. The "music circuits," generally speaking, are fitted at intervals with amplifiers which function only in one direction. A relayed debate requires then two distinct circuits, one with its amplifiers all set to work in an outward direction, the other with its amplifiers all working in an home-ward direction. When the diagram of such circuits is complete then there will follow the establishment of an international routine for the debates, and the much more difficult business of finding suitable debaters and subjects—with, as a precondition of it all, the solution of the question of whether the broadcasters can afford the present heavy charges for two complete international music lines. Each country of course has its eminent men, but not all who are good exponents of their pet subject have sufficient linguistic ability to make an international debate a really telling and worthwhile programme item.

There is not sufficient space here to permit one's entering into the many other problems before the International Broadcasting Union. The broadcasting organisations members of the Union have given their pledge that they will do all within their power to ensure that the stations under their control are not used in a manner calculated to give offence to other nations. The pledge has been well kept, the accidental departures from the conditions of the pledge being few, when one takes into account the vast amount of material broadcast and the complexity of the international political situation. In recent years the Governments have become alive to the risks attending an indiscreet use of the microphone for political purposes, and the League of Nations has placed this question on its programme of studies. It is gratifying to note that the International Broadcasting Union, whose members alone possess the practical experience, is to be invited to collaborate in these studies. Some of the delegates to the Union's meetings have indeed.

already taken part, in a private capacity, in the preliminary study upon this delicate question, made in Paris for the League by the International Institute for Intellectual Co-operation.

The European Governments at Lucerne repeated the decision made at Prague in 1929 in nominating the International Broadcasting Union as their expert body for the study of broadcasting problems of an international and technical character. This procedure, it will be agreed, has much to commend it, for it places at the disposal of the State Administrations (who alone can take official decisions and initiate the inter-Governmental negotiations in the case of these decisions being violated), the experience of those who by their daily practice have become specialists in a new and unique form of "telecommunication"—to use the term coined at the Madrid Conference of 1932. An extension of this procedure to all phases of broadcasting where official studies may be considered to be necessary would appear helpful to effective action.

It must be a source of satisfaction, and some pride, to British listeners that the International Broadcasting Union has had as its President since its foundation one of the principals in the organisation of British broadcasting—Vice-Admiral Sir Charles Carpendale, Controller of the British Broadcasting Corporation. Sir Charles has presided to date at eighty-six Council meetings held in twelve different cities of Europe, besides attending other International Conferences as a representative of European broadcasting interests.

Reference was made earlier to the tendency to scoff at international organisations and international conferences. This is a habit not peculiar to any one people. In the opinion of one who has spent eight years at Geneva—the world centre of international activity—this scoffing is a mistake. There are in the world to-day, by reason of the complexity of modern life, a large variety of problems which can only be solved by study on an international basis. In the making of these studies no satisfactory results can be hoped for if the delegates to the study groups play only the part of a champion of their various national causes. Satisfactory solutions to the great international difficulties of the time can only be reached by a liberal application of the policy of "give and take." For each delegate to be able to contribute his share in such a policy he must have

behind him a public opinion equally agreeable to make reasonable concessions.

Fortunately in the field of broadcasting, the International Broadcasting Union—the study circle which has been the main subject of this present article—was formed shortly after the birth of European broadcasting, before the skein of problems had become hopelessly tangled. Nevertheless there is still much to be done in the solution of problems and the international development of broadcasting on the lines of public service. In the advancement of this work, well-informed and constructive criticism is as helpful, as the support of public opinion is necessary.

GENEVA : 1st July, 1933.

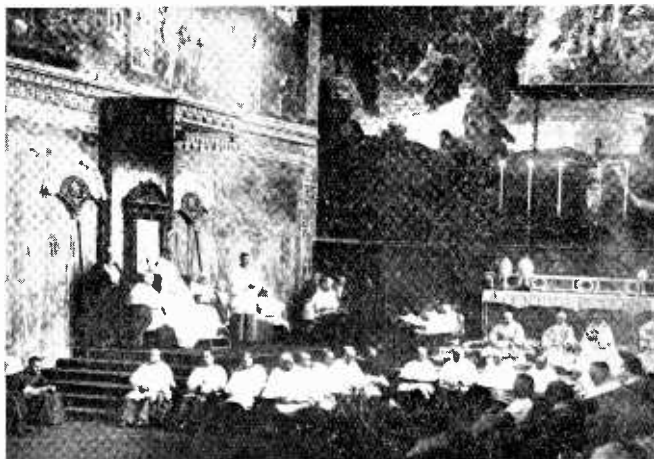

THE INAUGURATION OF THE HOLY YEAR FROM THE VATICAN, ROME
(April 1st, 1933)



HERR HITLER AT THE BERLIN RADIO EXHIBITION

THE RE-ORGANISATION OF GERMAN BROADCASTING

IN LESS THAN A YEAR German broadcasting has changed from an aggregation of privately-owned companies loosely bound to a point above, into a publicly-owned system of iron-bound centralisation, taking instructions from the Minister for Propaganda himself.

Like all brief statements of a complex situation, what has just been said invites contradiction and needs elaboration. There is the same number of regional broadcasting companies as before—now limited-liability companies in public hands—and there is the same central organism, the Reichsrundfunkgesellschaft—formerly a holding company exercising financial, technical, and administrative control, now the seat of irresistible authority and the source of ineluctable command. Ultimate technical control and transmitter-operation remain in the hands of the Post Office. The difference is simply that formerly the centre existed by virtue of the regions, while now the regions exist by mandate from the centre.

It was no secret that the Reichsrundfunkgesellschaft had for long hoped to see a firmer centralisation; but nothing very far-reaching had been achieved, because in spite of the practical advantages that might have been gained by the changes, the governing body of a regional broadcasting company (as they were then constituted) was too closely identified with the spirit of its province to submit to any important reduction of its freedom of action. The broadcasting system was in fact then, as it is now and was in the intermediate stages, an accurate enough parallel to the political organisation of the Reich. Then it exhibited all the weaknesses, and all the variety, of a federal structure with considerable provincial autonomy; now it reflects in some detail the political organisation of the Third Reich. The provinces—or, for our purpose, the regional companies—retain what they must retain: their own songs, their own passions, their own delights: those things that the psychology of the moment may colour, but that only the slow influence of generations can lastingly impair. But they have not retained the power—except in individual cases where power may be drawn from personal prestige—and the chief officer in

the regional company stands in something the same relation to the Director-General of the Reichsrundfunkgesellschaft as that in which the Statthalter of his province stands to the Chancellor of Germany.

The unfolding of the change began, from July 1932 on, with the achievement of increased centralisation and government control, obtained by the methods of elimination of private shareholders; appointment of a second Broadcasting Commissioner nominated by the Home Office in addition to the Commissioner nominated by the Post Office; open taking-over of programme control by the Reichsrundfunkgesellschaft; and the introduction of the principle that the senior officials must be acceptable to the government of the day (see Year-Book, 1933, pp. 315-16), with consequent changes in personnel (period of time corresponding to the Chancellorships of Herren von Papen and von Schleicher). New guiding lines for the conduct of broadcasting, drawn up by the Home Office, were published on November 17, 1932. Their tenor was conservative, but not undemocratic, and their weakness was the weakness of the government, *i.e.* that they desired much more of a reformation than they felt able openly to demand. Programme officials were left, in fact, with no more than a merely implied instruction to follow the spirit of the Deutsch-National party, and the effect on the programmes, particularly in Berlin, cannot be said to have been favourable; in fact, it was not long before the Commissioner of the Home Office was recalled. The most interesting points in the guiding lines, from the point of view of a comparison with the present régime, were the instructions to respect the opinions of others; to avoid hurtful or contemptuous remarks about other states and peoples; and the statement that broadcasting served no party, admitted no propaganda.

On the 30th of January, Herr Hitler became Chancellor, and the microphone was at his disposal. The governmental parties inevitably decided to make use of the means of propaganda as they lay ready to hand, and it was not until after their affirmation in power, at the March elections, that the rebuilding of the bases of broadcasting was begun, although very many changes in staff had already taken place. In the intervening period there was a spate of political oratory, that no doubt served its

purpose admirably, but that caused Dr. Goebbels to instruct programme directors after the election to refrain at once from overburdening the programmes with politics. Entertainment was to be the keynote, at least until the renovation of the system was complete; the new policy has now confirmed the high position of entertainment.

The first radical change was to form, in the Ministry of Propaganda, a broadcasting department, under Herr Horst Dressler-Andress, who was already head of the National Socialist party's radio section, an organisation that had existed for a number of years. On June 30th, the Commissionership (already reduced again to one) was abolished, and on July 8th Herr Eugen Hadamovsky, who had been for some months a senior official of the Reichsrundfunkgesellschaft, was appointed its General-Director, a new plenipotentiary position in which he controls the entire system, and is responsible only to the Ministry of Propaganda. Inevitably, the former directors of the company (and many others) were retired (under the new regulation permitting the dismissal of all public servants who were Jewish, alleged to be incompetent, or politically suspect). Their fate, so far as it is yet known, has been commented upon elsewhere.

Herr Hadamovsky's aims may be given in his own words: "My task . . . is to make of broadcasting a sharp and reliable weapon for the government." And, in another place: "I had incessantly and untiringly demanded that German broadcasting should be made the chief instrument of political propaganda. . . . I have always ridiculed . . . the old idea that there is such a thing as objectivity and neutrality *per se*." And at the opening of the Berlin Wireless Exhibition on 18th August: "All that happens in and through broadcasting to-day happens in order to create so broad a basis for National Socialism among the people that one day the entire nation will be drenched through and through with our philosophy, that one day it will be a thing taken for granted and an intimate need felt by every German to confess National Socialism."

The chief means taken so far to make a bridge from aspiration to achievement has been the compulsory formation, announced on 3rd July, of a Chamber of Broadcasting, in which are united the broadcasters, the industry, the trade (wholesale

and retail), the press, and the organised listeners, with other bodies, and which has come to be known in this country as the Unit. It was before the Unit that instructions were given to the industry to produce "the people's set," a two-valve receiver now on sale at about 76 marks; but this set will be the greatest concrete weapon in the Unit's propaganda campaigns: for very highly-organised propaganda is, of course, the purpose of the Unit, which is under Dr. Goebbels; the explicit intention is to "put a set into every house." The Unit will create for listeners in every urban and rural district advisory centres, which will be closely in touch on the one hand with the political organisation, on the other with the local broadcasting company. They will set out to gain new listeners, as well as to assist old ones. As ammunition they will have (1) printed material, officially prepared and distributed weekly to 2,000 journals; (2) *Funk und Bewegung*, the official (political and technical) journal of the Chamber, of which a million copies were printed in Exhibition week; (3) placards posted in every town and village in the land; (4) illustrated pamphlets, of which 20 million will be distributed from house to house; and (5) propaganda motor-vehicles with loudspeaker, such as have been in use for some time; but now there will be one to each region, working in collaboration with the local advisory centre. These efforts will cost large sums of money. The money is to come from the Community Propaganda Fund. What proportion may be drawn by this fund from licence revenue we do not know—the licence still costs 24 marks a year—but it is obvious that the propaganda can only flourish if the programmes are worth listening to: a set in every house is no good to the government if it remains dumb. Programme policy, of which it is too early to judge, will therefore be followed with much attention—no doubt in the first place by German listeners, but scarcely less closely by others, for the question of the rôle of broadcasting organisations in relation to society relations has become increasingly important in the last few years.

BROADCASTING AND ANGLO-AMERICAN RELATIONS

By CÉSAR SAERCHINGER

European Director of the Columbia Broadcasting System, U.S.A.

MORE THAN any other invention of recent times, broadcasting has, for better or for worse, brought the peoples close to one another. Telegraphy and telephony, it is true, had already established instant international communication; but only a fraction of the public was directly affected by it, and then chiefly for utilitarian ends. These great inventions made it possible for individuals in different countries to communicate with each other for specific purposes; broadcasting has made it possible for "nation to speak unto nation," and to listen to each other for no reason except curiosity or pleasure. Curiosity leads to information and understanding; pleasure leads to friendship and sympathy.

I have said that the nations have been brought close to each other "for better or for worse," because understanding and sympathy have not been the only result of international listening. We need only point to recent events between Austria and Germany, to see how their opposites—confusion and enmity—can be caused by broadcasting between two neighbouring states. But the broadcasting of the Munich and other stations which so disturbed the Austrian Government was done for a specific political purpose; it was aggressive in intent, and the case merely shows what can happen when an essentially international instrument is used for nationalistic ends. I do not think there are many cases on record in which normal broadcasting, *i.e.* broadcasting for the dissemination of information and entertainment, has led to international misunderstanding. Yet there is no doubt that the problem of international broadcasting can be aggravated by irresponsible and arbitrary control; and it may well be that in time some sort of "moral disarmament" will become necessary in order to restrain militant elements in Europe from spreading seeds of discord through the abuse of a medium whose potentialities are essentially pacific.

But there is one sphere in which this problem is not likely to arise, and that is the sphere of transatlantic broadcasting.

Technical limitations thus far have made indiscriminate listening between the two continents—transatlantic eavesdropping, as it were—a fortuitous and difficult proceeding. Short-wave “fans” in Great Britain and America do hear each other’s broadcasters at favourable times, but the feat itself is still the important thing, rather than the subject-matter of the broadcast.

This sporadic listening has, however, been supplemented by a purposeful and, on the whole, beneficial exchange between the two countries by means of relays engineered by the responsible broadcasting authorities on either side of the Atlantic, and during the past three years this “planned” inter-continental broadcasting has become an increasingly important programme feature in Great Britain and the United States.

It is perhaps too early at this stage to estimate the result of this exchange; but I venture to say that its effect on Anglo-American relations has not in any instance been bad, and that as a whole its influence has been for the good. It lies in the nature of the Anglo-Saxon mentality, and the Anglo-Saxon genius for tolerance to accept the other fellow’s point of view for what it is worth. We may not agree, but we are brought up to the democratic ideal that other people have a right to their opinions, ideals, and tastes; and we do make an effort to understand them. History has played many bad pranks, but it builded wisely when it united the world’s two greatest peoples in a common bond of language and habit of thought. For to-day, thanks to the wireless, we are able to strengthen this bond, loosened through centuries of physical separation, by a direct and constant communication of each other’s thoughts.

Consider the millions of Britons who listened to President Roosevelt’s inaugural address last March. Is it possible that their sympathies were not touched by the power and sincerity of this utterance? For the time being the problems of America became their problems; never again could the serious listener to this solemn pronouncement think lightly of the economic struggles of their fellow-men across the seas; every item of news about the President’s efforts for recovery must by such a listener be read and understood in the light of that personal appeal. It has been the same with British speeches heard in America: the King’s opening of the Round Table Conference; Mr. Ramsay MacDonald’s speech on the London Naval Treaty; Lord

Cecil's pleas for disarmament ; the Prince of Wales' appeal for the League of Nations Union, and many more. Millions of Americans have heard these speeches. Millions more have heard, Sunday after Sunday, talks by eminent British men and women on the great problems of the day from the British point of view, and thus have learned to sympathise with and understand that point of view.

These especially organised transatlantic talks have become a regular part of American and, to a lesser extent, of English broadcast fare. It is natural that this should be so, because Americans, having their ancestral roots in Europe, still look eastward for spiritual guidance in a greater degree than the English look westward. By means of B.B.C. relays and these special talks, American listeners have in the past three years become familiar with the voices of the outstanding personalities in English literature, science, politics, economics, and the Church. H. G. Wells, G. B. Shaw, John Masefield, Rudyard Kipling, Hugh Walpole, J. B. Priestley, are no longer mere names on title-pages, remote celebrities living in a strange, semi-mythical land, but fellow-beings who have, in a sense, entered the listener's own home. The Archbishop of York and the Bishop of London have preached to vast American congregations, the services of English churches have been "attended" by millions of American listeners. British scientists like Lord Rutherford, Sir Arthur Eddington, Sir Oliver Lodge, and Julian Huxley have spoken to the American audience on their special subjects ; British physicians like Lord Moyrihan and Sir Arbuthnot Lane have spoken on health ; English economists and sociologists have told Americans how problems which are common to both communities are being tackled over here.

Best of all, perhaps, English statesmen have spoken with sympathy about great figures in American history. For when a man like the late Lord Grey of Fallodon, paying a sincere and eloquent tribute to George Washington, is reverently listened to by Washington's countrymen, it becomes evident how old prejudices evaporate and how the two peoples are being drawn together in a common worship of racial heroes. Shakespeare's birthday, Defoe's and Faraday's centenaries, and a number of similar occasions have been celebrated simultaneously on both sides of the ocean, bridged by the unseen bond of the wireless.

A further step in the direction of closer intellectual relationship has been taken by the experiment of transatlantic debates. The Keynes-Lippmann debate before the opening of the Economic Conference, the debates between students of the Universities of Oxford and Columbia, and between Cambridge and Yale, have opened up a vista of a future exchange of ideas between the youth of the two countries which may one day play an important part in Anglo-American relations. And speaking of youth, American schools have listened to special programmes from England—a talk on the English Constitution by Commander King-Hall, a programme of English folk-music—which represent merely a beginning of what may one day be done in the way of international broadcast education.

Another type of relay which emphasises one common historic heritage is that of traditional ceremonies and customs, such as the Ceremony of the Keys at the Tower of London, and the Dunmow Flich Trial, as well as the broadcasting of great sporting events. For three consecutive years now, America has listened to commentaries on the Derby, the Grand National, and the Oxford and Cambridge boat race. These events arouse almost as much interest and excitement in the United States as they do in England; and in return, England is beginning to take a similar interest in the Kentucky Derby and the American baseball championship. Next year millions of Britons and Americans may “attend” together the challenge round of the Davis Cup tennis match at Wimbledon, and there is no doubt in my mind that the cheers engendered by sportsmanship and enthusiasm cause a thrill that goes to the very heart of international comradeship.

We have only scratched the surface of this vast field of Anglo-American sentiment; but we know that it is a field worth cultivating. However they may differ, England and America have in common the ideal of democracy and individual liberty. Transatlantic broadcasting has done its share in convincing both peoples of their ardent attachment to civilisation and peace. In the difficult times that lie ahead, this common faith will stand in constant need of reaffirmation, and here too broadcasting will continue to do its part.

BROADCASTING THE PRESIDENTIAL INAUGURATION

By RICHARD CHAPLIN

National Broadcasting Company, U.S.A.

ONE OF THE LARGEST CROWDS ever assembled in the American capital gathered in Washington on March 4th in the blast of an early March wind to witness the inauguration of Franklin Delano Roosevelt as President of the United States. And yet, through the wonders of radio, millions of listeners in all parts of the world knew more about the details of the proceedings than they. In fact, since the broadcast arrangements were more elaborate than any previously attempted, and since the event itself was of such world-wide interest that everyone listened who possibly could, Mr. Roosevelt probably was heard by more citizens of the world than ever before had focussed their attention on a single speaker.

It goes without saying that the broadcasting "chains" in the United States spared no effort to render the ceremonies as effectively as possible to their own nation-wide audiences. Here we are more concerned with how the rest of the world was able to listen. The British Broadcasting Corporation, the Reichsrundfunkgesellschaft, and certain French and Dutch stations picked up the programme for relay by means of the transatlantic circuits.

In addition, short-wave broadcasting transmitters associated with the National Broadcasting Company radiated the ceremonies to the far corners of the world for the benefit of direct short-wave listeners and for broadcasting stations not in touch with the point-to-point links.

The following is a brief description of the operations from the point of view of one of the American systems, namely, that of the National Broadcasting Company.

From 9.30 a.m. until late into the night N.B.C. microphones on the streets, in buildings, in airplanes, and strapped to the chests of announcers equipped with portable "pack-set" transmitters, sent out to the world the atmosphere and "colour" of the occasion. As the crowds surged through the Capitol corridors, pack-sets picked up the story of the scene. As Army, Navy



THE INAUGURATION OF FRANKLIN ROOSEVELT AS PRESIDENT OF T



Wide World

UNITED STATES OF AMERICA AT WASHINGTON ON MARCH 4TH, 1933

and Marine bands paraded through the streets their music flashed around the globe. Every move of the retiring President and the President-elect was made known to millions.

The broadcast really signalled the beginning of a new era in radio reporting. Through the use of half a dozen short-wave mobile transmitters, a picture was "put on the air" which could not have been equalled with a hundred stationary microphone positions. Mr. Roosevelt was never more than a few feet from a microphone. Listeners followed his movements closely, while the crowds which had journeyed to Washington struggled for an occasional glimpse.

The success of these arrangements has been attested by listeners in England, Ireland, Scotland, France, Germany, Norway, Poland, Australia, and South America, to mention only a few.

During the day the point of origin of the continuous broadcast was shifted thirty-eight times, back and forth among the various mobile units on the ground and in the air, and the stationary microphone positions where the formal addresses were delivered. The intricate arrangements and careful planning necessary to conduct such a broadcast without a single slip may well be imagined.

The various mobile units operated on short-waves to a central control board where they were cleared through to the networks. In addition all the mobile units and the control board were connected by a separate "cuc channel" through which "control" could issue instructions to the numerous announcers scattered all about Washington and flying over the city. Also, through this supplementary channel each commentator could communicate with all concerned without being heard by the public.

A brief excerpt from the log of the broadcast gives an idea of the rapidity of the switches from one point to another :

10.03—White House Grounds, Graham McNamee

10.07—Airplane, Frank Singiser

10.11—White House Grounds again

10.13—Reviewing Stand, Floyd Gibbons

10.15—Airplane again

10.24—Capitol Dome, William Hard

- 10.49—White House Grounds again
10.51—Capitol Steps, Anne Hard
11.02—Senate Chamber, David Lawrence.

And so the broadcast continued through the inauguration of the Vice-President, the adjournment of the new Senate, the inauguration of the President and his address, the departure of ex-President Hoover, the inaugural parade and the other events of the crowded day.

The broadcast director at the control board might be likened to an editor. As the editor receives his news and determines what is of sufficient importance and interest to print, so the broadcast director constantly received reports by short-waves and put on to the transmission system the announcer who had the most interesting and important story to tell at any given moment.

Thus, as shown in the log, McNamee at the White House had something of interest to tell listeners at 10.03. It required four minutes. Then Singiser, flying over the city, reported something unusual, and he was immediately put on to the network. At 10.11, however, McNamee apparently told "control" that something new had happened at the White House, and he was given the networks again.

Thirty-two engineers were required to handle the complicated control board and the receivers and transmitters in the field. More than a dozen announcers and an equal number of observers co-operated in the broadcast. Yet through the control system there was not a single faulty switch and the broadcast moved smoothly along without a break.

The broadcast conclusively proved the value of portable short-wave transmitters in reporting events as they occur. It demonstrated their reliability under trying conditions. The words from the White House were carried by short-wave from a little pack transmitter no larger than a typewriter to the control board in Washington; thence by wire to main control in New York; from there again by wire to the networks and the powerful short-wavers, and from these to networks and receivers all over the world. Yet through all these radio and wire relays the voice held its quality and its clarity.

RELAYS FROM AND TO AMERICA, 1933

FROM AMERICA

- 28th Jan. † "Hello, Fleet Street."
 11th Feb. * Debate between Yale and Cambridge.
 4th Mar. * The American Presidential Inauguration.
 8th Apr. † Debate between Oxford and Columbia.
 6th May * Commentary on the Kentucky Derby.
 11th June * Transatlantic conversation on the eve of the World Economic Conference between Mr. Lippman and Mr. Keynes.
 4th July * Mr. John Erskine on Independence Day.
 3rd & 5th Sept. * Commentary on Harmsworth Trophy.
 13th Oct. * First of a series of talks by Mr. S. P. B. Mais entitled "The Modern Columbus."

TO AMERICA

(Over and above these, facilities were provided for numerous regular talks by the National Broadcasting Company and by the Columbia Broadcasting System, not broadcast in this country, but telephoned to America. This activity was specially intense during the World Economic Conference.)

- 4th Jan. † Discussion between Sir Josiah Stamp and Mr. J. Maynard Keynes.
 25th Feb. † Discussion between Miss Bondfield and Mr. Priestley.
 24th Mar. *† Commentary on the Grand National.
 1st Apr. † Running commentary on the Boat Race.
 24th Apr. † Mr. Churchill's speech at Royal Society of St. George Banquet.
 29th Apr. * Commentary on Cup Final at Wembley.
 5th May *† Prime Minister's Speech on his American Visit.
 24th May † Empire Day Programme.
 10th June † The Aldershot Tattoo.
 12th June *† Proceedings of Opening of the World Economic Conference.
 17th July * Speech by Mr. Lloyd George.
 25th July † "America Calling."
 27th July *† Prime Minister's speech on close of the World Economic Conference.
 7th Aug. * Dunmow Fitch Trial.
 28th Aug. * Mr. Ruttledge on Mt. Everest Expedition.
 7th Sept. *† Mr. Whitley's Appreciation of Lord Grey.

* From or to National Broadcasting Company.
 † From or to Columbia Broadcasting System.

TECHNICAL SECTION

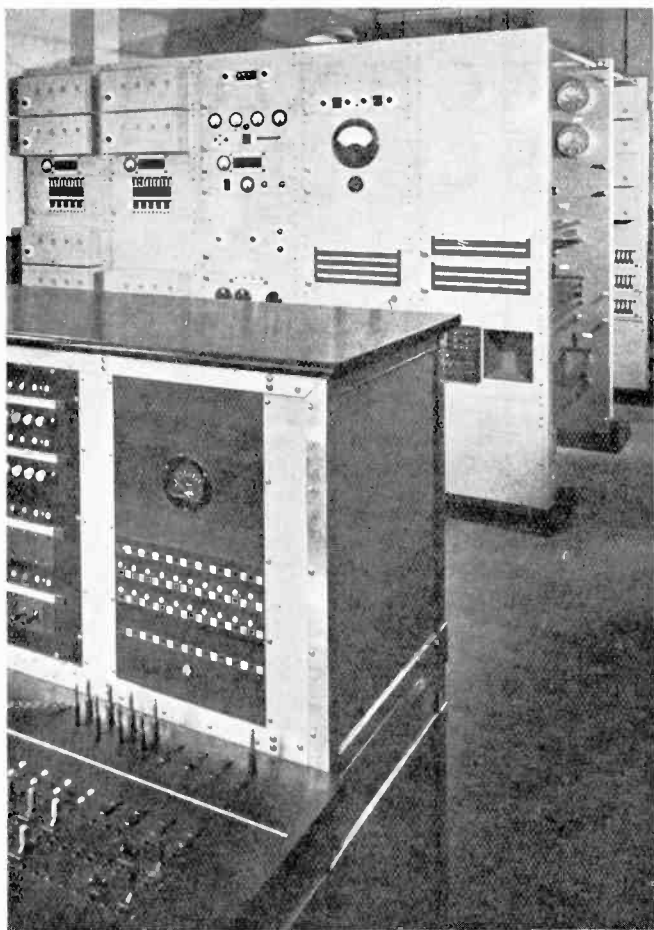

SWITCHING POSITION AND AMPLIFIER RACKS IN THE NEW CONTROL ROOM AT CARDIFF

NOTES OF THE YEAR

THE GREAT EVENT during the past year has been the inauguration of the Empire Service. It was in November 1931 that the B.B.C. decided to build a station devoted entirely to the broadcasting of programmes intended for direct reception by Empire listeners. By November 1932 this station had begun testing, and on December 19th, 1932, the first regular programme transmission took place. Some details of the results obtained appear elsewhere in this book, and it is only necessary to say here that although there are certain districts which the service has not succeeded in reaching satisfactorily, on the whole it has been well received overseas.

However, the station was designed on as flexible a basis as possible from the technical point of view, and it was never intended that it should remain unaltered for very long. Experiments are in progress with new types of aerials, and research will proceed along these lines until it is clear that nothing further can be done on this section of the station; after that the possibilities of transmitters of much higher power may be considered. For various technical reasons, however, high power is not generally used for short-wave transmitters, partly owing to technical difficulties of design and partly because, if the conditions are right, good communication can be obtained by the use of medium power.

A great deal of interesting information has already been gleaned from about 10,000 communications, including cables and completed questionnaire forms, which have been received from listeners overseas. The latter in particular give a great deal of interesting information as to the type of short-wave receiver which is in general use in the distant parts of the empire. In the large majority of cases these are of a comparatively simple type, with not more than one stage of high-frequency magnification. From one point of view this fact can be looked upon with considerable satisfaction, because it means that when listeners are able to provide themselves with better receivers the service will be of a vastly greater value. This is quite apart from improvements which it is confidently hoped will be effected at the transmitting station.

* * *

In the last Year-Book it was stated that a meeting of the International Telecommunications Conference was held in Madrid in September 1932. This conference lasted until December 9th, 1932, and one of its features was a long-drawn-out struggle between the interests of broadcasting and those of other services having claims to the use of the ether. The result might almost be called a draw; in fact, since the conference lasted over three months it was almost a draw on account of time! At any rate there is no doubt that the decisions were somewhat in the nature of a compromise, as was, of course, inevitable.

Another conference of Government representatives from thirty-five European countries was held at Lucerne in May and June 1933. Put briefly, the object of this conference was to fill in the details on the wavelength allocation chart for wavelengths between 200 and 2,000 metres, which includes all the wavelengths used for National broadcast services. It must be understood, however, that this conference only applied to Europe. A plan (see p. 323) was produced and agreed by a large majority of the representatives present, and although there were some non-signatories, it can be looked upon as an achievement to have secured even so large a measure of agreement.

* * *

Turning to home matters, the most important engineering work from the constructional point of view is the building of the new long-wave Transmitting Station, three miles north-east of Droitwich. This station will replace Daventry 5XX and the Midland Regional Transmitter (Daventry 5GB). The former will use a power of 150 kW, while the latter will use some 50 kW. Further details of this station are given on p. 319. The summer of 1934 should see the closing down of Daventry 5XX, but the Daventry site will continue to be used for the Empire Station, and any extensions to it which may be undertaken.

For several years Daventry 5XX was perhaps the most famous station in Europe. It was the first broadcasting station giving a regular programme service to use a long wave, and what in 1925 was called high power, though in these days its 30 kW only entitle it to be classed as a medium-

power station. Nevertheless, by the time it has closed down it will have provided a service potentially to the greater part of the British Isles for nearly nine years. Droitwich will take its place, and give a similar, but it is hoped far better, service, both from the point of view of strength and quality. The other transmitter at Daventry which will be replaced by a more up-to-date one at Droitwich has been familiarly known as 5GB, instead of the more dignified title of Midland Regional Transmitter. The reason for this is that it began life as an experimental transmitter, erected with the object of deciding on a standard design for the transmitters of the Regional Scheme. This experimental transmitter is very crude in appearance, but it has formed the basis of a design for eight other transmitters which have now taken their places in the regular service. These are at the London, North, Scottish and West Regional Stations.

At Droitwich the long-wave transmitter will use a circuit incorporating series modulation, which has not so far been used by the B.B.C. The masts will be higher than those which have been used so far, namely, 700 feet. The new Midland Regional Transmitter, however, will be on the standard lines used for the other regional transmitters.

* * *

Washford Cross, the fourth of the "twin" transmitter stations, began tests for the public on April 24th, 1933. It is the last of this type of station which had as its main object the giving of two programmes of sensibly equal strength. This station is particularly interesting technically because its National transmitter shares a wavelength with the National transmitter at the London Station. It is now well known that when two stations are working on the same wavelength it is practically essential, unless they are separated by several thousand miles, to radiate the same programme from both, at least during the hours of darkness. In this case, however, such an arrangement is quite convenient, because the two transmitters will radiate at all times the National programme.

Very elaborate synchronising apparatus has been used for these two transmitters. Each station has its own tuning-fork, from the oscillations of which is derived the high frequency which drives the transmitter. The accuracy with which they are working is, on an average, about one part in a million, but

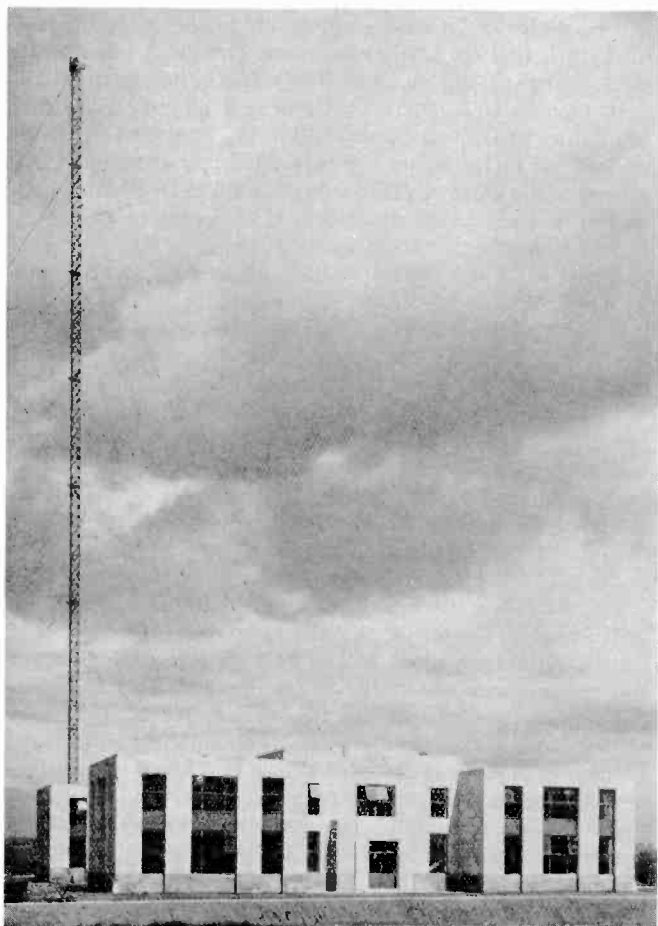

THE WEST REGIONAL STATION AT WASHFORD CROSS

for long periods the beat between the two stations is not more than one in five seconds, which corresponds to an accuracy of very roughly one part in six million. With an accuracy of this order satisfactory reception is possible when the ratio between the signal strengths of the wanted and unwanted stations is of the order of 3 : 1, a state of affairs which in practice only limits the range of the station by a small amount, except on the comparatively rare occasions when the indirect ray is considerably greater than normal. Were the stations to transmit a different programme the ratio would have to be between 100 and 200 : 1. This, of course, prevents stations in the same country sharing a wavelength if they remain independent with regard to programmes. Sharing can, however, be arranged between stations radiating different programmes when they are separated by distances of the order of 1,500—2,000 miles.

* * *

In October a site was acquired for a high-power station to serve Northern Ireland. This site is two miles from Lisburn, and has been chosen after very thorough tests of a number of alternative sites. Northern Ireland is difficult to serve, owing to the mountainous nature of the country to the west of Belfast. For this reason the site cannot be quite central and the selection becomes a question of finding a position where the best service can be given to the population as a whole. This station will contain a single transmitter, which will give the Northern Ireland Regional programme, and the transmitter itself will be similar to those in use at the other high-power regional stations. When the new long wavelength station at Droitwich is completed a good alternative programme service will be available in Northern Ireland, the National programme being received on the long wave. Further information concerning the Northern Ireland Station is given on page 339.

* * *

There has been a great deal of activity during the past year in connection with the rebuilding of studios in provincial cities. At Leeds entirely new premises have been rebuilt and adapted to provide one large music studio and a smaller studio for talks. These studios have been designed on similar lines to those at Broadcasting House, and Leeds will therefore be able to

provide at least as good quality at the source as London. Leeds Broadcasting House is also an amplifying and relaying centre for the trunk lines passing north to Newcastle and Scotland. Completely new apparatus has been installed for this purpose as well as for controlling the studios. From the technical point of view, therefore, Leeds forms an important centre in the B.B.C. system.

The studios at Birmingham have been completely remodelled and a new large studio has been built, so that Birmingham also will be in a position to give as good a programme as any other centre in the system. Completely new control and amplifying apparatus has been installed on similar, but naturally somewhat less extensive, lines to that at Broadcasting House. At Bristol entirely new premises have been taken in order to enable programmes to be given by West-country artists, and three studios have been provided. Bristol also performs a similar function to Leeds in connection with the trunk line circuits; thus, in addition to up-to-date control apparatus for the studios, there is the necessary switching and amplifying apparatus for lines passing to Cardiff, Plymouth and the West Regional Station at Washford Cross. Further information is given elsewhere in the book.

* * *

Research has been carried on during the past year in practically all branches of broadcast engineering work. Naturally, short-wave work has received particular attention, both on the transmitting side and on the receiving side. So far as transmitting is concerned, attention has been paid particularly to the many special forms of aerial which are available for use. These researches will be considerably extended when further accommodation and space is available at Daventry as a result of the closing down of 5XX and 5GB on the completion of the new Droitwich Station. A great deal of experimental work has also been carried on at Tatsfield, the receiving post in Surrey. A new receiver suitable for relaying programmes from distant short-wave stations has been developed.

Research on studio acoustics is carried on continuously, since every new building which has to be adapted for studio purposes presents its own special problems, both from the point of view of obtaining the right acoustics and providing the necessary

sound insulation between different studios, and between the studios and other sources of noise, such as traffic.

* * *

For some years past experimental work has been going on with 30-line television transmitted by our ordinary transmitters, but a somewhat different line of research is now being undertaken, namely, television of the high definition type, which cannot be transmitted on the ordinary wavelengths owing to the width of side-band which is necessary. These experiments are being conducted on ultra-short wavelengths by means of a special transmitter erected on the roof of Broadcasting House. This transmitter is capable of transmitting side-bands having a width of 500 kc/s on either side of the carrier wave.

* * *

The breakdown record for all the stations included in the B.B.C. system is still satisfactory, the total breakdown for all stations for 1932 being 17 hours 6 minutes, which is equivalent to an average of 57 minutes per transmitter. In these days the breakdown time consists largely of the time necessary to replace valves, in cases where it is not possible to switch in a spare valve without closing down.

* * *

In June 1933 the Institution of Electrical Engineers formed a committee composed of representatives from all interests concerned, to combat electrical interference with broadcast reception. This committee is now engaged in a thorough examination of all aspects of the problem, and various sub-committees have been formed to examine the problem as applied to the various classes of interference-causing apparatus.

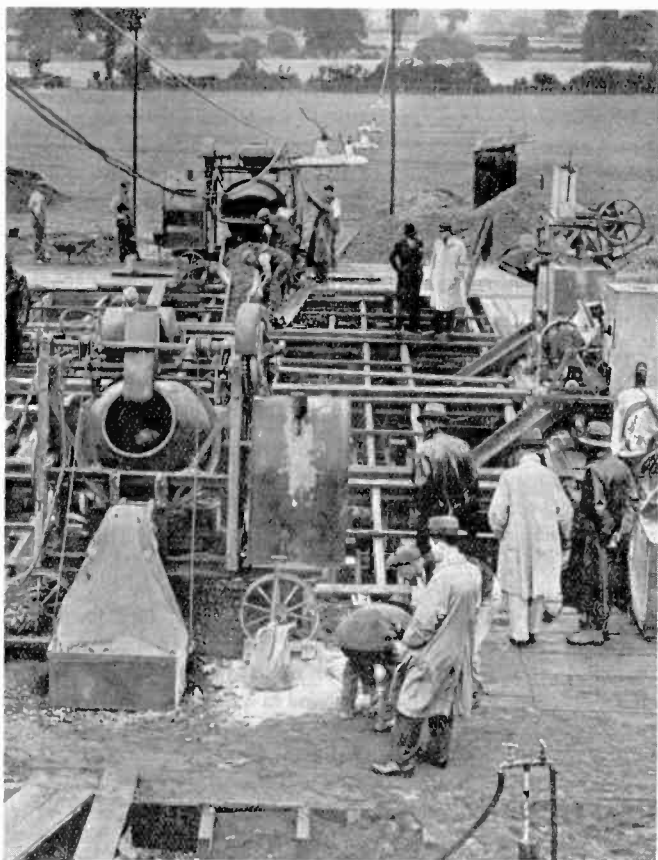

POURING 900 TONS OF CONCRETE TO FORM A MONOLITH BLOCK FOR
THE FOUNDATION FOR THE DIESEL ENGINES AT THE NEW DROITWICH
STATION

THE NEW DROITWICH STATION

THE ADVISABILITY of using so-called "long waves" for broadcasting came under serious consideration in the year 1923—in fact, as soon as broadcasting was started on an organised basis in this country. In those days the service was being given on "medium" wavelengths and by stations of about 1 kW power or less. These stations were, of course, located in big cities, and they gave an excellent service up to a range of about twenty miles. The more remote country districts and a very large number of towns, particularly those on the coast, remained more or less ill-served and it was fairly obvious that apart from wavelength difficulties, expense would prevent the erection of the very large number of stations necessary to cover the whole country. A station working on comparatively high power, and using a wavelength between 1,000 and 2,000 metres, therefore, seemed to offer a solution to the problem, since it was well known that the attenuation on long waves was very much less than on medium waves. Even before those days there was some broadcasting in Europe on long waves, notably by the Eiffel Tower and by a station in Holland. However, before embarking on the construction of a high-power station to work on a wavelength of this order, it was considered necessary to carry out tests to ascertain what range could be expected and whether any unforeseen difficulties would arise. It was particularly important to be cautious in this respect owing to the fact that considerable change in design for all broadcasting receivers would be required if they were to receive the new station.

Accordingly, in 1924 an experimental station was erected at Chelmsford, and since this gave distinctly promising results, it was soon incorporated in the regular service. At the same time, however, a site for a permanent station was selected at Daventry and constructional work was begun on the now well-known "5XX." This station originally began work with a power of 25 kW in the aerial, which was afterwards slightly increased to 30 kW, and its success from the point of view of increasing the audiences was most marked. 5XX was opened in July 1925, and it has therefore been in operation for eight-and-a-half years.

However, for some time past it has been realised that the station would have to be rebuilt in order to give a stronger

service to all those parts of the country not served by one or other of the regional stations. Before permission could be obtained to put this into effect, it was necessary to obtain approval from several government departments, through the General Post Office. Naturally there were certain difficulties in this connection, owing to the fact that a large high-power station in the middle of England is capable of causing interference to other services which use waves not far removed from that of 5XX. Eventually, however, permission was obtained to begin the construction of the new station with a power in the aerial of 150 kW, but it was stipulated that the station should not be built at Daventry but should be moved further west. This, however, did not offer serious disadvantages from the point of view of the service as a whole, and consequently a search for a site was begun in the neighbourhood of Birmingham. Eventually after thorough tests a site was chosen three miles north-east of Droitwich, on the Droitwich-Birmingham road.

As already stated, the new station will provide a far more robust service to all those listeners now in the habit of receiving the present 5XX, but there will be other advantages in addition. The present station does not transmit with as high a degree of quality as the other regional stations. There are, in fact, certain special difficulties in connection with quality when using a long wavelength, and a cut-off of the higher frequencies may arise from the design of the aerial which has nothing to do with the low-frequency circuits of the transmitter. This, however, will be rectified in the new long-wave station at Droitwich, so that listeners may look forward not only to better strength, which means less interference, but, in addition, better quality or, in other words, quality which is comparable with that of our existing modern stations.

There is another transmitter which will also move to Droitwich some months after the new long-wave transmitter has been put into operation. This, of course, is the Midland Regional Transmitter, frequently known as 5GB, which has also been at Daventry hitherto. Originally this transmitter was built in order to carry out experiments which would lead to the adoption of a design for all the new regional stations, such as Brookmans Park, Moorside Edge, etc. After this purpose had been fulfilled the transmitter, still in its experimental form, was used

A national work worthy of National Support.

360 crippled children from all parts of the country are given every chance of becoming physically normal citizens.

50 crippled lads in the College are being trained to enable them to earn a living.

This is the National work which is being carried out at Lord Mayor Treloar Cripples Hospital and College. The Institution is dependent on voluntary contributions. No matter if you can afford only a little; remember the widow's mite, and the urgent need of these children.

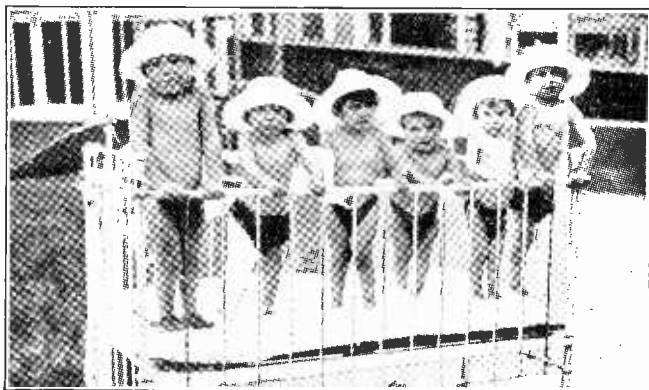

LORD MAYOR TRELOAR CRIPPLES HOSPITAL AND COLLEGE

ALTON and HAYLING ISLAND

TRUSTEES :

The Rt. Hon. and Rt. Rev. The Lord Bishop of London, D.D., K.C.V.O.
Miss Florence Treloar.

The Rt. Hon. The Lord Mayor of London.
Lt.-Col. The Hon. Frederick Lawson, D.S.O., M.C.
T. J. Harrowing, Esq., C.C. (*Treasurer*).

Secretary : H. B. Harper, J.P.

Communications to : 25 ELY PLACE, LONDON, E.C.1.



DROITWICH STATION UNDER CONSTRUCTION

to supply the regional programme to the Midland Region. It works at present on a power of 25 kW, about half of that used by other regional stations. A further point is that Daventry, being some thirty-eight miles from Birmingham, is not regarded as an ideal situation for a regional transmitter using a medium wave, in relation to the centre of density of the population of the region which it serves. From this point of view, therefore, the move to the new site at Droitwich will be a distinct advantage. The new 5GB, or, as it should be called, the Midland Regional transmitter, will be of exactly the same type as the transmitters at Brookmans Park, Moorside Edge, Westerglen and Washford Cross, and will employ a power of approximately 50 kW in the aerial. The distance between the new site and Birmingham is approximately sixteen miles, almost exactly the same distance as that between Brookmans Park and London.

Reverting to the new long-wave transmitter, it is probable that this station will affect the method of supplying the National programme to areas at present receiving it from other transmitters, but at the time of writing it is too early to make a detailed statement in this connection.

THE NEW WAVELENGTH PLAN

FOR THE SAKE OF REFERENCE the complete Lucerne Plan, with its provisions in connection with the power of stations and the maintenance of constant frequency, is printed in the Appendix Section of this Year-Book.

If this Plan is compared with the Prague Plan, which it is due to replace on January 15th, 1934, it will be found that there are many important differences, and that the technical conditions in the two cases are by no means the same. It is important, therefore, to consider what advantages and disadvantages are likely to arise from the new Plan, assuming, of course, that it is put in force as it now stands on paper.

The benefits to be derived must be looked upon from the point of view of European broadcasting in general and not from the view-point of any one particular country, because in some cases countries will gain from the application of the new Plan, while in others they will lose. It might be asked, why should this be so, and should not every country lose or gain equally? The answer to this is that those countries which started broadcasting, say, ten years ago, have naturally established themselves from the wavelength point of view, whereas others who are broadcasting still on a comparatively limited basis now wish to set up national systems to which it is argued they have a right, and for which they are demanding additional wavelength channels. Consequently the countries which have been broadcasting on a national basis for many years have in general been obliged to agree to some sacrifice, whereas countries less advanced in this respect have gained or been given facilities which are more suitable to their needs.

It is necessary, however, to emphasise that the most important thing for European broadcasting is to have an established plan, agreed by all countries, not only with regard to their broadcasting services but also with regard to the other services which have to work on the neighbouring wavelengths—in some cases they have actually to share wavelengths. It is now well known, of course, that all nations did not sign the Plan. There were actually 27 countries signing and 8 countries who abstained from signing. In order to get even this measure of agreement, it was necessary somehow or other to find channels for more



DR. BARNARDO'S HOMES:

NATIONAL INCORPORATED ASSOCIATION

Charter:

"No Destitute Child Ever Refused Admission."

**No Voting System.
No red tape.**

**The need of the child is
the only consideration.**

On an average 5 children are added to this Family every day, which is the Largest Family in the World.

The children are rescued from unfavourable surroundings, given a new environment, trained and placed out in life as useful and self-supporting citizens.

114,500 children admitted. 16,628 children and young people dealt with last year.

8,400 always being supported.

1,319 are babies and toddlers under 5.

447 are crippled or afflicted.

1,124 are under industrial training.

30,509 have been migrated to the Overseas Dominions.

Will you help Barnardo's in their work for the Nation?

Please send **2/6** for the Children's Food.

**³ Cheques and Orders payable "DR. BARNARDO'S HOMES" and crossed, may be sent to DR. BARNARDO'S HOMES, 297 BARNARDO HOUSE, STEPNEY CAUSEWAY, LONDON, E.1*

IMPERIAL CANCER RESEARCH FUND

Patron—HIS MOST GRACIOUS MAJESTY THE KING.

President—HIS GRACE THE DUKE OF BEDFORD, K.G.

Chairman of the Executive Committee—SIR HUMPHRY ROLLESTON,
Bt., G.C.V.O., K.C.B.

Honorary Treasurer—SIR HOLBURT WARING, C.B.E., P.R.C.S.

Director—Dr. J. A. MURRAY, F.R.S.

The Honorary Treasurer desires to thank those who have hitherto supported this Fund by their donations and subscriptions.

The object of the Research is for the good not only of the whole British Empire but of the whole world.

The Imperial Cancer Research Fund is working unceasingly in the cause of suffering humanity. Cancer is now one of the most important causes of death, and the suffering it entails in its protracted course makes the call urgent for improved methods of diagnosis and treatment, and in research work alone lies the one hope of checking its malevolent power. Radium treatment has been proved effective in some incipient cases and in cases near the surface of the body, but cancer when deep-rooted still presents a serious problem.

Donations and Subscriptions may be sent to the Honorary Treasurer, Examination Hall, 2-11, Queen Square, London, W.C.1, or may be paid to the Westminster Bank, Ltd., Marylebone Branch, 1, Stratford Place, London, W.1. A/c Imperial Cancer Research Fund.

FORM OF BEQUEST.

I hereby bequeath the sum of £ _____ to the Treasurer of the Imperial Cancer Research Fund under the direction of the Royal College of Physicians of London and the Royal College of Surgeons of England for the purpose of Scientific Research, and I direct that his receipt shall be a good discharge for such legacy.

stations, and we find that the new Plan provides for 232 stations, while the Prague Plan provided for 200. The most important difference, however, is in connection with the power of the stations provided for. The total power under the Prague Plan was approximately 420 kW, whereas the Lucerne Plan provides for stations having an initial total power of nearly 4,000 kW, and in addition provision is made for a number of stations not yet completed. Some extra channels have, of course, become available as a result of the Madrid Conference, of which the Lucerne Conference was, so to speak, an offshoot. However, the extra number of high-power stations accommodated is much in excess of the number of extra channels available, and such a result can only be obtained, (1) by sharing channels; (2) by reducing in some cases the separation between stations. Both these expedients have been adopted in the Plan, and it will be interesting, therefore, to consider what effect from the listener's point of view these measures will have.

Before doing so, however, we can sum up the main advantages of the new Plan as follows: several countries have benefited as compared with the Prague Plan, while many others have made sacrifices; but in the case of the latter a valuable advantage will be obtained from the new Plan if it can be put into operation as a universally agreed system. It may be mentioned that this applies particularly to Great Britain, where the broadcasting service is comparatively highly developed.

THE EFFECT OF SHARED CHANNELS

By the sharing of channels is meant the working of two stations in different countries on the same frequency with an accuracy of approximately 10 cycles per second. Under these conditions satisfactory working can be obtained if the stations are sufficiently far apart for the minimum field strength in the service area of the wanted station to be not less than 100 times the normal maximum field strength of the unwanted station. This ratio of 100 : 1 must be looked upon as a minimum and does not give reception which is entirely free from interference, whereas if the ratio can be maintained at 200 : 1, very little disadvantage is obtained from sharing. It may be said straight away that in practically all cases of sharing no difficulties should be experienced during daylight working, provided that the

two stations maintain the accuracy mentioned above in connection with their carrier wave frequency. Of course, if the frequency of one station wanders so as to make an audible heterodyne note with the carrier of the other station, then interference is probable even in full daylight. During night conditions, however, it is only in a very few cases that the 200:1 ratio will always obtain. A 100:1 ratio, however, should normally obtain in the vast majority of cases, but on nights when the indirect ray is unusually strong, some interference is probable on the shared channels, but just exactly how serious this will be is a matter which only experience can determine definitely. Curves have been constructed from a vast quantity of data giving the anticipated strength of the indirect radiation from stations at long distances, but these curves can do no better than give an estimation of the quasi maximum value (this is the maximum value which exists for 5 per cent. of the time of transmission during the hours of darkness) from a large quantity of data, some of which cannot be looked upon as representing normal conditions.

A station on a shared channel may therefore give—during the winter in particular—an appreciably smaller service area for a given power than one on an exclusive channel of the same order of frequency, but even if this is the case it is necessary to accept such a condition of affairs in order to obtain an orderly system.

All the remarks which have just been made refer to listening in the service area of the wanted station—that is, the area in which listening is satisfactory both during day and night conditions. When it comes to distant listening there is no use disguising the fact that, in general, shared channels will not be of much value. In the case of the vast majority of countries, however, there is at least one exclusive channel which is available for distant listening. In the case of Great Britain there are three channels available for this purpose, one of which is the longwave channel of 1,500 metres, which of course will be used by Daventry and later by Droitwich. It is laid down in the regulations that stations sharing channels shall provide themselves with “drive” apparatus which will maintain a constancy of carrier wave frequency which shall not depart by more than 10 cycles per second from the correct frequency. This, of course, is highly important; in fact, the whole success of shared channels

depends on the ability and willingness of broadcasting authorities to take the necessary trouble to obtain this figure on the basis of day-to-day working. This, of course, also applies to the international common waves, on which there are a number of small stations in different countries and where the limitation of power is 2kW. Such stations cannot be listened to at a distance. The same remarks apply to national common waves, but in this case all the stations concerned belong to one country.

THE REDUCTION OF SEPARATION BETWEEN CHANNELS

This is most noticeable in the "longwave" plan applying to wavelengths above 600 metres. It will be found that the separation here varies between a minimum of 7 kc/s and a maximum of 9 kc/s. It is difficult at this stage to say exactly what effect this will have. When receiving a station which has a powerful neighbour, separated by, say, 7 kc/s, there will be a certain limitation of range beyond which it will be necessary either to put up with a certain amount of interference from the neighbouring station or to work the receiver in a state of selectivity which must reduce its musical response to the higher audio-frequencies. This, however, need not apply when receiving with a high or fairly high field strength. It is difficult at the moment to give an exact ratio between the two fields in question for good quality reception. In the first place, it is not easy to define quality of reception, but apart from that, it depends very largely on how the selectivity is obtained in the receiver in question, and whether there are two strong neighbours or only one, the type of programme which is being listened to, and last but not least the volume of output. A receiver could be designed for speech only which would give perfectly good results with such a separation, but broadcasting does not consist of speech only and some difficulty must be anticipated. Here the question of accuracy of carrier waves is not of the same importance as in the case of shared channels. Obviously with two stations working at 7 kc/s separation, if one of them changes its carrier frequency by 50 cycles, no very great difference will result from the point of view of the neighbour station. Taking the specific case of this country, Daventry will be separated from Zeesen by 9 kc/s, whereas at the moment it is separated by $9\frac{1}{2}$ kc/s, while

on the other side there will be Minsk with a separation of 8 kc/s as compared with Moscow at $9\frac{1}{2}$ kc/s.

It is not anticipated that there will be serious interference on Daventry or Droitwich under the new Plan except possibly in the case of the older receivers when used at considerable distances. However, the fact remains that with these reduced separations, more selective receivers are necessary and therefore some sacrifice of quality, at least under certain conditions of reception, must be involved. In the medium wave bands there is much less difference between the old and the new plans from the point of view of general separation. The standard separation of 9 kc/s applies in most cases, but recently by special arrangement between the countries concerned, certain stations were separated by 10 kc/s and 11 kc/s instead of 9 kc/s. Some of these special separations still exist in the Lucerne Plan. For example, there will be 10 kc/s between Langenberg and North Regional, and between Milan and Scottish Regional. At the same time, a great deal of trouble has been taken to arrange neighbouring stations so that interference may be at a minimum. On the whole, therefore, there should be less interference in the medium wave band under the Lucerne Plan than exists at present from the point of view of channel spacing.

In conclusion, it may be said that the whole success of the Plan will depend on the efforts made by the various organisations concerned to make it work. Obviously it constitutes a highly elaborate mechanism very carefully balanced from the point of view of the various dangers which are likely to arise, and only by whole-hearted co-operation can it be a success in practice, but there is no reason to think that this co-operation will not be forthcoming.

THE S.B. LAND-LINE NETWORK

IN JUNE 1933, less than two years after the first long-distance underground music circuit ever used in this country was put into service between London and Leeds, the last links of a network of such circuits interconnecting nearly all the B.B.C. stations throughout the country were put into commission between Birmingham, Bristol, Cardiff and the new West Regional Station at Washford Cross.

The completion of this work marks a definite step in the development by the General Post Office of the simultaneous broadcasting network of land-lines. It marks the point at which the most modern long-distance telephone cable plant available has been successfully adapted by them to give, as judged by present-day standards, nearly perfect transmission of musical programmes. Over all routes between main programme centres, music circuits now consist of specially selected pairs in paper-insulated lead-covered cables, loaded, at the points normally used for long-distance telephony, with special low-inductance coils, so that the overall circuit has a cut-off high enough to permit of good transmission of all frequencies up to at least 6,500 cycles per second. New terminal equipment has been designed and installed by the B.B.C. to extend this performance to the overall links between broadcasting centres.

Long-distance telephone circuits are, nowadays, "repeated" every forty to fifty miles along their route, and at these stations music repeaters have been installed giving uniform transmission of all frequencies up to the limit imposed by the cut-off inherent in the coil-loaded cable circuit. These music repeaters, which have been specially developed for this work, include line-distortion correcting networks, and at each intermediate station testing apparatus specially designed for testing and maintenance work on broadcast circuits, has been installed.

Although, as mentioned above, underground music circuits of the new type now interlink all main programme centres of the B.B.C. throughout the country, the necessary cable plant is not yet available in the case of one or two S.B. links serving other stations. For these links, overhead circuits of the type used throughout the country for years are still in use, and the service accordingly is not up to the standard of that given by

the new underground circuits. Endeavours are, however, being made to improve matters as quickly as possible.

As a result of restrictions imposed by submarine working, the link connecting Belfast with Manchester is also not of the type in which reloading for broadcast requirements is possible. Further, owing to the relatively large number of communication channels which have to be derived from a limited number of circuits, the telephone apparatus necessarily in circuit is not always capable of transmitting faithfully the extreme lower frequencies, and, as a result, the service to Belfast is not as good as that to other main stations of the B.B.C. It is hoped that when the new cable scheme connecting Glasgow and Belfast is complete, it will be found possible to include in it circuits capable of transmitting the full frequency range involved in broadcasting.

As stated above, progress so far has been along the lines of adapting the best of the existing Post Office plant to broadcast requirements. As far as can be seen at present, the next important step in development will be the inclusion in new equipment of circuits specially designed for broadcasting. In the design of such equipment, there will be a number of points to receive special consideration if the programme currents at the receiving end of the line are to be a faithful copy of those at the sending end, and we shall now consider ways in which development is likely to occur.

It is well known that a long underground cable circuit will introduce marked attenuation or weakening in the programme currents. To prevent this effect from becoming excessive for a given reasonable spacing between amplifying stations, inductance has to be added to the circuit and, within limits, the more inductance added the less will be the attenuation. It is an unfortunate fact that the only way in practice of adding sufficient inductance to circuits overland is by adding coils at points evenly spaced down the line, and a necessary consequence of adding the inductance in "lumps" instead of evenly along the length of the line is that the necessary reduction in attenuation is obtained only up to a limiting frequency called the "cut-off" frequency of the circuit. For frequencies above this cut-off frequency there is absolutely no transmission, but the less the distance between coils, the higher is the cut-off frequency with

a given size of coil. A natural line of development for future cable schemes for broadcasting appears, therefore, to be in reducing the spacing between the inductance coils loading the line, and, as an indication of the advantage to be gained by this, it can be estimated that if the present coil interval were halved without changing the total amount of inductance per kilometer of circuit, the maximum frequency that could be transmitted would be approximately doubled.

Another improvement which may be expected is a reduction of the noise and general interference currents which are always present in telephone circuits. It should be remembered that a long-distance cable circuit containing some hundreds of pairs of wires may be no more than 3 to 4 inches in diameter, and that in all of them are electric currents liable to interfere by induction and capacity coupling with each other, and susceptible to interference from such outside sources as power lines, etc. The principle involved in keeping interference of this sort as small as possible is to arrange that the two wires of each circuit lie equally in the sphere of interference of all other circuits or of outside sources of interference. Under these conditions the interfering voltages will be equal and opposing in the two wires of the circuit, and no "noise" current will therefore flow in the receiving apparatus connected at the terminal. The power at the receiving end of a programme circuit is generally of the order of 1/100,000th part of a watt, so that it will be appreciated that if interference is to be negligible compared with this quantity, it must be kept very small indeed. Gradual refinement of cable manufacturing processes is resulting in the production of new cables, the individual circuits of which are "balanced," from the point of view of the cancellation of interfering voltages from neighbouring circuits and outside sources, far more closely than has hitherto been possible. In some cases, too, circuits to be used for broadcasting are surrounded with a metallic shield so as to be screened from interference which might otherwise affect them.

To keep pace with improvements in the circuits themselves, refinements in testing apparatus and in the design of distortion-correcting devices associated with the lines are gradually being introduced. As an example of this, the limits of amplitude distortion applicable to a modern land-line circuit, including all

amplifiers and associated equipment, are precisely one-quarter of those which would have been applied to a circuit giving the same service three years ago, and during this latter period the accuracy of testing apparatus used for routine and other measurements on overall circuits has increased more than fourfold.

As a final point, it may be mentioned that investigations are now proceeding into possible types of distortion not examined (at any rate quantitatively) hitherto. Waves of electric current travelling along land lines take an appreciable (though extremely short) period of time to reach the far end, and in general, this time will vary with the frequency of the current concerned. Highly specialised testing and correction technique is being applied to measure and annul distortion of this type, so that the various components of a complex programme wave may reach the far end of a long line simultaneously. All amplifier and repeater equipment introduces distortion in varying amounts, owing to the fact that the amplification ratio varies with the magnitude of the input voltage and, with the relatively large number of amplifiers in circuit in a long S.B. transmission, small amounts of this type of distortion may add up to become serious. Though the major part of the work remains still to be done, a definite start has been made on these problems, so that as the general technique of broadcasting advances, that section of it concerned with transmission of programme currents over land lines may keep pace and provide a general quality of "S.B." reproduction in accord with the requirements of the system as a whole.

NEW PROVINCIAL STUDIOS

THE PAST YEAR has seen a good deal of activity in improving the studio and office accommodation in provincial centres and the replacement of obsolete control-room apparatus by new equipment of up-to-date design.

This work has been proceeding in parallel with the completion of the twin-transmitter high-power stations, so that the local studio centres shall be equipped in a way which will enable them to produce regional programmes equal in merit to those produced in London with the aid of the modern plant installed in Broadcasting House.

So much information was obtained on the acoustical design of studios during the building of Broadcasting House, that by comparison all provincial studios were out of date as regards treatment, and moreover were in most cases too small for the work which was expected from them. Practically the only exception to this was the large studio in Edinburgh, a converted dance hall, which by virtue of its generous dimensions proved capable of relatively simple acoustical treatment. Exactly what this treatment was and the methods used for measuring acoustical performance have been described in previous Year-Books, and it is not the intention to discuss these technical matters in this article.

On the other hand, the studios at such important centres as Birmingham and Cardiff were bad from almost every point of view. They were too small, and their frequency-reverberation time characteristics were so far removed from straight lines that the shape of a camel's back was almost flat by comparison! Moreover, the growth of specialist productions in the field of drama and debate meant that more studios were necessary, each suited to its own particular purpose.

So rapid has been the progress in studio technique that (with the exception of the premises at Bournemouth, Plymouth and Swansea, which have not so far been dealt with) every other provincial studio centre either has recently been, or is now in process of being, enlarged and brought thoroughly up to date. Here is a list of them: Birmingham, Cardiff, Bristol, Manchester, Leeds, Newcastle, Edinburgh, Glasgow, Aberdeen and Belfast.

In most of these places it has fortunately been possible to

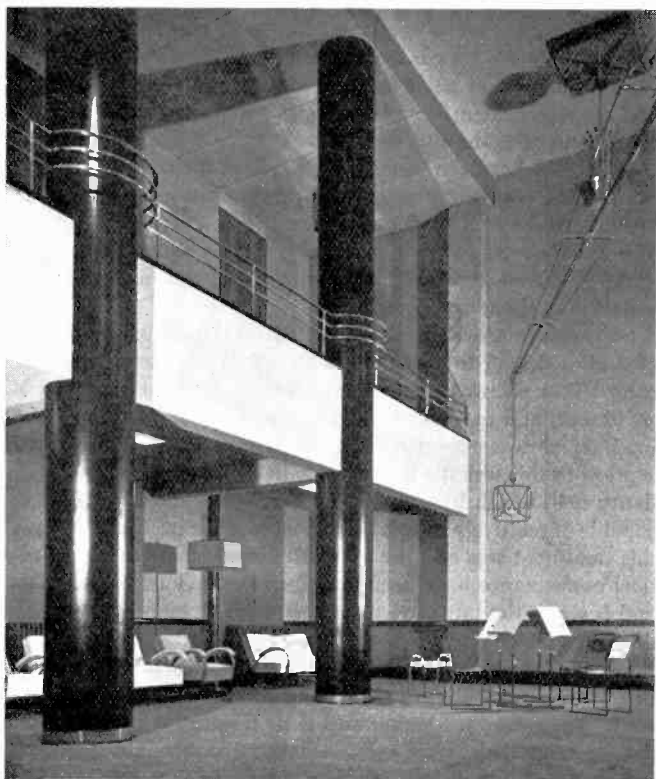

THE LARGE STUDIO, LEEDS

obtain the necessary additional space either by building an extension or by taking over adjoining buildings. In two cases, Bristol and Leeds, a move has been made to more commodious premises in another part of the city.

The new Leeds premises, a stately building in Woodhouse Lane, was opened in January, 1933. Two studios have been provided, the larger, 50 ft. by 38 ft., being suitable for orchestral music and in particular for the brass band concerts which are frequently broadcast from the North Regional transmitter. On page 334 is a general view of this studio, which was at one time a chapel. The smaller studio is for talks. There is another studio for dramatic work, but this also serves as an artists' waiting-room.

On the other side of the Pennines the Manchester premises have similar responsibilities for the adequate presentation of North Regional programmes. Here the studios (of which there are four), though only completed in October 1929, are not entirely satisfactory from an acoustical standpoint, and a programme of reconstruction and extension has been decided upon. The existing studios will be modernised and a new dramatic effects studio will be built on the top floor.

To complete the studio improvements in the North, the Newcastle premises are being almost doubled in size. The island premises in New Bridge Street make a fine centre for broadcasting. To accommodate the brass bands which are so popular in this part of the country, the large studio is being reconstructed, although the limitations of the building prevent any increase in area. A dramatic as well as a talks studio is being provided, with, of course, equipment for gramophone recitals and effects work. When completed, the reconstructed premises will be second to none in up-to-date design.

In Scotland the same process of modernisation has been followed. The Edinburgh premises, completed in 1931, have already proved to be too small for the increasing activities of the Scottish Region. It has fortunately been possible to acquire additional accommodation next door. New studios will be constructed to augment the three which already exist, and when completed the premises will be worthy of Scotland's capital city. The Glasgow studios have been increased by one for dramatic work, and all three have been acoustically treated and

decorated in the modern style. In Aberdeen a similar improvement has been made. Scotland, then, is well equipped with first-class studios for the production of regional programmes (which, incidentally, frequently contribute to the regional programme "pool" and to the National programme).

Nor have the Midlands and the West Country been neglected. In Birmingham, an extension has been built at the rear of the present premises, increasing the accommodation by 50 per cent. A re-arrangement of the whole available space has made it possible to build two new studios and in the new extension is a lofty studio some 38 ft. by 46 ft. giving a volume of approximately 34,000 cubic feet. This will accommodate all but the largest orchestras, and the newly-decorated smaller studios provide ample space for local programmes broadcast by the Midland Regional transmitter, which for the present is still at Daventry but is soon to be replaced by a new transmitter on the same site as the new long-wave National programme transmitter at Droitwich.

The Cardiff premises are close to the magnificent civic buildings and museum, a block of buildings of which Cardiff is justly proud. Here too, fortunately, it has been possible to secure adjacent premises to provide for necessary extensions, and Cardiff with five studios of various sizes is as well equipped as any other centre.

Until recently, Bristol possessed one tiny room which did duty as a talks studio, but nothing else. All this has now been changed, and the new premises in Whiteladies Road are for their size as good as any in the country. A large studio, 56 ft. by 44 ft. by 25 ft., is now being built at the rear of the premises, so that in future West Country items forming part of the West Regional programme will be broadcast mainly from the English side of the Bristol Channel. In addition there is a talks studio, a dramatic studio, and the usual effects room. With two studio centres, the West Region does not lag behind.

Finally, Northern Ireland has not been forgotten. With the taking over of adjoining premises, the Belfast offices and studios are now undergoing reconstruction and extension, and when finished they will be in accord with the needs of the region, which produces more local programme material than any other.

So much for studios. But there is another side of this develop-

CHALLENGEN



The **PIANO OF THE B.B.C.**

Why not have the same make of instrument in your home as in all the modern B.B.C. studios? No more convincing proof of superiority could be imagined than the thorough tests made before the B.B.C. decided to purchase Challen Pianos exclusively. We will gladly demonstrate these points to you without obligation to purchase.

A CHALLENGEN GRAND PIANO

will be delivered on
a first payment of **£3**

A CHALLENGEN UPRIGHT PIANO

will be delivered on
a first payment of **30/-**

Full Particulars from

**13 & 14 HANOVER STREET, REGENT STREET
LONDON, W.1**

'Phone: Mayfair 4218

ment which has been gradually proceeding during the past two years. This has been the replacement of obsolete control-room apparatus and technical equipment of all kinds by modern gear of new design, similar to that installed in Broadcasting House, London.

The old idea of arranging amplifiers on a table at which the control engineer sits has been entirely abandoned. All equipment is now rack-mounted, switching operations being done by relays worked by push buttons on the remote control desk. Power supply is derived from central batteries, of large capacities to avoid cross-talk, or, in some cases, direct from the mains.

Progress has been made in the design of special equipment, such as dramatic control panels for the production of multi-studio plays, fade units for broadcasts involving the use of two or three microphones in one studio, announcers' switch units and many other devices assisting in the smooth presentation of broadcast performances.

New equipment has recently been installed at Edinburgh, Leeds, Birmingham, Cardiff and Bristol, while plant for Newcastle, Glasgow and Belfast is on order. It is part of the Corporation's policy that all these important provincial centres shall be equipped and maintained in a manner worthy of the task of providing regional programmes to the densely populated areas which the regional transmitters serve. The simultaneous broadcast system of trunk telephone lines enables these programmes to be available on occasions to listeners in regions other than those in which the programmes originate.

THE SERVICE TO NORTHERN IRELAND

THE SIX COUNTIES which comprise Northern Ireland are roughly square in shape, the distance between Londonderry and Newry, the two most distant towns, being about seventy miles. Belfast, the largest city, stands at the head of Belfast Lough and has a population of approximately 415,000 out of a total of 1,256,000 for Northern Ireland. Londonderry, almost at the north-western extremity, comes next with 45,000, being separated from the eastern side by the Sperrin Mountains, which run north-east and south-west across the country. Armagh, Omagh, Lisburn, Newry, Newtownards, Coleraine and Ballymena are the only other towns with more than 10,000 inhabitants.

In the original eight main stations erected by the British Broadcasting Company, one for Northern Ireland was not included, but this omission was rectified in 1924 with the opening of a $1\frac{1}{2}$ kW. transmitter in the middle of Belfast. This plant is still in operation, situated on the site of the old power station which has now been replaced by the new Harbour Power Station.

Working on a medium wavelength, the service area of the present transmitter is limited to about twenty miles, which means that it serves little more than the city of Belfast and the immediate neighbourhood. The rest of the country has to depend upon a somewhat indifferent service from Daventry 5XX. Further, Irish listeners want to hear local programmes which are not available from Daventry. The present situation is, therefore, unsatisfactory, especially in view of the fact that, owing to the relatively inferior performance of the trunk line S.B. link with England, more local programme material originates in the Belfast studios than at any other regional centre.

So far as a national service is concerned, the new National programme transmitter at Droitwich will provide a signal approximately double the strength of that now provided by Daventry 5XX, which should ensure satisfactory reception of the National programme in any part of the six Counties.

In the original scheme of high-power twin transmitter

stations the problem of providing a suitable regional station for Northern Ireland was not finally settled, since when the scheme was formulated it was not possible to say whether a suitable wavelength would be available for use by such a station. It is obviously uneconomical to build an expensive high-power station if the wavelength which it is required to use is of the order of 200 metres, since such a low wavelength means that the service area of the station, however great the power, is limited to the order of forty or fifty miles, at which point fading begins.

As a result of the Lucerne Conference a wavelength of 267·4 metres has been allotted to Belfast for use on and after January 15th, 1934. This wavelength is sufficiently high to warrant the erection of a high-power transmitter to give a Regional programme service to as much of Northern Ireland as possible.

The problem of selecting a suitable site has been a difficult one. The geographical centre of the country is in the neighbourhood of Magherafelt on the north-west side of Lough Neagh, and the boundaries of the country are within about forty miles of this point in every direction. Assuming a flat country, therefore, a station placed at this point would give a service of sorts to the whole country. But there would be many serious objections to the siting of the station in this position. First, the largest centres of population, in Belfast and Londonderry, would be at the extremities of the service area. The area of strongest field strength would be wasted over sparsely populated country, and over Lough Neagh. The nearest big town would be Antrim, about fifteen miles away. Secondly, the station would be under the shadow of the Sperrin Mountains to the north-west, and it is most doubtful whether from this site the service to Londonderry would really be adequate. Thirdly, the station would be inaccessible and there would be difficulty in obtaining a satisfactory land-line link with the studios in Belfast. From almost every point of view, therefore, the siting of the station in the geographical centre of the country would be decidedly unsatisfactory.

Since nearly half the population is concentrated within twenty miles of Belfast, it was decided that the new station should be within this area. Belfast itself, which has been accustomed to a strong field strength from the local low-

An oval-shaped illustration of a house at night, illuminated from within. A tall, slender antenna tower stands to the right of the house. A wire with several insulators runs across the scene, connecting the tower to the house. The background is dark, suggesting a night sky.

3 MILLION AERIALS
LEAD DOWN TO
Mullard
MASTER VALVES

*The Mullard Wireless Service Co. Ltd., Mullard House, Charing Cross Road,
London, W.C.2.*

Arks.

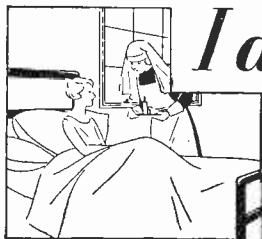

*I am amazed at
the Brightness of
everybody and
everything* {a Lady
Visitor}

Speaking to one of the Specialists in a ward last week, a lady visitor (a modern Florence Nightingale who loves to bring flowers and cheer the sick) said, "I am amazed how bright everybody and everything is at the Cancer Hospital." That is the keynote in the wards where patients suffering from cancer are being "cured" and in the Laboratories where unremitting research is carried on into the causes of Cancer and its possible eradication. Everywhere hope, brightness and courage, the only "dark" spot is a Bank overdraft of £40,000 on maintenance. Will you please send a gift?

The Cancer Hospital

(FREE)

FULHAM ROAD

LONDON, S.W.3

CHILDHOOD'S PROTECTOR

HOME should be the source of Hope and Happiness for every Child —yet there are still thousands of little ones suffering from the harmful neglect of ignorant parents or the cruelty of guardians.

Such ill-treated ones claim the sympathy and help of

The N.S.P.C.C

Please help the Society's efforts by sending a gift to Sir G. Wyatt Truscott, Hon. Treasurer, or William J. Elliott, Director, National Society for Prevention of Cruelty to Children, Victory House, Leicester Square, London, W.C.

Chairman: The Viscount Ullswater, G.C.B.

A Happy Life

is the right of every child. The death of a father takes away not only his kindly influence but the opportunities his help would have brought. At the Alexandra Orphanage at Maitland Park, Haverstock Hill, N.W.3, fatherless and other necessitous boys and girls from all parts of the country regain their happiness in cheerful company, and receive every care and a sound education. 370 are now resident and there is a long waiting list. £10,000 needed each year above the assured income. Gifts should be addressed to The Rt. Hon. Lord Marshall, P.C., K.C.V.O., Honorary Treasurer since 1897, at the Offices of the

ALEXANDRA ORPHANAGE

34/40, LUDGATE HILL, E.C.4.

power station, is thereby assured of a continuation of this satisfactory service, and at the same time the towns round about will be equally well served. On the other hand, it is unfortunately impossible on this basis to give a satisfactory service to Londonderry, and any alternative which would give an improvement of field strength in the north-west would necessarily do so at the expense of a far greater population. So that in effect Londonderry will have to continue to rely largely on the national service from Daventry 5XX, and, later, the improved service from Droitwich. It will be possible to receive the new Irish station in Londonderry during hours of daylight if sensitive receiving apparatus is used, but at night, severe fading will make consistently satisfactory reception impracticable.

Belfast lies in a hollow overshadowed by hills to the west and east. To the north is the Lough and to the south-west the Laggan Valley in which lie Lisburn, Portadown and Armagh. Apart from the fact that to place a station in the heart of a city is an inefficient arrangement from the wireless point of view, a powerful station too near the centre would put down such a high field strength in Belfast itself that listeners might have difficulty in cutting out the local station to receive the National programme without interference.

A search for sites was therefore made on the higher ground to the west and east and along the fairly densely populated Laggan Valley. The west of Belfast in the neighbourhood of the Divis Mountain proved to be unsatisfactory country in many respects. There are few roads and a very limited water supply. The east side, towards Stormont and Craigogantlet, appeared to be more satisfactory, and two sites were considered, one almost adjacent to the new Parliament Buildings and another further east. These sites, four miles and six miles respectively from Belfast, were each about 500 ft. above sea level. It was suspected, however, that the subsoil in this part of the country was such as to cause severe attenuation or weakening of the wireless waves. Another site was found near Lisburn. Being in the valley it was only about 150 ft. high, but since the country all round was equally low-lying, this was not considered likely to be a serious disadvantage.

Apart from the situation of the site in regard to the populated areas which the station is required to serve, many other points

have to be borne in mind in making a selection. It is essential that the site shall be served by good roads, in order that building costs may be kept to a minimum and supplies may be brought easily to the station. It is also essential for an adequate water supply to be available, and if a power supply is required this must not be too far away. Finally, the site must have an area of about 15 acres and should be reasonably flat.

It might be thought that land to fulfill these requirements could be obtained quite simply. Such, however, is not the case, and it has been found, not only in Ireland but elsewhere, that the number of sites fulfilling all these conditions within a specified area is usually extremely small. For this reason, after a preliminary weeding-out, only the three sites mentioned received really serious consideration.

Before a site is finally selected transmitting tests are carried out with the aid of a 1 kW. portable transmitter, to ensure that the site is satisfactory from the wireless point of view. It is known by calculation that if a certain power is radiated from a site, then the field strengths at specified distances away should reach certain definite values. If by test the results are appreciably below the calculated values, then it follows that either the subsoil or configuration of the site itself, or of the land between the site and the receiving point, is responsible for serious attenuation of the wireless waves. For this reason the site would be considered unsatisfactory, and would be rejected.

The tests carried out with the aid of the portable transmitter and field strength measuring vans on the three sites mentioned showed that the field strengths at short distances from the Stormont and Craigogantlet sites were relatively low, for the reasons stated. This rapid attenuation did not indeed continue at greater distances, but even so the damage was done. With the exception of the field strengths in Bangor and Newtownards which are close to the site, Craigogantlet was proved to be inferior to Stormont, and since the Stormont site was to be preferred for reasons of general accessibility, water supply, etc., the Craigogantlet site was not further considered.

The choice rested, therefore, between the Stormont and Lisburn sites. A station at Stormont would, of course, give greater field strengths in Belfast, Newtownards, Bangor and the East Coast generally, but the Lisburn site would give a better service



Marconi

THE MOBILE TRANSMITTER USED FOR TESTING THE SUITABILITY
OF A SITE

in general terms, and of course in particular to the population in the Laggan Valley, and to towns such as Antrim, Downpatrick, Newry, Armagh and Omagh. The strength in Belfast from Lisburn was adequate without being so high as to make it difficult to cut out the local station in favour of Daventry 5XX. The population map of Northern Ireland shows that there is a large population in the Laggan Valley. Lisburn is more or less the centre of this area, and is, therefore, taking one thing with another, the best choice possible in the circumstances.

The station will be of somewhat different design from the other high-power stations, since it will contain only one transmitter. Power will be taken from the mains instead of being generated locally by Diesel engine plant, as is the case at other regional stations. A standard 50 kW. regional transmitter will be installed, and the aerial will be supported on one mast 500 ft. high. It is anticipated that the station will be completed by the autumn of 1934.

Concurrently with the erection of the new transmitter the studio premises in Linenhall Street, Belfast, are being greatly improved and enlarged. Additional accommodation has been taken over in the adjoining premises, new studios are being constructed, and completely new control room equipment is being installed. The new plans provide for four studios—a large one for orchestral work, a dramatic studio, one for talks, and a medium-size general purpose studio for Children's Hour, small musical combinations, and similar performances. In addition there will be an effects studio and facilities for gramophone recitals. The premises will be fully equipped for multi-studio productions. The technical equipment in the Control Room will be of the latest type and will, in fact, be a small edition of that used in London.

The premises will be at least as good as those at any other regional centre, and will be fully capable of originating programmes particularly suited to the needs of Northern Ireland. The new high-power transmitter will enable these programmes to be heard without difficulty by a vastly greater number of listeners than has been served by the original transmitter, to close down in a few months' time after nearly ten years of hard service.

CALCULATION AND MEASUREMENT OF FIELD STRENGTHS

ELECTRO-MAGNETIC WAVES may be considered as lines of electric and magnetic force at right angles to one another travelling outwards from the radiating source, which is usually an aerial. The lines of electric force are usually vertical, and alternate in direction every half wavelength or half cycle. The magnetic lines are horizontal, and also alternate in direction every half wavelength or half cycle. The electric lines resemble, at any instant of time, the lines of force between two charged plates, while the magnetic lines resemble, at any instant, the lines of magnetic force due to a current passing through a coil of wire.

In an electromagnetic wave in free space, unaffected by reflection from the Heaviside layer or the earth, these two sets of lines of force are always at right angles to each other, and both at right angles to the direction of propagation. They are definitely related to one another in intensity, and the system of units is so chosen that the relationship is unity; that is to say, if in an electromagnetic wave the intensity of the vertical electric component is one unit, then the intensity of the magnetic component will also be one unit. The intensity is usually known as the field strength, and is measured in terms of vertical potential gradient. A strength of one volt per metre corresponds to a difference of potential in a wave of one volt for every metre of height, and, since the units are identical, this measure can be used to express the intensity even when the magnetic component is measured.

In practice the field strength is expressed in millivolts per metre—mv/m. As far as the electrostatic component is concerned, the expression represents a potential gradient, just as the current through a straight wire would give rise to potential differences which could be expressed as millivolts per metre of wire.

The field strength in mv/m is the R.M.S. value of the field, not the peak value, just as the current in an aerial is usually measured and spoken of as the R.M.S. value. As this point seems to be one which is generally not readily understood, a simple explanation may be of some service.

If the electric field has a maximum value of say 1 millivolt per metre in one direction at a particular instant of time, then its value will vary with time in a sinusoidal manner, and will pass through zero one quarter of a cycle later than the time when its maximum value in one direction was reached, and one quarter of a cycle later still, will reach a maximum value in the opposite direction, and so on. The R.M.S. value of the field at that point will be $\frac{1}{\sqrt{2}}$ mv/m or 0.707 mv/m.

The field strength is proportional to the current in the transmitting aerial and its effective height, and is inversely proportional to the wavelength and the distance. The relationship is given by the equation:

$$e = \frac{377h \cdot I}{\lambda \cdot d}$$

where e = field strength in millivolts per metre.

h = effective height of transmitting aerial in metres.

I = aerial current in amperes.

d = distance in kilometres.

λ = wavelength in metres.

The above equation is true only if the radiation takes place over a perfectly conducting plane. Unfortunately, the earth's surface, over which direct-wave broadcasting takes place, is far from being a perfectly conducting plane, and various methods have been used to calculate the losses of intensity to the wave, due to absorption of energy by passing over imperfectly conducting earth. The reason for the losses in the earth is that a wave passing over the earth's surface induces currents in it. If these currents have to pass through a conductor which has resistance, there will be losses. If the resistance is zero, there can be no losses, since the loss is $W = I^2R$, and if the resistance is infinite, again there will be no losses, since the current will be zero. Somewhere between zero and infinity lies a condition of maximum loss, and it is unfortunate that certain portions of the earth's surface appear to be far too near this condition for the efficient transmission of waves in the medium broadcast waveband.

The calculations are complicated by the fact that the depth to which the currents penetrate into the earth depends upon the wavelength and the conductivity. The degree of absorption

of energy by the earth at any point is therefore a complicated function of the earth's conductivity, wavelength and the intensity of the wave at that point. It is further complicated by the fact that the conductivity of the earth varies considerably from place to place, also with depth.

Sommerfeld has worked out a method of calculating the attenuation of waves over the earth's surface which is particularly applicable to broadcast wavelengths. This method takes into account the conductivity and dielectric constants of the earth, but at wavelengths above about 100 metres the dielectric constant can be neglected.

The method is to obtain from the variable factors of conductivity, distance, and wavelength, a factor which has been called the numerical distance and designated d_n , and from this quantity the attenuation factor is obtained. The numerical distance is given by

$$d_n = \frac{\pi d}{2\sigma\lambda^2 C}$$

where d = distance between transmitter and receiver in centimetres.

λ = wavelength in centimetres.

C = velocity of light in centimetres per second.

σ = earth's conductivity in electromagnetic units.

The formula is applicable for values of d_n not greater than 5; for greater values the curvature of the earth comes into play, and eventually the attenuation becomes a simple law, being inversely proportional to the square of the distance. It is not possible to go further into this matter here, but the interested reader is referred to T. L. Eckersley's paper on "Direct-Ray Broadcast Transmission" in the Proceedings of the Institute of Radio Engineers for October, 1932.

The curve connecting d_n with the attenuation factor "S" is shown in Fig. 1.

The equation for field strength for an imperfectly conducting earth becomes

$$e = \frac{377h.I}{\lambda d} \cdot S$$

where S is the attenuation factor obtained as above.

The general conditions of the method postulate a homogeneous earth as far as conductivity is concerned, and neglect

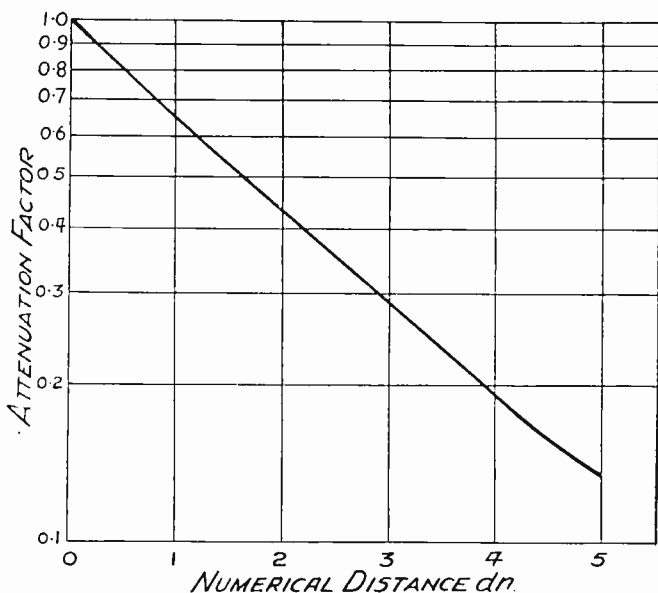

FIG. 1.—RELATIONSHIP BETWEEN ATTENUATION FACTOR AND NUMERICAL DISTANCE FROM SOMMERFELD'S FORMULA

the effect of hills, the absorption due to structures in towns, etc. In practice the conductivity is not homogeneous, and in making calculations allowing for such factors is largely a matter of experience.

Calculations of field strength can never be relied upon to any great degree of accuracy. Variations of two to one, or more, are often experienced owing to the local conditions, and must therefore be regarded as a possible error in the calculated field strength. On the other hand, some fairly accurate general calculations have been made by engineers and physicists who have had considerable experience of the subject.

The approximate figures of average conductivity may be used as a guide in calculations, but the would-be calculator is warned that field strengths so obtained are only approximate, and that he must not be disappointed if measured values differ considerably from those calculated.



*Sold by all
Radio Dealers.*

It is sure
to be fine
if it's
**G.E.C.
Radio**

G.E.C. Radio - Supremacy in Radio

Advt. of The General Electric Co., Ltd., Magnet House, Kingsway, W.C.2.

Nature of country.	Conductivity.
Average pastoral country	10^{-13} e.m.u.
Reclaimed or marshy land, such as Lincolnshire Fens	1.5×10^{-13} e.m.u.
Broken, hilly country such as West Yorkshire	0.5×10^{-13} e.m.u.
Old Red sandstone, such as is found in North Somerset, North Devon, and Cornwall	0.15×10^{-13} e.m.u.
Sea water	About 10^{-11}

In the case of granite subsoil, such as Dartmoor and Bodmin Moor (Cornwall), the attenuation is so high that no estimate has been made from field-strength measurements. On one occasion some field-strength measurements were taken on Dartmoor from a 1-kW. testing transmitter on the Brendon Hills in North Somerset, but signals disappeared after the first mile or so of Dartmoor.

(Note.—Conductivity is sometimes expressed in electrostatic units— 10^{-13} e.m.u. = 0.9×10^8 e.s.u.)

It is convenient to relate the field strength to the power radiated from the aerial; this is possible if the radiation resistance is known. For an aerial whose height is small compared with the wavelength, the radiation resistance in ohms is given by

$$R_r = \frac{1580 \cdot h^2}{\lambda^2}$$

where h is the effective height of the aerial in metres and λ is the wavelength in metres, and, since power radiated (W_r) is $I^2 R_r$, this will be

$$I^2 R_r = W_r = \frac{1580 \cdot h^2 I^2}{\lambda^2}$$

from which we get

$$\frac{h \cdot I}{\lambda} = \sqrt{\frac{W_r}{1580}}$$

By substituting this in the formula for field strength, we get

$$e = \frac{377 \sqrt{\frac{W_r}{1580}}}{d} \cdot S$$

and if the power radiated is expressed in kilowatts, this becomes

$$e = \frac{300 \sqrt{W_r}}{d} \cdot S$$

If higher acrials are used, a correction has to be made, since the field strength for a given power radiated is greater, and the radiation resistance relatively less than for a low aerial. We can also add another correction to take into account the dead loss resistance as follows.

The radiation resistance of a vertical half-wave aerial would be 160 ohms if it had the same radiation efficiency as a short aerial—radiation efficiency can be considered in terms of field strength for a given power radiated, and is proportional to

$\frac{e}{\sqrt{W_r}}$ —whereas in practice its radiation resistance is about 103 ohms. The dead loss resistance of an aerial lies between 5 and 10 ohms usually. The total resistance, therefore, of a half-wave aerial would be 108–113 ohms, say 110 ohms.

The correction factor can be calculated by comparing the aerial current obtained for a given power in the hypothetical half wave aerial, whose radiation resistance is 160 ohms, with the current in the actual aerial whose total resistance is 110 ohms. If the power is the same in both acrials the correction factor will be

$$x = \frac{I}{I_2} = \sqrt{\frac{R_2}{R_1}} = \sqrt{\frac{160}{110}} = 1.205.$$

If, in addition, we wish to express field strength in terms of 50 kW. aerial power, instead of 1 kW., we get an additional multiplier of $\sqrt{50}$, since field strength is proportional to the square-root of the power, making in all

$$x = 1.205 \times \sqrt{50} = 8.5.$$

Consequently, the equation for field strength from a half-wave aerial with a power input of 50 kW. becomes

$$e = \frac{2550 \cdot S}{d}$$

where e = field strength in millivolts per metre.

S = the attenuation factor.

d = distance from transmitter, in kilometres.

The constant 2550 is usually referred to as the *ed.* value (sometimes *er.*, where *r* is used to signify distance) and is a measure of the radiated field of the station; it is the value which, if divided by the distance, would give the field strength obtainable for zero attenuation.

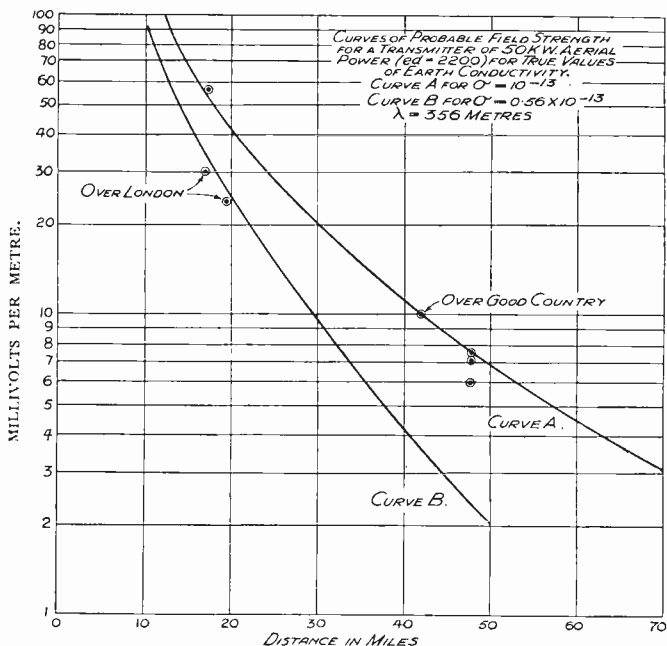

FIG. 2

Fig. 2 shows two curves of field strength calculated for 50 kW. input to an aerial for a wavelength of 356 metres, and a value of ed of 2200. The two curves are for values of conductivity of 10^{-13} and 0.56×10^{-13} respectively. The distance has been plotted in miles for convenience. Field strengths measured in various places are shown for comparison.

Fig. 3 is a curve giving the constant in the equation for field strength for a mast height of 500 feet with 50 kW. into the best aerial possible.

Reference to a geological survey map gives some assistance in showing the position of subsoil of very low conductivity, in particular the presence of red sandstone in North Somerset, North Devon, and Cornwall, and the granite of Dartmoor and Bodmin Moor accounts for the low field strengths obtained in these districts.

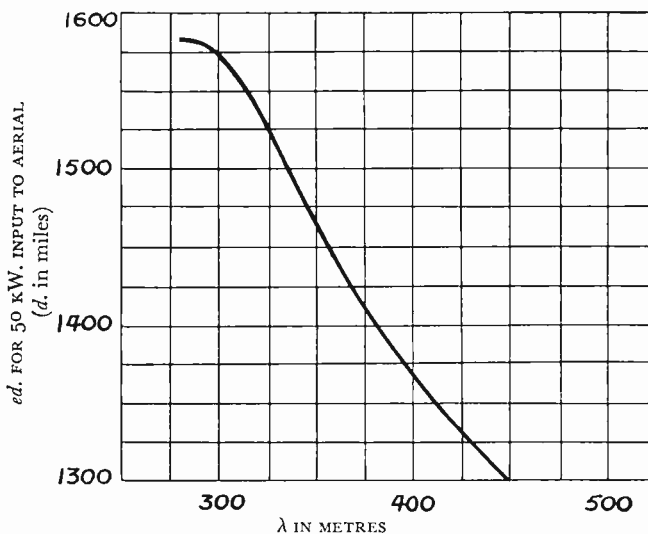

FIG. 3.—RELATIVE AERIAL EFFICIENCY IN TERMS OF FIELD STRENGTH FOR AN AERIAL SUPPORTED BY 500 FT. MASTS

Note.—The maximum aerial height which can be used is that of a $\frac{1}{2}$ -wave aerial.

We come now to the process of measurement itself. Either the electrostatic or the magnetic component can be measured, a vertical aerial being used for the electrostatic component, and a loop or frame aerial for the magnetic. In practice it is usual to use a frame aerial, as any errors due to local effects are shown up by a change in the apparent direction of the arriving wave. Thus the usual method is to receive the signal to be measured on a frame aerial and sensitive receiver, the rectified current due to the signal being indicated on a suitable instrument. The frame is then turned at right angles to the direction of the arriving wave, when no signals should be received, and a signal is fed into the receiver from a local oscillator, the settings of the receiver being left unchanged. The output from the local oscillator is adjusted to give the same rectified current reading as did the signal, when it can be said that the input to the receiver from the local oscillator is the

THIS GREAT WORK MUST BE CARRIED ON

A MOST EARNEST APPEAL is made
for IMMEDIATE DONATIONS for

THE NEW "ARETHUSA" TRAINING SHIP

Moored in the Medway, near
Rochester,

WHERE 230 POOR BOYS
ARE NOW BEING TRAINED
FOR THE ROYAL NAVY
AND MERCANTILE MARINE.

The Old "Arethusa" Training Ship
was condemned by the Admiralty as
worn out and unfit for further Service.
10,000 Boys have been sent to the
Royal Navy and Merchant Service.

**THE SHAFTESBURY HOMES &
"ARETHUSA" TRAINING SHIP
164, SHAFTESBURY AVENUE,
LONDON, W.C.2**

"I consider the CHURCH LADS' BRIGADE

to be the very finest organiza-
tion for the elder lads."

HIS GRACE THE
ARCHBISHOP OF YORK.

**Your Support is Earnestly
asked.**

All communications to:—

The REV. C. M. ARMITAGE,
M.A., Church Lads' Brigade, General
Headquarters, Aldwych House,
Catherine Street, London, W.C.2.

IT IS ALL SHADOW
FOR HOMELESS
CHILDREN

YOU
CAN GIVE
THEM
LIGHT &
HAPPINESS

Contributions gratefully received by the Secretary

WAIFS & STRAYS SOCIETY (GIO) KENNINGTON S.E.11



KEEP YOUR GOOD
DIGESTION BY DRINKING

Marzawatee
—ALL EMPIRE GROWN *Tea*

same as that from the signal. The signal is usually fed in across a low resistance in series with the loop aerial, and the voltage input of the signal from the local oscillator will be the current through the resistance multiplied by the resistance. This will be equal to the E.M.F. induced by the signal to be measured, and if the effective height of the loop is known (it can readily be calculated), the signal strength can be calculated. In practice the current through the resistance—about 1 ohm usually—is too small to be conveniently measured. The normal method is therefore to send out from the local oscillator a much larger current than is required and to measure it; an attenuator or current divider subsequently reduces the current to the required amount. A diagram showing the essentials of such a measuring device is shown in Fig. 4.

Another method is to use a fixed calibrating signal from the local oscillator, usually much larger than the signal to be measured, and to attenuate the local signal by an attenuator in the amplifier itself; usually in the I.F. portion of a superheterodyne receiver. The strength of the signal to be measured is then given in terms of the settings of the attenuators for local and distant signal, and the known fixed input from the local signal generator.

In measuring field strengths, it is usual to fix a measuring set into a motor vehicle of some sort which is stopped for the purpose of making measurements. It is usually necessary to make a number of measurements around one spot point, in order to eliminate any readings which may be incorrect due to local

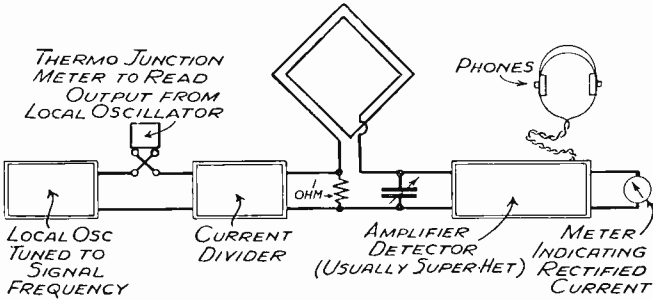

FIG. 4.—ESSENTIALS OF A FIELD STRENGTH MEASURER

effects, such as trees, houses, or telephone wires in the vicinity. This takes considerable time, and to avoid this waste of time a field strength measuring van can be equipped with a meter on the dash-board which can be made to read directly in field strength. The ignition system of the car is fitted with suppressors, and it is possible to read field strength while on the move. This has been found a very useful method of working, particularly in the case of attenuation runs and measurements for a polar diagram. Precautions have to be taken to minimise the effects of vibration, but no serious difficulty has been experienced.

Three types of measurements are normally made:—

(1) Attenuation runs, in which the van travels outward from the transmitter and takes measurements at various distances. This type of measurement indicates readily the nature of the country as regards conductivity and attenuation. The curve of field strength is usually plotted as field strength times distance, against distance, which would give a straight line if there was no attenuation.

(2) Polar diagrams, in which measurements are made at equal distances from the transmitter, in various directions from it. This type of measurement will show up any peculiarity of the site and/or aerial system, such as re-radiation from masts.

(3) Spot readings in towns. These measurements are made in the first instance when testing a site, when a mobile transmitter is used. From these readings the expected average field strength in the town from a transmitter of, say, 50 kW. aerial power is calculated. If the calculations show that the field will provide a satisfactory service, a transmitter is erected on the site being tested. Measurements are taken on signals from the actual transmitter, and are compared with those calculated from the measurements from the test transmitter, as a test of the efficiency of the transmitter. The comparisons are usually within a few per cent., which is considered satisfactory.

The calculation of field strength obtainable from a hypothetical high-power transmitter, from measurements of field

B.B.C. ARTISTS WHO MAKE RECORDS FOR COLUMBIA—

The B.B.C. Dance Orchestra

Directed by HENRY HALL

In Addition to the Latest Dance Music issued Monthly—
hear these :

Sweethearts of Yesterday.

No. DB1030 (2/6).

Two sides. (1) My Old Dutch; Sweet Genevieve; Goodbye Dolly Grey; My Pretty Jane; Alice Where Art Thou?; Dorothy Dean; Clementine; Nelly Bly. (2) Marguerite; Linger Longer Lou; Mary; Eileen Alannah; Sally in Our Alley; Sweet Rosy O'Grady; Maire, My Girl; Come Into the Garden, Maud; My Old Dutch.

Viennese Memories of Léhar.

No. DX472 (4/-).

Two sides: MERRY WIDOW—Waltz; Vilia; The Cavalier. GIPSY LOVE—You're in Love; A Little Maiden; Gipsy Love; Overture; Garden of Love; Love and Wine; Waltz. COUNT OF LUXEMBERG—Say Not Love is a Dream. LAND OF SMILES—You are My Heart's Delight.

The B.B.C. Wireless Military Band

Conducted by B. WALTON O'DONNELL

Woodland Pictures—Rural Suite (*Fletcher*). Two Sides. No. DX465 (4s.)

Rakoczy March (from *Damnation of Faust*) (*Berlioz*) } No. DB1087 (2/6)
Radetzky March (*Strauss*).

Passing of the Regiments (March Potpourri).

No. DB908 (2/6)

Two sides. (1) Belphegor; Battle of Magenta; The Last Stand; Punjab; Sylvia; Teufels; Manhattan Beach; The Happy Warrior; Flash of Steel. (2) Punjab; Prudana; Nevesta; Distant Greeting; Hoch Habsburg; Gallant Serbia; Light of Foot; El Abancio.

The B.B.C. Choir

Elijah—Complete on Fifteen Records.

In Album, £2.

Messiah—Complete on Eighteen Records. In Two Albums. Total £4.

Crucifixion—Complete on Six Records.

In Album, 28/-

Lincolnshire Poacher; Wrap Me up in My Tarpaulin Jacket.

(All above with Harold Williams, Baritone.)

No. DB524 (2/6)

The B.B.C. Wireless Singers

Conducted by STANFORD ROBINSON

It Was a Lover and His Lass; (a) Where the Bee Sucks; (b) Come Let Us Join the Roundelay.

No. DB564 (2/6)

O Who Will O'er the Downs so Free?; O Hush Thee, My Babe.

No. DB770 (2/6)



Write Columbia,
98-108 Clerken-
well Rd., London.
E.C.1, for free
complete list of
their records.

Columbia

strength from a testing transmitter, depend upon a knowledge of the power radiated from the testing transmitter, which depends upon a knowledge of wavelength, aerial current, and effective height. It has been the practice to determine the effective height of an aerial from measurements of field strength at a distance of a few wavelengths from the transmitter. This method, however, is entirely unsuitable for the purpose being discussed, as such a method presupposes negligible losses between the transmitter and point of measurement, whereas it is the object of the subsequent measurements to determine any losses. Further, the field strength depends considerably upon locality and surroundings, and its measurement cannot be relied upon to give an accurate measure of effective height.

The most satisfactory method is either to calculate the effective height, or compare the field strength obtained from the aerial whose effective height is required to be known, with that from an aerial whose effective height is readily calculable, and from these measurements and readings of aerial current to calculate the effective height. Comparison of these two methods has shown that the method of calculation employed is sufficiently accurate.

The method of calculating the field strength for the proposed transmitter is simple, and consists of determining the power radiated from the testing transmitter, viz. :—

$$W_r = \frac{1580h^2I^2}{\lambda^2}$$

and from this calculating a multiplier, taking into account wavelength, height of masts, and power of the proposed transmitter as described above.

MODULATION RECORDING

*“The moving Finger writes, and having writ moves on. Nor all their piety
nor wit
Shall lure it back to cancel half a volt; nor tears wash out a decibel
of it.”*

WHAT IS KNOWN as depth of modulation in a broadcast transmitter is the ratio of the amount by which the carrier wave is varied, in accordance with the speech, music or other impulses transmitted, to the steady or unmodulated carrier wave.

The carrier wave is sent out whether any modulation is present or not, and the power in the carrier wave is what is normally known as the power of the station. For example, British regional transmitters are normally rated at 50 kilowatts, which means that the carrier wave energy in the aerial is 50 kilowatts. This power is varied by the electrical impulses which are caused by sound waves striking the microphone.

Although the carrier wave always exists and transmits considerable energy, this energy is not useful; it is only the modulation or variation of the carrier wave which is useful. It would in some ways be more economical if the carrier wave were not transmitted but supplied at each receiver. Such a scheme, although common in commercial telephone communication, is impracticable at present so far as broadcasting is concerned for reasons which cannot be discussed here. It is not, however, a complete impossibility for the future.

Since it is the variations of amplitude which cause energy, corresponding to the programme to be conveyed to the receiver, and since the effectiveness of a system is the ratio of signal amplitude to unwanted noise, such as atmospherics, other electrical disturbances and interference from other stations, it is important to keep the variations in amplitude as great as possible. For full modulation of 100 per cent. the amplitude of the carrier wave is reduced to zero or increased to twice its steady value. If the variations be greater than this, however, distortion is bound to occur, and for successful broadcasting a compromise has to be made in order to keep the average level of modulation high without overloading on the peaks or losing the contrasts in volume which are necessary for good entertainment

value. It was explained in the 1932 issue of the Year-Book (page 355) that it is necessary to control the modulation and to keep a constant check.

In order to keep a still greater check and to obtain written evidence, an apparatus for recording modulation has been developed.

There are several possible methods of recording the modulation or variation of amplitude of the carrier. One method is to receive the required signals on a good receiver, to rectify the audio-frequency signal output from the receiver, and pass it through a recorder such as a moving-coil instrument with a pen instead of a pointer. This is the simplest method, but there are others, such as chemical recording and light recording. The first method has been more used, although the light method was seriously considered at one time.

Many attempts have been made from time to time to record modulation in a satisfactory manner, but most of these have failed for two reasons. First, the inertia of the moving parts of the recorder was too great, causing sluggish movement and unreliable readings; and secondly, most of the rectifiers for converting audio-frequency impulses to fluctuating D.C. for working the instrument, operated on either a square or a linear law. In a linear law rectifier the output—fluctuating D.C.—will be proportional to the input—audio-frequency alternating current—while in a square-law rectifier the output will be proportional to the square of the input. The reading on the chart will normally be proportional to the output of the rectifier.

In broadcasting, the variations of amplitude met with in normal circumstances is of the order of 1000 : 1 or 60 decibels; this, as was explained in the article already referred to, has to be reduced to about 30 decibels (30 or 40 to 1) for useful broadcasting to-day. With a square-law instrument the output amplitude would become a 900 : 1 variation, which would be absurd on a strip of recording paper two or three inches wide, where a mark of less than about one-tenth of the maximum width does not give a sufficiently accurate indication of the level. Even with a linear law most of the time the variations are too small for any accurate estimate of the level to be determined. With a logarithmic law, however, any variation can be accommodated theoretically and the degree of accuracy with

“Sterno”

Gramophone RECORDS



are always “first in the field” with all the latest vocal and instrumental “hits” popularised by broadcasting. Nationally famed Artists, perfect recording, superlatively high-class material and superb finish all contribute to that matchless degree of excellence for which “STERNO” Records are universally renowned.

There is a finesse about the playing qualities of every “STERNO” which appeals particularly to connoisseurs of gramophonic music. Every note is true—every word distinct. Surface noise in the needle track and “scratch” are eliminated by our unique and scientific process of manufacture. Hear these super Records play at your local Dealers, or write for catalogue which offers an almost unlimited variety of musical masterpieces by the world’s best dance bands and the greatest virtuosos of the age.

10-in. Symphonic
1/6

10-in. Long Playing
2/-

12-in. De Luxe
2/6

THE BRITISH HOMOPHONE COMPANY LTD., Barry Rd., Stonebridge Park, London, N.W.10.

SALVAGING WAR'S WRECKAGE

TIME heals. Memories of the war are becoming dim. But in the complacency of peace we must not forget those who suffer still from THE LINGERING WOUNDS OF MENTAL DISABLEMENT. The Ex-Services Welfare Society is straining its resources to do justice by those who have sacrificed all but life itself. At the Sir Frederick Milner Homes at Beckenham and Leatherhead nervous wrecks are being transformed.

The Society depends solely on the generosity of the public. Will you kindly send a donation to-day to Admiral Sir Reginald Tyrwhitt, Bart., President, THE EX-SERVICES WELFARE SOCIETY (Registered under the War Charities Act 1916) 53 Victoria St., London, W.1.

In
One Year

10,000 applicants for help interviewed. Over **2,000 beds** and **6,000 meals** given to destitute.

3,353 deserving cases given money grants, and **291 issues of clothing** made.

Many hundreds of new pension cases investigated and **old cases** reviewed.

Ex-Services Welfare Society
pleads for your Sympathy and Support

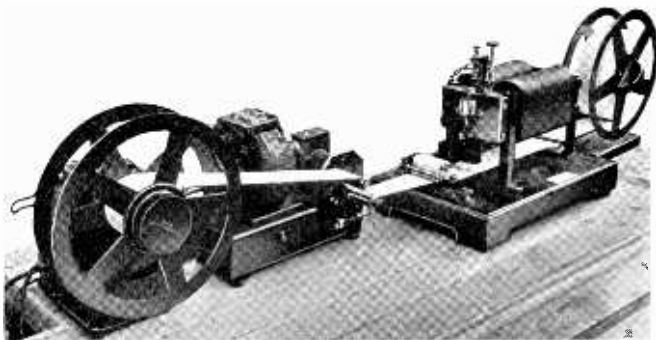

SYPHON RECORDER AND PAPER DRUMS USED FOR MODULATION RECORDING

which the chart can be read will be the same on all parts of the scale; but the greater the variation the less will be the accuracy.

In this respect, of course, there is no difference between an indicating instrument and a recording instrument, and it was the design of a suitable apparatus for operating an indicating instrument which made possible the design of satisfactory recording apparatus. A description of a logarithmic rectifier was given in *World-Radio* for February 26th, 1932. The apparatus has been called a programme meter for want of a better name.

THE RECORDER

The solution to the recorder problem lay in the adaptation of a syphon recorder such as is used for submarine telegraphy. A syphon recorder consists of a light coil suspended by fine phosphor bronze wires in the field of a strong magnet. Attached to the coil is a very thin glass tube. One end of the glass tube rests lightly on the record paper, while the other dips into an inkwell. As its name implies, the glass tube acts as a syphon and conveys ink from the inkwell to the paper. The moment of inertia of the moving parts is very small, and consequently very rapid movements are possible. The movement has a resonant frequency of a fraction of a second, and damping is provided

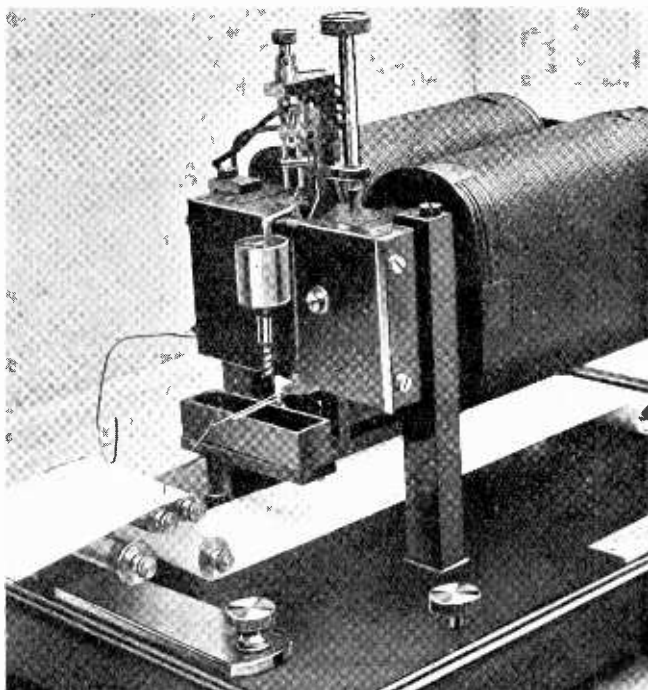

SYPHON RECORDER

by means of a vane attached to the moving coil and dipping into an oil bath. The amount the vane dips into the bath controls the damping, which is usually adjusted so that the movement is just dead beat.

The recording paper is 2 inches wide, and is subdivided and ruled as shown in the figures. The divisions correspond to divisions on the instrument which is used to indicate levels when controlling programmes, and each division corresponds to a change of level of 4 decibels which is approximately 1.6 : 1 in amplitude or 2.5 : 1 in power. As can be seen from the figures, the scale has two calibrations: one in numbers 0-7 corresponding to the divisions on the indicating instrument used for

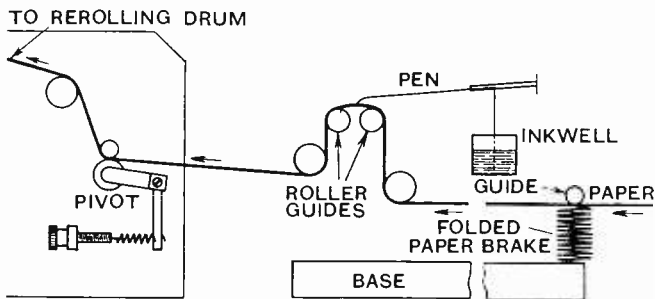

SCHMATIC DIAGRAM OF SYPHON RECORDER

controlling, and the other in decibels below 80 per cent. peak modulation, which is the maximum normally catered for in B.B.C. stations, as it has been found in practice that this value gives the most efficient all-round conditions.

CALIBRATION

The recording apparatus is normally used in conjunction with a receiver, and may be situated at considerable distances from the transmitter. In fact, recording is possible anywhere where the signal-to-noise ratio is sufficiently great, provided certain precautions are taken.

The modulation, as has been stated, is related to the carrier wave in amplitude, and for this reason recording apparatus can be calibrated in terms of the carrier amplitude in any convenient part of the receiver. The most convenient part is the detector, where the rectified carrier gives rise to a change in current which can be measured. The current passes through a resistance, and if the resistance and the current be known, the voltage developed across the resistance can be calculated. If certain types of rectifier are used, the voltage change across the resistance will be proportional to the carrier-wave amplitude, and the ratio of the variation of this voltage change to the voltage will be equal to the ratio of carrier variation to carrier amplitude, and this to the modulation depth. The remainder of the apparatus can be calibrated by applying known values of alternating voltage and adjusting the apparatus to give the necessary readings on the recorder.

DEEPEST BASS

to

HIGHEST TREBLE

You get every note
if you use

**McMichael Super Ranger
Port. needs these**

For best performance fit these
Ever Ready Batteries: H.T.
Port. 18; L.T. 2401 — both
made specially for this set.
Or simply ask your dealer for
the Ever Ready List, showing
all popular makes with their
special Ever Ready batteries.
Your set will be powered per-
fectly by its appropriate Ever
Ready Batteries.



**WIRELESS
BATTERIES**

made particularly

to power your set

THE EVER READY CO. (GREAT BRITAIN), LTD., HERCULES PLACE, HOLLOWAY, N.7.

When used to record the modulation depth of British Stations, advantage is usually taken of what is called the lining-up tone. This is a pure note of approximately 1000 pps. which is used to adjust the various amplifiers, transmitters and level indicating instruments, and its amplitude at the transmitter is normally adjusted so that a peak modulation depth of 30 per cent. is obtained when the level indicating instruments at control rooms are adjusted to read maximum, and consequently if the recording instrument is also adjusted to read maximum it will be calibrated in terms of percentage modulation at the transmitter and level at the control room.

It may be wondered why, during calibration, only 30 per cent. modulation is used, while the level indicating instruments read maximum. The reason is that the wave form of music and speech is not pure, and the peak value will be much higher than that of a sine wave of equal R.M.S. or average value. Therefore, since a pure tone is usual for calibrating, allowance must be made for the greater peaks which will occur on programme. A pure tone is used for calibration because of its known fixed ratio of peak to mean voltage. Neither the record nor the indicating instrument indicates true peak percentage modulation, but both, when suitably calibrated, serve as a very good indication of the probable peak modulation, which can be determined by other means.

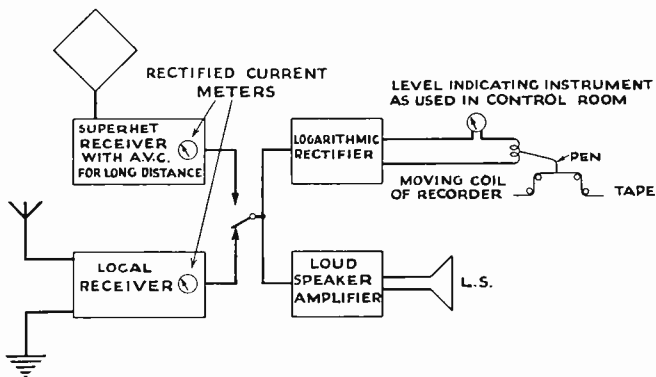

SCHMATIC DIAGRAM OF APPARATUS FOR RECORDING MODULATION

The Drum behind the Band

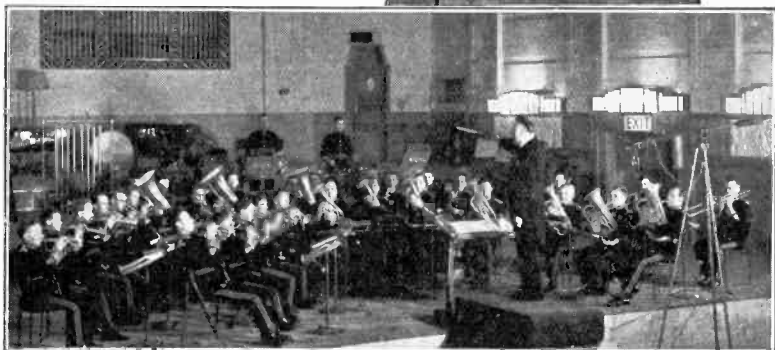

Reproduced by kind permission of the British Broadcasting Corpn.

Callender's Band in the Concert Hall, Broadcasting House.

CALLENDER'S hope that you have enjoyed the broadcasts given by their well-known Band. Hear them on an "all-mains" set for preference! However, if your house is not wired for electricity, then Callender's have another good thing to introduce to you—the Callender Wiring System. This neat and practical system defeats all the old arguments against "having the electric light put in," being quickly and easily installed without damage to the walls and ceilings. The Callender Wiring System is giving complete satisfaction in thousands of modern homes. Why not in yours?

ASK YOUR ELECTRICAL CONTRACTOR FOR PARTICULARS AND PRICES.

Callender "Kalibond" Metal-Sheathed Cable.

Callender "Kaleeco" Metal-Sheathed Cable.

Callender "C.T.S." Rubber-Sheathed Cable.



CALLENDER'S
CABLE & CONSTRUCTION CO., LTD.
Hamilton House Victoria Embankment, London E.C.4.
Telephone Central 3281 Telegrams: Callender 3107, London.

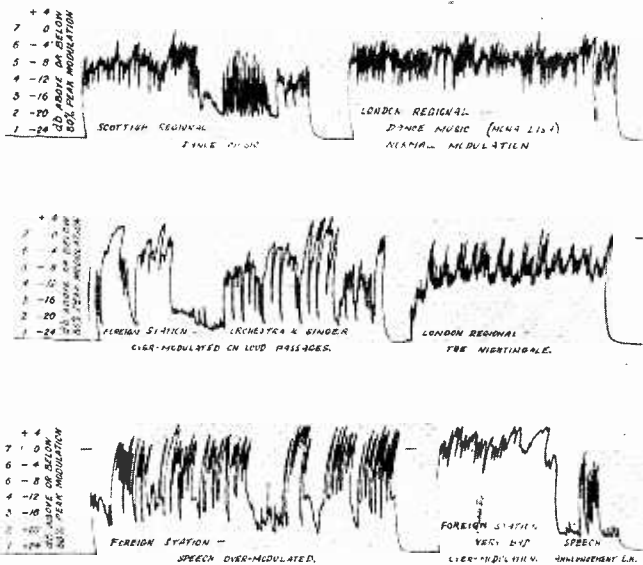

SOME MODULATION LEVEL RECORDS

The recording modulation meter has several uses. It can be used to keep a check on the control of modulation so that any tendency to under- or over-control may be checked. The nature of the item being broadcast is taken into account in checking records. For example, one does not expect a pianissimo passage to modulate to the same extent as a fortissimo passage. It can be used to keep watch on a suspected faulty transmitter or lines, and also to keep watch on any station suspected of causing interference by over-modulation.

When used to record the modulation of stations at considerable distances when fading occurs, it is necessary to use automatic volume control in the receiver to keep the input to the detector constant. The A.V.C. must be of such a type that the signal strength is kept very constant—within say 5 per cent. or better—over fairly wide variations of signal strength, otherwise the reading of modulation on the record will not be a true

indication. Fortunately the problem is not difficult, and there are several methods which may be employed.

The first satisfactory piece of apparatus used in this country to record the modulation of distant stations consisted of a superheterodyne type of receiver with a diode second detector, followed by a low-frequency amplifier, logarithmic rectifier and syphon recorder. The superheterodyne receiver employed one stage of screened grid H.F. amplification, separate first detector and beating oscillator and two stages of intermediate frequency amplification. The A.V.C. operated on the grid of the first H.F. valve—a variable-mu valve—via a two-stage battery-operated D.C. amplifier which was operated from the output of the diode second detector. For local station recording a straight set employing one-screened grid H.F. stage preceding a diode detector was used, volume control being operated by hand as fading was inappreciable.

A low-pass filter circuit cutting off at 7000 cycles per second is used in the low-frequency circuits in order to remove all traces of the heterodyne whistle due to neighbouring stations.

A schematic diagram is shown on page 368. Photographs of the original apparatus and some records taken with it are shown in the preceding pages.

The recording apparatus has now been installed at the Tatsfield Listening Station, and operates from any of the relaying receivers which are equipped with A.V.C. A specially highly selective receiver with a flat frequency characteristic up to 6000 cycles per second is being designed to operate the recorder. It is of course necessary that the overall frequency characteristic of the receiver shall be flat up to at least 3000 pps., otherwise inaccuracy will result.

The present recorder is not completely satisfactory. Fairly frequent—at least daily—adjustment is required, and the instrument is affected by temperature. It is probable that steps will be taken to obtain an instrument which is free from these defects, as it is highly desirable that an instrument used for this purpose should be wholly above suspicion, and should not require frequent adjustment or calibration.

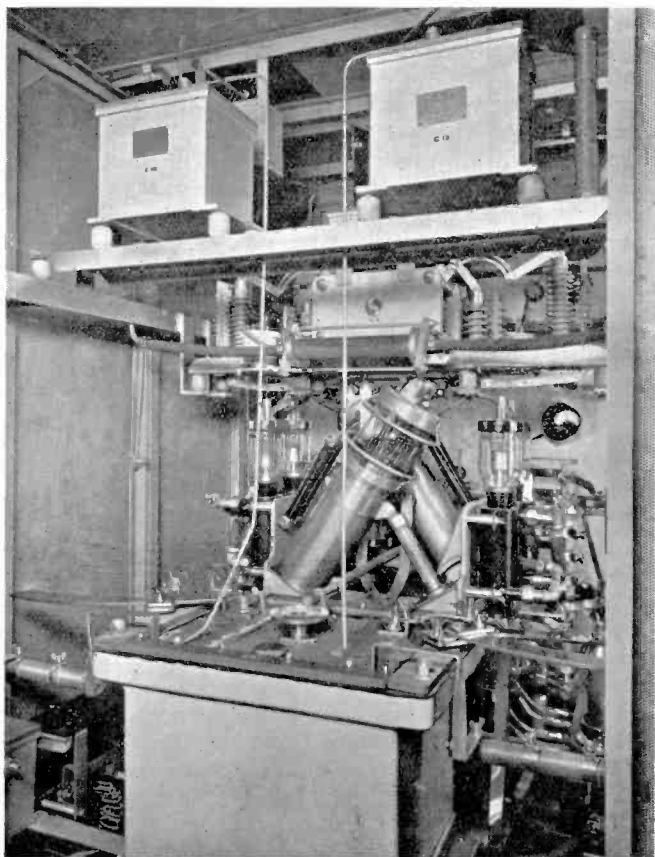

A VIEW OF THE INSIDE OF A POWER-OUTPUT STAGE OF ONE OF THE
EMPIRE TRANSMITTERS

AERIAL SYSTEMS FOR THE EMPIRE STATION

AERIAL SYSTEMS FOR short waves (12-50 metres) differ from those for medium and long waves mainly because the dimensions are such that it becomes convenient to erect systems, or arrays, of a complicated nature.

The fundamental element of length as far as an aerial is concerned is a half wavelength. The reason is that if in any conductor carrying alternating-current, standing waves are present, due to one or both ends of the conductor being either open circuited (insulated) or earthed, the direction of current at any instant of time is reversed in each half wavelength of conductor. For example, if we have a conductor, say, 40 metres long, and by some means cause a current in it having a frequency corresponding to a wavelength of 20 metres, the far end of the conductor being free, the state of affairs at a particular instant of time will be that the current in the half wavelength of wire next the free end is in one direction, while that in the next half-wavelength is in the reverse direction and so on. All the currents alternate in direction every half-cycle, but their relative direction is the same. In addition to the change of direction, the amplitude of the current is different in each part of the conductor. At the free end it is zero; in the centre of the first half wavelength it is maximum; at the end of the first half wavelength the current is minimum (zero if the resistance is zero) and a change of phase or direction takes place, and so on. The state of affairs is shown in Fig. I, where for convenience in illustrating it is assumed that the conductor has zero resistance. In practice the resistance is fairly high, and in an efficient system mostly due to radiation. If the current is fed into a half-wave aerial in its centre, the current distribution will be as shown in Fig. II, in which a transformer is used to couple the aerial to a transmission line.

DIRECTIONAL AERIALS AND FIELD INTENSITY DIAGRAMS

The reason for the use of the half-wavelength aerial as an element is that, since the currents in alternate half wavelengths are in opposition, the radiation from each half-wave element

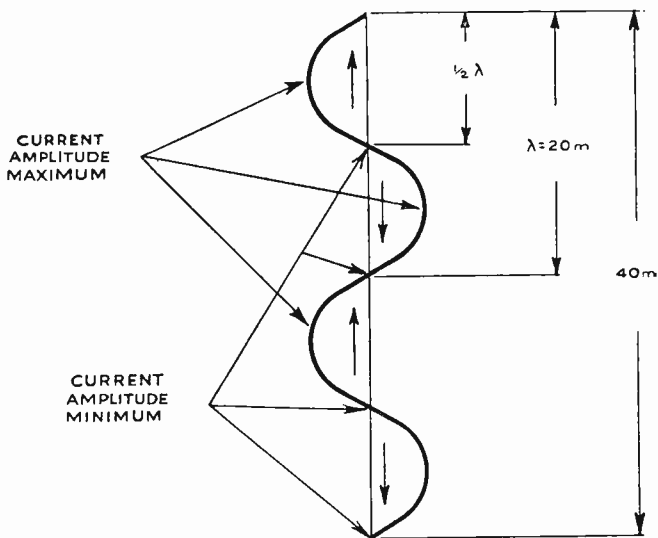

Note 1.—Instantaneous current direction shown by vertical arrows thus \uparrow or \downarrow .
 Note 2.—The distance from the wavy line to the straight line represents current amplitude.

FIG. I.—CURRENT DISTRIBUTION IN A STRAIGHT WIRE OF LENGTH GREATER THAN $\frac{1}{2}\lambda$

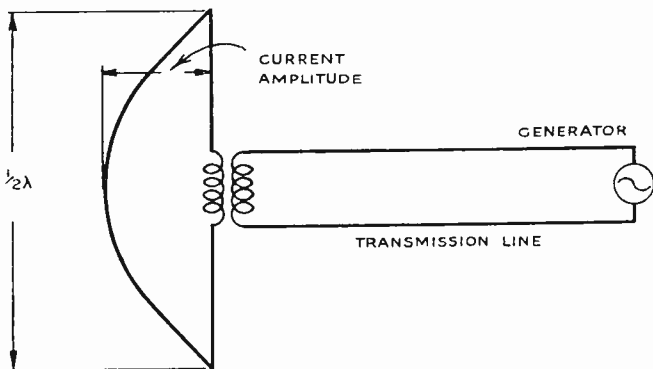

FIG. II.—CURRENT DISTRIBUTION IN A $\frac{1}{2}\lambda$ AERIAL FED IN ITS CENTRE

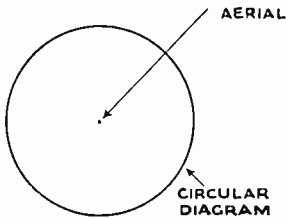

FIG. IIIa.—HORIZONTAL RADIATION

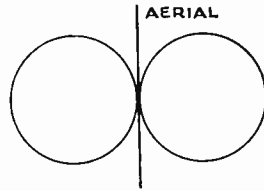

FIG. IIIb.—VERTICAL RADIATION

VERTICAL AERIAL IN FREE SPACE

cancels that due to the next in the direction at right angles to the aerial. The radiation from a half-aerial in space is zero in directions along the line of the aerial, and maximum at right angles. A diagram representing field intensity at all angles would look very much like a "toroid," *i.e.* a solid ring of circular crosssection, the inside diameter being zero. This diagram is known as the solid radiation diagram, or solid polar diagram. Fig. III(a) shows a section of such a diagram looked at end on from the aerial, while Fig. III(b) shows a section looked at at right angles to the aerial. In the case of a vertical aerial the former is called the horizontal polar diagram, while the latter is called the vertical polar diagram. In the case of a horizontal aerial the diagrams are reversed. If the aerial is situated at or near the earth's surface, the diagram is somewhat modified due to reflection from the earth, and a certain amount of energy is absorbed by the earth.

In a short-wave aerial system we are not concerned with radiation along the ground as we are in the case of normal waves of 200–2000 metres and upwards. All long-distance short-wave transmission takes place by reflection from the Heaviside layer or layers. Short-wave transmission along the ground is extremely inefficient, so much so that in some cases signals are attenuated by a few miles along the ground to about the same strength as those which have travelled vertically to the Heaviside layer and have been reflected back, the total distance from the earth to the Heaviside layer and back being between 200 and 600 kilometres, according to wavelength and conditions generally.

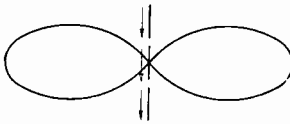

FIG. IVa.—VERTICAL DIAGRAM OF VERTICAL AERIALS STACKED VERTICALLY

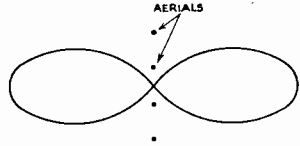

FIG. IVb.—HORIZONTAL DIAGRAM OF AERIALS ARRANGED IN A LINE HORIZONTALLY

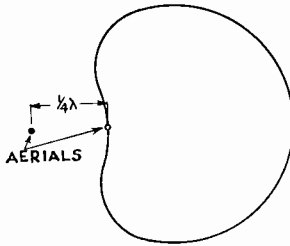

FIG. Va.—HORIZONTAL DIAGRAM OF TWO AERIALS ARRANGED $\frac{1}{4}\lambda$ APART, ONE BEHIND THE OTHER, WITH CURRENT 90° OUT OF PHASE

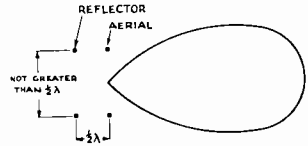

FIG. Vb.—HORIZONTAL DIAGRAM OF TWO HALF-WAVE AERIALS SPACED $\frac{1}{2}\lambda$ APART, EACH WITH A REFLECTOR

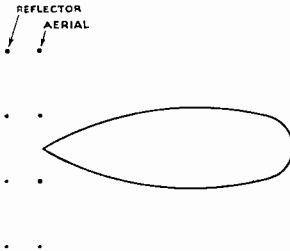

FIG. Vc.—HORIZONTAL DIAGRAM OF FOUR HALF-WAVE AERIALS SPACED $\frac{1}{4}\lambda$ APART, EACH WITH A REFLECTOR

The radiation diagram may be considerably modified by using a combination of aerials. For example, if a number of vertical half-wave aerials are stacked one above the other and the currents arranged all to be in the same direction or phase, the vertical diagram will be modified as in Fig. IV(*a*), while if a number of vertical aerials are arranged in a horizontal line at distances apart not greater than half a wavelength, and with all the currents in the same phase, the horizontal diagram will be modified as shown in Fig. IV(*b*). Two vertical aerials arranged one behind the other a quarter wavelength apart and with currents 90° out of phase will give the horizontal diagram shown in Fig. V(*a*). If instead we feed current into one aerial only, and allow the other to pick up current from it, the result will be almost the same; that is, the currents will be 90° out of phase and almost equal in amplitude. The free aerial is said to be a reflector. Figs. V(*b*) and V(*c*) show horizontal radiation diagrams of two and four element arrays, with reflectors.

When it is desired to send waves particularly in any one direction it is very economical to use such directional aerials, as the gain in the required direction is considerable. An appreciable gain can also be obtained by concentration in the vertical plane in certain circumstances. The efficiency of any directional system is usually spoken of as the gain above the radiation from a single half-wave aerial, and is usually expressed in decibels.*

In the simple case of one half-wave element with a reflector, the gain in the direction of maximum radiation over a single half-wave aerial is 3 decibels or 2 : 1 in power, while for more complicated arrays the gain may be 10 decibels or even more. A gain of 10 decibels means that the radiation in the direction of maximum radiation is equal to that given by a single half-wave aerial with 10 times the power input.

* Decibels = $db = 10 \log_{10} \frac{p_1}{p_2}$, where p_1 and p_2 are the two powers.

TYPES OF SHORT WAVE DIRECTIONAL AERIAL ARRAYS

There are various elaborations and combinations of the simple systems already mentioned which may be used to give directional effects, and as is usual in these matters, it is somewhat difficult to choose which is the best array for any particular purpose, as considerable difference of opinion on the subject exists.

The design of economical and convenient aerial systems for the Empire Station is a somewhat complicated matter, as it is necessary to take into account several factors, two of which are:

1. The most convenient time of transmission, from the point of view of time of reception in various parts of the Empire.
2. The best wavelength, having regard to the fact that the efficiency of transmission on different wavelengths depends upon the time of day and season of the year at each part of the path of the wave.

For example, consider the case of a transmission from England to New Zealand, the time in England being 8 a.m. G.M.T. and the date June 1st. It will be summer in England and daylight; over mid-Russia the sun time (the term "sun" time is used to differentiate from the "mean" or clock time of the district) will be three hours later, *i.e.*, 11 a.m.; over Mongolia (Lake Baikal) the sun time will be seven hours later, *viz.*, 15.00 or 3 p.m.; over New Guinea in the equatorial region the time will be nine hours later, *viz.*, 17.00; over Brisbane, ten hours later—18.00 or 6 p.m. midwinter, when it will be dark; in New Zealand the sun time will be 19.40 or 7.40 p.m. midwinter, and again dark. In this case it will be necessary to choose a wave which will be efficiently transmitted by the Heaviside layer when the greater part of the path is in daylight and summer conditions, but some of it in darkness and winter conditions. In winter in the Northern hemisphere a different state of affairs will exist, and therefore it may be necessary to use a different wavelength.

Seven wave-bands in the short-wave-band between 11 and 50 metres are allotted to broadcasting. These are around 11.5, 14,

17, 20, 25, 31 and 49 metres. The waves, frequencies and call signs allotted to the Empire Station are as follows:—

Call Sign.	Wavelength (metres).	Frequency (k.c.).
GSA	49·59	6,050
GSB	31·55	9,510
GSC	31·30	9,585
GSD	25·53	11,750
GSE	25·28	11,865
GSF	19·82	15,140
GSG	16·86	17,790
GSH	13·97	21,470

The aerial systems originally installed were such as would give a reasonable performance at a moderate cost, it being the intention to try out other systems subsequently as occasion arose, and as experience regarding the performance of the various aerials was gained.

Two types of aerial were used: directional aerials directed towards specified zones, and non-directional (or, colloquially, “omni-directional”) aerials for use in transmitting the same wave or waves in all directions simultaneously. In both types of aerials the half-wave aerial elements and the methods of coupling to the transmission lines are similar.

Each element consists of a wire somewhat less in length than half the working wavelength, with an inductance in the centre the value of which is such that the aerial element is tuned to the desired frequency, and that the impedance across the inductance is convenient for connecting to the transmission line.

It is almost universally the practice in short-wave systems to locate the aerial at some distance from the transmitter building, and to connect the two by a transmission line.

Fig. VI is a plan of the Empire Station at Daventry showing the various aerial arrays as originally installed, while Fig. VII is a Great Circle map of the world, the great circles all passing through England. In a Great Circle map all directions shown are “true” (*i.e.* minimum paths on a sphere), and all distances from the centre of projection to any point are correct. The distortion of shapes, which, as will be perceived, is enormous at the further limits of the map, has to be accepted. It is un-

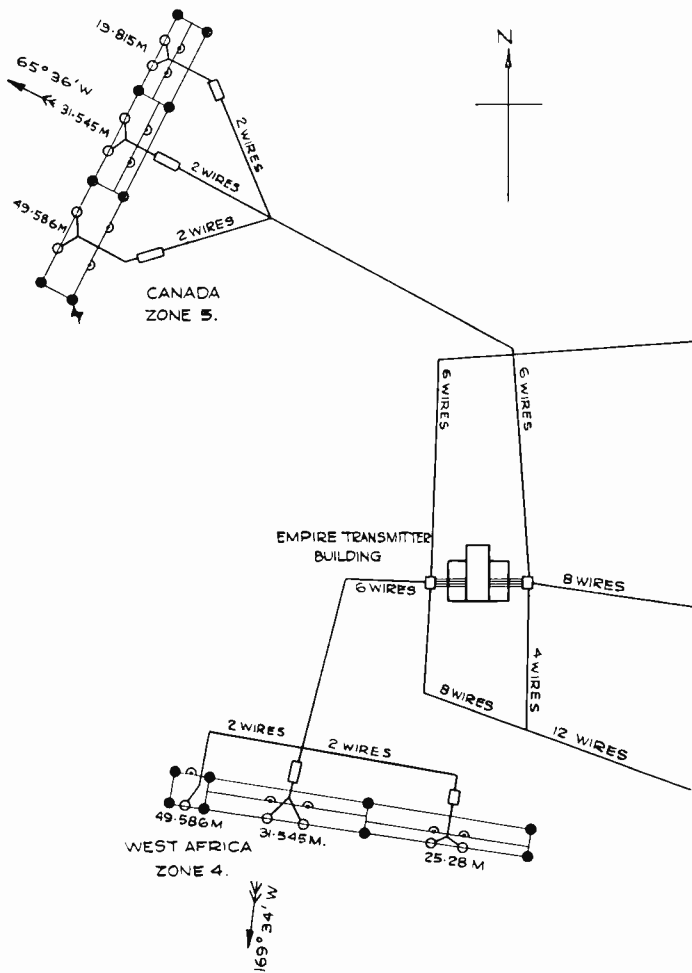
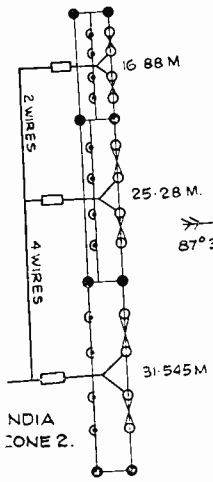

FIG. VI.—THE LAY-OUT OF THE ORIGINAL



- DENOTES MAST
- DRIVER
- REFLECTOR
- DRIVER-REFLECTOR (SEE BELOW)
- IMPEDANCE MATCHING TRANSFORMERS

THE DIRECTION OF RADIATION OF EACH ARRAY IS SHOWN THUS \Rightarrow

THE AUSTRALIAN ARRAY CAN BE USED TO RADIATE IN DIRECTION "X" OR "Y," FOR RADIATION IN DIRECTION "X" B & C ARE DRIVERS & A & D ARE REFLECTORS & VICE-VERSA FOR DIRECTION "Y."

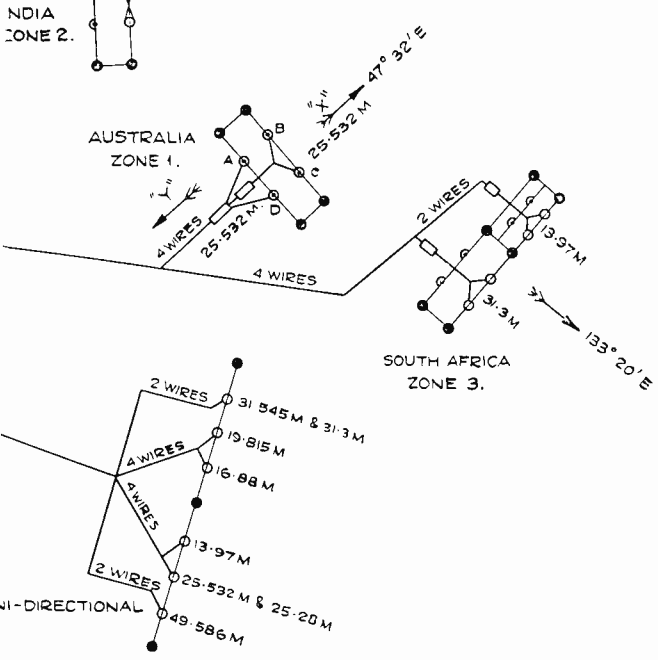

AERIAL SYSTEM OF THE EMPIRE STATION

MAP OF THE WORLD ON PLETT'S ZENITHAL AZIMUTHAL GRATICULE
 GIVING THE TRUE DISTANCE AND DIRECTION OF EVERY POINT
 FROM LONDON

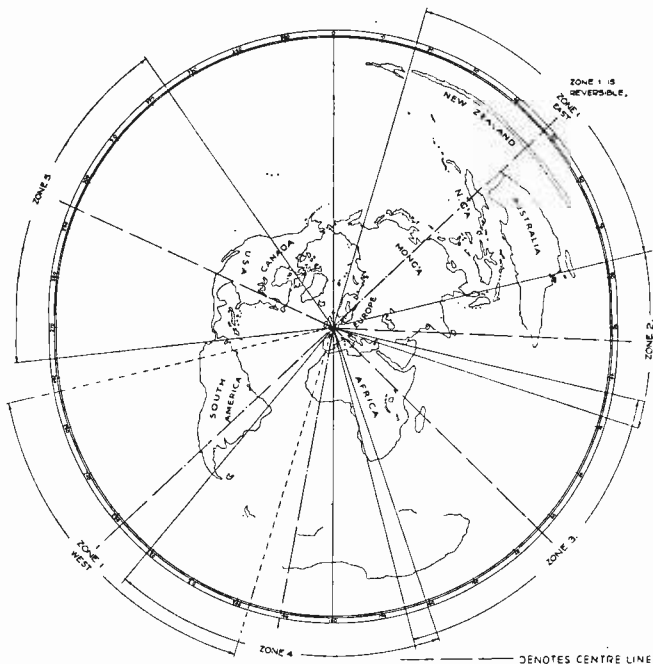

ZONE MAP.
 FIG.VII.

(Reproduced by permission of "The Wireless World")

THE APPROXIMATE BOUNDARIES OF THE ORIGINAL EMPIRE ZONES
 HAVE BEEN ADDED FOR PURPOSES OF ILLUSTRATION

important in this connexion, and no projection exists by which distances, directions, shapes and areas can all be rendered. For example, on a Mercator's Projection map of the world the direction of Montreal from Daventry is shown as about 97° West, whereas the true or Great Circle bearing is 66° West. This is well shown up in Fig. VII, where the directions of the arrays are not those one is accustomed to see on looking at an ordinary map of the world.

It will be seen that for the Indian Zone a four-element array was provided and for the remainder, two-element arrays. A four-element array has a narrower beam and greater concentration in the required direction. It is not possible to use such a narrow beam in the case of Australasia, as will be seen from the Great Circle map (Fig. VII).

The aerial systems shown in Fig. VI were erected as part of the original station, and were intended as a commencement of experiments and research into the suitability of various types of aerial array. Broadcasting differs from point-to-point communication in that much larger areas have to be covered, and the aeriels which have been found suitable for point-to-point service are not necessarily the best for broadcasting.

Attenuation of short waves passing along the ground is high, and considerable energy is absorbed by the earth. For this reason elevated aeriels have been used in some cases to reduce the loss of power in the earth due to the proximity of the aerial to the earth.

Some experiments have been made at the Empire Station with elevated horizontal and vertical half-wave aeriels, and as a result of these experiments horizontal half-wave aeriels for 17, 20, 25, 31 and 49 metres have been erected on triatics between the masts of the Daventry 5XX station and spare hal-yards; these aeriels have so far given very encouraging results, and in some cases are used in preference to the original aeriels. It is proposed to continue experiments on these lines as well as to try out other types of aerial systems which have been developed.

THE SHAFTESBURY SOCIETY



(Ragged School Union
1844)

Patrons: Their Majesties
The King and Queen.

FOR 89 YEARS THE
WELL-KNOWN
FRIEND OF

LONDON'S POOREST CHILDREN

8,300 Cripples receiving help of
varied kinds.

12,000 Fortnights' Holidays given
last year.

174 Associated Missions.

*Donations are urgently invited and should
be sent to:*

ARTHUR BLACK, General Secretary,
John Kirk House, 32, John Street, W.C.1

Treasurers: SIR EDWIN DODD;
WALTER SCOLES, ESQ.

Legacies Requested.

15th EDITION printing of
of
LORD

WAKEFIELD'S ON LEAVING SCHOOL

invaluable book

and the Choice of a Career

3/6 NET OF ALL BOOKSHOPS
HODDER & STOUGHTON

Succouring suffering Humanity

of all Sorts and Conditions
according to their varying
needs is the vital work of the

CHURCH ARMY

IT HELPS

MEN in Labour Homes; in
and out of Prison; in
Employment Bureaux; in Disabled
Men's Workshops, etc.

WOMEN in Classified Homes,
Clubs, etc.

CHILDREN Motherless,
Rescued, etc.

Support given to C.A. Work benefits
the individual and the community.

Gifts welcomed by
PREBENDARY CARLILE, C.H., D.D.,
55, Bryanston Street, London, W.1.

FRIENDS OF THE POOR

(Incorporated)

40 & 42, Ebury Street,
London, S.W.1

Royal Patron:
H.M. THE QUEEN

President:
H.H. PRINCESS MARIE LOUISE.

Hon. Secretaries:
MISS COLLIN, C.B.E.
MRS. H. R. BROMLEY-
DAVENPORT, C.B.E., J.P.

Hon. Treasurers:
LORD CLIFDEN.
MR. G. BROMLEY-MARTIN.

Plead for funds to assist all
classes and denominations in
times of illness and distress.

THE BOAT-RACE TRANSMITTER

THE ANNUAL running commentary on the boat race is given from the launch *Magician*, which follows the race from start to finish. To provide a flexible link between the launch and the shore, a low-power short-wave transmitter is carried on board and the signals are picked up by a receiver half-way along the course and sent by land line to Broadcasting House.

The present transmitter, constructed for the 1933 race, replaces that used since the occasion of the first broadcast of the race, and represents a considerable saving in space and weight. The accompanying diagram shows how the apparatus is disposed aboard the *Magician*. The commentator sits in the bows, the transmitter is installed in the stern, and the batteries and other heavy articles are spread out as much as possible in order to keep the launch in good trim. An inverted L aerial, runs the length of the boat on masts 12 feet high, and the earth connection is made to a copper sheet on the keel.

A moving-coil microphone, being little affected by wind, is used; two of them being housed in an open-fronted box lined with sound-absorbing material. The box is so arranged that it can be tilted up to the commentator's face and so localise the sounds received, thus minimising the noise picked up from the boat's engine. The output from the microphone is taken to a two-stage low-frequency amplifier. Two amplifiers, each connected to one microphone, are enclosed in a metal box together with all batteries. In this way there is complete duplication of the speech input apparatus, and owing to the screening, high-frequency pick-up is avoided.

The transmitter is enclosed in an aluminium box with four compartments, containing the crystal-controlled drive, intermediate high-frequency amplifier, modulator stages and modu-

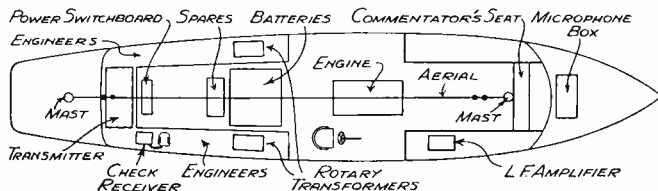

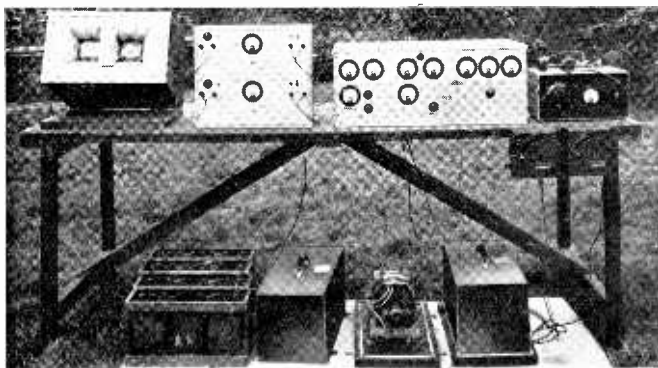

THE APPARATUS USED ON THE "MAGICIAN"

lated amplifier. The output of the drive is magnified in the intermediate H.F. amplifier which impresses carrier frequency volts upon the grid of the modulated amplifier valve to the anode of which the aerial is coupled. The speech input is taken through two L.F. amplifying valves in the transmitter to the two-modulator valves in parallel. The anode circuit of these valves is transformer coupled to that of the modulated amplifier, high-power modulation being thus effected.

With 25 watts delivered to the aerial, a satisfactory ratio of signal to background noise is obtained over the longest working range, that is to say, when the launch is beyond the finishing post. The transmitter is capable of 80 per cent. modulation and shows a practically flat frequency characteristic up to 7000 cycles. It weighs just under 100 lbs., is completely waterproof, and has been designed to stand continuous vibration. It may be picked up and dropped several inches during transmission with no noticeable effect on the received signal.

The high-tension supply is provided by a rotary transformer with an output of 1000 volts 200 milliamps, run from an input of 24 volts from accumulators. The filament lighting current of 10 amps is taken from a 6-volt battery. The entire power-supply arrangements are duplicated, in case of breakdown, and the batteries on board are sufficient for 6 hours continuous transmission.

REGIONAL CONTROL ROOMS

A TECHNICAL DESCRIPTION of the equipment installed at Broadcasting House has already appeared in the "Technical Description of Broadcasting House," and in *World-Radio*. The experience gained in installing and maintaining the Broadcasting House (London) apparatus has, of course, enabled certain improvements and modifications to be incorporated in the equipment at provincial centres. It is proposed in this article to give particulars of the variations of the general design of the Broadcasting House apparatus which have been adopted in the installations in provincial control rooms at Edinburgh, Leeds, Birmingham, Cardiff, and elsewhere.

The trend of microphone design and technique has made it possible to reduce to five the number of conductors installed between the control rooms, listening rooms and studio microphone points in the Provinces. The standard 8-pin microphone plug and socket is still used and wiring space has been provided for any additional wiring that may be required with future progress in microphone design.

The more important studios in the Provinces are being provided with mixers as at Broadcasting House, so that two or three microphones may be used simultaneously in one studio and their outputs mixed as desired. The mixer is usually located on a desk in a listening room adjacent to the studio, and the desk also houses the necessary microphone decoupling units. The desk thus serves as a central terminating and distributing point for all microphone mixing and associated equipment, and it is so constructed that all the engineering equipment contained in it is hidden from view and yet is made readily accessible by means of removable panels.

Studios from which gramophone recitals are given are each equipped with a special gramophone desk. On the surface of the desk are mounted two gramophone turntables and a three-way mixer, so that a person seated at the desk may make announcements and play gramophone records alternately, or mix the records with each other and superimpose his own commentary if desired. This desk also contains the necessary engineering equipment associated with the gramophones and microphone. A similar type of desk is provided for studios



TWIN TURNTABLE GRAMOPHONE UNIT, CARDIFF

from which special gramophone effects are required; but in this case, provision is made for additional turntables to be added if required. There are also facilities, as at Broadcasting House, for ordinary mechanical effects, a suitable mixer being provided for mixing the output of ordinary effects and gramophone effects. At the smaller premises ordinary effects are produced in the Dramatic Studio, and the functions of providing gramophone effects and recitals are combined in one instrument.

At all provincial stations a switching position has been provided at which all switching and all necessary telephonic communication with studios, outside broadcast points and other broadcasting centres takes place. It will be remembered that at Broadcasting House the engineer at the control position is

responsible for switching on his controlling or "B" amplifier and connecting its input to the appropriate source of programme; the S.B. position is provided with switching for the inputs of the "C" or outgoing amplifiers, and telephonic communication between the control room and studios, etc., is handled at a supervisory position. As programme activities in the Provinces are not so extensive as at Broadcasting House, it is obviously unnecessary to have all these positions; so that the combination of their several functions in one position is a "tidier" and more efficient arrangement.

All provincial control rooms are being provided with control positions similar to those at Broadcasting House. The number varies according to the programme activity at the centre; where two programmes are frequently originated simultaneously, three positions are provided, and in other centres two are provided. Each position is fitted with a main controlling potentiometer, a two-channel fade unit, a programme meter and the necessary keys for operating the studio red lights. Thus any position may be used to control the programme originating in any studio, exactly as at Broadcasting House, the only difference being that, as already explained, the setting up of the necessary circuits is done at the central switching position instead of by each engineer individually at his own control position.

A control cubicle is provided so that important musical items may be controlled by a member of the balance and control staff. This room is acoustically treated for good loud-speaker reproduction and the control desk installed has the same controlling, fading and monitoring equipment as the positions in the control room. This control desk may be associated with any of the control positions at will, so that any programme may be transferred to the cubicle for controlling purposes.

The dramatic control facilities include the provision of circuits to enable the producer to speak to his cast in all studios in use for a particular dramatic production. Those members of the cast who are in a studio which has not been faded up on the dramatic control panel may listen to the progress of the production by means of loudspeakers installed in the studios. The dramatic control return lights, by means of



THE AMPLIFIER BAYS AND CONTROL POSITIONS IN THE NEW CONTROL ROOM AT LEEDS

which the conductor of an orchestra can, for example, inform the producer of a certain point being reached in the score, are included in the dramatic control panel immediately over the potentiometers connected to the studios; small 24-volt lamps are used for this purpose instead of lamps operating from the electric lighting supply as at Broadcasting House. The provision of return lights in this position instead of in a separate indicator mounted on the wall simplifies matters for the producer. The dramatic control panels enable programme matter from six sources in all to be mixed in two groups of three. A cue light key is provided beneath each control potentiometer on the panel, and will operate the cue lights in the studio with which the potentiometer is associated for any particular production. Thus any channel may be allocated to any studio for a production and the setting up of the necessary circuits in the control room will automatically associate each cue light key with its particular studio.

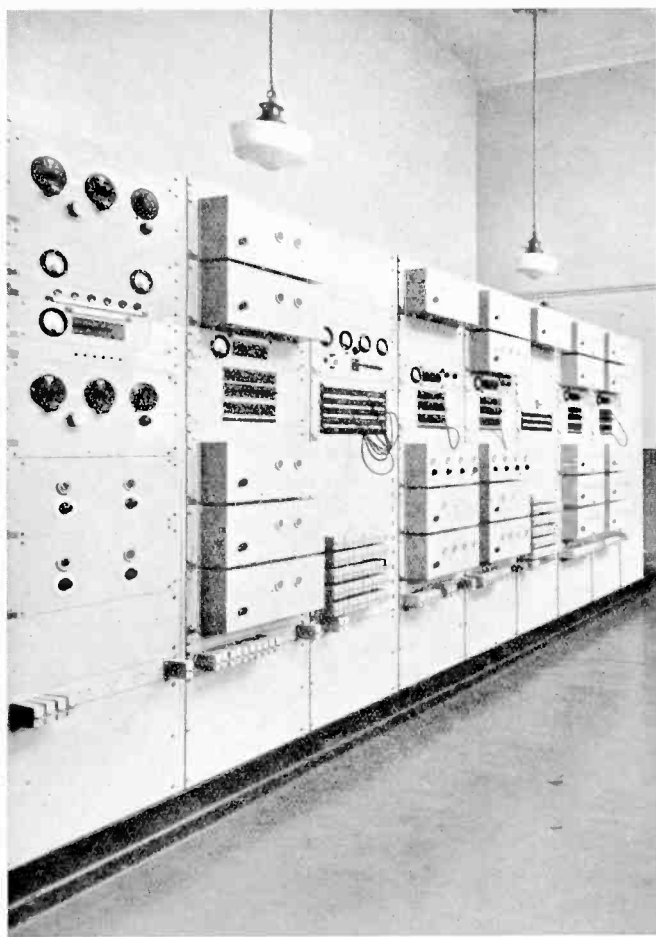

THE AMPLIFIER RACKS IN THE SCOTTISH CONTROL ROOM

To enable the quality of all programmes passing through the control room to be checked, provision is made on the control desk in the cubicle for the loudspeaker in the room to be supplied with any programme. A potentiometer is also provided on the desk so that when comparing the quality of a programme as received by radio with that of the same programme at the output of the controlling "B" amplifier, the volume of reproduction from these two sources may be made equal and a direct comparison of quality obtained.

Red, green and white studio signal lights are provided, in addition to the dramatic control return lights. Red lights, inside and outside all studios, are switched on from the control desks in either the control room or the control cubicle, and indicate that the studio is in use for either a transmission or rehearsal. Green lights are installed inside studios, and are switched on from the dramatic control panel to give cues to artists during the production of plays. White lights are installed inside studios and serve as an indication that the announcer is required on the control room telephone.

The control room telephone system provides for lamp signalling on the switching position. All internal telephone extensions to studios, dramatic control room, etc. are operated on the common battery principle, and all external extensions to outside broadcast points and to other broadcasting centres, regional offices and transmitters are operated on the magneto system. The adoption of both these systems on one switching position calls for a somewhat complicated cord circuit which will operate equally satisfactorily for both common battery and magneto extensions. A universal cord circuit has been designed and six such circuits are installed on each switching position for calling extensions or answering calls, and for connecting any two extensions together for direct communication, such as, for example, the announcer in the studio to an outside broadcast point. Included in these cord circuits are the necessary relays and supervisory lamps for indicating to the engineer at the switching position that a call has been terminated.

At some centres the whole installation is operated on the magneto system, and hand generators are provided in the extension instruments for calling the engineer on the switching position.

KALUNDBORG

Wavelength—1261 metres.
Aerial Power—60 kw.

The Kalundborg Broadcaster marks an epoch in the design and construction of broadcasting stations. It is the first station to be built on the new cellular method of construction and will go down into history as the pioneer of a new era in broadcasting technique.

This station, in common with the **Empire Broadcasting Station** erected for the B.B.C., was designed, manufactured and installed by Standard Telephones & Cables Limited.



Standard Radio EQUIPMENT

Advertisement of
Standard Telephones and Cables Limited, Aerodrome Road,
Hendon, London, N.W.9. (Telephone: Colindale 6533.)



ONE REASON **why** radios are what they are

D. C. AVOMETER 8 GNS.

AMPS.

1 milliamp. to 12 amps.
0-12 amperes
0-1'2 "
0-1'2 "
0-0'12 "

VOLTS.

1 millivolt to 1,200 volts
0-1,200 volts
0-120 "
0-12 "
0-1'2 "
0-1'2 "

OHMS.

1 ohm to 1 megohm
0-1,000,000 ohms
0-100,000 "
0-10,000 "
0-1,000 "

UNIVERSAL AVOMETER 12 GNS.

Gives the thirteen different ranges of D.C. readings as D.C. model, and also the following A.C. reading (50 cycles).

10 milliamps to 12 amps
0-12 amps.
0-1'2 "
0-0'12 "

100 millivolts to 1,200 volts
0-1,200 volts
0-120 "
0-12 "
0-1'2 "

As modern radio progresses to perfection, it is with the invaluable aid of the Avometer—checking and accurately testing every step. Radio manufacturers and service engineers find the Avometer to be the one instrument that adequately meets their needs. It is the only combination testing instrument in the world that gives DIRECT and accurate readings in amps., volts and ohms without the necessity

for mathematical calculations. Throughout the radio trade it is regarded as indispensable.



EVERY TEST D.C. - A.C.

*without any
Calculations,
External Shunts,
Multipliers or
Transformers*

BRITISH MADE • *Deferred Terms if desired.*

The **AVOMETER** REGD.

There are two different models of the Avometer as readings above. Write for fully descriptive pamphlets.

Automatic Coil Winder & Electrical Equipment Co., Ltd, Winder House, Doug'as St., London, S.W.7

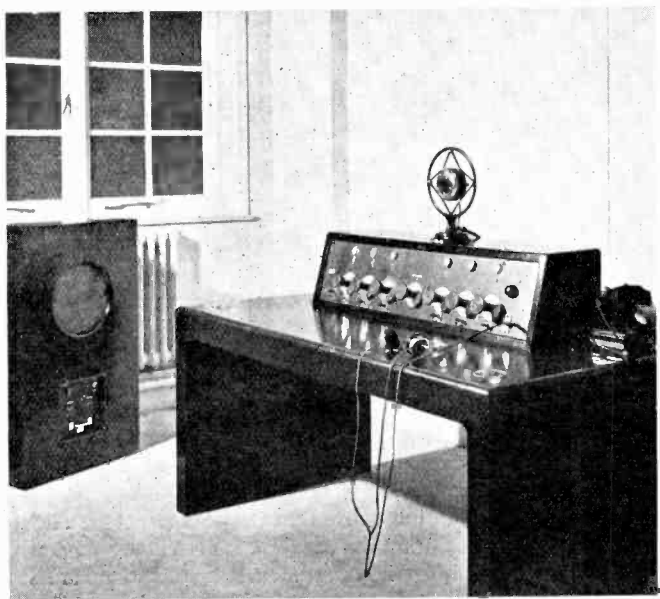

DRAMATIC CONTROL EQUIPMENT AT CARDIFF

Perhaps one of the most interesting pieces of equipment in the common battery systems is the calling relay which lights the white lights in the studio to call the announcer to the telephone; it is obviously impossible to provide any form of audible calling device, such as a bell in the studio. This relay, in series with which is a metal rectifier, is operated by the 16 cycle ringing supply in the same manner as an ordinary telephone bell. The rectifier converts the alternating current ringing supply into a pulsating direct current which will operate the relay without it chattering; when the ringing current is broken the 24-volt direct-current supply from the cord circuit will hold the relay in an operated condition till the call is answered.

At Broadcasting House two 6-volt low-tension batteries were installed, one for the filament supply of the studio or "A" amplifiers, and the other for the filament supply of all other amplifiers. The reason for this was the fact that considerable

difficulty was experienced at Savoy Hill in overcoming clicks, due to the switching on of amplifiers being audible on programme chains which were already in use. It was observed at Broadcasting House when first testing the control room equipment, prior to bringing it into service, that the switching on of one "A" amplifier still caused a click to be heard on the outputs of other "A" amplifiers already in use, and to prevent these clicks it was necessary to adopt filament decoupling. The same trouble was also experienced on the second L.T. battery, necessitating ultimately the adoption of filament decoupling on all amplifiers. This consists of a choke in series with the low-tension supply to each amplifier, with a condenser across the low-tension contacts of the amplifier filament relay. It was found that this method of decoupling was most satisfactory, and at all control rooms that have been installed since that at Broadcasting House, only one low-tension battery has been provided, the filament supply of every amplifier being taken from this one source.

It will be seen from the above that the equipment installed at provincial centres during the past year is of the most modern design, embodying the experience gained in Broadcasting House. Indeed in certain minor respects the provincial equipment is an improvement on that installed two years earlier in London.

WORK IN THE LONDON CONTROL ROOM

IN THE YEAR-BOOKS for 1932 and 1933 comprehensive descriptions were given of the technical apparatus to be found in the studios and in the Control Room of Broadcasting House. The story, however, would not be complete without a few words being said of the work which falls to the lot of the Control Room Engineers not only in maintaining all the plant but in adding that human element which is so vital to the smooth running of broadcasting.

In the London Control Room, since there is activity throughout every hour of the twenty-four, engineers are always on duty. They work in three sections—two large sections for the day and evening, and a smaller section for night work, engineers being allotted to the different sections each week according to a rota. The day section starts at 9 a.m. As the actual work that each engineer carries out is in most cases dependent on the subject-matter of the programmes to be broadcast or of the rehearsals or special tests taking place, it is best first of all to see what this entails.

Throughout the "office" day there is a stream of memoranda pouring in from all the various departments of Broadcasting House, such as "Music," "Outside Broadcasts," "Productions" and many others who have an active interest in the work which is required of the Control Room. This flow is centred on a very small but vital section of the control room staff. As an example, there may be a very urgent request for a special microphone lay-out for a "stunt" item to be broadcast in an hour's time—this must be dealt with immediately. Equally there may be detailed instructions for a discussion between speakers in London and New York to be broadcast two months hence, and this requires filing under the date in question. And so it goes on—instructions for the studios to be used for each item of the day's transmissions and for all the numerous rehearsals, with special mention of particular requirements, instructions for recordings to be made by the Blattnerphone, and their subsequent reproduction to the Empire or in the "Home" programmes, details of outside broadcasts, of simultaneous broadcast arrangements, of productions to be controlled

on the dramatic control panels, of engineering tests and of a hundred and one other things large and small which ultimately have their direct effect on the programmes as broadcast. Each evening the next day's "operation instructions" must be carefully prepared so that as soon as the first section of engineers comes on duty in the morning each man may know exactly what is required of him for the day. A slip here might easily mean a serious defect in a transmission. For example, a typing error of a D for a C in the special programmes made out solely for the engineers' use might easily cause the control engineer to become highly perturbed at receiving no response from Studio 3D; the speaker concerned meanwhile waiting calmly in Studio 3C for the red light to flick as an indication for him to begin his talk. Dead accuracy here, therefore, is an absolute essential, for once an operating engineer makes a mistake its effect is almost certain to become immediately obvious to the listening public.

Returning to 9 a.m. The fully charged batteries to be used for the day in supplying power to the amplifiers and the signalling and telephone systems have already been connected to the control room bus-bars by the battery engineer, and the discharged batteries, used the previous day, are being recharged by the motor generator sets two floors below the Control Room. The engineers who will be responsible for controlling the programmes are busy calibrating the programme meters on all control positions preparatory to the "line up" test with the Brookmans Park transmitters and the provincial stations. This latter test ensures that all amplifiers in the broadcast chain are adjusted to their correct gain, so that presently the control engineer in London will know that every transmitter taking the programme which he is controlling will be receiving the same input intensity. Similar tests are carried out from the provincial stations to London. Throughout the day all programme meters will be checked from time to time as a safeguard against any discrepancy which may develop.

The work entailed in controlling the programmes and of setting up the required programme channels has previously been described, so we may leave the control engineer who, with his assistant, will be controlling one of the transmissions for most of the day. His assistant, incidentally, keeps a log



TESTING THE AMPLIFIERS AND LINES IN THE CONTROL ROOM

SKYSCRAPER

RADIO
ALL-WAVE ALL-WORLD
RANGE AT LAST!

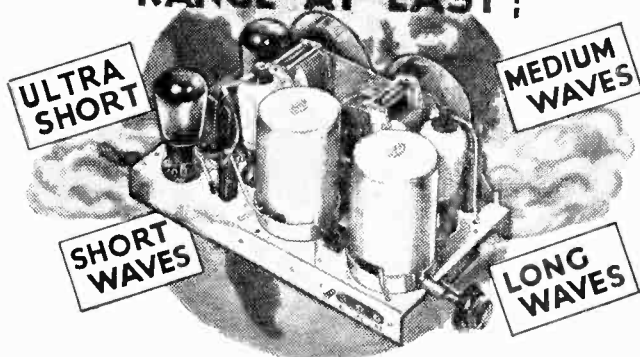

ENGLAND. EUROPE. AMERICA & AUSTRALIA
ALL ON ONE SET AT LAST!

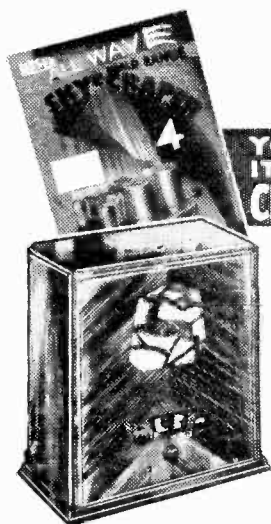

**YOU BUILD
IT YOURSELF
CHART FREE**

At last the day of All-World Radio has arrived, and you can build with your own hands the first receiver to give you not only England and Europe but America and Australia direct. The Lissen All-Wave All-World "Skyscraper" 4, tunes from 12 to 2,100 metres. It brings two complete new wavelength ranges within reach of the ordinary listener—stations and programmes which before he was never able to receive—Ultra Short and Short-Wave transmissions from the ends of the earth. Get the FREE CHART of the All-Wave All-World "Skyscraper" 4—then build for yourself the SET THAT SPANS THE WORLD!

LISSEN
ALL WAVE ALL WORLD
"SKYSCRAPER" 4

showing, correct to the second, the time and details of all changes in programme sources, and of all technical faults as heard by wireless, even to a momentary "scratch." This log is of paramount importance to the programme staff in compiling their statistics, in addition to its primary engineering value.

The S.B. (simultaneous broadcast) engineer starts his turn of duty by checking up all programme and technical arrangements with the nearest provincial S.B. centres, for he will be responsible for ensuring that they receive the correct programme at the correct time, and for most of the day he will be dealing with at least three separate transmissions. He also sees that the Greenwich Time Signal is broadcast according to schedule.

In the meantime the lines termination engineers have been setting up and carrying out insulation, listening and other tests on the circuits to be used for the outside broadcast (O.B.) transmissions and rehearsals to be carried out during the day. Each line requires a certain setting for the amplifier to be used in conjunction with it for "equalising"—that is, for correcting the line characteristics for frequency response. These values have been predetermined after tests carried out by the "Lines Department" engineers. When all is in order the "music" circuit is plugged over to the control position which will require the O.B. whilst the "control" or speaking circuit is plugged up to the supervisory position concerned. The lines termination engineers also deal with all tests and defects on trunk lines. They are the Control Room's linkage with the G.P.O. whether it be Welbeck Exchange for London O.B.'s, Trunks for S.B.'s, long distance O.B.'s and Continental work or Radio Terminal for transmission with New York, Australia, ships at sea and in fact any Post Office radio link.

Another section of engineers is responsible for testing the microphones in the studios. About half an hour before the commencement of every transmission or rehearsal the microphones are listened to through the normal chain of amplifiers, polarising feeds are checked and a very rigid routine is carried out to ensure that even with abnormal usage no technical fault is apparent. It must be remembered that the microphone—being the first link in the chain, and requiring as it does a considerable amount of amplification to bring its signal strength to within control limits—must of necessity be absolutely free from

the most minute defects if good transmission is to be obtained. The reason that microphone tests are carried out about half an hour before the microphones come into use is to ensure that they are in good order up to the latest time which is practicable, while also allowing a short time to remedy any defects which may be found. Were microphone circuits to be tested some hours in advance there would always be the possibility of a defect developing after the test.

It falls to the lot of these engineers also to prepare the circuits for all rehearsals which may be required. On an average there are about eight separate rehearsals being carried out at the same time between the hours of 10 a.m. and 6 p.m. (excluding the 1 p.m. to 2 p.m. period) and during a normal day as many as 30 to 40 individual rehearsals are dealt with, each requiring the microphones and associated equipment energised exactly as if it were a transmission. This entails setting up the correct amplifier circuits so that the rehearsal may be listened to on loudspeakers wherever required, and in certain cases the "talk back" facilities need setting up to suit the particular conditions of studio, listening point, etc., whereby the person listening to the rehearsal may speak over a microphone circuit and by means of a loudspeaker give instructions to those rehearsing in the studio.

Rather similar to the work described above, but very much more complicated, is the preparation of the circuits for dramatic productions using many studios. As will have been gathered from the article on "The Dramatic Control Panels" on p. 385 of the 1933 Year-Book, the possible combinations of circuits are endless. The normal lay-out requires usually some three studios, together with echo on perhaps two of them, an effects and a gramophone studio—in all some seven sources of "programme." All these have to be plugged up to the correct positions on the panel as indicated by the producer. Cue-light circuits, loudspeakers in listening rooms, headphone circuits, talk-back circuits to loudspeakers in the studios in the case of rehearsals, and probably circuits for recording purposes have to be set up and thoroughly tested before the producer can start his rehearsal. Such an intricate linkage requires the most careful and systematic testing, for it is obvious that when many studio circuits are mixed together a mistake in the setting up

MARCONI

BROADCASTING TRANSMITTERS

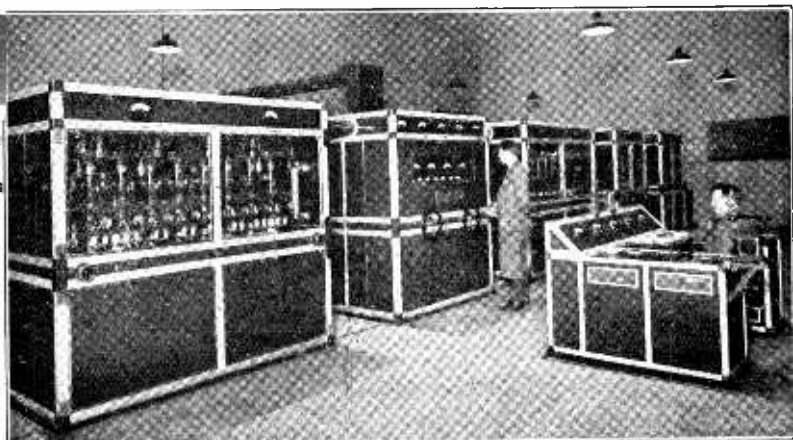

Marconi 60-kilowatt broadcasting transmitter installed at the Athlone Station, Irish Free State.

● Marconi broadcasting transmitters are used in 23 countries throughout the world, for long, medium and short-wave operation.

Their aerial power ranges from 120 kilowatts to $\frac{1}{4}$ kilowatt, and stations up to 150 kilowatts are now under construction.

The new 100 kilowatt long-wave National transmitter to be erected at Droitwich for the British Broadcasting Corporation is of Marconi design and manufacture, and all the B.B.C. high-power Regional transmitters were made to B.B.C. designs at the Marconi Works, Chelmsford.

MARCONI'S WIRELESS TELEGRAPH CO. LTD.

Electra House, Victoria Embankment, London, W.C.2

Telephone: Temple Bar 4321.

Telegrams: Expanse, London.

FOREMOST NAME IN SOUND REPRODUCTION

It is attention to detail that puts Celestion in the forefront of modern loud-speaker design. The name Celestion stands for high quality reproduction with unflinching efficiency. The PPM19 fulfils its function with remarkable success, the tonal quality and sensitivity being amazing. Ask your dealer to demonstrate it.

MODEL PPM19

(Chassis)

£2 7s. 6d.

MODEL PPM49

(Cabinet Model)

£4 10s. 0d.

Model PPM19

Chassis

£2 7s. 6d.

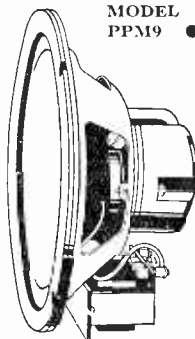
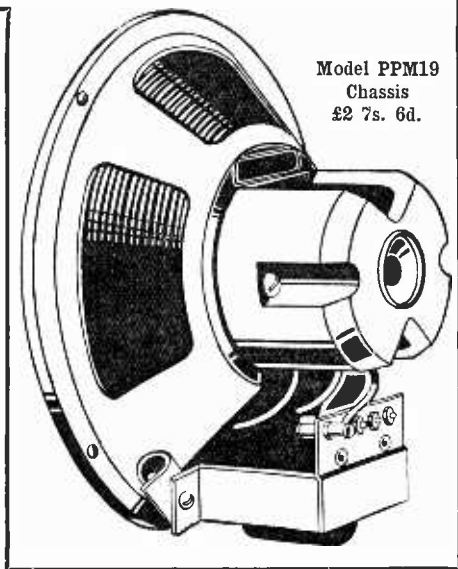

MODEL PPM39

(Cabinet Model)

£3 10s. 0d.

PRICE

£1 15s. 0d.

£3 10s. 0d.

£3 10s. 0d.

£3 10s. 0d.

£3 10s. 0d.

£3 10s. 0d.

£3 10s. 0d.

£3 10s. 0d.

£3 10s. 0d.

£3 10s. 0d.

£3 10s. 0d.

£3 10s. 0d.

£3 10s. 0d.

£3 10s. 0d.

£3 10s. 0d.

£3 10s. 0d.

£3 10s. 0d.

£3 10s. 0d.

£3 10s. 0d.

£3 10s. 0d.

£3 10s. 0d.

This moderately priced speaker embodies all the latest improvements in loud-speaker technique, and worthily upholds the Celestion reputation for purity of reproduction. It is sensitive and has a power-handling capacity more than adequate for all normal requirements.

PRICE

£1 15s. 0d.

MODEL PPM39 (Cabinet Model) £3 10s. 0d.

CELESTION

The Very Soul of Music

Write for full details of the Celestion range.

Celestion Ltd., London Road, Kingston-on-Thames.

Showrooms: 106, Victoria St., S.W.1.

[404]

would wreck the whole performance, whether it be a rehearsal or a transmission, since it would be extremely difficult, if not impossible, to locate the error once the performance had started.

In addition to those already mentioned, there are the engineers sitting at the supervisory positions dealing with the internal telephonic inter-communication and the engineers checking the transmission quality by loudspeaker three floors below, and the senior control room engineer who is the mainspring of the whole section of engineers.

But this is not the whole of the picture. Side by side with what might be called the main engineering routine there is the work at the Blattnerphone recording apparatus (now largely used for Empire Broadcasting as well as for rehearsal purposes), that connected with gramophone recording, running the television transmissions, and the ultra short-wave transmitter, not to mention the labour of maintaining and cleaning this vast amount of apparatus and wiring, the storage and issue of spare parts, and the testing of the valves actually in circuit (it takes one man a month to do them all).

Finally, there are the engineers responsible for broadcasting the programmes to the Empire throughout the night, and who in their spare time carry out most rigid tests on the loudspeakers which are used in the various listening rooms and studios, in order to maintain a high standard of quality of reproduction.

Add to all this the work entailed in testing out new types of microphones, control room amplifiers, valves, etc., and it will be admitted that the London Control Room and its staff must needs be a large and complex organisation.

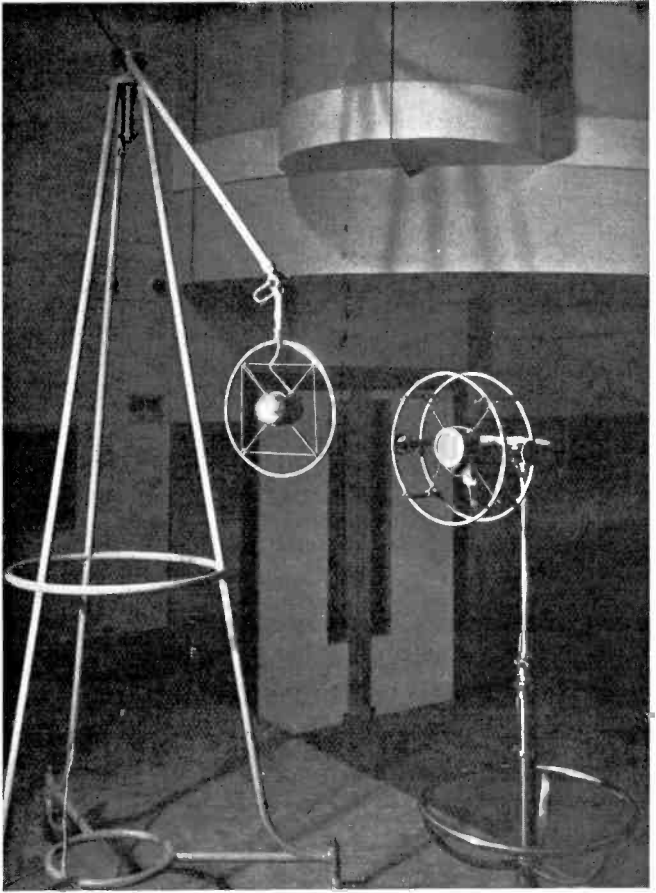

TWO TYPES OF MICROPHONE STAND AND MOVING-COIL MICROPHONES

RECENT DEVELOPMENTS IN MICROPHONE DESIGN

DURING THE PERIOD covered by the B.B.C. Year-Book for 1933 a great deal of experimental work had been undertaken in order to determine which of the many different types of microphone then available were most suitable for use in broadcasting, and what should be the characteristics of the amplifying and other equipment to be used in conjunction with them. During that time rather a large number of microphones of different types, in some cases experimental, were in use in Broadcasting House and even in the old studios at Savoy Hill. These were described fairly fully in the article on "Microphones" in the issue of the Year-Book referred to above. An account was also given of the requirements, from the theoretical standpoint, of a broadcasting microphone, and of the extent to which the various microphones appeared to fulfil those requirements, whilst mention was made of the effect on the apparent acoustical properties of the studio due to the use of microphones of different types.

More recently the attempt has been made, as far as Broadcasting House is concerned, to standardise the microphones in use and to reduce to a minimum the number of types employed. Naturally, those microphones which experience has shown to be most suitable for broadcasting have been retained. Condenser microphones of all types have always, in spite of their good performance from the laboratory standpoint, caused a certain amount of anxiety, on the score of absolute reliability and ease of maintenance, and, in addition, the necessity of embodying at least one stage of valve amplification in the microphone assembly itself has always constituted a difficulty. The original Reisz type of carbon microphone, on the other hand, whilst consistent in performance and easy to maintain, has hardly reached the somewhat critical standards necessary for broadcasting in regard to ground noise level and amplitude linearity or freedom from "microphone blasting."

It is hardly surprising, therefore, that the types of microphone now favoured are of the electro-magnetic or moving-coil type in conjunction with the modified type of carbon microphone. Condenser microphones of the stretched diaphragm type, how-

ever, still find considerable use outside Broadcasting House and give in practice results not very inferior to those obtained with the moving-coil microphone. Actually, two different types of moving-coil microphone are now in use in Broadcasting House. One of these is the microphone referred to in last year's article; the other, which is of British design and manufacture, has only become available for broadcasting during the last few months. The underlying principle of design differs somewhat in the case of these two microphones, but each possesses distinctive advantages and is adaptable to the particular requirements of different types of broadcast material.

It will doubtless be realised that one of the difficulties encountered in designing a microphone or any other piece of electro-acoustic apparatus according to any given principle is to obtain a sufficiently flat frequency response characteristic, on account of the mechanical properties of the moving parts and of the very wide range of frequencies necessary for the faithful reproduction of music and speech. If, for example, we are attempting to design a moving-coil microphone, we find that the mass of the diaphragm, together with that of the coil which is attached to it, is of such a magnitude that, in conjunction with the elasticity of its suspension, it forms a mechanically resonant system whose natural frequency is well within the audible range. This means that the efficiency of the microphone as a converter of acoustical into electrical energy will be much greater at or near the natural frequency than at other parts of the frequency range. In general, then, mechanical resonance in a microphone means a pronounced peak in the frequency characteristic, usually accompanied by a fairly rapid cut-off either immediately above or immediately below the resonance, according to the principle on which the microphone depends.

The conventional method of overcoming this difficulty is so to proportion the mechanical properties of the moving parts that the resonance is either towards the upper or the lower limit of the band of frequencies which it is necessary to transmit. In practice, the former alternative is usually adopted. In addition, arrangements are made to introduce a certain amount of mechanical damping so as to reduce the sharpness and intensity of the resonance, and reduce its effect to negligible

R & A

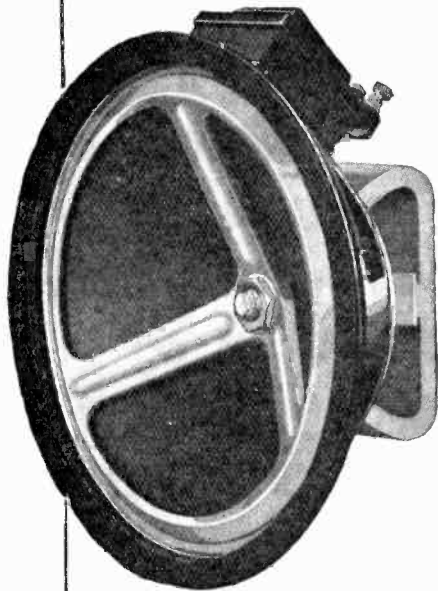

R. & A. Reproducers are designed by specialists to give reproduction of broadcast speech and music comparable with the original performance.

That they achieve this purpose is amply borne out by expert test reports and the fact that they are fitted by the leading set manufacturers in their 1934 receivers.

If you would enjoy perfect reproduction, instal an R. & A. Reproducer in *your* receiver. Models with specially designed transformers are also available for use as extension reproducers.

All reputable radio dealers can supply you. Prices range from 21/- to 70/-. Write us for 1934 Leaflet which fully describes each model.

REPRODUCERS & AMPLIFIERS LTD., WOLVERHAMPTON

309

BRITAIN'S FOREMOST REPRODUCERS



**AFTER A
THOROUGH
PERSONAL TEST I
HAVE NO HESITATION
IN SAYING THAT IN MY
OPINION ODOL IS BY FAR
THE BEST DENTIFRICE ON THE
MARKET**

'A B' L.D.S. R.C.S. London.

Odol TOOTH
PASTE

in tubes 6^d & 1/2

ODOL MOUTH WASH - in flasks - 1/6 · 2/6 · 3/6

**ODOL MAKES TEETH WHITER — REMOVES TARTAR — PRESERVES THE ENAMEL —
PREVENTS DECAY — DESTROYS GERMS — AND WHAT A REFRESHING FLAVOUR**

dimensions. This procedure is well exemplified in the case of the stretched diaphragm condenser microphone. This consists of a thin metal diaphragm tightly stretched about one thousandth of an inch in front of a solid metal back-plate. The diaphragm is insulated from the back-plate and forms with it an electrical condenser whose capacity varies as the diaphragm vibrates under the influence of the sound waves. The principle of construction is that the diaphragm is stretched until its natural frequency is near the upper limit of the useful range. In actual practice, however, it is not in general practicable to obtain a resonant frequency above about 4500 cycles per second. Above this frequency the response falls off rapidly, so that it becomes negligible above 6,000 cycles. This constitutes one of the limitations of the condenser microphone. Damping is introduced by means of a system of fine slots cut in the back-plate. As the diaphragm vibrates, the air enclosed behind it is caused to circulate in the slots, and the resistance to its flow constitutes the damping on the resonant system.

In the case of the two new types of moving-coil microphone, a totally different procedure has been adopted in order to avoid the undesirable effects of resonance. In one of these the mass of the diaphragm and the elasticity of its suspension have been so dimensioned and arranged in conjunction with the rest of the assembly as to form the first elements of a mechanical low-pass filter circuit. The remainder of the filter is constituted by specially arranged resonant features which have been incorporated in the design. In the microphone in question the cut-off frequency is of the order of 10,000 cycles, so that its range is extended considerably above that of the condenser microphone. It must be realised, however, that the necessity of designing for a cut-off frequency near the upper end of the audible range still constitutes a limitation as to the permissible mass and elasticity of the moving parts. The main advantage of the filter principle is the effective elimination of the principal resonance peak.

In the second type of moving-coil microphone the effect of resonance is obviated in a different way. No attempt has been made to remove the natural frequency to either the upper or the lower limit of audibility. It is allowed to remain at about 500 cycles, an intermediate frequency which is most convenient from the point of view of mechanical design. Steps are taken to

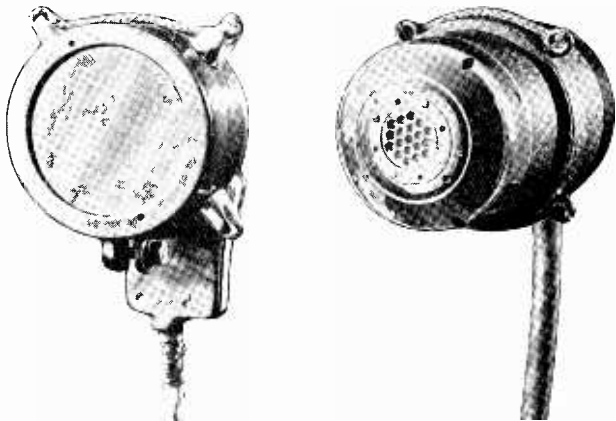

TWO TYPES OF MODERN MOVING-COIL MICROPHONE

render the resonance of as simple a type as possible, that is to say, solely between the mass of a rigid diaphragm moving as a whole, and the elasticity of its flexible suspension. In these circumstances the effect of the resonance may be almost exactly corrected by means of a simple electrical resonant circuit composed of inductance, capacity and resistance.

The advantages of the latter system, apart from the fact that a very good frequency response characteristic can readily be obtained for the combination of microphone and correction circuit, are that the sensitivity of the arrangement is such that a very small diaphragm can be used, and in addition the whole assembly can be of robust construction.

The advantages of the use of a microphone with a small diaphragm are seen by consideration of the directional effect. If a microphone is small compared with the wavelength of the sound wave which is incident upon it, its directional effect is small, that is to say it responds almost equally to sounds arriving from all directions. If, however, the reverse is the case and the wavelength of the sound is smaller than the dimensions of the microphone, the latter becomes very directional in favour of sounds arriving parallel to its axis, or normal to the sensitive surface. It follows that the average microphone is almost non-directional for the lower audible frequencies, semi-directional for

intermediate frequencies, and definitely directional for the higher frequencies.

The effect just described often constitutes a very real difficulty in microphone placing, owing to the difficulty of so arranging an orchestra, for example, that the harmonics imparting the characteristic tone to strings (or even the fundamental tones themselves, in the case of the violins), are adequately reproduced, since it is impossible for all the stringed instruments to be situated on or near the axis of the microphone. The causes of the effects under consideration are various, and are too complex for discussion in the present article. It will be realised, however, that if it were possible to make the microphone small enough, its directional effect would be the same for the highest audible frequencies as for the low, and the difficulties just described would not exist. This is not possible in practice, but by making the sensitive diaphragm small, even if the body of the assembly is necessarily somewhat larger, the desirable condition can be partially realised.

This is accomplished in the newer type of moving-coil microphone, and enables truer orchestral tone to be preserved as well as, for example, clearness of diction in dramatic work without the necessity of the actors directly facing the microphone. On the other hand, on other occasions the more directional properties of the moving-coil microphone first described are of advantage, particularly if it is desired to reduce the effects of excessive reverberation, and if the source of sound is fairly condensed. Such directional properties are, of course, confined to the higher frequencies in the case of the moving-coil microphone. Other microphones, in particular that known as the "ribbon microphone," have been developed, for which the response even at low frequencies can be made directional. Future experiment in microphone technique can alone show to what extent such a property is valuable in broadcasting.



RECORDING THE KING'S SPEECH AT THE OPENING OF THE WORLD
ECONOMIC CONFERENCE IN LONDON

THE APPLICATION OF SOUND RECORDING TO BROADCASTING

SOUND RECORDING in its application to broadcasting falls under two fairly general headings. The first of these is the use of gramophone records in programme building. These records are, of course, productions of the well-known gramophone companies and are on sale to the general public. The B.B.C. has amassed a very large collection of published gramophone records, all of which are in duplicate, and these are now stored under an extensive filing system at Broadcasting House. The responsibility for filing, keeping the records up to date and building them into programmes is vested in a section known as the Recorded Programme Section.

It is not the object of these remarks to discuss the way in which gramophone records play their part in the construction of the week's programmes, but rather to discuss the methods by which certain of the B.B.C.'s own programmes are recorded.

In the course of the last year the B.B.C. has found it necessary to record a far greater number of its programmes than previously. This is principally because the Empire Service demands the repetition of certain programmes at hours inconvenient for artists or at times when a repeat performance would be impracticable.

The B.B.C.'s recording requirements are a little peculiar, and differ widely from those encountered in the run of a gramophone company's normal recording work. Any recording system which the B.B.C. adopts should fulfil the following conditions:—

In the first place not only must the reproduction quality be generally good, but there must be the least possible variation in the reproduction standard, either from day to day or at different parts of the same record. Any severe background, such as needle scratch or tape hiss, although tolerable in certain types of recording, is quite inadmissible in other types of programme. The range of frequencies to which the record should give an excellent response should be practically the whole of the audible gamut, say, 50 to 5000 cycles per second, so that the "effect" will not be lost in records of such programme items as a motor hill climb, crowd noises at a race meeting, or other programmes where atmosphere plays an important part.

In the second place, the recording system satisfactory for broadcasting requirements is one which will give a long playing record. On an average an ordinary 12-inch gramophone record runs for approximately 4 to 5 minutes per side. This is an embarrassment for most broadcasting purposes, as the essential part of many recorded programmes is longer than this and continuity is essential. Again, a race such as that for the Chester Cup takes about 4 minutes to run. It is never known at the time of recording when, within a few seconds, the actual start of the race is going to take place, and as cutting has to begin as soon as there is any possibility of the race starting, a delay at the starting gate of, say, 2 or 3 minutes would run the record off the end of its playing time before the race had been completed. Quite apart from this, it is always desirable to have a few minutes of recording time in hand at the end of the item so that the commentator may repeat the result, and the noise of the crowd after the finish can be included.

In practice it is found that a playing time of not less than 8 minutes is often necessary; not only because this causes less embarrassment in the actual making of the records, but also because the cost per minute of recorded programme of making a long playing record is less than that of an ordinary record which plays for a shorter time.

The third requirement, which is almost as essential as those previously mentioned, is the possibility of recording at short notice. It frequently occurs that a very important programme item makes its appearance unexpectedly and only two or three hours before it is broadcast. For example, information may be received that an important political speech is to be broadcast by a foreign statesman, and it is required to record it for use later. A way to meet this requirement would be to install recording equipment at Broadcasting House which could be operated and maintained by the B.B.C.'s engineers in the same way as other engineering equipment. Up to the present, however, the amount of recording which has been required is insufficient to warrant the cost of installing disc recording equipment at Broadcasting House solely to obtain greater flexibility.

The final requirement of a broadcasting organisation's recording system is the ability to reproduce the record within the shortest possible time of the record being made. For

L i s t e n !



THE LITTLE DOG IN "HIS MASTER'S VOICE" TRADEMARK—the most famous trademark in the world—carries a graphic message to all intending purchasers of radio, radio-gramophones or records. He listens—and cannot believe that what he hears is not reality. For thirty years "His Master's Voice" have kept to this ideal—an ideal of the reproduction of sound so real as to be indistinguishable from life. And still today the test of "His Master's Voice"—whether radio or records—is to LISTEN . . . just listen! By that test you will appreciate the difference—the difference that really matters—between "His Master's Voice" products and others.

"HIS MASTER'S VOICE"

T R U E T O L I F E

RADIO AND RECORDS

THE GRAMOPHONE CO., LTD., 98-108 CLERKENWELL ROAD, LONDON, E.C.1

rehearsal work an immediate "play-back" is sometimes desirable. For example, in rehearsing a dramatic production the producers may want an artist to hear the effect given by certain intonation, or the conductor of an orchestra may wish a section of the orchestra to hear some passage which they have played, with a view to improving the rendering. Immediate play-back facilities can now be provided at a rather high cost, but slightly delayed play-backs can be given within, say, 5 minutes of the conclusion of an 8-minute record quite simply.

As is well known, the B.B.C. makes considerable use of the Blattner system of recording. It will be remembered that this works on the principle of making a magnetic record on a fine steel tape which is rolled up on a drum as the record is made, in much the same way as a cinema film. The Blattnerphone has many advantages. It is flexible in use, it gives a standard of reproduction which is satisfactory for most requirements, and it allows of a playing time of approximately 20 minutes without change of machine or any break in continuity. It is probable, therefore, that whatever other system is used the Blattnerphone will serve as a supplement to it. On the other hand, Blattner tape is expensive—too expensive in fact to make it practicable to store a large number of programmes permanently on tape. It is, however, possible to use Blattner tape over and over again, as the magnetic record can be wiped out by running the tape through a pair of polarised heads which are installed on the machines. In view of this facility the Blattnerphone has come into general use for "bottling" programmes for repeat transmission to the various Empire zones within 24 hours of the programme being originally performed. In this way the programme can be received in different parts of the Empire at convenient hours for listening. In certain important broadcasts Blattner and wax recording have been used together, the Blattner record having been employed for re-transmission until the disc records were ready.

Reverting to wax recording, the system which is used has been developed so that it will fulfil the requirements mentioned earlier in these remarks. In order to do this a fine cutting thread is used in the tracking of the recorder giving approximately 150 revolutions to an inch of track, as compared with 84 revolutions in the standard record. This, together with slow-speed

turn-tables running at 60 r.p.m., enables a 12-inch record to play for approximately 9 minutes. For immediate play-backs the Blattner system requires a little time (about half that taken for the recording) to re-wind the tape before running off again. The wax system is quicker than this, as the cutting head on a recording machine is changed for a specially designed pick-up which is tracked by the cutting mechanism and so can follow the grooves in the soft wax. This, of course, destroys the wax, but it is practicable to cut a number of waxes simultaneously when recording so that one or more may be used for play-backs and the others for processing. The ability to play-back a wax before processing is of great assistance in making records of running commentaries, as it enables the value of the record to be assessed and so eliminates the expense of an unsatisfactory record being processed.

Actually three types of wax recording are now used for broadcasting work. The first is a standard record running at normal gramophone speed of 78 r.p.m., and cut at approximately 80 grooves to the inch. This type of record is invariably used if there is no chance of the recording being longer than 5 minutes. For recordings up to 7 minutes a fine cut of 150 grooves to the inch is used and standard turn-tables speed of 78 r.p.m. This is to enable the record to be played on ordinary gramophone turn-tables without inconvenience. Where there is a possibility of the record extending over 7 minutes, fine cutting is used and the turn-table speed is reduced to 60 r.p.m. This gives a playing time of 9 minutes, although there is some possibility of a slight depreciation of quality due to needle wear in the last minute. Many gramophone motors will not govern steadily at this slow speed, and, therefore, these records can only be used on specially adjusted turn-tables. At present disc recording for the B.B.C. has been carried out by The Gramophone Co. and by The British Homophone Co., Ltd.

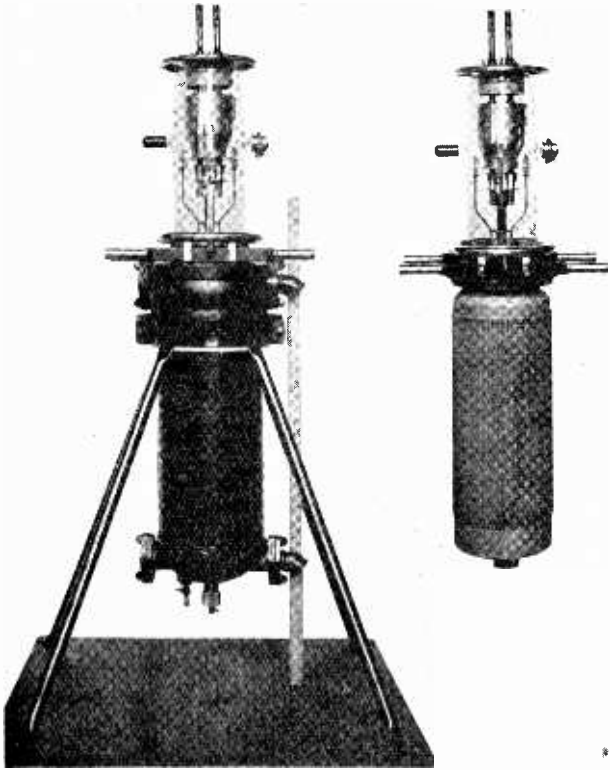

Marconi

ONE OF THE VALVES TO BE USED IN THE NEW LONG-WAVE TRANSMITTER
AT DROITWICH SHOWING WATER-JACKET AND A ONE-METRE RULE FOR
COMPARISON

VALVE DEVELOPMENTS

THERE HAVE BEEN many changes and improvements in valves during the past year, both on the transmitting side and the receiving side.

So far as transmitting valves are concerned, changes are, of necessity, very slow, and improvements come along gradually owing to the great expense of testing and proving new ideas. As the broadcasting stations of the world have been increasing their power, so it has been necessary to increase the power of transmitting valves. Up to a few years ago, cooled-anode valves could handle not much more than 10 to 15 kilowatts, and, in a station of some 30 kilowatts power, a small number of these valves was quite adequate. During the last year or so, the power of broadcasting stations for future design has been increased up to 500 kilowatts in some instances, and valves have been designed capable of handling this large power. (The photograph shows one of these large valves such as will be used in the new long-wave National transmitter being built by the B.B.C.)

The experience gained in manufacturing cooled-anode valves has enabled developments to take place in two other directions. The first is the development of small cooled-anode valves for transmission of very high frequencies between the wavelengths of 5 and 10 metres. These valves have been designed with very low inter-electrode capacities, and with a grid capable of dealing with large-capacity currents, so that conventional circuits may be employed with the advantage of considerable power-handling capacity. For such work as television developments, these valves should prove of great benefit.

The second development is that the experience gained in making cooled-anode transmitting valves has resulted in the perfection of the metal-glass seal. As a result it has been possible to extend its use, and receiving valves are now being made embodying this method of construction. In effect, these small valves are replicas of their bigger brothers, except that the anode is cooled by air instead of water. In the smaller types the anode is cooled merely by allowing a free circulation of air around it, while in the larger types the anode is cooled by a stream of air under pressure. These valves have been termed

“Metal” valves, but this is not strictly true, for the anode is merely fused on to a small glass base, through which the various leads are brought. It is claimed that valves manufactured in this manner possess several advantages, being less microphonic and more robust than valves having a glass envelope around the anode. This type of construction undoubtedly lends itself to considerable improvements, both mechanical and electrical, and manufacturing tolerances and shrinkages should be reduced. In any event the user will appreciate the neater appearance, smaller size, and robustness of construction of these new valves.

The past year has witnessed the first appearance in this country of valves having several uses. It has been the practice for some time amongst some radio engineers to employ a diode detector, followed by a triode as an amplifier, to obtain rectification which is to all intents and purposes linear. This method of rectification possesses considerable advantages over grid-leak or anode-bend rectification, but has the great disadvantage that it requires two valves, consuming twice the filament current, and taking up about double the space. The logical development was therefore to put the diode and the triode into the same envelope, to save space. So far as the filament was concerned, it was found that the modern indirectly heated cathode gave sufficient emission to supply both diode and triode. The new valve is therefore able to replace two valves of the older types.

The demand for automatic volume control and push-pull diode detection caused two diodes to be used in place of one, and from this the double-diode-triode valve was evolved. This type of valve is fitted with the new type seven-pin base, and is incorporated in many sets this year. It should be remembered that one valve, such as a double-diode-triode, doing duty for two valves of the older type, is no better than two valves, but there is considerable economy of space and filament current.

Another development for which special valves have been designed is what is known as Class “B” amplification. For convenience of description, it has been agreed amongst radio engineers to divide amplifier systems into two main classes. Class “A” includes those in which the anode currents of individual valves

DEFINITELY BETTER YET THEY COST LESS!

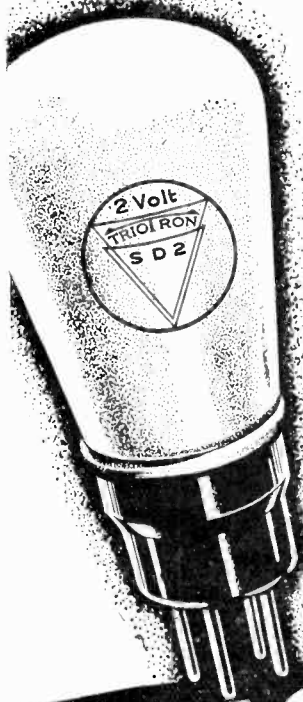

From the early pioneer days of Radio TRIOTRON VALVES have been in the forefront for high technical efficiency and uniformity. Some of the most notable improvements in valve design and manufacture originated in the TRIOTRON laboratories.

To-day, as ever, YOU CANNOT BUY A BETTER VALVE NO MATTER WHAT YOU PAY.

Equip your Set with TRIOTRON VALVES and make certain of trouble-free Radio all the year round.

Write for free Catalogue and Valve Data Chart.

TRIOTRON

THE VALVE FOR THE MULTI-MILLION AERIALS!

TRIOTRON RADIO Co., Ltd.
Triotron House, 26 Bloomsbury Street, London, W.C.1.

are held approximately steady by grid bias adjustment. This has been the system employed in most receivers to date so far as the low-frequency amplifying valves are concerned. The grid bias should be so adjusted that the excursions of grid voltage, caused by the signal about the fixed grid bias, cause a linear change of anode current. If the excursions of grid voltage caused by the signal are too large, distortion occurs. The efficiency of Class "A" is small, usually only about 10 to 15 per cent. Class "B" includes all those arrangements in which two similar valves are operated at, or near, the bottom bend of their anode current/grid voltage characteristics. This condition may be achieved by designing the valves to have small anode currents at zero grid bias, or by using appropriate negative bias with power amplifying valves of conventional design. The latter method is sometimes called by the special name of "Quiescent Push-Pull." In general, each valve amplifies only alternate half-cycles of the signal voltage applied, and the anode current is approximately proportional to the instantaneous value of the grid voltage during the active half-cycle. The advantage of Class "B" amplification is that the "rest" current of the anode circuit of each valve is very small, being usually of the order of a few milliamperes only. The average modulation percentage over an extended period is small, so that the mean value of the anode current is very little in excess of the "rest" current. A pair of valves operating in Class "B," and two such valves biased normally in Class "A," give equal outputs, but the mean value of the anode current to the Class "B" pair at full modulation is only half that of the Class "A" pair at any modulation. That is to say, for equal H.T. feed conditions, Class "B" gives twice the output obtainable from Class "A."

Special valves have been developed for Class "B" amplification, incorporating two valves in one glass bulb fitted with the new seven-pin base. They are designed to have a very small anode current at zero grid bias, so that the usual grid bias battery or resistance may be dispensed with. With these valves, the grid is driven positive by the signal, so that current will flow in the grid circuit. These valves require a "driving" stage, and special transformers having low-resistance windings to prevent distortion due to varying grid current conditions. The main application of Class "B" amplification is likely to be to

battery-driven receivers where economy of H.T. consumption is important.

During the year, manufacturers seem to have abandoned the fitting of solid pins, and the spring pins are again being fitted to all types of valves. As most valve-holders are now fitted with expanding sockets, the combination of spring pin and expanding socket should give a much more reliable and noiseless contact than has been possible before.

The introduction of so many new types of valves has checked the increase in mutual conductance which was so evident a year ago. This had developed into a race between manufacturers; no sooner had one manufacturer brought out a valve with say a slope of 4 ma/v. than another brought out a similar type of valve with a slope of 7 ma/v. This rapid increase in mutual conductance was not always in the interests of the user, as these very high figures, although representing an increase of efficiency, meant usually that the clearances between the electrodes had been reduced to very fine limits, with the result that contacts and noises were not uncommon. In addition, power valves with a very high conductance are apt to suffer from an effect known as "tailing off": in other words, the grid, being of open mesh to give a low value of amplification and impedance, and being very close to the filament to give a very high conductance, does not exercise complete control over the electron stream.

There have been considerable developments in both cathode-ray tubes and photo-electric cells, particularly for television purposes. The opinion is held by some engineers that the future television receivers will have no mechanical moving parts, but that a cathode-ray tube will be used to portray the moving image. Small cathode-ray tubes are also being made for use with broadcast receivers, particularly those fitted with automatic gain control, in order to assist in tuning-in to the correct position in the carrier centre. It is well known that one of the troubles with a receiver fitted with automatic gain control is that it is difficult to know when the receiver is tuned-in properly, and there is a danger that the receiver is left mistuned to one of the side bands, with consequent distortion. These new small cathode-ray tubes give a correct visual indication of the tuning, and should be a great asset for the non-skilled user.

Expert Fault-Detection WITH EASE

MILLIAMPS
0-6 millamps.
0-50 " "
0-120 " "

VOLTS
0-6 volts
0-12.5 " "
0-200 " "

OHMS
0-10,000 ohms
0-60,000 " "
0-1,200,000 " "
0-3 megohms



TEN TESTING INSTRUMENTS IN ONE

Providing a sure way to BETTER Results

40/-

*Dimensions: 4" x 3" x 1 3/4"
Complete in handsome case with pair of leads, interchangeable crocodile clips and testing prods.*

With the AvoMinor you can be sure of results that it previously took an expert to obtain. You can trace every source of trouble and detect every fault that mars the concert pitch performance of your set. You can test circuits, valves, components, batteries and power units, and test them ACCURATELY. The AvoMinor is an accurate moving coil combination instrument. It gives TEN different ranges of readings in milliamps, volts and ohms. It has a total resistance of 100,000 ohms, and full scale deflection is obtained with only 3 milliamps. No similar instrument makes so many tests—or tests so completely and with such accuracy.

The AVOMINOR TRADE MARK TELLS THE WHOLE TRUTH

Deferred terms if desired. Write for fully descriptive pamphlet.
The AUTOMATIC COIL WINDER & ELECTRICAL EQUIPMENT Co. Ltd.
Winder House, Douglas St., Westminster, S.W.1 Phone: Victoria 3405-7

MODERN RECEIVER DESIGN

A HISTORICAL SURVEY of the development of the modern receiver provides many interesting examples of technical ingenuity. There can be no other science in which inventions and improvements have followed each other with such unflinching regularity. In the early days of broadcasting a wireless set was a simple affair consisting of a number of components assembled on a panel littered with control knobs and, as likely as not, home assembled. To-day the home-made receiver is a comparative rarity. It is no longer able to compete successfully as regards either price or performance with the product of the manufacturer who has adopted the press tool and the drilling jig to produce the metal chassis and quantity production methods which ensure minimum prices and maximum reliability.

The aspects of receiver design in which the lay listener is primarily interested, are those affecting simplicity of operation, quality or fidelity of reproduction, selectivity or ability to separate transmissions on adjacent wavelengths, and sensitivity or ability to bring in distant stations.

SIMPLICITY OF OPERATION

Considerable attention has been paid to the question of making receivers capable of giving satisfactory results in the most unskilled hands, and much ingenuity has been spent in reducing the number of controls. Filament rheostats disappeared long ago. Then most of the cumbersome plug-in coils and multi-stud wave-change switches were swept into limbo. "Ganging" methods, in which a number of control operations are performed by means of a single knob, were developed, first for high-frequency tuning stages and later for many other purposes. Wavelength changing is invariably ganged between coil assemblies and may now quite conveniently be incorporated on the end of the tuning condenser shaft so that no additional knob is required. Means have been developed for ganging the local oscillator condenser of a superheterodyne receiver with the high-frequency tuning stages, and the functions of controls have been duplicated in many other ways. The volume control may operate simultaneously on

two different parts of the receiver circuit and may incorporate the "on-off" switch. It may even, with the provision of automatic gain control, be dispensed with altogether, or at least adjusted only in exceptional circumstances. A further aid to simplicity of operation in a receiver is the provision of tuning condenser scales calibrated directly in metres.

QUALITY

Fidelity of reproduction is probably the most important criterion by which the performance of a receiver may be judged, and a modern receiver shows very definite advances in this respect compared with its counterpart of a few years ago. Band-pass tuning circuits are in common use in order to avoid high note cut-off in the H.F. amplifying stages, and the necessity for care in the design of the detector stage is appreciated. Every effort is now made to provide linear rectification; the power-grid detector supplanted the older anode-bend method, and is now in its turn being replaced by diode rectification using indirectly heated cathode valves. The principles governing distortionless audio-frequency amplification are now more fully appreciated, so that "peaky" transformers and overloaded valves are less frequently encountered. Unfortunately, however, it is still true to say that the general quality of reproduction in broadcast receivers is considerably lower than it need be. This state of affairs is probably due more to lack of discrimination on the part of the listener than to lack of ability on the part of the manufacturer.

The moving-coil type of loudspeaker, when first introduced, was welcomed as a very definite advance towards the ideal of perfect reproduction, and a good moving-coil loudspeaker, mounted in a sufficiently large and rigid baffle, can give very pleasing results. The same unfortunately cannot be said of the majority of inexpensive moving-coil loudspeakers now on the market, in which fidelity has been sacrificed to sensitivity and price until the results are little, if any, better than could be obtained from their predecessors of the balanced armature cone type.

A possible fault of modern constructional methods is the inclusion in a single cabinet of the receiver and the loudspeaker. Microphonic trouble which may be experienced is simply a

THE RADIO TIMES

is issued every Friday by the British Broadcasting Corporation to supply, with notes & illustrations, its programmes for a whole week; thus enabling you to choose your programmes in advance. Price twopence of all booksellers, newsagents, bookstalls.



THE LISTENER

A typical recent issue of *The Listener*, selected at random, contained the following items: Lord Rutherford's National Lecture on the Transmutation of the Atom, reported in full: an analysis by Vernon Bartlett on one of the most important post-war events: contributions by the Rt. Hon. Stanley Baldwin, Stephen King-Hall, S. P. B. Mais, Francis Underhill, Maude Royden, Julian Huxley, G. K. Chesterton, Harvey Grace, Edwin Muir. . . . Do the opinions of such people interest you? If so, you will find regularly, unfailingly, an equal volume of articles of this calibre in *The Listener* every week.

You can't afford to miss it.

PRICE THREEPENCE EVERY WEDNESDAY
EVERYWHERE

matter for the ingenuity of the manufacturer, and this has received satisfactory attention. There is, however, a more fundamental fault in this method of design. Neither the materials nor the dimensions which are convenient for the production of a cheap, satisfactory and pleasing receiver cabinet are suitable for use as a loudspeaker baffle. The general result is to produce a loss of the extreme bass in conjunction with a resonance point in the lower register, and this effect, if pronounced, gives very unpleasant reproduction. It is doubtful whether these faults will be definitely cured until listeners appreciate the desirability, despite the present trend of fashion, of mounting the loudspeaker separately from the set.

SELECTIVITY

The ideal response curve of a receiver is one that includes in their correct intensities the complete sidebands of the wanted station whilst rigidly excluding all frequencies outside this relatively narrow band. This unfortunately remains an ideal; for in practice exceptional selectivity is usually obtained by purposely limiting the receiver response, with the result that the higher overtones which give precision to the consonants of speech and character to the several instruments of an orchestra are lacking. Selectivity is thus a two-edged sword.

There is a regrettable tendency for a prospective purchaser to judge a receiver by its ability to "cut out" the local station and receive a large number of distant stations, despite the low entertainment value of results, and to choose a receiver which is capable—for example—of receiving the Scottish Regional transmitter fairly well in London, rather than one which will receive the London Regional with excellent quality. The fallacy of this is obvious when it is considered that—after the first enthusiasm for station finding has disappeared—the local station will generally be received for the greater percentage of the listening time.

SENSITIVITY

Helped by the development of the screened-grid valve, modern receivers give ample sensitivity. A good three-valve receiver should be capable of receiving any station whose field strength is sufficient to provide reproduction of entertainment

value, and a modern super-heterodyne receiver should receive any transmission which is strong enough to be heard above the general background of static; beyond this point further amplification would be wasted.

O T H E R D E V E L O P M E N T S

The past two or three years have seen some very interesting detail developments in receiver design. New types of valves continue to appear, with increasing complexity of construction. A double diode-triode which detects, amplifies and also operates an automatic volume control, has been followed by a still more complicated valve, the pentagrid, which operates as combined local oscillator and frequency changer in a super-heterodyne receiver. An entirely new method of valve construction, referred to on p. 421, has been developed, in which the usual glass envelope is almost wholly replaced by metal.

The variable-mu screened-grid valve (and later still the H.F. pentode valve) has made possible a new and convenient method of volume control by variation of grid bias, and has rendered practicable automatic control, whereby the amplification of the receiver adjusts itself automatically to compensate for variations of incoming signal strength. A substantially constant signal is thus delivered to the detector.

Tuning circuits also have received the attention of the research worker, and a satisfactory solution has at last been found to the old problem of the development of iron-cored tuning coils. The result will be to make future receivers more sensitive, more compact and at the same time more stable.

Another development which has taken place is the introduction of what may be termed "tone compensation." This is a method of giving the low-frequency amplifier a rising characteristic, or in other words making it amplify the higher audible frequencies more than the lower ones. In this way the attenuation of the upper audible frequencies caused by the selective tuning circuits can be compensated for (up to the cut off frequency) and the final output to the loudspeaker made reasonably correct over the admitted range of frequencies.

For short-wave reception the super-heterodyne receiver has come into its own, and, as already mentioned, most of the complexities from an operational standpoint have been over-

START YOUR CAR as easily as you SWITCH ON YOUR SET!

One Touch—That's all,
and the Self-Starting
"Solex" Carburettor
gives instant starting and
"get-away," no matter
how long your car has
been standing, or even if
the temperature is below
zero.

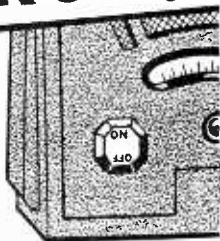

Fit the **SELF-STARTING**



SOLEX

CARBURETTOR

FOR INSTANT STARTING & "GET-AWAY"
LONGER LIFE TO THE ENGINE
LOWER PETROL CONSUMPTION
ABSOLUTE BATTERY EFFICIENCY

Your local garage can supply a "Solex" for your car on 30
Days' Free Trial, and give an allowance for your old carburettor,
whatever make it is. Write for full details to:—

Solex Ltd., Solex Works, 223-231, Marylebone Road, London, N.W.1

'Phones: Paddington 8621, 8622, 8623, 8624, 8625, 8626.

'Grams: "Solexcarb, Edge, London."

OSBORN RADIO CABINETS AND BAFFLE BOXES

OSBORN BAFFLE BOX

Protected by B. Patent No. 19101/33.

This Baffle Box will be hailed as a boon to all loud speaker users who are seeking "Finality" in reproduction. It supersedes all previous attempts at making a box suitable for obtaining the best possible frequency response without box resonance, containing all the advantages of these first models without the disadvantages. It is light in construction and can be fitted into any existing cabinet with the minimum of trouble, and cannot in any circumstances deteriorate through heat or moisture. The interior of this remarkable invention is manufactured from a series of rings of compressed sugar cane, which are joined together under a pressure of 50 tons. It can be used in any type of Speaker Cabinet that you may possess. We will gladly quote you an interior for same.

As illustrated in Stained Hardwood Case, with Dovetailed Corners.

24 in. x 24 in. x 12 in. ... £2 0 0
18 in. x 18 in. x 8 in. ... £1 0 0

PRICES CARRIAGE PAID U.K.

Be sure and send us the size of your Speaker at the extreme outside measurement, also the size hole you require cut in front baffle board.

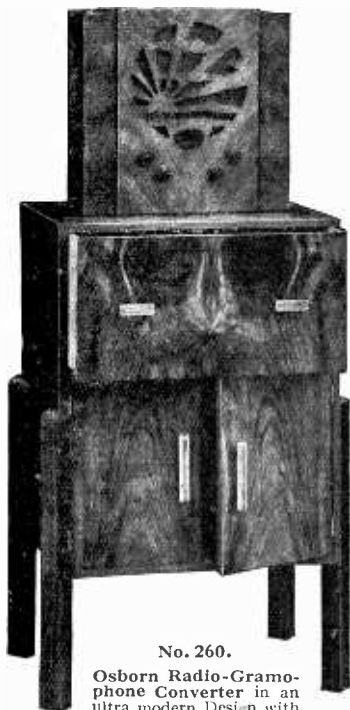

No. 260.

Osborn Radio-Gramophone Converter in an ultra modern Design with

drawer at top to take any type of gramophone motor, including Garrard Automatic Record Changing Unit. Fitted at the bottom with two doors opening on to a large cupboard for storage of records. Should you not require this space for records we would convert it into a cocktail cupboard free of charge, or a speaker compartment for an extra charge of 5/- for fret and baffle. Suitable for any type of set, including the Pye Portable as illustrated. 3ft. high, 2ft. wide, 1ft. 4½ in. deep. PRICES: *Machined Kit of Parts*: Oak £2 5s.; Mahogany £2 10s.; Walnut £2 15s. *Assembled Ready to Polish*: Oak £2 15s.; Mahogany £3; Walnut £3 5s.; *Assembled and Polished*: Oak £3 5s.; Mahogany £3 15s.; Walnut £4.

PRICES CARRIAGE PAID U.K.

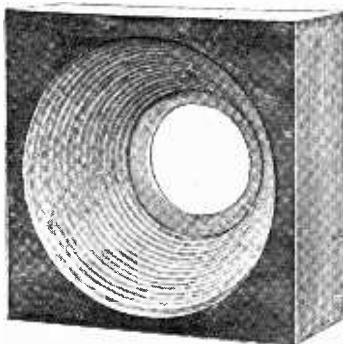

Send for illustrated Catalogue of Radio Cabinets of all types. Also Special Baffle Boards and Baffle Boxes.

CHAS. A. OSBORN

Showrooms: 21, Essex Road, Islington, N.1.

'Phone: Clerkenwell 5634.

Offices and Mills: The Regent Works, Arlington Street, New North Rd., London, N.1

'Phone: Clerkenwell 5095.

come by the adoption of ganging. There are also several simple short-wave adaptors on the market, both of the super-heterodyne and straight detector types, which can be readily coupled to an existing set designed primarily for reception on the normal broadcast wavelengths.

Cabinet work is an aspect of receiver design that was at one period very much neglected. Since the wireless set has now ceased to be a scientific toy and has become an important source of entertainment, it is entitled to be regarded, as is the grand piano, as a piece of furniture. It should, apart from utility factors, be pleasing to the eye and in harmony with its surroundings. The craze for disguising the loudspeaker as a clock or an oil painting has fortunately passed, and receivers are now being produced with cabinet work of definite artistic merit.

It would be natural to expect that all the technical improvements of the last few years which have combined to produce reliability, simplicity and quality, might be reflected in increased prices. It is gratifying, therefore, to find that the adoption of quantity production methods has resulted in a substantial reduction in costs so that, whereas three years ago a three-valve receiver cost something like twenty pounds, a much improved modern model may now be purchased for about two-thirds of this figure.

COMPTON ORGANS

REPRESENTATIVE WORK:

British Broadcasting Corporation,
Concert Hall, London, W.
Downside Abbey, Bath.
St. Stephen's Church,
Coleman Street, London, E.C.
St. Mary Magdalene, Paddington, W.
St. Luke's, Chelsea, S.W.

The COMPTON "MINI-TURA" is a pipe Organ of the highest quality designed for small Churches, Schools and Residences. It has a complete tonal scheme with electric blower and electric action. Prices from £595.

THE JOHN COMPTON ORGAN CO. LTD.,
CHASE ROAD, NORTH ACTON, N.W.10.

Telephone: Willesden 6666.

ROYAL SOLDIERS' DAUGHTERS' HOME

ROSSLYN HILL,
HAMPSTEAD,
N.W.3

Patrons

T.M. THE
KING & QUEEN

Necessitous Children of our Soldiers are maintained, educated and trained for Domestic Service and Trades.

The age of departure is seventeen, when a situation is guaranteed to them and they are supplied with an outfit.

Think of the incalculable value of this work both to the orphan girls and the Nation, and send a gift to the Secretary, Major H. S. Marshall, D.S.O., Rosslyn Hill, Hampstead, N.W.3



LAST JOINED

Your Problem SOLVED!

IF YOU ARE INTERESTED IN

Settlement Trade
Travel Sport

Kenya, Northern Rhodesia, Nyasaland, Tanganyika, Uganda, and Zanzibar offer inducements which defy comparison

Healthy climate, magnificent scenery, reasonable living costs and light taxation, every social amenity, fine sport with rifle and rod (and all home sports)

There may be some Settlement, Business, Travel or Sporting problem which the Eastern African Dependencies could solve for YOU!

Full particulars and illustrated handbooks can be obtained on application

**H.M. EASTERN
AFRICAN DEPENDENCIES**
Trade & Information Office
GRAND BUILDINGS, TRAFALGAR SQUARE, LONDON, W.C.2



RECEPTION OF DISTANT STATIONS

A LARGE NUMBER of listeners to British stations have undoubtedly heard European stations on their receivers, even though they are not what are generally called "distant listeners." Indeed, they may have had occasion to complain, from time to time, of interference from a foreign station when listening to local or regional transmitters. Some of the facts which are known about the propagation of waves are of great interest, particularly for the information of those who are interested in the "distant listening" side of broadcasting.

Radiation from a broadcasting transmitting aerial, or indeed from any ordinary wireless transmitting aerial, is not all sent out in the horizontal plane, *i.e.* parallel to the earth's surface. The vertical angle at which most of the radiation takes place depends on the form and dimensions of the aerial in relation to the wavelength in use and on the conductivity of the ground on which the station is situated and over which the waves travel. As the majority of listeners in the service area of a broadcasting station live at or about ground level, it is obviously desirable that a broadcasting station transmitting aerial should be so designed and sited that as much energy as possible is radiated at as low an angle as possible. It is for this reason that modern broadcasting stations have high aerials, the ideal being for the vertical height of the aerial to be equal to, or slightly greater than one half of the wavelength in use. Financial and mechanical considerations enter into this problem, for the aerial has to be supported by a mast or tower of some sort, and in general a mast height of 500 feet is a convenient maximum, although in special cases considerably higher masts have been built.

It is now generally known that the waves which are radiated at an angle to the horizontal do not escape into space, but that in certain conditions they are bent back again to earth by one or more ionised layers in the upper atmosphere (ionosphere). In this way the waves are returned again to earth, but as conditions of bending in the layers are continuously changing at night, and as the waves are not bent back to earth in the presence of full daylight, reception by means of this "indirect radiation," as it is called, is variable at night and more or less non-existent by day. In this statement "day" must be defined

as the period between about two hours after sunrise and about two hours before sunset.

The "direct" radiation—or radiation received direct from the transmitter without having passed up to the "ionosphere"—is attenuated relatively rapidly by its passage over the earth's surface in comparison with the indirect radiation which is not so attenuated. As will be seen later on, this indirect radiation reaches quite high values at considerable distances from the transmitter.

A moment's consideration will show that as the distance between a transmitter and the receiver is increased, three typical areas of reception will be experienced: firstly, an area in which the direct or ground radiation preponderates, and practically no indirect radiation is present; secondly, an intermediate area where both direct and indirect radiation are present and at times may be of equal intensity; and thirdly, a more distant area where the indirect or reflected radiation preponderates. These three areas are characterised respectively by no fading (*i.e.* "service" conditions of reception) in the first; intense, and often quick fading in the second; and generally less and slower fading, which can be made into partial service conditions by the use of receiver automatic gain control, in the third. The boundaries of the three zones are by no means clearly defined—in fact, they merge one into the other. The extent of the areas varies from day to day and from hour to hour, and it is possible to specify only the first, or service area, but with a degree of accuracy which itself is relatively low.

The design of the transmitting aerial also enters into the question, as has already been pointed out. By suitable design, the first or "service area" may be extended by as much as 15 to 20 per cent., but this does not necessarily bring about a reduction in strength in the third area, where only indirect radiation is present. In fact, even stronger signals may often be observed.

The conditions of propagation of the direct radiation have been the subject of research, experiment and measurement for a number of years now, and can be stated in certain laws which take into account, *inter alia*, the wavelength, the conductivity of the ground and the curvature of the earth. From a knowledge of the power radiated by a transmitting aerial, and of the

World-Radio

{ e m p i r e *short-wave*
c o n t i n e n t a l
B B C

p r o g r a m m e s

t e c h n i c a l *for beginner and
expert*

g e n e r a l *of the widest interest*

a r t i c l e s

price threepence every Friday

from all booksellers, newsagents, bookstalls.

*There is also a special edition—Empire World-Radio—
available for Empire listeners abroad.*

*The subscription to this for a year is 22/- including
postage to any part of the Empire.*

A SELECTION OF BBC PUBLICATIONS

→—————←

Broadcast English. (No. 1. Price 3*d.*, by post 4*d.*: No. 2. Price 1/-, by post 1½: No. 3. Price 3*d.*, by post 4*d.*)

Broadcasting House: an Illustrated Description. Price 5/-, by post 5/9.

Broadcast National Lectures. (Nos. 3, 5, 6, 7, 9, 10, 12, and 13. Price 1/- each, post free.)

World-Radio Broadcasting Map of Europe. Price 3/-, post free.

World-Radio Station Identification Panels Booklet. Price 1/-, post free.

World-Radio Calibration Charts Booklet. Price 1/-, post free.

Technical Tables and Glossary. Price 1/-, post free.

Services for Broadcasting. In cloth covers, price 2/-, by post 2¼; paper, price 1/-, by post 1/3.

Broadcast Talks Pamphlets. Price 3*d.* and 6*d.* each. By post, 4*d.* and 7*d.* (according to size).

School Pamphlets. Price 2*d.* each, post free.

These can be ordered from all bookstalls, newsagents and booksellers: or at the prices quoted by post direct from the BBC Publications Dept. Broadcasting House W. 1.

above three factors, it is possible to predict what direct radiation field strength will be produced at different distances (see p. 347). It is only within the past three or four years, however, that the propagation of the indirect radiation for wavelengths in the broadcast waveband has been studied quantitatively.

As a first approximation and based on certain theoretical calculations, Capt. P. P. Eckersley suggested in 1929 that the value of indirect radiation was the same for all waves between 200 and 2000 metres for distances up to 1000 kilometres, and that it was of the order of 0.1 millivolt per metre for a station radiating 1 kilowatt. A very large number of measurements has been made since then by the B.B.C. and by other organisations individually, while, internationally, several large-scale experiments have been arranged in Europe by the International Broadcasting Union (U.I.R.). One of the first results of these experiments was to show that it is not of much value to take a series of isolated measurements on any given station. Extremely large variations in the value of the indirect radiation were found, and it was apparent that continuous recording of these variations must be accomplished, and that these records must be taken over long periods. Even after this had been done, it was not at first apparent that any general laws could be deduced from the mass of material that had been collected.

The first analysis of the U.I.R. experimental results, made in 1931 by M. Braillard, indicated that the value of indirect radiation was dependent on the wavelength, being greater as the wavelength was decreased towards 200 metres, and that it was also dependent on distance, rising to a maximum at about 700 kM., and thereafter decreasing. Between the spring of 1931 and the autumn of 1932, further experimental evidence was collected, and at the World Radio Telegraph Conference at Madrid at the latter date, a scientific sub-committee was set up under the presidency of Dr. B. Van der Pol for the purpose of further considering this problem.

This committee had at its disposal evidence collected not only in Europe, but also from all over the world, and it produced a report in which attenuation curves for transmission over land and sea were given for direct and indirect radiation for wavelengths between 200 and 2000 metres up to a distance of 2000 kM. This work has since been extended for indirect

radiation up to 5000 kM. by a second Van der Pol Committee at the recent European Broadcasting Conference at Lucerne.

These curves show that, at distances from about 500 to 5000 kM., the night values are the same for all wavelengths involved and are the same for sea and land, but that the day values are different for each of these conditions. The night values decrease with increasing distance above 500 to 700 kM., at which distances they are a maximum of approximately 0.3 mV./M. for a station radiating 1 kW. One very important point, however, which must be borne in mind is the extreme variability of the night values. Indeed, they vary from half to twice the values given for the higher wavelengths and from one-third to three times those given for the lower waves. A point which has also been established is that fading is generally much slower on the longer waves, and high instantaneous maxima are reached but rarely on these waves.

In dealing with a varying quantity, it becomes necessary to introduce the question of the time during which it is above or below a certain value. The actual maximum value of indirect radiation observed from a station is a function of the time over which the observation is made. Furthermore, it seldom occurs. It has therefore been agreed that in dealing with indirect radiation measurements the average values given should be those which are exceeded by instantaneous values for a certain percentage of the total time over which the observations have been made. The percentages generally considered are 5 and 50 per cent., the former being known as the "quasi-maximum" value and the latter as the "probable" value.

If the field is recorded continuously on paper strip, it is possible to work out these values, but it is an extremely laborious process. The B.B.C. has therefore developed apparatus which counts automatically the number of seconds during which the indirect radiation field has exceeded ten predetermined values. The total duration of the record in seconds is counted at the same time, and it is thus possible easily to determine not only the 5 and 50 per cent. values, but also all other values from 0 to 100 per cent. of the time. The illustration on p. 444 shows a specimen record for the Beromünster station taken near London a few months ago. The total duration of the record was one and a half hours. It will be seen that the ratio of the quasi-maximum

THE MILNES H.T. SUPPLY UNIT

you buy now will
be just as efficient
in 20 years' time

PRICES IN GT. BRITAIN

90 volt £3 3 0

100 volt £3 9 5

120 volt £4 2 3

150 volt £5 1 6

Hire Purchase terms
from 6/3d. per month

Send a Post Card to-day for

BIG FREE BOOK

(Y.B.) giving fullest particulars

MILNES RADIO CO. LTD.,
CHURCH STREET, BINGLEY, YORKS

The Milnes Unit is a *permanent* solution of the H.T. problem. It never runs down for whenever the set is not in use it *recharges itself* from the L.T. accumulator—automatically and without current wastage. The nickel-cadmium plates are practically indestructible. Your set is *always* in tip top condition when you run it from a Milnes Unit.

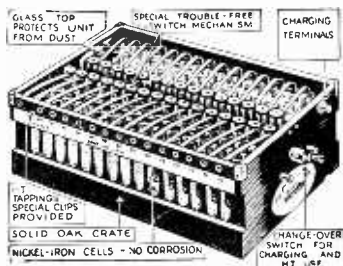

YOUR Set can get AUSTRALIA!

Fit an Eelex Short-Wave Converter to your present set. You can receive America, Russia, Australia, South Africa, etc.

Bring your set up-to-date. Sample the joys of short-wave reception by fitting an Eelex Short-Wave Converter to your present set and add 70 extra stations to your log. Only a moment to fit. This remarkable invention enables you to receive stations between 16 and 190 metres. You can double the enjoyment of your wireless with an Eelex Short-Wave Converter fitted to your present set—no alterations necessary. Makes your set a Super-Het. Send for booklet B.B.C. giving complete particulars.

J. J. EASTICK & SONS
118, Bunhill Row, London, E.C.1

Phone: METROPOLITAN 0314/5/6

S I N C L A I S P E A K E R

BRITAIN'S FINEST REPRODUCERS

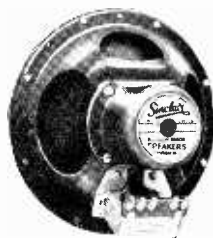

ENERGISED SPEAKERS

ALL VOLTAGES: 7", 22/6; 9", 27/6, retail.

PERMANENT MAGNET SPEAKERS

5", 22/-; 7", 25/- & 35/-; 9", 30/- & 40/-, retail.

49/50, Twyford Street, London, N.1
Telephone - - TERMINUS 1055/6

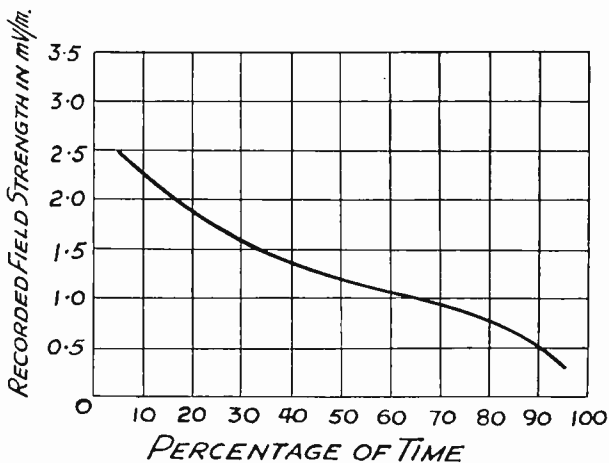

to probable value is 2.1 to 1, and experience shows that this ratio is approximately constant for all waves in the band 200 to 2000 metres and for all distances from about 500 to 5000 kM., although the actual values themselves may vary considerably.

It has only been possible to outline some of the more general aspects of this subject, but it is hoped that sufficient information has been given to allow readers who are interested in "distant listening" to appreciate some of the more important physical facts which govern the reception of distant broadcasting stations, and to account for some of the apparently paradoxical results they may have observed. In any event, it will be seen that knowledge of the behaviour of indirect radiation from radio stations using waves in the band 200 to 2000 metres has been considerably increased during the past three or four years. While it is now possible to estimate the order of magnitude of the received indirect radiation field in any particular case, it seems unlikely, from the nature and number of the variables involved, that it will ever be possible to predict actual values with great accuracy.

A P P E N D I X

B. B. C. ADDRESSES



Headquarters

HEAD OFFICE AND NATIONAL AND LONDON REGIONAL STUDIOS	} Broadcasting House, London, W. 1.	Telegrams : Broad- casts, London.
		Telephone : Welbeck 4468.

Regional Centres

Telegrams and Telephone

MIDLAND REGION	Broadcasting House, 282, Broad Street, Birmingham.	Birmingham Mid- land 3761
WEST REGION	Broadcasting House, 39, Park Place, Cardiff.	Cardiff 2514.
NORTH REGION	Broadcasting House, Piccadilly, Man- chester.	Manchester City 8396.
SCOTTISH REGION	Broadcasting House, 5, Queen Street, Edinburgh.	Edinburgh 30111.
BELFAST	31, Linenhall Street.	Belfast 5870.

Other B.B.C. Offices

ABERDEEN	15, Belmont Street.	Aberdeen 2296.
BOURNEMOUTH	72, Holdenhurst Road.	Bournemouth 3460.
BRISTOL	Broadcasting House, 23, Whiteladies Road, Clifton.	Bristol 33313.
GLASGOW	282, West George Street.	Glasgow Douglas 5230.
LEEDS	Broadcasting House, Albrecht Buildings, Woodhouse Lane.	Leeds 28131.
NEWCASTLE	Broadcasting House, 54, New Bridge St.	Newcastle 20961.
PLYMOUTH	Athenæum Cham- bers.	Plymouth 2283.
SHEFFIELD	47, Corporation St.	Sheffield 24227.
SWANSEA	Oxford Buildings.	Swansea 3107.

VISITS TO B.B.C. STUDIOS

Visits fall into two categories: (1) Presence in the studio during a broadcast, usually of a variety programme; (2) conducted tours round the studios. Application should be made to Administration, Broadcasting House, London, W.1, or to the Director of the B.B.C. Station concerned, but the following points may be of interest:—

London. It has been found from experience since the B.B.C. moved into Broadcasting House that, owing to the serious interference caused to transmissions or rehearsals taking place in the various studios, it is impossible to accede to all of the large number of applications for tours round the building.

Variety Audiences: the length of the waiting list necessitates a wait of several months after application.

Manchester. Audiences are allowed. Applicants should state type of programme and number of party, maximum 25: evening visits only.

Edinburgh. Audiences are allowed for both variety programmes and orchestral concerts. Accommodation for about 300.

Cardiff. Conducted parties, but not studio audiences, as accommodation is too limited.

WAVELENGTHS OF BRITISH STATIONS

(on and after January 15th, 1934)

Wave-length, M.	Power, kW.	Station.	Dial Readings.
1500	30	Daventry National	
449.1	50	North Regional.	
391.1	25	Midland Regional.	
373.1	50	Scottish Regional.	
342.1	50	London Regional	
307.1	50	West Regional	
296.2	50	North National.	
285.7	50	Scottish National.	
285.7	1	Bournemouth.	
267.4	1	Belfast (Ireland).	
261.1	50	London National.	
261.1	50	West National.	
222.6	1	Aberdeen.	
209.9	1	Newcastle.	
203.5	0.3	Plymouth.	

WEATHER FORECASTS

- 10.30 a.m. Daventry 5XX. Weather Forecast for ships. Read twice—first at natural speed, second time at long-hand dictation speed.
- 6.0 p.m. General Weather Forecast (National Programme).
- 9.0 p.m. General Weather Forecast (National Programme).
- 10.15 p.m. General Weather Forecast (Regional Programme).
- 11.00 p.m. Daventry 5XX. Weather Forecast for ships only.

In addition:—

- Gale Warnings are broadcast with the Shipping Forecasts, and at 1.0, 4.45, 6.0, and 9.0 p.m., and on Sundays at 4.15 p.m., when received from the Meteorological Office.
- Navigational warnings are broadcast with the Shipping Forecast at 11 p.m. when received from the Admiralty.

RULES FOR S.O.S. MESSAGES

1. FOR RELATIVES OF SICK PERSONS

The B.B.C. will broadcast messages requesting relatives to go to a sick person only when the Hospital Authority or the Medical Attendant certifies that the patient is *dangerously* ill, and if all other means of communication have failed. In the normal course of events messages will be broadcast only when the full name of the person wanted is available.

Note

When the person sought is known to be on board a ship at sea, a message can only be broadcast if the ship is not equipped with apparatus for the reception of messages by wireless telegraphy. Further, there must be a possibility that the return of the person sought can be hastened by the reception of such a message. This is not considered to be the case where the ship is on its way to a known port. In such cases, inquirers are advised to communicate with the owners or agents of the ship or with the port authorities.

In no case can an S.O.S. be broadcast requesting the attendance of relatives after death has occurred.

2. FOR MISSING PERSONS

Apart from official messages originated by the Police, the B.B.C. does not broadcast messages concerning other missing persons.

3. FOR WITNESSES OF ACCIDENTS

Requests for witnesses of accidents are not broadcast except when contained in official messages originated by the Police.

4. No message can be broadcast regarding lost animals or property.

5. There is no charge for broadcasting S.O.S. messages.

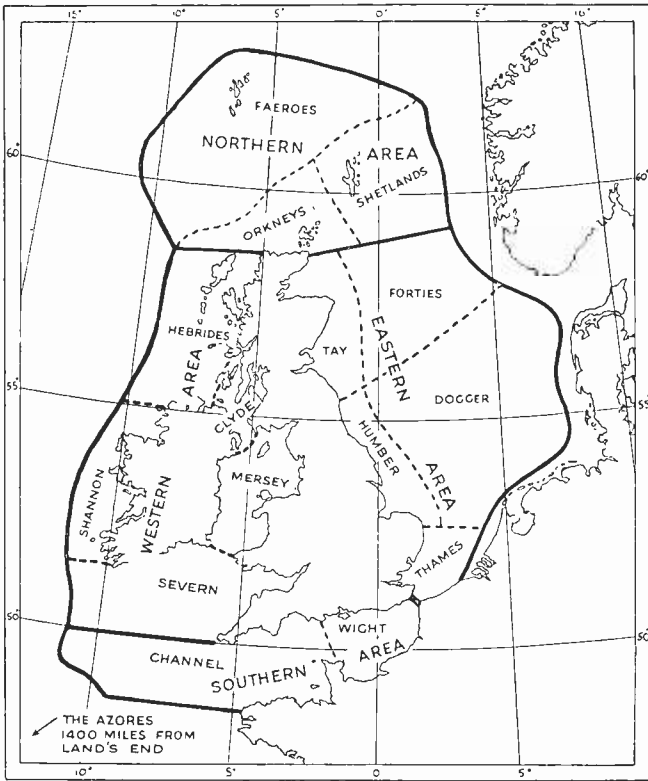

A MAP OF THE AREAS ALLUDED TO IN THE DAILY SHIPPING FORECASTS FROM DAVENTRY 5XX

THE TIME SIGNAL SERVICE

Time.	Signals on Daventry National Pro- gramme.	Signals on London Regional Pro- gramme.	Notes.
Week-days.			<p>The official Broadcasting Time Signal is that which is received from Greenwich Observatory. It consists of six dot seconds, the last dot indicating the point of time to a normal accuracy of one-twentieth of a second. Any signal, with the exception of those at 10.30 a.m. and 6 p.m., is liable to suppression if superimposition on a current programme is strongly inadvisable on artistic grounds. The signals at 10.30 a.m. and 6 p.m. will be suppressed only in exceptional circumstances, and advance notification will be given should such a case arise. Any signal, except those at 9.0 p.m. and 10.15 p.m., which may be suppressed on artistic grounds, will be radiated at the next quarter if that point of time is free from programme matter. The 9 p.m. National, and 10.15 p.m. London Regional signals will, if suppressed, be radiated at the next quarter, and superimposed on the topical talk, news, or whatever may be going on at the time, unless special advance notification is given.</p> <p>When the news is at 9.40 p.m., <i>e.g.</i> during the Promenade Season, the six dot seconds will be radiated at 10 p.m. instead of at the beginning of the news.</p> <p>Big Ben will be broadcast in accordance with the chart when possible, and will, in addition, be radiated at the beginning of any programme emanating from London, should the start of the programme coincide with a quarter.</p>
10.15 a.m.	Big Ben	Big Ben	
10.30 a.m.	G.T.S.	G.T.S.	
12.00 noon.	Big Ben	Big Ben	
1.00 p.m.	G.T.S.	G.T.S.	
4.45 p.m.	G.T.S.	—	
5.15 p.m.	Big Ben	Big Ben	
6.00 p.m.	G.T.S.	G.T.S.	
6.30 p.m.	Big Ben	Big Ben	
9.00 p.m.	G.T.S. (When 2nd News is at 9.00 p.m.)	G.T.S.	
10.00 p.m.	G.T.S. (When 2nd News is at 9.40 p.m.)	G.T.S.	
10.15 p.m.	—	G.T.S. (When 2nd News is at 10.15 p.m.)	
11.30 p.m.	G.T.S.	G.T.S.	
12.00 midn.	Big Ben	Big Ben	
Sunday.			
10.30 a.m.	G.T.S.	—	
12.30 p.m.	Big Ben	Big Ben	
4.30 p.m.	G.T.S.	G.T.S.	
9.00 p.m.	G.T.S.	G.T.S.	
10.30 p.m.	Big Ben	Big Ben	

EXPENDITURE.

To Expenditure on Programmes (including payment of Artists, Orchestras, News Royalties, Performing Rights and Simultaneous Broadcast Telephone System, Salaries and Expenses of Programme Staff)	663,424	1	3
” Maintenance of Plant, Power, Salaries and Expenses of Engineering Staff, Development and Research, &c.	252,260	15	5
” Rent, Rates, Insurance, Heating and Lightings, Upkeep and Expenditure upon Premises, Telephones, &c.	154,763	6	5
” Administration Salaries and Expenses	77,173	3	3
” Interest on Bank Loan, less Interest on Bank Current Account and Income from Investments	1,626	10	4
” Contributions to Staff Pension Scheme	22,393	6	6
” Governors' Fees	5,642	10	0
” Provision for Depreciation and Renewal of Premises, Plant, Furniture and Fittings, &c.	99,650	0	0
” Provision for Income Tax	110,007	0	0
” Balance carried down, being Net Revenue for year	241,797	13	5
	<u>£1,628,738</u>	<u>6</u>	<u>7</u>

INCOME.

By Licence Income (Net)	£	s.	d.
” Net Revenue from Publications, after providing for Bad and Doubtful Debts	1,306,453	15	10
” Grants to the Corporation amounting to £17,500 which have been made by the Postmaster-General during 1932 out of Licence Revenue in respect of the production of Grand Opera for the year 1932 are not included in the Licence Income shown above, nor are payments, to a corresponding amount, to the Covent Garden Opera Syndicate (1930), Ltd., included in the expenditure.	322,284	10	9

£1,628,738 6 7

REVENUE APPROPRIATION ACCOUNT.

To Transfer to Capital Account as a provision towards meeting Capital Expenditure	£	s.	d.
” Balance (unappropriated Net Revenue) carried forward at 31st December, 1932, as per Balance Sheet	250,000	0	0
”	3,776	16	0
	<u>£253,776</u>	<u>16</u>	<u>0</u>
By Balance (unappropriated Net Revenue) brought forward from 31st December, 1931	£	s.	d.
” Profit on Realisation of Investments	1,217	1	1
” Net Revenue for year, per Revenue Account (above)	10,762	1	6
	<u>241,797</u>	<u>13</u>	<u>5</u>
	<u>£253,776</u>	<u>16</u>	<u>0</u>

BALANCE SHEET

	LIABILITIES.			
CAPITAL ACCOUNT—	£	s. d.	£	s. d.
Value placed upon Premises and Plant, Furniture and Fittings, Musical Instruments, Music, Stores, &c., taken over (without payment) from the British Broadcasting Co., Ltd.	174,938	0 0		
Appropriated from Revenue towards meeting Capital Expenditure—				
Appropriated to 31st December, 1931 (per last Balance Sheet)	795,161	2 3		
Appropriated at 31st December, 1932	250,000	0 0		
			1,220,099	2 3
PROVISION FOR DEPRECIATION AND RENEWAL OF PREMISES, PLANT, FURNITURE AND FITTINGS, &c.—				
Balance at 31st December, 1931, per last Balance Sheet	176,750	10 10		
Add: Further provision during 1932, per Revenue Account	99,650	0 0		
	276,400	10 10		
Less: Book value (net) of Plant, Furniture and Musical Instruments discarded during 1932	26,134	16 8		
			250,265	14 2
CREDITORS AND RESERVE FOR CONTINGENCIES—				
Sundry Creditors (including provision for Income Tax)	297,886	15 0		
Reserve for Contingencies	20,000	0 0		
			317,886	15 0
REVENUE ACCOUNT—				
Balance (unappropriated Net Revenue) at 31st December, 1932, carried forward as per Account				3,776 16 0

(Signed) J. H. WHITLEY
 HAROLD G. BROWN } Governors.
 J. C. W. REITH, Director-General.

£1,792,028 7 5

REPORT OF THE AUDITORS TO THE MEMBERS

We have examined the above Balance Sheet dated 31st December, 1932, have obtained all the information and explanations we have required. The and correct view of the state of the Corporation's affairs at 31st December, us and as shown by the books of the Corporation.

5, LONDON WALL BUILDINGS,
 LONDON, E.C. 2.
 26th January, 1933.

as at 31st December, 1932.

ASSETS.		£	s.	d.	£	s.	d.
FREEHOLD LAND AND BUILDINGS—							
Acquired from the British Broadcasting Co., Ltd., as valued by the Corporation's Officials, plus additions made by the Corporation to 31st December, 1931, at cost, per last Balance Sheet							
		962,391	2	4			
Additions during 1932, at cost							
		100,883	8	8			
					1,063,274	11	0
PLANT—							
Acquired from the British Broadcasting Co., Ltd., as valued by the Corporation's Officials, plus additions made by the Corporation to 31st December, 1931, at cost, per last Balance Sheet							
		332,843	3	10			
Additions during 1932 at cost (<i>less</i> book value of Plant discarded during the year)							
		121,466	13	1			
					454,309	16	11
FURNITURE AND FITTINGS—							
Acquired from the British Broadcasting Co., Ltd., as valued by the Corporation's Officials, plus additions made by the Corporation to 31st December, 1931, at cost, per last Balance Sheet							
		65,108	17	5			
Additions during 1932, at cost (<i>less</i> book value of Furniture discarded during the year)							
		14,912	15	10			
					80,021	13	3
MUSICAL INSTRUMENTS, MUSIC AND BOOKS—							
Acquired from the British Broadcasting Co., Ltd., as valued by the Corporation's Officials, plus additions made by the Corporation to 31st December, 1931, at cost, per last Balance Sheet							
		33,487	15	9			
Additions during 1932, at cost (<i>less</i> book value of Instruments discarded during the year)							
		8,205	3	7			
					41,692	19	4
STORES ON HAND AND WORK IN PROGRESS, at cost or under							
					17,435	7	9
DEBTORS AND UNEXPIRED CHARGES—							
Sundry Debtors (<i>less</i> provision for Doubtful Debts)							
		94,819	9	3			
Unexpired Charges							
		16,670	11	11			
					111,490	1	2
CASH AT BANK AND IN HAND—							
At Bank, on Current Account (<i>less</i> Balance on Loan Account)							
		22,439	5	10			
In hand							
		1,364	12	2			
					23,803	18	0
					<u>£1,792,028</u>	<u>7</u>	<u>5</u>

OF THE BRITISH BROADCASTING CORPORATION.

with the books and vouchers of the British Broadcasting Corporation, and Balance Sheet is, in our opinion, properly drawn up so as to exhibit a true 1932, according to the best of our information and the explanations given to

DELOITTE, PLENDER, GRIFFITHS & CO., Auditors,
Chartered Accountants.

Trade Associations and Technical Societies

BRITISH RADIO VALVE MANUFACTURERS'
ASSOCIATION

59, Russell Square, London, W.C.1.

Secretary : H. Howitt.

INCORPORATED RADIO SOCIETY OF GREAT
BRITAIN

53, Victoria Street, London, S.W.1.

Hon. Secretary : John Clarricoats.

INSTITUTE OF WIRELESS TECHNOLOGY

72, Oxford Street, London, W.1.

Secretary : H. J. King.

INSTITUTION OF ELECTRICAL ENGINEERS
(WIRELESS SECTION)

Savoy Place, London, W.C.2.

Secretary : P. F. Rowell.

TELEVISION SOCIETY

Business Secretary : J. J. Denton, A.M.I.E.E.,
25, Lisburne Road, Hampstead, N.W.3.

Editorial Secretary : W. G. W. Mitchell, B.Sc.,
Linton, Newbury, Berks.

RADIO MANUFACTURERS' ASSOCIATION

Astor House, Aldwych, London, W.C.2.

Secretary : D. Grant Strachan.

RADIO WHOLESALERS' FEDERATION

Bloomsbury Mansions,
26, Hart Street, London, W.C.1.

Secretary : J. Macfarlane.

WIRELESS RETAILERS' ASSOCIATION OF
GREAT BRITAIN AND NORTHERN IRELAND

1, Mitre Court, London, E.C.4.

Secretary : Capt. H. A. Bain.

NEW WAVELENGTHS PLAN

(see page 323)

A. GENERAL PROVISIONS

1. The figure giving the actual power indicates, for each station, the power at the date of signature of the present Convention.

2. The stations using an identical frequency are indicated in the alphabetical order of their official names.

3. In the case where the maximum power is not indicated in the Plan, the non-modulated power measured in the aerial must not exceed the following values:—

- | | |
|---|---------------------|
| (a) For frequencies below 300 kc/s (waves above 1,000 m.) | 150 kW ¹ |
| (b) For frequencies between 550 and 1,100 kc/s (waves between 545 and 272·7 m.) | 100 kW ² |
| (c) For frequencies between 1,100 and 1,250 kc/s (waves between 272·7 and 240 m.) | 60 kW |
| (d) For frequencies between 1,250 and 1,500 kc/s (waves between 240 and 200 m.) | 30 kW |

¹ For the station Moscow 1, the maximum power admitted is 500 kW.

² For the following stations: Budapest, Leipzig, Paris PTT, Prague I, Rennes PTT, Toulouse PTT, Vienna, the maximum power admitted is 120 kW.

However, the power of stations mentioned in the Plan must not exceed the value which is necessary to ensure economically an efficient national service of good quality within the limits of the country in question.

4. On the other hand, the power of stations using common waves is limited as follows:—

- | | |
|---|--------|
| (a) for national common waves | 5 kW |
| (b) For international common waves Type 1 | 2 kW |
| (c) For international common waves Type 2 | 0·2 kW |

5. In the case where the maximum power is indicated in the list of stations on the Plan, this power will be modified after agreement of the interested Administrations, if experience, supported by measurements, shows that this modification is useful or necessary. The modifications must be limited to the value which will allow the avoidance of interferences if it is a case of diminution of power, or to the value shown in Section 3 if it is a case of an increase of power.

6. The admissible tolerances for the frequency of stations are fixed as follows:—

- | | |
|---|----------------------|
| (a) Stations using an exclusive frequency | ± 50 cycles/sec. |
| (b) Stations using a shared frequency | ± 10 cycles/sec. |
| (c) Stations using a national common frequency | ± 50 cycles/sec. |
| (d) Stations using an international common frequency Type 1 | ± 10 cycles/sec. |
| (e) Stations using an international common frequency Type 2 | ± 50 cycles/sec. |

However, a tolerance of ± 10 cycles/sec. is recommended for the frequency of stations mentioned under (a) and (c).

7. (a) A "shared wave" is a wave used by two or more stations specially named in the Plan.

(b) A "National Common Wave" is an exclusive or shared wave attributed to a country which that country may use for an unlimited number of synchronised stations.

(c) An "International Common Wave," Type 1, and an "International Common Wave," Type 2, are waves used by stations belonging to different countries and fulfilling the conditions laid down in Sections 4 and 6.

8. Frequencies mentioned in the Plan must only be used for a telephonic broadcasting service. A visual broadcasting service may be admitted on a frequency allotted to a station when this service does not cause any interference to the working of neighbouring stations.

9. In addition to the frequencies provided for stations of the contracting countries, the Plan also provides attributions of frequencies for stations of countries which are not signatories of the Lucerne Convention.

10. In conformity with the dispositions of Article 1, sec. 2, of the European Broadcasting Convention, modifications can be made to the Plan only under the conditions fixed in Article 5 of this Convention.

11. The final Protocol of the European Radio-electric Conference of Prague (1929) ceases to have effect on the date of the entry into force of the present Plan.

B. LIST OF STATIONS

Band No. 1: 150 to 300 kc/s (2,000 to 1,000 m.).

Frequency, kc/s.	Wave- length, m.	Station.	Aerial Power in kW.		
			Pre- sent.	Maximum	
				by day.	by night. ¹
160	1875	Brasov (Romania) . . .	1		
167	1796	Radio-Paris (France) . . .	75		
		Syria (Syria) . . .	0	20	20
175	1714	Moscow I (U.S.S.R.) . . .	500		
183	1639	Ankara (Turkey) . . .	7		
		Kaunas (Lithuania) . . .	7	7	7
		Madrid I (Spain) . . .	0		
		Reykjavik (Iceland) . . .	16	30	30
191	1571	Königs Wusterhausen (Ger- many) . . .	60		
200	1500	Daventry (Droitwich) (Gt. Britain) . . .	30		
208	1442	Minsk (U.S.S.R.) . . .	100		
216	1389	Motala (Sweden) . . .	30		
223	1345	Huizen (Holland) . . .	7		

Frequency, kc/s.	Wave-length, m.	Station.	Aerial Power in kW.		
			Pre-sent.	Maximum	
				by day.	by night. ¹
223	1345	Kharkov (U.S.S.R.) . . .	20		
230	1304	Warsaw (Poland) . . .	120		
238	1261	Kalundborg (Denmark) . . .	75	60	60
		Portugal (North) ² (Portugal)	0	20	20
245	1224	Leningrad (U.S.S.R.) . . .	100	100	100
253	1186	Oslo ³ (Norway) . . .	60	60	60
262	1145	Lahti ⁴ (Finland) . . .	40	150	60
271	1107	Moscow II (U.S.S.R.) . . .	100	100	100

¹ Applicable one hour after sunset at the transmitter.

² Must use a directional aerial towards the south and reduce the power during the night in case of interference with services not open to public correspondence of Spain and of France.

³ Norway will do all that she can to reduce the field towards the south-east without diminishing the national service of Oslo.

⁴ May use a power at night up to 150 kW if an aerial directed towards the north is installed.

Band No. 2: 300 to 500 kc/s (1,000 to 600 m.).

Frequency, kc/s.	Wave-length, m.	Station.	Aerial Power in kW.		
			Pre-sent.	Maximum	
				by day.	by night. ¹
355	845	Finmark (Norway) . . .	1	10	5
		Rostov-on-Don (U.S.S.R.) . . .	20	20	20
364	824	Smolensk (U.S.S.R.) . . .	10	10	10
392	765	Ostersund (Sweden) . . .	0.6	10	5
		Slovakia ² (Czechoslovakia) . . .	0	30	15
401	748	Geneva ³ (Switzerland) . . .	1.3	1.3	0.5
		Moscow III (U.S.S.R.) . . .	100	100	50
413.5	726	Boden (Sweden) . . .	0.6	10	5
		Voroneje (U.S.S.R.) . . .	10	10	10
431	696	Oulu ⁴ (Finland) . . .	2	5	1.5

¹ Applicable one hour after sunset at the transmitter.

² Must use a directional aerial towards the east.

³ Under the condition not to interfere with the services not open to public correspondence.

⁴ Must use a directional aerial towards the north. The power may be increased if experience shows that trouble does not result to the maritime service.

Band No. 3: 500 to 1,500 kc/s (600 to 200 m.).

Frequency, kc/s.	Wave-length, m.	Station.	Aerial Power in kW.		
			Pre- sent.	Maximum	
				by day.	by night. ¹
519	578·0	Hamar (Norway)	0·7	2	0·5
		Innsbruck ⁴ or ⁵ (Austria)	0	2	1
527	569·3	Ljubljana ¹¹ (Yugoslavia)	5	5	5
		Tampere ² (Finland)	1·2	1	1
		Finnish Common Wave (Fin- land)	0·5	1	1
536	559·7	Bolzano ³ (Italy)	1	1	1
		Wilno ² (Poland)	16	16	8
546	549·5	Budapest (Hungary)	18·5	120	120
556	539·6	Beromünster (Switzerland)	60		
565	531·0	Athlone (Irish Free State)	60		
		Palermo ⁹ (Italy)	3	3	3
		Italian Common Wave (Sicily) ⁹ (Italy)	0	3	3
574	522·6	Mühlacker (Germany)	60		
583	514·6	Madona (Latvia)	15		
		Tunis (Tunisia)	0		
592	506·8	Vienna (Austria)	120		
601	499·2	Athens (Greece)	0		
		Radio-Maroc (Morocco)	6·5		
		Sundsvall (Sweden)	10		
610	491·8	Florence (Italy)	20		
		Murmansk (U.S.S.R.)	10		
620	483·9	Brussels I (Belgium)	15		
		Cairo (Egypt)	0	20	20
629	476·9	Lisbon (Portugal)	0		
		Skoplje (Yugoslavia)	0		
		Trondheim (Norway)	1·2		
638	470·2	Prague I (Czechoslovakia)	120		
648	463·0	Lyons P.T.T. (France)	15		
		Petrozavodsk (U.S.S.R.)	10		
658	455·9	Langenberg (Germany)	60		
668	449·1	Jerusalem (Palestine)	0	20	20
		North Regional (Gt. Britain)	50		
677	443·1	Sottens (Switzerland)	25		
686	437·3	Belgrade (Yugoslavia)	2·5		
695	431·7	Paris P.T.T. (France)	7		
704	426·1	Stockholm (Sweden)	55		
713	420·8	Rome (Italy)	50		
722	415·5	Kiev (U.S.S.R.)	100		
731	410·4	Seville (Spain)	3		
		Tallinn (Estonia)	20		
740	405·4	Munich (Germany)	60		
749	400·5	Marseilles P.T.T. (France)	5		

Fre- quency, kc/s.	Wave- length, m.	Station.	Aerial Power in kW.		
			Pre- sent.	Maximum	
				by day.	by night. ¹
749	400·5	Viipuri (Finland)	13		
758	395·8	Katowice (Poland)	12		
767	391·1	Midland (Regional Britain)	25		
776	386·6	Stalino (U.S.S.R.)	10		
		Toulouse P.T.T. (France)	2		
785	382·2	Leipzig (Germany)	120		
795	377·4	Coruña (Santiago) (Spain)	0·5		
		Lwów (Poland)	16		
804	373·1	Salonica (Greece)	0	20	20
		Scottish Regional (Gt. Britain)	50		
814	368·6	Milan (Italy)	50		
823	364·5	Romania (Romania)	0		
832	360·6	Moscow IV (U.S.S.R.)	100		
841	356·7	Berlin (Germany)	1·5		
850	352·9	Bergen (Norway)	1		
		Norwegian Common Wave (Norway)	0·7		
		Sofia ⁶ (Bulgaria)	0		
		Valencia (Spain)	1·5	20	20
859	349·2	Simferopol (U.S.S.R.)	10		
		Strasbourg (France)	12		
868	345·6	Marrakesh (Morocco)	0	20	20
		Poznań (Poland)	1·7		
877	342·1	London Regional (Gt. Britain)	50		
886	338·6	Graz (Austria)	7		
895	335·2	France (Stn. Pyrenees) (France)	—	10	10
		Helsinki (Finland)	10		
904	331·9	Hamburg (Germany)	1·5		
		Spanish Morocco ² (Spanish Morocco)	0		
913	328·6	Limoges P.T.T. (France)	0·5		
		Dniepropetrovsk (U.S.S.R.)	10		
922	325·4	Brno (Czechoslovakia)	32		
932	321·9	Brussels (Belgium)	15		
941	318·8	Algiers (Algeria)	12		
		Göteborg (Sweden)	10		
950	315·8	Breslau (Germany)	60		
959	312·8	France (Paris region) (France)	—		
		Gomel (U.S.S.R.)	1·2		
968	309·9	Grenoble (France)	20	20	20
		Odessa (U.S.S.R.)	10		
		Oukhta (or Tiraspol) (U.S.S.R.)	2		

Frequency, kc/s.	Wave-length, m.	Station.	Aerial Power in kW.		
			Present.	Maximum	
				by day.	by night. ¹
977	307·1	Haifa (Palestine)	0	5	5
		W. Regional (Gt. Britain)	50		
986	304·3	Genoa (Italy)	10		
		Torun or Cracow (Poland)	2 or		
			1·7		
995	301·5	Hilversum (Holland)	20		
1004	298·8	Bratislava (Czechoslovakia)	13·5		
1013	296·2	North National (Gt. Britain)	50		
		Tchernigov (U.S.S.R.)	10		
1022	293·5	Madrid II (Spain)	3		
1031	291·0	Heilsberg (Germany)	60		
		Portugal (South) (Portugal)	0		
1040	288·5	Leningrad II (U.S.S.R.)	10		
		Rennes P.T.T. (France)	2·5		
		Syria (Syria)	0	20	20
1050	285·7	Bournemouth (Gt. Britain)	1		
		Krasnodar (U.S.S.R.)	10		
		Scottish National (Gt. Britain)	50		
1059	283·3	Bari (Italy)	20		
1068	280·9	Tiraspol (or Odessa) (U.S.S.R.)	10		
1077	278·6	Bordeaux P.T.T. (France)	12		
1086	276·2	Falun (Sweden)	2		
		Zagreb (Yugoslavia)	0·7		
1095	274·0	Barcelona (Spain)	7		
		Vinnitsa (U.S.S.R.)	10		
1104	271·7	Naples (Italy)	1·5		
		Kuldiga (Latvia)	0		
1113	269·5	Kosice (Uszhorod) (Czechoslovakia)	2·6		
		Oran ¹⁰ (Algeria)	0		
1122	267·4	Belfast (Gt. Britain)	1		
		Alexandria (Egypt)	0	5	5
1131	265·3	Hörby ⁷ (Sweden)	10		
1140	263·2	Turin (Italy)	7		
1149	261·1	London National (Gt. Britain)	50		
		Turkey (Turkey)	5	10	10
		West National (Gt. Britain)	50		
1158	259·1	Moravská Ostrava (Czechoslovakia)	11·2		
1167	257·1	Monte Ceneri (Switzerland)	15		
1176	255·1	Copenhagen (Denmark)	0·8		
		Malta (Malta)	0	5	5
1185	253·2	Kharkov II (U.S.S.R.)	10		
		Nice-Corsica P.T.T. (France)	0		

Fre- quency, kc/s.	Wave- length, m.	Station.	Aerial Power in kW.		
			Pre- sent.	Maximum	
				by day.	by night. ¹
1195	251.0	Frankfurt (Germany)	17		
		German Common Wave (Ger- many)	2		
1204	249.2	Prague II (Czechoslovakia)	5		
		Czechoslovak Common Wave (Czechoslovakia)	0		
1213	247.3	Lille P.T.T. (France)	5		
1222	245.5	Trieste (Italy)	10		
1231	243.7	Gleiwitz (Germany)	5		
		German Common Wave (Ger- many)	0.25		
1240	241.9	Yugoslavia (Yugoslavia)	0		
1249	240.2	Luxembourg (Luxembourg)	150		
1258	238.5	Riga (Latvia)	15	10	10
		Rome II ^s (Italy)	0.5	1	1
		San Sebastian (Spain)	3		
1267	236.8	German Common Wave (Ger- many)	2		
1276	235.1	Norwegian Common Wave (Norway)	0.7		
		Varna (Bulgaria)	0		
1285	233.5	Belgium (Belgium)	0		
		Southern Greece (Greece)	0		
1294	231.8	Linz (Austria)	0.5		
		Salzburg (Austria)	0.5		
1303	230.2	Danzig (Danzig Free City)	0.5	10	10
		Sombor (Yugoslavia)	0	10	10
1312	228.7	Swedish Common Wave (Sweden)	1.25		
1321	227.1	Budapest II (Hungary)	0.8		
1330	225.6	North German Common Wave (Germany)	0.5		
1339	224.0	Montpellier P.T.T. (France)	5	5	5
		Pinsk (Poland)	0	5	5
		East Polish Common Wave (Poland)	0		
1348	222.6	International Common Wave			
		Aberdeen (Gt. Britain)	1		
		Benghazi (Cyrenaica)	0		
		Cairo II (Egypt)	0		
		Dublin (Irish Free State)	1		
		Estonia (Estonia)	0		
		France (South-East) (France)	0		
		Königsberg (Germany)	0.5		

Fre- quency, kc's.	Wave- length, m.	Station.	Aerial Power in kW.		
			Pre- sent.	Maximum	
				by day.	by night. ¹
1348	222.6	Lithuania (Lithuania)	0		
		Lodz (Poland)	1.7		
		Milan II (Italy)	4		
		Monaco (Principality of Monaco)	0		
		Norway (Norway)	0		
		Vorarlberg (Austria)	0		
		Yugoslavia (Yugoslavia)	0		
1357	221.1	Italian Common Wave (Italy)	0		
		Norwegian Common Wave (Norway)	0.5		
1366	219.6	Cracow or Torun (Poland)	1.7		
1375	218.2	Swiss Common Wave (Switzer- land)	or 2		
			0.5		
1384	216.8	Albania (Albania)	0		
		Warsaw II (Poland)	2		
1393	215.4	France (Cent.) (France)	0		
		French Common Wave (France)	0		
1402	214.0	Bulgaria (Bulgaria)	0	5	5
		Swedish Common Wave (Sweden)	0.4		
1411	212.6	Bucharest (Romania)	12	12	12
		Portuguese Common Wave (Portugal)	2		
		Romanian Common Wave (Romania)	0		
1420	211.3	Finland Common Wave (Fin- land)	1.5		
		Yugoslav Common Wave (Yugoslavia)	0		
1429	209.9	International Common Wave (Type 1)	0		
		Alexandria II (Egypt)	0		
		Cork (Irish Free State)	1		
		France (Ile de France) (France)	0		
		Klagenfurt (Austria)	0.5		
		Newcastle (Gt. Britain)	1		
		Norway (Norway)	0		
		Holland (Holland)	0		
		Tripoli (Tripolitania)	0		
		Yugoslavia (Yugoslavia)	0		

Frequency, kc/s.	Wave-length, m.	Station.	Aerial Power in kW.		
			Present.	Maximum	
				by day.	by night. ¹
1438	208·6	Hungarian Common Wave (Hungary)	0	6·2	6·2
		Magyarovar (Hungary)	1·25		
		Miskolc (Hungary)	1·25		
		Nyiregyhaza (Hungary)	6·25		
		Pecs (Hungary)	1·25		
1447	207·3	Spanish Common Wave (Spain)	1		
		Lithuania (Lithuania)	0		
1456	206·0	French Common Wave (France)	0		
1465	204·8	German Common Wave (Ger- many)	0		
1474	203·5	British Common Wave (Gt. Britain)	0	5	5
		Plymouth (Gt. Britain)	0·3		
1483	202·3	Soviet Common Wave (U.S.S.R.)	0		
1492	201·1	International Common Wave (Type 2)			
1500	200	International Common Wave (Type 2)			

¹ Applicable to one hour after sunset at the transmitter.

² Must use an aerial directed towards the interior of the country.

³ In case of interference to mobile services must use an aerial directed away from the sea.

⁴ Must use an aerial directed towards the interior of the country and limit the radiation towards the sea to a value which is not likely to interfere with maritime traffic.

⁵ To be synchronised with Luy and Salzburg on 1,294 kc/s (231·8 m.) if this station compromises the maritime service.

⁶ Must use an aerial directed towards the east.

⁷ Must use an aerial directed towards the north if the power exceeds 60 kW, the maximum authorised being up to 100 kW.

⁸ In case of interference must use an aerial directed towards the east.

⁹ The power of Palermo and that of the stations of the Italian common wave (Sicily) may be increased to 5 kW if the power of Athlone is increased to 100 kW. In this case the Italian stations will use directional aeriels, limiting the radiation towards Ireland in order to avoid interference with the service of the Athlone station.

¹⁰ In case of interference with the service of Naples must use an aerial directed towards the interior of the country.

¹¹ In case of interference with the mobile services or with the services not open to public correspondence, must use a directional aerial and reduce its power during the night.

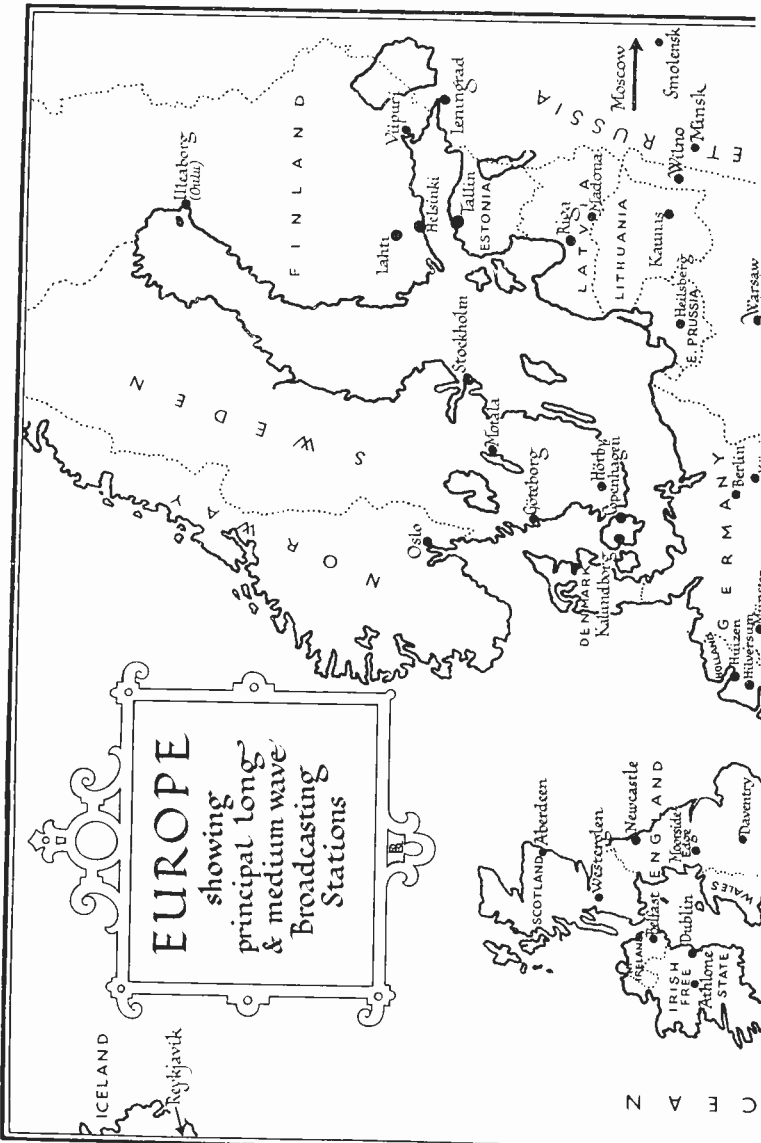

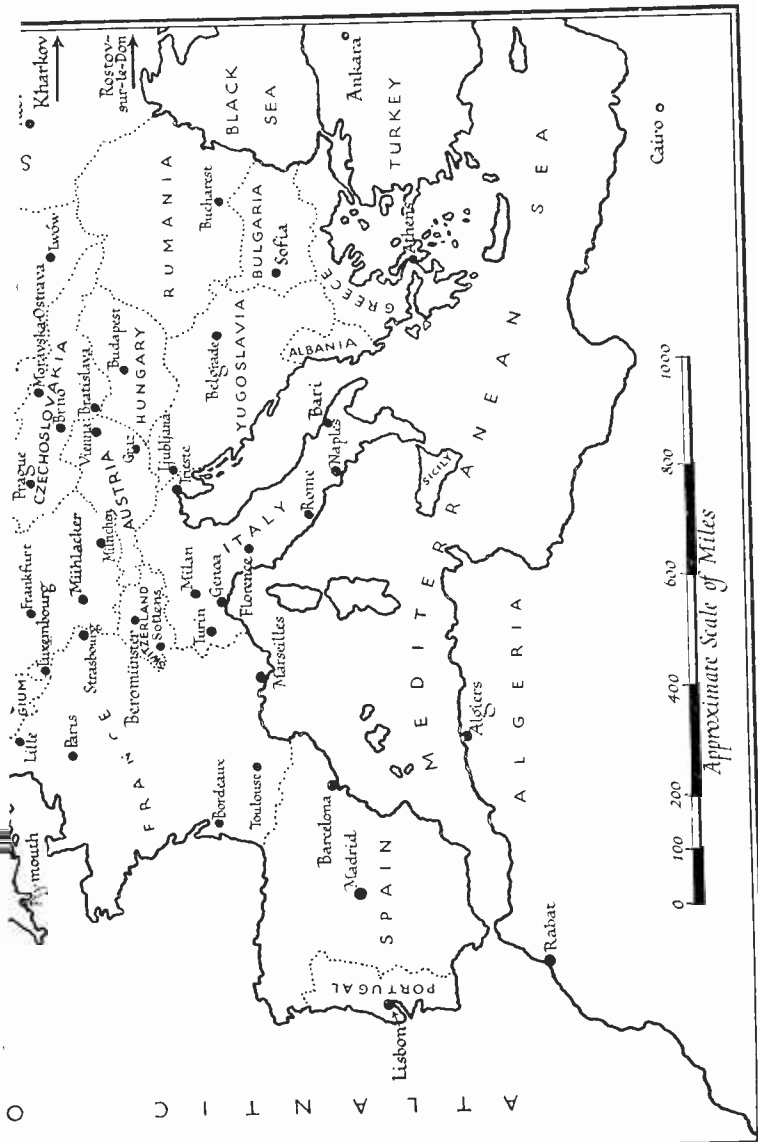

ADVISORY COUNCILS AND COMMITTEES TO THE B.B.C.

RELIGIOUS ADVISORY COMMITTEES

CENTRAL

- Rt. Rev. the Lord Bishop of Winchester (*Chairman*).
Rev. M. E. Aubrey.
Rev. Canon F. R. Barry, D.S.O., M.A.
Rev. Sidney M. Berry, D.D.
Rev. Fr. M. C. D'Arcy, S.J., M.A.
Rev. S. W. Hughes, D.D.
Rev. J. Scott Lidgett, C.H., D.D.
Rev. W. P. G. McCormick, D.S.O., M.A.
Rev. Father C. C. Martindale, S.J., M.A.
Rev. W. Lewis Robertson, D.D.
Very Rev. H. R. L. Sheppard, C.H., D.D.
- Rev. Canon T. Guy Rogers, M.C., B.D. (Midland Regional Committee).
Rt. Rev. the Lord Bishop of Wakefield (North Regional Committee).
Rev. Father T. L. Parker, M.A. (North Regional Committee).
Rt. Rev. the Lord Bishop of Llandaff (Welsh Council).
Ven. Archdeacon P. W. N. Shirley, B.D. (Belfast Committee).
Rev. Prof. Archibald Main, D.D., D.Litt. (Scottish Regional Committee).

MIDLAND REGIONAL

- Rt. Rev. A. Hamilton Baynes, D.D. (*Chairman*).
Rev. Canon S. Blöfeld, B.Sc.
Rev. Father Bernard Griffin, D.D.
Rev. Canon Stuart D. Morris, M.A.
Rev. E. Benson Perkins.
- Rt. Rev. Mgr. G. E. Price.
Rev. Leyton Richards, M.A.
Rev. Canon T. Guy Rogers, M.C., B.D.
Rev. F. C. Spurr.
Rt. Rev. Nevilles Talbot.
Basil A. Yeaxlee, O.B.E., Ph.D.

NORTH REGIONAL

- Rt. Rev. the Lord Bishop of Wakefield (*Chairman*).
Very Rev. the Dean of Manchester.
Rev. Canon R. Brook, M.A.
Rev. Father G. Brunner.
Rev. Canon J. N. Bateman Champain, M.A.
Ven. D. H. Crick, M.A., Archdeacon of Stoke-on-Trent.
Rev. Canon T. A. E. Davey.
Rev. A. J. Grieve, D.D.
Rev. N. Grieve, M.A.
- Rev. Father M. Harty.
Rev. A. Hooper, M.A.
Ven. J. F. Howson, M.A., Archdeacon of Craven.
Rev. Father J. I. Lane.
Rev. J. Longstaff.
Rev. Father T. L. Parker, M.A.
Rev. Canon J. E. Roberts, M.A.
Rev. G. W. Seager.
Rev. Canon A. E. Smallwood, M.A.
Rev. J. Wallace.
Rev. L. D. Weatherhead, M.A.

WELSH

- Rt. Hon. David Lloyd George, O.M., M.P. (*Chairman*).
Rt. Rev. the Lord Bishop of Llandaff.
- Rt. Rev. the Lord Bishop of St. David's.
Rt. Hon. Sir J. Eldon Banks, G.C.B.

Rev. Canon Benjamin Davies,
M.A.
Rev. D. Tecwyn Evans, M.A.
Very Rev. Canon D. J. Hannon.
A. G. Howell.
Rev. John Jenkins, D.Litt.
Gwili.
Alderman Sir William Jenkins,
M.P.

Rev. H. Elvet Lewis, D.D.
Rev. Michael McGrath, M.A.
Rev. Thomas Naylor, B.A.
Rev. W. J. Nicholson.
Rev. John Roberts, M.A.
Rev. R. S. Rogers, B.A.
Rev. J. Penry Thomas.
Major W. P. Wheldon, D.S.O.,
M.A.

Sub-Committee of Laymen

John Beynon.
Alderman Sir William Jenkins,
M.P.
Evan J. Jones, M.A.
J. T. Jones.

Alderman John Lewis.
Robert Richards, M.A.
Major W. P. Wheldon, D.S.O.,
M.A.
J. Lloyd Williams, Mus. Doc.

WEST COUNTRY

Rt. Rev. the Lord Bishop of
Bristol (*Chairman*).
Very Rev. the Dean of Exeter.
Rev. Patrick V. Hackett, B.A.
Hubert W. Hunt, Mus. Doc.
Rev. Archibald Parsons.

Rev. Porchery G. L. Porcher,
D.D.
Rev. Ivor J. Robertson, D.D.
Rev. T. E. Soddy, B.A.
Rev. J. M. D. Stancomb, M.A.
F. A. Wilshire.

SCOTTISH REGIONAL

Rev. Prof. Archibald Main, D.D.,
D.Litt. (*Chairman*).
Very Rev. the Dean of Edin-
burgh.
Rev. G. F. Stanley Atkinson,
M.A.
Very Rev. Canon John Gray.
Rev. W. H. Harrowes, M.A.

H. Lightbody.
Rev. George Macaulay, D.D.
Very Rev. Norman Maclean, D.D.
Rev. Charles Richardson, D.D.
Rev. James Scott, Ph.D.
Rev. T. B. Stewart Thomson,
M.C., B.D.
Rev. S. W. Wilson, M.A.

ULSTER

Rt. Rev. the Bishop of Down
and Connor and Dromore
(*Chairman*).
Rev. William Corkey, D.D.,
Moderator of the General
Assembly of the Presbyterian
Church in Ireland.
Rev. W. J. Calvin.
Rev. J. Glyme Davies.

Rev. Thomas Deane.
Right Rev. R. W. Hamilton,
M.A.
Rev. D. Henderson.
A. C. Marshall.
Ven. Archdeacon P. W. N.
Shirley, B.D.
Rev. W. H. Smyth, M.A.
Rev. J. Waddell, M.A.

MUSIC ADVISORY COMMITTEES

CENTRAL

Sir Hugh Allen, K.C.V.O.,
D.Mus.
Sir Edward Bairstow, D.Mus.
Sir Walford Davies, C.V.O.,
O.B.E., Mus.D.
Sir J. B. McEwen, D.Mus.
Sir Landon Ronald.

Colonel J. A. C. Somerville,
C.M.G., C.B.E.
W. G. Whittaker, D.Mus.
The President of The Incorporated Society of Musicians
(*ex officio*).

SCOTTISH REGIONAL

W. G. Whittaker, D.Mus.	Sir Hugh S. Robertson.
Henry Farmer, Ph.D.	Wilfred Senior.
Percy Gordon, Mus. Bac.	David Stephen.
Philip Halstead.	Prof. D. F. Tovey, D.Mus.
Francis Harford.	Herbert Bennett.

ULSTER

Charles J. Brennan, Mus. Bac.	G. H. FitzSimons, Mus. Doc.
E. M. Chaundy, Mus. Doc.	E. Norman Hay, Mus. Doc.
Captain T. O. Corrin, Mus. Bac.	

APPEALS ADVISORY COMMITTEE

Dame Meriel Talbot, D.B.E. (<i>Chairman</i>).	Dr. A. H. Norris, C.B.E., M.C. (Children).
Capt. L. F. Ellis, C.B.E., D.S.O., M.C. (Social Service).	Brig.-General R. H. More, C.M.G., C.B.E. (The Ser- vices).
The Lady Emmott (Women).	B. E. Astbury (Miscellaneous).
Sir Frederick Menzies, K.B.E., M.D. (Health).	

ADVISORY COMMITTEE ON SPOKEN ENGLISH

George Bernard Shaw (<i>Chairman</i>).	Professor Daniel Jones, M.A.
Professor Lascelles Abercrombie, Litt.D.	C. T. Onions, D.Litt.
Sir Johnston Forbes-Robertson, LL.D.	Logan Pearsall Smith, M.A.
	Professor A. Lloyd James, M.A. (<i>Secretary</i>).

NATIONAL LECTURES ADVISORY PANEL

Sir William H. Bragg, O.M., K.B.E., F.R.S.	Sir Oliver Lodge, F.R.S.
Rt. Hon. Earl of Crawford and Balcarres, K.T., F.R.S.	Sir Donald MacAlister, K.C.B., M.D., F.R.S.
Rt. Hon. Marquess of Crewe, K.G., LL.D.	Walter de la Mare.
Sir William Hardy, F.R.S.	Rt. Hon. Lord Macmillan, K.C., LL.D.
Sir James H. Jeans, F.R.S.	Sir Henry Newbolt, C.H., D.Litt.
Sir Frederic G. Kenyon, G.B.E., K.C.B., D.Litt.	Rt. Hon. Marquess of Zetland, G.C.S.I., G.C.I.E., F.B.A.

THE CENTRAL COUNCIL FOR BROADCAST ADULT EDUCATION

Chairman: His Grace the Archbishop of York.

Board of Education: G. G. Williams.
Universities Extra-mural Consultative Committee: J. H. Nicholson,
M.A., E. J. Patterson, M.A.
Central Joint Advisory Committee for Tutorial Classes: Rev. F. E.
Hutchinson, M.A., T. W. Price, B.Litt.

Association of Education Committees: W. Ludford Freeman, LL.D.
 County Councils Association: E. Salter Davies, C.B.E., M.A.
 Association of Municipal Corporations: F. P. Armitage, C.B.E., M.A.
 London County Council:
 British Institute of Adult Education: J. W. Brown.
 Workers' Educational Association: Ernest Green.
 The Co-operative Union: J. Reeves.
 Trades Union Congress: J. Bromley.
 National Confederation of Employers' Organisations: Sir Ernest W. Moir, Bt.
 National Federation of Women's Institutes: Miss G. Hadow, M.A.
 Young Men's Christian Association: A. Clifford Hall.
 National Adult School Union: G. Peverett.
 Rural Community Councils: Capt. L. F. Ellis, C.B.E., D.S.O., M.C.
 Juvenile Organisations Committee of the Board of Education: The Hon. Mrs. K. de Beaumont.
 The National Union of Teachers: G. S. M. Ellis.
 The Joint Committee of the Four Secondary Associations: R. F. Cholmeley, O.B.E.
 Committee of the Three Technical and Art Associations: J. Wickham Murray.
 Library Association: W. C. Berwick Sayers, M.A.
 Association of Technical Institutions: Principal W. Munn Rankin.
 West Midlands Area Council: P. D. Innes, D.Sc.
 Yorkshire Area Council: Sir Percy Jackson, LL.D.
 North-Western Area Council: W. H. Moberley, D.S.O., D.Litt.
 Western Area Council: W. Ludford Freeman, LL.D.

Nominated Members

P. J. Noel Baker, M.A.	Professor T. H. Scarls, M.C., M.A.
Cyril Burt, D.Sc.	T. Franklin Sibly, D.Sc.
Professor W. Cramp, D.Sc.	Viscountess Snowden.
Winifred Cullis, C.B.E., D.Sc.	Dame Meriel Talbot, D.B.E.
Sir Walford Davies, C.V.O., O.B.E., Mus.D.	Geoffrey Whitworth.
Miss E. S. Haldane, C.H., LL.D.	Sir J. Evelyn Wrench, C.M.G., LL.D.
Julian Huxley, M.A.	Basil A. Yeaxlee, O.B.E., Ph.D.
J. H. Oldham.	
Sir John Russell, O.B.E., F.R.S.	

NORTH-WESTERN AREA COUNCIL

Universities:

Manchester: W. H. Moberley, D.S.O., D.Litt. (*Chairman*). J. E. Myers, O.B.E., D.Sc.
 Liverpool: S. Dumbell, M.A.

County Education Authorities:

Lancashire: P. E. Meadon, C.B.E., M.A.
 Cheshire: F. F. Potter, M.A., B.Sc.
 Westmorland: C. J. R. Tipper, B.Sc.

County Borough Education Authorities:

C. F. Mott, M.A. (Liverpool).

Voluntary Bodies:

Workers' Educational Association (N.W. District) : Eli Bibby, B.A.
(West Lancashire and Cheshire District) : F. Garstang.
Co-operative Union : Professor F. Hall, M.A., B.Comm.
Educational Settlements Association : F. S. Milligan, M.A.
Joint Committee of the Four Secondary Associations : Miss M. H. Meade, B.A.
Joint Committee of the Three Technical and Art Associations : R. A. Dawson, A.R.C.A., F.S.A.M.
Lancashire Federation of Trades Councils : F. Knights.
Library Association : J. W. Singleton, F.L.A.
National Adult School Union (Lancs. and Cheshire Union) : W. J. Tuckett, B.A.
National Federation of Women's Institutes : Mrs. A. Bridge.
National Union of Teachers : W. Merrick.
Tutors' Association : Mrs. M. Stocks, B.Sc.
Women's Co-operative Guild : Mrs. E. Beavan.
Y.M.C.A. : J. T. McKerrigan.
Y.W.C.A. : Miss F. M. Yates.
Association of Education Committees : Alderman F. Naylor, C. F. Mott, M.A., A. R. Pickles, M.A., T. Samuel, M.A.

Nominated Members

H. Pilkington Turner, M.A.	C. James, B.A.
Rev. F. Heming Vaughan, B.A.	A. A. Purcell.
G. de L. Hough.	G. K. Grierson, M.A.
C. Nowell, F.L.A.	W. O. Lester-Smith, M.A.

WEST MIDLANDS AREA COUNCIL

Association of Secondary Teachers : R. G. Hails.
Association of Technical Teachers : W. E. Harrison, B.Sc.
Association of University Teachers : Professor C. W. Valentine, D.Phil.
Co-operative Union : E. C. Curtis.
Education Settlements Association : W. W. Lee.
Joint Committee of the University of Birmingham and the W.E.A. : Professor J. G. Smith, M.A.
Library Association : H. M. Cashmore.
Local Education Authorities :
City of Birmingham : Dr. P. D. Innes, M.A.
Worcestershire : A. W. Pricstley, B.Ch.
Leamington : J. E. Pickles, M.A., B.Sc.
Midland Adult School Union : T. G. Barford.
National Council for Women : Mrs. G. Cadbury, O.B.E.
National Federation of Women's Institutes : Miss M. B. Strachan.
National Industrial Alliance : L. Magson.
National Union of Teachers : E. W. Jones.
Rural Community Council : W. H. Rawle.

Trades Council: C. G. Spragg.
Tutors' Association: E. C. Cull.
University of Birmingham: Professor W. Cramp, D.Sc.
Workers' Educational Association and Brotherhood Federation:
H. G. Wood, M.A.
Working Men's Club and Institute Union: J. Barber.
Y.M.C.A.: H. G. Gerrard.
Y.W.C.A.: Miss E. Downes.

Nominated Members

Wolverhampton Union of Adult Education Associations: Dr. R. S. Morrell.
Director of Extra-mural Studies: B. I. Macalpine, M.A.
Religious Education: Basil A. Yeaxlee, O.B.E., Ph.D.
Board of Education: G. K. Grierson.
Townswomen's Guilds: Mrs. A. W. Priestley.

WESTERN AREA COUNCIL

Association of University Teachers: M. H. Carré, M.A.
Advisory Committee on Broadcasting: F. C. Luke.
Association of Technical Institutes: G. H. Burkhardt, M.A., M.Sc.
Bristol Group of S.W. Federation of Trades Councils: Alderman A. W. S. Burgess.
Co-operative Union: S. C. Pope.
Educational Settlements Association: Paul D. Sturge, B.A.
Federal Council of Teachers: A. E. Bullock.
Library Association: James Ross, F.L.A.
Local Education Authorities:
Bath: A. W. Hoyle, B.Sc.
Bristol: W. Ludford Freeman, LL.D.
Gloucester: Mrs. E. Cullis.
Gloucestershire: H. W. Houshold, M.A.
Somerset: W. A. Knight, M.A.
Wiltshire: Reuben George.
National Adult School Union: 1. Harold W. G. Dyer. 2. A. Foster.
National Council of Women: Miss A. Deane, O.B.E.
National Federation of Women's Institutes—Gloucester: Mrs. Veal.
Somerset: Mrs. M. E. Poynton.
Wiltshire:
National Union of Teachers: H. T. Morgan.
Rural Community Councils—Gloucestershire: G. H. Castle, M.A.
Somerset: Mrs. E. B. Clothier.
Tutors' Association: J. H. Nicholson, M.A.
University of Bristol: Alderman F. Sheppard, C.B.E.
W.E.A.: 1. W. R. Straker, M.A. 2. H. G. Crudge.
Y.M.C.A.: E. Lloyd.
Y.W.C.A.: Mrs. A. D. Field.

Nominated Members

H. E. Boothroyd, M.A., H.M.I. S. B. Dalston, M.A.
S. H. Cair, B.Sc. W. E. Salt, M.A.
A. E. Douglas-Smith, M.A.

YORKSHIRE AREA COUNCIL

Universities:

Leeds: Sir James Baillie, O.B.E., D.Phil.
Sheffield: W. M. Gibbons, M.A.
Hull: Professor T. H. Searls, M.C., M.A.

County Education Authorities:

West Riding: Sir Percy Jackson, LL.D.
East Riding: P. J. Whitehead.
North Riding: Councillor R. S. Butterfield.
North Riding: Martin Wilson, M.A.

County Borough Education Authorities:

Hull (East Riding): R. C. Moore, M.A., M.Sc.
Leeds (West Riding): W. J. Bees, B.Sc.
Sheffield (West Riding): H. S. Newton.
Bradford (West Riding): Thomas Boyce, M.A., B.Sc.

Yorks Council for Further Education:

Stanley Price, M.A.

Voluntary Bodies:

Workers' Educational Ass. (North Yorks.): G. H. Thompson.
Workers' Educational Ass. (South Yorks.): E. Fisher.
Co-operative Union: J. Cragg.
Educational Settlements Ass.: K. E. T. Wilkinson.
Joint Committee of the Four Secondary Associations: A. J. Spilsbury.
Joint Committee of the Three Technical and Art Associations: B. C. Gregory, M.Sc.
Yorkshire Federated Trades Councils: Councillor T. Crowe.
Library Association: R. J. Gordon, F.L.A.
National Adult School Union: R. Mennell.
National Federation of Women's Institutes: Miss J. B. Kitson.
National Union of Teachers: H. N. Penlington, M.A.
Women's Co-operative Guild: Mrs. Priestley.
Y.M.C.A.: J. W. Scholefield.
Y.W.C.A.: Miss Crosse.
Tutors' Association: A. H. Dainton, M.A.

Nominated Members

W. F. Dann, M.A.	E. P. Bates, M.A., B.Sc.
A. J. J. Ratcliff, M.A.	Rev. Canon A. E. Smallwood, M.A.
C. K. Frost.	E. C. Studdert-Holmes, M.A.

SCOTTISH AREA COUNCIL

Association of Counties of Cities in Scotland: Sir Charles Cleland, K.B.E., M.V.O., LL.D.
Association of County Councils in Scotland: Bertram Talbot.
Association of Directors of Education in Scotland: Gregor McGregor, M.A., B.Sc.
British Institute of Adult Education (Scottish Branch): Principal Sir Robert S. Rait, C.B.E., D.I.
Convention of Royal Burghs of Scotland: Sir Henry S. Keith, LL.D.

Educational Institute of Scotland: R. Bennett Miller, M.A.
 Scottish Education Department: W. W. McKechnie, C.B.
 Scottish Library Association: Edgar H. Parsons.
 Scottish Trades Union Congress (General Council): G. N. Gallie.
 Scottish Women's Rural Institutes (Central Council): Mrs. Douglas.
 Workers' Educational Association (Scottish Section): John Macleod.
 Aberdeen University and District Adult Education Committee:
 Henry Hamilton, D.Litt.
 St. Andrews University Extra-mural Committee: Professor J. H.
 Baxter.

Nominated Members

T. R. Burnett, B.Sc.
 Lt.-Col. J. M. Mitchell, C.B.E., LL.D.
 J. R. Peddie.

*THE CENTRAL COUNCIL FOR
 SCHOOL BROADCASTING*

Chairman: The Rt. Hon. Lord Eustace Percy, M.A., M.P.
Vice-Chairman: W. W. Vaughan, M.V.O., D.Litt.

Representative Members:

Board of Education (3): W. P. Wheldon, D.S.O., LL.B., G. T.
 Hankin, H.M.I., Miss A. G. Philip, C.B.E.
 Scottish Education Department: J. W. Peck, C.B., M.A.
 Ministry of Education for Northern Ireland: A. N. Bonaparte Wycse,
 C.B.E.
 Association of Education Committees: Percival Sharp, LL.D., B.Sc.
 Association of Directors and Secretaries for Education (2): A. L.
 Binns, M.C., M.A., B.Sc., F. Herbert Toyne.
 County Councils Association: E. Salter Davies, C.B.E.
 Association of Municipal Corporations: F. P. Armitage, C.B.E.,
 M.A.
 London County Council: G. H. Gater, C.M.G., D.S.O., M.A.
 Association of Directors of Education in Scotland: Gregor Mac-
 gregor, M.A., B.Sc.
 Association of Councils of Counties of Cities in Scotland: Sir Charles
 Cleland, K.B.E., M.V.O., LL.D.
 Association of County Councils in Scotland: Bertram Talbot.
 Federation of Education Committees (Wales and Monmouth): T. J.
 Rees, B.A.
 National Union of Teachers (4): W. W. Hill, B.Sc., H. H. Cart-
 wright, A. Tasker, M.B.E., W. Lloyd Pierce.
 Joint Committee of the Four Secondary Associations (3):
 Incorporated Association of Head Masters, Head Mistresses, As-
 sistant Masters, Assistant Mistresses: A. Hay, M.A., H. Hugh
 Jones, Miss D. W. Wright.
 Joint Committee of the Three Technical and Art Associations:
 Association of Teachers in Technical Institutes, Associations of
 Principals in Technical Institutes, National Society of Art
 Masters: J. Wickham Murray.
 Incorporated Schools' Association: S. Maxwell, M.A., LL.B.
 Incorporated Association of Preparatory Schools: Bernard Rendall.

Educational Institute of Scotland: Peter Comrie, LL.D.
Training College Association: H. E. J. Curzon.
Council of Principals of Training Colleges: H. A. S. Wortley, M.A.
Scottish Sub-Council for School Broadcasting:

Chairman: Ex officio.

Chairman of Scottish Executive: Ex officio.

Nominated Members:

The Rt. Hon. Lord Eustace Percy, M.A., M.P.
W. W. Vaughan, M.V.O., D.Litt.

Lord Allen of Hurtwood.	Sir Percy Nunn, D.Sc.
R. N. Armfelt.	W. H. Perkins, M.Sc.
O. F. Brown, B.Sc.	Sir Edmund Phipps, C.B.
Cyril Burt, D.Sc.	Frank Roscoe.
A. C. Cameron, M.C., M.A.	J. H. Simpson.
C. W. Cowen, M.A.	Miss H. V. Stuart, M.A.
Miss Mary Davies, H.M.I.	Sir Percy Watkins.
Miss W. L. Mercier, O.B.E.	P. Wilson.

Secretary: Miss Mary Somerville.

SCOTTISH SUB-COUNCIL

Chairman: Sir Charles Cleland, K.B.E., M.V.O., LL.D.

Vice-Chairman: George A. Burnett, M.A., B.Sc.

Representative Members on Central and Scottish Councils:

Scottish Education Department: J. W. Peck, C.B., M.A.
Association of Directors of Education in Scotland: Gregor Macgregor, M.A., B.Sc.
Educational Institute of Scotland: Peter Comrie, LL.D.
Association of Councils of Counties of Cities in Scotland: Sir Charles Cleland, K.B.E., M.V.O., LL.D.
Association of County Councils in Scotland: Bertram Talbot.

Nominated Member on Central and Scottish Councils:

(Not yet appointed.)

Representative Members on Scottish Sub-Council:

Scottish Education Department: J. Mackay Thomson, M.A.
Association of Directors of Education in Scotland: R. M. Allardyce, M.A., LL.B.
National Committee for the Training of Teachers: George A. Burnett, M.A., B.Sc.
Educational Institute of Scotland: John Summers, David J. Young, M.A.
Association of Councils of Counties of Cities in Scotland: P. H. Allan.

Nominated Members:

Rev. A. Andrew, D.D.	Margaret Kennedy, M.A.
Margaret Drummond, M.A.	Dr. George A. Morrison, M.A.
Joseph F. Duncan.	Dr. J. C. Smith, C.B.E., Litt.D.
J. T. Ewen, O.B.E., B.Sc.	Neil S. Snodgrass, M.A.

Secretary: (Vacant.)

BUYER'S GUIDE AND INDEX OF ADVERTISERS

GENERAL

	<i>See page</i>		<i>See page</i>
APPEALS, CHARITABLE		CAR EQUIPMENT	
Alexandra Orphanage	342	Solex, Ltd.	433
Cancer Hospital	342	GRAMOPHONES AND RECORDS	
Church Army	384	British Homophone Co., Ltd.	363
Church Lads' Brigade	356	Columbia Graphophone Co., Ltd.	359
Dr. Barnardo's Homes	324	Gramophone Company, Ltd.	412
Ex-Services Welfare Society	363	HOUSEHOLD COMMODITIES	
Friends of the Poor	384	Mazawattee Tea Co.	356
Imperial Cancer Research Fund	324	Wincarnis Beef Cubes	410
Lord Mayor Treloar Cripples' Hos- pital and College	321	PIANOS	
Moorfields Eye Hospital (<i>on wrapper</i>)		Challen Pianos	337
N.S.P.C.C.	312	ORGANS	
Royal Soldiers' Daughters' Home.	436	The John Compton Organ Co., Ltd.	436
Shaftesbury Homes and "Are- thusa" Training Ship	356	TRAVEL	
Shaftesbury Society	384	H.M. Eastern African Dependen- cies	436
Waifs and Strays Society	356		
BOOKS			
Hodder & Stoughton	384		

WIRELESS

	<i>See page</i>		<i>See page</i>
ACCUMULATORS (L.T. & H.T.)		CABLES AND WIRE	
Ever Ready Co. (Great Britain), Ltd.	367	Callender's Cable	369
General Electric Co., Ltd.	351	General Electric Co., Ltd.	351
Lissen, Ltd.	400	Standard Telephones & Cables, Ltd.	373
Milnes Radio Ltd.	443	CHARGERS FOR ACCUMULA- TORS	
ACCUMULATORS, STATIONARY BATTERIES		General Electric Co., Ltd.	351
General Electric Co., Ltd.	351	Lissen, Ltd.	400
AERIALS		COILS	
J. J. Eastick & Sons	443	General Electric Co., Ltd.	351
BATTERIES (DRY, H.T., AND GRID BIAS)		Lissen, Ltd.	400
Ever Ready Co. (Great Britain), Ltd.	367	COMPONENTS AND ACCES- ORIES	
General Electric Co., Ltd.	351	Automatic Coil Winder & Elec. Equipment Co., Ltd.	394 & 426
Lissen, Ltd.	400	J. J. Eastick & Sons	443
CABINETS		General Electric Co., Ltd.	351
J. J. Eastick & Sons	443	Lissen, Ltd.	400
Lissen, Ltd.	400	CONDENSERS	
Chas. A. Osborn	434	General Electric Co., Ltd.	351
		Lissen, Ltd.	400

ELIMINATORS, BATTERY	<i>See page</i>	RECEIVERS, PORTABLE	<i>See page</i>
General Electric Co., Ltd.	351	Columbia Graphophone Co., Ltd..	359
Lissen, Ltd.	400	General Electric Co., Ltd.	351
GRAMOPHONE PICK-UPS		Lissen, Ltd.	400
Celestion, Ltd.	404	RHEOSTATS	
Columbia Graphophone Co., Ltd..	359	Lissen, Ltd.	400
General Electric Co., Ltd.	351	London Electric Wire Co. &	
Lissen, Ltd.	400	Smiths, Ltd.	342
HOUSE WIRING		SHORT-WAVE APPARATUS	
Callender's Cable	405	J. J. Eastick & Sons	443
General Electric Co., Ltd.	351	General Electric Co., Ltd.	351
LOUDSPEAKERS		TELEPHONES	
Celestion, Ltd.	404	General Electric Co., Ltd.	351
Columbia Graphophone Co., Ltd..	359	Lissen, Ltd.	400
General Electric Co., Ltd.	351	Standard Telephones & Cables,	
Gramophone Co., Ltd.	417	Ltd.	393
Lissen, Ltd.	400	TERMINALS	
Reproducers and Amplifiers, Ltd..	409	J. J. Eastick & Sons	443
Sinclair Speakers	443	General Electric Co., Ltd.	351
Standard Telephones & Cables,		Lissen, Ltd.	400
Ltd.	393	TRANSFORMERS	
LOUDSPEAKER EQUIPMENT		General Electric Co., Ltd.	351
Lissen, Ltd.	400	Lissen, Ltd.	400
Sinclair Speakers	443	TRANSMITTERS	
MICROPHONES		Marconi's Wireless Telegraph Co.,	
General Electric Co., Ltd.	351	Ltd.	403
Standard Telephones & Cables,		Standard Telephones & Cables,	
Ltd.	393	Ltd.	393
RADIO-GRAMOPHONES		TRANSMITTING VALVES	
Columbia Graphophone Co., Ltd. .	359	General Electric Co., Ltd.	351
Gramophone Company, Ltd.	417	Mullard Wireless Service Co., Ltd.	341
General Electric Co., Ltd.	351	Standard Telephones & Cables,	
Lissen, Ltd.	400	Ltd.	393
RECEIVERS, BATTERY		Triotron Radio, Ltd.	423
Columbia Graphophone Co., Ltd..	359	VALVES	
J. J. Eastick & Sons	443	General Electric Co., Ltd.	351
General Electric Co., Ltd.	351	Lissen, Ltd.	400
Gramophone Company, Ltd.	417	Mullard Wireless Service Co., Ltd.	341
Lissen, Ltd.	400	Standard Telephones & Cables,	
Standard Telephones & Cables,		Ltd.	393
Ltd.	393	Triotron Radio, Ltd.	423
RECEIVERS, MAINS		WAVE TRAPS	
Columbia Graphophone Co., Ltd..	359	General Electric Co., Ltd.	351
General Electric Co., Ltd.	351	Lissen, Ltd.	400
Gramophone Company, Ltd.	417		
Lissen, Ltd.	400		
Standard Telephones & Cables,			
Ltd.	393		

INDEX

A

ABERDEEN, 333, 336
 Accounts, B.B.C., 451-453
 Acoustics, 33, 153, 156, 335
 Addresses, B.B.C., 446
 Adult Education, Councils for, 198, 468-473
 Advertising, 19, 37, 52
 Advisory Councils and Committees, 466-474
 Aerials, 265, 373-383
 Africa, 262, 263
 Amalgamated Broadcasting System of America, 281
 America, United States of, 19, 281-283, 299-308
 Anglo-American Relations, 299-302
 Appeals, 96
 Art, 61-65
 Artists, 29, 46
 Australia, 258, 259
 Authors, 57

B

Balance Sheet, B.B.C., 453-454
 Belfast, 333, 339, 346
 Big Ben, 256, 450
 Birmingham, 158-160, 316, 333, 336
 Blattnerphone, 50, 250, 418-419
 Boat Race, 106, 134, 385-386
 Boulton, Dr. Adrian, 64
 Breakdowns, 317
 Bristol, 163, 333, 336
 Broadcast Engineering Research, 316
 Broadcasting and the Law, 25
 Technique of, 75-77
 Tenth Anniversary of British, 14
 Broadcasting House, 39-54, 153, 154, 333, 395, 396
 Organ, 56, 74
 Restaurant, 47, 49
 Visits to, 54
 Broadcast Plays, 57, 109, 111-113
 Burlesque, 58, 59

C

Canada, 17, 18, 264
 Canterbury, Archbishop of, 92
 Capital Expenditure, 21
 Cardiff, 168, 181, 333, 336
 Carnegie Trust, 198
 Cathode Ray Tubes, 425
 Chamber Music, 74
 Charity Appeals, 96
 Children's Hour, 101-103, 213
 Choirs, 203-205
 Christmas Message by H.M. the King, 9
 Columbia Broadcasting System of America, 281
 Commentaries, 60, 106, 107, 199, 255, 362
 Composers, 58, 62, 63
 Committee, Appeals Advisory, 468
 Music Advisory, 467-468
 Religious Advisory, 466, 467
 Spoken English, 468

Concerts, 52, 73-74
 Control Rooms, London, 397-398, 401-402, 495
 Regional, 387-392, 395-396
 Controversy, 19, 80
 Copyright, 27-29
 Council, Central, for Broadcast Adult Education, 468-473
 Council, Central, for School Broadcasting, 60, 87, 473-474
 County Pageants, 211, 212
 Criticism, Musical, 74

D

Dance Music, 104, 120
 Daventry, 312, 313, 319, 320, 326, 328, 336, 339, 343
 Debates, 50, 302
 Diesel Engines, 169
 Direct Ray, 437-438, 441-442
 Distant Stations, reception of, 437-438, 441-442, 444
 Drama, 111-113. *See also* Plays.
 Dramatic Control Panels, 338
 Droitwich, 312, 313, 315, 319-320, 321, 326, 328, 336
 Dundee, 223

E

Edinburgh, 221, 333, 335
 Education, Adult, Council for, 468-173
 Authorities, 89
 Effects, 388
 Electrical Interference, 25, 317
 Recording, 27, 28, 50, 119-120, 248, 418, 419
 Empire Broadcasting, 17, 48, 243-271, 311
 Programmes, 120, 267-271
 Station, 243
 Statistics, 273-275, 373-383
 Zones, 50
 Engineering, 316, 317
 Engineers, 397-405
 Europe, 464-465
 Exhibitions, Radio, 17, 24, 31-33
 B.B.C. Exhibits, 17, 31
 Eye-witness Accounts, 83, 105, 107, 199, 255, 362

F

Fading, 438
 Festivals, Musical, 64, 73, 163, 164, 204, 205, 236
 Field Strengths, 347-350, 351-355, 357-358, 359, 373, 375
 Football, 107, 138, 223
 Foreign Relays, 46, 308
 "Frae a' the Airts," 223, 227-230
 Fuller, the late Walter, 35, 36

G

Geneva, 288, 292
 Germany, 67-71, 284, 295-298
 Glasgow, 333, 335
 Government's share of Licence money, 21

Governors, 7
Gramophone Records, 27, 28, 50, 119, 250,
418-419

H

Hallé Orchestra, 195, 201, 202
Highlands, 227-230
Horse racing, 106

I

Income Tax, 21, 451
India, 261, 262, 277-279
Indirect Ray, 437-438, 441-442
Interference, Electrical, 25, 317
International Broadcasting, 287-293
 Relations, 299-302
 Relays, 46, 47, 308
International Broadcasting Union, 287-
 293
Ireland, 235-240
Italy, 283

K

Kettelwell, the late John, 14
King, H.M. the, 9, 11, 17, 108, 122, 243,
 247

L

Languages, Minority, 191-194
Law and Broadcasting, 25
League of Nations, 291
Leeds, 155, 195, 199, 315, 316, 333, 335
Licences, 11, 20-21, 38
Lines, Trunk, 316, 329-332
Listener, The, 16, 48
Listener's Societies, 454
Liverpool, 195, 199
Local Authorities, 90
Loudspeakers, 26, 428, 429
Lucerne Conference, 287, 340
 Plan, 287, 323, 455-63

M

Madrid Conference, 292, 441
Management, 39-54
Manchester, 82, 195, 198, 333, 335
Microphones, 387, 407-408, 411-413
Midland County Week, 211, 212
 Region, 209-220
 Regional Station, 320, 322
Minority Languages, 191-194
Modulation, 361, 362, 363-366, 368, 370,
 371
Music, 62, 65, 195, 201-205, 224, 235, 236,
 255
 Advisory Committees, 467-468
 Festivals, 64, 73, 163, 164, 204, 205, 236
 First Performances, 72
 From Hotels and Cinemas, 104
Musical Comedy, 50
 Plays, 57, 58

N

National Broadcasting Company of
 America, 281, 303
National Lectures Advisory Panel, 468
National Transmitter, 316, 319-322, 421

Newcastle, 199, 200, 333, 335
News, 99

 Bulletins, 81, 82, 83, 255
New Zealand, 258-260
North Region, 195-208
Northern Ireland, 23, 235-240, 315, 339-
 340, 343-346
Norway, 284

O

Olympia, 17, 29, 31, 33
Opera, 58
 In Germany, 67-71
Orchestras, 221
Organisation, 2, 39
Organ, B.B.C., 56, 74
Outside Broadcasts, 2, 105-108, 222, 223,
 236, 237

P

Parliament, 19
Photo-electric cells, 425
Pitt, the late Percy, 13
Plays, 101, 197, 198, 222, 239
Poetry, 64, 65, 79-80
Politics, 19, 291
Post Office, 21
Prague Plan, 323, 325
Press and Broadcasting, 17, 282, 283
Prince of Wales, 83, 126, 223, 238
Profits, 21
Programmes
 Empire, 120, 243-246, 267-271
 Events, 123-150, 183, 186, 207, 208, 215,
 225, 226, 240, 267-271, 308
 Formation of, 39-47
 Recorded, 27-29, 119-121, 248
Promenade Concerts, 73
Prose, 65
Publications, Revenue from, 21, 451

Q

Queen's Hall, 73

R

Radio Associations, 454
 Criticism, 217-220
 Drama 111-113
 Exhibitions, 17, 21, 31-33
 Manufacturers' Association, 31, 454
 Operetta, 57
 Society of Great Britain, 454
Radio Times, The, 14, 35-38, 40, 43
Reception of Distant Stations, 437-444
Receivers, 26, 427-428, 431-432, 435
Recorded Programmes, 27, 28, 50, 119-
 120, 248, 250, 418-419
 Library, 50, 118, 119, 120
Rediffusion, 28
Regions, 2, 40
Regional Programmes, 40
Rehearsals, 43-46
Relays, International 46, 47, 308
Religious Activities, 95
 Advisory Committees, 466
 Broadcasting, 91
 Cathedrals and Churches, 95
 Preachers, 95
 Services, 91-95

Research, 316, 317
Restaurant at Broadcasting House, 47, 49
Revenue, 21, 451-453
Roosevelt, President Franklin, 300, 303-307
Running Commentaries, 106, 107, 199, 255, 362
Russia, 277, 284

S

S.B. Land-line Network, 329-332
School Broadcasting, 87-90
Scotland, 23
Scots Folk Song, 231-234
Scottish Region, 221-234, 335
 Regional Station, 221-223
 Studio Orchestra, 221
Selectivity, 431
Shared Channels, 325, 326
Side Bands, 431
Simultaneous Broadcasts, 2, 40, 43
Societies, Listeners' 454
S.O.S. Messages, 97, 98
 Results, 98
Sound Records, 119-121, 415-416, 418-419
South Africa, 261, 263
Southampton, 108
Sports Commentaries, 106, 107, 199, 255, 362
Stobart, the late John Clark, 13
Studios, New Provincial, 152-160, 209, 316, 333-336, 337, 346
Synchronised Broadcasts, 313

T

Talks, 48, 50, 60, 85, 86, 223, 300, 301
 Recording, 50
 Topical, 81, 82
Tatfield Listening Station, 371
Television, 29, 52, 53, 317
 Society, 454

Tennis, 106
Time Signals, 450
Transmitters, Portable, 344, 385-386
 High Power, 312, 319
Treasury, 21
Topicality, 81-83

U

Ultra-short Waves, 405

V

Valve Manufacturers' Association, 454
Valves, 421-422, 424-425
Variety, 57, 60, 115, 222, 255
Vaudeville. *See* Variety.
Visits to B.B.C. Stations, 54, 447

W

Wales, 163-168, 167
Washford Cross, 167, 168, 181
Watchet, 11
Wavelengths, 323, 325-328
 British Stations, 447
 Lucerne Plan, 455-463
Weather Forecasts, 340, 448, 449
Welsh Language, 191-194
Westerglen, 121, 221
West Region, 161-194, 336
West Regional Station, 11, 167-180, 181
Wireless Associations, 454
 Exchanges, 28
World Economic Conference, 82, 108, 122
World-Radio, 14, 40, 48, 246, 253

Y

York, Archbishop of, 92
Yorkshire, 198

Z

Zones, Empire, 249-265

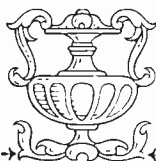

	<i>January</i>	<i>February</i>	<i>March</i>	<i>April</i>
S	7 14 21 28	4 11 18 25	4 11 18 25	1 8 15 22 29
M	1 8 15 22 29	5 12 19 26	5 12 19 26	2 9 16 23 30
T	2 9 16 23 30	6 13 20 27	6 13 20 27	3 10 17 24
W	3 10 17 24 31	7 14 21 28	7 14 21 28	4 11 18 25
T	4 11 18 25	1 8 15 22	1 8 15 22 29	5 12 19 26
F	5 12 19 26	2 9 16 23	2 9 16 23 30	6 13 20 27
S	6 13 20 27	3 10 17 24	3 10 17 24 31	7 14 21 28
	<i>May</i>	<i>June</i>	<i>July</i>	<i>August</i>
S	6 13 20 27	3 10 17 24	1 8 15 22 29	5 12 19 26
M	7 14 21 28	4 11 18 25	2 9 16 23 30	6 13 20 27
T	1 8 15 22 29	5 12 19 26	3 10 17 24 31	7 14 21 28
W	2 9 16 23 30	6 13 20 27	4 11 18 25	1 8 15 22 29
T	3 10 17 24 31	7 14 21 28	5 12 19 26	2 9 16 23 30
F	4 11 18 25	1 8 15 22 29	6 13 20 27	3 10 17 24 31
S	5 12 19 26	2 9 16 23 30	7 14 21 28	4 11 18 25
	<i>September</i>	<i>October</i>	<i>November</i>	<i>December</i>
S	30 2 9 16 23	7 14 21 28	4 11 18 25	30 2 9 16 23
M	3 10 17 24	1 8 15 22 29	5 12 19 26	31 3 10 17 24
T	4 11 18 25	2 9 16 23 30	6 13 20 27	4 11 18 25
W	5 12 19 26	3 10 17 24 31	7 14 21 28	5 12 19 26
T	6 13 20 27	4 11 18 25	1 8 15 22 29	6 13 20 27
F	7 14 21 28	5 12 19 26	2 9 16 23 30	7 14 21 28
S	1 8 15 22 29	6 13 20 27	3 10 17 24	1 8 15 22 29

