



B·B·C
Hand Book

1928

200 Years ago



The clamour of eager, excited voices . . . the friendly flicker of lights from the open door . . . the final toast, the last good-night . . . the parting guests are gone.

OLD customs vanish with the passing years, but the spirit of merry-making remains. It is revived in every glass of this fine old Family Wine they made in 1740—Stone's Original Ginger Wine.

To-day, as yesterday, there is Stone's Ginger Wine to speed the parting guest—its comforting warmth to fill you with

a sense of well-being — its penetrating glow to warm and cheer the very cockles of your heart.

In the golden depths of it there is the promise of good cheer—the tingling warmth of it goes with the crackling logs and the merry winter evenings.

It's friendly . . . with an old-time friendliness!

STONE'S GINGER WINE

From Wine Merchants and Grocers everywhere



THE ORIGINAL GINGER WINE—FAMOUS SINCE 1740

THE PERSONAL AND EXPERIENCE OF

It was realised by Mr. C. S. Dunham (who until some time ago was Radio Engineer to Marconi Scientific Inst. Co. and had been a member of the B.B.C. since its conception) that radio appliances should not be machine-made articles designed on conventional

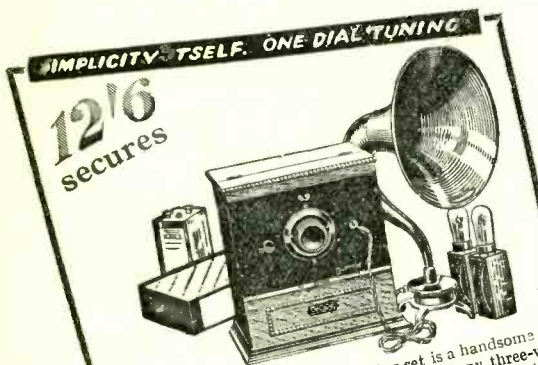

This Dunham two-valve loud-speaker set is a handsome oak cabinet model. In performance equal to many three-valve sets (at half the price and half the maintenance cost) the design of this receiver represents a combination of simplicity with efficiency that has met with universal approval. Valves fitted internally on anti-microphonic holders, and there is a compartment in base for high-tension battery. Tuning is by a single dial with a small knob to vary reception power to individual requirements. Coils are entirely dispensed with. Range on loud-speaker 25-30 miles on ordinary station, 100-120 miles from Daventry. Phone range includes reception from many other stations at excellent strength. The operation of the set is an achievement in simplicity, just plug in and out to start set working. This action automatically lights up valves and puts all switches on. Complete with two Cossor dull-emitter valves, Exide accumulator, extra large H.T. battery (100 volts), loud-speaker, in fact an installation complete. Marconi royalty paid, for £7/19/6, or 12/6 deposit secures and 12/6 monthly.

For Home Constructors. Envelope containing all details, drilling panel jig, wiring diagram, panel layout, complete list of components with full particulars, 7d. post free.

TRUTH IN ADVERTISING

We are prepared to prove the claims we make for our instruments. Sworn testimony supporting these claims together with a beautifully illustrated booklet showing the full range of Dunham models will be sent per return on receipt of 2d. for part postage.

**THE DUNHAM
EVERLASTING
GUARANTEE IS
YOUR ASSUR-
ANCE OF
LASTING AND
COMPLETE
SATISFAC-
TION.**

*Your own set
taken in part
exchange.*

BEWARE OF EASY TERMS. Buyers of various commodities have found to their cost that so-called easy terms are at times far from being what the name implies. There is a way of purchasing out of income—easy terms that are easy AND FAIR. You keep what you have paid for. This is the Dunham way. Before you buy ANYTHING out of income write for our free treatise that tells you clearly what to avoid and how to keep on the SAFE side of the deferred payment system.

**THE LATEST DUNHAM TRIUMPH—A SET THAT
NEEDS NEITHER AERIAL NOR EARTH**

RECOMMENDATION A RADIO ENGINEER

lines. So he applied his knowledge and experience to the production of a range of radio sets and components that would be entirely different in their design and performance. These, by skilful methods of production, are sold at prices which represent wonderful value.

DUNHAM "ALL-WAVE" TUNER

Increases Range and Tone, and adds another valve to your receiver. Covering wavelengths from 150 to 2,000, the "ALL-WAVE" Tuner is simple to operate and has one-hole fixing. Enthused over by Wireless Journals, this amazing instrument finally dispenses with coils and their accompanying complications. Complete with full instructions and Blueprint. Price 9/6

Personal Installation

A feature of the Dunham policy is the Dunham service organisation. There is a Dunham engineer-resident in your district who will gladly install your set and ensure your getting the full pleasure that is to be obtained from reception with Dunham Radio



60 STATIONS ON LOUD SPEAKER
35/6
secures complete installation

Another brilliant star in the firmament of Dunham achievements is the C.S.D. 51 D. A three valve set of exceptional attributes, this set has everything enclosed in a handsome cabinet that is fitted with lock and key. Valves are protected by "windows" from accidental damage. The cabinet itself is a beautifully decorated piece of furniture worthy of the most exclusive home, and is secured for 35/6 deposit and 25/- monthly, complete with valves, all batteries, and loud-speaker. As the set has no variable coil holders the expensive litter of interchangeable coils is entirely done away with. Loud-speaker range almost without limit. Complete set, all batteries, valves and cabinet loud-speaker, 21 guineas. Marconi royalty paid. For those who wish to construct a wireless set de Luxe, we issue full instructions that include five pictorial diagrams, drilling sheet and advice on earth and aerial systems. Every constructional detail is clearly explained and with the assistance of the diagrams amateurs will find pleasurable and profitable occupation in building this first-class set.

Full instructions sent post free for 2/9.

C.S. DUNHAM

(Late Radio Engineer to Marconi Sc. Inst. Co., Member of the B.B.C. since its inauguration)

ELM WORKS, ELM PARK
BRIXTON HILL, LONDON, S.W. 2
WRITE NOW FOR FULL PARTICULARS

The Perfect Five

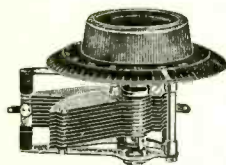

J.B. S.L.F.

Complete with beautiful 4" Bakelite Dial. '0005 mfd. 11/6: '00035 mfd. 10/6: '00025 mfd. 10/-: For short Wave Receivers, '00015 mfd. 10/-.



J.B. Log. Plain.

Complete with 4" Bakelite Dial. '0005 mfd. 11/6: '0003 mfd. 10/6: '00025 mfd. 10/-: '00015 mfd. 10/-.

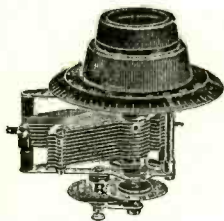

J.B.

True Tuning S.L.F.

Complets with 2" Bakelite Knob for Slow Motion and 4" Bakelite Dial for coarse tuning. '0005 mfd. 16/6: '00035 mfd. 15/6: '00025 mfd. 15/-: For Short Wave Receivers, '00015 mfd. 15/-.

Always choose the Condensers with years of reputation behind them—condensers which are as perfect as modern science can make them. In other words, do justice to your set and select from the Perfect Five with the Trade Mark J.B.

1. J.B. S.L.F. Separates the stations evenly throughout the scale. The high-water mark in S.L.F. Condensers. Brass skeleton end plates, nickel plated. Ball-bearing centre spindle, variable turning tension and pigtail connection. Brass vanes. A wonderfully finished job.

2. J.B. Slow Motion S.L.F. (J.B. True Tuning S.L.F.). Fitted with a double reduction friction drive making backlash impossible. Ratio 60-1.

3. J.B. Log. Plain Model. Outstanding feature of the 1927 season. Fitted with nickel-plated brass skeleton end plates. Ball-bearing centre spindle. Pigtail connection. Brass vanes. Rotor vanes tied at tips. Variable turning tension. Unsurpassed in radio.

4. J.B. Log. Slow Motion. Fitted with double reduction friction drive, Ratio 60-1.

5. J.B. Neutralising. Undoubtedly the condenser for any Neutrodyne Receiver. Cannot go wrong. Finished in polished nickel-plate. Self-locking and dust-proof. Smooth ultra-fine adjustment. Maximum capacity approximately 20 mmf. Minimum capacity negligible.



J.B. Log.

Slow Motion.

Complete with 2" Bakelite Knob for Vernier Control and 4" Bakelite Dial for main control. '0005 mfd. 16/6: '0003 mfd. 15/6: '00025 mfd. 15/-: '00015 mfd. 15/-.



J.B. Neutralising, 3/6.

JACKSON BROS.
8. POLAND ST—OXFORD ST
LONDON - W.1 Telephone: GERRARD 7414



NEUTROSONIC SEVEN RADIO RECEIVER



THE IGRANIC NEUTROSONIC—the portable set that makes distant radio reception so good as to be almost incredible. Compact, needing no outside aerial or earth, it may be taken and used anywhere. It becomes an accessory of your car—a companion of your travel. But you must see it, operate it, hear it, to appreciate fully its unique qualities. Write for a free copy of "The Giant Stride"—a fascinating account of an extraordinary radio development.

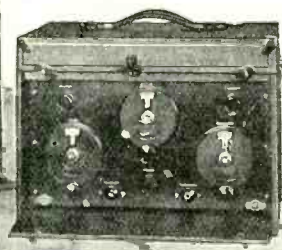

IGRANIC RADIO DEVICES put life into a circuit—life in the zest and virility they give to results—life in the extraordinary length of time they continue to give such complete satisfaction.

Write for lists describing our latest range of components.
Dept. J273

IGRANIC ELECTRIC CO LTD

149 Queen Victoria Street, LONDON

Works : BEDFORD

Exide

THE LONG-LIFE BATTERY

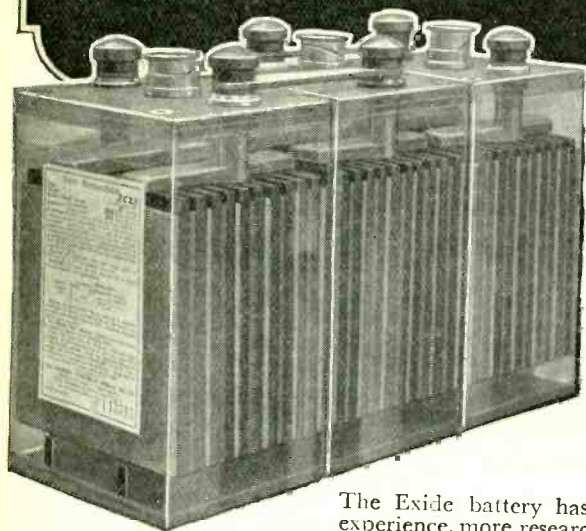

TYPE CZ
Exide
L.T. Battery

*Capacities from
20 to 60 amp. hrs.*

*Prices from
11/3 to 21/-
per 2-volt cell*

The Exide battery has more accumulated experience, more research, more sheer knowledge, and greater manufacturing facilities behind it than any other Battery.

Exide type CZ batteries for Low Tension give absolute reliability at the lowest price consistent with a first-class job.

They can handle comparatively heavy currents for long periods.

Supplied in glass or celluloid in 2, 4 or 6-volt units

Send for Catalogue "W"

Exide Batteries are obtainable from your local Dealer or Exide Service Agent

MADE AT THE LARGEST BATTERY WORKS IN THE BRITISH EMPIRE

Advertisement of The Chloride Electrical Storage Co., Ltd., Clifton Junction, Near Manchester.

See also the Company's Advertisements on pages 7 & 263.

Exide

THE LONG-LIFE BATTERY

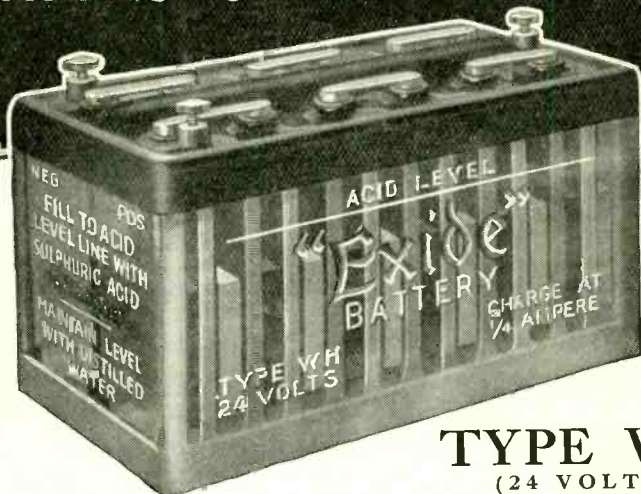

TYPE WH (24 VOLTS) High Tension Battery *Regd. Design No. 716,009*

No source of H.T. other than accumulators can satisfactorily pass the heavy anode currents required by modern high power valves for superfine quality reception—and the Exide "Mass" Type H.T. battery is the best H.T. accumulator in the world.

Its absolutely steady discharge and absence of any fluctuation of voltage or internal resistance give perfect freedom from background noises. Its merits are especially marked where weak signals, interference or other exacting conditions obtain.

SEND FOR CATALOGUE W

EXIDE WH 24-volt H.T. Battery.

Capacity 5,000 milliamp. hours.

Price 24/-

Supplied in dry charged condition.

EXIDE WJ 10-volt H.T. Battery.

Capacity 2,500 milliamp. hours.

Price 5/- per 10-volt Unit
(without crate).

USE AN EXIDE BATTERY FOR YOUR CAR

Advertisement of The Chloride Electrical Storage Co., Ltd., Clifton Junction, Near Manchester.

See also the Company's Advertisements on pages 6 & 263.

Thank you!

It is now more than two years since Fellows Wireless adopted their policy of selling wireless sets, accessories and Louden Valves direct to the public.

WE took that course because we were convinced that prices were too high—because prices and trade discounts were ruled by groups and rings of manufacturers in a way that we felt to be oppressive. So we took the big step of offering our products direct to the public. We lost many good trade friends by doing so. From the day we sold direct our success or failure depended upon one thing and one thing only—the quality of our goods.

Advertisement of the Fellows Manufacturing Co., Ltd.,

TO-DAY we look back on two years of triumphant success. To-day Fellows Wireless are the largest set manufacturers in the country. We have built a reputation for making only first-class products and selling them at fair and reasonable prices.

THEY say that gratitude is a lively sense of favours to come! In expressing our thanks to the British public for the great support they have given us, let us honestly admit that we hope to find that support growing for many years to come, as it has in the first two years of our direct to the public policy. OUR new Catalogue is now ready. Will you send for a copy?

Park Royal, London, N.W. 10

FELLOWS
WIRELESS

M.C. 423

Worryless Wireless!

MODEL M.1
H.T.
ADAPTOR
17/6



For 1 to 3 valve sets only.

"EKCO" H.T. UNITS

Patent 262567 and Patents pending.

Provide a constant H.T. supply for Wireless Receivers by just attaching adaptor to electric light or power socket. Models for H.T. and combined H.T., L.T., and G.B.

"EKCO" Models to suit all sets from 17/6

E.K. COLE LTD

"EKCO" WORKS,
LONDON ROAD, LEIGH-ON-SEA

Illustrated
Folder
Free.

LOW LOSS COILS

The world-renowned patented twin-wire winding is still without a rival for giving maximum distance and signal strength. Offers least possible resistance to H.F. Current. Prices from 2s. 6d. to 15s. 6d. each.

CENTRE

TAPPED COILS

Render even the straight circuit so selective that stations five metres above or below the local station's wavelength can be lagged easily. Tapped at true electrical centre. Prices, (No. 40 for 200/400 m.) No. 60 for 350/600 m.) 4s. 3d. each. Special Coil for Daventry, etc., 6s. 6d.

"X" COILS

Specially designed to give super-selectivity in Auto-coupled, "Reinartz" "Neutrodyne" Split-coil and similar circuits. Prices, No. 60, tapped at 7th and 17th turns, 5s. 6d. each. No. 250, tapped at 28th and 50th turns, 7s. 6d. each.

"CLARKE'S ATLAS"

The name that matters
in matters wireless

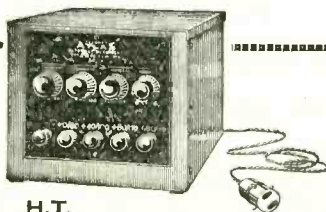

H.T.

BATTERY ELIMINATORS

The pioneer trouble-removers! There's a model for every need, whether the supply is A.C. or D.C. and every model is fully covered by the "ATLAS" guarantee. Simple and safe to work; easy to "fix and forget." Give a lifetime's constant H.T. at negligible current cost.

Models from £3 5s. fully described
in Folder No. 24.

THE

"NEUTROFOUR"

The ideal four-valve set at last.

The one stage only of H.F. is of the highest possible efficiency, the result being easily equal to two or three stages of highly-damped screened-coil H.F. Transformer.

The secret of the "Neutrofour" success is due to the special H.F. Transformer known as the "Select-atiner" in which the correct degree of magnetic reaction is applied without the least fear of Re-radiation when the set is properly neutralised.

Distant stations come in with an ease that delights; "Neutrofour" selectivity is a revelation, and you have never yet heard its equal for volume and purity.

Send to-day for fully illustrated 20-page "Neutrofour" booklet, free for the asking.

H. CLARKE & Co. (M/cr) Ltd., Atlas Works, Old Trafford, MANCHESTER

CONSTRUCT THE B.B.C.
EXHIBITION SETS WITH

BURNDDEPT COMPONENTS

HEAVY-DUTY WIRE-WOUND RESISTORS,
HEAVY-DUTY CHOKES, VALVE HOLDERS,
SUPER VALVES, POTENTIOMETERS,
RESISTORS AND RHEOSTATS

—THE RESULTS YOU GET WILL
BE WELL WORTH GETTING

Get the New Burnddept Catalogue

*For perfect reception and
reproduction Ethophone
Receivers are unexcelled.
Now available at reduced prices*

BURNDDEPT
WIRELESS LIMITED

BLACKHEATH

LONDON

S.E. 3.

The Master Non-Vibratory Valve Holder

THE SUPER VALVE HOLDER

This fine Valve Holder is recommended by the Wireless Press and used in their own Receiving Sets. The patent suspension employed is the latest discovery in the process of eliminating vibration and shock from metallic filaments. *No springs are employed* which, having an inherent periodicity, cannot eliminate vibration. The suspension is ultra-sensitive, and at the same time is mechanically strong. By the fitting of these Holders results equal to an extra valve can be obtained, owing to the valve functioning under perfectly stable conditions. They entirely damp out vibration, prevent breakage from shock, increase range and efficiency, give better and purer reception and eliminate microphonic noises. They pay for themselves by increasing the effective valve life and are a high-class production.

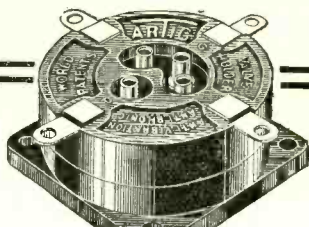

WITH PATENT INTERMITTENT MESH SUSPENSION

ANTI-Microphonic—Vibration
—Capacity—Shock.

Sprung, yet there are no springs or rubber suspension. World Patents. The ULTRA-sensitive Valve Holder. *Send for particulars and illustrations.*



EFESCA H.T.

Eliminators

The convenience of obtaining HIGH TENSION SUPPLY STRAIGHT OFF THE MAINS where electric light is available, has created a wide demand for High Tension Battery Eliminators. The series of Efesca Eliminators are attractive in form and efficient in use and cover all possible requirements. They can be run off any convenient lampholder or wall plug.



Efesca Junior Model

For direct current.

Contained in Oxidised Copper Casing, two fixed positive tappings 60 and 120 volts, 6 volt negative Grid Bias tapping, complete with cord and adapter.

Price 35/- each.

MODEL No. 1 For Direct Current.

In oak case with two fixed tappings and one variable with Grid Bias.

MODEL No. 3 FOR A.C.

In oak case with two fixed tappings and one variable and with Grid Bias.

FALK, STADELMANN & Co., Ltd.

Efesca Electrical Works, 83/93 Farringdon Road, London, E.C. 1
And at Glasgow, Manchester, Birmingham, Newcastle, Dublin and Cardiff.

We have introduced an entirely new series of

Efescaphone Receiving Sets

at popular prices, designed on the most simple lines to appeal to the non-technical public desiring to enjoy the broadcast programmes "trouble free." They may be purchased through your local dealer under our new scheme of

DEFERRED PAYMENTS

Write for catalogue and particulars, post free.

ANY TIME IS

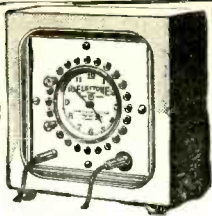

ELECTONE TIME

Round the clock—any hour is yours—Pick everything good out of the Wireless Programme—note the times and then with the aid of "ELECTONE" THE AUTOMATIC PROGRAMME SELECTOR your watching and waiting can cease.

Simply connect up with Receiving Set and L.T. Battery, put in the plugs opposite times required, and the items you have chosen will auto-matically come through at appointed hours. It switches off between selections without any move on your part. Truly the wonder machine of radio, it makes your set almost human in service, saves wastage of H.T. and L.T. supply and prolongs the life of Batteries and Valves. Remember you secure your full day's selection from the programme at one setting only by using the plugs provided. It is not only a Programme Selector but is at all times an attractive and reliable timepiece.

ALL BRITISH INVENTION AND MANUFACTURE
FOOLPROOF AND GUARANTEED
Price 27/6
FOOLPROOF AND GUARANTEED

In polished Mahogany or Oak Case

Write for a Free Copy of "Father Time Toss the Line," an Interesting Illustrated Folder. Obtainable from all Dealers or direct from the Licensees & Sole Manufacturers

Fredk. J. GORDON & CO. LTD.
92 CHARLOTTE STREET, LONDON, W. 1

STANDARD SAC LECLANCHE WET H.T. BATTERIES

Two No. 3 cells fitted with new detachable terminal.

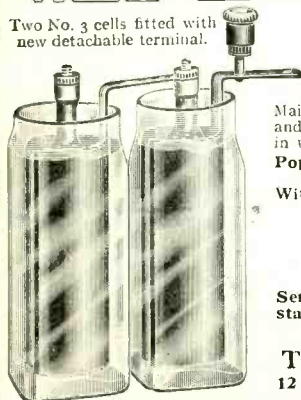

will end the everlasting expense of experimenting to find the PERFECT H.T. BATTERY. This battery possesses three qualities which are lacking in dry H.T. Batteries. Permanency—Silent in action—Self charging.

Maintenance and assembling is simple and interesting, and will greatly improve your reception and cost less in upkeep.

Popular Model, 90 volts, 60 cells, No. 1
Sac 21/9
With detachable terminal 25/1
Tray 7/- extra.

Sizes made: No. 1 Sac 7 milliamps.
" 2 " 14 "
" 3 " 30 "
L.T. " 300 "

Send to-day for the new edition of our booklet, stating number and type of valves. We will recommend most economical battery.

THE WET H.T. BATTERY Co.,
12 Brownlow St., High Holborn, London, W.C.1



1/= HANDBOOK

ON THE
Construction and correct uses of
FORMO
RADIO COMPONENTS
with BLUE PRINTS of
TWO VALVE TWO RANGE
SET

and
THREE VALVE
"TRUE SCALE" SET.

*Special Test Reports and
Contributions.*

FORMO-DENSORS.

Self-supporting
AIR COILS.

Mr. H. J. BARTON CHAPPLE,
Wh. Sch., B.Sc. Lond. A.C.G.I., D.I.C.
A.M.I.E.E.



LOW FREQUENCY AMPLIFICATION LOG CONDENSERS.

Mr. J. H. REYNER,
B.Sc., A.C.G.I., D.I.C., A.M.I.E.E., M.Inst.R.E.

COMPLETE COLLAPSIBLE SCREENS.

*Illustrating general arrangement of components
and sides of screen removed to facilitate wiring
and adjustment.*

- The Components shown are :
- Collapsible Screen . . . 9/6
 - Log Condenser . . . 10/6
 - Formo-Densor, from . . . 2/6
 - Air Coils, from . . . 5/-

22, CRICKLEWOOD LANE, N.W.2

Phone: Hampstead 1787.

Manchester: Mr. J. B. Levee, 23, Hartley
St., Levenshulme. Phone: Heaton Moor 475.

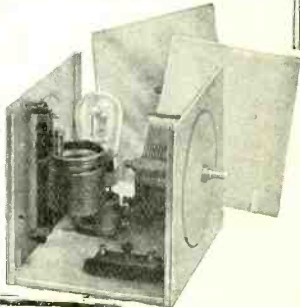

The name

CYLDON

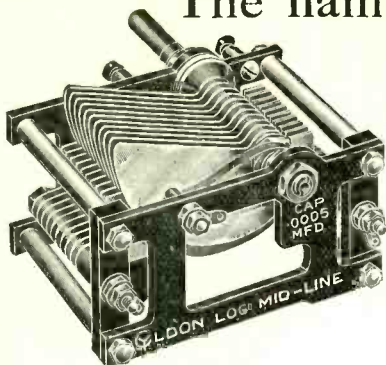

Prices: .001, 19/-; .0005, 15/6; .0003, 14/6;
 .00025, 14/-; .0002, 13/6.

With 4 in. knob dial - 2/- extra

In the case of gang condensers, Log Mid-Line are
 a necessity, not a luxury. Prices of CYLDON Log
 Mid-Line Gang Condensers:

2 Gang £2 10s. 3 Gang £3 10s. 4 Gang £4 10s.

TEMPRYTES the perfect filament control
 are made with the same care and precision which
 stamps all "Cyldon" products. Temprytes are
 guaranteed to control perfectly the filament of any
 make or type of valve. Reference to our current
 valve chart (free on request) will show you the correct
 Tempryte to use with your valves.

"CYLDON" TEMPRYTES
 are not variable

Their resistance will remain constant throughout
 their entire period of use. We ourselves have
 Temprytes controlling Valves which have been on
 test for over 2000 hours. In every case the valve
 emission remains unaltered. The Tempryte has
 given the valves 100 per cent. more life than even
 the valve manufacturers care to specify.

IMPORTANT NOTICE

The products of the world's best brains
 and manufacturing resources in any
 trade or profession have always inter-
 ested the "Cheap-Jack" imitator,
 the worthiness of whose products can
 only be compared with his lack of
 originality. "Cyldon" products un-
 fortunately have not been spared this
 form of unwelcome flattery. Every
 genuine "Cyldon" condenser bears our
 registered trade mark on the end plate.
 Insist on seeing this before purchasing.

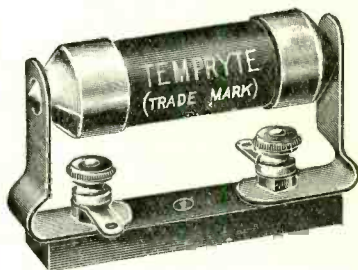

Prices

TEMPRYTES	-	-	-	-	1/6
HOLDER MOUNTING	-	-	-	-	1/-
PLUGS	-	-	-	-	6d.

SYDNEY S. BIRD AND SONS

Cyldon Works, Sarnesfield Road, Enfield Town, Middsx.
 Telephone and Telegrams - - - - - Enfield 0672

Contractors to the B.B.C., H.M. Royal Air Force, H.M. Office of Works and
 all the leading manufacturers of quality receivers. Sole Australian Agent:
 Mr. E. V. HUDSON, 55-57 Charlotte Street, Brisbane, Queensland.

*To see much is to
learn much*

See the World and be
well paid at the same
time by becoming a
Wireless Operator.
500 Vacancies.



*Take advantage of this splendid
opportunity by being trained at*

**The British School of
Telegraphy Limited**

179 Clapham Rd., London, S.W.9
(ESTABLISHED OVER 20 YEARS)

BLESSINGS FOLLOW GIFTS

Over 25,560 young lives have passed through
the doors of

**The Shaftesbury Homes &
'Arethusa' Training Ship**

Will **YOU** help us to give a chance
to 25,560 more?

*Patrons: Their Majesties the King and Queen.
President: H.R.H. The Prince of Wales, K.G.*

15,291 boys and girls have
been trained in the homes.
3,200 boys have joined the
Royal Navy; 6,769 boys
have joined the Mercantile
Marine; 300 boys have
joined the Service Bands
through the "Arethusa."



Chairman and Treasurer:
Francis H. Clayton, Esq.

Deputy Chairman:
Lord Daryngton.

Chairman of "Arethusa"
Committee:

Howson F. Devitt, Esq.

Secretary:

F. Brian Pelly, A.F.C.

164 SHAFTESBURY
AVENUE, W.C. 2.

**THE "LONGTON"
LOW TENSION UNIT**

For working sets direct off alternating
current house mains



Takes the place of 2, 4 or 6 volt accumu-
lators and can be used with any set without
alteration.

Always ready for switching
on—no charging, no worry

"Wireless World" says: "Perfectly satis-
factory results have been obtained."

PRICE - £7 15s.

Send for full particulars from the manufctrs.
H. LONGTON AND COMPANY
Josephs Road, GUILDFORD, Surrey

London Agents:

Messrs. Read & Morris, Limited
31 East Castle Street, Oxford Street, W. 1

"C.W."

BATTERY LINKS

PATENT NO. 217141



For building up your H.T. Unit with
4½ v. Flash-Lamp Batteries, ask for
and see that you get the original and
genuine "C.W." Battery Links.
Battery Terminals connected and
disconnected in an instant. Tight
grip on Battery Terminals always
maintained, ensuring a satisfactory
and silent working Unit.

No soldering required.

Price 6d. per doz.

Every genuine "C.W." Battery Link bears
its name

Obtainable from all dealers

ADVT. OF

THE JEB TRADING CO.
49 Avenue Road, Acton, W. 3

TO THE WOMEN OF BRITAIN

The Radio has undoubtedly helped you to keep your husband and boys away from the club and kept them at home where they thus experience the benefits of your gentle charm and influence, but you must now go *one step further* and make your home comfy and cheerful by having Hailglass Shades and Globes on your lights. Hailglass is made only by Hailwood & Ackroyd, Ltd., Morley, near Leeds. It is made in beautiful opals and is decorated or tinted with lovely colours and designs. Each piece is marked "Hailglass." Don't let your supplier foist upon you foreign glass which is made under sweated conditions. Your supplier gets a reasonable profit on our glass. We are putting up a hard fight in the face of unfair foreign competition and against certain atrocious British dealers who want *excessive profits*. Please help us to keep the Trade and British Money in Britain. Your men-folk, as they listen to the Radio in a home made bright and comfy by our charmingly coloured glassware, will indeed feel that they are in a real "Heaven on Earth," and you women of England will mutually join in this pleasure. We have an enormous range of sizes, shapes and designs.

Head Office and Works: MORLEY, Near Leeds

Showrooms { 98 Mansell Street, LONDON, B. 1
32 Shaftesbury Avenue, LONDON, W. 1
21 Waterloo Street, GLASGOW



**THE
NEW AND IMPROVED
R.C. THREESOME**

is not only as good
as the original receiver;
it has been made even
simpler, it is easier to
build than ever, and
the parts are cheaper.

♣

For free Instruction Book and Blue-
print, write to Handbook Section,
Publicity Department, The Edison
Swan Electric Co., Ltd., 123/5 Queen
Victoria Street, London, E.C.4.

EDISWAN

Radio Maritime Training Centres

A career in the Mercantile Marine Wireless Service offers immediate opportunity for employment to-day.

The Marconi Company say: "It is estimated that we shall require at least 500 of these men (First Class Certificated Operators) within the next twelve months."

Expert teachers in every branch of training with practical experience on the latest types of wireless apparatus make Radio Maritime training the success it is.

The schools are spacious, well lighted and hygienic, and can be inspected on application to the Principals.

Apply for free Prospectus to

RADIO MARITIME LTD.

37 NORFOLK ST., LONDON, W.C.2

26-27 ST. MARY ST., CARDIFF

PRIMUS AUTOCEL HIGH TENSION BATTERIES

The finest quality produced in the world to-day.

(See thousands of testimonials.)

Entirely different from any other dry battery. Will outlast any other battery. Rejuvenates whilst not in use.

Money refunded if not satisfied.

NEW REVISED PRICES

36 volts	5/6
63 volts	9/6
103 volts	15/6
120 volts	18/6
9 volts	Grid Bias Batteries	2/-
4.5 volts	Pocket Lamp Type	7d.

The Battery of Many Lives

If not obtainable through your local dealer, write direct to the manufacturers:—

THE PRIMUS MFG. CO.

114-115, Gt. Saffron Hill,
LONDON, E.C.1

Buy a GILLAN Receiver



Write for full particulars of the various models and of the "Charge-Adapta" for charging Wireless Accumulators from the Lighting System of a Motor Car.

GILLAN RADIO-ELECTRIC LIMITED

64 High Holborn, London, W.C.1

PHONE: CHANCERY 8512

TRADE MARK



REGD

THE RECOGNISED DETECTOR FOR ALL SETS AND CIRCUITS.

RD 40 . . . 2/-
Shield for same 6d.



By Insured Post 2/3 or 2/9 with shield. Can be mounted on brackets or through panel. Each one is tested on broadcast before despatch, and is perfect. Of all high-class Radio Dealers or Sole Makers:—

JEWEL PEN CO., LTD.,

RADIO DEPARTMENT 50,

21-22, GT. SUTTON ST., E.C.1.

ESSENTIAL!



"G.R."
TYPE 247-W
WAVEMETER

See also advert. below
and p. 334

In CASES of "WIPE-OUT"

This Series Rejector or Parallel Acceptor, made by Laboratory Instruments Manufacturers, will completely wipe out any interfering station without diminution of signal strength. Tune through your "local" with this device.

Moreover, it is also an accurate wavemeter, with dial calibrated in metres for reception or transmission. Comes complete. Installed in five seconds. Requires no alteration to wiring of your set. Full instructions covering all uses supplied with each.

1927-3 Season Reduced Price, only 55/-

From your dealer, or in case of difficulty remit direct.

CLAUDE LYONS, LTD.
76B Old Hall Street, Liverpool.

MARINE WIRELESS SERVICE

GOOD PROSPECTS FOR YOUTHS 16-24
SHORT TRAINING. MODERATE FEES.
APPOINTMENTS GUARANTEED

CALL OR WRITE FOR PROSPECTUS

LONDON RADIO COLLEGE, LTD.
82-3 HIGH STREET, BRENTFORD

THE ABC OF THE Super-Het

8d
POST FREE

88 pages: 17 designs, circuits or large photographs; complete point to point wiring plan and constructional details, hints and tips of the famous "Evening Chronicle-Lyons" Super-het. The only book of its kind at present in existence. Written by C. L. Lyons, M.I.R.E. Described by "Wireless World" as "A Fascinating Booklet. A lucid description of the operation of the Superhet Receiver: with useful hints for the Home Constructor." Order from: **CLAUDE LYONS LTD.** 76-B. Old Hall St., Liverpool, Lancs.



WHAT YOU GET IF YOU BUILD THE CHRONICLE SUPERHETERODYNE:

- Cost, in Cabinet, under £20.
- L.T. Consumption only 0.56 amps.
- H.T. Consumption only 15 milliamps.
- No Aerial: No Earth.
- Utmost possible Selectivity.
- Great Volume if desired.
- Perfectly silent background.
- Utter Simplicity of Operation.
- Only two tuning Controls.
- 1,000 mile speaker reception from Autumn to Spring, with ease.

AND LAST BUT NOT LEAST—
Our Mr. C. L. Lyons, M.Inst.R.E., will advise, free of charge, in case of any slight difficulty.

LEWCOS

RADIO PRODUCTS



CENTRE TAPPED COILS

give greatest selectivity at a moderate price. Full range available from 25 to 300.

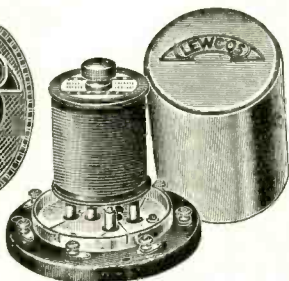

SIX-PIN COILS

Suitable for all circuits utilising this type. Tests prove that they have lowest H.F. resistance.

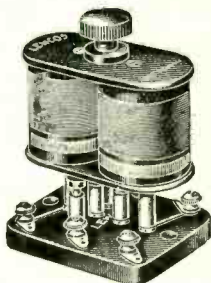

BINOCULAR COILS

Latest development in 6-pin coils. Interchangeable with Standard type. Full range.

DUAL COILS

This improved type of screened coil tunes both Daventry and B.B.C. ranges, without changing. No six-pin base necessary. Ideal for Solodyne receivers. Single coil and multi-coil units.

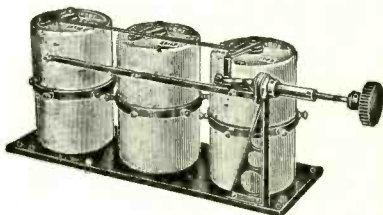

GLAZITE
BRITISH MADE

COLOURED CONNECTING WIRE

Ask for these LEWCOS Radio Products

FRAME AERIAL WIRE

LEWCOFLEX

BATTERY CORDS

LITZ WIRE

Write for complete radio catalogue

The LONDON ELECTRIC WIRE CO. & SMITHS, LTD.
Playhouse Yard, Golden Lane London, E.C. 1.

AMPLION

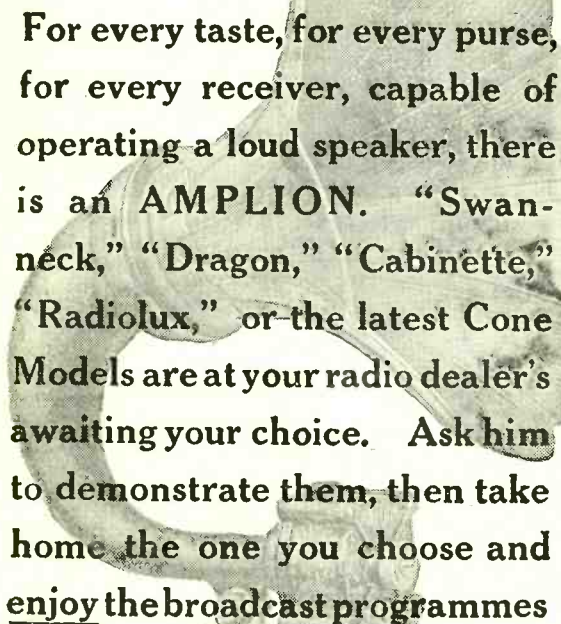

For every taste, for every purse, for every receiver, capable of operating a loud speaker, there is an **AMPLION**. "Swan-neck," "Dragon," "Cabinette," "Radiolux," or the latest Cone Models are at your radio dealer's awaiting your choice. Ask him to demonstrate them, then take home the one you choose and enjoy the broadcast programmes

**THE WORLD'S STANDARD
WIRELESS LOUD SPEAKER**

Models from 38/-

Announcement of Graham Amplion Ltd., 25 Savile Row, W. 1



B · B · C
HAND
BOOK

1928

BRITISH BROADCASTING CORPORATION

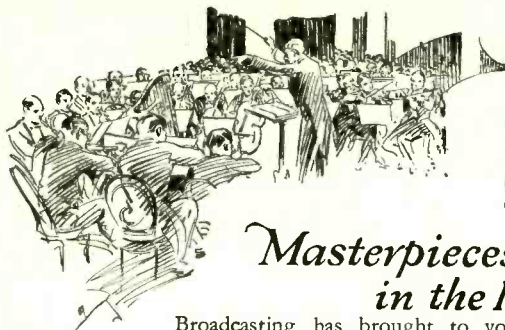

BY APPOINTMENT

Masterpieces in the Home

Broadcasting has brought to your home the works of the greatest composers and conductors in the world. Enjoy their art to the full by securing purity of tone and faithful reproduction.

Use "HART" Batteries for both Low and High Tension supply, and your set will be improved out of all knowledge. The valves will be supplied with steady current that will enable them to work at their best and you will lose nothing of the beauty of the actual performance.

Further proof of this is evidenced by the fact that many of the greatest musicians personally use and recommend "HART" batteries

HART BATTERIES

FOR ALL WIRELESS CIRCUITS



HART ACCUMULATOR CO. LTD.
STRATFORD. LONDON. E.15.

TABLE OF CONTENTS

	PAGE		PAGE
Foreword	29	The New Régime	43
Introduction	31	The Administrative System	50
The Old Régime	37	THE REGIONAL SCHEME	57

PROGRAMMES

<i>GENERAL</i>		Broadcast Debates	128
Programme Policy	71	Broadcasting and Religion	131
Programme Building	74	Adult Education	134
Listeners' Criticisms	79	School Broadcasting	137
<i>MUSIC</i>		Running Commentaries	140
Broadcasting and Music	83	Outside Broadcast Features	143
Broadcasting and the Composer	89	The Children's Hour	148
Broadcasting and the Artist	91	<i>SPECIAL SERVICES</i>	
Development of Broadcast Opera	93	Success of S.O.S. Messages	153
Chamber Music in Broadcasting	97	Time Signal Chart	154
Foundations of Music	100	The Weather	155
The Promenade Concerts	101	Broadcast Charity Appeals	157
The National Concerts	105	<i>ROUND THE STATIONS</i>	
The Military Band	108	The London Studios	161
Sound Balance and Control	110	The Industrial North	165
<i>THE SPOKEN WORD</i>		Broadcasting in Scotland	172
Production of Radio Plays	115	Broadcasting in Wales	175
Variety by Wireless	119	Broadcasting in Ireland	179
Lectures and Lecturers	121	In the Midlands	182
Organisation of Talks	124	REVIEW OF THE YEAR	185
Topical Addresses	126		

ENGINEERING

The Evolution of Wireless	193	H.F. Amplification	228
<i>TRANSMISSION</i>		Listening without Fear	235
Transmitters	199	The Broadcast Receiving Set	239
Studio Construction and Technique	207	Telephones and Loud-speakers	245
Microphone Amplifiers	213	Installation of an Aerial System	243
Outside Broadcast Problems	217	The Amateur in Wireless Progress	253
European Simultaneous Broadcasts	221	Measuring Instruments in Receivers	255
<i>RECEPTION</i>		Some Hints for the Novice	259
Methods of Detection	225	The Home Constructor Scores	261
		Twelve Don'ts for Listeners	262
		GLOSSARY OF TECHNICAL TERMS	265

T A B L E O F C O N T E N T S

ROUND THE WORLD

	PAGE		PAGE
The International Union	285	Broadcasting Outside Europe	301
European Broadcasting	289	Hours of Transmission	307
Empire Broadcasting	297	Foreign Identification Panels	313

PUBLICITY

Microphone Publicity	335	The Press and Broadcasting	343
B.B.C. Publications	337		

SIDELIGHTS

Wireless Societies	347	Wireless and the Blind	360
The Art of Listening	349	"The Braille Radio Times"	362
Study of Languages	353	Wireless in Hospitals	364
Announcers' English	357		

THE WIRELESS TRADE

Growth of the Industry	369	Radio Manufacturers' Association	377
Wireless Trade Associations	375		

GENERAL INDEX





Improved reception has been brought to radio owners all over the world by Mullard P.M. Valves with the wonderful Mullard P.M. Filament. Mullard P.M. Radio is a complete service to the radio public. It stands for the finest wireless accessories and components available, and every Mullard Product has a Mullard Label that carries full assurance of satisfaction.

Every radio dealer sells Mullard Master Radio

Mullard
MASTER • RADIO

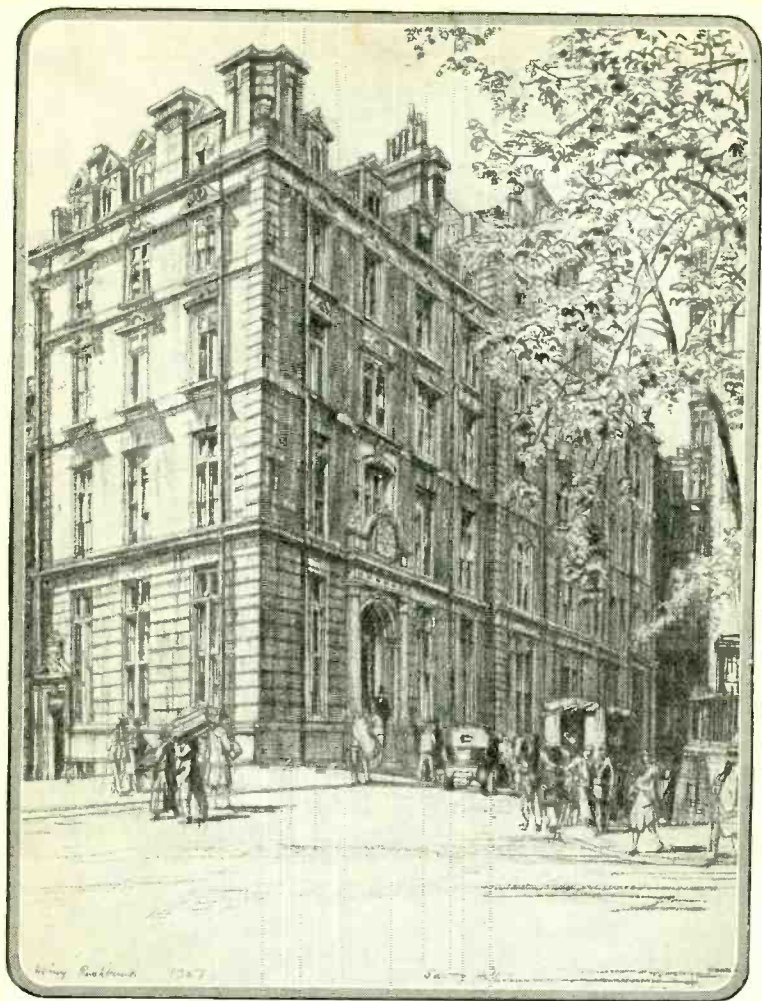

SAVOY HILL—THE HOME OF THE B.B.C.
Specially drawn for "The Radio Times" by Henry Rushbury, A.R.A.

FOREWORD

By the EARL OF CLARENDON

CHAIRMAN OF THE BOARD OF GOVERNORS

THE issue of this Handbook is a reminder that Broadcasting is an established and accepted institution. People may still marvel at the wonder of wireless, but perhaps they should marvel still more that in so short a space of time this new Public Service should have become so essential and so powerful a factor in our life. No doubt some of the ramifications of it will come as a surprise to readers of this book.

The change in constitution which took effect at the beginning of 1927 was indeed the logical and inevitable result of the public service policy adopted from the outset by the old Company. This change and the establishment of the Corporation by Royal Charter recognise the dignity and status due to the service of the B.B.C. The staff of the old Company was taken over complete, and the policy and methods of administration have been maintained.

With the change in constitution there came a greater degree of autonomy, absolute in some directions, relative in others. The Corporation, although it might be termed a State concern, is not under Government control in the ordinary sense of the expression.

Our Broadcasting system in four years and a half has assimilated the British public service tradition which it will be our privilege and duty to perpetuate and strengthen.

The Handbook contains much information of value to the listener. It should prove useful in improving reception, the problems of which are by no means confined to the technical side. With the public properly informed there must follow an enhanced respect for the medium and in general a better listening disposition. That Broadcasting in this country has been so comparatively free from errors of judgment and from technical break-downs has led to the dependability and precision of the service being taken for granted—a tribute indeed to the enterprise, imagination, discretion and vigilance of those who have developed it, but one

that carries with it the implication that the listeners themselves have an increasingly important part to play in future progress.

With few exceptions the articles herein have been written by the executive directly concerned with the branch of work described; hence the Handbook is authoritative. It is also interesting to note the many co-operative contacts with other associations. The record will make it clear how alert the B.B.C. is to the problems of development in the various fields, and to the possibility of achievements yet more significant and remarkable, all tending towards the greater efficiency and acceptability of its service.

Clarendon

INTRODUCTION

By SIR J. C. W. REITH

DIRECTOR-GENERAL

IT is not easy to write retrospectively. Sometimes the difficulty is that the writer has not lived the experience that he attempts to depict, or lacks analogous experiences with which to stoke the fires of his imagination, and then his philosophic contemplation of boiling seas from the view-point of the cliff-top is apt to issue in a tidy but emotionally untrue presentation of causes and effects. On the other hand, the mariner who has just been hauled ashore, half-drowned, out of these seas, will probably rush to the nearest temple and hang up his dripping garments as an *ex voto*—retrospect is the last thing that he can be capable of, he is too moved to be articulate. The most favourably situated back-looker is one who has weathered the storm and is sailing uninjured in calmer waters, yet even for him the retrospect that begins in thankfulness may, as the picture loses its vivid colouring, relapse into sheer complacency.

One trusts that the reader will be able to say of this retrospect of five years' Broadcasting activity that it has steered a reasonable middle course between philosophic neutrality and over-emotiveness without falling into self-satisfaction. Setting aside such factors as an astonishing expansion and development, the ramifications of a vast and far-flung organisation with all its interests and complexities of administration, there remains for review the things which are less readily comprehended but certainly more material.

One is sensible, sometimes, of an inclination on the part of several critics to wonder why it is necessary or desirable to insist, to the extent that is done, and so often as is done, upon public service as the keynote of the work. Is there not some risk, it may be said, of the phrase becoming a formula of vain repetition, a surrender to complacency? The answer definitely is in the negative. At the beginning it was an assertion—in view of the state of things in America, a very necessary assertion—of the position that it was intended to take up, a flag to hoist over claimed territory. As time went on, it flew as a flag to which allegiance was expected of and given by a staff of men and women of widely varied outlook and abilities, and at moments it was waved with some vigour in public. And now, like any other flag, it has fixed itself so thoroughly in the spirit that parade of it on ordinary occasions may well be regarded as bad taste.

The issue of this handbook, however, is not an ordinary occasion, and one may be permitted to show the flag a little and say something about its make-up.

A STANDARD AND AN OUTLOOK

In order to avoid misunderstandings, let it be said now that public service in this sense means primarily a standard and an outlook, and only secondarily a form of administration. The constitutional change-over from Company to Corporation status has for the moment drawn some attention to the administrative side, as it is change and not continuity that comes into the limelight. The outlook, though still developing by experience, is essentially the same.

What is this outlook? By the "public" is presumably meant the totality of the inhabitants of these Islands—and eventually those of the Continent and Overseas—irrespective of age and sex, tastes and education, religion and politics, wealth and status.

This generality of appeal was made a cardinal point of policy from the outset. Technically it determined the lay-out of the Stations on the map; it fixed the details of power and design by the average "poor man's" set; it imposed as a necessary ancillary the giving of free advice on technical matters of reception and interference; and it brought about contacts of all sorts all over the country as well as in London. Each year, except 1926, has witnessed the attainment of successive landmarks in this policy of getting within so-called "crystal" range of the whole population. Another landmark is now in sight.

In the field of programme selection and management, on the other hand, one is dealing with factors that are even less easily seen. Not only are they imponderable, they are often not even identifiable in advance of experience. One is liable, and indeed certain, to make mistakes which the instantaneity, the intimacy, and the universality of the mode of transmission render it almost impossible to retrieve and even to limit. And it was to be foreseen that other public programme interests would resent and oppose intrusions of the new social engine within their respective domains: the Press as regards news, the theatres and concert halls, the authors' and composers' associations, and the artists as regards music and drama, the cinema, the lecture-hall and—in another world of ideas—the churches, as regards the tying of people to their firesides (and even there the gramophone might look upon the radio set as an interloper). It was a sea full of more or less uncharted rocks, and to be navigated at fairly high speed into the bargain.

BROADCASTING "SERVICE"

By "service" is meant providing this public, to the best of one's power and ability of selection, with at least one programme a day, accessible in good strength and faithful quality to the owner of a cheap set and an average aerial; and now embarking upon a

new effort to make "one" into "two." The general policy and technique of building this programme are dealt with elsewhere, but here it should be mentioned that an inevitable element of Broadcasting is that a choice of fare usually exercised by the diner himself has in this case to be exercised for him, in fact it is exclusively a *table d'hôte*.

First of all, certain classes of material were, some still are, excluded by the technical certainty that justice will not be done to them in transmission. Secondly, many sources were available for programmes only to a limited extent, owing to the opposition of vested interests, *i.e.* authors, composers, newspapers, concert promoters, theatre managers, artists and others; an opposition based sometimes on artistic, but more often on commercial grounds, since the idea that radio will eventually help and not injure the concert-hall, the theatre and the newspaper is slow to penetrate. Thirdly, the most careful tapping of public opinion by way of correspondence, conversation and the Press cannot do more than afford data for consideration. It cannot, save in rare instances, give quite definite guidance; the preferences individually expressed cancel one another out as often as not and a proportion of the correspondence even praises or blames everything alike.

Much is owed to the diligence and zeal of advisory committees who have helped the Service in all its main aspects both in London and at the country centres.

CENSORSHIP AND COMMON-SENSE

But beyond and above this, the peculiar nature of Broadcasting—open to all to hear, yet individual and intimate in its approach—inevitably transfers the choice, within the stock of available and technically manageable material, from the listener himself to the broadcaster. The theatre manager, the editor, the preacher, deal each with *his own* public rather than *the* public, and the *prima facie* interest of the audience (or field of readers) in the subject and the opinions likely to be expressed is established by their assembling and buying. To impose limits upon the freedom of such publicists, therefore, is sheer censorship, to be justified or not as such. But the broadcaster's censorship, if it be fair to call it so, has a different basis. He has not to consider the willing but the *unwilling* audience, the people who if the matter were, say, performed in a hall would not be there. And he has further to consider that even for the same people, matter entirely proper in a hall or a newspaper may be in bad taste or even frankly objectionable in a family group. This is not Philistinism but common-sense.

One would go further still. It has not been possible or desirable to regulate the work solely according to the considerations dealt with above. These are to a great extent negative indications,

and there has been, and will continue to be, a positive side to policy as well.

In the domain of *information* this positive policy is to give clear, accurate, brief and impartial news of what is going on in the great world, in a form that will not pander to sensation and yet will arouse a continuing interest, to which end the bare facts are (a) vitalised by "running commentaries" on events, such as ceremonies and matches, and "topical" talks in which either the man of the moment or an expert in the subject of the moment speaks to the people, and (b) rationalised by balanced discussion before the microphone.

In the domain of *music* there is no secret made of the fact that good music is preferred to bad, nor of the conviction (wonderfully borne out by experience) that the public prefer it too. It is conceived as a privilege and duty to present certain grand works, to which a concert organisation run for local profit could never hope to mount; to popularise—as only this peculiar medium could popularise—the music that is addressed to the finer and quieter sources of emotion in a small audience; to make the British public, not to say the British musical world, acquainted with challenging new work; and to assist opera to overcome the barrier that the cost of presentation has set up between it and its eager multitudinous admirers. At the same time, knowing at least as well as critics know that the mood for grand music is not upon people at all times and places, such music is kept within reasonable bounds.

ENTERTAINMENT—A POSITIVE POLICY

As to the remaining time given to music and *entertainment*, let there be no idea that this category is one given grudgingly and under pressure from public or Press. It is not so. To provide relaxation is no less positive an element of policy than any other. Mitigation of the strain of a high-pressure life, such as the last generation scarcely knew, is a primary social necessity, and that necessity must be satisfied.

Of the potentialities of radio for *instruction* for adults and children, in continuous courses or by way of single appetisers, there is here no room to speak. The mere fact that such a medium is there—able to override distance, to overcome inequalities of teaching ability, to broadcast seed on a wind that will take it to every fertile corner—imposes the duty of taking advantage of it.

In *radio drama* and the *children's hour* are two forms of art that Broadcasting is developing as specifically its own. The former, tied to a long tradition of stage plays, and theatre audiences, was slow in reaching its true character; the latter, wholly novel, leaped at once into its permanent place in the scheme of popular life.

Lastly, a word concerning that branch of the work which might rest less upon the support of articulate opinion, though that is forthcoming in overwhelming measure, than upon an instinctive sense of fitness—*broadcast religion*. In this domain, against early protests of a section of the public on the one hand and a section of the clergy on the other hand, the policy was initiated, and persevered in, of broadcasting a non-sectarian Christianity—confined, in respect of doctrine, to those simplest essentials to which all Christians of the West can adhere, and thus able, with a participant congregation of millions, to maintain the devotional character which differentiates a service from a mere intimate talk upon serious things. Even with no articulate support there would still be a dominating “consensus” in the old sense of the term.



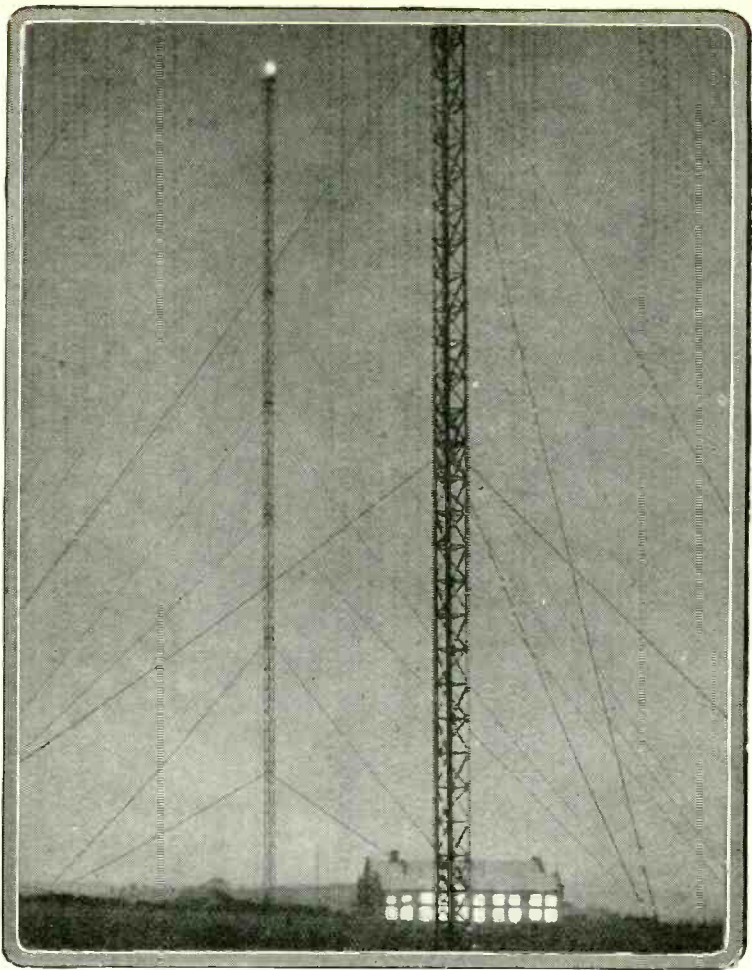

You shall hear their lightest tone
Stealing through your walls of stone;
Till your loneliest valleys hear
The far cathedral's whispered prayer.

*Daventry calling . . . Daventry calling . . . Daventry calling . . . Dark and still
The tree of memory stands like a sentry . . . Over the graves on the silent hill.*

Alfred Noyes.

B. B. C. — THE OLD REGIME

THE dividing line drawn on December 31st, 1926, between the old British Broadcasting Company, Limited, and the British Broadcasting Corporation constituted by Royal Charter, though the most important, is not the only epochal point of constitutional significance in the history of the Service, short as its span of years has been. The foundation of the Company itself, the Sykes Committee of 1923, the Crawford Committee of 1925 were such landmarks, and it is upon these points, and upon the successive developments of the transmission system, that the general history of British Broadcasting naturally builds itself up.

As is well known, the developments of wireless telephony in the War, and the spread of interest in wireless matters (due in part at least to the training that so many thousands of men had secured in the War) led, in Great Britain as elsewhere, to a considerable number of amateurs and wireless firms starting radio telephony amongst themselves on an experimental basis. But the sudden birth and florescence of large-scale "Broadcasting" (in the present sense of the word) in the United States placed the matter on quite a different footing. Whether or not the movement would prove ephemeral no one could with certainty foresee, but it was perfectly evident that a national demand was arising in Great Britain also, and the problem was how to satisfy it in such a way that Broadcasting would become a permanent element of national life.

FIRST NEGOTIATIONS

The first step was negotiation between the Postmaster-General

(as having supreme authority over all forms of communication) and a committee representative of the radio manufacturers of the country (who then totalled less than 300) between May and July 1922. Although the main lines of a scheme were soon drawn out, it was not until November 1922 and even January 1923 that all the practical, especially the financial, details were settled, so that the British Broadcasting Company, Ltd., formed of some 300 manufacturers and shareholders at a meeting on October 18th, 1922, and registered on December 15th, did not actually receive its licence till January 18th, 1923. Already, however, the first stations were in operation—London—Manchester and Birmingham from November 15th, 1922; Newcastle from December 24th, 1922. (References, Cmd. 1822 and Cmd. 1976, of 1923, 6d. each.)

The Company was constituted with a capital of £100,000, of which £60,000 was contributed in equal parts by six great wireless firms, all of whom were represented on the Board. The remaining capital was subscribed by other wireless firms with the right of election of two additional directors. The original members of the Board consisted of Lord Gainford (a former Postmaster-General) as independent chairman, Mr. Godfrey Isaacs (Marconi), Major Basil Binyon (Radio Communication Company), Mr. A. McKinstry (Metropolitan Vickers), Mr. John Gray (British Thomson-Houston Co.), Sir William Noble (General Electric), Mr. H. M. Pease (Western Electric). The two additional members were Mr. W. W. Burnham (Burndept) and Sir William Bull, M.P. After the death of Mr.

Isaacs, his place as representative of the Marconi Company was taken by the Rt. Hon. F. W. Kellaway, who, as Postmaster-General, had played an important part in the delicate task of adjusting the interests involved in the formation of the Company and in setting the venture on the right course. Mr. (now Sir) John Charles Walsham Reith was appointed General Manager, and joined the board as Managing Director in October 1923.

From the outset the position taken by those concerned was that confusion could only be avoided, and steady satisfaction given to the public, by a single centrally controlled non-competitive service, in which commercial considerations would count for as little as possible consistently with the necessity of creating a large-scale radio industry to provide the public with receiving apparatus. Direct profits from Broadcasting were foregone from the outset; only a small starting capital was called for by the Broadcasting Company itself and the return on this capital was limited to $7\frac{1}{2}$ per cent. Moreover, it was early decided not to follow the American example of using the microphone for advertisements.

It was accepted, then, that the maintenance and the development of the service should depend on listeners themselves and not on interested parties. The next question was, in what manner the listeners should be called upon for their contributions. Voluntary subscriptions were ruled out, and the vicissitudes of continental stations which have later attempted to rely on this service have amply borne out the wisdom of the decision. There remained, broadly, three alternative methods—in direct payment by way of taxes or tariffs upon sets and parts sold

by the Radio Trade, direct payment for the privilege of owning and using a receiving set, or a combination of both methods. At first, when both Broadcasting and the radio industry had to feel their way with the public, it was such a combination that was adopted. (It may be added here that practically no further capital was created, and all development and expansion was financed out of income). As time went on and experience grew, however, the element of contributions through the trade was dispensed with, and by the Autumn of 1924 the receiving-licence had become the sole important source of revenue. This, then, is the first landmark after that of the starting point, and with it is associated the work of the "Sykes Committee," which reported to Parliament in August 1923.

SYKES COMMITTEE REPORT

The report of this Committee (Cmd. 1951 of 1923, price 9d.) vividly reflects the initial difficulties which had to be won through, but which cannot be dealt with here for lack of space. In retrospect, however, the most interesting point is that it was found necessary to assemble a strong Governmental Committee to review the situation scarcely nine months after the service had started. This fact evidences both the speed of the popular reaction to the offer of Broadcasting, and still more its naturalness—for the difficulties that had to be adjusted were precisely those which the preliminary survey from a pedestal at the centre had not disclosed. The upshot was (1) the diminution of dependence upon the trade for revenue and the fixture of a date at which it should cease altogether, (2) the payment to the Broadcasting Company of 75 per cent. of

the listeners' licence fees instead of 50 per cent. as hitherto, (3) the establishment of a simple form of receiving licence at a uniform fee and (from an assigned date) free of restrictions as to origin or nature of the set, (4) permission to the B.B.C. to accept programmes "provided" by outsiders with publicity ends to serve, somewhat after the American fashion (this power, be it said, was only exploited in a few instances during

1925 and then quietly waived). (5) the admission of daytime programme, hitherto objected to on the ground of possible interference with other wireless services, (5) the extension of the network of stations, over and above the eight "main" stations originally required, by means of numerous "relay" stations in populous centres hitherto unprovided for.

This extension marks a definite

DEVELOPMENT OF B.B.C. SERVICE

(Based on figures of 1921 census. Natural increases not allowed for.)

	No. of licences in force (N. Ireland included).	Great Britain, I.O.Man, Channel Islands.		Remarks.
		Percentage of total population.	Number of people.	
		Within "uninterrupted service" range of a station.*		
		<i>Per cent.</i>	<i>Millions.</i>	
End of Dec. 1922.	(Figures prior to the introduction of the simple licence system not given.)	40.478	17.36	London, Birmingham, Manchester and Newcastle main stations opened in 1922.
End of Mar. 1923.		49.837	21.41	Cardiff and Glasgow main stations opened early in 1923.
End of June 1923.		"	"	
End of Sept. 1923.		"	"	
End of Dec. 1923.	595,311	53.009	22.77	Aberdeen and Bournemouth main stations, Sheffield relay station opened late in 1923.
End of Mar. 1924.	748,396	"	"	
End of June 1924.	823,894	57.040	24.47	Plymouth, Edinburgh and Liverpool relay stations opened second quarter 1924.
End of Sept. 1924.	998,657	60.735	26.03	Leeds, Bradford, Hull and Nottingham relay stations opened third quarter 1924.
End of Dec. 1924.	1,129,578	70.361 †	30.15 †	Stoke, Dundee and Swansea relay stations and temporary high-power station at Chelmsford opened last quarter 1924.
End of Mar. 1925.	1,348,874			Power of London station somewhat increased.
End of June 1925.	1,387,933			
End of Sept. 1925.	1,464,674	79.739 ‡	30.23 ‡	High-power station at Daventry opened, and Chelmsford discontinued.

* "Uninterrupted service" range—colloquially "crystal range"—is defined as that at which strong clear signals can be received on cheap apparatus.

† Thereafter, the area of London Station (20.7 to 20.9 per cent., 8.87 to 8.95 million people) had, in addition, alternative reception from Chelmsford till Daventry was opened.

‡ In addition, Daventry is an alternative station for the whole of London, Birmingham, Stoke, Nottingham and Sheffield areas, and for parts of the Bournemouth, Cardiff and Manchester areas. Thus Daventry can reach 54.999 per cent. of the population, or 23.60 million souls.

NORTHERN IRELAND.—The Belfast station was opened in October 1924, and the population within "crystal range" of it may be estimated at about 56 per cent. of the total population of Northern Ireland, or 715,000 souls. The number of licences (included in the appropriate column above but not differentiated) was, in May 1926, 19,206 for the postal district of Belfast alone.

It should be added that the British Broadcasting Company does not operate in the Free State.

victory of the broadcasting idea over the sceptics, and the virtual assumption by the B.B.C. of a responsibility that it had hitherto not had, viz. that of providing a *complete national system* accessible to the owner of the cheapest form of set, wherever he might happen to live. Even now this ideal is still in part unattained, but the attached table will show progress in giving effect to it during the lifetime of the Company. The figures of population served in 1925 are valid also for 1927, no changes having since taken place in the lay-out of stations owing to the whole system being under review under the aspect of "regional" needs and alternative programmes.

In the latter part of the table figures a new element, not previously alluded to—a "high-power" station. This marks a further development towards the ideal, motivated by the fact that relay stations not only could not be indefinitely multiplied but also could not serve the rural population. With the opening of Daventry in July 1925, this element for the first time figures heavily in the percentages.

Shortly after the opening of Daventry station we reach the third constitutional landmark, the "Crawford Committee" whose report led to the transfer of the service from the Company to the Corporation. The operating licence of the Company was due to expire at the end of 1926, and two years of steady working under the modified, one might almost call it the de-commercialised, régime that followed the Sykes Report had given a stable foundation on which to build a more permanent constitution and machinery. The task before the new Committee, therefore, was to make recommendations with the objects of (a) securing the results

achieved, (b) preparing the way for further results.

SECURITY

To attain the first of these objects, security, the Committee held that a long term of licence, increased financial powers, and a visibly non-commercial constitution were requisite. It has been said already that the Company operated from the first on the lines of a public utility concern, and the steps by which its commercial scaffolding were gradually removed have been alluded to. In 1925, therefore, the Company was operating almost purely and simply as a public service, to the satisfaction of all concerned. Criticism of its "monopolistic" character had practically disappeared in the light of public knowledge of the Board's policy, and the notion, once plausible enough to attract a measure of support, that programme quality would be improved if several broadcasting organisations were allowed to "compete" for public favour was no longer taken seriously. When, therefore, the Crawford Committee adopted centralised control in the hands of a disinterested body as the basic principle of the future, it was confirming current practice. But for *security* more was necessary. The Board of the "commercial" Company had created a national asset at once too powerful and too delicate to be allowed to retain a constitution which others might choose to operate on other lines and with other objects. The Committee, therefore, concluded in favour of the winding-up of the Company and the constitution of a public authority. What this authority is and how it secures the two objects of stability and development, will be dealt with in the following article.

The Marconiphone

The Triumph of the Master Mind

The outcome of close concentration on the fundamental principles of radio reception by the Marconi Company's Engineers.

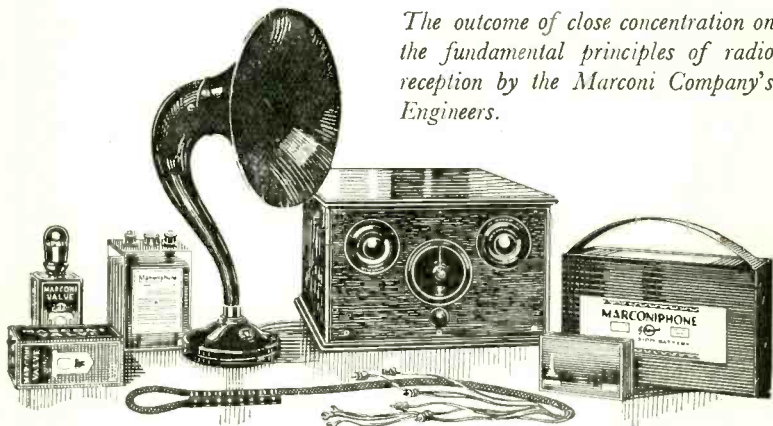

Marconiphone Model 22 (Two Valve) Receiving Set
with Sterling "Baby" Loud Speaker

Each type of Marconiphone, from a single valve to an eight valve, instrument represents the highest efficiency in its particular class for simplicity of operation, perfectly pure and natural reproduction of music and speech and above all *consistent reliability*.

Most of the new models of Marconiphone Receivers are adaptable for operation entirely from A.C. mains, D.C. mains or batteries, thus giving a choice of power supplies unobtainable with any other instruments of their type.

**DEFERRED
PAYMENTS**
Marconiphone
Apparatus
can be
purchased on
Deferred
Payment Terms

Descriptive literature on Marconiphone Wireless Equipment is obtainable from all responsible Radio dealers or on application to

THE MARCONIPHONE COMPANY, LTD.
210-212 TOTTENHAM COURT ROAD, LONDON, W.1
Registered Office: MARCONI HOUSE STRAND, W.C. 2

NEW HEADPHONE COMFORT



Five years after Broadcasting started there has come a new comfort in headphones. Never before was it thought possible to commercially make headphones so light and yet so sensitive, but LISSEN has done it. The cords, too, hang always straight down no matter how much you may turn or move your head. Ear-pieces may be adjusted and secured to the most comfortable position for each listener by the single movement of a special ball joint. And because of eliminating big wholesale profits price is so low that it is no extravagance to discard any existing headphones in order to get this new headphone comfort now.

NEW LISSEN HEADPHONES

N.B. Every set should have at least one pair of headphones. Then you may cut out the loud speaker and listen without interfering with others in the same room who may not wish to listen—or without disturbing a sleeping patient in the sick room through a long night vigil.

8/6

LISSEN LTD., 47-56 Friars Lane, Richmond, Surrey
MANAGING DIRECTOR: THOMAS N. COLE

L385

B. B. C. — THE NEW RÉGIME

THE recommendations of the Crawford Committee (Cmd. 2599 of 1926, price 6*d.*) were accepted with some modifications, definitive and temporary, by the Government, and led to the constitution of the British Broadcasting Corporation under Royal Charter as from January 1st, 1927 (Cmd. 2756 of 1926, price 6*d.*). On the previous day the old Company passed out of existence, the details being regulated by a formal winding-up process and by an agreement with the Postmaster-General of November 9th, 1926 (Cmd. 2755 of 1926, price 2*d.*). Simultaneously, a long-term licence of 10 years was granted to the Corporation. The place of the Board of Directors was taken by a Board of Governors nominated by the Government, presided over by Lord Clarendon as Chairman, with Lord Gainford as Vice-chairman, and Sir Gordon Nairne, Dr. Montague Rendall, and Mrs. Phillip Snowden as Governors, five years being fixed as the term of office of a governor.

From the point of view of the public, there was no visible (or shall we say audible) change at all. The staff, the plant and the programme machinery were taken over by the Corporation as a going concern under the executive control of Sir John Reith designated in the Charter as first Director-General.

It becomes necessary now to abandon chronological order in favour of a division according to subjects.

DUTY OF THE B.B.C.

The duty of the Corporation is to "carry on a broadcasting service" for Great Britain, Northern Ireland, the Channel

Islands and the Isle of Man "as a public utility service," and for that purpose it (a) is licensed by the Postmaster-General to operate stations under conditions presented by him, (b) may make agreements with governments (subject to Post Office consent) or municipal authorities, (c) may develop and exploit its service in any other direction and by means other than wireless telephony, if the Postmaster-General permits, (d) may broadcast any matter which for the time being may be permitted by or be within the scope or ambit of the Postmaster-General's "licence," (e) may itself collect news or subscribe to news agencies, (f) is empowered to receive and employ the funds "annually or otherwise granted by the legislature" and, further, may raise money by way of loan, (g) may publish books, journals, etc. In addition it has the necessary powers to develop and sell its property, to acquire and hold copyrights and patents, to establish pension funds and so forth.

Each of these headings mentioned involves points of interest, some of them points of dispute, and an idea of the constitutional basis of the service is best obtained by taking them in turn.

THE FORMULA

The formula defining the Corporation's duties speaks for itself. The Irish Free State and the overseas dominions and colonies generally fall outside the responsibilities of the licence, though subject to Post Office consent it may make agreements with dominion and foreign governments, and develop the service in other directions. But within the scope defined Broadcasting has to



LONDON'S NEWEST STUDIO

The seventh studio, brought into use at Savoy Hill in 1927, contains many novel features in design and equipment

be carried on as a public utility service. The last phrase is not further defined; what it means is, thanks to the old régime, well understood in practice. But it is worth noting that in making the public interest the sole authorised object of the Corporation's existence, it dispenses the service not only from obligations towards shareholders as under the old constitution, but also from seller-to-buyer obligations towards particular subscribers, as distinct from its responsibility towards the community as a whole. (This is also provided for by the system of receiving licences; payment for these is a payment to the State out of which the State provides funds for the broadcasting service, and not a direct payment to the broadcaster by a buyer). The Corporation is in short independent of commitments towards particular sections of the public, and responsible through the Government and Parliament to the community as a whole. But side by side with this chain of responsibility, there are more direct links between the public and the broadcaster. One is, that the revenue of the latter being proportioned to the number of people holding receiving licences there is a barometer of public interest and contentment reading to months. Another is that the Corporation is entitled to form any advisory committees that it pleases, whether to deal with particular subjects or with particular districts. And lastly, in being authorised to conduct journals of its own it is automatically entitled to have a public letter-bag and to recruit its income from subsidiary enterprises.

RELATIONS WITH THE P.M.G.

The details of the relations between the Postmaster-General

and the Corporation are intricate, and even the texts of the Charter and licence taken by themselves are liable to be misleading—not, of course, as to the powers taken by the Postmaster-General, but as to those actually exercised by him. For some of these powers have been delegated to the Corporation, fully or in part, finally or provisionally, by letters of instruction from the Post Office to the Governors.

Technical supervision is vested in the Postmaster-General by virtue of the fact that he licenses the transmitting stations and leases the interlinking lines and cables, under conditions drawn up by him. Here the new constitution introduces no fundamental novelty.

"PERMITTED" MATTER

Of wider public interest is the provision that the service may broadcast "any matter which may be permitted" or "be within the scope of the Licence," with which must be taken into consideration other provisions authorising the Postmaster-General to take over the plant on any emergency which he regards as sufficient to warrant his doing so, and requiring the Corporation to broadcast government matter free of charge at all times. But with it also must be taken the Postmaster-General's assurance to Parliament that the Corporation was to enjoy the greatest degree of autonomy that Parliament was willing to concede. In sum, then, the situation is one paralleled in every line of British constitutional history (and many would say, native to the British character), one of compromise. Under rather more rigorous texts than before, the Corporation enjoys in fact a rather greater autonomy. The experience of the National Strike

of May 1926 had demonstrated the potentialities of the microphone as a direct link between the statesman and the citizen. No one can yet foresee the ultimate results of this discovery, but it was plain that the simple ban on the broadcasting of any controversial matter was obsolete. This in fact had been realised, long before the Strike, by the broadcasting executive and by the Crawford Committee, which had recommended the admission under proper safeguards of a moderate amount of controversial matter. While, therefore, the Government provided for the unrestricted use of the microphone by itself—*i.e.*, by the "Government of the day"—on its own responsibility, the admission of controversial matter into the ordinary programme is by agreement being tried out by small, gradual steps. The view of the Corporation is that the presentation of sober and sane views of all sides of a controversy can only be productive of good. Mere exclusion is a negative and evasive impartiality; the broader impartiality has to see to it that each point of view has its chance.

UNFETTERED PROGRAMMES

A negative of quite another sort is the absence from the Charter and Licence of any restrictive clauses bearing upon programmes generally. In the choice of material and artists the Corporation is unfettered. So far as the words of its constitutional texts go, the only reference to these matters is where specific authority is given to *do* or to *own* things. The recommendations of the Crawford Committee, which may be summed up in the words "no privileges and no restrictions," have, therefore, been implemented.

In particular, the old restric-

tions upon "news" have been abolished. The former arrangements were imposed upon, and not negotiated by, the Company. Now, pursuant to the policy of "no restrictions," the Corporation is not only able to negotiate for its news supply with the alternative of setting up a news service of its own if the terms of the regular agencies become too onerous, but it has been free to introduce that long-desired feature, the "running commentary" on ceremonies, gatherings and sports events.

PUBLICATIONS

The specific authorisation to publish books and journals, etc., settles for good what was once a burning question. When the Company and Messrs. Newnes jointly started "The Radio Times," in September 1923, the existing radio papers felt their interests to be challenged by a journal which enjoyed an overwhelming advantage in its monopoly of printed programmes. Some held, too, that the business of a broadcaster was simply to broadcast, and that any publishing was outside his legitimate sphere. The Company took up and adhered to the position that such publications were a proper and necessary supplement to its broadcast programmes. Nevertheless, as a concession to these points of view, the Company accepted certain limitations which the public never understood. Technical articles were excluded and all advertisements for component parts were rejected. Experience over several years showed that these fears were exaggerated and the restriction upon component advertisements both illusory and vexatious, and the agreement was accordingly brought to an end. Meantime the publishing activities of the Company were extending, the programmes calling

more and more for a special technique of annotation, commentary, illustration and expansion as they developed in quality and variety. And the new constitution, by placing the legitimacy of this auxiliary effort beyond question, enabled the new régime to initiate a still wider policy of which the effects will appear chiefly, though not by any means exclusively, in the field of adult education. It is not without interest in this connection that the constitution permits development (subject to Post Office consent) of the service itself by means other than radio telephony.

FINANCE

It has been shown in the preceding article how on the one hand a system of eight stations grew to one of twenty-one, all except the last based upon the idea of serving an urban area, and how, on the other hand, the revenue of the service came to be fixed at 75 per cent. of the revenue from listeners' licences, without subsidy from the radio trade, or in fact any ancillary sources except profits from publications. With the entry into the service of Daventry station, evolution on existing lines seemed to be closed. To the executives of the service, indeed, it appeared that Daventry was rather a starting point than a terminus. But many interacting questions of permissible power, available frequencies, sites, distribution of population and of artistic resources, etc., had to be thoroughly considered before the next move, and meanwhile the Postmaster-General, acting upon a clause in the then current licence under which payments to the Company could be limited to those required for an "adequate" service, fixed the revenue for the last year of the Company's exist-

ence at a figure based on maintenance and not development. (It must be remembered that under its commercial constitution the Company had no power to raise capital save by way of creating shares.) The handicap of such restrictions upon development was represented to, and taken into account by, the Crawford Committee, which recommended as follows:

"The present licence fee is 10s., which we do not consider excessive. . . . It is, of course, essential that the Postmaster-General should be completely indemnified against the cost of collecting these fees and against all other expenditure incurred by them in relation to the broadcasting service.

"Subject thereto, it will be the duty of the Postmaster-General to pay to the Commissioners (*i.e.*, Governors) from the licence fees an income thoroughly adequate to enable them to ensure the full and efficient maintenance and development of the service.

"On these conditions, and when the adequate service has been assured, but not until then, it is expedient that the surplus should be retained by the State. . . ."

ALLOCATION OF REVENUE

On this basis, which recognises explicitly the needs of development as well as maintenance, various schemes were privately discussed, and eventually it was settled that, after deducting 12½ per cent. of the gross licence revenue for cost of collection:

- 90 per cent. of the net revenue on the first million licences,
- 80 per cent. of the net revenue on the second million licences,
- 70 per cent. of the net revenue on the third million licences,
- 60 per cent. of the net revenue on

the fourth and each subsequent million licences,

should be paid over to the Corporation. Further, the Corporation would be entitled after the end of 1928 to apply for more favourable percentages, and under the Charter it was given powers to raise capital sums by way of loan, up to a limit of £500,000 total. In this connection, bringing the table in the previous article up to date, the figures of licence holders since Sept. 1925 are:

End Dec. 1925	. . .	1,645,207
„ Mar. 1926	. . .	1,964,174
„ June 1926	. . .	2,076,230

End Sept. 1926	. . .	2,104,198
„ Dec. 1926	. . .	2,178,259
„ Mar. 1927	. . .	2,263,854
„ June 1927	. . .	2,299,822

It is outside the scope of this article to describe the developments which it is hoped to carry out on the basis of this financial system. It must suffice to say that their practicability, now as heretofore, depends on the response of listeners. The new régime cannot entrench itself behind the Exchequer, nor inflate its resources by unsecured borrowings. It is directly face to face with the public, whom it is its duty to serve. C. F. A.

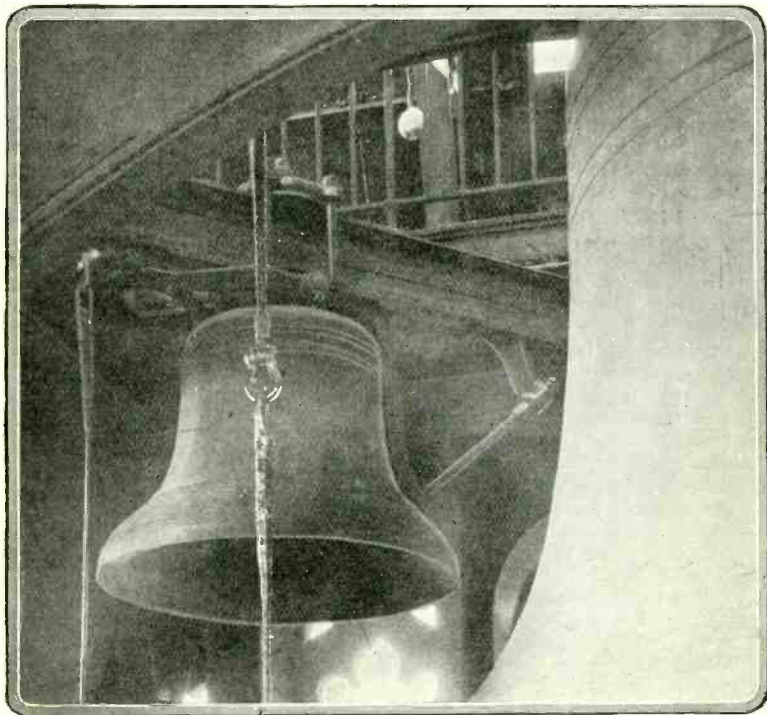

"BIG BEN"

Whose voice from Westminster is now heard all over the world.

GRAPH SHOWING THE GROWTH OF WIRELESS LICENCES SEPTEMBER 1923-JULY 1927

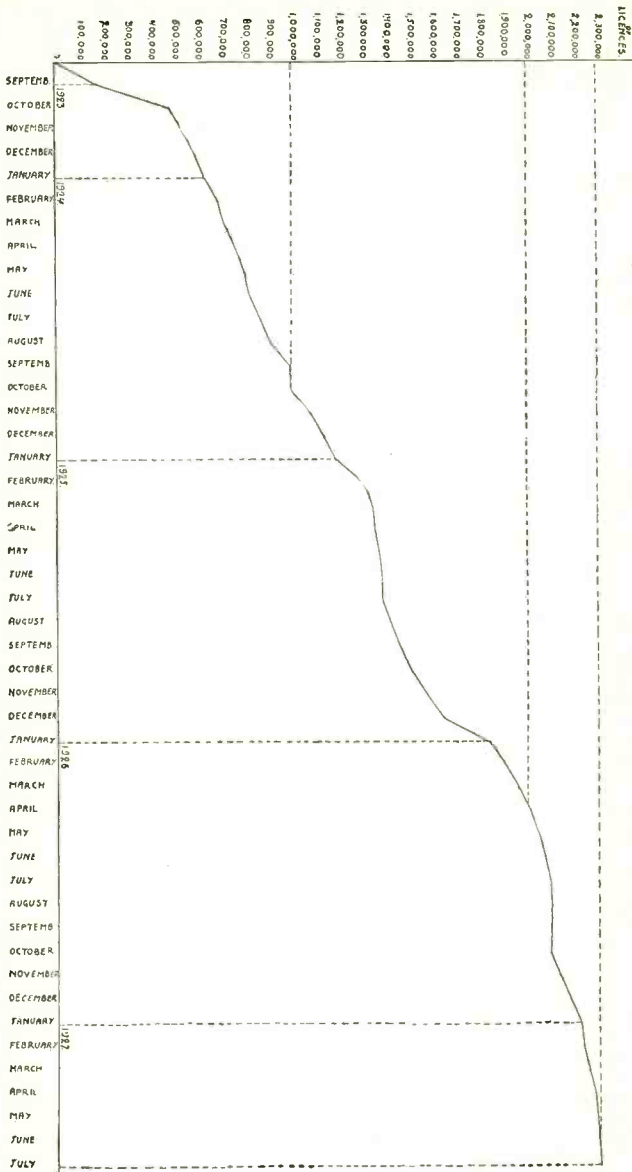

THE ADMINISTRATIVE SYSTEM

THE Royal Charter of December 20th, 1926, established the British Broadcasting Corporation for a term of ten years from January 1st, 1927, with a Chairman, Vice-Chairman, and three other Governors.

THE EXECUTIVE

The chief executive of the Corporation, nominated in the Royal Charter, is the Director-General. He is assisted by the Controller, and an Assistant Controller at the head of each of the five Departments; one who is administrative; one the Chief Accountant; one whose function is to maintain outside relationships and both take in and give out information; one the Chief Engineer, and one who is responsible for Programmes.

CONTROL BOARD

The executives mentioned are members of the Control Board, and the heads of all departments are thus kept in general touch with the service as a whole. This liaison, which prevents the formation of water-tight compartments, is essential in so fluid and quickly moving a business as Broadcasting, where detail so immediately impinges upon policy, and where no direction of policy can be applied without knowledge of the intentions that lie behind it.

INTERNATIONAL LINK

The Controller, in addition to his duties as general assistant to the Director-General, is also the elected President of the Union Internationale de Radiophonie, and is directly assisted by the Foreign Liaison Officer. The latter is a channel of communication

for broadcasting concerns abroad, and keeps a continual survey of their activities, in order that the Corporation shall have information of the developments of Broadcasting in all parts of the world. A policy of mutual help has been followed from the first between international broadcasters, and whilst B.B.C. officials are to be found studying methods abroad, the stream of visitors from foreign countries to Savoy Hill is uninterrupted.

ADMINISTRATION

The department of the Assistant Controller, which deals with administrative work, calls for no detailed description here. It deals with formal and official relationships with outside organisations, with staff, premises, office matters, and particularly with the constant review of organisation in the light of rapidly changing needs. The total personnel of the Corporation is nearly 1,000, housed in fifty premises up and down the country. Few of these thousand people can be considered and legislated for in a group as a unit, for Broadcasting requires great diversities of talents and personality in its executives.

The detailed organisation of the Chief Accountant's department may also be taken for granted. The Chief Accountant controls the financial system and accounts throughout. As Assistant Controller (Finance) he is responsible for the budget, and has direct liaison with all departments, in each of which he has an assistant through whom he supervises commitments.

INFORMATION AND PUBLICATIONS

With the department of the

Assistant Controller (Information). Apart from the fact that the department is the sensitive antenna of the B.B.C., in it lie those duties more easily described, such as the editorial of the "Radio Times" and of "World Radio," and the issue of numerous minor publications in pamphlet form. These include libretti for opera-lovers, prospectuses of concerts, programmes of forthcoming lectures to schools, and those pamphlets which aid the listener who, interested in talks, wishes to know how best he can follow up the subject for which his appetite has been whetted. There is a continually increasing demand for all these. This department also controls the issue of all information and photographs to the Press, and those lectures on the activities of the B.B.C. arranged at the request of particular societies. All B.B.C. participation in Public Exhibitions is arranged by the Information Staff.

ENGINEERING

The Chief Engineer has, as General Assistant in charge, an Assistant Chief Engineer. Under them is the Senior Superintendent Engineer, in charge of the maintenance department, which controls the twenty-two engineering Stations, through the Superintendent Engineers (North and South), who travel constantly in their respective areas.

There is also a Civil Engineer, responsible for the erection of and repairs to premises, fixtures, and standing plant; an Equipment Engineer, who is in charge of all stores of every kind in the Corporation, and their upkeep and replacement; a Technical Correspondence section, constantly employed in aiding listeners, and tracking down and obtaining the elimination of electrical "inter-

ference" with reception, and working in close liaison with the Post Office engineers in the anti-oscillation campaign; and a Lines section, again in close liaison with the Post Office, at work upon the maintenance and improvement of the high standard of line communication necessary for the continual transmission of programmes from point to point as required for "simultaneous broadcasting" and "outside broadcasts." The "Outside Broadcast" section is also separate in this department. Although outside Broadcasts are frequently handled by the Station engineers all over the country, a special department at Head Office deals with the more important ones, which are handled through Savoy Hill, and at times its engineers travel to the provinces for occasions of exceptional difficulty. For example, it is these engineers who travel to the Continent for such Broadcasts as the Carillon of Malines or the recent opening of the Menin Gate.

Finally, in this department come two sections whose touch with day-to-day Broadcasting may be the most remote, yet whose influence upon it may yet be the most far reaching—the Development section, constantly at work on new ideas, new applications of old ideas, and improvement of material, and a Research Engineer, whose work is almost that of an independent scientist studying problems of acoustics in connection with studios, microphones, etc.

PROGRAMME DEPARTMENT

And next the Programme department. It will be no surprise to anyone to know that this is the largest department, as the B.B.C. is, so to speak, a programme-manufacturing concern,

but it may not be realised by all that this matter of programmes, which seems so simple, requires the constant interaction of numberless sections of the most complex department of all.

Variety managers, the legitimate stage, concert promoters, lecture organisers or news editors have probably all at various times regarded the B.B.C. as amateurs, and must at all times regard their methods as peculiarly different, for whilst the B.B.C. have to handle all these things, they can follow the traditional and standard methods of none of them, but must transform all into the form required by a new medium, and administer all with the responsibility of a powerful Corporation, with all that that implies as opposed to the single interest of a theatre directed to the reaping of profit by pleasing a particular clientèle, or of a lecture organisation designed to forward a particular object.

The head of Programmes has under him separate sections for Music, Productions (drama, etc.), Education, Talks.

Starting with the more closely administrative end, he has as Assistant an Executive dealing with the detailed programme communications to all Stations, and forming a linking reference for the Finance section of the Programme department (the Chief Accountant's point of touch with the largest spending department of the B.B.C.); the Copyright section, employed not only in the checking of copyright payments for the thousands of minor items broadcast—and the B.B.C. is one of the largest single copyright users in the country—but in constant negotiation for the use of major items of musical, operatic, and dramatic works, whose use in a new medium has never been con-

templated until the B.B.C. makes its first approach, and each of which, therefore, has to be the subject of careful and special treatment; the "S.B." section, communicating all details of simultaneous Broadcasts to all Stations; and finally the Programme Correspondence section, dealing with the thousands of letters of appreciation, criticism, comment, and suggestion which pour in from all parts of the country.

LONDON AND DAVENTRY

Co-relating other sections, the London Station Director is responsible for the complete linkage and much of the selection and presentation of the programmes from the London and Daventry Stations, and those S.B. from the London studios to other Stations throughout the country. The difficulty of this linkage is not apparent on the face of things, but if anyone interested reads with care through the programmes for one week as given in the "Radio Times" he will, if he applies his imagination, get some small idea of the problem in organisation which lies behind the stream of items which flows unbroken from the transmitter. Apart from the questions of selection and building, this simple matter of linkage is comparable to the work of the Traffic Superintendent of a network of railways. Nothing previous to Broadcasting has had to face this difficult reconciliation between artistic licence and the meticulous accuracy required by a railway. Lives do not suffer, it is true, when items collide or where one has to give way to another, but the artistic presentation of the programme suffers, and the Programme Correspondence section registers the effect on succeeding days.

LONDON STATION

The London Station Director controls an Outside Broadcast section which, as its name implies, makes the arrangements with other parties for every performance which takes place outside the Studios, from the regular transmission from a restaurant to the special arrangements for a State function, working hand in hand with the chief of the Outside Broadcast section of the Engineering Department; he has under him sections putting together the programmes for London and for Daventry; the allocation of performances and rehearsals which fill the nine studios throughout the whole day; the reception of artists; and finally at the microphone itself the announcers who, with knowledge of the whole flow of the programme, link in unbroken line items from this studio and from that, from Outside Broadcasts and from distant Stations.

MUSIC

The Music section, directing the general musical policy, includes the various conductors, with orchestra, military band, dance band, quartette and chorus; musicians of long standing handling special concerts and writing annotations for their programmes, seeking works of merit which have never before been performed in this country, sometimes classics well known on the Continent, which have not come to us owing to the rare performance here of orchestras of sufficient size, and sometimes modern compositions which may or may not be classics in a century from now, but which surprise the unaccustomed ear. Controlled by the Music section there is at Savoy Hill the largest music library in the world. Then there is a section responsible for

the commercial organisation of the B.B.C.'s public concerts, and the "front of the house"; another group comprises musicians who are employed on the balance of orchestral performances, so that the various instruments are at the correct relative distance from the microphone—a matter which varies not only with every Broadcast in an outside hall, but also with each combination and frequently with individual works in the B.B.C.'s own studios.

DRAMA

The Productions Director is responsible for the dramatic works and their presentation, for revues and for "variety," each having to be treated both in general effect and in detail from the new point of view of a special medium. He also is responsible for those effects, such as the representation of the Wembley Tattoo, which are peculiar to Broadcasting, and in which at times as many as four studios have been in constant performance, with the chief action from one, background from another and so forth, all faded in and out and intermingled with each other into a balanced whole going through the engineer's control-room. A special section deals with the reading of plays for presentation in the B.B.C. studios all over the country, and the selection of those most suitable.

EDUCATION

The Education Director has under him the important sections for schools transmissions, which, in close touch with the Education Authorities throughout the country, broadcasts daily to thousands of classes in all types of schools; the Adult Education section, which within the strict confines of its programme time arranges those series of talks

which, though the number of their listeners may not perhaps be as large as that for the variety programmes, are valued most highly by their followers, and have a continuously increasing clientèle. In furtherance of their activities these sections prepare matter for issue to schools and to other interested listeners.

The Children's Hour is also in this section, though it would be incorrect to assume that its aim is primarily educational. Whilst the Children's Hour at each Station has its own specialist, much of the material is prepared and circulated from the London office.

The Education Director is also responsible for the broadcasting of religious services, and for the control of charitable appeals.

TALKS

The Talks Director, arranging topical and critics' talks, is constantly on the watch for personalities of importance in all spheres, endeavouring to get them to the microphone in the limited time available. The Talks Director works in close liaison with the London Station Director and the O.B. section on the arrangement of running-commentaries made from the scene of outside events. This section is also responsible for the News Bulletins.

The above gives an outline of the central administration.

MAIN AND RELAY STATIONS

The space below given to Main and Relay Stations is disproportionately small. But it will be readily understood that the work in them is a replica in small of the work of the Programme Department in London.

Outside London, in the Main and Relay Stations, the responsibility for the direction of the

Station's activities and the organisation of programmes falls upon the Station Director, subject, of course, to general control from Head Office. In the work of compiling programmes, finding new artists, seeking outside Broadcasts, producing dramatic works, he is assisted in the case of main Stations by a Music Director and three to six assistants, and in the case of relay Stations by two assistants. In each instance one of the assistants is a woman, who, apart from her other duties, has under her special charge the Children's Hour and the women's interests in the afternoon programmes.

Constant liaison between the Station Director and Head Office is required for the decision as to the parts of the London programme which shall be incorporated in the local programme by means of S.B. transmissions. Conversely, certain of the provincial programmes are S.B. to London or to other Stations.

A Station Liaison Officer travels between the various Stations and Head Office to supplement by personal contact the constant interchange of memoranda.

Interchange of ideas is also maintained by periodic visits of Main Station Directors and Music Directors to Head Office, and occasional visits of Music Directors to conduct at other Stations.

The administration of the four Scottish Stations and Belfast is further assisted by a Northern Area Director resident at Glasgow, as certain problems which arise for these Stations can be conveniently handled together. Programmes are interchanged among Scottish Stations, for example, and the question of simultaneous Broadcasts for the North is handled in the Northern Area

Director's office. The Children's Hour, school transmissions and religious services and many other questions are conveniently separable in their treatment from similar work in the south.

The Cardiff Station Director has a measure of control over the Programme policy of the Swansea relay Station, which is maintained by an interchange of visits between the two Station Directors.

Whilst each Station as a whole is in the charge of the Station Director, the Engineer-in-Charge of each Station is independent within his technical sphere. He

conforms to the Station Director's policy, but performs his work under the direct control of the Superintendent Engineer (North or South), who has already been referred to. The Engineering staff at a main Station consists of an Engineer-in-Charge, a Maintenance Engineer and at least five Assistant Maintenance Engineers and a junior Assistant; at a relay Station an Engineer-in-Charge with four Assistant Maintenance Engineers and a junior Assistant, and at S.B. centres on the trunk-line system there are staffs of several engineers.

*British Broadcasting : 65,800 hours
of programmes in one year (represented by large inclusive square).*

*Breakdown Time : 0.07%
of total time (represented
by small black square).*

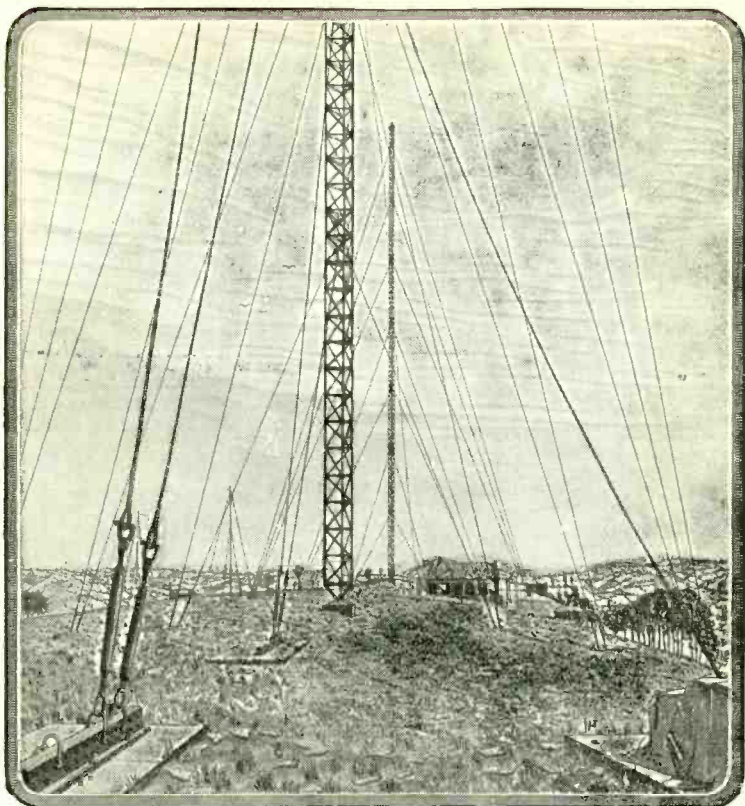

THE MASTS OF DAVENTRY

From the heart of England, on ground trodden by Briton, Roman and Dane and by many famous folk in the long pageant of English history, Daventry to-day calls the world. This picture was specially drawn for "The Radio Times" by Alan McNab.

THE REGIONAL SCHEME

Discussion of a proposed scheme for the reorganisation of the means of distribution of B.B.C. programmes, taking account of existing conditions and arranged so that all listeners may be assured of alternative programmes.

THIS article divides itself into three sections: a summary defining what is implied by the Regional Scheme, a detailed discussion of the technical principles which have determined the Corporation in selecting a particular scheme for the redistribution of the service and an appendix defining certain terms which are used in a way possibly unfamiliar to most people.

SUMMARY

The Regional Scheme implies the re-organisation of transmitters so that the present low-power stations are replaced by fewer and higher power stations, in general with two wavelengths. Basic to the Scheme is the desirability of giving more widespread distribution of signal strength, and at the same time of enabling at least one alternative programme to be received on simple apparatus.

LIMITATION OF WAVELENGTHS

The development of Broadcasting in foreign countries as well as in Britain has shown that there is a limit to the number of wavelengths or channels that may be employed. This is due to the fact that even a moderately low-power station in Europe may spoil the performance of another similar station in Europe, however far away, unless the frequencies are separated by more than a definite amount. A certain number of available wavelengths have therefore been allotted to each of the different nations. In this country there are nine medium wavelengths and one long.

INVESTIGATION OF THE PROBLEM

Various schemes have been subjected to careful investigation. The one finally selected was approved in principle by the British Broadcasting Company in 1926, and an outline of it furnished to the Post Office. At the beginning of 1927 the Corporation appointed a Committee of independent experts, namely, Dr. W. H. Eccles, F.R.S., M.I.E.E., President of the Institute of Electrical Engineers (Chairman), Professor E. V. Appleton, D.Sc.,

F.R.S., Mr. L. B. Turner, M.A., M.I.E.E., and their Terms of Reference were as follows :

To advise the Corporation :—

- (1) Whether the Regional High-Power Distribution, as proposed, is the most satisfactory and efficient method of achieving what is desired.
- (2) In the event of agreement, whether the further plans for its execution are approved. If not, what alterations are suggested.
- (3) Whether it is considered that there will be any justifiable opposition from other users of the ether.
- (4) In the event of disagreement in principles, whether any alternative methods or any lines of research to bring about the same end can be suggested.

This Committee was appointed because the Corporation realised that a scheme involving drastic alterations to the existing service, considerable financial commitment, and some dislocation and inconvenience for listeners, was a serious matter. The Committee have produced an Interim Report, in which they advise that the Corporation's Regional High-Power Distribution Scheme is, with slight modifications, the most satisfactory and efficient possible with the wavelengths available; that the plans provided for its execution are approved in their broad lines but should be discussed in detail at a later date; and that there can be no justifiable opposition from other users of the ether. The Committee gave most careful consideration to the listeners' point of view, realising that the Scheme affects a large proportion of listeners technically and also in what may be termed the "civic" sense.

POST OFFICE APPROVAL

The Post Office gave permission early in 1927 for the erection of a high-power station to operate on a medium wave, and this station, 5 GB, at Daventry, has been in experimental operation for some time. The results of these tests have been communicated to the Post Office and to the independent Committee. After consideration of the whole scheme in detail, together with the Interim Report of the independent Committee, the Post Office have agreed with the B.B.C. that while there are no positive and fundamental reasons why the scheme should not eventually be put into operation, it will be better to introduce it along the lines of progressive experimentation under practical conditions. Thus a new service started on August 21st, when a programme contrasting with that given by 5 XX was radiated from a new high-power medium-wave station, 5 GB, at Daventry.

IMMEDIATE PROCEDURE

The operation of 5 GB necessitated the closing of the Birmingham transmitter, but it is believed that on simple receiving sets

of average quality as good a service will be given in the Birmingham area as in other thickly-populated industrial areas. 5 GB takes the frequency of 610 kilocycles (wavelength, 491.8 metres) and has a power of 30 kilowatts in the aerial. Bournemouth takes the present Birmingham wavelength. 5 GB in general transmits programmes contrasting with those of 5 XX, and in this way for the first time a considerable proportion of listeners will have a real alternative programme. Much of the 5 GB programme is provided from the Birmingham studio; the rest emanates from London.

ADVANTAGES OF THE SCHEME

As indicated above, it is believed that a more adequate distribution of signal strength will be achieved under the Regional Scheme, and in addition alternative programmes will be available. It is proposed that one wavelength at each of the regional centres should relay a London programme, the programme on the other wavelength being provided locally several evenings weekly. Valve users should have several alternatives available to them.

FUTURE OF EXISTING STATIONS

It is impossible at present to state definitely what will happen either to stations or transmitters at existing B.B.C. centres. Owing to the limitation of wavelengths some transmitters must shut down, but, where there is sufficient local material available, studios will remain open, and will, when required, serve the transmitter at the nearest regional station. Where there is sufficient local interest the transmitters may be retained on non-exclusive wavelengths for purely local purposes, although the area served by them is within the service area of the regional station. The extent to which this is advisable or desirable can only be shown by experience. In the event, however, of an area now served by a transmitter being found to be outside the service area of a regional station, the local transmitter would be retained for relay purposes as well as for local purposes. In general, however, the listener should envisage the possibility of the local transmitter being replaced by a powerful twin-wave regional station giving alternative services.

DISLOCATION

The B.B.C. is fully alive to the fact that some inconvenience and dislocation will be caused by the proposed re-organisation on regional lines, and that some changes, however slight, are involved to receiving sets. In places unnecessarily great strength of signals will be replaced by weaker, but none the less the strength should be sufficient for an uninterrupted service. In general weak signals

will be replaced by stronger. Some crystal sets, of the direct-coupled variety, will have to be slightly modified to be able to receive one programme rather than another. A fear has been expressed that these modifications will so upset listeners as to make it unwise to introduce the scheme, but it would seem unfortunate if the whole progress of Broadcasting were to be stopped and listeners never to have proper alternatives—some listeners never to have a proper service at all—simply because of the obsolescence of a relatively small number of sets, modification of which is so simple. The B.B.C. asks for the support and co-operation of listeners, which, in the light of past experience, should be readily forthcoming.

HISTORICAL SURVEY

When the staff of the British Broadcasting Company took over the service they found that it had been already decided to erect eight main stations, in Aberdeen, Glasgow, Manchester, Cardiff, Birmingham, London, Newcastle and Plymouth. The Company decided later to substitute Bournemouth for Plymouth and later Belfast was added to the main station list. It was found after this building programme had been completed that about 50 per cent. of the population lived within a *B service area*.* The Company embarked then upon an extension of the existing scheme and erected relay stations at Dundee, Edinburgh, Leeds, Bradford, Hull, Liverpool, Stoke, Sheffield, Swansea, Liverpool and Nottingham.

This brought 75 per cent. of the population within a *B service area* of some one station, but gave a service, in fact, only to the urban but not the country districts.

It was obvious that an extension of the relay station principle beyond a certain point would be foolish, for two reasons: firstly, that the method was only satisfactory for small but very densely populated areas; secondly, because the nations of Europe were rapidly building up similar systems, and interference between stations even within their proper *service areas* was becoming acute.

The erection of the Daventry long-wave high-power station marked the experimental beginnings of a Regional Scheme. The development was logical. The relay stations consolidated the Company's financial resources and made Daventry possible. No organisation had formerly used high power, and the new service was to some extent experimental.

Lastly, conditions on the Continent † rendered the erection of further low-power stations impossible. The introduction of

* Words printed in italics will be found defined in the Appendix.

† See under Definitions—Plan de Genève.

Daventry into the scheme of distribution brought 80 per cent. of persons within a *B service area* of one programme.

The only further change in distribution that can be recorded during the Company's existence was the adoption, in common with the leading broadcasting organisations of Europe, of the *Plan de Genève*. This meant the severe restriction of the *service areas* of many stations and has temporarily reduced the effectiveness of the scheme of distribution.

REDISTRIBUTION ESSENTIAL

The above brief historical outline is sufficient to indicate that there has been for some time a need, on the technical side alone, for redistribution. Restriction of *service area* owing to inadequacy of power and/or the use of *common waves* is the main reason why, on a one-programme basis alone, there is need for revision.

A great part of programme criticism cannot be levelled at those responsible for programme-building, but rather at the scheme of distribution which forces programme-builders to adopt compromises. "One man's meat is another man's poison," and without the possibility of alternative programmes a deal of irritation is caused to listeners because of continual compromise. There is a large field open for the development of services which have a limited appeal and may be classed as speciality programmes. Such items are essential to the service, but, unfortunately, their restriction on the one hand, and their obtrusion on the other, make for a compromise which tends to please no one.

THE REGIONAL SCHEME

With the above facts in view the Board of the British Broadcasting Company recommended the adoption of a scheme called the Regional Scheme which was designed not only to overcome technical difficulty and to fit in with international conditions, but also to give the alternative programmes so vital to the growing needs of the service.

THE PROBLEM

To give to every listener in the British Isles an uninterrupted service and the easiest selection between as many programmes as possible.

GIVEN

1. Ten wavelengths alone are available.* (9 medium, 1 long.)
2. That the whole country must be covered by such a field strength that it can be considered to lie within a B service area.

* See Definitions—Plan de Genève.

3. The fewest number of persons, seeing that requirement 2 is probably impossible, must be found in *C service areas* or in wipe-out zones.
4. Densely-populated areas should lie within an *A service area*.
5. There should be a minimum of change of existing field strength in changing from the old to the new.
6. The maximum number of persons must be able to receive alternative programmes on the simplest and most easily handled apparatus.
7. The scheme must be efficient and economical.
8. There shall be a minimum of interference with existing wireless services.

DIFFERENCES BETWEEN SCHEMES

It is obvious, if conditions 1, 2 and 3 above are to be observed, that the stations must be few in number and of high power, and that they must be actually situated in lonely parts of the country, and yet, to meet condition 4, they must be near to large cities.

There are, however, two main points of difference between proposed schemes: firstly, on distribution itself, and secondly, on the means of giving alternative programmes.

On the former point it has been proposed that very few stations and very high power are necessary, but against this it is argued that, to keep the field strength as uniform as possible it is better to use as many wavelengths as are available in conjunction with suitable power.

On the latter point it has been proposed, on the one hand, that alternative programmes can be perfectly well given at field strengths different from the local transmission, whereas it is argued on the other hand that ease of switching from one programme to another and equal ease of reception of both must be fundamental.

The scheme adopted by the Corporation is based upon using all available wavelengths and making selection between programmes as simple as it can be.

Each of the schemes discussed hereafter bases itself upon the eight requirements above and has, as a fundamental, few stations of high power.

In general, rival schemes can be compared as between those which base themselves upon very high power and believe that *service areas* can be over 100 miles radius, and those which cover the country from more centres and with therefore somewhat less power.

It is believed that the latter is the best basis for any scheme, because, firstly, there is not so much "embarras de richesse" near the station, nor so much poverty far away. Secondly, there is no

fear that however strong the signal, fading will prejudice the service. Another general conflict of ideas occurs as to Clause 6. On the one hand, it is advocated that alternative programmes need only be picked up by the exercise of some skill, that it must definitely require a selective valve set to do it, that the field strength of the one alternative can perfectly well be different from the other. On the other hand, it is advocated that the service must be simple to use and understand, and that the listener must always find himself in a *service area* for BOTH programmes.

The basic principle of the service has always been democratic, and the Corporation is in favour of the continuance of a policy which has proved both popular and effective, namely, that Broadcasting must rely for its permanent appeal upon what is received, and the methods of its reception must be as little obtrusive as possible.

Broadcast reception must in fact become as simple as any electrically operated domestic appliance.

THREE SCHEMES

Scheme I is to have a central station at which are located five transmitters of at least 300 kilowatts each.

The advantages of this scheme are centralisation, the fact that all have the choice of five programmes. The further advantages are that only five wavelengths will be used instead of ten, and a 15 kilocycle separation from foreign stations will be possible.

The chief disadvantage is the fact that the field strength would be embarrassingly large near the station, and embarrassingly small far away from it, not to mention the fact that 80 to 100 miles may be, for really good service, the limit of a broadcast station's range, because of fading and attenuation greater than that given by the inverse square law.

Scheme II is to have two central stations of three wavelengths each, of 300 kilowatts each. The same may be said of this scheme as was said of scheme I, but in a less degree. It is not feasible, for the reasons (albeit these are not so strong) given above.

Scheme III is to have in essence five regional stations of two wavelengths each and 30 kilowatts power.

The advantages of this scheme are as follows :—

1. It uses exactly the number of wavelengths allotted internationally.

- 2, 4. It brings, by locating the stations well away from Glasgow, Manchester, Cardiff, London and Belfast, nearly all the densely populated areas which at present enjoy such facilities within an *A service area* and many areas into the *B service area*.

3. It gives manageable *wipe-out areas* and leaves only sparsely populated places within a *C service area*.

5. The change from present distribution is mostly in the direction of stronger signals.

6. It certainly gives the maximum opportunity for persons to select between one programme and another.

7. The running costs are not excessive.

8. By spreading the field strength as moderately as possible under the alternative programme scheme over the country, there should be the minimum interference with other services.

The scheme has been criticised because it is said that it makes the lot of the reacher-out unenviable, since, as he will most probably live within a densely populated area, he will have an embarrassingly large field strength spread over two wavelengths to cope with. More reaching-out sets are sold in the large cities of America than in any other place in the world, and the field strength from the

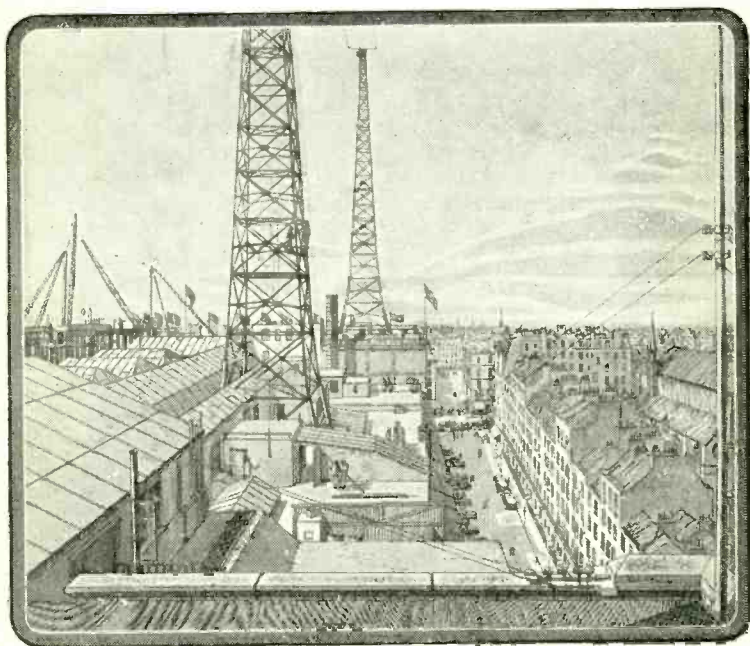

THE LONDON MASTS AT OXFORD STREET

A familiar landmark of the West End since the early part of 1923, when the London transmitter was removed from Marconi House in the Strand. Specially drawn by Mr. Alan McNab for "The Radio Times"

usual 10 or 12 stations to be found in these large cities must not only be large, but must be spread over a considerably greater number of wavelengths, so that the criticism is not deserved. In fact, reaching out can be done by those who wish to if they are properly equipped.

A further criticism against Scheme III is that there will be considerable dislocation on its introduction, not necessarily because the field-strength distribution is bound to be changed, but also because the selectivity of existing sets will be insufficient to choose between one programme and another.

The reply to such criticism is simply that obsolescence cannot be allowed to stand in the way of progress, that the adaptations to existing sets to make them take full advantage of this scheme will be both cheap and slight, and that once these improvements have been effected a considerable advantage will accrue. It is true that there will be some dislocation when the scheme is introduced, but we are sure that listeners will, in their natural desire to benefit from alternative programmes, soon adapt themselves to the new conditions.

ANOTHER SCHEME

Scheme IV bases itself upon the erection of five stations of 30 to 50 kilowatts each but of single wavelength. That is to say, there would be one station outside Glasgow, another outside Belfast, another outside Manchester, another outside Cardiff, another outside London. Under this scheme the alternative for a Manchester listener would be given from London, the alternative to Glasgow would be given from Manchester. The Cardiff listener would have the choice of Manchester, London or Cardiff, and Glasgow the choice between Belfast and Manchester, for instance.

The advantages of this scheme are that it is less costly (but not greatly so) and occupies fewer wavelengths, uses less S.B. and is beneficial to the reacher-out.

It is felt, however, that this scheme is based upon the conception that wireless reception is a technical achievement, not a domestic supply. In the *wipe-out zone* of one station, there is no alternative to anyone unless equipped with a complicated and expensive set. In the *A service area* the excellent reception of one programme on the simplest sets is offset by the fact that the alternative needs a 40:1 change in sensitivity, is weak enough to be jammed and interfered with by trains, electric signs, and so on, while the only place where both programmes are equal is where both are liable to be interfered with and where valve sets are a necessity.

There is, lastly, the difficulty of programme arrangements.

An analogy, which, if a little far-fetched, is none the less essentially sound, can be given.

The problem of broadcast distribution is not unlike that of trying to illuminate a square, a market-place or a room with red and blue light so that a two-colour (red and blue) picture can be seen and appreciated anywhere.

There are two problems :

- (1) To keep the actual illumination constant over the area ;
- (2) Never to have a preponderance of either red or blue.

The problem (1) is best solved by having the greatest number of lamps practically possible ; the problem (2) is solved by using pairs of lamps so that one colour can never dominate.

So in Scheme III the greatest possible number of wireless wave (instead of light wave) emitters are used in pairs to give out two wavelengths which relatively will always remain of the same strength. The number is restricted by international agreement, which is the only limitation that need be discussed.

SITES FOR STATIONS

The following are the guiding principles, not necessarily realisable, in choosing the new sites for the stations :

- (1) That the *wipe-out area* and the *C service area* shall cover sparsely populated districts.
- (2) That capital cities and densely populated areas and important towns shall be covered by an *A service area*.
- (3) That the point determined by conditions (1) and (2) as the site for a station shall be further considered in its relation to the *B service area* of the station, to make such an area cover as much land (as opposed to sea) as possible, and as important an area as possible.
- (4) That *B service areas* of different stations must nowhere overlap, and that as far as possible no part of the country shall lie outside a *C service area*.

FREQUENCY SEPARATION

It is found that it will be possible to separate the frequency of the two transmitters located at any one Regional Station by 130 kilocycles at minimum. Certain *C service areas* have a minimum of 40 kilocycles separation, but a valve set is a necessity in a *C service area*.

Any reasonably designed set should be perfectly capable of separating two stations of equal strength with this separation, but users of crystal sets of the direct-coupled variety are warned that it will be necessary to modify their sets to give the effect of indirect coupling to the aerial. The changes need be inexpensive and slight, but they will be none the less necessary. It is believed that

in general no adaptations on the score of selectivity will be required for valve sets.

PROGRAMME ARRANGEMENTS

The contrasting of programmes is not as easy as it may at first appear.

In general, however, the contrast will be between universal and speciality. Under universal are included all programmes that do not call fundamentally for the undivided attention of the listener; that may be in fact a background or an ordinary occupation.

Speciality—by contrast thus includes talks, plays, news, variety. Definition by example may make this basic principle clear.

Universal—bands and orchestras of all sorts. Jazz, piano recitals, organ music, etc.

Speciality—talks of all sorts, opera, plays, variety, news, etc.

DAVENTRY EXPERIMENTAL STATION

The Daventry Experimental Station was designed and erected by the B.B.C. for three reasons. Firstly, to give B.B.C. engineers facility for investigating the best form of transmitter, and secondly to enable other users of the ether to test the amount of interference on other wavebands that might be caused by such a station, and lastly to enable the B.B.C. to start an experimental programme service on which to gain experience for the future.

The Daventry Experimental Station began transmission on August 21st. The London programme continues as heretofore to be relayed from long-wave Daventry; added to this, however, there is a programme contrasted with the normal London programme radiated from the new station of medium wave located at Daventry. In general, one may say that listeners who take their service normally from Daventry will have a complete alternative and that this will be also alternative in such cities as London, Cardiff and Manchester provided the sets used by listeners in such cities are (only during this interim period) sufficiently selective to "cut out" the relatively stronger local station in favour of the new station.

The Daventry Experimental Station radiates a great deal of programme matter from the Birmingham studio. The transmitter actually replaces the Birmingham (5 IT) transmitter, and listeners in Birmingham have had to make some changes to their sets in order to take account of the new distribution. There is no question, however, that they will not have enough strength—in cases they will obviously not have so much. A listener now living two miles from the Summer Lane transmitter has been accustomed to a tremendously strong signal; under the new scheme he will still have a good signal, but not so strong as heretofore.

Daventry Experimental Station is not designed as a service station and there may be breakdowns to a greater extent than with other stations equipped on a basis of permanent service. It will be recollected that the Chelmsford station, the forerunner of Daventry, was likewise experimental.

CONCLUSION

The Regional Scheme has come about as a logical development of B.B.C. policy. The need for alternative programmes must be obvious. All that is now required is the support of listeners so that the minor inconveniences incidental to any change of distribution are not magnified out of their right proportion. The guiding principle is that partial obsolescence must not stand in the way of progress and that progress must be made continually towards better service to the public.

APPENDIX

DEFINITIONS

Common Waves

Waves shared between several stations in the same or different countries.

Exclusive Waves

Waves used for the exclusive use of one station.

Plan de Genève

The Geneva plan is a plan for the repartition of medium wavelengths in Europe agreed upon by 80 per cent. of the authorities running broadcasting services in Europe. In principle it allots, of the 100 wavelengths available, a certain number to each country, some common, some exclusive. This number is determined by a formula according to the area, population and intellectual activity of the country.

Britain has 9 exclusive medium waves. Thus in Britain, of the 20 medium-wave stations at present in use, 9 use *exclusive* and 11 *common* waves.

It is certain that the Plan de Genève must form the basis for future building. Although there are many difficulties in its operation, there is reason to believe that nations will in the end co-operate to make it a success. The chief difficulties now met with are :

1. The reluctance of the less serious to take measures to ensure the necessary constancy of wavelength. In this connection the U.I.D.R. have adopted resolutions to ensure that all stations are furnished with an accurate wavemeter of standard design calibrated from the same source. A neutral and central listening post will publish the deviations of each station from its allotted wavelength, and this will, it is hoped, form a check upon unstable stations.
2. The fact that it is assumed that the waveband of from 200 to 600 metres will be given to the B.B.C. at the Washington Conference. Several Governments have consented to this allocation in their proposals.
3. The fact that some stations have not adhered to the plan and cause interruption which might become so irritating to the impatient

as to make them start changing wavelength and so bring confusion on us all. Continual meetings between all delegates, however, reinforce the determination of the Union to adhere both in principle and in practice to the *Plan de Genève* and to base redistribution upon the formula "fewer stations, higher power."

Service Areas

Four categories of service areas are defined as follows:

- (1) *Wipe-out area*, in which the field strength is greater than 30 millivolts per metre;
- (2) "*A*" *service area*, in which the field strength is greater than 10 millivolts per metre;
- (3) "*B*" *service area*, in which the field strength is greater than 5 millivolts per metre;
- (4) "*C*" *service area*, in which the field strength is greater than 2.5 millivolts per metre.

A listener within a *wipe-out area* can be absolutely guaranteed a service from the local station whatever (within obvious limits) the sources of extraneous electrical interference, but will find a difficulty in hearing foreign stations unless equipped with the more complicated forms of receiver.

A listener within an *A service area* can be guaranteed service even if he lives near the usual sources of electrical interference, namely, trains, electro-medical apparatus, etc., and he will have a good chance of distant listening with properly designed receiving apparatus.

A listener within a *B service area* can be guaranteed crystal reception with a good outdoor aerial, but will be at the mercy of the worst types of interference which occur in perhaps 5 per cent. of cases normally met with.

A listener within a *C service area* will be subject to interruptions from spark sets, trains, atmospherics, but in time should be assured of an 80 per cent. service because it is hoped that much interference under the above categories will be eliminated at the source.

Fading may set in outside a radius of about 100 miles, and so the obvious ideal is to make a *B service area* about 100 miles radius. This requires stations of high power.



ANALYSIS OF PROGRAMMES

A TYPICAL WINTER MONTH

	Per cent.	Per cent.
MUSIC		
(a) <i>Classical</i> :		
Opera, Orchestral, Symphonic, Chamber, etc.	10.02	
(b) <i>Light</i> :		
Light Opera, Comic Opera, Light Orchestral	11.85	
(c) <i>Popular</i> :		
Military Band, Musical Comedy, Revue, Entertainers, Ballads, etc.	26.53	
(d) Dance	12.50	
(e) Gramophone Records	1.27	
	<hr style="width: 100px; margin-left: auto; margin-right: 0;"/>	62.17
DRAMA		
<i>Straight Plays, i.e.</i> Drama, Farce, Comedy, etc.		1.69
SPECIAL FEATURES		
Radio Revels, Round the Continent, Nightingale, Divers and Miners at Work, etc.		1.67
TALKS		
(a) News Bulletins	5.38	
(b) Instructional	14.50	
(c) Poetry and Literature Readings	.95	
	<hr style="width: 100px; margin-left: auto; margin-right: 0;"/>	20.83
RELIGIOUS SERVICES		4.18
CHILDREN'S HOUR		7.40
MISCELLANEOUS		2.06
		<hr style="width: 100px; margin-left: auto; margin-right: 0;"/>
		100.00

PROGRAMME POLICY

TO provide some sixty thousand hours annually of performance for an audience that is possibly never less than a million and may sometimes reach fifteen million, necessitates something more than a mechanical organisation. On this scale of operation, experience piles up so rapidly that almost in a moment one finds one's self fortified or hampered or both by a tradition. This tradition may be built upon right lines or upon wrong; in either case it is very hard to reverse. The steps taken to ensure that more or less irrevocable results are good results, constitute policy.

"Exercise is what you want," said Mr. Carter's friend in the "Dolly Dialogues." "Exercise is what I need," he corrected. So in the case of the broadcaster who, in spite of the valued co-operation of listeners, is necessarily the actual chooser of the programmes. A false step would be taken if, carried away by his sense of what the public needs, he supposes it to be the same as what the public wants. Often—curiously often, a pessimist would have to allow—the two coincide, but it does happen that they disagree.

THE DECISION

Consequently the first element of programme policy is the decision—to whom to address the programme. It is certain in any case that some will not like it. The aim of pleasing everybody always proved itself to be, as was expected, an illusory ideal. Even a majority demand cannot be admitted if the programme or item demanded is either barred to Broadcasting, or unsuitable to the

particular medium, or likely to be repugnant to any considerable body of people, listening as individuals in their own homes. On the other hand, minorities, though in Broadcasting their rights are considerably greater than in other matters, are still minorities. Lastly, it would be a derogation of duty for those placed centrally, in a position to know what of cultural value and interest is, or is about to become, available, not to give the great public the opportunity of knowing it for itself, without waiting for anything in the nature of a public indication that it is wanted. In sum, experience has evolved a practical working rule, "Give the public something slightly better than it now thinks it likes." One has to be in the business itself to realise all the implications that are involved in this terse formula. Here it must be sufficient to say that a working period of nearly four years has shown that the public becomes not less but more exacting.

STRUCTURE

The second, and perhaps to executants the main point in programme policy, is the structure of the programme as a whole, apart from the items composing it. It is here that the effort is made to please as many people as possible. The nearest approach to the impossible ideal of universality has been found to be by way of *balance*. That is—and even at the risk of the programme being called "bitty" by sections of the audience with specially marked and developed tastes—it is necessary to compound the programmes, ordinarily of diverse elements, calculated not only for many



DANCE MUSIC FROM THE SAVOY

*An artist's impression of one of the most popular items of the broadcast programmes.
Specially drawn for "The Radio Times" by Alfred Thompson.*

kinds of people, but for the gradations of preference in the individual, not to mention the said individual's moods and reactions. In its very nature, therefore, balance is psychological and demands on the part of the programme builders rather a trained general "sense" than adherence to specifiable rules.

BALANCE

It is worth adding that the principle of balance applies equally within a programme built up round a central idea, while evenings devoted to long programmes of major importance are balanced with adjacent evenings as far as possible.

As a pendant to "balance," the future development of alternative programmes for all will set up "contrast." The possibilities of contrast are as yet for the most part unexplored, but the general

idea is that, of two transmitters considered as alternative, the programme of the first will be a general and balanced programme, while the second will transmit, not a programme in this sense at all, but a succession of items "contrasting," each with each, against the items sent out from transmitter No. 1. This is the idea in its most general form. Obviously it will be subject, in practice, to modifications and adjustments, and a cross-section taken on some particular night in the future might fail to disclose any sign of the principle at all. Nevertheless it is a principle, only less concrete than the principle of "balance" because the latter has been clothed with flesh and blood by experience.

CRITERIA

Criteria of item-choice, and balance and contrast in programme

building, have been treated hitherto as applicable to the whole area served by the B.B.C. How far is this the fact? This is a question that has exercised the authorities almost from the inception of Broadcasting. Initially, working on the basis of service to a few particularly important areas, it was sufficient to lay down broad lines of policy and money assignment, and to leave the programme "sense" to develop in each local station on lines suitable to the local population. But with the introduction of numerous relay stations and the gradual perfecting of line linkages between stations—in a word, S.B.—the relations between a local station and Head Office underwent a considerable change. Experience showed that the artistic resources of the country were even more unequally distributed than had been thought.

The public was educating itself meanwhile to greater appreciation of quality, both of material and of artists, while within the body of artists as a whole, a smaller body specially apt for microphone work was being discovered by trial and error. Other factors intervened to complicate the question, but purely from the angle of programme building the considerations just set forth could only lead to one conclusion, viz., an increase in the proportion of programmes originated in London and the limitation of local pro-

grammes, even from main stations, to such a number of evenings in the week as their true programme resources, as judged by up-to-date standards, warrant. Even with this degree of centralisation—if it can be called so—opportunity is still available locally for (a) local talent of less than national quality and (b) events of local interest, while, of course, local talent and local events of national importance are caught up with the S.B. network as a matter of course.

With improved technical distribution, with increased resources, financial and artistic, and with growing experience, the B.B.C. is confident of greatly enhancing the value of its programmes in the near future. The programme builders believe that in the long run the 60,000 hours of programmes will receive the liveliest and most general approval and will serve their maximum social purpose by the application of a common-sense policy aimed primarily at a general level of excellence rather than at the provision of "high lights" to the disadvantage of the average standard.

A new permanent aerial, which took six months to manufacture, was brought into use at Daventry in August 1926 to take the place of one which broke during the exceptional frosts of the previous winter.



PROGRAMME BUILDING

PERHAPS the best method of explaining the details of programme building is to follow a week's programmes from their first beginnings to the days on which they are broadcast.

PROJECTED ARRANGEMENTS

This programme is first considered at a conference as a skeleton ensemble of projected programme arrangements in the form of headings. This must be done just over five weeks before the date of performance of the first week's programmes, but the programmes for that week have been growing for some weeks previously in the form of advance notices of special events, such as important concerts, operatic performances, outside broadcasts and so on. Notifications of these come in continually, sometimes some months in advance, and are noted provisionally for the weeks in question. A few days prior to the Conference these advance pencillings, together with the Station's minor commitments and certain routine arrangements, are surveyed by London Station and worked up into a week's projected programmes. These programmes are then considered at the Conference and there confirmed, and immediately circulated to all Stations and other people concerned. On the receipt of London's projected events all the provincial Stations go through a somewhat similar procedure to that already gone through in London, and frame their own projected arrangements in the light of commitments already entered into locally and the desirability of taking certain special programmes by relay from London and the necessity of contrasting with the London or Daventry programme.

The necessity of accurate advance publication in "The Radio Times" is a factor in requiring five weeks to elapse between the settling of projected arrangements and the performance. So big is the circulation that a week is required for printing. Another week can be allowed for the proof stages, and slightly over a week for the preparation of the copy and survey by Head Office officials; and again slightly over a week for the actual immediate administrative work necessary in connection with the booking of artists and the building of the programmes. This five weeks of preparation is not long when considered in relation to advance bookings of artists as made in the older branches of the concert and entertainment industry. It suffers, however, in comparison with them from a great lack of elasticity in the last fortnight before the date of performance of the first (Sunday) programme of the week. This becomes nearly three weeks in relation to the last (Friday and Saturday) programmes of the week, and is a severe handicap from the point of view of topicality and last-minute additions which might otherwise enhance the value of the programmes.

NEWSPAPER TEMPO

After the week's projected arrangements have been discussed at the Conference, a detailed machinery for programme building is immediately put into action; and it should here be noted that in spite of the inelasticity of the last ten days or so before performance, the *tempo* of the work in the Programme Department is somewhat similar to that of a newspaper office. It

is not a question of merely carrying along one week's projected programmes to the date of actual performance, but of simultaneously carrying on five such streams of programmes for the five weeks which elapse before the first week's programmes are finished with.

MASS OF DETAIL

The first step in carrying into effect the projected week's programmes is to decide on what types of artists will be wanted, what individual artists will be engaged, what special items, if any, and what amendments and alterations will be admitted as they arise. Both the type of artist and the actual artist engaged have to be watched from the point of view of frequency of repetition. It is frequently found that when a particular artist is wanted for a special feature, the artist finally chosen is a third or fourth choice, owing to the others not being available. A great deal of work is also involved even after the artist has accepted, in scrutinising the items sent in, correlating them with the necessities of the programme timing and with items already accepted from other artists for the same week or the neighbouring one. Even after this scrutiny it is found that there are distinct tendencies for a song to be repeated at too frequent intervals, particularly if it is the type of song by a composer who happens to be what we may call, for want of a better word, "fashionable" among artists at the moment. The correct timing of programmes also involves constant attention to the checking of programme detail, and this becomes so much a matter of routine that it is difficult to realise how constantly and closely it is carried out.

Approximately ten days after the Conference the week's programmes have to be typed out in as much detail as possible and in a semblance of their final form. It often happens that practically no details are available at this stage for many of the more important programmes. A week's negotiation over the copyright of some work, the difficulty of getting a busy conductor to frame a programme within a few days of being asked to do so, difficulties encountered in summer owing to the absence of artists on holiday and in winter owing to the best ones being often too busy to be able to handle their correspondence promptly, will probably prevent any final details being obtained of some of the programmes until almost the proof stage has been reached.

DOVE-TAILING

The programme thus typed out in its final form, but with the details of many programmes still missing, is circulated to the Head Office sections chiefly concerned for survey and comment. In the case of the copyright expert, the survey is of a close and detailed nature. In the case of the Music, Productions, Education and Talks sections, the survey takes the form of, firstly, a check of any detail with which that section is concerned, and, secondly, general comments on any subject in connection with the programmes on which that section may be assumed to speak with authority. The head of the Programme Department also must examine the programmes from the point of view of balance and other general considerations, and finally the comments are passed on to the Stations concerned and there answered or acted upon as may be desirable. Meanwhile the copy for "The Radio Times" is being

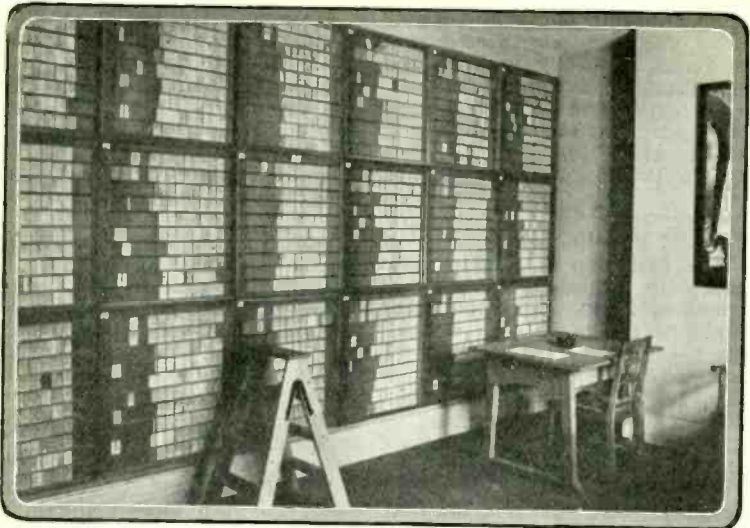

SIMULTANEOUS PROGRAMME CHART

prepared and, about ten days after the receipt of the programme in Head Office a clean copy of all programmes, as amended to date, is passed to the Editor of "The Radio Times." Galley proof and page proof stages follow in quick succession, and the programmes go to press ten days before the first performance of the week's programmes on the Sunday.

THE MONEY FACTOR

No mention of the routine of programme building would be complete without reference to its financial aspect, which in fact governs the whole. A continuous programme seven days a week averaging ten hours a day, each day's programme being different, is necessarily a very costly business, and, from a programme builder's point of view, money is always the chief limiting factor.

Each Station has a weekly allowance, which it must not have

exceeded on a balance struck every four weeks. The spending of this allowance is carefully watched and safeguarded, partly in so far as the programme builder's "reach must exceed his grasp," and partly in that the Corporation, as a public service, has always assumed an attitude of strict guardianship towards money which it regards almost as public funds. Financial difficulties are increased by the fact that many artists believe that those funds are almost unlimited and some of them are apt to try, generally without success, to value their services accordingly.

ANNOUNCERS

The supervision of the performance of the programmes lies in the hands of the Announcers. A day or two previous to the actual performance any final amendments are issued to the daily Press, together with a



LONDON RADIO DANCE BAND CONDUCTED BY MR. SIDNEY FIRMAN

summary of the day's programmes. On the day before the actual broadcast, and from time to time before then, the senior Announcer collects the Announcer's material for the day of broadcast. This material consists of, firstly, a correct and up-to-date amended version of the day's programmes, and, secondly, any special notes, instructions, announcements, S.O.S. messages, etc. which may have to be used in connection with the programmes. On the day of broadcast the Announcer on duty collects the relevant material for the morning and afternoon programmes before going on duty in the studio in the morning. The material for these programmes is generally not very much beyond the actual programme itself. The Announcers on evening duty relieve the day Announcer just before 7.0 o'clock and the senior of them comes in shortly after 6.0 p.m. to discuss the Announcers' material with the London Station Director, who gives him any special instructions or warnings or explanations

that may be necessary. On going on duty the senior Announcer takes charge of the studio and all matters in connection with the performance of the programmes, and allocates certain duties to the other Announcer on duty. The senior Announcer usually announces all the more important programmes and, as a matter of custom, generally reads the second General News Bulletin. He takes all decisions on questions which may arise as far as possible on his own responsibility, but if he cares to do so, he can generally refer to the Station Director by telephone.

The London Announcer's responsibilities are many in view of the fact that programmes of all the other Stations of the Company depend on and work by the London programme. This responsibility is particularly affected by considerations such as the relaying of the London programme by various provincial Stations and the necessity for the provincial Stations co-ordinating as far as possible the timing of their own

programmes with that of the London programmes. A slight error of judgment on the part of the London Announcer, or some slight mistake in an announcement, may have the effect of throwing out practically all the Stations. The responsibilities of the Announcer are frequently increased by the necessity of making almost instantaneous decisions in circumstances which are largely beyond his control. This most frequently happens in the case of outside broadcasts, whether concerts, plays, speeches or anything else, which often either start before the advertised time—in which case the Announcer has to make a rapid decision as to the cutting of the programme then being performed or the missing of part of the outside broadcast—or end many minutes late, the Announcer then being faced with the reverse problem. It will be realised that in such circumstances the Announcer has to use the utmost tact in dealing with the artists who may happen to be affected adversely by the decision he has just made.

Normally the Announcers' work involves constant activity and alertness in supervising the performance, keeping it up to time, and often co-ordinating the supply of artists to several studios at once when a complicated programme or series of programmes is being broadcast. The Announcer works right in the public ear and any slip or mistake may be noticed by thousands.

M. Feodor Chaliapine, the world-renowned Russian bass, made his first appearance before the microphone in this country in the autumn of 1925. His performance—a memorable musical treat—consisted of nine songs.

Records of "S.O.S." messages broadcast from all Stations in 1926 show that 38.43 per cent. were successful, 33.45 per cent. unsuccessful and 28.12 per cent. result unknown. "S.O.S." messages are accepted only under certain carefully defined conditions, which are given on p. 153.

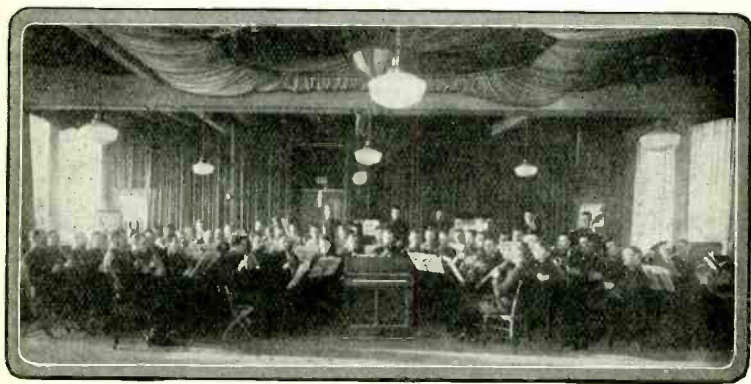

BIRMINGHAM—EUROPE'S LARGEST STUDIO

LISTENERS' CRITICISMS

SOME misguided person once originated a rumour that the Programme Correspondence Section of the B.B.C. is a home of lost illusions, inhabited by dreary people of suicidal tendencies, professing a peculiar cult of Pure Pessimism. To this is returned a complete denial. Too much stress can hardly be laid upon the value of a bond of friendship and understanding between the B.B.C. and its listeners, and to devote one's working days to that end is the very negation of dreariness and pessimism. Although appreciative letters form the bulk of correspondence, criticism is there too, and it is the enviable duty of the Correspondence Staff to give it that full consideration to which it is undoubtedly entitled.

CATEGORIES OF CRITICS

The appeal of Broadcasting to the emotional side of individuals naturally renders the subject of programme criticism so diffuse as to be difficult of analysis, but there are certain broadly defined categories into which our critics fall, although the exceptions to each almost disprove the rule. Covering all these there are to be found some simple psychological manifestations which emerge constantly: hardly ever does a critic admit in so many words that he is expressing his own views only. One will speak on behalf of his whole circle of Wireless friends; another for the overwhelming majority of listeners in his vicinity; others—yet more confident—voice the views of anything from 90 to 99 per cent. of the entire audience. The latter is a very favourite percentage and is applicable impartially to any type of matter broadcast.

There is, again, the impression that anything particularly disliked invariably predominates. To those to whom dance music is anathema it appears to be broadcast in every programme. A listener who does not care for talks cannot switch on without finding one in progress, and another who longs for variety entertainment is utterly bewildered at the interminable transmissions of symphony concerts. Allowance is made for an element of the exaggeration of vexation in this, but much is written in perfectly good faith, and many a correspondent has retracted his words when his complaint has been answered. This leads us to one of the best characteristics of listeners—they are so ready to retract what has been written in a moment of disappointment or irritation, and before they have had an opportunity of considering the other side of the case. Very few indeed of the critics really intend to be rude or cross. Many do not even pretend to be, and write with a sincere desire to help in the improvement of the service. Their knowledge of the conditions under which it is carried on is sometimes insufficient to enable them to frame practicable suggestions, but the B.B.C. has not infrequently benefited by honestly constructive criticism, which is always welcome to us.

TYPES OF CORRESPONDENTS

But it must not be presumed that the atmosphere of Savoy Hill is one of unbroken peace, nor that every listener who has a bone to pick with the programmes does so without showing his teeth. It is not always easy to placate the correspondent who calls every-

thing that he does not like or understand "piffle," and all that really does appeal to him "not half good enough," and the feelings of some critics can never be allayed. There is a respectable gentleman living in a respectable suburb of a respectable town who does not permit his daughters to hear love songs or dance music. He, it is feared, will never again look leniently upon the B.B.C. And the aunt (real) who was almost sure that she heard one of her clan say "Botheration!" in the Children's Hour "one day last week" has doubtless already carried out her intention of demanding the return of her licence money. In such matters defeat is regretfully acknowledged.

THE INCORRIGIBLES

A very curious type of critic exists, fortunately in small numbers. He generally possesses a super-something set with innumerable valves, purchased at incredible cost, but its use imbues him with a feeling of dislike of everything broadcast and a personal antipathy to all connected with the service. He is a most regular listener and delivers himself at frequent intervals of letters in which he points out that the B.B.C. is, beyond doubt, a hotbed of incompetence and drivel. It is not quite certain whether such listeners derive pleasure or pain from their reception and correspondence. They never express the former, so the B.B.C. is usually inclined to rank them, with due admiration and honour, among the martyrs. "I hope your face is getting red with temper as you read this," wrote one of the incorrigibles recently. It wasn't, but a terrible mental picture of the writer was being formed.

There is no need to devote much space to the anonymous critic

who scribbles "Your programmes are ROTTEN" on a post-card and furtively drops it into a letter-box round the next corner but one. In fact he is believed to be a lineal descendent of the small boy who chalked "No Popery" on the door and ran away, so we do not take him seriously. Anonymous correspondents are so shockingly wasteful of time, stationery and postage!

Taking the subject of these notes as a whole, however, there is only one real complaint, and that is that there is not enough of it. This does not mean that programmes are put out for the purpose of arousing adverse comment, but where a public service such as ours works unseen, there must be innumerable listeners who are puzzled as to why seemingly incomprehensible things are done when a straight and simple path appears to lie ahead. It is too much to expect them all to take it on faith that the sole purpose of the B.B.C. is to broadcast acceptable programmes in an acceptable manner, and doubts or perplexities may sometimes engender a spirit of suspicion and resentment which need not arise at all. Let such listeners present their problems, and they may be certain that they will receive sympathetic individual attention, and, moreover, that the opinions they may express will be definitely recorded in that register which is so helpful in the appraisal of the public taste.

One of the finest Broadcasts of the sporting events of 1927 was that of the Oxford and Cambridge Boat Race, described from a launch following the crews. Connection between the launch and the tow-path was maintained by wireless link.

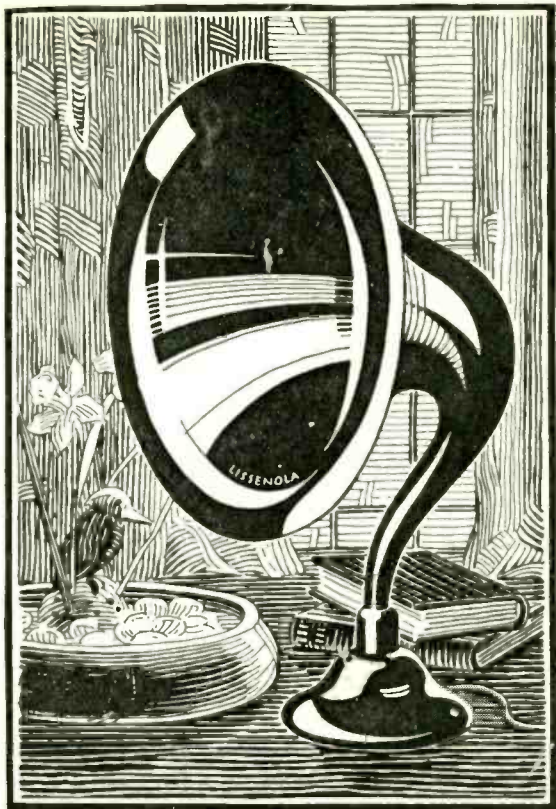

Here is the LISSENOLA Loud Speaker as sold complete for those who do not wish to build their own loud speaker.

Full toned—full sized—full powered. Volume coming to you with a richness of tone that makes radio broadcast a thing of sheer entertainment. No faintness of sound, no harshness of voice, but a surge of glorious music that transcends any reproduction you have heard before. Listen to the bass. Hear how natural the soprano sounds. Marvel at the way the timbre of each instrument is preserved. Yet due to the elimination of big wholesale profits the complete

LISSENOLA costs only **34/-**
LOUD SPEAKER

Hear it talk, play and sing across the room.

LISSEN LTD., 47-56 Friars Lane, Richmond, Surrey
MANAGING DIRECTOR: THOMAS N. COLE

L384



*Hear Your Favourites Again
on Your Gramophone!*

These Great Artists
Record **ONLY** for

Columbia
New Process **RECORDS**

SIR HENRY J. WOOD
AND SYMPHONY ORCHESTRA

PERCY PITT and **B.B.C.**
WIRELESS SYMPHONY ORCHESTRA

DAME CLARA BUTT **NORMAN ALLIN**
ALBERT SAMMONS **W.M. MURDOCH**
REX PALMER **HAROLD WILLIAMS**
AND MANY OTHER FAMOUS FAVOURITES

*Complete Catalogues of Columbia Records and the
New "Viva-tonal" Columbia, post free from
COLUMBIA, 102-108 Clerkenwell Rd., London, E.C.1*

Hear Them on the New 1927 Scientific Gramophone

A complete departure from all accepted practices—new principles of reproduction and amplification. It has raised the existing musical range by a further 50 per cent. to 6 octaves—and is the **ONLY** gramophone giving even response throughout its **ENTIRE** musical range.

The Viva-tonal
Columbia
Prices £4 15s. to £25

BROADCASTING AND MUSIC

THE desire to share delight with others is deeply in-born in the human being. When the shepherd, playing his pipes on the hills of Greece while his flocks were grazing lazily around him, invented a particularly lovely tune, he must have wanted his friends and acquaintances to hear it and share his joy.

This human trait has been largely responsible for a good many of the finest inventions of history. The mediæval composers—men who possessed more than their fellows the divine gift to hear music—needed a method of conveying to their unknown fellow-countrymen, and to the generations that would follow them, the melodies that were their daily companions and the subtle harmony in which they combined. There gradually grew, therefore, the system of musical notation—that written language through which we know accurately, and can attempt to reproduce, the inspirations of the master-musicians of the past. Then through the invention of printing, which has preserved for us not one or two, but hundreds of thousands of identically similar copies of their masterpieces, the great music, like the great books, of the world is available at once to millions of people in every part of the globe. We are independent of hearsay, of the human frailties of forgetfulness and the tendency to exaggerate, to change a point of view or a sense of proportion, which explain the hundreds of variants we find, in even a small country like our own, of a single simple folk tune.

Then, during the last three or four hundred years have come concerts. Printed though music

may be, one has yet to learn the mysteries of musical notation before one can begin to appreciate the sounds that the signs and symbols are intended to convey. But this is not all. Music may appeal to us deeply, but this alone will not enable us to perform it. What is more, with the best will in the world we cannot, as we play the piano or sing, supply the noise of instruments, perhaps of a full orchestra. Thus the concert was the next logical step in the democratisation of music. The composers had heard the ethereal noise, had analysed it and committed it to paper; some means had to be devised to enable the people to hear it with their own ears.

This country has been less fortunate than many others. In Germany and Austria, for instance, royalty and nobility encouraged the art of music unceasingly. They organised orchestras and choirs and engaged composers as organists, "choirmasters" and conductors. In this way much of the noble music of Haydn, Mozart and Bach was heard almost as soon as it was written. Here there were no orchestras; the fashion of music-making in the home passed, and while we were thus debarred from hearing some of the finest continental music that has ever been written, we did not even take advantage of the wealth of vocal and instrumental music bequeathed to us by our own Tudor composers, much of which has lain forgotten until these present days.

SOME FAMOUS CONCERTS

In the late 'fifties of the last century the famous Saturday Afternoon concerts began at the

Crystal Palace under August Manns. These were in some respects the forerunners of the present-day "popular" Symphony Concerts in London—of the Proms if you wish, although, of course, the London Philharmonic Society had been founded in 1813, and was giving its regular annual series of orchestral concerts with famous conductors. The Liverpool Philharmonic Society was formed in 1840. There had been musical festivals there at odd intervals since 1784, and they opened their regular concert hall in the city in 1849. In Manchester, Charles (afterwards Sir Charles) Hallé founded the now famous orchestra and concerts known by his name, but the so-called "Gentleman's Concerts" had been an institution there since 1745.

From those days onwards concert-going has grown, and although one realises that in many cases the promoters regard the proposition as a commercial venture, there are yet many concerned in the undertakings because of the opportunity to try and realise the ideal of giving the best music to the people. One sees now, in almost every city and municipality, long lists of guarantors willing to lose money regularly, season by season, in order to keep good concerts running.

The advent of the gramophone has done a great deal for music, particularly since, in recent years, the leading companies have realised their responsibilities and provided a tremendous library of first-rate music at a moderate price. It was the more significant because it brought to the *fireside*, for the first time, music which could previously be heard only by comparatively few people privileged to attend first-rate performances, as by a fine orchestra under a great conductor, or per-

haps a unique artist performing once only on a flying visit to this country. It is true that there had been introduced on a small scale the electrophone, a device for allowing people to listen at home to a concert received by microphone in a hall or theatre and transmitted by wires, like telephone lines, to the house; but a microphone efficient for this type of work had still to be invented, and the results were not sufficiently attractive to guarantee the commercial success of the scheme. The pianola, too, had begun to make its way in this country, and has already done its smaller share in the spreading of the gospel of good music.

Then came Broadcasting—that magical agent that has made available, by means of comparatively simple apparatus, and at next to no cost, the finest things there are to hear in music. It annihilates distance. No longer is the Promenade Concert available only to Londoners, the Hallé Concerts to Mancunians, the Belfast Philharmonic to inhabitants of that city, and the Scottish Orchestra to those living in Glasgow. The shepherd on the downs or the lonely crofter in the farthest Hebrides and, what is equally important, the labourer in his squalid tenement in our but too familiar slums, or the lonely invalid on her monotonous couch, may all, in spirit, sit side by side with the patrons of the stalls and hear some of the best performances in the world. Not only this. Broadcasting has brought into the lives of millions such as these the ever-flowing stream of music performed with sociable intimacy in the studio, the interesting series of talks, not only on music, but on every conceivable subject by the greatest authorities known, whether they be explorers, scien-

tists or professional and business men and women; famous poets reading their own works, and dramas from Marlowe and Shakespeare down to the present day, and including not only many standard works but, in addition, new plays specially written for the wireless medium.

TRUE DEMOCRATISATION OF MUSIC

The effect of Broadcasting on the growth of the understanding of music must already have been profound. Literally, millions of people have heard, for the first time in their lives, the simple youthful and sparkling quartets by Papa Haydn and the elegant quartets of Beethoven, and realised that therein lies a wealth of melody hitherto undreamed of; of rhythms that incite the toe to tap as well as any reel or foxtrot. Sir Walford Davis' homely talks, illustrated by his ever-nimble fingers, have awakened the unsuspected interest in the way music is made. Hosts of bright, impressionable children, whose music had consisted mainly of snatches of music-hall ditties inflicted by itinerant executants in the bar entrance, or sobs of the worst type of sentimental slop played in the local cinema at the weekly "tuppenny" Saturday performances, have heard nightly over the Broadcast such music as must have had a great and good influence on the sensitive unfolding mind.

Thousands of people, who have previously regarded the Military Band solely as the vehicle of a limited repertoire of noisy, banal music, discover that it can sound even more attractive playing a dignified, refined programme of stuff that proves its worth by unresented repetition.

It is commonly admitted that

the standard of reproduction and transmission of speech and music in this country is the best in the world. That is to say, our listeners hear a nearer approximation to the original than is possible elsewhere. Such improvement as remains still to be made will be at the receiving end rather than the transmitting. But the B.B.C. desires it to be clearly understood that it does not wish to suggest that this approximation, however near to the original in quality, can ever replace that original. It is admirable that hosts of people prevented by distance, by illness, by limited means or by other unhappy circumstances from hearing an important performance can in their homes share the joys of those privileged to be present. On the other hand, it is most important that the wireless listener should not confuse "tone" as broadcast, with its original, and in order to provide him with more opportunity of hearing music as it really should be heard, the B.B.C. has organised for some seasons past important series of symphony and other concerts given in London and elsewhere, charging such prices for admission as to place the concerts within the reach of almost everyone interested in music.

PUBLIC BROADCASTING CONCERTS

Under this heading come the series of Symphony Concerts at the Central Hall, Westminster (1923-4) and at Covent Garden (1924-5); the first production in this country of Rimsky-Korsakov's opera "Kitesh" at Covent Garden (1926); the "National" Concerts at the Royal Albert Hall (1926-7), and the further series of similar concerts planned for the Queen's Hall (1927-8). What is more, music-making has been taken into the heart of the East End itself;

in a series of Symphony Concerts, with conductors of such standing as Sir Henry Wood, Sir Landon Ronald and Mr. Percy Pitt, organised for the 1927-8 season at the People's Palace. In addition to this there have been series of Chamber Music Concerts at the Chenil Galleries, Chelsea, the Grottrian Hall, London, and elsewhere; and in nearly every city and centre of importance in the country large concerts, organised by the B.B.C., have been given. The B.B.C. is pursuing this policy further in collaboration with other concert-giving organisations by relaying some, or even all, of their important concerts; for instance, the Hallé, the City of Birmingham Orchestra, the London, Belfast, Liverpool and Newcastle "Philharmonics," the Glasgow concerts of the Scottish Orchestra, various festivals, such as the Three Choirs and Norwich Festivals, and, regularly, Chamber Concerts from Halls in London, Manchester and elsewhere.

Those pessimists who insist that in making the concert available to the public by Broadcasting one greatly reduces the box-office takings, must find it hard to sustain their arguments against such evidence as the attendance at the "Proms" this year (1927), where almost every night not a seat has been unbought, and queues of would-be promenaders have been turned empty away. Many similar cases may be quoted from broadcasting history during the last few years. Even allowing for the fact that at first many people came for the novelty of seeing a microphone, or that publicity such as was given early in 1927 to "the impending doom of the Queen's Hall and of the 'Proms'" doubtless has accounted for a certain amount of hall attendance, there is no real

cause for thinking that Broadcasting has affected concerts as badly as some would have us believe. On the contrary, we are convinced that Broadcasting has created a great field of potential concert-audiences — people who until their interest was awakened by radio in music would never have dreamed of going to a symphony concert, but who soon (if they are not now) will be among the most zealous of regular attenders at the Queen's Hall and elsewhere.

It is appropriate here to mention the influence of radio upon the music trade. The branches of it which have benefited most have undoubtedly been the gramophone industry and the publishing of very light, *e.g.* syncopated, music. This was most noticeable first in the case of the Savoy Bands' transmissions and the enormous demand for records by these orchestras. It applies also, to a less extent, to records of classical music; the growing interest in, and the desire for, better music have had a definite reaction indicated by the increasing demand for this class of record. The music publishing and instrument trades are passing now through a period of depression, and it is not fair to lay the blame entirely at the door of the poor scapegoat Broadcasting. There are many causes partly responsible—the general trade depression, owing to a present comparative lack of ready money, and the introduction of the "hire purchase" principle in many other lines, *e.g.* the automobile, are perhaps the chief.

BROADCASTING AND THE AMATEUR

This is a reflection of the temporary effect upon amateur art of the introduction into homes, upon a huge scale, of music played well. People—many of them, at any rate—are discouraged from trying to make music for themselves. There

will be a reaction, the cumulative effect of increasing appreciation of music itself, and eventually those people will return to their pianos, their violins, their singing, with renewed energy and interest. What is good to believe, too, is that they will then try, not to smash out "Rachmaninoff's Prelude" as it was done at the local concert last night, but to play musically and joyfully the delightful little Bach movement they heard at 7.15 to-night on the wireless; not to imitate the un-rhythmical, unphrased, unmusical noise of the prima donna singing bad English songs at the Royal Albert Hall, but the restrained, musical singing by a good radio artist of some good (though still tuneful!) English songs.

The attitude of the B.B.C. to amateur art is entirely one of encouragement. It is always agreeable to consider choral and orchestral societies' performances with a view to relaying them by microphone, on condition that the performance given is of such a standard as to provide something of definite programme value. This attitude is shown by the happy relations existing between the Corporation and the Federation of Music Festivals, with whose interests and activities it is entirely in sympathy, and by its co-operation with Community Singing and similar organisations.

THE FUTURE OF MUSIC

The effect of Broadcasting on

music itself—what will it be? This is a question which cannot be answered. The growth of discrimination among the listening masses must already be tending to discourage to some extent the production of poor quality, and to encourage better, healthier music. It is improving the standard of performance beyond measure, and this is all for the good of music itself. One sees with satisfaction that the accepted masterpieces in music—symphonies, for instance, of Beethoven, Mozart, Haydn—are yet more firmly established by their increased performance and hearing over radio. Music is of the stuff of immortality; in the finest written music there is this quality, and it cannot, surely, be changed. What is certain is that masterpieces themselves will be recognised as such sooner than ever before, firstly, because of the desire of the broadcasting authorities to give performance to new and sincere work, to afford the composer's fellow-countrymen an opportunity to hear it, and secondly, because of the increasingly receptive and understanding mind of the average listener.

Broadcasting, in short, is the greatest ally that the divine Muse has ever had on earth. It is the final step in the democratisation of music that perhaps had its beginnings in a community sing-song among missing links in a primeval forest—who knows?



CHAPPELL PIANOS

ARE USED THROUGHOUT
THE WHOLE OF THE BRITISH
BROADCASTING STATIONS
BECAUSE OF THEIR GREAT
PURITY OF TONE



Scaled to produce an exceptionally
powerful and rich volume, and of
rare dignity and beauty of design,
the Chappell Piano is incompar-
able both in performance and
construction

The
CHAPPELL PIANO CO. LTD.
50 NEW BOND STREET
LONDON, W. 1



BROADCASTING AND THE COMPOSER

THE composer has an ally in Broadcasting. Radio needs all the music it can get. If the composer can write the kind that is wanted he need not wait for a performance. Music with attractive melodies, used and harmonised with distinction of thought and fancy, is nowadays hard to find—or so it seems, for no opportunity to hunt for it is lost by the programme builders. Generally speaking, when a man gets home tired and “fed up,” he wants to be cheered by a good, lilting tune and harmony that is distinctive without being so “modernish” as to disturb the increasing tranquillity of his mental state. Sullivan and Edward German fill this want so adequately that a programme of works by these thoroughly “English” composers is always welcomed.

MICROPHONE IS INSATIABLE

Broadcasting swallows up an astounding quantity of music, and is always asking for more. The central library at Savoy Hill, supplying London and provincial programmes daily, is already probably the most comprehensive of its kind in the world, for it contains the scores and band parts of almost every conceivable published work from a new foxtrot to a classical symphony; and mountains of vocal scores, hymn-books, miniature scores, military band manuals, and heaven knows what else beside, stock its hundreds of shelves. There are in addition bookcases filled, for reference purposes, with the best editions of standard vocal, pianoforte, violin and other works, from the sonatas of Beethoven and the songs of Schubert and Brahms to the

most recent creations of the Paris “Six” and of our own and other contemporary “Schools.” Nor does this library adequately give an idea of all the music consumed by the programmes, for there are daily reaching the various Stations prodigious parcels of music such as may only be hired; for example, the manuscript parts of operas and arias therefrom. Then there are yet the many programmes, all using music, which, being relayed from elsewhere, show no tangible indication in the actual studios or B.B.C. library.

SCARCITY OF GOOD LIGHT MUSIC

The remarks in the first paragraph of this article refer, naturally, to the lighter side of music, for after all there are more “popular” and “light” programmes of various kinds than of classical recitals and chamber concerts. It is true that the world seems (when one glances through publishers’ catalogues) full of such music, but the truth is that it is extremely difficult to find *good* light music. Most of it is completely lacking in distinction, and merely plagiarises other men’s ideas, frequently being extremely badly written into the bargain.

As an example of the encouragement by the B.B.C. of young composers, one may quote the fact that it frequently pays for the cost of copying orchestral parts from the score of a new work—composers know how difficult it is to obtain performance without providing, at considerable expense, these parts—in order to perform it. It has even had a whole opera “scored” by a competent musician because it was felt *good* work, as shown by its

pianoforte score, would justify the expense by the pleasure it would give to listeners. Every month or so a programme of new (usually manuscript) works is broadcast from London, and other Stations follow suit when they discover good material.

COMPETITION FOR COMPOSERS

In 1926 was held a competition for British composers covering symphonic, choral, vocal and military band music. Unfortunately the judges, who included men of the eminence of Sir Edward Elgar, Sir Landon Ronald, Sir Hugh Allen, Mr. John B. McEwen and Colonel Somerville, decided that none of the half a ton of manuscripts submitted came up to the desired standard, and none of the attractive prizes was awarded. This all goes to show how difficult it is to find really *good* music of whatever type is desired.

For the composer whose work is acceptable to the broadcasting public, radio is a definite source of

income, for every time a work is broadcast, in the ordinary way a certain definite remuneration is paid automatically to his publisher, or to the Performing Right Society if he is a member, and of that he receives his proportion (fixed arbitrarily independently of the B.B.C.).

One day perhaps a second Sullivan or German will send in his work to the B.B.C. Maybe he has already done so, in which case it is likely that it has been broadcast, for the readers there deal with material with no delay. We wonder who it will prove to be?

At the end of 1925 a new studio was established at Oxford with the object of providing contact with the best thought of the University. Musical programmes by the Elizabethan Singers, performances by the O.U.D.S. and lectures by prominent University "dons" have been broadcast from the studio from time to time.



THE WIRELESS NATIONAL CHORUS

Probably the most rehearsed vocal organisation in existence. Chorus Master, Mr. Stanford Robinson

BROADCASTING AND THE ARTIST

WHEN Broadcasting first came into public use in this country there were many who were anxious to explain how it spelt ruin to the musical profession—how it would take work from the artist, empty the schools, academies, and concert halls, and cause music sales to fall to nothing, and the gramophone, piano and pianola to drop into disuse.

In practice it proves to have done none of these things. The artist least of all has cause for complaint. The amount of work, in the form of broadcasting engagements, given to artists every week by the B.B.C. is astounding. So far as singers and instrumentalists are concerned, excluding orchestral and similar players and choristers, there are probably on an average well over a hundred artists engaged to perform in the London broadcasting studios every week, and each provincial Station has its own programmes to prepare, and local or other artists to book. There never was such a field of "work" opened to the professional vocalist or instrumentalist.

NEW TECHNIQUE

On the other hand, Broadcasting makes severe demands on its artists. It is true that to some extent a new technique is needed for successful microphone work. Nevertheless, its chief demand is for *better* performance than the majority of artists have, it is sad to relate, been prepared to give. In consequence, although many would-be broadcasters roll along to auditions, comparatively few are accepted. Too few realise, at the outset, that the old repertoire

of a couple of dozen songs—no matter what their quality—is totally inadequate. Those songs have all been sung so much as to be relegated to the B.B.C. "black list" of war-horses which it is unkind to disturb.

Again, they do not realise (and in this they are scarcely to be blamed, for it is a new and unique art) that Broadcasting is essentially an *intimate* thing. It needs performance for the people in their homes, at their firesides; and the artist must remember that he is singing or playing, not to a multitude of people, a host of white faces in a vast hall, but to each listener individually. The attractions of beauty of face and figure, the dress, the gesture, the smile, the suggestion of lips, are lost. The voice must do it all.

VOICE CONTROL

What are the qualities that make a successful broadcast singer? Briefly these. A voice, not necessarily large, but of pure, well-produced quality; easy throughout its register, but not too hard and "white" in quality—it should be coloured by the vowel sounds to convey the mood, the subtle intentions, of the music. Good breath control—that "support" that means a beautifully modulated variation from pianissimo to fortissimo without the annoying "vibrato" that characterises the production of fully ninety per cent. of our native singers, who have learned something about "placing" the voice for resonant, "carrying" quality and little about its "control." Exceptionally good diction—articulation that should have, but has not, characterised

singing on the concert platform in the past. Intelligence, musicianship—those rare qualities that are so essential where a constant stream of new songs is to be learned and sung; parts in works that, to satisfy the voracious and never-ending programmes, are revived for a performance and never touched again for years. Personality—a gift of the gods—yet possessed, in some degree, by us all, although many singers have not yet learned to convey it to the listener through the medium of the voice alone.

EXPERIENCE

One other quality is essential—experience, in the profession and in Broadcasting. Professional experience is necessary in that the faults of amateurishness are as liable to creep in in a studio with, say, a full orchestra and chorus as in the hall. Broadcasting experience is gradually acquired: from the time when the artist is accepted at microphone audition as “possible” and given a first trial under broadcasting conditions, to the appearance in an important evening programme in a recital, or perhaps in an exacting rôle in some opera or musical comedy.

It is obvious, therefore, that there are springing up a number of broadcasting “stars”—artists who by their unique equipment for the new art establish themselves as efficient broadcasters, yet whose essentially intimate performance would not necessarily “get over” footlights. Similarly there are many stage “stars” whose art does not lend itself to the microphone. Of these, there are some whose work may pass muster in public place where the evidence of the ear is outweighed by the seduction of the eye, but

the sensitive electrical instrument's photographic reproduction of the performance shows lamentably how much is lacking in finesse, in delicacy.

Much of what has been said in reference to singers applies similarly to instrumentalists. The microphone favours none. It allows no “faking.” It asks clean, legitimate execution and beautiful tone, and if an artist has these, he need not fear the reception. A successful pianist should be accurate and clear in his technique and clean in his pedalling, and possess a tone that is “warm” without being “woolly” and, when necessary, incisive without being hard.

All considered, Broadcasting is helping rather than hindering the professional artist. It gives him work. It causes him the trouble to produce a first-rate performance (which his artistic nature should in any case demand), but it gives him tremendous publicity of a very real kind. It is his friend, if he realises how to adapt his art to suit its new conditions.

It is illegal to operate a receiving set without first taking out a licence costing 10s. a year, from the Post Office. Some people do manage to listen without a licence, but it costs much more in the end. It also costs a lot in self-respect.

The first radio film to be screened in this country was “Charlot's Revue,” which in January 1925 was simultaneously enacted at the Prince of Wales Theatre, London, and screened at Shepherd's Bush Pavilion, the music being broadcast by the B.B.C.

DEVELOPMENT OF BROADCAST OPERA

SINCE the earliest days of its existence the B.B.C. has made a practice of broadcasting operatic performances both of the International summer seasons held at the Opera House, Covent Garden, as well as those of the British National Opera Company, in the provinces and elsewhere. These transmissions have been supplemented by studio operas broadcast from time to time, *i.e.* "The Marriage of Figaro," "Tales of Hoffmann," "Carmen," "Il Seraglio," "The Immortal Hour," to mention only a few works; and further, of course, there was the outstanding first production of Rimsky-Korsakov's "Kitesh" in Great Britain, broadcast from Covent Garden Theatre (in concert form) in 1926 under the direction of Mr. Albert Coates.

In 1926 it was felt that this side of Broadcasting would gain by being developed more systematically, and to this end a series of so-called "libretto" operas was initiated; that is to say, studio transmissions of musico-dramatic works with principals, chorus and orchestra, for which a printed book of words, preceded by biographical notes about the composer and a condensed synopsis of the dramatic action, was published. And as a result of the first year's experience, this has proved itself to be one of the outstanding features of the Corporation's musical activities.

The series of transmissions has covered a certain amount of ground—even virgin soil in some cases—which is generally neglected by the other operatic organisations of Great Britain; for instance, such works as "Dido and Æneas," Purcell's master-

piece, "Orpheus" (Gluck), "Fidelio" (Beethoven)—this latter work was one of the B.B.C.'s offerings during the week of the Beethoven Centenary celebrations—"Philemon and Baucis," a charming and well-nigh forgotten work by Gounod, Flotow's sparklingly melodious "Martha," so undeservedly neglected in recent years, and a novelty in the shape of "The Piper" by Herbert Ferrers. Attention should also be drawn to two light operas which formed part of the general scheme, one the perennial "Les Cloches de Corneville" by Planquette, which remains as fresh now as when composed, in spite of the many years—fifty, to be correct, for it was produced at the Folies Dramatiques, Paris, in April 1877—that have elapsed since first it saw the light, and another work of considerable charm by a native composer—"The Red Pen," with music composed by Geoffrey Toye and a libretto by A. P. Herbert.

So much, then, for the lesser known works. Other operas included in the list were: "Rigoletto" and "La Traviata" (Verdi); "Faust" and "Romeo and Juliet" (Gounod); "The Bohemian Girl" (Balse); Rossini's one and only comic opera (if one excepts his earlier works, such as "Adina," "I due Bruschini," etc.). "The Barber of Seville," a work somewhat rarely performed at the present moment, was also included; "I Pagliacci" (Leoncavallo), that heavenly twin of Mascagni's "Cavalleria Rusticana," and last, but certainly not least, Mozart's immortal "Magic Flute." And in order not to neglect junior listeners, "Hansel and Gretel" was added at Christmas. From this short *résumé* it will be observed that

seventeen operas were broadcast, of which seven were well known and form part of most Opera Companies' so-called "outfit," four less so, and the remaining six practically novelties; two indeed had not been publicly performed before.

Something should be said about the prospects for the Winter-Spring period of 1927/8. It is intended to elaborate the previous plan of campaign both with the so-called "libretto" operas, and also with those copyright works of which it is unfortunately impossible to obtain permission to print the words. As a beginning eight operas have been selected, namely, Bizet's "Carmen" and three works by that very popular and world-famous composer, Puccini,—“La Bohème,” “Tosca” and “Madame Butterfly,”—to be followed by Verdi's “Il Trovatore,” “Tannhäuser” (Wagner), “Penelope,” a new work by Herbert Ferrers, whose “Piper” was so successful some months since, and Nicolai's “The Merry Wives of Windsor.” With the beginning of the new year

it is intended to feature a chronological review, a short survey of the various developments this particular art form of opera has undergone during the past two centuries. For this purpose operas will be selected from the works of Monteverdi, Händel, Méhul, Gluck, Mozart, Weber, Wagner, Cornelius, Rimsky-Korsakov, Debussy, etc. This series will surely help to enlighten those listeners who have hitherto had little, nay, perhaps no opportunity, of familiarising themselves with that rich store of musical works composed for stage performance; and it may also stimulate the interest of those who are better acquainted with this side of music but to whom many of the operas on the list will appear as novelties.

No fewer than 1,072 “S.O.S.” messages were broadcast by the B.B.C. in 1926. Of this number 439 were sent out from London and Daventry, or an average of one and a half messages for every day of the year.

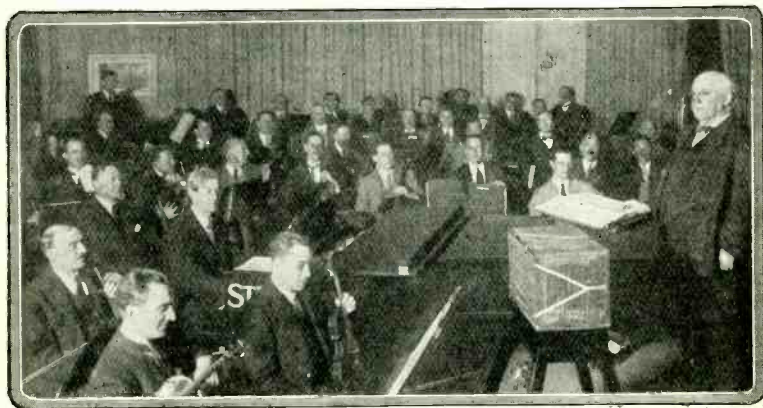

THE LONDON WIRELESS ORCHESTRA

Whose playing has been a feature of the Radio programmes since Broadcasting was inaugurated in Great Britain. Mr. Percy Pitt, Music Director to the B.B.C., is seen on the extreme right

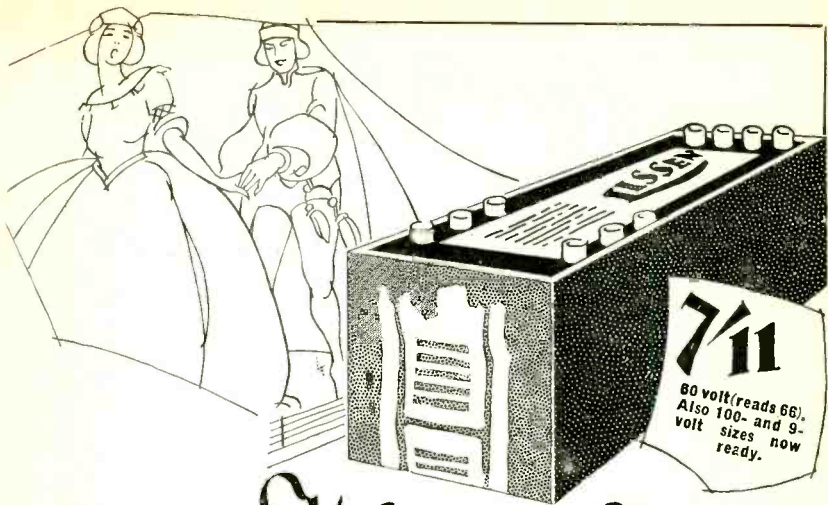

*Make sure of hearing
the Opera perfectly ~
RIGHT THROUGH*

Before any opera or really fine concert is broadcast again make sure that you have got a LISSEN Secret Process Battery in your set. You can draw on it for hours at a stretch, the longest programme will not affect it. You will find your loud speaker with a new power, smoothness and freshness of tone never there before. There are intriguing musical complexities in every great opera and the LISSEN Secret Process Battery will help your loud speaker to truly reproduce them.

60 volt (reads 66)

First . . . 13/-

Then . . . 10/6

NOW **7/11**

100 v. (reads 108 v.) 12/11
9 v. 1/6

Users everywhere are talking about the improved loud speaker reproduction now obtainable, and the new results are due to a new chemical combination and process embodied in the LISSEN Secret Process Battery which are exclusive only to LISSEN, and because big wholesale profits have been eliminated the price of this fine battery brings it within the reach of all.

10,000 DEALERS STOCK IT

LISSEN Secret Process **BATTERY**

LISSEN LTD., 47-56 Friars Lane, Richmond, Surrey
MANAGING DIRECTOR: THOMAS N. COLE

L387

At Last!

TROUBLE FREE WIRELESS

Here is the receiver that is always ready to bring radio entertainment to you—it has no batteries or accumulators to run down and you do not need any knowledge of wireless to use it. *Gambrell Mains Receivers* work off your electric light—you just switch-on or plug-in to the electric light mains like one does for a standard lamp.

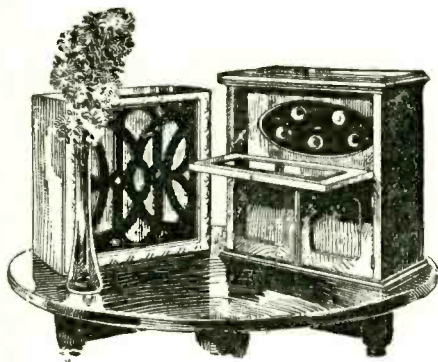

The highest degree of musical excellence is obtained as everything comes through as though you were hearing the actual performance.

Demonstrations without obligation gladly arranged through your local Dealer.

If desired our own staff will demonstrate within a radius of 50 miles from London.

Write for our Illustrated Folder No. 12

GAMBRELL BROS. LTD.

76 VICTORIA STREET, LONDON, S.W. 1

CHAMBER MUSIC IN BROADCASTING

UNTIL these days of wireless in the home the average man completely shunned that mysterious something which for an unknown reason was called "Chamber Music." He had probably never heard any of it; it was something remote, intangible, incomprehensible to all but a few mad enthusiasts who for a quite inconceivable reason would sit for an hour on end in an uncomfortable seat listening to four people amusing themselves with four fiddles, to the complete disregard of anyone else who happened to be present.

The ordinary man was perfectly right in one matter at least. Chamber Music was primarily designed by the old Masters as the material for self-enjoyment among music lovers in the privacy of a room or salon. It was never intended as music for public performance in the sense of a Symphony or an Opera. It was obviously a pity, therefore, that Chamber Music, much of which contains the most glorious musical literature which has ever been penned, should be denied to all but those who could participate in it, and Chamber Music concerts, therefore, came into being.

A POTENT ALLY

When Broadcasting was invented it was realised by the programme builders that here was its most potent ally, for Broadcasting (as is stated elsewhere) is essentially an intimate thing, as is Chamber Music, and that there could be no more enjoyable way of listening to it than by overhearing it, as it were, relayed by a microphone from its performance inside the four walls of a studio.

Broadcasting favours Chamber Music in still another way. By its nature it is essentially the most simple in texture of all concerted music, and there is probably nothing more perfect in wireless musical transmission than the sound of a well-balanced String Quartet or Trio. Additional instruments such as a Clarinet or a Flute or a Piano well played and blended do not add in complexity so much as to greatly affect this unique efficiency in reproduction.

INTRODUCTION TO MILLIONS

Broadcasting found, on its arrival in this country, millions of people who had never heard Chamber Music in their lives. It was obvious, therefore, that the programmes ought to be built in such a way that the strangers might be attracted to the new sound, and the bright and cheery Quartet movements of Haydn, Mozart and early Beethoven were ideal for this purpose. These gems of "absolute" music—music, that is, that depends not on a picture-story or words for its understanding, but to be taken sheerly as pieces of joyous sound—are a constant source of pleasure to the connoisseur of Chamber Music as well as to the beginner.

From the earliest days Chamber Music has thus had a fair share of programmes. To quote only two cases of provincial Stations, Manchester and Cardiff had from the outset weekly concerts of Chamber Music with its usual companions, recitals of good songs. In 1925 a series of fortnightly hours devoted to Chamber Music and songs of living British composers was broadcast from London. Representative program-

mes of J. B. McEwen, Arnold Bax, John Ireland, Cyril Scott, Frank Bridge, Gerrard Williams, and Benjamin J. Dale were included, and met with a fair amount of support from the public, though it was obvious from the correspondence received at Savoy Hill that many people listening to this series were not accustomed to the modern idiom in music, or, in fact, to Chamber Music at all. The musical public already interested in this art were not yet interested in wireless, and it was natural that this would be so until Chamber concerts became an established feature of wireless.

INTERNATIONAL CONCERTS

A year later the support among listeners of Chamber concerts had grown to such an extent that it was felt that the principle of giving a certain number of concerts actually in public in order to enable those who wished to hear the music "first hand," and not through the medium of any reproduction; could be extended to these programmes. Six interesting concerts were broadcast from the Chenil Galleries, Chelsea, and included the first performances of some important works as well as revivals of old and recent Chamber Music. In the following season a further application of this principle was incorporated in the International Chamber Concerts given in the Grottrian Hall, London. Representative programmes by composers of Hungary, Italy, Germany, France, Czechoslovakia and Holland were included, and they were devoted to the latest phases in the musical development of these countries. Practically all the artists engaged, as well as the music itself, were entirely new to England, and in many cases, too, opportunity was

given to hear the actual performances of works by distinguished contemporary continental composers—performances the equivalents of which are regarded as events of considerable musical importance at the various European Festivals. England stands a little outside the main currents of thought of our continental neighbours, and much of the music appeared strange; but it was that very strangeness which the B.B.C. wished to lessen, and it felt that in giving this music a chance to be heard it was rendering an important service to musical England.

For the coming season 1927-8 a further series of important Chamber concerts has been planned. While they may be considered as in one sense a separate series, it should be borne in mind that they are all a part of a carefully considered scheme of Chamber Music for the principal Stations for the whole of the period under consideration. In this period, as always, a very fair proportion of contemporary and other British music is included—roughly thirty per cent. It is interesting to know that several of the less familiar new British works to be given have won Carnegie awards in recent years.

The special "International" series it is hoped will succeed in giving a picture of what is most valuable in present-day Chamber Music of all countries. It is felt that the movement turns round two axes, namely, Schönberg and Stravinsky. The Chamber Music of these two composers is very little known in England and is represented by key works which are likely to lead to keener appreciation of the masters in question. Several works are included which go further back, such as the Sonata of Debussy and the songs

of Ravel, whilst among the names of the younger composers will be found only those which have already reached a certain celebrity. Nothing is included that is simply experimental. In Germany at the present moment, the two outstanding names amongst the younger generation are Hindemith and Alban Berg. In France, in spite of all the musical politics, nothing has emerged which has overshadowed the old group of Milhaud-Honegger-Poulenc-Auric. Amongst the English composers represented are Peter Warlock, E. J. Moeran, D. T. Walton, and others.

An important point of differ-

ence between these (studio) concerts and the Grotrian Hall concerts will be that the programmes are compiled out of contrasting schools of composition, and not arranged in national groups, so that from the listeners' point of view there will be much more variety in each concert. A further noteworthy point is that two features are included which are very characteristic of present-day activities abroad, namely, one concert with Chamber Orchestra and another with Chamber Opera and Ballet. The concerts will be broadcast the first Monday of every month from October to April inclusive.

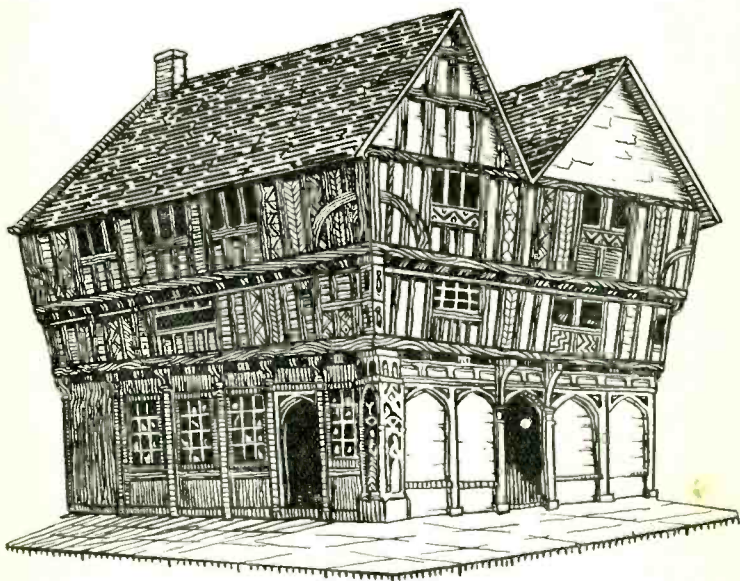

IN THE MIDDLE AGES

One of the illustrations by Elinor Lambert in the School Transmission Pamphlet "Boys and Girls of the Middle Ages" by Rhoda Power

THE FOUNDATIONS OF MUSIC

A FEATURE which is probably unique in the records of public musical performance is that which occurs every night (except Sundays) at 7.15, entitled "The Foundations of Music."

There is a great deal of the music composed by the great masters which is never performed in public because it is not of an essentially popular character, or likely to attract the attention and excite the interest of people who go to concerts and recitals, but which nevertheless forms part of that body of written music on which the superstructure of modern music rests.

Most amateurs and students of music would like to hear everything that, for example, Bach or

Beethoven has written; and so far as keyboard music goes, the B.B.C., in this daily transmission at 7.15, aims at going through the works of the great masters in their entirety and, so far as is possible, in chronological order. The principal keyboard music of Handel, Scarlatti, Gluck, Mendelssohn and other composers of the eighteenth and nineteenth centuries, whose work may be regarded as classical, and constituting the true foundation of modern music, will be performed; and those who listen regularly at this time every day are thus sure, not only of a quarter of an hour's quiet enjoyment of the best music, but of an education in and knowledge of the less familiar, as well as the better-known, works of the great composers.



THE ORCHESTRA COLUMBO (LEADER A. MANTOVANI)

THE PROMENADE CONCERTS

MUSIC'S lucky star was in the ascendant when in the spring of 1895 Henry J. Wood and the late Robert Newman came into contact and jointly influenced the destinies of popular music in London. Newman was a man of great business resource—he had recently been appointed manager of the newly opened Queen's Hall—and recognising the unusual gifts of the young English conductor, he soon engaged him to conduct the Promenade Concerts.

The early history of the Promenade Concerts is a tale of faith justified. Both manager and conductor were convinced that a latent love of music existed outside the exclusive patrons of a few musical societies. To call it into activity was the aim of both of them. Whether the inauguration of these Concerts actually created an enthusiasm for orchestral music among the people, or merely coincided with the reaction from "the oratorio industry" of mid-Victorian days, is a question open to discussion; but it soon became evident that there existed a numerous public keen for something more adventurous and sensational in music than oratorio.

There arose an audience, elementary and uncritical perhaps, but one which craved for living forms, energetic movement, colour, and genius of race—in a word, the audience which discovered Tchaikovsky first and Bach afterwards. The public is often illogical and insists on the cart preceding the horse. English people prefer self-education to sedulous cramming on historical lines, and it appeared that only gulps of what was then very modern orchestral music (Tchaikovsky and the other Russians, Richard Strauss, Elgar and Sibelius) could appease this awakening hunger for a vital, secular art. The classical reaction came a few years later.

BALANCING THE PROGRAMMES

The first series of "Promenades" comprised forty-nine concerts; in 1901 there were as many as a hundred and six; but a ten weeks' season of sixty concerts came to be the general rule. In very early days Tuesday nights were devoted to Sullivan, and Thursdays to Schubert; but as a great quantity of new music flowed into the repertory, the scheme of one-man programmes

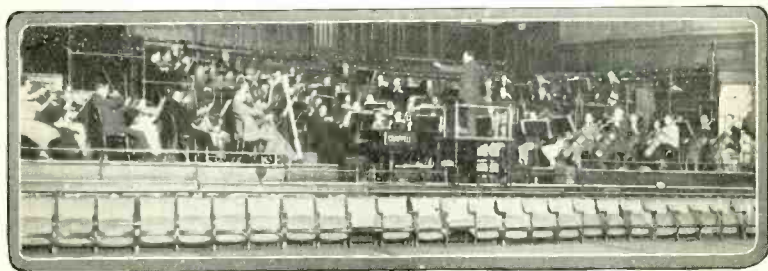

SIR HENRY WOOD'S QUEEN'S HALL ORCHESTRA

Rehearsing for the first Promenade Concert of the 1927 Season, broadcast on Saturday, August 13

underwent modification. The standard of the orchestral works in the second half of the concerts has risen steadily. Vocal music will now have a chance to rise too, since, presumably, 1927 will see the permanent exit of the royalty ballad. Among the classical programmes, works of a lighter character are interspersed, such as Grieg's "Peer Gynt" suites, Rossini's Overture "William Tell," and other dear old friends. There is also the question of novelties. A difficult question, because, as a race, musical experiments do not excite our interest. We would rather pay to hear over-familiar items than risk money on the unknown. The attitude is reasonable, but must not be encouraged if modern art is to be kept alive. Therefore under each change of management a fair proportion of the programmes has always been given up to novelties, although two Wagner or two Bach nights in the week might have paid better. A considerable number of the novelties produced at the Promenade Concerts have become repertory works for the Queen's Hall and other orchestras, but a certain proportion has fallen into oblivion. The insatiable minority who contend each year for a still greater percentage of British novelties show little consideration for the tastes of the great public. The increasing custom of inviting English composers to conduct their own works at the Promenade Concerts has given many of them their first opportunity of conducting a great orchestra, while bringing them into personal relations with the public.

THE ORCHESTRA

The orchestra, drawn from the first ranks of London and provincial musicians, underwent a radical change when, in 1904, Sir

Henry Wood, objecting to the system of deputies, reorganised the band and took in many younger players less urgently in request. The leaders of its various groups are soloists of reputation, and their appearances in that capacity in the course of the season are popular. During the war women found work in the orchestra, and, proving themselves eminently capable, their services are still retained.

There have been years in which no less than ninety artists—vocalists and instrumentalists—have been specially engaged as soloists at the Promenade Concerts. As the Concerts have been running for thirty-two years, a simple sum in arithmetic will show what opportunities they have offered to artists born or resident in this country. It is impossible in a short article to enumerate the many well-known names connected with these Concerts.

THE CONDUCTOR

The centre of the whole system of the Promenade Concerts is the Conductor. From 1895 to 1927 Sir Henry J. Wood has remained consistently the life and soul of the democratic movement in music. The public scarcely realise the amount of work he accomplishes for it in the course of the year. The Promenade Concerts alone comprise in a full season the conducting of some five or six hundred works (including arias and concertos), and to each item he brings a spirit and vivacity that never flag. The mere wielding of the baton is a small part of his work; there is the scoring of many interesting compositions in order to present them in orchestral form to a public who might otherwise never hear them; the careful annotation of hundreds of band parts, the bowing of the

strings clearly indicated; things which represent years of that kind of skilled labour which does not show upon the surface of a successful man's career. Sir Henry's capacity for fresh enterprise seems to grow with the years. Those who work with him realise that he is more interested in his art than in himself, therefore he is never bored. This enviable and joyous keenness for every branch and phase of music is the secret of his perpetual flow of vigour and enthusiasm. He is essentially a sower—a broadcaster.

VICISSITUDES

Thrice between their inauguration and their thirty-second anniversary the Promenade Concerts have passed through a sharp crisis. Their vitality seems proof against all vicissitudes. When, in 1902, Robert Newman found the financial burden of the Queen's Hall Orchestra too much for one

individual, the future of the Concerts was momentarily imperilled. Sir Edgar Speyer took over the organisation, formed a small syndicate, retained Mr. Newman as manager, and, in close co-operation with Sir Henry Wood, ran the Concerts on a high artistic level. During Sir Edgar Speyer's directorship (1902-1915) many serious works—among them the symphonic poems of Richard Strauss—were boldly added to the repertory. In 1915 the Queen's Hall Orchestra passed into the hands of Messrs. Chappell & Co., who had in the meantime become sole lessees of the Hall. The Promenade Concerts, under Mr. Newman's management, were continued on much the same lines as before, and under this régime survived the most critical years of the Great War.

Dejection fell upon the musical world when earlier in the current year news went round that there

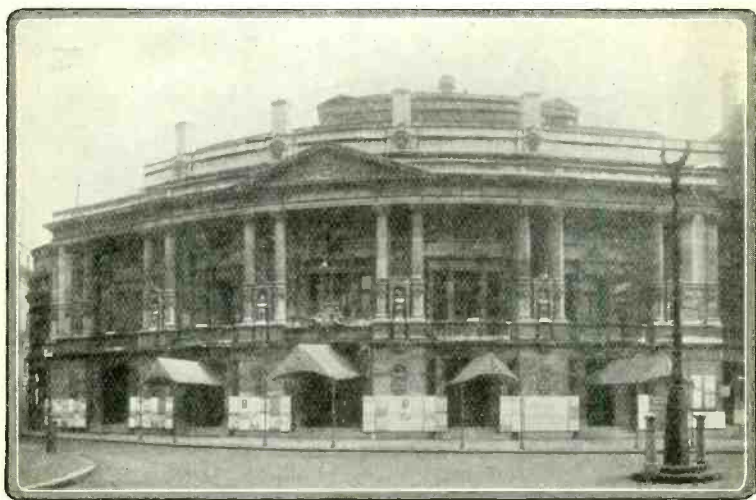

THE HOME OF THE "PROMS"

Queen's Hall, London, where Promenade Concerts have been given for 33 years, this season's being under the direction of the B.B.C.

would be no more "Proms," as they have come to be known affectionately to a grown-up and a growing-up generation. Apart from mere sentiment, so much practical good would have passed with their passing: the closing of a great outlet for creative and executant artists; the extinction of an important educative force. The closing down of the "Proms" would have constituted a national loss.

ENTER THE B.B.C.

Now, under the auspices of the B.B.C., the Promenade Concerts not only have the chance of a fresh spell of activity, but possibly the most potent phase of their influence on English musical life is yet to come. The spirit of Broadcasting—its widespread democratic appeal—is in complete harmony with the spirit of the "Proms," which were never planned for any particular class or æsthetic clique.

The B.B.C. has proved its appreciation of the artistic value of the concerts by its wise policy of

leaving all their best features unchanged and supporting them as a going concern. Let all London music lovers, and as many as possible from the provinces, attend at Queen's Hall as often as they can during the season. Only in this way can be kept burning that wonderful flame of enthusiasm which astounds our foreign visitors when they witness it in a packed "Prom" audience.

As a result of negotiations between the B.B.C. and the Royal Academy of Dramatic Art, a special course of training was instituted at the Academy in the autumn of 1926 with the object of discovering and fostering talent for broadcast purposes. Special examinations will be held and two prizes of £10 each will be awarded by the B.B.C. to successful students of either sex at the conclusion of each half-yearly term.

At least 2,500 schools in different parts of the country are equipped with wireless receiving sets.



MR. EUGENE CRUFT AND HIS OCTET

Often heard and always enjoyed by listeners to programmes of popular music

THE NATIONAL CONCERTS

WITH a view to presenting important works on a scale which cannot be attempted in the ordinary concert or studio performance, the B.B.C. organised, in the winter season of 1926-1927, a series of National Concerts in the Albert Hall. Admission tickets were on sale to the public at popular prices, and the concerts were broadcast, with only slight exception, simultaneously from all the B.B.C. Stations in Great Britain and Northern Ireland. The programmes included, along with many universally popular works, a number which were practically unknown, and more than one which had not hitherto been heard in this country. The conductors and artists presented to the largest audience in history included not only British musicians who have attained to positions in the front rank in their respective spheres, but also a number of distinguished guests from other countries, several of whom were as yet hardly known to the British musical world.

ROYAL ALBERT HALL

The orchestra was one of the largest, as well as one of the best, which had ever been assembled in London for any series of concerts, consisting of 150 artists under the leadership of Mr. Wynn Reeves, Principal First Violin of the Royal Opera and other orchestras. In one concert at least, the sixth, even that great orchestra had to be reinforced by the addition of four brass orchestras drawn from the Besses o' the Barn and the Irwell Springs Brass Bands. In the same concert the Hallé choir from Manchester took part, the occasion

for this specially large force being the performance, under Sir Hamilton Harty's baton, of Berlioz' great "Requiem," a work whose difficulties place it beyond the reach of the ordinary concert undertaking. Even in the great Albert Hall this choral work, under such conditions and guidance, achieved all that its composer intended of strength and bigness.

Sir Hamilton Harty also conducted the first concert, which included a Brahms' Symphony and other favourite works. The singer at that concert was Maria Olczewska, the distinguished operatic singer, who made a profound impression in Beethoven's "An die Hoffnung" and in three Wagner songs.

Among the other British conductors was Mr. Albert Coates, who was in charge of the second concert, with a Wagner, Elgar, and Scriabin programme. Sir Edward Elgar conducted a programme of his own music at the fourth concert, at which Mr. Albert Sammons played the Elgar Violin Concerto.

The ninth concert was in the hands of Sir Landon Ronald, who gave a programme of well-established favourites to one of the largest and most enthusiastic audiences of the series. Further interest was lent to that evening by the first appearance in England of the young tenor Jan Kiepura, whose advent had been awaited with more than usual expectancy.

Part of the tenth concert was devoted to Gustav Holst, who himself conducted the first performance of his choral dance, "The Morning of the Year." This work was specially commissioned by the Corporation.

Dr. Richard Strauss was the first distinguished foreign composer to appear in the series, conducting a concert of his own works, including the great "Alpine" Symphony, at the third concert. He was followed at the fifth concert by Gustav Brecher, Director of the Leipzig Opera.

Another of the younger German school of conductors appeared at the seventh concert—Hermann Scherchen. He introduced, among other interesting works, the recently discovered original version of the "Leonora" Overture No. 2. As a comparatively unknown work, Scherchen gave us Schönberg's "Verklärte Nacht" in its arrangement for string orchestra. The soloist at his concert was Pouishnoff, who appeared in a brilliant rendering of Liszt's E flat Concerto.

At the eighth concert, Bernardino Molinari gave a programme which, except for the

Beethoven Fifth Symphony, was, appropriately, Italian in character, and included Casella's Ballet Suite, "La Giara," and Respighi's "Pines of Rome."

Arthur Honegger, at the tenth concert, conducted the first performance in this country of his own Symphonic Psalm, "King David," a work which made a profound impression alike on those in the hall and on the wireless listeners. The National Chorus made its first appearance in "King David," scoring a noteworthy success, and the soloists were Misses Suddaby and Archibald, and Mr. Titterton, with Mr. Robert Loraine as narrator. Honegger conducted also his Symphonic Movement "Pacific 231."

The next distinguished visitor was Ernest Ansermet, best known in this country from his conducting of the Russian Ballet. His programme was catholic in



THE PEOPLE'S PALACE, MILE END ROAD, LONDON

From which well-known institution some of the National Concerts are being broadcast

character, including such divergent music as a Handel Concerto Grosso, a Schumann Symphony, and modern works by Balakiref, Ethel Smyth, and Ravel.

The series had a brilliant finish, in a programme of Wagner works, conducted by the Master's son, Siegfried Wagner, who has had so large a share of the responsibility for the Bayreuth Festival performances. Listeners all over Britain, as well as overseas, heard these concerts by wireless with a clarity and distinctness which are all too often lacking in the hall. Many enthusiastic letters from near and far testified to the interest aroused by the series, and the Press and the world of music generally recorded a whole-hearted appreciation of the B.B.C.'s enterprise in carrying out so important a scheme.

For the ensuing season 1927-8, a larger number of "National Concerts" have been arranged. Twelve Symphony Concerts are to be broadcast from Queen's Hall, to be conducted by Sir Edward Elgar, Sir Hamilton Harty, Sir Henry Wood and Albert Coates. As an interesting point in the fulfilling of its duties as the great Democratizer of Music, the B.B.C. is bringing up for his Concerts not only Sir Hamilton Harty himself, but, with him, the whole of the Hallé Orchestra; its reappearance will be warmly welcomed by its orchestral friends in London. In addition, Arnold Schönberg, one of the most noteworthy of present-day composers, will direct the first performance in this country of his immense work the "Gurrelieder."

Among little-known British music in the "National Concerts" will be orchestral and choral works which during the last few years have been given Carnegie awards.

This is in pursuance of the B.B.C.'s policy to include as much good and promising British music as possible in its performances. In its Chamber Concerts, for instance, a high proportion (almost 30 per cent.) of British works (Carnegie award and others) is included in the Syllabus, as well as carefully chosen works of foreign origin of special significance.

From the People's Palace eight orchestral and choral concerts are to be broadcast, conducted by Sir Edward Elgar, Sir Henry Wood, Sir Landon Ronald, Percy Pitt and Geoffrey Tovey. Besides these, there will be a series of ten orchestral concerts in the provinces, two in each of five centres (Birmingham, Manchester, Glasgow, Belfast and Cardiff), all conducted by Sir Henry Wood. Nor should it be forgotten that the studio programmes include many Symphony Concerts, given by what is virtually the National Orchestra, though not under this name, conducted by such famous conductors as Oscar Fried, Schleevoigt, Scherchen and Ansermet, and in addition native conductors of admitted distinction. These programmes contain much music of interest to followers of modern composition—for instance, works by Schönberg, Stravinsky, Bartok and de Falla, conducted or played by the composers themselves, and performances such as are considered of the utmost importance in European international music festivals.

Simultaneous Broadcasting, by which a number of Stations are linked together by land line and transmit one item from a single point, was a B.B.C. "invention." It was first introduced in 1923, being designed to bring the best programmes within reach of the holders of the cheapest crystal sets.

T H E M I L I T A R Y B A N D

As a result, probably, of its title, there has always been some misconception in the musical significance of that combination of wind instruments popularly known as "The Military Band."

It is true that, at the beginning, the *raison d'être* of the Military Band was purely in connection with the "Fighting Services"—to add to the pomp and panoply of war, to raise the spirits of the soldiers, even to "affright the enemy."

A natural development was the more peaceful employment of the band in barracks, to play martial airs on parade and, occasionally, to indulge in a light programme for the amusement of the officers and men.

Only in comparatively recent years has the Military Band come into touch with the general musical public—performer as well as listener—by way of the pier and the park. Since these performances took place *en plein air*, it was pardonable, perhaps, that a spirit of frivolity should predominate.

But the Military Band, as an artistic combination, has gradually forced its way to the front, and is now a really important factor in the musical world, as capable of taking its place and sharing the task of the education of the public as the String Quartet or the Orchestra.

REPERTOIRE

With this view before it, the new Wireless Military Band comes into existence. To set a standard of Military Band performance for the world, to lead the musically inclined listener along a not unknown path to higher and better

things, to open up a new avenue for composers, young and old alike, are its aims and intentions.

The first of these presupposes a supply of material, in the way of artist performers, which, if it cannot be found in England—and especially in London—cannot be found anywhere.

The repertoire on which the Military Band has, as it were, found its feet consists almost entirely of "arrangements," but few first-hand compositions having, as yet, appeared for this particular combination. The arrangements worthy of consideration—unfortunately somewhat limited in number at present—are those of well-known and standard orchestral works (overtures, rhapsodies, suites—even movements of symphonies), and the listener is therefore on familiar ground at the outset, to be led by, it is hoped, the aid of the composer to new fields of musical expression and thought.

Lest it should be feared that the "new fields" might display the exotic plants which acute and ultra modernity has attempted to produce, only too frequently, in recent years in other departments of this and the sister arts, listeners might be comforted to know (and composers are hereby warned) that the Military Band is an entirely unsuitable ground for any freakish experiments. Lack of knowledge and culture is equally easy of detection in this field, the hand of the novice being as patent as would be the efforts of the trisler.

OPPORTUNITY

The young composer—and surely all composers are young, at least in their minds, while they

draw breath—would do well to examine the possibilities of this field. The present "arrangements" will, at any rate, show him what can—and perhaps what cannot—be done with the Military Band; he will acquire some useful information as to suitable and profitable blending of colours, and so forth; he will be introduced to "effects" which he might not have thought possible on wind instruments alone. If he applies this knowledge faithfully, he will have the multitudes to interest in his work, whether it be through the microphone or by way of the pier or the park, and he will be helping in the work of affording pleasure and musical advancement to the public—for no other reason, indeed, is he endowed with his gifts.

A steady perseverance to achieve something worthy of these gifts is essential. Failure at the commencement should neither deter him from further effort nor occasion him any misgivings as to the motives of the Military Band conductor or performer. The composer, the band and the public alike suffer by the production of immature, weak, unhealthy or noxious work.

Sincere effort, therefore, on the part of the composer, and a sympathetic interest—which does not mean lack of discrimination—on the part of the listener will cultivate the Military Band field for their mutual enjoyment. And both may assuredly rely on the sincere and sympathetic endeavours of the Wireless Military Band.

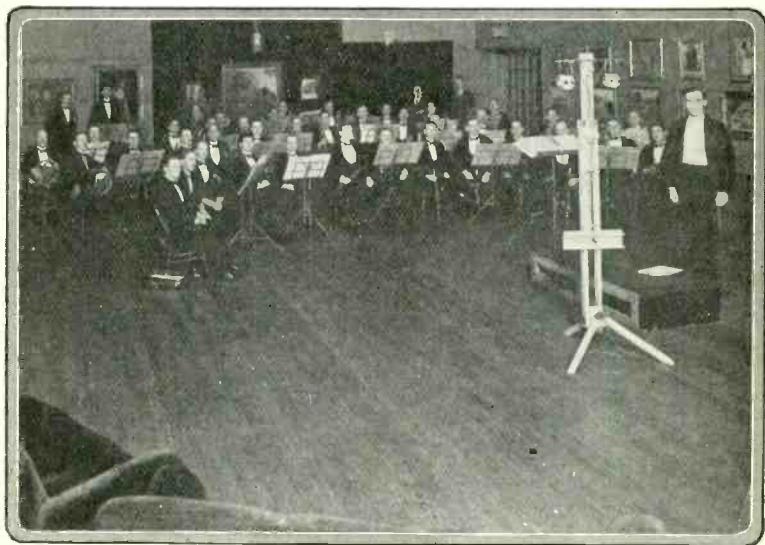

THE WIRELESS MILITARY BAND

Here photographed at the Chenil Galleries, London, under the conductorship of Mr. B. Walton O'Donnell, is recognised as one of the finest military bands in the world

SOUND BALANCE AND CONTROL

HOW many listeners think of the vigilant figure seated in the control room of the Station with the musical score on the desk before him, his eyes always aware of the flick of a delicate needle and his ears unheedful of everything but the head-phones placed about them? Yet it is within the power of that man, by the slightest turn of his wrist, to make or to mar the beauty of a transmission. His function is to control the actual strength of the music as it leaves the studio circuits on its way to the transmitter.

Reference will be made later to his function as "controller" of strength, in order to examine first his duties as a "balancer." Before a sound of any kind can be broadcast in an organised programme, the relative position of the microphone and the source, or sources, of sound have to be most carefully examined and adjusted. It affects anything from a single speaker, or a singer accompanied by an instrument, to the greatest of symphony orchestras and choirs, or the many noises that merge into what eventually reaches the listener as an interesting sound picture of, say, the Tattoo at Aldershot.

RELATIVE STRENGTH

Balance, then, may be described briefly as the relative strength of sounds as received by the listener, as, for example, between soloist and accompanist—whether piano or orchestra—or the relative strengths of the members comprising a musical ensemble or dramatic work.

The balance of these strengths is obtained by the placing of performers at varying distances

from the microphone. Before the actual performance, through a complete rehearsal, or number of rehearsals if possible, experiments are carried out on what is known as a "local circuit" (*i.e.*, an electrical circuit from the microphone through the amplifier on to the head-phones, though not actually broadcast). Naturally experience of former transmissions assists to a great extent. There are, however, two difficulties against which the balancer has to contend. Firstly, the microphone, unlike the human being, has only one ear, and what, therefore, may seem a perfect balance in a concert hall or studio is not recorded as such by the microphone when placed in the same position as the human listener.

The reader may experience this for himself by listening to a well-balanced quartet, for example, in a concert hall, first with both ears and then with only one ear. When no microphone is available a fairly good approximation to the microphone balance may be obtained by stopping up one ear and listening with the other ear, "facing the music." Secondly, different ear-phones and loud-speakers will record varying balances, so that what may seem a good balance to one listener does not necessarily appear so perfect to another using a different type of apparatus. In consequence, in order to maintain consistency, balance is estimated at B.B.C. Stations by uniform ear-phones and loud-speakers which have been chosen as the most faithful reproducers of tone quality.

RELATIVE POSITIONS

So far as studio orchestral items are concerned the relative positions

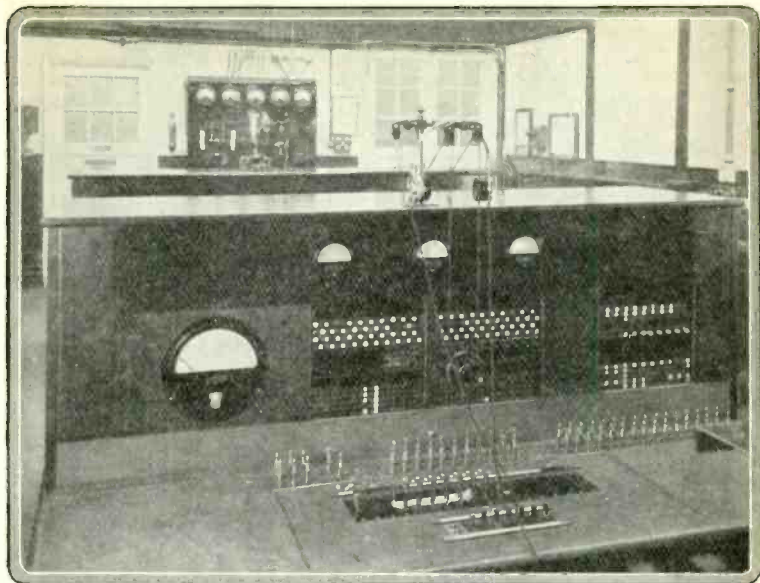

THE S.B. CONTROL DESK AT SAVOY HILL

of the members of the orchestra are fixed, though slight alterations may be necessary from time to time to suit particular compositions.

In outside broadcast work the placing of the microphones for orchestras has, in some measure, to be adapted to circumstances. For orchestras in cinemas, playing in the orchestral well, two instruments are generally employed, placed at suitable positions on the orchestral rail. When opera or musical comedy is broadcast from the theatre, as many as three to six microphones may be used. In such a case it is arranged so that any one microphone, or group of microphones, can be "faded out" or cut out entirely if required, and the balance adjusted in this way to compensate for movement or other altering conditions on the stage itself.

Each concert hall or theatre has its own peculiarities, and the best positions have to be ascertained by experiment during tests. Many problems have to be solved in each Broadcast, and perhaps the most difficult is that of placing the microphone in such a position as to ensure the best results, at the same time complying with local arrangements and regulations.

Should the test take place in an empty hall, due allowance must be made for the fact that the acoustics change considerably on the advent of the audience. Generally speaking, the presence of the audience reduces extensively the amount of echo and resonance.

Studio performances give greater opportunities for correction of balance throughout the transmission. Constant supervision is maintained by a musical

authority and adjustments made when necessary. Each studio is equipped with a silence cabinet which practically eliminates actual studio sounds, making it possible to check the balance by listening to the actual transmission in the cabinet. There is a glass window through which the balancer's assistant, who is in constant touch with his colleague in the control room by means of telephone, can signal instructions to the announcer on duty. He in turn has tactfully to move the artist, signal her to be less enthusiastic on high notes, or give the accompanist the tip to "keep it down," and so forth.

Rehearsals, however, reduce the necessity for these changes to a minimum, so that the artistic temperament, already sorely tried by the experience of broadcasting,

is not further irritated by small distractions. Not infrequently, this very artistic temperament causes the artist, through the excitement of the performance, to sing quite differently in the "Show" itself than at the rehearsal. Further, it is natural that an artist prefers not to sing "full out" at the final rehearsal, out of consideration for the voice itself, which would easily tire and lose its freshness for the performance.

Now for the "controlling." In his responsible task the man to whom this function is entrusted has to achieve a result which, while interpreting the composer's wishes regarding light and shade, never becomes so loud as to over-modulate at the transmitter and cause the effect known as "blasting," and never



BALANCE AND CONTROL

Regulating the transmission and entering up the Station log.

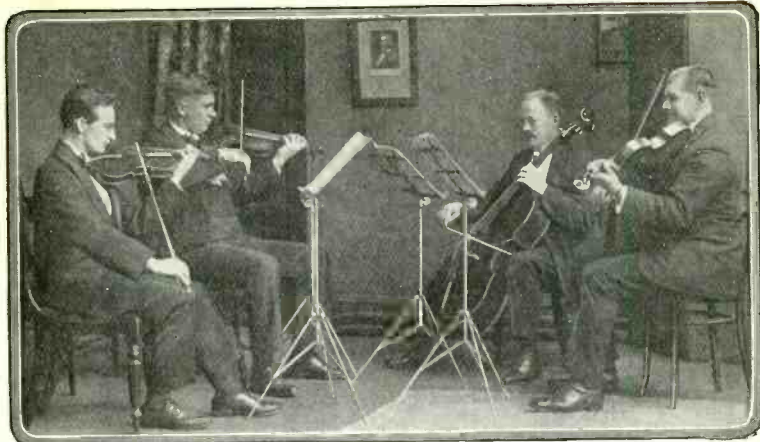

THE ABERDEEN STATION QUARTET

so soft that listeners receiving weak signals, particularly crystal-users, fail to hear a reasonable volume of music. To assist him to do this he has before him the complete score of the musical work being performed; whenever possible a small "miniature score," such as students use, of the actual full orchestral score. He then may anticipate any otherwise unexpected changes in strength, such as the not uncommon tremendous outburst by drums and brass, followed by the whispered pianissimo which is so effective in the hall, but which would be entirely lost to about 90 per cent. of the listeners unless the controller carefully and unobtrusively brings up the strength by turning his control knobs.

This function of "controller" has so become part of broadcast routine at Savoy Hill, that the full score of every musical work of importance is automatically stocked in duplicate; and further, every special performance outside London, whether it be opera, ballet or public concert, is attended

by a member of the section handling this work, in order, in co-operation with the outside broadcast engineers, to ensure the best possible results for the listener.

The work of the "controller" is such as to demand peculiar abilities and training. The successful candidate should have a very sound practical knowledge of musical matters, including acoustics, no mean understanding of tone colours and values, and quiet self-assurance, relying upon the evidence of tireless ears and eyes. Even so he has to go through some months of careful training, gaining experience with transmissions both inside the studio and out, before he may be entrusted with the responsibility of "putting a symphony concert through."

Receiving licences were first issued without charge to blind persons on January 1st, 1927. Within one month, 2,360 blind listeners had receiving licences—six months later the number had risen to 8,150.

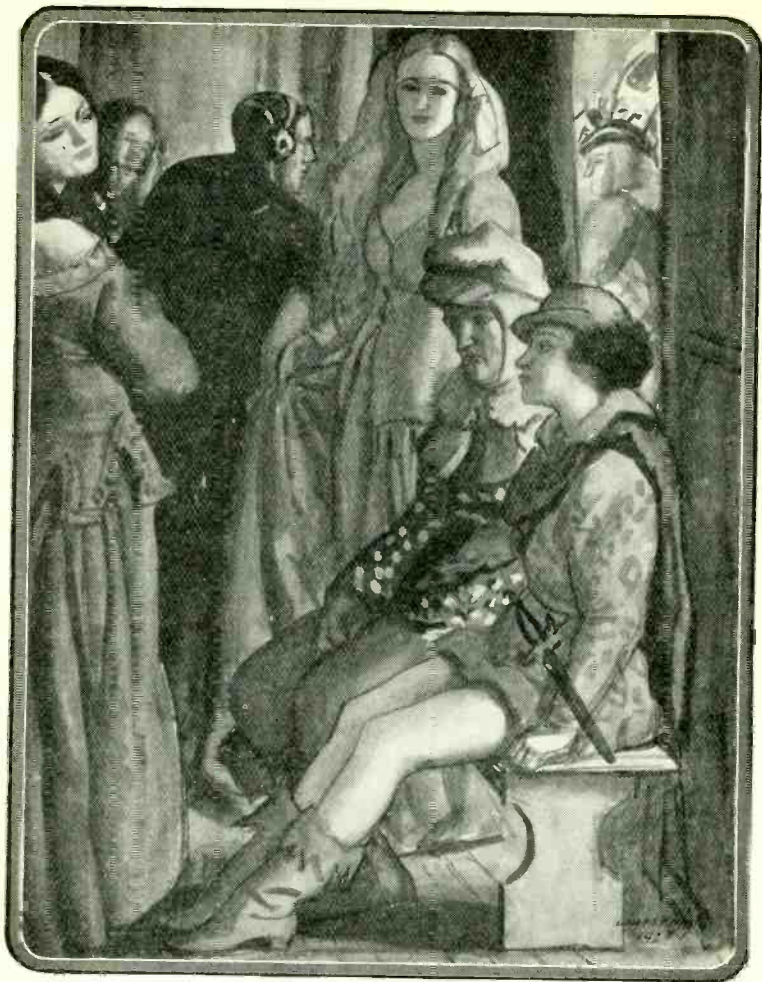

FROM THE WINGS OF A THEATRE
Broadcasting as the artist sees it. Specially painted for "The Radio Times"
by Laura Knight

PRODUCTION OF RADIO PLAYS

THERE is probably no form of Radio entertainment which has made greater strides, either from the point of view of popularity or presentation, than the Radio Play. Doubtless the steady improvement in the latter has led to the equally steady growth of the former.

From being an experimental feature, of short duration and irregular appearance—sponsored, be it said, with some trepidation—these items are now as vital to the programmes as music itself. Some three hundred different productions are presented annually, and the services of hundreds of the best actors and actresses—from the vocal standpoint—are from time to time engaged by the Corporation.

The task of selecting so much material that shall be alike suitable for transmission and for reception by listeners of all ages and types is stupendous. Naturally it is not possible always to please; but it is, in fact, extremely rare that any offence is given even to the most partisan mind.

Apart entirely from the plays which have been specially written for the medium ("Dweller in the Darkness," "The White Château," "Congo Night," "Christopher Columbus" etc.) by authors such as Reginald Berkeley, Richard Hughes, Edgar Wallace, Frank Shaw, etc., the wide field of dramatic writings is daily explored to find material for play transmission which shall be stimulating, diverting or moving, and in addition shall maintain the policy of the Dramatic Department by conforming to a definitely cultural standard. When it is recalled that the works of such writers as Shakespeare, Rostand, Parker,

Sutro, Wilde, Synge, Drinkwater, Sheridan and a host of others whose names are familiar in the literary and dramatic world have been frequently included in Radio transmissions, it will be admitted that the matter of selection leaves little to be desired.

PRODUCTION

There is, however, still the question of adapting and presenting such material in that form which renders it capable of reception and appreciation by the listener; and in this there has been extraordinary progress on both sides. It is not always realised that the arts which serve entertainment have two facets—that of the entertainer and that of the entertained. The actor must give of his best—that is well known—but each individual member of an audience, whether concentrated in a theatre or widely dispersed, as in the case of listeners, must also give his or her best receptive faculties if the full entertainment value is to be received and appreciated.

Thus the progress of plays by radio has been such that one hears quite a lot of what usually appears as "stage directions" in the form of actual dialogue. The references to settees, telephones, bureaux and the like would be tedious in a stage play, because unnecessary—the actual properties being there, as it were, to speak for themselves.

But those who listen have by now absorbed something of the convention of the Broadcast stage. The mention, however brief, of settees, telephones and bureaux serves to stimulate the imagination: forthwith the listener constructs mental scenes which are



"THE CHINESE PUZZLE"

Sir Roger explains the chart by which he hopes to trace the culprit

entirely satisfactory to him—although differing from those conceived by his next-door neighbour. Three years ago very few listeners thus stimulated could have pictured the scene at all.

When the B.B.C. adds, as it so often does, to this stimulation of illusion, sounds suggestive of both scene and action, the listener finds little difficulty in re-creating for himself King's Cross Station, Portsmouth Dockyard, the mid-Atlantic or the bottom of a coal-pit.

THE LISTENING SENSE

Little of this would be possible, however, if it were not for the fact that the listener has during these three years developed his "listening sense" to a far greater extent than formerly. By now he is as experienced in the conventions of the wireless play as the most hardened dramatist is in the

case of the stage plays. He has learned to accept the announcer's voice as he would the printed programme setting forth sundry details concerning the performance, and in the swift transition from speech to music he has learned to discover the fall of a "wireless curtain."

The end and form of the new art of Radio Drama are hardly yet in sight. Much more thoughtful, analytical and constructive work is foreshadowed than has yet been achieved. But in all this the chief difficulty does not lie in the studio, but rather with the listener, who *must* give his undivided attention to the Broadcast play. Distracting influences *must* be eliminated—the listening room of the house must be as free from interruption as the auditorium of the theatre.

As beauty has been said to lie

in the eye of the beholder, so also may it be said that the success of the wireless play, no matter what its development in form and scope, will always be in the ear and mind of the listener, and the receptive mood is to it the essential condition of success.

Every B.B.C. Station is permitted to broadcast two local appeals for charity each month, the remaining Sundays being reserved for national efforts.

So great is the demand by hospitals and other organisations dependent on public support for their revenue, to be included in the list of those for which appeals for funds are broadcast every Sunday, that there is now a waiting period of more than eighteen months.

One of the United States Federal Radio Commissioners predicts that more than one hundred American Broadcasting Stations will discontinue operations before the end of this year.

One of the chief developments of Broadcasting in 1924 was the establishment of a high-power transmitting Station at Chelmsford. This led to the installation of the permanent high-power station at Daventry, which it is estimated now serves an area inhabited by 23 million people.

During 1926 the B.B.C. Information Department gave 2,250 interviews to representatives of the Press. Programme information is distributed daily to hundreds of publications throughout the Empire, Europe and the U.S.A.

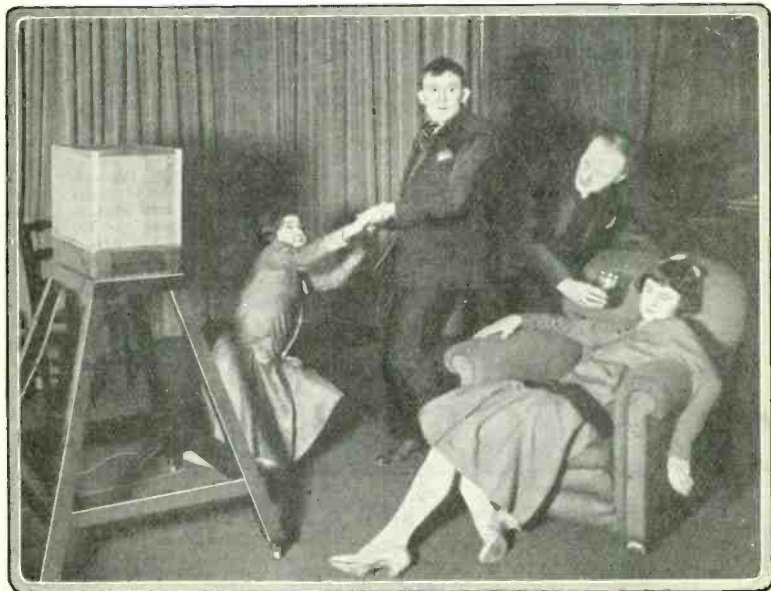

"THE GREY ASH"

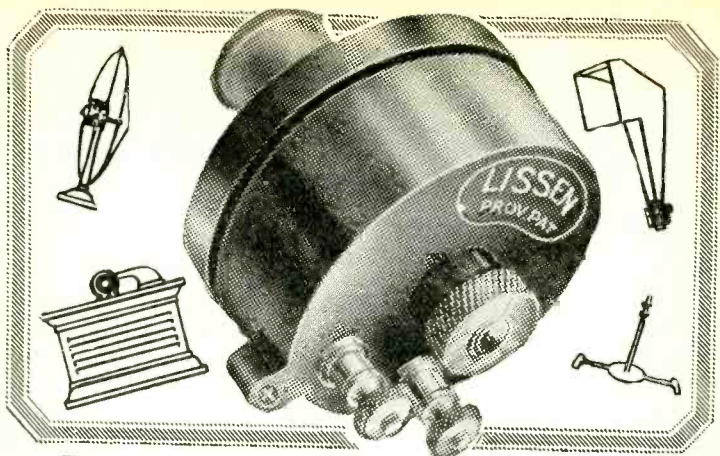

Build a Big, Powerful Loud Speaker yourself for 13/6

FOR LESS THAN the cost of head-phones you can buy the "LISSENOLA"—the loud speaking unit that needs only the addition of a horn to make it a powerful instrument, equal in volume and tone purity to the most costly on the market. With every "LISSENOLA" are given complete instructions, including full-sized diagrams, for making a horn of proved efficiency, as shown above (illustration No. 2). If you possess a gramophone, the "LISSENOLA" instantly converts it into a loud speaker (illustration No. 3).

MAKE THIS TEST. Go to your

nearest dealer—ask him to put on the best loud speaker he has in stock—then use the same horn on the "LISSEN" Unit, and see if you can notice any difference.

The secret is in the "LISSENOLA," which possesses an electro-magnetic sound-reproducing mechanism concentrated in the most effective manner yet achieved, and sold at a record in low price.

By using the Lissen Reed, Price 1/- (illustration No. 4), you can adapt the "LISSENOLA" to carry any cone or any other diaphragm working on the reed principle (illustration No. 1).

Your dealer will gladly demonstrate and supply, or post free by return from the makers

The LISSENOLA

Now no home need lack a Loud Speaker

LISSEN LTD., 47-56 Friars Lane, Richmond, Surrey

MANAGING DIRECTOR: THOMAS N. COLE

VARIETY BY WIRELESS

THE demand for light entertainment of a popular character, coupled with the success achieved in the early days of Broadcasting, confirmed the belief already existing that the regular inclusion of Musical Comedy, Revue and Variety programmes would be acceptable to a majority of listeners.

The difficulties attending this development were numerous and peculiar. Taking the half-hour of Variety "turns," the average Music-Hall bill for a given week includes a number of items such as juggling, conjuring, dancing, trick cycling and the like, all of which are presentable *only* on the visible stage. Subtracting these, the turns available for wireless programmes comprise singers, instrumentalists and speakers—all of whom from a listening point of view bear a certain resemblance to the artists of any other wireless programme.

AIDS TO ATMOSPHERE

In devising Variety programmes, therefore, the department had to find artists possessing some speciality which could be transmitted in its entirety or, failing this, lend itself to description such that the listener could imagine that which he could not see. Further, the temperament of many Variety artists is such that they find Broadcasting a much greater strain than do artists on the legitimate stage; consequently aids to atmosphere had to be arranged, such as spot-lighting, and the inclusion of a visible—and audible—audience in the studio itself.

The requirements of Broadcasting are such that all spoken material must be submitted in

advance for approval. But much of the success of a comedian rests upon his spontaneity and ability to improvise a clever gag: so that this requirement, although essential, has not rendered easier the provision of the light Variety programme.

Yet great success has undoubtedly been achieved, and the work of many a comedian, or "comedy duo," is now far more widely known than was the case prior to the wireless Variety half-hour.

WIRELESS REVUE

Bearing in mind how much of the success of revue depends upon the visible chorus, with its dancing and elaborate effects of costume and lighting, it seemed almost impossible that the atmosphere of such entertainment could be conveyed by wireless. But careful experiment and investigation led to the appearance of the first wireless revue in 1925, and since then it has remained a standard feature of the programmes.

A swift-moving hour, comprising a rapid succession of musical numbers, alternating with specially written and very short sketches requiring no announcement, aided by a chorus, and an orchestra of the popular dance type, proved the recipe for wireless revue. The use of chorus and orchestra was skilfully manipulated to reproduce the essential atmosphere of such a performance taking place in a large theatre; and in this form several scores of performances of successive editions were given.

Developments of the idea, making such alterations in form which should not affect the essential character of the programme, have occurred from time to time. The



BROADCASTING A REVUE—"HOW'S THAT?"

services of well-known producers of revue have been enlisted (Archie de Bear, André Charlot, Graham John, etc.), and these by their presence have ensured that the atmosphere of revue has been retained in spite of the new and more difficult form of presentation rendered necessary by wireless. And so in turn have been presented the hour in the Cabaret, or the swiftly moving programme of the type made popular by the Follies and the Co-Optimists.

MUSICAL COMEDIES

The long list of musical comedies famous in the generation preceding 1914 has been laid under contribution many times for songs and selections. The B.B.C., however, was responsible for a novel burlesque of the comedies themselves—their structure and sequence—in the long series of musical extravaganzas which it

presented. Assuming that the essential characters and plots of all these comedies were much alike, burlesque dialogue was prepared leading up to the well-known numbers of such works as "The Geisha," "Country Girl," "Floradora" and many others, thus providing a thoroughly popular programme without suggesting too much of reminiscence. In like manner many of the ballads of other days have been presented; and such programmes remain among the most popular of those presented.

On the whole it may be said that the development of the "Variety" side of wireless entertainment has involved a "variety" in presentation methods little suspected by those who in the early days set out to devise some variation upon the sequence of definitely announced instrumental and vocal items.

LECTURES AND LECTURERS

TO all listeners who wish to get the fullest value out of their set, it might be suggested that they should not only try to improve the quality of their reception by every technical means in their power, by seeing that the set is kindly treated, but that they should also extend, if they can, the range of their enjoyment to cover as much as possible of the programme; meet the B.B.C. halfway, in fact, in its attempt to satisfy them. Some people seem to pride themselves upon a narrow range of interests. They boast, for example, that they do not like this, that or the other; it may be Chamber Music or it may be Variety; it may be Anthems or it may be Plays. Surely the B.B.C. may argue that the Wireless menu is that of a *table d'hôte*, provided by people extremely anxious to please the tastes of their guests, and surely that guest is the wisest who deliberately tries to extend the scope of his tastes.

Probably there is no one who would say categorically that he dislikes the mere sound of the human voice, or even that he dislikes all talks by all speakers, whatever their subject. There may be a few so argumentative by disposition that they are Nature's Bad Listeners because they prefer to do the talking themselves, or because they feel such an overmastering urge to answer back that they cannot hear any sort of discourse without impatience.

It is a common opinion among the impatient who write those snappy letters which appear from time to time in the generally favourable correspondence, that

the B.B.C. wantonly and arbitrarily cut them off in the middle of a delightful concert and announce a talk by Professor Haxau on Prehistoric Crustaceans, without any rhyme or reason. They picture an aged man with preposterous whiskers, mumbling over an undecipherable manuscript full of unintelligible technicalities. But this is not exactly what happens.

DEFINITE PLANNING

The talks and lectures of the B.B.C. are not arranged without some definite plan. They occur at regular places in the programme. There are talks destined for the schools at some point between 2.30 and 4 o'clock in the afternoons, and these are arranged in consultation with teachers and authorities on education. One series is fixed in conference with the Women's Institutes on a particular afternoon in the week. Later in the afternoon there may be a talk intended to interest housewives or stay-at-home women. The talk which sometimes figures in the Children's Hour is specially intended to appeal to the interest of children. At seven on every day of the week there is something of local or topical interest, lasting a quarter of an hour. This is journalism, and is designed to round off the news like the articles which appear in the evening papers. It must not be assumed that all our listeners, or even half of them, are within reach of the regular evening paper. At 7.25 there is an adult education talk on five nights of the week. This is planned to meet the demands of various important bodies, and will gener-

ally be found to consist of a series of six talks by some highly eminent authority on some particular subject of general interest. Care is taken to avoid the dry-as-dust technical subjects. Efforts are made to get scholars who are themselves engaged in advancing the boundaries of knowledge, and to select from among the highest academic authorities in the universities and elsewhere those who have already exhibited the most conspicuous powers as popular interpreters of their subject. The time selected is again a kind of compromise. It is a time not too convenient for the well-to-do City worker, since it will probably clash with his or her dinner-hour, but it is the earliest time in the programme when those multitudes who are engaged in daily work in the factory or on the farm or in the City office can be ready to listen. Although it has an educational purpose, it has, we venture to believe, an intrinsic interest for people who have not allowed the cobwebs to grow in their upper storey. From 7.45 to 9 there is a clear run of entertainment programme. After the news, at 9.20, there will be often, but not always, a late talk intended to interest the thoughtful members of the general public.

THE LECTURE METHOD

Some critics argue that lectures are and always have been useless as a method of conveying ideas or information. The lecture method, they are never tired of reminding us, was the method of the Sophists: conversation was the method of the true philosophers. "Socrates, the wisest man in the world," they say, "survives in his dialogues, but where is the wisdom of Gorgias, of Leontini? Where now is Protagoras? or Prodicus? Where

are Corax and Tisias of Sicily? 'Russelas' hath fallen into oblivion and desuetude, but Samuel Johnson's conversations are immortal." They are Sophists themselves who speak thus. It is not the dialogues nor the conversations that survive, but the literary work of Plato and Boswell that embalms them. Survival is not the only criterion of value. It is true that the spoken word of Socrates set many a young man's heart afire, including the heart of Plato. But many of the discourses of Socrates lasted longer than one of our wireless talks, unbroken by a single "Certainly" or "Quite so!" from his disciples. When Socrates warms up in the course of his dialogue, when his "demon" bids him deliver a message, he talks and his pupils are silent. Not every wireless talker is a Socrates or a Spurgeon or a Liddon, but each is, or should be, a man with a message.

Some would argue that the lecture is to-day an extinct form. It never can be extinct. It may have declined in importance with the growth of cheap printing; it may no longer represent the essential feature of university training. No doubt it is true that the most valuable part of a young man's course at one of the older residential universities consists in the contact with his tutor, and not in his attendance at formal lectures. Nevertheless, it is still the case, but possibly less so in this country than in others, that keen students make long pilgrimages to hear the voice of a great teacher, and there is still no substitute for the voice of a great man as a means of provoking thought, guiding study, breaking fresh ground and stimulating new interests. Even supposing that books cost nothing and that books

on all subjects could be obtained at a moment's notice everywhere, the lecture would not be extinct. In the voice there is a conveyance of personality beyond the power of any book.

The B.B.C. has advanced a stage or two beyond those early times when a selection was made of as many subjects as possible given singly, simply as thought-provokers. Just scratching a very wide surface of popular interest was not the best way of husbanding time. For this reason it was decided more than three years ago to link a certain number of talks into a connected series and give them in a set of six or a dozen on one subject. In that way it is possible to do something more than scratch the surface, and in order still further to avoid the charge of superficiality, everything possible is done to assist those who are interested beyond the preliminary stage to carry forward their studies. Printed pamphlets contain suggestions for reading and hints for further study or discussion in groups.

THE GOOD BROADCASTER

And all the time there are improvements going on in the studio. Those in charge of this section of the organisation are continually observing studio methods and trying to improve them. It is not very easy to lay down hard-and-fast rules for the production of a good talk; so much depends upon personality, and as a general principle it is better that each speaker who has the necessary gifts should develop his own style. There are some very simple rules which are impressed upon new speakers, for it should be mentioned that practically all who speak for the first time at the microphone are now invited to undergo a pre-

liminary rehearsal. A wireless speaker should endeavour to establish contact with his listeners and arouse their interest in his first sentence; he should deliberately set himself to stimulate thought by adopting a pointed and pungent style. He should imagine himself addressing not a vast multitude in a hall, but endeavouring to convince a friend seated in an armchair about six feet away from him. The wireless listener is not a multitude but an individual. Seldom nowadays will you hear the rustling of papers that used to crackle like artillery in the early days of Broadcasting. But precepts such as these will never make a good broadcaster. The essential requirement is the possession of an interesting personality faithfully represented by the voice, and undoubtedly those are the best broadcasters who give the most attention to their methods, who study technique as listeners first, and try to imitate the factors which have made their predecessors successful. The good broadcaster recognises that he must avoid on the one hand being too technical, and on the other hand any appearance of talking down to an audience far beneath him. It will be found that the most successful microphone personalities, whatever their subject, not only stimulate the interest of those who have no acquaintance with their subject, but also provide material for thought for their fellow-experts. It would be invidious to mention names, but examples could be quoted not only in the field of music, but in that of science and literature.

More than £25,000 was subscribed by listeners during 1926 as a result of broadcast appeals for charity.

ORGANISATION OF TALKS

THE Talks Department is responsible for the news service, the S.O.S. service, the "bulletins" for farmers, gardeners, scouts, guides, wireless societies, etc., running commentaries of important events, debates, talks on current affairs, critics' talks, Government department talks, and all the sporting, humorous, travel, literary, and general talks. Its field of operations covers the actual provision of these programme items for London and Daventry, most of which are also taken by the other stations; and a general responsibility for local talks. In other words, the Department is responsible for planning ahead such talks as can be fixed in advance, and for securing at the eleventh hour, or the fifty-ninth minute, "red-hot" talks on current events, both small and great, and by men and women of the hour. Its work is therefore a curious hybrid, partly like that of a weekly or monthly review, partly like that of a daily newspaper, and partly like that of a club arranging its literary, debating, or sporting fixtures several months ahead.

MICROPHONE CONDITIONS

The members of the staff of the Department seldom take any personal share in actual broadcasting. Their function is to search for the ideal broadcaster, the man or woman who not only knows a subject intimately, or who has an interesting experience to relate, but who can also convey the interest to other people through the wireless medium. This is not as easy as it may sound. It is often difficult for a speaker to adapt himself to microphone conditions.

It is often equally difficult for us to tell, until a speaker has actually broadcast, whether he will do it well. It is still rather a puzzle to decide what constitutes a good broadcasting personality and how it can best make itself felt. One is sometimes placed in the dilemma of having to choose between a first-rate authority with a poor delivery or an uninspiring style, and a less able speaker with a gift for popularising, an excellent manner, and an attractive voice. Rehearsals too may be either very much better or very much worse than the actual performance. In the case of a hastily-arranged "red-hot" topical talk, time may not permit of a rehearsal at all, and the manuscript may only be presented for scrutiny at the time of broadcasting. It is then too late to offer the kind of advice which sometimes helps a prospective broadcaster.

SOME "DON'T'S"

"Don't speak as if you were addressing a public meeting, but as if you were talking to a friend. Don't begin with a dull introductory page, but plunge at once into your subject, so as to attract your listeners' attention in the first thirty seconds. Don't waste any of your eighteen hundred words in explaining what you are *not* going to talk about, or in apologising for your shortcomings. Don't use long sentences with many dependent clauses, or your listeners will get lost before they reach a full-stop. Don't read in a level monotone, but vary your voice and your emphasis." People sometimes ask whether celebrated speakers do not mind being given hints on broadcasting, or

having their manuscripts scrutinised, by those who cannot pretend to any specialist knowledge. In actual fact most speakers are glad of advice or even of criticism given on behalf of the ordinary listener, and the more eminent the speaker the more ready he usually is to welcome it.

There is little doubt that the ideal for most good talkers would be to talk extempore, but there are many difficulties in the way. The need for accurate timing is one of them; the nervousness of many broadcasters another; the need to ensure the best handling of a subject a third. The fact that the B.B.C. is held responsible for what is said, and must therefore scrutinise the manuscript, is an added difficulty. In the case of debates, where there is a much greater margin of time, and where other safeguards are taken, there are generally no manuscripts; and the freedom adds enormously to the interest. But even a carefully prepared manuscript can be read so as to convey the atmosphere of a talk.

"ONE MAN'S MEAT," ETC.

It is obviously very difficult, in fact impossible, in a general programme going out to several millions of listeners, to arrange that all talks shall please everybody. One man's meat may be another man's poison, or at any rate one man's jam may be another man's powder. An irate elderly gentleman may complain that he turned on his set and heard a boy scouts' bulletin. Alternative programmes will, of course, settle his difficulty; but, in the meantime, he can, like the magazine reader, skip the pages that do not interest him by turning off his set, and, like the theatre-goer, he can always consult the play-bill beforehand.

Apart from these specialised talks, however, travel talks and book talks seem to tie with talks on current events for the first place in general appreciation, along with series by well-known lecturers who already have a wide public through their writings.

SYMPATHETIC PERSONALITY

There do exist a few people who ask us to cut out all talks. On the other hand, we have evidence of a very large number who greatly appreciate talks, and of an increasing demand for the Talks programme and the Talks pamphlet. The truth seems to be that even the listener who does not profess to be interested in talks will listen with pleasure to a sympathetic person speaking in a natural, human and interesting way. Personality has an almost uncanny way of revealing itself on the wireless, and of revealing its absence if it isn't there. But, as in so many other sides of Broadcasting, bad reception is often responsible for prejudicing programmes, and especially talks. The voice even of an angel would be repellent if it came through as an indistinct roar, mumbling or booming according to the powerfulness of the set.

Good talks, more than almost any other part of the programme, can help to keep listeners in touch with the events that stir the world, with the books, the leaders of thought, the travellers, and the sportsmen of this and other countries. Whether the talker appeals to his hearers by illuminating familiar things, or by lighting up strange and remote subjects, he may set moving trains of thought, sparks of imagination, a wish to read more, to see more, to learn more, and perhaps to do more.

T O P I C A L A D D R E S S E S

THIS sounds very like an anomaly, a begging of the question. A talk which had no topic would either be the product of a genius for fooling or the mumbblings of a half-wit. But the word "topical" has come to mean something dealing with a topic of the moment, and, in the broadcasting sense more particularly, something that has just occurred. That is to say more especially those which are "red hot" (another new arrival in the phraseology of contemporary English usage). Roughly speaking there are two categories of these talks; in the first come talks on subjects of which it can be foreseen that they will be topical on a given date in the future. Liners, warships, great public buildings, excavations and explorations are being made, and will, upon some approximate date, be launched, declared open, finished, reported upon, and so on. But fortunately, or unfortunately, it is not yet possible to foresee that on any date, even approximately, a notable public character will die, a volcano will erupt and lay waste, or a vicarage gardener discover the philosopher's stone in the geranium bed. And so into the second category come talks on those things which must occur quite unforeseen, and these it is which are such fun to find.

The best example would be an entirely imaginary one. Fiction is often so much truer than truth. Therefore, thus: the 9.20 space on Monday evening is still vacant on the morning of the same day, and somebody on the staff of the B.B.C. is wondering whether it would not be possible to shift the centenary

date of Dante or King Charles the Martyr on the strength of some historical quibble, and make it, rather abruptly, that very Monday as ever is, and by the same token telephone to Professor Asterisk Space, the celebrated Italian authority, and get him to Broadcast at 9.20. Other schemes of the same description pass through his head, when all at once news reaches him that a Dorset man has walked from France to England on the bed of the Channel in a suit designed by himself for this purpose, and he is at this moment being welcomed by his enthusiastic townfolk. Within ten minutes Bournemouth station has had a telephone message and a telegram shot at it, and within twenty minutes someone is in a train heading south-west. The rest of that day up to a quarter to six is spent in a zig-zag course of bribery and persuasion, until at last the great man is reached. He is probably found to be surrounded by an impassable barrier of County Councillors and newspaper reporters. But there are means of passing the apparently impassable, and having got him into a corner, the proposition is made to him that he shall come to Bournemouth at once and tell the British Isles exactly how and why he walked on the bed of the Channel in a suit designed by himself for that purpose. It turns out that in spite of his daring in the world of Action he feels nervous of the world of Talk. In order to comfort him he is told that the whole thing can be written down beforehand. Then the idea of getting his thoughts arranged and his story unfolded in three and a quarter hours staggers him. It can't be done!

—he would muddle it!—he discovers a slight huskiness in his voice due perhaps to salt water!—he has promised to do something else that evening. . . . Outside the door the Mayor is rattling the handle—under the windows the crowd calls for the great man. A bell rings—it is getting dark. The B.B.C. man lights a flickering gas-jet. “Never mind the Mayor,” he says, “but tell me, did you pass any wrecks bulging with bullion, and is there really such a thing as a mermaid?” The more the Mayor rattles the handle the firmer grows the B.B.C. man’s voice. Eventually, with some clearly written sheets stuffed into his pocket and his prize held firmly by the arm, the B.B.C. man descends the fire escape, hops into a waiting car, and is whisked away to Bournemouth studio. He arrives as the announcer is opening his mouth to say that owing to the unavoidable

absence of the speaker there will be music for a change.

A train going north-east bears someone back to London, who, on the following day, gives his mind to the problem of whether, as the situation in a certain country has become too controversial even to be mentioned in a whisper, and as therefore the topical talk on it and its condition will have to be cancelled—whether, in view of this unfortunate fact, it would not be advisable to discover a hitherto unpublished poem by Keats. . . .

A talk broadcast from London was attacked in letters on the following grounds: (a) that it had a Communist bias; (b) that it was Fascist propaganda; (c) that it was anti-clerical; (d) that it was sectarian propaganda; (e) that it was frivolous and (f) that it was over-intellectual.



Illustration from B.B.C. Pamphlet, "How Writing and Reading Began," Broadcast Schools Transmissions by Sir Ernest Gray

B R O A D C A S T D E B A T E S

FROM the Broadcasting point of view debates have two tremendous advantages over ordinary "talks." The first is that any element of one-sidedness is entirely removed, and the second is that the speakers can be entirely spontaneous, as they are not bound to stick to the prearranged words of a manuscript. It is clear, of course, that these things only remain advantages when they do not apply to the wrong people. It would obviously be nauseating to hear a *two-sided* talk where one of the speakers was the only proper and competent person to talk about a specific subject of fact, and not of opinion. Again, fiasco and fatality are to be met with by letting free from pre-arranged words speakers who with well-written manuscripts are capable of complete success.

There is no longer room for doubt that a continuously increasing number of people are listening to each broadcast Debate with keen interest from start to finish; there is also no room for doubt that remarkable things can be done by this means, and will be done. The effect will be cumulative. At the end of any given year it may be possible to look back on the Debates which have been broadcast, and to find that an actual step forward in contemporary thought has been made. Nothing is such fun as argument, and really nothing is so stimulating. Perhaps it would be more meticulously true to say that stimulation of nothing else lasts so long. Lots of things are stimulating and exciting, and nothing is so good for live people as stimulation and excitement. The intoxication of oratory, of great elo-

quence, is one thing. We most of us know what it is to be carried away by the excitement of listening to a wonderful speaker, whether he is a preacher of religion or a preacher of some idea in art or politics. Who has not left the scene of some brilliant speech-making with his head in a whirl, feeling, as he did not before, that life really holds more new and interesting things than he had imagined? *But there one gets that one-sidedness*, which has been referred to.

Two incidental qualities which broadcast debates have must not be forgotten. On these occasions a small public hall is made use of, and according to the limits of its capacity, members of the public are invited to be present. Those who receive an invitation are either listeners already, and therefore will find it interesting to see Broadcasting being done (and the pleasures of their subsequent listening will be enhanced), or if not already listeners they may be inspired to take out licences. Also to most people who are good debaters the actual presence of a visible audience is of inestimable value. Not altogether because then not too much strain is put upon their credulity and because they know then for a fact that *somebody* is actually listening to them. Sometimes the strain upon the imagination is too great. Speakers are told that their voices can be heard, and they accept the truth of this statement with one part of the mind only, not with the imagination. Thus the two hundred *visible* listeners are very considerably helping the many invisible to have something worth hearing. Again, sometimes one or

two of these members of the visible public stand up in response to an invitation by the Chairman, and it is then that it is discovered that a good broadcaster has been entertained unawares.

In debate one can have all sides expressed, not by hecklers who put their own point of view in sudden, ill-tempered sentences, but by clear-headed people whose logic is given space to develop. To take, one after another, some of the main problems which *do* of themselves often arise wherever men and women start to talk; and to set up against each other exceptional men or women who stand in some form as champions of different opinions, and to have them express those opinions as well and fully as they can be expressed; and eventually, if possible, to come to some conclusion—that is worth organising—that is worth broadcasting—that is worth listening to. It is said, no doubt with some truth;

that it is not possible to reach a conclusion in argument; but that is only a half truth, and, even if no conclusion is arrived at, the stimulation of hearing good argument has a value well appreciated by every conceivable type of mind in which thought is not dead.

In May 1925, listeners were provided with a broadcast auction, when the proceedings at the sale in Messrs. Christie's rooms in St. James's, London, of pictures belonging to Almina Countess of Carnarvon were transmitted.

An uproarious performance by "Old Bill" the Walrus, the piercing shrieks of parrots, and noises by lions and other mammals have been broadcast from the London Zoo by means of a specially designed portable transmitter called the "Wireless Pram."

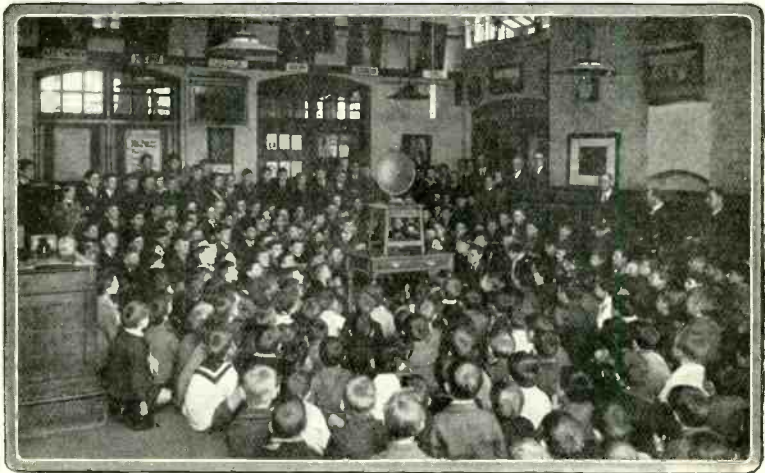

LISTENING TO ONE OF THE SCHOOL TRANSMISSIONS



INTERIOR OF CANTERBURY CATHEDRAL

Many beautiful transmissions have been heard from Canterbury. Our photograph shows the engineers fixing the microphone into position

BROADCASTING AND RELIGION

IN a national service to which nothing that pertains to the life of men is foreign, it was natural that from the beginning religion should find its place in British Broadcasting. It could not be otherwise. Even if the programmes aimed only at providing education and recreation, religion could not be denied a place; but when those who were responsible for Broadcasting set before themselves the object of raising the national standard of values and of a constructive idealism, it was obvious that the religious service should be one of the regular programme features. The policy which was adopted at the first has been fully justified, and there is now no item in the weekly programme which is more popular or which is looked for more eagerly than the Sunday evening religious service. It has been welcomed by the Church authorities and by the general public alike.

GUIDING PRINCIPLES

This successful result has been achieved by observing certain principles. First of all, the co-operation of the Christian Churches has been secured, and in connection with each Station a committee representative of the leading Christian denominations, Anglican, Presbyterian, Roman Catholic and Free Church, is responsible with the Station Director for the general arrangement of the services. Secondly, care has been taken that the broadcast service shall not enter into competition with the ordinary Church services. With the exception of those somewhat infrequent occasions when an ordinary service

is broadcast in full from a cathedral or church, the wireless religious services are held outside the regular church hours. Thirdly, nothing of a controversial character is ever allowed to pass the microphone; the sermon to be preached is normally submitted to the Station Director several days in advance, although it is rarely that he has to suggest amendments. Lastly, the type of Christianity that is presented is that of "a thorough-going, optimistic and manly religion." It does not concern itself with a narrow interpretation of dogma, but with the application of the teaching of Christ to everyday life. It is the strict observance of these principles which has for ever established the broadcast religious service in the affections of listeners.

TWO KINDS OF SERVICE

These services may be described as being of two kinds. The one is that broadcast from a church when the form of service which is there normally in use is more or less closely followed; the other that from the studio. The framework of this latter service may be the liturgical forms of the Anglican Church or the freer uses of the Presbyterian and non-established Churches, but in all the singing of hymns and psalms, prayers, the reading of Scripture and an address are integral parts. Two of these services are usually simultaneously broadcast from every Station on one Sunday in each month. While there is thus a unity of purpose and idea, provision is also made for necessary variety; the B.B.C. has no intention of stereotyping any one type of religion either in

the form or the content of its services. It recognises that among its public there are those whom sickness or age or household duties debar from attendance at church, that there are those who for one reason or another have become dissatisfied with the opportunities for organised and common worship which are within their reach, as well as those who have an undefined desire for religion but who would never class themselves as religiously minded

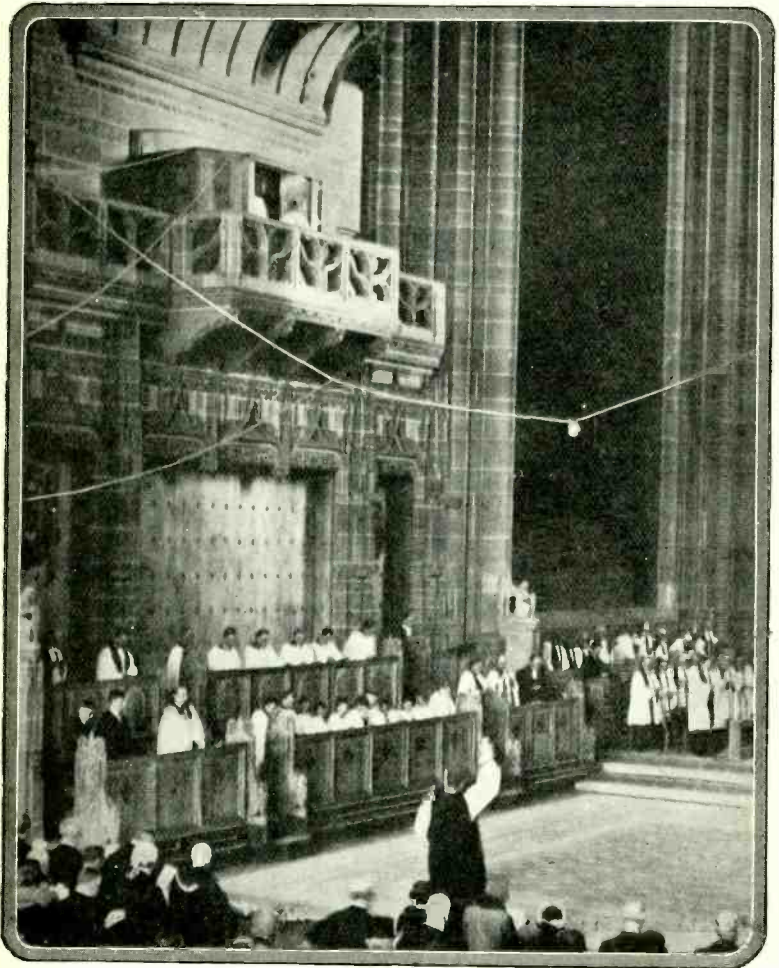

SERVICE AT LIVERPOOL CATHEDRAL

people. For each and all of these the broadcast religious service is providing what none of them would forgo without a sense of loss.

Nevertheless, the trend of evidence available is that however widely this aspect of Broadcasting is appreciated, it does not involve a falling off in church attendance; on the contrary there are clear indications that religion as broadcast is encouraging church attendance by generally enriching religious experience.

CHILDREN'S SUNDAY AFTERNOONS

Among the other features of a religious nature in the broadcast programmes, there may be mentioned the Sunday afternoon children's services (monthly) and the reading of classic passages from the Bible (weekly); there are also given occasional lunch-hour services from some City church, and from one Station at least a weekday service intended especially for invalids. A place is also found monthly in the Sunday programme for a special address on mission work overseas by a speaker who has had personal experience of this work, and a useful beginning has been made with hymn recitals in which it is attempted to improve the standards of congregational music and to introduce to listeners hymn-tunes which are both unfamiliar and good. Westminster Abbey Evensong is given at 3 o'clock every Thursday for the special benefit of the sick. Nor is the opportunity lacking for the response of listeners to the religious appeal which they have heard. The Week's Good Cause, which immediately follows the service, takes the place of the church collection, and large sums are contributed each year to hospitals and other religious and philanthropic organisations which are

seeking the welfare of mankind. Last of all comes the Epilogue, which, with its quiet suggestions through hymn and reading, fitly brings the Sunday programme to a close. It is gratifying to learn that the record of listeners' letters to the B.B.C. shows that the Sunday evening epilogue is the most popular single item in all the programmes. There is much appreciation also of the church bells and carillons, which before Divine Service help to produce a religious atmosphere through association of thought.

At a time when complaint is sometimes made that religion is losing its hold upon the world—a complaint that may be said, by the way, to be founded upon a misapprehension of religion—the B.B.C. is doing the best of service to prevent any decay of Christianity in a nominally Christian country. It is handling the subject with a broad and sympathetic understanding, with a true educational purpose and a deep sense of its responsibility to the nation. It is far from supposing that its ideals have been attained or that its methods of presentation are perfect. Each year will see developments in this department of its work, but it has already done enough to justify the claim that in broadcasting religion it is not only keeping alive but giving new life and meaning to the traditionally Christian character of the British people.

The special shipping forecasts sent out by the Daventry Station every day are designed to help skippers of fishing trawlers and others engaged in inshore navigation. Evidence proves that the forecasts are fulfilling their purpose admirably.

A D U L T E D U C A T I O N

THIS country is justified in boasting that it has always taken the lead in the development of adult education. From the days of the Mechanics' Institutes down to the present moment, the enthusiasm of our democracy for self-education has shown itself in a series of voluntary movements connected with the churches, universities, trade unions and co-operative societies, etc. Through the provision of generous financial assistance by public authorities a network of classes, study circles and other educational facilities for adults has been spread over the whole country, supported by the voluntary enthusiasm of those who benefit from these facilities. But even all this vast movement has but touched the fringe of our population and reached only the minority that is consciously seeking after knowledge and anxious to develop its mind. Everywhere the enthusiast has had to deplore the so-called "apathy" of the mass of the people, and sometimes to admit the existence of a definite reaction against anything that is labelled "education," due to a survival of the old-fashioned prejudice that education must be of a formal, painful and unpractical character.

A WIDENING MOVEMENT

The essential basis of the education of the adult is, however, *his own* activity and creative instinct; the task of the lecturer or teacher is one of stimulation, co-operation and assistance. The last year or two have seen the adult education movement going forward to widen its field so as to appeal beyond the student minority to the great mass

for whom education must take the most elementary and attractive forms. Broadcasting is likely to take a place as one of the greatest agencies for promoting this work of elementary adult education, for the vast wireless audience of many millions is infinitely greater than all the student bodies hitherto touched by adult education put together.

From the beginning the British Broadcasting Company included in its programme a certain proportion of talks intended to impart knowledge and stimulate thought, and in September 1924 the idea of giving up part of the evening programme to adult education took definite shape. The B.B.C. soon found that it could avail itself of the experience and knowledge gained by the older adult education bodies, although it was apparent from the beginning that this new form of adult education would be different in method, aim and organisation from anything that had gone before. The setting up in October 1926 of a Joint Committee of Inquiry into Broadcasting and Adult Education by the British Broadcasting Corporation and the British Institute of Adult Education was a landmark in the growth of this new form of education. Innumerable problems confronted the Inquiry, such as the relations between the new educational Broadcasting and other adult educational work, the possibilities of extending the existing educational broadcast services, the needs of listeners, the selection and treatment of subjects for broadcast education, the technique of wireless teaching, the organisation of listeners and the development of supplementary aids to study. It is safe to say that the

report of this Committee will be eagerly awaited and read by thousands.

FRESH EXPERIMENTS

All this time, however, the B.B.C. has been carrying on fresh experiments, many of them in collaboration with the Committee of Inquiry, for developing the work. In the spring of 1927 a separate Adult Education Section of the Education Department of the B.B.C. was set up, and at the beginning of 1927 the time available for adult education was extended to include five evening periods from 7.25 to 7.45 p.m. each week, together with a late evening period and an afternoon period of fifteen minutes each. This has enabled the provision of a programme of talks covering a very wide range of subjects; *e.g.* Anthropology, Architecture, Astronomy, Botany, Economics and Social History, Foreign Affairs, Languages (French

and Spanish), Literature, Music, Natural History, Psychology and Physiology.

Most of the courses in these subjects are arranged in series of six talks each. However, no hard-and-fast line can be drawn between series of this kind arranged by the Adult Education Section and a great many of the individual talks arranged by the Talks Department, which are also in the widest sense of the term adult education. Besides the establishment of a systematic programme on these lines, progress has been made in the direction of following up the series of talks by providing more help for the listener who wishes to pursue his subject further. The usefulness of a twenty-minutes talk can be enormously increased by providing the listener with supplementary aids to study in the form of summaries of the text of talks, short references for book reading, pictures and

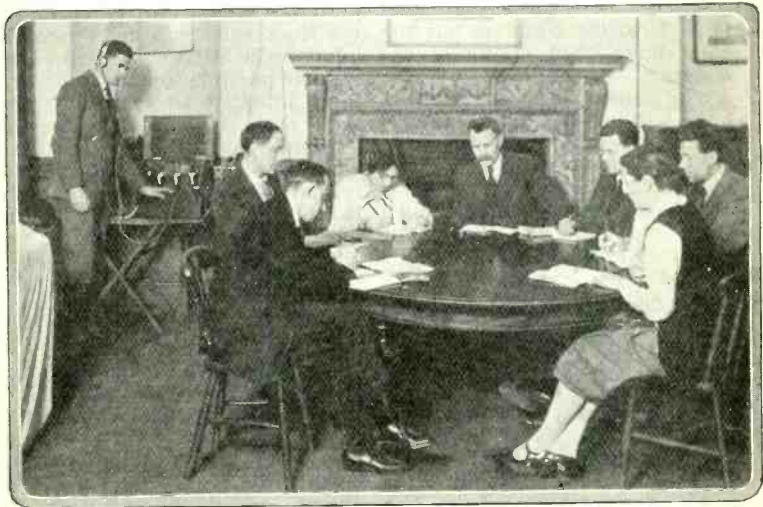

WORKERS' EDUCATIONAL ASSOCIATION

A Tutorial Class listening to a Wireless lecture at their Headquarters in Theobalds Road, London

diagrams, questions for discussion, etc. A beginning has already been made by issuing several pamphlets along these lines for use by listeners in connection with particular courses. The demand of the public for these follow-up pamphlets has been very great. In the case of one series of six talks, five thousand copies were applied for by the time the second talk had been given.

DISCUSSION GROUPS

Another kind of experiment which has naturally developed as the nature of broadcast adult education became clearer has been the formation of discussion groups which meet together in an informal way in private houses, schools, club and library rooms, etc., to discuss the talks and enter into correspondence with the lecturers. There is a great variety of ways in which these groups can operate. So far only a small number of them have been formed in various parts of the country, but the results have been distinctly encouraging. In addition to this more organised form of profiting by the wireless courses, there is a growing volume of correspondence between individual listeners and the lecturers which provides the chief evidence that the talks are serving the great purpose of awakening interest and stimulating the listener to active thought.

Here one comes back to what, after all, is likely to be the principal achievement of educational Broadcasting—the formation of intelligent public opinion, the dispersal of apathy through the awakening of mental curiosity, the formation of sound social habits, and the stimulation of thought into action. Take the reading of books. The past two or three generations have seen the

creation of a great public library system in this country which enables the citizen to get books, to study for himself, to acquire the knowledge he wants. The great drawback has been that so few avail themselves of these advantages. Now, as a result of recent inquiries made from public libraries all over the country, the B.B.C. is informed by scores of public librarians that the wireless talks on Literature, Music, Science, Travel, social subjects, etc., are regularly followed by a substantial increase in the issue from the libraries of books referred to by the lecturers. Here is one example of what adult educational Broadcasting can achieve in raising the general level of culture. This is surely democratic education in a very wide and sound sense.

In the near future it is hoped that the facilities for adult educational Broadcasting will be still further extended as the establishment of alternative wireless programmes enables an extension of the time which can be devoted to adult education. It will then become possible to cater for many more interests as well as to provide still more attractive programmes for the general listener who, whilst he has no time for formal education, is ready to be led insensibly along those paths where education, recreation and amusement are indistinguishable.

The ceremony of Changing the Guard was twice broadcast during 1926, with the approval of H.M. the King. It should be mentioned that His Majesty sent an order for the band to continue playing beyond the regulation time, thus giving additional pleasure to millions of his subjects throughout the kingdom.

SCHOOL BROADCASTING

AMONG the first to recognise the change that Broadcasting would effect in the conditions of everyday life were the teachers. Music, plays, debates, contact with great personalities, with great public occasions, from which the country teacher had hitherto been cut off, which even the town teacher did not have his full share of—suddenly all these were brought within daily reach. Flagging interests were revived, new interests awakened, points of contact with life increased tenfold.

And at once such teachers began to want for their pupils what they were getting for themselves from Broadcasting. Teachers know well how hard it is to keep abreast of the progress of knowledge while they are immersed in the day's routine. They know—and the most highly educated and the most con-

scientious of teachers know best—how many subjects they have to teach from a surface knowledge only, and how in the boiling-down of text-books all the life and glamour are often lost before the facts reach the children.

Could not the wireless bring to the schools something that the very best class teachers could not give continuously—variety, inspiration, lessons at first hand, and, finally, an increased consciousness of their being part and parcel of the whole modern society?

GOOD RECEPTION ESSENTIAL

Even before any desire for special transmissions to schools was definitely expressed by teachers as a body, the B.B.C. had seen that there was a possibility that Broadcasting could be used as a medium of school



A CLASS AT WORK DURING THE WIRELESS LESSON AT ELSTON SCHOOL
E 2

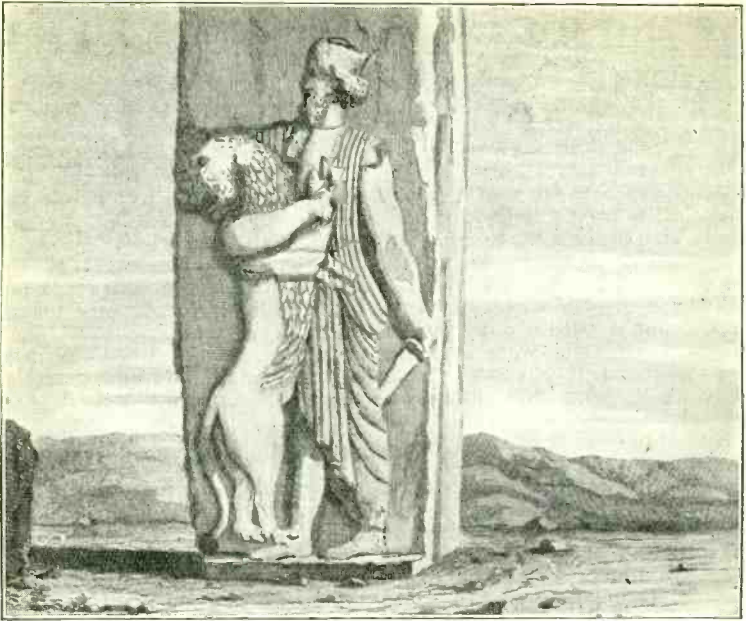

KING AND LION

Illustration from the B.B.C. Schools Transmissions pamphlet, "How Writing and Reading Began." Broadcast by Sir Ernest Gray

education, and soon, all over the country, as far north as Orkney, as far south as the Channel Islands, such teachers as Sir Walford Davies, Mr. Geoffrey Shaw, Mr. E. Kay Robinson, Professor Lyde and Sir Stanley Leathes had joined the staffs of hundreds of schools. Now many thousands have their school set with its loud-speaker, and School Broadcasting has become a subject for educational research on the part of official educationists. For, as in the case of any new educational medium, the practice brings many problems to light, and suggests many lines of improvement. Good reception is a *sine quâ non* of School Broadcasting, if listening is not to be a strain,

and if the personality of the wireless teacher is to reach his unseeing pupils. The choice and maintenance of the school set are problems in themselves to most teachers, and the B.B.C. have found it necessary to institute a service of Schools Advisory Engineers to help to solve them.

Who is to pay for the school set and its maintenance? That is another problem, happily solved up to the present stage by the enterprise of teachers and children. From one school we hear how the aerial mast—a tree presented by the squire—was felled, dragged, trimmed and set in position by the older boys. From others come programmes of concerts and plays given by the

school in order to raise the necessary funds. Some schools get grants from their Local Authority : some build their own sets in the handiwork centres.

THE TEACHER'S INTEREST

Then, when the set is installed and going well, the teacher on the spot must enter into the spirit of the thing, and train himself to work with his wireless colleague. And the expert at the microphone, no matter how great and inspiring he is, must learn to adapt himself to his medium. The form of the wireless lesson—how much exposition, how much demonstration, how much active response from the class—has yet to be determined in relation to the various subjects. Sir Walford Davies can make his invisible class sing with him, but Mr. Kay Robinson cannot take them into the school garden to illustrate the difference between a monocotyledon and a dicotyledon,

or to the woods to watch a stag shedding its antlers in the spring.

A great deal of work has already been done, and still more remains to do. Remember the motor-cars of twenty years ago. Who, starting in his car in 1907, knew how he would reach his journey's end, or when? Of the sixty-two cars that started for Brighton in one of the earliest reliability trials, only two arrived! School Broadcasting has never tried the faith of its advocates so sorely as this, but, like motor transport, it will be developed year by year by intelligent *use*. Many have made good use of it from the start, and there is little doubt that, long before twenty years are past, continuous investigation and experiment will have evolved a service of wireless lessons fully satisfactory even to such as those whose faith was shaken because of the sixty motor-cars that broke down by the way.



Illustration from the Schools Transmissions Pamphlet, "Boys and Girls of the Middle Ages"

R U N N I N G C O M M E N T A R I E S

THE perfect commentator, like the economic man so convenient to the hypotheses of nineteenth-century philosophers, does not exist. There are, indeed, commentators who can please all the people some of the time and some of the people all the time, but there never has been found, and there never will be, the man who will please all the people all the time.

The Oxford Dictionary defines a commentator as a "writer of a commentary," a definition, of course, laid down before the days of Broadcasting. A commentary, according to this excellent and useful work, is an "expository treatise, or a comment." Were the B.B.C. to announce in their programmes that "an expository treatise" on the Derby or on the Boat Race would be broadcast, there would be trouble. "Comment," too, is hardly satisfactory, and the use of the word resulted in a good deal of quite unmerited criticism after the first Broadcast of a Rugby football match because the nimble-tongued gentleman in the observation box gave his hearers a thrilling picture of the game but did not, while play was in progress, give his own views of what ought, or ought not, to have been done. It was, in fact, a narrative and not a commentary. He and all his species are, strictly speaking, narrators and not commentators. Still, the English language gives one every excuse for using a word in a sense somewhat different from its classical definition.

NEWS VALUE

Running commentaries fall easily under two different headings—Sporting, and purely De-

scriptive. In the former, of course, considerable technical knowledge is required of the commentator, and any of his shortcomings as an artist visualising a scene and transcribing it rapidly into words are, to a certain extent, modified by the fact that his very words have news value. His efforts to describe the dresses of the crowd may make him an object of pity in the eyes, or rather the ears, of the fairer sex, or the beauty of the scene on the downs at Epsom or in the Pavilion at Old Trafford may escape him altogether, but at least he will satisfy a large number of listeners when he announces that Call Boy has won, or that Macdonald has done the hat trick.

MISTAKES EASY

Still, however great his technical

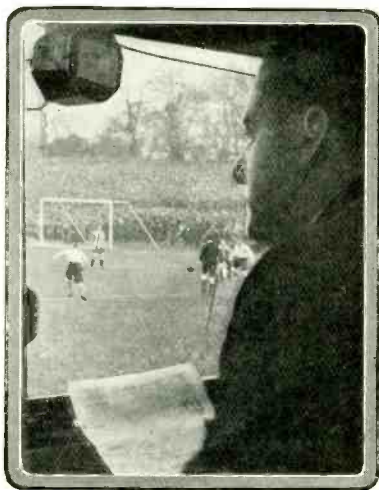

HOW THE COMMENTATOR SEES IT
Broadcasting a Football Match



BROADCASTING THE DERBY

A picture which recaptures the thrill experienced by those who heard the vivid description of the Great Race of 1927

knowledge, the sporting commentator has no easy task before him, and experts in the Racing, Football and Cricket worlds have confessed without shame after their first Broadcast that the preceding night had found them distressfully wakeful. "There's many a slip 'twixt the eye and the lip," and though the expert may know perfectly well the name of the winning horse, his mind, darting to seize the names of the second and third, may easily jerk out on to his lips and into the microphone the correct names, but, alas, in inverse order.

FLUENCY

In addition to expert knowledge, the sporting commentator must also obviously have a good voice and great fluency. His thoughts must transpose them-

selves into words accurately and easily. He must have the knack of selecting from the mass of material that flashes into his mind through the medium of his eyes those things which are most pertinent to a clear narrative of the game in progress. There is obviously no time to turn into words every movement on the football field and on the tennis court; only those which are most significant can be described, and a commentary which consists of a sequence of broken incidents is meaningless to the listener.

PRESENTATION

Technical knowledge and fluency, even when supported by a good voice, are by no means enough. The backers and supporters will gulp down the facts, but they

must be recognisably transmitted in the form of a series of delirious thrills to those with no direct interest in the result. Here, of course, the engineers can help him by bringing in as a background the roars of the crowd and the incidental noises of the game.

It is often forgotten that a commentator depends largely for his success upon the nature of the event which he is describing. The Boat Race, for example, formed an admirable subject for a running commentary: it lasted long enough, but not too long, and, thanks to a fine technical achievement on the part of the engineers, the commentators were able to follow just behind the crews with a perfect view of the race. These factors and, of course, to a large degree their own skill, helped to make it the most successful event yet Broadcast. Football and tennis, where the struggle is more protracted, have also proved amenable to the commentator's art.

RACING

Racing, though a fine subject, is the most difficult of all. Investigations have proved that a race Broadcast in sections by several commentators would be a veritable Babel of confusion. The solitary commentator has by no means a clear view even in a short race like the Derby, and all his skill has to be concentrated into three short minutes; whilst in the Grand National only a tiny circle of experts is able to pick out the colours at the far end of the course, with the result that their faculties, for a time at least, are concentrated on seeing rather than on speaking.

CRICKET

Cricket, of course, is in a totally different category. Here the com-

mentator, however pleasing his voice, entertaining his reminiscences and interesting his criticism of the game, has often to speak thirty-six hours away from the result of the game.

Turning to purely descriptive Broadcasts, such as the arrival of President Doumergue at Victoria Station, the commentator has an even more difficult task. Here there are no results to give his efforts news value, and technical knowledge counts for very little. The formal intricacies of a ceremonial make no appeal whatsoever to the average listener. A good voice, fluency, and an eye for what will tickle the fancy of those listening are all important. The significance of the ceremony, however eloquently expressed, is as nothing to the knowledge that the Prime Minister cannot get his gloves on, or that a "Distinguished Visitor" has just cracked a joke with Lord So-and-So. In fact a good commentator for Broadcasts of this kind is born and not made, for obviously he cannot rehearse beforehand.

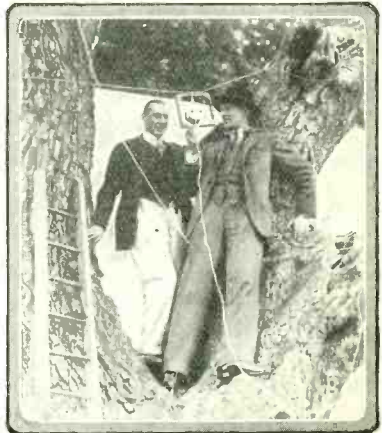

BROADCASTING BUMPING RACES

OUTSIDE BROADCAST FEATURES

OUTSIDE Broadcasts are those whose origin is outside the studios, and include cathedral and church services, concerts, speeches, debates, theatrical and operatic excerpts, dance music, running commentaries on sporting and other events, orchestral performances, concert parties and ceremonials. Some of these, organised by members of the B.B.C. staff, when once the particular site has been connected up with our local Station and the microphone adjusted to the balance position and in circuit with the apparatus and lines, present no points of unusual interest. They are then equivalent to studio Broadcasts. In other than a few exceptional cases which may combine both methods, the material to be transmitted is amplified locally and received via ordinary telephone lines by the Station Control Room at normal speech or music frequency. It is then broadcast in the usual way and not, as some listeners still believe, direct from the site.

In certain cases, the Aeroplane Concert of 1925 and the Boat Race of 1927, for example, the sounds were broadcast direct from the aeroplane and the launch on wavelengths of 900 metres and 115 metres respectively, received locally, converted to normal frequency, transmitted as such to the Control Room at Savoy Hill and broadcast from London, Daventry and other stations.

TECHNICAL NECESSITIES

As an additional complication, provincial stations received the Boat Race description from the Daventry aerial and re-broadcast it on their own wavelengths.

Every O.B. of the simplest

and most straightforward nature necessitates the provision of two complete telephone line circuits, known as "Music" and "Control," between the site of the performance and the Station Control Room. Each of these circuits is generally a combination of trunk and private local lines provided by the Post Office to order and routed in such a manner as to transmit the widest range of frequencies. At the terminal position are installed the necessary amplifiers in duplicate, high-tension and low-tension batteries, head-phones, switches, and the usual gear, including the microphone circuits. When the waiting engineers are advised over the control line that the Station is ready, the microphones are sensitised and the sounds faded in by the Station concerned.

In complicated cases (such as theatrical excerpts, Seaside Nights, the Grand National and the Derby), local fade-units are installed which provide facilities for bringing in and out various microphones without the transmission of those disturbing bangs which are so offensive to sensitive ears. By the time that the delectable moment of actual transmission arrives, all kinds of tests will have been carried out and often a series of minor crises—not always technical—overcome.

STILL PIONEERING

It should be remembered that the B.B.C. is still pioneering in the technique of O.B.'s. Its activities have not, in consequence, been without humorous aspects. In the now distant days of 1926, while a contract with the newspapers precluded the broadcasting of one word of descriptive matter



THE MENIN GATE BROADCAST

The King of the Belgians making his speech at the opening of the Menin Gate Memorial. The ceremony made one of the most memorable transmissions in British radio history

of events as they were taking place, attempts were made to broadcast some Derby "atmosphere" from Tattenham Corner. It had seemed possible at least to put out the rattle of the horses' hoofs as they swept round Tattenham Corner within a foot or two of our microphone, and to record the shouts of the book-makers, the persuasive efforts of the tipsters, and the cheers or groans of the public according to the popularity of the winner. Listeners will remember that terrible Derby. From early in the morning to late afternoon the rain came down in torrents, and during the Race, not only

were there no sounds from the hoofs in the soft going, but even the bookies, tipsters and onlookers were more occupied in taking shelter under their umbrellas than in speeding home the winner. Consequently, it was impossible to record anything in the least typical of Derby Day, despite the noble efforts of helpers, including the very plucky little Vera Lennox. It was not permissible even to mention the name of the winner.

During the Derby Broadcast of 1927, after Geoffrey Gilbey had left our position on the roof of the Club Stand to go down to the Unsaddling Enclosure, George

Allison had to give a description of the reception of the winner. It may be said of Mr. Allison that his dimensions extend chiefly sideways. It was necessary for him, wearing a mask-phone, which does not add to one's personal dignity, to lean over the roof, which had no kind of rail or protection, and view the proceedings a sheer drop of more than sixty feet below. Mr. Allison, still broadcasting furiously, was held in a close embrace by a gigantic member of the B.B.C. transport staff—much to the amusement of the onlookers, who were calculating the odds against the possibility of a tragic *dénouement* and the picture of these two

descending, locked in each other's arms, to the enclosure below.

From a popular point of view probably one of the most appreciated Outside Broadcasts is Sandler's orchestra from the Grand Hotel, Eastbourne. In part this is due to the exceptional acoustic properties of the Grand Hotel Lounge. There is an extraordinary "liveness" in these transmissions, the effect being almost stereoscopic, if a word belonging to another medium may be legitimately borrowed. It is as if the microphone were receiving with both ears instead of one.

In general, theatre Broadcasts are the most difficult to carry

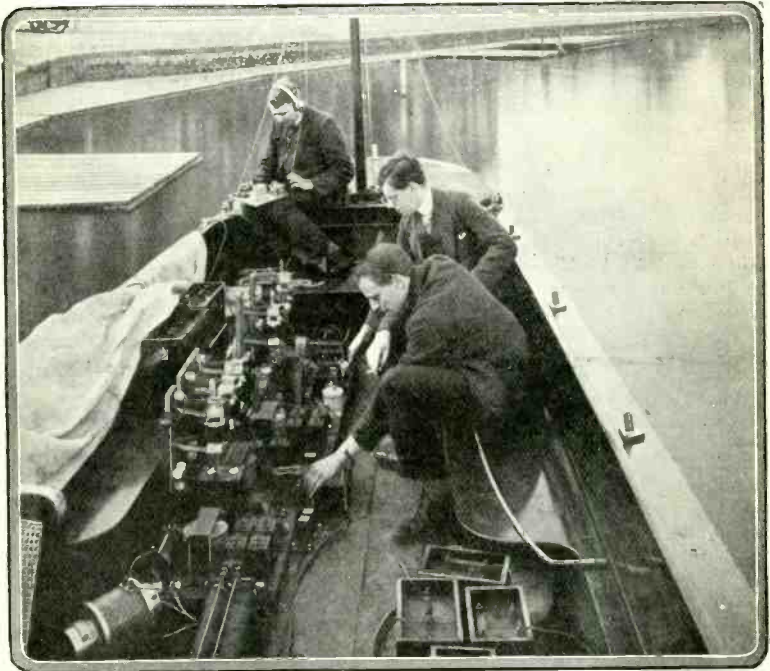

PREPARATIONS FOR THE BOAT RACE

B.B.C. engineers installing apparatus on the "Magician," from which a description of the 1927 Boat Race was broadcast

out with good quality; acoustically, via the microphone, stage performances are nearly always hollow-sounding. Great care is necessary in maintaining correct balance between the orchestra and the various artists as the latter move from place to place. The present system involves the use of two or more microphones controlled through a fade-unit in the wings. A successful theatre Broadcast depends upon quick observation in forestalling the movement upon the stage. There is a wide field here for further experimentation and improvement.

CATHEDRAL SERVICES

It may be of interest to refer briefly to the problem of Cathedral Broadcasts, since these are usually of special interest to listeners, and extremely difficult to carry out effectively. Chiefly on account of the resonance associated with Cathedrals, the abnormal distance separating the speech, organ, congregation, and choir microphones, and the bells which are often broadcast as an introduction to the Service, very thorough preliminary tests have to be carried out when possible to ensure continuity in the Broadcast and to fix suitable microphone positions for clarity of effect. Generally speaking these positions should be as close to the speaker and sources of music as possible without danger of blasting; otherwise there is risk of "mush" and echo ruining the transmission. It is particularly necessary also to install the wiring and apparatus so as not to be unsightly, and this requires considerable thought.

Each Cathedral Broadcast requires individual treatment; Lincoln, for example, is more easily dealt with, the high woodwork and details of internal construction resulting in better acoustics,

particularly for choral and solo work. The difficulties with Canterbury and Westminster Abbey, after much preliminary work, have now been eliminated, helped by a permanent installation of wiring, and consequently a more or less cut-and-dried technique.

York, Norwich and Liverpool are among the more difficult. In the case of Norwich the numerous pillars disperse the sound waves and create subsidiary echoes which are technically very disconcerting. York is very lofty; in consequence the echo is extremely noticeable during Broadcasts from the Minster. Despite this some of the exceptionally fine Musical Services held there, more particularly the Annual Military Service in 1926, have been successfully transmitted.

The Liverpool Cathedral organ is in a class by itself. Although so far only two Organ Recitals have been broadcast, the preliminary installation and tests occupied six days of constant work. The organ, of over 10,000 pipes, is in two parts, and three microphones in different positions in parallel were necessary to include the full range of the instrument; all were suspended from the roof, which is 116 feet from the ground, respectively 90 feet, 45 feet and 45 feet from the floor. During the tests the engineers had continually to climb the full height of the Cathedral before adjustments to the microphones could be carried out. It may interest the reader to know that the maximum allowable echo "lag" of $1\frac{1}{2}$ seconds is exceeded in Liverpool Cathedral. This "lag" when as much as 2 seconds makes clarity and quality in broadcasting impossible.

MENIN GATE

On July 24th this year the Service at the Dedication and

Unveiling of the new Menin Gate Memorial at Ypres was broadcast throughout the country. Special arrangements had been made for its reception in certain churches, public halls and open spaces, so that those unable to be present in Ypres might nevertheless take part in this tribute to the memory of our people who had been killed in the Salient, but who have no known graves.

Consequently the staff concerned felt a very great responsibility in the matter, and every possible precaution was taken, in co-operation with the British and Belgian Post Offices, to ensure a successful line connection between Ypres and London. A special piece of apparatus was designed and installed for the first time in the Ypres Telephone Exchange with a view to eliminating line noises, and proved successful in conjunction with the new and

efficient Ostend channel telephone cable.

FRIENDLY AUTHORITIES

All successful O.B.s depend upon close and friendly co-operation between the authorities outside, the Engineering Department of the Post Office and the B.B.C. This is almost always received. It is a curious fact that even when outside associates do not at first enter fully into the spirit of Broadcasting, they seem very soon to capitulate to the interest of the proceedings, a spirit which is always cultivated.

Some United States scientists advance the interesting theory that it should be possible to recall historical events by locating and tapping the wavelengths on which these events are alleged to be permanently recorded.

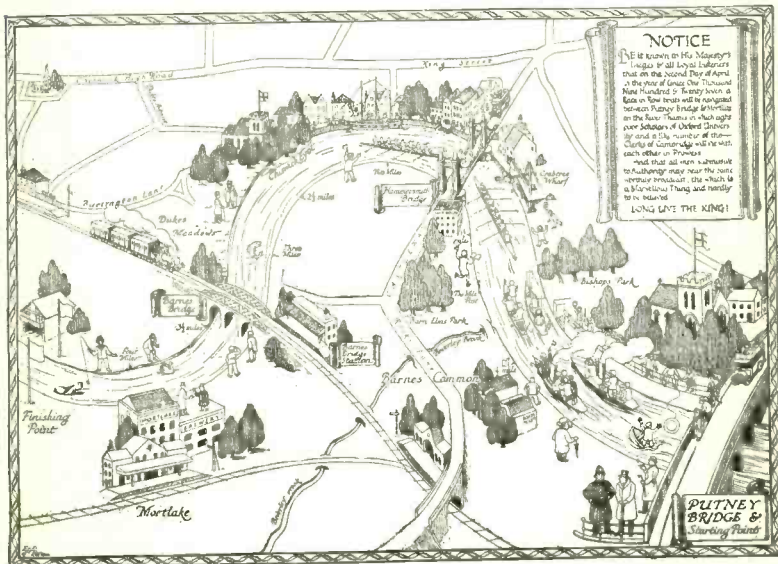

"THE RADIO TIMES" CHART FOR THE BOAT RACE BROADCAST

THE CHILDREN'S HOUR

QUITE early in the development of Broadcasting there sprang up the custom of regularly devoting a small portion of the programme time to items specially suited to children, and from the outset the idea "caught on." It was as good an example as could be found of the pleasing principle contained in Longfellow's

"Between the dark and the daylight,
When the night is beginning to lower,
Comes a pause in the day's occupations,
That is known as the Children's Hour."

In the Broadcasting environment this period was a pause in the day's occupations in the truest sense of the word. Every member of the staff who had any contribution to make to the pleasure of child-listeners co-operated very willingly. In their service he put aside pressing problems, urgent tasks and official staidness, braced himself to overcome the fatigue that results from a strenuous day, and established a tradition that still survives in the fact that almost anybody "on the strength" will give to the Children's Hour any assistance that lies within his power.

At the beginning, naturally enough, there was nothing very systematic about the arrangements for the programmes. They were "an extra," as it were, and nobody had much time to give to them. It was not any one person's main job to plan and supervise them, and, looking back, it is astonishing that so much good work was done under such conditions.

But with the gradual establishment of the Children's Corner, or the Children's Hour—it is called indifferently by both names—as a

definite and popular part of Broadcasting activity, it became clear that this section of the work must be systematically organised, like other sections, and, as opportunity arose, steps were taken to appoint at every Station some one official who should be responsible for the preparation of programmes and their transmission over the microphone.

PROBLEM OF AGE

Such a task has peculiar difficulties. First and foremost, what is a child from the Broadcasting point of view? Anyone who has had experience of children knows that there is a wide gulf between a boy or girl of eight and one of twelve, and an even wider gap between the youngster of twelve and the adolescent of sixteen. The planning of programmes for children is seriously complicated by the fact that the children themselves vary greatly in age, mental attainment, personal tastes, experience and environment—to name only some of the factors involved.

There is only one short daily period available for the Children's Hour, and the programmes must satisfy, as far as possible in that one period, requirements that would need several periods to satisfy thoroughly.

Another great difficulty lies in the determination of what is "a good programme" in relation to the Children's Hour. The period set apart for them comes at or near the end of their day, in most cases between school and bedtime or school and home-work. Inquiry, reflection and experience have shown that children view with distaste a type of programme definitely and obviously educational—school out of school, in

fact. The accepted principle is, therefore, that the purpose of the Children's Hour is mainly recreation and not instruction or moral improvement. In the Standing Instructions it is laid down that "if the organisers of the Children's Hour keep in mind the creation of the atmosphere of a good home and the presentation of real beauty in song, story, music and poetry on a plane attractive to the young, they will inevitably, without self-conscious efforts, raise the standard of culture in their young listeners, and the result will be educative in the best sense."

A survey of the elements which one might reasonably expect to find in the programmes gives some such table as the following:—

STORIES: Tales about fairies, gnomes, etc.; tales about school-life, adventure, animals; classical legends and folk-tales; excerpts from famous books; stories about great personages and great achievements.

INFORMATIVE "CHATS": Simple, interesting (and often amusing) talks on books, music, animals, railways, ships, aeroplanes, gardens, the countryside, other lands and peoples, astronomy, hobbies, games.

MUSIC: Songs and part-songs, including nursery rhymes, folk-songs, songs of nature and animals, ballads, songs of the "Gaudeamus" type. Instrumental selections, including classical and modern compositions; chamber music; operatic music.

VERSE: Old and new.

MISCELLANEOUS: Plays, competitions, concert party programmes, staff programmes, programmes for special occasions, "My Programmes," programmes S.B. from other Stations, programmes by children.

These and other features are mixed together in a way which

makes for variety, homogeneity, reasonable proportion and frequency. Special care has to be taken that nothing is included which is frightening, harmful or subversive of the training that is being given in the school and the home.

LETTERS

In the planning of programmes the opinions not only of children but also of their parents and teachers enter largely. The letters received from listeners are in this, as in the case of other types of programme, by no means conclusive. But if they are numerous, unbiassed and drawn from all sorts of people, they are bound to be a useful indication of programme suitability and must be given some weight. During the year 1926 the number of letters received in connection with the London and Daventry Children's Hour was 54,334. These concerned many subjects, but 8,810 of them contained expressions of approval of the work that was being done, while only 22 contained adverse comments of any kind—which means that 400 people expressed satisfaction for every 1 who expressed disapproval. It is noteworthy that the letters of appreciation received in November 1926 were just over twice as numerous, while the letters of criticism were less than one-third as many, as those received in the corresponding month of the previous year.

A useful and interesting corollary to the Children's Hour is the Radio Circle. Every Station has its own "Family" of youngsters, and, though the name given to it, the activities with which it concerns itself, and the rules governing it may vary slightly from the corresponding features of another Station, the basic principles are the same in every case. The

general aims of the Circle are two : to link together those who arrange and broadcast Children's Hour programmes and those who listen to them, and to turn to altruistic usefulness the vast amount of energy presented by some thousands of children.

Every Station has its own "good causes," and devotes to them the contributions (monetary and otherwise) made by the Circle members. In this way a substantial amount of useful work has been done. Membership of a Radio Circle carries with it the right to wear a special badge, and in some cases it confers the privilege of receiving Broadcast birthday greetings.

Formerly admission to a Circle was by the payment of an entrance fee which gave membership for an indefinite period. At the end of four years, however, it was found that the lists were inaccurate so far as concerned actual and active members. In June 1927, therefore, it was decided to substitute

an annual subscription for the entrance fee.

The atmosphere surrounding the Children's Hour is peculiar to this section of the Corporation's activities, the intention being to maintain during the broadcasting of the programmes a "happy informality" between the participators themselves on the one hand and between participators and listeners on the other. This laudable aim is difficult to carry out, and great care has to be exercised lest the "informality" should open up the way to "cheapness." The danger is, however, fully recognised and provided against. The note of friendliness led from the outset to the general use of the terms "Aunt" and "Uncle" to denote those who broadcast the programmes. There has more recently been some restriction in the use of these names, but no better ones seem to be discoverable, and they continue, therefore, to be employed, in a limited fashion, as courtesy titles.



Illustration by Elinor Lambert from the Schools Transmissions Pamphlet, "Boys and Girls of the Middle Ages," by Rhoda Power

The Loudspeaker of Distinction

British—

Guaranteed

The very **CELESTION** *SOUL OF MUSIC*



Model C14

an exquisite combination of
ELEGANCE AND EFFICIENCY
IT IMPROVES WITH AGE

CELESTION radiophones have attained the highest pinnacle yet reached in loudspeaker design. Their beautiful appearance is only excelled by the extraordinarily natural response they give

FIRST ON MERIT—ON DEMONSTRATION

Ask for demonstration or write for illustrated literature
CELESTION—33 VILLIERS STREET—STRAND, W.C. 2

Phone: Ger. 0397

Announcement of Celestion Radio Co., Hampton Wick, Kingston-on-Thames

SECURITY FIRST



TOTAL FUNDS £35,790,927

SPECIALISES IN MOTOR INSURANCE

POLICYHOLDERS HAVE THE BENEFIT OF—
Unrivalled personal service.
Liberal policy conditions.
Own choice of Repairer.
General authority to order immediate repairs.

LIVERPOOL:
NORTH JOHN ST.

HEAD OFFICES

LONDON:
LOMBARD ST.

SUCCESS OF S.O.S. MESSAGES

IT is nearly a quarter of a century since the world was thrilled by the first wireless S.O.S. message, and even to-day the mention of S.O.S. conjures up visions of sinking ships and rough seas.

It was inevitable that part of the functions of the B.B.C. should be to help those who were in real distress. The S.O.S. service has been the means whereby literally thousands of persons have been recalled back home, in time to see and speak to some member of their family who before they left was hale and hearty, but now lay dying. During the last year and a half a total of 1,549 S.O.S.'s were sent out, and it is known that at least 600 of these were successful in their object.

A service like this can very easily be misused, and there are unscrupulous persons who would take advantage of it for purposes of their own. Accordingly, it is now insisted that where an absent relative, whose address is unknown, is wanted urgently at the bedside of a sick person, the doctor must certify that the patient is dangerously ill. The only messages giving descriptions of people who

are lost which can be broadcast are those that come through the police. After all, the police are the people primarily responsible for tracing lost persons, and they know much better than the B.B.C. or the applicant whether in each particular case the broadcast service is likely to be useful.

Those in charge of the S.O.S. service have at times to be stony-hearted, and must seem, to those who come to them in trouble, callous and tied up with "red tape."

The service has, however, its lighter side, and it is hard to take seriously an agitated request from a young lady for a partner for a dance, or a somewhat unintelligible conversation with a more aged female, who wanted an S.O.S. sent out for her missing false teeth. Luckily there is a fixed rule that no message for lost property can be sent out, so that it is not necessary to weigh the relative merits between such things as a wooden leg, a lost perambulator, or a pet cockatoo.

Messages have reached people in curious and distant places such as the Sahara, Persia and Australia, and this free service has been a boon to rich and poor alike.

In view of the greatly increasing number of S.O.S. messages that the British Broadcasting Corporation is asked to broadcast, listeners are reminded of the rules and procedure which must be adhered to, careful attention to which will save a great deal of time and trouble to all concerned.

The B.B.C. will broadcast messages requesting relatives or friends to go to a sick person only when the Hospital Authority or the Medical Attendant certifies that the patient is *dangerously* ill, and if *all other means of communication have failed*.

In no case can an S.O.S. be broadcast requesting the attendance of relatives, etc., after death has occurred.

Originators of S.O.S. calls would help considerably if they would let their nearest Station know if the S.O.S. has been successful or not.

S.O.S. calls for 'missing' people cannot be broadcast unless the B.B.C. is directly requested to do so, in the case of London or Daventry, by New Scotland Yard, and, in the case of provincial Stations, by the Chief Constable of the district in which the Station is situated.

No S.O.S. can be put out regarding lost animals or property.

B. B. C. TIME SIGNAL CHART

WEEK-DAY SERVICE

Station.	10.30 a.m.	Noon.	1 p.m.	3 p.m.	4 p.m.	5.15 p.m.	6 p.m.	6.30 p.m.	7 p.m.	9 p.m.	10 p.m.	Midnt.
2 LO		Big Ben	Big Ben	Big Ben		Big Ben	Big Ben	G.T.S.	Big Ben	G.T.S.		Big Ben
5 XX	G.T.S.	Big Ben	Big Ben	Big Ben	G.T.S.	Big Ben	Big Ben	G.T.S.	Big Ben	G.T.S.	G.T.S.	Big Ben
5 GB				Big Ben				G.T.S.			G.T.S.	Big Ben
Other Stations								G.T.S.	Big Ben	G.T.S.		Big Ben

SUNDAY SERVICE

Station.	10.30 a.m.	3.30 p.m.	4 p.m.	8 p.m.	9 p.m.	10 p.m.
2 LO		Big Ben		Big Ben	G.T.S.	
5 XX	G.T.S.	Big Ben	G.T.S.	Big Ben	G.T.S.	G.T.S.
5 GB		Big Ben		Big Ben	G.T.S.	
Other Stations		Big Ben		Big Ben	G.T.S.	

Reference.—Heavy type indicates Compulsory Time Signals. Ordinary type indicates that Time Signal will be radiated if circumstances permit.

Note.—Programmes beginning at times other than normal broadcasting hours will be preceded by a Time Signal from **Big Ben** (if available).

WEATHER FORECASTS

THERE are more sets switched on at 6.30 p.m. and 9.0 p.m. than at any other time of the day, for at those times the News Bulletins and Weather Forecasts are broadcast from all Stations. These two regular services have a wider general interest than any other item in the broadcast programmes. The desire for news is fundamental in humanity—as witness the number of newspapers and the magnitude of their sales—and the desire for news of the weather is common to everyone in these islands, which are not gifted with the regularly fine weather of other and more southerly climates. Farmers, holiday-makers, the cap-

tains of ships along the coast, all have a special reason to listen at 6.30 and 9.0, but there are few other listeners who do not indulge the national complex and switch on the loud-speaker or pick up the headphones with an unspoken prayer that they may not hear that another “deep depression” is in the offing.

The weather forecasts are of two kinds: those broadcast at 6.30 and 9.0 p.m. at the same time as the General News Bulletins; and the Daventry shipping forecast which is put on the air at 10.30 a.m. and again after the Second News Bulletin at 9.15 p.m. The Weather Forecast covers the whole land area of Great Britain for the



[Reproduced by permission of the Proprietors of "Punch"]

THE DECLINE OF LOCAL PROPHECY

"Sky be very bad to-night, Jarge. What do that mean?"
"Can't tell 'e. 'Erbert. Us'll 'ear it on wireless later."

period of the next twenty-four hours. It is short and to the point, containing few technical terms to baffle the listener without meteorological knowledge. A typical example of this forecast is the following:

"An anticyclone off our S.W. coasts is gradually extending north-eastwards, while small secondaries move eastwards across the northern half of the kingdom. Weather will be mainly fair, but a little cooler. Temperatures, however, will continue high for the time of year. There will be a few local showers, or perhaps drizzle, and morning mist or fog will be rather widespread. Local showers will be accompanied by thunder.

"Further outlook:—Mainly fair and warm over southern districts; rather uncertain in the north."

For the benefit of listeners who are not conversant with the meaning of such terms as "anticyclone," "depression," "secondary depression," there are at fairly frequent intervals broadcast talks on meteorological subjects, and articles in "The Radio Times."

The second form of Weather Forecast is that known as "the Daventry shipping forecast," which is put out from 5 XX only and is intended for the use of shipping along the coasts within range of the Daventry transmitter. This forecast covers briefly the various coastal areas, giving probable weather and winds. When it is given for the first time, at 10.30 a.m., it is read twice—once at normal reading speed and again at long-hand dictation speed so that ships' captains may have it taken down for reference.

These forecasts are supplied by the Meteorological Office of the Air Ministry at Adastral House, Kingsway, which has to prepare the fullest and most accurate weather reports in the country owing to the immense influence of weather conditions upon aircraft in flight. Their interest for listeners is an accepted fact, as witness the accompanying cartoon which appeared in the pages of "Punch" some time back. This is a service discontinuance of which would raise a storm of protest all over the country. Listeners must have their weather forecasts, however grim hearing they may make.

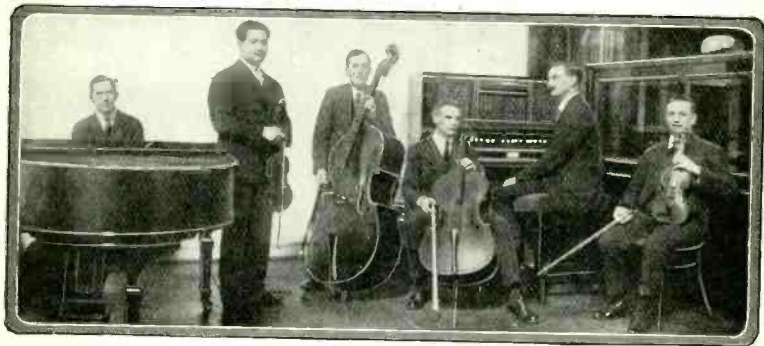

SANDLER AND HIS ORCHESTRA

The regular appearance of these musicians in the Sunday evening programmes, relayed from the Grand Hotel, Eastbourne, has long been a popular feature with listeners

BROADCAST CHARITY APPEALS

PROMISCUOUS begging is one of the curses of modern life. The War sanctioned it, and like so many of the evils of the War, it is with us still. The generous man began by spending all his money in buying flags. Flag-days had no sooner waned than he found all the resources of modern large-scale publicity being invoked to shatter his parsimony and play on his charitable emotions. On hoardings, on the buses, in the newspapers, appeal after appeal, phrased by experts, for really deserving objects, have given the man in the street an uneasy feeling that the world is full of outstretched hands.

When Broadcasting began, the question of charity appeals soon arose. Obviously the cause of charity could not be ignored; equally obviously, appeals broadcast irregularly throughout the programmes would be apt to annoy those listeners who heard them, whilst, from their very irregularity, many listeners would miss them altogether.

The solution was the five-minutes period on Sunday evening, which has become one of the fixed points in the programmes, and, it is fair to say, the goal of almost every charitable institution or cause in the country. Five minutes is a short time, but it has been proved that its potentialities are almost unlimited. A good speaker, appealing for an object with a wide popular appeal, can reach an audience that could be moved in no other way. Once again has been demonstrated the unrivalled power of the spoken word.

It is a wonderful thought: that from 8.55 to 9 o'clock on Sunday evening, all over the British Isles,

and wherever a B.B.C. Station is heard, listeners are being asked to do something for those in some way less fortunate than themselves. For the Sunday evening appeal, like the Sunday evening Service, is universal. The new Daventry does not vary the rule, nor will the new Regional Stations when they come. The present local Stations either broadcast their own appeals for their local hospitals, or, when the Good Cause from London or Daventry is of a national character, relay that.

Whilst the time of the Good Cause appeal is fixed and definite, so that listeners can be sure of hearing it without hunting through their programmes every week, the subjects and the speakers vary as widely as the objects of charity can. Amongst the most successful appeals from London and Daventry this year have been such varied causes as the Braille programmes for the blind, the Mental After-Care Association, Pearson's Fresh-Air Fund, Westminster Abbey, and the Lord Mayor's Fund for the Armenians; and the speakers on the occasions were Sir Beachcroft Towse, V.C., Sir Charles Wakefield, the great industrialist, Lord Riddell, the newspaper magnate, the Dean of Westminster and Lord Cecil. Many other successful appeals have been made by actors and actresses, such stars as Sir Gerald du Maurier and Dame Madge Kendal well maintaining, in this newest of all mediums, the historic reputation of their profession for charity. Lord Knutsford's appeal for the London Hospital some time ago was an outstanding success.

But not all of the appeals are for money. For instance, nothing

has been more striking than the rise in the results obtained by the Hospital Library of the British Red Cross and Order of St. John, which asks not for money, but for old books and magazines. Last year the number received was over 122,000. The Professional Classes' Aid Council appealed not only for money but for clothes, and the response was remarkable. For it is not the rich who are the bulwark of the Broadcast charity appeals, but the people of moderate means. Now and again, as in the case of the Westminster Abbey appeal in July this year, some really princely gift comes as a result, but normally the bulk of those sums, ranging from hundreds to thousands of pounds, which the microphone attracts every Sunday evening, comes in small amounts. The Listener's Mite, they have been called; and no doubt the man to whom ten shillings a year for a wireless

licence is a not inconsiderable sum feels that he can enjoy his crystal set more happily during the week if he has given his mite on Sunday to the Week's Good Cause—to help the blind or the aged or the sick, or those to whom ten shillings is not merely a considerable sum, but a fortune to which they can never attain.

Twenty-seven special news bulletins were broadcast between May 4 and May 18, 1926, in connection with the General Strike. This number does not include other bulletins dealing with the emergency railway arrangements.

Over 100 elementary schools in the L.C.C. area are equipped with wireless receiving apparatus, which is in regular use during the afternoon transmissions for schools.

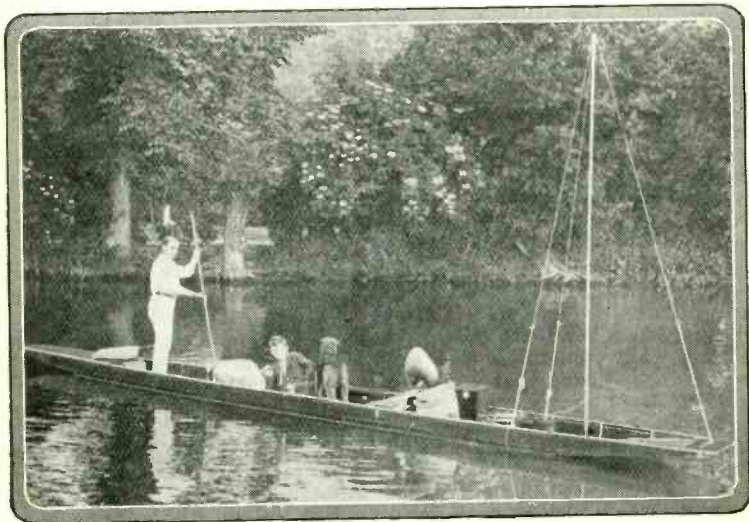

MUSIC ON THE THAMES

ONE BOY · £10

Ten pounds is the total cost to Salvation Army Funds for every boy settled in the Overseas Dominions by the Army

Selected boys are TRAINED in farm work; provided with OUTFITS; CONDUCTED OVERSEAS by Army Officers; placed in SITUATIONS; and KEPT IN TOUCH WITH until satisfactorily established.

How many Boys will you help to become EMPIRE PIONEERS?

*Correspondence
Invited:*

GENERAL BOOTH
101 QUEEN VICTORIA STREET
LONDON, E.C. 4

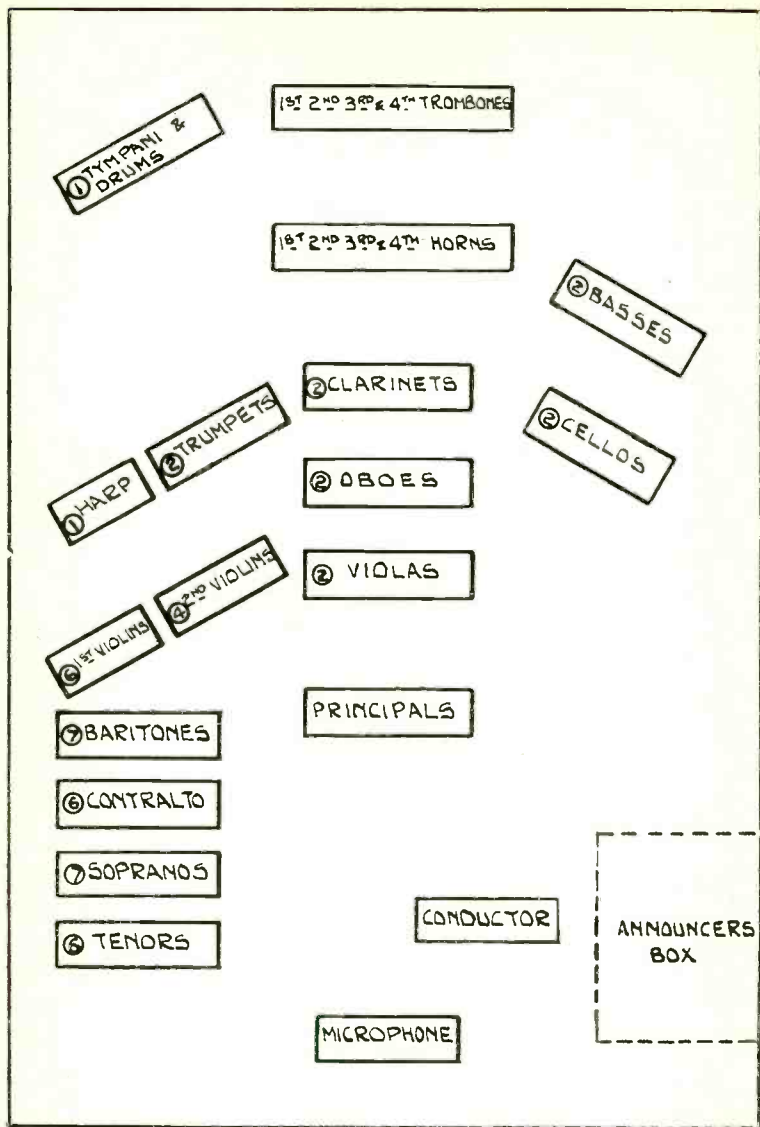

FIG. A.—POSITION OF ARTISTS IN ORCHESTRAL CONCERTS
AND OPERATIC PERFORMANCES

THE LONDON STUDIOS

EACH of the seven Studios at Savoy Hill is occupied almost continuously throughout each week-day with Rehearsals, Auditions and Tests, and it is even necessary for a number of preliminary "reads" to take place in Band-rooms or even in offices. A visitor able to peep into each of the Studios and Band-rooms at, say, noon, might discover the morning Transmission to London and Daventry taking place in No. 3, the Orchestra rehearsing in No. 1, and the Military Band equally busy in No. 7; that a Revue was being produced in No. 4, an audition was taking place in No. 5, and a play was being produced in the new No. 2 Studio, both sections of this Studio being in use: the plot might be laid at some quayside, and the appropriate effects would be greatly in evidence. They are many and varied; zephyrs or typhoons, they are all in the day's work, even to the bomb effects required in "R.U.R." Realism in effects is not always easily obtained, and there is on record the story of the comparatively new office boy who was found dashing round the corner of a passage in this building; he explained that his haste was due to the fact that while he was walking quietly past No. 2 (B), a door had suddenly opened, and a hand had appeared grasping a huge revolver which had immediately "gone off"! In the new Studio it is possible to produce the necessary effects *without* opening the door, except on the rarest occasions. In No. 6 might be found the larger chorus, composed of seven sopranos, six contraltos, six tenors and seven

basses, going over the parts of some Musical Comedy. The smaller chorus is composed of eight singers, who are usually heard in the Sunday night Epilogue.

In one of the Band-rooms our visitors might perhaps find a new "act" being tried out, and in another the Dance Band running over some new tunes.

BOOKED WEEKS AHEAD

Studios are ordinarily booked several weeks ahead, but urgent calls for "a Studio with microphone in five minutes, please," are not uncommon.

Final Rehearsals are arranged, whenever possible, in the Studio from which the items are to be broadcast. Those responsible for "balance" are thus able to arrange artists, instruments, effects, etc., so that a properly balanced Broadcast may be put over. The necessity for the large number of rehearsals is clear when it is realised that it is becoming quite common for four programmes to be broadcast simultaneously from the one building; for instance, there might be a light orchestral programme to 2 LO, a Chamber Music Hour to 5 XX, a Military Band Concert to 5 GB, and a "touring" or rota turn to Manchester.

The need for so many Studios is also made apparent when it is explained that in the endeavour to minimise the "few moments, please," there is switching from Studio to Studio during the run of even a short evening programme. By making all Studio arrangements in advance it is thus unnecessary to hold up the Transmission, even for a few seconds, while "the Orchestra takes its place."

Following a representative 2 LO programme from 6.30 p.m., it might be accommodated as follows: 6.30 p.m., First General News Bulletin, No. 5; 6.45 p.m., London Radio Dance Band, No. 7; 7 p.m., Talk, No. 5, with No. 7 in reserve (there is always a Studio in reserve during any talk or Outside Broadcast between 6.30 and 10.30 p.m.; here an Accompanist is sitting at a piano, ready to improvise in case the Talk runs short, or the O.B. line breaks down); 7.30 p.m., Orchestral Programme in No. 1, solo Artists in No. 4, a short play in No. 2 (both sections); 9 p.m., Second General News Bulletin, No. 5; 9.15 p.m., Talk on Music with piano illustrations, No. 6 (the larger Talk Studio, equipped with piano); 9.30 p.m., Variety Programme in No. 1 (with stage, spotlights and small audience); 10.30 p.m., an Outside Broadcast (No. 4 in reserve); 11 p.m., London Radio Dance Band, No. 7.

THE BIGGER BROADCASTS

Some of the bigger Broadcasts, such as the "Radio Fantasy," "White Château," and "R.U.R.," need several Studios simultaneously, with an Orchestra in No. 1, voices in No. 2 (A), effects in No. 2 (B), and perhaps the Dance Band in No. 7. Echo is also applied externally as required. The cue sheet for such a production is a most interesting piece of work. In the past it has been literally followed blindly, as those taking part cannot see their colleagues in the other Studios. The artists in the various Studios come "on" when warned to do so by various members of the Dramatic Producer's staff. Through wearing headphones the latter are in constant touch with the course of the production. In the case of the Orchestra, the conductor

wears headphones, and by following a similar cue sheet he brings the Orchestra into the programme whenever necessary by raising his baton in silence, and the "background of music" comes into evidence. The closest co-operation is required between the Programme and Engineering staff concerned. Till recently it was necessary for the sound products of the various Studios to be blended into a composite whole in the main Control Room, the general balance between the various components being arranged by the Productions Director—calling for much skilful "fading in" and "fading out." Since the introduction of Room 97 the production of such a programme has been greatly simplified. Installed in this room is a piece of apparatus, the use of which enables the producer to be in touch with each of the Studios concerned by means of loudspeakers placed in the Studios concerned, so that he can give the necessary instructions from a central point while the Rehearsal proceeds, and blend the products of the various Studios into one harmonious whole which he is able to hear on an efficient loud-speaker.

All the Studios, with the exception of No. 5, are equipped with one or more pianos, which are tuned weekly, or more often when necessary. Nos. 3 and 7 sometimes resemble very fine piano showrooms, as eminent pianists often send in their special pianos; these are the only Studios containing sufficient spare space, and there have been as many as five different makes of piano in No. 3 at once.

DISPOSITION OF PLAYERS

The large permanent B.B.C. combinations are the Wireless

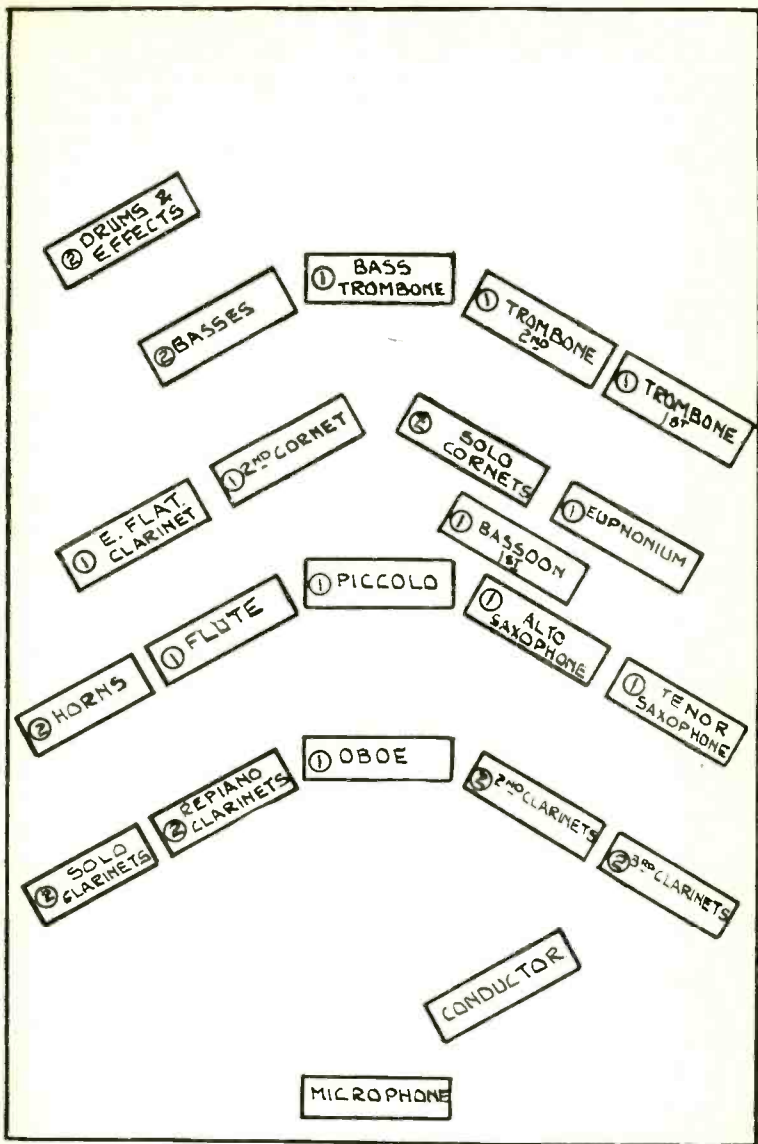

FIG. B.—POSITION OF PERFORMERS IN THE WIRELESS MILITARY BAND

Orchestra, the Wireless Military Band, and the London Radio Dance Band. Fig. A shows the lay-out of the normal Orchestra, which is augmented for special programmes. Fig. B shows the disposition of the players when the Military Band is broadcasting.

The London Radio Dance Band is composed of ten players, many of whom play several instruments during the course of even a short programme. The following is a usual combination: piano, banjo, trombone, first and second trumpets, sousaphone, two alto saxophones, tenor saxophone, and one drum and effects. At other times the sousaphone player wields the string bass, the banjo is exchanged for the guitar, one of the alto saxophonists plays the 'cello, clarinet or soprano saxophone, while the other plays any of the following instruments—tenor, soprano, alto or baritone saxophones, clarinet or oboe.

Auditions help to keep the studios quite busy. The post-bags delivered at Savoy Hill continually contain applications for auditions, and these are dealt with by the sections concerned with Concert Artists, Dramatic and Variety Artists, and Speakers respectively. Concert Artists are asked to give details of their training, past work, etc. In the case of Dramatic and Variety Artists, an audition is usually arranged quickly; speakers are asked to supply proof of their adequate qualifications to speak on the subject they have suggested.

PARAPHERNALIA

In the audition waiting-rooms have been instrumentalists of all kinds. Some have been content to bring modest flute cases; others a van load of cases containing the "works" of a xylophone ensemble; others a set of

bells or native (African) drums; some have produced vicious-looking saws from brown-paper parcels; others have extracted miniature mouth-organs from the innermost recesses of their clothing; some have asked for a few dozen glasses, a gallon or so of water, and a large table. Occasionally a would-be broadcasting artist has asked us to produce a full orchestra to accompany his or her trial song. Various birds, animals, and even insects, have come for auditions, and have later broadcast from the Studios.

Special arrangements are made for many programmes, particularly Variety and Revue. In many Revues there is a dancing chorus, the dances being performed on strips of thick lino. In many of the Variety programmes a stage fifteen inches high is now used, and an illumination supplied by two amber-coloured spotlights. This is done in an endeavour to help Variety Artists to "get over" by giving them an atmosphere to work in similar to their normal working environment, and it is for this reason that often a small audience is used in the Studio during such Transmissions. Here it might be well to state that there is a waiting list of listeners anxious to see "how it is done."

The ventilation of the Studios is accomplished by several huge ventilating plants, connected to the heating plant so that the air may be heated during the winter months.

The bed of the Thames near the County Hall, Westminster, was described to listeners as Mr. F. Shield, a diver of Whitstable, saw it one evening in July 1926. He carried a small microphone in his helmet as he moved about under the water.

THE INDUSTRIAL NORTH

IT is peculiarly appropriate, quite apart from technical and other reasons, that the new regional transmitters serving the north of England should stand high on the Pennine hills. The great range of the Pennines, often referred to as the "backbone of England," runs, almost imperceptibly, from the Derbyshire hills till it meets the Cheviot Hills on the borders of Scotland. Its western offshoots fall abruptly into the industrial basin of Lancashire and join, in an intricate maze of hill and moor, the mountains of Cumbria further north, while on the eastern side the range stretches away into the moors and industrial areas of Yorkshire. To him who travels north for the first time this region cannot fail to give an impression of striking contrasts with the south country and the Midlands. Nightingales are not known north of the Trent. With the Derbyshire hills or the Potteries in his wake, the traveller north will find himself in a country that tells him pointedly of its gaunt and rugged character. Some of the great industrial towns and smaller hamlets lie in the bowls of the hilly country, while others, joined almost one to another as in the Lancashire basin, stretch their tentacles towards the lower slopes, so that belching chimney-stacks rise out of the northern Derbyshire dales and Pennine valleys. Everywhere the impression is given of man working in a harsh climate and against rugged elemental forces to extract and deal with the industrial products that are vital to the prosperity of England.

The annihilation of distances and consequent breaking down of provincial barriers through train

and telephone and wireless are having their slow and cumulative effects, but it is small wonder that the populations to be served by the Pennines Station lead lives and have interests of a different kind from those of the South. The people themselves differ to some extent in origins from their southern cousins, and Professor Fleure, in his book on "The Races of England and Wales," has pointed out that the old pre-Roman stocks predominate in the Black Country and the Pennines as they do also in Wales. Their environment, and in particular the growth of industry during the last century, have served to accentuate the rugged and independent character of this population, which within a radius of fifty miles from Manchester, the industrial metropolis of the North, numbers a quarter of the whole population of England, Scotland and Wales. The Wars of the Roses have long since faded into the past, but healthy and friendly rivalry, particularly in sporting activities, still exists to-day between the Red Rose and White Rose counties. Many ties unite them—ties of somewhat similar dialects (the Scandinavian "burr," the shortened "a" in words like "grass," the continental pronunciation of the vowel "u," etc.), of common commercial and social interests, and of progressive instincts. The typical northerner is shrewd or "jannock" in business, very outspoken in his opinions, sensitive to the opinions of others, and extremely warm-hearted and generous; he has dogged determination, a very dry sense of humour, and, generally speaking, a more highly developed love of music than has the southerner.

The new Pennine aerials will draw their programme material from all over the North, using as their channels of supply the existing centres where Stations have been established under the original scheme of Broadcasting—the main Station at Manchester, which will become the regional headquarters, and the smaller Stations at Liverpool, Leeds-Bradford, Sheffield and Hull.

MANCHESTER

Of those Stations which were eventually incorporated in the B.B.C., Manchester is the second oldest, its origins dating back to September 1922, London being opened in the earlier summer of that year. It was originally established by the Radio Communication Co., Ltd., and Metropolitan-Vickers, Ltd., and its first studio was located in the premises of the latter firm at Trafford Park. It was officially opened as a B.B.C. Station on November 15th, 1922.

Manchester is, as everyone knows, the business centre of the British cotton industry. From the days of the Civil Wars it has counted as a strong factor in politics, and in the last few decades as a decidedly progressive factor. Much political history has been made at its Reform Club, and much musical as well as political history at its Free Trade Hall. Its Ship Canal and docks still rank as one of the greatest achievements in engineering, and its principal newspaper, "The Manchester Guardian," as one of the most intellectually independent and internationally influential newspapers in the world. Its banking returns are second only to those of London. Its University educates annually about 2,500 students, and many eminent men in science and scholarship have occupied Chairs of learning in Man-

chester. It has always been to the fore in the repertory movement and, though Miss Horniman's theatre exists no longer, the school of Lancashire dramatists which it so largely helped to foster is still thriving, and other repertory movements are receiving strong support. The Manchester Station, since its inception, has striven to mirror the life of this stronghold of industry and the arts, and of the life of the towns and cities in its near neighbourhood—great centres in themselves of cotton-spinning, cotton-weaving, coal-mining and engineering, many of them with populations numbering well over 100,000 inhabitants.

HALLÉ CONCERTS

To most listeners the Station is chiefly associated with the broadcasting of the Hallé Society's Concerts from the Free Trade Hall. Its own orchestra, recruited largely from Hallé musicians, has some of the finest instrumentalists in the country. It was the first Station to broadcast full-length operas performed in the studio and to issue libretti in connection with them. The development of radio drama has also been a feature of its work. On the educational side it has done pioneer work in fostering interest in school transmissions and has supplied many outstanding talks S.B. to all Stations. In January of this year its novel experiments to show how far the human voice as heard over the microphone can convey the personality of its possessor to the listener—experiments conducted by Professor T. H. Pear—created wide interest and brought in 4,600 answers. The Station has always taken much interest in charity work; its concerts on behalf of various charities have resulted in the

*Imperial Aerial Photo. Co.*

MANCHESTER FROM THE AIR

collection of several thousand pounds; its Radio Circle, run in connection with the Children's Hour, includes over 15,000 members and has been responsible for installing wireless sets in children's wards in hospitals all over the area, and its Wireless for the Blind Fund, inaugurated late last year, has already installed more than 150 sets in blind institutions and in the homes of blind people in impoverished circumstances.

LIVERPOOL

Nearly forty miles from Manchester, and on the right bank of the estuary of the Mersey, stands Liverpool, one of the world's greatest and most progressive sea-ports. Like its sister city, Manchester, it is an important cotton centre. As a port it is

closely associated with the principal industrial enterprises of Lancashire as well as with international maritime traffic. Liverpool makes an immediate impression on the traveller as a city of outstanding architectural beauty. Very few of its public buildings date back beyond the nineteenth century, but its comparatively new buildings show to the world that its inhabitants value the appearance of their city. Few cities in the whole of Great Britain could boast of such magnificent creations of modern architecture as the Liverpool Town Hall, St. George's Hall, and, dominating the city from a high elevation, the massive grandeur of its new Cathedral.

The Station, opened on June 11th, 1924, was the fourth relay Station to be established by the

B.B.C. It has had the advantage of being set down in a city in which a wealth of musical, dramatic and cultural activities flourish, and such activities have found their full expression in its programmes. Many orchestral programmes emanating from Liverpool have been heard by listeners all over the country, and the Liverpool Philharmonic Society's Orchestra has made important contributions to these programmes. The development of radio drama has been carefully nurtured, and the Liverpool Radio Players have a large number of successful broadcasts to their credit. The Liverpool Children's Hour has always maintained a reputation for its charming qualities, and the Radio Circle has over 5,000 members. The Station has specialised in relaying nautical concerts from some of the well-known liners that use Liverpool as their port, and in relaying public concerts from the Philharmonic Hall and the Crane Hall. It was responsible for the broadcasting to all Stations of the consecration of the Liverpool Cathedral, and was the first provincial station to broadcast a speech by His Majesty the King.

SHEFFIELD

It was in Sheffield that the first broadcasting Station in Yorkshire was opened, and, in fact, the first of the relay Stations. Sheffield lies on hilly ground in the extreme south of the county, and its blast furnaces in the Don Valley are famous for their production of steel and cutlery. It is a city old in its native industry and with important literary and educational associations. Sir Henry Hadow, Vice-Chancellor of the University, and Sir Henry Coward, Conductor of the Sheffield Musical Union, have

done much to forward the importance of the city as a musical centre.

The origins of the Sheffield Station date back to the summer of 1923, when a transmitter, subsequently removed to the house of Mr. Frederick Lloyd, was installed at the University. Mr. Frederick Lloyd kept the interest of listeners going until the inauguration of the official B.B.C. Station on November 14th, 1923. The educational side of the Station's activities has been greatly developed recently, and the Station has made an interesting and unique contribution to the art of broadcasting talks to schools by what has become known as the "Sheffield System of Group Reception." The experiment owes much to Sir Henry Hadow, Mr. Frederick Lloyd, and Mr. Cecil Sharp, the Sheffield Director of Education. Under this system one school is used as a reception centre and a number of other schools are wired to it by land-line, each school thus connected being equipped with an amplifier and a loud-speaker. On the musical side considerable progress has been made, and the Station has achieved much success with its broadcasts of choral music by Sir Henry Coward's famous choir and Dr. Stanton's Chesterfield Choir. The Station has relayed a large number of services from places of worship in the city. Its Radio Circle membership numbers nearly 3,000. One of the most unusual outside Broadcasts that it has organised was that from the underground working of Nunnery Colliery on June 27th, 1925.

LEEDS-BRADFORD

In the new scheme of things the Leeds-Bradford studios will act as a channel for conveying to the Pennines transmitters the atmosphere of the very extensive activities of the West Riding of

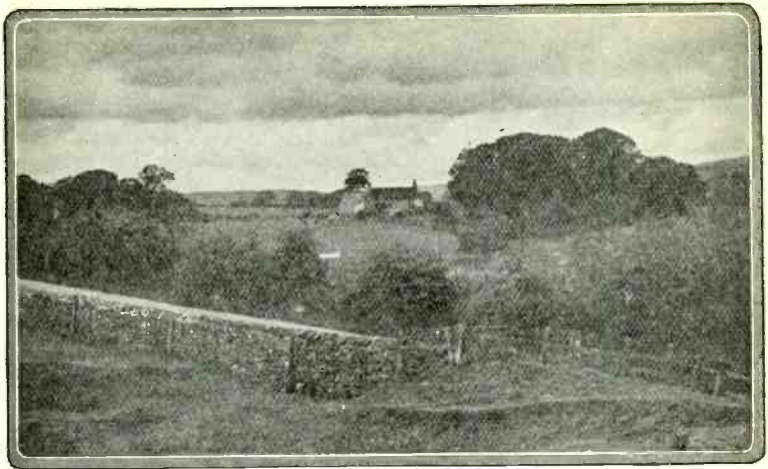

ROUND GIGGLESWICK WAY

Yorkshire. The city of Leeds lies in the valley of the River Aire, while its sister city, Bradford, lies in an offshoot of this valley, its houses extending up the hills on either side. These two cities represent between them the principal centres of the woollen, worsted and other textile industries of Yorkshire, and are also the centres of important coal-mining districts. The Leeds-Bradford Station, from its inauguration on July 8th, 1924, has always been characterised by its distinct catering for Yorkshire interests in its programmes. Leeds has always been to the fore in musical and dramatic activities and can boast of a very fine Municipal Orchestra and of its Leeds Repertory Players, who gave a beautiful rendering of Masefield's play, "Good Friday," broadcast to all Stations on Good Friday of last year. The dramatic side of the Station's activities has, in fact, been considerable, and another extremely interesting dramatic programme that has emanated

from the Station was the performance of "St. Simon Stylites," a short play by Mr. Sladen-Smith, the Manchester dramatist, given by the Huddersfield Thespians before their departure to America to compete with this play for the David Belasco Cup. On the educational side, many listeners will remember the series of talks on poetry broadcast by Professor Lascelles Abercrombie from Leeds to all Stations in 1925.

YORKSHIRE TOWN "NIGHTS"

The Station has paid particular attention to taking its microphone outside its studios in order to give its listeners opportunities of listening to public events of outstanding interest, and concerts from the large industrial centres and resorts in its near neighbourhood, "Huddersfield Nights" and "Harrogate Nights" having figured among some of the popular relays of this description. Leeds-Bradford was the first station to broadcast a concert from a mine, this concert being arranged on

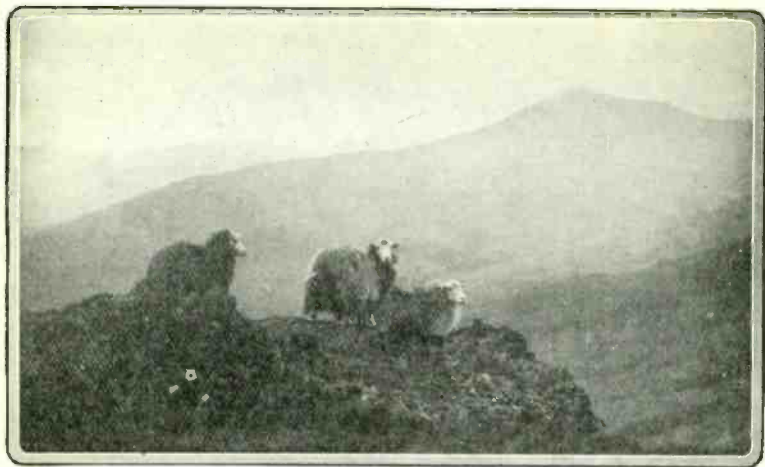

A CHARACTERISTIC VIEW IN THE PENNINE COUNTRY

November 28th, 1924, at the bottom of one of the pits of the Whitwood Collieries, at Norman-
ton.

On the religious side of its work the Station has specialised in relaying Sunday services from various places of worship in both cities rather than in arranging studio services. The Station has done much for charity, and its Children's Radio Circle has a membership of over 5,000.

IN THE EAST

The interests and culture of the extreme east of the region are tapped through the Hull Station. Kingston-upon-Hull stands at the junction of the Hull and Humber rivers twenty-two miles from the coast in the East Riding, and is the eastern port of Yorkshire and Lancashire, as Liverpool is the western. The Station was the last of the Stations in the present Pennine group to be opened, having been inaugurated on August 15th, 1924. Though rather isolated from the activities of the other

great cities of the North, Hull has fostered the arts of music and the drama, and the Station has been able to reap the benefits of various enterprises in this direction. It has relayed many of the popular celebrity concerts, organised in the Queen's Hall, in conjunction with the Sheffield Station. Chamber music has found a frequent place in the Station's programmes, but perhaps the chief event of musical interest was the relay from the City Hall in March 1925 of performances of "The Dream of Gerontius" and "The Ode to the North-East Wind," performed by the Hull Vocal Society. In the province of talks the Station at one time made an important feature of Women's Half-Hours to serve Women's Institutes, while it has catered for the wide agricultural area in its radius by a regular series of talks on "Country Topics." Speeches by many well-known visitors to Hull have been relayed and broadcast by the Station, including speeches by H.R.H. the Prince of

Wales, H.R.H. Princess Mary, Mr. Lloyd George and the Archbishop of York. The Station's Children's Hour has always been a popular feature of its programmes, and its Radio Circle has done much to help various different charities.

The aerials high on the Pennines will not want for programme material. It should be added that the region contains the Archbishopric of York and its beautiful Minster, from which many services have been heard by listeners, and a number of other historic and well-known Cathedrals, including Chester, Carlisle, Manchester, and Liverpool, into which microphones have been installed at one time or another. The religious life of the area, not only of the Established national Church, but also of the Roman Catholic Church and of all Christian denominations, is indeed a strong one. The North country has made great contributions to English literary history, and the Romantic Revival at the end of the nineteenth century received its chief inspiration from the Lakeland poets—to name only one of the many literary movements which have emanated from the North. As showing that the region is one fertile in journalistic activities, the "Sheffield Daily Telegraph" and the "Yorkshire Post," like the "Manchester Guardian," may be mentioned as carrying influence far beyond the counties in which they are published, and a modern trend in the national journalism has been to publish Northern editions of the London papers in Lancashire and Yorkshire for distribution all over the North, Wales, and Scotland. Intimate relations have already been established between the stations in this Pennine group and the four

great universities of Manchester, Liverpool, Leeds, and Sheffield, and the value of these will be more than ever realised in the educational side of Northern broadcasting. The importance of the co-operation between the Lancashire and Yorkshire stations during the summer of 1927 in relaying and interchanging between each other music and entertainment from many of the well-known spas and pleasure resorts of the area—Harrogate, Buxton, Blackpool, Morecambe, and other places—will become more than ever apparent as the regional conception of broadcasting materialises. The people of the industrial North have learnt the art of rising above the harsh realities of their surroundings through music and literature and humour. To their achievements and their talents full expression will be given in the talks and programmes that will be collected in the studios from the great cities on both sides of the Pennine Chain, wired up to the lonely Station on the hill-tops.

NEWCASTLE

Northumbria is served by Newcastle (5 NO), the Northern outpost of the B.B.C. in England. Newcastle is famous for its military band competitions organised by the Station staff. There is close co-operation with Tyneside, and several extremely interesting Broadcasts have been given from the shipyards.

Local historical talks are widely appreciated by Newcastle listeners, whose desire for the spoken word is more pronounced than in most other areas. Newcastle is one of the veterans among the Stations. Its voice was heard as early as Christmas 1922. It has contributed materially to the musical achievements of the B.B.C.

BROADCASTING IN SCOTLAND

HE would indeed be a bold man who set out to define adequately those differences of character, tradition and temperament which differentiate the taste and outlook of the average Scots listener from those of the English listener; they arise from a distinctive national background, educational and religious, which in its turn is the result of the course of national history and development. There are even subtle differences of taste, special prejudices and preferences between the listeners to Glasgow, Edinburgh, Dundee and Aberdeen, the four Stations which are grouped together for administrative purposes with Belfast, in the Northern Area. Scots listeners are perhaps more than ordinarily reticent in commendation, and unusually ready and exacting in criticism.

Early in October last year there was held in Glasgow a two-day Conference on "Broadcasting and Scottish National Life." Those who took part on this occasion included the Secretary of State for Scotland (Sir John Gilmour) and his Under-Secretary (Major Walter Elliott, M.P.), the Minister of Education for Northern Ireland (Viscount Charlemont), the Permanent Secretaries of the Educational departments of Scotland and Northern Ireland, the Moderator of the United Free Church of Scotland, and specially nominated clergymen of all denominations. There were also present representatives of Education Authorities from all over the country, from the Women's Rural Institutes and from the Workers' Educational Association. In the months that have followed since that occasion every attempt has been made to follow up the

interest which was then aroused in Broadcasting as a potential factor of real influence in the national life. The main Churches in Scotland appointed representatives to a Religious Advisory Council, with whose aid the arrangement of religious transmissions within the Northern Area has been effected, two services each month being broadcast to all Scots listeners. An Educational Advisory Council was also set up and held its first meeting at this time, containing representatives from the Scottish Universities, the Association of Education Authorities, the Association of Directors of Education, the Provincial Training Colleges, and the Educational Institute of Scotland. With the advice of this body and its various sub-committees, School Transmissions, which were first regularly arranged in Glasgow several years before, have been organised throughout the year, and there has been a considerable increase in the number of schools who make regular use of them. Demonstrations have been carried out for the benefit of over a dozen Education Authorities, and also at a Summer School of Teachers at St. Andrews. An ever-widening interest has been taken by Scottish teachers in the possibilities of the new educational adjunct, and correspondence and articles in the Press have provided evidence of the serious consideration being given to the matter in a country which prides itself on its advanced views in educational matters. If Scotland is far behind England so far as the number of listening schools is concerned, it must be remembered what a large extent of her territory is outside the range of the best reception,

and that this fact militates against a really complete service to rural schools.

While it has always been the aim of the B.B.C. to include in its Scottish programmes the best of the London fare, special attention has been given to the national requirements of Scotland. First of all, apart from the entertainment side of the work, special market prices bulletins have been issued regularly for Scottish farmers, together with fortnightly talks arranged in collaboration with the Board of Agriculture and the Scottish Agricultural Colleges. A series of fishery bulletins has also been transmitted to convey to the fishermen the location of the herring and the prices ruling at various ports of call. While the four Scottish Stations have arranged their own Appeals for local Good Causes, special time has been set apart for Scottish National Appeals likely to be of interest to all Scottish listeners.

DRAMA COMPETITION

In the sphere of the regular wireless programmes an attempt was made to stimulate the writing of music and drama by Scotsmen through the organisation of two competitions, one for Radio Plays and one for Choral or Instru-

mental Music of a national character. The Adjudicator expressed disappointment with the standard maintained in the large number of plays entered for the former competition, but the winning play, "The Clan of Lachlann," by Mrs. Bessie Macarthur, which was broadcast from Glasgow Station, was widely praised by listeners. The winning works in the musical competition were two part-songs by Mr. Kenneth Findlay and a trio by Miss Dorothy Wauchope Stewart. Plays by local authors are regularly put on at Scottish Stations, more especially at Aberdeen, but there is demand for a larger supply of contemporary Scottish, music and the B.B.C. is always on the look-out for new national composers.

FORTNIGHTLY SCOTTISH S.B.S

Every fortnight a special Scottish Programme has been arranged, the four Stations taking it in turn to provide the evening's entertainment, and on special anniversaries, such as those of Robert Louis Stevenson and Sir Walter Scott, special transmissions have been arranged for simultaneous broadcast to all Scottish listeners. St. Andrew's Day and Burns' Night, however, being the chief anniversaries, have been celebrated by joint programmes

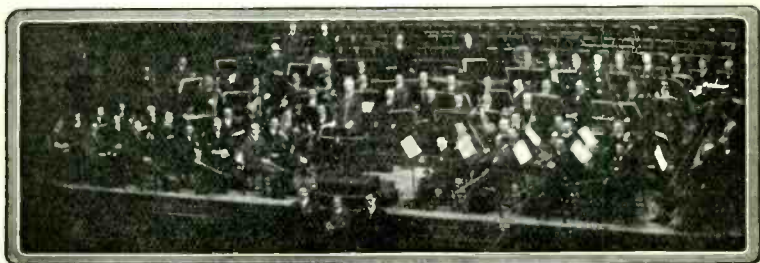

GLASGOW STATION SYMPHONY ORCHESTRA

contributed to by all four Scottish Stations.

TALKS

Three further national features are perhaps worthy of mention here—a series of talks by well-known Scots writers, ten humorous episodes by well-known national humorous writers, and finally the celebration of the anniversaries of a large number of well-known Scots by the reading of brief two-minute sketches of their lives following the local news. Among those included in the first feature may be mentioned Neil Munro, Annie S. Swan, O. Douglas, John Brandane, Bruce Marshall, Joseph Laing Waugh and Joe Corrie. None of these authors had ever faced the microphone before, and it is hoped it was interesting to many listeners in remote parts of the country to hear in this way the voices of familiar authors. For the Scottish Humour Series which was also broadcast from all Scottish Stations, features were commissioned from J. J. Bell, Neil Munro, Catherine Slater, and others, and the B.B.C. was fortunate in securing many pieces of characteristically pawky Scottish humour.

NATIVE WIT AND LETTERS

In the year that is to come it is hoped to be able to continue to secure many features of national interest, and thereby to foster an appreciation of national music and letters and native wit. B.B.C. aims do not stop short here, however, and it will not be content until Broadcasting is more closely linked up with the vital interests of Scotland—co-operating to a still greater extent with the Musical Festival movement, Community Drama, and the great work of the Scottish Women's Rural Institutes and bodies like them.

In conclusion, no organisation could play a completely adequate part in the national life of Scotland that was not closely linked up with the work of organised Christianity, and it is an important aim of broadcasting to play its part in the life of the National Church, disseminating to a wider congregation than ever before the message of Scottish preachers, making known the work of the joint committee which issues the revised hymnary, and co-operating, wherever possible, through the advice of a Council representing the main Churches in Scotland.

Opportunities are provided for enabling a limited number of listeners to be present at studio performances where audiences are desirable. There are long waiting lists of listeners anxious to take advantage of this privilege, in order to see Broadcasting being done.

In dealing with controversial subjects the B.B.C. attempts to give all points of view. The broadcast debate is now accepted as the normal method of handling controversy over the microphone.

The B.B.C. observes Sunday in a religious but non-sectarian way. Religious services are broadcast regularly from all stations, and no entertainment alternative is recognised. This part of the programmes attracts more appreciative letters than does any other kind of broadcast.

The B.B.C. applies an anonymity rule in all its work. The names of announcers and officials are given only on rare occasions. By special training, B.B.C. announcers try to attain a high common standard of diction and enunciation.

BROADCASTING IN WALES

CARDIFF CITY has many claims to fame, one of the less well known being that it is the first port in the world for the import and export of potatoes. History might have been different if Sir John Hawkins had not brought the tuber back with him from Virginia in 1563.

Sad to say, in spite of this interesting link, a Mayor in Virginia until recently knew nothing about this city, but when he got a wireless set and adventured on the ether, he followed the potatoes and got Cardiff. Got it and liked it and could not get any other Station, and at length searched the map of the world and "located" Cardiff. There may be readers of this book who are likewise unacquainted with the exact position of Cardiff, and if they look at the map they will see that this Station, working in conjunction with Swansea, serves the industrial area of South Wales and the historic city of Bristol, as well as the counties of Gloucester, Monmouth, Somerset and N. Devon. In this area the Cathedral bells of Llandaff and St. David's on one side of the Channel echo the message of those of Gloucester, Bristol and Wells on the other, and the spirit of the Arthurian legends still broods over Glastonbury as over Caerleon. Wales is a land of legend and song and fairy tale, and so is the West Country. Tradition has it that Joseph of Arimathea founded the first British church at Glastonbury and that St. Paul visited Llanwit Major, where relics of a fourth-century church still exist.

In Wales and the West tradition is still a living thing. Residents in the great capitals of the world have realised that in becoming listeners they have had to tear

themselves away from accustomed habits. They have grown to depend upon the evidence of the written and printed word, and to regard it as more binding than the spoken word. This practice has, to a large measure, cut them off from such portions of the past as are not recorded in black and white. It is not difficult to imagine that from the loud-speaker is heard once more the mystic music of King Arthur's Court, or again the song of some ancient Welsh Bard. Yet if one travels from Wales to Somerset one is struck at once by the difference, not only of environment, but of the type of Briton, and to these two types Broadcasting has brought a constructive element which is acting very differently on each type, but none the less potently.

WELSH LANGUAGE

In Wales, as is well known, the old language is variously regarded as a help and as a hindrance. Those who prize the individual nationality of Wales above her contribution to the British Empire look to the language as the foundation stone of her unity; while those who regard the language as an archaic survival are none the less interested in the Principality and in its development. Broadcasting cannot take sides in such a matter, but it has done this: it has made the problem more urgent. Is there a majority vote in Wales for the exclusive use of the Welsh language? Is the Drama in Wales in a healthy state? Is Music fostered? In other words, has Wales at the moment a message for the world, or is she only in the position that she would like to have one?

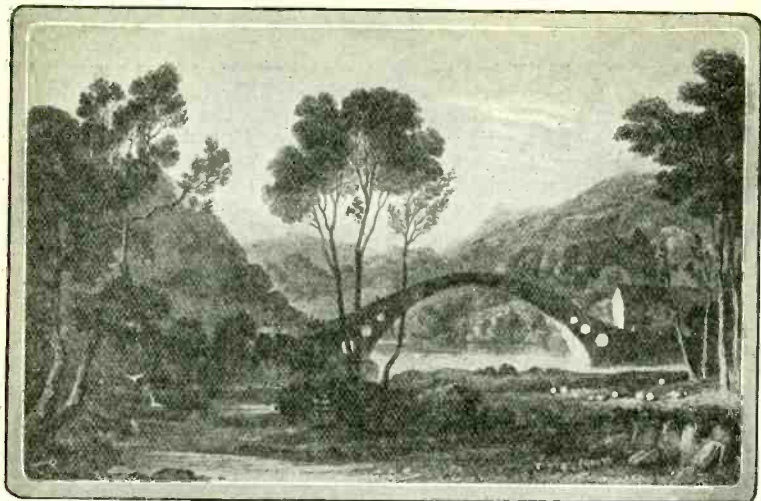

PONTYPRIDD

From a picture in the National Museum of Wales

Wales herself must decide this, although Broadcasting has hastened the problem. At present various groups of prominent people in Wales are striving to influence Broadcasting, but unfortunately they are often divided against themselves. Some want the almost unrestricted use of the Welsh language, others believe that salvation lies in a return to the old Welsh folk-song, and others, uncompromising nationalists too, have asserted that Welsh music is puerile stuff and that her literature alone is worth preserving.

In Wales, unlike many other countries, learning is not divorced from the common life. Also the preachers of Wales—and they are many—are usually poets, many of them writers of good verse in both English and Welsh. Wales is a nation of Bards. Welsh people love to sing, and they adore good singing when they hear it; there is to them nothing incongruous in

mingling hymns with popular songs before a football match, and, strangely enough, the two most talked-of events in Wales are the Welsh Revival led by Evan Roberts about twenty-one years ago, and the Welsh Rugby Football triumph over the All Blacks in 1905!

NATIONAL ASPIRATIONS

Further still, Wales is a nation, and can act as a nation without incurring the jealousy or distrust of the greater Powers. For instance, the League of Nations Union in Wales is an endowed body, its educational activities have won the admiration of many countries, and its committees meet in the Music Room at Gregynog, a beautiful room which contains some of the world's finest paintings. Wales will be a living example of the truth of the underlying unity of Education, Religion and the Arts. She will prove that

Life is One, and that Life is Beautiful. She will put Life first and the conditions of living second. In doing so she will encounter much opposition from within, political and sectarian.

THE NATIONAL MUSEUM

For Broadcasting, like the National Museum of Wales, is helping to "teach the world about Wales and Welsh people about their own Fatherland." A microphone has invaded the magical bardic Circle and the national Eisteddfod has been proclaimed throughout Europe. His Majesty the King, speaking in Cardiff, has broadcast a message about Wales throughout Great Britain, whilst the most famous Welsh people of all kinds have talked or sung into the microphone about their native land. Further still, Broadcasting is teaching Wales about the rest of the world, is bringing the Arts of the world into the most isolated cottages, and Wales, given the opportunity, can be trusted to infuse into the Arts a warmth and a vigour which are her own.

Wales, like most countries, needs a fuller appreciation of the Beautiful in her social affairs. Quite recently, in Cardiff, their Majesties the King and Queen opened the National Museum and Art Gallery, one of the most beautiful buildings in Europe. Within the building the B.B.C. will give free of charge daily concerts in conjunction with the Welsh National Council of Music. These concerts will also be broadcast, but unfortunately they will not be heard throughout Wales.

That is one of the chief difficulties at Cardiff; the B.B.C. cannot yet cover Wales. Steps are being taken to overcome this difficulty at the earliest possible moment, and to ensure that all Welsh-speaking people shall be able to hear the Welsh programme.

For the love of the old language is very strong. Pathetic letters are received from all parts of Wales after one of the Welsh Broadcasts through Daventry, and from many Welshmen scattered over Europe who wait up to hear the Lord's Prayer recited in Welsh during our Silent Fellowship at the close of Sunday's programmes.

Truly, Broadcasting in Wales is an adventure beset with pitfalls and difficulties, but there is a spirit in the people which makes it a lovable business.

It should be noted that the West of England is included in the Welsh Region. About one-half of the Cardiff correspondence comes from each side of the Channel. From the famous Pump Rooms at Bath concerts are frequently broadcast and also from the Promenade at Weston-super-Mare. In order to bridge the Channel, and to strengthen friendships in the West Country, outside concerts are given there as often as possible. The annual Garden Party in Weston-super-Mare is already one of the biggest events in the West of England. Last year and the year before, this "5 WA Sunshine Carnival," as it is called, raised over £2,000. The Carnivals are in aid of the Weston-super-Mare Hospital for the purchase and maintenance of X-ray and Artificial Sunlight Apparatus.

RADIO SUNBEAMS

Some day, perhaps, when the 50,000 members of Cardiff's Children's League, the "Radio Sunbeams," grow up, the sunlight of the world will be used to the fullest advantage. Amongst other things these children promise not to throw any rubbish about the streets or countryside, a small promise which may lead to an appreciation of the Beautiful.

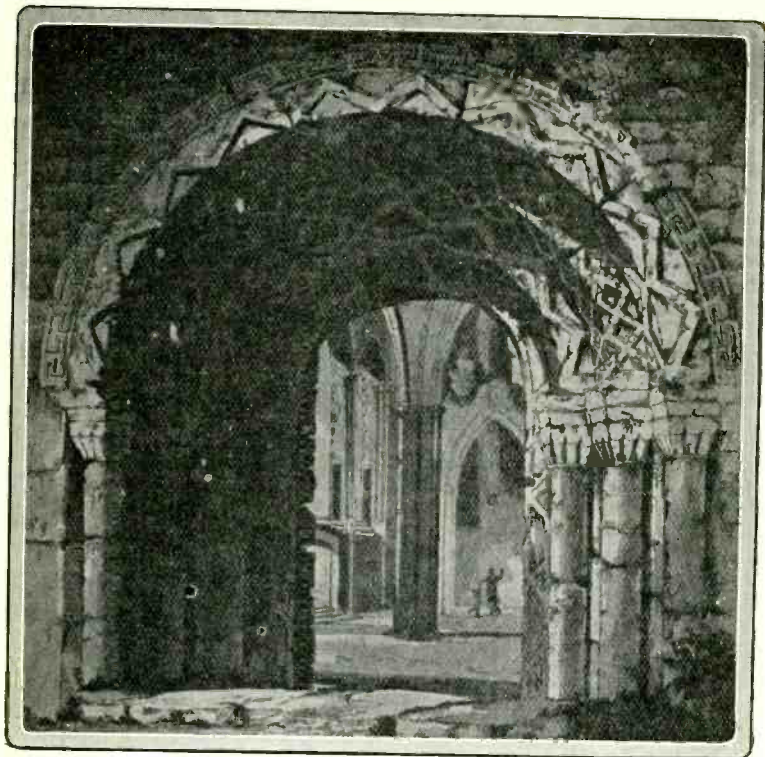

SOUTH ENTRANCE, LLANDAFF CATHEDRAL, 1807
From an aquatint in the National Museum of Wales, by G. Cooper

These children form a link to bind the scattered area together. Another strong link is the fund for the provision of wireless sets for sick and impoverished folk in their own homes. There is one central fund, and as likely as not people in Bristol buy sets which go into the Rhondda Valley.

To act as a medium by means of which the finest talent and ideals of Wales and those of the West are made known to each other has been one of the most interesting functions of the Cardiff Station; eventually it may appear

that it has also been the most potent.

More than 50,000 listeners participated in a competition for which a prize of £100 was offered by the B.B.C. in 1926 for the solution of a radio drama. In order to stimulate interest among listeners, a mystery story entitled "The Mayfair Mystery" was transmitted in episodes at intervals. The final episode consisted of a re-enactment of the mystery together with the solution.

BROADCASTING IN IRELAND

THE political division of Ireland carries with it a division of broadcasting activities. The Irish Free State, comprising all but the six Northern Counties, has undertaken to provide its own service as a purely State enterprise, whereas Northern Ireland has placed itself for Broadcasting under the régime of the B.B.C. There is still a certain amount of misconception as to the true state of affairs. It is important to hold very clearly in mind the fact that, though Dublin and Belfast do at times co-operate and exchange programmes one with the other, the Free State broadcasting system and the Northern Irish broadcasting system are entirely separate. The former is quite independent, having no connection with any other country, whereas the latter is as integral a part of the B.B.C.'s system as are the Glasgow or Cardiff Stations.

The independent Irish broadcasting service has two Stations, one in Dublin and another at Cork. It is believed that a considerable extension of the service is under contemplation, and that eventually a multiple Station organisation on the lines of the B.B.C.'s system will be established with additional transmitters in the centre and on the west coast. Dublin will then hold a position corresponding to that of the B.B.C. headquarters in London.

NORTHERN IRELAND

Northern Ireland, being considerably smaller in area than the Free State, has one Station only, situated in Belfast. Contact with London and other British Stations is maintained by two methods.

The first is a combination of land lines and submarine cables. This means is employed chiefly at night. The second is the relay from the high-power Station at Daventry. This latter is employed chiefly during the day when the cables are not available. By its means Irish listeners are able to hear the big running commentaries and important happenings which are so frequently transmitted from the other side. The reader can now appreciate the fact that dwellers in Northern Ireland, though separated from London by hundreds of miles of water and land, are kept in contact with events in the metropolis quite as effectively as are the inhabitants of Birmingham. Unfortunately, the reverse process is not yet so efficient, but it is hoped that before long London and Daventry listeners will be able regularly to take Belfast programmes.

MUSICAL VERSATILITY

One of the outstanding features of the Northern Irish Station is its musical versatility. It employs regularly its own Symphony orchestra, varying between thirty and forty in number; it has a permanent station orchestra of twenty fine musicians. The Station Military Band is one of the best in the country. It has its own dance band and chamber music quartet.

Five Concerts of the Belfast Philharmonic Society are relayed annually from the Ulster Hall. Two Symphony Concerts have already been relayed from the Queen's University, Belfast, on February 9th and April 28th of this year. On February 5th and March 5th of this year, two Popular Symphony Concerts were relayed from the Wellington Hall.

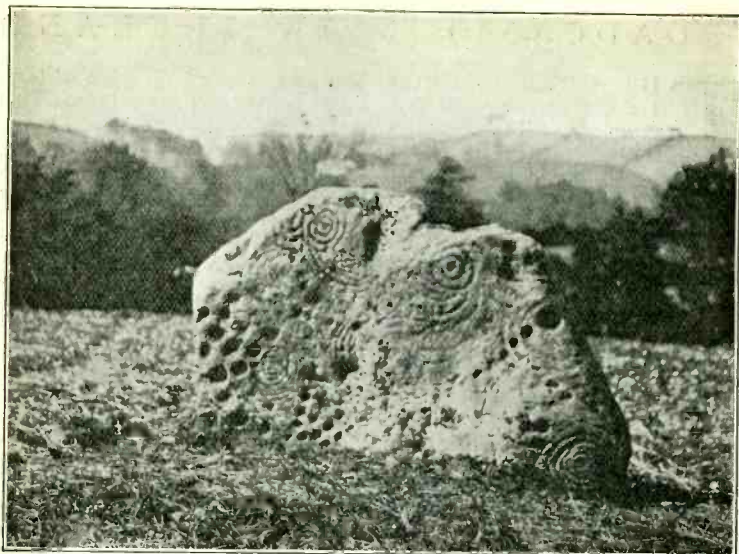

SESKILGREEN, CO. TYRONE

Illustration from the B.B.C. Pamphlet, "Irish Archaeology," by H. C. Lawlor

A Symphony Concert in aid of the funds of the Musicians' Union was relayed in April from the Ulster Hall. Special Symphony Concerts broadcast from the Studio have included one conducted by Sir Ivor Atkins of Worcester, September 22nd, 1926. Two have been conducted this year by Dr. W. G. Whittaker and Dr. F. W. Wadely of Carlisle on January 5th and May 11th respectively. On May 2nd a Symphony Concert for Children was relayed from the McArthur Hall, Methodist College, Belfast.

A great deal of attention is paid to the dramatic side of the programmes. Actors and actresses from London frequently cross the water to take part in Belfast's plays, while local talent is employed extensively for the typically Irish drama in which the proverbial brogue plays so im-

portant a part. Some of the Plays which have been broadcast from the Station are:

One-Act Comedy, "The Shadow of the Glen," by J. M. Synge.

One-Act Heroic Drama, "The Death of Cuchulainn"—a Tragedy of the Gael written specially for broadcasting by H. Richard Hayward. In this play an old Ulster legend was used as the basis.

A Comedy in Two Acts, "The Lone Man," a tale of County Down, written specially for broadcasting by Charles K. Ayre.

First Act of Drama, "Deirdre," by A. E.

"The Shadowy Waters," by W. B. Yeats.

RELIGIOUS MATTERS

In religious matters Ireland co-operates with English centres

and to a still larger extent with Scottish centres. The greatest preachers of the British Isles are broadcast simultaneously from all Stations, and Ireland does its share in providing preachers for England, Scotland and Wales.

The educational policy is an energetic one. Enlightenment on general subjects is for the most part taken from London, while subjects of essentially Irish appeal are dealt with by local lecturers.

GOVERNMENT CENTRE

The six Northern Counties have their own Government, therefore Belfast, like London and Dublin, is a Government centre. The broadcasting Station, though in no sense under the control of the Northern Government, does to a considerable degree co-operate with it. Announcements of public importance are frequently made at the request of one or other of the Ministries, and the elucidation of new Government regulations is broadcast by Northern Government officials. The Belfast Station also co-operates to a large extent with the municipalities in its area, the Belfast municipality in particular. An example of this was the recent Belfast Empire

Week, which caused so much satisfaction throughout the British Empire. Here the broadcasting services co-operated to the full in making this week a successful one. All the big public functions were transmitted and the voices of the important visitors to Ireland were heard by all listeners.

Running commentaries of local events take frequent place in the programmes. In addition to the usual sporting commentaries, there have been others of a more unique nature. The recent launch of the *Laurentic* may be quoted as an example. This vessel, weighing nearly 18,000 tons, was built in the Belfast shipyard for the White Star Line. The cracking of timber and the rush of water as the ship took to her natural element were conveyed in a most realistic manner to those who were unable to witness the launch.

The B.B.C.'s Station in Northern Ireland performs two most important functions: first of all it is an indispensable adjunct to Irish music, Irish drama and Irish life; secondly, it provides a living contact with the "hub of the Empire," and there are no more enthusiastic lovers of our Empire than the people of Ulster.

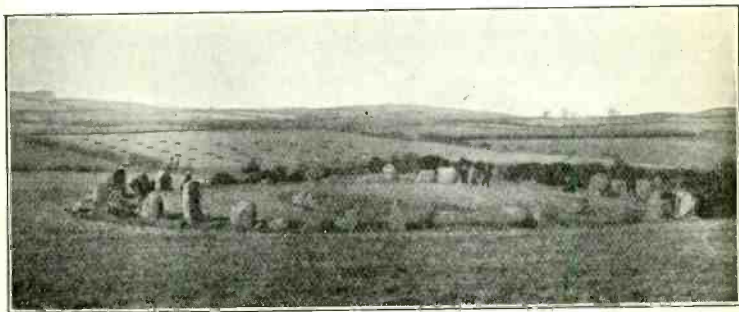

BALLYNOE STONE CIRCLE

Illustration from the B.B.C. Pamphlet, "Irish Archaeology," by H. C. Lawlor

I N T H E M I D L A N D S

NEARLY five years ago, from a quiet corner of a huge works three miles from the centre of the city of Birmingham, was sent out the first broadcast programme specially for the Midlands.

On November 15th, 1922, just twenty-four hours after the inauguration of 2 LO, the Birmingham Station, with call sign 5 IT, transmitted a programme of music provided by a few intrepid artists who had braved a fog that hung like a pall over the city, the suburbs, a player piano, and a gramophone. There they were in a tiny, heavily draped studio separated from the transmitter only by a microscopic office with a staff of about five harassed people to run both programme and the transmission of it. From such a small beginning has grown Broadcasting as it is in the Midlands to-day.

The B.B.C. experience of Birmingham has proved that it was artistically advantageous for one of the main stations of the broadcasting system to be situated in the heart of the industrial Midlands. From among the "workers in gold and silver and precious stones" and iron and steel and coal has been drawn material with which programmes of an exacting standard have been constructed—programmes sought and appreciated all over the country. Beginning with Birmingham's million population, there are Wolverhampton, Walsall, Coventry, Stafford, Lichfield, Leicester, Nuncaton and Leamington, to name only a few of the surrounding towns, which formed the nightly listening audiences of Birmingham Station and which placed at the disposal of the B.B.C. the artistic resources with which they abound.

A feature of the work of Birmingham throughout has been intimate contact with the various civic authorities. The first broadcast by a member of the Royal Family, on the occasion of the visit of the Prince of Wales to Birmingham in 1923, was one particularly happy result of this co-operation with local authorities. Prince Henry, the Prime Minister, Admiral Lord Jellicoe and many other eminent people have been heard through the Birmingham Station. The University, Wolverhampton Musical Choral, Birmingham musical organisations and kindred societies have all identified themselves continuously with Broadcasting.

After occupying its original home at Witton for a few months the Station had to move to larger and more central premises in the city itself. Hardly had this move been completed when still more extensive accommodation became essential. And so in 1927, at the tender age of barely five years, Birmingham Station possesses the largest and most up-to-date studio in Europe, providing programmes for the first experimental high-power medium wavelength transmitter under the Regional Scheme of Distribution.

In April 1923 a little girl at Birmingham suggested the formation of a Radio Circle. This suggestion was acted upon, and Birmingham began the first Radio Circle in connection with Children's Hour work. The membership at Birmingham is now 10,000, and more than £1,200 has been subscribed to the Circle's funds for the installation of receiving sets for local hospitals and institutions. Listeners to the Children's Hour are continuing their good work

by amassing more money for the endowment of a cot in the Birmingham Children's Hospital. To the Midlands must go the credit for the first installation of wireless for hospitals. The Crippled Children's Home at Northfield was equipped with receiving sets and loud-speakers on Christmas Eve, 1923. This was made possible by local Radio Circles' activities. In addition to its other numerous activities, the Birmingham Radio Circle has provided Saturday afternoon concerts, which have been a welcome feature of local programmes for more than two years. Much promising talent has been discovered through these concerts.

Among broadcasting innovations introduced at Birmingham is the Radio Fantasy, an attempt at effective artistic expression by a new combination of music and the spoken word. On the dramatic side, the West Midland Station has produced more than its share of big productions, giving

such plays as "The Merchant of Venice," "Trilby," "Tale of Two Cities," "Under Two Flags," "School for Scandal," "Cast," and "The Christian." Choral singing has been another feature of the studio work at Birmingham, where complete performances have been given of most of the oratorios, operas and musical comedies, one of the latter resulting in no less than 3,000 letters of congratulation.

And now, as the Lord Mayor of Birmingham so aptly stated in his inaugural announcement of the change-over from 5 IT to 5 GB, the listening audience of Birmingham is extended far beyond the area of the West Midlands. Through 5 GB, the artistic resources which have been stimulated and evolved during the past five years are now made available to many millions of listeners elsewhere.

NOTTINGHAM

It is three years since the Nottingham Relay Station was first

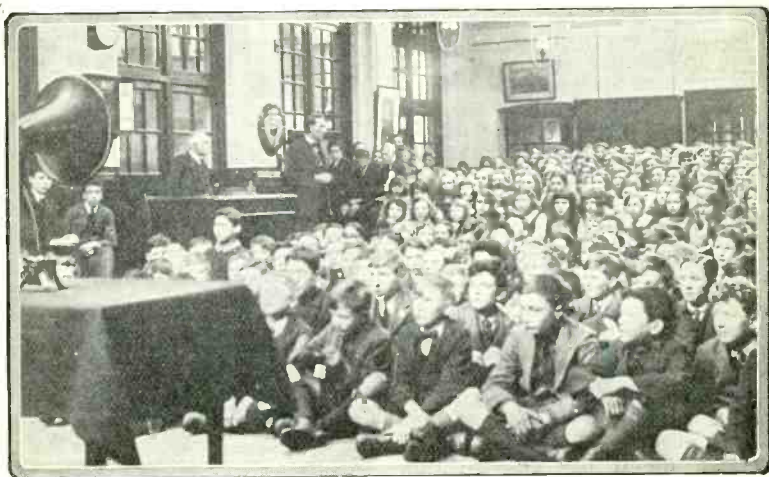

THE WIRELESS LESSON

opened, and from that date began a revolution in the artistic life of the city. So much a part of the life of the community has Broadcasting now become that it is difficult to imagine its absence.

In these three years more than 40,000 licences have been taken out in the Nottingham area, which has as many and perhaps more listeners per thousand of the population than any other centre of the B.B.C. activities. How has this been achieved? Nottingham is not renowned as a musical town, and yet musical artists of all kinds have offered their services for Broadcasting. The encouragement given to promising artists has been no small factor in building up the popularity of the Station.

In addition to routine concert work, a number of popular community singing concerts have also been given from which local charities have benefited. Outside Broadcasts of events of civic importance have been a regular feature of the programmes. The cumulative effect of this work has been to identify very closely the Nottingham Station with the life of the people. Nowhere has this been more apparent than with the work carried on in the Children's Hour. Nottingham has been singularly fortunate in those whose lot it has been to bring joy and happiness into so many homes. Day after day, year in, year out, the younger generation have been able to listen to songs, tales and jokes, a form of entertainment to which many of them had been strangers hitherto.

The help given by the staff of the University College, Nottingham, must be gratefully acknowledged, for it has enabled this Station to broadcast talks which have reached a very high standard.

Broadcasting has come to stay. The B.B.C. has set up a standard in Nottingham which must never be lowered in any way. Radio is quite as much a part of the daily life of the people as the newspapers, a position which must be kept and consolidated.

For the first time in the history of wireless a concert was broadcast from the Whitwood Collieries in Yorkshire at the end of 1924. It included a talk from the pit bottom, 1,500 feet below the surface, by a well-known comedian, and some musical selections performed by the Whitwood Colliery Silver Prize Band. The programme, lasting about an hour, was relayed to the Leeds-Bradford Station. Some months later a similar programme was given from Sheffield, but on this occasion the sounds of coal cutting and other noises incidental to the working of a mine were broadcast.

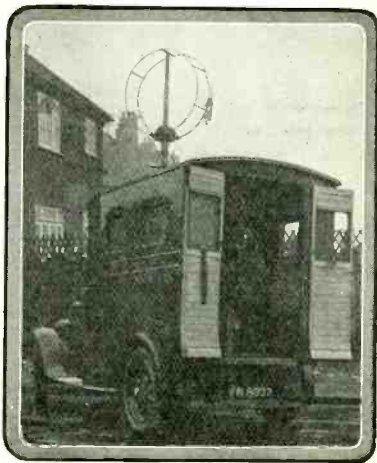

POST OFFICE VAN FOR DETECTING OSCILLATORS

REVIEW OF THE YEAR

August 1926.

- 4.—H.R.H. the Prince of Wales at the annual meeting of the British Association at Oxford.
- 7.—Dublin Programme from the recently-opened Dublin Station.
- 12.—The Northern Ireland District Command Military Tattoo, relayed from the Balmoral Showgrounds, Belfast.
- 14.—The Saturday Night Revue.
- 16.—Revival of "The White Château" by Reginald Berkeley.
- 18.—Act II, "Yvonne" from Daly's Theatre. Ivy Tresmond, Gene Gerrard and company.
- 20.—Verdi's opera "Rigoletto."
- 24.—"The Pied Piper of Hamelin" (Ch. H. Parry) from Manchester.
- 26.—Opening of the Centenary Exhibition of the Dundee Horticultural Society by H.R.H. the Duchess of York, from Dundee. Emory Glee Club of America.
- 29.—Dedication of the Bells of York Minster.

September 1926.

- 1.—John Ansell, Conductor of the Winter Garden Theatre, joins the B.B.C.
- 3.—Sacheverell, Edith and Osbert Sitwell, the Modernist poets, in "The Wheel of Time." Symphony band conducted by Sir Hamilton Harty.
- 4.—Radio Exhibition at Olympia. Broadcast of Speeches from the League of Nations, Geneva.
- 5.—Day of Remembrance Parade at Glasgow.
- 8.—Dvorak—a commemorative performance conducted by Percy Pitt.
- 9.—"Trelawney of the Wells": play by Sir A. Pinero.
- 10.—Margate Night.
- 11.—Charlot Revue, arranged by André Charlot.
- 15.—"The Bohemian Girl": Balfe's opera.
- 20.—First Broadcast of "The Mikado."
- 21.—Gustav Holst—birthday programme.
- 22.—"Resus" of Euripides, the first Greek play to be broadcast.
- 23.—Relay of "Riverside Nights" from Lyric Theatre, Hammersmith.
- 24.—Eastbourne Night.
- 29.—"On a Chinese Screen"—a feature programme by C. A. Lewis.
- 30.—First National Concert at the Albert Hall. Conductor, Sir Hamilton Harty. Marie Olegewska, contralto of the State Opera, Vienna.

October 1926.

- 1.—Arrival of Sir Alan Cobham from Australia. Scenes on the Terrace of the House of Commons.
- 3.—Celebration of the Seventh Centenary of St. Francis of Assisi, arranged by G. K. Chesterton.
Opening of Manchester Civic Week, to which the Manchester Station daily contributed.
Manchester Civic Week—a special series of Programmes and Talks, from Manchester.
- 4.—Broadcast Folk Dancing Festival.

- 5.—First International Chamber Concert (Hungary). The Hungarian String Quartet. Grotrian Hall.
- 6.—Broadcast by the English Singers and the Revellers.
- 7.—Relay of the Ceremony of Laying the Foundation Stone of Drypool Church by H.R.H. Princess Mary, from Hull.
Evensong, now a weekly feature, broadcast from Westminster Abbey for the first time.
- 8.—Annual Meeting of the Classical Association—speeches by the President, Lord Hewart of Bury, and the Bishop of Manchester, from Manchester.
Lord Chief Justice Hewart at the Classical Association at Manchester.
- 9.—The Manchester Beecham Operatic Chorus in "Gems of Opera."
- 11.—Symphony v. Foxtrot—an illustrated discussion.
- 13.—Relay from City Hall of official welcome to, and speech by, H.R.H. the Prince of Wales, from Hull.
Jerome K. Jerome's play, "The Passing of the Third Floor Back."
- 15.—Gounod's "Faust" by B.B.C. artists, including Robert Radford and Mignon Nevada.
- 17.—Chopin Memorial programme.
- 18.—Dedication ceremony of Liverpool Cathedral Organ.
"The Piper," an operetta by Herbert Ferrers.
- 20.—Liverpool Civic Week. Orchestral Concert in the Philharmonic Hall.
- 21.—Second National Concert at the Albert Hall. Conductor, Albert Coates. Frederick Lamond (piano).
- 22.—Speeches of Dominion Premiers at Guildhall Banquet. (Imperial Conference.)
Prime Minister of New Zealand, the Rt. Hon. J. Gordon Coates, M.C., "What we are up against in New Zealand."
- 25.—Gilbert and Sullivan's opera, "The Gondoliers," from the Prince of Wales Theatre.
- 26.—Opening of the Canadian short-wave high-speed Beam Service erected by Marconi's Wireless Telegraph Company.
- 27.—Concert at the Free Trade Hall, Manchester, inaugurating the Manchester Station's Wireless for the Blind Fund, from Manchester.
- 28.—Sir Owen Seaman (editor of "Punch"), on "Humour."
- 29.—"Tip Toes" from the Winter Garden Theatre.
The Maharajah of Burdwan, on "India."
- 31.—Evensong from Rochester Cathedral. Address by the Very Rev. John Storrs, D.D.

November 1926.

- 2.—Glasgow University Rectorial Address by Sir Austen Chamberlain, from Glasgow.
Second International Chamber Concert at the Grotrian Hall. (Italy.) The Venetian String Quartet.
"Acis and Galatea," by Mr. Harold Brooke's choir in the Bishopsgate Institute.

- 3.—Eric Coates.
 4.—"The Marriage of Figaro" by the B.N.O.C. at The Theatre Royal, Leeds.
 5.—Speeches by the Dominion Premiers on receiving the Freedom of the City, from Manchester.
 7.—Walloon and Huguenot Services, from the crypt of Canterbury Cathedral. The Rev. Jean R. Barnabas.
 Handl's "Messiah" by Sir Henry Coward and his choir in the London Studio. Broadcast by Elizabeth Schumann.
 8.—Broadcast by Neil Kenyon.
 9.—Third National Concert at the Albert Hall. Conductor, Richard Strauss.
 10.—"The Little Michus," from London studio. The Brussels String Quartet.
 11.—Armistice Day Service, from Canterbury Cathedral.
 Viscount Grey of Fallodon, at the League of Nations Union meeting at Caxton Hall. Armistice Day Special Programme including "The Spirit of England" (Binyon). Music by Sir E. Elgar.
 12.—"The Yellow Jacket," a Chinese play produced in the Chinese manner.
 Special performance of "Pagliacci."
 14.—The Bishop of Kingston at St. Martin's-in-the-Fields.
 The Geneva Scheme reorganising the allocation of European wavelengths was introduced.
 "Paddy the Next Best Thing," broadcast play.
 15.—Debate on "Science" between C. A. Lewis and Prof. Julian Huxley.
 17.—The Rt. Hon. W. S. Monroe, Prime Minister of Newfoundland, on "Our Economic Difficulties."
 "Tannhauser" performed by the B.N.O.C. and played from the Opera House, Manchester.
 "Canada and the Imperial Conference" by the Rt. Hon. Mackenzie King.
 18.—"The Partners," a Lancashire Play (Vincent Douglas), at Manchester and Daventry.
 19.—Vaughan Williams programme.
 20.—"Daily Express" Community Singing concert at Royal Albert Hall.
 21.—Revival of "Hassan" (James Elroy Flecker). Music by Delius.
 22.—"Bethlehem": a Nativity play relayed from Marazion, Cornwall.
 25.—Fourth National Concert. Conductor, Sir Edward Elgar, Albert Sammons (violin).
 27.—"Cinderella."
 The Chamber Music Trio.
 30.—St. Andrew's Day Programme contributed by Scottish Stations.
 A Wessex programme from Bournemouth.
- December 1926.*
- 2.—The Rt. Hon. J. Ramsay Macdonald, M.P., speaking on his holiday in "The Desert." Gloucester repeater Station opened. This Station was designed to clear the land lines of noises and give to transmissions in the west of England greater amplification.
 5.—Service from "Our Lady of Victories," Kensington. The Very Rev. Canon T. Carey.
- 7.—Third International Chamber Concert. (Germany.) The Amar Quartet. Grottrian Hall.
 Dame Nellie Melba in excerpts from "Othello" relayed from the Old Vic.
 9.—"The Ceremony of the Keys" at the Tower of London.
 10.—"The Barber of Seville" by Rossini.
 "The Cancer Campaign" by the Rt. Hon. Viscount Cave.
 13.—"Romance" relayed from the Playhouse.
 15.—"Parsifal" by the B.N.O.C. relayed from the Prince of Wales Theatre, Birmingham.
 Opening of direct high-speed wireless service "via Marconi," London-Lisbon.
 16.—Fifth National Concert. Conductor, Gustave Brecher. Frida Leider (soprano).
 17.—"Australia" by the Rt. Hon. S. M. Bruce, Prime Minister of Australia.
 18.—"My Lady Frayle," a musical play by Arthur Wimperis and Max Pemberton.
 21.—Humperdinck's "Hansel und Gretel" conducted by Percy Pitt.
 23.—"A Pickwick Party," a Dickens dream phantasy.
 25.—Special Christmas musical service relayed from Canterbury Cathedral.
 26.—Bach's "Christmas Oratorio."
 Carols from Norwich Cathedral.
 29.—Symphony Concert conducted by Sir Landon Ronald. Lafitte (piano).
 30.—A Wessex Programme arranged in collaboration with Thomas Hardy, O.M., from Bournemouth.
 31.—A Dream-fantasy of 1926. A programme bringing memories of the transmissions of the past year.

January 1927.

- 1.—The British Broadcasting Corporation takes over the duties and responsibilities of the B.B. Company.
 Daventry Experimental Station started tests.
 New Radio Vicar of St. Martin-in-the-Fields. Rev. W. P. G. McCormick appointed to succeed Rev. H. R. L. Sheppard.
 2.—Arts League of Service.
 "Orpheus and the Orpheans," a future stage of jazz v. classic.
 4.—Fourth International Chamber Concert (France).
 7.—Wireless Telephony started through Rugby P. O. Station.
 "Prunella" a play by Laurence Housman and Granville Barker.
 10.—Play—"Rouget de Lisle," with Martin Harvey.
 12.—"The Year's Work of the League of Nations." Prof. Gilbert Murray.
 13.—Mendelssohn's "Hymn of Praise" from Norwich Cathedral.
 14.—"The Chocolate Soldier"—comic opera.
 15.—First Broadcast description of a Rugby match, England v. Wales, at Twickenham.
 17.—"Voice and Personality"—experiments conducted by Professor T. H. Pear, from Manchester.
 20.—Sixth National Concert at the Albert Hall. Berlioz Programme. Conductor, Sir Hamilton Harty. The Hallé Choir. Messe des Morts.

- 24.—"The Beggar's Opera" and "Julius Caesar."
 25.—Symphony Concert—Frank Bridge.
 26.—Australia Day Programme.
 27.—Debate with G. K. Chesterton, G. Bernard Shaw and Lady Rhondda.
 28.—"Martha"—Flotow's opera.
 29.—Corinthians v. Newcastle United. Cup Tie described.
 30.—Jelius—birth-day programme.
 31.—Debate, "Stage v. Screen."

February 1927.

- 1.—Fifth International Concert. (Czechoslovakia.) The Zika String Quartet.
 3.—Seventh National Concert. Conductor, Hermann Scherchen. Pouishnoff (piano).
 4.—"The Chinese Puzzle," with Ethel Irving.
 5.—Running Commentary, International Rugby Match, Wales v. Scotland, from Cardiff Arms Park to London and Daventry, from Cardiff.
 7.—"The Red Pen" (Geoffrey Toye).
 10.—"The Revision of the Prayer Book" by the Very Rev. the Dean of Canterbury. "La Ville" (Glasgow), opera by Puccini.
 12.—Commentary on the International Association Football Match, England v. Wales, at Wrexham, from Manchester.
 13.—Chenil Chamber Orchestra. Oriana Singers.
 14.—Speech by the Rt. Hon. David Lloyd George, M.P., at the dinner of the Women's Advertising Club.
 16.—The Prime Minister at the Annual Dinner of the Chamber of Shipping.
 17.—Eighth National Concert. Conductor, Bernardino Molinari.
 18.—Gloucester Orpheus Society Concert. "Lord Jim," a play adapted from Conrad's novel.
 21.—H.R.H. Prince George at the Annual Concert of the Seaman's Hostel Society, Hotel Cecil.
 23.—"Trilby," with Phyllis Neilson Terry.
 24.—Command Performance before their Majesties the King and Queen at the Victoria Palace in aid of the Variety Artists' Benevolent Fund.
 25.—"Orpheus" (Gluck).
 26.—Running Commentary of the Wales v. France International Rugby Match, from St. Helen's Ground, Swansea, by Capt. H. T. B. Wakelam from Swansea.
 27.—Wagner programme (conducted by Sir Hamilton Harty).
 28.—"Lilac Domino": Chamber music, with Violet Gordon Woodhouse.

March 1927.

- 1.—Welsh National Dinner of the Cardiff Cymrodorian Society, relayed from the City Hall—speech by the Prime Minister, from Cardiff.
 Sixth International Chamber Concert. (Holland.)
 St. David's Day programme.
 3.—Ninth National Concert. Conductor, Sir Landon Ronald. Jan Kiepura (tenor). At the Albert Hall.
 8.—University of Sheffield Concert.
 9.—Performance of Ibsen's Dramatic Poem "Peer Gynt," from Liverpool.

- 10.—"The Apostles" (Elgar) from Cardiff.
 12.—"Irene" (musical comedy).
 14.—"Old Empire Memories." Debats—Dr. Norwood and Mrs. Cholmondeley.
 16.—An experiment in Mass Telepathy conducted by Sir Oliver Lodge and the Society for Psychological Research. "My Son John." O.B. Relay of Hebrew Folk-songs from People's Palace, E. 1.
 17.—Tenth National Concert. Arthur Honegger and Gustav Holst. "King David" (Honegger). At the Albert Hall.
 18.—Inaugural Banquet of the Company of Master Mariners. Rt. Hon. Viscount Inchcape. Sir Burton Chadwick and Sir Bertram F. Hayes proposed and replied to toasts.
 19.—Rugby International. England v. Scotland at Murrayfield. "Arcadians" (Monckton and Talbot).
 20.—Beethoven Centenary Week. A religious service arranged by the National Brotherhood Movement. Chairman and Announcer, the Lord Mayor of London, Sir Rowland Blades, M.P.
 22.—The Prime Minister, Mr. Stanley Baldwin, at the dinner of the Worcestershire Assocn., Hotel Victoria. "Fidelio" (Beethoven).
 23.—Beethoven Centenary Chamber Music Concert.
 24.—Beethoven's Mass in D (Royal Philharmonic Society), relayed from the Royal Albert Hall.
 25.—First Broadcast description of the Grand National. Mr. Meyrick Good, narrator.
 26.—First Broadcast of an Athletic Meeting. Inter-Varsity Sports, Queen's Club. Narrator, Mr. H. M. Abrahams. Beethoven Centenary Concert by the Wireless Orchestra. Conductor, Alex. von Zemlinsky. Solomon (piano).
 28.—"Kismet": an Arabian night arranged for broadcasting.
 31.—Eleventh National Concert. Conductor, Ernest Ansermet. At the Albert Hall.

April 1927.

- 1.—Debate on "Chivalry." "Il Trovatore" (B.N.O.C.), relayed from Liverpool.
 2.—The Boat Race, reported by Radio for the first time. Narrators, Mr. Oliver Nickalls and Mr. J. C. Squire. Running Commentary on the Association Football International, Scotland v. England, from Glasgow.
 5.—Concert of Sir Hamilton Harty's Works, conducted by the composer.
 7.—Twelfth National Concert. Conductor, Siegfried Wagner. Norman Williams (baritone). At the Albert Hall.
 8.—"The Blue Mazurka" relayed from Daly's Theatre. Opening of high-speed short-wave Australian Beam Station erected by Marconi's Telegraph Company.
 10.—"St. Matthew Passion" music conducted by Dr. E. C. Bairstow, relayed from York Minster.

- 11.—Radio version of "Cyrano de Bergerac," featuring Robert Loraine.
 12.—"Polly," an opera by Mr. Gay.
 15.—Sir Edward Elgar conducted the Wireless Symphony Orchestra in "The Dream of Gerontius."
 17.—Service from Carlisle Cathedral.
 21.—Opening of National Museum of Wales by H.M. the King, accompanied by H.M. the Queen, relayed to London and Daventry, from Cardiff.
 22.—Sir Samuel and Lady Maud Hoare, "Our Experiences on the Flight to India."
 "The Merchant of Venice" (Shakespeare). Phyllis Neilson-Terry as Portia.
 23.—First Broadcast of the Final of the Association Football Cup Tie at Wembley.
 Press Club Dinner Concert.
 27.—The Musicians' Benevolent Fund Concert. Miss Isolde Menges (violin).
 29.—"Romeo and Juliet" (Gounod).
 30.—Opening of beam services constructed by Marconi's between Lisbon, Cape Verde Islands, Angola and Mozambique.
 Launch of the M.S. "Port Gisborne" of the Commonwealth Dominion Line, from Newcastle.

May 1927.

- 1.—Dora Labbette, Hubert Eisdell and Leff Pouishnoff.
 2.—"Der Rosenkavalier" relayed from the Royal Opera House, Covent Garden.
 2.—Debate—Beverley Nicholls and Hamilton Fyffe.
 3.—"The Importance of Being Ernest" by Oscar Wilde.
 5.—Dressmaking by Wireless.
 Admiral of the Fleet, Lord Jellicoe, R.N., O.M., G.C.B., on "The Development of Boy Scout Work."
 Tchaikowsky concert, conducted by Sir Landon Ronald.
 10.—"The Arcadians," a fantastic musical play.
 11.—"White Wings," S.B. from Bournemouth.
 12.—Meeting of the Pickwick Club, proceedings introduced by Sir Ernest Wild, Recorder of London.
 14.—Essex v. New Zealand at Leyton.
 15.—"Elijah" (Mendelssohn).
 Service from Trinity College, Cambridge.
 16.—The arrival at Victoria Station of M. Doumergue, President of the French Republic, on the occasion of his State Visit, described by L. Hore-Belisha, M.P.
 18.—"The English Rose" (musical comedy).
 Guildhall Luncheon speeches. M. Doumergue (French President).
 21.—A narrative of the Royal Military Tournament at Olympia, with "effects."
 24.—"Empire Day." The Prime Minister, Mr. Stanley Baldwin, broadcast an Empire Message.
 25.—Symphony concert conducted by Schneevogt.
 26.—"Magic Flute" (Mozart).
 27.—The successful Broadcast of "Rossum's Universal Robots" (Karel Capek).
 Sir Henry Wood joined the B.B.C.
 28.—Mr. Bernard Darwin on the Amateur Golf Championship, from Liverpool.
 30.—"Les Huguenots," conducted by Vincenzo Bellezza. Relayed from the Royal Opera House, Covent Garden.

- 31.—The French Naval Squadron visits Portsmouth. Speeches at the Guildhall.

June 1927.

- 1.—First Broadcast of the Derby. Narrator, Mr. Geoffrey Gilbey.
 H.R.H. the Prince of Wales made an appeal from Savoy Hill for Funds for the National Playing Fields Association.
 2.—Elgar's seventieth birthday concert, conducted by Sir E. Elgar.
 3.—A debate between Major John Hay Beith (Jan Hay) and Mr. Douglas Woodruff (late President of the Oxford Union Society) on the motion "That Sport is a Menace," with Lord Thompson of Cardington in the Chair.
 4.—The King's Birthday. Trooping of the Colours from the Horse Guards Parade.
 5.—British Legion Memorial Service. Prayers by the Dean of Westminster, the Very Rev. W. Foxley Norris, relayed from the Cenotaph, Whitehall.
 "Liebesmal" (Wagner), conducted by Eugene Goossens.
 6.—Hand of Bridge played by Lord and Lady Asquith.
 7.—"The Wandering Jew," featuring Matheson Lang.
 Opening of Wing at the University College of the South-West at Exeter by H.R.H. the Prince of Wales, from Plymouth.
 Lieut. B. W. O'Donnell joins the B.B.C.
 8.—Mr. W. T. Layton, "How the Economic Conference affects the Ordinary Listener."
 "Bubbly" and "1870" a period programme.
 9.—H.R.H. Princess Mary, Viscountess Lascelles, lays the foundation stone of Bedford College for Women, University of London.
 Symphony concert conducted by Scherchen.
 11.—"May Week" at Cambridge.
 15.—"B.B.C. Composers' Programme" relayed to Daventry, from Birmingham.
 Schubert Chamber Music.
 16.—Running Commentary on the Launch of the "Laurentic" from Belfast.
 17.—"Philemon et Baucis" (Gounod).
 19.—Igor Stravinsky conducts a programme of his own works.
 Haydn's Works.
 20.—Kedroff Quartet.
 21.—A visit to the Theatrical Garden Party.
 "A Midsummer Night's Dream" (Shakespeare). Orchestra conducted by Percy Pitt.
 24.—"Pixie Led," a midsummer fantasy.
 "Carmen" from Covent Garden.
 27.—The arrival from their Australasian tour of T.R.H. the Duke and Duchess of York aboard H.M.S. "Kenown," relayed from the jetty, Portsmouth.
 28.—Speech by H.R.H. the Prince of Wales at the Opening of the New Miners' Convalescent Home, Blackpool, from Manchester.
 "Ball of New York," a musical comedy.

July 1927.

- 1.—The Romance of Canada. Introduced by Mr. Gladstone Murray. Speeches at the

- Canadian ceremonies relayed by Beam Wireless from Ottawa and re-broadcast in England.
- Rt. Hon. Neville Chamberlain, M.P., "How to have Cleaner Cities!"
- Dominion Day Service relayed from Westminster Abbey.
- 2.—A Running Commentary on the Finals of the Lawn Tennis Championships at Wimbledon.
 - 3.—Appeal by the Prime Minister, Mr. Stanley Baldwin, for Funds for the Restoration of Westminster Abbey.
 - 4.—Oxford v. Cambridge Cricket Match described by Mr. P. F. Warner.
 - 5.—Opening of the short-wave high-speed beam service to South Africa erected by Marconi's Telegraph Company.
Bach's Mass in B minor relayed from Minster.
 - 8.—Works of Joaquim Turina.
 - 9.—Eton v. Harrow cricket match from Lords.
 - 12.—Opening of the New Kelvin Hall of Industries by H.M. the King, from Glasgow.
"L'Histoire du Soldat" by C. F. Ramuz. Music by Igor Stravinsky. Staged by R. E. Jeffrey. Relayed from the Arts Theatre Club.
 - 13.—Prince Henry opens the Lees Cliff Pavilion at Folkestone.
 14. The Prince of Wales opens the Scottish War Memorial at Edinburgh Castle. Scenes including the arrival of the King and Queen described by Major J. H. Beith (Ian Hay).
 - 15.—Eye-witness account of the finals of the Open Golf Championship at St. Andrews by Bernard Darwin, from Dundee.
"Les Cloches de Corneville" (Planquette), a comic opera.
 - 16.—Commemoration of the 800th Anniversary of the Foundation of Furness Abbey, relayed from Abbey Park, Barrow-in-Furness, from Leeds-Bradford.
 - 18.—"Vauxhall Belles," a light romantic opera.
 - 19.—Description of the ceremony at the opening of the Gladstone dock, Liverpool, by H.M. the King.
Speech by H.M. King Fuad of Egypt, replying to Address of Welcome by the Town Clerk, from Manchester.
 - 22.—"Lido Lady" relayed from the Gaiety Theatre. Jack Hulbert, Phyllis Dare and company.
Recital by Myra Hess (pianist).
 - 23.—England v. The Rest. A description of the trial Cricket Match at Bristol. Narrator, Mr. P. F. Warner.
H.E. the Viceroy of India, Lord Irwin, opened the Bombay Station of the Indian Broadcasting Company. The first performance was then transmitted.
 - 24.—The Ceremony and Service at the unveiling of the Memorial Arch at the Menin Gate, Ypres, by Field-Marshal Lord Plumer. Speech by H.M. the King of the Belgians.
A French National Programme. One of a series typifying the mind and soul of each country of Europe. Fauré, Rameau, Debussy, Massenet, César Franck, Christine, Charpentier, Saint-Saëns.
 - 28.—"The Vagabond King," a musical comedy based on the J. H. McCarthy's "If I were King," featuring Derek Oldham, Winnie Melville and company.
- 30.—International Athletics—England v. France at Stamford Bridge. Narrator, H. M. Abrahams.
- August 1927.
- 1.—Southern Command Searchlight Tattoo, relayed from Tidworth, Hants.
"Miss Hook of Holland," a musical comedy by Paul A. Rubens.
 - 2.—Singing relayed from Duke of York's camp, New Romney, with message by H.R.H. The Duke of York.
"Carmen," the opera by Bizet.
 - 3.—"The Butterfly on the Wheel," a play by Edward Hemmerde and Francis Neilson.
 - 4.—Ceremony of the Presentation of Colours to the 1st Batt. Royal Scots, by H.R.H. Princess Mary, Colonel-in-Chief of the Regiment, from Glasgow.
Reminiscences of an Indian Army Concert Party.
 - 6.—"Entre Nous," The B.B.C. Concert Party in first performance, "W.O.W."
 - 7.—Broadcast of speech by H.R.H. The Prince of Wales, relayed from Canada.
 - 8.—Special Handel Concert relayed from Liverpool.
 - 12.—William Blake (died August 12th, 1827). Special programme of verse and song arranged by Mr. A. G. B. Russell.
 - 13.—Opening Night of B.B.C. Promenade Concerts, relayed from Queen's Hall, Sir Henry J. Wood and his Symphony Orchestra.
 - 16.—B.B.C. Promenade Concert—Mozart, relayed from Queen's Hall.
Sir Edward Dennison Rosse—Persian Poetry.
 - 17.—My Programme by a Middle-aged Man.
Programme of Music by Arne.
 - 17, 18.—5 WA's Sunshine Carnival at Weston-super-Mare (approx. £2,000 raised for local hospital), from Cardiff.
 - 18.—"Heart's Adrift," a burlesque operetta in one act by J. and H. A. Melluish.
 - 19.—"La Bohème," an opera by Puccini.
 - 21.—Davertry Experimental Station, 5GB, broadcasts its first programme.
First Vesper Music programme.
 - 22.—First of series of Suite of Handel, played by Gerda Nette.
B.B.C. Promenade Concert relayed from Queen's Hall—Wagner.
 - 23.—"Mary Stuart," a play by John Drinkwater.
5 GB—B.B.C. Promenade Concert, relayed from Queen's Hall—Mozart.
 - 24.—Will Oakland, the Radio King of America.
 - 25.—Part of Royal National Eisteddfod of Wales, at Holyhead, from Cardiff.
 - 26.—"1770," an Eighteenth Century Programme arranged by Iolo Williams.
 - 28.—Relay from the Kursaal D'ostende by 5 XX.
Reading of this year's Newdigate Prize poem of Oxford University, "Julia the Daughter of Claudius," by Gertrude Trevelyan.
5 GB—"Judas Maccabæus," an oratorio by Handel.
 - 29.—Chamber Music by Irene Scharrer (piano) and Daisy Kennedy (Violin).

- 29.—5 GB—B.B.C. Promenade Concert relayed from Queen's Hall—Wagner.
- 30.—Excerpt from "Lady Luck" relayed from Carlton Theatre, London.
5 GB—B.B.C. Promenade Concert, relayed from Queen's Hall—Haydn and Mozart.
- 31.—Meeting of the British Association at Leeds. Presidential Address by Sir Arthur Keith, M.D., LL.D., F.R.S., relayed from Leeds.
Jewish Concert—a programme entirely by Jewish artists.
5 GB—"Tosca," an opera by Puccini.

September 1927.

- 1.—"Tosca," a melodrama in three acts with music by Puccini.
- 2.—B.B.C. Promenade Concert relayed from Queen's Hall—Beethoven.
- 4.—A relay from Sydney, Australia.
A further series of Tales from the Old Testament.
Sullivan and German programme.
5 GB—Opening Service of The Three Choirs Festival, relayed from the Cathedral, Hereford.
- 5.—"The New Morality," a play by Harold Chapin, S.B. from Cardiff.
- 6.—Recital by Cesare Formichi and Grace Holst.
5 GB—B.B.C. Promenade Concert, relayed from Queen's Hall.
- 7.—A Running Commentary on the St. Leger, relayed from Town Moor, Doncaster.
- 7.—The Three Choirs Festival. Music by British Composers, relayed from Shire Hall, Hereford.
- 8.—B.B.C. Promenade Concert, relayed from Queen's Hall.
- 9.—German National Concert.
5 GB—B.B.C. Promenade Concert, relayed from Queen's Hall—Beethoven.
- 12.—The Pavlova Ballet Season, a relay from Royal Opera House, Covent Garden, of the first performance of "Don Quixote."
Programme of Works of Eric Coates.
5 GB—B.B.C. Promenade Concert, relayed from Queen's Hall—Wagner.
- 13.—5 GB—B.B.C. Promenade Concert, relayed from Queen's Hall.
- 14.—B.B.C. Promenade Concert, relayed from Queen's Hall—Bach.
- 15.—Symphony Concert, relayed from Harrogate, S.B. from Leeds.
5 GB—"Madame Butterfly," a Japanese Tragedy with music by Puccini.
- 16.—Performance of "Madame Butterfly" (Puccini).
- 19.—5 GB—B.N.O.C. performance of "The Barber of Seville," relayed from Newcastle.
- 20.—An Italian Programme.
- 21.—5 GB—Symphony Concert conducted by Schneewoigt.
- 23.—5 GB—B.B.C. Promenade Concert relayed from Queen's Hall—Beethoven.
- 24.—Last Night of B.B.C. Promenade Concerts relayed from Queen's Hall.
- 27.—5 GB—"Il Trovatore," an opera by Verdi. (Libretto issued.)
- 28.—"Il Trovatore" (Verdi).
- 30.—Symphony Concert conducted by Oskar Fried.

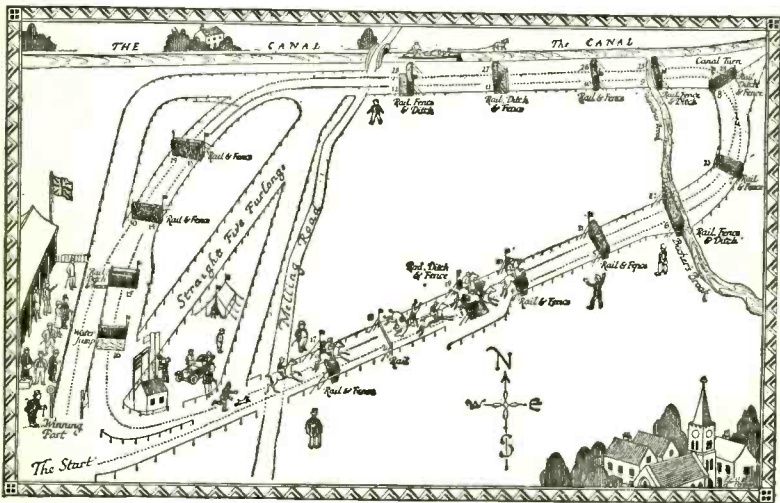

"RADIO TIMES" CHART FOR THE GRAND NATIONAL

The Best of every
Musical Programme
is recorded on "His Master's Voice"

A GLANCE at "His Master's Voice" Record Catalogue will reveal that the best items of a concert programme are always obtainable on "His Master's Voice" Records, enabling you to choose all that is best in music interpreted by the world's greatest artists, who record only for "His Master's Voice." On the new "His Master's Voice" Electrical Recordings you hear the music as clearly as if you were at the actual performance. Call on any "His Master's Voice" dealer and ask him to play over a record of your favourite song or orchestral work and judge for yourself.

"His Master's Voice"
Electrical Recordings

The Gramophone Co., Ltd.

Oxford Street, London, W. 1



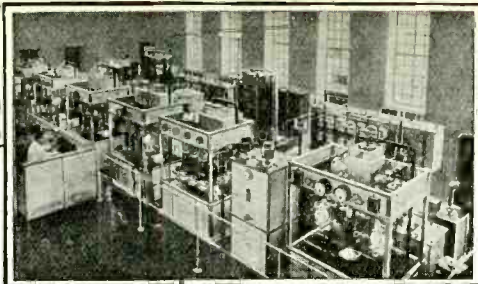

Motala High-Power Broadcasting Station, Sweden.

MARCONI

BROADCASTING APPARATUS

Marconi's Wireless Telegraph Company, Limited, manufacture broadcasting transmitters to meet all requirements, ranging from small stations for strictly local purposes to high-power stations for the widest ranges, such as the stations at Daventry and Motala.



The Marconi Company contract for the supply and construction of complete broadcasting stations, including studio equipment, control apparatus, etc.

The microphones they supply are justly famous for the production of high quality and purity of tone.

MARCONI'S WIRELESS TELEGRAPH Co., LTD., MARCONI HOUSE, LONDON, W.C. 2.

Telegrams.
Inland:
Expanse,
Estrand,
London.
Foreign:
Expanse,
London.

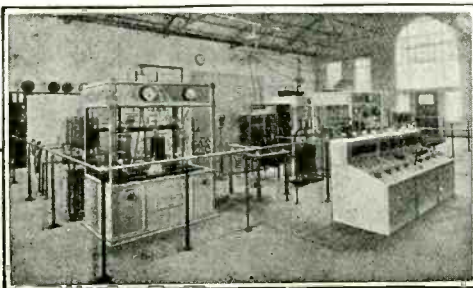

Telephones
No.:
City 8710
(Private
Branch
Exchange).

Daventry High-Power Broadcasting Station.

THE EVOLUTION OF WIRELESS

THIS is not intended to—nor can it in so small a space—be a complete history of Wireless. It is more in the nature of a “refresher” than a treatise, and thus will record only the more outstanding events and discoveries of the past (and first) thirty years or so in Wireless development, with, of course, particular reference to inventions which have led up to Broadcasting as it exists to-day. The reader who wishes and who has the time to trace the development of Wireless in all its implications would do well to turn to one or other of the many histories and treatises on the subject.

Senatore Marconi is regarded by the layman as the inventor of Wireless. He was, in fact, the first person to put Wireless into the realm of a practical means of communication rather than a laboratory experiment. Many other names must be associated with the earlier development of the theory of communication without wires.

CLERK MAXWELL

Firstly, sixty-three years ago, in 1864, Clerk Maxwell, basing his theories upon the experimental researches of Michael Faraday, gave to the world his “dynamical theory of the electromagnetic field,” which he supported with mathematical proofs, and thus paved the way for subsequent investigations. It was not until twenty-four years after Clerk Maxwell had predicted the possibility of producing ether waves that they were actually produced experimentally by Heinrich Hertz, a German. Hertz succeeded in

creating electric waves and in detecting their presence, thus confirming Clerk Maxwell's predictions. Interesting as it would be to follow Hertz's experiments in detail, we must pass on. It should be realised that practical “wireless communication” over any distances had not been achieved, nor had “tuning” been discovered (*i.e.* it was not possible to pick out a particular wireless transmission from a number which were being made on different frequencies). In the following ten years, however, great advances were made—particularly in the discovery of various devices which would respond to the Hertzian waves and thus indicate their presence at a distance. Professor (now Sir) Oliver Lodge in 1889 invented his first coherer, in which he used two metal spheres separated only by a minute air-gap for this purpose; and in 1894 Professor Branly found that metal filings would “cohere” if Hertzian waves were produced in their vicinity. In 1896 Marconi applied for his first patent for a coherer and decohering circuits intended for the reception of wireless signals. In the 1898 naval manœuvres wireless telegraphy was carried out up to a distance of sixty miles, Captain Jackson, R.N. (now Admiral of the Fleet Sir Henry Jackson) collaborating with Senatore Marconi and the British Post Office.

“SYNTONIC JARS”

Although as early as 1889 Lodge foreshadowed the principles of “tuning” circuits to respond to a desired frequency by his famous “Syntonic Jars” experiment, it was not until 1897 that he took

out a patent based on this earlier work, in which he stated the fundamental principles of "tuning," which, it is interesting to note, are, or should be, incorporated in every broadcast receiver of to-day. At this time, also, both Lodge and Marconi were using metal cones and cylinders in place of the "aerial" and "earth" as we know them to-day; but in the succeeding years various other forms of "aerial" were used, which approached more nearly to present-day practice. From 1897 onwards Marconi set up many "long"-distance records, culminating in signalling across the Atlantic from Poldhu in Cornwall to St. John's, Newfoundland, a distance of 1,800 miles. At the receiving Station in Newfoundland Marconi used as an aerial a single wire which was held aloft by kites, and as a detector a mercury type of coherer then in use in the Italian Navy.

EARLIER RECEIVERS

All these early experiments were carried out by means of "spark" transmission. In this system, which, in modified forms, is still in use to-day, especially in ships, a condenser is charged to a high voltage, and allowed to discharge through a spark-gap in series with an inductance, thus producing a train of waves for each spark. The frequency of the waves will depend on the value of the condenser and inductance, while the number of wave trains per second obviously is the same as the number of sparks per second. Each separate wave train dies away before the next one is produced, and thus "spark" transmitters are said to produce "damped" waves—as opposed to "undamped," or "continuous" waves. The latter type of wave

is now basic to all modern means of communication.

As has already been mentioned, the earlier receivers all used a coherer for reception; but from the year 1900 onwards many other devices, too numerous to describe in detail, were invented, each adding to the knowledge of the art and its general efficiency. It may perhaps not be invidious to mention two or three. Firstly, the magnetic detector, on which many scientists worked, was patented in a commercial form by Marconi in 1902 and used by Marconi's Wireless Telegraph Company in some of their ship installations right up to the Great War. Secondly, many forms of crystal detector were patented—those which came into most general use being the galena due to Braun in Germany; the carborundum due to Dunwoody, and the "Perikon" due to Pickard—both the latter in the U.S.A. Thirdly, in 1904 Professor J. A. Fleming patented the first thermionic "valve." This was a two-electrode valve, or diode, and although as a detector it was not very sensitive, and therefore not a great advance on some of the crystal detectors, yet it was one of the most important advances made in the science of wireless telegraphy. It paved the way to the invention, in 1907, by Dr. Lee de Forest in America, of the three-electrode thermionic valve (or triode), which is used in the majority of transmitting and receiving sets of to-day, both for telegraphy and telephony. It is not an exaggeration to say that this invention of the triode revolutionised the whole of the art and practice of wireless, for it gave at once a device capable of producing continuous oscillations of any desired frequency, and of magnifying such oscillations to any desired degree. It was therefore applicable

to both transmitting and receiving circuits, and the many ingenious uses to which it has been put have been the subject of continuous investigation and research by many scientists, notably de Forest, Franklin, Meissner, Armstrong, H. J. Round and E. V. Appleton, from 1907 until the present day.

Up to this point this outline has dealt only with wireless telegraphy; for the advance of wireless telephony, and indeed all allied forms of communication—telephotography and television—were, and are, entirely dependent on the progress made in signalling through space without wires—the vehicle of the message as it were.

TELEPHONY

In wireless telephony it should be realised that, in order to reproduce the notes of music and the voice (frequencies from 30 up to 10,000 per second), the Hertzian waves employed must be of sufficiently high frequency to give many high-frequency oscillations to each low frequency, that they must be continuous, and not damped. If the waves are damped, we shall hear the spark note superimposed on the telephony—in fact, the quality of reproduction would be so bad as to be unrecognisable.

It was the difficulty of producing continuous waves of sufficiently high frequency that held back the progress of wireless telephony for several years. The problem was partly solved by Valdemar Poulsen in 1902, who developed the "Singing Arc" of William Duddell for the purpose of producing continuous waves, but it was not until the thermionic valve gave a much more simple and reliable method that wireless telephony was in any way commercialised. The arc method was employed for wireless telegraphy

for many years; but even for this purpose it is being gradually ousted by the thermionic triode. It has several inherent disadvantages, the foremost of which is the difficulty of confining the oscillations generated to the one desired frequency. Oscillations of double and treble the frequency are generated, and unless especial precautions are taken, these are radiated and cause interference to other stations.

Several other methods of producing continuous waves have been devised—particularly that which employs an alternator to generate the high-frequency oscillations direct. Fessenden in 1903 produced the first machine of this type, and since that date Alexander, Goldsmid and Latour have produced machines of various types for the same purpose. However, the high initial cost and the limitations in frequency did not allow these machines to come into general use for wireless telephony.

TRANSATLANTIC TESTS

The first Transatlantic radio telephony tests were made in October 1915, by the American Telephone and Telegraph Company and the International Western Electric Company. It was during the War, however, that such great progress was made in the design and manufacture of thermionic valves, and of circuits suitable for use with them.

Broadcasting itself may be said to date from the early part of 1920, when a wireless "concert" was given at the Marconi Works, Chelmsford, and was received at distances up to 1,500 to 2,000 miles. In February 1922 an experimental station of the Marconi Company at Writtle, Essex, under the direction of Captain P. P. Eckersley, began a series of weekly broadcast concerts which created

such interest that the Postmaster-General was asked to provide a regular broadcasting service. This was done by the formation of the British Broadcasting Company in November 1922, and regular programmes have been broadcast from the London Station from November 14th, 1922. In the United States, Broadcasting services had already been in existence for two years at this time.

At the present time—in 1927—it cannot be claimed that finality has by any means been reached in overall broadcast reproduction; but the available scientific knowledge is such that if it be all applied to the construction of broadcast transmitters and receivers, then the resultant loud-speaker reproduction will be a very true picture of the original. The term transmitter is here taken to include the microphone, and the term receiver to include the loud-speaker, with their associated amplifiers in each case.

The details of the whole broadcast system in this country will be dealt with in subsequent sections of this handbook, and consequently will find no place in this outline of wireless progress.

Broadcasting organisations now exist in all the countries of Europe and in many other parts of the world—those in Germany and the U.S.A. being particularly active. Experimental interchanges of programme between this country and America have taken place, a short-wave wireless link across the Atlantic being used for relaying the American programmes in Great Britain.

SHORT WAVE

At this point we must leave Broadcasting in particular, and consider briefly the outline of progress in short-wave wireless transmission in general. It will

be recalled that Hertz, in his original experiments, used short waves, *i.e.* waves of only a few metres length. Subsequent experimenters followed him, and it was found that these waves became quickly attenuated as they travelled away from their source over the earth's surface; and further, that the attenuation was reduced as the wavelength was increased. Thus in the race for long-distance transmission wavelengths were increased, until we find the transoceanic telegraph services using wavelengths of the order of 10,000 to 20,000 metres. Increase in wavelength also involves a corresponding decrease in frequency of the oscillations, thus simplifying many electrical problems which arose.

Within the past ten years, however, an immense amount of work has been done, and a corresponding amount of experience has been gained in the actual propagation of ether waves round the earth; and we are led to believe that there exists, at a varying height above the earth's surface (from 60 to 180 miles) a layer of atmosphere which becomes ionised by the sun's rays during daylight. The existence of such an ionised layer was originally pointed out by Oliver Heaviside, and in 1911 Dr. Eccles called it "the Heaviside Layer" in postulating his theory of wave propagation.

Now it has been found that short waves which reach this layer are refracted when they enter it and are bent back, and may finally reach the earth again. Thus, if the receiver happens to be situated at such a point on the earth's surface, the signal will be received at considerable strength, for the wave will not be attenuated to the same large extent that it would have been had it travelled all the way on the earth's surface.

In this way it is now possible to signal over great distances on short waves, using very small powers. The main difficulties are varying strength of signals due to the changing states of the Heaviside layer—variations which may reach the limit and stop the service. Many scientists and engineers are at present working on the problem, and in particular T. L. Eckersley and E. V. Appleton in this country may be mentioned. It is believed that by using the right wavelength at the appropriate time of day this unreliability will be reduced to a minimum.

MARCONI BEAM SYSTEM

The Marconi Beam System has produced a reliable telegraph service by using reflectors to concentrate the transmitted waves in the desired direction, and to concentrate the waves at the receiving Station on to the aerial. It should be noted that the mechanical size of the reflector must be large in comparison with the wavelength, and for this reason it is not commercially possible to employ such reflectors on a long wavelength.

This system is due to Marconi and C. S. Franklin, and commercial services are now operating direct from London to Australia, Canada and South Africa. Another service to India will start soon.

In 1888 Hertz used reflectors and showed that ether waves could be concentrated into a beam, thus obeying the laws governing the transmission of light as predicted by Clerk Maxwell in 1864, and now in 1927 a system of Empire Wireless Telegraphy makes particular use of these principles.

ENGLAND-AMERICA SERVICE

In concluding, reference must be made to the England-America wireless telephone service which

was opened last year, and by which it is possible to telephone direct from any subscriber's telephone in this country to any subscriber's telephone in the United States. A valve transmitter of considerable power is used on a wavelength of the order of 5,000 metres, and a method known as "single side band" telephony is employed. The system is due to the Western Electric Company in conjunction with the General Post Office.

Sir William Crookes, in forecasting wireless communication by means of electromagnetic waves, wrote in 1892, "this is no dream of a visionary philosopher . . . we may any day expect to hear that it has emerged from the realm of speculation into the realm of sober fact." It has indeed.

During 1926 a special section was formed by the B.B.C. with the object of obtaining correct balance of musical combinations in the studios both at rehearsals and during performances. The personnel of the section was representative of the music, engineering and outside broadcast departments, as amplifier control of outstanding musical programmes and outside Broadcasts had also to be exercised.

The first successful re-broadcasts in Great Britain of American programmes were carried out on December 28th and 29th, 1923. The actual re-transmission was also picked up and heard very distinctly in South Africa.

"World Radio"—sister journal to "The Radio Times"—brings to British listeners news of all the chief Dominion and foreign programmes. Technical articles are a standing feature of "World Radio."

ESTABLISHED IN PUBLIC SERVICE

All these
B.B.C. and Public Wireless
Stations
use

Tudor

L.T. ACCUMULATORS

London	Poldhu	Lima, Peru	Loanda
Cardiff	Skegness	Curacao	Lisbon
Newcastle	Somerton	Rio de Janeiro	Oslo,
Glasgow	Bridgwater	Beam Stn.	Norway
Aberdeen	S. Georgia	Melbourne	Ponta Delgava,
Bournemouth	Cape Town	Beam Stn.	St. Michaels
Belfast	Lourenço Marques	Cape de Verde	Stockholm
Dorchester	Natal	Islands	Calcutta
	Bombay		
	Kirkee (India) Beam Stn.		
	Warsaw		
	Kobe		
	Nagoya, Yokohama		

A complete range of Tudor Accumulators, 2, 4, and 6 volt,
is available in sizes to suit your set at standard prices.
Your wireless dealer can supply you.

THE TUDOR ACCUMULATOR CO. LTD.
2 NORFOLK STREET, STRAND, LONDON, W.C.2

M.C. 148

BROADCASTING TRANSMITTERS

THE function of a broadcasting transmitter is two-fold. In the first place it must generate high-frequency alternating currents in a radiating system called the aerial; secondly, it must have the means to modulate the intensity of these waves in accordance with the intensity of the modulations supplied by the microphone.

Put quantitatively this means that the transmitter must generate oscillations of, say, a frequency of a million a second, and must have the means of increasing and decreasing these million a second oscillations at any other lower frequency between 10,000 and 50 cycles per second, *i.e.* between the limits of the audible frequency range.

FOR IDEAL PERFORMANCE

The conditions for ideal performance of a broadcasting transmitter can be stated as follows:

(a) The frequency-amplitude characteristic of the whole system shall be level. More exactly, for equal input alternating voltage to the system, at any frequency between 50 and 10,000 cycles a second, there must be an equal modulation of the amplitude of the high-frequency current.

(b) At any frequency between the limits stated, the modulation of the high-frequency aerial currents must be proportional (between the limits of practical full and minimum modulation) to the input voltage of modulation. To make this point perfectly clear (confusion has arisen), the shape of the input wave form shall be copied in the shape of the envelope of the modulated high frequency for all amplitudes between the limits of practical, full and

minimum modulation of the high-frequency aerial currents.

(c) While the power absorbed from the prime mover by the Station is greater in the case of a broadcasting transmitter than in a commercial telephone set, where distortion is allowable, and while it is tremendously greater than where continuous wave Morse is used to transmit messages, nevertheless the cost of maintenance in power charges should be seriously taken into account. Power economy for ideal performance should, in fact, be studied in comparing different types of transmitters.

(d) The high-frequency aerial currents should be able to be modulated to the fullest possible extent without introducing distortion, *i.e.* non-compliance with conditions (a) and (b) above.

(e) Visual methods of detecting both the depth of modulation at any time and distortion should be part of the equipment of every Station.

(f) Great constancy of fundamental carrier wave frequency is essential; particularly the frequency of the carrier wave should be free from momentary "wobble" under conditions of modulation.

(g) As in every wireless transmitting Station, freedom from harmonics or overtone is desirable.

DIFFERENT TYPES OF TRANSMITTER

It must be obvious that inventors have made many proposals as to how to carry out the ideal performance as indicated above. Curiously enough, out of many methods only two seriously survive for the purpose of Broadcasting. It is quite true that other methods can be used for commercial telephony, but even

here it is becoming more and more to be realised that intelligibility is of paramount importance, and methods which approach the ideal performance are as much valuable commercially as they are valuable for the particular conditions of Broadcasting. The two methods are known respectively as Choke Control and (a clumsy word) Amplification of Modulated High Frequency. Really the methods are very much the same; in the former case modulation takes place at high power, in the latter, modulation takes place at low power, and is thereafter amplified in a high-frequency system not in the least unlike the ordinary high-frequency system found in many receivers.

CHOKE CONTROL

Choke control is so extremely well known, it might be considered almost redundant to describe it here. This can be the only excuse for making the description extremely brief.

In essence the system comprises an ordinary high-frequency oscillation generator, the power supply

to which is fed through a highly inductive choke. At the end of the choke, remote from the supply, a path, parallel to that representing the oscillation generator, is occupied by the control triode, to the grid of which is supplied the alternating potentials of modulation. In the diagram the square upon the right represents the oscillation generator, and the control system consists of the triode and choke. The application of varying potentials, between any frequency 50 to 10,000, to the grid of the control triode causes sympathetic variations of current in the choke itself. This choke, however, being highly inductive, resists changes of current, and the potential of the power supply to the oscillation generator varies sympathetically with the voltage of control.

In effect, choke control is a power control. It has been called by some a constant current system. It is preferable to call it a constant power system, inasmuch as in moments of quiescence equal power is theoretically expended in the control system and in the oscilla-

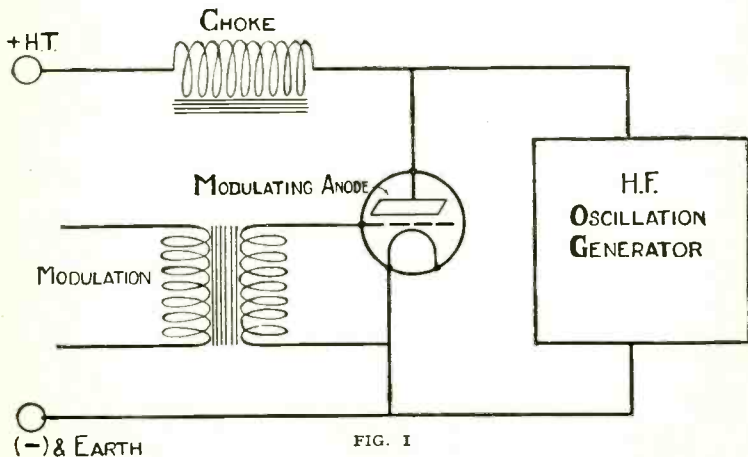

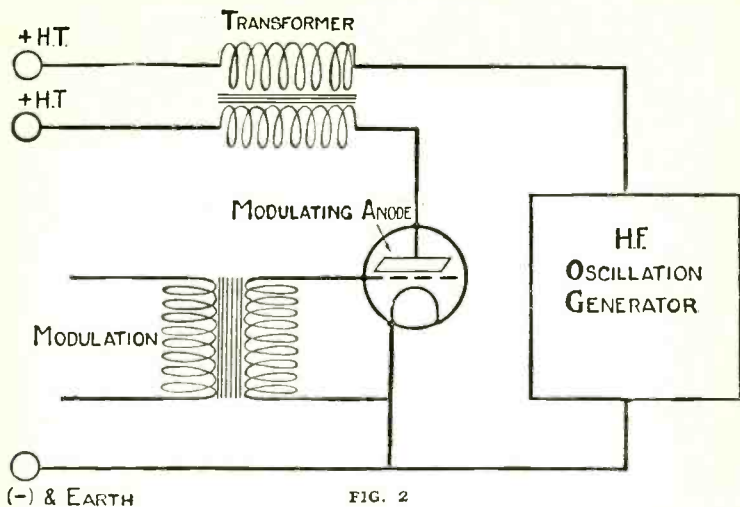

FIG. 2

tion generator. A moment later double power is absorbed in the control system and none is applied to the oscillation generator, and at the next half-cycle of modulation (under conditions of full control) no power is supplied to the control system and all the power flows into the oscillation generator. On the average, therefore, the control system takes half the power supplied to the whole system, the remaining half power being absorbed in the oscillation generator.

The disadvantages of this system are not numerous, but are certainly worthy of notice.

In the first place, any condenser which is effectively connected between the high potential end of the choke and the earth tends to cause a shunting effect to the higher frequencies of modulation; secondly, the capacity of the control triode grid and anode may tend to produce an anti-reaction effect opposing the forces of modulation. The effect of the condenser is different at different

frequencies. At the lower frequencies there may tend to be a cut-off owing to an insufficient value of choke, and it is thereafter imperative to build a choke of high impedance even to very lowest frequency. When using high power the designer has to face the necessity of no low-frequency cut-off, a little self-capacity in the choke, and no saturation in the iron of the choke. This involves great difficulty. Such difficulty has been partially overcome by the Marconi Company by substituting for the choke a one-to-one transformer. The ordinary choke of Fig. 1 is, in effect, a one-to-one transformer, but it is an auto-transformer. The effect of D.C. saturation can be eliminated by using a separate winding as shown in Fig. 2. The D.C. currents oppose each other's magnetic effect, and the iron is only magnetised by the flux from the alternating currents of control. The difficulties of designing a transformer, however, to have a performance which is equal over

the full frequency range and yet so big as to be able to handle 50 or even 100 kilowatts, are considerable.

The fundamental difficulty with choke control is that it involves a high-power low-frequency amplifier system involving several k.w. chokes, which should have an equal performance over a frequency gamut of 200 to 1.

AMPLIFICATION OF MODULATED HIGH FREQUENCY

All the difficulties cited above in connection with choke control can be eliminated by extravagance in power. If twice as much power, for instance, is put in the control system, high-frequency cut-offs can be, by correction circuits, eliminated. Control valves can be used not working near their limits, and so rectification can be eliminated. The basic principle of the amplification of modulated

high-frequency system is to arrange a choke control system at perhaps a power not greater than a kilowatt, and then add stages of high-frequency amplification until the desired power in the aerial is obtained. If a perfect performance can be arrived at by being extravagant in power in the 1 k.w. system, then there is nothing that need stand in the way of designing a perfect high-frequency amplifier up to power.

It is interesting to note that the low-frequency gamut ratio dealt with at high power is, with choke control, 200 to 1, with amplification of modulated high frequency roughly 1.01 to 1 at 300 metres.

COMPARISON OF CHOKE CONTROL AND AMPLIFICATION OF MODULATED HIGH FREQUENCY

Discussing the points raised under the heading of Ideal Per-

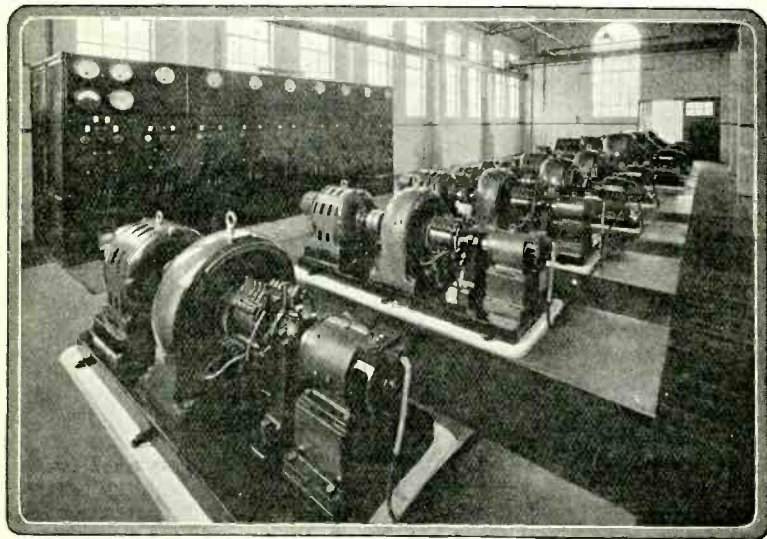

DAVENTRY HIGH-POWER STATION

The Machine Room at 5 XX

formance, one sees that the frequency amplitude characteristics, condition (a), are theoretically better with the method using amplification of modulated high frequency. Satisfaction of condition (b), which is concerned with the proportionality between input modulation at any one frequency with output modulation, shows little to choose between the two systems. This statement is made on the basis of measurement.

As to condition (c), which is concerned with the power efficiency of the whole system, there is, by measurement, little to choose between the two systems.

With regard to condition (d), which is concerned with the sudden change from the state of the linear to non-linear modulation because of overloading of the system, it is probably less easy to satisfy this condition with choke control than with the other method. Some extremely unpleasant effects are produced with the sudden introduction of grid current with choke control, although it is admitted that this can be designed against to some extent. In the one case the transmitter goes into the condition of instability with a crash, in the other it changes from the linear to the non-linear state gently and imperceptibly.

With regard to the question of frequency constancy (condition (f) above), this can be done equally well under both systems. Many sets have been designed with a single master oscillator. The writer believes this system must be insufficient for maintaining constant frequency under modulation, because the drive will be working on to an oscillation generator the conditions in which are varying under modulation. For instance, in choke control, the oscillation triode grid current

is widely variable. It is impossible to expect to maintain absolutely constant frequency in these circumstances. The trouble is easily overcome by the introduction of two drives, or more exactly to design the broadcast transmitter with a master drive, and a separator interposed between the drive and the high-frequency stage which is suffering modulation.

Many engineers have used or proposed the use of the quartz crystal for maintaining absolute frequency constancy. The writer believes that this is unnecessary; firstly, because a separator appears to be sufficient for frequency constancy under conditions of modulation, secondly, because it is simpler, and thirdly, because it is unnecessary to guard against variations of perhaps 100 cycles from hour to hour or day to day. The really important point, provided a reasonable general constancy is achieved, is to keep the frequency steady under conditions of modulation from one fraction of a second to another. This is achieved by using a master separator and the drive. The quartz crystal as it were "gilds the lily."

When designing high-power systems it is almost essential to use water-cooled triodes. Wireless engineers are aware that this type of triode cannot be so hard as the glass type, and is liable to the so-called "Rocky Point" effect. This describes the sudden "flash-over" of the valve internally. Many theories exist to explain this effect; some assert that there is a sudden expelling of occluded gas, producing a momentary softening of the triode and a consequent "flash-over" between anode and filament. This "flash-over" is assisted, no doubt, by any points which may

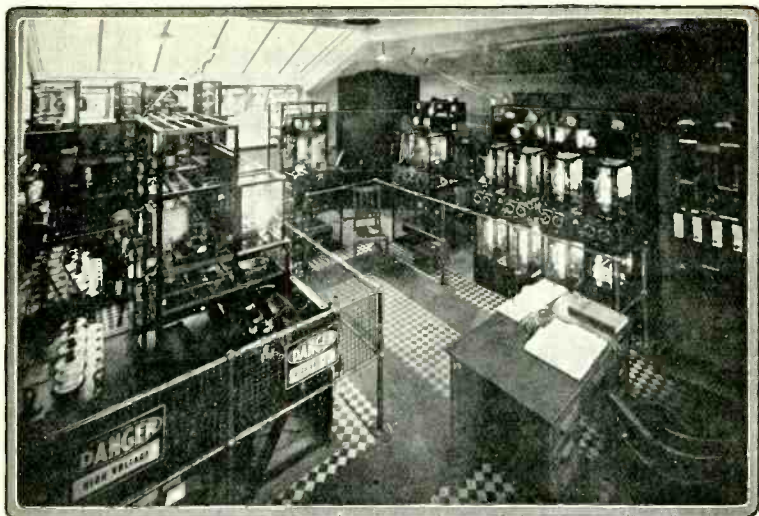

LONDON STATION

General View of Transmitter, showing Control Table on right

exist in the construction of the triode, for instance, in the filament support. When the power supply is limited, or, should one say more exactly, where the regulation of the power supply is not, from an electrical engineer's point of view, good, this momentary "flash-over" is extinguished by the failure of the supply to keep up a voltage across a triode which is taking far more than its normal share of load. The use of alternating current in the power supply is often effective in quenching the sudden arcing over of the triode. In the choke control system the presence of an inductive choke in series with the supply to the triodes may also tend to lower the strain imposed upon the defective triode. The choke is highly inductive to surges of current of so effectively low frequency. The use of the amplification of modulated high-frequency system obviously throws

greater strain upon the power triodes because there is no protecting choke. The writer believes that the best way to tackle the "Rocky Point" effect is to design triodes which are able to handle far more power than they do normally to-day. For instance, with the amplification of modulated high-frequency system the efficiency of the power magnifier is about 33 per cent. For 50 kilowatts in the aerial, therefore, 150 kilowatts have to be supplied to the anodes of the power magnifier. Assume that the best triodes will handle 12 to 15 kilowatts, or say at the maximum 15. This involves 10 triodes in parallel, and one triode is handling only $\frac{1}{10}$ of the total power to the bank. On exhibiting "flash-over" theoretically a minimum of ten times the normal power is applied to one valve. If, however, to take this simple case again, two triodes each

handling 75 kilowatts were taking the load, the maximum power that could be applied to a faulty triode would be only twice normal. Certain it is that "Rocky Point" effect is one of the great difficulties that have to be faced by the wireless designer, not only for broadcasting transmitters, but for any transmitter using triodes.

POWER SUPPLY

The question of power supply is extremely interesting. It is a fact that apart from wages cost, the greatest item in maintenance cost is power. Anything that may be done to economise will result in a great financial gain. The efficiency of a rectifier system is 60 per cent., the efficiency of a motor generator is 80 per cent. This in itself only makes the designer desirous of using direct current. He has, however, to face a great many difficulties in this respect. In the first place 10,000-volt D.C. machines are not standardised products, in this country at any rate, and the risk of breakdown has to be faced. At 5 GB, a high-tension generator has been used with great success for the past eight months without exhibiting any signs of breakdown.

Perhaps the most serious disadvantage that has to be faced when using D.C. is the "Rocky Point" effect. The use of rectified alternating current automatically limits the power which can be passed. The D.C. generator has better regulation and is more liable, therefore, to impose just that extra strain which may result in the destruction of a faulty triode. With A.C. the defection of one member of a group passes practically unnoticed.

The writer believes, however, that it is better to use D.C. and for the moment to employ some

sort of electrical palliative to protect faulty valves. We are waiting for the day when triodes will be designed which do not exhibit "Rocky Point" effect, but it would be a pity not to have a power supply system which will eventually be efficient when valve design and construction improve.

AERIAL DESIGN

Broadcasting is a new technique, a technique involving the close study of the field strength immediately around a Station. Before Broadcasting we studied microvolts per metre at long distances, to-day with Broadcasting we have to consider millivolts per metre at short distance. A quantitative study of this subject shows two facts. First, that the rapid attenuation of the direct ray limits service areas to an alarming extent; second, that large masses of steel involved in mast construction exercise considerable shielding effects. It is early as yet to say much, and there are many difficulties to overcome, but it is certain that aerials having a natural wavelength of something like twice that used give a considerable gain in the extent of service area, particularly with the longer medium waves.

With regard to mast shielding, one is strongly tempted to ask whether wooden masts would not eliminate shielding to a marked degree.

Since 1924 more than 150 separate institutions have benefited from the London and Daventry Stations' appeals for charity. In the same period over 1000 other appeals have been broadcast from provincial Stations.

NEW
**Osram
Valves**

An Important Announcement

The General Electric Company Ltd.
announce the introduction at cheaper
prices of an entirely new and
improved range of Osram Valves
for Broadcast reception

The outstanding merits are:-

Extremely low current consumption
Entire absence of microphonics
Great Robustness

*These Valves have been adopted and
are recommended, after trial, for
clearer and better reception by:-*

MISS EDITH DAY
MR DE GROOT.

Obtainable from all Electricians & Wireless Dealers

STUDIO CONSTRUCTION AND TECHNIQUE

THE broadcasting chain divides itself most naturally into a sequence of three physical processes—the conversion from sound waves into electrical vibrations, the electrical transformations involved in transmission and reception, and the re-conversion into sound at the loud-speaker.

In these processes, the first (with which this article deals) has its chief difficulties in problems of measurement. It is a difficult enough matter to measure the characteristics of a microphone, to find out how it deals with the various musical frequencies in the conversion from sound into electrical energy. It is a much more difficult matter to obtain any definite information on the effect of environment—of the studio or hall—on musical broadcast transmission. This effect is very much greater than would be at first imagined.

FAITHFUL REPRODUCTION

The subject is further complicated by the fact that it involves the art of broadcast listening. So far results have been judged mainly by ear without any adequate scientific conception of what they represent. But recently methods of microphone calibration have improved; and a study of studio and hall characteristics has been made from a broadcasting point of view, and has enabled new studios to be designed and built with greatly improved results.

Apart from the question of environment, the whole broadcasting system must be capable of dealing faithfully with and reproducing correctly whatever is put into it. This means not only

that the complete system should respond equally throughout the whole scale of musical frequencies, but that each component part should do so too. The chief obstacle is in the loud-speaker. No loud-speaker at the present time gives anything like equal pressure output for all frequencies.

The microphone used by the B.B.C. gives a remarkably even response for equal sound pressure waves of all frequencies. The microphone amplifiers are even better in this respect, being very little short of perfection. With such apparatus it should be possible to investigate studio characteristics in a scientific manner.

ACOUSTICS

The general acoustic problem in Broadcasting can be most easily understood by a comparison with the requirements of the ear in listening to music. The evolution of music has always been in relation to its environment. In other words the environment has been made suitable for any particular type of music or entertainment (or vice versa), to satisfy the ear and its capabilities of artistic appreciation.

For example, certain kinds of chanting have been evolved as suiting best the conditions experienced in a cathedral; chamber music is written for and sounds best in a medium-sized room; and the spoken word, as exemplified in the drama, is heard to best advantage in the rather deadened conditions of a small theatre, or, in some cases, in the open air. In the same way the environment must be chosen to give the best results for the microphone, and

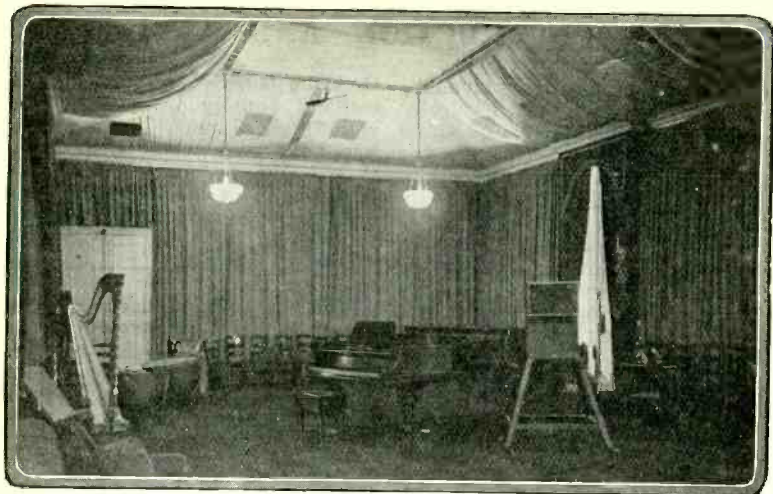

NO. 1 STUDIO AT SAVOY HILL

Recently re-modelled and adapted to the improving technique of Broadcasting

in general the conditions are quite different from those necessary for the ear, and much more difficult to satisfy. Furthermore the two ears of the listener in the theatre or concert hall can with the help of the eyes accommodate themselves to make up for any deficiencies in audition; this latitude is not available for the somewhat rigid conditions of the microphone-loud-speaker system, so that the greatest care has to be taken at the microphone end in order that the reproduction at the loud-speaker gives the most satisfaction from an acoustic point of view to the listener seated in front of it.

Acoustic effect can in general be expressed scientifically in terms of the length of time an impulse of sound takes to die away.

Fire a revolver in the open air and it sounds like a sharp crack. Fire it in a hall and the sound reflects backwards and forwards between the walls and lasts for

several seconds. This latter effect is called the reverberation, and the length of time that it lasts gives an approximate criterion of the acoustic effect of a hall. In the case of a lecture room or theatre this length of time should not be greater than a second when the audience is present, or the speech will be difficult to understand. But in a concert hall it should be much greater, say up to two or three seconds, to give the best musical result for a symphony orchestra. In this case the wise concert-goer will find for himself various positions where he may hear the best musical tone. In these places the reverberation time may be actually the same as elsewhere, but the way in which the sound dies away, due to a certain combination of reflections at those spots, gives a warmth of tone which makes all the difference in the appreciation of the music.

In the same way, as far as Broadcasting is concerned, the

correct acoustic effect, as a result of proper choice of studio or hall and of correct microphone placing, can be found to give the most agreeable result at the loud-speaker. And this result may, if it is just right, be so striking as almost to compel people to listen to it; at any rate it will satisfy fully those listeners who have any idea of musical appreciation.

STUDIO CONSTRUCTION

The B.B.C., when it realised the importance of this, started building studios which would be suitable for every type of performance. Originally there was one studio at Savoy Hill, built with very heavily draped walls to try and make it sound-proof. Inside, everything was very dead indeed.

Subsequently better studios were built with lighter draping on the walls and having a much freer atmosphere. Each of these studios was then adapted to certain types of performance. One was for large orchestras; another for small orchestral combinations and solos; a third, smaller still, for talks; a fourth, with an adjoining noise manufactory, for plays.

The equipment in these studios was standardised, consisting of a microphone slung on a heavy movable stand with long flexible leads to a wall or floor plug; and connected to the corresponding microphone amplifier placed fairly close to the studio. The output from this amplifier, at medium telephone strength, was taken to the main control room, where all programmes were dealt with.

ARTIFICIAL ECHO

These studios were sufficiently good at the time, but later investigation showed that what-

ever alterations were made in the way of draping or leaving bare the walls of a studio, such studio would always give, via the microphone, the effect of a "room." In the case of orchestras it is the "hall" effect which is required for their correct transmission. This effect is obtained by a method, now in use, of adding "artificial echo." The tendency now is to have studios which are acoustically of medium deadness, but with bright decorations and upholstery. Draping is replaced by artistic panelling and pillars, and the effect on artists is enlivening. Then just the right amount of artificial echo is introduced electrically to give the correct reverberation effect for any particular item which is being broadcast. The method of doing this is as follows: Two microphones are used side by side in the studio. One of these leads through its appropriate amplifier direct to the control room. The other leads to a loud-speaker situated in a distant echo room which has bare plaster walls and concrete floor and ceiling and which is kept closed. The sound from the loud-speaker is reflected many times by the walls of this room, the resulting sound being rather a confused reproduction of the original music in the studio. It is picked up by a microphone in the echo room and taken to be combined in the control room with the direct music from the first microphone. By varying the proportions combined, various effects can be obtained. With direct music alone the result is like the original music in the studio. By adding increasing proportions of the music via the echo room, the result sounds as if the music were being successively played in a large room, a small hall, a large hall, and a cathedral.

By adjusting the proportion control, it is possible to give just the artistically correct effect for any particular item. The arrangements in the echo room are such that the type of reverberation can be altered very considerably. But usually this is set at a mean value and then the effective length of time of reverberation is controlled by an experienced musician whose duty it is to watch the balancing of orchestras and of solo artists in relation to the piano and the acoustic effect of transmissions.

Transmissions are usually adjusted for best results on a really good type of cone loud-speaker. This does not represent the very best type of loud-speaker, but the average type used on good receiving sets. Those who find echo effect continuously wrong in their reception must look for some serious unsuspected fault in their receiver.

THE LISTENING ROOM

In order to help such balancing during rehearsal each studio is provided with a small local listening room just outside the studio with a glass window between the two. It is in effect a silence cabinet where the balancer can listen with headphones or loud-speaker to whatever is taking place in the studio, and can thus make any alterations in microphone placing or the positions of artists that may be necessary in preparation for the actual transmission. Furthermore these cabinets are provided with microphones and a local switch, so that the announcer can switch off the studio microphone, and make his announcements through the cabinet microphone.

One of the most interesting innovations at Savoy Hill has been the installation of a new set of dramatic controls. The use of several studios simultaneously has been a feature of some of the dramatic productions during the last year or so. The system of combining and controlling, say, four studios at once has up to now been rather difficult. In the present arrangement the producer of an entertainment involving several studios can use a new control board which comprises any desired number of studios. He can listen during rehearsal to a loud-speaker reproducing the combined results, and correct faults by talking via a microphone in front of him to each assistant in charge of each studio at the time. During transmission he has the strength control for each studio in front of him, and he can alter the balance, continuously maintaining it correct while listening to the transmission reproduced by the loud-speaker in front of him.

In ordinary plays he would only use two controls, one for the players in the studio, and one for the noises in the noises room. But very often it would be necessary to use an orchestra simultaneously, and then he would use an additional control for this; and one more control if echo were required.

When this arrangement is in use the microphones in the various studios to be used are disconnected from their respective amplifiers and connected right through to this dramatic control system.

The director in each studio keeps "in time" by listening on phones to the transmission, taking his cues accordingly.



DO YOUR OWN CHOOSING

The old idea in set building was to follow blindly the use of the parts named by the various writers. Now this is changed because users know that the products of advertising manufacturers are used in turn, and that you can replace every part named in any published circuit with the corresponding part in the LISSEN range, with an improvement in the volume and clarity of signals, and a big saving in the cost of building, and at no increased cost.

LISSEN parts use all the available energy, and build up signals strongly. There are no losses and no leakages to be overcome in the parts themselves. The LISSEN direct-to-dealer policy of distribution cuts out big wholesale profits, and passes the savings on to the user. Do your own choosing. Compare LISSEN parts side by side with any others. If you build with LISSEN you build with a certainty of getting clearer, louder signals.

Obtainable at all dealers throughout the country.

LISSEN LTD., 47-56 Friars Lane, Richmond, Surrey
MANAGING DIRECTOR: THOMAS N. COLE

1383

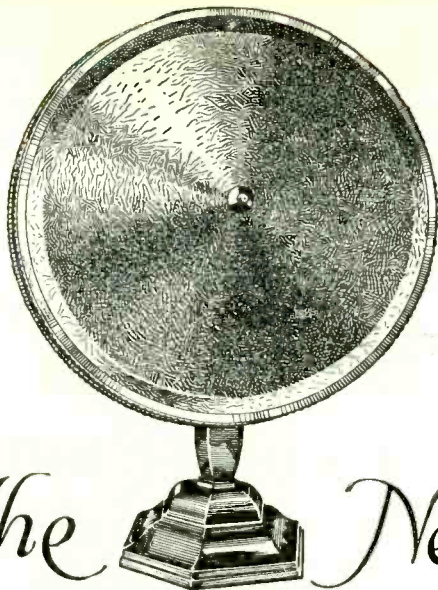

The New
CONE
LOUD SPEAKERS

Cultured refinement, unequalled delicacy, accuracy and fidelity of reproduction are idealised in the new GECophone Cone Loud Speakers. There are four beautiful and distinctive models to suit individual requirements. Above is depicted the Standard Cone Loud Speaker, a handsome model with self-coloured and beautifully grained cone and fine coin bronze finished metalwork.

Ask your dealer to demonstrate the Standard, Screen, Plaque, and Cabinet Models with GECophone Radio Receivers and Gramophone Reproducers.

GECOPHONE

(REGISTERED TRADE MARK.)

**RADIO RECEIVERS AND GRAMOPHONE
REPRODUCERS AND CONE LOUD SPEAKERS**

The G.E.C.-your guarantee

Advt. of The General Electric Co., Ltd., Magnet House, Kingsway, London, W. C. 2

M I C R O P H O N E A M P L I F I E R S

IN all present-day Broadcast apparatus it is necessary to use amplifiers to magnify the weak impulses generated by the microphone to a sufficient strength to modulate the transmitter.

It is necessary, moreover, that the amplifier shall produce a minimum of distortion. Distortion is of two kinds, amplitude distortion and tone distortion. Amplitude distortion can be defined as that distortion which, when a pure tone is applied to the input of the apparatus, causes an impure tone to be delivered from the output terminals, or unequal amplification at different intensities or amplitudes.

Tone distortion is caused by the failure of an amplifier to magnify equally at all frequencies.

AMPLITUDE DISTORTION

This is usually caused by overloading valves, transformers, etc., and can only be reduced to a negligible amount by allowing ample factor of safety everywhere.

There are two essential causes of valve distortion—grid current and curvature of anode current characteristics. Of these the former is the most violent, but is prevented easily by the use of suitable grid bias. The latter can be overcome by choosing valves which have straight characteristics, using high values of output impedance, sufficient high tension voltage, and allowing a factor of safety of at least two, if possible more.

Amplifiers may be of three essential classes :

- (1) Resistance capacity coupled.
- (2) Transformer coupled.
- (3) Choke capacity coupled.

In most amplifiers used in Broadcast Transmission work it is usual to have input and output transformers, for three reasons :

(1) The input and output (grid and plate) impedances of an amplifier are very different from that of a line—to which the amplifier is usually connected. Consequently a transformer is necessary to "match up" the impedances, as, were the impedances not "matched," the line would produce serious reflections giving rise to a very bad frequency characteristic.

(2) In order that line noises are not accentuated, neither side of the line should be earthed. It is, however, necessary to earth the filaments of an amplifier for stability, and for convenience the line has to be separated electrically from the amplifier by a transformer.

(3) Owing to the great difference in impedance between the output impedance of a valve and the line impedance, inefficiency would result from direct coupling. Inefficiency means using more valves and greater power. Roughly five times as many valves would be required for direct coupling as for transformer coupling.

TRANSFORMER DESIGN

Transformers can be divided into input, intervalve and output transformers.

Intervalve and input transformers are essentially the same. Output transformers are different in that they have to produce power.

The three points governing transformer design are—self-capacity, magnetic leakage and self-inductance of the windings.

Self-capacity has the effect of

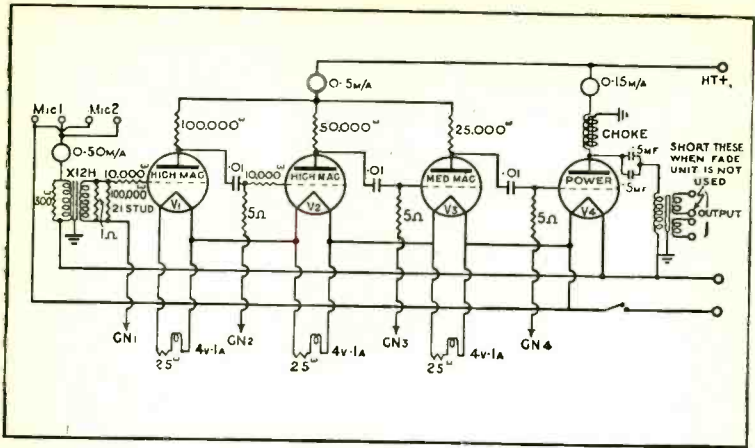

shunting the high frequencies, but this effect can be partially neutralised by the magnetic leakage, in input and intervalve transformers. Magnetic leakage by itself in a loaded transformer (one which is supplying power) has the effect of reducing high frequencies. It acts as if it were a series inductance in the circuit equal to $L_0(1 - K^2)$, where L_0 is the self-inductance and K is the coefficient of coupling between primary and secondary.

Lack of self-inductance of the windings has the effect of shunting the lower frequencies, and is a very common defect in transformers. Self-inductance can only be increased by increasing the turns, area of core, or permeability of core. The initial permeability of stallo is about 250, nickel iron alloy about 600-1200, specially treated nickel iron (mu-metal and permalloy) 2000-7000. The permeability of some transformer iron varies considerably with flux density and frequency. Great care has to be taken to design for the lowest flux density to be used.

In order to obtain a good frequency characteristic with a transformer, the secondary cannot have more than a certain number of turns, otherwise capacity and leakage effects will impair the transmission of higher frequencies; while the primary winding must have more than a certain number of turns in order to obtain sufficiently high self-inductance to avoid low frequency loss. The step-up ratio is therefore definitely limited. For this reason there is practically no advantage in using transformers for intervalve coupling unless very low impedance valves can be used.

In a perfect transformer, if a resistance R_p is connected across the secondary, the primary will behave as if it were a resistance

$$R_p = \left(\frac{tp}{ts}\right)^2$$

on the primary and ts the turns on the secondary. When R_p is equal to the resistance of the circuit supplying power to the primary winding, the transformer is said to have matched impedance, and in this condition produces maximum power in the secondary.

This condition can seldom be obtained in practice, as the primary turns have usually to be increased beyond their optimum value to increase the primary self-inductance. This results in R_p being higher than it should, where it is necessary to match impedance, as in input transformers from a line; a resistance may be placed across the primary winding to make its total effective resistance correct.

In an output transformer for a line it is not possible to design for matched impedance condition, as the line impedance is not constant over the frequency range; it may vary from as much as 1500 ohms at low frequency to 150 ohms at high frequencies. If a transformer was designed for the mean impedance, say about 600 ohms, the effect would be to produce greater voltage on the line at low frequencies than at high frequencies, as the voltage regulation of the transformer is bound to be bad over such a wide range of load impedance condition, unless the transformer impedance (this is the valve resistance \times ratio²) is made low compared with the lowest impedance the transformer has to deal with. This is analogous to voltage regulation in a power system.

In a valve output circuit a relatively large direct current flows. If this were allowed to flow through the transformer winding it would reduce the effective self-inductance considerably by saturating the iron (or partially so). To avoid this effect the H.T. is supplied to the anode through a high inductance choke, the anode being connected to the transformer primary via a large condenser which passes alternating currents but stops direct

currents. This is shown in the diagram.

CHOKE COUPLING

Choke coupling has the advantage over resistance coupling in that the voltage at the plate is higher; consequently the magnification and output without distortion will be greater. Its advantage over a transformer is that more turns (consequently higher self-inductance) can be used on a given core. This results in less loss of low frequencies. But even so the loss of low frequencies is sufficient to bar the use of choke coupling for a multi-stage amplifier where high magnification valves are used and a straight frequency characteristic is required.

RESISTANCE CAPACITY COUPLING

In theory, resistance capacity coupling produces a straight frequency characteristic over a wide frequency range. It is limited at low frequencies by the capacity of the intervalve condenser, and at high frequencies by the capacity of leads, valve electrodes, etc., although the latter effect is negligible provided low magnification valves are used. In high magnification valves the internal resistance is high; this makes the effect of any small capacity, large. And also the Miller effect increases with magnification. The Miller effect is the increase of effective grid filament capacity by interaction of the plate and grid circuits through the plate grid capacity; *i.e.* the voltage at the plate induces a voltage on the grid electrostatically, which has the effect of increasing the grid filament capacity, the effect increasing as the magnification increases.

LOTUS COMPONENTS ARE WORLD FAMOUS

EMINENT constructors stake their reputations on "Lotus" Components; wireless journals the world over recommend them; they are relied upon by professional and amateur alike, for "Lotus" stands for the quality by which the best is recognised.

THE LOTUS REMOTE CONTROL is the greatest wireless success of the year. It provides simultaneous reception and control throughout the house without interference at small cost.

Choose also Lotus Buoyancy Valve Holders, Lotus Vernier Coil Holders and Lotus Jacks, Switches and Plugs.

LOTUS

GARNETT, WHITELEY
& Co., Ltd.

"Lotus Works"

BROADGREEN ROAD
LIVERPOOL

J.C. & S.

OUTSIDE BROADCAST PROBLEMS

WORK outside the studio is often the most difficult that the broadcast engineer can be asked to undertake; not so much from a technical as from a practical point of view.

Very often he has to take his apparatus to some place he has never seen before, set up his amplifiers in most awkward positions, test his lines to the studio, decide on his microphone placings, and run out the wiring in the space of an hour or so, with little previous experience to guide him. And yet the broadcast result has to compare favourably with the studio performance, where there is every opportunity for rehearsal, and where all the apparatus and wiring are in permanent commission.

MICROPHONE PROBLEM

It is in fairly echoey halls, theatres, and churches that the majority of outside Broadcasts take place. For example, a sermon preached in a church would be intelligible probably to the whole of the congregation. But to render it intelligibly on a loud-speaker, the microphone would have to be, say, not more than 10 feet from the speaker. This is due not so much to lack of sensitivity as to the inability of the ear to discriminate between direct sound and echo (with incidental noises). At greater distances, the direct sound from the speaker is swamped by the reflected sounds from the walls and roof and loses its intelligibility. A similar result is observable in a theatre where usually a player is only intelligible on Broadcast when he is within 10 feet of the microphone. The difficulty is most acutely experi-

enced when the microphone can only be placed in certain definite positions—for example on the footlights in a theatre.

KEEPING WITHIN RANGE

When the speakers are moving about, as in the case of a play, or when several speakers are taking part, the only way of dealing with the problem is to use several microphones and a mixing device which enables the engineer to change silently from one microphone to another, or to combine them in varying proportions.

The speaking voice must always be kept within speaking range of a microphone. In the case of banquets with several speakers, the change is made between the speeches. The engineer must know the programme exactly in order to lay-out his microphones among the diners. In theatre broadcasts the movement of a player, or the change of dialogue from one side of the stage to the other, must be followed by rapid switching from one microphone to another. If there is orchestral accompaniment with a corresponding microphone for the orchestra, then balance between music and voice must be maintained as well as following the voice about.

In a church or cathedral service, similar procedure must be adopted, but the changing over is more regular. Furthermore, the use of several microphones is often valuable in obtaining a good rendering and correct balance for choir and organ, a thing that is often difficult to do with only one microphone.

ORCHESTRAL TRANSMISSION

In the case of orchestral transmissions from halls it is usually easier to find during rehearsal

GRAND NATIONAL O.B. 1027.
GENERAL ARRANGEMENT.

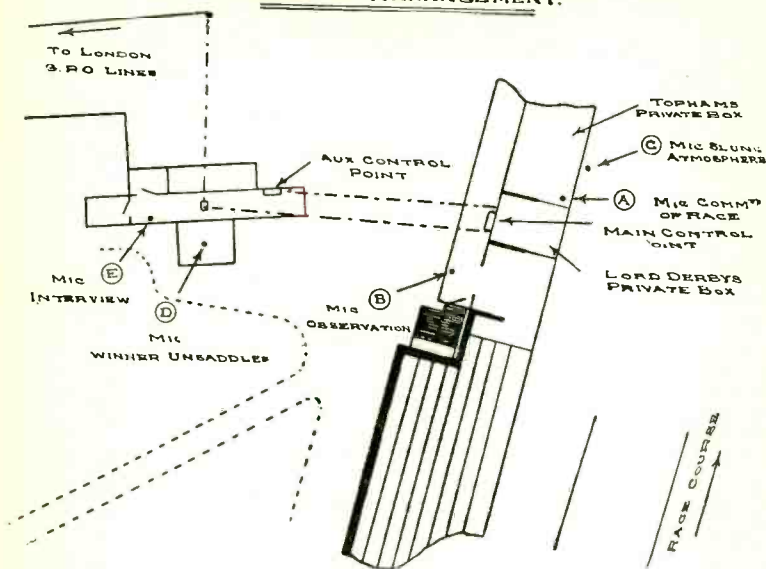

TECHNICAL ARRANGEMENT

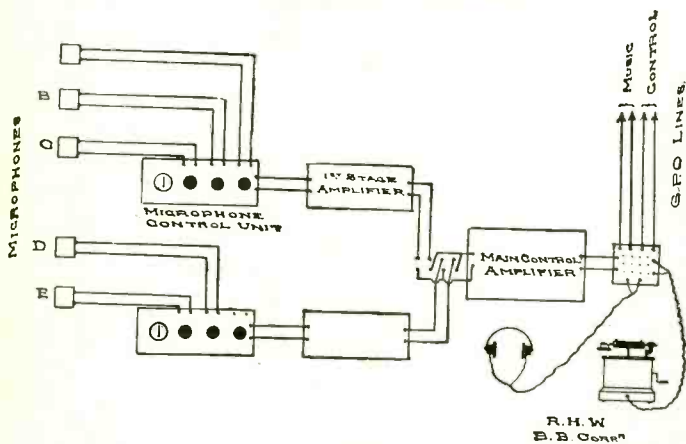

a suitable position for a microphone to give correct balance between the instruments. But the engineer has to remember that there is a great difference between an empty and a full hall, and although the presence of an audience may not alter appreciably the balance, it may alter considerably the general effect.

Also it does not necessarily follow, as for example in the case of opera, that artists will take up the same positions during the actual performance as they did during rehearsal. One must be prepared for unexpected and unrehearsed changes.

LAND-LINES

Even with good microphones and amplifiers the outside engineer may often experience difficulties with the lines connecting the outside point to the studio. The majority of these lines run underground, and do not transmit the higher frequencies adequately. It is often difficult to correct these

faults, especially on the longer lines. Fortunately most of the O.B. lines to Savoy Hill are short and do not need much correction. But these line difficulties are small in comparison with those experienced on long-distance outside Broadcasts. The engineer must always be prepared for noises and other faults developing on the particular line he is using for the transmission of music, and must maintain continuously a close co-operation with Savoy Hill so that any changes of line that may be necessary can be carried out simultaneously at both ends. At the same time he must keep a close observation at his own end to see that the quality of the music he is putting on the line is up to standard.

Lady Tree, Lady Gainford, Miss Zena Dare (the Hon. Mrs. Maurice Brett) and Commander Kenworthy, M.P., were among those who took part in the first mass telepathy Broadcast during 1926.



A QUIET HOUR ON THE THAMES

Such is the accessibility of the broadcast programmes that outdoor listening is now a popular summer pastime

NO MUSIC ENTERTAINS
UNLESS IT IS PURE

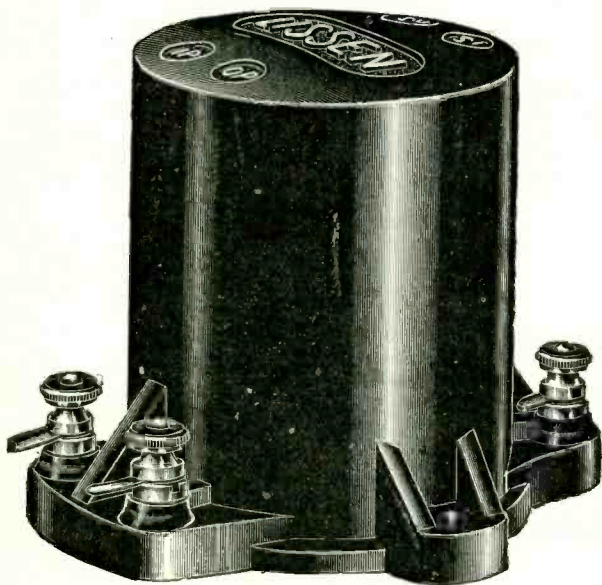

Your transformer must be good before you get good music amplified. With a LISSEN Transformer you will clearly hear every note on the piano—the strings retain their individualities—wind instruments sound melodious as they should—and the voice of the singer has the realism you want. This is because the LISSEN Transformer fully amplifies every note, every tone, every harmonic, every overtone.

Price is surprisingly low because the LISSEN policy of direct-to-dealer distribution eliminates all wholesale profits.

Guaranteed for 12 months

LISSEN L.F. TRANSFORMER

LISSEN LTD., 47-56 Friars Lane, Richmond, Surrey.
MANAGING DIRECTOR: THOMAS N. COLE

8/6

L388

EUROPEAN SIMULTANEOUS BROADCASTS

ELSEWHERE will be found an article on Empire Broadcasting—a subject so specialised as to deserve separate treatment.

No engineer would dream of using anything but the telephone wire to link up National Broadcasting systems to other similar systems if he could do so. Some experiments on the continental wireless link have done no more than reveal its unreliability. The undersea telephone line, however, does not give either good or even understandable quality of speech if it is longer than hundreds of miles. This article, however, deals with the question of the linking of national systems of Broadcasting by telephone line, assuming this to be possible.

At present every nation seriously operating a national system finds it a convenience to link one centre to another by land-line. The use of the "S.B.," or simultaneous broadcasting system, is obvious. Elsewhere it is pointed out that the distribution of transmitters bases itself upon having as many centres of transmission as possible to prevent large wipe-out areas near the stations and feeble signals far away. If, therefore, a programme of national importance is to be given at justifiable clarity, and with justifiable ease of reception to the scattered population of any nation, it is obvious that its simultaneous radiation from many centres is the only efficient technical method available. The land-line linking together of distribution centres thus constitutes an almost essential feature of any national service.

B.B.C. AS PIONEER

The B.B.C. has been the first in the world to exploit "S.B." to its fullest advantage for a national system, and, thanks to the co-operation of the Post Office engineers, it is possible to pick up a programme wherever it may take place within the British Isles and radiate it simultaneously from all distribution centres.

Carrying this development a step forward, it is necessary to see how to link together systems similar to that existing to-day in Britain, so that any European programme may be picked up and, by means of telephone line linking, radiated simultaneously from as many European distribution centres as may be considered advisable.

Looking ahead still further and assuming that the wireless will supplement the wire link, there is no reason why a simultaneous Broadcast of something of fundamental importance to the whole civilised world should not take place.

The future of world-wide Broadcasting is so dazzling that it blinds many to the facts of the situation, and this article is intended

to discuss the mechanical difficulties standing in the way of even the simple problem of the wire link.

In the first place Britain is disadvantageously placed, because there is bound to be an undersea link. On the Continent this difficulty, at any rate, is removed.

THE TECHNICAL PROBLEM

For the rest the problem is purely technological. In expert opinion, future technique involves the use of underground lightly-loaded cables having a cut-off above 5,000 cycles, and frequently interrupted by one-way repeater links. A cable has greater reliability than the overhead wire, but up to now it has not been used for Broadcasting because it has not been able to pass the higher frequencies and because it requires frequent "repeater" stations.

The first point is met because for pure telephone work it is beginning to be realised that intelligibility is a factor of greater importance than strength, and so high-grade circuits are everywhere to-day being built to link up important capitals. The second point is met only by incurring large capital cost, and by installing high-grade one-way repeaters every 50 to 100 miles to take the incoming programme, to correct distortion, amplify the volume, and so pass on a "corrected" edition to the next section of cable. It will be appreciated that if this correction and repetition are necessary for ordinary commercial telephony (as they are) they are more important for Broadcasting.

There is, however, this difference, that for ordinary telephony some compromise is allowable, and the repeater has to work on a single circuit both ways, so that your speech may be corrected and amplified passing in one direction, and that of your interlocutor amplified and corrected and passed in the other. For Broadcasting there is no compromise, but the communication is uni-directional. All this is tantamount to saying that special repeaters are required in cable connection for Broadcasting, and the difficulty in building up International S.B. is partly concerned in the design, installation, and upkeep of these repeaters, which, installed at points 50 to 100 miles apart, will, in a long line, be numerous.

INTERNATIONAL INTEREST AROUSED

Apart from these purely physical difficulties there are no fundamental barriers to progress. There is no reason why in time it should not be a commonplace to see in "The Radio Times," "Programme S.B. to Berlin, Prague, Paris, and Budapesth" or "Programme S.B. from Moscow," the latter perhaps more difficult in many ways.

It is certain that, considering the interest being taken in this

matter by the Technical Committee of the U.I.D.R., there is no reason why tentative beginnings this winter should not develop into actual service of the widest character during the next decade.

It is interesting at the conclusion of this article to state the fundamental difference between the possibilities of the wire and wireless link. The former's difficulties are certainly soluble in time—technological improvement, international understanding, and capital cost; the latter problems, however, present no such obvious solution. Empire Broadcasting and the wireless link still present difficulties that have no obvious solution. That such solutions are being sought goes without saying, but no guarantee of the conditions pre-requisite to service can yet be given. The pre-requisite conditions of service with the wire link exist to-day; it is only a matter of time to realise certain potentialities.

When such potentialities are converted to the dynamics of fact, Broadcasting will enter a newer and more significant phase, and there will be soundly laid the foundations, at least, of the idea of world-citizenship.

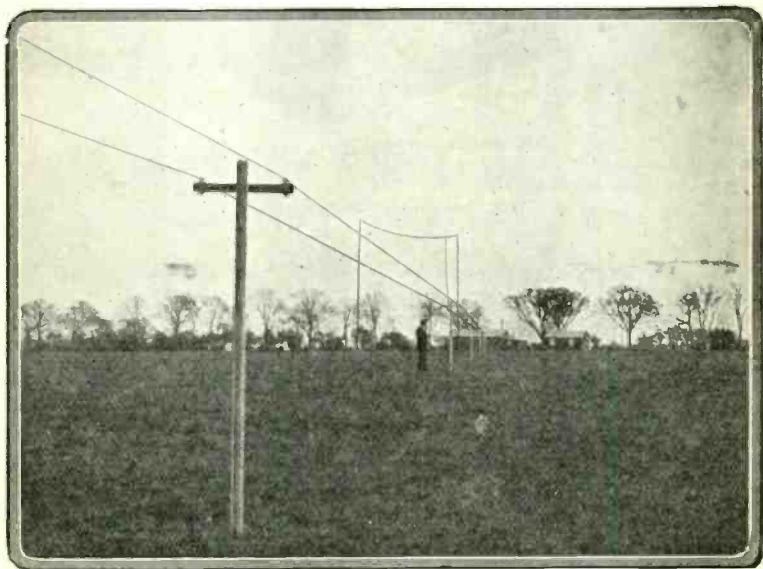

A WIRELESS LINK WITH THE CONTINENT

The directional aerial used at Keston for reception from long-wave European stations. Although only nine feet above the ground, the aerial is 600 yards in length

SIEMENS

SUPER-RADIO

H.T. DRY BATTERY



DIMENSIONS (including lid) $8\frac{1}{2} \times 5\frac{1}{2} \times 9\frac{1}{2}$ ins. high.
NORMAL DISCHARGE RATE. 10 milliamperes
MAX. ECONOMICAL DISCHARGE RATE. 20 " " " " " "
WEIGHT 20 lbs.

PRICE 25/- each

STANDS ALONE
 for
 SUPREME RELIABILITY
 and
 PERFORMANCE

Obtainable from all dealers

SIEMENS BROTHERS & CO. LTD.
WOOLWICH, LONDON, S.E. 18

METHODS OF DETECTION

IT is probably true to say that in connection with detectors there has been less improvement during the last few years than with any other important component of the complete receiver.

Obviously a device is wanted which, in effect, has a negligible resistance to current in one direction and infinite resistance in the other. Moreover, the negligible resistance must extend over a wide range of amplitudes and there must be no limiting effect.

Unfortunately no existing detectors comply with these ideal requirements. The more commonly used detectors may be classified as follows :

- (a) Crystals.
- (b) Three electrode valves.
- (c) Two electrode valves.

We will not discuss crystal detectors in detail, but there is one interesting fact which may be mentioned. This is that various forms of galena in conjunction with a fine, springy metal point are almost invariably used for broadcast reception in preference to a more stable combination such as carborundum and a flat steel blade. The first type is certainly very sensitive and requires no potentiometer, but more importance might well be attached to the very desirable property of stability.

THE GRID LEAK

The commonest method of using a three-electrode valve for rectification is the grid leak method, which has several important factors in its favour. A medium impedance or "general purposes" valve is suitable; detection is at least as efficiently carried out from the point of view of sensitivity

as in any other ordinary method, and it lends itself to the use of reaction.

However, there are many disadvantages in grid leak rectification, although to an extent these may be overcome by correct design. It has been stated above that the effective resistance in the conductive direction of the detector must remain the same for large or small amplitudes. In this case, since the signal causes a reduction of anode current in order to prevent limitation of its maximum amplitude, there must be sufficient available grid sweep to prevent the negative peaks of anode current reaching the "bottom bend." The choice of a suitable H.T. voltage overcomes this difficulty, which nevertheless is often responsible for distortion, especially when a fairly high impedance valve is used with a low anode voltage in order to procure maximum sensitivity to weak signals.

Clearly distortion will also result from the use of too high a value of grid leak in relation to the grid condenser value, since the time constant of the circuit will then be too high to follow the modulation and the grid will tend to take up a steady mean value of potential. There are other more subtle ways of introducing distortion by using too large a grid condenser and too low a value of leak, but space will not permit a full discussion of all these possibilities.

THE ANODE BEND

The well-known anode bend rectification method, though safer, is less sensitive to a *weak* signal. The variation of anode current is in a positive direction, and limitation with large amplitudes is

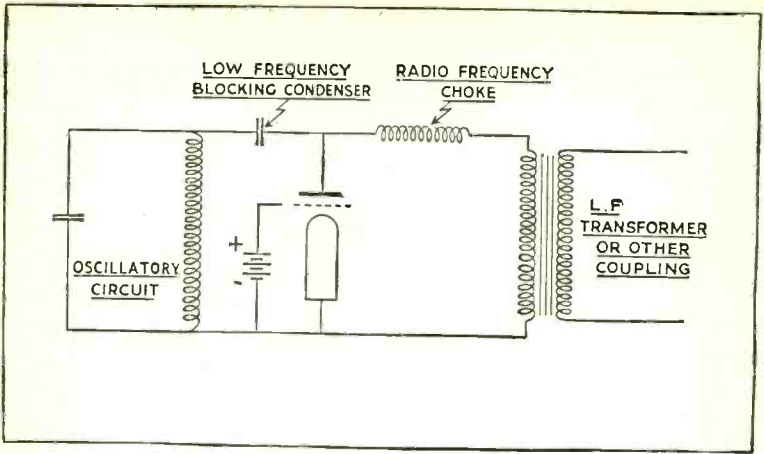

FIG. 1

less likely to occur except with obviously unsuitable values of high-tension voltage. Comparatively few valves give a sharp enough bend in their characteristic curve for efficient detection, but there is compensation in the fact that negative grid bias can and should be used to reduce the damping on the oscillating circuit. When this is done, however, care has to be taken that the working grid sweep is great enough to prevent any danger of grid current.

P. P. Eckersley emphasised in a lecture before the Radio Society of Great Britain that with the grid leak method rectification may be considered to take place before amplification, the processes being reversed when the "anode bend" method is used.

Upon careful consideration the balance in favour of the anode rectification method for receiving strong broadcast signals is considerable. Both methods depend on the bends of the characteristic curves of the valve. In the grid leak case the grid current-grid

voltage curve is involved; in the anode method the anode current-grid voltage curve, but with the grid leak method the values must be determined with the utmost care to ensure correct conditions electrically.

TWO-ELECTRODE PRINCIPLE

The third method mentioned above is comparatively little used, because the sensitivity is considerably less than with either of the two methods just described.

Fig. 1 shows one circuit of this type which is frequently used in order to get distortionless rectification with large amplitudes. It works on the two electrode principle of rectification, which is in essence similar to a crystal. The grid has a permanent positive bias and is only used to reduce the internal resistance and prevent the effects of space charge. There is no amplification with this device, in fact some loss is unavoidable, but it is comparatively safe from the point of view of dis-

tortionless rectification and its impedance is low.

A receiver designed with this type of rectifier is usually allowed an extra high-frequency stage, although this should more than cover the loss of amplification.

Perhaps we may look forward in the future to the introduction of the perfect rectifier, which would largely remove the necessity of high-frequency amplification, even for distant reception.

It is estimated that nearly ten million people heard the King's

Speech by radio when he opened the British Empire Exhibition at Wembley in 1924.

The chimes of Big Ben have been heard by radio in practically every country throughout the world.

Because no suitable land lines could be provided by the Post Office, the first operas broadcast from the Old Vic in the Waterloo Road, London, were relayed to 2 LO by a short-wave transmitter. Such were the difficulties confronting the early broadcasters.

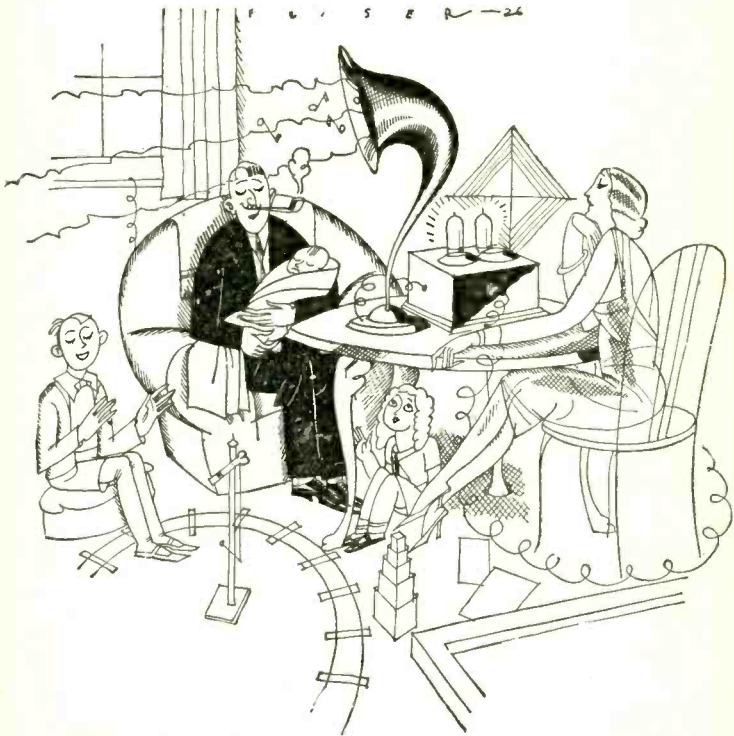

THE GOOD LISTENER DOES NOT OSCILLATE

H.F. AMPLIFICATION FOR RECEPTION

THERE are several methods of carrying out high-frequency amplification which can be used in connection with Broadcast receivers, but there are really only two methods which we need consider, the remainder being comparatively infrequently used.

The two methods which we will consider are as follows :

- (a) Tuned high frequency.
- (b) Supersonic.

The former is perhaps the more commonly used and essentially employs a circuit tuned to the incoming signal as a means of coupling one valve to the next. This covers the large class known as "tuned anode" receivers. When more than one stage of amplification is used they are frequently called "neutrodyne" receivers, because it is almost essential to neutralise the unavoidable capacity between the electrodes of the

valves. This, of course, applies to the type of valve in common use to-day, but there are, as a matter of fact, special valves designed with the object of avoiding or eliminating the effect of spurious inter-electrode capacities.

NEUTRODYNE METHOD

The neutrodyne method of preventing instability makes it possible to construct magnifiers having very high over-all amplification, and successful receivers have been built on a commercial basis employing as many as six or more stages.

To obtain the best results, the coils used for the tuned circuits must have nearly perfect electromagnetic screening, or alternatively some form of astatic winding must be employed to prevent external electro-magnetic fields. If this is done, only the electro-static interaction introduced by the electrodes of the valves and leads remains

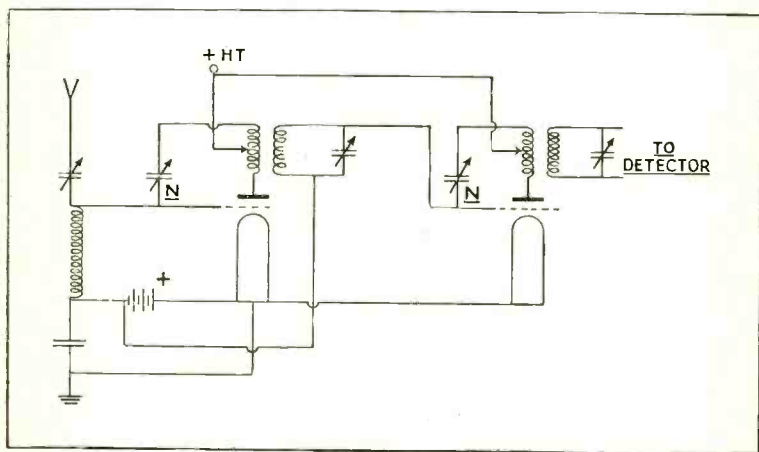

FIG. 1.

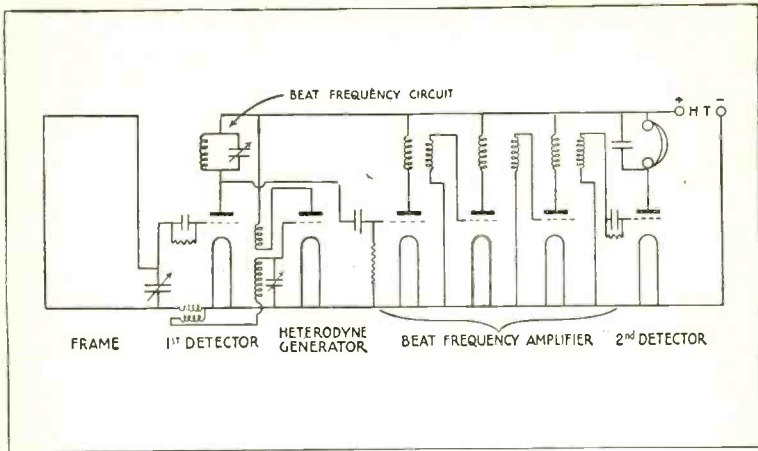

FIG. 2.

to be eliminated. This can be exactly balanced out by small condensers, as shown in Fig. 1. If such a circuit is correctly designed there will be no re-transference of energy from the later stages towards the aerial, thus reaction could be used in the last stage with comparatively little risk of causing interference, although this is inadvisable from another point of view which will be discussed later.

The principal disadvantage of this type of receiver is the number of adjustments when tuning. To obtain maximum amplification with selectivity, the tuned circuit between each valve must be exactly in resonance, and for this reason it is difficult to couple all the condensers together mechanically without loss of performance, although now there are many excellent condensers on the market designed with this object in view.

SUPERSONIC RECEIVER

The second type is known as a supersonic receiver because amplification takes place at a frequency

usually just beyond the limit of audibility, although much higher frequencies are often used. However, essentially amplification is carried out at a frequency low enough to make efficient design a simple matter.

The comparatively low-frequency oscillations are generated by causing the incoming signals to beat with oscillations generated locally at a slightly different frequency. The two sets of oscillations combine and, after rectification, produce a frequency equal to the difference of the two primary components. Amplification is then carried out at this much lower frequency, which normally remains the same throughout the range of frequencies covered by the receiver. Thus in the simple form (as shown in Fig. 2) this type of amplifier has two essential adjustments, the aerial tuning and the frequency of the local oscillations. The greatest advantage of this type is simplicity of adjustment, although it will be realised that there are always two possible ad-

justments of heterodyne frequency for every received frequency. Although reaction may be used on the secondary circuits without risk of causing interference, nevertheless this type of receiver cannot be used on an open aerial owing to re-radiation of oscillations at the heterodyne frequency. If, however, one or two stages of neutrodyne primary amplification are used, this defect is to some extent removed, but this is liable to introduce a distortion, as will be seen later.

SENSITIVITY AND SELECTIVITY

Having briefly considered the principles of these two important types of amplifier, we may now discuss a few main problems of design. In the case of an amplifier consisting of a number of tuned stages in cascade, if we draw a

graph showing the amplification plotted against radio frequency, we can see what ratio of signal strength we shall obtain from two Stations close together in frequency whose relative strengths are known. If the receiver as a whole had the resonance curve shown in Fig. 3, a Station transmitting at 1,000 kilocycles would be amplified about 1,000 times more than one of the same strength but using a frequency of 990 or 1,010; thus for all practical purposes we should have eliminated Stations B and C in comparison with A. The question is, is it possible under these conditions to get distortionless amplification of Station A? As a practical compromise we may assume that a transmitter radiates a band of frequencies covering only up to 5,000 cycles on either side of the carrier frequency. Fig. 3 shows us that a frequency differing from the fundamental by about 5,000 cycles would be magnified about one-tenth as much as one in the immediate neighbourhood of the fundamental frequency. Therefore the high tones would be reproduced at a much-reduced strength as compared with the low ones, *i.e.* those formed by radio frequencies, differing from the fundamental by, say, 200

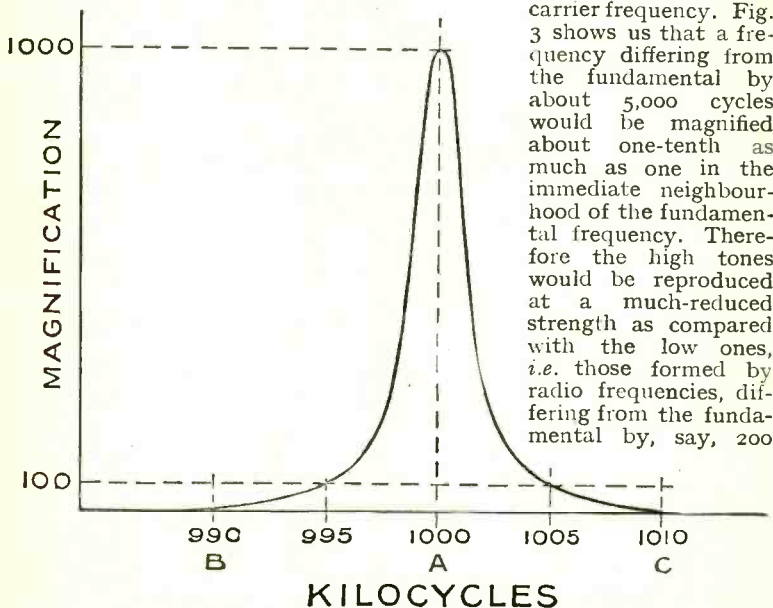

FIG. 3.

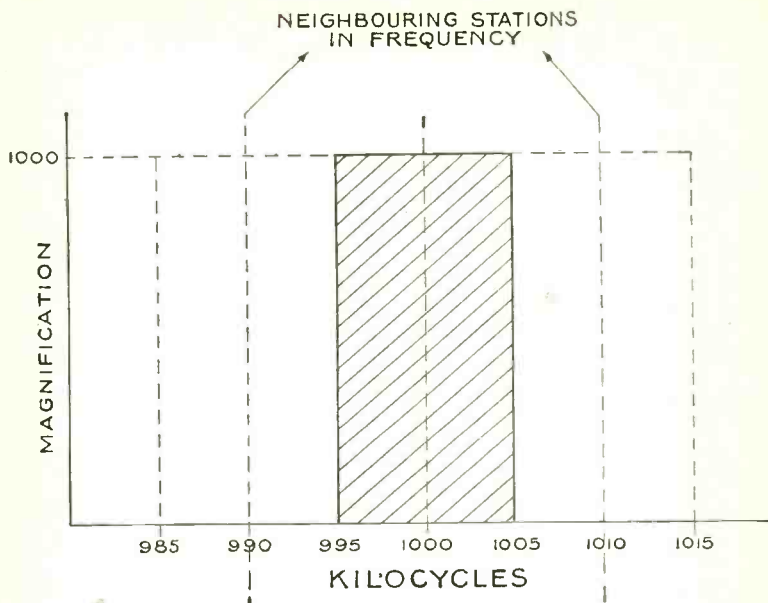

FIG. 4.

cycles, and from the point of view of broadcast reception this would give distortion. Since many loudspeakers and telephones do not reproduce the low frequencies at their true value, this effect is often pleasing, because it tends to bring up the bass notes in music, but it never gives accurate reproduction.

IDEAL RESONANCE CURVE

Theoretically the ideal resonance curve would be that shown in Fig. 4, but in practice there would be a danger of bringing in the side bands of the two neighbouring Stations, which are separated by 10 kilocycles from the Station being received. Could such a curve be produced there would be no loss of high tones at 5,000 cycles, and yet theoretically no trace of a Station with a frequency differing by 10 kilocycles would be

heard, disregarding the side band frequencies above 5,000 cycles. Although theoretically insufficient, the separation of 10 kilocycles between Stations has been adopted by the Office Internationale de Radiophonie as a practical compromise. It is almost impossible to produce this ideal condition, although radio frequency filters are constructed which give this sharp cut-off effect to a considerable extent.

Hence we find that it is difficult, though not absolutely impossible, to design a multi-stage tuned high-frequency amplifier to separate Stations of the same strength working at the *minimum* practical frequency separation, namely, 10 kilocycles, unless some distortion is allowed due to side band cut-off.

Actually this distortion becomes

less obvious than one might expect, since atmospheric and parasitic noises, which nearly always accompany the reception of Stations at a great distance, usually mask other slight imperfections. It does not often happen that two Stations in the same geographical neighbourhood and, therefore, both giving strong signals in certain areas, are transmitting on frequencies differing only by 10 kilocycles. Should the frequency separation be a few tens of kilocycles, then the unwanted Station may be many times stronger than the wanted one, and even then the problem of separating the two without distortion becomes a comparatively simple one. When, however, the unwanted Station is situated very close to the receiving set, we encounter the trouble of "shock excitation," the severity of which depends largely on the depth of modulation. This may prevent complete elimination of the "local" Station when a very weak distant Station is being received, but a loosely coupled aerial circuit is very effective in reducing this trouble.

The design of highly selective amplifiers has to be a matter of compromise: either some distortion has to be permitted or the ratio of the wanted to the unwanted signal increased, that is to say, selectivity has to be reduced. However, a good deal can be done by selecting the best values of capacity inductance and resistance for the tuned circuits. A number of stages each in itself moderately selective gives, in general, a more rectangular - shaped resonance curve than one or two stages with extremely low damping. Strictly speaking this means that strong reaction should not be used on any part of the high-frequency circuit.

Turning now to the super-

heterodyne receiver, we are faced by a similar problem, but perhaps it is less easy to visualise. Taking an example similar to that just considered where the received signal has a frequency of 1,000,000 cycles per second, we shall require to amplify all frequencies between 1,005,000 and 995,000 cycles equally. If the beat circuit is tuned to a frequency of, say, 60,000 cycles the heterodyne frequency will be 1,060,000 (or 940,000).

Neglecting the selectivity of the primary circuit, which will not be very high in the case of a direct-coupled frame aerial, the beat frequency circuit should have a resonance curve so shaped that frequencies between 65,000 and 55,000 are amplified equally, while frequencies outside this band are reduced to a negligible quantity. There is, however, an additional complication. Assuming that we are working with a heterodyne frequency of 1,060,000 we shall get equally good reception from two similar Stations, one working on 1,000,000 cycles and the other on 1,120,000 cycles, again neglecting the selectivity of the primary circuit. This is a serious difficulty when considering a chain of Broadcasting Stations each differing by 10 kilocycles, and it can only be obviated by introducing further selectivity into the primary circuit; for example, by means of two neutrodyned primary stages, as shown in simplified form in Fig. 5. Unfortunately this increases the number of necessary adjustments.

"SHOCK EXCITATION"

"Shock excitation" by strong local Stations and jamming from Stations working on the beat note frequency are other troubles common to this type of set. Both are reduced by making the primary circuits selective, but this in-

effective unless good screening is provided for the beat frequency amplifier. However, the magnification obtainable is very high, which makes the use of a small frame aerial quite practicable, and by rotating the frame most cases of primary shock excitation can be prevented.

When primary high-frequency magnification is used, the selectivity of the primary circuit cannot be neglected when considering the frequency band which will be reproduced. The resonance curve of the whole receiver will be obtained by combining the primary circuit curve with that of the beat frequency circuit, and it will be obvious that a receiver of this description is liable to distort very badly.

Some of the difficulties met with in the design of multi-stage high-frequency amplifiers have now been discussed, but it is hardly necessary to say that such amplifiers are only necessary for the reception of long-distance Stations, and when receiving a Broadcasting

Station in its normal service area the need for high-frequency magnification should not exist.

The transference of the 2 LO transmitter from Marconi House to Oxford Street was accomplished on April 6th, 1925, the power used being raised at the same time to three kilowatts.

The growth of the circulation of "The Radio Times" is one of the outstanding events in publishing since the beginning of the century. Four years ago the B.B.C. encountered difficulty in securing co-operation in the production of their official journal. To-day its circulation approaches a million copies weekly, and its profits are a substantial auxiliary to programme revenue.

Wireless waves travel at a speed of about 186,000 miles per second, so that the time taken for signals to pass between a broadcasting Station and a listener's aerial is negligible.

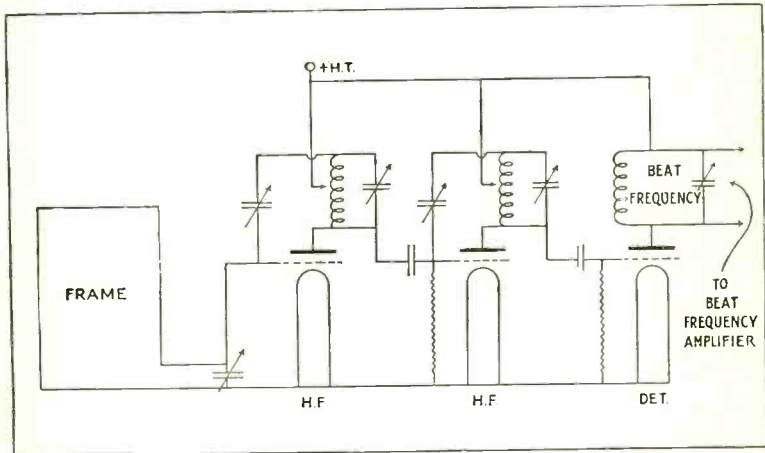

FIG. 5.

LISTENING WITHOUT FEAR

A QUESTION that is often cropping up in the postbag of the B.B.C. is whether listeners run any risk of receiving an electric shock while wearing headphones. This question has been asked more frequently of late because of a recent unfortunate accident in which a lady received a fatal shock from the electric-light mains while listening on a crystal set. Naturally this regrettable event has caused some alarm, but if the conditions which brought it about are examined, and reasonable care is taken to avoid a repetition of such conditions, it will be seen that there is no need whatever for anyone to feel the slightest uneasiness concerning their safety while listening to the broadcast programmes.

First of all, it should be said that in the accident referred to the shock was received from the electric-light mains through a defective reading lamp, *and not from the wireless set or from a lightning flash.* With a wireless set in a good state of repair such an accident could not have happened—unless the metal-frame spectacles which the victim was using were being worn in such a way that they touched one of the nuts fixing the leads to the telephone. Most electric lighting systems have one of the two wires connected to the earth, so that if the listener touches any metal object which happens to be in contact with the other wire owing, say, to a worn cable, then it is only necessary to touch another object in contact with the earth to receive a shock. If one is merely standing on the damp ground a sufficiently good earth connection is formed.

In most crystal and valve sets there is intentionally a connection

between the coils of wire in the telephones and the earth connection of the set. Even so, care should be taken to see that these windings are insulated from the metal parts of the headphones. If by any chance some of the insulation has been rubbed off, a connection may be set up between the wire and the metal bands. This will not necessarily affect reception, but it supplies the earth connection which, in conjunction with the other conditions described above, gives the listener a severe shock, and since the current flows through the head the results are liable to be somewhat serious. If a water-tap or gas-pipe were touched under the same conditions a shock would be received, quite apart from the wireless set altogether.

What, then, the listener may ask, must I do to prevent any possibility of shock?

Undoubtedly the most important thing is to be certain that all your electric fittings are in perfect condition. If at any time a slight shock or tingling sensation is noticed when handling any part of the fittings, a competent electrician should be called in to make tests and, if necessary, effect repairs.

As far as the wireless set is concerned, the headphones should be removed from the head whenever the listener wishes to touch any part of the lighting system, not only the simple household switch, but especially the plugs to which leads are attached, such as those used for portable reading lamps, electric irons, etc. If there is any danger of this injunction being forgotten, then a good quality condenser for crystal sets should be connected between the earth

connection, and the terminal on the wireless set marked "E." A suitable condenser would have a value of about .001 microfarad. This can be obtained at a small cost from any wireless dealer, and it will not appreciably affect the tuning when using a normal broadcast receiving aerial.

In the case of valve sets, when headphones are used, a telephone transformer is a solution of the problem; but if a listener does not wish to go to the expense of one of these instruments, there is always the very sound—and inexpensive—alternative of removing the headphones from the head whenever it is necessary to touch any part of the household lighting system.

Furthermore, headphones should not be worn while adjusting "mains high-tension supply units." These instruments are quite safe when used with reasonable care, but it is as well not to alter connections while wearing

headphones, because if the phones should happen to be defective, the metal work may become connected to the positive high-tension terminal, and in some cases the normal voltages are high enough to give an uncomfortable shock. Of course, in this case the circuit is completed through the body to the negative terminal of the unit whenever one touches a metal object connected to earth. The same thing will happen with accumulator high-tension batteries or with dry cells whenever voltages of 200 or 300 are used. In most cases of this kind a loud-speaker would be used, and then, of course, no special precautions are necessary; but sometimes an experimenter will connect a pair of telephones to his set in order to listen to a very distant station.

Thus it will be seen that in any case the element of risk is very small indeed, and if reasonable care be taken it is nil.

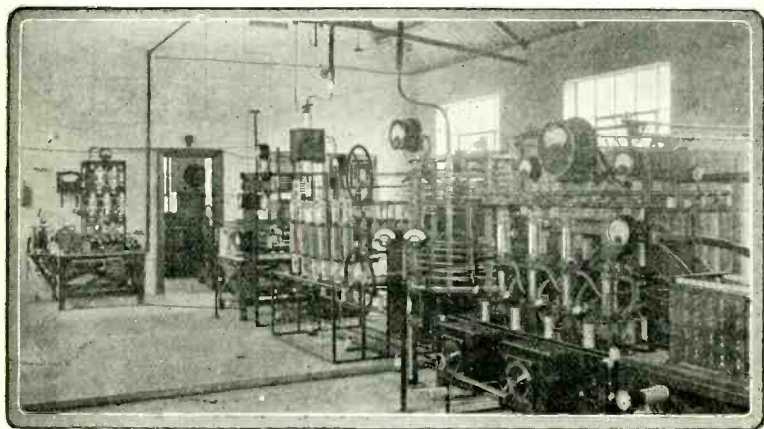

DAVENTRY EXPERIMENTAL STATION

General view of the transmitter, showing, on the right, the final stage of the power amplifier

“THREE★☆☆★” STAR

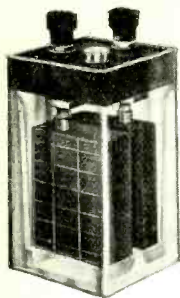

Type D.E.

20 A.H. 4/6 each.
45 A.H. 8/6 each.

This Patent High Tension Unit is designed to eliminate all H.T. Accumulator troubles. Each Unit is self-contained, and all parts are readily accessible. It can be assembled and dismantled in one minute by anyone, without previous experience.



Type P.H.



Type M.L.

Pat. No. 192185.

No intercell leakage.
Ample space for electrolyte.
Retains its charge for six months.
Capacity 3,000 M.A.H.
Price 2/- per cell complete with terminals and inter-cell connecting bar.

Type M.L. 60.
60 Volt Battery, 67/6.

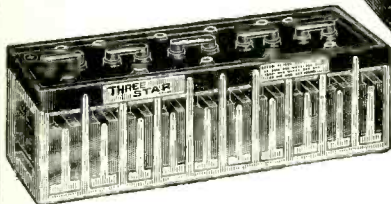
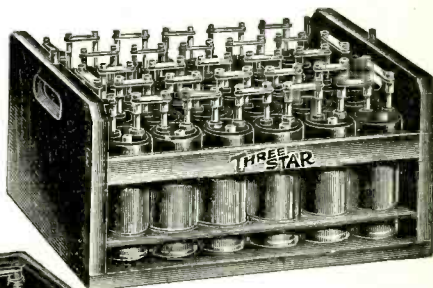

Type H.T. X, 20 volts.
Capacity, 2,500 M.A.H.
Price 10/- or complete with crate 12/6.

THREE STAR ACCUMULATORS, Ltd., Rosebery Avenue, Tottenham, N. 17.
Telephones: Tottenham 2777-2778.

At last —
Aproved cure for
Sulphation!

DAR

The "Monkey Gland"



DOUBLES BATTERY LIFE

The Greatest Battery Improvement since 1881

**PARTICULARS OF £1,000
GUARANTEE WITH EACH BOTTLE**

*See "Popular Wireless," 13th August, 1927
and "Wireless Constructor," September
issue, for reports on tests carried out under
supervision of the respective technical editors*

DAR, LTD., AUSTRALIA HOUSE, STRAND, W.C.2

THE BROADCAST RECEIVING SET

THIS article is written for the benefit of those who contemplate buying a receiving set, and others who, having made a purchase, are uncertain how to install and maintain it.

These remarks fall into four sections: first, the choice of the set, having regard to the distance at which it will be used from the broadcast Station it is desired to receive; second, some hints on set construction; third, the installation of the apparatus, and fourth, its use and maintenance.

CHOICE OF SET

The choice of set is determined by the type of reception required (*i.e.* headphone or loud-speaker) and the circumstances and locality in which the set is to be used. Reception conditions vary so much with locality that it is extremely difficult to give definite figures regarding range. Advice will readily be given by the local wireless dealer, or the Wireless Society, if one exists. The range of a Relay Station is limited whatever type of set is used owing to interference from other Stations working on the same wavelength.

The simplest and cheapest type of set is the crystal set, while the more expensive types may employ one, two, or more valves. The three-valve set may consist either of one high-frequency valve, one detector and one low-frequency, or one detector and two low-frequency valves. When there is plenty of signal strength available the latter arrangement is the one generally to be preferred, but if it is desired to increase the selectivity of the set, then the former arrangement is the better one.

The most usual arrangement of valves in a four-valve set is one high-frequency valve, one detector and two low-frequency valves, with possibly a switching arrangement enabling either one or two low-frequency valves to be used at will.

When making a choice it should be borne in mind that the set should have an adequate factor of safety, that is to say, it should be able to receive at greater distances than it will normally be required to do. Reception conditions vary from time to time, and with something in hand the set can be adjusted to give good results under any conditions likely to be met. Speaking generally, slightly more strength is obtained at night than during the day at a given range, but the capability of a set should always be judged on its daylight range. When a listener is situated nearly at the limit distance of one type of set it is desirable to consider the installation of a receiver of the next larger size. The prospective purchaser should arrange to hear the set working and satisfy himself that it will meet his needs, before making a purchase.

CONSTRUCTION

Those who have some knowledge of the working of receiving sets may prefer to make up their own rather than buy a manufactured article. If this is decided upon, the circuit must first be considered in the light of the required performance, and the number of valves having been fixed upon, the general lay-out should be drawn out. There are one or two golden rules to follow which we can briefly touch upon. Each component associated parti-

cularly with each valve should be grouped round that valve. The valves themselves should be laid out from left to right, that is, from aerial to output. Other components may be put where convenient, but long lengths of wiring should be avoided; particularly wiring associated with grids and anodes of valves should be short. All joints must be well soldered, using a non-acid flux. The panel may be wood (teak or mahogany) or best quality ebonite, preferably with a matt finish. The connecting wire should be No. 18 gauge tinned copper wire, sleeved where necessary with $1\frac{1}{2}$ mm. systoflex.

The construction of a set is an instructive and interesting hobby, but, on the other hand, there are many pitfalls to be avoided, and if the new-comer to wireless wishes to get good results without much trouble to himself, he would be well advised to purchase a ready-made set rather than venture on the work of construction himself.

INSTALLATION

An efficient aerial and earth system is very important. This question is fully dealt with in another article in the Handbook, and those contemplating the installation of a set are advised to study this article carefully.

When connecting up the set for the first time, connect the L.T. battery first and see that all the valve filaments light before the H.T. battery is connected. The value of high-tension voltage used should be in accordance with the instructions issued with the set. For the high-frequency valve probably 50-100 volts will be required, according to the type of valve used. For the detector about 50-60 volts will be required if grid rectification is used, and 60-100 volts, with suitable grid

bias, if anode rectification is used. For the low-frequency valves the more high tension that is used the better will be the results. Some valves will not stand more than about 100-150 volts on the plate without risk of damage. With large loud-speakers, for the last stage of low frequency it is essential to use a "power" valve, which will stand at least 200 volts on the plate, a suitable value of grid bias, depending upon the resistance of the valve, being used.

The acoustics of the room in which the set is to be used should be studied, and the best position selected for the loud-speaker. It is not easy to give specific advice on this point, but it is essential that a modern type of loud-speaker be employed, capable of dealing with sufficient volume of sound to fill the room in which it is to be used. It must be remembered in this connection that the voice of the speaker will not sound natural, and therefore cannot retain its personality, if it is produced at a very much greater or very much less volume than that which obtains in the studio.

USE AND MAINTENANCE

(a) *Low-tension accumulator.*—The user of the set will be chiefly concerned with the accumulator charging. If the accumulator has been fully charged it should always last just the same number of hours after each charge unless it is getting very old. It is not a bad idea to have a card attached to the set whereon the times of use are written down, so that a check may be kept upon the battery charging. Two accumulators preferably are kept, one in use, and one as a stand-by. When one runs down, *i.e.* when the valves burn dimly and the strength of the loud-speaker gets less, the other should be used, while the first should

at once be sent away for charging. This discharged condition should be anticipated, as harm may be done by allowing the accumulator to run completely down. A rough test of the state of an accumulator may be effected by testing the voltage of each cell whilst the accumulator is being used. The voltage of each 2-volt cell should not be allowed to drop below 1.8 volts.

It is bad for an accumulator to be left unused for long. If the set is not going to be used for a month, the accumulators should be left fully charged. If the set is going to be out of use for a longer period than a month, the acid should be emptied out, after the accumulator has been fully charged, and distilled water should replace the acid. When the accumulator is wanted again, the proper solution of acid should be substituted for the distilled water, and a fresh charge given, when the accumulator will again be ready for use. It is suggested that the local expert will best perform these duties.

(b) *High-tension battery.*—A dry H.T. (or high-tension) battery cannot be recharged. It is usually in the form of a large box with a number of little holes into which fit red or black plugs. If there is any doubt about which is the L.T. (*i.e.* low-tension) battery and which the H.T. battery, it would be as well to consult the person who has installed the set in order that there should be no mistakes. The H.T. battery should last from four to six months with normal usage. When reception gets weaker and weaker after this time, even though the accumulator is charged and the valves are properly alight, it is almost certain that the H.T. battery is failing.

(c) *Grid battery.*—The non-

technical person should not worry about the grid battery, beyond following the instructions given with the set, but when renewing the H.T. battery he should see that the grid battery (which is probably inside the set and which looks like a little high-tension battery) is renewed too.

(d) *Valves.*—It is most important that the filament voltage should not be greater than that stated on the valve. If carefully treated, valves will last for years. They should not be removed from their holders unnecessarily.

(e) *Hints on tuning-in.*—The word "tuning-in" means making the best adjustments on the set to get intelligible speech or pleasant music. There are several knobs on the set for making those adjustments, but the user is advised to take a careful note of all the settings as they have been left by the installing engineer, and not readjust these unnecessarily. The set may be located at the point where the service areas of two Stations overlap; in such cases it would be possible for the set to receive two Stations satisfactorily instead of one, and in this case the setting for each Station should be written on a card fixed to the set so that a quick change over from one Station to the other may be effected.

When tuning the set, the reaction coupling should be as loose as possible, that is to say, the movable coil which is mounted in the adjustable coil-holder should be brought no closer to the fixed coils than is absolutely necessary. Excessive reaction not only tends to produce distortion, but may cause the receiver to break into oscillation, thus energising the aerial and interfering with neighbouring sets. If it is found that in order to obtain sufficient volume

from the set it is necessary to use a considerable amount of reaction, that is, to have the two coils very close together, this is an indication that the set has not a sufficient factor of safety, and that it is therefore inadequate in respect of the transmissions for which it is intended.

The set may be fitted with a volume control. If when the set is properly tuned the volume given is too great, then this may be reduced by adjustment of the volume control; in no case should the volume be reduced by detuning.

Beyond recharging accumulators and, at long intervals, renewing the H.T. battery, the unskilled user should have no need to make any adjustments whatsoever.

If the user has no technical knowledge the tracing of faults should certainly be left to an expert. There are many handbooks on the subject of fault tracing, but it is advisable that any serious trouble of this sort

should be referred either to the maker of the set or his local agent. Simple faults, however, can often be cured by the user himself. For example, crackles may be produced by loose connections to low- and high-tension batteries, loose grid battery plugs, or bad aerial insulation. Also a badly run down high-tension battery may give rise to the same trouble.

Mendelssohn's Wedding March was specially broadcast one day in September 1926 for the benefit of a newly-married couple at Workington. The music was relayed from St. Lawrence Jewry, London, and heard by the bride and bridegroom from loudspeakers during the wedding breakfast.

Nearly 16,000 beds in 122 hospitals in London are now equipped with wireless provided by the *Daily News* "Wireless for Hospitals Fund."

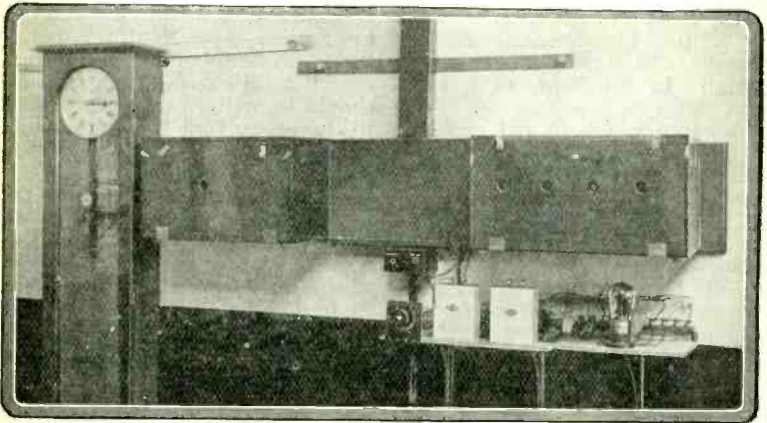

GREENWICH TIME SIGNAL AND TUNING NOTE APPARATUS AT THE LONDON STATION

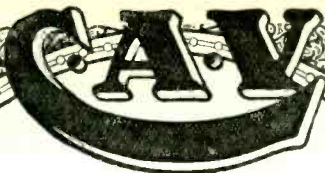

∴ H.T. RADIO ∴
ACCUMULATORS

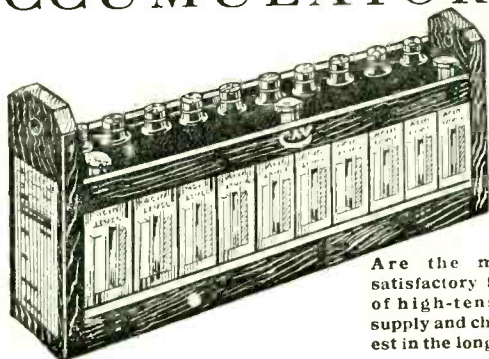

Are the most satisfactory form of high-tension supply and cheapest in the long run

H.T.G.2

MASS PLATE HIGH TENSION

A new type of H.T. Accumulator embodying all the latest improvements. Made up in 20-volt crated units with a tapping point at 10 volts
Supplied dry charged

20 VOLTS 2,500 MILLIAMPS. HOURS

15/-

Write for Catalogue "B"

H.T. and L.T. Accumulators, Receivers, Loud Speakers, etc.

Manufacturers of Car Electrical Equipment



By Appointment to H.M. THE KING

Telegrams: "Vanteria, Act., London."

CAVandervell & Co., Ltd.
ACTON, LONDON, W. 3.

Telephone: "Chiswick 3801" (Private Branch Exchange)

SALES AND SERVICE DEPOTS

at all the following centres

LONDON : MANCHESTER : COVENTRY : BIRMINGHAM : LEEDS : NEWCASTLE-ON-TYNE.
GLASGOW : BRISTOL : TAUNTON : DUBLIN

EDISON BELL RADIO

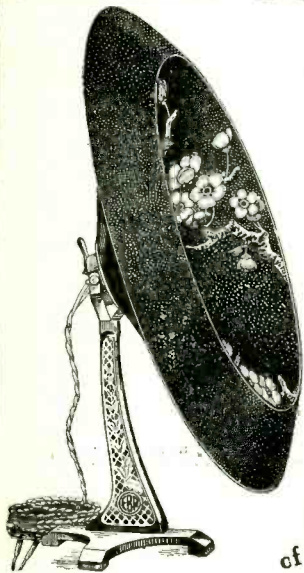

Cat. No. R/308.

THE EDISON BELL DOUBLE CONE TYPE SPEAKER has no marked resonance point on the musical scale, making the reproduction of music exceptionally sweet. Everything that is broadcast is faithfully reproduced.

Price . . . £2 2s.

SEND for FULL CATALOGUE
of SETS & COMPONENTS FREE.

EDISON BELL REGENT CABINET SPEAKER

EMBODIES all the characteristics of the double cone, with added improvements. In solid mahogany case with mother-o-pearl grill.

Price . . £5 10s.



Cat. No. R/364.

TESTED 500 VOLTS
FLAT TYPE



Edison Bell Ltd., Glengall Rd., London, S.E. 15

TESTED 500 VOLTS
UPRIGHT TYPE



INSIST ON EDISON BELL CONDENSERS

THEY ARE BRITISH MADE AND GUARANTEED BY A NAME WITH 30 YEARS REPUTATION BEHIND IT

TELEPHONES AND LOUD-SPEAKERS

BEFORE the days of Broadcasting, good wireless telephones were very sensitive and comparatively expensive. The high-resistance type were wound with an enormous number of turns and depended for their remarkable sensitivity on a certain amount of mechanical and electrical resonance in the neighbourhood of 1,000 cycles per second. On the introduction of Broadcasting, the same telephones were used, and they were obviously unsuitable. The modern headphones are much improved acoustically, but whether sufficient attention has been given to the response/frequency curve in every case is open to question. No doubt the necessity for a low price is largely responsible for this.

Recently, a capacity type of telephone earpiece has been developed on the Continent, which gives excellent reproduction of the extreme ends of the frequency scale, but suffers commercially from the fact that the necessary input is many times that required for the ordinary type of headphone.

The design of loud-speakers has presented more difficulties than perhaps any other part of the broadcast receiver. The most outstanding difficulties have been the suppression of strong mechanical resonance effects, and the accurate reproduction of frequencies below about 200 cycles per second, especially when they have, as is usual, a complex wave shape.

The necessary mechanical displacement of a diaphragm for accurate reproduction increases with a reduction of frequency. This fact in itself makes the design of the conventional type

of loud-speaker with steel armatures and wound magnets difficult owing to the large movement necessary for the lower frequencies. Again, if a high frequency is superimposed on a low, the former may be distorted owing to the fact that the armature is not at a constant mean distance from the magnets so far as the superimposed higher frequency oscillations are concerned.

DIAPHRAGM AND HORN

Nevertheless, the vast majority of loud-speakers in use by the public are of the diaphragm and horn type, but most of these lack the lower frequencies to some extent.

A diaphragm of the type used in these loud-speakers is bound in itself to have one or more resonant frequencies, but the damping effect of the air column contained in the horn reduces the resonant effects to a large extent if the whole instrument is carefully designed. However, there is naturally a large amount of compromise in the design of the models sold to the public.

There is, however, an entirely different type, which is very widely used in America. This loud-speaker consists of a magnet system, which may be of the "permanent" variety, or it may be energised by a special winding. The air gap is annular, and in this a coil of wire is suspended with freedom to move backwards and forwards along its own axis. To this coil is rigidly attached a cone-shaped diaphragm. These moving parts are held in position by a circular strip of some very flexible material, such as rubber, one edge of which is attached to the outer edge of the cone, and the

other to the inside edge of a circular metal flange. The coil and cone move together, and the only resistance to movement, apart from air damping, is that exercised by the rubber strip, but this should be negligible. The input is applied to the moving coil by flexible leads.

In general, this arrangement has several advantages over the metallic diaphragm or reed type apart from commercial considerations. In the first place, the force exercised by the magnetic field on the coil does not vary largely with the exact position of the coil in the air gap. Again, the resonant frequency of the moving parts as a whole can be made very low, in fact in the neighbourhood of the lower limit of audibility, while the mechanical construction allows the diaphragm to move through the large amplitudes necessary for the reproduction of the lower frequencies.

ENSURING CORRECT REPRODUCTION

There are, of course, a number of further precautions to ensure correct reproduction, but we can only touch on some of the more outstanding points. For example, there is a phenomenon which causes a loss of low tones, and is due to the fact that the waves of air pressure are inclined to leak round to the back of the conical diaphragm and neutralise themselves. This takes place to a far greater extent with low frequencies than high, owing to the fact that with the former there is a greater interval of time between successive wave crests. This is usually prevented by fitting a flat baffle in the same plane as the diaphragm, and large enough to

prevent the effect taking place to a serious extent, except for frequencies below audibility.

Thus, there is a considerable number of factors which affect the frequency-response curve, and there is a tendency for a combination of these factors to produce a kind of resonance at certain frequencies.

There is also a difficulty in connection with high frequencies consequent upon the fact that the coil and diaphragm cannot be made scientifically rigid. The result is that the whole moving system will not respond instantaneously to the impulses given by the coil, that is to say, there will be a lag due to the elasticity of the material. Again, the diaphragm may vibrate in itself in addition to its movement as a whole, giving rise to "fuzzing noises."

In general all loud-speakers are extremely inefficient from the power point of view, and it is interesting to note that if an instrument could be devised which converted all the electrical energy supplied to it into sound-wave energy, the effects of resonance would disappear.

It would seem, however, that the essentials of design of loud-speakers as well as receivers are being realised more generally, so that in the future we may hear much less frequently the too common remark that "loud-speaker reception gives too much distortion."

Part of the Newcastle programme was picked up by members of the Merton College (Oxford) expedition to the Arctic in 1924, a distance of about 1,600 miles.

The Very Soul of Music

BRITISH

CELESTION

THROUGHOUT

**LOOK AT THIS NEW CELESTION!
NOW COME AND HEAR IT!!**

You will immediately admit that no greater evidence is required to indicate the remarkable advance made in loud speaker design during the past four years.

The FIRST large diaphragm loud speaker on the market was a Celestion over three years ago, and now this new C.12 model appears with its beautiful appearance and remarkable results.

THE WORLD'S BEST LOUD SPEAKERS ARE BRITISH. THE BEST BRITISH LOUD SPEAKER IS CELESTION

**PROVEN
FIRST ON MERIT
ON
DEMONSTRATION**



THE NEW CELESTION
C.12 MODEL

OAK £7 5s.
MAHOGANY . . £7 10s.

THIS IS BUT ONE OF THE 1927-28 CELESTIONS, which range in price from £5 10s. to £25. They all definitely improve with age.

HEAR CELESTION FIRST

without obligation, at your nearest stockist or at:—

33-35 VILLIERS STREET, STRAND, LONDON, W.C. 2

Illustrated literature post free

Phone: Gerrard 0397

CELESTION RADIO COMPANY

29-37 HIGH STREET, HAMPTON WICK

KINGSTON-ON-THAMES

Phone: Kingston 2474

**"Assurance before you buy-
Satisfaction after"**



THAT is our policy. Come along and see concrete proofs of the efficiency and reliability of R.I. and Varley products. If you are at Olympia at the Wireless Exhibition, a visit to our Stand No. 143 will convince you. Or call any time at our Showrooms at 12, Hyde Street, New Oxford Street, LONDON, W. 1.

Our new products for 1927/8 mark a real advance in wireless, and we know that our specialised lines are unequalled by any similar components or accessories obtainable. Watch our advertisements—they will prove the truth of our statements. Thousands have already expressed their satisfaction—you will be one more added to this long list.



THE MARK OF BETTER RADIO

KINGSWAY HOUSE, 103 KINGSWAY
LONDON, W.C. 2 Tel. Holborn 5303

INSTALLATION OF AN AERIAL SYSTEM

THE Glossary in this Handbook defines an aerial as "A wire or wires supported at a height above the ground and insulated from it except for a connection to earth through the wireless . . . receiver." It is the object of this article to enlarge on this definition, and to show particularly the best way of achieving an efficient aerial system for an ordinary broadcast receiver. The importance of having an efficient aerial system cannot be over-emphasised, and the small extra initial outlay, both of time and money, to secure such efficiency will be amply repaid. How, then, to set to work?

THE AERIAL

The function of an aerial is to pick up energy from the ether, and to supply it to the broadcast receiver. The amount of energy picked up depends, *inter alia*, on the "effective height" of the aerial, and this bears a direct ratio to the actual height above the ground or building on which it is erected. Therefore, to secure the best "pick-up," our aerial should be as high as possible.

The combined height and length of an aerial is limited under the terms of the broadcast receiving licence to 100 feet. We may therefore have an aerial 20 feet high and 80 feet long, 30 feet high and 70 feet long, 40 feet high and 60 feet long, etc. A convenient height is between 20 and 30 feet, house chimney-stacks at this height and masts of this length being readily available. In general, the aerial should be composed of a single stranded wire in one length of 100 feet in the form of an inverted L—a horizontal wire with the down-lead at one end. The free end may be sup-

ported on a mast or a tree, and the other end (from which the "lead-in" is taken) can often conveniently be attached to the house.

The effective height of the aerial also depends on its distance from buildings, trees, etc. For instance, an aerial may be supported at 30 feet from the ground, but may run parallel to and at a short distance from a wall or roof for part or all of its length, and in this case the effective height will be considerably decreased. Thus it behoves us to erect the aerial in as open a space as we can. Obviously, the lead-in end must be near to the house, but the horizontal part of the aerial should be terminated at such a distance from the actual support at this end that the lead-in wire itself does not run near and parallel to the roof and walls of the house for any great distance. The lead-in wire should, therefore, slope gradually down to the lead-in tube.

Having picked up as much energy as possible, we must arrange that it is all delivered to the receiver, and it is here that the insulation of the aerial must be considered. We must bear in mind that the aerial circuit of the receiver will terminate at the lower end in an earth connection. If, through faulty insulation of the aerial, some of the energy can reach the earth by leakage, then a smaller proportion of the energy will be available in the receiver. An aerial should, therefore, be completely insulated from its supports and at the lead-in tube, so that no such leakage takes place. In general, porcelain insulators should be used to separate the aerial wire itself from the supporting wire or rope, and the lead-in tube should be of suitable material and adequate dimensions. It should

be noted that it is not necessary to make actual metallic contact with the aerial wire to cause serious losses, it being quite sufficient for the leaves or branches of trees, pieces of wood, or even brickwork—especially if they are damp—to come in contact. Bad insulation of the aerial caused by such defects will have the added disadvantage of variation, and thus the energy available at the receiver will vary—producing noises in the telephones or loud-speaker in some cases, and varying strength of signals in others. It is well to bear this latter point in mind, for the causes of intermittent noises in a receiver are often elusive. If such noises are not heard with the aerial switched off, the receiver itself and its accessories need not be suspected.

Considering further the efficiency of our aerial, we must take into account the aerial resistance. A further reference to the Glossary under "Aerial Resistance" will show that certain losses are present in any aerial, and that radiation resistance must be high compared with the other losses. This we achieve by making our effective height large, and keeping the aerial in the open. When, in order to receive 5 XX, we decrease the response frequency of our aerial by using a large aerial coil, we effectively decrease the radiation resistance and increase the other losses; and thus our aerial will, of necessity, be less efficient than at the higher radio frequencies which are used in the "broadcast band." It will therefore be seen that for reception of 5 XX, great importance attaches to having a really good aerial.

Assuming now that care has been taken with the outside installation of the aerial, let us consider the lead-in arrangement. Firstly, the aerial and earth leads should be kept as far apart as

possible, within limits, right up to the respective terminals of the set. A double-pole change-over switch should be provided for disconnecting the aerial from the set, and for connecting it to earth when not in use. The aerial and earth themselves should be connected to the centre movable contacts, and the aerial and earth leads from the receiver to the respective pair of fixed contacts at one side of the switch, while the other pair of fixed contacts on the switch should be connected together by a short piece of copper wire.

THE BEST RESULTS

The position of the receiver relative to the aerial lead-in is of importance, as we should endeavour to have the connecting leads short. It is far better to arrange to have the receiver near to the lead-in, and to use the loud-speaker or telephones at a distance from the receiver, if necessary, than vice versa. The internal aerial lead should be treated just as the external wire is, and should not be stapled up round cornices, skirtings, etc., for the aerial efficiency will be considerably reduced by so doing. If the receiver is of necessity far from the lead-in, then it is best to sling a connecting wire clear of the wall, ceiling, etc. by several inches. This need not be unsightly if suitably arranged.

The foregoing has assumed that the listener wishes to get the most out of his aerial, so that he may use the simplest form of receiver. By using more magnification in the receiver, *i.e.* by making it more complicated and expensive, it is obviously possible to use a smaller input to it. Again, if the desired signal is very strong, due to the receiver being situated near to the broadcast transmitter, then a less efficient aerial may be adequate. Thus it is possible to use

indoor aerials consisting of a piece of insulated wire stretched across the room, round a loft, or even stapled up hidden behind a picture rail.

THE EARTH

The efficiency of an aerial system—even with a good aerial—may be low, if attention is not paid to the earth connection. The object to be kept in view is to keep the resistance of the earth connection as low as possible. To achieve this, it is advisable to use as large an earth plate as convenient, say 3 feet square, buried in ground which, if not naturally damp, can be made so artificially. The plate should be buried vertically, with 6 inches or so at its bottom edge bent round. The connecting wire to the set should be soldered on to the plate at one or more points along its top edge—which will be just below ground level—and it is convenient to arrange a small wooden cover over the joint, so

that it may be inspected from time to time. The lead to the set should be run as directly as possible, and kept as short as possible. Either bare or insulated wire may be used for this lead, but the latter is sometimes preferable. In any case it should be of copper, and of adequate cross section.

As in the case of the aerial, if the maximum efficiency is not required, the arrangements may be amplified.

In conclusion, there is a point which may be of assistance to the listener who suffers from an embarrassingly strong signal from one Station, and who wishes to receive a weaker Station. Supposing an adequate receiver be available for the reception of the more distant Station, it may materially assist in eliminating the near-by one if the size of the receiving aerial be reduced. This does not remove the need of having an adequately selective receiver; but it may materially assist.



BROADCASTING A HAND OF BRIDGE

Players left to right: *Viscount Massereene, Viscount Castlerosse, the Countess of Ossory, and Viscountess Massereene*

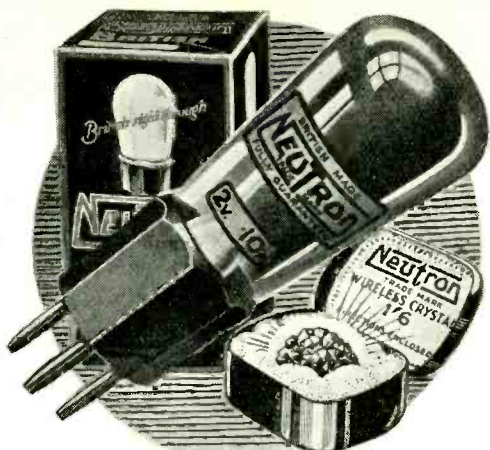

Once used—Always used

NEUTRON

Valves & Crystals speak for themselves.

British made, fully guaranteed. Full range of 2-volt, 4-volt, and 6-volt Dull Emitter Valves. Highest quality, consistent performance.

NEUTRON (1927) LTD.
8, Laurence Pountney Hill, E.C.4

The following four articles by Editors of Wireless Journals represent the distinctive points of view of their authors. The subjects dealt with are selected for their general interest.

THE AMATEUR IN WIRELESS PROGRESS

By BERNARD E. JONES,
Editor of "Amateur Wireless" and "Wireless Magazine"

EVEN if you think my title is cumbersome let me hope you will regard my subject as interesting. To be frank, neither of them is my choice; I am simply complying with the Editor's request that I should write a few words upon a topic that he has given me and in which I naturally am interested.

I should like to believe that the amateur's rôle has been that of an inventor. Of course, he must have thought out thousands of details, a large number of which have in due course become commercialised, but I cannot call to mind at the moment any big innovation due to him. But what the amateur has done is something which could not possibly have been done in the same time under any other circumstances whatever. Amateurs have constituted themselves research workers by the hundred thousand, and through the furnace of their criticism have passed every published idea, system and circuit and every component that has been placed on the market.

COST OF RESEARCH

We know of the great cost of the research and experimental work carried on in expensive laboratories by the wireless manufacturers, and of the way in which it affects prices by adding seriously to the overhead costs of production. But no manufacturer, however rich and conscientious, would or could have afforded the vast experimentation which the universal amateur public has voluntarily provided. As the editor of periodicals appealing to wireless amateurs I am often painfully aware of the amazing thorough-

ness with which the amateur puts to the test any published suggestions and schemes, and though individually he is seldom a highly trained technician or a learned scientist, collectively there is so many of him, and his energy and zeal are such that it is impossible for any unpractical component or inefficient system to survive long in his hands. The manufacturers often grumble at him, but undoubtedly they owe him a big debt.

Had the amateur been restricted entirely to sets made up and sold as complete units, wireless technique would not be where it is to-day. Educated by the wireless Press and encouraged to experiment in hundreds of different ways, the amateur has provided a great body of practical comment and criticism which has aided the manufacturer in eschewing the bad and developing the good.

INFLUENCE OF THE AMATEUR

The influences of the amateur in valve design and construction, for instance, cannot be ignored. He has tried out each valve in a variety of circuits, and has quickly proved its good points and its bad ones. He has corresponded with the manufacturers at interminable length and insisted that the producer should see things from the consumers' standpoint.

Compare the valves of to-day with those of six years ago—their number, their efficiencies, their variety. For how much of the extraordinary improvement can we thank the amateur? It is the amateur reaching out for long-range and long-distance reception who has seen the need for the radical improvement

of valves with regard to their inter-electrode capacities—and the manufacturer has been glad to meet his requirements. To the amateur, experimenting with various valves in every possible position in the set with the object of finding special-purpose types, goes the credit of encouraging the manufacturer to develop special designs for H.F. amplification, rectification, low-frequency amplification, and power.

SHORT-WAVE WORK

Short-wave work is another example. Wireless engineers were not fully aware of its possibilities, being rather inclined to leave it to the amateur. That was just as well, perhaps, for the short-wave transmitting amateurs in their enthusiasm were not long in proving to the official broadcasting authorities and to professional wireless men throughout the world the great advantages inherent in the use of short waves as a means of transmission and reception of telephony and telegraphy over great distances. We have to thank a zealous band of amateurs for the

great improvement in short-wave apparatus due to the elimination of those features of design and construction that only two or three short years ago led to considerable losses.

The amateur transmitters studied the problem of aerials for short-wave work and introduced economic and thoroughly successful aerial systems for long-range operation.

Even the less-skilled amateur who has been content to make up set after set for listening-in to broadcast programmes has done his bit towards improving the quality of reproduction. He has tried out and approved or found fault with this and that coupling or circuit detail or with this and that design of loud-speaker or other equipment. The very marked improvement in the quality of broadcast reproduction is as much due to the amateur as to anybody—contrary to the opinion held in certain "high places." Personally, I am convinced that even if the rôle of the amateur has been the humble one of the appreciative and constructive critic, he has played a big part in wireless development.



MUSIC BY THE WAYSIDE

MEASURING INSTRUMENTS IN RECEIVERS

By HUGH S. Pocock, Editor of "The Wireless World"

THE use of one or two measuring instruments in conjunction with a wireless receiving set adds quite considerably to the interest of wireless, besides ensuring that the receiver is kept at its highest efficiency.

Perhaps the most useful instrument of all is a two-range voltmeter for battery testing.

One of the commonest causes of the gradual deterioration of the quality and volume given by a receiving set is the lack of attention paid to the various batteries. These batteries are three in number in the majority of sets: first, the filament heating or low-tension (L.T.) battery, which usually consists of an accumulator; second, the high-tension (H.T.) battery, which supplies the energy for the reproduced signals and may consist of H.T. accumulators or of the ordinary dry cells, or in some cases of other fluid types of cell; and third, the grid bias batteries, which are almost invariably of the dry cell type.

In order to understand why attention should be paid to the various batteries, we will see just what effect the variation of each has on the quality and volume of the output from the set.

REGULAR ACCUMULATOR TESTING

First of all, assuming that the H.T. and grid bias batteries are in order and that the L.T. accumulator is running down, we shall find that the signals begin to get weaker and weaker without a very considerable diminution in *quality* until, if the accumulator is allowed to run right down, no signals at all will be obtained. This is a particularly annoying thing to occur, and it always seems to happen just when it is most inconvenient. However, there is no need for this to happen if the accumulator is tested regularly with the low range side of the

voltmeter, since an indication of the fact that the accumulator is approaching the running-down point is given on the voltmeter before the battery actually gives out.

Another useful check that may be made by means of the test voltmeter is whether the accumulator has been correctly charged when it is received from the charging station. When fully charged, and disconnected from the charging apparatus, the ordinary type of lead accumulator should read from 2.2 to 2.1 volts per cell for some hours after it has been taken off charge; thus a 6-volt accumulator should show from 6.6 to 6.3 volts when charged.

TEST "ON LOAD"

The ordinary accumulator should not be run below about 1.8 volts per cell so as not to damage it (for it is harmful to let an accumulator run right down), and if the voltage is never allowed to drop below this figure the accumulator will have a life of many years. A 4-volt accumulator should not be allowed to drop below 3.6 volts and a 6-volt below 5.4 volts. A word of warning is necessary here—*the voltage of the accumulator should always be tested with the valves in the set switched on.* In other words, the accumulator should be tested "on load." The voltmeter alone forms such a tiny load for the L.T. accumulator that the latter might give, say, 1.9 volts on this alone, but only 1.6 volts "on load," which would be beyond the danger point.

H.T. SUPPLY

The next battery to consider is the high-tension supply. If the other two batteries are in order, and the H.T. voltage is reduced, a decided falling off in quality and volume will be noticed.

If the battery consists of dry cells, and is fairly old, and the other two

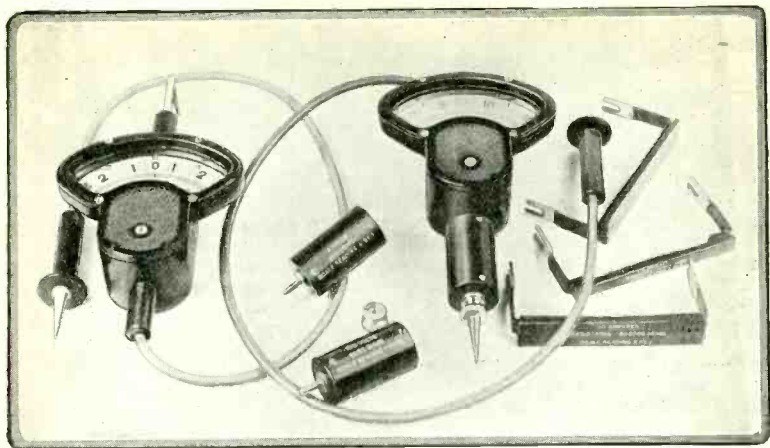

MEASURING INSTRUMENTS

batteries are known to be all right, what will probably be noticed is that on switching on the set, signals are fairly loud, though perhaps the quality is not so good as it had been before, but after a time the signals get weaker and the quality gets worse.

This is due to the H.T. battery running down in use and recuperating to some extent in the periods in which the set is not used. Of course, the battery should have been discarded before this happens, but it is difficult, if not impossible, to know when to replace the battery if no means of measurement is available.

For this purpose the high range of the voltmeter will be found useful. The usual type of voltmeter, especially the cheaper variety, requires a current to operate it which, although negligible for an L.T. accumulator, yet is appreciable and usually quite sufficient load in itself for testing an H.T. battery, especially if the latter is of the dry cell type.

The H.T. voltage on the set should be kept within 10 per cent. of the intended voltage if really good results are required, and the dry battery should be completely discarded when it shows a reading of less

than two-thirds of its rated voltage—before this if it can be afforded.

AN EXPENSIVE METHOD

It will be found that it is very expensive to run a loud-speaker set of three or four valves with the cheap small-capacity dry battery H.T. if good quality is to be maintained, since with a heavy load these little batteries last for so short a time, and it is more economical to use the large-capacity type, which, although they may cost two to two and a half times as much initially, will last five or six times as long.

If the H.T. supply is from accumulators, these should be tested in a similar fashion to the L.T. accumulator, the same remarks applying—thus a 100-volt battery should not be allowed to drop below 90 volts before being charged.

The remaining battery—the grid bias battery—is one which usually receives no attention at all, although it certainly requires the least of the three. It must be remembered that a dry battery does not last for ever, even if no current be taken out of it—in fact a life of twelve months under these conditions is all that can reasonably be expected. The electro-

lyte in the battery gradually dries up completely in the course of time, rendering the cell useless even if it is not used at all during this time, so that the grid bias battery should be renewed as a matter of course every year. The voltage, as shown on the testing voltmeter, will decrease gradually owing to the increase of resistance of the battery due to drying up of the electrolyte. If the grid bias, especially to the amplifier valves, is too small, or becomes too small, quite serious distortion will occur, which will be noticeable. Here again, provided the original settings were right, it is an easy matter to test each tapping point with the voltmeter.

Another measuring instrument which is perhaps not quite so essential as a two-range voltmeter is a milliammeter, again preferably a two-range instrument (0-2.5 and 0-25 mA.), though this is by no means strictly necessary.

It is possible by means of a milliammeter to tell whether the valves are working efficiently, and to adjust the grid bias voltages for any valve for the best operating conditions to give the least distortion.

ADJUSTING CORRECTLY

In order to adjust correctly the grid bias voltage on an amplifier valve, the procedure is as follows:— Insert the milliammeter in the plate circuit of the valve in question by putting it in series with its H.T. supply. If the set is of the type which has a separate +H.T. terminal for every valve, then it is only necessary to connect the negative (—) side of the milliammeter to the appropriate + H.T. terminal and the positive side (+) to the H.T. battery. If only one H.T. + terminal is used, then insert the meter as above, but remove the valves not being tested.

(Note.—It is advisable to disconnect the positive H.T. lead from the H.T. battery when removing or replacing valves.)

The following tests should be made:—(1) Note the reading of the

milliammeter when *no* grid bias is used (*i.e.* when the grid bias plug is connected to the *positive* end of the grid bias battery). This should be done with normal filament and H.T. voltages on the valve, but the grid bias should be removed for as short a time as possible. (2) Adjust the grid bias tapping until the reading of the milliammeter is approximately half the reading with no grid bias. The value of grid bias so found will be correct, and if there appears to be a choice between two tappings, one giving just over half and one just under half the current, choose that value which gives the lesser current.

This may be tried with all the amplifier valves in turn if the amplification factor of the valves is unknown. If the latter information is available, a sufficiently close

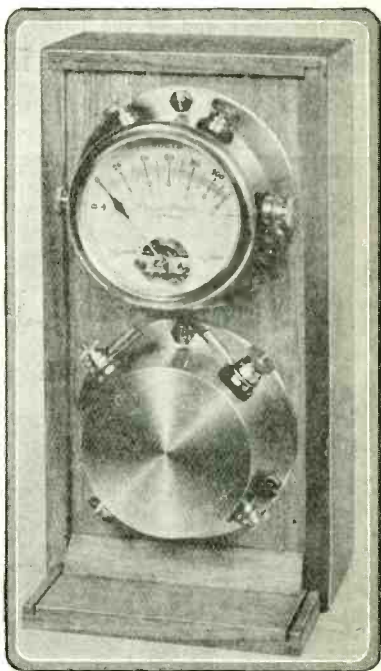

UNIVERSAL MEASURING INSTRUMENT

approximation to the grid bias is obtained by dividing the H.T. voltage for the particular valve by twice the amplification factor.

Thus for a valve with amplification factor 6 and 120 volts H.T., the correct grid bias is 120 divided by 12, or 10 volts.

Another useful indication given by a milliammeter is whether the valve itself is giving out. If all the batteries are known to be in good condition, and the plate current as indicated on the meter is lower than it used to be, then the emission from the valve filament is falling off and the valve will have to be replaced.

USE OF THE VOLTMETER

One of the uses of the voltmeter is for fault-finding in a set, since by connecting one voltmeter lead to a battery and taking a lead from the other end of the battery and the other voltmeter lead it is possible to test for continuity. If these two free leads are connected together, the voltmeter will indicate

something, so that if the ends of these leads are connected to two points through which there should be a circuit, the voltmeter will show whether there is or not. If the voltmeter pointer moves, and stays in the new position, then there is a circuit; if not, then there is not a circuit.

(Note that these remarks will not apply to testing grid leaks, which are of much too high a resistance for this scheme.)

The actual reading of the voltmeter will also give some idea of the order of resistance of the circuit under test; if nearly the full battery voltage is indicated on the voltmeter, then the circuit resistance will be comparatively low, while if only a small fraction of the full battery voltage is indicated, the circuit will be of very high resistance. In this way it is possible to trace out faults, for example, due to bad soldering, which may make a joint appear perfect, but which actually may perhaps be making bad or intermittent contact.

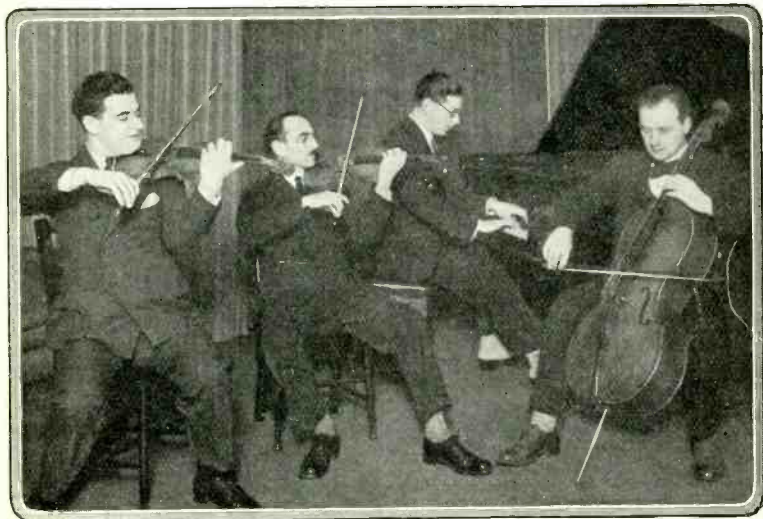

THE DAVENTRY QUARTET

SOME HINTS FOR THE NOVICE

By NORMAN EDWARDS, Editor of "Popular Wireless" and
"Modern Wireless"

THE pleasure of building one's own receiving set is only exceeded in intensity when, to one's acute surprise, it works—first time.

The problems to be faced by the novice are often numerous and puzzling—and before he starts on the job he should make up his mind, definitely, on these points:

1. How much money he can spend on "parts," etc.

2. Bearing point 1 in mind, what sort of set he wants to build—a crystal set, a one-valve "straight" set for 'phone reception, a multi-valve loud-speaker set for distant or home Station reception, etc., etc.

If the tyro has his pockets well lined, he is in danger of falling into the trap of making his first set an ambitious effort; he may decide to build an eight-valve super-heterodyne, or something beyond his technical powers, if not his financial powers.

In nine cases out of ten the results will be disappointing. There is a decided art in set-building at home—a technique which has to be acquired by a good deal of experiment and practice—and so I should advise the new constructor to start moderately. Later on, when he has discovered which end of the soldering iron to hold, the proper way to drill an ebonite panel without cracking it in half-a-dozen places, etc., he can indulge in more ambitious efforts with a greater chance of success.

For a first valve set I should advise the novice to try his 'prentice hand by building a simple one-valve receiver for 'phone reception. The wiring of such a set is extremely simple and the lay-out

of the components a matter of no difficulty. The first thing to do is to draw up a specification of the set—a list of the component parts required, even down to the last nut and bolt. It is no good ordering the components haphazardly, just as it is no good building (or trying to build) a house without preparing the plans and calculating the amount of material required.

Draw out the circuit on a piece of paper and, if you are going to use an ebonite panel, make sure that the right size is chosen. It is no use buying a small panel and then finding that all the necessary components cannot be mounted on it.

Most home constructors make up sets from the instructions given in wireless papers. In nine cases out of ten the panel lay-outs of such sets are shown in diagram form illustrating the text—and they are drawn to scale. But it has been my experience that new amateurs, having made up their minds to follow the printed instructions, often fail to adhere to the specified measurements. For example, an amateur wrote to me the other day bitterly complaining about a set which he had built—a five-valver—and upon which he had spent much time, money and ingenuity. But the results it gave were poor—certainly below the standard and excellence obtained by the actual designer with the original model. I had a look at the complainant's set. The reason for his non-success was easily apparent.

Although he had bought the best components and had wired up the set correctly, he had used a

smaller ebonite panel to mount them on. Consequently he had found it impossible to keep to the lay-out recommended by the designer of the set, and so had altered the lay-out to suit the smaller panel. Technical difficulties were thus introduced when he tried the set out—interaction effects and other troubles. In the end he built the set again to the correct design, and it worked perfectly.

WORKING TO PLAN

The above example illustrates the absolute necessity of working to plan when building a set. If you ignore the designer and the architect of the set you want to copy, then you have only yourself to blame if the set does not behave well on test.

Good lay-out and good wiring are, indeed, essential. Soldering, if it is done carelessly, will mean bad joints and consequently bad electrical contact. And that means an inefficient set.

Another important point when constructing a set is the choice of material. I am always reminded of the old proverb, "Don't spoil the ship for a ha'porth of tar," when building a set. Admittedly if one is planning to build a five-valve set one wants to keep the expenses down as much as possible, but, on the other hand, if this is carried to excess and cheap or unsuitable components are used in preference to those which, although costing more, can be relied upon, then one is likely to finish the set, having spent several pounds on it, and find that a good deal of the money one has spent has been wasted because certain components in the set prove inefficient.

If L.F. transformers are going to be used, for example, always buy the best possible. And again, when buying valves, don't be

attracted by the cheap foreign variety. The British valves are the best on the market. They may not be very cheap, but they are at any rate efficient and reliable. It is much better to buy six valves at 18s. 6d. apiece than six at 5s. or 6s. apiece, because in the long run you know the British valves will long outlast any other type of valve, both as regards efficiency and durability.

'WARE CHEAP EBONITE

Cheap ebonite is another thing to beware of. Surface leakages are very apt to ruin reception if the ebonite panel on which the components are mounted is of inferior quality.

It must always be remembered that in a wireless set one has to make the most of very small quantities of energy. One really cannot afford to waste anything. This is even more important when building a crystal set, and consequently the slightest leakage due to bad insulating material will considerably reduce the efficiency of the receiver as a whole.

Finally, I should advise the new constructor to take his time over building his first set. There is always the temptation to rush one's first receiver. The circuit is chosen, the components are purchased and the job is started, perhaps, late one evening. The one idea is to get it finished, connected to the aerial and tested. Scamping work like this will never result in an efficient receiver, and it is more than likely that wrong connections will be soldered up and the set will not work at all. Or, worse still, connections will be made which will result in a short circuit which will impair the efficiency either of the H.T. or L.T. battery, perhaps burning out the valves in less time than it takes to say "Jack Robinson."

THE HOME CONSTRUCTOR SCORES

By PERCY W. HARRIS, M.I.R.E., Editor of "Wireless Constructor"

THE male folk of this planet may be divided, roughly, into two classes—the "handymen" and the "ready-maders." The first needs no explanation—they are the men who prefer to put up their own kitchen shelves; to whom the fitting of a new washer on the bathroom tap is a pleasant diversion rather than a job for the plumber; the men, in short, of whom their wives or mothers proudly say, "George is so useful round the house."

The "ready-maders"—I call them this for lack of a better term—are really a much more numerous class; for they are those who are left when the handymen are sifted out. At a guess we may say they represent seventy-five per cent. of the male population. Unknown to them is that ghastly urge to get up and make something. Do they pull their motor-cycles to pieces on Saturday afternoon and laboriously reassemble them on Sunday morning? No, sir!! Crestfallen, they slink into "the other room" when wifey suggests that if they were as clever as Mrs. Smith's husband they would have fixed that fuse in the girl's room a week ago!

"Wireless" is a godsend to the handyman. It is a heaven-sent hobby which seems to satisfy his every longing. Its fascination lies, not as some mistakenly think, in the few pounds saved in "building your own." This idea has been definitely exploded by the development of the art in the United States, where it is now distinctly more expensive to build your own, but where home constructors buy some twelve million pounds' worth of components each year. At present ready-made sets are very expensive in England, but prices will fall in the next year or two, just as they have fallen in America. When they are so low that it "does not pay" to build your own, Mr. Handyman will still be busy with his soldering-iron.

For the real charm of home-made

radio lies in its infinite variety. When you get tired of a Ford you cannot use its cylinders, buy two more, make another gear-box, order a new body, and evolve a Rolls Royce; but you can do something perilously like this in radio. Valve-holders, rheostats, terminals and many other parts are the same in all sets, while identical components wired up in a different way will produce quite different, and very likely much better, results. Perhaps you may find one of the new ways—an exciting possibility which makes radio a powerful competitor of such national industries as football competitions and greyhound racing.

At the present time the home constructors outnumber the purchasers of ready-made sets many times over, but this is only because they need no persuasion to become interested in radio. The "ready-mader" still fears that radio is not for him—that it is something "scientific" and beyond his mental grasp. No ready-made set should be offered to the public unless its operation is as simple as that of a gramophone. If it needs skill to work, it will not sell, for the man who can operate it will invariably want to express his individuality and skill in a home-built receiver.

I am writing this in a room looking out over the Atlantic on the northern Cornish coast. There is no broadcasting Station for many miles. Receiving conditions here are totally different from those a few miles away, and it would be extremely difficult—nay, impossible—to predict just how any ready-made set would work without trying it. The home constructor, on the other hand, by spending a few evenings in experiment, can easily determine what arrangement will give him the results he desires, and having done so, will be in a position to advise the "ready-maders" as to which type of factory-built receiver will suit *their* particular requirements.

TWELVE DON'TS FOR LISTENERS

- DON'T run your aerial parallel to other aerials near by.
- DON'T connect your earth to the same point as that used by your neighbour.
- DON'T try and communicate with your neighbours by making your receiver howl.
- DON'T use a longer aerial than necessary if you have strength to spare.
- DON'T vary your strength of reception by disturbing your receiver. It spoils the quality and is liable to increase interference in your own set.
- DON'T try to work a loud-speaker from a plain single-valve set.
- DON'T "fiddle" with your set if the results are satisfactory.
- DON'T forget that it is impossible practically to get true reproduction when receiving in the "silent point."
- DON'T forget that the B.B.C. is prepared to send a copy of a special oscillation pamphlet to anyone, free of charge.
- DON'T forget that when you oscillate you are running the risk of having your licence cancelled by the Postmaster-General.
- DON'T use a super-heterodyne receiver on an ordinary aerial. A frame aerial is essential.
- DON'T compensate for the running down of your batteries (both low and high tension) by increasing reaction. If you do this your set may oscillate when switched on after standing idle for a few hours.

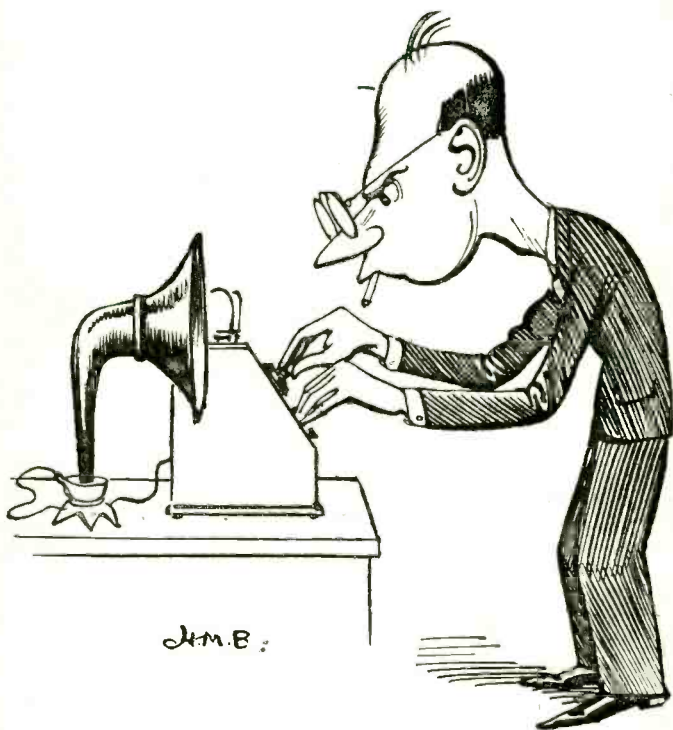

THERE ARE SOME "ODD" EXPLANATIONS FOR OSCILLATING
(Drawn by H. M. Bateman for the B.B.C. Anti-oscillation Pamphlet)

Chloride Batteries

For
**WIRELESS
BROADCASTING
and
COMMERCIAL
STATIONS,
TELEPHONE
EXCHANGES,
POWER
STATIONS
ETC.**

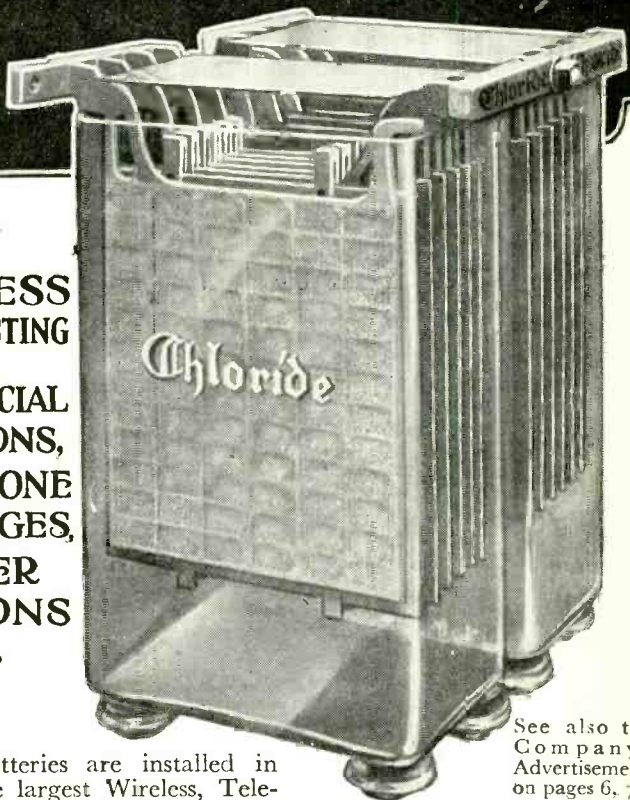

Chloride Batteries are installed in many of the largest Wireless, Telephone, and Power Stations throughout the world, and are extensively used by the B.B.C.

The Company is always pleased to advise as to the best type for any particular purpose.

See also the
Company's
Advertisements
on pages 6, 7.

THE Chloride ELECTRICAL STORAGE
COMPANY LIMITED.

Head Office:—
Clifton Junction
Nr. Manchester

London Office:—
137 Victoria Street
London, S.W. 1

Chloride Batteries for Country House Lighting

The Products of Dobilier

The Products of Dobilier include Fixed Mica Condensers, Mansbridge Condensers, Variable Condensers, "Dumetohms" and other Resistances both Fixed and Variable.

There are Resistance Capacity Units, High Tension Supply Units and, besides the wonderful Dobilier Toroids, a number of other components and accessories.

If you are buying a set, choose one which incorporates Dobilier Products.

If you are building a set, Dobilier Products will make it a better set.

We have been designing and manufacturing Radio Apparatus to meet Government and Commercial needs for seventeen years.

May we send you our new Catalogue?

Your dealer
stocks



products—ask
him

*Advt. of the Dobilier Condenser Co. (1925), Ltd., Duçon Works, Victoria Road,
North Acton, W. 3.*

TC. 21

GLOSSARY OF TECHNICAL TERMS

"A" BATTERY—An American term for the L.T. battery or *accumulator* used to heat the filaments of *thermionic valves*.

A.C.—An abbreviation for *Alternating Current*.

ACCEPTOR CIRCUIT—A tuned *oscillatory circuit*, having the opposite characteristics of a *rejector circuit*.

ACCUMULATOR—One or more *secondary cells* connected in *series* or in *parallel*. Cf. "A" battery.

ACOUSTICS—The science of sound.

ACOUSTIC WAVES—Waves of sound. They may be transmitted through a gas (as air), a liquid (as water), or a solid, their speed depending on the density of the medium. Sound waves have a speed of 1090 feet per second in air at a temperature of 0° C. and a pressure of 30 ins. of mercury.

ADJUSTABLE CONDENSER—See *Condenser*.

ADMITTANCE—The admittance of a circuit is the reciprocal of its *impedance* or apparent resistance. It is measured in *mhos*.

AERIAL—A wire or wires supported at a height above the ground and insulated from it except for a connection to earth through the wireless transmitter or receiver. For special types of aerial see under separate headings.

AERIAL CIRCUIT—In a wireless transmitter or receiver, the circuit between aerial and earth through which the high-frequency *oscillations* pass.

AERIAL INSULATION—By this is meant the insulation of the aerial from its supports and thus from earth. The aerial wire itself may be, and generally is, bare.

AERIAL INSULATORS—Pieces of non-conducting material used for fastening the aerial wire to its supports. They are generally made of porcelain or glass.

AERIAL RESISTANCE—By this term is meant the *resistance* of the aerial to *high-frequency currents*. It may be split up into three parts: (1) *Radiation resistance*, (2) *Dielectric loss resistance* and (3) *Ohmic resistance* of the wire itself. Aerial resistance (effective resistance) varies with frequency, and an aerial is most efficient when (1) is large compared with (2) and (3). See *Radiation Resistance*.

AERIAL TUNING CONDENSER, INDUCTANCE OR COIL—A *condenser* or *inductance* (variable or fixed) connected in the aerial circuit of a transmitter or receiver to *tune the aerial* to a particular frequency.

AIR CONDENSER—A *condenser*, either fixed or variable, having air as a *dielectric*.

ALTERNATING CURRENT—Abbreviated as A.C.—is a current which flows in alternate directions in a circuit, *i.e.*, it starts in one direction from zero, increasing to a maximum through which it passes, decreasing to zero again, and then increasing in the other direction to a maximum and again decreasing to zero. This complete sequence is called one *cycle*, and the number of complete cycles passed through in one second is called the *frequency* or *periodicity* of the A.C. When two alternating currents pass

through zero at the same instant and have their maximum values in the same direction at the same instant, they are said to be "in phase."

An alternating current is measured by its effective or Root Mean Square (R.M.S.) value, which is the value in amperes of the direct current which would produce the same heating effect. For sine waves it is

$\frac{1}{\sqrt{2}}$ or .707 of the maximum or peak value of the A.C.

ALTERNATOR—A dynamo for producing *alternating currents*.

AMMETER—An instrument for measuring current in "amperes." Abbreviation for "ampere meter." See *Voltmeter*.

AMPERAGE—Means the current in *amperes*.

AMPERE—The practical unit of electric current.

AMPERE-HOUR—The unit of quantity of electricity. An accumulator is rated in ampere-hours, *i.e.*, according to the quantity of electricity it will store.

AMPERE METER—See *Ammeter*.

AMPLIFICATION FACTOR OR AMPLIFICATION CONSTANT—of a three-electrode *thermionic valve*, often designated the "M" value, is the maximum *voltage amplification* which the valve can give. It is the ratio of the change of *plate voltage* to change of *grid voltage* necessary to bring about the same change in *plate current*. See *Voltage Amplification*.

AMPLIFIER—An apparatus used to increase the strength of electrical oscillations. In a wireless receiver, amplification may take place before the high-frequency *oscillations* are rectified by the *detector* valve or crystal, and also after rectification. If before, the amplifier is called a high- or radio-frequency amplifier, and if after, it is called a low- or audio-frequency amplifier. For other types of amplifier see under separate headings.

ANODE—The *plate* of a *thermionic valve*. See *Plate*.

ANODE BATTERY—Another name for *high-tension battery*.

ANODE BEND RECTIFICATION—Rectification using the bend (usually the lower one) in the anode current-grid volt characteristic of a *thermionic valve*. Cf. *Grid rectification*.

ANODE CIRCUIT—See *Plate Circuit*.

ANODE CONVERTER—A small rotary electric machine designed to run off an *accumulator* of about 6 to 12 volts, and to give an output voltage suitable for a high-tension supply to a *thermionic valve*.

ANODE CURRENT—See *Plate Current*.

ANTENNA—See *aerial*.

ATMOSPHERICS—Electro-magnetic waves set up by flashes of lightning or other electrical disturbances in the atmosphere affect wireless receivers by producing irregular "grinding" or "grating" in the telephones or loud-speaker. Also called X's, strays or static.

- AUDIO-FREQUENCY TRANSFORMER**—A transformer which is used in an audio-frequency amplifier. It may be an input transformer (as from a telephone line), an intervalve transformer, or an output transformer (as to a loud-speaker). It should be capable of dealing with all frequencies between 30 and 10,000 cycles per second so that none is favoured more than another, if it is used in a broadcasting receiver. It consists essentially of two separate windings on an iron core. See *Transformer*.
- AUDION**—Dr. Lee de Forest's first three-electrode *thermionic valve*. The term is still used in the U.S.A.
- AUTODYNE**—A *thermionic valve* incorporated in a circuit so that it generates oscillations due to grid and plate windings forming an *auto-transformer*.
- AUTO-TRANSFORMER**—A transformer either for radio or audio frequency in which the primary and secondary windings are formed by one and the same coil having three connections to it.
- "B" BATTERY**—An American term for a high-tension battery used to supply the *plate current* in a *thermionic valve*.
- BACK E.M.F.**—An *electromotive force* or *voltage* which acts in opposition to the flow of current in an electrical circuit.
- BALLAST TUBE**—An American term for *barretter*.
- BAND-PASS FILTER**—A *filter* circuit which is so designed that it will only pass a particular band of frequencies. See *Filter*.
- BARRETTTER**—An instrument for keeping constant the flow of current in a circuit irrespective of any change in *voltage* (within limits) across the circuit.
- BASKET COIL**—A coil generally used as an *inductance* in a wireless receiver formed by winding wire round an odd number of pins projecting radially from a central boss. Such a coil has the appearance of certain forms of basket work.
- BEAM WIRELESS**—A particular system of wireless transmission in which the *waves* are concentrated on the receiver in the form of a beam. An electrical reflector is used, and as this must be of large mechanical dimensions in comparison with the *wavelength*, beam transmission is in practice confined to short wavelengths.
- BEAT RECEPTION**—A method of receiving continuous waves in which use is made of the Beat principle. It should be noted that the *beats* themselves are inaudible and must be rectified to produce combination tones which will be heard, and which are usually referred to as the beat frequency.
- BEATS**—If two *oscillations* or *alternating currents* of different frequencies are superimposed, a further set of *oscillations* will be produced. This set will have a changing amplitude and the *frequency* of the amplitude change will be equal to the difference in the two original frequencies. If the two original frequencies are near together, then the difference between the two will be small, and in this case the beats due to the change of amplitude will be of low frequency.
- BEVERAGE AERIAL**—An *aerial* whose length is several times the *wavelength* to be received, its height being only a few feet from the ground. It may be either connected to earth or left insulated at the free end. It has marked directional properties and gives a relatively large ratio of signal to *atmospherics*.
- BINDING POST**—An American term for a *terminal*.
- BI-PASS CONDENSER**—A fixed-capacity *condenser* of suitable value connected across an electrical circuit or part of it so that certain desired frequencies will pass through it in preference to passing through the part of the circuit across which it is connected.
- BLASTING**—Used in the electrical sense to indicate *distortion*, although originally brought into use from the sound produced in the loud-speaker on particularly loud signals when such *distortion* was occurring. In the general case blasting is produced in a valve by overloading it so that it does not work without *grid current*.
- BLOCKING CONDENSER**—A fixed-capacity *condenser* of any suitable value connected in a circuit to stop direct current flowing, but to be conductive to A.C. of the desired frequencies.
- BORNITE**—Used as a *crystal detector* in conjunction with *zincite*. Bornite is a chemical compound of iron, sulphur and copper.
- B.O.T. UNIT**—Board of Trade Unit. One *kilowatt-hour*. See *Watt-hour*.
- BRIDGE**—An electrical circuit for the measurement of various electrical quantities. See *Wheatstone Bridge*.
- BRIGHT EMITTER**—A *thermionic valve* in which the *filament* gives its normal *emission* only when heated to a high temperature so that it glows brightly.
- BUZZER**—A piece of apparatus so called because it produces a buzzing sound, due to an armature vibrating.
- BUZZER WAVEMETER**—A *wavemeter* in which a buzzer is used to make the *wavemeter* act as a small wireless transmitter.
- "C" BATTERY**—Term used in America to denote the *grid-bias* battery.
- CAPACITY**—(of an accumulator or storage battery) is measured in *ampere-hours*, and indicates the number of *ampere-hours* the cell will give when fully charged. This quantity will depend on the discharge rate. In stating the capacity of a cell the manufacturers will also state the discharge rate. The capacity of an accumulator is sometimes stated on an ignition rate; this is double the actual capacity.
- CAPACITY**—(of a condenser or isolated body) is a measure of the charge (or quantity of electricity) it is capable of storing. If it holds a charge of one *coulomb* and the difference of *potential* between its plates is one *volt*, then the condenser is said to have a capacity of one farad. This is too large a unit for practical purposes. Therefore, the microfarad is more generally used, and is equal to one millionth of a farad.
- CAPACITY COUPLING**—Indicates that the coupling between two circuits is formed by a *condenser*. See *Coupling*.

- CARBON MICROPHONE**—See *Solid-back Microphone*.
- CARRIER WAVE**—The high-frequency oscillations emitted by a wireless telephone transmitter. These are modulated during telephony. The analogy is that the telephony (music, speech, etc.) is "carried" by the high-frequency oscillations from the transmitter to the receiver.
- CASCADE**—Pieces of electrical apparatus are said to be connected in cascade when the output of the first is connected to the input of the second, the output of the second to the input of the third, and so on.
- CATHODE**—See *Kathode*.
- CAT'S-WHISKER**—A fine wire used to make contact with a particular point of a crystal in a *crystal detector*.
- CELL**—See *Secondary Cell* and *Primary Cell*.
- CHARACTERISTIC CURVE**—See *Static Characteristic* and *Dynamic Characteristic*.
- CHARGE**—See *Capacity*.
- CHECK RECEIVER**—A wireless receiver installed in the *control room* of a broadcasting station to enable a constant check to be kept on the quality of the transmission.
- CHOKER**—A coil of wire which, although it may be of small D.C. resistance, will offer a high impedance to A.C., the impedance offered depending on the frequency of the A.C. If the choke is for use with A.C. of low frequency it will generally be wound on an iron core, whereas for use with high-frequency A.C. it will have an air core, i.e., be wound on a former of non-magnetic material.
- CHOKER CONTROL**—A method of "controlling" the high-frequency oscillations delivered to the aerial in a wireless telephone transmitter, so that they vary in amplitude at the low frequency of modulation. A large iron-core choke is used in the common H.T. circuit to the modulator and oscillator valves. See *Modulation*.
- CLOSED-CORE TRANSFORMER**—A transformer in which the iron core forms a continuous magnetic circuit, i.e., it has no air gap. Cf. *Open-core Transformer*.
- COEFFICIENT OF COUPLING**—A percentage indicating the tightness or otherwise of the coupling between two circuits. See *Tight Coupling* and *Loose Coupling*.
- COHERER**—A detector used in early wireless experiments. It worked by virtue of the property of metal filings, which were only in imperfect contact, of cohering and forming a relatively good contact under the influence of *Hertzian waves*.
- CONDENSER**—The simplest form of condenser consists of two metal plates separated by an insulator, which is called the *dielectric*. It has capacity and will store electrical energy.
- CONDENSER MICROPHONE**—A microphone consisting of two plates of a condenser, whose distance apart is altered by the sound waves impinging upon one of them. The consequent variations in capacity are made to affect an external circuit where they can be amplified to any desired extent.
- CONDUCTOR**—A substance which offers a comparatively low resistance to the passage of electric currents through it.
- CONTINUOUS CURRENT**—Another term for *direct current*.
- CONTINUOUS OSCILLATIONS OR WAVES**—Undamped oscillations or waves, i.e., the amplitude of successive cycles remains constant and does not diminish. Abbreviated as C.W. Cf. *Damped Oscillations*.
- CONTROL ROOM**—The "Nerve-centre" of a broadcasting station. In this room are situated the low-frequency amplifiers and associated apparatus by which the microphone currents are controlled, before they are passed on to the *modulation system* of the transmitter.
- CONTROL SYSTEM**—Of a wireless telephone transmitter is that part of the transmitter which modulates the high-frequency oscillations. See *Choke Control* and *Modulator System*.
- CORRECTOR CIRCUIT**—An arrangement of inductances, capacities and resistances which is placed in a long telephone line circuit to counterbalance any effect the line may have on the speech currents passing along it, owing to the attenuation not being constant at all frequencies. See *Repeater Station*.
- COULOMB**—Quantity of electricity given by one ampere flowing for one second. One ampere-hour = 3,600 coulombs.
- COUNTERPOISE**—An arrangement used in some wireless transmitters instead of an "earth" connection, consisting of a system of wires supported on short masts underneath an aerial and insulated from earth.
- COUPLING**—Two electrical circuits are said to be coupled when a change of current in one circuit produces an E.M.F. across the second circuit.
- CRYSTAL**—See *Natural Crystal*.
- CRYSTAL DETECTOR**—A form of rectifier of alternating currents which works by virtue of the contact between certain dissimilar crystals, only allowing current to pass in one direction.
- CUMULATIVE GRID RECTIFICATION**—See *Grid Rectification*.
- CURRENT**—The flow of electricity along a wire or other conductor from a point of high potential to a point of low potential. The unit of current is the ampere. Mechanical analogy is gallons of water per minute flowing through a pipe.
- CYCLE**—See *Alternating Current*. One cycle per second is sometimes referred to as one Hertz.
- DAMPED OSCILLATIONS OR WAVES**—Oscillations or waves in which the amplitude of each successive oscillation or wave is smaller than that of the previous one. The amount by which each wave is smaller than the preceding wave depends upon the logarithmic decrement of the circuit. Cf. *Continuous Waves*.
- DAMPING**—The rate at which a train of oscillations dies away.
- D.C.**—Abbreviation for *direct current*.
- D.C.C.**—Double cotton covered (insulation of wire).
- DETECTOR**—In a wireless receiver is a device for rectifying the high-frequency oscillations. See *Rectification*.
- DETECTOR VALVE**—A thermionic valve

- used as a *detector* or *rectifier*. See *Anode Bend Rectification*, *Grid Rectification* and *Rectification*.
- DIELECTRIC**—A substance whose resistance to the passage of electric currents is extremely high. The insulator separating the plates of a *condenser*.
- DIODE**—A *thermionic valve* having only two electrodes, *i.e.*, a *kathode* (filament) and an *anode* (plate). The original Fleming valve was a diode.
- DIRECT COUPLING**—See *Auto-transformer*.
- DIRECT CURRENT**—Abbreviated as D.C., and sometimes referred to as continuous current. A current which flows in one direction only. Cf. *Alternating Current*.
- DIRECTIONAL AERIAL**—An aerial which will send out wireless waves in, or receive them from, one direction to a greater degree than other directions.
- DIRECTION FINDER**—A wireless receiver in which the directional properties of one or other forms of aerial are made use of to find the direction from which wireless signals are arriving.
- DIS**—Disconnection.
- DISTORTION**—A term used in telephony to indicate any deviation from the original *wave form* of the speech or music which may be brought about during any of the various changes which take place between the *microphone* and *loud-speaker* or telephones.
- DOWN LEAD**—The wire which "leads down" from the elevated part of an aerial to the transmitting or receiving apparatus.
- DRAPING**—Material hung in a *studio* to decrease the *reverberation* and *echo*.
- DRIVE CIRCUIT**—An *oscillatory circuit* tuned to the same frequency as the main *oscillatory circuit* of a transmitter and coupled to it in such a manner that the latter is forced to generate *oscillations* of exactly the same frequency, thus preventing any slight wave change due to keying or heavy modulation.
- DRY CELL**—A *primary cell* in which the liquid *electrolyte* is replaced by a paste.
- DULL EMITTER**—A *thermionic valve* in which the *filament* gives its normal emission at a relatively low temperature, thus using only a little current and lighting up only to a dull red.
- D.W.S.**—Abbreviation for "Double Wound Silk" (the insulated covering of a wire).
- DYNAMIC CHARACTERISTIC**—Curves, generally of a *thermionic valve*, showing the performance under working conditions when the values of *plate* and *grid voltages*, etc., may be varying simultaneously.
- DYNAMO**—A rotary machine which generates direct-current electricity.
- EARTH POTENTIAL**—The electrical *potential* of the earth is said to be zero and therefore connections made to the earth at various places will be at the same potential. It should be noted that if a large current is flowing through a lead connecting a wireless transmitter or receiver to earth, the potential of the earth terminal of the apparatus will only be zero if the resistance of the earth lead and connection is very low.
- ECHO**—The recurrence of a sound after an interval of time due to the original sound being reflected from a surface, *e.g.*, a bare wall.
- ECHO ROOM**—A room designed to produce *echoes*. In the broadcasting of certain musical items from a *studio*, an artificial echo is superimposed to obtain a more pleasing effect.
- EDDY CURRENTS**—If a piece of metal is placed in a varying *magnetic field*, currents will be induced in the metal. These are called "eddy currents." The higher the frequency of variation of the field, the larger will be the eddy currents. The metal will become heated by these currents, and thus energy will be dissipated.
- EFFECTS STUDIO**—A *studio* in which the noise effects incidental to a transmission are made. See *Mixing Unit*.
- ELECTRIC FIELD**—If a body becomes electrified, certain effects will be observable in its vicinity, such as the attraction or repulsion of other electrified bodies. The space in which these effects can be observed is said to be in the electric field of the body. The magnitude of these effects at a given distance is a measure of the strength of the field. Sometimes called *Electrostatic Field*.
- ELECTRODE**—A component part of a *vacuum valve*, or of a primary or secondary *battery*.
- ELECTROLYTE**—The liquid (generally dilute sulphuric acid) in a *secondary cell*.
- ELECTRO-MAGNET**—Soft iron becomes a magnet only in the presence of a *magnetic field*. If this field is provided by a current passing through a coil of wire wound round the soft iron, the latter is said to be an *electro-magnet*.
- ELECTRO-MAGNETIC WAVES**—See *Waves*.
- ELECTROMOTIVE FORCE**—(Abbreviated as E.M.F.) is electrical pressure or *voltage*. As, in the mechanical analogy, water is forced through a pipe by the "head" of water overcoming the resistance of friction in the pipe, so electrically the current is forced through the circuit by the E.M.F. overcoming the *resistance* of the wire.
- ELECTRON**—Thought to be the smallest particle of a substance which can exist as an entity. It is negatively charged electrically. See *Negative Charge*.
- E.M.F.**—Abbreviation for *Electromotive Force*.
- EMISSION**—The stream of *electrons* which is given off from the *filament* of a *thermionic valve*.
- ETHER**—For wave motion to be transmitted through space there is assumed to be an all-pervading medium through which it is transmitted. Ether is the name given to this assumed medium. See *Waves*.
- FADE UNIT OR MIXING UNIT**—A *potentiometer* arrangement placed in the input circuit of a microphone amplifier in order that the outputs of several microphones may be connected to the amplifier at will and at any desired strength.
- FADING**—The variation in strength of a signal received from a distant station, assumed to be due to changes in the *Heaviside layer* altering the angle of reflection of the transmitted ray in an irregular manner. See *Reflection*.

- FARAD**—The unit of *capacity*.
- FEED BACK**—See *Reaction*.
- FIELD STRENGTH**—The intensity of the *electric and magnetic field* due to a wireless transmitter at any point is called its field strength, which may be measured in millivolts induced in an *aerial* having an effective height of one metre. *i.e.*, field strength may be expressed in millivolts per metre.
- FILAMENT**—In a *thermionic valve* the filament is a fine wire which is heated by the passage of electric current. Generally this filament itself emits *electrons*, but in some valves it heats a cylinder which surrounds it closely, and the latter gives the *emission*.
- FILAMENT RESISTANCE**—A *resistance* included in the filament-heating battery circuit to limit the *voltage* across the filament to the correct value.
- FILTER**—An electrical filter is a circuit composed of *inductances* and *condensers* which will pass or prevent from passing certain frequencies. See also *Band-pass, High-pass, and Low-pass Filters*.
- FLAT TUNING**—A circuit is said to be flatly tuned if a large change in its resonant frequency (produced by changing its *inductance* or *capacity*) is accompanied by only a small change in the amplitude of the oscillatory current flowing in the circuit, the frequency of the applied voltage remaining constant. Cf. *Resonance*.
- FLEMING VALVE**—See *Diode*.
- FLUX DENSITY**—Is a measure of the strength of a *magnetic* or an *electric field*, and is stated as the number of lines of magnetic or electrostatic force per unit area of cross section of the field. Cf. *Permeability*.
- FOUR-ELECTRODE VALVE**—A *thermionic valve* having a cathode (filament), two *grids* and an *anode*. Sometimes called a *tetrode*. Cf. *Diode* and *Triode*.
- FRAME AERIAL**—An aerial, generally used for wireless reception, consisting of a number of turns of wire supported on a wooden frame of convenient shape. It has marked directional properties and is used on certain types of *direction finders*. See *Loop Aerial*.
- FREQUENCY**—The frequency of an alternating current is the number of complete *cycles* it passes through in one second. See *Alternating Current*. Frequencies are sometimes stated in Hertz, where one Hertz = one cycle per second.
- FREQUENCY: AUDIO-, HIGH-, RADIO-, SUPERSONIC**—See under appropriate letters.
- FULL-WAVE RECTIFICATION**—A system of *rectification* in which both half *cycles* of an *alternating current* are utilised.
- FUSE**—Usually in the form of a piece of wire included in an electric circuit as a protective device. On the current passing a certain value this piece of wire melts, thus breaking the circuit.
- GALENA**—A sulphide of lead used as a crystal detector in conjunction with a fine metal wire called a *cat's whisker*.
- GALVANOMETER**—A sensitive electrical measuring instrument.
- GENERATOR**—A machine for converting mechanical energy into electrical energy. It may be either a *dynamo* or an *alternator*.
- GRAMOPHONE ATTACHMENT**—A device for converting directly the mechanical vibrations given by a record to a gramophone needle into electrical currents, which can be amplified and caused to work a loud-speaker or to modulate a wireless telephone transmitter. For broadcast transmission of gramophone records this obviates the use of a gramophone soundbox and a microphone, with a consequent reduction in possibilities of *distortion*.
- GRID**—The third electrode in a *thermionic triode*, which controls the stream of *electrons* emitted by the filament. Mechanically it may have many forms, the normal being a spiral of wire.
- GRID BIAS**—The *voltage* applied to the *grid* of a *thermionic triode* to determine its *potential* with respect to the *filament*. To ensure that a *triode* shall work on the straight portion of its *static characteristic* a negative bias must be applied, the voltage being dependent on the characteristics of the valve.
- GRID CIRCUIT**—The circuit connected between the *grid* and *filament* of a *thermionic triode*.
- GRID CONDENSER**—A condenser, usually fixed in capacity, connected directly to the *grid* of a valve so that it is between the *grid* and the rest of the *grid* circuit. Cf. *Resistance-capacity Coupling*.
- GRID CURRENT**—If the *grid* of a *triode* becomes positively charged with respect to the filament, some of the *electrons* leaving the *filament* will not pass the *grid* on their way to the *anode*, but will return through the *grid* circuit to the *filament*, thus producing *grid current*. Cf. *Grid Rectification*.
- GRID LEAK**—A high resistance connected either directly across a *grid condenser* or else from the *grid* to the *filament* of a *triode* in order to maintain the mean potential of the *grid* at any desired predetermined value, providing a path for any charge, which may accumulate on the *grid*, to leak away.
- GRID RECTIFICATION**—Sometimes called *cumulative grid rectification*. For this system of *grid rectification grid current* must be allowed to flow in the *triode*, and use is made of the curvature of the *grid* volt-grid current characteristic. During an incoming high-frequency oscillation, the *grid* of the valve receives a negative charge through a *grid condenser*, and this reduces the value of the *anode current*. The presence of a *grid leak* allows this *negative charge* to leak away, thus ensuring that the mean *potential* of the *grid* shall not become so negative as to stop the *grid current* flowing. See *Rectification*.
- GROUND**—An American term for "earth."
- HALF-WAVE RECTIFICATION**—A system of *rectification* in which only one half cycle of the alternating current is made use of. Cf. *Full-wave Rectification*.
- HARD VALVE**—A *thermionic valve* from which all the gas has been exhausted, particular care being taken that no gas is left even in

- the surface of metal parts in the valve.
Cf. Soft Valve.
- HARMONICS**—Frequencies which are multiples of another frequency are said to be harmonics of it; thus a frequency of 50 cycles per second (or Hertz) has harmonics or frequencies of 100, 150, 200, etc., cycles, being twice, three times and four times the original frequency, and being called the second, third and fourth harmonic respectively.
- HEAVISIDE LAYER**—An upper layer of the atmosphere which is thought to exist and to vary in height from 60 to 150 miles above the earth's surface, and to become ionised by the sun's rays. Was originally postulated by Oliver Heaviside, and has since been held to account for fading of wireless signals and the transmission of short-wave wireless signals round the curvature of the earth. See *Reflection*.
- HENRY**—The unit of *inductance*.
- HERTZ**—A term sometimes used to designate frequency, meaning one cycle per second.
Cf. Kilohertz.
- HERTZIAN WAVES**—Electromagnetic waves by which all wireless signalling is accomplished. They were called after Hertz, who first succeeded in producing them in 1888, but they were postulated by Clerk Maxwell, who gave mathematical proof of their existence in 1864.
- HETERODYNE INTERFERENCE**—Interference caused to broadcast reception by the carrier wave of an unwanted station beating with that of the wanted station, and giving an audible beat note in the receiver due to the two stations being on *wavelengths* or frequencies separated by too small an amount. It should be noted that two nearly equal and relatively low-powered stations as far apart as 1000 miles can produce an audible beat note even at a few miles from either.
- HETERODYNE RECEPTION**—A method of receiving C.W. wireless signals in which use is made of a local oscillator to "beat" with or "Heterodyne" the incoming C.W. See *Beat Reception*.
- HETERODYNE WAVEMETER**—A wavemeter using the heterodyne principle by generating oscillations of a known frequency which may be tuned to the oscillations whose frequency is to be measured. When the "beat" note is zero the two sets of oscillations have the same frequency.
- H.F.**—Abbreviation for *High Frequency*.
- HIGH FREQUENCY**—There is no definite dividing line between high- and low-frequency oscillations; but oscillations or alternating currents of frequencies up to about 12,000 are generally considered as low- or audio-frequencies, while those above this are spoken of as *Supersonic*, *High* or *Radio frequencies*.
- HIGH-FREQUENCY AMPLIFIER**—An amplifier which amplifies high or radio frequencies, e.g., the incoming wireless signals before they are rectified. See *Amplifier*.
- HIGH-FREQUENCY CHOKE**—A choke which offers considerable *impedance* to high-frequency currents. See *Choke*.
- HIGH-FREQUENCY RESISTANCE**—See *Aerial Resistance*.
- HIGH-FREQUENCY TRANSFORMER**—A transformer for coupling together high-frequency circuits, e.g., an intervalve transformer in a high-frequency amplifier. See *Transformer*.
- HIGH-PASS FILTER**—A filter circuit which is so designed that it will pass all frequencies above a certain value. See *Filter*.
- H.T.**—Abbreviation for high tension.
- HIGH TENSION**—The voltage applied to the anode or plate of a triode is called the high-tension voltage, as opposed to the low-tension voltage which is applied to the filament.
- HIGH-TENSION BATTERY**—A battery of dry cells or accumulators used to give the high-tension voltage for a triode.
- HONEYCOMB COIL**—A coil for use as a high-frequency inductance wound so as to reduce its self capacity, and so named from its resemblance to a honeycomb in appearance.
- HORSE POWER**—The unit of mechanical power, equal to 33,000 foot-pounds per minute.
- HOT-WIRE AMMETER**—An ammeter for measuring alternating or direct currents. The current to be measured is passed through a wire, which it heats. The wire expands, and the expansion is measured by a pointer moving over a scale. The temperature and therefore the expansion of the wire is proportional to the square of the current. The instrument is calibrated directly in amperes. See *Ammeter*.
- HYDROMETER**—An instrument for measuring the specific gravity of liquids. Used in particular for finding that of accumulator acid.
- HYSTERESIS**—If a magnetising force be applied to a piece of iron and increased or decreased, the magnetisation of the iron will lag behind the magnetising force. This effect is known as magnetic hysteresis.
- I.C.W.**—Abbreviation for *Interrupted Continuous Waves*.
- IMPEDANCE**—The opposition offered to an alternating current by a resistance, inductance or capacity, or a combination of the three. It is expressed in *Ohms* and is dependent on the frequency of the A.C. except in the case of a pure resistance. See *Resonance*.
- IN PHASE**—See *Alternating Currents*.
- INDUCED E.M.F.**—If a conductor is moved in a magnetic field, or if the magnetic field changes in intensity so that the number of lines of magnetic force passing through the conductor is changed (either increased or decreased), then an E.M.F. will be induced across the ends of the conductor, its value depending on the rate of change of magnetic flux through the conductor.
- INDUCTANCE**—A conductor is said to possess inductance if a current flowing through it causes a magnetic field to be set up round it. A straight wire therefore has inductance, but the value will be greatly increased if the conductor is wound in the form of a coil with the turns close together, so that

the flux due to one turn will cut not only itself but also the neighbouring turns.

INDUCTIVE CAPACITY—See *Specific Inductive Capacity*.

INDUCTIVE COUPLING—*Coupling* between two circuits by virtue of *inductances* in the circuits. A changing current in the one winding will cause a varying *magnetic flux* in it which will cut the other, thus inducing an E.M.F. in the latter. See *Tight Coupling* and *Loose Coupling*.

INDUCTIVE RESISTANCE—A *resistance* which has *inductance* and thus has an *impedance* to alternating currents which is greater than its D.C. resistance.

INSULATION RESISTANCE—The resistance in megohms (millions of ohms) between two conductors or circuits which are insulated from each other.

INSULATOR—Any substance which offers an extremely high resistance to the passage of electric current through it, and which is therefore used to separate two circuits electrically from each other, or from earth.

INTER-ELECTRODE CAPACITY—The capacity between the *electrodes* of a *thermionic valve*. That between the *grid* and *anode* is appreciable in the majority of *triodes*, and gives a capacity coupling between the *grid circuit* and the *anode circuit*, thus causing the valve to generate *oscillations* if these two circuits are tuned to the same frequency. This capacity may be balanced out by suitable arrangements. See *Neutrodyne Receiver*.

INTERFERENCE—Unwanted signals in a wireless receiver due to any cause, e.g., *atmospheric*, other transmitting stations, etc.

INTERNAL IMPEDANCE—Called also the "differential resistance" of a *thermionic valve*. The resistance referred to is that of the anode-filament circuit. It is given by the change of *anode voltage* divided by the change in *anode current*, the grid potential being kept constant. It will vary depending on the position on the *characteristic curve* at which it is measured. In general, it is measured over a small portion of the straight part of the curve.

INTERRUPTED C.W.—Abbreviated as I.C.W. A method of wireless telegraph transmission in which C.W. is used but is interrupted at an *audio frequency* so that it can be received on a wireless receiver without the use of *beat reception*.

INTERVALVE COUPLING—The components used to transfer *oscillations* from the *anode circuit* of one valve to the *grid circuit* of the following valve in a multi-stage *cascode* amplifier. It may be designed for radio or audio frequencies, and may be inductive (using a *transformer*), or capacitive (using *condensers*).

INTERVALVE TRANSFORMER—See *Intervalve Coupling*, *Amplifier*, and *Transformer*.

INVERTED L AERIAL—An aerial having a horizontal portion and a vertical down lead at one end.

IONISATION—When a gas is split up into minute particles carrying *positive* and *negative charges* of electricity, it is said to be ionised, and these particles are called *ions*. In such a state the gas becomes a

conductor of electricity. Ionisation of a gas can be effected by applying a high *potential* across it.

JACK—A device used originally on telephone switchboards to allow connection to be made to a number of circuits by a plug having at least two *concentric contacts*. At the same time a number of separate contacts may be closed or opened in the jack to allow any desired switching arrangement.

JAMMING—*Interference* with wanted wireless signals due to other wireless transmitters.

JIGGER—A *high-frequency transformer* used originally and so named by Marconi to couple the *aerial circuit* of a wireless transmitter to the circuit in which the *oscillations* are produced.

JUNCTION, THERMO-ELECTRIC OR VACUO—See *Thermo-couple*.

KATHODE—The *electrode* of a *thermionic valve* from which *electrons* are emitted. In general the kathode is the *filament*, and it is heated by the passage of a current through it.

KATHODE - RAY OSCILLOGRAPH—An *oscillograph* in which a stream of *kathode rays* (*electrons*) is made to impinge on a fluorescent screen which glows, at the spot on which they are focussed, under their influence. This *kathode stream* can be made to move to and fro at any desired frequency under the influence of electrostatic or electromagnetic forces, and the spot lengthens into a line of light on the screen. Two pairs of plates are mounted inside the bulb and are disposed at right angles to each other for connection to the alternating E.M.F. to be examined.

KILOCYCLE—One thousand cycles. Abbreviation k.C. A frequency of 1000 k.C. is equivalent to a wavelength of 300 metres.

KILOHERTZ—One thousand cycles per second.

KILOWATT—The practical unit of electrical power = 1000 watts.

KILOWATT HOUR—The practical unit of electrical energy. See *Board of Trade Unit*.

kw.—Abbreviation for kilowatt.

LAMINATED CORE—An iron core used in *transformers*, *chokes*, etc. for use in *alternating-current* circuits, laminated or built up of thin sheets of iron, each sheet being insulated on one side by a coating of shellac varnish or other insulating material so that *resistance* will be offered to the passage of *eddy currents*. See *Transformer*.

LEYDEN JAR—The original *condenser* consisting of a glass jar coated inside and out with metal foil. It was invented at the University of Leyden.

L.F.—Abbreviation for low frequency.

LINEAR AMPLIFICATION—Amplification in which the output *voltages* at all values and *frequencies* are directly proportional to the input *voltages*.

LINES OF FORCE—A *magnetic* or *electric field* is said to consist of an infinite number

- of imaginary lines which are called lines of force, and the electric or magnetic force acts along these lines. The density of these lines, or the number per unit cross-sectional area, is said to be the measure of the strength of the field. See *Flux Density*.
- LOADING COIL**—An inductance connected in series with an aerial to increase the *wavelength* to which the aerial can be tuned with its existing *inductance* and *capacity*.
- LOCAL OSCILLATOR**—An oscillator arranged to produce *oscillations* "locally" to act as a separate *heterodyne* for heterodyne or *beat* reception.
- LOGARITHMIC DECREMENT**—A number indicating the *damping* of an *oscillatory circuit*. It is dependent upon the *resistance* of the circuit.
- LOOP AERIAL**—An American term for *Frame Aerial*.
- LOOSE COUPLING**—Two inductances are said to be loosely coupled when they are so separated that the mutual *inductance* between them is small in comparison with their self-inductances.
- LOUD-SPEAKER**—A loud-speaking *telephone*. For true reproduction of Broadcasting it is necessary to have a loud-speaker capable of reproducing all *frequencies* from 30 to 10,000 cycles equally well. The original loud-speaking telephone does not do this. Loud-speakers are now made in many diverse forms with this end in view.
- LOW FREQUENCY**—Frequencies up to about 12,000 cycles per second. Cf. *High Frequency* and see *Audio Frequency*.
- LOW-FREQUENCY AMPLIFIER**—See *Amplifier*.
- LOW-FREQUENCY TRANSFORMER**—See *Audio-frequency Transformer*.
- LOW-PASS FILTER**—A *filter* circuit which is so designed that it will pass all frequencies below a certain value.
- LOW TENSION**—The *voltage* applied to the *filament* of a *thermionic valve* as opposed to the high tension.
- LOW-TENSION BATTERY**—The battery used to heat the *filament* of a *thermionic valve*. See "A" Battery.
- L.T.**—Abbreviation for low tension.
- MAGNETIC CIRCUIT**—Refers to the path through the air or the iron core of a *transformer*, *choke*, etc., which provides a circuit for the *magnetic flux*. See *Reluctance*.
- MAGNETIC DETECTOR**—A *detector* which makes use of the *hysteresis* in an iron wire for rectifying high-frequency *oscillations* in a wireless receiver. It was first used by Marconi, and was used for many years, particularly in ship installations, on account of its reliability and robustness. It is, however, comparatively insensitive and now obsolete.
- MAGNETIC FIELD**—See *Electric Field*. (For "electric" read "magnetic.")
- MAGNETIC FLUX**—See *Flux Density*.
- MAGNETIC SCREEN**—A screen of magnetic material such as iron, generally in the form of a box, placed over a piece of apparatus to screen it from the effects of any *magnetic field* in the vicinity.
- MAGNETISATION CURVE**—A curve showing the relation between the *magnetising force* applied to a piece of iron and the resulting *flux density*.
- MAGNETISING FORCE OR MAGNETO-MOTIVE FORCE**—The force required to create a certain magnetic field. Analogous to *E.M.F.* in current electricity. See *Reluctance* and *Flux Density*.
- MAGNETO-MOTIVE FORCE**—In a *magnetic circuit* the *M.M.F.* may be compared to the *E.M.F.* in an electric circuit. The *M.M.F.* forces the magnetic flux through the *magnetic circuit* against the "reluctance" of the iron.
- MAGNETOPHONE**—A form of *microphone* in which the sound waves impinge on a light, flat coil of wire supported in a *magnetic field*. The coil moves in the field and thus has an *A.C.* generated in it. The magnetophone is relatively insensitive, and its output requires considerable amplification before signals of telephone strength are obtained.
- MAIN STATION**—A wireless telephony broadcasting station of medium power.
- MANSBRIDGE CONDENSER**—A form of fixed *condenser* particularly suited to give large capacities in a relatively small space. The *dielectric* consists of a strip of waxed paper which is coated on both sides with tinfoil to form the conductors. The whole strip is then rolled and pressed together.
- MAST**—A steel or wooden erection for supporting an *aerial*. Masts have been built to a height of about 900 feet.
- MEGGER**—An instrument for measuring high resistances.
- MEG OHM**—One million ohms.
- MFD.**—Abbreviation for Microfarad.
- MHO.**—The unit of *admittance*.
- MICROFARAD**—One millionth of a farad.
- MICROHENRY**—One millionth of a henry.
- MICROPHONE**—With the advent of Broadcasting the term microphone is now applied to any instrument which will convert sound waves into electrical currents; whether it be a *carbon microphone* which depends for its action on the varying resistance of carbon granules under the variable air pressure produced by the sound waves, or a *magnetophone*, or a *condenser microphone*. These are the three most important types.
- MICROPHONE AMPLIFIER**—A low-frequency amplifier used in conjunction with a *microphone* and generally in its vicinity, to amplify the weak electrical currents given by the *microphone* to a desired amplitude.
- MILLIAMPERE**—The thousandth part of an *ampere*.
- MIXING UNIT**—See *Fade-unit*.
- M.M.F.**—Abbreviation for Magneto-motive Force.
- MODULATION**—If *continuous waves* have their amplitude varied at an *audio frequency*, they are said to be modulated by it. For true reproduction of the audio frequency at the wireless receiver, it is essential that the change of amplitude of the continuous waves (*carrier wave*) shall be a true copy of the *wave form* of the audio-frequency *oscillations* at all frequencies and amplitudes. If this be the case, the modulation is said to be "linear."
- MODULATION METER**—An apparatus for

indicating the depth of *modulation* in a telephone transmitter.

MODULATOR SYSTEM—The part of a wireless telephone transmitter in which the audio-frequency *oscillations* are magnified and caused to modulate the carrier wave. See *Choke Control*.

MOTOR GENERATOR—A generator which is mechanically directly coupled to an electric motor by which it is driven.

MUSH—A form of *interference* emitted by *continuous wave* transmitting stations using an arc to generate the C.W.

MUTUAL INDUCTANCE—If two *inductances* are coupled together so that a changing current in the primary winding produces an E.M.F. across the secondary winding, the two circuits are said to possess mutual inductance. See *Inductance and Coupling*, and cf. *Self-inductance*.

NATURAL CRYSTAL—A chemical compound in crystal form which possesses the property of being able to pass an electric current in one direction only, and which therefore may be used as a *detector* in receiving sets.

NATURAL FREQUENCY OR NATURAL PERIOD—The *frequency* or *period* at which a circuit containing *inductances* and *capacity* will naturally oscillate if set in electrical vibration. The natural frequency is given by the formula $f = \frac{1}{2\pi\sqrt{LC}}$ cycles per second, where L is the inductance in henries and C is the capacity in farads. At this frequency, the condition of *Resonance* occurs.

NATURAL TIME CONSTANT—See *Time Constant*.

NATURAL WAVELENGTH—The *wavelength* at which an *aerial* or a *tuned circuit* will most readily oscillate by virtue of its own *inductance* and *capacity*. The natural wavelength of an *inverted L-type* aerial is about four times its length.

NEGATIVE CHARGE—The quantity of static electricity of negative sign which is not neutralised by the positive electricity in a body when it is negatively electrified.

NEGATIVE ELECTRIFICATION—A body is said to be negatively electrified when it contains an excess of *electrons* or particles of negative electricity.

NEGATIVE POLE—A pole that is at a lower *potential* relatively to another, the positive pole. Electron currents always flow from the negative pole to the positive pole, but it is generally assumed that electricity flows from positive to negative.

NEGATIVE POTENTIAL—See *Potential*.

NEGATIVE RESISTANCE—If when the *potential difference* across a piece of apparatus falls, the current rises, then the apparatus is said to have a "negative resistance." This property is made use of in various ways to produce continuous electrical *oscillations*.

NEGATRON—A special type of *thermionic valve* having four *electrodes* and possessing the property of *negative resistance*.

NEON LAMP—A glass bulb containing two metal *electrodes* and filled with neon gas at

a low pressure. When a sufficiently high *potential difference* is applied across the *electrodes* the negative electrode glows, owing to a discharge taking place through the gas. If a neon lamp is placed across the *condenser* forming part of the closed circuit of a *wavemeter*, a visible indication will be given when the current in the wavemeter circuit is a maximum, that is to say, when the circuit is in *resonance* with the radiating oscillating circuit whose wavelength it is desired to measure.

NEUTRAL WIRE—The wire at earth potential in a *three-phase* system of electric power distribution.

NEUTRODYNE RECEIVER—A receiver employing a special circuit to neutralise the inter-electrode capacity of the H.F. valves. In the *high-frequency amplifier* part of this receiver the stray capacity coupling between the valve *electrodes* is neutralised by a reverse capacity coupling between the grid and a suitable point in the anode circuit, thus overcoming the inherent tendency of a multi-stage high-frequency amplifier to burst into self-oscillation.

NODON RECTIFIER—A form of chemical *rectifier*, having an aluminium *cathode* and a lead *anode* immersed in a solution of ammonium phosphate, and suitable for charging accumulators from alternating current mains.

NON-INDUCTIVE RESISTANCE—A *resistance* whose *inductance* is negligible. Such a resistance is useful when it is desired to alter the *damping* of an oscillatory circuit without altering the *natural frequency* of the circuit.

NOTE MAGNIFIER—See *Amplifier*.

OHM—The practical unit of *resistance*.

OHM'S LAW—One of the fundamental laws of current electricity, which states that in a circuit carrying a constant current, the value of this current is proportional to the *potential difference* across the circuit and inversely proportional to the *impedance* of the circuit. The practical units of *current*, *voltage* and *impedance* have been so chosen that a P.D. of one volt is required to force a current of one ampere through an impedance of one ohm. In other words—

$$I \text{ (amperes)} = \frac{E \text{ (volts)}}{R \text{ (ohms)}}$$

OPEN CIRCUIT—A circuit which is not continuous and through which current cannot flow.

OPEN-CORE TRANSFORMER—A *transformer* in which the *magnetic circuit* consists partly of iron and partly of air. Owing to its bad *characteristic curve* an open-core transformer is never used in a *low-frequency amplifier*. Cf. *Closed-core Transformer*.

OSCILLATION CONSTANT OR RESONANCE CONSTANT—The *natural frequency* of a circuit depends upon the L.C. value of the circuit, and the product L.C. is called the Oscillation Constant.

OSCILLATION TRANSFORMER OR JIGGER—An air-core transformer used for transferring high-frequency *oscillations* from one circuit to another.

- OSCILLATIONS**—The high-frequency alternating current which flows round an *oscillatory circuit* which has been set in electrical vibration by an outside source of power. If the power supplied is sufficient to compensate for the resistance (heat) losses in the circuit, then the *oscillations* will be continuous or *undamped*, but if the resistance loss is greater, then the *oscillations* will gradually die away and are said to be *damped*. If the *reaction* coil of a receiving set is tightly coupled to the grid coil which may also be the aerial coil, then the transfer of power into the latter may be sufficient to overcome the losses in the circuit and sustain *continuous oscillations* which may be radiated from the aerial and cause interference to nearby receiving sets.
- OSCILLATION VALVE**—See *Valve*.
- OSCILLATOR**—An apparatus (generally an electrical circuit employing a three-electrode valve) for producing *oscillations*.
- OSCILLATOR VALVE**—The valve in a transmitting set or in certain types of receiving sets that produces continuous oscillations.
- OSCILLATORY CIRCUIT**—A circuit containing *inductance* and *capacity* which when supplied with energy from an outside source is set in electrical vibration and oscillates at its *natural frequency*. The *resistance* of the circuit must not be greater than a certain value, dependent upon the values of *inductance* and *capacity*, otherwise the *oscillations* will not be continuous. See *Damping*.
- OSCILLATORY CURRENT**—The current in an *oscillatory circuit*.
- OSCILLOGRAPH**—An instrument for showing the shape of waves of *alternating currents* and particularly used for the examination of high-frequency *oscillations*. The *Kathode Ray Oscillograph* is the most common type.
- OUTSIDE BROADCAST**—A broadcast item taking place at some point other than the *studio*.
- PACKING**—A trouble which occurs with microphones of the loose-contact carbon type when the granules settle into a heap. The instrument becomes less sensitive, and the inherent carbon hiss increases. Generally cured by shaking.
- PANCAKE COIL**—A flat *inductance* coil.
- PARALLEL CONNECTION**—If two or more pieces of apparatus are joined across a common voltage supply they are said to be in parallel, and the current flowing through each path is inversely proportional to the *resistance* of the path.
- PARASITES**—Another term for *atmospherics*.
- P.D.**—Potential Difference. Difference of electric pressure between two points of a circuit. See *Voltage*.
- PEAK VALUE**—The maximum value of an alternating quantity. The *peak voltage* reached in any circuit is an important quantity, as the components of the circuit must be designed to withstand this voltage and not merely the average voltage value.
- PEANUT VALVE**—A type of three-electrode receiving valve requiring *low filament current* and *anode voltage*. The dimensions of the valve are very small and it is therefore of use where space and small battery consumption are a consideration.
- PERCENTAGE COUPLING**—The *coefficient of coupling* between two circuits expressed as a percentage.
- PERIKON DETECTOR**—A *crystal detector* consisting of *zincite* and *hornite* in contact.
- PERIOD**—The time in seconds of one complete *cycle* of an alternating quantity.
- PERIODICITY**—See *Frequency*.
- PERMANENT MAGNET**—One which retains its magnetism for an indefinite time after it has been magnetised. Specially prepared steel is generally used. Heavy blows and heat will destroy the magnetism.
- PERMEABILITY**—The magnetic conductivity of a material, generally denoted by the symbol " μ " and given numerically by the ratio of the *flux density* (B) in the material to the *magnetising force* (H) producing that flux density, *i.e.* $\mu = B/H$. The permeability of air and all other non-magnetic materials is unity, but that of iron varies according to the purity of and heat treatment given to the iron. The quantity is of considerable importance in *inter-valve transformer* design.
- PHASE ANGLE**—When two things occur at the same time they are said to be in phase. If two alternating quantities do not pass through their maxima or minima at the same time one will lead relative to the other, and assuming the quantities are represented as rotating *vectors*, then the amount of lead (or lag looked at from the point of view of the other quantity) may be represented by the difference in angular displacement, the maximum, of course, being 360 degrees or 2π radians. The position and hence the value of either *vector* at any instant may be defined by its phase angle (remembering that 360 degrees represent a complete cycle) and the difference between the angles made by the two vectors is called the Phase Difference or Phase Displacement. If the *Periods* of the two vectors are the same, then the Phase Difference is constant. If a voltage *vector* leads or lags behind a current *vector* by exactly 90° (*i.e.*, $\pi/2$ radians) they are said to be "in quadrature." On a pure inductive load the current lags behind the voltage by 90° ; on a capacitive load the current leads by 90° .
- PHONE**—Abbreviation for telephone.
- PHOSPHOR BRONZE**—An alloy of phosphorus, copper and tin, having greater tensile strength than pure copper and equally good electrical properties, and therefore largely used for *aerials*.
- PITCH**—In music there are various standard pitches for the tuning of musical instruments. In broadcasting a transmission is said to be "low pitched" or "high pitched" according to whether the lower or higher audio *frequencies* are present to a greater extent in the reproduction than in the original.
- PLAIN AERIAL**—An *aerial circuit* arrangement which is connected directly to the transmitting or receiving circuit without the use of any form of *loose coupling* or intermediate circuit. The tuning in such cases is liable to be flat.

- PLATE**—The usual name applied to the *anode* of a *thermionic valve*. It consists of a cylinder of metal (generally nickel, tungsten, molybdenum or copper) surrounding the *kathode* or *filament* and at a higher relative potential, which enables it to attract the negative *electrons* emitted from the *filament* and thus give rise to the *anode current*, *plate current* or *space current*.
- PLATE BATTERY**—See *High-tension Battery*.
- PLATE CIRCUIT**—That part of a circuit of a transmitter or receiver connected between the *plate* or *anode* of a valve and the source of high-tension supply.
- PLATE CURRENT**—The current flowing in the *Plate Circuit* and between the *plate* and *filament* in the valve. See *Plate*.
- PLATE IMPEDANCE**—The *internal impedance* of a *three-electrode valve*.
- PLATE VOLTAGE**—The positive voltage of the *plate* or *anode* relative to the negative end of the *filament*. See *Plate*.
- PLUG-IN COIL**—A convenient form of inductance coil, fitted with a plug and socket termination to facilitate quick coil changing. In order that the coil should always be fitted the same way round, it is provided with one plug and one socket which fit into one socket and one plug on the coil holder.
- PLUG-IN TRANSFORMER**—A *high-frequency transformer* in a form convenient for quick changing to another transformer to cover a different range of wavelengths. The windings terminate in plugs which fit into sockets on the instrument.
- POLARISED ELECTRO - MAGNET**—One whose magnetism is partly permanent and partly due to a magnetising current flowing in the winding. Whether the latter adds to the total magnetism or otherwise depends upon the direction of the magnetising current. By arranging that the value of permanent magnetism brings the iron on to the steep portion of the *magnetisation curve*, then a relatively small value of magnetising current in either direction will cause a large variation in *magnetic flux* in the core. A *telephone* makes use of this arrangement.
- POLARISED RELAY**—A *relay* in which a *polarised electro-magnet* arrangement is used. A soft iron armature is magnetised by a *permanent magnet* and one end is also under the influence of an electro-magnet. Thus this end will swing one way or the other according to the direction of the magnetising current flowing in the coils of the electro-magnet.
- POLARITY OF MAGNETS**—Every magnet has two poles, one at each extremity. The north pole tends to move towards the north magnetic pole and the south pole towards the south.
- POLE**—See *Polarity of Magnets, Positive Pole, Negative Pole*.
- POLYPHASE**—An alternating current system consisting of several *phases*, the currents in each *phase* having a certain definite and constant *phase difference* relatively to each other.
- PORTABLE TRANSMITTER**—A transmitter of low power and limited range which can easily be moved from place to place.
- POSITIVE ELECTRIFICATION**—The state of a body when it contains less than its normal number of *electrons*.
- POSITIVE POLE**—The *pole* that is at a higher *potential* relatively to the other (negative) pole in any piece of apparatus when considered from the point of view of the external circuit.
- POTENTIAL AND POTENTIAL DIFFERENCE**—The force tending to drive electricity from a point of higher potential to a point of lower potential. In current electricity, a potential difference may exist between the poles of a piece of apparatus, but the *electromotive force* generated by the apparatus will be slightly greater, the difference being lost in overcoming the internal resistance of the apparatus itself when a current flows. Potential difference is measured in *volts*.
- POTENTIALLY - OPERATED DEVICE**—A piece of apparatus whose operation is solely dependent upon changes of potential and not upon current. A three-electrode valve is an example of this, provided that the *grid* is always negative with respect to the *filament*, thus avoiding *grid current*.
- POTENTIOMETER**—If a *resistance* is connected across a source of *potential*, the potential across any part of that resistance will be proportional to the resistance of that part. Thus by means of tapping points, any fraction of the total potential is available. Such an arrangement is called a potentiometer, and is often used to obtain variable grid potentials by connecting it across the *filament battery*.
- POWER**—The rate of doing *Work*. Unit: one horse-power = 746 watts.
- POWER AMPLIFIER**—A *low-frequency amplifier* designed to handle without *distortion* relatively high power for working *loud-speakers*.
- POWER FACTOR**—A number having a value less than unity by which the product of the *volts* and *amperes* in an alternating circuit must be multiplied to give the power in the circuit.
- POWER VALVE**—A *three-electrode valve* used in a *power amplifier*, and designed to handle a large output without *distortion*. To ensure this the plate current-grid voltage characteristic must be straight over as wide a range of grid voltage as possible.
- PRIMARY CELL**—A source of electrical energy, dependent upon the chemical action between two electrodes producing an *E.M.F.* Such a cell cannot be re-charged, as can a *secondary battery*.
- PRIMARY CIRCUIT**—The circuit which takes power from the source of supply and passes it on to the *secondary circuit*. The *voltage* may be stepped up or down during this transference of power from one circuit to another. See *Transformer*.
- PRIMARY WINDING**—See *Primary Circuit*.
- PROTON**—The smallest possible quantity of *positive electricity* existing in a free state.
- PULSATING CURRENT**—A current whose magnitude varies regularly, but whose direction remains constant.
- PUSH-PULL AMPLIFICATION**—A system of amplification employing two similar three-electrode valves per stage. The *grids* of

- the valves are fed from a single *secondary winding*, one end to each grid, and a centre tapping is connected to the common filament circuit. The two plates are connected one to each end of the output transformer primary winding, the H.T. being fed to the centre point of this winding.
- QUADRATURE**—See *Phase Difference*.
- QUANTITY OF ELECTRICITY**—In current electricity, quantity is measured by the product of the current flowing in a circuit and the time for which it flows. The unit is the coulomb, which is equal to one ampere flowing for one second, but the practical unit is the *ampere-hour* which equals 3,600 *coulombs*.
- R**—The usual symbol for *resistance*.
- RADIAN**—The angle subtended at the centre of a circle by an arc equal in length to the radius. The value of a radian is approximately 57.5° . 2π radians being equal to 360° .
- RADIATING CIRCUIT**—A circuit carrying a *high-frequency* current, which is capable of throwing out its energy in the form of electrical waves. The amount of energy radiated is proportional to the *radiation resistance*. The *aerial circuit* is a radiating circuit.
- RADIATION**—The transference of energy from a physical circuit carrying *high-frequency* current into space in the form of electric waves, the medium through which the waves travel being the *ether*.
- RADIATION EFFICIENCY**—In a radiating circuit part of the energy is radiated in the form of electric waves and part is lost owing to the *resistance* of the circuit. The percentage radiated of the total energy in the circuit is the radiation efficiency of that circuit. See *Aerial Resistance*.
- RADIATION RESISTANCE** (of an aerial)—That quantity expressed in ohms which when multiplied by the square of the value of *aerial current* in amperes gives the power in watts being radiated from the circuit in the form of electric waves. See *Aerial Resistance*.
- RADIO BEACON**—A transmitting station situated near the coast, which sends out special telegraphic signals to assist the navigation of ships at sea.
- RADIO-FREQUENCY**—A frequency used for radio-transmission purposes. The range at present in use is from approximately 300,000,000 cycles per second down to about 12,000 cycles per second. Transmissions on the very high frequencies are still at an experimental stage only.
- RADIO-FREQUENCY AMPLIFIER**—See *High-frequency Amplifier*.
- RADIO-FREQUENCY RESISTANCE**—See *Aerial Resistance*.
- RADIO-FREQUENCY TRANSFORMER**—See *High-frequency Transformer*.
- RADIO-GONIOMETER**—A calibrated instrument used in the Bellini-Tosi system of *direction finding*.
- RADIOTRON**—Another name for an ordinary *three-electrode valve*.
- RATIO OF TRANSFORMATION**—The ratio of the primary to the secondary voltage of a transformer. In the case of an iron-core transformer this ratio is approximately the same as the ratio of the turns in the two windings.
- REACTANCE**—The *resistance* offered to a current in an alternating circuit, due to the presence of *inductance* or *capacity* or both. See *Impedance*.
- REACTION**—An arrangement in a *three-electrode valve* circuit whereby the amplified currents in the *plate circuit* react on the *grid circuit*, thus compensating to any desired extent for the losses in that circuit. This is generally effected by means of a coil connected in the *plate circuit* of the valve, which is magnetically coupled to the grid coil. If this coupling is sufficiently tight then the transfer of energy is so great that the losses are completely overcome and the circuit is set into self-oscillation. In this case the circuit radiates energy, and if this occurs in a receiving circuit it is likely to interfere with nearby receivers. See *Oscillation*.
- RECTIFICATION**—The operation of converting an *alternating current* into a *unidirectional pulsating current*. This operation occurs in the detection of wireless signals, a *detector* or rectifying valve being used for the purpose. The term rectification is also used in heavy current work to indicate the operation of converting a low-frequency alternating current into a pulsating current, which is generally passed through a *smoothing circuit* in order to obtain a D.C. current without ripple. Either *half-wave rectification* or *full-wave rectification* may be employed.
- RECTIFIED CURRENT**—The current resulting from the process of *rectification*.
- RECTIFIER**—A piece of apparatus which performs the operation of *rectification*.
- RECTIFYING DETECTOR**—See *Detector*.
- RECTIFYING VALVE**—A *thermionic valve* capable of rectifying.
- REFLECTION**—(a) Of wireless waves. Electric waves travelling away from an aerial in an upward direction strike the *Heaviside Layer*, which refracts and partially reflects the waves to the surface of the earth. Thus at any point there may arrive two electric waves, one direct from the source and the other reflected from the *Heaviside Layer*. See *Fading*.
(b) On land-lines. The interference caused to speech-current frequencies when transmitted along long land-lines, generally due to incorrect terminal conditions or changes in the composition of the line along its length. Some of the frequencies are reflected back, producing nodes and loops of current and potential along the line.
- REFLEX CIRCUIT**—A valve circuit containing a high-frequency amplifying valve which acts as a low-frequency amplifying valve as well.
- REGENERATION**—See *Reaction*.
- REGIONAL STATION**—A high-power broadcasting station designed to serve a large area.
- REINARTZ CIRCUIT**—A valve circuit especially suitable for the reception of short waves.
- REJECTOR CIRCUIT**—A tuned *oscillatory circuit*, consisting of an *inductance* and a

- capacity*, the values of which are arranged so that the circuit offers a very high *impedance* to *oscillations* of a particular *frequency* which it is desired not to pass, and a low *impedance* to all other frequencies. Such an arrangement is used to obtain selectivity in a receiving set, the rejector circuit being tuned to the wavelength of the signal it is desired to receive.
- RELAY**—A device generally consisting of an *electro-magnet* and an armature which makes or breaks a local circuit when current is passed through the coils of the magnet. The coil current is generally small compared with the current in the local circuit.
- RELAY STATION**—A low-power broadcasting station which receives most of its programme material via a telephone line from a distant studio.
- RELUCTANCE**—The magnetic *resistance* offered to the passage of *magnetic flux* in a substance when a *magnetising force* is applied. Analogous to electrical *resistance*.
- RELUCTIVITY**—The reciprocal of *permeability*.
- REMOTE CONTROL**—The operation of electrical apparatus at a distance, generally by means of a *relay*.
- RE-RADIATION**—When a valve receiver is adjusted with a tight *reaction* coupling, thus bringing the receiver nearly to the point of *self-oscillation*, the volume of the received signals is greatly increased and this increase will, to a certain extent, be re-radiated from the aerial of the receiver and will improve the signal strength in nearby receivers. If, however, the reaction is coupled too tightly the receiver will self-oscillate and cause interference. See *Reaction and Oscillation*.
- REPEATER**—A piece of apparatus placed in a long telephone line circuit in order to amplify the speech current before passing further along the line to a distant station. It consists generally of a *low-frequency amplifier* with suitable input and output transformers to match the incoming and outgoing lines. If it is desired to amplify speech currents passing in both directions at the same time, then a "two-way" repeater is used.
- REPEATER STATION**—One at which a number of *repeaters* is situated, and through which pass a large number of long-distance telephone lines. Such a station is used in Broadcasting in connection with *Simultaneous Broadcasting*.
- RESISTANCE**—The opposition which an electric circuit offers to the passage of an electric current. The power wasted in a resistance appears as heat. In a homogeneous wire the resistance is directly proportional to the length and specific resistance, and inversely proportional to the area of cross section. The practical unit is the *ohm*. See *Ohm's Law*.
- RESISTANCE-CAPACITY COUPLING**—A method of coupling *three-electrode valves* together in cascade in a high- or low-frequency *amplifier*. A high resistance is placed in circuit with the *plate* of the valve and the signal E.M.F. produces a varying *potential* at the plate end of this resistance and this is applied through a *grid condenser* to the *grid* of the next valve. This condenser is necessary to prevent the high-tension potential from affecting the second grid. In order that the negative charge on this grid may gradually leak away, a *grid leak* resistance is connected between the grid and the filament of the valve.
- RESISTANCE-COUPLED AMPLIFIER**—A high- or low-frequency *amplifier* employing *resistance-capacity coupling* between valves.
- RESISTOR**—A *resistance* generally of fixed value, often used in a filament circuit to reduce the *low-tension* voltage to a value suitable for the valve in use.
- RESONANCE**—Occurs in a circuit containing *inductance* and *capacity* when an alternating *potential*, whose *frequency* is equal to the *natural frequency* of the circuit, is applied to it. When this occurs the current is in *phase* with voltage and the inductive *reactance* is neutralised by the capacity *reactance*.
- RESONANCE CURVE**—Curve showing the relation between the current flowing in a circuit containing fixed values of inductance and capacity when a constant voltage of varying frequency is applied.
- REVERBERATION**—The continuation of a sound for a short period after the original sound has ceased, due to reflection from hard surfaces, e.g., walls. Note the difference between reverberation and *echo*.
- RHEOSTAT**—A variable *resistance*.
- SATURATION (MAGNETIC)**—When a *magnetising force* is applied to a piece of iron the *flux density* in the iron will increase up to a point. When a further increase of *magnetising force* will not increase the *flux density*, the iron is then said to be saturated, and this point is called the "saturation point."
- SATURATION CURRENT**—As the *anode voltage* applied to a *three-electrode valve* is increased, the *anode current* also increases up to a point, when a further increase in *anode voltage* does not increase the *anode current*. This maximum value of current is called the "saturation current."
- SCREENED TRIODES**—A four-electrode valve having two grids, and designed to eliminate the *capacity coupling* between electrodes. Such a valve is particularly useful in a multi-stage *high-frequency amplifier*.
- SCREENING**—An arrangement to prevent one circuit carrying alternating current from affecting another adjacent to it. It generally consists of a sheet of metal (usually copper) placed between the two circuits.
- SECONDARY BATTERY**—A battery of secondary cells, the most common being the lead-acid type. These cells can be recharged when run down by having electricity pumped into them in the reverse direction.
- SECONDARY CELL**—See *Secondary Battery*.
- SECONDARY CIRCUIT**—See *Primary Circuit*.
- SECONDARY WINDING**—See *Primary Winding*.
- SELECTIVITY**—The power of being able to

- select one particular *wavelength* or *frequency* to the exclusion of others.
- SELENIUM CELL**—A *primary cell* whose *resistance* varies according to the intensity of the light falling upon it.
- SELF-CAPACITY**—The *capacity* that exists between different parts of the same piece of apparatus. For example, the self-capacity of an inductance coil is due to the capacity that exists between turns, and that of a three-electrode valve to the capacities between *filament*, *grid* and *anode*.
- SELF-INDUCTANCE**—If the current passing through a coil of wire is changed, a back E.M.F. is set up which tends to stop the change from taking place. This is due to the "self-inductance" of the coil and is analogous to mechanical inertia.
- SELF-OSCILLATION**—See *Oscillation*.
- SERVICE AREA**—Of a Broadcasting Station is the area in which listeners can be guaranteed a service, i.e., an area in which the *field strength* of received signals from that station is such that satisfactory reception is assured. It is the ratio of the strength of the wanted signal to that of the interference which will determine the extent of this area. It has been found convenient to divide the area into four parts: (1) the *wipe-out area* in which the field strength is greater than 30 millivolts per metre, (2) "A" service area between 10 and 30, (3) "B" service area between 5 and 10, and (4) "C" service area between 2.5 and 5.
- SHORT-CIRCUIT**—A connection having very low *resistance* made between two parts of a circuit. If this connection is made accidentally, then the current in the circuit, owing to the drop in the resistance, may rise to a very high value and do damage to the apparatus in that part of the circuit which is not short-circuited.
- SHORTENING CONDENSER**—A *condenser* connected in *series* with the *aerial* in order to reduce its *resonant frequency* to a value below its *natural frequency*.
- SHUNTED BUZZER**—A modified *buzzer* often used to energise a receiving circuit in order that the wavelength of the latter may be measured.
- SIDE-BANDS**—When a constant high-frequency *carrier wave* is modulated by a low-frequency speech component in order to transmit telephony, a number of high-frequency waves is produced, the values of which are above and below the actual *frequency* of the *carrier wave* itself. The frequency bands occupied by these waves are called "side bands." See *Modulation*.
- SIDE-BAND TELEPHONY**—A system of telephony transmission in which the *side-bands* only are transmitted and not the *carrier wave*. The *carrier wave* having been modulated and the *side-bands* produced, the carrier wave is eliminated and supplied again at the receiving end. In this system of transmission there is a considerable saving in power, the disadvantage being that unless a special receiver, which will supply the missing *carrier wave*, is used, the sounds that will be heard will be unintelligible.
- SIMULTANEOUS BROADCASTING**—A system whereby the programme of one broadcasting station may be transmitted simultaneously from a number of other broadcasting stations, connections between the stations being made by ordinary telephone lines. See *Repeater Stations*.
- SINE WAVE**—A *wave form* representing an alternating quantity which varies according to a sine law.
- SINGLE PHASE**—A system of alternating current electricity consisting of one *voltage* and one *current* passing through one pair of wires only.
- SLAB COIL**—An *inductance* coil wound in a flat shape having the disadvantage of high *self-capacity*.
- SLIDE BACK**—An apparatus for indicating in the *control room* of a broadcasting station the presence of grid current (and hence distortion) in the modulation system of the transmitter.
- SMOOTHING CIRCUIT**—A circuit consisting of a number of *inductances* and *condensers* used for eliminating the ripple or *pulsating* component of a uni-directional current, such as that obtained from a *rectifier*. A smoothing circuit is generally required if the resulting D.C. supply is to be used for supplying *high tension* to a wireless receiver or transmitter.
- SOFT VALVE**—One which contains an excess of gas. Extremely efficient when used as a detector, but difficult to operate.
- SOLID-BACK MICROPHONE**—A type of microphone employing two carbon discs, one attached to the diaphragm and the other to the solid back of the instrument, with carbon granules between them. See *Microphone*.
- SPACE CHARGE**—A cloud of electrons given off from the *filament* of a *thermionic valve*, which impedes the free flow of electrons between the *filament* and the *anode*.
- SPACE CURRENT**—See *Plate Current*.
- SPECIFIC INDUCTIVE CAPACITY**—Of a material, is the ratio of the *capacity* of a *condenser* with that material as *dielectric* to the capacity of an exactly similar condenser with air as dielectric.
- SPECIFIC RESISTANCE**—The *resistance* between two faces of a one-centimetre cube of any material.
- SPEECH AMPLIFIER**—See *Low-frequency Amplifier*.
- SPREADER**—A pole or hoop, generally of wood, used for separating the parallel wires of an *aerial*.
- SQUARE LAW CONDENSER**—A *variable condenser* in which the angle of rotation is proportional to the square of the *capacity*, and thus proportional directly to the change in *wavelength*.
- STALLOY**—A silicon-steel largely used for the cores of *low-frequency transformers*.
- STANDING WAVES**—Waves of sound produced in a *studio* due to reflection from the walls or ceiling or from objects in the studio itself.
- STATIC CHARACTERISTIC**—A curve showing the relation between various steady *voltages* and *currents* of a *thermionic valve*. Cf. *Dynamic Characteristic*.
- STATICS**—See *Atmospherics*.
- STEP-DOWN TRANSFORMER**—A trans-

- former in which the *secondary voltage* is lower than the *primary voltage*, and the *secondary current* higher than the *primary current*.
- STEP-UP TRANSFORMER**—A transformer in which the *secondary voltage* is higher than the *primary voltage*, and the *secondary current* lower than the *primary current*.
- STORAGE BATTERIES**—See *Accumulators*.
- STRAYS**—See *Atmospherics*.
- STUDIO**—A room in which broadcast items are performed, generally *draped* to reduce *reverberation* and *echo*.
- SUB-CONTROL**—A low-frequency amplifying circuit preceding the *modulation system* of a transmitter.
- SULPHATING**—A white deposit of lead sulphate that appears on the plates of an *accumulator* when it is left uncharged for a long period. The removal of this deposit requires special treatment.
- SUPERHETERODYNE RECEIVER**—One employing a special circuit relying on a *beat reception* arrangement. The selectivity of such a receiver is considerable.
- SUPERSONIC FREQUENCY**—A *frequency* which is just above the audible range.
- T AERIAL**—One in which the vertical down lead is attached to the middle of the horizontal span.
- TELEPHONE**—The instrument that converts the electrical energy of the receiving set into sound energy. It consists essentially of a soft iron diaphragm supported close to the poles of an *electro-magnet*. The speech currents passing through the coils of the electro-magnet attract the diaphragm, causing vibrations in the air which are audible.
- TELEPHONE CONDENSER**—A small fixed *condenser* sometimes connected across a *telephone receiver* or *loud-speaker* to assist in the bypassing of the *high-frequency currents*. It is not essential, as the *self-capacity* of the telephone winding itself is generally sufficient for the purpose.
- TELEPHONE TRANSFORMER**—A *transformer* whose primary *winding* is connected directly in the receiving circuit and whose *secondary* is connected to the *telephones*, thus isolating the telephone itself from direct electrical connection with the receiver.
- TELEPHONE TRANSMITTER**—A *transmitter* designed for the transmission of speech or music.
- TELEVISION**—A system, as yet in the experimental stage only, whereby a fixed or moving object is made visible at a distance by electrical means.
- THERMIONIC VALVE**—A *vacuum tube* containing two or more *electrodes*. The action of the valve depends upon the *electron emission* from a heated cathode, the *electrons* being attracted to the *anode* which is given a positive *potential* with respect to the *filament*. The valve can be made to act as a rectifier, high- or low-frequency *amplifier*, or a generator of electrical *oscillations*. It forms the basis of all modern wireless engineering.
- THERMIONIC VOLTMETER**—An instrument using a two- or three-*electrode valve* for the purpose of measuring small differences of *potential*.
- THERMO-AMMETER**—A type of *ammeter* suitable for the measurement of *high-frequency currents*. Its movement is dependent upon the heating effect of the current passing through a wire and its consequent extension in length. See *Hot-wire Ammeter*.
- THERMO-COUPLE**—A generator of *E.M.F.*, consisting of two dissimilar metals joined together, their junction being heated above the temperature of the rest of the circuit.
- THORIUM**—A rare metal used in the manufacture of the filaments of some *dull-emitter valves*, the Tungsten filament being coated with thorium-oxide.
- THREE PHASE**—An alternating current system in which the current and voltage of each phase are quite distinct and the *phase angle* between any two phases is 120° .
- TIGHT COUPLING**—If two coils are placed so close together that most of the energy in one is transferred to the other by *induction*, they are said to be "tightly coupled"; that is to say, the mutual inductance between the coils is large in comparison with their *self-inductances*. Cf. *Loose Coupling*.
- TIME CONSTANT**—In a circuit containing *self-inductance*, any change in the value of current in the circuit will be opposed by a back *E.M.F.* which at any instant is proportional to the rate of change of current. Thus if a steady *voltage* is applied to such a circuit the *current* will not suddenly reach its maximum value of $\frac{E}{R}$, but will build up gradually, because the effective voltage at any instant will be the applied voltage minus the back voltage. The time taken to reach the maximum current value is called the "Time Constant" of the circuit and is equal to $\frac{L}{R}$ seconds in the case of a steady applied voltage, and $\frac{2L}{R}$ seconds where an oscillating voltage is connected across an *oscillating circuit*, *R* being the *resistance* in *ohms* and *L* the *inductance* in *henries* in each case.
- TIME PERIOD**—See *Period*.
- TIME SIGNAL**—The broadcast Greenwich Time Signal consists of six dot-seconds, the first at five seconds before the hour, and the sixth exactly at the hour.
- tone**—The term applied to the sound heard in a telephone receiver when low-frequency *alternating* or *pulsating current* is passing through it.
- tone SOURCE**—A calibrated apparatus capable of producing pure sine-wave low-frequency alternating currents of constant amplitude between the limits of audibility, *i.e.*, from about 25 to 12,000 cycles per second. The apparatus is largely used to obtain the characteristic curves of *low-frequency transformers*, *loud-speakers*, etc., by supplying an input of known frequency and amplitude from the *Tone Source* and measuring the output.
- TOROIDAL COIL**—An inductance coil wound on a ring-shaped core. The coil may be made self-supporting, in which case no core is necessary.

- TRANSFORMATION RATIO**—See *Ratio of Transformation*.
- TRANSFORMER**—An apparatus for changing the *voltage* of an alternating current supply. It consists essentially of two windings tightly coupled to one another, so that energy in the one may be transferred to the other by *electro-magnetic induction*. Power and low-frequency transformers have a laminated iron core, while those used for high-frequency work have a non-magnetic core. The action of a transformer depends upon the E.M.F. which is induced in the *secondary winding* by the magnetic flux that is set up in the core due to the current flowing in the *primary winding*. The value of this E.M.F. is proportional to the number of turns which are linked by the *magnetic flux*, and therefore the *secondary voltage* is proportional to the number of turns in the *secondary winding*, losses being neglected. If the secondary is open-circuited, the primary will act as an ordinary *choking coil* and the only current flowing in the primary will be that due to its high *impedance*. This is called the *magnetising* or *no-load current*. When the secondary is connected to the ends of a *non-inductive resistance* a current will flow which will tend to produce a flux in the opposite direction to that already existing in the core, thus momentarily reducing the primary *reactance*. This will cause an increased current to flow in the primary until a state of equilibrium is again reached. The secondary ampere-turns must be counterbalanced by an equal and opposite number of ampere-turns in the primary, and, neglecting losses, the power (i.e., the product of current and voltage assuming unity *power factor*) in the primary circuit is equal to the power in the secondary circuit. That is to say, the ratio of *voltages* equals the ratio of turns and the inverse ratio of currents.
- TRANSMITTER (WIRELESS)**—The apparatus used for radiating into space electric waves, which may represent either telegraphic or telephonic signals. It consists generally of some form of *oscillation generator*, the output of which is remotely controlled by a Morse key for the sending of telegraphic signals, or modulated by a *low-frequency* (speech) current for telephony.
- TRIODE**—Another term for a *three-electrode valve*.
- TRUE POWER**—Is the *apparent power* (product of volts and amperes) multiplied by the *Power Factor* of an alternating current circuit.
- TUNED ANODE**—A type of *intervalve coupling* used between two high-frequency amplifying valves in cascade, or between a high-frequency valve and the detector in a receiving set. An *oscillatory circuit* is connected in the *plate circuit* of the first valve and tuned to the frequency of the received signals. A *rejector* action is thus obtained and the high oscillating voltage set up across the inductance of the *oscillatory circuit* is passed on to the grid of the second valve by means of a *grid condenser*. Cf. *Resistance-capacity Coupling*.
- TUNED CIRCUIT**—An *oscillatory circuit* whose *resonant frequency* has been adjusted to a desired value.
- TUNED PLATE CIRCUIT**—See *Tuned Anode*.
- TUNER**—An arrangement of one or more *oscillatory circuits* whose *resonant frequencies* are easily variable to receive any desired signals or to give an *acceptor* or *rejector* action.
- TUNING**—The operation of adjusting a *tuned circuit* to give *resonance* at any desired *frequency*.
- TUNING COIL**—An *inductance coil*, either fixed or variable in value, used in a *Tuned Circuit*.
- TUNING CONDENSER**—A *variable condenser* used in a *Tuned Circuit*.
- TUNING INDUCTANCE**—See *Tuning Coil*.
- TWO-ELECTRODE VALVE OR DIODE**—A *thermionic valve* containing two *electrodes* only, a *plate* and a *filament*. The original form of the *thermionic valve* is still used for rectifying purposes, but largely replaced by the *three-electrode valve* for other purposes.
- TWO PHASE**—An alternating current system having two distinct circuits carrying current, the currents and E.M.F.'s of these circuits differing in *phase* by 90°.
- TWO-POLE SWITCH OR DOUBLE-POLE SWITCH**—A switch which opens or closes both *poles* of a circuit at one operation. In a "single throw" switch this operation is done to one circuit only, in a "double throw" two circuits may be controlled alternately.
- TWO-WAY REPEATER**—See *Repeater*.
- UMBRELLA AERIAL**—An *aerial* arrangement consisting of a vertical centre pole from the top of which the aerial wires radiate symmetrically towards the ground.
- UNDAMPED OSCILLATIONS OR UN-DAMPED WAVES**—A train of electrical *oscillations* or waves whose amplitude is constant. The basis of all *continuous wave* telegraphy and telephony transmission.
- UNIDIRECTIONAL**—A current flowing or a voltage acting in the same direction but not necessarily with a constant *amplitude*. See *Pulsating Current*.
- UNILATERAL CONDUCTIVITY**—The property possessed by certain apparatus of being able to pass a current in one direction only. The most important examples of such apparatus are the *thermionic valve* and the crystal, which are used in the process of *rectification*.
- UNIT (BOARD OF TRADE)**—The commercial unit of electrical energy equal to 1,000 watt-hours or one kilowatt-hour.
- UNIT POLE**—A *magnetic pole* which when placed at a distance of one centimetre from an equal *pole* exerts on it a force of one dyne.
- UNLOADED AERIAL**—One which has no added *inductance* or *capacity* and which will oscillate at its *natural wavelength* when energised from an outside source.
- UNTUNED AERIAL OR APERIODIC AERIAL**—The *aerial circuit* of a receiving set which has not been specially *tuned* to the *frequency* of the incoming signal, an arrangement which is sometimes advantageous in the reception of short waves. The *aerial* is inductively coupled to the closed circuit *inductance* in the usual way.

- VACUUM**—A space entirely free from all matter.
- VACUUM TUBE**—A general name for all types of tubes or glass bulbs containing *electrodes* and from which all the gas has been exhausted.
- VACUUM VALVE**—A vacuum tube possessing *unilateral conductivity*, e.g., the *two- or three-electrode thermionic valve*.
- VALVE**—See *Vacuum Valve*.
- VALVE AMPLIFIER**—See *Amplifier*.
- VALVE DETECTOR**—See *Detector Valve*.
- VALVE OSCILLATOR**—See *Oscillator*.
- VALVE RECEIVER**—A wireless receiver employing one or more *thermionic valves*.
- VARIABLE CONDENSER**—One whose *capacity* is easily altered and consisting generally of two sets of plates which can move relatively to each other. Cf. *Square Law Condenser*.
- VARIOCOUPLER**—An arrangement consisting of two *inductance* coils, which can be moved relatively to each other to vary the *inductive coupling* between them. Cf. *Variometer*.
- VARIOMETER**—A form of variable *inductance* consisting of two coils, one of which rotates within the other. The coils are connected in *series* and by altering the relative position of the coils the *magnetic fields* set up by the currents in them are made either to assist or to oppose each other. Thus the effective inductance value of the combination is continuously variable between these limits without any alteration being made to the actual amount of conductor in the circuit. In a well-designed unit, an inductance ratio of about 10 to 1 may be obtained.
- VECTOR**—A straight line whose length represents the magnitude of a quantity and whose direction represents its direction in relation to other vector quantities. Vectors may be added or subtracted by the method of parallelogram of forces.
- VELOCITY**—Distance traversed in unit time. The term implies a given direction and in this sense has not the same meaning as "speed."
- VELOCITY OF ELECTRIC OR ETHER WAVES**—Electric or Ether *waves* travel through space with the same *velocity* as light (which is itself an *electro-magnetic wave*), about 300 million metres per second or 186,000 miles per second.
- VERNIER CONDENSER**—The name given to a *variable condenser* of small *capacity*, generally used in *parallel* with a larger *variable condenser* in order to give a fine adjustment. It may either be a separate unit or incorporated in the main condenser, which will then have two control knobs.
- VOLT**—The practical unit of electrical pressure. If one volt is applied across the ends of a resistance of one ohm, a current of one ampere will flow. See *Ohm's Law*.
- VOLT-AMPERES**—The product of the *voltage* and *current* in an alternating current circuit. This gives the apparent power in the circuit, and to obtain the *true power* the former has to be multiplied by the *power factor*.
- VOLTAGE**—A term meaning *electromotive force* or *potential difference* measured in volts.
- VOLTAGE AMPLIFICATION**—The ratio of the output *voltage* to the input *voltage* of an amplifier. In a three-electrode valve amplifier, the static voltage amplification or *amplification constant* is dependent upon the physical measurements and *internal impedance* of the valve, but the dynamic factor (i.e., the voltage ratio actually obtained when the valve is used in an amplifying circuit) depends also upon the external *impedance* of the plate circuit and is always less than the static constant, gradually approaching that value as the external *impedance* is increased relatively to the total *impedance*. There are, however, other considerations which limit the value of the external *impedance*.
- VOLTAGE AMPLIFICATION FACTOR**—See *Amplification Constant*.
- VOLTAGE DROP**—Across a circuit or a piece of apparatus is the *E.M.F.* or *potential difference* that is used up in driving a current through the circuit or apparatus. By *Ohm's Law*, the voltage drop in a direct current circuit is the product of the *current* in amperes and the *resistance* in ohms. In an alternating current circuit, it is the product of *current* and *impedance*.
- VOLTAGE MULTIPLIER**—A fixed *resistance* which is connected in series with a *voltmeter* to decrease the sensitivity of the instrument and allow higher *voltages* to be read.
- VOLTMETER**—An instrument used for the measurement of *voltages*. It is connected directly across the voltage to be measured and has a high *resistance* permanently in series with it so that the *current* passing through the instrument may be limited to a small value. In the moving coil type, the *current* is passed through a coil which is free to rotate between the *poles* of a permanent horseshoe magnet. The coil tends to move so that its *flux* is at right angles to the magnet flux, thus for a given current the coil will take up a certain definite position and the pointer attached to it will indicate a certain voltage value on a scale. This type of instrument can only be used for the measurement of direct currents. In the cheaper and less accurate moving iron type, the coil carrying the current is fixed and is made to attract a pivoted iron disc to which the pointer is attached. Such an instrument will measure either direct or low-frequency alternating currents. There are other types, such as the *hot-wire instrument* for high-frequency measurements, but the moving coil and moving iron instruments are the most common. The working parts of an *ammeter* are similar, but the instrument is connected in series with the supply and the fixed resistance or "shunt" is connected in *parallel* with the instrument.
- VULCANITE**—See *Ebonite*.
- WANDER PLUG**—A brass plug connected to the end of a flexible wire to make connection with any one of a number of sockets in a *high-tension* dry battery or *grid battery*.
- WATER-COOLED VALVE**—A *thermionic valve* in which arrangement is made to cool the *anode* by circulating water round it.
- WATT**—A practical unit of electrical *power*,

- and equal to one joule per second. The watts in a D.C. circuit are equal to the product of the volts and amperes. In an A.C. circuit, this product gives the *apparent power*, which has to be multiplied by the *power factor* to give the *true power*.
- WATTFUL CURRENT**—That part of the current in an A.C. circuit which is in *phase* with the applied voltage, and which can therefore do useful work.
- WATT-HOUR**—The work done by a power of one watt in one hour. The commercial unit of electrical energy is the Board of Trade Unit which equal 1,000 watt-hours.
- WATTLSS CURRENT OR WATTLSS COMPONENT**—That part of the current in an A.C. circuit which is 90° out of phase with the applied voltage, and which therefore cannot do useful work.
- WATTMETER**—A meter for indicating directly the power in a circuit.
- WAVES (ELECTRICAL)**—A movement in the ether consisting of electric and magnetic forces alternating in direction, produced by electrical *oscillations* in a conductor. These disturbances spread outwards in the form of *electro-magnetic* or *ether waves* and travel at the speed of light, 300 million metres per second. Energy is conveyed by these waves. They are not perceptible directly to the ear, but can be made to be so by the aid of a suitable *detector*. See *Radiation*.
- WAVE DISTORTION**—See *Distortion*.
- WAVE FORM**—The shape of the curve obtained when values of an alternating quantity are plotted on a time base.
- WAVELENGTH**—The distance between the crests of two successive *waves*. All electro-magnetic waves travel with the same velocity (300 million metres per second) which is obviously equal to the product of *wavelength* and *frequency*, i.e.,
- $$\text{Wavelength (metres)} = \frac{300,000,000}{\text{Frequency (cycles per second)}}$$
- In an *oscillatory circuit*, its *natural wavelength* (λ) is given by $\lambda = 1,885\sqrt{LC}$, where λ is in metres, L is the *inductance* of the circuit in *microhenries* and C is the *capacity* in *microfarads*.
- WAVEMETER**—An apparatus for measuring *wavelength*. The most general types are the *Buzzer wavemeter* and the *Heterodyne wavemeter*.
- WAVE SHAPE**—See *Wave Form*.
- WAVE TRAP**—A *rejector* or *acceptor* circuit used in some receiving sets in order to minimise the interference caused by an unwanted signal whose *frequency* is close to that of the signal it is desired to receive.
- WEAK COUPLING**—See *Loose Coupling*.
- WET BATTERY**—A term often used to denote an *accumulator battery*. Cf. *Dry Battery*.
- WHEATSTONE BRIDGE**—An instrument used for determining the electrical *resistance* of an apparatus by balancing it against another of known resistance.
- WIPE OUT**—The state of affairs that occurs in a valve receiving set employing *grid-leak rectification* when an exceptionally powerful signal, e.g., an atmospheric, gives the *detector* grid such a high negative charge that the operation of the receiver is paralysed until the charge has had time to leak away through the *grid resistance* to earth.
- WIPE-OUT AREA**—The term given to the area very close to a transmitting station where the *signal strength* is so great that it is impossible, however selective the receiver, entirely to tune out the signal in favour of another and more distant one.
- WIRED WIRELESS**—A system of communication employing high-frequency currents in which the transmitter and receiver are very similar to those used for wireless communication, but in which the medium is not the ether but ordinary telephone or power cables. By varying the *frequency*, several communication channels can be established on the same pair of wires.
- WIRELESS BEAM**—See *Beam Wireless*.
- WIRELESS LINK**—An arrangement in which use is made of a *portable transmitter* for broadcasting purposes. The item is first radiated by the portable transmitter on a short wavelength, received by a receiving station and sent by telephone line to a distant transmitter from which it is again radiated.
- WOOD'S METAL**—A soft alloy of lead, tin, bismuth and cadmium which melts at 60° C.
- WORK**—Work is done when a force overcomes a resistance over a certain distance. When a current of one ampere flows through a resistance of one ohm, the potential difference necessary is one volt. The power in the circuit is one *watt* and the work done per second is one *joule*.
- X—The usual symbol for *reactance*.
- "X's"—Another name for *atmospherics*.
- "X" STOPPER—An *acceptor* or *rejector* circuit incorporated in a wireless receiver to minimise interference due to *atmospherics*.
- Z—The usual symbol for *impedance*.
- ZERO POTENTIAL—See *Earth Potential*.
- ZINCITE—An oxide of copper used together with *hornite* as a *crystal detector*. This combination is known as a "*Perikon detector*."

One of the final rehearsals of the revue, "R.S.V.P.," which was later presented at a London Theatre, was transmitted from the studio on February 22nd, 1926, the actual members of the

theatrical cast taking part in the performance. This was the first occasion in the history of Broadcasting that a production intended for the stage was heard previously by listeners.

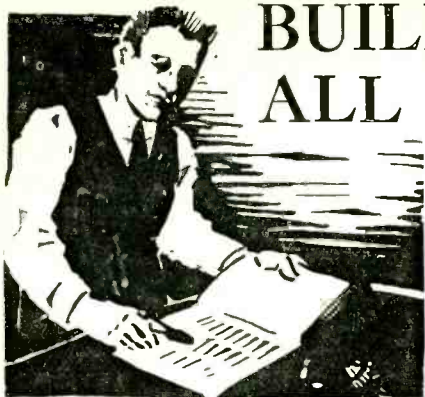

BUILD WITH ALL LISSEN PARTS

LISSEN has put into practice the new idea in industry: high quality—high wages—big production—and lower selling prices. This is how you gain by it:

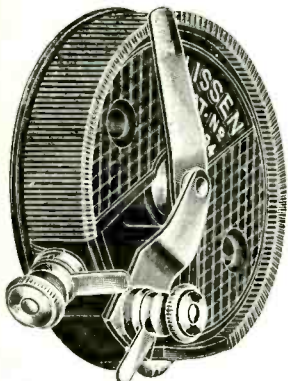

LISSEN Rheostats, selling previously at 4/- - - - Now 2/6

LISSEN Transformer, replacing every previous expensive transformer made by Lissen - - - Now 8/6

LISSEN Secret Process Battery, intended first for sale at 13/- - - Now 7/11



LISSEN Fixed Condensers, Now 1/- and 1/6

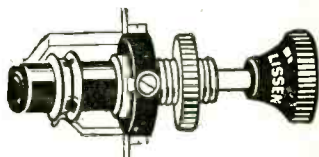

LISSEN Switches, previously 2/6 and 4/- - - - Now 1/6 and 2/6

LISSEN Coilholder, replacing those sold before at 16/6 - - - Now 4/6

LISSEN Telephones, lighter and more sensitive than any at twice the price. Now 8/6

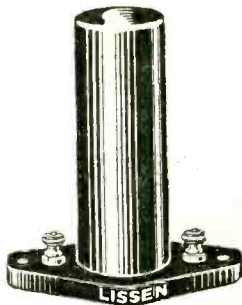

LISSEN H.F. Choke, previously 10/6 Now 5/6

Make this your decision, therefore: before you buy any radio part ask to see the corresponding part in the LISSEN range—handle it, compare it with anything else, and if you appreciate value you will buy LISSEN

LISSEN LTD., 47-56 Friars Lane, Richmond, Surrey
MANAGING DIRECTOR: THOMAS N. COLE

L389

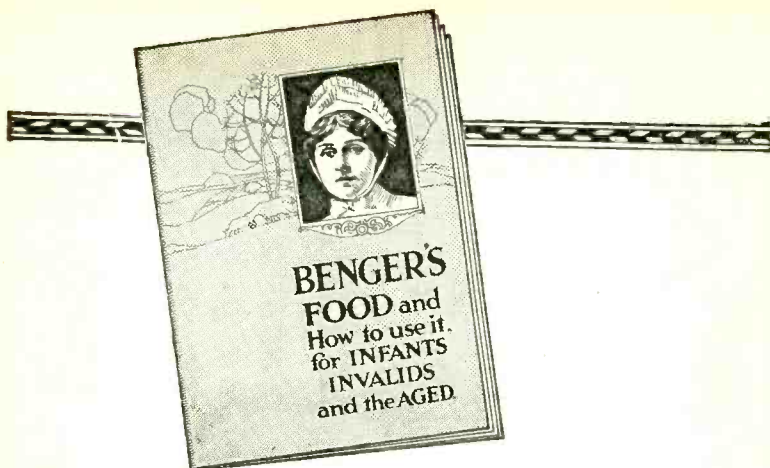

Is there illness in the house?

If so, send to-day for a copy of Benger's Booklet, post free. This will help you with the problem of giving the patient a change of food.

Among the contents are recipes for the preparation, with Benger's Food, of dainty dishes which relieve the monotony of plain milk diet, so trying to invalids.

Benger's Booklet is so full of interest that even if you have no invalid in the house you should send for a copy and keep it safely. A new edition has just been published.

Benger's Food is not only very highly nutritious, but gives relief from the distress and nervous debility caused from overworked or disordered digestion.



*Sold in tins by Chemists, etc.,
everywhere. Prices 1/4, 2/3,
4/- and 8/6*

To obtain the Booklet write name and address plainly on a post card and send to-day to—

BENGER'S FOOD LTD., MANCHESTER.

NEW YORK (U.S.A.): 90 Beekman Street.
SYDNEY (N.S.W.): 350 George Street.

CAPE TOWN (S.A.): P.O. Box 573.

THE INTERNATIONAL UNION

THE rapid growth of Broadcasting in various European countries soon indicated the desirability of some means whereby a general exchange of ideas to the mutual benefit of broadcasters and listeners could be effected, and primarily the immediate necessity for some scheme of control and mutual adjustment of wavelengths amongst the ever-multiplying broadcasting Stations in Europe.

In March 1925 a preliminary Conference was held in London at the offices of the B.B.C. to consider the desirability of forming an international bureau in Europe. At this meeting delegates from ten European countries took part, representing various broadcasting companies. It was agreed that an international Union should be formed, that its title should be the Union Internationale de Radiophonie, and that the seat of its permanent Office should be at Geneva, funds for the upkeep of the Office and the work of the Union being provided annually by contributions according to an annually revised scale.

Subsequently, within a month, the first General Assembly was held at Geneva, at which the statutes were framed and a general outline of the work of the Union was gone into. Vice-Admiral C. D. Carpendale, C.B. (Great Britain), was elected President, with Ministerialrat H. Giesecke (Germany) and Monsieur R. Tabouis (France) as the two Vice-Presidents. All three were re-elected at the successive annual assemblies of 1926 and 1927. The Council of Administration, at first of nine members, now comprises fifteen (including the President and Vice-Presidents), drawn

from as many different European countries. Mr. Burrows, until recently Director of Programmes of the B.B.C., was appointed Director of the Office and Secretary-General permanently resident at Geneva.

THE TECHNICAL COMMITTEE

The most urgent item to occupy the attention of the Conference was the allocation of wavelengths in Europe. This gave rise to the formation of a Technical Committee in 1925, which was under the Presidency at first of Captain Eckersley (Great Britain) and subsequently (1926) of M. Brillard (Belgium). From time to time the meetings of this Committee have expanded into General European Conferences of the Engineers of broadcasting authorities, whether actually members of the Union or not.

A considerable amount of work was done by this Committee in evolving methods for the distribution of wavelengths, of which the outstanding result is the so-called "Plan de Genève." In explanation of the significance and effects of this "plan" I cannot do better than quote Captain Eckersley, one of its principal promoters:

"It is a fact that any Station erected in Europe can interfere with any other European Station (assuming normal powers) unless the frequencies of carrier wave emission are different from each other by a certain fixed amount. This is tantamount to saying that for a limited number of wavelengths there must be, to reduce interference, a limited number of Stations. Unfortunately, when the International Organisation came to discuss this prob-

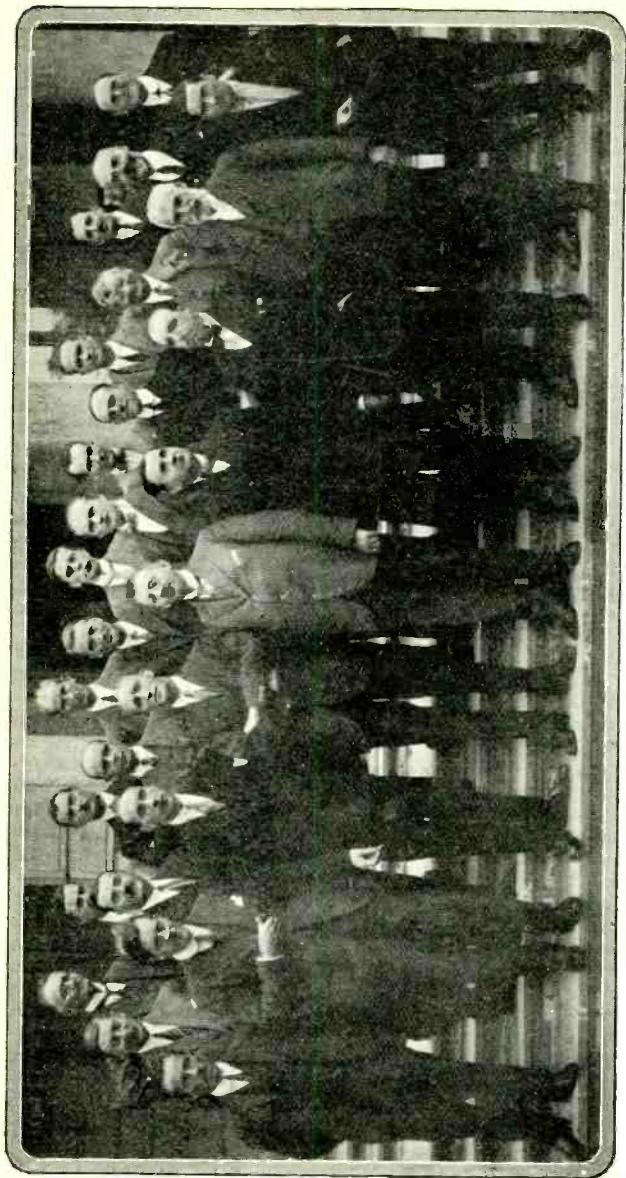

THE UNION INTERNATIONALE DE RADIOPHONIE: A GROUP OF DELEGATES.

The B.B.C. was prominently associated with the formation of the International Union of Broadcasters which established its headquarters at Geneva in 1925. The Union has already done much useful work in arranging an equitable distribution of broadcasting wavelengths among various European countries. The inevitable continuous and progressive adjustment of wavelengths adds to the importance of the Union.

lem, they found that there already existed more Stations than available channels, and taking into account projected Stations, there looked like being—unless prompt action was taken—an enormous preponderance of Stations over channels.

“The Plan de Genève was a plan which attempted not only to guide organisations in terms of fact into a sane conception of National Broadcasting, but also, on the basis of a compromise, still allowed room for the surplus Stations in spite of the lack of channels.

“The actual Plan de Genève bases itself upon the allocation of a certain number of exclusive waves to all countries; these waves—as their name implies—being for the exclusive use of a certain limited number of Stations. Eighty-three such waves were allocated between countries according to a formula based upon area, population, and commercial activity. Ninety-nine total wavelengths are available, and the remaining sixteen are allocated to be shared among several Stations. From what has been said before, this may seem as if interference would be produced between Stations sharing a wave. It is true that some interference may be produced, but within a limited area around a Station employing a common wave there is reasonable insurance of a service. Thus the service area of a Station using an exclusive wave is theoretically unlimited; the service area of a Station using a common wave must be in the nature of things limited. There is no chance of one Station on a common wave overpowering another, because it has been agreed that each shall not use more than a power of 500 watts in the aerial.

“The Plan de Genève is a compromise, and the separation between Stations is not that which would have been chosen were not facility so limited. It has therefore been found essential to try and insure that each Station shall keep to the frequency allotted to it, and the Union has been at some pains to design and distribute to all Stations a wavemeter of sufficient accuracy. A large number of broadcasting Stations in Europe are now equipped with such wavemeters.

“Although no definite plan has yet been made for the allocation of long waves, several conferences have taken place on the subject, and a ‘gentlemen’s agreement’ has been arrived at which has some assurance that if and when a waveband is allocated by Governments, some sort of new plan will be arrived at.”

OTHER COMMITTEES

In 1926, as the work developed, it was found necessary to form special committees on the same lines as the Technical Committee, and the spring saw the creation of the Juridical Committee, consisting of four or five members specially selected to inquire into the legal aspects of broadcasting problems, and of the so-called Rapprochement Committee, which studies questions dealing specifically with the artistic side, such as exchange of programmes, artists, etc. The President of the Juridical Committee is Dr. Sourek (Czecho-Slovakia), and of the Rapprochement Committee, Dr. Czeija (Austria).

THE COUNCIL

Meetings of the Council take place three or four times a year, at Geneva and other centres. The official language at all these meetings is French.

The General Assembly meetings take place in the spring of each year at Geneva.

Independently of these meetings, the special Commissions meet from time to time as necessary, to settle points as they arise, in various European centres, and the Office maintains a daily flow of circulars, information, questionnaires, etc.

PROBLEMS FOR CONSIDERATION

A never-ending list of problems appears for discussion. To name only some, we have to examine questions of international copyright, the position of broadcasters in relation to news distribution, co-operation between broadcasters and allied interests generally, particularly the entertainment industry, exchange of programmes from one country to another by land-line, studio technique generally, in addition to the whole of the technical side of Broadcasting previously mentioned.

WASHINGTON CONFERENCE

One of the adjuncts to the reorganisation of wavelengths was the preparation for the forthcoming Washington Conference, which takes place in the autumn of this year, 1927, in order that the European broadcasters should have their house in order and a definite policy, framed on careful experiments and proved by recent experience to be satisfactory, with which to support their claims for the necessary wavebands to be allocated to Broadcasting at this Conference. A representative of the Union has been invited to attend, and the Council has nominated in this capacity the Chief Engineer of the B.B.C.

MEMBERSHIP

In addition to European "active" members (*i.e.* organ-

isations actually working Broadcasting enterprises), it has been decided that extra-European members may be included in the Union, including certain British Colonies and foreign countries overseas, who, without participating actively, receive documentation of various subjects of interest from time to time, and are kept in touch with what is being done.

CONCLUSION

Such, in brief, are the constitution and the press of work of the Union. The possibilities of international benefit that radio holds are too obvious to need repetition here. It must suffice to say that if those possibilities are to become actual in the fullest measure and at the earliest possible moment, some such organisation as the Union—capable of bringing together responsible broadcasters for effective business and yet flexible enough not to be compelled to formulate its results as rigid law—is an indispensable organ for achieving them.

Conversations on the foot-plate of an express locomotive running between King's Cross and Aberdeen were broadcast in 1925. A short-wave transmitter was used on the train, a telegraph line between Potter's Bar and Hitchin being used as a receiving aerial, the sounds thus picked up being transferred over Post Office lines to Savoy Hill.

Items of B.B.C. programmes have been picked up on the frontier of Afghanistan, in Ecuador, in Greenland, in Australasia, and in the Yukon. It is hoped that ultimately reception at such distances will fulfil the conditions pre-requisite to satisfactory service.

EUROPEAN BROADCASTING

THE Great War took away with one hand and gave with the other. In the technical field it forced the pace of progress to the utmost, while its economic result was to restrict the power of the peoples for taking advantage of that progress. It is more difficult, therefore, to explain the quick rise of Broadcasting in Britain and Europe than it is to account for the same phenomenon in the United States of America. There the arrival of radio telephony coincided with a boom in industry, found a population relatively unstrained by the War, and, in addition, met the peculiar needs of a scattered, highly individual, and wideawake agricultural population which was beginning to succumb to the lure of the great cities. In such conditions it is not surprising that stations sprang up all over the United States, providing every entertainment, propaganda, advertisement, market prices, instruction, religion, news, police notices and so on—with all the luxuriance of which an energetic individualism is capable. But Europe was exhausted and unsteady; most of the vitality that had survived the War, as well as the pseudo-vitality that had been engendered by the War, was absorbed in industrial, political and social conflict. It seemed an unpromising field for a totally new cultural movement to begin on, the more so as radio telephonic technique itself was new and its conditions were largely unexplored. Nothing but a real need of the times, combined with a sufficient belief on the part of some pioneers in the reality of that need, could have produced European Broadcasting as it is understood to-day. Where one of these two factors

was deficient, or was inhibited from acting, Broadcasting has developed under handicaps or not at all. Where both were found, Broadcasting with astonishing rapidity reached its present form as a nation-wide service appealing to the masses.

BRITAIN AND GERMANY

The countries in which the two factors co-operated soonest and most effectively were Great Britain and Germany (with which in this connection should be reckoned Austria). Now, in retrospect, the most remarkable fact about European Broadcasting is that it took root and spread most widely in precisely those two countries where the industrial strain of the War (the purely military strain does not here concern us) had been greatest. The fact is remarkable enough as judged after the event. It is still more remarkable when we remember that in these countries not only the Broadcasting Stations with all their expensive equipment and organisation, but also a great industry for the manufacture and marketing of receiving apparatus, were conditions *precedent*—in other words that the need for popular Broadcasting and the probability of its "catching on" were somehow sufficiently evident to justify heavy capital outlay and effort in advance. There was, of course, the evidence of America in support of a *prima facie* case, and it was very strong, but it would have been easy to argue that (a) radio was a passing craze, (b) the European peoples were too impoverished to follow the lead of a prosperous country of high wages, (c) the vast size of the United States gave radio communication an advantage that it

would not have in the smaller States on this side (European Broadcasting was not and could not be imagined then). From the standpoint of Europe as it was in 1922 there were very serious considerations to face. The term "pioneers," as a title of honour for the executants of those days, is as correct as it is legitimate. In a situation where the weighing of positive *pros* and *cons* gave no very decisive lead, they sensed the spirit of the age and went ahead.

RELAXATION FROM STRAIN

What this spirit of the age demanded in Europe was primarily relaxation from strain. The War

was over, but it had left a reduced capacity for bearing strain, at the same time as it had set up a new fiercer rhythm and pace of living. Entertainment, therefore, was needed, and not only on a scale never before thought of, but also in a form which involved little effort and little expense in seeking it. The fireside had come into its own again, but the community had become too sharpened merely to doze at it.

But this very sharpening meant not only a great extension of the term "entertainment"—so as to include, for instance, a talk on recent books or one on historical curiosities—but also an increased

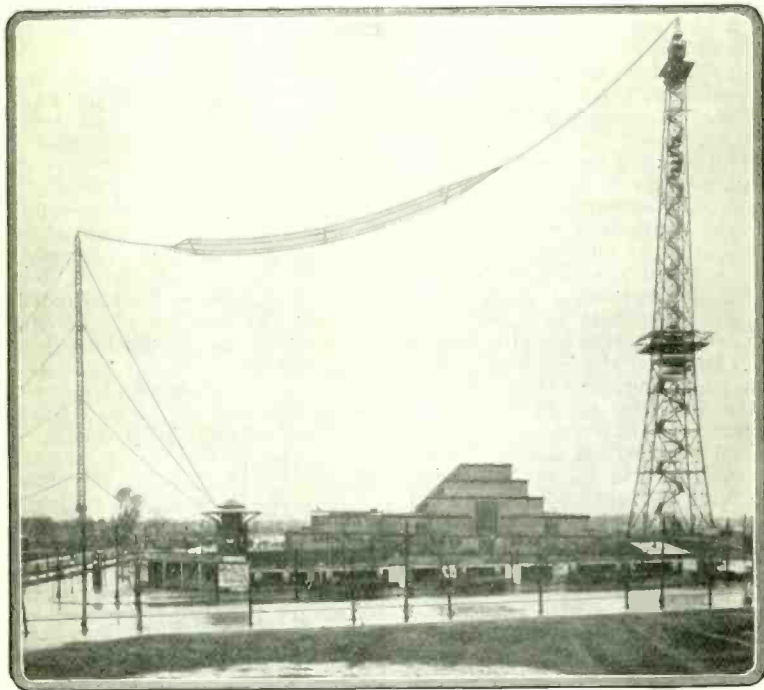

NO. 1 STATION AT BERLIN

In the background is the Exhibition Hall of the German Wireless Industry

demand for information of interest and utility, the class of information, in fact, that figures in Broadcast programmes as news, weather, prices, agriculture talks and so forth. And ere long there were two other great elements of the Broadcasting programme as we know it to-day which made their appearance—so soon that they can fairly be considered as elements of the original need and not (as they are sometimes represented to be) superimpositions: viz. educative and religious Broadcasting.

From this point of view, the enormous programme advances that were realised afterwards are seen as, in the main, an unfolding of what was implicit in the proposition at the outset.

Given these conditions—the mass-demand, the fireside, and the budget—how did the more radio-conscious countries of Europe proceed to meet them?

DECIDING POLICY

The main decisions of policy that had to be made were those issuing from the fact that the people to be catered for were primarily the masses of the great urban agglomerations, who could not be expected to provide themselves with any more elaborate apparatus than simple crystal sets and moderately good aerials. These conditions, as is well known, prevail still to a large extent, and every European nation which has adopted a systematic Broadcasting policy has based it on the "crystal" listener.

Moreover, such sets being unselective, the public need imperatively demanded control and limitation of the number of Stations allowed to operate in an area. A further point of major importance (though in this case it was a matter rather of experience than of prevision) was that the proper dis-

tribution of Stations, so as to give the best nation-wide service, differed considerably from the distribution of artistic resources, with the result that more or less inter-linkage of Stations, pooling of financial resources, and centralisation of management became essential.

NO ADVERTISING REVENUE

Lastly, as the radio audience in Europe was not a spending audience, and as mass-publicity as understood in America scarcely existed on this side of the water (as each national unit corresponded to a relatively small market), advertisement as a mode of financing Broadcasting did not and could not play the part in Europe that it did and does still in America. Many Stations do "sell time" directly or indirectly, many more have the power to do so if they think fit, but, broadly speaking, Europe chose the direct method of financing Broadcasting, viz. the payment by listeners of licence fees sufficient for the upkeep of the Stations and their programmes. And it may be said, roundly, that in European countries the efficiency and popularity of Broadcasting have increased proportionately to the enfranchisement of the broadcaster from sources of revenue other than the fees of those who enjoy the programmes.

In the main, then, the initial provisions which inspired the policy of European Broadcast promoters at the outset have been fulfilled in experience. On the speculative point of whether Broadcasting would "take on," they have been much more than fulfilled, and the peak of the ascending curve has not even yet been attained. The primacy which Great Britain can claim in the movement is due chiefly to her having been the first to see the

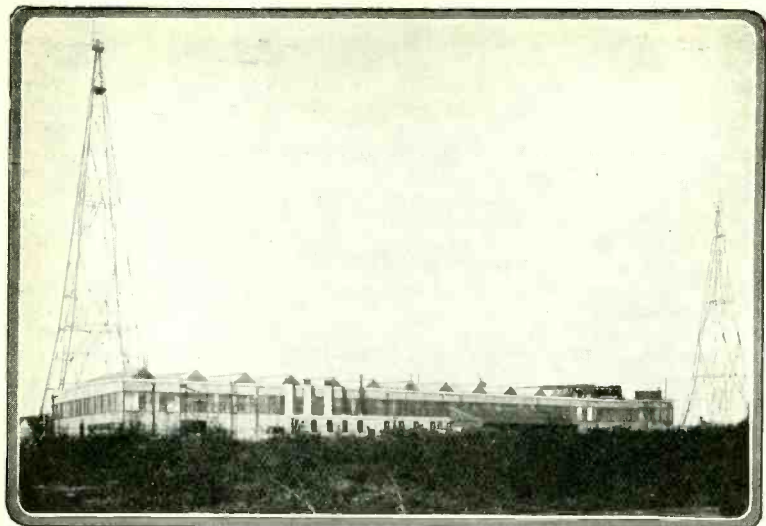

HILVERSUM (HOLLAND)

correct lines of development, but her example was promptly followed by Germany, Austria and others, while most of the countries in which Broadcasting is still relatively unorganised owe the lag under which they suffer principally to the fact of following other lines of policy, and notably the policy of attempting, in European conditions, to copy American individualism and *laissez faire*, and to apply the American method of finance by publicity in a manner, on a scale, and in an ambient where success is practically impossible. How difficult it is to retrieve an originally incorrect orientation is seen conspicuously in the case of France, where, however, as elsewhere, there is no reasonable doubt that difficulties will decrease in the course of events. We are within measurable distance of the time when all national European systems will conform, as regards general outlook, organ-

isation and finance, to what is known as the British type, but is really the standard European type intelligently anticipated at the time the B.B.C. was founded. Differences there will always be—though diminished as compared with what they are to-day—owing to differences of language, religion, outlook, prosperity, distribution in space, of the different components of the political nation. But it is permitted to believe that, from what we know to-day, the national distinctions of to-day will become, from the Broadcasting point of view, regional and local distinctions, the source of healthy, interesting and stimulating contacts between different sorts of communities.

EUROPE AS ONE FIELD

Be this as it may, the development of a number of national systems side by side very soon opened up a question that the

most prescient of those who settled Broadcasting policy in 1922-3 could scarcely have foreseen as an urgent problem, although it was the natural result of the effort of each to serve adequately the news of his own nation. The effort to bring the best and most varied programme material to the fire-sides created an intermediate class of radio amateur, who is neither the long-distance "D.X. fan" nor yet the "local-station" listener, but habitually picks and chooses amongst the programmes of the day. The endeavour to provide as many people with, not mere signals, but strong, clear and undistorted signals, led *inter alia* to a general tendency to increasing the power of Broadcasting Stations. And lastly, the obligation or quasi-obligation to provide every important agglomeration of human-

ity, however situated geographically, with a service led to the multiplication of the Stations themselves. Two years' influence of these tendencies naturally sufficed to overcrowd the available wave-bands allotted to Broadcasting by Governments. It was not merely the "intermediate" or valve listener who was affected *vis à vis* the searcher, towards whom broadcasters admit only a secondary responsibility overridden by their primary responsibility towards the local listener; but unfortunately the beat-note between closely adjacent carrier frequencies is audible to the crystal listener as well, and the more audible as the power employed increases.

INTERNATIONAL ORGANISATION

Early in 1925, therefore, after preliminary negotiations in 1924, the International Radiophony Union was founded, with headquarters at Geneva, for the handling of common problems. It was this first move, actually imposed by existing facts, towards international co-operation between broadcasters that accelerated the pace towards a goal of general international co-operation. The step once taken, many other subjects emerged on which common discussion and agreements were desirable, and would soon become necessary; for instance, international copyright, touring artists, permission to use one's set on a foreign holiday, Esperanto, international relays, co-operation with the League of Nations—not to mention the exchange of useful executive information. Culturally and technically, the whole of these studies were justified in the interests of the "local-station" listener alone. But their importance to the eclectic listener was obviously

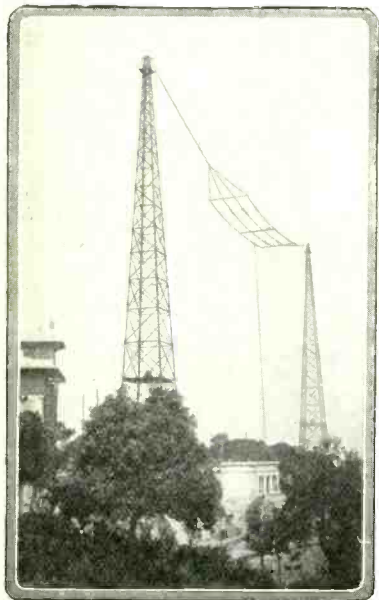

RADIO BARCELONA

greater still, as is evidenced by the continual increase in the numbers of papers which think it worth while to publish foreign programmes.

To conclude, it is interesting, in turning from retrospect to survey of things as they are, to note the degree of characteristic uniformity that has already been attained in the chief continental countries of Europe.

GERMANY AND AUSTRIA

In Germany the technical executive and plant are provided by the Post Office, while the Stations are grouped for programme purposes by regions under the control of regional programme companies. Germany, it must not be forgotten, is constituted federally, and the distinctions between the different "lands" go deep into history. For two years, therefore, each group of Stations operated, so far as programmes were concerned, independently. But in 1925 the programme companies themselves came to an agreement with the Central Government whereby the organisation named the Reichs Rundfunk Gesellschaft (a body somewhat like the "old" B.B.C.) should be formed, to hold a controlling interest in each of the regional companies. Following upon this, there has been a steady increase in the interlinkages and co-operation of regions, though provincial feeling is so strong, and artistic resources are so evenly distributed, that the system probably will not, and indeed ought not to develop the same degree of executive unification as prevails in the B.B.C. The Austrian system is somewhat similar and is best compared to that of a region of Germany, with the important difference that its centre, Vienna, is one of the premier art-foci of the world, able not only to turn out

high-quality "local talent" like a German region, but to attract and even hold all the great international figures as well. In both countries the service is maintained out of the licence fees paid to the State by listeners.

SCANDINAVIA

In the three countries of Scandinavia, Broadcasting is likewise managed by single authorities, public or semi-public, and financed partly or wholly out of licence yield. A very characteristic feature of Sweden, due to its geographical conformation and the lay-out of the population, is the profusion of small relay Stations all connected by wire to one or two main programme centres.

ITALY

In Italy the system is, again, one of unified control through private ownership. The tendency is for the Government to assume a more and more direct influence upon the programmes, and it is now intended to maintain the service out of ordinary taxation instead of listeners' licence fees.

SWITZERLAND

In Switzerland a number of Stations belonging to local companies operated until recently without interdependence. A Union has now been formed which includes all Stations except, for the time being, one. Licence revenue is available for their support, but the nature of the country and the distribution of its people make the situation of Broadcasting exceptional.

FRANCE

In France it cannot even yet be said that nationally co-ordinated Broadcasting exists. The history of French Broadcasting has been a chequered and troubled one.

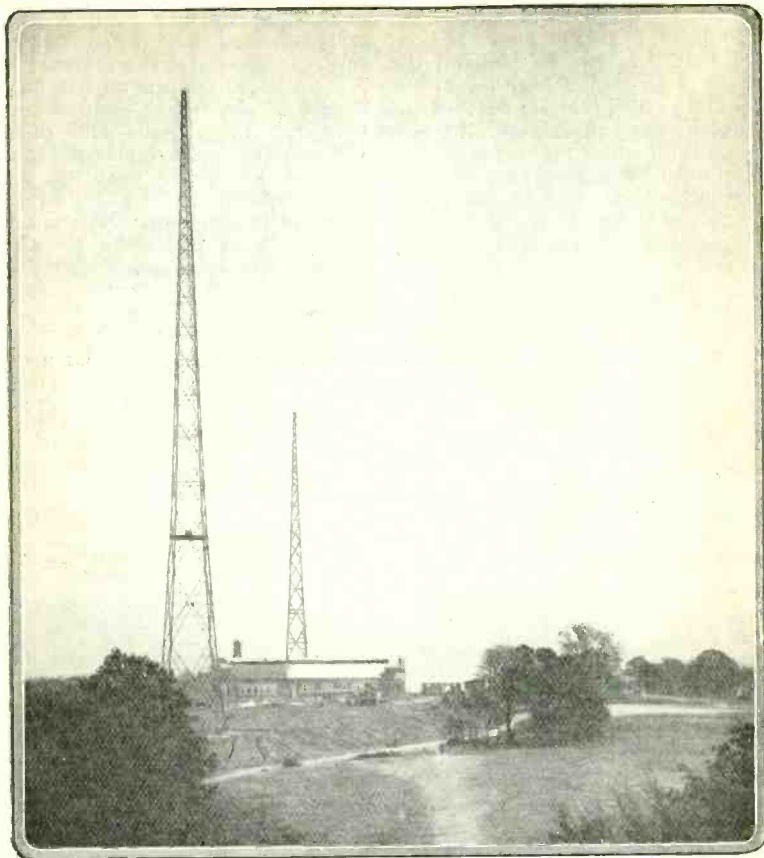

THE LANGENBERG STATION

The elements of a national system were, however, laid down in a new law in December 1926. The prestige of French Broadcasting, therefore, attaches to particular Stations, and above all "Radio Paris."

SPAIN

In Spain we have the nearest European equivalent to American competition and freedom from regulations. Commercial consolidation is, however, at work, and

a Government inquiry into the whole subject was begun in 1927.

OTHER EUROPEAN COUNTRIES

In Czecho-Slovakia sole operating right is held by a commercially-constituted company, in which, however, the Government holds a major interest.

In Belgium, although licence fees are charged to the public, the "Radio Belgique" Company has operated for a number of years

under great financial difficulties, as no part of this revenue has been paid over to it. In Holland the state of affairs has been somewhat similar; a peculiar feature of Broadcasting in this country has been the regular mounting of programmes by the various religious organisations. But in both Belgium and Holland large changes are impending which will tend to the creation of national Broadcasting supported by licence revenue.

In other countries of Western and Central Europe, Broadcasting is still in its infancy as a national institution, although in particular areas particular Stations command and deserve popularity.

RUSSIA

In Russia, Broadcasting, as was to be expected, took a form special to the conditions and institutions of the U.S.S.R. The most pro-

nounced features of a widespread system, which is, of course, State-controlled, are, (a) the systematic promotion of communal listening (loud-speaker, public address system) in village halls and open spaces; (b) the overriding influence of the State with, as its corollary, the use of radio as an organ of propaganda; (c) the development of the news bulletin into a veritable spoken newspaper.

A full-size replica of the main studio at Savoy Hill, in which several of the actual broadcast programmes were performed, provided thousands of people with their first insight into how Broadcasting is carried out, when it was included among the B.B.C.'s exhibits at the Olympia National Radio Exhibition in 1926.

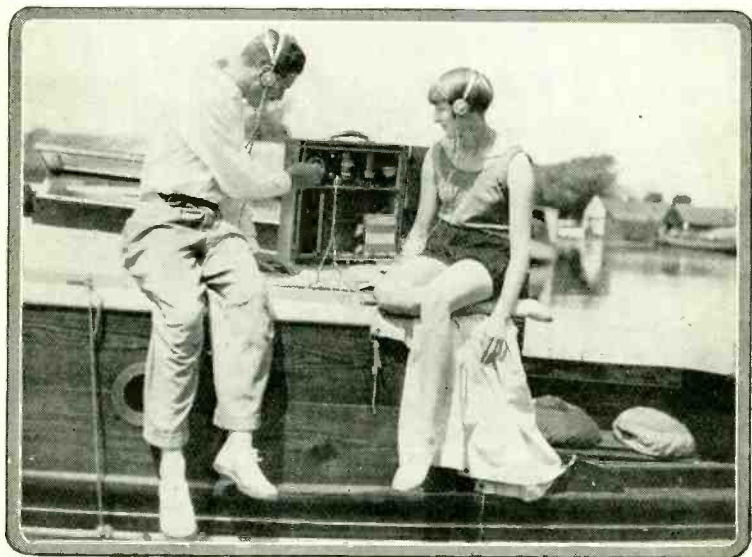

WIRELESS ON THE BROADS

EMPIRE BROADCASTING

THE popularity so rapidly attained by Broadcasting in Great Britain, and the achievements of commercial and amateur transmitters in establishing reciprocal contact over continents and oceans, inevitably suggested the idea of "Empire Broadcasting." Common sentiments, common language, and cultural and other interests which at lowest present more identities than differences—here, surely, it appeared, were the elements of a homogeneous Broadcasting system.

It was in 1923 that the B.B.C. began experiments leading to Empire Broadcasting. On the transmission side considerable progress is recorded and full advantage has been taken of the results of successful experiments elsewhere. On the reception side progress has not been so rapid and research is still going on. The practical result of work done during these four years, including the experiments in Holland, the United States and elsewhere, is that at isolated moments it is possible in almost any part of the world to pick up somewhat distorted music and speech transmitted by a short-wave station. On only some of these occasions is reception reasonably good. Neither the time nor the duration of the occasions can be anticipated. All factors essential to *service* are absent. Nevertheless, as a result of the work done and the experience gained, the B.B.C. engineers are now more hopeful of early satisfactory results than ever before. By the end of 1927 a short-wave station will be operating experimentally. This step is being taken in conjunction with the Radio Corporation of America and the Marconi Company, whose experience in short-wave work is

unique. While the engineers are at work on the technical side, cognate problems of programmes and expenditure are being considered. An implication of Empire Broadcasting is that there must be transmission throughout the twenty-four hours of the day. Active co-operation of the broadcasting authorities overseas is indispensable. Effective Empire Broadcasting will become possible only in terms of relays through the broadcasting systems of the Dominions and Colonies. By the word "effective" in this connection is meant the kind of broadcasting capable of reception with reasonable clarity by the average listener throughout Greater Britain. Intelligibility, continuity, and quality are essential conditions prerequisite to successful broadcasting of this kind.

CONTINUOUS RECEPTION

Particular emphasis should be laid on the word "continuously." In effect, programme planning requires that there should be very nearly a certainty of good reception over the period of the programme, and this last has, for the public, come to mean a whole evening. This does not, of course, exclude the idea of relaying special items, which is done already (though even here success is usually unpredictable), but it does exclude the present possibility of a programme service which can be received regularly.

Moreover, it will not suffice that programmes should be received regularly—they must also be acceptable and welcome regularly. For in the last resort (and setting aside, of course, the special occasions above referred to) the interest of a programme and nothing else

will determine its popularity, and Empire Broadcasting, like all other forms of re-broadcast, will soon be judged by the listening public by that criterion.

An Australian paper, commenting on the recent chance relay of the London Station programme via the Australian stations, expressed disappointment in the artistic quality and interest of the items broadcast as compared with the fare provided by the local Stations. Its opinion is a significant indication that the overseas programme cannot expect to enjoy a privileged status in point of acceptable quality.

REGULAR EMPIRE SERVICE

Thus in establishing an Empire Broadcasting Service, as distinct from that of occasional special efforts, questions of certainty and quality are of quite overriding importance. Neither sentiment nor other considerations would justify the capital and maintenance expenses of a Station which would be subject day after day to the risk of its programmes either not being received at all or coming over in a condition in which they would be less acceptable than the standard output of the local Station.

Another question to be gone into would be programme control. It is obvious that a continuous service of programmes drawn up principally for listeners in A would not be uniformly acceptable to listeners in B, while, on the other hand, an intermittent service of selected items might not be held to justify the expense of the Station. The problem would then present itself as to whether, for example, the Empire Station in England should fill in time by broadcasting from a studio of its own in this country; but if so, such broadcasting would be audible to English listeners and would constitute an additional

alternative programme, competitive or co-operative with British Broadcasting, according as the interlocking of the two was loose or intimate.

PERFORMING-RIGHT

A more important question still is that of performing-right. To state a complicated matter in the simplest terms, it is fairly universally agreed that authors and composers are morally entitled to fees in respect of broadcasts as in respect of other performances; but it follows that a re-broadcast, say in Australia, of an item broadcast in England, owes a fee to whoever owns the Australian "rights" of that item, irrespective of the fact that the B.B.C. has bought from the English owner the right to broadcast from its Stations. Clearly, the adjustment of relations on this score will need careful consideration and settlement in advance. The same applies to news bulletins, owing to the complexity of Press relations in and between different countries in the Empire.

These are some of the business problems which arise in addition to the technical and psychological questions already alluded to, and the reader will agree that though they may be surmountable, they are anything but negligible.

SEVERAL SYSTEMS

From a more abstract point of view, there are several kinds of Empire Broadcasting to be considered. One is the sending of programmes for re-broadcasting to a Dominion which has itself a well-developed Broadcasting system capable of finding its own artistic material and performing its own programmes. Another is that of Britain or a great Dominion broadcasting to a colony which has a local Broadcasting Station or



THE PRINCE OF WALES AT THE OPENING OF GREAT PEACE BRIDGE
Connecting Buffalo and Fort Erie, the bridge commemorates more than a century's peace between the British Empire and the United States

Stations but very small resources on the spot in the way of artists and outside concert-halls or theatres. The third, which does not involve re-broadcast, is that of broadcasting direct to isolated individuals or residents outside the service area of local Stations, who are equipped with adequate re-

ceivers. It is not easy to forecast a policy which would satisfy the several needs of these three; for example, the listening circle of the second class would welcome extraneous programmes, say, five times a week, whereas those of the great Dominions would need, say, one, while their respective

ability to contribute financially to the upkeep of the sending station might be in the inverse proportion. For this intermediate class, the smaller re-broadcaster, the future development of some form of "bottled radio" is, therefore, of the highest interest. The position of the isolated individual listener, on the other hand, is that, by hypothesis possessing a first-class apparatus, he can get the world's programmes and not only those of the British Empire, while, on the other hand, the "voice from home" has a deeper sentimental meaning for him in his isolation than it can have for any community.

The B.B.C. considers that its duty in connection with Empire Broadcasting is the linking together of national systems for the benefit of the ordinary listener, that is, for the general public of the Empire, rather than the pro-

vision of sporadic technical entertainment for comparatively few wireless amateurs.

By the reorganisation of the land-line system for simultaneous Broadcasting, carried out in 1924-25, Leeds became the pivot controlling all transmissions relayed between the South and the North. Hitherto land-line connections between one Station and another had been operated through London, except for a small switchboard at Glasgow for linking up Scottish Stations. The chief function of Leeds and the Gloucester repeater station, subsequently added as pivotal points, was to improve the quality of all items received from London to the same excellence as when they left London, distortion and other faults being corrected and weak signals amplified before they are passed on.

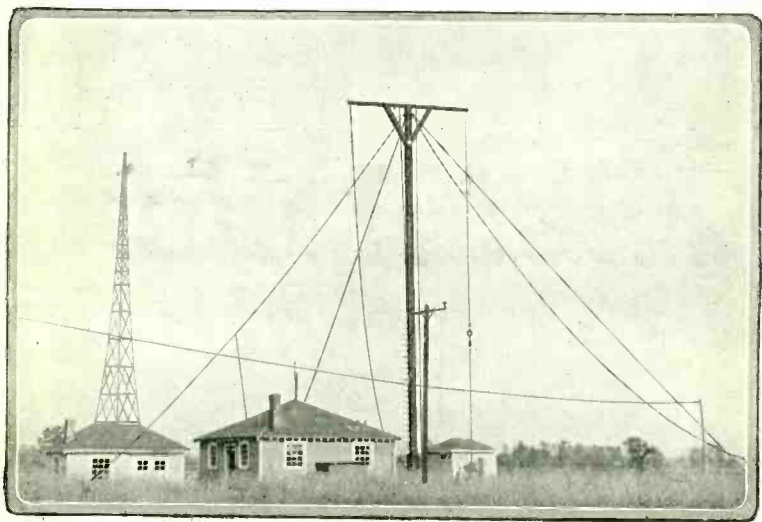

WHEN BRITAIN RELAYS AMERICA

Station 2 XAF of the General Electric Co. at S. Schoenectady, New York, which relays the programmes of Station WGY for re-broadcasting. It operates on a wavelength of 32 metres

BROADCASTING OUTSIDE EUROPE

UNITED STATES

ALTHOUGH promising experimental transmissions are recorded in Europe in 1919, it was in the United States that large-scale popular Broadcasting originated. 1920 may be taken as the year of its birth, 1921 as the year of its official registration.

Here, even more than elsewhere, the ground had been prepared by the spread of the "radio amateur" movement, but wider and deeper causes than this must be sought for to explain the rapid and universal spread of broadcasting stations over all parts of the country.

Individualism, publicity, high wages, desire of the urban masses for amusement, desire of the isolated agriculturist for the news facilities as well as the distractions of the towns, the desire for "uplift" which is widely spread amongst individuals of all classes and has made America the characteristic field of the popular lecture, the active sentiment in favour of consolidating the national type which is colloquially called the "100 percent American" movement—each contributed its quantum of motive and helped to determine the particular form of self-expression.

Under these combined influences of individualism and the publicity sense, stations grew up absolutely at hazard and in enormous numbers. At the time the regulating law of 1926 was passed, a huge number of licences had been issued to broadcasting stations. Many of them were installations of high or reasonable power, giving regular programmes of fair to excellent quality and owned by great Corporations, but the large

majority were stations of very low power set up by radio traders, churches, colleges, stores, local newspapers, police stations and others, each with purposes of its own in view. These stations, of which at times there have been as many as 700 in operation, were distributed in the main according to the hazard of private enterprise and prospects of popularity (50 stations in Chicago, for example), and not systematically according to the distribution of the population. All had to be accommodated within a narrow waveband—low power, distance, the quality of receiving sets (which are predominantly valve sets), friendly agreements for the sharing of programme time, and other palliatives being relied upon to minimise mutual interferences.

The result was chaos, a chaos that became worse and worse as time went on. For although a large proportion of the licensed stations were in course of time bought up by rivals, or discontinued for other reasons, others sprang up. Yet such is the strength of individualism in law and practice in the United States, that the State department concerned (Commerce, Mr. Hoover) eventually found itself legally prohibited from refusing a broadcasting licence to any qualified applicant, and even from assigning particular wavelengths.

This and the general discontent of the listening public brought matters to a head. After prolonged inquiry, and some delay due to accidents of politics, a Federal Commission was set up in February 1927 with full powers to control Broadcasting in conjunction with the Secretary of Commerce. Even now, however,

the Commission's "unscrambling of the Ether" has only just commenced. The private ownership and operation of stations (which is continued under the new régime) have created large vested interests, and the intention of the new authority to cut down the total of stations to about 300 has made it an invidious task to select the survivors, the more so as the new law has provided no machinery for compensating the expropriated.

Meantime, however, another process has been at work—as typically American as the instinct which dislikes to give powers to a governmental executive. It has been mentioned above that many of the more powerful and important stations were owned and worked by corporations with large artistic and financial resources. Now all broadcasting stations in the United States, whatever the purpose, were and are financed by their promoters, there being no "licence" revenue, and, as free competition reigned, a powerful corporation could anywhere set up a station, with better gear and better programmes, to outbid local rivals in its appeal to popular favour.

In August 1924, of 1,105 stations licensed up to that date, 572 had ceased to operate, a "mortality" of 52 per cent., and the process of elimination and absorption continued. Finally, the great corporations themselves joined forces, and the outcome of their union is the system of the National Broadcasting Company (President, Mr. M. H. Aylesworth), which from its main offices in New York, Chicago and San Francisco controls a network capable on occasion of giving a simultaneous Broadcast from 50 stations situated in all parts of the United States. The formation of another important

though much smaller "chain" under the auspices of the Columbia Gramophone Company was announced in August 1927; an interesting point in this organisation is that it is to operate indifferently in the United States and in Canada.

As to how these two factors, governmental regulation and private enterprise on the grand scale, will combine to solve the problem of giving the people of the United States a fully co-ordinated national service based on the needs and distribution of the people, only a fine judge of the imponderables of American public life could venture to prophesy. For broadcasting finance continues to be based indirectly upon the play of competitive forces, in that advertising remains its chief, almost its only source of revenue.

The word advertising, however, scarcely conveys an exact idea, to British readers at any rate, of what is meant by radio publicity in the United States. The best class of stations broadcast little or no "direct" publicity. On the other hand, the greater part of their programmes is provided and paid for by multiple shops, typewriter companies, life-insurance companies, etc. The promoter's name occurs only incidentally once or twice in the course of the programme—no more. But Americans are keen students of psychology applied to business, and the aim of "indirect" broadcast publicity is to create an association of the mind between a well-enjoyed evening and a well-known firm or product. In some connections, indeed, even remoter consequences of an appreciated broadcast are thought to be worth paying for, as for instance when a life-insurance company pays for the broadcasting of morning physical

exercises. In truth no real idea can be conveyed in a few words of the subtle interactions and linkages of a publicity campaign as understood in America. For the present purpose it is enough to indicate how the elements of the ensemble hang together, and thereby to explain how difficult is the task awaiting the Radio Commission, which has to ensure that this aggregate of freely competitive individual efforts, legitimate and consonant with the outlook of the community, shall develop into an organised system dedicated to the ideal that all broadcasters in the long run see before them, of serving the community as a whole equitably and well.

CANADA

Situated as the larger Canadian cities are, in comparative proximity to some of the chief centres of American Broadcasting, there is, of course, a good deal of mutual listening across the border, and it was only to be expected that Canadian broadcasting methods should be largely influenced by those of her big and progressive neighbour. Moreover, it was clearly necessary that the wavelengths of Canadian Stations should be chosen with a view to the avoidance of interference between the two countries. Thus an arrangement was made whereby Canada was allotted 17 wavelengths, 6 of them exclusive and 11 common to Canadian and American Stations. It was the encroachment by an American Station upon one of these exclusive wavelengths, and the refusal of the broadcasters in question to conform to the order of Mr. Hoover, of the American Department of Commerce, to "quit," which precipitated the crisis in

American Broadcasting last year, and resulted in the appointment of the Federal Radio Commission. Although, after the manner of the United States, Broadcasting Stations in Canada are under individual control, yet there is one unified system—that of the Canadian National Railways—which has a chain of Stations practically coterminous with its system from Montreal in the east to Vancouver in the west. These Stations are mainly operated under "phantom" licences, which permit the occasional use, under a special call sign, of an existing Station and plant. It is estimated that listeners in Canada number more than a million, and a licence fee of one dollar is charged on each set. The money thus raised accrues to the Radio Branch of the Department of Marine and Fisheries, which maintains a service of radio inspectors with direction-finding apparatus mounted on cars for the elimination of interference. The Department further ensures the listener's comfort by replacing obsolete spark Stations with valve transmitters. It has been justifiably said of Broadcasting in Canada that it is playing its part in every department of life, and has linked civilisation with the yet untamed places of the Dominion, and has been a further factor in revolutionising the existence of the pioneer agriculturist.

SOUTH AND CENTRAL AMERICA

South America is as progressive in Broadcasting as in other directions. In the *Argentine* particularly, the value of Broadcasting has been recognised, and Buenos Aires alone possesses eight Stations. Of these usually not more than two transmit at the same time. Broadcasting in Argentina is largely in the hands of amateurs, and at present no licence fees are

charged to listeners, but it is likely that it will be reorganised on systematic lines.

Brazil is not the best type of country from the physical aspect for Broadcasting, possessing as it does its principal cities along its extensive coast-line, with a hinterland largely uninhabited, but its broadcasting Stations are nevertheless relatively numerous, though generally of low power.

Mexico possesses some twenty Stations, nine of them in Mexico City. Of these the most powerful is CYJ, which works on 2 kw.

Perhaps the South American Station whose voice is best known is OAX of Lima, *Peru*. Although having a power of but 1.5 kw., its transmissions are frequently heard in the United States.

AFRICA, ASIA, OCEANIA

It is perhaps no injustice to those enterprising radio amateurs whose persistence in adverse circumstances has maintained a broadcasting service in *India* to say that Indian Broadcasting will be deemed to have dated from the opening of the first Station (Bombay) of the Indian Broadcasting Co., Ltd., in July last. Probably no broadcasting organisation in the world has entered on its task in circumstances involving more unknown factors or greater possibilities. As a field for the cultural potentialities of Broadcasting, surely India, with its diversified races, its many tongues, and its systems of caste, is unique in the world. It is, of course, too early yet to speak of the progress of Broadcasting, but already Stations, each of 3 kw. power, are operating in Bombay and Calcutta, and the intention is to erect further Stations, probably of similar power, in the larger provincial centres. Relay transmitters may be erected later in suitable dis-

tricts. It may be mentioned that not only the General Manager, but also the principal officials of the existing Stations, have been recruited from the staff of the British Broadcasting Corporation.

Broadcasting in Ceylon is confined to Colombo, where a Station of 1.75 kw., and 800 metres wavelength, broadcasts regular programmes

In *Australia* and *New Zealand* Broadcasting began on a small scale in 1924. It is entirely in the hands of private companies licensed by the respective Postmasters-General. The principal Stations in Australia include: in Melbourne 3 LO and 3 AR; in Sydney 2 FC, 2 BL and 2 GB; in Adelaide 5 CL; in Perth 6 WF; and in Brisbane 4 QG. With the exception of 3 AR and 2 GB, which are of 3 kw., each of these Stations has 5 kw. power. The tendency has been to raise the power of the Stations and to reduce their wavelength. Hobart, Tasmania, has also a Station; it works at present with a small power, which, however, it is intended to increase in the near future. Australian Broadcasting came into prominence on the occasion of the opening of the Federal Parliament House at Canberra by the Duke of York, the proceedings being broadcast. New Zealand has recently reorganised its Broadcasting, in order to bring it into line with modern requirements. The controlling organisation is called the Radio Broadcasting Company of New Zealand, and Stations are working at Christchurch, Auckland, Wellington, and Dunedin. These are of relatively low power, except at Wellington, where a new 5 kw. Station has just been opened.

South African Broadcasting has had a chequered career during its short life. In 1924 the Govern-

ment granted licences for public broadcasting Stations to the Capetown Publicity Association, to the Associated Scientific and Technical Club, Johannesburg, and to the Durban Municipality. Although reasonable licence fees were charged, "piracy" (*i.e.* the use of unlicensed listening sets) was rampant and gravely affected the financial success of the Stations. Nevertheless, Cape Town and Durban managed to work with a fair measure of success, but Johannesburg found the struggle too great, and after employing various expedients, such as relinquishing its own orchestra and relaying others, it was compelled to close down on January 31st last. Fortunately its period of inactivity was a short one—in fact the gap was actually bridged by local enterprise. Mr. Schlesinger, of the African Theatres, Ltd., formed a Company called the African Broadcasting Co., which bought the Station and restarted Broadcasting on more promising lines. Later this Company entered into negotiations for purchasing both the Capetown and Durban Stations, which now belong to the same group. It is now possible to co-ordinate effort and to economise in several directions, at the same time affording the listening public of South Africa an improved service. It is intended to erect a high-power Station in Johannesburg, and to remove the existing transmitter to Bloemfontein. With a relay Station in Pretoria and possible Stations in Northern and Southern Rhodesia, South Africa will be well served with a broadcasting system on modern and progressive lines.

There are three fairly well known broadcasting Stations in *North Africa*—Radio Carthage in

Tunis, Radio Casa Blanca in Morocco, and Algiers (PTT). Of these the only one of considerable power is the Tunis Station, which has 5 kw. The success of the Algiers Station has led the French Government to decide upon replacing it by one of the most modern type and of greater power. In Morocco it is proposed shortly to build a Station at Rabat, to be called "Radio Maroc."

Broadcasting in *Japan* began regularly in the middle of 1925, the ground having been previously prepared with characteristic thoroughness. It is probably true to say that Japanese Broadcasting has been greatly influenced by the system established in Great Britain, and in some degree the conditions are similar. The Tokyo Station (JOAK), that in Osaka (JOBK), and the Nagoya Station (JOCK) were opened at about the same time in July 1925. These three Stations have now been amalgamated under the title of the Broadcasting Corporation of Japan. For broadcasting purposes the country has been divided into "territorial broadcasting divisions." It is a part of the plan of the new Corporation to install a high-power Station (10 kw.) about 20 miles north of Tokyo. This Station is now in course of erection, and when ready next spring will replace the existing Tokyo Station. The licence fee for a receiving set is 2s. a month, which is paid to the Broadcasting Association; in addition the Government levies an annual charge of 2s. for expenses.

In *China* Shanghai and Hong-kong have a broadcasting Station each, the former under American auspices, having a power of 500 watts, and the latter 1.5 kw.

The ORMOND 5 VALVE PORTABLE SET

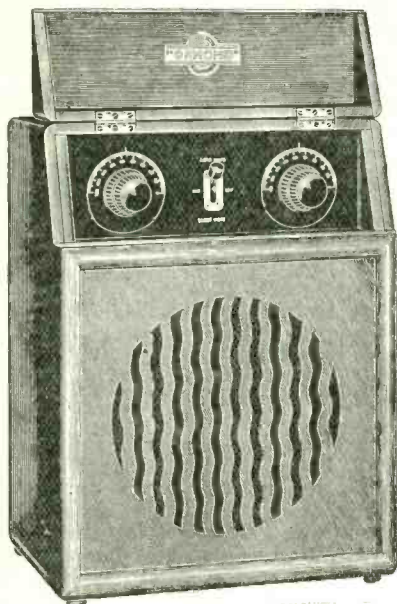

This set is ideal for indoor and outdoor use. It is contained in a Handsome Mahogany Cabinet, is extremely simple to control, and will render perfect reproduction under average conditions from a main B.B.C. Station within about 30 to 40 miles, and about 400 miles of Daventry.

A simple switch gives choice of short and long wavebands. Entirely self-contained and is fitted with a Celestion Loud Speaker. Complete with all Accessories and ready for immediate use.

Price = = = £24 10 0
Marconi Royalty extra - - - - £3 2 6

BAKELITE MOULDINGS

Quotations given for Bakelite Mouldings of every description, for which enquiries—large and small—are invited.



In addition to the 5 valve Portable Set, Ormond Manufacture 2 and 3 valve Sets. Also, Condensers—Logarithmic S.L.F., Square Law, 2, 3 and 4 Gang Models, etc., etc.

199-205 PENTONVILLE ROAD, KING'S CROSS, LONDON, N.1
Telephone: Clerkenwell 9344-5-6. Telegrams: "Ormondengi, Kincross."
FACTORIES: WHISKIN ST. & HARDWICK ST., CLERKENWELL, E.C.1
Continental Agents: Messrs. Pettigrew & Merriman Ltd., "Phonos House," 2 and 4, Bucknall Street, New Oxford Street, London, W.C.1

B. B. C. MAIN STATIONS

HOURS OF TRANSMISSION (WHITE PORTIONS OF CLOCK FACE)

ABERDEEN (2 BD)

1½ kw. 500 metres. 600 kc.

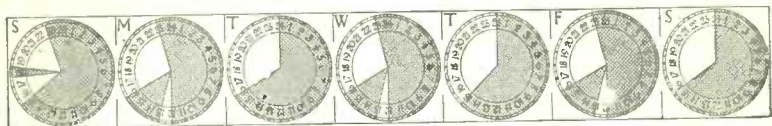

BELFAST (2 BE)

1½ kw. 306.1 metres. 980 kc.



BOURNEMOUTH (6 BM)

1½ kw. 326.1 metres. 920 kc.



CARDIFF (5 WA)

1½ kw. 353 metres. 850 kc.



DAVENTRY (5 XX)

25 kw. 1604.3 metres. 187 kc.



B. B. C. M A I N S T A T I O N S

DAVENTRY EXPER. (5 GB) 30 kw. 491.8 metres. 610 kc.



GLASGOW (5 SC) 1½ kw. 405.4 metres. 740 kc.



LONDON (2 LO) 3 kw. 361.4 metres. 830 kc.



MANCHESTER (2 ZY) 1½ kw. 384.6 metres. 780 kc.



NEWCASTLE-ON-TYNE (5 NO) 1½ kw. 312.5 metres. 960 kc.



B. B. C. R E L A Y S T A T I O N S

DUNDEE (2 DE)

0.2 kw. 294.1 metres. 1020 kc.

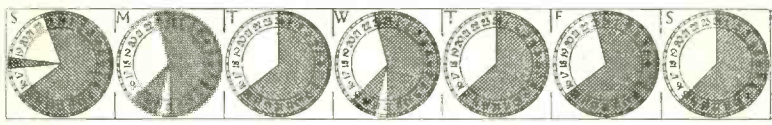

EDINBURGH (2 EH)

0.2 kw. 288.5 metres. 1040 kc.

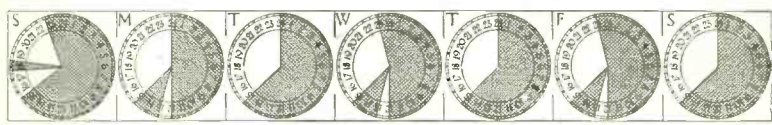

HULL (6 KH)

0.2 kw. 294.1 metres. 1020 kc.

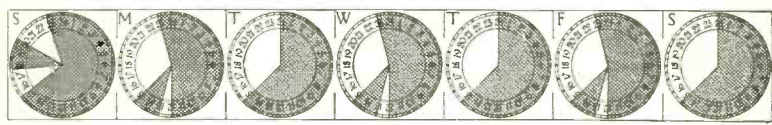

LEEDS-BRADFORD (2 LS) 0.2 kw.

{ 277.8 metres. 1080 kc.
{ 252.1 metres. 1190 kc.

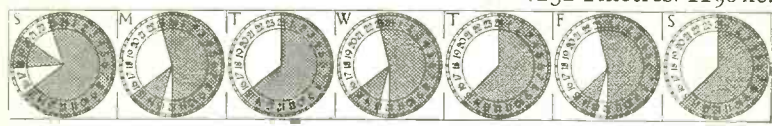

LIVERPOOL (6 LV)

0.2 kw. 297 metres. 1010 kc.

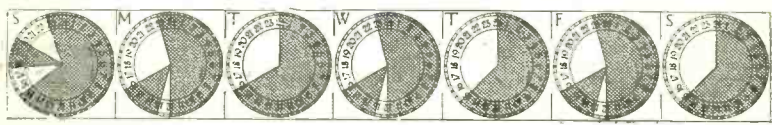

B. B. C. R E L A Y S T A T I O N S

NOTTINGHAM (5 NG) 0.2 kw. 275.2 metres. 1090 kc.

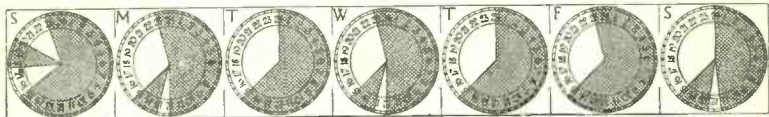

PLYMOUTH (5 PY) 0.2 kw. 400 metres. 750 kc.



SHEFFIELD (6 FL) 0.2 kw. 272.7 metres. 1100 kc.



STOKE (6 ST) 0.2 kw. 294.1 metres. 1020 kc.

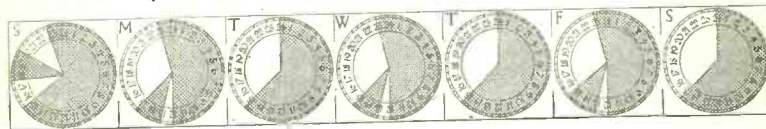

SWANSEA (5 SX) 0.2 kw. to 0.25 kw. 294.1 metres. 1020 kc.

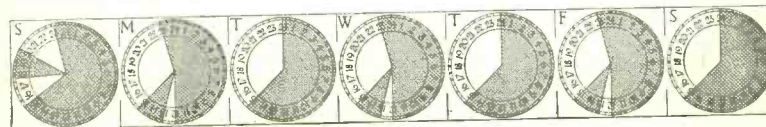

£150-£300



SALARY
FOR
CERTIFICATED
BOOK-KEEPERS

EXPERT POSTAL TUITION
in Book-keeping and Accounting

This Course covers the whole ground of the subject, i.e. Elementary, Intermediate, and Advanced Stages. Text and Exercise Books are supplied free of charge. Success at the **London Chamber of Commerce Senior**, and the **Association of Book-keeping Teachers' Advanced Examinations** is **Guaranteed** in writing, signed by the Principal. Fee **£4.14s. 6d.** payable in full on enrolment, or **£5.10s.** payable £1 on enrolment and nine monthly payments of 10s. Valuable cash prizes are awarded to all students securing **Honours, Distinction** or **First Class Diplomas.**

BOOKLET, TESTIMONIALS FREE.

CITY CORRESPONDENCE
COLLEGE (Dept. 504), 89, New Oxford St., London, W.C. 1.

Round the World for Sixpence

"I'll put a girdle round about the earth in forty minutes," said Puck. We don't quite do that. But for sixpence we tell you in thirty-two pages what the world is doing, why it won't try to disarm, why there is no peace in China; and men and women with expert knowledge throw light on the dark places where wars and revolutions are made.

Foreign Affairs

A Journal of International Understanding.

Edited by H. M. SWANWICK.

Has recently published articles by Hugh Dalton, M.P., J. A. Hobson, Rt. Hon. William Graham, M.P., Lt. Commander Kenworthy, M.P., J. Krishnamurti, Rt. Hon. Lord Olivier, Rt. Hon. Charles Trevelyan, M.P., Barbara Wootton. Full-page Cartoon by Raphael Nelson. Owl-glass makes you laugh!

"If every young man in the Empire read it, we should develop a sane patriotism that would help to adjust harmoniously disintegrating influences at work in the Empire and outside," writes an Australian reader.

Price 6d. monthly, of all newsagents. Annual subscription, 7s.

Send for a specimen copy to the Manager, Foreign Affairs, 24 Victoria Street, London, S.W. 1.

NOW!
LISTEN to PARIS
OR BERLIN
WITHOUT
AN
AERIAL



TAKE the Rees-Mace Wireless Set with you wherever you go, and enjoy full volume and pure tone reception from the cone loud-speaker embodied in the set.

THE Rees-Mace is handsome and self contained; it has no earth wire and no aerial wire and it receives English and Continental Stations even as you carry it about.

An illustrated folder describing these wonderful sets will be sent to you post free on request.

THE 2, 3 AND 4 VALVE MODELS
16 to 25 GUINEAS

THE 'SUPER FOUR' VALVE MODEL
35 GUINEAS

The
REES-MACE
Portable Wireless Set

The Rees-Mace Manufacturing Co., Ltd., 39a Welbeck Street, London, W.1. Phone: Mayfair 3758

AND REES-RADIO
46 RUE PIERRE CHARRON, PARIS

THE
WORLD'S
BEST
COM-
PONENTS

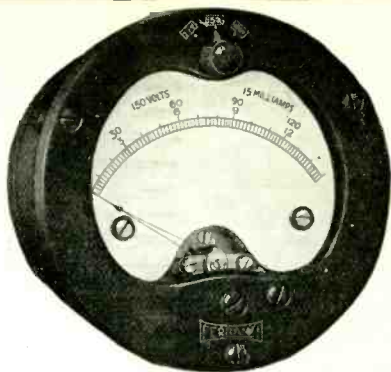

FERRANTI

Audio-frequency Transformers
Output Transformers
Power Transformers and Chokes
Ammeters and Voltmeters
Loud Speakers, Etc.



FERRANTI LTD.
HOLLINWOOD
LANCASHIRE

FERRANTI
ELECTRIC LTD.
TORONTO, CANADA

FERRANTI INC.
130 W. 42nd STREET
NEW YORK

FOREIGN IDENTIFICATION PANELS

The following Station Identification Panels, all of which have already appeared in "World Radio," have been revised in accordance with the latest information. While these panels include all European Stations accessible to the great majority of distance-listeners, they are necessarily incomplete because new stations are constantly being established, and small relay stations, which are not included in this book, are from time to time raised to the dignity of main stations. Note.—A twelve-hour clock face is represented, but in a number of cases programmes go beyond midnight. The white portion of the clock face indicates hours of transmission.

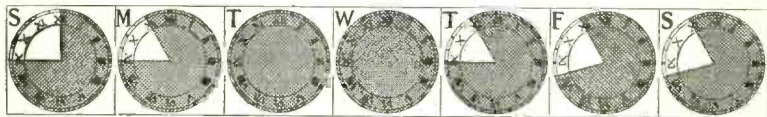

BARCELONA (Spain), EAJ 1.

Wavelength : 344.8 m. Frequency : Kc. 870. Power : 2 kw.

Approximate distance from London : 730 miles.

Call : "Allo! Allo! Aqui estacion Radio Barcelona. Eh-ah-hota oono [phonetically], instalada en la cumbre del Monte Tibidabo."

Woman announcer at times.

Closes down with Spanish National Anthem.

Chimes from Cathedral.

NOTES

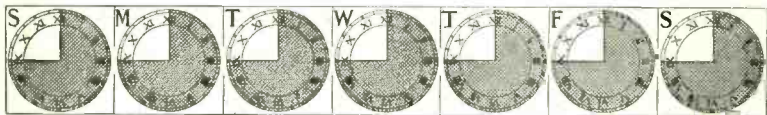

BARCELONA (Radio-Catalana), EAJ 13.

Wavelength : 462 m. Frequency : Kc. 649. Power : 1 kw.

Approximate distance from London : 730 miles.

Call : "Esta es la estacion Radio-telefonica EAJ 13 de la Radio Catalana en Barcelona, instalada en el edificio de la fabrica Industria Española de Perlas Imitacion," repeated at intervals of one hour, in Spanish, Catalan, English, French, Italian, and German.

Closing-down Words : "La Estacion EAJ 13 de la Radio Catalana en Barcelona, va a cerrar. Buenas noches, Señoras y Caballeros" (in languages previously mentioned).

Closes Down : Midnight, B.S.T. In case of outside broadcasts, not later than 1.30 a.m., B.S.T.

NOTES



BASLE (Switzerland).

Wavelength: 1,100 m. **Frequency:** Kc. 273. **Power:** 0.25 kw.

Approximate distance from London: 445 miles.

Call: "Hallo, hier Rundspruch Basel auf elf hundert Meter"
(Here Basle broadcasting station on 1,100 metres).
Announcements frequently made in German, French,
Italian, and, at times, English. No special interval signal.

Closes down in a similar way to German stations.

NOTES



BERGEN (Norway).

Wavelength: 370.4 m. **Frequency:** Kc. 810. **Power:** 1 kw.

Approximate distance from London: 655 miles.

Call and Interval Signal: "Bergen Kringkaster," with the wavelength.

NOTES



BERLIN (Germany).

Witzleben WL.: 483.9 m. **Frequency:** Kc. 620. **Power:** 4 kw.

Magdeburgerplatz. WL.: 566 m. **Power:** 1.5 kw.

(S.B. Programme.)

Approximate distance from London: 570 miles.

Call: "Achtung! Hier die Rundfunksender Berlin, auf
'Wellen . . .'" (repeated twice).

A clock chimes the hours.

Closes down with the National Anthem: "Deutschland über
alles" (old Austrian hymn).

Relay Stations: Stettin (236.2 m., 0.75 kw.); Koenigswuster-
hausen (1,250 m., 8 kw.).

NOTES



BERNE (Switzerland).

Wavelength: 411 m. Frequency: Kc. 730. Power: 1.5 kw.

Approximate distance from London: 460 miles.

Call: "Radio Berne" (pronounced "Rah-dee-oh Bairn").

Women announcers. Calls in German, French, and English.

Preliminary Signal: Transmissions opened by a few notes on a post horn or single tuning note.

Intervals: Each item preceded by two strokes, and closing with one stroke on a gong.

Closes down with "Gute nacht, Schlafet wohl!"; also in French-Italian and English ("Good-night, everybody. Sleep well!").

NOTES

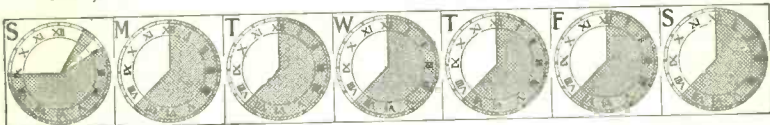

BILBAO (Spain), EAJ 9.

Wavelength: 434.8 m. Frequency: Kc. 690. Power: 0.5 kw.

Approximate distance from London: 590 miles.

Call: "Atención! Esta es la Estación Union Radio de Vizcaya, Emisora Radio Carlton."

No interval signal, but abbreviated call repeated between items.

On some evenings relays transmission from Madrid (EAJ 7).

Closes down with: "Buenas noches a todos" ("Good-night, everybody"), followed by a few bars of the Spanish National Anthem.

NOTES

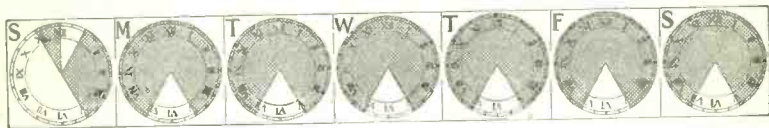

BRATISLAVA (Pressburg), Czecho-Slovakia.

Wavelength: 263.2 m. Frequency: Kc. 1,140. Power: 0.5 kw.

Approximate distance from London: 790 miles.

Call: "Hallo! Hallo! Radio-Bratislava Cesko Slovenska."

Interval Signal: Four bells (F A, C, C) and call "Hallo, Bratislava" repeated between items.

Woman announcer (Czech and French languages used).

NOTES



BRESLAU (Germany).

Wavelength : 322.6 m. **Frequency :** Kc. 930. **Power :** 4 kw.

Approximate distance from London : 735 miles.

No opening signal; during intervals in programmes metronome is sometimes used.

Call : "Achtung! Achtung! hier ist die Schlesische Funkstunde Breslau, auf Welle 315.8 und Gleiwitz auf Welle 250."

Closes down with one verse of German National Anthem.

Relay Station : Gleiwitz (250 m.).

NOTES



BRUENN (Czecho-Slovakia).

Wavelength : 441.2 m. **Frequency :** Kc. 680. **Power :** 3 kw.

Approximate distance from London : 750 miles.

Call : "Hallo! Hallo! Radio Journal Cesko Slovenska Brno" (pronounced "Brr-no"). Also indicates wavelength of transmission.

Closes down with "Good-night" in both German and Czech ("Gute Nacht; Dobrounoc"). On special occasions the National Anthem is played. (Kde domov muj.)

NOTES



BRUSSELS (Belgium).

Wavelength : 508.5 m. **Frequency :** Kc. 590. **Power :** 1.5 kw.

Approximate distance from London : 196 miles.

Opening Signal : A high-pitched whistle similar to the tuning note of our home stations.

Call (phonetic) : "Ah-low! Ah-low! Ici Radio Belgi-que," repeated between items.

On occasion announcements are made in French and Flemish.

After an orchestral programme, the station closes down with National Anthem, "La Brabançonne."

NOTES



BUDAPEST (Hungary).

Wavelength : 555.6 m. **Frequency :** Kc. 540. **Power :** 2 kw.

Approximate distance from London : 900 miles.

Preliminary Signal (also used during intervals in programme) : Oscillating valve on two notes, namely : - · - · - · the dots of somewhat higher tone than the dashes.

Call : "Hallia! Itt Budapest," followed by wavelength in Magyar, then a German translation "Hier Budapest, auf Welle 555.6 Meter."

On most evenings, a woman announcer.

Closes down with the call in Magyar, French, and German.

NOTES



CADIZ (Spain), EAJ 3.

Wavelength : 400 m. **Frequency :** Kc. 750. **Power :** 0.55 kw.

Approximate distance from London : 1100 miles.

Call (Phonetic) : "Estación Oonion Rah-dee-oh Cádith Eh-ah-hota-trez."

Preliminary Signal : Ticking of metronome. A time signal is given at 8 p.m., followed by concert. Usually dance music from 8 to 9 p.m.

Closes with Spanish National Anthem or dance tune from Spanish operetta.

Daily, except Sundays, tests are made from midnight to 12.30 or 1 a.m., or after Madrid (EAJ 7) has closed down.

NOTES

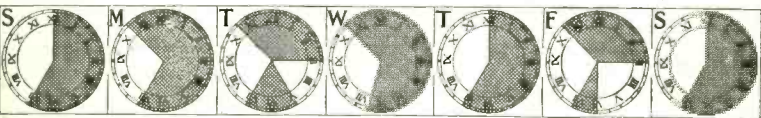

COPENHAGEN (Denmark).

Wavelength : 337 m. **Frequency :** Kc. 890. **Power :** 0.7 kw.

Opening Signal : Three strokes of a gong.

Approximate distance from London : 590 miles.

Call : "Her København's Radiofonistation." With details of wavelength.

(Approximate pronunciation : "Hair Kerpenhowns rahdio/pho/ni sta/shone.")

Translation : "Here is Copenhagen's radiophony station."

Closes down with a provisional Danish "National" anthem.

"Det er et yndigt land" ("dare air it erndikt lann" : "There is a winsome land"), and "Glem ikke at sætte antennen til Jord. God Nat, God Nat." ("Glem igga at setta antennen til Yor Goathe Nat, goathe Nat" : "Don't forget to earth your aerial. Good-night, good-night.")

Relay : Kalundborg (1,153.8 m., 7 kw.)

NOTES

WHAT THE "ZAREBA" WILL DO FOR YOU!

It will definitely protect your receiver against lightning. It will also make your set absolutely up-to-date by enabling it to separate dual programmes. Thus, if you incorporate the "Zareba" in your existing set, it will be unnecessary to make any further alteration to it when the new dual programmes are instituted.

Speed. Efficiency. Economy. Safety.

WHAT IT DOES!

1. Cuts out local station.
2. Protects receiver.
3. Improves selectivity.
4. Reduces static.
5. Eliminates Morse.
6. It is of low-loss design.
7. Is in dust-proof bakelite container.

INTERFERENCE ELIMINATOR



LIGHTNING ARRESTOR

IT IS ALSO.....

1. A Wave trap.
2. A Lightning arrestor.
3. A Reinartz reaction tuner.
4. An H.F. Transformer (split primary).
5. A Selective Aerial Tuner.
6. A Selective Crystal Set.
7. A Testing Device.

Price 12/6 post free, or 12/10 C.O.D.

All types of Radio Repairs are executed, and Receivers brought up-to-date promptly and efficiently by skilled wireless engineers under the personal supervision of the General Manager of

RADIO REPAIRS SERVICE **40-43 FLEET STREET, LONDON, E.C.4**

Telephone: CENTRAL 7747

THE MONOMARK

THESE *EIGHT SERVICES* ARE OFFERED TO YOU FOR FIVE SHILLINGS A YEAR ONLY!

1. Lost articles promptly restored
2. Free letter-forwarding service when travelling
3. "Telephone Restante" service
4. Free Box Number for advertisements
5. Emergency Telegraphic address
6. Insurance Premium reduction
7. Use of Members' Room
8. Greatly increased facilities for communication between amateur Radio transmitters

SPECIAL OFFER

If you take out a Monomark now a FREE MARKING OUTFIT bearing your Monomark will be presented with your first year's subscription.

Write for Booklet "R" giving full information to

BRITISH MONOMARKS LTD.
MONOMARK HOUSE HIGH HOLBORN LONDON W.C. 1

TELEPHONE: HOLBORN 3663



CORK (Irish Free State).

Wavelength : 400 m. Frequency : Kc. 750. Power : 1.5 kw.

Approximate distance from London : 363 miles.

Call Sign : 6 CK.

Opening Signal : Tuning note.

Opening and Interval Call (in Irish and English) :

Irish : "Se Seo Corcaigh ag Glaohach" ("Shay shuh

Kur-ig egg Glay-ock").

English : "Cork calling—6 CK."

Relays Dublin. Transmits its own programme one night weekly from 8 to 10.30 p.m.

NOTES



DUBLIN (Irish Free State) 2 RN.

Wavelength : 319.1 m. Frequency : Kc. 940. Power : 1.5 kw.

Approximate distance from London : 287 miles.

Preliminary Signal : Tuning note.

Call : In Erse and English at beginning and end of transmissions :

"Sé Seo, Baile Atha Cliath, ag Glaodhach" ("This is the Dublin Broadcasting Station calling").

Relay : Cork (400 m.).

NOTES



FRANKFURT-ON-MAIN (Germany).

Wavelength : 428.6 m. Frequency : Kc. 700. Power : 4 kw.

Approximate distance from London : 410 miles.

Opening Signal and Call : Three strokes on a gong. "Achtung! Hier ist Frankfurt-am-Main auf Welle vier hundert acht und zwanzig punkt sechs, und Cassel auf zweihundert zwei und siebzig punkt sieben Meter."

Interval Call : Abbreviated call—"Hier Frankfurt-am-Main und Cassel."

Interval Signal : Metronome.

Men and women announcers.

Closes down with a few bars of German National Anthem.

Relay : Cassel (272.7 m., 0.7 kw.).

NOTES



GENEVA (Switzerland).

Wavelength : 760 m. **Frequency :** Kc. 395. **Power :** 0.5 kw.

Approximate distance from London : 460 miles.

Opening Signal : A long-drawn-out whistle thrice repeated.

Call : "Allo! Allo! Ici Radio Genève, Auditorium de l'Hôtel de la Métropole."

No interval signal, but "Allo! Ici Radio Genève" repeated between items.

Closing Sentence : "Bonsoir, Mesdames," etc.

NOTES



GRAZ (Austria).

Wavelength : 357.1 m. **Frequency :** Kc. 840. **Power :** 0.5 kw.

Approximate distance from London : 750 miles.

Preliminary Signal : Series of V's in Morse (••• ▬ ••• ▬).

Call : "Hallo! Hallo! Hier Radio Graz auf Welle 357.1 m."
(Phonetically: "Here Radio Gratz owi Vella . . .")

Interval Signal : Ticking of metronome; also letter K in morse (—••).

Closes down with call and morse signal: ••• ▬.

NOTES



HAMBURG (Germany).

Wavelength : 394.7 m. **Frequency :** Kc. 760. **Power :** 4 kw.

Approximate distance from London : 450 miles.

Preliminary Signal (used also during intervals in programme) : H A (•••• ▬) in morse. One stroke on a gong before each item.

Intervals : A number of strokes on gong after item indicate interval in minutes, followed by metronome.

Relays : Bremen (252.1 m.), Hanover (297 m.), Kiel (254.2 m.).

Call : When S.B. to relays: "Hier die Norag Sender Hamburg auf Welle 394.7 Meter, Bremen auf . . ." etc. If Hamburg, Bremen, Hanover, or Kiel alone: "Hier . . . auf Welle [wavelength] . . . Meter."

Closes Down : Short military march or few bars of German National Anthem.

NOTES



HANOVER (Germany).

Wavelength : 297 m. **Frequency :** Kc. 1,010. **Power :** 0.7 kw.

Approximate distance from London : 418 miles.

Call : "Hier Norddeutsche Sender Hanover" (if own transmission).

Intervals indicated by strokes on gong to denote minutes.
Morse sign: HR (· · · · · - - -) sent out.

Closes down with usual German formula, to which is added, on occasions, the National Anthem.

For most of the transmissions, relays Hamburg.

Woman announcer.

NOTES



HILVERSUM, Holland (ANRO).

Wavelength : 1,060 m. **Frequency :** Kc. 283. **Power :** 5 kw.

Approximate distance from London : 226 miles.

Calls : "Hier Hilversum, Holland." On certain days the call is given in full, namely, "Hier het Algemeene Nederlandsche Draadlooze Omroep," and is repeated in French, German, English, and Spanish; but announcements are frequently given in Dutch and English on other evenings.

The station closes down with the National Anthem, "Wilhelmus Van Nassau," followed by the announcer's "Goeden avond, Dames en Heeren, Wel te rusten" (Good-night, Ladies and Gentlemen, sleep well).

NOTES



INNSBRUCK (Austria).

Wavelength : 294.1 m. **Frequency :** Kc. 1,020. **Power :** 0.5 kw.

Approximate distance from London : 600 miles.

Call (phonetic) : "Hallo! Hallo! Here Spricht Innsbruck owf Vella . . ." (repeated).

Interval Signal : Ticking of metronome.

Relays Vienna.

NOTES

L

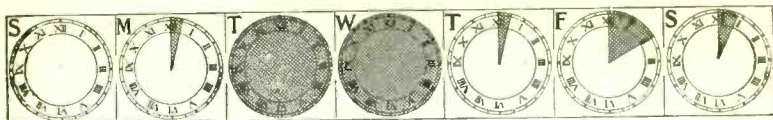

KIEL (Germany)

Wavelength: 254.2 m. **Frequency:** Kc. 1,180. **Power:** 0.7 kw.

Approximate distance from London: 480 miles.

Initial Call: "Hier Norddeutsche Sendergruppe Kiel, Hamburg, Bremen, Hannover, die Norag. Wir senden von Kiel auf Welle zwei hundert vier und fünfzig punkt zwei."

Interval Signal: KL in morse (- - - . - - -). Gong struck between the items.

Closing-down Words: "Wir schliessen unser heutiges . . . Programm," followed by the German National Anthem.

Closes Down: 10.30 p.m. B.S.T. (approx.).

NOTES

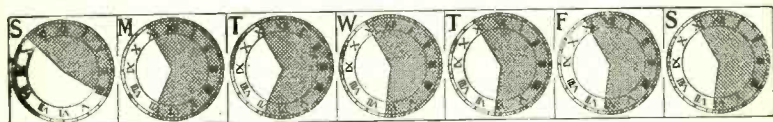

KLAGENFURT (Austria).

Wavelength: 272.7 m. **Frequency:** Kc. 1,100. **Power:** 0.75 kw.

Approximate distance from London: 725 miles.

Call: "Hallo! Hallo! Sie hoeren den sender Klagenfurt auf zweihundertzwei und siebzig Komma sieben."

Interval signal: Ticking of metronome and call repeated: "Hallo! hier Klagenfurt," between items.

Relays Vienna.

NOTES

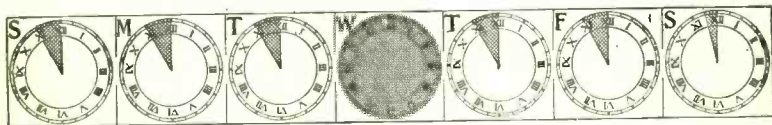

KOENIGSBERG (Prussia).

Wavelength: 329.7 m. **Frequency:** Kc. 910. **Power:** 1 kw.
Approximate distance from London: 880 miles.

Call: "Achtung! Achtung! Hier ist Koenigsberg in Preussen," or "Hier Koenigsberg und Danzig. Wir senden auf Welle drei hundert neun und zwanzig punkt sieben" ("We are broadcasting on 329.7 metres").

The name of this station is frequently repeated during intervals in transmission.

Interval Signal: Ticking of metronome.

Closes down with German National Anthem, and: "Vergessen Sie bitte nicht Ihre Antenne zu Erden (Please do not forget to earth your aerial). Gute Nacht."

Relay: Danzig (272.7 m., 0.75 kw.).

NOTES



KOENIGSWUSTERHAUSEN (Germany).

Wavelength : 1,250 m. **Frequency :** Kc. 240. **Power :** 8 kw.
Approximate distance from London : 575 miles.

Opening Signal : Ticking of metronome, followed by call :
"Achtung! Achtung! Hier die Hauptfunkstelle Koenigswusterhausen, auf 1,250 Meter" (repeated twice).

Interval Signal : Metronome and abbreviated call between items.

Own transmissions daily (afternoon); relays Berlin or other main German station evening programmes. Also transmits Press bulletins throughout day on 2,525 and 2,900 metres, in which cases calls are respectively: "Hier W.T.B. (Vay, Tay, Bay)" and "Hier Sopa" (initials of News Agencies).

Frequently relays Berlin programmes on 58 m.

This Station will shortly be replaced by a new transmitter situated at ZEESEN, on the same wavelength but with its power increased to 40 kw.

NOTES



KOVNO (Lithuania).

Wavelength : 2,000 m. **Frequency :** Kc. 150. **Power :** 15 kw.
Approximate distance from London : 1,040 miles.

Call : "Allo! Allo! Ici Radiotéléphonie Kovno," followed by an announcement in Lithuanian: "Alio, Alio, Radio Lietuva Kaunas."

Man announcer.

Interval Signal : Strokes on a gong.

NOTES

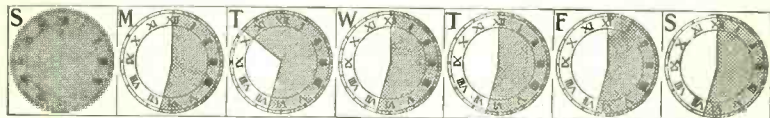

LANGENBERG (Rhineland), Germany.

Wavelength : 468.8 m. **Frequency :** Kc. 640. **Power :** 25 kw.
Approximate distance from London : 305 miles.

Call : "Achtung! Achtung! Hier Westdeutscher Sender Langenberg." Usually opens with Studio chimes (four bells).

Interval Signal : U in morse (· - -).

Relays entertainments from the Muenster, Dortmund, Düsseldorf, and Cologne Studios.

Closes down with Deutschland Lied ("Deutschland über alles")

NOTES



LAUSANNE.

Wavelength : 680 m. **Frequency :** Kc. 441. **Power :** 0.6 kw.

Approximate distance from London : 470 miles.

Opening Signal : Chimes to indicate time, followed by carillon and "Allô! ici Radio-Lausanne."

Initial call repeated before each item.

Closing-down Words : "Bonsoir, Mesdames; bonsoir, Mesdemoiselles; bonsoir, Messieurs."

Language used for Announcements : French only.

NOTES

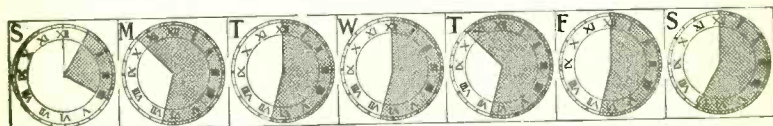

LEIPZIG (Germany).

Wavelength : 365.8 m. **Frequency :** Kc. 820. **Power :** 4 kw.

Approximate distance from London : 530 miles.

Call : "Achtung! Achtung! Hier sind die Mitteldeutschen Sender Leipzig und Dresden, auf Wellen . . ." ("Here are the Central German transmitters, Leipzig and Dresden, on Wavelengths . . .").

Man announcer.

Interval Signal : Ticking of metronome.

Relay : Dresden. **Wavelength :** 275.2 m. **Power :** 0.7 kw.

When Dresden is broadcasting, Morse Interval Signal : DR (- . . . - . .).

NOTES

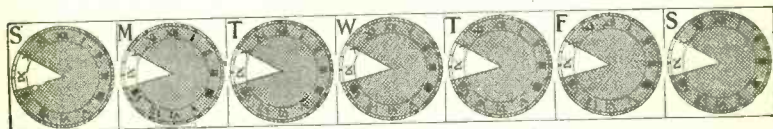

LYONS (France), PTT.

Wavelength : 476.2 m. **Frequency :** Kc. 630. **Power :** 1 kw.

Approximate distance from London : 465 miles.

Call : "Allo! Allo! Ici le poste radiotéléphonique des PTT de Lyon."

No regular interval signal, but on some occasions a bell is heard.

Abbreviated call between items: "Ici Poste de Lyon, PTT."

Apart from own concerts given on Tuesday, Wednesday and Thursday, relays entertainments from either Paris or Marseilles (PTT). On Mondays no transmission after 9.40 P.M.

Closes down with a few bars of "La Marseillaise," followed by usual French formula, as other stations.

NOTES

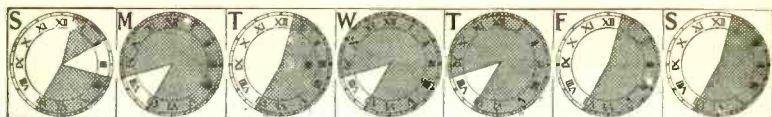

MADRID (Union Radio), EAJ 7.

Wavelength : 375 m. **Frequency :** Kc. 800. **Power :** 3 kw.

Approximate distance from London : 840 miles.

Opening Signal : A bugle-like call consisting of three or four notes or a few chords struck on piano.

Call : EAJ 7 (pronounced "Eh-ab-hota-siête"), followed by the name of the station, "Estación Union Radio, Madrid."

When closing down, frequently relays chimes from Government Building, followed by Spanish National Anthem.

Men and women announcers.

NOTES

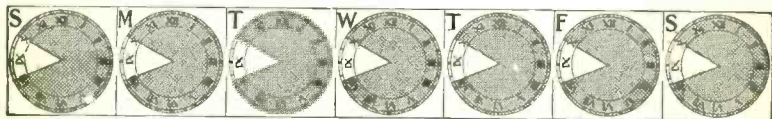

MARSEILLES (France).

Wavelength : 309.3 m. **Frequency :** Kc. 970. **Power :** 0.5 kw.

Approximate distance from London : 620 miles.

Call : "Allô! Allô! Ici le poste radiotéléphonique de Marseilles."

No interval signal.

At opening and end of transmission a few bars of an old Provençal folk-song from Bizet's opera *L'Arlésienne* are played.

Apart from own concerts, relays at times from PTT, Lyons, and Paris (École Supérieure).

Closes down as usual with French stations: "Bonsoir, Mesdames," etc.

NOTES



MILAN (Italy), 1 MI.

Wavelength : 315.8 m. **Frequency :** Kc. 950. **Power :** 1.5 kw.

Approximate distance from London : 560 miles.

Preliminary Signal : Tuning note.

Call (woman announcer): "Unione Radiofonica Italiana, Radio Milano Uno Emm-Ee (1 MI)."

No interval signal, but abbreviated call, "Radio Milano," between items.

Closes down with the words: "Fine della trasmissione (end of transmission); buona notte a tutte (good-night, everybody)"; and a few bars of the Italian National Anthem.

NOTES

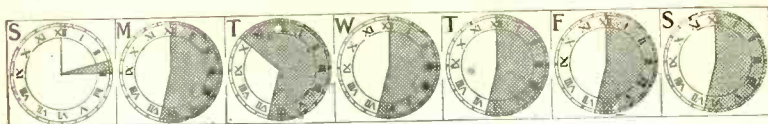

MUENSTER (Germany).

Wavelength: 241.9 m. Frequency: Kc. 1,240. Power: 1.5 kw.

Approximate distance from London: 327 miles.

Call: A gong signal between items, also morse sign: - - . . . (MS) at intervals of five seconds.

Closes down with German National Anthem, "Deutschland über alles" (old Austrian hymn).

Interval Signal: Morse letter U if relaying Langenberg.

Relay Stations: Dortmund (283 m., 1.5 kw.); Langenberg (468.8 m., 25 kw.).

NOTES

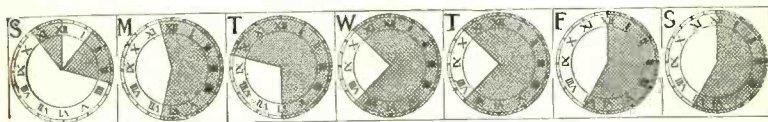

MUNICH (Germany).

Wavelength: 535.7 m. Frequency: Kc. 560. Power: 4 kw.

Approximate distance from London: 578 miles.

Opening and Interval Signals: M-u-n-g in morse, followed by three notes (oscillating valves) A, F sharp, D.

Call: "Hier Rundfunksender München und Nürnberg." Gong struck in intervals of plays.

Closes Down: "Unsere Sendung ist hiermit beendet. . ."

Relay Station: Nuremberg (303 m., 4 kw.).

NOTES

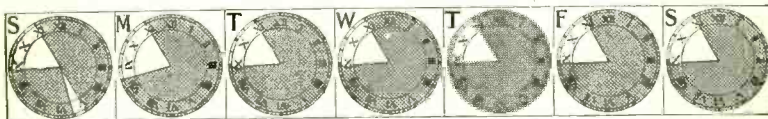

NAPLES (Italy), 1 NA.

Wavelength: 333.3 m. Frequency: Kc. 900. Power: 1.5 kw.

Approximate distance from London: 960 miles.

Opening Signal: Oscillating valve.

Call: "Unione Radiofonica Italiana, Radio Napoli, Uno Enn-Ah."

Interval Signal (temporary): Ticking of metronome, and abbreviated call, "Radio Napoli," between items.

Men and women announcers.

Closes down with a few bars of the Italian National Anthem

NOTES

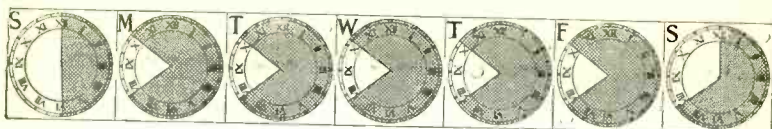

OSLO (Norway).

Wavelength : 461.5 m. **Frequency :** Kc. 650. **Power :** 1.5 kw.

Approximate distance from London : 735 miles.

Opening Call : "Halloo, Oslo!" (repeated twice).

Time Signal 8 p.m. B.S.T., rapid ringing of small bell.

Man announcer.

Closes down with a few bars of National Anthem and words "Godnatt, godnatt."

Relays : Frederiksstad (434.8 m.); Porsgrund (500 m.); Hamar (566 m.); Rjukan (448 m.); and Notodden (423 m.).

NOTES

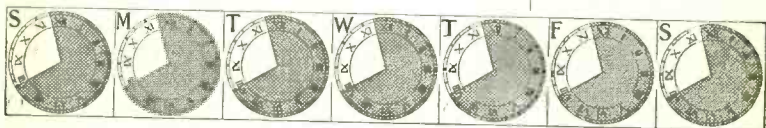

PARIS (Eiffel Tower).

Wavelength : 2,650 m. **Frequency :** Kc. 113. **Power :** 5 kw.

Approximate distance from London : 212 miles.

Opening Signal : Usually a series of seconds counted in the French language.

Call : "Allô! Allô! Ici le poste radiotéléphonique de la Tour Eiffel" (given twice).

No interval signal.

All announcements in French.

Closes down with call, a few bars of "La Marseillaise," and "Bonsoir," etc., as for Radio-Paris.

NOTES

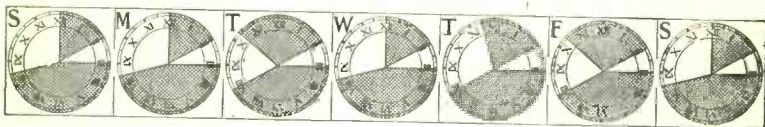

PARIS (FPTT) (École Supérieure des Postes et Télégraphes).

Wavelength : 458 m. **Frequency :** Kc. 655. **Power :** 0.5 kw.

Approximate distance from London : 212 miles.

No preliminary signal.

Call and announcements in French only : "Allô! Allô! Ici le poste Radiophonique de l'École Supérieure des Postes et Télégraphes de Paris." Regularly relays outside broadcasts, but call is not frequently repeated.

Relayed by Eiffel Tower (2,650 m.), **Bordeaux (PTT)** (270 m.), **Lyons (PTT)** (476.2 m.), **Marseilles** (309 m.), **Toulouse (PTT)** (260 m.), **Lille** (265.5 m.), **Grenoble** (278 m.).

NOTES



PARIS (Petit Parisien).

Wavelength : 340.9 m. Frequency : Kc. 880. Power : 0.5 kw.

Approximate distance from London : 212 miles.

No special opening signal. All calls and announcements frequently given in both French and English. " Ici le Poste du Petit Parisien, Paris " (This is the station of the Petit Parisien calling).

When closing down, announcer invariably gives bilingual call, and states date and time of next transmission.

NOTES

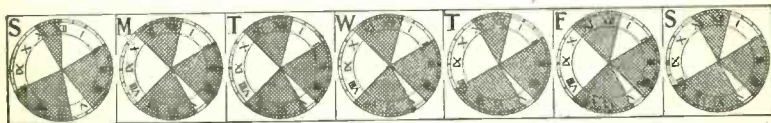

PARIS (Radio Paris).

Wavelength : 1,750 m. Frequency : Kc. 171. Power : 8 kw.

Approximate distance from London : 212 miles.

Preliminary Signal : Electric gong at 12.30 and 8.30 p.m.; weekdays, the studio clock chimes at the full hour.

Call : " Allô ! Allô ! Ici le poste de Clichy des Emissions Radio Paris, de la Compagnie Française de Radiophonie."

No interval signal.

Closes down with call and " Bonsoir, Mesdemoiselles; Bonsoir, Mesdames; Bonsoir, Messieurs."

When orchestra is in studio, preliminary bars of " La Marseillaise."

NOTES

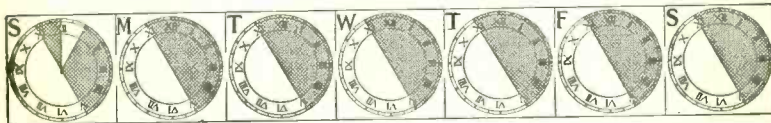

PRAGUE (Czecho-Slovakia).

Wavelength : 348.9 m. Frequency : Kc. 860. Power : 5 kw.

Approximate distance from London : 637 miles.

Call : " Hallo, Radio Journal Praha Csekoslovensko " in Czech and frequently in French and English. (Czech is unlike either the Latin or Teutonic languages, but more akin to Russian and Polish.)

No interval signal, but call " Hallo, Praha," repeated between items.

Concludes programme with short morse signal, followed by the word " Dobrounoc " (Good-night).

Relays : Brunn (441.2 m.); Bratislava (263.2 m.).

NOTES



ROME (1 RO).

Wavelength : 450 m. **Frequency :** Kc. 667. **Power :** 3 kw.

Approximate distance from London : 890 miles.

Preliminary Signal : Oscillating valve (similar to B.B.C. stations).

Call : "Unione Radiofonica Italiana, Roma, Uno air-o" (1 RO).

Interval Signal : A trumpet call and "Radio Roma" repeated between items.

Closes down with "Unione Radiofonica Italiana (1 RO), Fine della trasmissione," followed by the Italian National Anthem and the words: "Buona notte a tutte" (Good-night, everybody).

NOTES



SAN SEBASTIAN (Spain) EAJ 8.

Wavelength : 297 m. **Frequency :** Kc. 1,010. **Power :** 2 kw.

Approximate distance from London : 585 miles.

Call : "Atención, Atención! Aqui Union Radio (or Estación San Sebastian), EAJ 8 (pronounced 'Eh Ah Hota Ocho'), instalada en el Monte Igueldo."

Woman announcer. Calls made before every item.

Closes down by playing Spanish National Anthem, after which announcer bids good-night in French, English and Spanish: "Buenas noches! Hasta mañana."

NOTES



SEVILLE (Spain) EAJ 5.

Wavelength : 400 m. **Frequency :** Kc. 750. **Power :** 1 kw.

Approximate distance from London : 1,030 miles.

Call : "Atención! Atención! Aqui Estación Radio Club Sevillano (EAJ 5) (Eh Ah Hota Thinko)"

No interval signal.

Woman announcer at times.

NOTES



STAMBOUL (Constantinople, Turkey).

NOTES

Wavelength: 1,200 m. **Frequency:** Kc. 250. **Power:** 10 kw.

Approximate distance from London: 1,580 m.

Call (in Turkish): "Allo! Telsiz-telegrafie Stamboul"; in French: "Ici, Radiophonie de Stamboul."

No interval signal.

Closes down with a few bars of Turkish National Anthem and final "Good-night" in Turkish, French, German and English.

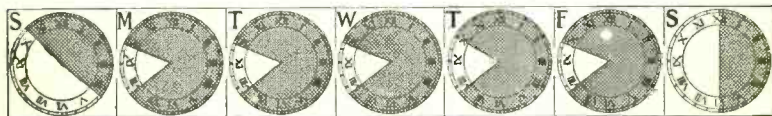

STOCKHOLM (Sweden).

NOTES

Wavelength: 454.5 m. **Frequency:** Kc. 660. **Power:** 1.5 kw.

Approximate distance from London: 905 miles.

Opening Signal: Short Swedish folk songs played on a spinet.

Call: "Stockholmes Rundradio."

Interval Signal: The rapid ringing of a bell, when no announcements are made.

Closes down with announcement of exact time and the word "Godnatt" (twice repeated).

When orchestra is present in studio, a few bars of the Anthem "Du Gamla du Frå" are played.

Principal Relays: Motala (1,320 m., 227 kc.) and many smaller stations.



STUTTGART (Germany).

NOTES

Wavelength: 379.7 m. **Frequency:** Kc. 790. **Power:** 4 kw.

Approximate distance from London: 448 miles.

Preliminary and Interval Signals: Three notes (C, D, G) produced by oscillating valves and metronome.

Men announcers.

Call: "Achtung! Achtung! Hier ist Stuttgart, auf 379.7 Meter," repeated before and after each item transmitted. Three strokes of a gong used when plays are given in studio.

Usually closes down with a few bars of German National Anthem

Relay: Freiburg-in-Breisgau (577 m., 0.75 kw.).



TOULOUSE (France).

Wavelength : 391 m. **Frequency :** Kc. 767. **Power :** 3 kw.

Approximate distance from London : 550 miles.

Call : "Allo! Ici Radio Toulouse. Emissions de la Radiophonie du Midi."

Interval Signal : Ticking of metronome.

Abbreviated Call : "Ici Radio Toulouse," before and after each item in programme.

A woman announcer at times.

Closes down with a few bars of "La Marseillaise," preceded by the local patriotic March, "La Toulousaine."

NOTES



TOULOUSE (France), PTT.

Wavelength : 260 m. **Frequency :** Kc. 1,154. **Power :** 0.5 kw.

Approximate distance from London : 550 miles.

Call : "Allo! Allo! Ici le poste Radiotéléphonique de Toulouse-Pyrénées."

No interval signal, but abbreviated call: "Ici Toulouse-Pyrénées."

Transmissions : Own concerts on Tuesdays, Thursdays and Saturdays; relays PTT Paris on Sundays and PIT Marseilles on Wednesdays and Fridays. Does not transmit on Monday evenings.

Closes down with "La Marseillaise," followed by "Bonsoir, Mesdames," etc.

NOTES



VIENNA (Austria).

Stubenring : 577 m.; **Frequency :** Kc. 520; 0.75 kw. **Rosen huegel :** 517.2 m.; **Frequency :** Kc. 580; 5 kw.

Approximate distance from London : 760 miles.

Tuning Signal : V (· · · -).

Call : "Hallo! Hallo! Hier Radio Wien, Sender Stubenring, Welle 577 m.; Sender Rosenhuegel, 517.2 m."

Interval Signal : Ticking of metronome.

Closes down with: "Gute Nacht, meine Damen; gute Nacht, meine Herren; gute Nacht"; followed by the morse signal SK (· · · - · · ·).

Relays : Graz (357.1 m., 840 kc., 0.5 kw.); Klagenfurt (272.7 m., 1,100 kc., 1.5 kw.); Innsbruck (294.1 m., 1,020 kc., 0.5 kw.).

NOTES



WARSAW (Poland).

Wavelength: 1,111.1 m. **Frequency:** Kc. 270. **Power:** 10 kw.

Approximate distance from London: 900 miles.

Opening Signal: Morse letter W (· - -).

Call (phonetic): "Rhaho! Rhaho! Polskie Raadjo Varschava," followed by indication of wavelength.

Woman announcer.

Interval Signal: Morse letter W (· - -) and abbreviated call: "Raadjo Varschava."

Closes down by playing Polish National Anthem ("Dabrowski Mazurka").

On occasions announcements are given out in French, English, and German, as well as Polish.

Relays: Posen (280.4 m., 1070 kc., 1 kw.); Cracow (422 m., 711 kc., 0.5 kw.).

NOTES



ZAGREB (Agram), Jugo-Slavia.

Wavelength: 310 m. **Frequency:** Kc. 967. **Power:** 0.35 kw.

Approximate distance from London: 870 miles.

Opening Signal: Ticking of metronome.

Interval Signal: Bell struck twice.

Initial Call: "Radio Zagreb." Also indicates wavelength of transmission.

Closing-down Words: "Lahku noc" (Good-night), followed by the beginning of the Croatian National Anthem played on the piano.

Language used for Announcements: Croatian, Slav, German, Italian, and Greek.

Closes Down: 10 p.m. (B.S.T.).

NOTES

ZEESEN. See Koenigswusterhausen.

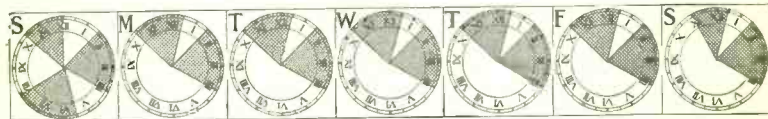

ZURICH (Switzerland).

Wavelength: 588.2 m. **Frequency:** Kc. 510. **Power:** 1.45 kw.

Approximate distance from London: 474 miles.

Call (phonetically): "Allo! Allo! Hier Radio Zeerich owf Vella funfhoondert acht oont achtzig poonkt tswy (Zurich on WL. 588.2 m.)."

All announcements are made in German. A gong is used as interval signal.

Closes down with a sentence in Zurich dialect.

NOTES

LISSEN

*HEAR EXQUISITE
MUSIC :: BY
HEADPHONES*

You get no distortion with LISSEN headphones. One big objection to headphones previously has been the discomfort when they are worn for a long period, such as throughout an opera. This objection exists no longer, for LISSEN have now produced a pair of headphones so light they can be worn all the evening without the wearer knowing they are on the head.

New Lissen 8/6
Headphones

LISSEN LTD., 47-56 Friars Lane, Richmond, Surrey

MANAGING DIRECTOR: THOMAS N. COLE

L386

TO THE
DEAF

Unprecedented success of the new and most wonderful hearing aid in the world—the

SHELLACON
A Marvel in Miniature

THE "Shellacon" removes for ever the danger and inconvenience of deafness, and brings within reach of the deaf the delights of wireless. Not only is it so small as to be practically invisible but so sensitive that the average deaf user can hear every word of conversation at any distance within the reach of normal ears, even with the instrument concealed under the clothing.

A FREE TEST will CONVINCE you that scientists have now cleared the way to PERFECT HEARING in PERFECT COMFORT.

GENERAL ACOUSTICS, LTD.
77 WIGMORE ST., LONDON, W.1

Branches: 14 St. Ann's Square, Manchester; 66½ Corporation St., Birmingham; 75 Buchanan St., Glasgow; 29 Shandwick Place, Edinburgh.

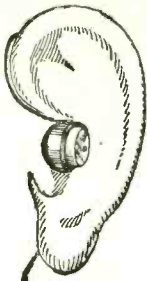

**WHY BUY EXPENSIVE
ACCUMULATORS**

when you can hire ours and be sure of constant efficiency in your reception? Subscribers to our Hire Service receive a "Rotax" Wireless Accumulator (L.T. or H.T.), suitable for their set which we call and exchange weekly, fortnightly or monthly for another fully charged, anywhere within 12 miles from Charing Cross.

If you already possess your own accumulators, let us correctly re-charge them under our skilled maintenance Service.

And perhaps you are sometimes dissatisfied with your reception. The collection of receivers for expert examination, test and report is only part of the service rendered to our subscribers entirely free of charge.

Write for full details and moderate inclusive terms

**RADIOSERVICE (London)
LIMITED**

105, TORRIANO AVENUE,
CAMDEN ROAD, LONDON, N.W. 5



**AN ANNOUNCEMENT
OF GREAT INTEREST
TO ALL LISTENERS!**

See also
advertisements
on page 20

Our 1927-8 Season ART CATALOGUE (60 pages, profusely illustrated!) is now ready. Not only a Catalogue, but also a radio education—contains much exclusive information. Each article listed (over 200) has been subjected to the most thorough tests in our extensive Laboratory, by an expert staff under the direction of Mr. C. L. Lyons, M.I.R.E., whose free advice is at the service of all postal clients. An example of value and quality is pictured here—The "Little Spitfire" Loudspeaker: handles real volume; height, 18 ins.; dia. of Flare, 9 ins.; adjustable diaphragm; contains the famous "Tower" reproducing unit. Price only 32s. 6d. post free.

Catalogue free, but please enclose 4d. postage.

(N.B. This ART CATALOGUE is limited to 25,000 copies).

CLAUDE LYONS, LIMITED
76B, OLD HALL STREET LIVERPOOL

**WORLD
RADIO**

~~~~~  
THE ONLY WORLD  
PROGRAMME WEEKLY  
Price Twopence  
AT ALL NEWSAGENTS  
~~~~~

M I C R O P H O N E P U B L I C I T Y

IT can safely be said that "microphone publicity" is at least as different in kind from other modes of publicity as radio performances of music or drama or speech differ from ordinary public performances. For the peculiar characters of the medium—the fact that its message is quantitatively universal and yet qualitatively highly individual, and the fact that it is heard, and only heard—tell with special force when the purpose of the message is to make a direct announcement or appeal, and the listener becomes a participant, a principal, an addressee, instead of a passive auditor.

This change of rôle cannot be suddenly imposed upon a listener, otherwise a certain hostile reaction will almost infallibly take place. We all know the break of atmosphere that occurs when the collection begins to be taken in church or when a performance is interrupted to "send round the hat," not to mention the shyness which overcomes the individual member of an audience when he is asked to come forward, or has to put a question, or is otherwise called upon to make himself a principal. And if such effects occur in public assemblies—where a psychological unity has been almost visibly set up in the audience—they have still more to be reckoned upon in the relation of privacy that exists between the broadcaster and the individual home listener. The valued friend suddenly turns out to be a canvasser—and on one's own hearth-rug at that!

In matters of broadcast publicity, therefore (using the term in the widest sense), the first of all rules is, *not* to take advantage

of the listener. Listening to someone interesting, he must not become suddenly aware that he is listening to someone "interested." Hence a broadcasting organisation must decide at the outset whether its public is to be led to expect an "interested" element in what it hears or not. This is not the place, nor have we the space for a full discussion of the question—more intricate than it seems at first sight—as to which alternative should be the chosen one. As everyone knows, the B.B.C. (though it does, in fact, possess the power to accept indirect advertisement in the form of "provided" programmes) elected for and has adhered to the policy of *not* using the microphone for ordinary publicity purposes. The "provided" programme, it may be mentioned in passing, remains the backbone of all broadcasting concerns which are not financed out of licence revenue, and its history exemplifies what has been said above as to the listener's reaction to the voice and offerings of interested parties, for even in the case of audiences habituated to expect "commercial" programmes, experience abroad has demonstrated that the listener must be (a) interested in, and consequently (b) pleased with and grateful for, what he receives. *The sense of obligation must finally be on his side and not on the other.* It is symptomatic that a certain European broadcasting concern charges advertisers for the privilege of providing a concert, *without* any calling of wares, about ten times as much as it charges for direct advertisement.

Commercial experience, therefore, has given a cold factual proof of the principle that the broad-

caster must never be tempted to take advantage of his foothold on the listener's hearthrug. It is a principle which is not special to advertising, but applies to publicity in all senses of the word, and to the broadcaster's own publicity not less than to that of which he is merely a vehicle. It is an instinct, perhaps, rather than a policy argued out on paper, that has guided the B.B.C. in this matter, but the result has been that the principle, whether sensed or posited, has been observed. Announcements, e.g. of the contents of "The Radio Times," have been limited to the merest indications such as one friend could take from another without feeling that he was being pressed or being put on the defensive.

Similarly, explanations of policy made over the microphone have been subject to the rule of *bona fides*, without which the broadcaster has no legitimate footing with the listener. "Feelers," friendly negotiations and the like are as legitimate in the intercourse of the microphone—which under this aspect is only a multiplication, not an intensifying of ordinary contacts—as in other intercourses of life. Anything, in fact, is legitimate that can be done on a basis of trust—but nothing else.

Nevertheless, the quantitative

aspect has to be considered as well as the individual. It is probably impossible for anyone who has not experienced it to appreciate the feeling of irremediable finality that accompanies the release of a critical microphone pronouncement. Out it goes, into more than two million private homes, to the ears of perhaps twelve million people, whom it reaches—not under the "strap-hanging" conditions of their morning and evening papers, nor yet in the mass-atmosphere of the meeting-hall, but under circumstances in which they are all individuals at rest, their daytime armour put off, their minds attuned and receptive. Broadcasting cleverly used is indeed the most powerful publicity weapon that man has yet imagined—a platitude, perhaps, yet one that no executant can afford to lose sight of, lest he forget that in the exercise of power cleverness is neither so necessary nor so impressive as restraint.

Hundreds of thousands of people all over the country heard the sounds of Sir Alan Cobham's aeroplane, together with the subsequent speeches by Sir Samuel Hoare, the Air Minister, and Sir Charles Wakefield, when the famous airman arrived at Westminster after his great Australian flight on October 1st, 1926.

B.B.C. HEADQUARTER'S LETTER-BAG

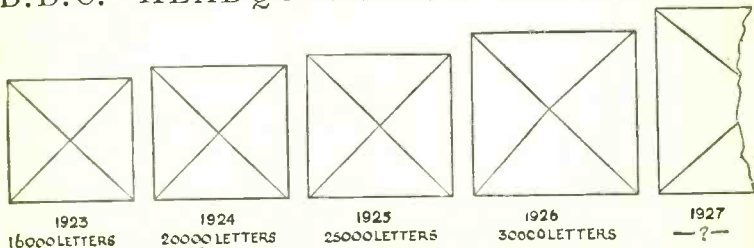

PROGRAMME CORRESPONDENCE ONLY

IT is perhaps not generally realised that this miracle of Wireless—and may the day be far distant when it shall cease to be thought of as a miracle—is itself the parent of many miracles. Thus, within a decade, a great new industry, employing many thousands of skilled craftsmen, has been called into existence; new forms of entertainment and artists of a new genius have been created; the farthest cottage on the moors now instantly hears the music, plays, and speakers of the town; the old heart-breaking sense of loneliness and isolation has been banished from the lives of the sick, the aged, and the infirm; the blind have been set free. . . .

" THE RADIO TIMES "

But there are still other miracles besides all these, and one of them is "The Radio Times." The success of this, the B.B.C.'s official journal, expressed in the solid terms of arithmetic, is in itself a miracle. How else indeed can it be described, this weekly programme paper that sprang like Venus "full-fashioned from the waves"—the waves of ether, not, as in the case of the goddess, the foaming waves of some celestial sea?

To-day the circulation of "The Radio Times" approaches a million copies weekly! No other radio paper in the world—not even in America, where the palm for record-breaking achievements so often goes nowadays—can boast such a circulation. This vast body of regular readers has been achieved by no attractive offers of money prizes or insurance benefits, nor has there been any advertising campaign to promote circulation;

the only direct publicity the paper has received has been a microphone announcement every week reminding listeners that the new issue of the paper is now on sale.

Here surely is the most effective answer to the gibe of those critics of Broadcasting who say that while everybody may have a radio set, nobody listens. The circulation of "The Radio Times" denies that assertion—otherwise incapable of proof or disproof—a million times over, for it means nothing else than that a million listeners (and many more, of course, besides—because each copy of the paper serves a whole household) are sufficiently interested in the programmes each week to buy "The Radio Times" in order to find out what is coming on the air and all about it.

Four years ago "The Radio Times" began with the bare programmes and a few pages of editorial matter—not technical—relating to Broadcasting in general and to the programmes and the work of the B.B.C. in particular. Fundamentally, it has not changed its policy during these years, but it has striven always to develop and perfect its programme service until, to-day, it may fairly be said that no radio set is complete without a copy of the current number of the paper. The programmes now occupy an average of twenty-four pages in each issue, the remaining space in a forty-eight-page number being taken by articles and notes of general interest and by advertisements. As far as space permits, the programmes are fully annotated with notes and pictures that are designed to awaken the interest of the reader and to aid his understanding and enjoyment of the

programmes. Important articles and news of coming events at all the B.B.C.'s Stations appear every week. Among the contributors during the past twelve months may be mentioned Bernard Shaw, Arnold Bennett, H. M. Tomlinson, Bertrand Russell, C. E. Montague, Henry W. Nevinson, Sir Ian Hamilton, Dame Clara Butt, Liam O'Flaherty, Bohun Lynch, Sir Henry Hadow, Professor Gilbert Murray, Sir Walford Davies, etc.

Perhaps the outstanding achievements of "The Radio Times" during the past twelve months have been the two special numbers that were issued, one at Christmas and the other on the occasion of the Beethoven Centenary in March. The Christmas number, with its striking cover by E. McKnight Kauffer, was a notable production, with stories by Stephen Leacock, E. F. Benson, Ian Hay, Mrs. Belloc Lowndes, Denis Mackail, Jerome K. Jerome, and others. And among those who contributed humorous drawings were Arthur Watts, Aubrey Hammond, George Morrow and Eric Fraser.

The Beethoven number was a striking tribute to the great composer, and attracted widespread attention. It was distinguished by contributions from Bernard Shaw, Arnold Bennett and Romain Rolland, and by an eight-page record of the life of Beethoven by Percy A. Scholes (the B.B.C.'s Music Critic and Music Editor of "The Radio Times"), which was illustrated by more than a score of delightful woodcuts by several prominent artists.

With the coming, this year, of the Sporting Broadcasts, when a running commentary is made of some notable football match or other sporting event, listeners have been greatly aided by the publication in "The Radio Times"

of an outline map of the field of play in the case of football, or of the Thames from Putney to Mortlake in the case of the Boat Race, and of the racecourse in the cases of the Grand National and the Derby. Appreciative letters from listeners all over the country have shown this to be a most popular feature of the paper, and one which has opened up a new sphere of usefulness.

"WORLD RADIO"

Having assumed the initiative in the formation of the Union Internationale de Radiophonie at Geneva early in 1925, the B.B.C. undertook a new weekly Dominion and Foreign Programme journal.

This was the first publication of its kind, and its production, at a time when financial success appeared remote, was a test of faith in the future of International Broadcasting. "The Radio Times" had previously carried a feature page giving foreign programmes in a very much condensed form. The B.B.C. policy in launching the new paper is best described in the following extract from the leading article of No. 1 of "The Radio Supplement," dated Friday, July 17th, 1925:—

"It is the duty no less than the privilege of the British Broadcasting Company to bear its part in the development of this new instrument of international comity. It is a truism to say that nothing is calculated to remove misunderstandings and re-establish friendship more than a personal exchange of ideas. If this is true of individual relationships it is no less so of international intercourse; and, surely, when this intercourse is of the informal and recreative character of Broadcast programmes, the effect—first socially, then politically—is likely to be far-reaching."

The primary idea of this journal was that it should be a supplement to "The Radio Times," devoting its space to the interests of foreign Broadcasting. Hence its first title. Its original scope, however, was soon extended, and it was clear that the title "Radio Supplement" certainly did not properly describe the paper as it had then become. Moreover, such a title made it appear rather as a pendant to its sister publication than as a separate publication. "World Radio" was therefore chosen and clearly describes its interests. The change was made in June 1926.

It became evident that there was a demand for the publication, week by week, of the detailed programmes of, at any rate, the chief Continental Broadcasting Stations, together with a chronicle of Broadcasting movements throughout the world. Unfortunately the time factor was an obstacle to the publishing of more than a very few of the chief American Stations, and for this reason, as well as for that of the great distances involved, it was quite impossible to print the programmes of the Dominions. Nevertheless, it was eminently desirable to publish a list of such Stations, giving not merely their wavelengths but also their principal features—call sign, power, and (in some cases) the times of transmissions. This list became a regular and important feature, and took the form of a Time-Table of Stations not included among Programmes, which later became a List of Stations in Order of Wavelength.

From its start "World Radio" received weekly a number of inquiries concerning the identity of certain Stations heard by readers, and decided to create the special service entitled "Which

Station Was That?" in order systematically to answer the numerous questions.

"World Radio" is now firmly established in Great Britain and on the Continent. Technical articles have become a recognised and acceptable feature. In addition to a series dealing in an elementary style with the theory of wireless transmission and reception, there are more advanced articles on concrete problems of reception and the maintenance of sets. Captain Eckersley's series, "Technical Considerations," running throughout the summer of 1927, has been especially popular. Then the foreign language competition has attracted many new readers. Thus, "World Radio" in its third year is much more than a collection of foreign and Dominion programmes. The linking together of national systems and the evolution of Continental "S.B.s" should find in "World Radio" a valuable auxiliary and stimulus. It is believed "World Radio" will go forward not only to a circulation throughout the vast area covered by the programmes which it publishes, but also to become a force contributing constantly and cumulatively to the cause of world citizenship and international amity through the enlightened use of the wireless medium.

OTHER PUBLICATIONS

Despite the far-reaching influence of "The Radio Times" and "World Radio," the use of the microphone itself for publicity purposes and the assistance of the Press, there are still many listeners who have not yet realised the variety and extent of the facilities offered to them. Accordingly it is becoming a new function of the B.B.C. to devise means for bridging this gap and helping listeners to

use their sets to the best advantage.

In education the B.B.C. undertakes the more or less centralised work of school transmissions and adult education. But these for their success require co-operation, both locally and nationally, from other bodies, official and unofficial. The listening end needs both information and organisation. The principal vehicle for informing educational opinions is found in the various conferences and committees which are continually meeting all over the country. The B.B.C. has to undertake the task of keeping its ever-developing work before the eyes of such bodies, welcoming their criticism and considering their suggestions. Practical demonstrations and short addresses by B.B.C. representatives are among the best means of stimulating interest.

The considerable expansion which has taken place in the issue of publications to supplement Broadcasting goes hand in hand with this work. It has been

realised that whilst the primary appeal of Broadcasting must be through the ear, *the eye* can be brought in to help the listener, by means of the picture, the diagram, the printed word. An extensive field is being opened up by these publications, which take the form of opera libretti, school manuals (*e.g.* language and music), and adult "Aids to Study." In the latter are given summaries of the talks dealing with a particular course, together with guidance for individuals and groups of listeners who wish to follow the talks with discussions and reading. The experiments which have been made with these publications show that we are as yet but at an early stage in the use of Broadcasting for purposes of information and culture.

Each new step in this direction brings the B.B.C. into fresh contact with institutions and interests hitherto unaffected by its work, and so increases the need for bringing home to the public what is being put within its reach.

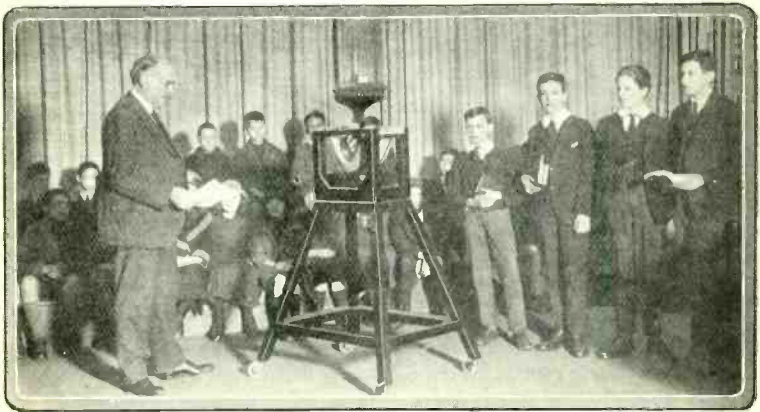

SIR WALFORD DAVIES AND THE CHAPEL ROYAL CHOIR

THE PRESS AND BROADCASTING

HOW have the newspaper Press and Broadcasting adjusted their relations in Great Britain? Before it was determined that Broadcasting in Britain was to be under unified control and administered as a public service, some elements of the newspaper industry considered adopting the new medium, to the possible discomfiture of their competitors. This was the course previously followed in the United States, where Broadcasting was readily incorporated into the machinery of competitive journalism. And, while certain newspaper proprietors in Britain were thinking of following the American lead, some of the great stores and other leading advertisers also contemplated operating their own wireless services as adjuncts to their publicity. Had the American example been followed we know now that chaos would have supervened, with the probable result that there would now be no Broadcasting of any account in Britain.

NEWSPAPERS UNITED

Having agreed not to exploit Broadcasting as against each other, the newspapers formed a united front to protect their interests against the expected deprecations of this unknown new instrument of distribution. Before the Broadcasting Company was actually formed, the newspapers induced the P.M.G. to agree that the new organisation could distribute news only at their sufferance. Thus, when the B.B.C. began to transmit, it found itself considerably handicapped on the news side of its work. There was to be no independent news activity on the

part of the B.B.C. The two bulletins, provided by the Agencies working for the newspaper industry, were to be broadcast as prepared by Messrs. Reuter, and the first was not to go out before 7 p.m. The newspapers believed that under this arrangement they had safeguarded themselves against serious damage from the broadcasting of news.

Some newspaper proprietors then considered how they might participate in B.B.C. revenue in the form of payment for the space occupied by the published programmes. This grew to the dimensions of an attempt at a general boycott. But the B.B.C. held its hand, and allowed events to determine the issue. Then an enterprising advertiser was induced to begin inserting the B.B.C. programmes in the space he bought in a London evening paper, whose circulation rapidly expanded as a result. The boycott collapsed after a few days, and thenceforward the newspapers anxiously sought and published all the programme information they could get. It was demonstrated that the B.B.C. was "big news."

HOSTILITIES BEGIN

The next stage in the development of these relations was due to the realisation of the remarkable hold which Broadcasting was securing on public opinion.

Those newspaper proprietors who still regarded Broadcasting as the natural enemy of the printed word, with those who were just jealous of its amazing popularity, sought in a variety of ways to discredit the B.B.C. Hostile correspondence was inspired, and big attacks were launched

on the alleged bad programmes. These attacks took place at intervals which could be judged in advance with reasonable accuracy. In between hostility evinced itself in periodical sniping. For either the large-scale attacks or the sniping to succeed it was necessary so to damage the *morale* of the B.B.C. that it would be induced to reply with the same truculence. But the B.B.C. refused to be "drawn." It would not "play." Great care was taken to distinguish between friendly constructive criticism and the criticism calculated only to cripple. For it must be kept in mind that even while these "interested" attacks were in progress the vast majority of the newspapers and periodicals of the country were offering valuable straightforward criticism which exercised a great deal of influence in shaping both policy and programmes. By paying due attention to the latter, and by disregarding the former, the B.B.C. went on building its programmes to the best of its ability.

ATTACKS FAIL

The failure of large-scale "interested" attacks was followed by a period of comparative quiescence. The newspaper front did not retain its unbroken character. There were important defections, notably by those who made overtures to the B.B.C. to be allowed to provide programme material in return for courtesy acknowledgment. The first "firm offer" of this kind was received towards the end of 1924, when B.B.C. funds were low. The Licence did not rule out the acceptance of such provided material; it did in fact specifically admit it. Here then was a needed opportunity of enriching programmes, and also of weaken-

ing the hostility of the newspapers. The result was a series of about twelve programmes spread over some eighteen months, provided by various newspapers, both in London and the Provinces. With a satisfactory increase in revenue, and a general improvement in relations with the Press, the practice of accepting programme material provided in the studios was discontinued. It was not a practice which the B.B.C. meant to become a permanent feature of British Broadcasting; but as a temporary measure it was fully justified on grounds of expediency. Thereafter, all proposals from newspapers, as from other outside organisations, were to be considered primarily as "outside broadcasts," that is, that where entertainments were being given in the ordinary way, the B.B.C. would be disposed to consider taking excerpts if programme values justified this course. The element of advertising was not to be obtruded in any way, direct or indirect, beyond bare courtesy acknowledgment.

FRIENDLY CO-OPERATION

By the end of the four years of the Company's Licence, relations between Broadcasting and the Press were much more satisfactory than at any time previously. The policy of deliberate "B.B.C. Baiting" and "interested" discrediting was gradually abandoned in the face of accumulating evidence of its boomerang effect. Moreover, by the moderation of its policy, and by its constant endeavours to establish a firm basis of friendly co-operation with the Press, the B.B.C. changed many enemies into allies in public service. The more far-sighted elements in the newspaper industry recognised that Broadcasting had come to stay and that



CAPTAIN ECKERSLEY EXPLAINS

Press Demonstration of the European Technical Commission Wavemeter

they were fortunate in having it handled as in Britain rather than as in the United States.

It is not surprising therefore that when the old contract for news expired with the Broadcasting Company at the end of 1926, the negotiations for renewal were conducted in a spirit of remarkable cordiality. Naturally the newspaper interests sought to stabilise and perpetuate the old arrangement; whereas the B.B.C. asked for greater freedom in all directions. The result was a reasonable and amicable compromise, which took the form of a year's agreement. The B.B.C. would broadcast running narratives and commentaries on all the leading sporting events and great public occasions, as well as put out more comprehensive and varied news bulletins, the first to be at 6.30, half-an-hour earlier than before. These extensions were considered to be adequate as a temporary

measure. It was clearly understood on both sides that a new agreement with more latitude would be sought for 1928. Meanwhile the 1927 agreement has worked very well. On the score of general policy there has not been any large-scale Press attack on Broadcasting since the attempt in the spring of 1927 to shake the nerve of the new Corporation because of its alleged Government control. Needless to say this failed. For the rest, relations have continued to improve. Newspapers are less and less inclined to discover imaginary devious and dastardly motives in programmes broadcast. They are increasingly inclined to bring forward suggestions for active co-operation to the mutual advantage of the listener, the B.B.C., and themselves. This may be regarded as concrete recognition of the spirit of partnership in public service

which it has been the earnest endeavour of the B.B.C. to foster at all its points of contact with other public organisations.

LINGERING "DIE-HARDS"

While "sweet reasonableness" is now definitely in the ascendant in newspaper circles, there is, of course, the inevitable "diehard" minority which still believes that the printed word should crush the spoken word before it gets too strong. There was a time when, if the "wild men" of the newspaper industry had had their way, the consequences to Broadcasting might have been damaging. Not that they would ever have crushed Broadcasting, but they might have materially impeded its progress. That time, however, is now passed. The B.B.C. is no longer based on a provisional experimental constitution: it is now firmly established. The B.B.C. has founded the nucleus of a Press of its own which will expand to be an important safeguard of, and auxiliary to, the microphone. But of course the ultimate factor is public opinion. Herein the B.B.C. is firmly entrenched, and there is not the possibility of the success of a campaign designed to crush or mutilate Broadcasting in this country. Nor does it appear likely that the "diehard" minority will ever again secure the power to test these factors. The partnership conception is so well rooted that it should bear wonder-

ful fruit in the years and generations to come.

A DEBT TO THE PRESS

While Broadcasting owes and gladly admits a debt to its numerous friends of the Press, there are not wanting those who foresee an interesting and beneficial reaction on the Press itself as a result of this new contact. The journalism of serious comment, of imaginative detailed description, and of thoughtful presentation generally will become increasingly important. The editorial and literary mind as distinct from the news mind will tend to increase its influence over both the tone and content of the newspaper and periodical. This provides a new field for speculation as interesting as it is controversial. The B.B.C. holds that whatever temporary adjustments are necessary, the advent of Broadcasting will serve not only in the provision of programmes, but also in the exercise of its influence and example at all the points at which it impinges upon other agencies whose task it is to inform, amuse, or instruct the public mind.

The B.B.C. is now engaged in the later stages of experiments, the results of which will determine the date of the establishment of world-wide broadcasting and, in particular, of Empire broadcasting.



THE RADIO SOCIETY OF GREAT BRITAIN

Patron

H.R.H. THE PRINCE OF WALES, K.G.

President

Sir Capel Holden, K.C.B., F.R.S., M.I.E.E.

Acting Vice-President

Captain Ian Fraser, C.B.E., M.P.

Hon. Treasurer

Professor W. H. Eccles, D.Sc., F.R.S.

Hon. Secretary

H. Bevan Swift, A.M.I.E.E. (G2TI).

Hon. Secretary, General Committee

J. F. Stanley, B.Sc., A.C.G.I.

Hon. Members

Sir Oliver Lodge, D.Sc., LL.D.,
F.R.S.

Senator G. Marconi, G.C.V.O., D.Sc.,
LL.D.

Editor Secretary

J. A. J. Cooper, Member I.R.E., Grad. I.E.E., F.R.S.A.

Council

O. F. Brown, M.A., B.Sc.

H. de A. Donisthorpe.

G. F. Gregory, A.M.I.E.E.,
A.M.I.M.E. (G5PZ).

J. R. Halliwell.

A. Hambling, Associate I.R.E.
(G2MK).

F. H. Haynes (2DY).

Thos. Hesketh, M.I.E.E.

R. J. Hibberd, Member I.R.E.,
F.R.S.A.

R. Hodge.

Gerald Marcuse (G2NM).

F. A. Mayer (G2LZ).

H. S. Pocock.

E. J. Simmonds, Member I.R.E.,
F.R.S.A. (G2OD).

Address

53, Victoria Street, London, S.W. 1.

THE RADIO ASSOCIATION

Officers and Council for the Year 1927

President

HIS GRACE THE DUKE OF SUTHERLAND

Council

Lieut.-Com. the Hon. J. M. Kenworthy, R.N., M.P. (Chairman).
Lieut.-Col. C. L'Estrange Malone, F.R.Ae.S. (Vice-Chairman).

C. M. R. Balbe, A.M.I.E.E.,
A.C.G.I.

Major J. H. Beaumont.

A. E. Chapman, F.R.A.

Prof. E. E. Fournier D'Albe, D.Sc.,
F.Inst.P.

J. L. Jeffrey, F.R.A.

S. Landman, M.A.

R. R. Pecorini, F.R.A.

A. W. Sharman, F.R.A.

A. J. V. Underwood, M.Sc.,
A.M.I.Chem.E.

E. J. Nock Winstone, F.R.A.,
A.M.I.E.E.

B.B.C. HANDBOOK

Hon. Treasurer

David Finnie, M.A., Chartered Accountant.

Hon. Secretary

S. Landman, M.A.

Hon. Technical Secretary

E. J. Nock Winstone, F.R.A.

Head Office

22, Laurence Pountney Lane, London, E.C. 4.

THE WIRELESS LEAGUE

Chairman

The Hon. Sir Arthur Stanley, G.B.E., C.B., M.V.O.

Vice-Chairman

Sir Lawrence Weaver, K.B.E.

General Secretary

A. E. Parnell.

Technical Secretary

H. H. Cowley.

Executive Committee

C. G. Ammon, M.P.

Sir Harry Brittain, K.B.E., M.P.

Captain Ian Fraser, C.B.E., M.P.

Major L. Hore-Belisha, M.P.

Sir Fred. Radcliffe, K.C.V.O.

Sir Landon Ronald.

Head Office

Chandos House, Palmer Street, Victoria Street, London, S.W. 1.

THE WIRELESS ASSOCIATION OF
GREAT BRITAIN*Chairman*

Earl of Drogheda, C.M.G.

Council

Earl of Northesk.

George Gordon.

Major Charles F. C. Jarvis.

Lieut.-Com. L. Mansfield Robinson, R.N.

Secretary

H. Anthony Hankey.

Head Office

7, Southampton Street, London, W.C. 1.

THE ART OF LISTENING

By FILSON YOUNG

WITH people who refuse to have anything to do with Broadcasting I have a certain amount of sympathy. They are not all so foolish as we who have discovered how to use it rightly sometimes think. There is such a thing as being over-entertained; and people who live in large towns and have the means to pay for entertainment are apt to get too much of it rather than too little, and consequently to value less what they do get.

Every new invention that brings desirable things more easily within our reach thereby to some extent cheapens them. The man who has to walk five miles, and perhaps deprive himself of some little luxury, in order to hear a symphony, will probably enjoy it more than the man who has only to turn on a switch and sit down in an arm-chair. There are people who love music, for example, very much, but who like to keep it as something rare and precious in their lives, to be savoured and enjoyed deliberately, with a mind singly devoted for the time being to that enjoyment, and that enjoyment alone. To such people the idea of having music, so to speak, on tap, to be turned on like gas or water in their homes, is not attractive; and the abuse of Broadcasting which they find in the houses of some of their friends who are in possession of indifferent receivers encourages rather than weakens their disinclination to avail themselves of it. I think they are wrong; but people are sometimes wrong for very good reasons.

The truth is that there is too

much rather than too little entertainment for town dwellers. I am thinking particularly of them at the moment, because to the isolated dweller in the country, the invalid, the aged and the lonely, Broadcasting can be one of the greatest of blessings. But the town dweller, now that amusement and entertainment have become commercially organised industries, tends more and more to have everything brought to him, and less and less to go out in search of the things that constitute a full life. The age of strenuous physical adventure, of travel and exploration, is almost over; and we seem to be entering upon a kind of arm-chair period of civilisation, when everything that goes to make up adventure is dealt with wholesale, and delivered, as it were, to the individual at his own door. This being so, we have to learn a new technique in life; we have to learn how to use, and not abuse, the marvellous inventions that make facile and cheap what were once the rewards only of strenuous effort, patience, toil or adventure.

THE LISTENER'S PART

There are thus a right and a wrong way to use Broadcasting. It is the business of the Broadcasting organisation to give the best of everything that can truthfully, usefully or agreeably be transmitted; but it is the business of the individual listener to discriminate and choose between what he should listen to and what he should leave alone. There are people, I believe, who have their wireless sets switched on practically the whole afternoon and evening;

they take what comes, and loudly complain if what they hear is not to their taste. Now there would be something quite wrong with Broadcasting if any individual listener really enjoyed the whole programme from afternoon to midnight. Such a state of affairs would indicate that the broadcasting organisation was far too narrow in its outlook, and that it was not providing anything like broadly enough for the many and various needs of its many and various listeners.

INTEMPERATE LISTENING

No one, however leisured his or her life, ought to listen all the time. There would be something excessive and intemperate about such a person. Yet, like so many other things, listening to wireless transmissions may become a habit, and a bad habit. Fear that one may be missing something by not listening is one cause; but a more insidious one is the feeling that something is going on somewhere, and that rather than take the trouble to do anything else for oneself, one might as well listen to it. That, of course, is as great an injustice to the art of Broadcasting as it is to the listener himself. It is a misuse of what, properly used, can be a very real boon and addition to the æsthetic life of any household. I would urge listeners to cultivate the art of using their wireless receivers intelligently and artistically, so that the immense care and trouble that are taken in compiling and presenting the programmes shall achieve their true direction and effect.

THE ART OF CHOOSING

The first advice that I would give to the listener, after the first enthusiasm and wonder at the miraculous part of the business have quieted down into familiarity,

is that as much restraint should be exercised in the use of Broadcasting as is exercised in the enjoyment of any other of the good things of life. To this end an intelligent study of the programme will contribute very materially. Too many people simply switch on their receivers at a certain habitual hour, and then praise or blame Broadcasting according to the measure of their personal appreciation or otherwise of the item that they happen to be listening to. I think that one should look at the programmes beforehand and decide what one wishes to listen to, and listen only to that. It is inevitable, if the programmes are rightly compiled, that there will be many items to which any given listener will have no inclination to listen; and he will be very well advised not to listen at all at such times. But if one listens with discrimination, prepared for what is coming and anxious to hear it, one will enjoy it very much more than if it is simply heard haphazard and by accident.

Our enjoyment of anything is to some extent dependent on what we bring to it ourselves. You cannot love or enjoy anything without giving a part of yourself to it; and the listener to the wireless transmission of music or speech must play his part if the purpose and effect of the transmission are to be fully enjoyed. It is not at every moment of one's life that one wishes to listen to music; it is not always that one desires to hear a talk or a lecture; it is not always that one wants to hear a play, not always that one wants to be instructed; but at some time or other we desire all these things. The listener, in other words, should be an epicure and not a glutton; he should choose his broadcast fare with discrimination, and when the time comes

give himself deliberately to the enjoyment of it.

There is such a thing as listening carefully, and there is such a thing as listening carelessly. In my own experience I have often found that music which may seem uninteresting and heavy will at least be much more interesting and enjoyable if one listens carefully to every note. That requires a little effort; and that is one of the things the listener, if he is to get full value, has to bring and contribute to the general effect.

BEAUTY AND PLEASURE

Another point which may seem fantastic to some readers, but which has a very definite effect, is the appearance of one's receiving set. Anything that is associated with art, or with a thing so wonderful and mysterious as wireless transmission and reception, should be beautiful in itself. A listener whose receiving apparatus consists of a pair of rusty ear-phones at the end of a tangle of wire will in time come to rate what he hears as cheaply and contemptuously as he has treated the mechanism which brings it to him. In the same way an ugly box with valves sticking out of it, a number of untidy odds and ends of wire and a loud-speaker in the form of a monstrous horn, are so aesthetically displeasing that it is difficult to associate them with pleasure and artistic enjoyment. Your wireless set, however simple or however elaborate, should never be an ugly thing. Personally I do not like things that disguise themselves as something else; and there is no reason why a valve set should be made to look like a writing bureau or a loud-speaker be disguised as a flower-pot or a lamp-shade. One of the most beautiful receivers I have ever seen had panels of glass, and the

components inside it were not only beautiful in themselves but beautifully spaced and arranged; the thing looked what it really is—a kind of magic box. There are loud-speakers of the disc type which are not ugly in themselves and yet suggest something of the mystery and beauty of the miracle of which they are the medium. There is no reason why a wireless set should be obtrusive or dominate the room; and there is no reason whatever why it should not be as carefully designed as any other piece of furniture. But whatever it is, treat it at least with the respect and care that you would devote to a valuable clock; for it will do much more marvellous things than tell you the time.

To sum up, I would urge upon those who use wireless to cultivate the art of listening; to discriminate in what they listen to, and to listen with their mind as well as their ears. In that way they will not only increase their pleasure, but actually contribute their part to the improvement and perfection of an art which is yet in its childhood.

Instruction and entertainment were combined in a flying lesson broadcast by Sir Alan Cobham, the famous airman, in May 1925. Miss Heather Thatcher, the actress was the pupil. Sir Alan's words were transmitted from the aeroplane to a receiver on the ground, and together with the noises connected with the aeroplane and its landing after the flight, were broadcast from the London Station.

The song of the nightingale can now be regarded as an annual event for listeners. Continental people look forward to this Broadcast from the Surrey woods almost as keenly as British listeners.

Parlez vous français ?

¿ Habla Ud español ?

Parla Lei italiano ?

Sprechen Sie deutsch ?

Товорите ли Вы на русском ?

貴下ハ英言トヲ言ヒマスカ

LEARN
LANGUAGES
AT
BERLITZ

To acquire rapidly a practical SPEAKING
knowledge of Foreign Languages THE
BERLITZ METHOD is without comparison

PRIVATE LESSONS
DAY AND EVENING CLASSES

ENGLISH LESSONS FOR FOREIGNERS

TRIAL LESSON FREE

LONDON { 321 Oxford Street, W. 1
60 Queen Victoria Street, E.C. 4
3 Harrington Road, South Kensington
2 Queen's Road, Bayswater

BIRMINGHAM, 32 Paradise Street

BRADFORD, Penny Bank Buildings

LIVERPOOL, May Buildings, Lord Street

MANCHESTER, 41 Oxford Street

NEWCASTLE-ON-TYNE, Barras Bridge

GLASGOW, 206, Sauchiehall Street

EDINBURGH, 100 Princes Street

etc., etc.

300 BRANCHES THROUGHOUT THE WORLD

STUDY OF LANGUAGES

THE expansion of foreign trade was never more urgent than at present. It is a truism that in order to be able to sell abroad, one has to know intimately the psychology of the buying public concerned. He who knows the country's history and real economic position, as well as its prospects, has a unique advantage in competition. It is impossible to acquire such knowledge unless one knows the language of the country in which the prospective market is situated.

Many British firms still use English in all their correspondence with places abroad, such as the Republics of South America. They even advertise in English in foreign newspapers. The Prince of Wales mentioned recently that he came across British paint in South America with instructions on the tin printed in English. Although British goods have very great prestige in all South American states, sales are lost simply because the man who buys a tin of such paint does not understand the instructions, and therefore does not know how to use it.

ASSET TO TRADE

Admitting the urgency of expanding export trade, the general study of foreign languages becomes a matter of national importance. Many of the young men and women engaged in commerce today in export houses would improve their prospects considerably if they knew one or two foreign languages. The knowledge of languages by itself, unless one has academic qualifications, is not a paying proposition, but when coupled with experience of some branch of commercial science it becomes an important asset to the

commercial house and to the individual.

Most people imagine that the study of foreign languages is a very lengthy process, coupled with the great expense of residence abroad. It used to be so before Broadcasting came into existence. Nowadays, with wireless in nearly every home, with regular language courses such as the B.B.C. radiates, and with the growing practice of "reaching out" for distant Stations, foreign languages are almost on tap everywhere.

LANGUAGE TALKS

There is a certain definite procedure in studying a foreign language. Before any real success can be recorded the student must get used to foreign sounds. Wireless offers a means of doing so at a minimum of expense. Once the ear can distinguish between separate words, one can with confidence take up any of the existing methods of acquiring languages, and by studying either at home or at a school make rapid progress with the daily aid of wireless. Extensive reading and writing under the direction of a teacher or postal school will enable anyone with average intelligence to master a language within two years.

Talks are broadcast from the London and provincial Stations on French, German and Spanish. These talks are not intended to be complete courses. The aim of the B.B.C. is to show a definite line of study by outlining to listeners the main features of the language, as well as indicating easy stages in reading.

"World Radio," which brings news of Continental programmes to British listeners, includes in its columns all the foreign talks broadcast from British Stations; and

holds competitions in essays in foreign languages, giving valuable cash prizes to registered readers.

During the long winter evenings most people, particularly those who work in commerce all day, might easily find an occasional hour for the study of languages. An hour a day amounts to three hundred and sixty-five hours in a year—more than sufficient to master a language in order to be able to read and write sufficiently clearly to be understood by a native.

There are three definite groups of European languages with a "key" language to each. French (or rather Latin) is the key language of the Latin group, which comprises French, Italian, Spanish and Portuguese. German is the key language of the Teutonic group of languages, which consists of German, Swedish, Norwegian, Danish,

Dutch and Flenish. Russian is the key language to the Slavonic group of Russian, Polish, Bulgarian, Serbian and Czecho-Slovakian. If one studies the key languages, the rest is easy; thus it is not such a difficult matter to become a linguist with a mastery of, say, twelve languages.

A knowledge of French is the unlocking of the door to the Latin group, while German qualifies for trade in Central Europe. The Slavonic group is not of much importance at the moment from a commercial point of view.

An experiment of considerable and immediate practical value was the attempt to transmit the opening speech of M. Painlevé from the League of Nations Assembly in Geneva on September 7th, 1925. Sir Austin Chamberlain's speech on the following day was also broadcast with considerable success.



RED INDIAN CHIEFS IN THE LONDON STUDIO

French

GERMAN

Spanish, Italian or Russian

Anyone can now speak and understand one or more of these languages—Hugo's have made it as easy as ABC.

NO longer need thoughts of irregular verbs or problems of grammar put you off from acquiring knowledge which you know is so necessary both in social and business life. Hugo's have veritably revolutionised language teaching; they have found a way by which anyone with scarcely any effort at all can learn to speak a foreign language. The drudgery and boredom previously associated with this subject are banished, and what was once a task has been changed into a pleasant recreation. This is no exaggeration; during recent years over 500,000 students have *proved* that Hugo's claims are justified.

HUGO'S

Postal Self-Tuition Language Courses

Each course costs only
5' monthly
or 55/- paid
in advance.

contain everything necessary for acquiring a practical knowledge of a language. All non-essentials are eliminated and with them every atom of drudgery. Hugo's method is therefore not only the easiest but also the quickest in existence.

Each Course consists of 50 carefully graduated lessons with the imitated pronunciation of every word, a set of reference books, and in addition six oral lessons (privately or in class) by which you can prove for yourself how much you have learnt, as well as obtain additional conversation practice.

A free lesson and booklet "The Common-sense Way of Learning Languages" will be sent free of all charge on receipt of a post card. Please mention B.B.C.

For those learning at home, Hugo's "Self-Tuition" Courses are the only way to acquire languages quickly and thoroughly. Some people imagine they can master a

LANGUAGE BY GRAMOPHONE

alone. This is impossible, no matter how the Course is arranged.

Hugo's new "Two-Voice" records, the best in existence, are only for students, knowing French, desiring extra conversation practice. No records can do more. The "Hugophone" series is offered for 7 days' free trial. Let actual test convince you that it has no equal. Prospectus on application. Free Demonstrations daily.

HUGO'S LANGUAGE INSTITUTE

103, NEWGATE STREET, LONDON, E.C.1

205, EARL'S COURT ROAD, S.W.5

64-66, OXFORD STREET, W.1

ANIMALS CALLING!

THE R. S. P. C. A.

(Royal Society for the Prevention of Cruelty to Animals)

ASKS YOU TO LISTEN TO THE

CRIES OF THE MANY THOUSANDS OF ILL-USED, NEGLECTED,
HALF-STARVED ANIMALS IN THE COUNTRY, AND TO ASSIST
THE SOCIETY IN ITS EFFORTS ON BEHALF OF THOSE ANIMALS

Please report any case of cruelty to an animal to The R.S.P.C.A., 105
Jermyn Street, London, S.W. 1 (Telegrams : "Cruelty," London ;
Telephones : 5433 and 5434 Gerrard).

NEW ZEALAND *Imperial Bee* Honey

Thick, creamy and delicious. Nature's
finest food. It contains vitamin B
and is ALL nutriment, easily digested
and mildly laxative. It is guaranteed
Pure and without Preservatives.

*Of all Stores, Grocers, etc., in r's
and y's screw-top Glass Jars. If
any difficulty in obtaining locally
write to*

SOLE EUROPEAN AGENTS

A. J. MILLS & Co., Ltd.
14 Tooley Street, LONDON, S.E.1



*"Imperial
Bee Esq."
Regd.
Trade
Mark.*



EMPIRE PRODUCE

ANNOUNCERS' ENGLISH

By A. LLOYD JAMES

A RECENT Anglo-American conference upon the English Language has called forth an abundance of criticism in the Press, and the publicity thus afforded to the subject has served to bring home to us the fact that there is such a thing as the Language Problem. As a rule, language problems are not considered worthy of attention until the languages are dead; then, a thousand years after a language ceases to be spoken, we proceed to indulge in archæological exercise, digging amongst the ruins for the fragments of forgotten tongues. In the meantime, we have forgotten that we move in the midst of living tongues, which are as slowly and steadily becoming obsolete as those that went before them. Why try to study the principles governing the life of languages from the fossils of dead tongues when the living tongue is ready to hand? But that is another question.

For the moment we are concerned with a very living problem, so let us understand its nature and the part played in it by Broadcasting.

SPREADING A TYPE

The B.B.C. is responsible for a feature that has never hitherto been present in the life of any language since the world began: it enables a certain type of language to be heard simultaneously over the whole extent of these islands. Soon its voice will be heard over the whole world.

This means that hundreds of thousands of children, with whom the future lies, are now hearing a type of language that is, in the

majority of cases, quite unlike the language that their parents use, and that they hear around them.

That is the only fact that is of importance: we may either accept this fact as interesting and dismiss it without further attention, or we may ask ourselves whether this fact is likely to have any bearing upon the future of the language. Possibly it is more intelligent to adopt the latter attitude, but even here we must avoid the temptation to exaggerate the importance of the fact that we have observed.

ACCEPTABLE ENGLISH

Having made this reservation, and having accepted the fact as evident, we cannot fail to observe further that any public body having this potential power over the language would indeed be ill-advised to give no thought to the type of language with which it floods even the remotest schools and hamlets of the land. It is above all things essential, whatever be the degree of influence we assign to this Broadcast speech, that the type of English used shall be a good one. That is how the B.B.C. is concerned, and the finding of the type of language most acceptable to the majority of the nation is one aspect of the language problem. If children throughout the land are influenced by the speech they hear Broadcast, then let the influence be for good and not for ill.

The B.B.C. is convinced, as the result of its experience, that there is a type of English that is generally acceptable to the large body of listeners; it is equally convinced that there are other types

which call forth protests from all over the country. To attempt to define this type of acceptable English is beyond the scope of an article, but we may make some general comments upon it:

1. It is not, of necessity, used by all people who can be described as educated.

2. It is not found in speakers of any one particular part of the country.

3. It is not the prerogative of any social class, of any university, or of any profession. Indeed, some professions are notorious for not using it.

4. It seems to steer a course midway between the lapses of the uneducated and the affectations of the insufficiently educated.

5. It is doubtful whether young people use it: they are setting the fashion of their generation.

This question of a widely acceptable variety of language is met with in all the languages of the world; a native of Abeokuta, for instance, will be very outspoken on the type of Yoruba spoken by a native of Lagos.

But there is another aspect of the Language Problem that is in a remarkable degree peculiar to English: it is the question of alternative pronunciations. These arise from many causes, *e.g.* uncertainty of the value given to consonant letters, length of vowel sounds and position of the accent. For example:

Is the *C* in *Celtic* hard or soft?

Is *infinite* to be pronounced to rhyme with *fine night* or with *in it*?

Is *laboratory* to have the accent on the first, second or fourth syllable?

AN AUTHORITATIVE LEAD

Possibly there is no language in the world so full of enigma and inconsistency as our own: it is time some authoritative body

gave us a lead in doubtful cases, and here the B.B.C. has a very peculiar degree of authority, for by constantly repeating *one* alternative it will give that one greater currency and so tend to bring about the disuse of the others. This will be a boon to many of us, and a blessing to those millions of foreigners who learn our language. The Advisory Committee on Spoken English has for its special task the decision of such doubtful cases: its decisions are for the use of the B.B.C. staff in the discharge of their public duty before the microphone.

These decisions are difficult to arrive at, for the reason that there is often nothing to choose between the alternative pronunciations of a given word. There is no absolute standard of right in most cases, other than the custom of educated speakers whose calling makes them most familiar with the use of the word.

But a decision is advisable and expedient: it is arrived at only after much discussion, and after a consultation of all the recorded pronunciations of the word in question; finally, it is placed on record for the benefit of the B.B.C. officials to guide them in their perplexity and to protect them from ill-informed criticism.

THE COMMITTEE AT WORK

It will be of interest perhaps, as showing both the nature of the task and its complexity, to quote briefly from the minutes of a typical meeting of the Committee—

“It was agreed that it was desirable to determine certain broad principles of pronunciation and to draw up rules, based thereon, for announcers, *e.g.*

- (a) Differentiation of vowel sounds
 - (1) in stressed syllables,
 - (2) in unstressed syllables.

- (b) Purity of vowel sounds.
- (c) The 'h' in words beginning with 'wh.'
- (d) The pronunciation of untrilled final 'r,' and the medial 'r' before consonants.
- (e) Recognition of the broad 'a' (of father) in words such as mirage, garage, Rajah. Adoption of French 'age' sound."

INTERNATIONAL ASPECT

Lastly, there remains to be mentioned the international aspect of the language problem, which is briefly this:—Up to the present, in the world's history, it has invariably happened that when a language has spread over a large area it has split up into several languages which have ultimately become mutually unintelligible: Is this to be the fate of the English Language? Are England and America to have separate languages? Will disintegration be delayed by the increasing degree of communication between the two countries? What language is to be used when we broadcast to America or America broadcasts to us? Can they find, in America, a generally acceptable variety of American that will do duty for the Eastern States, the South, the Middle West and the Pacific Coast, all of which have their dialects? Can, in short,

anything be done to arrest the disintegration that shows alarming signs of having set in? Here, again, it is as easy to ignore the signs as it is to exaggerate their significance. All that we can say is that at the present stage in the history of the English language, many English people are not easily understood in America and many Americans are not easily understood in England. Will the measure of unintelligibility be greater in a hundred years' time or less? Perhaps, when both English and American are dead languages, some learned central Asiatic will rummage among the dead bones of these forgotten tongues and laboriously establish that they were once identical. On the other hand, they may never die; indeed they may never become separate languages, if an enlightened generation realise that the language problem wants handling with intelligence. In the meantime the B.B.C. is not unmindful of all these aspects of the language problem, for it may be that the hope of the future lies in the Broadcasting of the spoken word.

A missing dance partner, wooden legs, false teeth and attache cases by the score are among the things which the B.B.C. has at some time or other been asked to trace.

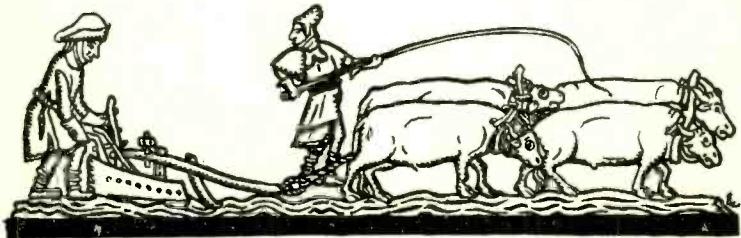

From the B.B.C. Pamphlet, "One Hundred Years of Working-class Progress," by G. A. Ross

WIRELESS AND THE BLIND

By CAPT. IAN FRASER, C.B.E., M.P.

THE ordinary listener enjoys wireless; the blind listener needs it. Broadcasting might have been invented for the blind by a philanthropist who desired to give them the best thing they could have, so exactly does it meet their need for recreation and instruction. Broadcasting is the blind man's newspaper, his entertainer, his musician—indeed in every way his Guide, Philosopher and Friend.

The busiest blind man, and there are nowadays hundreds who lead extremely active lives, has an odd hour or two at intervals when there is no one available to read or walk with him. If it were not for his wireless set, he would probably sit and wait. He might read Braille, many do this with infinite pleasure; but some who have lost their sight in adult life, notably our blinded soldiers and sailors, cannot learn to read with their fingers with such fluency that the effort of reading is forgotten. In spite of heroic efforts it remains a fact that in this country the majority of blind people are not busy, nor can they afford readers or guides, nor can their relations or friends, however kindly disposed, find time, with the urgent necessity of caring for a family or going out to work, to help them pass the lonely hours.

Into this world from which light has disappeared has come an agency which for its operation and fulfilment does not need light. At the service of every blind man and woman in Britain is a storehouse of perpetual audible entertainment and education, if only we can clear away the one remain-

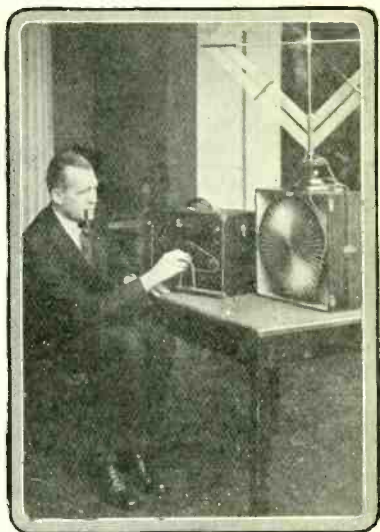

CAPT. IAN FRASER

ing obstacle. Parliament has granted a free wireless licence to the blind; funds have been raised to put "The Radio Times" in Braille, and many hundreds of individual listeners have presented wireless sets to blind institutions or direct to blind persons of whom they have heard.

There are still unfortunately thousands who cannot afford a wireless set, and it is my hope that some of those who read these lines may dig out from that dusty cupboard or shelf a wireless set which has been scrapped, get it put into working order, and present it to a blind man living near.

The average blind man or woman can operate and care for a wireless set without assistance. Some with

whom I am acquainted are extremely clever with their fingers and have made themselves sets, in some cases even winding their own coils and conducting elaborate experiments.

The parallel between the problems which have for years faced blind people and those interested in their welfare, and some of the problems of the B.B.C., is rather interesting. Years ago at St. Dunstan's a successful effort was initiated to enable some of the blinded soldiers and sailors to appreciate football matches, in which before the War they had taken a great interest. Parties would be organised to go to the Cup Final or some similar match, and gradually a technique was developed by the guide who accompanied them which resembles the technique of the running commentary so well known to and appreciated by all listeners. Five years ago I myself followed the Boat Race on a launch, a friend standing by me explained what

was happening. Now all the world which cannot go to see the Boat Race can "hear" it. Many of the experiments which I made, and which doubtless have been made over and over again by blind men in the past, with readers and reading aloud, have been repeated by the B.B.C. in their effort to arrive at the best method of conveying thought to the brain by means of the ear.

Just as ten years ago those of us who were blinded in the War had to learn to be "read to"—for in England the art of reading and listening had been killed by the popular newspaper—so has the whole British public in the last few years had to learn the same lesson. In my opinion much of the criticism of B.B.C. Lectures and Talks was due to the fact that listeners had not learnt the art of concentrating with the ear. The B.B.C. has rendered an incalculable service to the blind, for which the blind community is extremely grateful.



"THE RADIO TIMES" IN BRAILLE

A blind listener enjoying the wireless programmes with the aid of "The Braille Radio Times," which is now specially prepared for those who are unfortunately "in the dark"

"THE BRAILLE RADIO TIMES"

IT is no exaggeration to say that wireless has revolutionised the outlook of the blind world. With the head-phones on his ears, a blind man is equal in all respects to a man with sight; the whole world is open to him, and he can become acquainted with life from every aspect revealed by the microphone.

Accordingly, since the inception of wireless, the need for a reliable programme in Braille has been obvious, and the National Institute for the Blind, the largest institution of its kind in the world, has been unceasing in its efforts to issue a Braille edition of "The Radio Times." A difficulty, however, hindered its earlier production. The embossing presses at the Institute were working at full capacity and no new publications could be undertaken with the then existing plant. Accordingly, it was with deep gratitude that the Institute accepted the kind offer of the British Broadcasting Corporation (who from the first were much interested in the proposition) to broadcast an appeal for funds sufficient to enable the Institute to purchase the necessary additional plant. The Chairman of the Institute's Executive Council, Capt. Sir Beachcroft Towse, V.C., K.C.V.O., C.B.E., made the appeal, and backed up by an announcement kindly made by the Editor of "The Radio Times" in the columns of that paper, it was immediately successful. In fact the ready and generous response to this appeal is a remarkable proof of the keen interest of the general public in anything that touches its imagination by promising to lighten the lot of the less fortunate.

"The Braille Radio Times" is now an accomplished fact, and 1500 copies of this periodical are being sold weekly—the circulation increasing with every issue. The journal gives an authoritative *résumé* of programmes broadcast from the English and Welsh Stations, by permission and with the kind co-operation of the British Broadcasting Corpora-

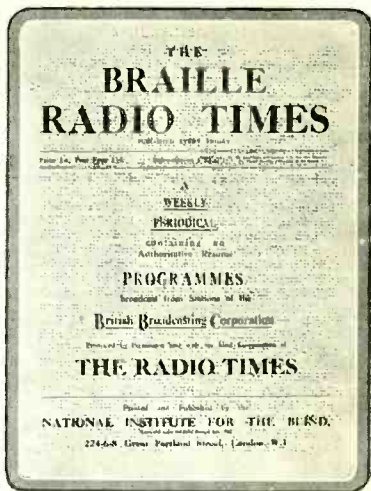

tion and "The Radio Times." As it was necessary to limit the size of the paper, for the time being the programmes of the Scotch and Irish Stations are omitted; but as it is the object of the Institute to enhance as far as possible the value of the periodical, there should be no reason why, in the near future, the programmes of all Stations should not be included.

The periodical is sold at the nominal price of 1d. per copy, but many supporters of the Institute have subscribed donations to cover the cost of the free issue of the paper for one year to blind people unable to afford to pay anything at all.

Although in an abbreviated form, every main item in the programmes mentioned is included, and wherever possible additional information is given relative to operas, ceremonies and public functions. For instance, the scene, period and time of a play are always given, as such details greatly assist the blind listener to visualise the action.

The arrangement follows the actual

"Radio Times" as far as possible, but to save space, regular features are summarised at the beginning of each issue, while an item recurring during the evening is grouped with the separate times as one entry. The programme of each Station begins on a new line and the beginning of each day is indicated by an embossed star in the margin; thus the blind reader can run his fingers down the borders of the pages and find immediately the day and the Station he requires.

The following extracts from many letters received by the Institute bear witness to the value of this periodical to blind people:

"It is with the greatest possible pleasure that I received 'The Braille Radio Times,' and I only hope that it may receive the support it merits."

"This new publication—'The

Braille Radio Times'—is an editorial triumph, and it is little short of remarkable that the principal items of the programmes to be broadcast throughout England and Wales can be compressed into twenty-seven pages of Braille."

"'The Braille Radio Times' is most beautifully planned and executed and already has afforded me great pleasure."

A novelty of 1925 was the broadcasting of a concert from the aeroplane "Vanguard," which ascended from Croydon aerodrome with several well-known stage artists, together with members of the Savoy Orpheans Band. The concert was picked up at Keston and relayed to London and other Stations.



MANCHESTER STATION REPERTORY PLAYERS

A Scene from "Independent Means"

WIRELESS IN HOSPITALS

THE curative powers of music have been known and studied for many hundreds of years. Towards the end of the sixteenth century, Robert Burton—philosopher and humorist, wrote these words: "Music is a roaring meg against melancholy to rear and revive the languishing soul; affecting not only the ears but the very arteries, the vital and animal spirits, it erects the mind and makes it nimble."

A hundred years later, the poet, John Armstrong, published a poem on the "Art of Preserving Health," in which these lines appear:

"Music exalts each joy, allays each grief,
Expels disease and softens every pain,
Subdues the rage of poison and the plague."

In more recent years the subject has been studied on a scientific basis with the most encouraging results.

MUSIC'S CURATIVE POWERS

Some years ago the Columbia University, New York, started a scientific study of the whole field of the treatment of certain forms of disease by music. The results were astonishing: memories were restored, insanity was cured and paralysed muscles were restored to their normal state. The part played by music in the reconstruction of shattered nerves and broken spirits during the Great War is known to everyone. There is the story of a French officer who had lost his speech and hearing as a result of shell shock. These were restored, after numerous experiments by the most advanced specialists had failed, by playing a gramophone record of the Marseillaise.

Broadcasting brings these curative powers within the range of sufferers of all ages in hospitals and homes throughout the land. It brings more than this, for, whether one is in pain, weary with illness, awaiting an operation, or confined to bed as a chronic invalid, there is comfort and distraction through the long hours of the day and night. One is at once in contact with the outside world from which one has been severed; its news is one's own news; loneliness is gone; the dangers of introspection disappear; one is able to forget troubles and to lose for a time the atmosphere of sickness and sorrow in which one lies. For the man who is a regular listener it is a part of his normal healthy life which he can bring with him to his enforced captivity. For the uninitiated its very newness is a fascination which will add to its powers of alleviation.

BEFORE THE OPERATION

A famous surgeon at one of the London hospitals said recently: "Wireless in hospitals is especially useful to a patient just before and shortly after an operation. Many patients have the headphones on an hour or so before they are due at the operating theatre, and in all these cases we have noted an even pulse and a low temperature, which are, of course, most valuable aids to a successful operation."

In several hospitals, headphones are provided actually in the surgical theatre, and patients undergoing minor operations under local anæsthetics may have their minds diverted by listening to a broadcast programme.

An American journal recently

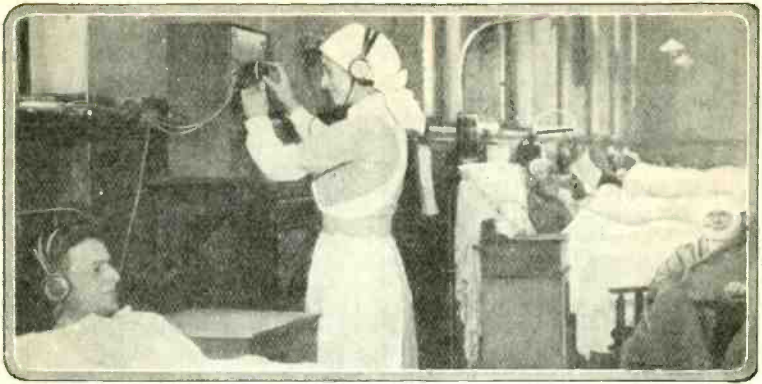

BRINGING HAPPINESS TO THE WARDS

published a photograph of a boy actually undergoing a minor operation under a local anaesthetic with the headphones on. In the accompanying article it was described how the boy, who was of a nervous and highly strung disposition, had refused to undergo the operation without his headphones, and it was stated by the surgeon that the operation was successful because the boy's nervous and physical condition was such as to stand the strain with comparative composure.

One is told that it is a nightly duty in some hospitals for a nurse to go round the ward removing headphones from patients who have fallen asleep under the soothing influence of music.

LIFE SAVED

There is at least one case definitely established where life has been saved by listening to wireless programmes. An elderly man from Loughborough was in a very bad condition and his life despaired of. In conversation with a nurse some days after his arrival, he said that he was determined to hear the Loughborough

Carillon before he died, explaining that he had seen it announced in "The Radio Times" as a future item. The event was at least a week ahead, and the doctors doubted whether his wish would be fulfilled. By sheer will-power, however, he kept himself alive, and by the time the Carillon was broadcast his condition had so changed for the better as to make recovery certain. He was eventually discharged from the hospital in good health.

But it is not only in terms of alleviation of suffering that the benefits of wireless in hospitals must be considered; it must also be assessed as a power for the reduction of the time of stay of patients in curative wards. Wireless is now considered an essential part of the equipment of every hospital in the country.

GREAT NEWSPAPER SCHEME

It is only two years ago that the London "Daily News" launched a scheme to provide wireless receiving apparatus in every hospital in London. Under the inspiring guidance of the late Mr. J. Hugh Jones, the gigantic task of equip-

ping London's hospitals with wireless apparatus was successfully accomplished in about eighteen months. The idea has been taken up just as actively in all parts of the country; but it is still too early to be able to produce definite statistics which will show how much the average stay of patients in hospital is shortened. Apart from the benefit to the patients themselves, the financial struggle which faces the Governors of every hospital in the country is well known. What may not be known is the fact that the average cost of the maintenance of a patient is £5 per week. Take the London hospitals alone. There are 122 hospitals fitted with wireless; in these institutions there are 16,000 beds, which each cost £5 per week. If the average stay of each patient could be reduced by one day from the present figure of fourteen days, the total annual reduction of cost to London

hospitals equipped with wireless would be about £300,000, a saving to the patient, to the hospitals, and to the community at large. Put in another way, this would mean that an additional 32,000 patients a year could be accommodated.

One of the most important musical events of 1926 was the concert performance—the first in Great Britain—of Rimsky Korsakoff's opera "Kitesh," which was performed at the Royal Opera House, Covent Garden, under the conductorship of Mr. Albert Coates. More than 10,000 listeners applied for copies of the special libretto published by the B.B.C., a fact which led to the decision to issue libretti of other operatic performances in the studio.

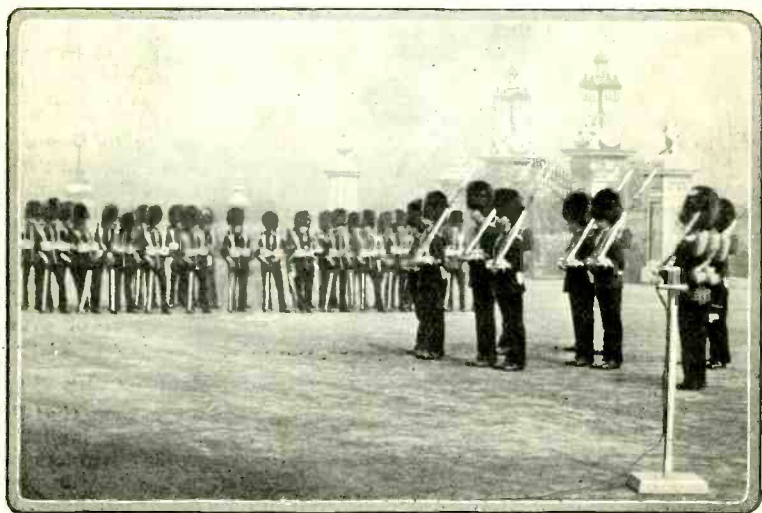

CHANGING OF THE GUARD

Broadcasting the time-honoured ceremony at Buckingham Palace

500 Miles Range!

A Portable and Self-contained Set



Four Outstanding Features:

There are four things necessary to the ideal Radio Receiver:

It should have no outside aerial or earth.

It should have one dial control.

It should be easily moved about from room to room.

It should be economical with H.T. batteries and accumulators.

There is such a set—it is the Langham Portable. It is entirely self-contained and needs no outside connections at all. Tuning is by a single dial, with a separate control for volume. It weighs only 25

lbs. complete with batteries, and the accumulator needs recharging only about once in 3 weeks.

500 Miles Range

Important though these features are, however, there is still a most important one which we have not mentioned—the question of range. Most portable sets are admittedly very limited in range. But the Langham, with its absolutely unique 4-valve circuit, has a phenomenal range. It gets short-wave stations up to 150 miles with perfect loud-speaker reproduction, while long-wave stations are received in the same way up to about 500 miles. This means that you can get Daventry, Daventry Junior, Radio Paris, Berlin, Hilversum, Madrid, Langenberg and many other stations on the loud-speaker as well as, if not better than, with the old type of set with outside aerial and earth.

Each set is calibrated before it is sent out, and a calibration chart with the dial settings for about 40 stations is issued with every set.

Further, we give a 12-months' guarantee and, if desired, a week's free trial without obligation to purchase.

Price 30 guineas complete and absolutely ready for use. Deferred terms; Initial payment of £5 and 12 monthly instalments of £2 7s. 6d.

Write for full particulars now.

Langham Radio

Albion House
59

NEW OXFORD STREET
LONDON, W.C.1

Telephone: Museum 2878 and 8293

TMCD 13

“Ever Ready” Batteries are standard equipment with most well-known receiving sets and are recommended by designers because, without question, they are the best by test and tradition, built on the experience of users over a quarter of a century.

“I can endorse every word the ‘Ever Ready’ Company say in favour of their Wireless Batteries. They are grand value and can be depended on.”

Extract from customer's letter, 14/7/27.

The “Ever Ready” range of sizes and voltages includes a unit for L.T., H.T., and Grid designed for economical service with every set.

Obtainable everywhere—list sent post free on request to The Manufacturers, The Ever Ready Company (Great Britain) Ltd., Hercules Place, Holloway, London, N. 7.

Regd. Trade Mark

“EVER READY”

BRITAIN'S BEST BATTERIES

Ensures pure, distortionless, trouble-free reception.

GROWTH OF THE INDUSTRY

By F. H. ROBINSON, A.M.I.R.E.

Editor of "The Broadcaster, Electrical and Wireless Retailer"

EARLY in the year 1922 there came to the ears, or rather to the eyes, as the tidings were brought by the Press, of the British public, rumours of a certain magical craze practised by our American cousins. With credulity strained to the utmost, Mr. G. Britain read how Mr. U. S. America had the sounds of dance music, the voices of singers brought to his ears in his home by "wireless."

"Wireless," ruminated Mr. G. Britain; "I know, one of the things old men with beards and test tubes play about with in scientific laboratories. And that building with the ugly great masts I passed on my walk through the fields last Sunday. Well, there's no knowing what may happen these days."

Now although he had no more thought of ever hearing this latest "craze" than I have of accompanying the next Atlantic flier on his long hop, it was the business of his particular morning paper to keep his interest in its columns alive—and so he read and read and was interested.

Then perhaps the local barber—enterprising man—obtained by fair means or foul a crystal set and a pair of headphones.

Mr. G. Britain had the phones placed on his head and then glared at the next customer who came in and slammed the door.

Mr. G. Britain of Balham could not possibly allow his barber to patronise science whilst he stood by uninterested. He wanted a crystal set and a pair of headphones. A demand was created and a source of supply followed.

BUTTS OF THE INDUSTRY

That is my idea of the birth of the Radio Industry. I do know a barber's shop which had a crystal set before any but the experimenters had heard "wireless."

Frankly, it is impossible to state when the Industry was born. Long before 1922 there were, of course, one or two manufacturing concerns from whom wireless apparatus could be obtained, and providing one could persuade the Postmaster-General that genuine experiments were to be undertaken, it could be used.

There were several experimental transmitting stations which communicated with each other, mostly in a technical jargon entirely unintelligible to the average listener.

For some time previous to this the few listeners had become familiar with strange noises from a station at Writtle near Chelmsford. Capt. Eckersley, the present Chief Engineer of the B.B.C., was one of the guiding spirits of this station, which had a considerable influence on the birth of the Industry.

During the summer of 1922 the Marconi Company applied for and obtained permission to broadcast occasional concerts from their station at Marconi House, Strand, known as 2I.O.

The Radio Trade had then commenced. Shops dealing in all kinds of commodities began to show most extraordinary-looking bits of apparatus.

The birth of the radio Press was practically coincident with the commencement of the public demand for radio apparatus, and it is interesting to note that by August 1922 there were in existence, I believe, four wireless papers, one of which, "The Wireless World," had been in existence for some years.

The remaining three were "Amateur Wireless," "Popular Wireless" and "The Broadcaster."

What might be called the laying of the foundation stone of the Trade took place in November 1922, when six firms combined to form the original B.B.C.

By that time there were in existence

quite a number of radio manufacturers. Many of them became members of the B.B.C., and their apparatus was approved by the Postmaster-General and stamped with the B.B.C. stamp and the words "Approved by the P.M.G."

EXHIBITIONS

It may be of interest to call to mind the first two wireless exhibitions to be held in this country. The first was known as the "International Radio Exhibition and Convention," and was held from September 2nd to September 8th, 1922, at the Central Hall, Westminster. The second was known as the "First All-British Wireless Exhibition and Convention," and took place at the Horticultural Hall, Westminster, from September 30th to October 7th, 1922.

I am afraid that I retain practically no impressions at all of the first of these and only slight recollections of the second. The caption to a photograph published in an issue of "The Broadcaster," which appeared on November 5th, 1922, has an historical interest. The letter-press in question appeared beneath a photo of part of one of the stands at the All-British Wireless Exhibition referred to above, and read:—"A model of the Metropolitan Vickers station at Trafford Park, Manchester. This station, we understand, may eventually be one of those controlled by the British Broadcasting Company."

One outstanding fact emerges from my recollections of this exhibition, and that is that even so early in the history of the Industry the public had realised the advantages to be gained from the use of really high-class British apparatus. "All-British" in 1922 meant the same as "National" means to-day—British radio apparatus for the British listener because there is none better.

The year of 1922, therefore, can be stated to have seen the birth of the Radio Industry. And what kind of Industry was it? What could it be when one of the largest radio firms of the day was advertising the fact that a complete range of receivers would

be offered to the public "immediately the official broadcasting scheme is announced"?

Obviously trade was chaotic, and conditions were similar to broadcasting itself—somewhat erratic.

By November 1922 official Broadcasting had definitely commenced, and by January 1923 programmes were being transmitted from London, Birmingham, Manchester and Newcastle, and the Radio Trade, having at last a means of creating a demand, commenced to organise a source of supply.

Apart from the recognised firms of standing in the wireless and electrical trade, hosts of unknown persons commenced to manufacture sets and parts, and one cannot be far short of truth in making a statement that at least 50 per cent. of the radio sets and parts purchased by the public were utterly and entirely useless. One has only to remember the common phrase which was heard in the morning trains: "Loud-speakers—useless; the only pure results, old man, are from crystal sets and headphones," to realise how the public built valve sets to specifications designed by people who did not even know enough of radio to realise their entire inability to design a set. And this, plus the shoddy, ill-designed components used, placed loud-speaker reception in ill odour for many, many months.

The first definite move towards organising the trade occurred in October 1922, when manufacturers met and discussed the possibilities and the advisability of forming a trade association. This and subsequent deliberations led to the formation in February 1923 of the National Association of Radio Manufacturers, popularly known as the N.A.R.M. This was followed in February of the same year by the formation of the Wireless Retailers' Association.

EARLY TROUBLES

This is not the place to discuss details of the early troubles of the B.B.C., but it is necessary to mention that at this time the company was severely handicapped by lack of

funds, chiefly due to the large number of "pirates" paying no licence fees. As a result, programmes generally were not on a high level and the trade began to wonder whether, when the "novelty" had worn off, the public would continue to buy.

It is interesting to study the 1923 wireless advertisements which were appearing in great numbers, and which announced "pocket" amplifiers, "matchbox" crystal sets and other "stunts." For the year 1923 was the "stunt" year—may we never see another such outbreak of foolish absurdities in radio goods on the U.K. market.

In March 1923 the Manchester All-British Wireless Exhibition and Convention opened and proved the best radio show which had then been organised. It is significant to find that roughly 40 per cent. of the exhibitors at this exhibition now come under the heading of "address unknown."

In April a Manchester Radio Exhibition and Convention took place at the City Hall, Deansgate.

A feature of the 1923 trade year was the disposal of out-of-date ex-Government material, not at all suited to the reception of Broadcasting. In fact, more "junk" was unloaded on the unsuspecting public in that year than one would to-day imagine ever existed.

THE N.A.R.M.

In November 1923 the All-British Wireless Exhibition and Convention was held at the White City, London, and here for the first time the public were informed of the existence of the N.A.R.M. by means of the special section in the Show devoted to the members of the Association.

The N.A.R.M. was the first attempt on the part of the manufacturers to organise the Trade, and in particular to eliminate the curse of cutting of list prices.

At this time only a few firms were undertaking the complete-set trade. Many manufacturers, however, were designing apparatus on the "Meccano" principle—elastic sets of compo-

nents which could be assembled in a variety of forms. The '06 type valve was all the rage, and prices of all wireless components were high.

The early part of 1924 witnessed considerable price reductions of most of the component parts made by the smaller firms.

In February 1924 the authorities in the Irish Free State decided to issue licences for reception, which opened to the British manufacturer a new field for the sale of apparatus.

The panel type of receiver which had all valves and controls mounted on a horizontal or vertical panel, and unprotected, was the standard type of instrument. In fact any type of cabinet apparatus was deemed so expensive as to be far beyond the pocket of the average listener. One of the best-selling components of the time was the variometer, whilst the twin condenser for multi-stage H.F. work was creating considerable interest amongst the constructor type of buyer.

Probably because the vast majority of the buying public knew little or nothing of radio, we saw a whole host of "super-crystal detectors" and "wonder cats'-whiskers," the latter guaranteed to double the range of reception or receive K.D.K.A. on a sixpenny crystal set.

Up to the opening of the British Empire Exhibition at Wembley in 1924 practically no export wireless trade had existed in this country. The exhibition, however, turned the thoughts of the many to the export side, and there was quite a large wireless section at Wembley.

This year also saw something in the nature of *definite* and well-designed wireless advertising. Previously a riot of announcements had appeared, much of it entirely ill-designed and some of it frankly misleading.

The summer slump bogey appeared in 1924. A few enterprising firms kept their sales schemes at full pressure during the summer, but the retail trader generally made no special summer efforts.

In the late summer and early autumn came the more general adop-

tion of geared devices for tuning applied to components such as condensers and coil holders.

Some of the early attempts at portables arrived in 1924, and looking back upon them to-day they seem clumsy and entirely unsuitable—in fact a number of firms did not trouble to design portable receivers, but attempted to sell a standard set, merely enclosing it in a case with a handle. The result, of course, was a foregone conclusion.

In June the manufacturers of valves organised an Association known as the Valve Manufacturers' Association.

September and October 1924 saw several events of importance. Late in September and during the first week in October the N.A.R.M. organised an exhibition at the Albert Hall, and called it "All-British," but immediately prevented it becoming so, in fact, by restricting it to its own members. Consequently a second show was organised at the White City at which many large firms exhibited.

Secondly, in October the N.A.R.M. was reconstituted as the N.A.R.M.A.T.—the National Association of Radio Manufacturers and Traders, thus opening its ranks to retailers and wholesalers in addition to manufacturers.

The Manchester Exhibition was held just after the Albert Hall show, and was extremely successful.

We have now come to the end of 1924, and a glance at the technical improvements of commercial radio apparatus should prove interesting.

CONDENSER DESIGN

Condenser design showed at this time a marked improvement. By January 1925 we had anti-capacity dials, ball-bearing movements, vernier attachments; and square law design had been accepted. Transformers too had been improved, and although they were by no means equal to the type obtainable to-day, great strides had been made.

When Broadcasting first commenced, the low-frequency stages of

most receivers provided the loud-speakers with a type of noise which could only be described as a veritable nightmare.

The valve market had undergone what practically amounted to revolutionary changes, mainly through the introduction of the dry-cell filament valve. High-tension accumulators in place of high-tension dry batteries began to make an appearance, and at one time seemed to be about to oust the dry type entirely. Subsequent events, however, have proved otherwise. At the Albert Hall Exhibition earlier in the year the super-sonic receiver had appeared, and late 1924 saw the public commencing to take an interest in this type of circuit.

Loud-speakers too had improved both in efficiency and appearance, and were steadily emerging from the "dog with a bad name" period through which they had passed, and which, generally speaking, was usually created by inefficient transformers and badly designed sets.

VALVE PRICES

Early 1925 saw a reduction in valve prices and reductions on other apparatus as well. It was also the start of the "better-looking radio" period, and it began to be realised that a neat-looking instrument was a better seller than a mere collection of knobs and dials.

During 1925 we had the seemingly inevitable slump, and valve prices were still further reduced. There was quite a craze for the antiphonic valve-holder, produced as an attempt to counteract the microphonic propensities of the later types of valves. A slightly improved attempt to make and sell portable sets also occurred. In the main, however, the sets were ill-conceived and showed a lamentable lack of "ideas."

In Sept. 1925 the N.A.R.M.A.T. organised another exhibition at the Albert Hall. The tendencies indicated at this show were firstly the definite arrival of the era of the decorative loud-speaker, and secondly the almost complete disappearance of the panel type of receiver with

its visible controls. Further, the shrouded transformer gained popularity at the expense of the open type.

In October a second London Exhibition was held at the Horticultural Hall. The Manchester show was held in November.

By the time the season was in full swing, probably the outstanding feature of the component trade was the demand for the "low loss" condenser of square law type, whilst the cabinet loud-speaker was gradually making an appearance in increasing numbers. Slow-motion tuning for condensers and coils also prospered, and the cumbersome vernier attachments disappeared. In regard to complete receivers, the last low-frequency stage, usually called the "power" stage, received increased attention; resulting in improved tone. Prices of complete sets showed a decrease.

FOREIGN COMPETITION

One problem faced by the trade during 1925 was that of foreign competition. In certain cases this competition was aggravated by the fact that the imported apparatus was of the "cheap and nasty" variety. The effect was not, however, so severe as had been predicted. The '06 valve lost a lot of its popularity and the two-volt type increased in the public favour. Short-wave apparatus began to benefit from a definite demand and the straight-line tuning condenser absolutely conquered its own particular market.

By the time 1926 had arrived one of the promising features of the Trade was the H.T. supply unit, which has maintained its popularity ever since.

The N.A.R.M.A.T. found itself in difficulties and there were numbers of resignations from the manufacturers' section. A new body, the Society of Radio Manufacturers—known as the S.R.M.—was in process of formation.

Apart from the technical improvements, the better appearance of such small items as knobs, dials and switches was all tending to interest

the public in the radio set as "something for the home" and to eradicate the scientific toy impression.

An abnormal feature of the Trade made itself felt owing to the General Strike. The suppression of the Press resulted in a wild scramble for radio sets. Unfortunately, many unscrupulous individuals unloaded "junk" material and out-of-date apparatus. As a result many buyers were "stung," and the reaction set in shortly afterwards.

Cone speakers began to get a firm footing in the loud-speaker market and tended to raise the standard of efficiency of speakers generally. The mains receiver also received considerable attention.

In July the V.M.A.—Valve Manufacturers' Association—became the B.R.V.M.A., the words "British Radio" being added to the existing title.

September 1926 was a doubly important month. The first National Radio Exhibition was held at Olympia, and the Radio Manufacturers' Association was formed from the ashes of the manufacturers' section and the majority of the firms who were connected with the S.R.M. movement.

With regard to the exhibition, two facts were apparent. Firstly, the strides made in simplifying radio sets, so that practically no technical knowledge was necessary, and secondly, the whole exhibition showed an advance in the quality of manufacture and consequently in the appearance of the instruments. I should imagine also that there were less exhibits of the "stunt" type at Olympia in 1926 than at any previous exhibition—a feature which was heartily welcome.

National Wireless Week, 1926, was fixed for November 7th to 13th, and, whilst it promised well for the future, mainly demonstrated the amazing lack of foresight of many manufacturers and of initiative on the part of retailers.

Resistance-capacity coupling for L.F. stages took a hold of the public and was extremely popular, and

still is. The Manchester Exhibition was held in November.

A summary of 1926 events shows that year to have been the most important in the history of the Trade. The General Strike and its effect have been discussed. An uncertain factor which was felt throughout the Industry was the question of the wavelength changes and the findings of the Broadcasting Commission. When these were settled, the public—having many doubts dispelled—felt more inclined to buy. The formation of the R.M.A. lifted a cloud and the W.R.A. continued in its sterling work.

PRESENT CONDITIONS

We now come to the present year, and find the position more hopeful than it has been hitherto. The R.M.A. is firmly on its feet, the W.R.A. continues to increase its influence and should become a really telling force. Our London Exhibitions are to be held at Olympia for the next few years, and show every sign of improvement.

The sale of sets grows, and when they become cheaper—as they must do—they will begin to form the basis of trade. Set construction has improved, and this fact alone will undoubtedly help to popularise the sale of commercially built receivers.

I should like to add a word of warning both to the Trade and the listener.

To the Trade I say that more powerful efforts should be made to sell complete sets as distinct from components. The present tendency of set designers is to add every type of refinement that can be devised. That is excellent, but the production of cheap efficient sets but without the "frills" is a matter to be considered.

The "Morris" type of car has made the motor trade, not the "Rolls."

To the listener I would say that many, many pounds sterling are being wasted in home-built sets. Not one listener in a thousand is capable of building a set which will compare in efficiency, reliability—especially

tonal quality of reception—with a really well made commercial set. I know of cases where a home-made set has eventually, after reconstruction by one "expert" after another, cost two or three times the amount it is necessary to pay for a really good commercial instrument.

I do not think that more than 10 per cent. of the listening public using loud-speakers have yet heard really good loud-speaker reproduction of B.B.C. programmes, and few can pass judgment on the musical and entertainment value of radio on results obtained by many home-built sets.

No trade has ever been successfully built up on the sale of bits and pieces.

If you want efficiency and reliability, Mr. Listener, buy a ready-made set of reputable make, and then if you are dissatisfied you have the satisfaction of being able to grumble at the manufacturer. The Radio Trade to-day has something to satisfy you *whatever* your requirements. The Trade has surmounted many of the difficulties with which, as a new industry, it was confronted, and will certainly overcome those that remain. The British Manufacturer made the first active step to give the man in the street radio entertainment, and can now offer the best radio goods in the world. His efforts, Mr. Listener, at least entitle him to your support.

The urban population served by the twenty Stations of the B.B.C. at the beginning of 1927 was estimated to be 21,943,000, there being a broadcast receiving licence for every third house. The population of rural areas to a total of something like 21,000,000 cannot be classified as being served by any particular Station. Under the proposed regional scheme of high-power Stations, the whole of the population of Great Britain and Northern Ireland will be brought within a service area of broadcasting distribution.

WIRELESS TRADE ASSOCIATIONS

By WARING S. SHOLL, A.M.I.E.E., Acting Editor, "Wireless Trader"

IN common with the older established industries, the wireless trade has certain Associations which exist for the purposes of control and also, to a certain extent, for development. Foremost among these is the R.M.A., which interpreted is the Radio Manufacturers' Association, a body whose membership is restricted to actual manufacturers of wireless apparatus. At the time of writing, the membership is 100 per cent. British, but provisions are made for the inclusion of non-British members of approved standing.

The aims and objects of the R.M.A. are:—to promote, encourage, foster, develop and protect the radio industry and auxiliary and allied industries in the United Kingdom; to endeavour to maintain a high standard of quality and to enforce the adherence to fixed prices in the retailing of goods. From the public point of view this question of price maintenance, is apt to be associated with "rings" and "trusts" and other unpleasant organisations which exist for the purpose of squeezing the public early and often. It may be as well, at this point, to indicate the essential difference between a trade association and a "trust" or a "ring." The former is associated with design and production as well as vending, and the members have to put up a large amount of time and money in research and development before production can be commenced or the merest spark of profit entertained.

On the other hand, a "trust" or "ring" is more often a monopolistic body merely concerned in exploiting a concession—and the public—for all it is worth. Such bodies "toil not, neither do they spin," so far as pure production is concerned. They are profit-snatchers only and make no contribution to real progress or development.

Price maintenance is necessary, not only in fairness to the dealer, but equally so to the purchaser. In this

connection it is desirable that no incorrect ideas should be fostered as to the "keeping up" of prices by the R.M.A. The prices are fixed by the manufacturer in circumstances of keen competition, but when fixed are registered at the R.M.A., and due notice must be given of any intended change. In no way does the R.M.A. interfere in the fixing of its members' prices to the public.

What will probably interest the public more than anything else in connection with the R.M.A. is the National Radio Exhibition, held annually at that famous show venue, Olympia. This show is entirely under the control of the R.M.A. and is at present restricted to British products. Here may be seen a representative exhibition of our leading receiving sets, components and accessories, staged amid the most attractive surroundings and well worth a visit from the most exacting expert and the "man in the street" alike.

Coming now to another trade association, we may briefly deal with the body responsible for the control of wireless valves, viz. the British Radio Valve Manufacturers' Association. This body is registered as a Trade Union and exists, primarily, in promoting the development of wireless valves and safeguarding a key industry. In this respect valves enjoy a protective tariff which, to some extent, keeps foreign dumping within economic limits. Practically the whole of the recognised British valve manufacturers are members, and their products are protected against price-cutting by a fixed retail figure. The user of valves has a very large choice of types which, by continually being added to, leave no grounds for complaint on the often alleged stagnation consequent upon control.

A considerable number of wireless traders are members of the Wireless Retailers Association, the Wireless'

Association of Great Britain and the Radio Society of Great Britain, which latter two bodies include a trade section. These associations exist for the promotion of trading on regular lines and the suppression of bogus firms and their exploitation of the trade and the public. A valuable feature of regularly organised trading is the promotion of service to the purchaser, which not only assists him in obtaining the best results from his apparatus, but protects him from the

ignorant and unprincipled element which is apt to intrude upon all new industries.

An encouraging feature of our various trade associations is the large amount of honorary work put in by some of the best men in the industry, without hope of any reward beyond that which undoubtedly comes from giving of their best for the good of their side. This is summed up in the words "team work." Long may it continue and prosper.

Plymouth was the first Station to bring the sound of the sea to listeners' homes, when in the early summer of 1925 a microphone was placed on the beach in Bovisand Bay. The noises of the waves were broadcast from all Stations. A remarkable fact of the transmission was that the sounds went to London and back to Plymouth before they were actually radiated from the Plymouth aerial.

"An Hour in a King's Ship" was a memorable relay in 1925 from H.M.S. *President*, the headquarters of the London Division of the Royal Naval Volunteer Reserve, which lies in the Thames off Blackfriars. Three microphones and a hydrophone were installed for the "man overboard" episode, the most thrilling part of the whole show.

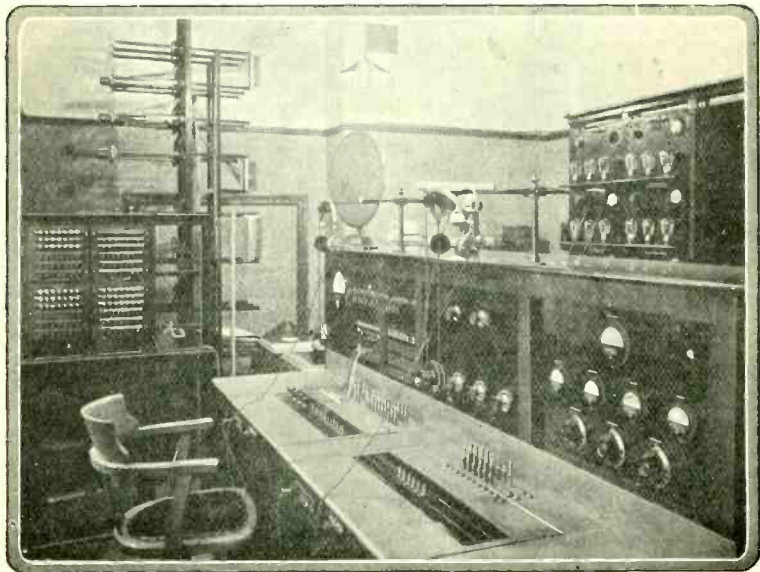

GLOUCESTER REPEATER STATION

RADIO MANUFACTURERS' ASSOCIATION

BROUGHT into being on the 6th September, 1926, by a resolution passed at a meeting of Radio Manufacturers at the first National Radio Exhibition, at Olympia, this Association, familiarly known as the R.M.A., has during its first year steadily increased in Membership.

The only Association of Radio Manufacturers in this country, it includes in its ranks the majority of the best-known firms engaged in the Wireless Industry.

Leaving each firm free to determine their own domestic policy, the R.M.A. gives its attention to matters affecting the Trade as a whole, such as—

(a) The promotion, encouragement, development and protection of the Radio Industry, and Trade and ancillary and allied industries in the United Kingdom.

(b) The maintenance of retail list prices as fixed in every case by the individual member concerned.

(c) The promotion of Exhibitions open to all *bona-fide* British manufacturers and distributors for the showing of British-made radio apparatus.

From the outset the Association has adopted an "open and above-board" policy in its dealing with the Radio and Technical Press, resulting, it may safely be claimed, in the establishment of friendly relations which can only make for the betterment of the industry.

In regard to the British Broadcasting Corporation, the R.M.A. was largely instrumental in the formation of the Radio Trade Committee on Broadcasting, which is recognised by the Corporation as the medium through which the Trade may approach the B.B.C. or vice versa, to discuss matters affecting the industry.

This year's Show at the New Hall, Olympia (September 24th to October

1st), is the *second* National Radio Exhibition held at that venue, but is the *first* Exhibition exclusively promoted by the R.M.A. with what success may be gathered from the fact that close on 200 firms are exhibiting.

The business of the Association is mainly carried out by various Committees under the guidance and control of an Executive Council.

The chief office-bearers are—

President: The Rt. Hon. Sir William Bull, Bt., M.P.

Chairman: Mr. W. H. Goodman (Dubilier Condenser Co. (1925), Ltd.).

Vice-Chairman: Mr. A. E. Bowyer-Lowe (the Bowyer-Lowe Co., Ltd.).

Trustees: The Chairman,
Mr. J. Joseph (Radio Instruments, Ltd.),
Mr. J. T. Mould (Igranic Electric Co., Ltd.).

Conditions of membership are such as make the Association open to any *bona-fide* British Radio Manufacturer, and non-member firms are cordially invited to apply for full particulars to—

The Secretary,
Radio Manufacturers' Association,
Astor House,
Aldwych,
London, W.C.2.

The Broadcasting Company was started by a combination of leading firms in the wireless industry. The policy of the Company was to administer broadcasting purely as a public service in the interests of the majority. The policy is carried on and developed by the Broadcasting Corporation, which took over the organisation as a going concern at the beginning of 1927.

G E N E R A L I N D E X

A

ABERDEEN, 307
Accumulators, 240, 255
Acoustics, 207
Administrative System, 50
Adult Education, 134
Aerials, 205, 249
Aids to Study, 341
Amateur in Wireless Progress, 253
Amateur Musicians, 86
America, 301
Analysis of Programmes, 70
Announcers, 77, 357
Announcers' English, 357
Anode Bend, 225
Appeals, 157
Argentine, 303
Art of Listening, 349
Artificial Echo, 209
Artists, 91
Australia, 298, 304
Austria, 294

B

Balance, 110
Bands, 108
Barcelona, 313
Basie, 314
Batteries, 241, 255
Beam System, 197
Belfast, 179, 307
Belgium, 295
Bergen, 314
Berlin, 314
Berne, 315
Big Ben, 154
Bilbao, 315
Birmingham, 182
Blind Listeners, 360
Boat Race, 142, 143
Bournemouth, 307
Bradford, 168, 309
"Braille Radio Times," 362
Bratislava, 315
Brazil, 304
Breslau, 316
Bruenn, 316
Brussels, 316
Budapest, 317

C

Cadiz, 317
Canada, 298, 303
Cardiff, 175, 307
Categories of Critics, 79
Cathedral Services, 131, 146
Central America, 303
Ceylon, 304
Chamber Music, 97
Charity Appeals, 157
Charter, 43
Children's Hour, 148
Children's Services, 133
China, 305
Choke Control, 200
Choke Coupling, 215
Church Services, 131

Committee on Spoken English, 358
Composers, 89
Composers, Competition for, 90
Concentrating with the Ear, 360
Condenser Design, 372
Constitution of the B.B.C., 43
Constructing a Receiving Set, 239
Copenhagen, 317
Copyright, 52, 298
Cork, 319
Correct Reproduction, 245
Crawford Committee, 37
Critics, 79
Crystal Sets, 259
Curative Powers of Music, 364
Czecho-Slovakia, 295

D

Daventry, 52, 307
Daventry Experimental Station, 58, 308
Debates, 128
Democratisation of Music, 85
Derby, 140, 143
Descriptive Broadcasts, 140
Detection, 225
Directors, 37
Discussion Groups, 136
Distortion, 213, 241, 245
Dominions, 297, 303
Don't Oscillate, 262
Drama (Scottish Competition), 173
Dublin, 319
Dundee, 172, 309

E

Early Receivers, 194
Earth System, 251
Ebonite, 260
Echo, 209
Edinburgh, 172, 309
Education, 53, 134
Empire Broadcasting, 297
Engineering, 51
England-America transmission, 197
Entertainment Policy, 34
European Broadcasts, 289
European Simultaneous Broadcasts, 221
Evolution of Wireless, 193
Executive of B.B.C. 50
Exhibitions, 373
Existing Stations, Future of, 59

F

Famous Concerts, 83
Finance of Broadcasting, 47
First B.B.C. Stations, 37
Foreign Competition, 373
Foreword, 29
Foundations of Music, 100
France, 294
Frankfurt-on-Main, 319

G

Geneva, 320
Germany, 289, 294
Glasgow, 172, 308

Glossary of Technical Terms, 265
 Good Cause Appeals, 167
 Governors, 43
 Grand National, 142, 143, 218
 Graz, 320
 Greenwich Time Signals, 154
 Grid Battery, 240, 256
 Grid Leak, 225
 Group Discussions, 136

H

Hallé Concerts, 166
 Hamburg, 320
 Hanover, 321
 High-frequency Amplification, 228
 High-tension Batteries, 241, 255
 Hilversum, 321
 Historical Survey, 60
 Holland, 296
 Home Constructor, 261
 Hospitals' Wireless, 364
 Hours of Transmission British, 307
 Hull, 170, 309

I

Identification Panels, 313-332
 India, 304
 Innsbrück, 321
 International Link, 50, 221
 International Problems, 285
 International Union, 285, 293
 Ireland, 179
 Italy, 294

J

Japan, 305

K

Kiel, 322
 Klagenfurt, 322
 Königsberg, 322
 Koenigswusterhausen, 323
 Kovno, 323

L

Landlines, 219, 234
 Langenberg, 323
 Language Talks, 353
 Languages, 135, 353
 Lausanne, 324
 Lead-in, 249
 Lectures, 51, 121
 Leeds, 168, 309
 Leipzig, 324
 Libretti, 341
 Licence Figures, 48
 Listeners' Criticisms, 79
 Listening, 349
 Listening Room, 210
 Listening without Fear, 235
 Liverpool, 167, 309
 London, 52, 161, 308
 London Radio Dance Band, 164
 London Studios, 161
 Loud Speakers, 345
 Low-frequency Transformers, 260
 Low-tension Accumulators, 240, 255

Lunch-hour Services, 133
 Lyons, 324

M

Madrid, 325
 Manchester, 166, 308
 Marseilles, 325
 Measuring Instruments, 255
 Menin Gate, 147
 Mexico, 304
 Microphone Amplifiers, 213
 Conditions, 124
 Problems, 217
 Publicity, 335
 Midlands, 182
 Milan, 325
 Military Band, 108
 Milliammeter, 257
 Modulation, 199
 Muenster, 326
 Munich, 326
 Music, 83, 97, 100
 Musical Comedies, 120

N

Naples, 326
 N.A.R.M., 373
 National Concerts, 105
 National Radio Exhibition, 273
 National Wireless Week, 373
 Neutrodyne Method, 228
 New Zealand, 304
 Newcastle, 171, 308
 News Service, 343
 North Africa, 305
 Northern Ireland, 179
 Nottingham, 184, 310

O

Opera, 93
 Opera Libretti, 341
 Oscillation, 262
 Oslo, 327
 Outside Broadcast Features, 143
 Outside Broadcast Problems, 217

P

Panels, 313-332
 Paris, 327, 398
 People's Palace, 107
 Peru, 304
 Plays, 116
 Plymouth, 310
 Policy, 31, 71
 Prague, 328
 Press and Broadcasting, 343
 Projected Arrangements, 74
 Programmes—
 Analysis, 70
 Balance, 75
 Building, 74
 Criteria, 72
 Department, 51
 Policy, 71
 Provided, 335, 344
 Promenade Concerts, 101
 Public Broadcast Concerts, 85
 Public Service, 29, 31
 Publications, 337
 Publicity, 335

R

Radio Association, 347
 Radio Circles, 149, 183
 Radio Manufacturers' Association, 375, 377
 Radio Plays, 115
 Radio Society of Great Britain, 347, 376
 Radio "Sunbeams," 177
 "Radio Times," 337
 Re-Broadcasting, 221, 297
 Receiving Sets, 239
 Regional Scheme, 57
 Relay Stations, 54, 309, 310
 Religion, 55, 131
 Reproduction, 245
 Resistance-capacity Coupling, 215
 Resonance Curve, 231
 Revenue, 47
 Review of the Year, 185
 Revues, 119
 Rome, 329
 Royal Albert Hall, 105
 Running Commentaries, 140
 Russia, 296

S

San Sebastian, 329
 Scandinavia, 294
 School Manuals, 341
 Schools, 137
 Scotland, 172
 Scottish Talks, 174
 Sensitivity-Selectivity, 230
 Service Areas, 69
 Seville, 329
 Sheffield, 168, 310
 Shipping Forecasts, 156
 Short Wave Work, 196, 254
 Simultaneous Broadcasting, 221, 234
 S.O.S. Messages, 153
 Soldering, 259
 Sound Balance and Control, 110
 South Africa, 304
 South America, 303
 Spain, 295
 Spoken English, 357
 Sport, 140
 Stamboul, 330
 Stockholm, 330
 Stoke-on-Trent, 310
 Studio Construction and Technique, 207
 Studio Services, 131
 Studios. 161. 207
 Stuttgart, 330

Supersonic Receiver, 229
 Swansea, 176, 310
 Switzerland, 294

T

Talks, 124
 Teachers, 137
 Technical Terms, 265
 Telephones, 245
 Theatres, 146
 Time Signals, 154
 Topical Addresses, 126
 Toulouse, 331
 Trade Conditions, 374
 Transatlantic Tests, 195
 Transformer Design, 213
 Transmission, Hours of, British, 307
 Transmitters, 199
 Trunk Circuits, 234
 Tuning Hints, 241

U

United States, 301

V

Valve Manufacturers' Association, 375
 Valves, 241
 Variety, 119
 Vienna, 331
 Voice Control, 91
 Voltmeters, 258

W

Wales, 175
 Warsaw, 332
 Washington Conference, 288
 Weather Forecasts, 155
 Welsh Language, 175
 Westminster Abbey, 133, 146
 Wireless Association of Great Britain, 348
 Wireless Industry, Growth of, 369
 Wireless League, 348
 Wireless Retailers' Association, 375
 Wireless Societies, 347
 "World Radio," 340, 353

Z

Zagreb, 332
 Zeesen, 332
 Zurich, 332

Have you seen the 1927-28 **BROWNIE** WIRELESS achievements?

The centre of attraction at the National Radio Exhibition

Such a good set at the price seems too good to be true—a two-valve set at fifty shillings! Amazing loud-speaker clarity within 30-35 miles main B.B.C. Stations or 120 miles Daventry. Instant tuning-in on 200 to 2000 metres. Handsome design. Built for World demand, which alone makes the low price possible.

Complete with any two moulded plug-in coils, but without valves.
Marconi Royalty extra. For additional coils see Brownie List

BROWNIE
2-VALVER
50/-
—a set for
the
million!

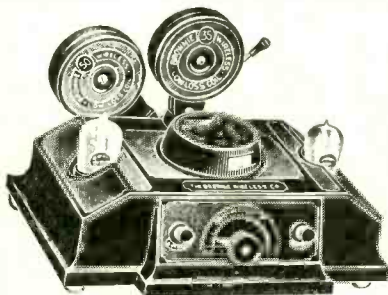

New enlarged 1928
Edition of
"Wireless Without
Worry"
—the Brownie Book
for all listeners—
now ready.

A revolution in Crystal Receivers—two tuning ranges in one set!

BROWNIE
No. 3
CRYSTAL
RECEIVER
12/6

Here's a set that embraces all broadcast wavelengths—200-600 metres and 300-1800 metres—for the first time in the history of Crystal Receivers! No loading coil required. You simply move a neat switch to change the range. Big brother to the famous Brownie No. 2—supplied as before, at 10/6.

Complete with semi-opal glass protected Detector, D.L. 5 Crystal and Palladium Cat Whisker.

BROWNIE TAG SOCKET brings radio into every room. 1/3

BROWNIE LOW-LOSS COILS—complete range 2/6 to 5/6 each.

BROWNIE
HIGH-POWER
TRANSFORMERS

The Super-Transformer has unique characteristics (never seen before) which scientifically solve a hundred transformer troubles. Ask for details. 15/- each. The Popular Transformer is a reliable guaranteed all-British product at a remarkable price. 9/6 each.

BROWNIE WIRELESS COMPANY (G.B.) LIMITED
NELSON STREET WORKS, MORNINGTON CRESCENT, LONDON, N.W.1

You mustn't miss the 1927-28 **BROWNIE** WIRELESS achievements

BELLING-LEE TERMINALS



Type B. Patent
6d. each.

Non-rotating names, bakelite insulated, soldering eliminated.



Type K. Patent
3½d. each.

Rotating names engraved on bakelite, insulated non-removable head.

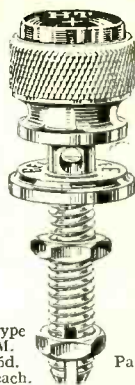

Type M. Patent
6d. each.

Non-rotating names as type B but not insulated.

30 DIFFERENT ENGRAVINGS.

BELLING & LEE, Ltd., Queensway Works, Ponders End, Middlesex.

Chakophone

REGD

RADIO RECEIVERS

One of the most popular medium priced simple sets now on the market. Straight circuit (Det. and 2 L.F.). Long and short waves (no loose coils.) All terminals at back.

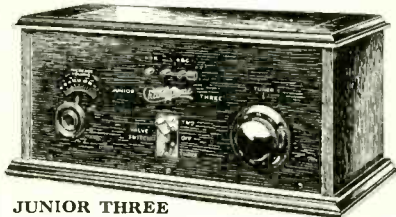

JUNIOR THREE

PRICE. Bare with 9 v. G.B. battery and leads, including Royalty, £7 16s. 9d., Complete £12 9s.

Manufacturers:

EAGLE ENGINEERING CO. :: LTD. WARWICK

London Office: 44 PALL MALL, S.W. 1
Export Department: 45 PALL MALL, S.W. 1

Send for leaflets of our other "Chakophone" models.

**A
post
card
will
bring
you
won-
derful
news!**

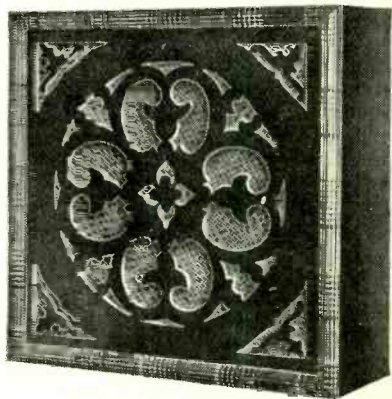
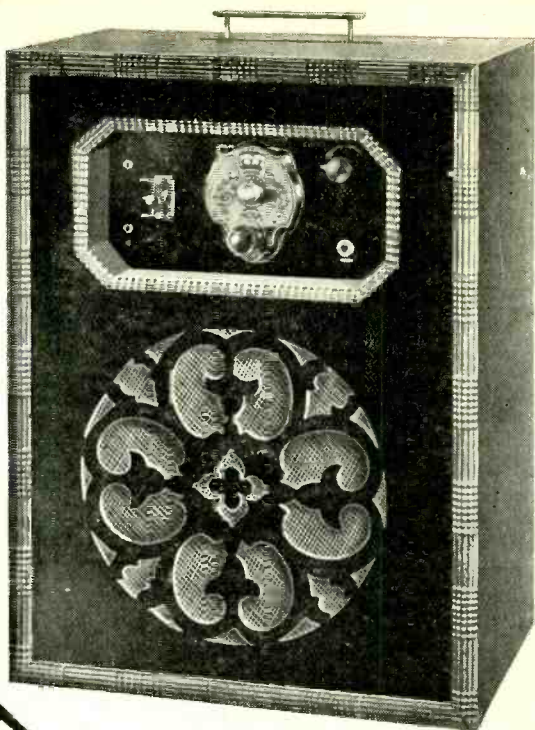
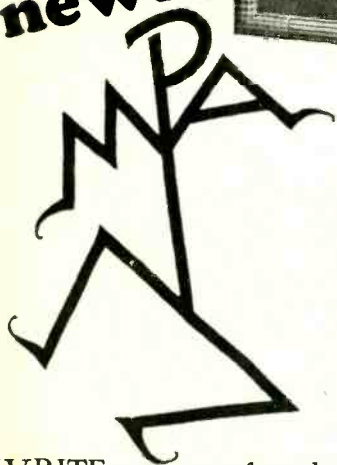

WRITE at once for the coloured leaflets telling you all about the amazing MPA transportable Wireless Sets (no aerial, and no earth !),

and the world's most amazing loudspeaker. Address: MPA Wireless (Dept. 11) 62 Conduit Street, London, W.1.

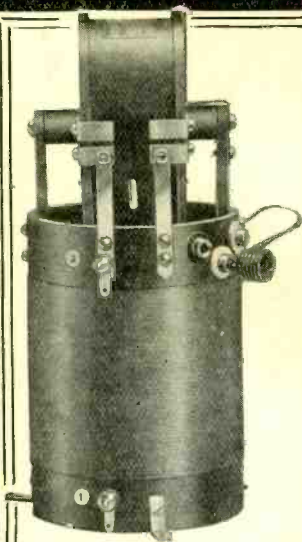

B.R.C.
High Frequency
Combination
Transformer
200-2000 metres

30/-
each

Increased Range and choice of Programmes!

THE new B.R.C. Transformer ensures reception at one point only on the dial. *This is absolutely unique amongst Transformers, and has never previously been effected.* In this new instrument the intermediate frequency is at such high value that the re-appearance of any station throughout the entire broadcast range 200 to 2000 metres is eliminated. It is simple to adapt to your present Receiver, and will give you a choice of programmes which hitherto you have never heard.

The B.R.C. Transformer has been specially designed for use with the new Marconi Shielded Valve Type S625. Diagrams and full instructions supplied with each Unit.

Catalogues of our Long Range Receivers and the B.R.C. Radio Exchange will be sent on application to Dept. B. Agents throughout the Country.

The
British Radio
CORPORATION LTD.
WEYBRIDGE SURREY

Telephone: Weybridge 593. Telegrams: Astraphone, Weybridge

